

**Czech University of Life Sciences Prague**

**Faculty of Economics and Management**

**Department of Information Technology**



**Master's Thesis**

**Design of Control System for Electric Vehicle Industry**

**Vinit Patel**

**© 2024 CZU Prague**

# CZECH UNIVERSITY OF LIFE SCIENCES PRAGUE

Faculty of Economics and Management

## DIPLOMA THESIS ASSIGNMENT

Ing. Vinit Patel, BE (mechanical)

Informatics

Thesis title

**Design of Control System for Electric Vehicles**

---

### Objectives of thesis

The thesis aims to design an output control system based on the feedback control theory for selected electric cars. The practical goal is to verify this proposal on empirical data regarding functionality and reliability.

### Methodology

The diploma part is divided into two essential parts. The theoretical part presents an overview of the findings of the current theory of output control applied in electric vehicle driving dynamics. The practical part of the work then uses this theoretical knowledge to design and verify the selected regulation area (here, for the chosen dynamic control and charging system for the selected electric vehicles). The methodological steps (research activity, synthesis of knowledge, modification of knowledge for a practical proposal) are purposefully chosen to implement both essential parts of the thesis.

**The proposed extent of the thesis**

60-80 pages

**Keywords**

dynamic control, output control, reliability, system design.

---

**Recommended information sources**

- BUEDE, Dennis M.; MILLER, William D. *The engineering design of systems : models and methods*. Hoboken, New Jersey: Wiley, 2016. ISBN 978-1-119-02790-4.
- CROLLA, David A. *Automotive engineering : powertrain, chassis system and vehicle body*. Oxford: Elsevier, 2009. ISBN 978-1-85617-577-7.
- HEIZER, Jay; RENDER, Barry. *Operations management/ Jay Heizer, Barry Render*. New Jersey: Pearson Prentice Hall, 2008. ISBN 978-0-13-234271-1.
- CHANG, Ching M. *Service systems management and engineering : creating strategic differentiation and operational excellence*. New Jersey: John Wiley & Sons, 2010. ISBN 978-0-470-42332-5.
- KELLY, Anthony. *Maintenance management auditing : in search of maintenance management excellence*. New York, NY: Industrial Press, 2006. ISBN 0831132671.
- LAUDON, Kenneth C.; LAUDON, Jane Price. *Management information systems : managing the digital firm*. London: Pearson, 2010. ISBN 0-13-609368-.
- PROJECT MANAGEMENT INSTITUTE. *A guide to the project management body of knowledge (PMBOK® guide)*. Newtown Square, Pennsylvania: Project Management Institute, 2013. ISBN 978-1-935589-67-9.
- RUSSELL, Roberta S.; TAYLOR, Bernard W. *Operations management: quality and competitiveness in a global environment*. Hoboken, NJ: John Wiley & Sons, 2006. ISBN 978-0-471-69209-6.
- SEBORG, Dale E. *Process dynamics and control : international student version*. Hoboken: Wiley, 2011. ISBN 978-0-470-64610-6.
- ULMER, Marlin Wolf.; SPRINGERLINK (ONLINE SERVICE). *Approximate Dynamic Programming for Dynamic Vehicle Routing [electronic resource]*. Cham: Imprint: Springer, 2017. ISBN 9783319555119.
- 

**Expected date of thesis defence**

2023/24 SS – PEF

**The Diploma Thesis Supervisor**

doc. Ing. Tomáš Macák, Ph.D.

**Supervising department**

Department of Management and Marketing

Electronic approval: 25. 3. 2024

**doc. Ing. Ladislav Pilař, MBA, Ph.D.**

Head of department

Electronic approval: 26. 3. 2024

**doc. Ing. Tomáš Šubrt, Ph.D.**

Dean

Prague on 26. 03. 2024

---

## **Declaration**

I affirm that I have independently completed my master's thesis entitled "**Design of Control System for Electric Vehicle Industry**" and have exclusively utilized the sources referenced in the conclusion of the thesis. As the author of the master's thesis, I assert that there are no infringements on any copyrights within this work.

In Prague on 26-03-2024

---

**Vinit Patel**



## **Acknowledgement**

I would like to express my sincere gratitude to doc. Ing. Tomáš Macák, Ph.D., the esteemed individual who served as my thesis adviser, for their invaluable guidance, unwavering assistance, and insightful critique throughout the research project. The expertise and abilities possessed by these individuals have played a pivotal role in influencing the direction and quality of this thesis.

I extend my heartfelt appreciation to my esteemed professors, beloved classmates, and the dedicated academic staff of the Informatics department at the Czech University of Life Sciences, Prague. Their consistent support has been crucial in shaping and enhancing my academic journey over the past two years. The encouragement, guidance, and shared knowledge have not only deepened my comprehension of the subject matter but have also fostered a cooperative and enriching learning atmosphere. I am genuinely grateful for the collective efforts that have contributed to my personal growth and development, and I am indebted to the entire academic community for their invaluable contributions to my educational experience.

Ultimately, I would like to express my thanks to my family and friends for their understanding, perseverance, and support during my scholarly pursuit.

# Design of Control System for Electric Vehicle Industry

## Abstract

The present work shows the creation, advancement, and practical confirmation of an output control system specifically designed to regulate particular components in the manufacturing processes of electric cars (EVs). This system is designed to improve the effectiveness and efficiency of electric vehicle (EV) manufacturing, based on ideas from feedback control theory. Its goal is to contribute to the progress of the industry. The thesis develops a correlation between theoretical design and practical execution through systematic testing and improvement, thereby bridging the divide between academics and industry. The approach includes an extensive review of existing literature, the creation of a theoretical design, the development of a prototype, the testing of the prototype using empirical methods, the analysis of the resulting data, the refinement of the methodology based on the analysis, and the validation of the final version. The simulation testing validates the functioning of the control system by exhibiting its capacity to accept signals, calculate vehicle trajectories, assign control values to motion actuators, and adhere to motor and braking limitations. Test scenarios demonstrate the system's ability to effortlessly attain specified speeds, minimize overshooting, and seamlessly incorporate Steer-by-Wire (SWA) technology. An important finding is that the weighting matrices have a substantial impact on the performance of the control system, emphasizing the need for meticulous design considerations. When it comes to selecting software for implementing the EAST-ADL paradigm, there exist problems. However, Enterprise Architect is considered the preferable solution due to its stability and user-friendliness. Ultimately, the empirical verification of the suggested control system affirms its viability and applicability in real manufacturing environments. This thesis makes a valuable contribution to the continuous development of electric car manufacturing by improving manufacturing processes and increasing the efficiency of control systems. These advancements are crucial for advancing towards a future of sustainable transportation.

**Keywords:** Design, control system, electric vehicle, battery, charge

# Návrh řídicího systému pro průmysl elektrických vozidel

## Abstraktní

Tato práce ukazuje vytvoření, pokrok a praktické potvrzení výstupního řídicího systému speciálně navrženého pro regulaci konkrétních komponent ve výrobních procesech elektromobilů (EV). Tento systém je navržen tak, aby zlepšil efektivitu a efektivitu výroby elektrických vozidel (EV) na základě myšlenek z teorie zpětnovazebního řízení. Jejím cílem je přispět k rozvoji odvětví. Práce rozvíjí korelaci mezi teoretickým návrhem a praktickým prováděním prostřednictvím systematického testování a zlepšování, čímž překlenuje propast mezi akademií a průmyslem. Tento přístup zahrnuje rozsáhlý přehled existující literatury, vytvoření teoretického návrhu, vývoj prototypu, testování prototypu pomocí empirických metod, analýzu výsledných dat, zpřesnění metodiky na základě analýzy a ověření finální verze. Simulační testování ověřuje fungování řídicího systému tím, že prokazuje jeho schopnost přijímat signály, vypočítat trajektorie vozidel, přiřazovat řídicí hodnoty pohybovým akčním členům a dodržovat omezení motoru a brzdění. Testovací scénáře demonstrují schopnost systému bez námahy dosáhnout specifikovaných rychlostí, minimalizovat překmity a bezproblémově začlenit technologii Steer-by-Wire (SWA). Důležitým zjištěním je, že váhové matice mají podstatný vliv na výkon řídicího systému, což zdůrazňuje potřebu pečlivých konstrukčních úvah. Pokud jde o výběr softwaru pro implementaci paradigmatu EAST-ADL, existují problémy. Enterprise Architect je však považován za preferované řešení díky své stabilitě a uživatelské přívětivosti. V konečném důsledku empirické ověření navrženého řídicího systému potvrzuje jeho životaschopnost a použitelnost v reálném výrobním prostředí. Tato práce je cenným příspěvkem k neustálému rozvoji výroby elektromobilů zlepšováním výrobních procesů a zvyšováním efektivity řídicích systémů. Tyto pokroky jsou zásadní pro pokrok směrem k budoucnosti udržitelné dopravy.

**Klíčová slova:** Design, řídicí systém, elektromobil, baterie, nabíjení

## Table of Content

1. Introduction.....	2
2. Objective and Methodology.....	7
2.1 Objectives .....	7
2.2 Methodology.....	7
3. Literature review.....	9
3.1 Introduction.....	9
3.2 Context on Electric Vehicle Industry.....	9
3.3 CAN Protocol Overview.....	11
3.4 Vehicle Configuration and Modelling .....	27
3.4.1 System Modelling .....	28
3.5 EV design – vehicle control modes .....	35
4. Practical part .....	46
4.1 Simulation Results .....	46
4.2 Methodology.....	46
4.2.1 Management of vehicle motion .....	47
4.2.2 Devices for Motion Support .....	48
4.3 Validation of Driver’s Wish Interpretation.....	50
4.4 Control System Design Validation.....	53
5. Discussion and Recommendations .....	61
5.1 Discussion of findings .....	61
5.2 Recommendations.....	63
6. Conclusion .....	65
7. References.....	66
8. List of Table and List of Figure .....	72

## 1. Introduction

Electric and alternatively powered vehicles, including plug-in hybrid electric vehicles (PHEVs), pure battery electric vehicles (BEVs), and hybrid electric vehicles (HEVs), are receiving significant funding from researchers and innovators. These vehicles are viewed as a sustainable solution to reduce our environmental footprint and reliance on fossil fuels. By transferring the energy from the internal batteries to the engine, it is feasible to increase the travel distance covered by electric vehicles. Come back and acquire more batteries when this store runs out. In most cases, this can only be accomplished with a system that is hardwired into the electrical grid. Sustainable mobility will benefit greatly from the innovative inductive charging technology.

Inductive or wireless charging refers to the transfer of energy between two objects via the use of an electromagnetic field. In order to charge the batteries of electric vehicles (EVs), it offers customers a convenient alternative to directly plugging in the vehicles. When you park your car over an underground inductive coil, the charging process will begin immediately as the receiving coil in your vehicle detects the signal. The technology for inductive charging is already available, but for the technology to work, the alignment of the coils must be exact. Technologies for transmitting large amounts of electricity wirelessly with little loss of efficiency should be fully developed in the "near-future," according to him and his colleagues (He, Yin, Zhou 2013).

The impact of electric vehicles on the power grid is becoming increasingly apparent as they continue to gain popularity. According to Leemput, Van Roy, Geth, Tant, Claessens, and Driesen (2011), some of the outcomes include altered grid load profiles, increased peak power, and broader voltage magnitude deviations. When peak power demand and plugged-in at-home charging of electric vehicles happen simultaneously, leading to uncoordinated charging, it may be difficult to determine the impact on the residential low voltage (LV) grid. As a result, there has been a lot of research on coordinated billing approaches. (Bradley, Frank 2009).

A comparable percentage of EV batteries will die eventually as a result of the increasing number of EVs. So, many are trying to figure out how to recycle, remanufacture, and reuse electric vehicle batteries. Electric vehicles (EVs) have

gained popularity and practicality due to advancements in lead-acid batteries. As a result, production of lead-acid batteries and electric vehicle research have both increased.

Instead of using fuel oil, a power battery will power the original motor engine in fully electric automobiles. Consequently, a certain amount of driving is necessary for fully electric vehicles to enhance their vehicle management system and achieve optimal energy allocation. In traditional gas-powered vehicles, the EMS ensures that the engine runs smoothly in all conditions, leading to improved fuel economy, reduced emissions, and exceptional handling. Moreover, research on control systems in fully electric vehicles has demonstrated that these systems significantly affect the vehicles' ability to handle in traffic. (Zhang 2008).

Electric vehicles have a lengthy history, although few people know this. Electric vehicles were widely available not long after Joseph Henry's 1830 invention of the first DC driven motor. Professor Stratingh built a scale model of an electric vehicle in 1835 in the Dutch town of Gröningen. It wasn't until 1834 that American Thomas Davenport built the first full-sized electric vehicle. In 1847 Moses Farmer constructed the first two passenger electric automobiles. Rechargeable batteries and electric cells did not exist at that era. Electric vehicles were not a realistic option until the storage battery was invented by two Frenchmen, Gaston Plante (1865) and Camille Faure (1881).

An electric automobile made by Krieger in 1903 is seen in Figure 1.1. With power steering, this vehicle is a hybrid of electric and gasoline powering the front wheels. The powertrain is augmented with a gasoline engine. Many four-wheel drive and hybrid electric vehicles were on the road from 1890 to 1910. The industry prioritized the production and development of combustion engine vehicles due to the high cost of electric automobiles compared to gasoline cars during that period (Didik 2007).

Compared to cars fueled by gasoline or liquid petroleum gas, electric vehicles—also called zero-tailpipe emissions vehicles—generate far less air pollution. Because there are fewer moving components in an electric car, it requires less maintenance. There would be no need for tune-ups, oil changes, or exhausts if there was no internal

combustion engine. Additionally, compared to gasoline-powered automobiles, electric vehicles are far quieter and use substantially less energy.

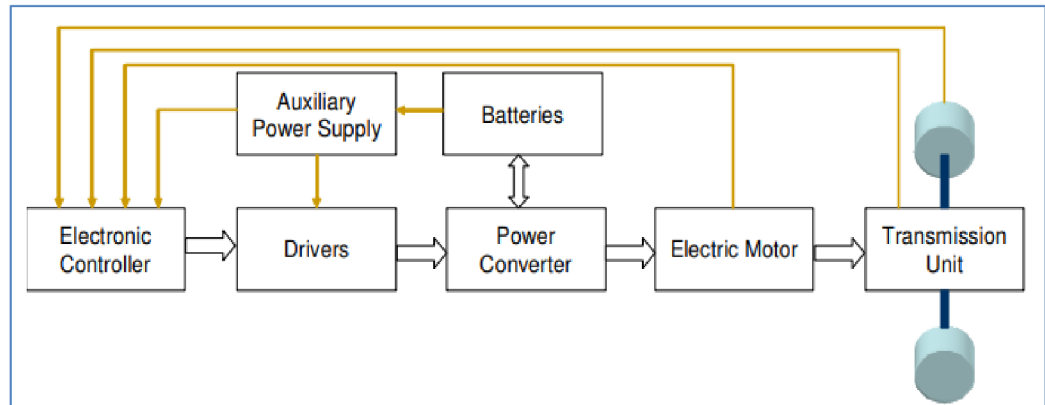

**Fig 1.1 1903 Krieger electric car**

**Source:** <https://core.ac.uk/download/pdf/35458473.pdf>

Electric vehicles, which first appeared in the early 1900s, have found many other applications since then. More than only golf carts are available currently among these eco-friendly cars. Suitable electric vehicles for usage on city streets have been developed as a consequence of research and development efforts by major automakers, as well as recent advancements in battery technology, system integration, and aerodynamics (Chen 2003).

The motor, controller, power source, and charger are the main parts of an electric vehicle's system (wry, 2003). The electric vehicle's system model is shown in Fig. The controller, or brains behind an electric vehicle, is responsible for making a high-performance vehicle that combines the best possible acceleration capabilities, maximum speed, and driving range per charge.(Huang, Li, Chen 2010)



**Source:** [https://cdn.intechopen.com/pdfs/12061/InTech-Control\\_of\\_electric\\_vehicle.pdf/src=%22chrome-extension://mhjfbmdgcfjbbpaeojofohoefgihjai/3a58b22e-c97a-4958-8a0d-bda2aa41bbfc%22](https://cdn.intechopen.com/pdfs/12061/InTech-Control_of_electric_vehicle.pdf/src=%22chrome-extension://mhjfbmdgcfjbbpaeojofohoefgihjai/3a58b22e-c97a-4958-8a0d-bda2aa41bbfc%22)

Controlling an electric vehicle (EV) is a difficult task because of its basic time-variant functioning, which means that both the road's conditions and the vehicle's operating parameters are always changing. The controller needs to be robust and flexible in order to enhance the system's performance in both dynamic and stable states. This is another element that sets EV control apart, since EVs are fundamentally "energy-management" devices. The primary obstacle preventing EVs from being widely used is now their short range between battery charges. Therefore, controlling the vehicle's performance (such as maintaining a steady speed for a pleasant ride) and the batteries' energy consumption requires serious consideration.

EVs have an edge over traditional automobiles with internal combustion engines thanks to advancements in electric and control engineering. The outstanding motion control capabilities of electric vehicles (EVs) are among their most remarkable qualities. Summarized, these capabilities are as follows

- (1) More rapid and precise control of electric motors is possible with fast and accurate torque generation.
- (2) Output torque makes sense.
- (3) Motors small enough to be attached to individual wheels.
- (4) Easily designed and implemented controllers at a relatively low cost.



Consequently, a large number of research looking at complex control methods for electric automobiles have been conducted recently. The development of highly computationally competent microprocessors such as DSPs (Digital Signal Processors) has made it possible to establish complete control over electric cars for optimal performance

These features can be used to run vehicles in formation for certain objectives, as well as to improve the efficiency and safety of individual vehicles.

Electric automobiles frequently utilize intelligent or fuzzy control to boost economy and manage several operation modes because of their complex operating circumstances. To achieve optimal and dependable control for the electric vehicle system, a thorough feature research and the development of a model-based control system are essential. Electric vehicle (EV) model-based control design and platform implementation for alternate control method realization are the main subjects of this chapter.

## **2. Objective and Methodology**

### **2.1 Objectives**

The thesis aims to design the development of an output control system that regulates particular components involved in the manufacturing process of electric vehicles. This system is based on feedback control theory principles. The objective of implementing this system is to maximize the efficacy and efficiency of these manufacturing processes. The pragmatic aim is to authenticate the stated control system through the utilization of empirical data, evaluating its operational effectiveness and dependability within authentic manufacturing settings. The empirical validation of the proposed control system is an essential component in establishing its feasibility and practicality. In turn, this validation contributes significantly to the improvement of electric vehicle manufacturing processes. By means of empirical testing and subsequent refinement, this thesis aims to establish a connection between theoretical design and practical implementation, thereby promoting progress in the manufacturing of electric vehicles.

### **2.2 Methodology**

At home, engineers would rather focus on developing pure electric vehicle control technology; abroad, they're trying to find ways to recycle braking energy more efficiently for ECUs used in stability and traction control.

#### **Examining the Needs for System Design**

The intricate design of fully electric vehicles necessitates the integration of many nonlinear dynamic systems apparatus, including motors, converters, power batteries, transmissions, and other electric control systems. It follows that if the vehicle controller fails, the electric vehicle will not function well, will not be able to execute energy recovery control, and could potentially cause an accident, notwithstanding the efficiency of the other electric car assemblies, will not be able to perform energy recovery control, and may even cause an accident. Keeping the controller of a pure electric automobile affordable and efficient while coordinating all of its components is one of the trickiest design challenges.

After building the overall structure of the system, we analyze the controller from a working principle perspective. Then, we determine the controller's functions based on the current state of research on the system, both at home and abroad, while also considering certain roadblocks to improving the technology.

### **3. Literature review**

#### **3.1 Introduction**

The electric motors often used in electric vehicle (EV) propulsion systems are defined and discussed in detail in this chapter, along with hybrid electric vehicles (HEVs). It delves into various energy sources utilized in these vehicles, ranging from traditional fossil fuels to alternative sources such as electricity and hydrogen fuel cells. Additionally, the chapter explores modern control techniques applied in the management and optimization of EV performance, including regenerative braking systems, powertrain control algorithms, and battery management systems. An output control system to regulate the functioning of specific electric vehicle production components is the principal aim of this thesis. Foundational concepts from feedback control theory form the basis of this system. Making these production processes as efficient and effective as possible is the goal of adopting this system. The practical goal is to verify the claimed control system by analyzing its reliability and efficiency in real-world production environments using empirical data. To determine whether the suggested control system is feasible and practicable, it must first undergo empirical validation. The validation has a multiplicative effect on the enhancement of electric car production methods. This thesis seeks to advance electric car production by linking theoretical design with practical implementation via empirical testing and subsequent refining.

Furthermore, the chapter presents an overview of the literature survey conducted to gather insights into the current state-of-the-art in electric vehicle technology. By synthesizing findings from existing research, this survey aims to identify key trends, challenges, and advancements in the field of electric transportation. In order to ensure that the output control system that is suggested in later chapters is in line with current research trends and industry practices, the literature study is used as a basis to guide its design and development.

#### **3.2 Context on Electric Vehicle Industry**

There have been a number of brief periods in history when electric automobiles were popular before vanishing into oblivion. The unreliability and limited range of early steam and gasoline-powered automobiles made electric vehicles popular in the

early 1900s (Schiffer 2010). Later improvements in gasoline car performance and reliability caused electric vehicle popularity to plummet. The increasing cost of oil and concerns about pollution from gas-powered cars sparked a new wave of interest in electric vehicles in the 1960s. Legislators have since pushed for a set percentage of new car sales to go toward electric vehicles. Because of its subpar performance, particularly regarding range, the electric car was unable to capture a substantial portion of the market. Recent developments in battery technology have allowed electric vehicles to achieve respectable ranges with relatively short recharging times (Westbrook 2001). Electric vehicle technology may have finally caught up to gasoline-powered automobiles in terms of economic viability, according to the Tesla Model S's commercial success and the development of new battery technologies. This is why the Intelligent Systems and Automation Lab at the University of Kansas is developing a proposal for an electric bus to make EVs more efficient. My work includes the design and testing of a six-module CAN-based electric vehicle control system.

Although few are aware of it now, electric automobiles were a common alternative to steam and gasoline-powered vehicles in the early days of the automobile industry. In 1900, electric motors powered more than 25% of the 4,192 vehicles produced in the US. At that year's New York Auto Show, electric vehicles were the most numerous type of automobiles. All the rage prior to the peak of electric car manufacture in 1913. It was then quickly considered outdated. The gas-powered car market grew as a result of rising demand for faster and longer-distance vehicles and improvements to the internal combustion engine. In addition, the methods for recharging electric cars were complicated and expensive, while those for gasoline-powered cars were much simpler. In the beginning, only electricians could run the specially built charging infrastructure that were necessary for electric automobiles. By 1920, the electric automobile had essentially died out, with the exception of a handful of niche markets.

As concerns about pollution from automobiles and the cost of gasoline continue to rise, interest in electric vehicles has soared once again. In an effort to create electric vehicles that were both quicker and more efficient, Ford and GM began developing their own designs in the mid-1960s. The performance of a gasoline-powered car was still too much for these vehicles, despite the fact that they were far more powerful than

their forebears. Companies who sold 35,000 or more automobiles per year were obligated to construct 2% of their light-duty vehicles as zero-emission vehicles according to a law set by the California Air Resources Board (CARB) in 1990. The RAV4 Electric, TH!NK City, Hypermini, and EV1 were some of the electric vehicles developed by major manufacturers as a result. Even these automobiles weren't very good when compared to gas-powered vehicles. In 1996, GM's first mass-produced EV1 electric vehicle could only go 90 miles before it needed recharging (Kirsch 2000). Since most of the new electric cars were on the pricier side, it's no surprise that they bombed at the box office.

### **3.3 CAN Protocol Overview**

Most modern vehicles rely on interconnected networks of various electronic parts to ensure proper operation. Prior to the creation of the Controller Area Network (CAN), it was common practice for bus modules to link to each other in isolation. Midway through the 1980s, Robert Bosch developed the CAN bus (Pazul 1999) to supplant complex automotive networks with something easier, lighter, and cheaper. A simple twisted-pair connection with 120 ohm resistors at either end allows any two modules to be linked together in a multi-bus network (Corrigan 2002).

Modules frequently communicated via wire connections before the CAN bus was developed. Processing power tailored to communications and complex, cumbersome wire harnesses were thus often necessary. Figures 2.1 and 2.2 show the simplified wiring of this control system. Given the sheer volume of interdependent parts, many electric vehicles might be even further stripped down.

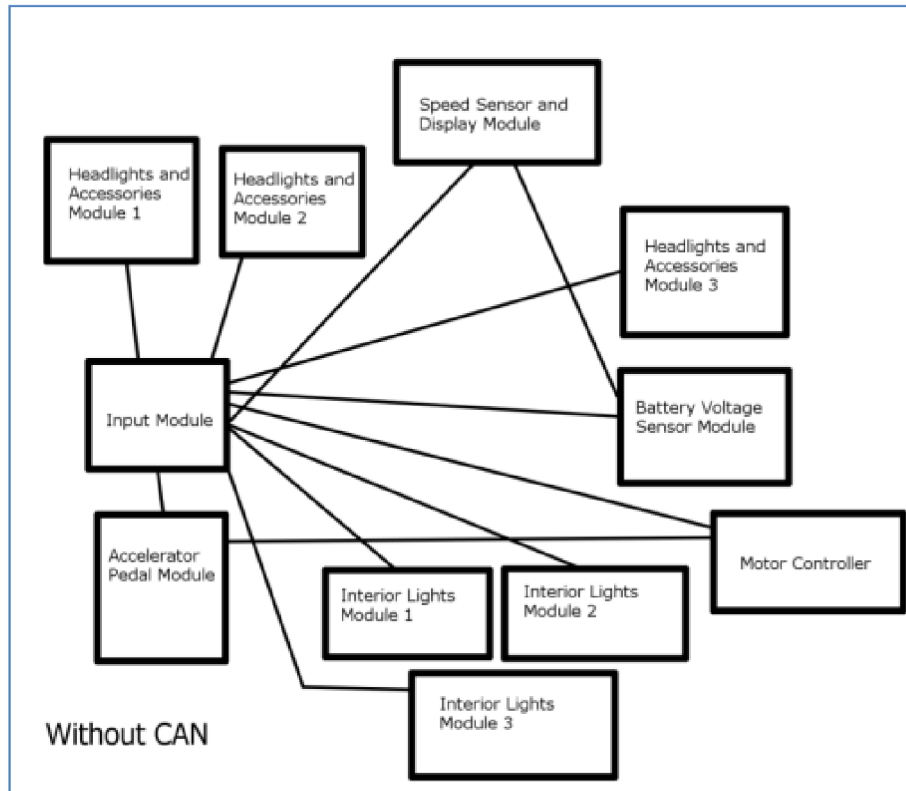

**Figure 3.1: Wiring Diagram without Controller Area Network**

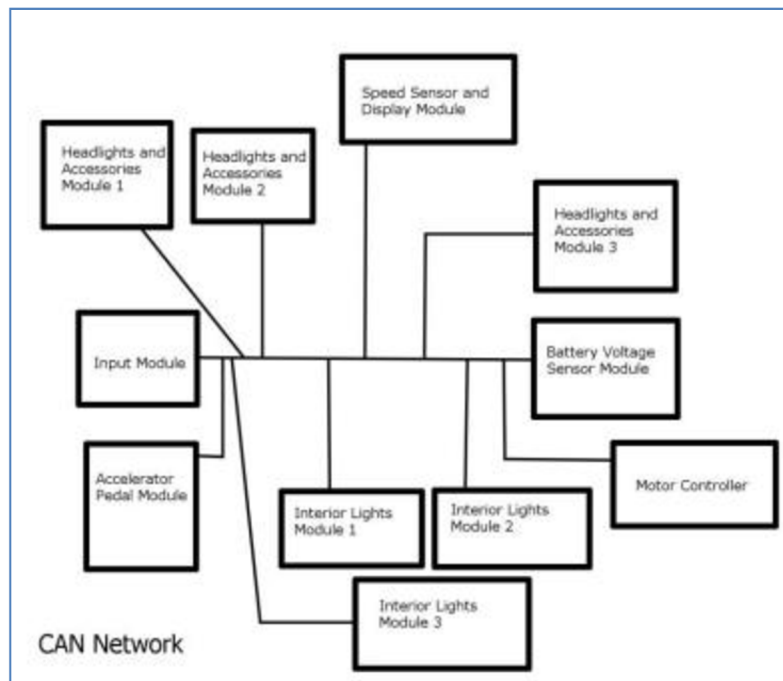

**Figure 3.2: Wiring Diagram with Controller Area Network**

Typical digital states communicated via conventional serial communication include a high state of 3.3 V or 5 V for a 1 and a potentially ruinous low state of 0 V for a 0. When traveling great distances, the constant hum of automobile electrical

systems becomes noticeable. To monitor the changes in the states of twisted pairs of wires, the CAN bus makes use of a differential pair. Since it is anticipated that both wires in the twisted pair would be similarly affected by electrical noise, the disparity between the two wires is likely to be less influenced. Take the CAN bus as an example; when the twisted pair is dominant, the differential mechanism transmits a value of 0, and when it is recessive, it sends a value of 1. System recessive situation (Fig. 2.3) occurs when both the high and low sides of the CAN bus are at a potential of 2.5 V. With a 3.3 V CAN transceiver, a dominating situation occurs when the voltage difference between the high and low sides of the bus is 2 volts, meaning that the high side is 3.5 volts and the low side is 1.5 volts (Blackman, Jason and Monroe 2013). Both the transmission and the voltage differential are unaffected by electrical noise in a differential system.

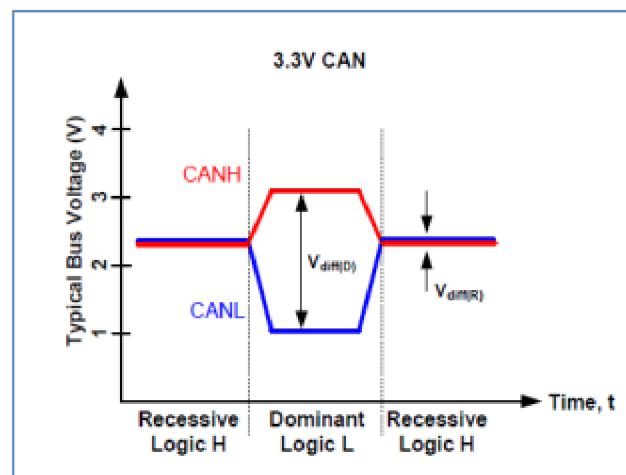

**Figure 3.3: Differential Signal Voltages (Blackman, Jason and Monroe 2013)**

For CAN networks, a bus length of 40 meters or less allows for data transfers of up to 1 Mbit/s when operating in high speed mode (Corrigan 2002). Because CAN IDs only need 11 bits of data, CAN networks can handle error checking and support a large number of nodes (Pazul 1999).

In CAN bus networks, not only is wiring simplified, but every message is sent to the CAN bus instead of being addressed to a specific module because the network is message based. This has the advantage that all CAN bus modules can receive messages from all other CAN bus modules. Because of this, the system may be easily upgraded and expanded with new features without requiring complicated wiring. The next step is for modules to decide for themselves whether to use or discard each



incoming message (Pazul 1999). Because of this, it is very simple to create multiple identical modules and relay sensor data to multiple modules. The control system implemented in this thesis makes use of a number of identically programmed and hardware-based interior lighting modules that respond in unison to CAN bus messages.

Figure 2.4 depicts the mandatory data and structure elements required by the CAN protocol for each message.

SOF	11 bit CAN ID	RTR	IDE	R0	DLC	Data	CRC	ACK	EOF	IFS
-----	---------------------	-----	-----	----	-----	------	-----	-----	-----	-----

Table 3.1: CAN Message Structure

- **Super OLED:** 1 bit Beginning of Sending the dominant bit first indicates that a frame has begun. Once all of the modules have been idle for a while, this bit helps them synchronize.
- **11 bit CAN ID:** (11 bits) binary a higher identifier. Lower values have priority.
- **RTR: (1 bit):** This bit is the most important one when data needs to be sent from another node.
- **IDE: (1 bit):** Identifier extension.
- **R0: (1 bit)** Reserved bit: Keep this in mind for any changes to the standard that may be made in the future.
- **DLC: (4 bits)** Data Length Code: This 4-bit integer specifies the data bit rate of transmission.
- **DATA: (8 bits):** This is where the 8 bits of data that were sent to the bus are saved.
- **CRC: (16 bits):** Error detection is made possible via Cyclic Redundancy Check, which includes a checksum of data from previous applications.
- **ACK: (2 bits):** A delimiter bit and an acknowledgement bit are contained within this. As a recessive bit, the first bit is transmitted in the original message. If the message is correctly received by each node, it will replace this bit with its dominant bit. The data sent via the CAN bus is checked for integrity in this way.
- **EOF: (7 bits):** The last seven bits of a communication frame.

- **IFS: (7 bits):** The term for these seven bits is the inter-frame space. They allow a can controller to transfer the subsequent message to the buffer at the appropriate time. (Corrigan 2002)

Most microcontrollers do not have the necessary interfaces to natively connect to a CAN bus network. This design utilized a separate CAN controller, even though some microcontrollers come with one already built in. Among a CAN controller's many roles is the storage of messages, the establishment of communication between the microcontroller and the CAN messaging protocol, and the acceptance or rejection of messages sent over the CAN bus. Instead of implementing CAN, the microcontroller's resources may be better put to use by employing a may controller. A Texas Instruments SN65HVD230 CAN transceiver IC [8] (Figure 2.5) connects with the CAN bus on behalf of the system's CAN controller, a Microchip MCP2515 Can controller IC (Stand-Alone 1999). The may controller can use a CAN transceiver to send data over a differential bus, which will lessen the impact of transmission noise. In order to cut node power consumption in half, the SN65HVD230 3.3 V transceiver was selected instead of the 5 V transceiver (Blackman, Jason and Monroe 2013).

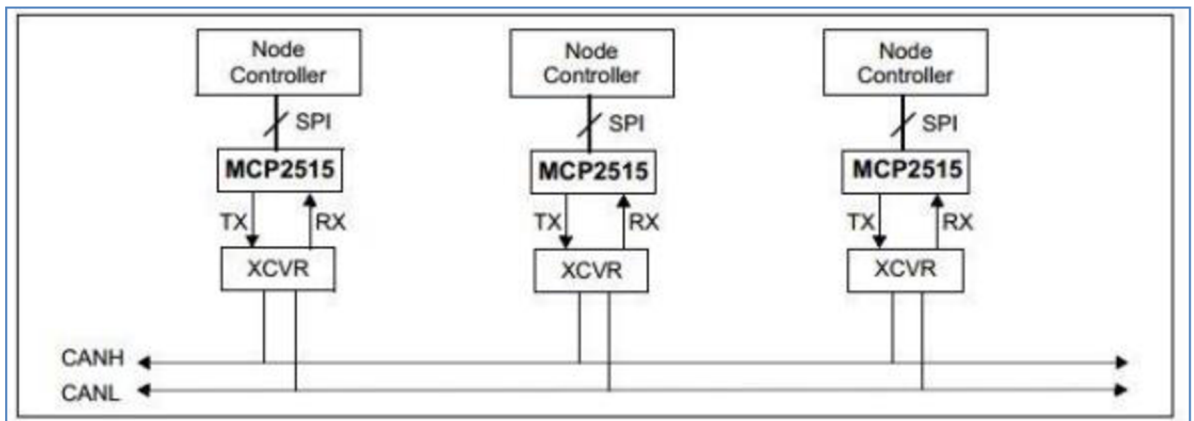
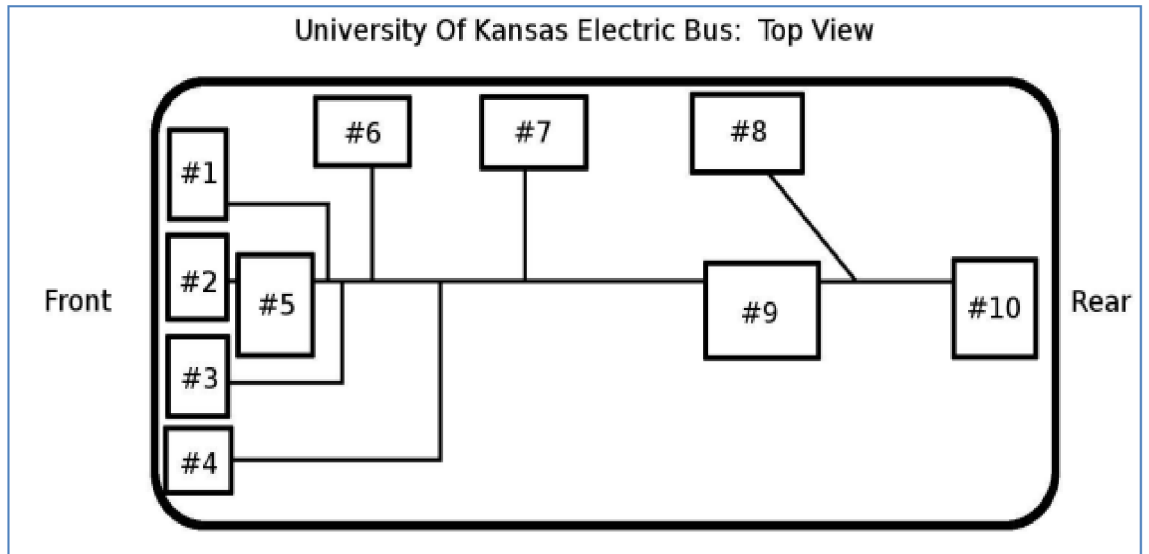

Figure 3.4: Example System Implementation (Stand-Alone 1999)

The flexibility in module placement is much enhanced compared to an analog system, as all modules require is a connection to the CAN bus and a DC power supply ranging from 9 to 16 volts. Minimizing the overall quantity of wire is achieved by positioning modules adjacent to the components with which they interact, as shown in Figure 2.6 and Table 2.1.



**Figure 3.5 : Bus Node Layout**

**Overall design scheme**

When the driver presses the brake, accelerator, or shift lever, the automobile's controller receives data. It then analyzes this data to figure out what the driver meant and how to operate the car correctly. The motor control unit receives data on the vehicle's state and torque output when the vehicles are in motion. When the engine is started and stopped, the car is designed to sequentially turn on and off its low voltage power source, which is connected to external equipment, and high voltage power source. The motor controller and power management system are adjusted to control the beginning and running states in order to meet the demands of vehicle control. Through the controller area network (may), the vehicle's controller is able to coordinate the state of each module by interacting with other control units(Zhao, Hou, Wang, Chen, Sun 2019a).

The vehicle control system comprises various essential components, each playing a crucial role in ensuring the proper functioning of the vehicle, as illustrated in the figure. These include the motor and motor controller, power battery, gear-box, main reducer, auxiliary system, fault diagnosis management unit, and power battery management system (BMS). The auxiliary system further integrates components like the steering motor and controller, air conditioning motor and controller, braking system, and DC/DC converter. The power battery serves as the energy source for all electrical components within the vehicle. With these elements working together

harmoniously, the vehicle control system empowers the driver with complete command over the car, enabling a seamless driving experience.

The widely employed CAN network topology in vehicle controls is depicted in Figure 2, showcasing a system with two communication channels. Channel 1 operates as a high-speed CAN bus, while channel 2 serves as a low-speed CAN bus. Components with high real-time requirements, such as the motor controller, BMS, fault diagnosis system, and on-board charger, utilize the high-speed CAN bus with a communication rate of up to 500 kbps. In contrast, the low-speed CAN bus is employed for acquiring and relaying control signals with lower real-time demands in the vehicle, encompassing systems like air conditioning, combination instruments, cooling systems, and vacuum booster pump brake systems, with a communication rate of up to 100 kbps. The fault diagnosis management unit operates on the high-speed CAN bus, responsible for storing vehicle fault information, controlling fault signal lamps, and interacting with non-vehicle diagnostic instruments. This unit also serves as a high-voltage safety management subsystem, monitoring the state of the high-voltage circuit, including insulation, contact resistance, pre-charging status, and overall health, while controlling the main contactor and pre-charging relay (Zhao, Hou, Wang, Chen, Sun 2019b).

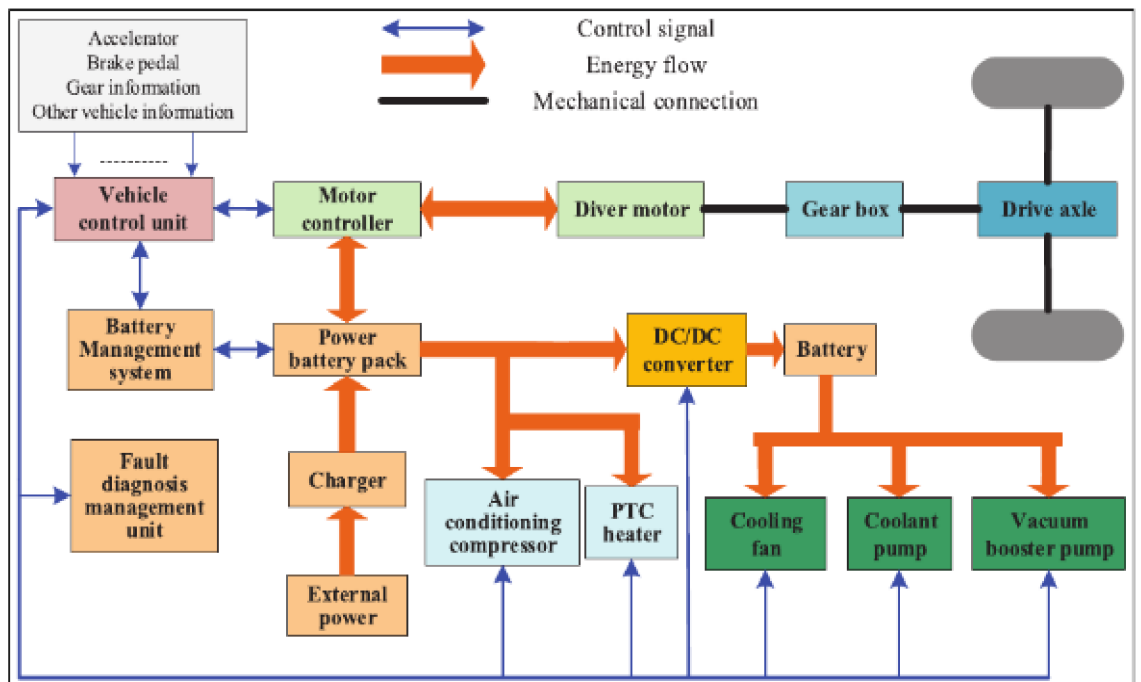

**Figure 3.6: The structure of the vehicle control system**

Sources: <https://shorturl.at/uBMQT>

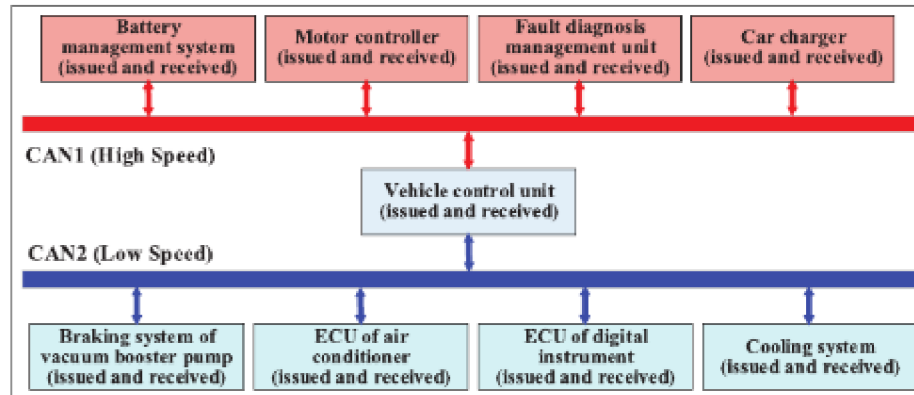

**Figure 3.7: CAN network topology**

Sources: <https://shorturl.at/uBMQT>

The centralized motor drive mode, in which a single motor provides all of the torque necessary to propel the vehicle, is the primary emphasis of this research. The gearbox, main reducer, and differential unit transfer the driving force from the motor to the wheels, allowing the vehicle to move. The controller of the vehicle is able to manage the motor speed or torque in order to make the vehicle driveable by evaluating signals from the pedals, gears, and other sources. Here are the essential signals needed by the vehicle controller (Wang, Fujimoto, Hara 2017)

1. Signal from the accelerator pedal. The vehicle's controller determines the total amount of speed or torque needed based on the various degrees of the accelerator pedal.
2. Pedal signal for braking. The vehicle has the ability to turn the motor on and off in response to signals from the brake pedal.
3. Signal for the gears. The vehicle gains forward and reverse driving capability by controlling the motor's neutral, forward, and reverse motions in response to the gear signal.
4. Signal that indicates the pace at which the wheel is rotating. If the vehicle's controller wants to know how the driver is doing and implement closed-loop wheel speed management, it has to get a signal from the wheels.

5. Signal for speed. For both display and to aid in determining the driving condition of the vehicle, the speed signal is acquired.

Module	No. of channels
Digital input	12
Digital input with frequency capturing	4
Digital output	12
PWM output	8
Analog input	8
CAN bus communication	3
RS 485 Communication	1
124 V to 5 V power supplies	2

**Table:3.2 the number of ports required for this project**

Table shows digital input, output, analogue input, pulse width modulation (PWM) output, and three CAN bus communication channels are all necessary ports for this project. The system's CPU is a freescale MC9S12XDP512 microcontroller, which is more than enough to handle the development and commissioning of the vehicle's controller.

### **Developing a System for Vehicle Management**

In its role as an electric vehicle's sole control unit, the vehicle's electronic control unit (ECU) gathers feedback and real-time dynamic parameters from the controlled object, sends them to the core controller for analysis, and finally, uses the VCU to

instruct the electronic control unit (ECU) to control its operation in a way that maximizes efficiency. This ensures the electric vehicle's performance. The two main types of controller schemes for pure electric vehicles are centralized and distributed, as illustrated in Table.

Module	Control method	Advantages	Dis advantages
Centralized control	By the core processor to complete the processing of signal, energy data and distribution of work	deal with concentration high implement fast response low cost	PCB complex bad heat dissipation
Distributed control	By the core controller through field bus and communication electronic control unit (ECU) for each	modular low complexity flexible configuration	high cost complicated structure

**Table 3.3. The Realization of the Function of Electric Vehicle Controller**

With the proliferation of CAN bus-based distributed control systems and the two types of control schemes presented in the table, this study uses a CAN bus-based distributed control system to communicate and control the ECU in a pure electric vehicle controller.

Improvements in correlation across all vehicle subsystems; distributed control system constructed modularly. Each operation is handled by a subordinate controller, while an overarching controller supervises the entire vehicle. A look at Figure 1 reveals the many components of the vehicle combination instrument, battery management system, and motor controller. An example of such a component is the vehicle central unit (VCU), which processes data and issues commands at the highest level of control. The control object serves as the primary object, while the motor controller is a subsystem. In order to build the controller that integrates centralized and decentralized control, information interaction functions, and more, it is necessary to gather real-time

state parameter subsystems at all levels via CAN bus and send them to VCU for analysis and debate.

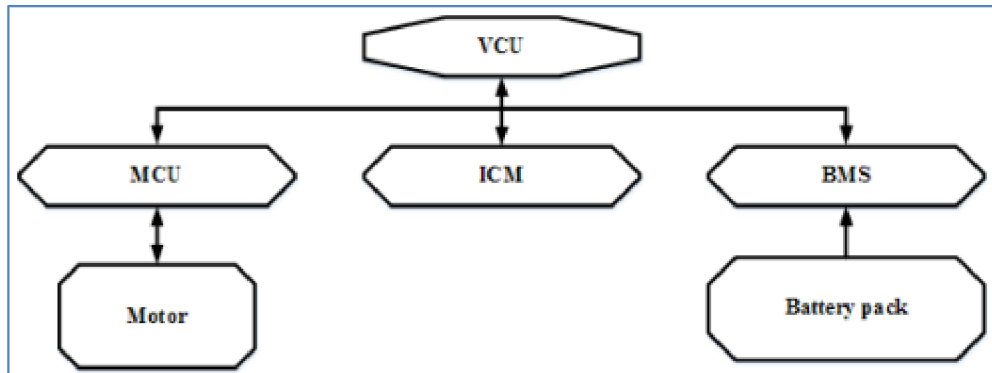

**Figure 3.8: Hierarchical Control System Schematic Diagram of the Vehicle**

Sources: <https://shorturl.at/bhlyH>

### **Electric Vehicle Control System**

The dynamic control system of a fully electric vehicle is comprised of the three main parts shown in the figure: the power supply system, the motor drive system, and the vehicle control system. Technology related to vehicle control, which encompasses energy management, control strategy, control software, and vehicle structural design, forms the backbone of the entire control system. One of the ways to tell if a vehicle controller is doing its job well is by looking at how well it reflects the state of the art in single-chip microcontroller technology used in vehicle control systems. The electronic control unit is a key component of a vehicle's control system, and the degree to which it realizes its functions greatly impacts the vehicle's control effect.



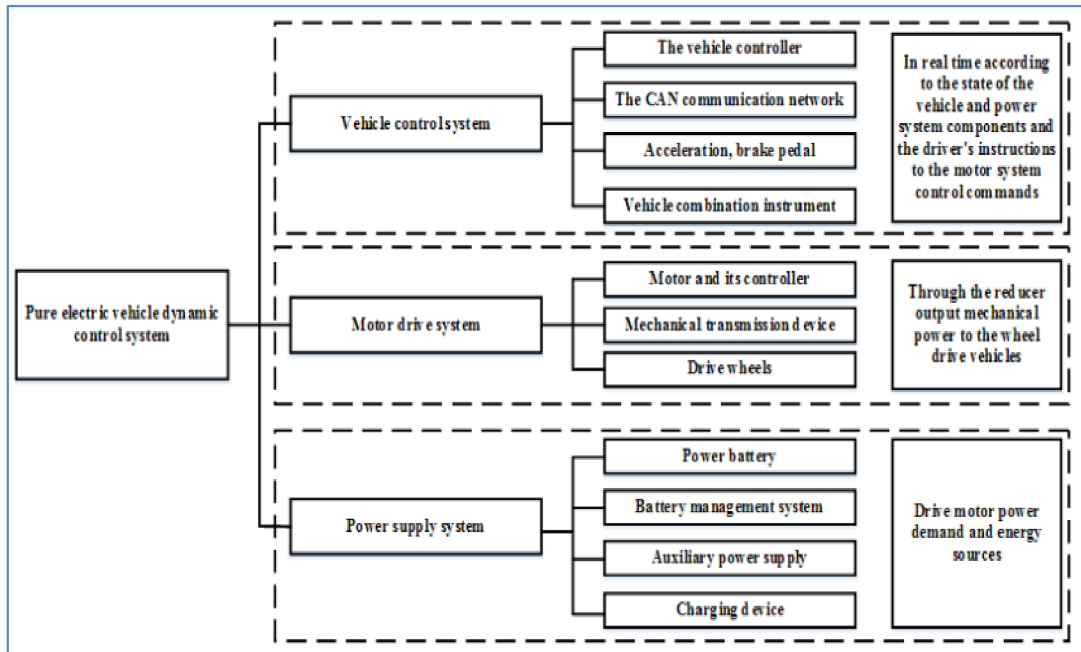

**Figure 3.9: Pure Electric Vehicle Dynamic Control System Structure**

Sources: <https://shorturl.at/sGJNS>

An essential component of any pure electric vehicle control system, the vehicle controller is in charge of a wide range of operations, including but not limited to: managing energy, diagnosing faults, controlling and monitoring the vehicle's running state, operating the pilot signal and sensor signals via the control strategy, and displaying this data on the LCD automotive instrument display. In order to create a fully operational vehicle controller, it is necessary to enhance the electric vehicle control system's design. Figure portrays the schematic of the vehicle's control system.

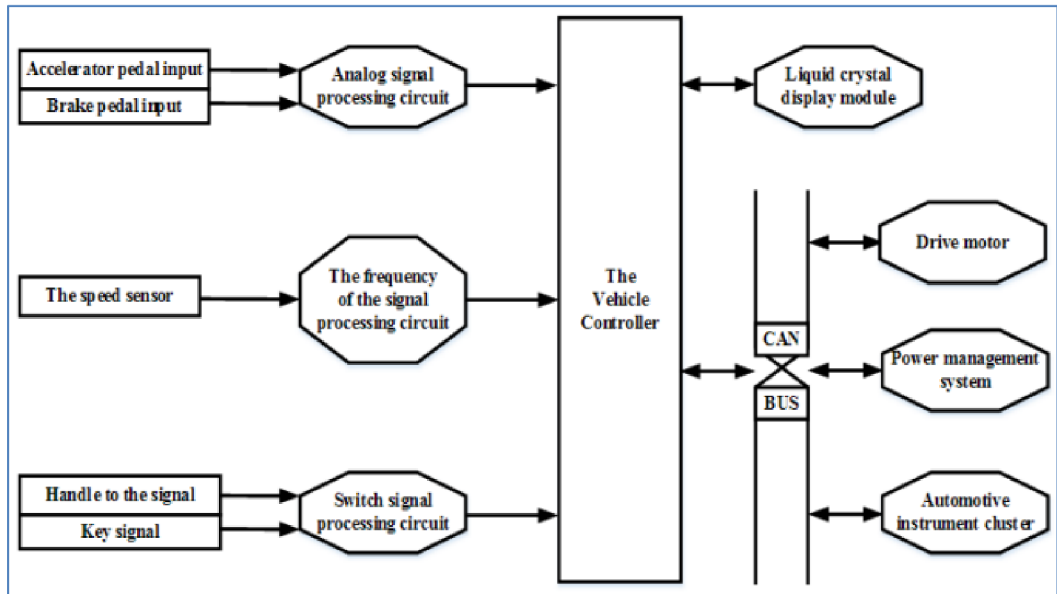

Figure 3.10: Vehicle Controller

Sources: <https://shorturl.at/jHLPR>

### Working Principle of the Control System for Vehicle

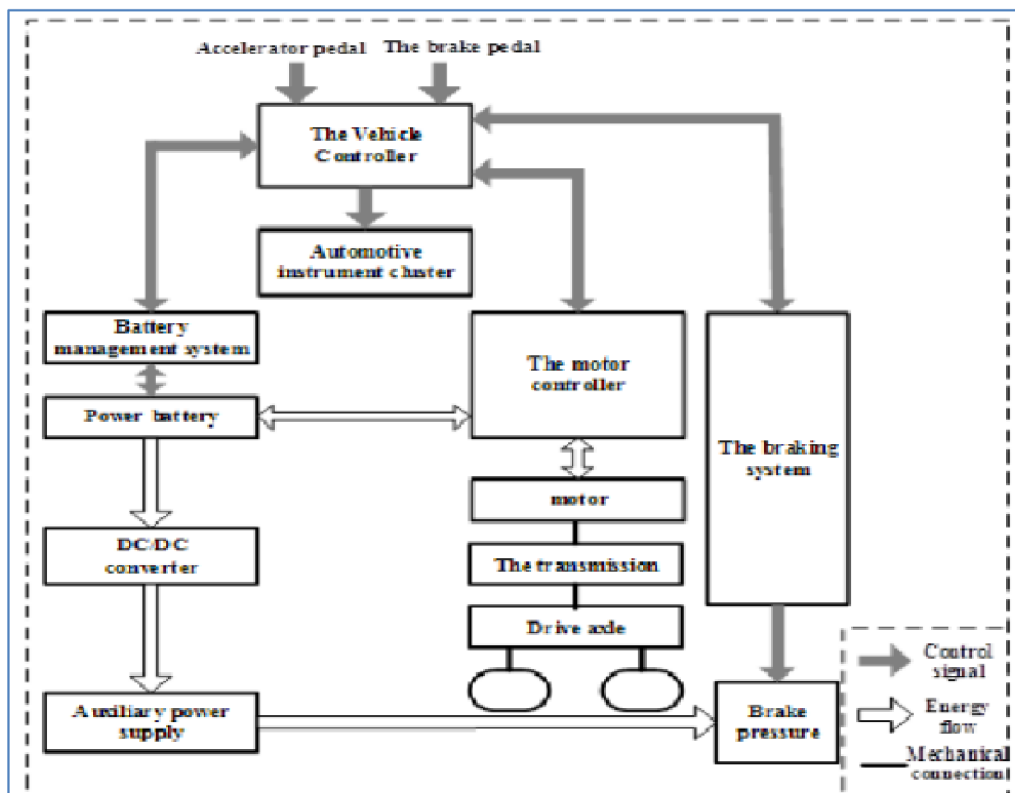

Figure 3.11: Vehicle Controller Works

Sources: <https://shorturl.at/jpzDU>

A closed-loop control system, the vehicle's control system is artificially hierarchical according to the following: policy makers, who are the driver themselves; Coordination layer, where the vehicle's controller processes the driver's best guesses based on real-time status data and control commands; Managing the vehicle controller's pertinent control instructions is an executive-level responsibility. System control error feedback correction can make the vehicle's control system more stable and safe. The vehicle's main controller is depicted in Figure.

On the ground you can find charging equipment for completely electric cars. At the turn of the key to start the car, power is transferred from the engine to the dashboard, interior lights, and other low-voltage electrical components via the DC/DC converter. Motor controllers, such as dc inverter motor controllers, receive three-phase alternating power from the vehicle controller and use it to spin the motors. A number of components work together to transfer power, including the engine, gearbox, differential, and system that drives the back axle. To engage the controller, simply instruct the automobile to move ahead or backward.

When you want to start your car, the first thing you must do is press the accelerator. Before the motorist can choose "forward" or "backward," they must first block your path. By altering the aperture of the pedal, you may regulate the amount of driving torque applied when the accelerator pedal is depressed from its starting position. In particular, when the throttle is fully engaged, you should apply the least amount of drive torque at the very bottom of the pedal's travel, and the most amount when the pedal is fully depressed. The motor controller regulates the energy supply to the motor in response to the control signal and, using the driving torque signal, establishes the quantity of torque and the direction of rotation.

There are two distinct modes of braking available on fully electric vehicles: emergency braking and regular braking. When it comes to brakes, the former often use mechanical systems, while the latter typically combine mechanical and regenerative braking techniques. When the scene environment requires a lower braking intensity, the braking system will prioritize regenerative braking; mechanical braking will be

used in conjunction with this system when the secondary braking intensity is high; and vice versa when the braking intensity is low.

When the driver starts pressing down on the brake pedal, the motor controller receives three signals: control signals, brake level, and braking torque values. In order to brake, it regulates the amount of power that the engine uses. The controller will use the data on the brake torque to calculate the motor's output torque, which will then engage regenerative braking and charge the battery. The braking status indicator and braking torque parameter both go back to zero the second you touch the brake pedal. The motor controller's output disables the braking torque, the last component. As the vehicle comes to a stop, the motor transforms the vehicle's motion into mechanical energy, which is subsequently utilized to charge the battery. This allows for an expansion in the driving range of purely electric automobiles.

### **The Main Function of Electric Vehicle Control System**

In fully electric vehicles, the controller acts as the central nervous system, directing and controlling the vehicle as well as all of its individual electronic control units (ECUs). Each part of the electronic control unit performs a specific control function, allowing the original complicated control system to be divided into numerous smaller subsystems. A small portion of each module will carry out the actual work when a modular approach is used.

A portion of the sensor receives input from the driver's mental commands and information, processes and analyzes it in line with the control strategy, and then, on the third and final part, transmits control commands to the vehicle's motor control unit, battery management system, and instrument cluster control unit. At the same time, the driver can view the car's status at any time. The vehicle's ECU can receive control directives via may bus and other data information. Faster and more reliable data transfer is made possible by the vehicle controller, which acts as the center of the vehicle's communication network.

The vehicle controller to realize the main functions are:

#### **(I) Drive torque control**

The pedal is the nerve center of the vehicle's control system; it receives information, processes it in accordance with the pilot's commands, and then turns it into a torque demand for the motor. By depressing accelerator and brake pedals, among others, the driver conveys commands to the process. The driver inputs signals into the car's controller, which then processes them based on the desired amount of braking torque or driving moment.

## **(2) The braking energy optimization control**

Its ability to gather energy during braking is one of the significant ways in which it varies from both totally electric automobiles and conventional energy vehicles. The motor is the sole part that requires power because it is also a generator. When the driver presses down on the accelerator pedal, the engine works similarly to a motor. To counter this, stepping on the brakes causes the engine to transform into a generator. This means that kinetic energy is created when a vehicle brakes and might be stored in a battery for use in electric automobiles. When specific requirements are met, that power is transferred to the battery pack. For each given moment, the car's controller takes into account the accelerator and brake pedal positions, the speed of the vehicle, and the power battery's State of Charge (SOC) to determine if the braking energy can be recovered. If all went according to plan, the controller would resolve issues with the motor controller, boost energy efficiency by reusing part of the braking energy, etc.

## **(3) The vehicle energy management**

Fully electric vehicles can only be powered by the electric supply system. The drive system, air conditioners, motors, and other electronic control equipment are all part of this. The range of a completely electric vehicle can be increased by the controller through reasonable optimization of energy consumption. When the battery life is getting low, the controller will instruct the auxiliary electrical equipment to activate in order to ensure the safety and efficiency of the vehicle's electrical system.

## **(4) CAN the maintenance and management of the network**

All of the communication devices in the network are overseen and controlled by the vehicle controller. This hub is built on CAN bus technology and features several

master-slave nodes. The controller also has the power to regulate the condition of the vehicle network in real-time and dynamically allocate information priorities.

#### **(5) Fault diagnosis and processing**

The controller is able to keep the car operating by continuously and in real-time monitoring the running status of the vehicle, including the work condition of the ECU. The controller will simultaneously activate security measures and sound an alarm if the ECU makes a mistake. The next step is for the controller to detect the issue, document it, and finally send the code. Future inspections and maintenance on the vehicle will be based on the data gathered here.

#### **(6) The vehicle condition monitoring**

The driver is shown the vehicle's status in real-time by the vehicle's controller using data from the on-board equipment. Vehicle condition monitoring technology has improved the driver-vehicle interaction through the use of CAN bus connectivity. Motor speed, remaining battery power, running condition metrics (such as current), and more are all provided in an intuitive manner in the car's instrument cluster. More convenient circumstances result from the driver's accurate comprehension of the vehicle's entire operating condition.

### **3.4 Vehicle Configuration and Modelling**

The decision to build a hybrid electric compact automobile was made right from the start of the EDV project. There are primarily three distinct body styles for HEVs.

- **Parallel hybrid:** The vehicle can be powered by either an internal combustion engine (ICE) or an electric motor (EM) working in tandem or independently thanks to the shared drive shaft..
- **Series hybrid:** Just the car can be propelled by the electric motor. Either a generator or batteries can provide the power.
- **Combined hybrid:** The name of this configuration gives it away: it's a combination of mechanical and electrical links that run in parallel.
  - The series HEV propulsion system augments the vehicle's operational range by the utilization of the ICE as an auxiliary power unit. A generator converts the energy

produced by the internal combustion engine (ICE) into usable form, which may be used to either replenish the battery or power an electric motor. A feature that series hybrids have is the option to use regenerative braking. A vehicle employs regenerative braking when it slows down by drawing power from its electric motor. Then it turns into a generator, and you may put the power it makes into a battery. The fact that a clutch is unnecessary for the gearbox is an additional perk. The HEV series' fundamental configuration is shown in Figure.

The EDV project began with the development of the optimal vehicle configuration. Considering this, the car should have these specs:

- The vehicle's powertrain ought to be a series hybrid.
- Each rear wheel should have its own motor (2-inputs).
- Be sure to use brushless DC motors (BLDCM) for the motors.
- There should be a brake on each wheel (4-inputs).
- You should be able to steer using the two wheels on the front axle.

### 3.4.1 System Modelling

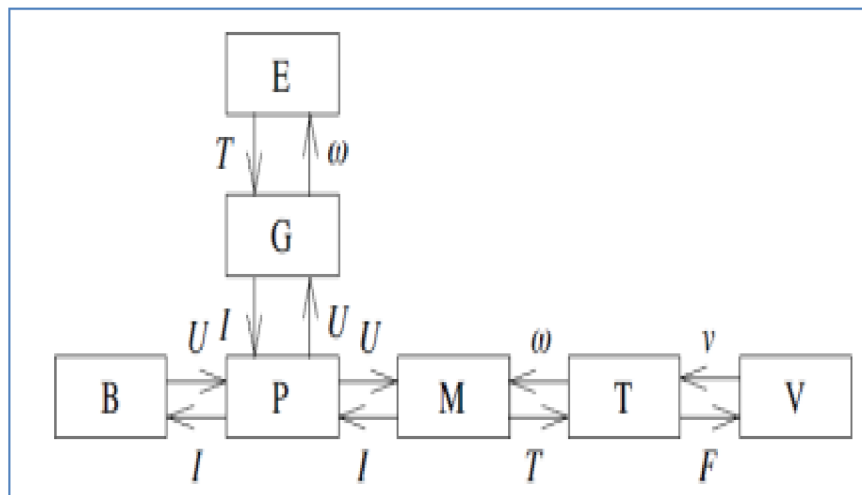

**Figure 3.12: Basic series hybrid configuration. B: battery, E: engine, G: generator, M: motor, P: power converter, T: transmission, V: axles and vehicle. Flow of the physical exchanged data for a series hybrid configuration with dynamic approach. F: force, I: current, P: power, T: torque, v: speed, U: voltage,  $\omega$ : rotational speed. Illustrated at.**

### 3.4.1.1 Chassis Modelling

The SAE standard [9] provided the principal framework for determining the axis orientation. Yaw (around the z-axis), lateral, and longitudinal motion are the three degrees of freedom (DOF) systems that comprise the chassis. In this setup, the chassis's C-center will act as the framework. Additionally, the axis orientation may be seen in picture 3.2, which shows the vehicle model from above. The parameter values are displayed in Appendix B, however the text and graphics give a better description of the different variables. As a result of Newton's laws of motion, we may express the forces operating in both the longitudinal (x) and lateral (y) directions as follows:

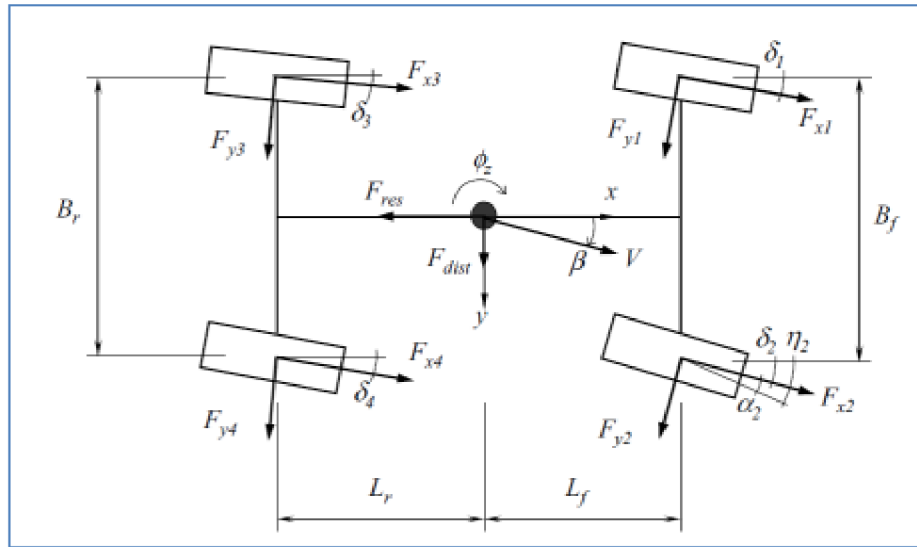

Figure 3.13: Chassis model, x – y view, from top. Illustration from [10].

$$ma_x = \sum_{i=1}^4 F_{x,i} \cos(\delta_i) - \sum_{i=1}^4 F_{y,i} \sin(\delta_i) - F_{res} \quad (3.1)$$

$$ma_y = \sum_{i=1}^4 F_{x,i} \sin(\delta_i) - \sum_{i=1}^4 F_{y,i} \cos(\delta_i) \quad (3.2)$$

The accelerations are approximated as  $a_x$  and  $a_y$ . The total of all forces acting counter to the direction of motion of the vehicle is called the  $F_{res}$ .

$$F_{res} = F_{drag} + F_{roll} + F_{grav} \quad (3.3)$$



The aerodynamical drag force, roll resistance, and loss due to gravity are represented by  $F_{drag}$ ,  $F_{roll}$ , and  $F_{grav}$ , respectively, in the case when the road is sloped and the vehicle is traveling uphill. Assuming that the resistance forces operate on the vehicle body's center of gravity (CoG), appendix B presents some further analysis for these forces. In addition, no disruptions were taken into account for the sake of simplicity.

The following equation represents the sum of moments around the center of gravity (CoG) in the yaw direction.

$$\begin{aligned}
I_{zz}\ddot{\phi}_z = & L_f \left( \sum_{i=1}^2 F_{y,i} \cos(\delta_i) + \sum_{i=1}^2 F_{x,i} \sin(\delta_i) \right) \\
& - L_r \left( \sum_{i=3}^4 F_{y,i} \cos(\delta_i) + \sum_{i=3}^4 F_{x,i} \sin(\delta_i) \right) \\
& + \frac{b_f}{2} \left( \sum_{i=1}^2 (-1)^{1+i} F_{x,i} \cos(\delta_i) + \sum_{i=1}^2 (-1)^i F_{y,i} \sin(\delta_i) \right) \\
& + \frac{b_r}{2} \left( \sum_{i=3}^4 (-1)^{1+i} F_{x,i} \cos(\delta_i) + \sum_{i=3}^4 (-1)^i F_{y,i} \sin(\delta_i) \right).
\end{aligned} \tag{3.4}$$

### 3.4.1.2

#### Brushless DC Motor

A DC motor's electrical and mechanical components are broken down into their respective divisions in a basic form. While Newton's second law forms the basis of mechanical dynamic equations, Kirchhoff's voltage law forms the basis of electrical dynamic equations.

Though it doesn't have a brush, a brushless DC motor functions similarly to a synchronous machine. The armature windings of the stator receive a three-phase AC voltage to activate the permanent magnets in the rotor. They differ from each other because the power electronics are replacing the brushes. Using a BLDC motor as a motion actuator in a vehicle has the following advantages over using an ICE or AC motor:

1. Just regulating the current supplied to the motor's electrical component makes it simpler to regulate a DC motor than an AC motor.

2. A DC motor eliminates the need for a gearbox. This is so that even at zero motor speed, DC motors—unlike ICE motors—can generate maximum torque across a larger range.

### 3.4.1.3 EV engineering design

One of the most important factors in an electric car's fuel efficiency is the engine architecture. The powertrain of a BEV typically consists of a battery pack, motor or motors, and a final drive, which reduces torque applied to the wheels. A plug-in hybrid electric vehicle's gearbox is responsible for transferring power from the engine, motors, and final drive to the wheels. An internal combustion engine is also a part of the vehicle. Figure 1 displays the BEV and PHEV systems, as well as the powertrain components, of the Toyota Prius and the Nissan Leaf. A battery pack consists of several branches that are connected in parallel with each other and in series with the battery cells. Batteries have limitations on voltage and current that are affected by the number of connections in series and parallel, which in turn restricts the maximum power output of the motors. Fuel efficiency, pollution, and acceleration performance are all affected by the vehicle's mass, which is in turn affected by the capacity of the battery pack.

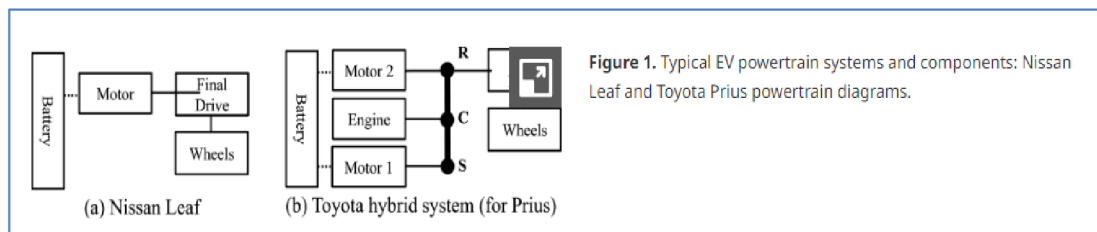

Figure 1. Typical EV powertrain systems and components: Nissan Leaf and Toyota Prius powertrain diagrams.

Source: [https://www.researchgate.net/figure/nput-data-from-MATLAB-SIMULINK-to-Xilinx-System-Generator-model\\_fig2\\_336937536](https://www.researchgate.net/figure/nput-data-from-MATLAB-SIMULINK-to-Xilinx-System-Generator-model_fig2_336937536)

The final drive of a BEV transforms the gearbox's high-velocity, low-torque input into the wheels' low-velocity, high-torque output. When the input and output speeds are compared, the result is the final drive ratio. A lower ratio allows the vehicle to reach a higher maximum speed, whereas a higher ratio provides greater torque for acceleration from a lower to a higher speed. Because of its significant effect on fuel economy and emissions, the final drive ratio is situationally and vehicle-specific. Planetary (epicyclic) gear sets are used by some hybrid electric vehicles (PHEVs) and electric vehicles (EVs) to allow the engine to run at more efficient speed-torque ranges.

#### **3.4.1.4 Stakeholders and decision framework**

The decision-making process takes into account the three stakeholders: the state, infrastructure operators, and vehicle manufacturers. Electric vehicle (EV) manufacturers choose the designs of the powertrain and batteries used in BEV and PHEV products, as well as the costs of these vehicles. Charging station (CS) operators decide on the location, number, and cost of charging stations, while governments make the legislative decisions. Based on the answers to a survey questionnaire, we can build a customer choice model that takes charging service and car design specs into account. After that, we calculate the market shares of PHEVs, conventional vehicles, and EVs. The parameters, outputs, and input choice criteria of the models are detailed in Table, and the interactions between stakeholders are summarized in Figure 3..(Cairns, Goodwin, Wright 2016)

#### **Control strategies for electric-drive vehicles**

Designing an appropriate control method is a challenge for electric-drive vehicles. In the control strategy, an algorithm takes into account the wheel power need, battery charge status, and current ICE power level to decide when and at what power level to run the vehicle's ICE. A broad range of control systems, including global control systems, dynamic real-time control strategies, and static real-time control strategies, are utilized by this function.

With a global control strategy, you know every step of the driving cycle. One method for global optimization is to use genetic algorithms. Using the engine's best efficiency curve, it determines the ideal speed and torque for all input power levels, optimizing the overall system efficiency. When it comes to optimizing designs, genetic

algorithms offer an efficient and derivative-free solution. By analyzing the most crucial design parameter, they simplify a multi-objective optimization problem into a single objective problem. Nevertheless, these approaches necessitate extensive computational data and information about future driving cycles, making their implementation challenging. Furthermore, these optimization control mechanisms at the global level are vehicle-specific, making them very difficult to modify.

Adaptive fuzzy reduces the reliance on fuzzy rules to achieve a goal, whereas adaptive equivalent fuel consumption minimization method (AECMS) centers on parameter choice for expressing electric motor cost in fuel terms, with the goal of maximizing electric motor performance. Both strategies are examples of dynamic real-time control strategies. So, these tactics get the best possible result by adjusting the rules according to driving circumstances or some other crucial optimization element.

This section delves into the topic of static real-time control strategies, which encompass basic rule-based algorithms such as load (or power) followers and thermostats. Using both historical data and current conditions, static real-time control methods are put into action. Both the fuzzy-based approach and the rule-based control strategy are comparable. In contrast to fuzzy logic, which focuses on system efficiency, this approach seeks to maximize engine efficiency by maintaining a constant position on the efficiency curve. (Pradana, Haque, Nadarajah 2023)

### **Selection of powertrain**

The electrical and mechanical parts that work together to produce and transfer power make up what is known as a powertrain. As mentioned earlier, with series HEVs, the ICE's mechanical energy is transformed into electrical energy by means of a generator. The battery is charged by the converted electrical energy, which powers the electric motor and mechanical connections that turn the wheels. One benefit of disconnecting the engine from the wheels is the increased mobility it provides when it comes to positioning the ICE generator set. Because of its straightforward design, the series powertrain is ideal for shorter journeys. Having to size all of the propulsion components for maximum continuous power means the series powertrain is expensive, but it allows the vehicle to operate for longer on slopes. The motor, generator, and engine are all part of this. Since they are easy to handle and can run on energy alone

at high speeds, vehicles with a long all-electric range benefit immensely from series powertrain systems. (Raut 2017)

### **Rule-based control strategies**

Using a predetermined framework created in PSAT, this part discusses control strategies for a succession of HEVs. The hybrid electric powertrain used in this series is detailed in the accompanying table, along with its components and ratings. According to PSAT, a midsize SUV is the preferred car type. The vehicle's two operating modes, charge depleting mode (CD) and charge sustaining mode (CS), dictate the control approaches that are achievable. These two operational modes served as the basis for the two PSAT approaches that were later developed. (Huang, Nguyen, Chen 2022)

Parameter	Series Powertrain
ICE peak power (kW)	110
Generator peak power (kW)	110
Electric motor peak power (kW)	170
Battery Capacity (kWh)	1.62
Power Converter Efficiency (%)	95

**Table 3.4: Ratings of Components in Series Powertrain**

### **Load Follower Control Strategy**

One technique that keeps the connection between the engine's power output and the wheels' power in a close relationship is load follower control. The ICE operates across its whole power range and experiences rapid power transients, while the battery's state-of-charge (SOC) is relatively stable during a specific driving cycle. (Fig). This results in a 26 percent reduction in losses caused by charging and discharging the battery. On the other hand, ICEs' efficiency and emission characteristics might be negatively impacted by their rapid power transients..(Luo, Shen, Evangelou, Xiong, Wang 2019)

### 3.5 EV design – vehicle control modes

This article will go over the car Control System (VCS), a high-level controller for an electric car. The vehicle control system of a mass-produced car is intricate, spanning several electronic control modules and interacting with various other systems (such as HVAC, battery management, brakes, etc.). Learning the fundamentals of a simplified controller and the data sent between its many modules is the goal of this article.

From a technical standpoint, there are four primary systems to think about while analyzing an electric vehicle::

- energy system
- A high-voltage power source
- The vehicle's body
- Braking

Here are a few control systems to think about from a software (controller) perspective:

- electric machine control system (EMCS)
- stability control system (SCS)
- battery management system (BMS)
- driver mode system (DMS)
- vehicle control system (VCS)

You may think of the inverter as part of the Electric Machine Control System (EMCS). Electric machines are so named because, in response to the driver's inputs (the location of the accelerator and brake pedals), they may transform into either motors (producing positive torque) or generators (producing negative torque). In response to torque requests sent by the VCS, the EMCS adjusts the stator's phase voltage to provide the necessary torque.

The EMCS also checks the electrical equipment and reports back any problems it finds. If heat protection is in place, for instance, the EMC will let the VCS know that

it is unable to apply the desired torque and will instead transmit the derated torque limit. **(Rashid, Mollik 2016)**

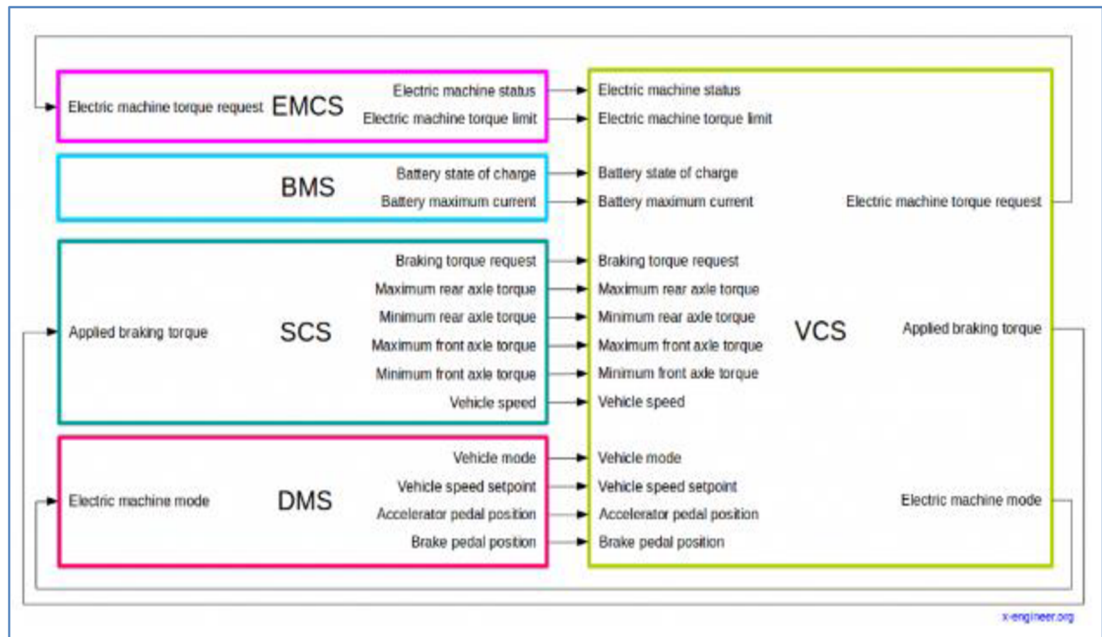

**Image:** Signal interface between the major electronic control modules

Source: <https://x-engineer.org/>

The PM100 and PM150 series of propulsion inverters manufactured by Rinehart Motion Systems are EMCS. Uses for these include controllers for integrated starter generators (ISGs), high-performance automobiles, professional motorsport, hybrid propulsion for large vehicles, static energy conversion, hybrid range extenders, and more.

Both on-road and off-road electric and hybrid vehicle (HEV) applications are well-suited to the PM series of propulsion inverters. Electric machines rely on them to transform direct current (DC) from high-voltage batteries into the three-phase alternating current (AC) needed by the machinery.

Rinehart Motion Systems produces EMCS propulsion inverters in the PM100 and PM150 series. These find use in a wide variety of settings, such as large-scale hybrid propulsion, high-performance cars, professional motorsport, static energy conversion, hybrid range extenders, and integrated starter generator (ISG) controllers.

Electric and hybrid vehicles (EVs) and off-road vehicles (HEVs) alike can benefit from the PM series of propulsion inverters. A high-voltage battery's direct current (DC) is transformed into the three-phase alternating current (AC) needed by the electric machine using these devices..(Alanazi 2023)



**Image:** Inverter control module (RmS)

**Source:** [https://www.phi-power.com/wp-content/uploads/2017/04/pm100-150datasheet\\_2-1.pdf](https://www.phi-power.com/wp-content/uploads/2017/04/pm100-150datasheet_2-1.pdf)

- Cooling circuit connections (input/output)
- Communication and input-output ports
- high voltage battery connections (DC)
- 3-phase output connections (AC)

Controller Model	PM100DX	PM100DZ	PM150DX	PM150DZ
DC Voltage – operating [V]	50 – 400	100 – 800	50 – 400	50 – 800
DC Overvoltage trip [V]	420	840	420	840
Max. DC Voltage – non-operating [V]	500	900	500	900
Motor current (continuous) [A]	300	150	450	225
Motor current (peak) [A]	350	200	450	300



Output electrical power (peak) [kVA]	100	100	150	150
DC bus capacitance [ $\mu$ F]	440	280	880	560
Size, length x height x width [mm]	200 x 87 x 314		200 x 87 x 436	
Volume [l]	5.5		7.6	
Weight [kg]	7.5	7.5	10.6	10.7

Technical specification:

**Source:** Reinhart Motion Systems

Communication and input-output ports summary:

- Six analog inputs ranging from 0 to 5 V
- Two selectable RTD inputs (PT100 and PT1000)
- Eight digital inputs (STB and STG)
- Four high-side driver outputs and two low-side driver outputs
- One interface for a resolver
- One quadrature encoder and one sin-cos encoder
- Two CAN 2.0A/B ports • One 1MB RS232 data port

The analogue feeds can be utilized by a variety of sensors, including position, pressure, and others. It is possible to connect temperature sensors using inputs designed for use with resistance temperature detectors (RTDs). In order to provide data into the resolver, quadrature encoder, and sin-cos encoder, sensors that measure rotational position and speed are used. Modules (such as VCS) are able to exchange data with each other over the CAN protocol. In order to calibrate the module or modify the software algorithm, you can use the programming interface.

The Stability Control System (SCS) communicates with the Vehicle Control System (VCS) for a variety of purposes. Primarily, it controls the brakes and also precisely reports the vehicle's speed to the other systems. The electric equipment is braked by use of the VCS, which is activated by means of EMCS communication. The

idea behind this arrangement is that the hydraulic foundation brakes are not activated instantly when the driver presses the brake pedal. Instead, when the vehicle slows down, the electric machines recover electrical energy by shifting into generator mode and providing negative torque.



**Image:** Brake control module

**Source:** <https://x-engineer.org/ev-design-vehicle-control-modes/>

As a safety measure, the SCS limits the maximum torque that an electric motor may generate, effectively stopping the vehicle. To prevent instability and wheel slip, electric machine torque must be regulated when traveling on low-friction surfaces such as ice or snow. In order to enable energy recovery, the VCS informs the SCS of the maximum permissible braking torque. The nominal torque capability of the electric machine or the derated value (provided by EMCS) are used to establish this torque limit..(Satzger, de Castro 2018)

The main metrics that the Battery Management System (BMS) intends to track are the state of charge (SOC), cell voltage balancing, and state of health (SOH) of the high voltage battery. It prevents the battery from overheating by capping its maximum current, whether positive or negative.



**Image:** Battery control module (Orion BMS)

**Source:** <https://www.lifepo4battery-factory.com/lithium-ion-battery-manufacturers-in-china/>

One such product is the Orion BMS, which is made and created by Ewert Energy Systems. Primary characteristics:

- Keeps track of each cell's voltage
- It can be programmed and upgraded in the field.
- Efficient passive balancing, as a result of intelligent cells.
- Requires specific cell voltages at all times.
- Limits the maximum current that can be applied.
- Manages set temperature restrictions.
- Strong and expertly crafted design. Monitors state of charge (SOC).
- Keeps track of your battery life
- Works with third-party apps for your smartphone. (Torque, EngineLink).

**Battery compatibility:**

- Works with the vast majority of lithium-ion cells
- Supports a wide variety of common battery types with only one click.
- One BMS module can accommodate a series of 4-180 cells.

**Calculations:**

- Optimal health status
- Cell voltage when open circuit
- Charging current maximum
- The discharge current that is considered maximum
- Cellular and overall body resistance (internal resistance).

**Centralised design:**

- There is no external circuitry or cell tap boards.
- Regular and quick monitoring of cell voltage (usually every 30 ms).
- Very little effect from background noise or electromagnetic interference (EMI).
- Measurement of cell voltage with exceptional precision.

**Two programmable CAN bus interfaces:**

- CAN2.0B (supports both 11-bit and 29-bit IDs).
- Work autonomously at various baud rates.
- Message formatting is fully configurable.
- Firmware and settings can be upgraded in the field over the CAN interface.
- Support for numerous popular chargers and inverters with a single click.
- Compatible with the OBD2 protocol (multiple scan tools are supported).CAN Open and J1939 programs are compatible with it.

**Input / Output**

- Charging and loading are easily interfaced with.
- Charge and discharge can be controlled via on/off outputs.
- Analog outputs ranging from 0 to 5 V allow for a slow drop of current, which extends the battery's useable life.
- Temperature controls for the cooling and heating of batteries.

## **Diagnostic Features**

- Problems with the batteries can be promptly identified and diagnosed using diagnostic issue codes.
- When a fault occurred, the freeze frame data records exactly what was happening.
- The OBD2 protocol allows for the recording of diagnostic issue codes and the polling of real-time data in automobiles.

## **Data Logging**

- The device keeps tabs on the total number of cycles that the battery goes through.
- It logs the number and duration of over-temperature and over-current events.
- With the optional data logging display, you may record any parameters to a memory card.
- All BMS parameters can be accessed through PC utility software.

## **Other features**

- Identifying isolation failures.
- The usage of multiple BMS units in series is possible.
- Secure connectors made for automobiles
- Changing the temperature to better monitor at different temperatures.

## **Interaction between the driver and the vehicle is facilitated by the Driver Mode System (DMS). With this option, the driver can input:**

- The need for torque, as measured by the position of the accelerator pedal
- The demand for brakes, as measured by the position of the brake pedal
- The position of the shift lever (park, reverse, neutral, drive)
- The desired maximum speed (for use with cruise control)

Using this data, the VCS determines the electric machine's torque value and rotational direction. The DMS receives the torque from the electric machine and uses it to show the powertrain mode (be it braking or accelerating) and the amount of energy recuperation.

The VCS is the master controller of the vehicle. Its principal uses are to select the torque value and the mode (motor/generator) of the electric machine. When making decisions, the control logic takes into account the following: the state of the electric machine(s), the high voltage battery, the state of the vehicle, and the inputs from the driver. As a potential master controller for electric vehicles (EVs), the graphic below depicts a simplified high-level state machine.

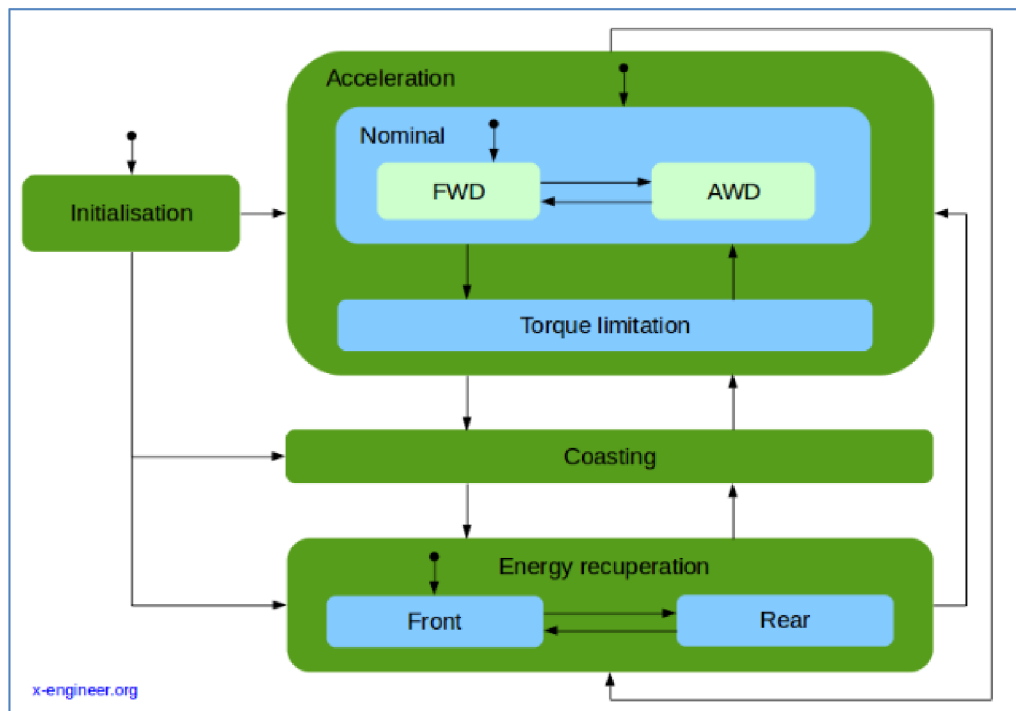

**Image:** State machine for energy and torque management

**Source:** <https://x-engineer.org/ev-design-vehicle-control-modes/>

The VCS enters the Initialization state when the car is switched on (ignition key ON). It can be in the acceleration, coasting, or energy recovery states depending on the speed of the car and the driver's inputs (shift lever, accelerator pedal, brake pedal position). The state's admission requirements are described in the table below.

<b>State</b>	<b>Initialisation</b>	<b>Acceleration</b>	<b>Coasting</b>	<b>Energy recuperation</b>
<b>Entry conditions</b>	Ignition key ON	shift lever in Drive (D) AP position > 0 % BP position = 0 %	shift lever in Drive (D) vehicle speed > 0 kph AP position = 0 % BP position = 0 %	shift lever in Drive (D) AP position = 0 % BP position >= 0 %
<b>Output</b>	None	EM torque > 0 Nm EM state = MOTOR	EM torque = 0 Nm EM state = MOTOR	EM torque < 0 Nm EM state = GENERATOR

- AP – accelerator pedal
- BP – brake pedal
- EM – electric machine

Since the acceleration state's default sub-state is nominal, the high voltage battery and electric machine(s) can both produce unlimited power and torque. Depending on the position of the accelerator pedal, the driver can engage front-wheel drive (FWD) or all-wheel drive (AWD) and direct torque to either the front or rear axles. A torque limitation state might be entered by the vehicle when the electric machine or battery encounters thermal protection. This limits the maximum amount of torque that can be applied to the machine and the maximum amount of electrical current that can be inputted or outputted from the battery.

To maximize the vehicle's kinetic energy for motion, the VCS coasts by not applying any braking or traction torque to the electric machine or machines. For the electric devices, the torque set point is 0 Nm.

The electric devices turn into generators and create electricity when they are in the energy recovery condition. The amount of negative torque acting on the electric machine changes when the location of the brake pedal is adjusted. Furthermore, the front and rear axles could share the full negative torque depending on the vehicle's state and the driving conditions.

Although this is a simplified illustration of an electric vehicle (EV) controller, it provides an excellent idea of the information shared between various control modules and the possible modes of operation based on the input signals.(Molavi, Husar, Hjortberg, Nilsson, Kogler, Monreal, Eldigair, Prat 2024)



## **4. Practical part**

### **4.1 Simulation Results**

The built control system was put through its paces utilizing a battery of simulated test cases to guarantee it performed as anticipated. Despite the random selection of test cases, their objective was to encompass a range of driving commands. Two sets of cases were examined. Priority number one was validating the Driver Wish Interpretation platform. The simulated studies did not employ any specific vehicle model. The Yaw Rate Calculation subsystem was not examined either because it had already been tested in a previous Volvo project. The primary objective of these trials was to get the target longitudinal velocity by modifying the GP ratio and driving modes. The control allocator was double-checked by a second round of simulation testing as this thesis came to a close.

The simulations were conducted using the ODE23 solver. Because it uses fewer time steps than explicit approaches, this solution—a variable-step implicit approach—is ideal for models that use the SimMechanics toolkit, such the Environmental Model. In the CVC architecture, each layer has a distinct time span. However, for the purpose of this thesis, a single sampling period was designated. The value of  $T_s$ , which is 0.2 seconds, was chosen arbitrarily, but it was also considered that it must satisfy the Nyquist criterion. Therefore, it was decided to have a frequency that is at least twice as high as what the hardware components may have. In addition, the QCAT weighted least squares function necessitates the specification of the number of iterations it should do before producing a solution. The function designer set the maximum number of iterations to  $I = 100$ , which was the value used for the simulations.

### **4.2 Methodology**

To help with the development of the EDV's framework, Volvo supplied a model. The pattern, which provides a theoretical basis for control architecture, is known as Complete Vehicle Control (CVC) and it is based on the [5]. Figure 2.1 shows the architecture's separation into several hierarchical stages, which is a basic summary. The numerous systems that are encompassed by each layer can be thought of as realms of functionality. Given the complexity of vehicles and the variety of needs for

execution times, it is reasonable to divide the capabilities. The lowest level has a limited time frame of milliseconds, so it must be given priority to ensure timely execution. In contrast, higher levels can have a time span exceeding sixty minutes. Another justification for implementing separate functionality systems is that it enhances the reusability of different functionalities, resulting in a reduction in the time required for designing. Furthermore, according to the CVC pattern, there are some fundamental guidelines that the designer must adhere to, which are outlined below.

- Interactions or demands between functional objects within the same layer are prohibited.
- Points or requests should be communicated from a layer with a longer time frame to a layer with a shorter time frame, and not the other way around.
- Each layer should only share its combined nominal and dynamic abilities and restrictions with the following layer that has a greater scope.
- Information regarding the current condition, characteristics, and constraints may be exchanged among various functional domains or entities within the identical level.
- The HMI should convey the driver's objectives rather than specific fixed points across all levels.

These standards guarantee that the CVC pattern will have a consistent structure, making it easier to create modular components and separate functionalities according to specific time intervals. In addition, no drawbacks or constraints were identified in the controller's capabilities, even when employing the prior guidelines in the design process. The main areas of attention for this thesis were primarily "Vehicle Motion Management" and secondarily "Motion Support Devices".

#### **4.2.1 Management of vehicle motion**

The primary attribute of this area is its focus on the ongoing and fluid behavior of the vehicle as a unified system. This area carries the potential for substantial bodily harm, financial losses, and even endangerment of human life in the event of a failure. This level does not incorporate any mechanical components such as actuators or sensors. Instead, it solely relies on software to govern and establish target values for

the actuators in the lower level. This level is mostly dedicated to the design of the propulsion system's controller.

#### **4.2.2 Devices for Motion Support**

This level directly interfaces with the vehicle at its most basic level. The features encompassed at this level pertain to the movement of the vehicle. One key feature of these devices is that they are unable to directly manage the movement of the vehicle. Instead, they assist and enable higher levels of computer vision control to regulate the vehicle's mobility. This area encompasses devices that are comprised solely of actuators, solely of sensors, or a combination of both, in addition to accompanying software. The primary purpose of this system is to efficiently manage and oversee various equipment within the vehicle, including monitoring, measuring, and controlling them. An example will be provided to help clarify what is included in this domain. The "Steering Management" is one kind of equipment that fits this category. The steering actuators alone can do this; they get a fixed location from up above and just turn the wheels. The "Body Management" system is another possible gadget; it consists entirely of sensors that report the vehicle's rotational velocity, lateral and longitudinal velocities, and other metrics to higher authorities. An example of a system that combines software, actuators, and sensors is the "Motors Management" system. The required torque is transmitted by the higher tiers of this device. The software can determine if the wheels will slip under the load of this torque and, if so, choose to reduce its intensity. After that, the software can tell you whether the program was executed and what the motors' present capabilities are; some sensors can measure the angular velocity of the wheels; and last, the actuators put the command into motion.

#### **4.2.3 EAST-ADL Concept**

Vehicle electrical and electronic systems are becoming more complex all the time. Because of this trend, a tool that helps with car embedded system documentation, presentation, design, and analysis needs to be created. Automotive embedded systems make use of EAST-ADL, an architecture description language. It was developed through a number of European programs that included car manufacturers including Volvo. Feature, function, requirement, software/hardware component, and communication descriptions can all be standardised with EAST-ADL. The

fundamental system model consists of abstraction levels. Each level provides a distinct perspective of the system, offering varying degrees of detail.

The Technical Feature Model element, which provides a high-level representation of a vehicle's numerous parts without implementation details, is part of the vehicle level. At this tier, you can tell the car how to behave exactly how you want it to.

The Functional Analysis Architecture (FAA) is a part of the analysis level that gives an abstract representation of all the functionality. The FAA records every single subsystem's behavior and basic interfaces. It is possible to look at important problems and analyze them without thinking about the implementation details. This level, along with the ones below it, describes how the vehicle carries out the operations mentioned in the Vehicle level.

Design Level Comprises of two primary components. The Functional Design Architecture is a framework that incorporates the introduction of implementation aspects. The Hardware Design Architecture imposes limitations on the development process, necessitating their simultaneous implementation. Furthermore, there is an impact observed at elevated levels. It may be necessary to modify control techniques or the complete functionality in order to be compatible with a practical hardware design.

Implementation Level: The execution of the shown embedded system utilizing AUTOSAR1 components.

In addition to the core system model, it is necessary to have an environmental model to aid in the verification and validation of the vehicle's characteristics. Components' interactions with the central model are depicted here, along with their traits and activities. Everything from the vehicle's dynamics to its mechanical and hydraulic systems to the road and traffic conditions are all part of this model. Furthermore, EAST-ADL has been improved with new features that make it easier to specify models that focus on different characteristics. For instance, a model can be analyzed using time modeling, requirements modeling, functional safety, and variability modeling.

### 4.3 Validation of Driver's Wish Interpretation

The system's functioning was validated using the following simulated test cases:

- Simulation solely utilizing the Pedal Position Interpretation subsystem.
- Simulation utilizing the interpretation of pedal position and the request for vehicle speed:

1. The GP ratio was increasing from zero to one starting at time 0.5 and with a step of 0.2 per two seconds for initial speed  $V_0 = 0 \text{ m/s}$ .
2. The pedal ratio was set to  $GP = 0.4$  for initial speed  $V_0 = 7 \text{ m/s}$ .

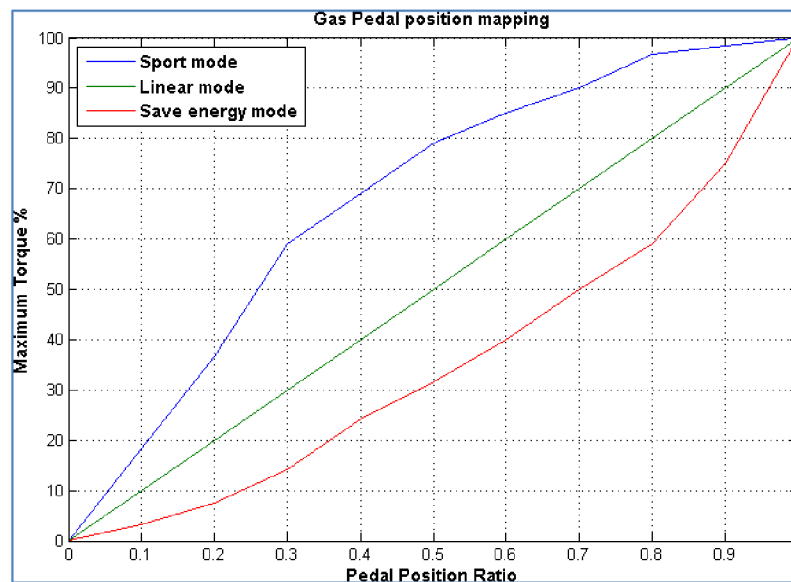

**FIGURE 4.1: Test case 1. The GP ratio corresponds to a percentage representation of the total torque allocation for various driving modes.**

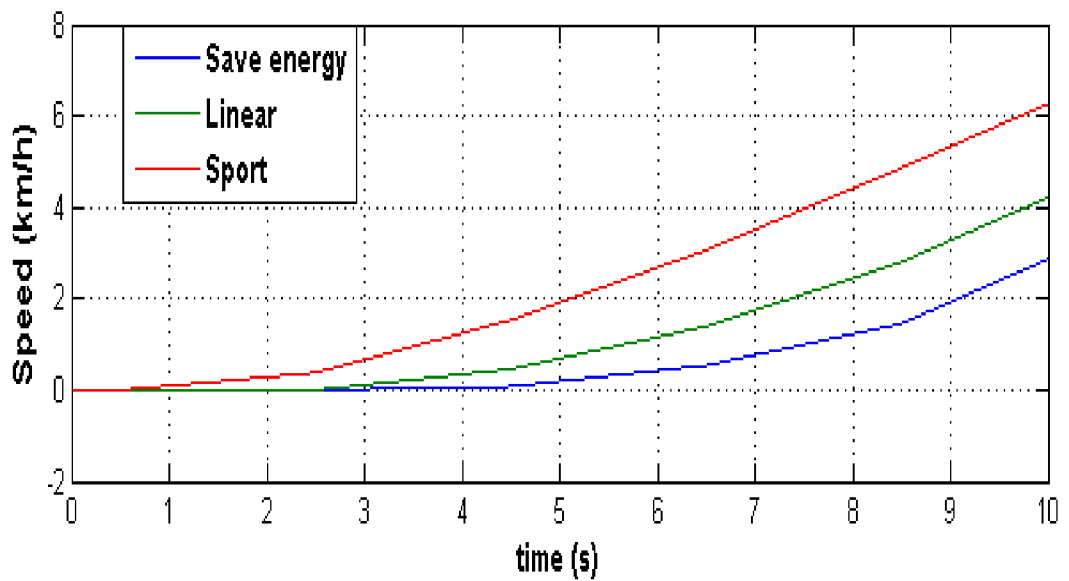
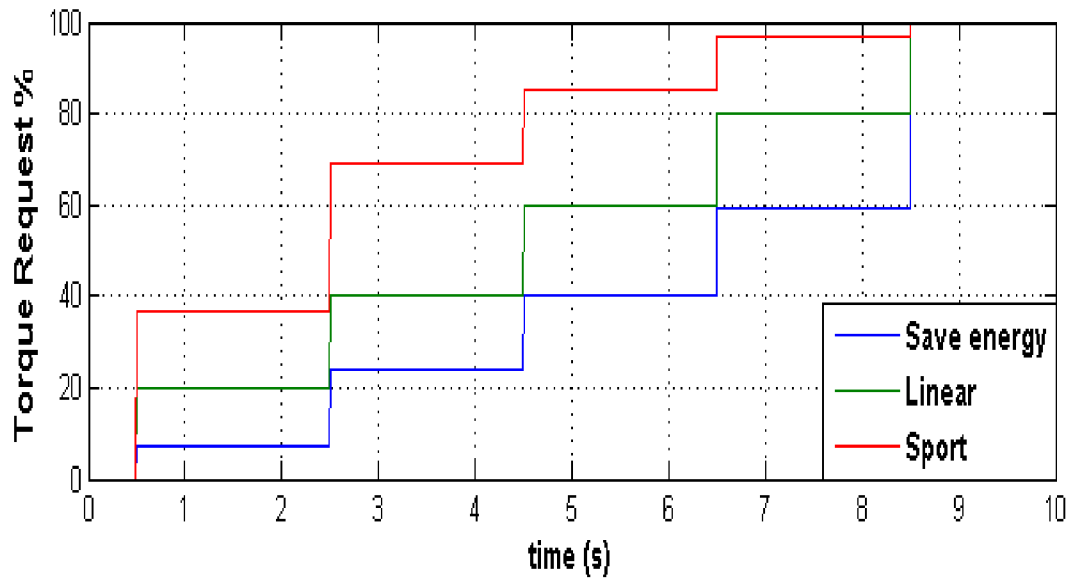

**FIGURE 4.2: Test case 2a. The initial graph displays the proportion of torque requested for various driving modes, while the subsequent graph illustrates the  $V_{xdes}$  generated during test scenario 2a.**

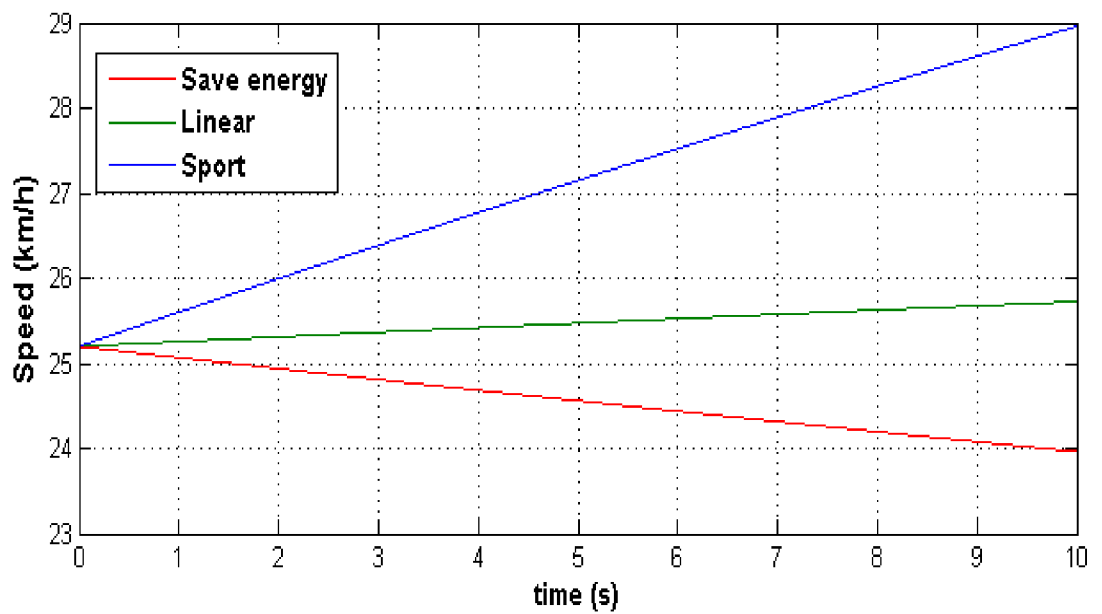
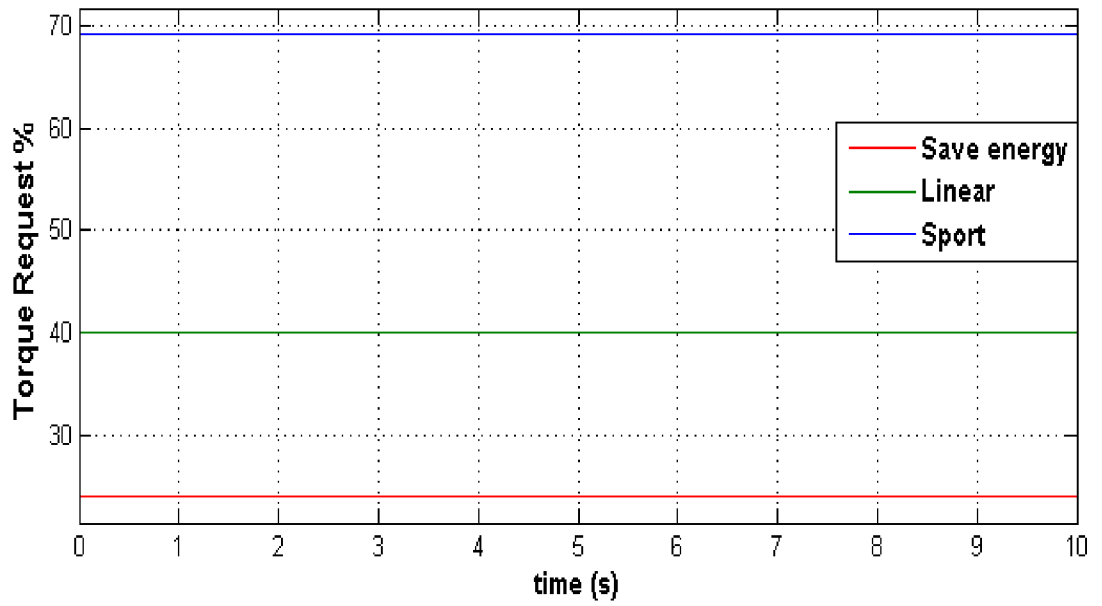

**FIGURE 4.3:** Test case 2b. The initial graph displays the proportion of torque requested for various driving modes, while the subsequent graph illustrates the  $V_{xdes}$  generated during test scenario 2b.

## 4.4 Control System Design Validation

The system's functioning was validated by the simulation of the following test cases:

3. The acceleration demand is 3 m/s during the initial 10 seconds of the simulation, and then changes to 10 m/s for the remaining duration.
  - (a) Maximum torque assigned for motors' limits at  $T_{mmax} = 18.61 \text{ N.m}$
  - (b) Maximum torque assigned for motors' limits at  $T_{mmax} = 10 \text{ N.m}$
4. Acceleration demand for desired speed  $V_{x_{des}} = 10 \text{ m/s}$  during the first 10 sec. Then for time  $10 < t < 30$ , the desired speed was set at  $V_{x_{des}} = 20 \text{ m/s}$  and finally deceleration demand to  $V_{x_{des}} = 5 \text{ m/s}$  for time  $30 \leq t$ 
  - (a) Maximum torque assigned for motors' limits at  $T_{mmax} = 18.61 \text{ N.m}$  and brakelimits at  $T_{bmin} = -100 \text{ N.m}$ .
  - (b) Maximum torque assigned for motors' limits at  $T_{mmax} = 10 \text{ N.m}$  and brakelimits at  $T_{bmin} = -200 \text{ N.m}$ .

A certain desired speed was directly established for test cases 3-4. The Driver Wish Interpretation system was also used for the following test cases. In addition, a steering maneuver was incorporated into the driver's actions.

5. During the initial 10 seconds of the simulation test, the target speed was initially set to 10 m/s and then changed to 20 m/s. The table below displays the steering maneuvers performed during the simulation.

Time interval	SWA
$5 \leq t < 10$	1 rad
$10 \leq t < 15$	0 rad
$15 \leq t < 20$	-1 rad
$10 \leq t < 25$	0 rad
$25 \leq t < 30$	1 rad
$30 \leq t < 35$	-1 rad

- (a) The virtual weighting matrix was as usually used in the thesis' simulations,  $W_v = \text{diag } 1 \ 1 \ 1$
- (b) The virtual weighting matrix was set to  $W_v = \text{diag } 1 \ 1 \ 106$ , penalizing the yaw moment of inertia  $M_z$  more than the other two virtual inputs.



6. For the last test case simulation, all three methods of Vehicle Motion Management were used. The driver received instructions via the GP, while the control allocation computed the actual input values by considering the estimated desired trajectory. The GP ratio exhibited a linear increase from zero to one, commencing at time  $t = 1$  sec, with an incremental step of 0.2 every five seconds.

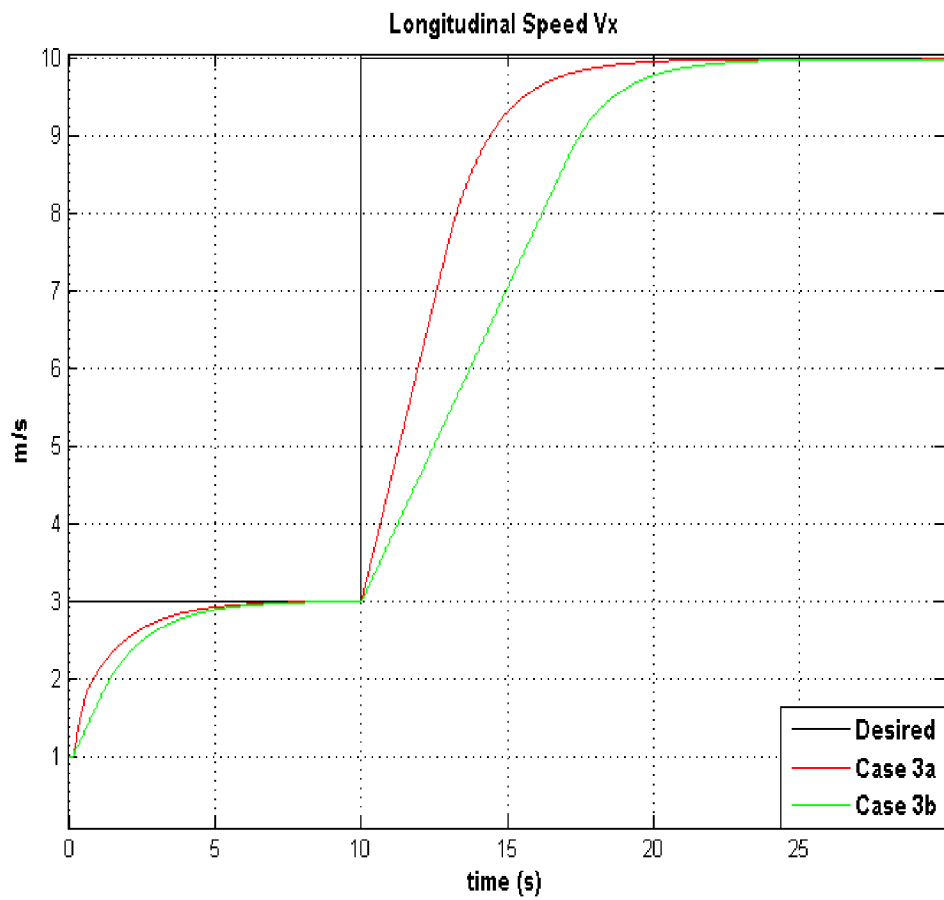

(a)

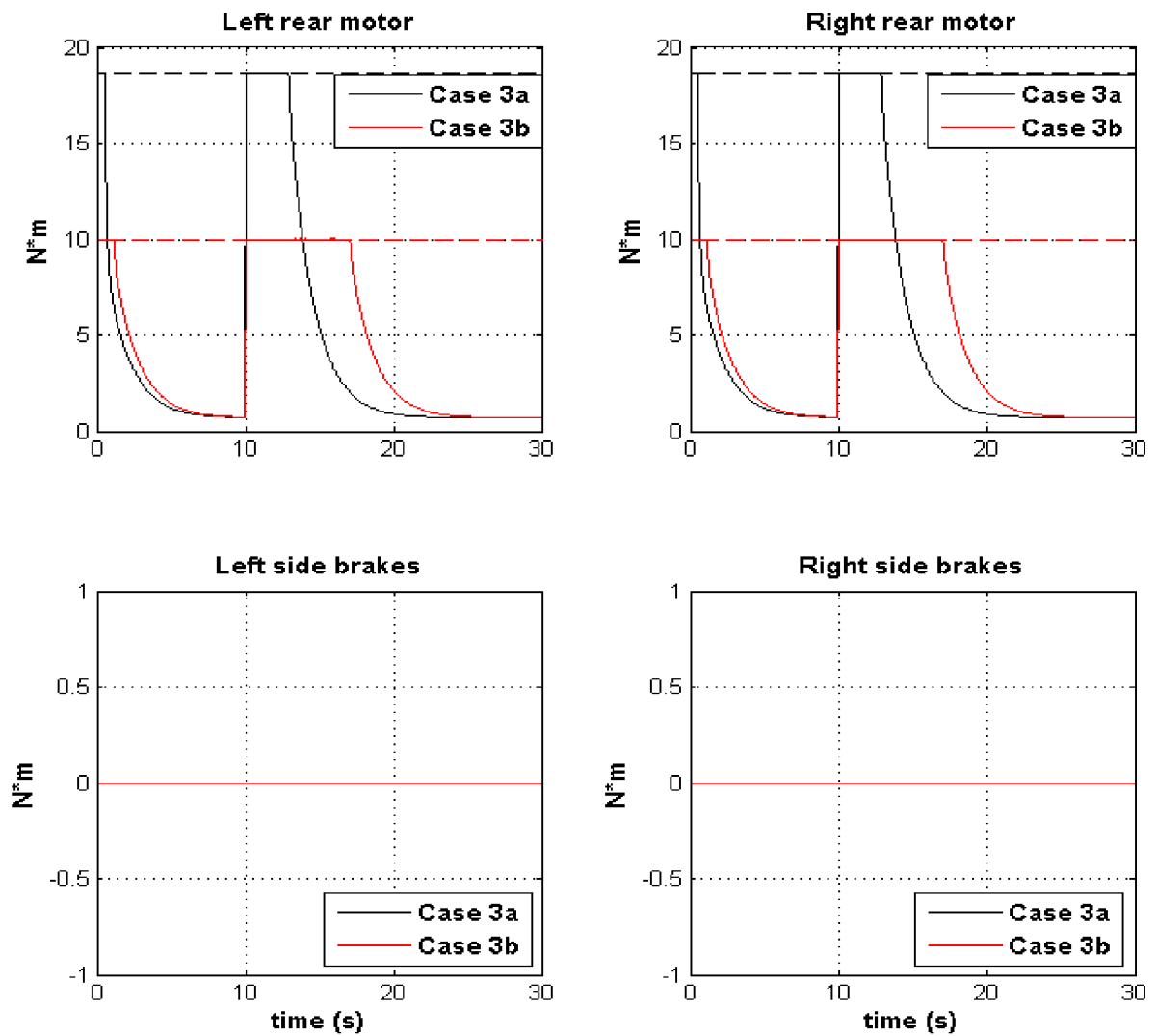

(b)

**FIGURE 4.4: Test case 3.**

(a): The input speed that the system receives is the required speed,  $V_x$ . Conversely, with two separate motor limit setups, case 3a and 3b show the resulting measured speeds from the vehicle model.

(b): This subfigure shows the real inputs. Two electric motors and a brake system are the parts that are involved. In each case, the dashed lines represent the motors' confines.

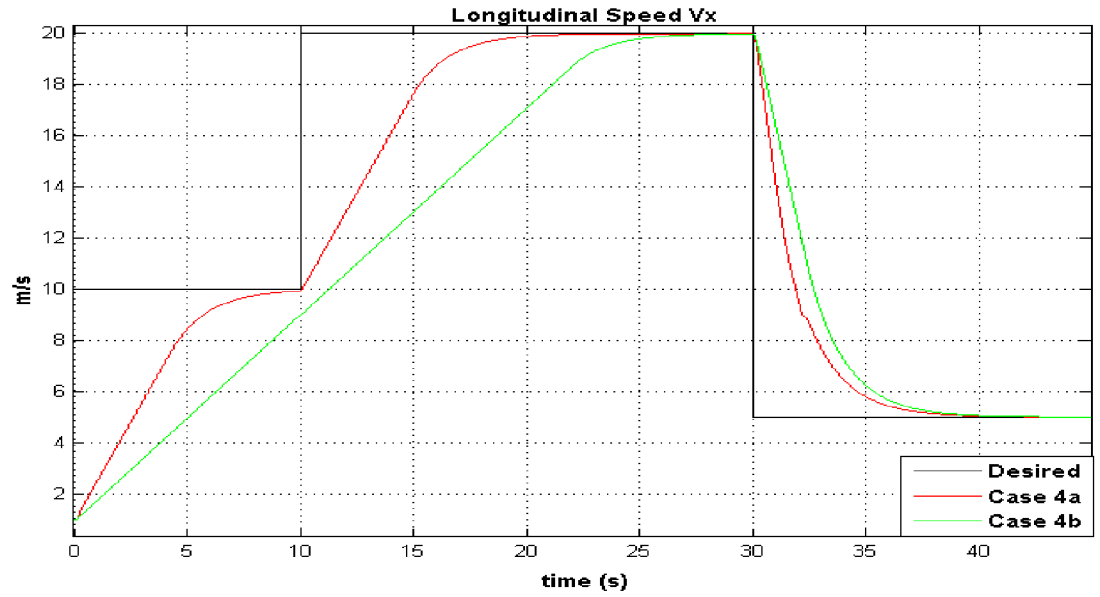

(a)

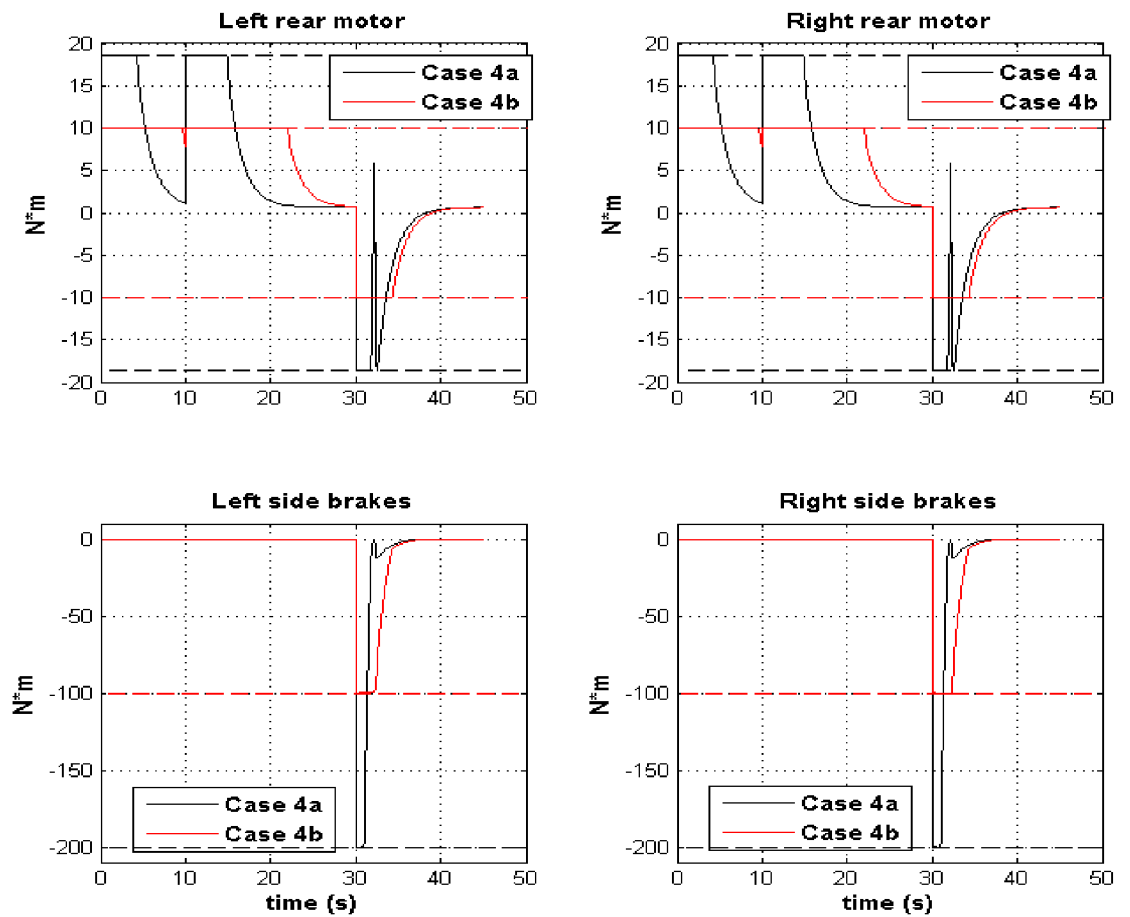

(b)

FIGURE 4.5: Test case 4.

(a): Cases 3a and 3b display the recorded speeds of the vehicle type with two different configurations for torque limits for all actuators, while the system has been configured to attain the target speed.

(b): This subfigure shows the real inputs. Two electric motors and a brake system make up the parts. In each case, the dashed lines demarcate the actuator bounds.

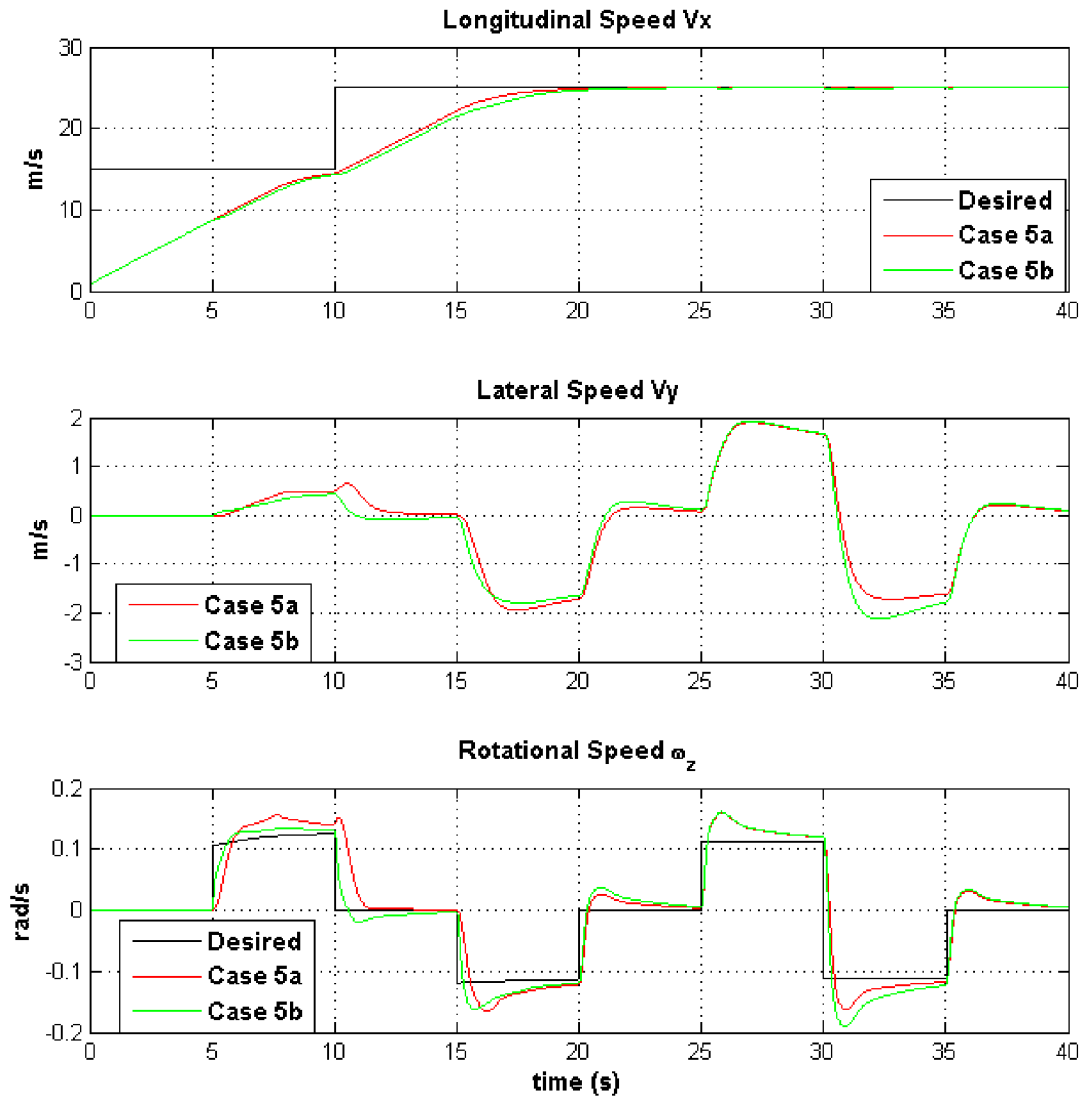

**FIGURE 4.6:** The vehicle's three primary movements are demonstrated for various values of the weighting matrix  $Wv$ . The ideal values for the linear velocity  $V_x$  and angular velocity  $\omega_z$  have been established, but, the controller lacks the ability to directly affect the lateral velocity.

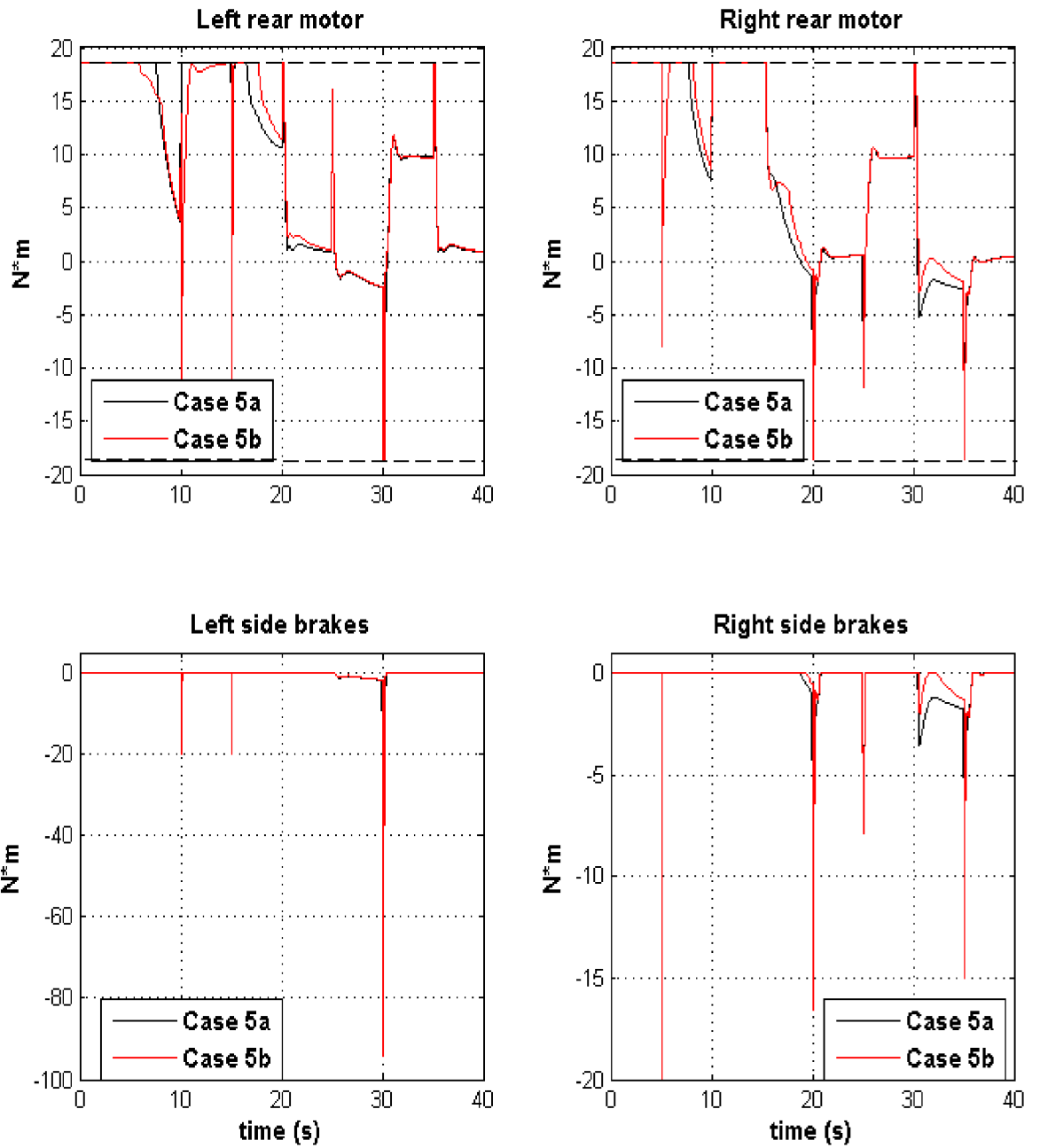

**FIGURE 4.7:** The actual inputs for case 5a and 5b consist of two electric motors and the brakes. The dashed lines indicate the boundaries of the actuators.

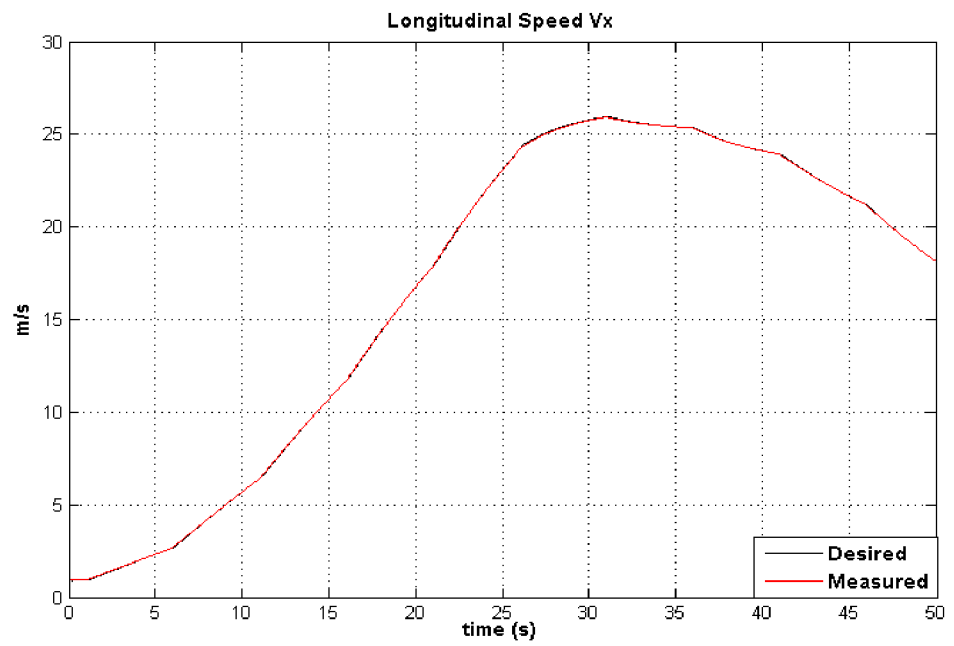
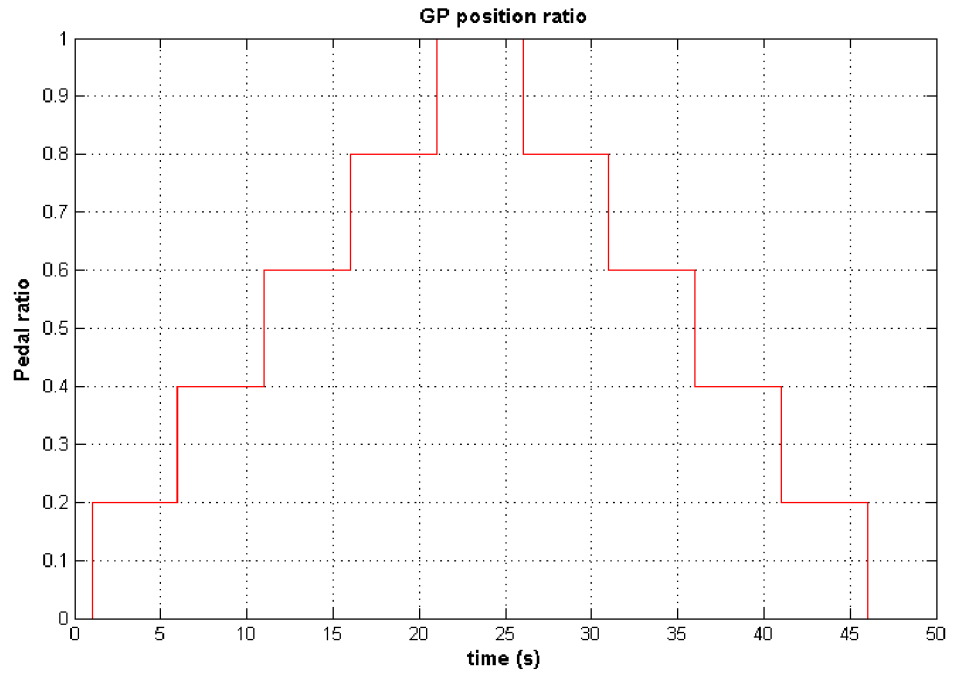

(a)

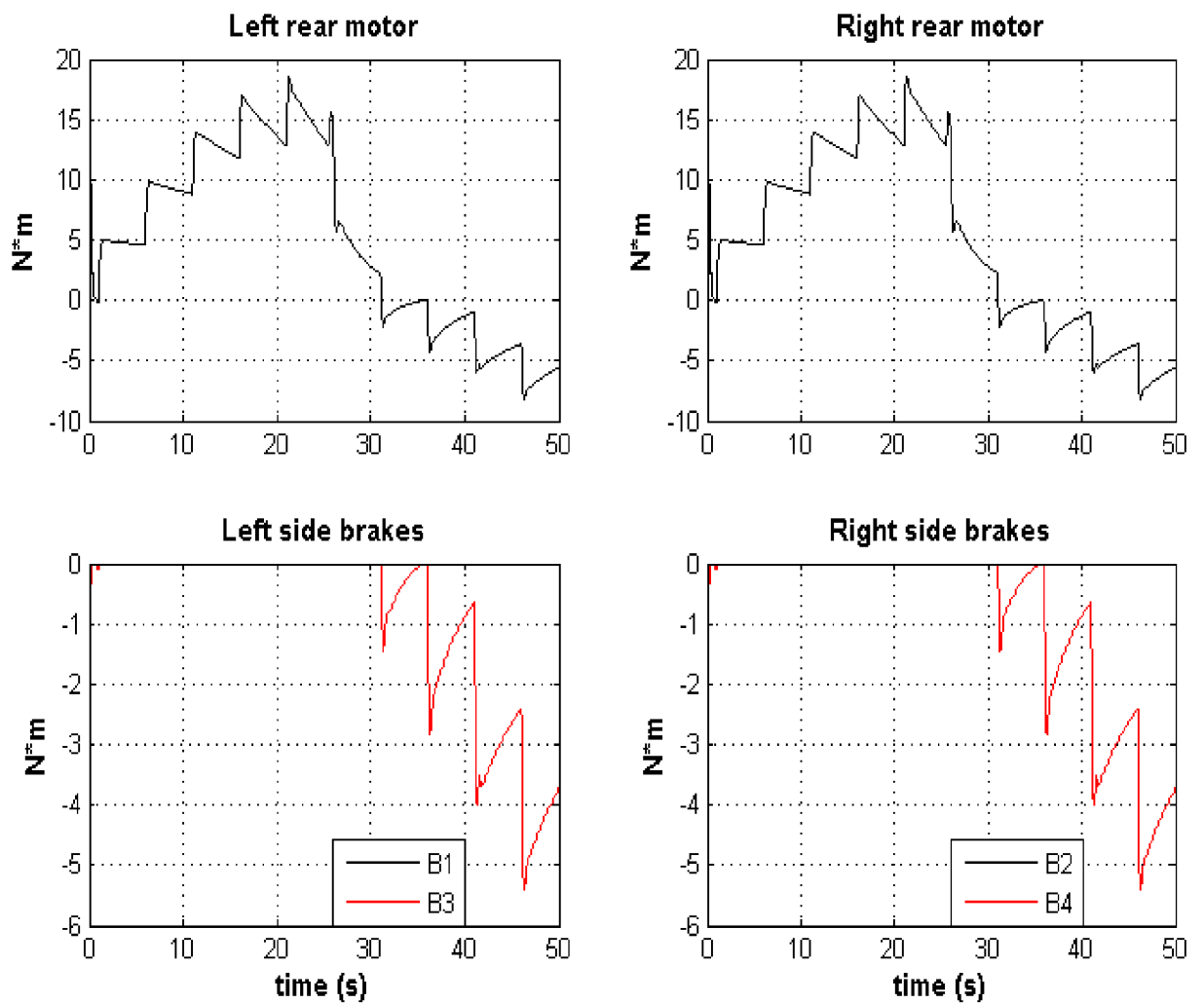

**FIGURE 4.8: Test case 6.**

**(a):** The evolution of the GP is depicted in the left-hand graphic. In the image on the right, you can observe the vehicle model's actual speed as well as the expected speed needed by the Vehicle Speed Request module.

**(b):** The subfigure shows the values of the actual inputs that the control allocation system determines in order to achieve the desired speed.

## 5. Discussion and Recommendations

### 5.1 Discussion of findings

The findings of the simulation testing indicate that the desired control system performs as predicted, according to most people. The control system can receive signals like the GP, DM, and SWA, so that's good. Using these signals, we can predict the vehicle's path. The control allocator then determines, in accordance with the planned trajectory, the values to be assigned to the system's motion actuators, taking into account the given physical constraints. According to the reports, there were a hundred iterations in the control allocation procedure. However, after little more than fifteen iterations, the simulations proved that the best solution had been found. Each simulation test evaluates a different aspect of the whole system.

The first test scenario shows how the chosen DM affects the torque request maps. The differences in the estimated intended speed produced by the selected DM are illustrated in test cases 2a and 2b, respectively, when employing all GP positions and a fixed one.

Test scenario 3 clearly demonstrates that the control system complies with the motor's constraints. The controller will strive to achieve the desired speed, regardless of its magnitude, while sticking to the given constraints. Test case 4 demonstrates the same observation, not only in relation to the motors but also with respect to the braking limitations. At this point, it is crucial to discuss the necessary torque value needed to maintain a constant velocity. Based on the plots, it is clear that once the desired speed is reached, only a little amount of torque is needed to maintain that speed, regardless of its value. While impractical in practice, this can be ascribed to the configuration of the vehicle model. Aerodynamic drag ( $F_{drag}$ ) is not included in the model; it only takes rolling resistance force ( $F_{roll}$ ) into account. A minimal amount of motor torque is required to keep the speed constant because the rolling resistance ( $F_{roll}$ ) is tiny and constant in comparison to the drag force ( $F_{drag}$ ).

A notable observation is that the arrangement of the weighting matrices has a substantial influence on the control system. The weighting matrix  $W_u$  was formulated to provide higher priority to the utilization of motors compared to brakes for real



inputs. This approach allows for a clear understanding of why the controller consistently utilizes negative motor torque in conjunction with the braking system to reduce speed. The importance of the virtual weighting matrix,  $W_v$ , setting is apparent in test scenario 5. In the instance of 5a, the desired velocity is reached slightly faster compared to 5b and remains consistent for the rest of the experiment. Conversely, in instance 5b, when the  $M_z$  is significantly penalized, the difference between the measured and desired  $\omega_z$  is less than in case 5a. It should be emphasized that the controller lacks any steering mechanism. Alternatively, the vehicle is controlled directly by utilizing SWA (Steer-by-Wire) technology. When the control system requires to manipulate the car's direction, it employs the pre-existing motion actuators like motors and brakes. This can be identified, for example, during a simulation duration of 10 seconds. The controller's objective is to steer the car to the left by decreasing the torque in the left motor and applying torque to the left side brakes.

Test case 6 was undertaken to evaluate the whole functionality of the control system through simulation. The exclusive application of the GP validates the efficacy of the control system devised for this thesis. The system accurately computes the necessary velocity by taking into account the driver's inputs, and subsequently assigns appropriate values to the motion actuators to guarantee precise conformity to the intended speed.

All of the control allocation test scenarios point to the same conclusion: the control system meets the intended speed without any hiccups or disturbances in the equilibrium state. The car industry cannot function without prioritizing driver comfort. An important feature of the control allocator is its ability to reduce the vehicle's speed fluctuations or overshoots. In addition, by testing each component independently and ensuring their seamless connection, the control system's modularity is validated. Having parts of this thesis applicable to other projects is a huge plus.

There was no steering in the previous test situation, but the General Practitioner (GP) was nevertheless employed everywhere it should have been. The control system accurately assigns values to the actuators, resulting in a perfect alignment between the target speed and the observed speed, as seen in these charts. Computing the target speed using a dynamic equation makes the process more

streamlined than in earlier test cases when a fixed number was used. Therefore, the target speed can be achieved by the controller with the help of empirical data, like the dynamic equations, for estimation.

Choosing the right software to implement the EAST-ADL paradigm was a challenge at the outset of the project. Enterprise Architect and Papyrus-Eclipse were the two contenders. The first contender was selected after testing both software programs. There were issues with installing and using Papyrus-Eclipse, which is open-source software. Enterprise Architect, on the other hand, was performing as planned, and the company's official documentation and more seasoned employees offered superior assistance. Since it has been around for a while, it is also more trustworthy than Papyrus-Eclipse.

The EAST-ADL model was limited to the first two tiers for its design. This was due to the fact that additional information was required before descending to lower levels. Certain aspects, such as the HW or SW to be put in the EDV, were undetermined until the conclusion of this thesis. While there is no denying that the EA software provides a means to generate a variety of documentations, there are a few downsides to consider when evaluating its usefulness. In comparison to the other candidate, EA is more user-friendly in my opinion, although it is still not very user-friendly. It is typical for designers to have to undo and redo their work multiple times when they are working on a project. It takes a lot of time to do this in EA. Besides that, the application is incompatible with any software other than AUTOSAR, which is utilized at the implementation level. This is why the majority of its usage has been in manuals up until this point. For both documentation and analysis, I think EA will become a far more valuable tool once it is made interoperable with programs like Simulink.

## **5.2 Recommendations**

Promote the implementation of standardized practices throughout the electric vehicle sector to guarantee compatibility and seamless operation among diverse components and systems. Establishing established protocols for communication between control units, implementing standardized interfaces, and ensuring compatibility standards for charging infrastructure will simplify smooth integration

and encourage the widespread use of electric vehicles. Adopt open-source software and hardware solutions for the creation of control systems. Collaborative endeavors within the open-source community have the potential to expedite innovation, diminish development expenses, and cultivate enhanced transparency and confidence in control system designs. Allocate resources towards continuous research and development endeavors aimed at tackling emerging issues and capitalizing on opportunities in electric vehicle control systems.

Possible areas of emphasis could encompass the enhancement of battery technology, the improvement of vehicle-to-grid connection, the optimization of powertrain efficiency, and the advancement of cybersecurity measures to safeguard against potential risks. Facilitate cooperation and alliances among car manufacturers, technology providers, research institutes, and regulatory bodies. Through the utilization of combined knowledge and available assets, individuals or groups with an interest in a particular issue can effectively tackle intricate problems, exchange optimal methods, and expedite the global acceptance and implementation of electric vehicles. Emphasize the implementation of design concepts that prioritize the needs and preferences of users while developing control systems for electric vehicles.

To ensure a seamless user experience, it is important to take into account the requirements and preferences of end-users, such as drivers, fleet operators, and maintenance technicians. This involves providing intuitive interfaces, ergonomic controls, and user-friendly designs. These suggestions, along with an emphasis on innovation, cooperation, and user-centric design concepts, will help the electric vehicle industry accelerate the broad acceptance of EVs as an efficient and environmentally friendly mode of transportation. The sector will be able to use this information to improve control system design even more.

## **6. Conclusion**

In the end, the development of control systems for the electric vehicle (EV) sector plays a crucial role in the ongoing shift towards environmentally friendly transportation. Control systems for electric vehicles have undergone significant developments in technology and rigorous engineering efforts, resulting in extremely sophisticated systems that provide improved performance, safety, and efficiency. The incorporation of power electronics, battery management systems, motor controllers, and regenerative braking systems has enabled the smooth functioning of electric vehicles (EVs) while maximizing energy efficiency and enhancing vehicle performance. Advanced algorithms and sensor technologies allow for accurate manipulation of different vehicle operations, guaranteeing a seamless and prompt driving encounter for consumers. Nevertheless, notwithstanding the advancements achieved, obstacles endure in the development of control systems for electric vehicles. The problems encompass enhancing battery efficiency and durability, addressing thermal management concerns, guaranteeing cybersecurity, and complying with regulatory standards and interoperability requirements. It is crucial for players in the electric vehicle (EV) industry to emphasize ongoing research and development endeavors focused on tackling these difficulties. By adopting cutting-edge technology like artificial intelligence, machine learning, and open-source solutions, we may enhance the development of control systems for electric vehicles. This will lead to improved efficiency, dependability, and sustainability. Furthermore, the cooperation and alliances of automobile producers, technology providers, academic institutions, and governing bodies will be essential in propelling the progress and acceptance of electric vehicles on a global scale. Through collaborative efforts to surmount technical obstacles, establish uniform procedures, and foster compatibility, stakeholders can expedite the shift towards an environmentally friendly and enduring transportation ecosystem. The design of control systems for electric vehicles is a crucial aspect of the EV industry's development, with the potential to significantly transform transportation and reduce the environmental effects of conventional fossil fuel vehicles. The future of electric mobility shows potential for a transportation landscape that is cleaner, more efficient, and more sustainable, thanks to collaborative efforts and innovative solutions.

## 7. References

- ALANAZI, Fayez, 2023. Electric Vehicles: Benefits, Challenges, and Potential Solutions for Widespread Adaptation. *Applied Sciences*. Online. 13 May 2023. Vol. 13, no. 10, p. 6016. DOI 10.3390/app13106016.
- BLACKMAN and JASON AND MONROE, Scott, 2013. Overview of 3.3v CAN (Controller Area Network) Transceivers. *Texas Instruments, Application Note*. 2013.
- BRADLEY, Thomas H. and FRANK, Andrew A., 2009. *Design, demonstrations and sustainability impact assessments for plug-in hybrid electric vehicles*. 2009.
- CAIRNS, George, GOODWIN, Paul and WRIGHT, George, 2016. A decision-analysis-based framework for analysing stakeholder behaviour in scenario planning. *European Journal of Operational Research*. Online. March 2016. Vol. 249, no. 3, p. 1050–1062. DOI 10.1016/j.ejor.2015.07.033.
- CHEN, W., 2003. An Auxiliary Power Distribution Network for an Electric Vehicle. *vol. Master of Engineering: University of Canterbury*. 2003.
- CORRIGAN, Steve, 2002. Introduction to the controller area network (CAN). *Application Report, Texas Instruments*. 2002.
- DIDIK, F., 2007. Electric Vehicle Companies Since 1834. . 2007.
- HE, Fang, YIN, Yafeng and ZHOU, Jing, 2013. Integrated pricing of roads and electricity enabled by wireless power transfer. *Transportation Research Part C: Emerging Technologies*. 2013. DOI 10.1016/j.trc.2013.05.005.
- HUANG, Kuohsiu David, NGUYEN, Minh-Khoa and CHEN, Po-Tuan, 2022. A Rule-Based Control Strategy of Driver Demand to Enhance Energy Efficiency of Hybrid Electric Vehicles. *Applied Sciences*. Online. 25 August 2022. Vol. 12, no. 17, p. 8507. DOI 10.3390/app12178507.
- HUANG, Qi, LI, Jian and CHEN, Yong, 2010. Control of Electric Vehicle. . 2010.

P. 1–32.

KIRSCH, D. A, 2000. The electric vehicle and the burden of history. *New Brunswick, N.J., Rutgers University Press*. 2000.

LEEMPUT, N., VAN ROY, J., GETH, F., TANT, P., CLAESSENS, B. and DRIESEN, J., 2011. Comparative analysis of coordination strategies for electric vehicles. In: *IEEE PES Innovative Smart Grid Technologies Conference Europe*. 2011. ISBN 9781457714214. DOI 10.1109/ISGTEurope.2011.6162778.

LUO, Can, SHEN, Zhen, EVANGELOU, Simos, XIONG, Gang and WANG, Fei-Yue, 2019. The combination of two control strategies for series hybrid electric vehicles. *IEEE/CAA Journal of Automatica Sinica*. Online. March 2019. Vol. 6, no. 2, p. 596–608. DOI 10.1109/JAS.2019.1911420.

MOLAVI, Ali, HUSAR, Attila, HJORTBERG, Hampus, NILSSON, Niclas, KOGLER, Markus, MONREAL, Juan Sanchez, ELDIGAIR, Yousif and PRAT, Maria Serra, 2024. State machine-based architecture to control system processes in a hybrid fuel cell electric vehicle. *International Journal of Hydrogen Energy*. Online. January 2024. Vol. 52, p. 1220–1235. DOI 10.1016/j.ijhydene.2023.07.039.

PAZUL, K., 1999. Controller area network (can) basics. *Microchip Technology Inc. Preliminary*. 1999. P. 1.

PRADANA, Adlan, HAQUE, Mejbaul and NADARAJAH, Mithulanathan, 2023. Control Strategies of Electric Vehicles Participating in Ancillary Services: A Comprehensive Review. *Energies*. Online. 10 February 2023. Vol. 16, no. 4, p. 1782. DOI 10.3390/en16041782.

RASHID, Mahbub and MOLLIK, Md Sazib, 2016. The design and control system of small electric vehicle (EV): A review. . 2016.

RAUT, Panakj, 2017. SELECTION OF POWERTRAIN TO ACHIEVE PERFORMANCE OF VEHICLE. . 2017.

SATZGER, Clemens and DE CASTRO, Ricardo, 2018. Predictive Brake Control for Electric Vehicles. *IEEE Transactions on Vehicular Technology*. Online. February 2018. Vol. 67, no. 2, p. 977–990. DOI 10.1109/TVT.2017.2751104.

- SCHIFFER, M. B., 2010. Taking charge: the electric automobile in America. *Washington, Smithsonian Books*. 2010.
- STAND-ALONE, C., 1999. Controller with SPI Interface. *Microchip Technology Inc*. 1999.
- WANG, Yafei, FUJIMOTO, Hiroshi and HARA, Shinji, 2017. Driving Force Distribution and Control for EV With Four In-Wheel Motors: A Case Study of Acceleration on Split-Friction Surfaces. *IEEE Transactions on Industrial Electronics*. Online. April 2017. Vol. 64, no. 4, p. 3380–3388. DOI 10.1109/TIE.2016.2613838.
- WESTBROOK, Michael H., 2001. *The Electric Car: development and future of battery, hybrid and fuel-cell cars*. Institution of Engineering and Technology. ISBN 9780852960134.
- ZHANG, Y., 2008. Pure electric vehicle powertrain control system research. *Doctoral Dissertation of Shanghai Jiao Tong University*. 2008. Vol. 1–3, p. 42–45.
- ZHAO, Ying, HOU, Jinsen, WANG, Chong, CHEN, Linlin and SUN, Qun, 2019a. Design of vehicle control research and development platform for a pure electric vehicle. . 2019. P. 1–17.
- ZHAO, Ying, HOU, Jinsen, WANG, Chong, CHEN, Linlin and SUN, Qun, 2019b. Design of vehicle control research and development platform for a pure electric vehicle. *Advances in Mechanical Engineering*. Online. 24 February 2019. Vol. 11, no. 2, p. 168781401982642. DOI 10.1177/1687814019826427.
- ALANAZI, Fayez, 2023. Electric Vehicles: Benefits, Challenges, and Potential Solutions for Widespread Adaptation. *Applied Sciences*. Online. 13 May 2023. Vol. 13, no. 10, p. 6016. DOI 10.3390/app13106016.
- BLACKMAN and JASON AND MONROE, Scott, 2013. Overview of 3.3v CAN (Controller Area Network) Transceivers. *Texas Instruments, Application Note*. 2013.
- BRADLEY, Thomas H. and FRANK, Andrew A., 2009. *Design, demonstrations and sustainability impact assessments for plug-in hybrid electric vehicles*. 2009.
- CAIRNS, George, GOODWIN, Paul and WRIGHT, George, 2016. A decision-analysis-based framework for analysing stakeholder behaviour in scenario planning.

*European Journal of Operational Research*. Online. March 2016. Vol. 249, no. 3, p. 1050–1062. DOI 10.1016/j.ejor.2015.07.033.

CHEN, W., 2003. An Auxiliary Power Distribution Network for an Electric Vehicle. *vol. Master of Engineering: University of Canterbury*. 2003.

CORRIGAN, Steve, 2002. Introduction to the controller area network (CAN). *Application Report, Texas Instruments*. 2002.

DIDIK, F., 2007. Electric Vehicle Companies Since 1834. . 2007.

HE, Fang, YIN, Yafeng and ZHOU, Jing, 2013. Integrated pricing of roads and electricity enabled by wireless power transfer. *Transportation Research Part C: Emerging Technologies*. 2013. DOI 10.1016/j.trc.2013.05.005.

HUANG, Kuohsiu David, NGUYEN, Minh-Khoa and CHEN, Po-Tuan, 2022. A Rule-Based Control Strategy of Driver Demand to Enhance Energy Efficiency of Hybrid Electric Vehicles. *Applied Sciences*. Online. 25 August 2022. Vol. 12, no. 17, p. 8507. DOI 10.3390/app12178507.

HUANG, Qi, LI, Jian and CHEN, Yong, 2010. Control of Electric Vehicle. . 2010. P. 1–32.

KIRSCH, D. A, 2000. The electric vehicle and the burden of history. *New Brunswick, N.J., Rutgers University Press*. 2000.

LEEMPUT, N., VAN ROY, J., GETH, F., TANT, P., CLAESSENS, B. and DRIESEN, J., 2011. Comparative analysis of coordination strategies for electric vehicles. In: *IEEE PES Innovative Smart Grid Technologies Conference Europe*. 2011. ISBN 9781457714214. DOI 10.1109/ISGTEurope.2011.6162778.

LUO, Can, SHEN, Zhen, EVANGELOU, Simos, XIONG, Gang and WANG, Fei-Yue, 2019. The combination of two control strategies for series hybrid electric vehicles. *IEEE/CAA Journal of Automatica Sinica*. Online. March 2019. Vol. 6, no. 2, p. 596–608. DOI 10.1109/JAS.2019.1911420.

MOLAVI, Ali, HUSAR, Attila, HJORTBERG, Hampus, NILSSON, Niclas, KOGLER, Markus, MONREAL, Juan Sanchez, ELDIGAIR, Yousif and PRAT, Maria



Serra, 2024. State machine-based architecture to control system processes in a hybrid fuel cell electric vehicle. *International Journal of Hydrogen Energy*. Online. January 2024. Vol. 52, p. 1220–1235. DOI 10.1016/j.ijhydene.2023.07.039.

PAZUL, K., 1999. Controller area network (can) basics. *Microchip Technology Inc. Preliminary*. 1999. P. 1.

PRADANA, Adlan, HAQUE, Mejbaul and NADARAJAH, Mithulanathan, 2023. Control Strategies of Electric Vehicles Participating in Ancillary Services: A Comprehensive Review. *Energies*. Online. 10 February 2023. Vol. 16, no. 4, p. 1782. DOI 10.3390/en16041782.

RASHID, Mahbub and MOLLIK, Md Sazib, 2016. The design and control system of small electric vehicle (EV): A review. . 2016.

RAUT, Panakj, 2017. SELECTION OF POWERTRAIN TO ACHIEVE PERFORMANCE OF VEHICLE. . 2017.

SATZGER, Clemens and DE CASTRO, Ricardo, 2018. Predictive Brake Control for Electric Vehicles. *IEEE Transactions on Vehicular Technology*. Online. February 2018. Vol. 67, no. 2, p. 977–990. DOI 10.1109/TVT.2017.2751104.

SCHIFFER, M. B., 2010. Taking charge: the electric automobile in America. *Washington, Smithsonian Books*. 2010.

STAND-ALONE, C., 1999. Controller with SPI Interface. *Microchip Technology Inc.* 1999.

WANG, Yafei, FUJIMOTO, Hiroshi and HARA, Shinji, 2017. Driving Force Distribution and Control for EV With Four In-Wheel Motors: A Case Study of Acceleration on Split-Friction Surfaces. *IEEE Transactions on Industrial Electronics*. Online. April 2017. Vol. 64, no. 4, p. 3380–3388. DOI 10.1109/TIE.2016.2613838.

WESTBROOK, Michael H., 2001. *The Electric Car: development and future of battery, hybrid and fuel-cell cars*. Institution of Engineering and Technology. ISBN 9780852960134.

ZHANG, Y., 2008. Pure electric vehicle powertrain control system research. *Doctoral Dissertation of Shanghai Jiao Tong University*. 2008. Vol. 1–3, p. 42–45.

ZHAO, Ying, HOU, Jinsen, WANG, Chong, CHEN, Linlin and SUN, Qun, 2019a. Design of vehicle control research and development platform for a pure electric vehicle. . 2019. P. 1–17.

ZHAO, Ying, HOU, Jinsen, WANG, Chong, CHEN, Linlin and SUN, Qun, 2019b. Design of vehicle control research and development platform for a pure electric vehicle. *Advances in Mechanical Engineering*. Online. 24 February 2019. Vol. 11, no. 2, p. 168781401982642. DOI 10.1177/1687814019826427.

## 8. List of Table and List of Figure

### 8.1 List of Table

Table:3.2 the number of ports required for this project .....	19
Table 3.3. The Realization of the Function of Electric Vehicle Controller .....	20
Table 3.4: Ratings of Components in Series Powertrain.....	34

### 8.2 List of Figure

Fig 1.1 1903 Krieger electric car .....	4
Figure 3.1: Wiring Diagram without Controller Area Network.....	12
Figure 3.2: Wiring Diagram with Controller Area Network.....	12
Figure 3.3: Differential Signal Voltages (Blackman, Jason and Monroe 2013) .....	13
Figure 3.5 : Bus Node Layout .....	16
Figure 3.6: The structure of the vehicle control system.....	18
Figure 3.7: CAN network topology.....	18
Figure 3.8: Hierarchical Control System Schematic Diagram of the Vehicle .....	21
Figure 3.9: Pure Electric Vehicle Dynamic Control System Structure.....	22
Figure 3.10: Vehicle Controller.....	23
Figure 3.11: Vehicle Controller Works .....	23
FIGURE 4.1: Test case 1. The GP ratio corresponds to a percentage representation of the total torque allocation for various driving modes. ....	50
FIGURE 4.2: Test case 2a. The initial graph displays the proportion of torque requested for various driving modes, while the subsequent graph illustrates the $V_{xdes}$ generated during test scenario 2a. ....	51
FIGURE 4.3: Test case 2b. The initial graph displays the proportion of torque requested for various driving modes, while the subsequent graph illustrates the $V_{xdes}$ generated during test scenario 2b. ....	52
FIGURE 4.4: Test case 3. ....	55
FIGURE 4.5: Test case 4.....	56

FIGURE 4.6: The vehicle's three primary movements are demonstrated for various values of the weighting matrix  $W_v$ . The ideal values for the linear velocity  $V_x$  and angular velocity  $\omega_z$  have been established, but, the controller lacks the ability to directly affect the lateral velocity. .... 57  
..... 58

FIGURE 4.7: The actual inputs for case 5a and 5b consist of two electric motors and the brakes. The dashed lines indicate the boundaries of the actuators. .... 58

FIGURE 4.8: Test case 6. .... 60