

**Czech University of Life Sciences Prague**

**Faculty of Economics and Management**

**Department of Information Technologies (FEM)**



## **Bachelor Thesis**

**Improvement of Network Connectivity by Implementing  
Structured Cabling**

**Amin Al-Akwaa**

**© 2023 CZU Prague**

**CZECH UNIVERSITY OF LIFE SCIENCES PRAGUE**

Faculty of Economics and Management

**BACHELOR THESIS TOPIC**

Author of thesis: Amin Al-Akwaa  
Study programme: Informatics  
Thesis supervisor: Ing. Tomáš Vokoun  
Supervising department: Department of Information Technologies  
Language of a thesis: English

Thesis title: **Improvement of Network Connectivity by Implementing Structured Cabling**

Objectives of thesis: The main objective of this thesis is to study the problems in network connectivity environments caused by unorganized cabling and find out the reasons behind them. The partial objectives are to:  
- Student will provide designs and implementation steps of the Network Connectivity structured cabling.  
- Overview of the benefits of Implementing structured cabling and how to maintain the design and documentation with administrative software.  
- Narrow down the incidents and downtime causes.  
- Suggestions and solutions for incidents & downtime causes.

Methodology: The thesis is based on the qualitative study and analysis of professional information sources. The practical part is based on the design of experiments, and collection and analysis of data obtained from secondary and historical sources. For designs and drawing Microsoft Visio will be used. Additionally, a student will elaborate on cabling administrative by using the software.  
  
A student also will evaluate the performance of network connectivity of different organizations, by collecting data and pictures from them. Based on the synthesis of theoretical knowledge and the results of the practical part, the conclusions of the work will be formulated.

The proposed extent of the thesis: 50

Keywords: Network Connectivity, Structured Cabling

Recommended information sources:

1. Architecture Design for Soft Errors by Shubu Mukherjee Published:29 August 2011
2. Cabling. Part 2, Fiber-optic cabling and components by Bill woodward Date: 5 March 2014
3. Designing a Fiber Structured Cabling System for the Data Center by John M. Struhar Published on year 2005
4. INTRODUCTION TO STRUCTURED CABLING by Sonam Dukda Date: September 2000
5. Optical Interconnects for Future Data Center Networks by Christoforos Kachris, Keren Bergman, Ioannis Tomkos Date: 7 November 2012
6. The Benefits of Structured Cabling Systems for Your Business by James Kirby Date: 26th of March 2021 <https://micropro.com/blog/benefits-of-structured-cabling/>
7. The Cost of Network Downtime by David Bjerke and Nilson Gabela Date: August 31, 2018
8. 2 - 129 CCNA 1: Networking Basics v3.1 – Structured Cabling Supplement Date: year 2004

Expected date of thesis defence: 2022/23 SS - FEM

Electronically approved: 19. 6. 2022  
**doc. Ing. Jiří Vaněk, Ph.D.**  
Head of department

Electronically approved: 27. 10. 2022  
**doc. Ing. Tomáš Šubrt, Ph.D.**  
Dean

## **Declaration**

I declare that I have worked on my bachelor thesis titled "Improvement of Network Connectivity by Implementing Structured Cabling" by myself and I have used only the sources mentioned at the end of the thesis. As the author of the bachelor thesis, I declare that the thesis does not break any copyrights.

In Prague on 15.03.2023

\_\_\_\_\_ 

## **Acknowledgement**

I want to express my gratitude and appreciation to Professor Ing. Tomáš Vokoun for his support and guidance throughout the process of writing my thesis. I also extend my heartfelt thanks to my family for their unwavering support and encouragement during my studies and thesis writing.

# **Improvement of Network Connectivity by Implementing Structured Cabling**

## **Abstract**

The bachelor's thesis aims to analyze the network connectivity issues that arise when a structured cabling system is not in place. Additionally, it addresses the potential problems if the system is not correctly implemented and maintained.

The theoretical section of the thesis explains the advantages of a structured cabling system, its components, and the relevant industry standards. The practical section focuses on the implementation process, testing steps, costs involved, and the importance of proper documentation using software such as Pathfinder.

Upon completion of both the theoretical and practical sections, the results and discussions will present the findings.

**Keywords:** Network, Connectivity, Structured cabling, Cabling, standards, vendor, hardware, TIA.

# Zlepšení síťové konektivity implementací strukturované kabeláže

## Abstrakt

Bakalářská práce si klade za cíl analyzovat problémy s propojením sítě, které vznikají v případě, že není implementován strukturovaný kabelový systém. Dále se práce zabývá potenciálními problémy, které mohou vzniknout, pokud není systém správně implementován a udržován.

Teoretická část práce vysvětluje výhody strukturovaného kabelového systému, jeho komponenty a relevantní průmyslové standardy. Praktická část se zaměřuje na proces implementace, testovací kroky, náklady a důležitost správné dokumentace pomocí softwaru, jako je Pathfinder.

Po dokončení obou částí, teoretické a praktické, budou představeny výsledky a diskuse.

**Klíčová slova:** Síť, konektivita, strukturovaná kabeláž, kabeláž, standardy, dodavatel, hardware, TIA.

## Table of content

<b>1 Objectives and Methodology .....</b>	<b>9</b>
1.1 Objectives.....	9
1.2 Methodology .....	9
<b>2 Literature Review.....</b>	<b>10</b>
2.1 Problems and Downtimes in Network Connectivity.....	10
2.2 Structured Cabling.....	14
2.2.1 Advantage of Structure cabling .....	14
2.2.2 The Six Subsystems of structured Cabling .....	17
2.2.3 Standards & Rules to Ensure the Effectiveness.....	19
2.3 Structured Cabling Materials .....	22
2.3.1 Copper Cables.....	22
2.3.2 Fiber-Optic Cables .....	24
2.3.3 Backbone & Horizontal Cabling Components .....	26
2.3.4 Racks.....	28
2.3.5 Cost of Structure cabling .....	29
<b>3 Practical Part.....</b>	<b>31</b>
3.1 Proposed Design.....	31
3.2 Implementation.....	33
3.2.1 The Subsystems .....	34
3.2.2 Testing & Measurement.....	40
3.2.3 Total Cost of the Structure cabling .....	45
3.3 Documentation Using Software Pathfinder.....	46
<b>4 Results and Discussion.....</b>	<b>47</b>
<b>5 Conclusion.....</b>	<b>50</b>
<b>6 References .....</b>	<b>51</b>
<b>7 List of pictures .....</b>	<b>55</b>
7.1 List of tables .....	56
7.2 List of abbreviations.....	56
<b>Appendix.....</b>	<b>57</b>

## **Introduction**

Network connectivity is an essential aspect of our daily lives, both directly and indirectly. Companies and organizations rely on network connectivity to connect their servers and devices, enabling them to indirectly provide services that we use, such as online banking, transportation, healthcare, and many others. Over the years, there have been significant advancements in network connectivity, leading to the implementation of new technologies to meet the demands of the modern world.

Despite significant advancements in network technology, network connectivity has posed several challenges that have caused problems, outages, and complications for network administrators and on-site technicians. The root causes of these issues can vary, but one common culprit is an unorganized and inefficient cabling system that can lead to human error. For example, a server rack with a cabling mess can cause downtime due to human error, resulting in significant financial losses.

To avoid such problems, it is recommended to implement structured cabling. Structured cabling consists of several subsystems, including a work area, telecommunications room, backbone, horizontal cabling, equipment room, and entrance facility, which complete and complement the entire cabling system.

To ensure successful implementation, quality, effectiveness, and future growth expectations, it is essential to adhere to worldwide standards such as TIA and ISO standards. These standards provide specifications and requirements that must be followed to achieve optimal results.



# **1 Objectives and Methodology**

## **1.1 Objectives**

The main objective of this thesis is to study the problems in network connectivity environments caused by unorganized cabling and find out the reasons behind them.

The partial objectives are to:

- Provide designs and implementation steps of the Network Connectivity structured cabling.
- Overview of the benefits of Implementing structured cabling and how to maintain the design and documentation with administrative software.
- Narrow down the incidents and downtime causes.
- Suggestions and solutions for incidents & downtime causes.

## **1.2 Methodology**

The thesis is based on the qualitative study and analysis of professional information sources. The practical part is based on the design of experiments, and collection and analysis of data obtained from secondary and historical sources. For designs and drawing Microsoft Visio will be used. Additionally, a to elaborate on cabling administrative by using the software.

To also evaluate the performance of network connectivity of different organizations, by collecting data and pictures from them. Based on the synthesis of theoretical knowledge and the results of the practical part, the conclusions of the work will be formulated.

## **2 Literature Review**

### **2.1 Problems and Downtimes in Network Connectivity**

The term downtime or outage means when the company or enterprise network connectivity (Switches, Servers, PCs. etc.) cannot perform the services it is designed to do. Unplanned Downtime usually leads to substantial financial loss and potential reputation damage to the company. (Gabela, 2018)

Over the past 30 years, and especially since the dot com bubble, the use and need for Network infrastructure have greatly increased in many sectors such as government departments, health care, transportation, e-commerce, and more. It played a role in revenue growth. However, even if enterprises and organizations expect their datacenter to be fully operational and functional, many failures happen, and the risk of costly downtime incidents keeps increasing. Based on Vertiv's report in 2016, there was a survey done on September 2010 by the ponemon Institute study commissioned by Vertiv. They surveyed around 400 Datacentres and IT operations professionals, and the result was 71% of Senior-level respondents expressed that their company depends on their data center to generate profits. Their respondents have experienced an average of two downtimes that lasted up to 120 minutes over two years. However, they agreed that these unplanned outages didn't happen frequently.

To determine the cost of the downtime, the research used the 'activity-based costing model,' which evaluates based on direct and indirect cost opportunity. When the study was completed, they revealed an estimation of \$5600 cost per minute for every downtime. The reports indicated that the length of 90 minutes of downtime cost approximately \$505,500, and the cost of the recent downtime of the 41 datacentres that participated in the survey has been estimated to be a total of \$20,735,602. The reason behind those downtimes is many and not just related to human errors. (Vertiv co., 2016)

The reliability of the Network connectivity can depend on its infrastructure cabling, how all the network components are connected to each other, and how those cables are physically installed. Every major company depends on it to connect their branches and offices worldwide, and it is a success depends on it as well. (Gabela, 2018)

Another case study of Information Technology Intelligence Consulting (ITIC) done by Datacentre Journal rolled the root cause of unplanned outages were 24% in 2010 and 22% in 2013 & 2016 caused the accidental human error. The financial loss is estimated from \$380,000 in 2013 to \$489,000 in 2016. (Gabela, 2018)

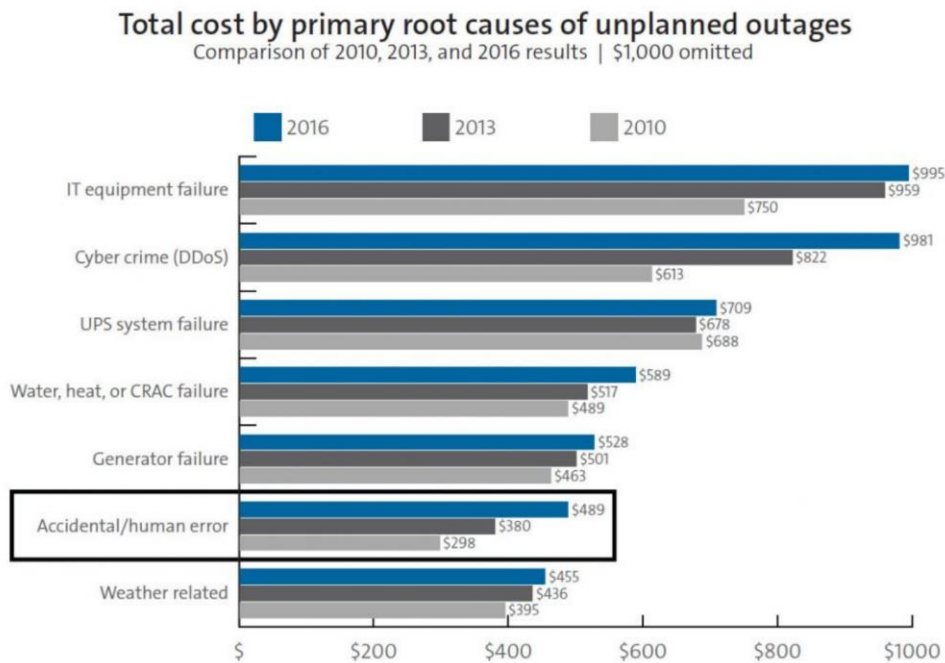

Figure 1 Cost of Data Center Outages by Ponemon Institute January 2016

The costs of financial loss caused by human errors have increased since 2013 by 28%. As shown in the graph, cabling has been seen as a cause of a problem. (Gabela, 2018)

The reasons behind the downtime can be many, but by only considering the cause of the unorganized structure, cabling is happening. (Gabela, 2018) A scenario of having a badly maintained cabling infrastructure with a big pile of cables or poor installation quality is possible if the right vendor for such installation is not chosen. Getting a cheap quote does not always mean it is good and all the quality standards will be met. The result of poor cabling can cause slow connection; connectors are not compatible, cabling does not meet standards, downtime, and many other issues. (Andrew Oliviero, 2014)

### Slow Connection

Experiencing a slow internet connection or a total loss would bring the company's business down. The root cause may relate to not having a proper cabling system in place. It is obvious that network connectivity issues will kill the organization's productivity; therefore, having a good team managing the infrastructure cabling will benefit the organization. Hiring a service

to provide that will handle the structure cabling problems and ensure it is up to date and meet the standards is also another option. (Nye Technical Services, LLC, 2019).

To be able to use and perform a certain task, some users require a fast connection, like 10 Gigabit per second. For example, a company relocated their Datacenter to a new location. The lift & shift activity was completed, the Datacenter was brought up, all connection has been restored, and all services are up again. The 10 Gigabit users immediately reported slow access. The problems included slow access to emails, documents and accessing their sales database. (Andrew Oliviero, 2014)

This network problem continued for many months. It finally ended when the company decided to run a cable test, and they figured out that many cables didn't even meet the minimum requirements.

What contributes to a problem is that often Managers intend to think that if the connection is working and the cable is working, then there is no problem. Either it works, or it doesn't, and do not think there is in between. (Andrew Oliviero, 2014)

### **Potential Downtime**

Poor cabling means the technician will have difficulties understanding the infrastructure cabling, yet alone performing a certain task. It is harder to identify a particular connection when having an unorganized cable or a big pile of messy cables. In case of an incident, it will not be fast and easy to resolve it. Instead of solving an incident, the technician may end up creating another one by getting confused between cables. (Data Telco, 2021)

Network cables that are twisted or damaged are more likely to experience unanticipated downtime. If this happens, a critical system failing and employees being unable to do their tasks will likely be the case. The unplanned downtimes are increasing, and the cost of it is rising, for that is wise to follow the prevention methods to lower the risk. (Complete Document Solutions, Inc, 2019)

## **The Effect of an IT Outsourcing**

The demand for Outsourcing is increasing. The market share of Outsourcing companies has increased to 526.6 billion in 2021 and is expected to reach 682.3 billion by 2027, registering a 4.13% CAGR during the period 2022 – 2027. The significant outsourcing destinations are India and China. Outsourcing brings some benefits, such as reducing development costs. India, over the past 25 years, has maintained its position to be the top dominant in the market with an average IT labour fee of 30 USD. (Mordor Intelligence LLP, 2022)

On the other side, having an outsourcing company managing the infrastructure cabling could fail. In some cases, outsourcing companies that are located overseas fail in many ways, such as lack of coordination, lack of internal familiarity, and loss of control. Figure 2 it is shown the IT Outsourcing vendor performance vs. the customer expectations. (Mai, 2021)

In the need of making a change to the network connectivity or an upgrade, one of the successful factors is to have a good coordination between the different teams and to have the right people involved. (ddib, 2021).

Replacing switches or routers, for example, could bring some servers offline, affecting the users and customers. Weeks before the change, different teams are informed about the activity in a proper planning, and they inform the end user and customers. During the change the team members will be available on call to support with monitoring and post change validation. This kind of coordination is needed to ensure a successful change. Now that vendors lack coordination, lack of internal knowledge means such a change can end with a company disaster. (ddib, 2021)

When having a vendor under contract, during an incident it may take time to get an onsite technician to work on that incident (Consolidated Technologies, inc., 2018).

Having a delay with attending the onsite technician in some cases could be via 3rd party, and re-considering the fact of lack coordination and internal knowledge, the scenario of having a human error may happen. If not, a lack of control can also lead to bad cable management and documentation. (Mai, 2021)

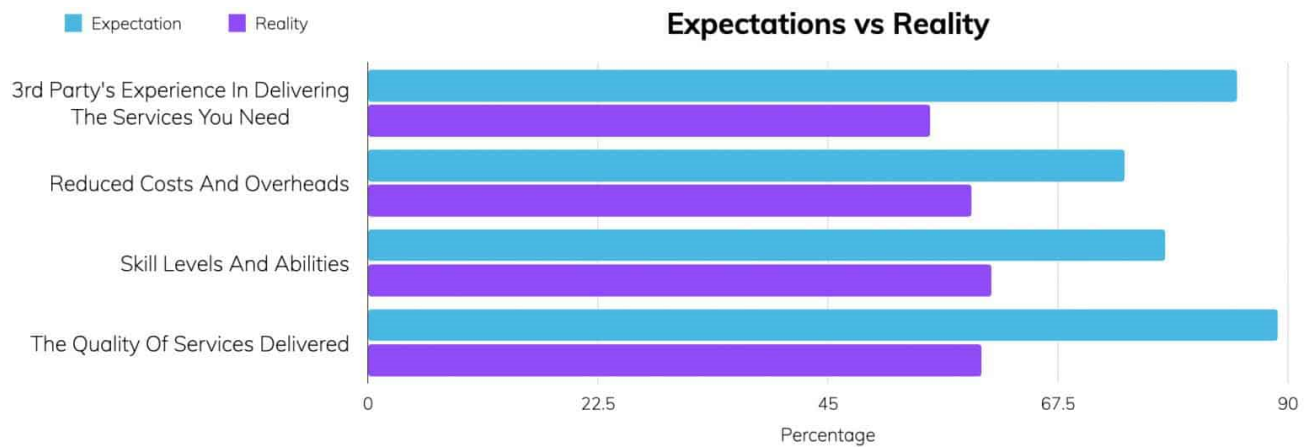

Figure 2 Expected vs. Actual benefits of IT Outsourcing (WYNGAARD, 2022)

## 2.2 Structured Cabling

Structure cabling supports various communication systems within the data centers, buildings, or campus, which include the cabling of the data, voice, video, and connection to computers or servers. The cables are typically installed in a good design manner and followed by a set of standards. The benefit of structured cabling is that the maintenance and troubleshooting are simplified and easier with the implementation, and it saves costs as well in the future run. (Kirvan, 2021)

### 2.2.1 Advantage of Structure cabling

Given that, with time there is an increase in the electronic devices that are connected to the network through Wi-Fi or with ethernet connection. It is becoming wiser to consider and evaluate the benefits of structured cabling system. For Enterprises, institutions, and other businesses that around the clock transfer data, voice, videos, alarms, and more through the network. Those data run in the network infrastructure mostly through network cables because they are considered more secure and stable than Wi-Fi transmission. (Data Telco, 2021)

### Structured Cabling vs Unstructured Cabling

Using unstructured cabling means a form of cabling where all the devices are connected directly to each other with no patch panels or cross-connect in between. This type of installation is messy, and it lacks organization.

Unstructured cabling came in the early days when there wasn't a structured system in place, and there wasn't an understanding of the complexity of the network connectivity. (Communications Solutions, Inc., 2022) (Squiers, 2018)

Comparison of both Structured and Unstructured Cabling:

	<b>Structured Cabling</b>	<b>Unstructured Cabling</b>
Efficiency	Allow max efficiency	Not efficient
Scalability	Scalable	Not Scalable
Load Speed	Fast	Slow
Complexity to alter	Not Complicated	Very Complicated
Downtime recovery	Faster	Slower
Maintenance cost	Lower	Higher
Install cost	Expensive	Cheap
Appearance	Organized	Messy

*Table 1 Structured Cabling vs Unstructured cabling (Communications Solutions, Inc., 2022) (Squiers, 2018)*

When it comes to making the decision, looking at the comparison the structure cabling wins when taking into consideration the long-term performance. (Communications Solutions, Inc., 2022).

Detailed advantages of Structured cabling:

### **Easier to maintain and manage**

Defects are challenging to locate and fix in disorganized cable systems. Another problem is that unorganized cabling systems are more likely to lead to an error during the installation. The engineer will need to sort through a mess of networking cables when a problem occurs. The structured cabling allows a quick and easier repair, it will make the cabling system more effective and reliable. (Data Telco, 2021).

## **Adaptability**

The Technology that is used for the structure cabling system is created to have the flexibility and growth for the business needs. The system can handle very high bandwidth and handle different types of installation requirements. It can support all needed functions with room to accommodate the functionality.

The business can save a lot of time and money especially if there is always a need for increasing telecommunication requirements. The structure cabling can increase it without having to rebuild. (Data Telco, 2021)

## **Security**

Modern technology has improved the effectiveness and efficiency of enterprises, but it can also make some tasks more challenging. Systems can easily get corrupted, and resources can be easily redirected to other hands. Such circumstances can never arise in a structured cabling system. The unique security features and functionality of this structured cabling system are only accessible to authorized users. With these kinds of safeguards in the cabling system, there is very little likelihood that the business will encounter cybersecurity problems. (Data Telco, 2021)

## **Fault isolation**

Fault isolation is one of the key benefits of structured cabling. It is possible to execute a test and isolate the exact source of the problem and be able to fix it with a very small disruption to the network connectivity. This is possible because the structure cabling system breaks down the cabling system into simple, manageable blocks. This helps reduce the cost of the structure cabling maintenance as well.. (Field Nation, 2018)

## **Immunity to Electromagnetic Interference (EMI)**

Using fiber optic in structure cabling, which doesn't transport electrical current and transmit data using light in a glass fiber, it doesn't generate a magnetic field making it immune to EMI. When using fiber cables in locations that are known to have electrical lines, it eliminates the problems such as having data loss and line distribution. (Andrew Oliviero, 2014)



### 2.2.2 The Six Subsystems of structured Cabling

The Structure cabling is divided into six parts called subsystems; each part provides functionality that completes the system.

- **Entrance Facilities (EF)**

Is the area where the cables are coming from outside the building through the service carrier. The cabling connects to a room where the Demarc point, patch panels, and equipment racks. (Kirvan, 2021)

- **Equipment Room (ER)**

The equipment room serves as the central hub where the cabling system connects to the internal infrastructure. This critical area houses patch panels that facilitate connection to both backbone and horizontal cabling. Additionally, the equipment room contains devices such as routers and switches which are racked in the metal frames. (Kirvan, 2021) (Andrew Oliviero, 2014).

The room contains one or more racks (MDF, IDF, or EDA), which house essential components such as the main cross-connect (MC), intermediate cross-connects, horizontal cross-connects, a business telephone system, and server racks. (CommScope, Inc, 2017)

In a data center or commercial building, the equipment room consists of rows of racks or cabinets that house servers, storage systems, network equipment, and other vital devices. These racks are arranged in a grid pattern, with aisles between them to allow for easy maintenance and access.

- **Main Distribution Frame (MDF):**

A main distribution frame (MDF) is a central hub in a telecommunications system that is used to connect and distribute incoming and outgoing connections. It is typically located in a central location within a building or campus, such as a closet or basement, and is used to connect the various communication systems, including telephone, data, and video, to the outside world. An MDF rack is a rack or cabinet that is used to house and organize the various components of an MDF, such as cables, connectors, patch panels, and other hardware. (Zola, 2022)

- Intermediate Distribution Frame (IDF):

An intermediate distribution frame (IDF) is a secondary hub that is used to connect and distribute signals within a building or campus. It is typically located on each floor of a multi-story building and is used to connect devices on that floor to the MDF.

The MDF and IDF play important roles in the overall performance and reliability of a telecommunications system. The MDF is responsible for distributing signals to and from the outside world, while the IDF is responsible for distributing signals within a building or campus. Together, the MDF and IDF form a structured cabling system that allows for the efficient transmission of signals throughout a building or campus.

IDF is used to handle the telecommunication connectivity within the company as it is used to connect end-user equipment such as computers or phones instead of making a straight longer connection to the MDF. (Qamar, 2022)

▪ **Backbone Cabling**

Vertical or riser cabling, commonly known as the Backbone, serves as the primary network cabling system in a building. Its purpose is to provide interconnectivity between telecommunication rooms and the equipment room and to establish communication between subsystems on each floor. The Backbone utilizes twisted pair cables like cat6, cat6e, and cat7, as well as the single mode and multimode optic fiber cables. One end of the cabling connects to the main designation cross-connect in the main distribution frame (MDF), which is used to link to devices, while the other end is attached to the interconnect rack (IDF) located on each floor. (CommScope, Inc, 2017) (Kirvan, 2021)

▪ **Telecommunications Room (TR)**

The telecommunication room is a component of a building's network infrastructure. It serves as a location for terminating both horizontal and backbone cables and houses the necessary hardware for cabling termination. In addition to an interconnect rack (IDF), the room may also feature other essential components such as patch panels. (Kirvan, 2021)

- **Horizontal Cabling**

It is called distribution cabling as well; it is a cabling system that runs from the telecommunication room to the work area. The typical cabling run from the client devices to the nearest TR on the same floor. (Kirvan, 2021)

- **Work Area**

The work area includes the wall plates, user patch cables, and user devices. The work area receives the cabling through horizontal cabling from the telecommunications room. Each work area contains a minimum of two permanent links for telecommunications. The WA includes multiuser telecommunications outlet assemblies. (CommScope, Inc, 2017) (Kirvan, 2021)

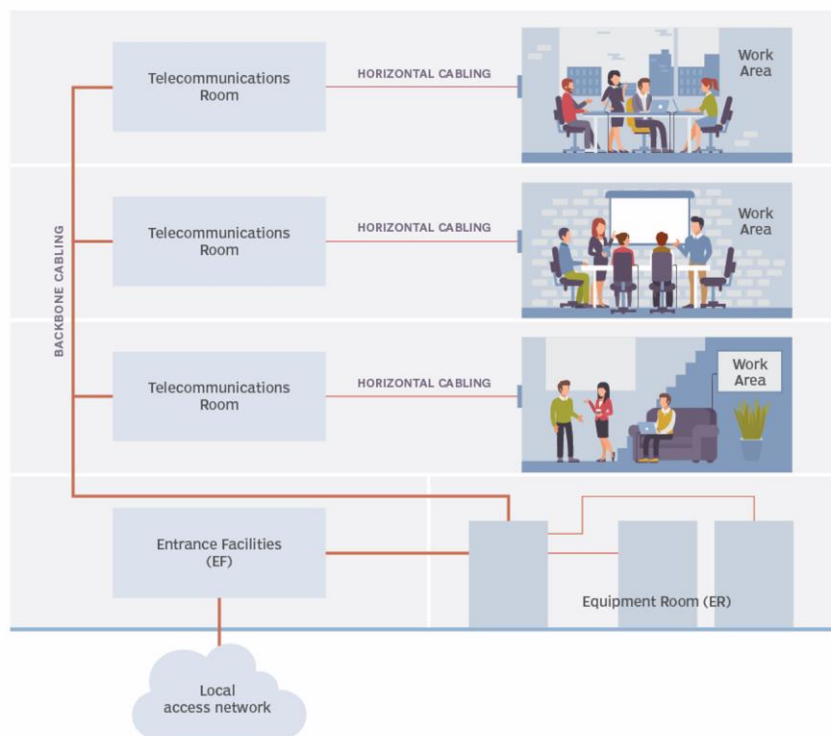

Figure 3 The 6 subsystems of Structured cabling

### 2.2.3 Standards & Rules to Ensure the Effectiveness

Standards are the sets of rules that govern the guidelines and quality of the structure cabling installations. Suppliers that provide structure cabling must ensure the safety of the installation, that the installation provides all the requirements for buildings and the infrastructure. Suppliers use those standards to ensure they provide a high-quality performance. (Margaret, 2022)

The standards are many but the ones used for structure cabling are:

- Telecommunications Industry Association (TIA) Electronic Industries Alliance (EIA)  
The TIA & EIA is an associate trade organization, they develop and improve the fundamentals of the Structure cabling and share a series of standards that set the cover, functionality, quality, and safety of the installation for data, voice, and video.

The standards have been recognized by the American National standards institution (ANSI).

A list of the TIA EIA standards: (Cisco Systems, Inc. , 2014)

- ANSI/TIA-568.0 Generic Telecommunications Cabling for Customer Premises
- ANSI/TIA-568.1 Commercial Building Telecommunications Infrastructure Standard.
- ANSI/TIA-568.2 Balanced Twisted-Pair Telecommunications Cabling and Components Standard.
- ANSI/TIA-568.3 Optical Fiber Cabling and Components Standard
- ANSI/TIA-568.4 Broadband Coaxial Cabling and Components Standard
- ANSI/TIA-568.5 Balanced Single Twisted-pair Telecommunications Cabling and Components Standard. (Cisco Systems, Inc. , 2014)

- International Organization for Standardization (ISO)

The ISO is the international originations for standards that include many standards from more than 140 countries, including the ANSI. The ISO is a nongovernmental organization and its work resulted in international agreements of standards that are used worldwide. Current valid versions are 2017/COR 1:2018/AMD 1:2021 - Current edition. (ISO, 2018)

- ISO/IEC 11801-1 Part 1: Generic cabling requirements for twisted pair and optical fiber cables
- ISO/IEC 11801-2 Part 2: Office premises Cabling for commercial (enterprise) buildings.
- ISO/IEC 11801-3 Part 3: Industrial premises cabling for industrial buildings, with applications including automation, process control, and monitoring.
- ISO/IEC 11801-4 Part 4: Single-tenant homes cabling for residential buildings, including 1200 MHz links for CATV/SATV applications.

- ISO/IEC 11801-5 Part 5: Data centres Cabling for high-performance networks used by data centres.
- ISO/IEC 11801-6 Part 6: Distributed building services cabling for distributed wireless networks for building automation and IOT devices (ISO, 2018)

### **Rules To Ensure the Effectiveness, compatibility of Structured Cabling**

To help ensure the effectiveness, compatibility, and efficiency of the structure cabling design there are 3 rules to be followed.

#### First rule:

Obtaining a complete connectivity solution is the first rule. All the systems created to connect, route, manage, and identify cables in structured cabling systems are part of an ideal network connectivity solution. Both present and future technologies are supported via a standards-based implementation. The project's reliability and long-term performance will be increased by adhering to the guidelines.

#### Second rule:

Working on future requirements by adding several cables to be installed. To guarantee that the needs will be addressed, solutions in categories 5e, 6, and fiber optics should be taken into consideration. The installation strategy for the physical layer would be durable for ten years or more.

#### Third Rule:

The last rule is to keep vendors' choices open. A closed, proprietary system might be less expensive at first, but it might end up being far more expensive in the long run. Moving, adding, or changing a non-standard system from a single vendor could be more challenging in the future. (Andrew Oliviero, 2014).

## 2.3 Structured Cabling Materials

For the implementation of the structure cabling system, a set of controlled materials is required to ensure the efficiency and quality of the cabling system.

### 2.3.1 Copper Cables

Copper cables, which are composed of copper wires, are widely used to transmit data and electronic signals in networks. Various types of copper cables are available, each designed for specific uses. In structured cabling, unshielded twisted pair (UTP) is the most commonly used type but shielded twisted pair (STP) can also be used as it provides additional protection in challenging environments and cable routes. UTP/STP Copper cables consist of pairs of copper wires twisted together, reducing interference and crosstalk. They are widely utilized in Ethernet and other networking applications and are available in different categories, each with varying levels of performance and features. Choosing the appropriate type of UTP or STP cable is essential to ensuring optimum network performance and reliability.(Scarpati, 2019) (Monk Cables, 2021)

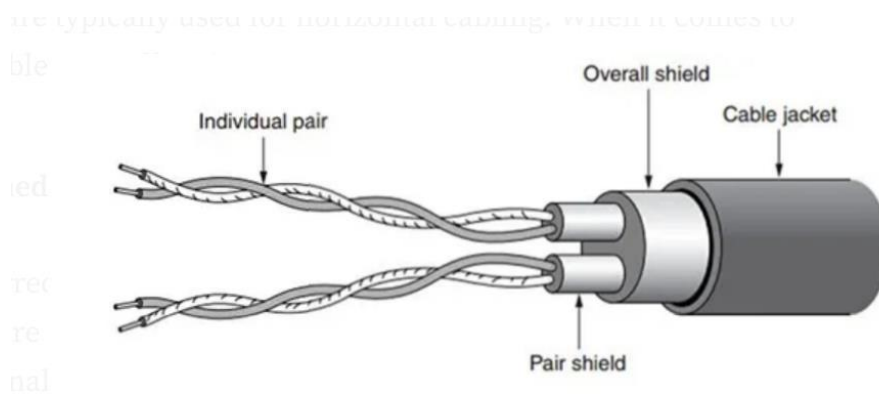

Figure 4 STP Cable (Zhu, 2017)

### Categories of Copper Cables

There are several categories of copper network cables that are used in networking applications. These categories are defined by industry standards and specify the performance characteristics of the cable, such as its bandwidth and data transmission speed.

Some of the newest and most common categories of cables are:

- Cat6a:

Category 6a is an enhanced version of CAT6 cables and is designed to support data speeds up to 10 Gbps bandwidth of 500 megahertz (MHz). They are commonly used in Ethernet networks and are available in both UTP and FTP versions. (Segura, 2022) (Awati, 2022)

- Cat7:

Category 7 (CAT7) is a new type of copper network cable with newer specifications than cat6e. It has a high-speed cable that can support data rates up to 10 gigabits per second (Gbps) with distances up to 100 meters. (Segura, 2022) (Awati, 2022)

- Cat7a:

Cat7a is an enhanced version of cat7a and is designed to support higher data rates with speed rates up to 10 Gbps at 100 meters and 40 Gbps at 50 meters. It can support also up to 1 gigahertz (GHz) bandwidth which makes it suitable for the 10 Gigabit Ethernet demands (Awati, 2022)

- Cat8:

It is the newest cable with the IEEE standard. It supports data transmission speeds of up to 40 Gbps with a distance of 30 meters. It has a bandwidth of up to 2 GHz. Category 8 cables are available in UTP and FTP which eliminate the crosstalk. CAT8 cables are typically used in high-speed network environments where fast data transfer is critical, such as data centers and enterprise networks. They are also used in applications that require high-frequency transmissions, such as video conferencing and virtual reality. (Awati, 2022) (Lite, 2020)

**Cat 6 vs Cat 7 vs Cat8**

	<b>Cat 6</b>	<b>Cat 7</b>	<b>Cat 8</b>
<b>Frequency</b>	250 MHz	600 MHz	2000 MHz
<b>Max. Speed</b>	1 Gbps	10 Gbps	40 Gbps
<b>Max. Length</b>	328 ft. / 100 m	328ft. / 100 m	98 ft. / 30 m

*Table 2 Cat 6vs cat7vs Cat 8 (Lite,2020)*

### 2.3.2 Fiber-Optic Cables

Fiber optic cables are composed of glass or plastic strands used to transmit data, capable of transmitting at the speed of light and ideal for longer distances. They function by transmitting light signals along the length of the fiber. The types of fiber optic cables are single-mode, multi-mode, and graded-index, with single-mode and multimode cables being the most used. Single-mode cables are identified by yellow cables with blue connectors, while multimode cables are recognized by green cables with gray or white connectors. Each type has its unique advantages and disadvantages. (Andrew Oliviero, 2014) (John, et al., 2022)

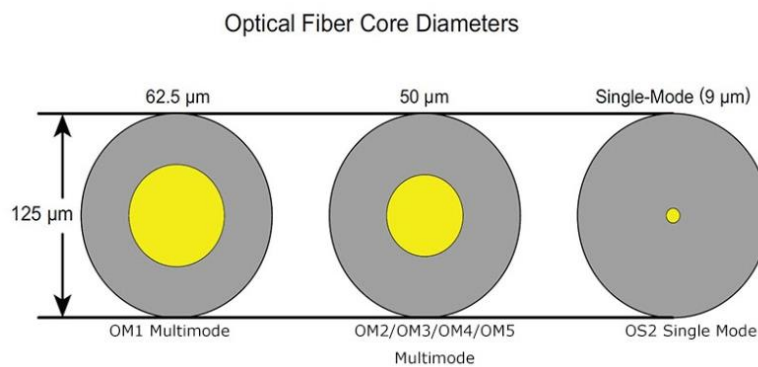

Figure 5 Fiber Optic core Diameters (John, et al., 2022)

#### Single-mode fiber:

Single-mode fiber (SMF) is used for longer distances as it has a small diameter core with a diameter of 5 to 9.5 micrometers. This minimizes signal attenuation which can occur during transmission. The small diameter of single-mode fiber allows for the isolation of light into a single beam, providing a more direct path for the signal to travel. This enables the signal to travel longer distances without experiencing a loss in strength. In addition to its ability to transmit over longer distances, single-mode fiber also has a higher bandwidth capacity than multimode fiber. Laser light is typically used as the light source for single-mode fiber, which requires careful calculations and precision to produce in the small opening of the fiber. This added level of complexity and specialized equipment makes single-mode fiber more expensive to produce. The connectors that are used in structure cabling are usually LC, ST, or SC. (Andrew Oliviero, 2014) (Al-Azzawi, 2017) (Jennifer English, 2021)



## **Multimode cable:**

Multimode fiber (MMF) cables are used to transmit data over shorter distances, e.g., in the horizontal cabling in the same building or data center. They have a larger diameter glass or plastic fiber core than single-mode fiber with 50 or 62.5 microns, which allows for the transmission of multiple light modes or signals at once. This higher capacity for multiple signals enables the multimode fiber to transmit data at faster speeds over shorter distances. The maximum distance of transmission is 550m with speed 10Gbit/s, it is possible to transmit up to 2km with lower data rates with 100Mb/s/

One of the main advantages of multimode fiber is its lower cost compared to single-mode fiber. It is easier to manufacture and does not require the same level of precision as single-mode fiber, making it a more cost-effective option for shorter-distance communication. However, it is important to note that multimode fiber has a lower bandwidth capacity and is not suitable for long-distance transmission due to the higher likelihood of signal attenuation. (John, et al., 2022) (John, 2021)

MMF has many types, but the newest and most used are:

- **OM4:**

OM4 fiber supports high-speed transmission with 10 Gbit/s link at a distance up to 550 meters compared to the older version OM3 which covers up to 300 meters. The OM4 is designed for optimized 50/125 um having 47000 MHz\*km. It is also compatible with the OM3 fiber if sharing the same jacket. It can run 40/100GB up to 150 meters with the use of the MPO connectors. (John, et al., 2022) (John, 2021)

- **OM5**

OM5 fiber is the newest fiber type and is also known by the name WBMMF (wideband multimode fiber) The cable has a different color than other cables with a lime green color. It is designed to support a minimum speed of 28Gbps per channel. It has a diameter of 50/125µm, same as OM4 but higher bandwidth with 28000 MHz\*k. It is also compatible with the OM4 cable. (John, 2021)

### 2.3.3 Backbone & Horizontal Cabling Components

In the subsystem of the structure cabling backbone and horizontal cabling, they complement each other they connect all the parts of the system together. Both are different in purpose and components. ( Blue Wave Communications, 2020)

#### Backbone cabling

The backbone components can vary based on the environment and requirement, but the essentials are:

- Cable Pathways: It used to run the network cabling, and they are commonly used as plastic materials, or metallic their size depends on the number of cables that need to be used. The pathway can include shafts, raceways, or floor penetrations like sleeves or slots. ( Blue Wave Communications, 2020).
- Termination point: It can be called a cross-connect or Patch panel. It terminates the incoming cables. Patch panels are installed in a rack with one rack unit or two rack unit sizes. Some patch panels are four rack unit sizes containing more ports. The patch panel is also used for maintaining organized cabling. They also accommodate twister pair cables, most often type RJ45 and fiber optic cables in the equipment room. The patch panels contain a blank port on one side and pins on the back side for the termination point. (Froehlich, 2021)

Fiber optic patch panels are chosen based on the connection requirement. There are single-mode patch panels and multimode, with different types of connectors like a lucent connector or little connector (LC), straight tip (ST), subscriber connector (SC), fiber connector (FC), multi-fiber push-on (MPO). LC multimode patch panels are used to transfer 10Gb/s data to the equipment. On the other side, MPO is used to carry 40Gb/s data. (Froehlich, 2021)

- Backbone wiring: These are cables that are used in the connections. They could be either optical fiber or twisted pair copper as need. ( Blue Wave Communications, 2020)

### **Horizontal cabling**

Components are like the Backbone cabling containing cable pathways, termination points, and cables. If the cabling system runs at a shorter distance so different cables could be used such as MPO OM4 multimode cables. ( Blue Wave Communications, 2020)

More details on the component that can complement the Horizontal cabling:

- Network cables: The cables that carry the data, voice, and video signals between devices. The most common types of cables used in horizontal cabling are twisted pair and fiber optic cables.
- Connectors: These are the devices that are used to terminate the ends of the cables and allow them to be connected to devices or patch panels. Examples of connectors include RJ-45 connectors for twisted pair cables and ST or SC connectors for fiber optic cables.
- Patch panels: These are panels that contain a series of connectors and are used to organize and manage the horizontal cabling in a communication room or closet. Patch panels allow cables to be easily connected and disconnected and allow for changes to be made to the network without disrupting the cables.
- Communication room or closet: This is a central location where all the horizontal cabling is terminated and connected to the rest of the network. The communication room or closet typically contains patch panels, switches, routers, and other network equipment.
- End-user devices: These are the devices that are connected to the horizontal cabling, such as computers, printers, and phones. ( Blue Wave Communications, 2020)

### 2.3.4 Racks

Racks are a metal frame that contains the devices and helps organize the cabling infrastructure. The racks inside height and the mount location are measured by the rack unit (RU). Those mounting holes are between 5/8 inch to 2 inches apart and use mounting nuts and screws to mount the devices in.

Some racks require a different type of mounting screws and nuts, it is preferred to check the type of mounting holes before purchasing the rack.

There are many heights for the racks, they are usually from 38 inches to 84 inches and with widths between 19 inches and 23 inches. The most used racks are the 19inch and they have been used for almost 60 years. (FS.com, 2021)

Types of racks:

- Wall Mounted Brackets: This is a smaller rack with a small frame that is used to mount a few devices only. It is suitable when considering an economical space, smaller companies use this rack, but it is still under concern as it has a smaller space for cable management. (FS.com, 2021)
  
- Open Server Rack: The rack needs to be mounted to the floor to be stable and to avoid it falling. This type is usually used for patch panels and cabling, but it can also be used for racking telecommunication devices and rack mount chassis. The size of the rack is from 39 inches to 84 inches, with a base plate for the stability of 22 inches. During the installation, space between the rack and the wall is kept enough space for mounting the devices. (Andrew Oliviero, 2014) (FS.com, 2021)
  
- Server Rack Cabinet: This rack has many benefits. It has doors that give better security, self-cooling systems, and protection from electromagnetic interference. The full equipment cabinet is more costly than other types but is the most suitable option for any network equipment, servers, and storage devices. For cable management, there are accessories that call cable managers. Those are metal or plastic plates that are mountable in those racks with a size of usually between 1 rack unit or two rack units. The plate has fingers installed that are used to pass the cables from one side to the other and to keep the extra size of the cable in it. (FS.com, 2021)

The cable manager is covered or closed with its plastic cover. Some racks come with cable managers installed, but others arrive empty, so those cable managers can be ordered separately. (FS.com, 2021)



Figure 6 Server Rack Cabinet (FS.com, 2021)

### 2.3.5 Cost of Structure cabling

There are factors that can determine the cost of the cabling system, and a single cable drop can range from 100 \$ to 500 \$ It depends on the quantity of the cable drop requested, the size of the building, difficulty, and among other factors.

The equipment that is needed for the structure cabling their cost can depend on the quality of the equipment and material. Usually, big suppliers and vendors have higher prices, but their equipment is far more reliable and has a longer life cycle than others. (SeaGlass Technology, 2021).

There are also costs for the materials, which can go into two categories certified and generic. Certified materials are the ones manufactured by certified brands like CommScope, Panduit, and Hubbell. Their cost usually ranges between 0.30\$ and 0.60\$ per foot of cat6 cable and 8\$ to 18\$ per network jack. The benefit of having this type of material is the quality of the design and testing alongside the company's reputation. Those brands are also able to certify companies that provide installation services that allow customers to receive up to 25 years of warranty.

The other category is generic, and the cost range between 0.25\$ to 0.30\$ per foot for cat6 cable and 2\$ to 4\$ per network jack.

Generic materials are usually manufacturers by companies overseas which recently flood the market with a wide range of cheaper materials. (Runningcables.com, 2022). An additional cost that is added to the installation is the labor rates, and those as well can vary from one supplier to another and range from 60\$ to 120 \$ per hour and per person. The difficulty of the job can also determine the cost, and the travel time is added to the cost as well. During the selection of the vendor, some vendors may offer a lower rate, but, in some cases, the quality and the experience of the technician are not good. Choosing a reliable supplier can ensure the satisfaction of the installation result. (SeaGlass Technology, 2021)

In 2018 the company Montservices, s.r.o., implemented a structure cabling for a state property which was intended for approximately 115 users and systems in total. The materials used for the project were a server rack of 18 units (wall mount), patch panels of 24 ports UTP CAT5e, wall sockets of 2xRJ45 UTP for end users, UTP cables of 12200 meters, wiring strips, and other materials. The Material cost was 125,795.20 CZK. The labor cost was 211,631.00 CZK additional cost for the structured cabling, such as transport and secondary materials, was 15,014.80 CZK The subtotal of the entire cost without VAT was 352,441.00 CZK. (smlouvy.gov.cz, 2018)

RECAPITULATION				Material total	Assembly total	Total price	
Structured cabling				CZK 125,795.20	211,631.00 CZK	CZK 337,426.20	
Additional costs						CZK 15,014.80	
<b>TOTAL EXCLUDING VAT</b>						<b>352,441.00 CZK</b>	
Description	Quantity	i.a	Material/j	Assembly	Material total	Assembly total	Total price
TRITON data hanging cabinet RBA-18-AS5-CAX-A6	1	pcs	3450.00	800.00	3,450.00	800.00	4,250.00
Patch panel 19" UTP 24 port CAT5E LSA 1U with riser	11	pcs	800.00	1000.00	8,800.00	11,000.00	19,800.00
Socket SX9 white under the plaster 2xRJ45 UTP CAT5E	115	pcs	107.00	105.00	12,305.00	12,075.00	24,380.00
Box - white box under the SX9 socket	115	pcs	33.00	40.00	3,795.00	4,600.00	8,395.00
Data socket UTP 2xRJ45 - relocation	24	pcs	0.00	105.00	0.00	2,520.00	2,520.00
UTP wire CAT5E - 4 x 2 x 0.5 solid copper data cable	12200	m	6.10	11.00	74,420.00	134,200.00	208,620.00
LV 40x20 Wiring strip	94	m	21.60	19.00	2,030.40	1,786.00	3,816.40
LV 40x40 Wiring strip	38	m	33.60	25.00	1,276.80	950.00	2,226.80
LV 70x40 Wiring strip	132	m	64.00	30.00	8,448.00	3,960.00	12,408.00
LV 100x40 Wiring strip	30	m	88.00	36.00	2,640.00	1,080.00	3,720.00
170x70 parapet channel	20	m	420.00	90.00	8,400.00	1,800.00	10,200.00
Uncapping/capping wiring strips	350	m		10.00	0.00	3,500.00	3,500.00
hole penetration up to 600mm	7	pcs		390.00	0.00	2,730.00	2,730.00
hole penetration up to 300mm	9	pcs		150.00	0.00	1,350.00	1,350.00
penetration of the opening through the partition up to 160 mm	83	pcs		90.00	0.00	7,470.00	7,470.00
Description of the four pair	230	pcs	1.00	5.00	230.00	1,150.00	1,380.00
Route measurement incl. CAT5e protocol exposure	254	pcs		40.00	0.00	10,160.00	10,160.00
Removal of unnecessary SK distributions	1	cpl		3,000.00	0.00	3,000.00	3,000.00
Cleaning walls after breakthroughs	1	cpl		7,500.00	0.00	7,500.00	7,500.00
<b>Additional costs of structured cabling</b>							
secondary material	1	6%					7,547.71
Share of PPV affiliate performances	1	3.6%					2,667.09
transport	1	cpl					4,800.00
<b>Totally structured cabling without VAT</b>					<b>125,795.20</b>	<b>211,631.00</b>	<b>352,441.00 CZK</b>

Figure 7 Total cost of Structure cabling (smlouvy.gov.cz, 2018)

### 3 Practical Part

#### 3.1 Proposed Design

The proposed structure cabling design is for a commercial building with a ground floor and two upper floors. The ground floor is used for reception and meeting rooms and a smaller working area. The upper two floors are used as a working area.

The equipment room will be on the ground floor with an MDF rack along with two racks, IDF & EDA/Server rack. The upper two floors will have the Telecommunication rooms IDF rack, which will be used for Switching, LAN connections, and other devices. Single-mode fiber (SMF) & Multimode fiber (MMF) will be used for the backbone cabling, which will run from the MDF rack in the Equipment room, connecting to the IDF rack on each floor. In the horizontal cabling, cat7 cables will be used to connect to the working area.

The floor plans will be used from the simulated plans provided by the software company tripunkt GmbH. These floor plans from the software Pathway will be used for the measurements to determine the needed materials and cost. (tripunkt GmbH, 2023)

- Total 280 users with 10Gbps demand.
- Each IDF rack is available to support 40 and 100 Gbps appliances.
- Hight of the building 13 meters.
- Each floor measurement is 2,272 m<sup>2</sup>.

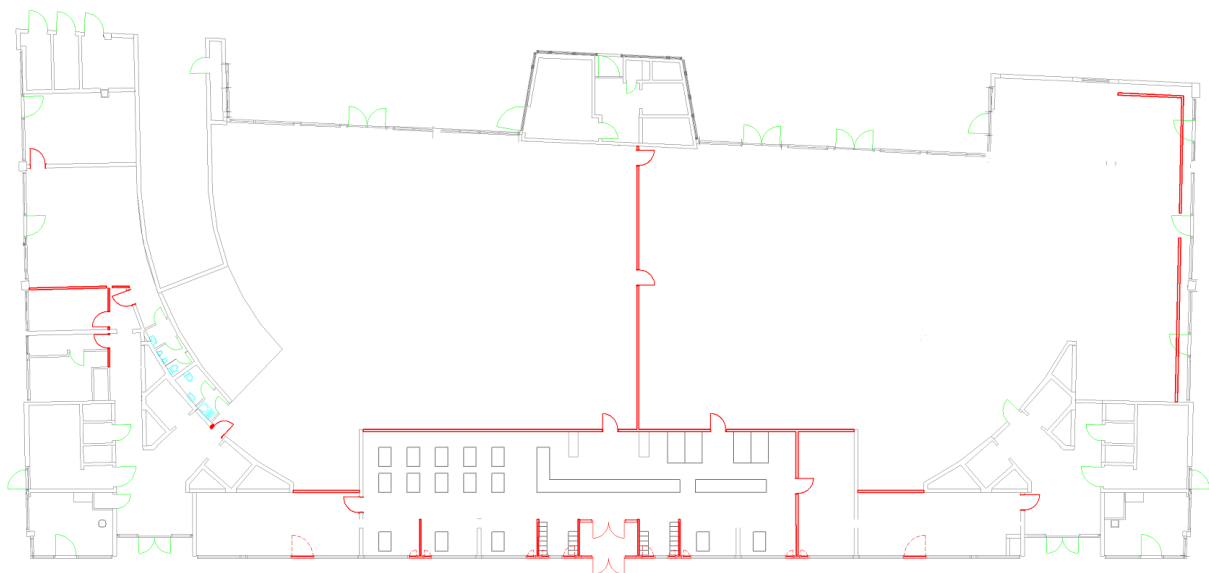

Figure 8 Floor plan for the proposed Design (tripunkt GmbH, 2023)

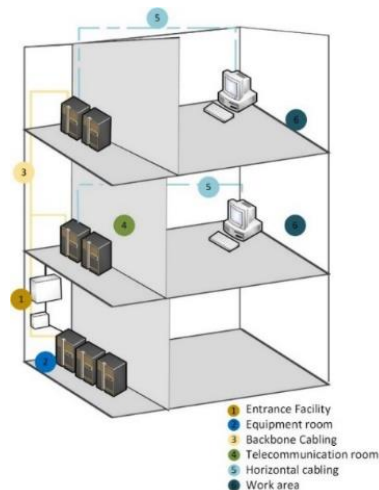

Figure 9 Basic Subsystems Proposed Design - Microsoft Visio

The design features a combination of single-mode and multimode fiber in the backbone cabling (vertical cabling). This type of hybrid install takes advantage of both technologies and future offerings. It is a general approach similar design to what was used in the case study of Notre Dame backbone cabling. According to CommScope white paper for "backbone cabling inside the building," installing single mode and multimode fiber in backbone cabling will ensure to accommodate the speed demand as the OM5 cables fibers do provide extended support for the 40G and 100G applications instead of placing a fabric switch at each floor for the purpose of connecting few devices. In general, this approach can be used in a situation where there is a need for high-speed connection or to accommodate 40G or 100G server applications. (Commscope, 2017) (SuperiorEssex, 2019).

Using this type of design will also decrease the cost of the installation as single-mode cabling and the devices associated are more expensive than multimode cabling. Using this type of design will also decrease the cost of the installation as single-mode cabling and the devices associated are more expensive than multimode cabling. The use of cat7 cables in this design instead of an older version, e.g., cat6a, is because cat7 cables' data rate is 10Gbps in distances up to 100m and 40Gbps at 50m. The cat6a can cover 10Gbps only at distances up to 50m, so above 50m, the data rate will be less than 10Gbps. Taking into consideration that the floor length of the building is 76m with a user requirement of 10Gbps, cat7 cables become ideal for this installation. (Commscope, 2017) (INTELEK, 2020) The subsystems will be constructed in a way that will bring total visibility into the network and control over the traffic. It will also reduce the time spent on critical tasks and downtime. The suggested Design for the Company will eliminate the point-to-point cabling and ensure the use of the newest materials and quality according to the TIA & ISO standard. (Cable Express, 2015)



## 3.2 Implementation

Designing and implementing the structure cabling system will require careful planning and attention to requirements and details. The implementation steps start with the proposed design, which involves determining the networking requirements of users and hardware, and then choosing the most appropriate type of cabling and infrastructure to support those needs. The next step is measuring the distance between floors, from ER & TR to the work area, as well as determining the number of devices that need to be connected. After the measurements are completed, the materials required for the installation are determined, and the installation process begins in accordance with TIA/EIA-568-B.2 standards. Once the installation is completed, it is tested to verify the installation was successful. (TIA/EIA, 2001)

The first step will be the measurement of the height between the ground floor and the second floor to determine the length needed for the backbone materials.

Using a laser meter to measure the height of the building, the result is around 13 meters, and the height of each floor is around 4.3 meters.

So, the cable raceway for the fibers will be 13 meters plus the distance to the IDF racks and additional 6 meters spare, a total of 19 meters.

Applying the same measurement of 13 meters for the second floor and 8,6 meters for the first floor, and 4.3 meters for the ground floor to know the number of fiber cables needed is:

SMF MPO: Ground floor 2 x 5 meters. First floor 2 x 8.6 meters cables. Second floor 2 x 13 meters cables. Total 54 meters of SMF cables.

MMF MPO: Ground floor 24 x 5 meters. First floor 12 x 8.6 meters cables. Second floor 12 x 13 meters cables. Total 379 meters of MMF.

The second step is calculating the distance from the furthest points to check if it does not exceed the TIA/EIA-568-B.2 standards. The distance is 76.31 meters which meet the maximum length of 100 meters. The estimated number of cables per floor will calculate based by multiplying the amount of wall ethernet ports needed and the estimated distance of 76.31 meters which is  $195 \times 76.31 = 14,880$  meters for each of the first and second floors.

$170 \times 76.31 = 13,972$  meters for the ground floor because there is a need for only 170 wall ethernet ports. In the work area 2 x Ethernet wall ports for each user. Total users are  $280 \times 2 = 560$  Ports. (Sandra, 2021)

Measurement overview:

Material	Quantity	Measurement
SMF Cable – MPO connector	2	8.6 meters
SMF Cable – MPO connector	2	13 meters
SMF Cable – MPO connector	2	5 meters
MMF Cable – MPO connector	12	8.6 meters
MMF Cable – MPO connector	12	13 meters
MMF Cable – MPO connector	24	5 meters
Plastic fiber raceway/pathway	1	19 meters
STP Cat7	1	43,732 meters
Ethernet wall port	561	-

Table 3 Overview of the measurements and needed Quantity

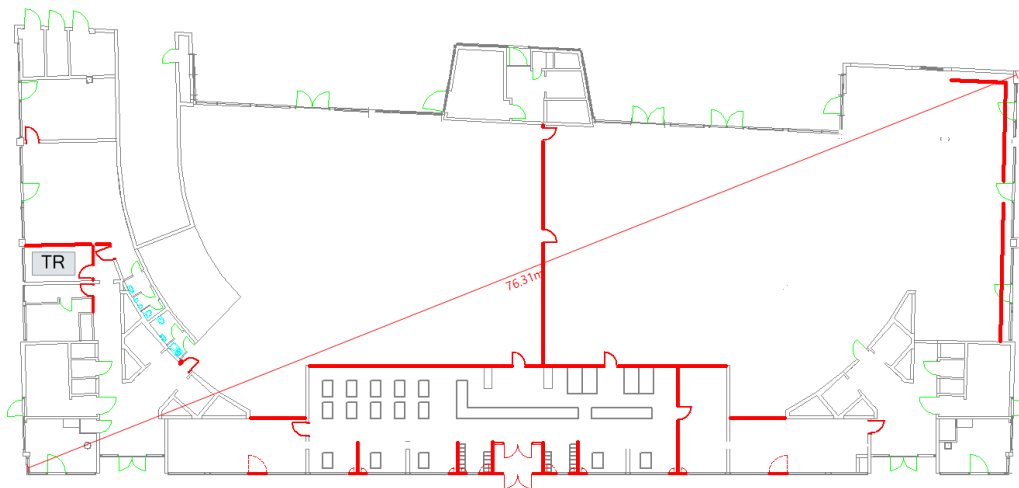

Figure 10 Floor measurement for Horizontal cabling

### 3.2.1 The Subsystems

- **Backbone cabling**

The backbone cabling will run from the ground floor to the upper two floors distance of up to 13 meters. Based on the requirement for the use of newer technology and according to the SuperiorEssex case study and CommScope, a combination of SMF-MPO and MMF- MPO type OM5 will bring higher bandwidth and will accommodate application requirements. OM5 MPO will transmit 100Gbps using only two fibers and provides extended distance support for 40G and 100G SWDM4 applications. In general, the ISO & ANSI/TIA standards recognize using both single mode and multimode fiber for Backbone cabling. Using MPO connectors at the back side of the patch panel cassettes will allow a simplified installation and save in labor costs as technicians will need to just plug it.. (Commscope, 2017) (SuperiorEssex, 2019) (FS5, 2022).

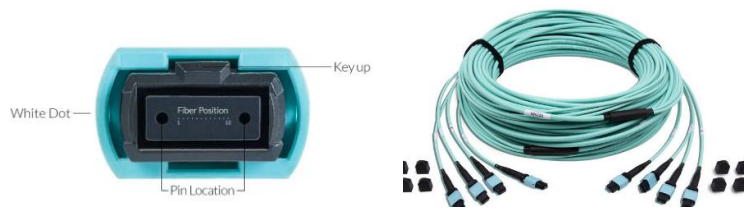

Figure 11 MPO connector (ICC.com, 2018)

As fiber cables will be used for the backbone, a plastic cable raceway of 13 meters will be installed throughout the building. Using bad materials or not proper cable management would cause an increase in operational costs. It could cause an inability to identify and access cables for maintenance. The fiber raceways must protect the cables from impact and other physical strains. (Amphenol Network Solutions, 2020)

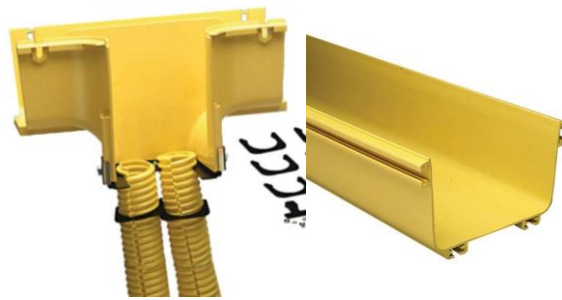

Figure 12 Fiber Cable raceways (Commscope, 2023)

To pull the cables through the cable raceway will use pulling tools which contain:

- wire mesh pulling grip (figure 14).
- Pulling tool (Swivel and pulling line)
- Tape to tighten the cable and the Mesh together.

First, the fiber is inserted into the cable mesh and ensured it is well installed. Then will pass the pulling line through the fiber raceway from the second floor to the ground floor. At the ground floor, the pulling swivel and pulling line will be connected to the wire mesh pulling grip, and the pulling process is started and repeated for all cables.

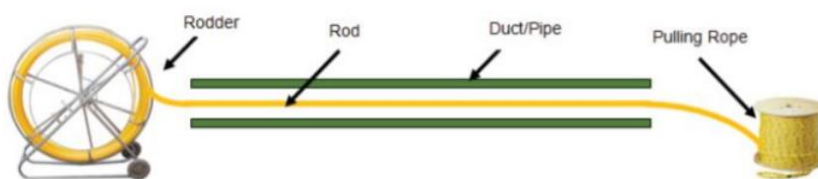

Figure 13 Fiber cable pulling method (FSS, 2021)

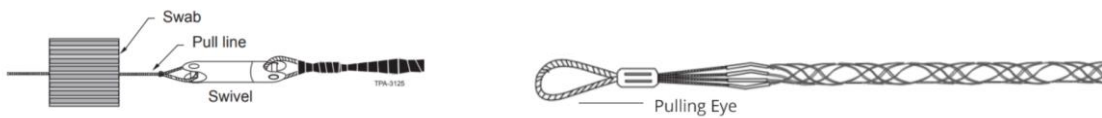

Figure 14 Pulling component & wire Mesh (FS5, 2021)

Once all the cables are pulled to each floor, the cables will be plugged into the MPO Cassettes. Each SMF cassette has 2 x MPO fiber cables and is split into 12 x LC ports. as each cassette accept 2 MPO cable (figure 14). This solution allows an easy method of termination.

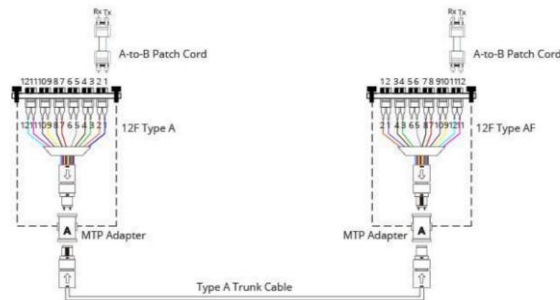

Figure 15 MPO to LC connectors trunk cabling (FS5, 2022)

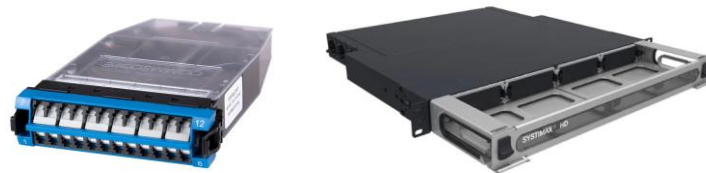

Figure 16 CommScope SMF MPO/LC Patch panel & Cassette (CommScope 2023)

MMF MPO cables have 6 x MPO ports at the backside and the same in the front. The 40-100Gbps appliances will be connected directly to the patch panel port. (Commscope, 2017) (SuperiorEssex, 2019) (FS5, 2022)



Figure 17 MPO Cassette and patch panel

- **Horizontal cabling**

A horizontal cabling solution will be installed from STP Cat7 cables (Figure 18). The estimated count of cat7 cables that will be used for the installation is 43,732 meters. The installation will be starting from the IDF racks in the telecommunication room on each floor and terminate at the wall outlet port in the work area. In the IDF racks, Rj45 Cat7 patch panels (Figure 19) will be installed, and the cables will be terminated with the corresponding connector and location on the floor.

Overview of the cabling and corresponding ethernet wall port at the WA:

Ground floor:

- 24 x STP/Cat7 IDF1 Path Panel IDF1-A1 to WA wall outlets Port 1-24
- 48 x STP/Cat7 IDF1 Path Panel IDF1-A2 to WA wall outlets Port 25-73
- 48 x STP/Cat7 IDF1 Path Panel IDF1-A3 to WA wall outlets Port 74-122
- 48 x STP/Cat7 IDF1 Path Panel IDF1-A4 to WA wall outlets Port 123-170
- 24 x STP/Cat7 IDF1 Path Panel IDF1-A5 to EDA Patch Panel EDA-A1

First Floor:

- 24 x STP/Cat7 IDF2 Path Panel IDF2-B1 to WA wall outlets Port 171-195
- 48 x STP/Cat7 IDF2 Path Panel IDF2-B2 to WA wall outlets Port 196-244
- 48 x STP/Cat7 IDF2 Path Panel IDF2-B3 to WA wall outlets Port 245-293
- 48 x STP/Cat7 IDF2 Path Panel IDF2-B4 to WA wall outlets Port 294-342
- 24 x STP/Cat7 IDF2 Path Panel IDF2-B5 to WA wall outlets Port 343-367

Second Floor:

- 24 x STP/Cat7 IDF3 Path Panel IDF3-C1 to WA wall outlets Port 368-392
- 48 x STP/Cat7 IDF3 Path Panel IDF3-C2 to WA wall outlets Port 393-441
- 48 x STP/Cat7 IDF3 Path Panel IDF3-C3 to WA wall outlets Port 442-490
- 48 x STP/Cat7 IDF3 Path Panel IDF3-C4 to WA wall outlets Port 491-539
- 24 x STP/Cat7 IDF2 Path Panel IDF3-C5 to WA wall outlets Port 540-561



Figure 18 Cat7 STP (Alza.cz, 2023)



Figure 19 RJ45 Patch panel

## Equipment area & Telecommunication room

The equipment room will have three racks, MDF, IDF & EDA equipment rack. Each rack will have a backbone cabling component and a horizontal cabling component. The cabling inside the rack is designed to be done with short cables of 0.2-0.3 meters only. Each switch of 48 ports is placed between 24 patch panel ports from the top & 24 ports from the bottom. The short cables will be plugged, e.g., switch port 1 to patch panel port 1 (figure .20). This suggestion to use short cabling in the installation will avoid confusion with cabling or “cable spaghetti” in the future.

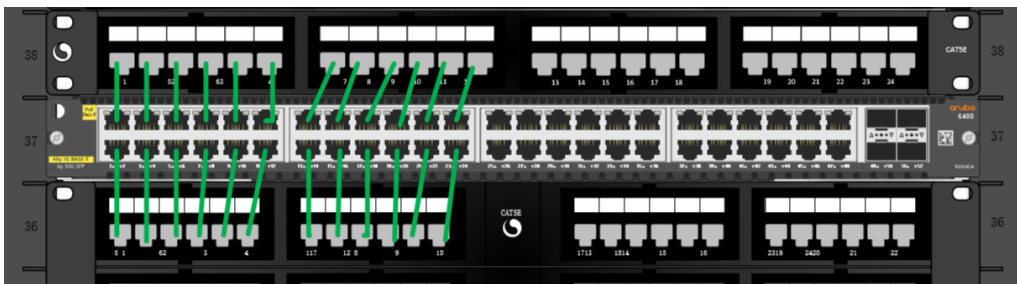

Figure 20 Switch & Patch panel cabling - Visio

### MDF:

- 1 x SMF MPO/LC Patch panels with Cassettes 48 ports
- 1 x MMF MPO/MPO Patch panels with Cassettes 48 ports
- 8 x 1x Cable management panel

### EDA:

- 1 x MMF MPO Patch panels with 2 x Cassettes 12 ports
- 1x Cable management panel
- 1 x Copper RJ45 Patch panels 48 port

### IDF1:

- 1 x SMF MPO/LC Patch panels with 2 x Cassettes 24 ports
- 1 x MMF MPO/MPO Patch panels with 2x Cassettes 24 ports
- 3 x Cable management panel (For organizing cables)
- 3 x Copper RJ45 Patch panels 48 ports
- 2 x Copper RJ45 Patch panels 24 ports

## IDF2:

- 1 x SMF MPO/LC Patch panels with 1x Cassettes 12 ports
- 1 x MMF MPO/MPO Patch panels with 2x Cassettes 12 ports
- 12 x Cable management panel (For organizing cables)
- 3 x Copper RJ45 Patch panels 48 ports
- 2 x Copper RJ45 Patch panels 24 ports

## IDF3:

- 1 x SMF MPO/LC Patch panels with 1x Cassettes 12 ports
- 1 x MMF MPO/MPO Patch panels with 2x Cassettes 12 ports
- 3 x Cable management panel (For organizing cables)
- 3 x Copper RJ45 Patch panels 48 ports
- 2 x Copper RJ45 Patch panels 24 ports

### ▪ Work area

At the work area, several ethernet wall plates (figure 21) will be installed near the user's desk. Every wall plate will have two ports (figure 22). The ethernet wall port is designed to accept the termination of cat7 cables from the backside. Users will connect their devices, such as laptops, VoIP, and printers, through an ethernet port that is installed on the wall. The ground floor will have 170 ports for users, assuming two ports per desk.

If VoIP devices are used, some can also be used as a switch to connect a 3rd device. The first and second floors will have around 196 ethernet wall ports and 98 Ethernet wall plates.



Figure 21 Ethernet wall plate (Alza.cz, 2023)



Figure 22 Ethernet wall port (Alza.cz, 2023)

### 3.2.2 Testing & Measurement

#### Fiber Measurement Using Optical Loss Test Set (OTLS)

The OTLS test is the most accurate method to determine the total loss in the fiber link and is required by the TIA 568-3. D and ISO/IEC 14763-3 standards. (Fluke N, 2018). The tester devices consist of two devices, the source of light, and the other end, a power meter with a photodetector. Starting the test will produce a wavelength to the other end, where the power meter is connected. The detector will measure the optical power, and on the device screen, it will be shown the total amount of light loss. TIA standard specifies a maximum loss value for fiber connectors of 0.75dB as the worst-case scenario. Using the tester devices to measure the link, on one side of the fiber, the light source is connected to the port, and another side, the power meter is connected (Figure 23).

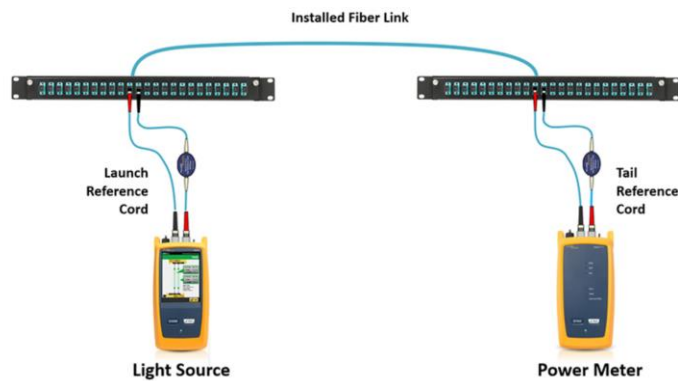

Figure 23 Fluke Network testers. (Fluke N, 2018)

Test result shows (figure 23) loss of 0.49 dB and 0.58 dB which is below the 0.75 dB allowance. The test is considered successful.

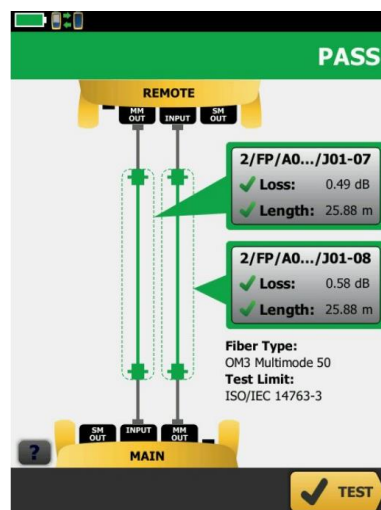

Figure 24 OTLS test result (Fluke N, 2018)



## Fiber Measurement using Optical Time Domain Reflector (OTDR)

OTDR test will send a pulse of light down the fiber and measure the time it takes for the light to be reflected, which will determine the length, attenuation, and other characteristics of the fiber. The traces then can also be examined in software. OTDR testing will be used to certify the installation. The test could be used also to troubleshoot problems with fiber optic cables, such as breaks or poor connectivity.

The OTDR measures the fiber optics in a simplified form:

$$d = \frac{3 \times 10^8}{n} \times \frac{t}{2}$$

The 'n' value is known and can be obtained from the fiber optics manufacturer. 't' is the pulse width and it's light traveling time which is measured automatically by the OTDR.

(Sinaran optik, 2015)

The test traces are checked to tell if there is cracks, bend, or loss in the transition. Using Simulator vanguard to conduct a simulation test on a fiber trace, the cable is a length of 4km.

The result shows no cracks or other problems, and there is one connector in the line only.

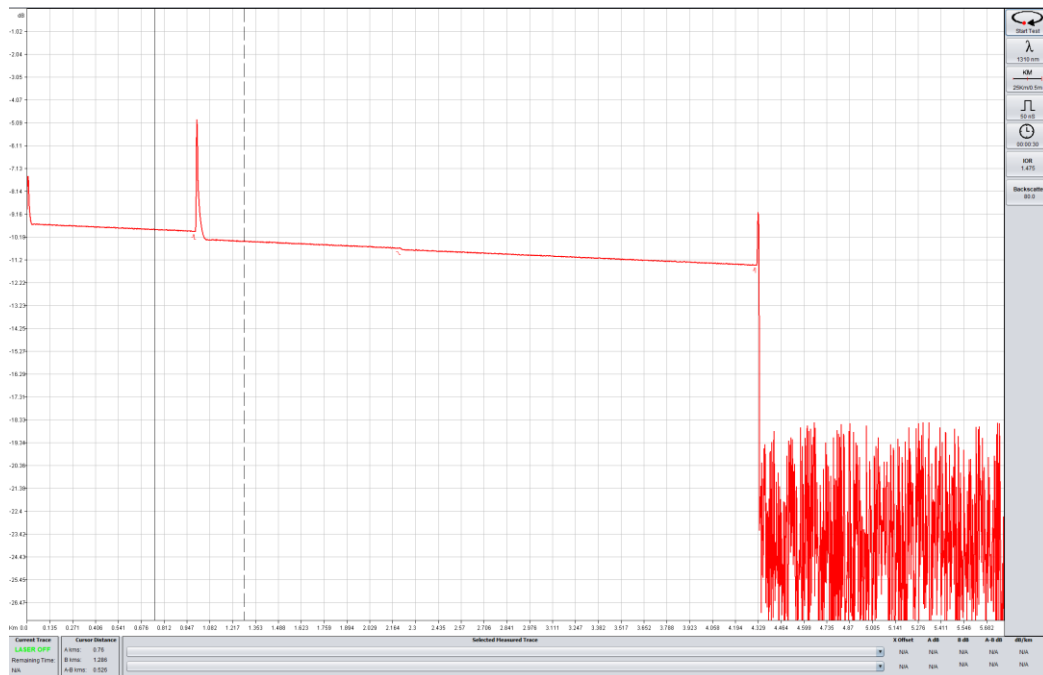

Figure 25 Vanguard OTDR Simulating Report

## Copper Measurement:

There are different methods that can be used to measure and test the cable installation. The test will report the status of an installed pin, Insertion loss, length requirement, and NEXT status.

- Wiremap:

First will test to ensure that the connectors from one end of the link are connected to the correct pin according to TIA/EIA-568 / ISO/IEC 11801-1:2017/Cor 1:2018 standards. The test can be run in any copper cables tester. Correct wiring test result should show as (figure 26).

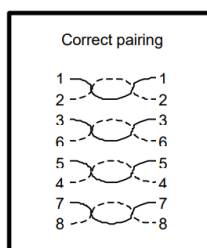

Figure 26 Correct Pairing TIA/EIA-568-B.1

- Insertion loss:

After the wire map test is completed successfully, performing an insertion loss test will report the signal loss in the cable link or channel. The test is performed by connecting a source on one side and a power meter on the other side. The maximum cable length is 90 meters, including the length of patch cords used in the patch panels and equipment, according to the TIA standards. The maximum allowed insertion loss Category 7 specified to 100 MHz is 19 dB.

The insertion loss requirements are simply calculated from the following equations:

$$\text{insertion loss}_{\text{channel}} = \text{insertion loss}_{4 \text{ connections}} + \text{insertion loss}_{\text{cable } 90\text{m}} + \text{insertion loss}_{\text{cord } 10\text{m}}$$

$$\text{insertion loss}_{\text{permanentlink}} = \text{insertion loss}_{3 \text{ connections}} + \text{insertion loss}_{\text{cable } 90\text{m}}$$

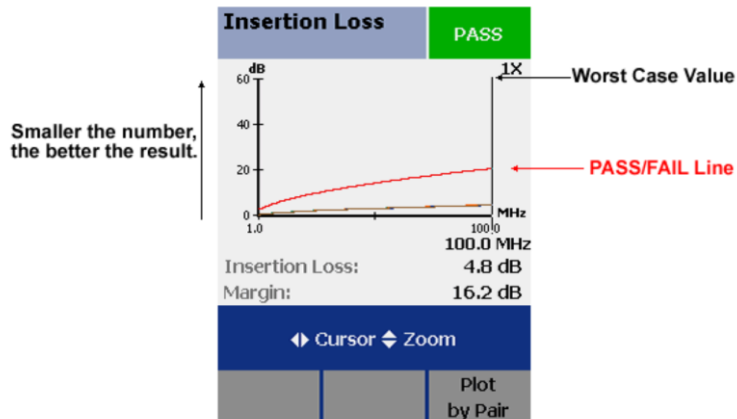

Figure 27 Insertion loss test (Fluke Network, 2021)

- Near End Crosstalk (NEXT):

If cables are not tightly twisted, this will result in Near-End Crosstalk (NEXT). It will occur if a strong signal is transmitted on one pair, and the other pair will pick a portion of that transmission. The NEXT test will measure the difference in signal strength between the pairs. Performing the test with Fluke Network testers with a cable distance of 50 meters and applying 100 MHz, the successful test report will show the shape of a roller coaster going uphill, which because the twisted pair coupling will be less effective during the high-frequency (figure 28). (Fluke Network, 2014)

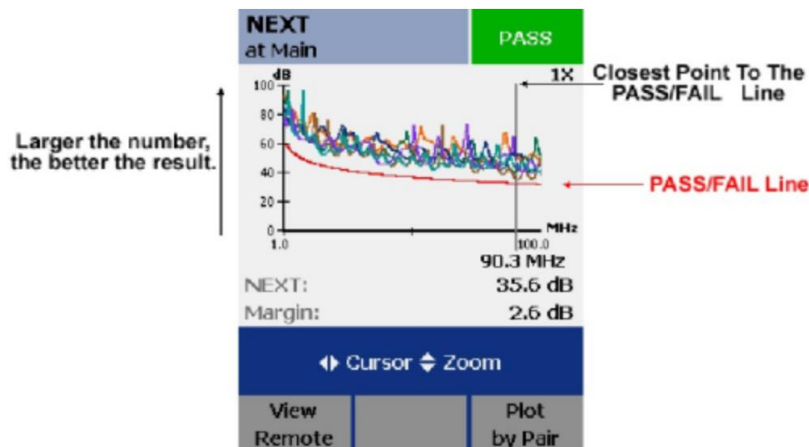

Figure 28 NEXT (Near-End Crosstalk) Pass Result – Fluke Network Tester

In the case of cable issues, the result report fails, as shown in the figure. For example, a testing length of 38 meters with a frequency of 233 MHz. The NEXT result report failed with -0.9dB, indicating a problem with pairs 1,2-4 & 5.

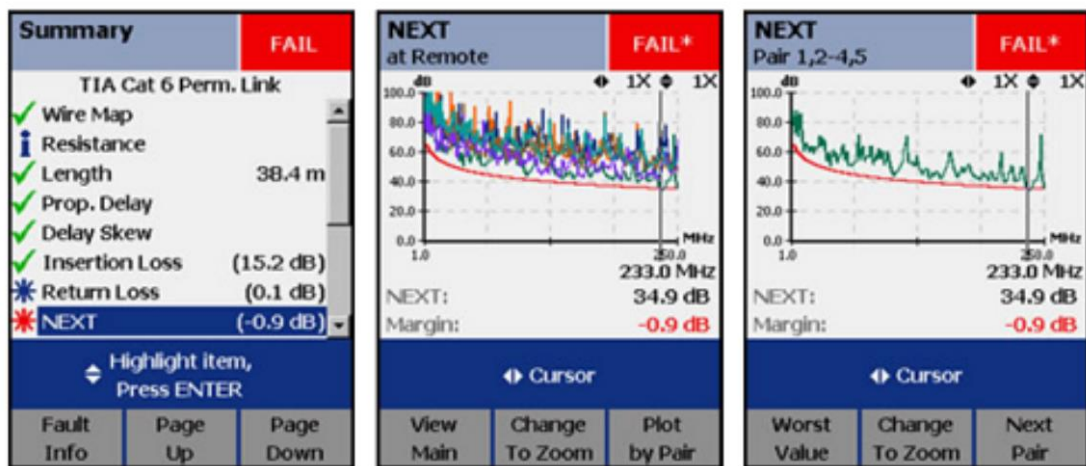

Figure 29 Failed NEXT test

After analyzing the trace, there is a crosstalk in the link, causing the NEXT test to fail. When doing the further check on the HDTDX analyzer, the event is exceeding the range of 5% or -5% in the cable, as in figure 20. This suggests that there is a problem with the cable, and it needs to be replaced. Regerminating the cable will not solve the issue. (Network, Fluke, 2014)

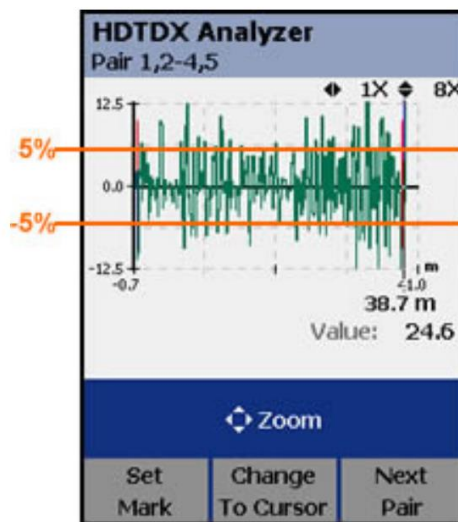

Figure 30 HDTDX Analyzer (Network, Fluke, 2014)

To avoid this scenario, an extra 50 meters will be put aside until the test is performed. In case a problem happened, which could from because of incorrect manufacturing, it would be possible to pull the extra cables. Then will need to terminate and run the test again instead of replacing the whole cable. (Network, Fluke, 2014).

### 3.2.3 Total Cost of the Structure cabling

The quote for the installation was based on pricing provided by two companies. Costs were compared with suppliers who provide just the materials and suppliers who perform the entire installation, including the providing the materials. Items are then averaged.

The cost of the materials by suppliers was almost the same.

Cost overview:

Items	Quantity	Cost per unit	Cost before VAT
Rack,42U, 600 x 600, glass door	5	17,100	85,500
STP Cat7 Cable	43,732	21.73	950,296
Patch panel Cat7 24 port	7	335.0	2,345
Patch panel Cat7 48 port	9	520.0	4,680
Cable management panel	18	249.0	4,482
MMF MPO/MPO Patch panel 24x MPO	6	53,577.0	321,462
SMF MPO/LC Patch panel 18x LC	4	9,751.0	39,004
Keystone-10G-STP- CAT 7	562	104.0	58,448
Optic cable-OM5-MF	379	235.0	89,065
Optic cable-OS2-SM	54	124.0	6,696
MPO connector	54	1,034.0	55,836
channel for optical fibers + couplers + branches	20	18,829.0	376,580
RJ-45 CAT7	1,122	29.0	32,538
Data socket	561	257.0	144,177
Plastic tube fixed KOPOS 50mm	10,000	61.0	610,000
Pipe clamp 50mm	10,000	24.0	240,000
Fasteners - screws, screws, binders, etc.	1	27,300.0	27,300
Transport	1	272,000.0	272,000
Installation of routes for the cabling, routing of cabling, installation of switchboards and accessories, assembly data sockets, functionality test	1	2,604,000	2,604,000
<b>Total Cost before VAT</b>	<b>CZK 5,924,409</b>	<b>Total Cost with VAT</b>	<b>CZK 7,168,535</b>

Table 4 Estimated Total Cost of The Structured Cabling in CZK

### 3.3 Documentation Using Software Pathfinder

The purpose of this software is to document, maintain, and track the cabling structure. Implementing this documentation process will provide a clear overview of the cable availabilities. To achieve this, we will use the Pathfinder software provided by Tripunkt GmbH, which has been known to minimize downtime through proper diagnosis and provide technicians with all the necessary information for troubleshooting.

To start the documentation process, the following steps will be taken:

- Create basic details including the location, building, floor, room, and rack.
- Add components of the rack such as patch panels and switches.
- Connecting the cables from the source device to the corresponding destinations (Backbone cabling, horizontal cabling, cabling within rack).

Following these steps will provide a clear overview of what is connected and where, including graphical and non-graphical visualizations of the connections, as in attachments numbers 4,5&6.

During the process of creating the details, there will be options to upload floor plans in multiple formats. It will allow to create, and assign the outlet port and telecommunication rooms to the corresponding location in the floor plan in an easy way and clear visual view. To make the connectivity, I create the links by filling in the details shown in the connection. The details to be filled in are (cable type, definition, destination, name, and number). All these details will be available in the reports.

The software also allows the printing ready-designed labels for the patch panels and cables for easier troubleshooting in the ER & TR.

Once all the documentation is done, it is possible to generate accurate the following reports of the infrastructure (Patch connections report, Network overview report, Room overview, Network Path report, Line connections report, Data outlet report, and Print Labels).

Those reports include the structured cabling details (the backbone cabling, horizontal cabling, and cabling within the rack) as in attachments 5& 6.

## 4 Results and Discussion

Structured cabling is a beneficial technology for commercial buildings as it provides a reliable and efficient infrastructure, as was described on pages 14-16. The cost of structured cabling varies depending on various factors such as the size of the building, the number of users, and the type of cabling needed, for example, the quote on page 30 (Figure 7). In this thesis, I assumed a 3-floor building with 280 users, fiber backbone, horizontal copper cabling, and installation in the Czech Republic.

The estimated cost of structured cabling for this building is 25,600 Czech Koruna per user. The cost of structured cabling can be broken down into three main components: installation, materials, and equipment, as shown in table 4, page 45. The installation cost includes the labor cost for installing the cabling, which depends on the installation's complexity and the installers' experience. The materials cost consists of the cables, connectors, and other accessories required for the installation.

In the theoretical part, pages 10-13, problems that are caused to the network connectivity when not having structured cabling was evaluated. The issues are downtimes, slow connections, human error, low efficiency, etc. Implementing the structure cabling system decreases potential downtime and ensures the users' demands and requirements are met.

The estimated average downtime per year is at 22 hours, and the costs are 675,000 euros and 5,600 euros per minute, according to Dell Technologies, Global Data Protection Index, 2019. (Pathfinder, 2019).

According to the software company Pathfinder, which their software is used in the practical to document the Structure cabling system, 59% of all network failures are caused by faults in the physical layer, and 51% of the downtime can be avoided.

One in ten of the network failures and downtime is caused by a lack of documentation. Therefore a suggestion to use administrative software, as on page 46, helps technicians to identify and fix network problems faster by providing all necessary documentation and plans for troubleshooting. The second suggestion, as was done in the practical part on page 38, is the use of short cables within the rack cabling. It can provide benefits, including reduced cable clutter, as long cables can create cable clutter within the rack, which can make it difficult to manage and maintain. Short cables are neater and easier to organize, making it simpler to identify and troubleshoot any issues that may arise.

This thesis combines the use of technologies by using both MMF and SMF fibers in backbone cabling, resulting in reduced installation costs and bringing the benefits of both cable types.

While SMF cables offer high speed and bandwidth, the associated termination and devices/transceivers can be expensive. To minimize the costs, SMF is used only for uplinks to the Access switches, which connect users, while MMF is used to connect 40Gbps - 100Gbps appliances. Using this approach, both technologies are present, and installation costs are reduced. Elaborating more on the cost-saving details, the transceiver associated with fiber cables is usually for 40Gb Cisco QSFP-40G-SR4 for MMF & for SMF Cisco QSFP-40G-LR4S. For 100Gb Cisco QSFP-100G-SR4-I for MMF & Cisco QSFP-100G-LR4-I for SMF. The cost of the transceiver calculated includes VAT and is pulled from the fs.com e-shop on the 05.03.2023. (Cablesys, 2018)

Cost of MMF Transceiver:

40G Transceiver - Cisco QSFP-40G-SR4: 1099 CZK

100G Transceiver Cisco QSFP-100G-SR4-I: 7899 CZK

Cost of SMF Transceiver:

40G Transceiver - Cisco QSFP-40G-LR4S: 8765 CZK

100G Transceiver Cisco QSFP-100G-LR4-I: 31208 CZK

The fiber cables in the backbone are 48 ports in total so the transceiver associated with the MMF cable will cost a total of  $48 \cdot 1099 = 52,752$  CZK for 40G &  $48 \cdot 7899 = 379,152$  CZK. Transceiver associated with the SMF will cost  $48 \cdot 8765 = 420,720$  CZK for 40G and  $48 \cdot 31208 = 1,497,984$  CZK for 100G.

The approximate Cost saved by using MMF for a 40G Transceiver is:

$420,720 - 52,752 = \mathbf{367,968}$  CZK (Incl. VAT)

The approximate Cost saved by using MMF for a 100G Transceiver is:

$1,497,984 - 379,152 = \mathbf{1,118,832}$  CZK (Incl. VAT)



The saved cost may differ from project to another by the amount of transceiver module needed & type connectors.

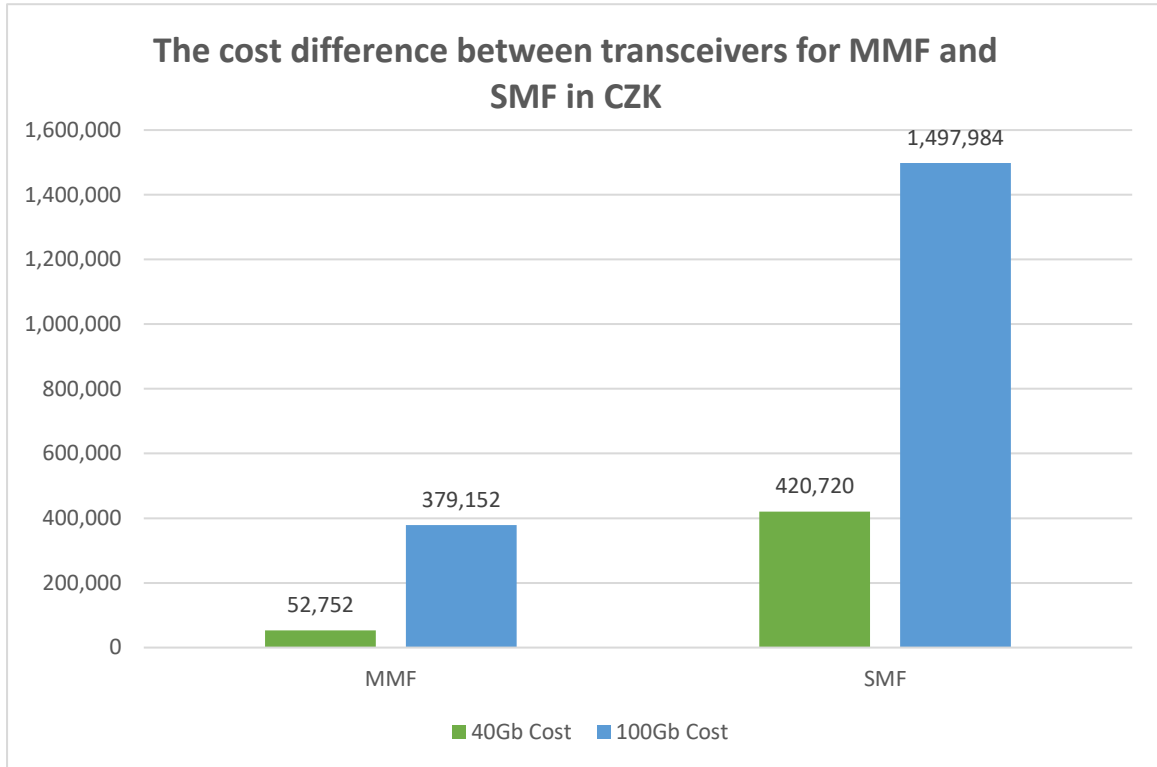

The MPO connectors used in backbone cabling provide high density as MPO connectors allow multiple fibers to be terminated in a single connector, which makes them ideal for high-density applications. This also reduces the amount of space required for cabling and allows for more efficient use of space within data centers or telecommunications rooms. MPO connectors are easier to install and terminate, which reduces installation time and cost. They also provide a quick and reliable connection that reduces the risk of connection errors or downtime.

The MPO connectors also support high-bandwidth applications, making them ideal for use in high-performance computing environments as they support data rates of up to 100 Gbps or higher, which makes them ideal for applications such as cloud computing, virtualization, and high-speed data transfer.

## 5 Conclusion

Based on both the theoretical and practical parts, it is possible to conclude that structured cabling provides some advantages over unstructured cabling. Unstructured and disorganized cabling can lead to potential human errors that cause downtimes, as well slow data transmission and network disruptions.

Structured cabling offers a clear and organized infrastructure for connecting devices, making it easier to manage and troubleshoot while also providing better scalability. The infrastructure can easily accommodate new devices and technology upgrades without requiring a complete overhaul of the cabling system. Additionally, structured cabling is typically more reliable and less prone to errors or downtime, which translates into cost savings over time and improved productivity.

Ensuring adherence to industry standards during planning, purchasing, and implementation is a key factor in achieving a successful installation that guarantees quality and success.

In the theoretical part the effect of outsourcing was evaluated, therefore, to keep the infrastructure up and well maintained is beneficial to either choose outsourcing companies with a good reputation and assurance or avoid them totally as it can dramatically affect the whole infrastructure over time and cause a human error and downtimes.

Although the implementation of structured cabling may seem expensive, it is possible to save some costs in maintenance, failures, and future expansion.

In conclusion, structured cabling is the preferred option for businesses that require a reliable and flexible cabling infrastructure. The thesis brings together a variety of features and technologies in the implementation of a structured cabling system, which can be useful for future students and researchers. As I used newer technologies in the implementation and testing, thesis can be also used as a installation guide and to find estimation cost of the similar installation and materials.

## 6 References

- Blue Wave Communications. 2020.** HORIZONTAL AND BACKBONE CABLING EXPLAIN. [Online] 07 29, 2020. <https://www.bwcfcla.com/blog/horizontal-and-backbone-cabling-explained#:~:text=Backbone%20cabling%20consists%20of%20the,also%20includes%20cabling%20between%20buildings.%E2%80%9D>.
- Al-Azzawi, Abdul. 2017.** *Fibre Optics, Principles and Advanced Practices*. 2nd. Boca Raton : Taylor & Francis Group, LLC., 2017.
- Alza.cz. 2023.** [Online] 2023. [https://www.alza.cz/zasuvka-profi-uhlova-2x-d69971.htm?kampan=adwacc\\_prislusenstvi-pro-mt\\_pla\\_all\\_obecna-css\\_kabely-redukce-a-radice\\_c\\_9062906\\_\\_MN331\\_456135983220\\_~106264923253~&gclid=Cj0KCQiAz eSdBhC4ARIsACj36uHm5gBngQ01iiLaLgp8IgcBKnSrk5yN3qnWwV1GuPrjb1](https://www.alza.cz/zasuvka-profi-uhlova-2x-d69971.htm?kampan=adwacc_prislusenstvi-pro-mt_pla_all_obecna-css_kabely-redukce-a-radice_c_9062906__MN331_456135983220_~106264923253~&gclid=Cj0KCQiAz eSdBhC4ARIsACj36uHm5gBngQ01iiLaLgp8IgcBKnSrk5yN3qnWwV1GuPrjb1).
- Amphenol Network Solutions. 2020.** *CASE STUDY - A comparison of three fiber cable*. 2020.
- Andrew Oliviero, Bill Woodward. 2014.** *Cabling: The Complete Guide to Copper and Fiber-Optic Networking*. Indianapolis, Indiana : Wiley Publishing, Inc., 2014.
- Anixter. 2023.** [Online] 2023. [https://www.anixter.com/en\\_us/search/?searchFlag=true&text=wire+mesh+tray](https://www.anixter.com/en_us/search/?searchFlag=true&text=wire+mesh+tray).
- Awati, Rahul. 2022.** Categories of twisted-pair cabling systems. [Online] 02 2022. <https://www.techtarget.com/searchdatacenter/definition/Categories-of-twisted-pair-cabling-systems>.
- Cable Express. 2015.** Health System Increases Efficiency and Scalability Case study. [Online] 2015. <https://www.cablexpress.com/sites/default/assets/File/WellSpanCaseStudy.pdf>.
- Cablesys. 2018.** Fiber: What's the Difference: Single-mode Cabling Cost vs. Multimode Cabling Cost. [Online] 02 2, 2018. <https://cablesys.com/updates/fiber-whats-the-difference-singlemode-cabling-cost-vs-multimode-cabling-cost/>.
- Chompff, Louis. 2021.** Effective Cable Management Planning In Modern Data Center Architecture. <https://andcableproducts.medium.com/>. [Online] 5 17, 2021. <https://andcableproducts.medium.com/effective-cable-management-planning-in-modern-data-center-architecture-a90235a05561>.
- Cisco Systems, Inc. . 2014.** *129 CCNA 1: Networking Basics v3.1 – Structured Cabling Supplement*. s.l. : Cisco Systems, Inc., 2014.
- Comfor.cz. 2023.** SÍŤOVÉ KABELY (METALICKÉ KABELY). [Online] 2023. [https://www.comfor.cz/prislusenstvi/kabely-prepinace-a-redukce-2/sitove-kabely-\(metalicke-kabely\)-\(1\)/datacom](https://www.comfor.cz/prislusenstvi/kabely-prepinace-a-redukce-2/sitove-kabely-(metalicke-kabely)-(1)/datacom).
- Commscope. 2023.** Commscope. [Online] 2023. <https://www.commscope.com/product-type/cable-management/raceways/itemfsgs-mshs-b/>.
- . 2017. Fiber backbone cabling in buildings. [Online] 2017. <https://www.commscope.com/globalassets/digizuite/2506-fiber-backbone-in-buildings-wp-109423-en.pdf?r=1>.
- CommScope, Inc. 2017.** Data center cabling design fundamentals, Telecommunications cabling infrastructure requirements according the availability. [Online] 2017. <https://www.anixter.com/content/dam/Suppliers/CommScope/Documents/CommScope%20HSM/Whitepaper%20-%20Data%20Center%20Cabling%20Design%20Fundamentals.pdf>.

- Communications Solutions, Inc. 2022.** Structured Cabling vs. Unstructured Cabling. [Online] 12 2022. <https://csijax.com/structured-cabling-vs-unstructured-cabling/>.
- Complete Document Solutions, Inc. 2019.** 6 Reasons why your business needs structured cabling. *6 Reasons why your business needs structured cabling*. [Online] 09 27, 2019. <https://www.cdsla.com/2019/09/6-reasons-why-your-business-needs-structured-cabling/>.
- Consolidated Technologies, inc. 2018.** Outsourced IT Services. [Online] Consolidated Technologies, inc., 6 28, 2018. <https://consoltech.com/blog/benefits-and-risks-of-managed-it-services/>.
- Contributed Article. 2015.** Redundancy in Cabling: A Must-Have for Any Network. [Online] 10 26, 2015. <https://connectorsupplier.com/redundancy-cabling-a-must-have-for-any-network/>.
- Data Telco. 2021.** TOP 11 BENEFITS OF STRUCTURED CABLING SYSTEMS. [Online] Telco Data, 2021. <https://www.telco-data.com/benefits-of-structured-cabling-systems/>.
- ddib. 2021.** 8 Tips for a Successful Network Migration. *8 Tips for a Successful Network Migration*. [Online] Daniels Networking Blog, Networking articles by CCIE #37149/CCDE #20160011, 11 14, 2021. <https://lostintransit.se/2021/11/14/8-tips-for-a-successful-network-migration/>.
- Dukda, Sonam. 2000.** *INTRODUCTION TO STRUCTURED CABLING*. Thimphu : Division of Information Technology, Ministry of Communication Thimphu, Bhutan., 2000.
- Field Nation. 2018.** Pros and Cons of Fiber Optics. [Online] 3 2018. <https://fieldnation.com/resources/pros-and-cons-of-fiber-optics>.
- Fluke N. 2018.** [Online] 2018. <https://www.flukenetworks.com/edocs/olts-otdr-complete-testing-strategy>.
- Fluke Network. 2021.** Insertion Loss. [Online] 08 2021. <https://www.flukenetworks.com/blog/cabling-chronicles/cable-testing-101-insertion-loss-matters-fiber-and-copper>.
- . **2014.** NEXT (Near-End Crosstalk) Troubleshooting. [Online] 2 2014. <https://www.flukenetworks.com/support/knowledge-base/dtx-cableanalyzertm/next-near-end-crosstalk-troubleshooting>.
- Fluke Networks. 2019.** In the Data Center - Where and What Am I Testing? [book auth.] Fluke Networks. 2019.
- Froehlich, Andrew. 2021.** Patch Panel. [Online] 2021. <https://www.techtarget.com/searchnetworking/definition/patch-panel#:~:text=A%20patch%20panel%20in%20a,incoming%20and%20outgoing%20LAN%20cables..>
- FS.com. 2021.** Data Center Server Rack Wiki: Definition, Types and Buying Guide. [Online] 03 2021. <https://community.fs.com/blog/different-types-of-server-rack-used-in-data-center.html>.
- FS5. 2021.** How to Install Pulling Grip for Fiber Optic Cable Pulling? [Online] 2021. <https://community.fs.com/blog/how-to-install-pulling-grip-for-fiber-optic-cable-pulling.html>.
- . **2022.** MTP/MPO Cabling System. [Online] 2022. [https://img-en.fs.com/file/white\\_paper/mtp-mpo-trunk-cable-assemblies.pdf](https://img-en.fs.com/file/white_paper/mtp-mpo-trunk-cable-assemblies.pdf).
- Gabela, David Bjerke and Nilson. 2018.** The Cost of Network Downtime. [Online] 8 31, 2018. <https://www.corning.com/catalog/coc/documents/articles/The-Cost-of-Network-Downtime.pdf>.

- Gillis, Alexander S. 2022.** Spine-leaf (spine-leaf architecture). [Online] 8 2022.  
<https://www.techtarget.com/searchdatacenter/definition/Leaf-spine>.
- ICC.com. 2018.** [Online] 2018. <https://icc.com/white-papers/differences-between-mpo-mtp-cables/>.
- iesmartsystems. 2021.** A Guide To Understanding Fiber Optic Installation. [Online] 10 13, 2021. <https://iesmartsystems.com/fiber-optic-installation/#:~:text=Fiber%20Optic%20Installation%20Costs&text=In%20general%2C%20it%20will%20cost,%2420%2C000%20and%20%2430%2C000%20per%20mile..>
- INTELEK. 2020.** Cat 7 600 MHz STP Horizontal Cable. [Online] 2020.  
[https://www.intelek.cz/db/repository.nsf/0/492c756cdca9cbcf125735c004a1883/\\$FILE/Datasheet\\_RiT\\_horizontal\\_cable\\_CAT7\\_STP.pdf](https://www.intelek.cz/db/repository.nsf/0/492c756cdca9cbcf125735c004a1883/$FILE/Datasheet_RiT_horizontal_cable_CAT7_STP.pdf).
- ISO. 2018.** Information technology — Generic cabling for customer premises. [Online] 2018.  
<https://www.iso.org/search.html?q=ISO/IEC%2011801>.
- ISO/IEC. 2018.** SO/IEC 11801-1:2017/Cor 1:2018. [Online] 2018.  
<https://www.iso.org/standard/66182.html>.
- Jennifer English. 2021.** fiber optics (optical fiber). [Online] 10 2021.  
<https://www.techtarget.com/searchnetworking/definition/fiber-optics-optical-fiber>.
- John and FS. 2022.** Fiber Optic Cable Types: Single Mode vs Multimode Fiber Cable. [Online] 05 10, 2022. <https://community.fs.com/blog/single-mode-cabling-cost-vs-multimode-cabling-cost.html>.
- , **2021.** Multimode Fiber Types: OM1 vs OM2 vs OM3 vs OM4 vs OM5. [Online] 09 22, 2021. <https://community.fs.com/blog/advantages-and-disadvantages-of-multimode-fiber.html>.
- Kirvan, Paul. 2021.** What are the 6 components of structured cabling?  
<https://www.techtarget.com/searchnetworking/answer/What-are-the-6-components-of-structured-cabling>. [Online] 11 2021.
- Kozischek, Dave. 2017.** Structured Cabling Design for Large IT/Service Provider Data Centers. 2017.
- Lite, Tripp. 2020.** Cat 8 Ethernet Cable Explained. [Online] 4 1, 2020.  
<https://blog.triplite.com/what-is-cat8-cable#:~:text=Cat8%20cable%20supports%20Power%20over,maximum%20range%20of%2098%20ft..>
- Mai, Truong. 2021.** 15 OUTSOURCING IT PROS AND CONS YOU SHOULD KNOW ABOUT. [Online] Magenest JSC, 2 2, 2021. <https://magenest.com/en/outsourcing-it-pros-and-cons/>.
- Margaret. 2022.** Basic Knowledge & Tips for Data center Cabling. [Online] FS, 6 10, 2022.  
<https://community.fs.com/blog/basic-knowledge-tips-of-data-center-fiber-cabling.html>.
- Monk Cables. 2021.** Want to Know About UTP Vs FTP Ethernet Cables? [Online] 12 20, 2021. <https://www.monkcables.com/blog/want-to-know-about-utp-vs-ftp-ethernet-cables/>.
- Mordor Intelligence LLP. 2022.** IT Outsourcing Market - Growth, Trends, COVID-19 Impact, and Forecasts (2022 - 2027). [Online] 03 2022.  
<https://www.reportlinker.com/p06039534/IT-Outsourcing-Market-Growth-Trends-COVID-19-Impact-and-Forecasts.html>.
- Network, Fluke. 2014.** Case Study 2 - NEXT Fails on DTX CableAnalyzer due to cable. [Online] 2014. <https://www.flukenetworks.com/knowledge-base/dtx-cableanalyzer/case-study-2-next-fails-dtx-cableanalyzer-due-cable>.

- Nye Technical Services, LLC. 2019.** 5 Common network cabling problems. [Online] 02 28, 2019. <https://www.nyetechnicalservices.com/2019/02/5-common-network-cabling-problems/>.
- Pathfinder. 2019.** [Online] 2019. <https://www.pathfinder.de/en/benefits-network-documentation/>.
- Qamar, Ali. 2022.** Implementing an Intermediate Distribution Frame (IDF) Maintaining It. [Online] 5 16, 2022. <https://techgenix.com/idf-guide/>.
- Reichle & De-Massari AG. 2019.** R&M Data Center. [book auth.] Reichle & De-Massari AG. 2019.
- Rita, Younger and Sheldon, Dan. 2022.** Comparing Two-Tier and Three-Tier Data Center Networks. *wwt.com*. [Online] 02 17, 2022. <https://www.wwt.com/article/comparing-two-tier-three-tier-data-center-networks>.
- Runningcables.com. 2022.** Commercial Pricing. *Commercial Pricing*. [Online] Runningcables.com, 2022. <https://runningcables.com/commercial-pricing/>.
- Sandra, Jong. 2021.** Benefits of Zone Cabling Architecture over Conventional Cabling » Molex. [Online] 04 2021. <https://www.molexces.com/blog/benefits-of-zone-cabling-architecture-over-conventional-cabling/>.
- Scarpatti, Jessica. 2019.** Unshielded Twisted Pair (UTP). [Online] 4 2019. [https://www.techtargget.com/searchnetworking/definition/Unshielded-Twisted-Pair#:~:text=Unshielded%20twisted%20pair%20\(UTP\)%20is,a%20different%20amount%20of%20bandwidth..](https://www.techtargget.com/searchnetworking/definition/Unshielded-Twisted-Pair#:~:text=Unshielded%20twisted%20pair%20(UTP)%20is,a%20different%20amount%20of%20bandwidth..)
- SeaGlass Technology. 2021.** How Much Do Structured Cabling Services Cost? [Online] 08 30, 2021. <https://www.seaglasstechnology.com/how-much-do-structured-cabling-services-cost/>.
- Segura, Bobby. 2022.** CAT 5 vs CAT 6 vs CAT 7 vs CAT 8 Cables: What's The Difference? [Online] 11 03, 2022. <https://www.neogamr.net/cat-5-vs-cat-6-vs-cat-7-vs-cat-8/>.
- Sinaran optik. 2015.** OTDR Setup. [Online] 2015. <https://www.sinaranoptik.com/fiber-optics-blog/otdr-setup-index-of-refraction-fiber-distance>.
- smlouvy.gov.cz. 2018.** ROZPOČET-Strukturovaná kabeláž. *smlouvy.gov.cz*. [Online] 8 1, 2018. [https://smlouvy.gov.cz/smlouva/soubor/8698159/zz\\_RS\\_SML\\_1822010005\\_P2\\_AN.pdf](https://smlouvy.gov.cz/smlouva/soubor/8698159/zz_RS_SML_1822010005_P2_AN.pdf).
- Squiers, Joe. 2018.** 3 (un)structured cabling nightmares (and how to avoid them). [Online] 04 2018. <https://www.tfeconnect.com/3-unstructured-cabling-nightmares/>.
- SuperiorEssex. 2019.** Case Study\_NotreDame\_SPSX. [Online] 2019. [https://superioressexcommunications.com/wp-content/uploads/2020/01/SPSX\\_CaseStudy\\_NotreDame\\_2019.pdf](https://superioressexcommunications.com/wp-content/uploads/2020/01/SPSX_CaseStudy_NotreDame_2019.pdf).
- TIA/EIA. 2001.** Commercial Building TIA/EIA-568-B.1. [Online] 2001. <https://www.csd.uoc.gr/~hy435/material/TIA-EIA-568-B.1.pdf>.
- tiafotc.org. 2019.** [Online] 2019. <https://www.tiafotc.org/article/know-your-fiber-connectors/>.
- Tripunkt. 2021.** Automotive supplier in transition. [Online] 9 2021. <https://www.pathfinder.de/en/blog/automotive-supplier-in-transition/>.
- tripunkt. 2020.** Digital Public Administration. [Online] 07 2020. <https://www.pathfinder.de/en/blog/digital-public-administration/>.
- tripunkt GmbH. 2023.** Visualize networks. [Online] 2023. <https://www.pathfinder.de/en/modules/vector-graphics/>.
- Vertiv co. 2016.** UNDERSTANDING THE COST: An Analysis of the Financial Impact. *VertivCo.com*. [Online] 2016.

[https://www.vertiv.com/4a3537/globalassets/images/about-images/news-and-insights/articles/white-papers/understanding-the-cost-of-data-center/datacenter-downtime-wp-en-na-sl-24661\\_51225\\_1.pdf](https://www.vertiv.com/4a3537/globalassets/images/about-images/news-and-insights/articles/white-papers/understanding-the-cost-of-data-center/datacenter-downtime-wp-en-na-sl-24661_51225_1.pdf).

**www.cablexpress.com. 2018.** Moving From Point-to-Point Cabling to Structured Cabling. *Moving From Point-to-Point Cabling to Structured Cabling*. [Online] 01 19, 2018. <https://www.cablexpress.com/education/blog/point-to-point-cabling-to-structured-cabling/#:~:text=The%20cost%20per%20square%20foot,building%2C%20or%20starting%20from%20scratch..>

**WYNGAARD, JEAN VAN. 2022.** WHAT IS IT OUTSOURCING AND WHAT BENEFITS DOES IT PROVIDE? [Online] *Tournal of Accountancy*, 8 11, 2022. <https://www.networklondon.co.uk/what-is-it-outsourcing/>.

**Zhu, Aria. 2017.** Horizontal Cabling: Choose the Right Copper Cable. [Online] 2017. <https://medium.com/@AriaZhu/horizontal-cabling-choose-the-right-copper-cable-4cc3953cad0b>.

**Zola, Andrew. 2022.** intermediate distribution frame (IDF). [Online] 7 2022. <https://www.techtarget.com/whatis/definition/intermediate-distribution-frame-IDF>.

## 7 List of pictures

Figure 1 Cost of Data Center Outages by Ponemon Institute January 2016.....	11
Figure 2 Expected vs. Actual benefits of IT Outsourcing (WYNGAARD, 2022) .....	14
Figure 3 The 6 subsystems of Structured cabling.....	19
Figure 4 STP Cable (Zhu, 2017) .....	22
Figure 5 Fiber Optic core Diameters (John, et al., 2022).....	24
Figure 6 Server Rack Cabinet (FS.com, 2021).....	29
Figure 7 Total cost of Structure cabling (smlouvy.gov.cz, 2018) .....	30
Figure 8 Floor plan for the proposed Design (tripunkt GmbH, 2023).....	31
Figure 9 Basic Subsystems Proposed Design - Microsoft Visio.....	32
Figure 10 Floor measurement for Horizontal cabling .....	34
Figure 11 MPO connector (ICC.com, 2018).....	35
Figure 12 Fiber Cable raceways (Commscope, 2023) .....	35
Figure 13 Fiber cable pulling method (FS5, 2021).....	35
Figure 14 Pulling component & wire Mesh (FS5, 2021).....	36
Figure 15 MPO to LC connectors trunk cabling (FS5, 2022).....	36
Figure 16 CommScope SMF MPO/LC Patch panel & Cassette (CommScope 2023) .....	36
Figure 17 MPO Cassette and patch panel.....	36
Figure 18 Cat7 STP (Alza.cz, 2023) .....	37
Figure 19 RJ45 Patch panel.....	37
Figure 20 Switch & Patch panel cabling - Visio.....	38
Figure 21 Ethernet wall plate (Alza.cz, 2023) .....	39
Figure 22 Ethernet wall port (Alza.cz, 2023) .....	39
Figure 23 Fluke Network testers. (Fluke N, 2018) .....	40
Figure 24 OTLS test result (Fluke N, 2018).....	40
Figure 25 Vanguard OTDR Simulating Report .....	41
Figure 26 Correct Pairing TIA/EIA-568-B.1.....	42
Figure 27 Insertion loss test (Fluke Network, 2021).....	43
Figure 28 NEXT (Near-End Crosstalk) Pass Result – Fluke Network Tester .....	43
Figure 29 Failed NEXT test .....	44
Figure 30 HDTDX Analyzer (Network, Fluke, 2014).....	44

## 7.1 List of tables

<i>Table 1 Structured Cabling vs Unstructured cabling (Communications Solutions, Inc., 2022) (Squiers, 2018).....</i>	<i>15</i>
<i>Table 2 Cat 6vs cat7vs Cat 8 (Lite,2020) .....</i>	<i>23</i>
<i>Table 3 Overview of the measurements and needed Quantity.....</i>	<i>34</i>
<i>Table 4 Estimated Total Cost of The Structured Cabling in CZK.....</i>	<i>45</i>

## 7.2 List of abbreviations

ER – Equipment room

TR – Telecommunication room

DC – Data center

ISO – International Organization for Standardization

UTP – Unshielded twisted pair

STP – Shielded twisted pair

LC - Lucent Connector

MPO – Multi Fibre push on

MMF – Multi mode fibre

SMF – Single mode fiber

NEXT – Near End Crosstalk

MDF – Main distribution frame

IDF – Intermediate distribution frame

OTLS – Optical Loss Test Set

OTDR – Optical Time Domain Reflector



# Appendix

1.

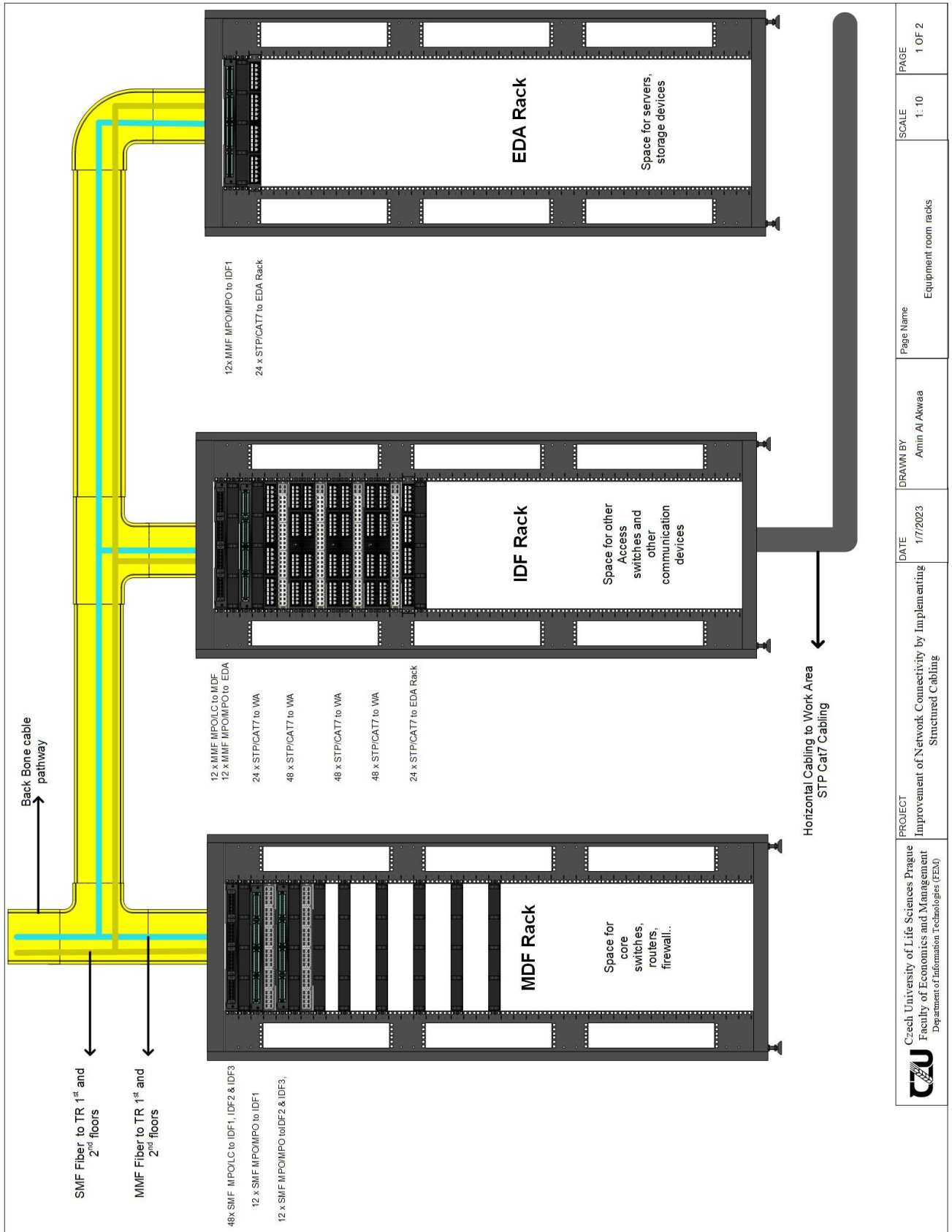

**IDF1**

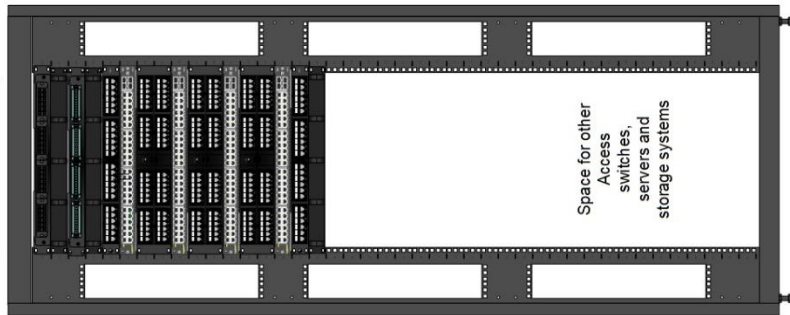

- 12 x MMF MPO/LC to MDF
- 24 x STP/CAT7 to WA
- 48 x STP/CAT7 to WA
- 48 x STP/CAT7 to WA
- 48 x STP/CAT7 to WA
- 24 x STP/CAT7 to WA

**IDF2**

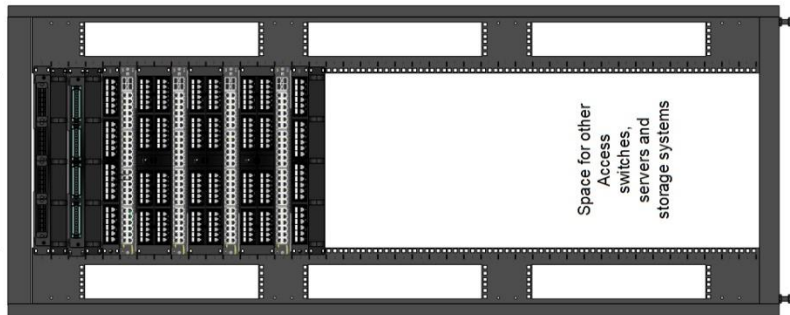

- 12 x MMF MPO/LC to MDF
- 24 x STP/CAT7 to WA
- 48 x STP/CAT7 to WA
- 48 x STP/CAT7 to WA
- 48 x STP/CAT7 to WA
- 24 x STP/CAT7 to WA

**IDF3**

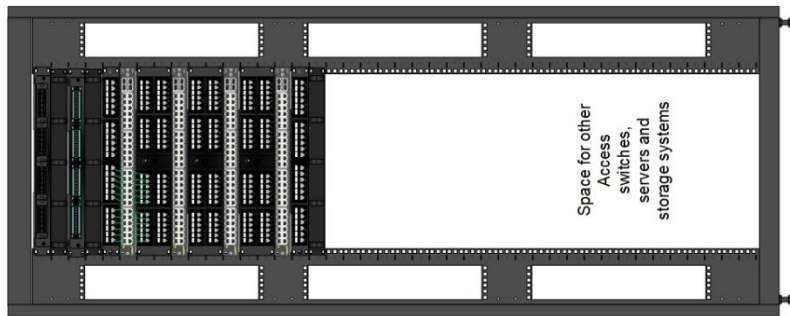

- 12 x MMF MPO/LC to MDF
- 24 x STP/CAT7 to WA
- 48 x STP/CAT7 to WA
- 48 x STP/CAT7 to WA
- 48 x STP/CAT7 to WA
- 24 x STP/CAT7 to WA

 <p>Czech University of Life Sciences Prague Faculty of Economics and Management Department of Information Technologies (PEM)</p>	<p>PROJECT Improvement of Network Connectivity by Implementing Structured Cabling</p>	<p>DATE 10/01/2023</p>	<p>DRAWN BY Amin Al Akwaa</p>	<p>Page Name Telecommunication racks IDF1-3</p>	<p>SCALE 1:10</p>	<p>PAGE 2 OF 2</p>
	<p>Space for other Access switches, servers and storage systems</p>					

3.

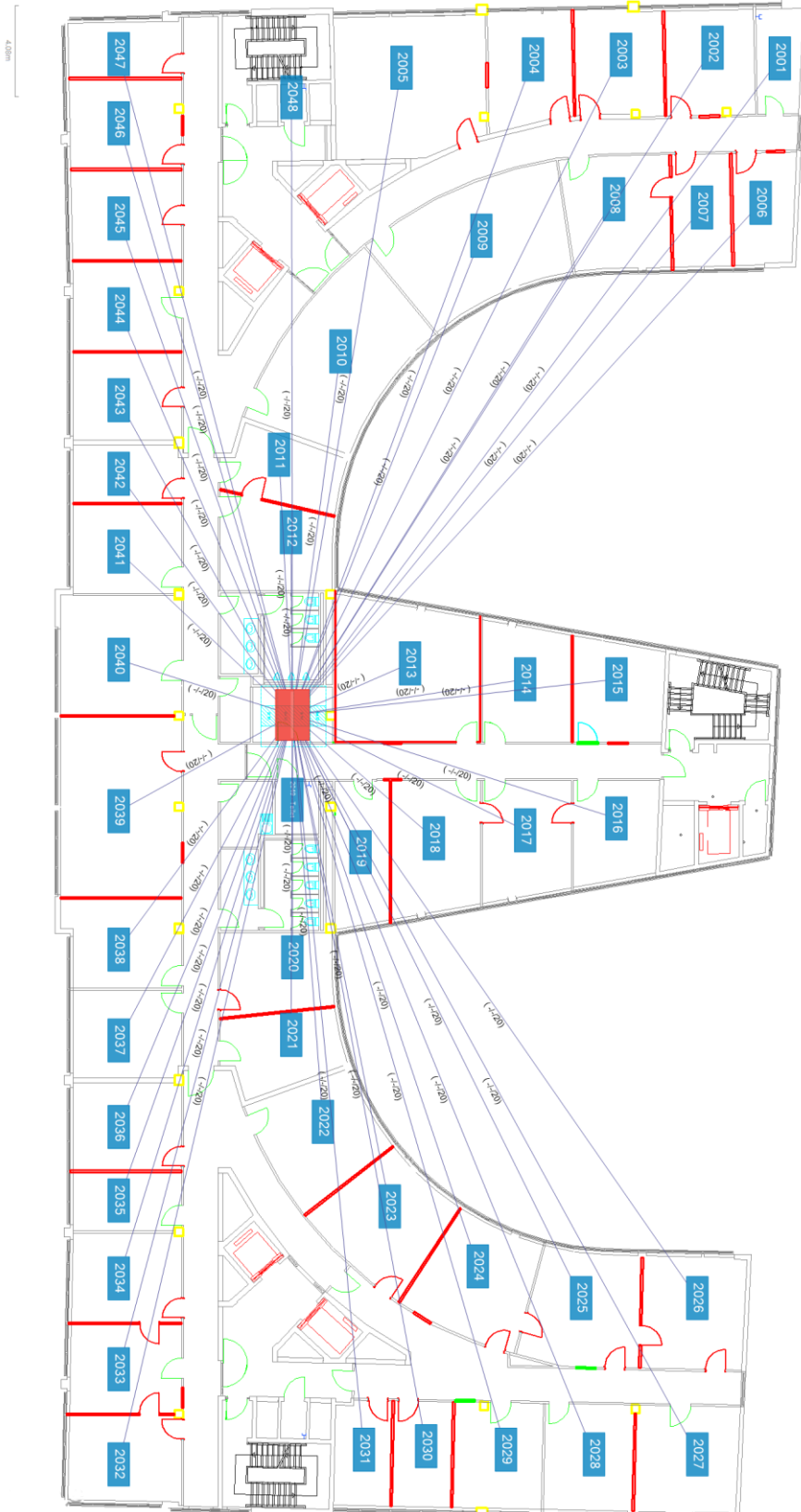

4.

IDF  
19" Rack

Weight: 50.6 (0) [kg]  
 Power Consumption: 6.1 (0) [kW]  
 Dissipation Loss: 1228 (0) [BTU/h]  
 Occupancy: 35.7 %

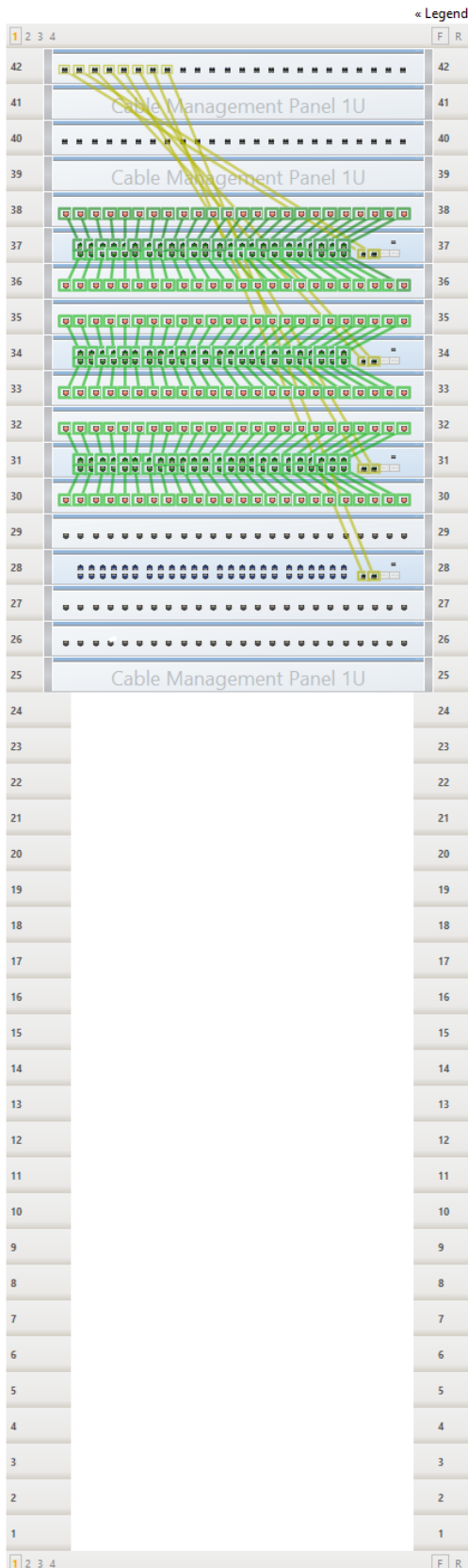

- IDF1-MDF-SMF
- IDF1-MDF-MMF
- IDF1A1 to WA wall outlets Port 1-24
- Switch 1
- IDF1A2 to WA wall outlets Port 49-97
- To WA
- IDF1-SW3
- To WA
- To WA
- To WA
- SW-1589
- To WA
- PP-AD-29
- SW-1590
- PP-AD-27
- PP-AD-26

5.

Location: Prague > CZU > Ground floor > ER-MDF - Zone Distribution Area (AD)  
 Cabinet: IDF1

Front:

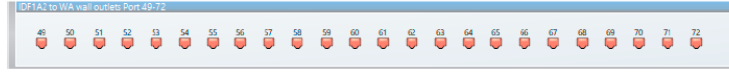

Back side:



	Cable	Component	Port
WA 49 RJ45 Socket	● CPATCH-03264 Patch Cable CAT6 RJ45, green	IDF1 > Switch 1 Cisco Catalyst 9300L-48P-4X	Port 2 RJ45 Socket
WA 50 RJ45 Socket	● CPATCH-03265 Patch Cable CAT6 RJ45, green	IDF1 > Switch 1 Cisco Catalyst 9300L-48P-4X	Port 4 RJ45 Socket
51 RJ45 Socket	● CPATCH-03266 Patch Cable CAT6 RJ45, green	IDF1 > Switch 1 Cisco Catalyst 9300L-48P-4X	Port 6 RJ45 Socket
52 RJ45 Socket	● CPATCH-03267 Patch Cable CAT6 RJ45, green	IDF1 > Switch 1 Cisco Catalyst 9300L-48P-4X	Port 8 RJ45 Socket
53 RJ45 Socket	● CPATCH-03268 Patch Cable CAT6 RJ45, green	IDF1 > Switch 1 Cisco Catalyst 9300L-48P-4X	Port 10 RJ45 Socket
54 RJ45 Socket	● CPATCH-03269 Patch Cable CAT6 RJ45, green	IDF1 > Switch 1 Cisco Catalyst 9300L-48P-4X	Port 12 RJ45 Socket
55 RJ45 Socket	● CPATCH-03270 Patch Cable CAT6 RJ45, green	IDF1 > Switch 1 Cisco Catalyst 9300L-48P-4X	Port 14 RJ45 Socket
56 RJ45 Socket	● CPATCH-03271 Patch Cable CAT6 RJ45, green	IDF1 > Switch 1 Cisco Catalyst 9300L-48P-4X	Port 16 RJ45 Socket
57 RJ45 Socket	● CPATCH-03272 Patch Cable CAT6 RJ45, green	IDF1 > Switch 1 Cisco Catalyst 9300L-48P-4X	Port 18 RJ45 Socket
58 RJ45 Socket	● CPATCH-03273 Patch Cable CAT6 RJ45, green	IDF1 > Switch 1 Cisco Catalyst 9300L-48P-4X	Port 20 RJ45 Socket
59 RJ45 Socket	● CPATCH-03274 Patch Cable CAT6 RJ45, green	IDF1 > Switch 1 Cisco Catalyst 9300L-48P-4X	Port 22 RJ45 Socket
60 RJ45 Socket	● CPATCH-03275 Patch Cable CAT6 RJ45, green	IDF1 > Switch 1 Cisco Catalyst 9300L-48P-4X	Port 24 RJ45 Socket
61 RJ45 Socket	● CPATCH-03276 Patch Cable CAT6 RJ45, green	IDF1 > Switch 1 Cisco Catalyst 9300L-48P-4X	Port 26 RJ45 Socket
62 RJ45 Socket	● CPATCH-03277 Patch Cable CAT6 RJ45, green	IDF1 > Switch 1 Cisco Catalyst 9300L-48P-4X	Port 28 RJ45 Socket
63 RJ45 Socket	● CPATCH-03278 Patch Cable CAT6 RJ45, green	IDF1 > Switch 1 Cisco Catalyst 9300L-48P-4X	Port 30 RJ45 Socket
64 RJ45 Socket	● CPATCH-03279 Patch Cable CAT6 RJ45, green	IDF1 > Switch 1 Cisco Catalyst 9300L-48P-4X	Port 32 RJ45 Socket
65 RJ45 Socket	● CPATCH-03280 Patch Cable CAT6 RJ45, green	IDF1 > Switch 1 Cisco Catalyst 9300L-48P-4X	Port 34 RJ45 Socket
66 RJ45 Socket	● CPATCH-03281 Patch Cable CAT6 RJ45, green	IDF1 > Switch 1 Cisco Catalyst 9300L-48P-4X	Port 36 RJ45 Socket
67 RJ45 Socket	● CPATCH-03282 Patch Cable CAT6 RJ45, green	IDF1 > Switch 1 Cisco Catalyst 9300L-48P-4X	Port 38 RJ45 Socket
68 RJ45 Socket	● CPATCH-03283 Patch Cable CAT6 RJ45, green	IDF1 > Switch 1 Cisco Catalyst 9300L-48P-4X	Port 40 RJ45 Socket
69 RJ45 Socket	● CPATCH-03284 Patch Cable CAT6 RJ45, green	IDF1 > Switch 1 Cisco Catalyst 9300L-48P-4X	Port 42 RJ45 Socket
70 RJ45 Socket	● CPATCH-03285 Patch Cable CAT6 RJ45, green	IDF1 > Switch 1 Cisco Catalyst 9300L-48P-4X	Port 44 RJ45 Socket

6.

Location: Prague > CZU > Ground floor > ER-MDF - Zone Distribution Area (AD)  
 Cabinet: IDF1

Front:

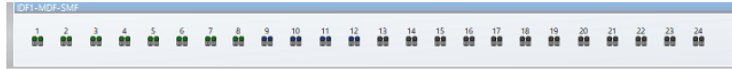

Back side:

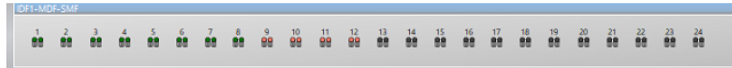

Port	Cable	Component	Port
Port 1 LC Duplex Socket	● FCABLE-00656 line (Fibers: 1, 2) I-V(ZN)H 24E9/125 (12x2E9/125), OS2	MDF > MDF-SMF-ISP-IDF Patch Panel 24 LC, duplex, 1U	Port 1 LC Duplex Socket
Port 2 LC Duplex Socket	● FCABLE-00656 line (Fibers: 3, 4) I-V(ZN)H 24E9/125 (12x2E9/125), OS2	MDF > MDF-SMF-ISP-IDF Patch Panel 24 LC, duplex, 1U	Port 2 LC Duplex Socket
Port 3 LC Duplex Socket	● FCABLE-00656 line (Fibers: 5, 6) I-V(ZN)H 24E9/125 (12x2E9/125), OS2	MDF > MDF-SMF-ISP-IDF Patch Panel 24 LC, duplex, 1U	Port 3 LC Duplex Socket
Port 4 LC Duplex Socket	● FCABLE-00656 line (Fibers: 7, 8) I-V(ZN)H 24E9/125 (12x2E9/125), OS2	MDF > MDF-SMF-ISP-IDF Patch Panel 24 LC, duplex, 1U	Port 4 LC Duplex Socket
Port 5 LC Duplex Socket	● FCABLE-00656 line (Fibers: 9, 10) I-V(ZN)H 24E9/125 (12x2E9/125), OS2	MDF > MDF-SMF-ISP-IDF Patch Panel 24 LC, duplex, 1U	Port 5 LC Duplex Socket
Port 6 LC Duplex Socket	● FCABLE-00656 line (Fibers: 11, 12) I-V(ZN)H 24E9/125 (12x2E9/125), OS2	MDF > MDF-SMF-ISP-IDF Patch Panel 24 LC, duplex, 1U	Port 6 LC Duplex Socket
Port 7 LC Duplex Socket	● FCABLE-00656 line (Fibers: 13, 14) I-V(ZN)H 24E9/125 (12x2E9/125), OS2	MDF > MDF-SMF-ISP-IDF Patch Panel 24 LC, duplex, 1U	Port 7 LC Duplex Socket
Port 8 LC Duplex Socket	● FCABLE-00656 line (Fibers: 15, 16) I-V(ZN)H 24E9/125 (12x2E9/125), OS2	MDF > MDF-SMF-ISP-IDF Patch Panel 24 LC, duplex, 1U	Port 8 LC Duplex Socket
Port 9 LC Duplex Socket	● FCABLE-00656 line (Fibers: 17, 18) I-V(ZN)H 24E9/125 (12x2E9/125), OS2	MDF > MDF-SMF-ISP-IDF Patch Panel 24 LC, duplex, 1U	Port 9 LC Duplex Socket
Port 10 LC Duplex Socket	● FCABLE-00656 line (Fibers: 19, 20) I-V(ZN)H 24E9/125 (12x2E9/125), OS2	MDF > MDF-SMF-ISP-IDF Patch Panel 24 LC, duplex, 1U	Port 10 LC Duplex Socket
Port 11 LC Duplex Socket	● FCABLE-00656 line (Fibers: 21, 22) I-V(ZN)H 24E9/125 (12x2E9/125), OS2	MDF > MDF-SMF-ISP-IDF Patch Panel 24 LC, duplex, 1U	Port 11 LC Duplex Socket
Port 12 LC Duplex Socket	● FCABLE-00656 line (Fibers: 23, 24) I-V(ZN)H 24E9/125 (12x2E9/125), OS2	MDF > MDF-SMF-ISP-IDF Patch Panel 24 LC, duplex, 1U	Port 12 LC Duplex Socket
Port 13 LC Duplex Socket			
Port 14 LC Duplex Socket			
Port 15 LC Duplex Socket			
Port 16 LC Duplex Socket			
Port 17 LC Duplex Socket			