



Bachelor Thesis

Impacts of bio-based microplastics on horizontal gene transfer of antibiotic resistance genes



Bachelor Thesis Assignment Form

Impacts of bio-based microplastics on horizontal gene transfer of antibiotic resistance genes

Name and surname:

Martina Marušková

Identification number:

M21000074

Study programme:

B0719A130001NA – Nanotechnology

Assigning department:

Ústav nových technologií a aplikované informatiky

Academic year:

2023/2024

Rules of Elaboration:

1. Study the theory on horizontal gene transfer and biobased microplastics.
2. Run a horizontal gene transfer experiment with different bioplastic types and Escherichia coli as a donor.
3. Verify the results by various methods such as DNA extraction, qPCR, fluorescence microscopy and flow cytometer.
4. Evaluate the effect of bioplastics on horizontal gene transfer and antibiotic resistance.

Scope of Graphic Work: by appropriate documentation
Scope of Report: 30–40 pages
Thesis Form: printed/electronic
Thesis Language: English

List of Specialised Literature:

- [1] ARIAS-ANDRES, Maria; Uli KLÜMPER; Keilor ROJAS-JIMENEZ a Hans-Peter GROSSART, 2018. Microplastic pollution increases gene exchange in aquatic ecosystems. online. *Environmental Pollution*, roč. 237, s. 253–261. Dostupné z: <https://doi.org/10.1016/j.envpol.2018.02.058>.
- [2] DONG, Han; Yuliang CHEN; Jun WANG; Yue ZHANG; Pan ZHANG et al., 2021. Interactions of microplastics and antibiotic resistance genes and their effects on the aquaculture environments. online. *Journal of Hazardous Materials*, roč. 403, s. 123961. Dostupné z: <https://doi.org/10.1016/j.jhazmat.2020.123961>.
- [3] NGUYEN, Nhung H. A.; Yehia S. EL-TEMSAH; Sebastien CAMBIER; Magdalena CALUSINSKA; Pavel HRABAK et al., 2021. Attached and planktonic bacterial communities on bio-based plastic granules and micro-debris in seawater and freshwater. online. *Science of The Total Environment*, roč. 785, s. 147413. Dostupné z: <https://doi.org/10.1016/j.scitotenv.2021.147413>.
- [4] NGUYEN, Nhung H. A.; Marlita MARLITA; Yehia S. EL-TEMSAH; Pavel HRABAK; Jakub RIHA et al., 2023. Early stage biofilm formation on bio-based microplastics in a freshwater reservoir. online. *Science of The Total Environment*, roč. 858, s. 159569. Dostupné z: <https://doi.org/10.1016/j.scitotenv.2022.159569>.

Thesis Supervisor: Mgr. Nhung H.A. Nguyen, Ph.D.
Ústav pro nanomateriály, pokročilé technologie a inovace

Date of Thesis Assignment: 2023
Date of Thesis Submission: 2024

{Dean of faculty}
Dean

S.S.

{Head of institute}
Head of institute

Liberec {Date of assignment}

Declaration

I hereby certify, I, myself, have written my bachelor thesis as an original and primary work using the literature listed below and consulting it with my thesis supervisor and my thesis counsellor.

I acknowledge that my bachelor thesis is fully governed by Act No. 121/2000 Coll., the Copyright Act, in particular Article 60 – School Work.

I acknowledge that the Technical University of Liberec does not infringe my copyrights by using my bachelor thesis for internal purposes of the Technical University of Liberec.

I am aware of my obligation to inform the Technical University of Liberec on having used or granted license to use the results of my bachelor thesis; in such a case the Technical University of Liberec may require reimbursement of the costs incurred for creating the result up to their actual amount.

At the same time, I honestly declare that the text of the printed version of my bachelor thesis is identical with the text of the electronic version uploaded into the IS STAG.

I acknowledge that the Technical University of Liberec will make my bachelor thesis public in accordance with paragraph 47b of Act No. 111/1998 Coll., on Higher Education Institutions and on Amendment to Other Acts (the Higher Education Act), as amended.

I am aware of the consequences which may under the Higher Education Act result from a breach of this declaration.

{Date of declaration}

Martina Marušková

Impacts of bio-based microplastics on horizontal gene transfer of antibiotic resistance genes

Abstrakt

Rostoucí znečištění životního prostředí mikroplasty (MPs) se stává stále zřejmějším problémem. Tyto MPs infiltrovaly ekosystémy z různých zdrojů, včetně spotřebitelských aktivit, distribučních sítí, průmyslových procesů a odvětví jako jsou stavebnictví, chemický průmysl, doprava a textilní průmysl. Paralelně s tímto jevem dochází také k rychlému nárůstu prevalence antibiotik rezistentních bakteriálních kmenů, představující významné zdravotní riziko zejména pro jedince s oslabeným imunitním systémem jenž prodlužují dobu hospitalizace. Mikroorganismy schopné kolonizovat MPs v prostředí mohou vytvářet biofilmy, usnadňující interakci s antibakteriálními látkami a výběr rezistentních genů. Tyto antibiotické rezistentní geny (ARGs) se pak mohou horizontálně přenášet (HGT) mezi různými mikroorganismy, přispívající k rozšíření fenotypické rezistence napříč mikrobiálními populacemi.

První fáze této studie zahrnovala zkoumání odolnosti čtyř izolovaných bakterií aktivovaného kalu *A. xinjiangensis*, *G. bergerei*, *A. bouvetii* a *R. zophii* vůči antibiotikům (ATBs) AMP, AZM, CRM, CTX, GEN, KAN, PEN, SMX, STR, TET, TMP pomocí zónové inhibice (IZ), přičemž hlavním cílem bylo analyzovat, jak bio-MPs ovlivňují frekvenci HGT. *E. coli* (donor) a *R. zophii* (příjemce) byly společně inkubovány po dobu 48 h s různými bio-MPs (bioHDPE, PHBV, PLA) a konvenčními MPs (HDPE, PET) a s nízkými a vysokými koncentracemi dvou ATBs KAN a TMP. Nízká koncentrace ATBs KAN byla 30 µg/mL a TMP 50 µg/mL, zatímco KAN 45 µg/mL a TMP 75 µg/mL pro vysokou koncentraci. Všechny vzorky byly připraveny v tripletech. Po inkubaci byly vzorky analyzovány pomocí epifluorescenčního mikroskopu, jednotek tvořících kolonie (CFU) a flow cytometru (FCM).

Výsledky zónové inhibice (IZs) ukázaly, že všechny čtyři izolované bakterie byly odolné vůči více ATBs. *A. xinjiangensis* plně odolala SMX, CRX a AZM. *G. bergerei* plně odolala CRX a AZM. *A. bouvetii* plně odolala SMX, CRX a AZM. *R. zophii* plně odolala SMX a AZM. Což znamená, že všechny tyto bakterie mají ARGs pro více ATBs. ARGs jsou potenciálně přenášeny na jiné bakterie, když jsou vystaveny stresovým podmínkám v přítomnosti ATBs. Následující výsledky přenosu ARGs *R. Zophii* v přítomnosti ATBs ukázaly, že vyšší koncentrace ATB získala vyšší přenosovou míru ARGs ve srovnání s nízkou koncentrací. Přenosová míra ARGs byla vyšší u vzorků bio-MP (cPLA > gPLA > bioHDPE > PHBV) ve srovnání s konvenčními MPs (HDPE > PET). Celkově MP z PLA významně ovlivnily zvýšení přenosu ARGs u izolované bakterie *R. zophii*. Studie ukázala, že je naléhavě nutné zkoumat více bio-MPs jako nosiče pro další environmentální znečišťující látky, jako jsou ATBs.

Klíčová slova

Mikroplasty, antibiotika, horizontální přenos genů, antibakteriální rezistentní geny

Impacts of bio-based microplastics on horizontal gene transfer of antibiotic resistance genes

Abstract

The increasing pollution of the environment with microplastics (MPs) is becoming an increasingly evident problem. These MPs infiltrate ecosystems from various sources, including consumer activities, distribution networks, industrial processes, and sectors such as construction, chemical, transportation, and textile industries. Concurrently with this phenomenon, there is also a rapid rise in the prevalence of antibiotic-resistant bacterial strains, posing a significant health threat, especially to individuals with weakened immune systems, and prolonging hospitalisation periods. Microorganisms capable of colonising MPs in the environment can form biofilms, facilitating interaction with antibacterial agents and selection for resistant genes. These antibiotic-resistant genes (ARGs) can then be horizontally transferred (HGT) among different microorganisms, contributing to the spread of phenotypic resistance across microbial populations.

The first phase of this study involved investigating the resistance of four isolated activated sludge bacteria *A. xinjiangensis*, *G. bergerei*, *A. bouvetii* and *R. zophii* to antibiotics (ATBs) AMP, AZM, CRM, CTX, GEN, KAN, PEN, SMX, STR, TET, TMP by the zone inhibition (IZ), while the main goal was to analyse how bio-MPs affect the frequency of the HGT. *E. coli* (donor) and *R. zophii* (recipient) were coincubate for 48 h with various bio-MPs (bioHDPE, PHBV, PLA) and conventional MPs (HDPE, PET) and low and high concentrations of two ATBs KAN and TMP. The low ATB concentration of KAN was 30 µg/mL and TMP 50 µg/mL, while KAN 45 µg/mL and TMP 75 µg/mL for high concentration. All samples were prepared in triplicates. After the incubation, the samples were analysed using an epifluorescence microscope, colony-forming units (CFU) and flow cytometer (FCM).

The results of IZs showed that four isolated bacteria were resistant to multiple ATBs. *A. xinjiangensis* fully resisted SMX, CRX and AZM. *G. bergerei* fully resisted CRX and AZM. *A. bouvetii* fully resisted SMX, CRX and AZM. *R. zophii* fully resisted SMX and AZM. Which means they all have ARGs for multiple ATBs. The ARGs are potentially transferred to other bacteria when they are under stressful conditions in the presence of ATBs. The following results of transferring ARGs of *R. Zophii* in the presence of ATBs showed that the higher ATB concentration gained a higher transfer rate of ARGs compared to the low concentration. The transfer rate of ARGs was higher in bio-MP samples (cPLA > gPLA > bioHDPE > PHBV) compared to conventional MPs (HDPE > PET). Overall, PLA MPs had significantly impacted on increased the transfer of ARGs in the isolated bacterium *R. zophii*. The study showed that there is an urgent need to investigate more bio-MPs acting as vectors for other environmental pollutants such as ATBs.

Keywords

Microplastics, antibiotics, horizontal gene transfer, antibacterial-resistant genes

Acknowledgements

I want to express my sincerest gratitude to all who have assisted me in completing this bachelor's thesis.

This thesis was supported by the Ministry of Education, Youth and Sports of the Czech Republic through the project "Textile-derived microplastics in aquatic ecosystems: identification, characterizations, and effect assessment" under grant agreement No. LUAUS23054. I want to express my sincere gratitude to the Ministry for their financial support, which made this research possible.

First and foremost, I would like to thank Mgr. Nhung Anh Huynh Nguyen, Ph.D., my excellent thesis supervisor, for her constant support, expert guidance, and valuable advice.

I thank Marlita Marlita, M.Sc., my dear laboratory colleague, for her willingness, patience, and valuable contributions to my work.

I cannot forget CXI, the Institute of Nanomaterials, Advanced Technologies, and Innovations in Liberec, especially RNDr. Alena Ševců, Ph.D., and her team from the Department of Applied Biology, for the opportunity to work on my project.

Furthermore, I would like to express my sincere appreciation to The Leibniz Institute of Freshwater Ecology and Inland Fisheries (IGB), mainly to Prof. Dr. Hans-Peter Grossart, for their support and the opportunity to work on my bachelor's thesis.

My colleagues, especially Jaffer Yousuf Dar, deserve special recognition for their valuable assistance and support during the research.

I also must thank my family for their constant moral and financial support, especially my beloved father and grandmother. Special thanks to my friends and partner, who stood by me and encouraged me throughout the process.

Thank you all for the kindness, support, and motivation you provided me while writing this thesis.

Contents

| | | |
|----------|---|-----------|
| 1 | Introduction | 16 |
| 2 | Theory section..... | 17 |
| 2.1 | Conventional plastics..... | 17 |
| 2.2 | Bioplastics (BPs) | 18 |
| 2.3 | Definition of MPs | 20 |
| 2.4 | Behaviour of MPs in the aquatic environment | 21 |
| 2.5 | Antibiotics (ATBs)..... | 23 |
| 2.6 | Horizontal gene transfer (HGT)..... | 24 |
| 2.7 | World ATB resistance | 26 |
| 3 | Materials and Methods | 27 |
| 3.1 | MPs | 27 |
| 3.2 | Bacterial culture..... | 27 |
| 3.3 | ATB | 28 |
| 3.4 | Growth curves of isolated bacteria | 28 |
| 3.5 | Zone of inhibition (IZ)..... | 28 |
| 3.6 | Plastic characterisation using SEM | 30 |
| 3.7 | HGT experiment | 30 |
| 3.7.1 | Plating CTRL | 32 |
| 3.7.2 | Extraction of bacteria on MPs..... | 32 |
| 3.7.3 | Plating bacteria after extraction of bacteria on MPs..... | 33 |
| 3.8 | HGT under epifluorescence microscope..... | 33 |
| 3.9 | Flow cytometer (FCM) | 33 |
| 3.10 | DNA extraction | 35 |
| 3.11 | qPCR..... | 36 |
| 4 | Result and discussion | 36 |
| 4.1 | DNA concentration and qPCR..... | 36 |
| 4.2 | Preliminary experiments | 38 |
| 4.2.1 | Growth curve | 38 |
| 4.2.2 | IZ..... | 40 |
| 4.2.3 | FCM..... | 43 |
| 4.2.4 | SEM | 44 |
| 4.3 | HGT experiment | 48 |
| 4.3.1 | Counting colonies | 48 |

| | | |
|----------|---|-----------|
| | 4.3.2 Counting bacteria green fluorescent signals | 49 |
| 5 | Conclusion..... | 53 |
| 6 | References | 55 |

List of figures

| | |
|---|----|
| <u>Figure 2.1: A graphic representation of plastic production between 2018 and 2022. Adapted from Plastic the facts 2023 (PlasticsEurope, 2023).</u> | 17 |
| <u>Figure 2.2: A graphic representation of BPs production between 2018 and 2022. Adapted from Plastic the facts 2023 (PlasticsEurope, 2023).</u> | 19 |
| <u>Figure 2.3: Plastic sizes according to (Bermúdez and Swarzenski, 2021; Nguyen et al., 2021) and comparison to the aquatic biota.</u> | 21 |
| <u>Figure 2.4: Sources of MPs pollution according to (Du et al., 2021; Wang et al., 2021b).</u> | 22 |
| <u>Figure 2.5: Pathways of ATBs to the environments according to (Manaia et al., 2024).</u> | 24 |
| <u>Figure 2.6: HGT conjugation mechanism. The donor cell carrying a plasmid with antibiotic resistance genes (green arrow) approaches the recipient bacterium (A). A conjugative pilus is formed, through which the duplicated genetic material in the form of the plasmid is transferred to the recipient bacterium (B,C). Subsequently, the bacteria are separated, and the donor cell synthesizes the duplicated genetic material (D). According to (Brito, 2021).</u> | 25 |
| <u>Figure 3.1: Scheme of HGT experiment.</u> | 30 |
| <u>Figure 3.2: Sample illustration. On the left, a diagram for one selected plastic type. On the right, a diagram for the control sample. All samples were prepared in triplicates.</u> | 31 |
| <u>Figure 3.3: Scheme of plating CTRL.</u> | 32 |
| <u>Figure 3.4: Scheme of extraction of bacteria on MPs.</u> | 32 |
| <u>Figure 3.5: Scheme of plating extraction.</u> | 33 |
| <u>Figure 3.6: : Modified protocol from Manual of FastDNA™ SPIN Kit for Soil.</u> | 35 |
| <u>Figure 4.1: Bacterial growth curves by cell density by OD600.</u> | 38 |
| <u>Figure 4.2: <i>A. xinjiangensis</i> growth curve by cell density by OD600.</u> | 38 |
| <u>Figure 4.3: <i>G. bergerei</i> growth curve by cell density by OD600.</u> | 39 |
| <u>Figure 4.4: <i>A. bouvetii</i> growth curve by cell density by OD600.</u> | 39 |
| <u>Figure 4.5: <i>R. zophii</i> growth curve by cell density by OD600.</u> | 39 |
| <u>Figure 4.6: Number of transconjugants by HGT rate using FCM.</u> | 44 |
| <u>Figure 4.7: SEM and measurement from ImageJ, (A) cPLA, (B) gPLA.</u> | 45 |
| <u>Figure 4.8: SEM and measurement from ImageJ, (A) bioHDPE, (B) PHBV.</u> | 45 |
| <u>Figure 4.9: SEM and measurement from ImageJ, (A) PET, (B) HDPE.</u> | 46 |
| <u>Figure 4.10: Results for SEM with bacteria. (A) cPLA, (B) gPLA. The white arrows indicate bacteria on MPs.</u> | 46 |
| <u>Figure 4.11: Results for SEM with bacteria. (A) PHBV, (B) bioHDPE. The white arrows indicate bacteria on MPs.</u> | 47 |
| <u>Figure 4.12: Results for SEM with bacteria. (A) PET, (B) HDPE. The white arrows indicate bacteria on MPs.</u> | 47 |
| <u>Figure 4.13: Graphical evaluation of data from counting ARGs from Table 4.11.</u> | 50 |

List of tables

| | |
|--|----|
| <u>Table 3.1: List of used MPs in this study.</u> | 27 |
| <u>Table 3.2: Table of used ATB concentrations.</u> | 29 |
| <u>Table 3.3: Example of measurement of IZs.</u> | 29 |
| <u>Table 3.4: List of samples.</u> | 31 |
| <u>Table 3.5: List of samples for a flow cytometer.</u> | 34 |
| <u>Table 4.1: Data for DNA concentration [ng/μL]. Average from triplicate.</u> | 37 |
| <u>Table 4.2: Results for qPCR.</u> | 37 |
| <u>Table 4.3: Results of IZ for <i>A. xinjiangensis</i>.</u> | 40 |
| <u>Table 4.4: Results of IZ for <i>G. bergerei</i>.</u> | 41 |
| <u>Table 4.5: Results of IZ for <i>A. bouvetii</i>.</u> | 41 |
| <u>Table 4.6: Results of IZ for <i>R. zophii</i>.</u> | 42 |
| <u>Table 4.7: List of results for flow cytometer [green signals / 15,000]. Transconjugants (green signal) received ARGs from the <i>E. coli</i> donor detected by FCM. LR is free-living bacteria (LR) and bacteria attached on MPs (PR) This experiment was not added ATBs.</u> | 43 |
| <u>Table 4.8: Measurement MP sizes using ImageJ presenting by width (W) and height (H).</u> | 44 |
| <u>Table 4.9: The number of colonies in 30 μL of each sample, which was diluted 200 times.</u> .. | 48 |
| <u>Table 4.10: Recalculation of CFU/mL in the starting/original samples.</u> | 49 |
| <u>Table 4.11: Counting of ARGs of green fluorescent bacteria and present number of cells/mL after 24 h and 1.5 months.</u> | 50 |
| <u>Table 4.12: Table of pictures of the recipient <i>R. zophii</i> having ARGs with the green fluorescence from the donor <i>E. coli</i> after 24 h and 6 weeks. Scale bar is 500 μm.</u> | 51 |

List of abbreviations

| | |
|------------------------|---|
| AMP | Ampicillin |
| AMR | Antimicrobial resistance |
| ARBs | Antibiotics-resistant bacteria |
| ARGs | Antibacterial-resistant genes |
| ATBs | Antibiotics |
| AZM | Azithromycin |
| <i>A. bouvetii</i> | <i>Acinetobacter bouvetii</i> |
| <i>A.xinjiangensis</i> | <i>Algoreiella xinjiangensis</i> |
| bioHDPE | Bio High-density polyethylene |
| bio-MPs | Bio-microplastics |
| BPs | Bioplastics |
| CFU | Colony forming unit |
| cPLA | Cup polylactide |
| CRX | Cefuroxime |
| CTRL | Control sample |
| CTX | Cefotaxime |
| CXI | Institute of Nanomaterials, Advanced Technologies, and Innovations in Liberec |
| EPS | Extracellular polymeric substances |
| <i>E. coli</i> | <i>Escherichia coli</i> |
| FCM | Flow cytometer |
| GEN | Gentamycin |
| <i>G. bergerei</i> | <i>Glutamicibacter bergerei</i> |

| | |
|------------------|--|
| gPLA | Granule polylactide |
| HDPE | High-density polyethylene |
| HGT | Horizontal gene transfer |
| HV | Hydroxyvalerate |
| IZ | Zone of inhibition |
| KAN | Kanamycin |
| MAR | Antibiotic multiple resistant |
| MDR | Multidrug-resistant strains |
| MPs | Microplastics |
| MRSA | Methicillin-resistant <i>Staphylococcus aureus</i> |
| NaCl | Sodium chloride (physiological solution) |
| NPs | Nanoplastics |
| OD | Optical density |
| PBS | Sodium pyrophosphate solution |
| PEN | Penicillin |
| PET | Polyethylene terephthalate |
| PHAs | Polyhydroxy alkanates |
| PHBV | 3 – hydroxybutyrate – co – 3 – hydroxyvalerate |
| PLA | Poly lactide or Polylactic acid |
| <i>R. zophii</i> | <i>Rhodococcus zophii</i> |
| <i>S. aureus</i> | <i>Staphylococcus aureus</i> |
| SEM | Scanning electron microscope |
| SMX | Sulfamethoxa |
| STR | Streptomycin |
| TET | Tetracyclin |

| | |
|-------|---|
| TMP | Trimethoprim |
| TUL | Technická univerzita v Liberci |
| VRE | Vancomycin-resistant <i>enterococci</i> |
| WWTPs | Wastewater treatment plants |

1 Introduction

In today's world, the issue of microplastics (MPs) is becoming increasingly urgent in the field of environmental conservation. MPs, defined as plastic particles smaller than 5 mm, are spreading into various ecosystems and have the potential to impact biodiversity, ecosystem services, and human health negatively. Concurrently, there is a growing problem of antimicrobial resistance (AMR), which has severe implications for public health and the effectiveness of infection treatment (Dong et al., 2021). This study investigates the impact of bio-microplastics (bio-MPs) on the horizontal transfer of genes responsible for antibiotic resistance.

Understanding the mechanisms of horizontal gene transfer (HGT) is crucial for uncovering the extent and consequences of antibiotic (ATB) resistance spread. The main experiment of this study focuses on the transfer of trimethoprim (TMP) and kanamycin (KAN) resistant genes from the donor bacterium *Escherichia coli* (*E. coli*) to the recipient the isolated activated sludge *Rhodococcus zophii* (*R. zophii*). This experiment takes place in an environment created by a biofilm formed on MPs. These MPs include three types of bio-MPs such as PLA, PHBV, and bioHDPE, as two types of conventional plastics HDPE and PET. Studying the influence of MPs on the dynamics of GHT of ATB resistance will provide valuable insights into how bio-based MPs affect interactions between microorganisms and resistance spread. Such data could lead to a better understanding of the impacts of MPs on microbial resistance development and to proposing measures to minimise the adverse effects of this phenomenon on the environment and human health.

This study aims to comprehensively examine the interaction between bio-MPs and bacteria, having antibiotic resistant genes (ARGs). The donor bacteria of fluorescent ARGs and recipient (isolated bacteria) were incubated for 48 h in triplicate, with two (low and high) concentrations of KAN and TMP ATBs. Subsequently, the samples were examined under an epifluorescence microscope, allowing for the observation of the process of resistant gene transfer between bacteria and the formation of biofilm on the surface of MPs. The obtained data will be analysed to identify the influence of different bio-MPs on the frequency and success of HGT of resistance. The study also examined conventional MPs as reference MP controls (CTRL). Understanding these interactions and HGT can provide crucial insights for future environmental protection of bio-MPs, which could provide strategies for combating AMR. This study will contribute to a better understanding of the dynamics of microbial communities in bio-MPs polluted environments and help identify measures leading to a more sustainable future.

2 Theory section

2.1 Conventional plastics

The Encyclopedia Britannica defines plastics as polymeric materials that can be moulded or shaped using pressure or heat. Often, this property is combined with others that are applied in specific fields of application. For example, chemically resistant and lightweight PET bottles are frequently employed (Rodriguez, 2024). Plastics are most commonly made from fossil materials, with their essential components being a high molecular weight polymer chain (Gazal and Gheewala, 2020). Plastics can be divided according to the type of polymer material into thermoplastics and thermosets. A thermoplastic is a plastic that can be reshaped into a different form after heating. This process can be repeated. Conversely, a thermoset hardens after the initial heating and shaping and cannot be further reshaped (Rudin and Choi, 2013).

Due to their wide application, plastic production increases every year. Since 2018, global plastic production has increased by approximately 30 million metric tons (PlasticsEurope, 2023).

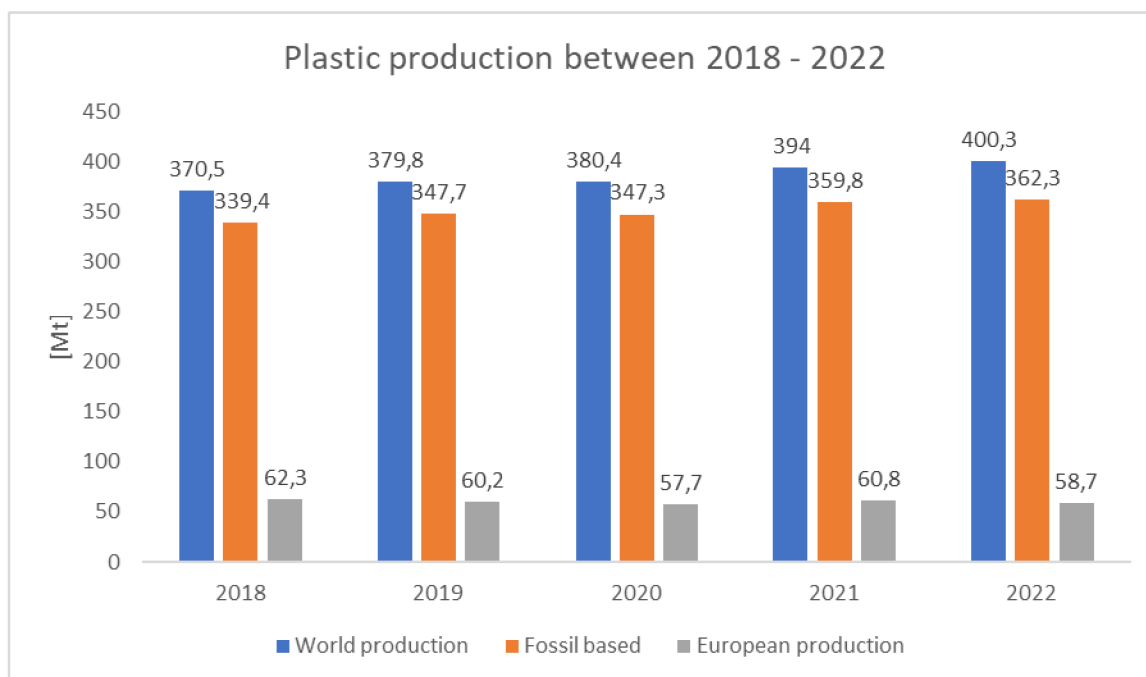

Figure 2.1: A graphic representation of plastic production between 2018 and 2022.

Adapted from Plastic the facts 2023 (PlasticsEurope, 2023).

Industrial and commercial waste, primarily packaging materials, are the most significant contributors to plastic pollution (Gazal and Gheewala, 2020). In 2022, the largest consumer sector in Europe was packaging, accounting for 39% of total plastic consumption. The construction industry followed with 23%. Among the most commonly produced types of plastics were, for example, PP 15.4%, PVC 9.1%, PET 5% (PlasticsEurope, 2023).

PET with recycling number 1 is a linear thermoplastic from the polyester group¹ (Dhaka et al., 2022). PET is one of the most popular plastics due to its chemical resistance, low weight, low production cost, and safety for humans. Its utilisation has expanded from everyday use to specific applications, primarily in the packaging industry, most commonly beverages, films, and fibres for clothing and medical devices (Piccardo et al., 2020). Meanwhile, HDPE with recycling number 2 is a thermoplastic polymer in the form of a linear chain with very little or almost no branching. HDPE is resistant to chemical processes between it and foodstuffs. For this reason, it is widely used in food and drink packaging, specifically milk or butter containers. However, it also finds great use in everyday life, where it is encountered, for example, in the form of water pipes or packaging for cleaning products (Khanam and AlMaadeed, 2015; Kumar et al., 2011).

The unique properties of conventional plastics, along with their cheap production and processing, have caused extreme growth in the production of this material. Alongside the increasing production of plastics, there is a growing imbalance among states between the products manufactured and their ability to handle and recycle them. In 2023, according to plasticovershoot.earth, over 68 million tons of plastic ended up in the environment (plasticovershoot.earth, 2023). However, conventional plastic materials possess a remarkable resistance to degradation, with their longevity extending hundreds to thousands of years depending on various factors such as polymer composition and environmental conditions. Plastics undergo both abiotic and biotic degradation processes, encompassing environmental chemical, physical, and biological reactions. UV radiation predominantly initiates degradation, leading to oxidation and chain scission of polymer structures, thereby generating low molecular weight degradation byproducts and inducing alterations in physicochemical and mechanical properties. The emergence of microplastics (MPs) due to plastic degradation has garnered heightened concern due to their widespread distribution and potential hazards to ecosystems and human health (Zhang et al., 2021).

During degradation, undesirable substances that serve as plastic additives may be released. These substances are often toxic or carcinogenic. Thus, a wide range of risks related to human health are associated with plastic pollution. One such risk, for example, is the adsorption of antibiotics (ATBs) and the formation of antibiotic-resistant bacteria (ARBs). The substitution of conventional plastics with bioplastics may address several of these issues (Manali Shah et al., 2021).

2.2 Bioplastics (BPs)

BPs can be defined as biodegradable material or partially composed of biological material (Atiwesh et al., 2021). Biodegradable materials decompose in the presence of microorganisms, producing water, carbon dioxide, and methane. This process depends on the properties of the specific BPs, such as their thickness or composition (Venkatachalam and Palaniswamy, 2020). Biological material is either partially incorporated into the composition of the BP or constitutes

¹ Polyester is type of synthetic polymer composed of numerous repeating chemical units connected by ester (CO-O) groups (Britannica, 2024a).

it entirely. Renewable carbon sources include potatoes, rice, corn, or wheat starch, such as PLA, PHBV and bioHDPE (Manali Shah et al., 2021).

The increasing production of bioplastics is related to the growing awareness of the environmental impacts of traditional plastics and efforts to replace them with more environmentally friendly alternatives. Bioplastics are made from renewable sources such as plant materials or biomass, making them attractive as an eco-friendly option. Their production can potentially reduce dependence on non-renewable resources and greenhouse gas emissions. Additionally, bioplastics can generate less waste and are often biodegradable, making them even more environmentally favourable. With a growing awareness of the environmental impacts of plastics, more industries are turning to the production of bioplastics as a promising alternative to traditional plastics derived from fossil fuels (Bezirhan and Bilgen, 2015).

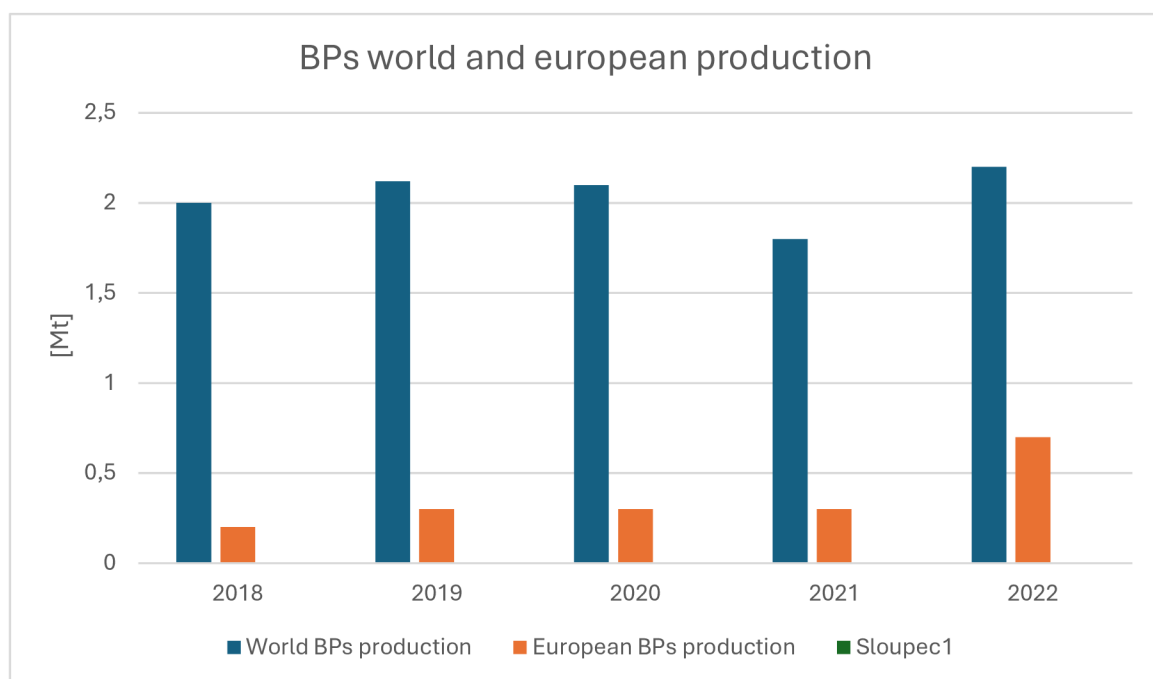

Figure 2.2: A graphic representation of BPs production between 2018 and 2022. Adapted from Plastic the facts 2023 (PlasticsEurope, 2023).

Polylactic acid or polylactide (PLA) is a thermoplastic from the polyester group. By increasing the molecular weight, PLA can take the form of a soft, elastic character to a rigid and complex form. Due to the properties that occur after increasing the molecular weight and the biodegradability factor, PLA is used to replace non-biodegradable plastics. It competes with, for example, PET, PE, and PVC. It is used as packaging material, textiles, and fibres. One of the significant advantages of this plastic is biocompatibility and non-toxic products produced after degradation (Gupta and Kumar, 2007; Nampoothiri et al., 2010).

3-hydroxybutyrate-co-3-hydroxyvalerate (PHBV) is one of the best-known representatives of biodegradable plastics from the group of polyhydroxyalkonates (PHAs) (Mazur et al., 2020).

Most of the physical and mechanical properties depend on the ratio of components in the copolymer². Specifically, the quantity of 3HV units, which, as the number increases, increases the crystallinity and thus facilitates the degradation of PHBV (Policastro et al., 2021; Rivera-Briso and Serrano-Aroca, 2018). PHBV resists UV radiation, water or oils (Brdlík et al., 2022). Thanks to its non-toxicity and biocompatibility with the human body, it is often used in the medical environment for drug delivery, bioimplants, and resorbable applications (Rivera-Briso and Serrano-Aroca, 2018).

Biodegradable high-density polyethylene (bioHDPE) is the resulting product of bio-ethanol polymerisation³, which is obtained through various processes, including biomass fermentation such as vegetable oils or sugarcane. This process allows for the creation of a plastic material with properties similar to traditional HDPE but with the critical feature of biodegradation in natural environments. BioHDPE finds applications primarily in the packaging industry, agriculture, textile manufacturing, and construction, where it represents an environmentally friendly alternative to traditional plastics and contributes to more sustainable use of plastic materials (Burelo et al., 2023; Siracusa and Blanco, 2020).

2.3 Definition of MPs

MPs are defined as particles with solid structures or polymeric matrices. These particles may vary in shape and additives. The size can also vary. Typically, MPs are defined as smaller pieces up to 5 mm – 100 nm (Dong et al., 2021; Wang et al., 2021a). Some articles refer to the size of MPs as less than 130 µm in diameter (Cox et al., 2019). MPs also break down over time, forming nanoparticles (NPs). Defining the precise boundary of sizes between plastic particles is rather challenging. For this reason, data in the literature may vary. Some articles define macroplastics as particles ranging in size from 20 cm to 2 mm (Bermúdez and Swarzenski, 2021). Mesoplastics size is defined as 20 – 5 mm, microsize 1000 – 20 µm and nanosize < 1000 nm (Nguyen et al., 2021).

² High molecular weight substances formed by chemically combining molecules from two or more simple compounds, known as monomers (Britannica, 2021).

³ Chemical process where small molecules, called monomers, combine to form large chainlike or network molecules, known as polymers (Britannica, 2020).

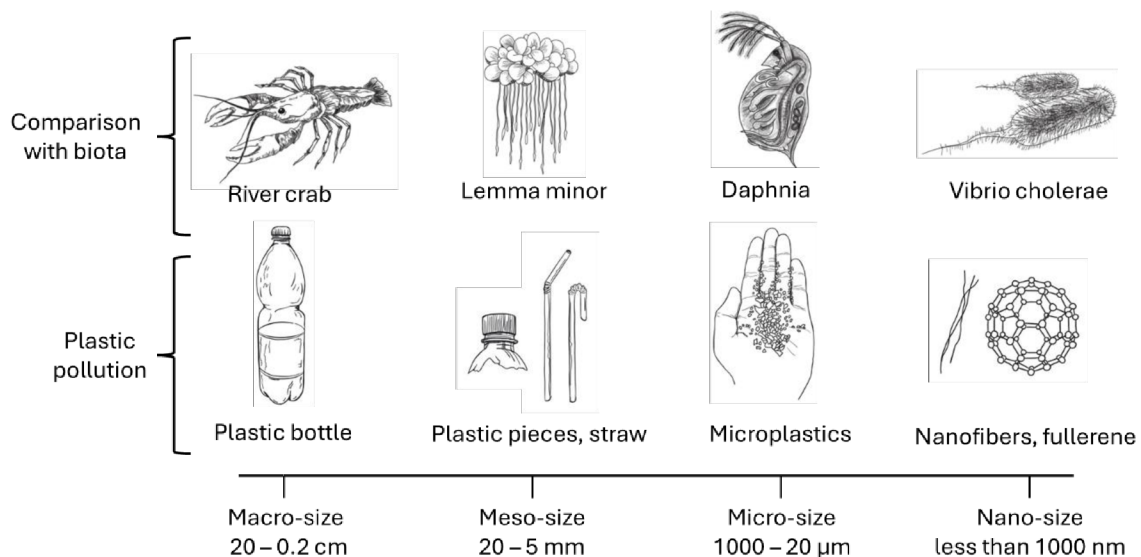

Figure 2.3: Plastic sizes according to (Bermúdez and Swarzenski, 2021; Nguyen et al., 2021) and comparison to the aquatic biota.

According to the mechanism of MPs formation, they are categorised into primary and secondary MPs (Hale et al., 2020). Deliberately manufactured MPs are referred to as primary MPs. Plastics produced in this way are mainly utilised in cosmetic and cleaning products. Consequently, they quickly end up in wastewater. From consumers, they can easily pass through wastewater treatment plants (WWTPs) (Gazal and Gheewala, 2020). Secondary MPs are formed by breaking larger pieces through mechanical wear or environmental influences. They occur in much larger quantities than primary ones and are more commonly found on land, where a greater variety of factors may contribute to the breakdown of the base plastic piece (Hale et al., 2020).

Bio MPs, conversely, are either made from renewable sources like plant materials or are biodegradable, meaning they can degrade and reduce their toxicity over time (Manali Shah et al., 2021; Venkatachalam and Palaniswamy, 2020). Bio-MPs are more attractive to microorganisms, aiding in the degradation process. However, increased colonisation by microorganisms often leads to the formation of biofilms on the plastic surface. These biofilms may harbour pathogenic bacteria and serve as reservoirs for ARGs, which can spread and contribute to ATB treatment failures (Nguyen et al., 2023; Rummel et al., 2017).

2.4 Behaviour of MPs in the aquatic environment

MPs can enter aquatic environments in various forms and from multiple sources. Primary MPs, often found in cosmetic products such as facial scrubs, enter ecosystems through domestic wastewater. Secondary MPs frequently originate from illegal landfills, direct input to the aquatic environment, or terrestrial sources. WWTPs are considered one of the primary MP sources (Wang et al., 2021b). One of the significant sources of MPs in water is the terrestrial ecosystem. Rivers flowing through urban areas or near factories are particularly susceptible to MP contamination. Additionally, pollutants can enter rivers through rainfall, which helps

transport waste on and within the earth's surface. Critical pollution areas include urban areas and farmland (Du et al., 2021).

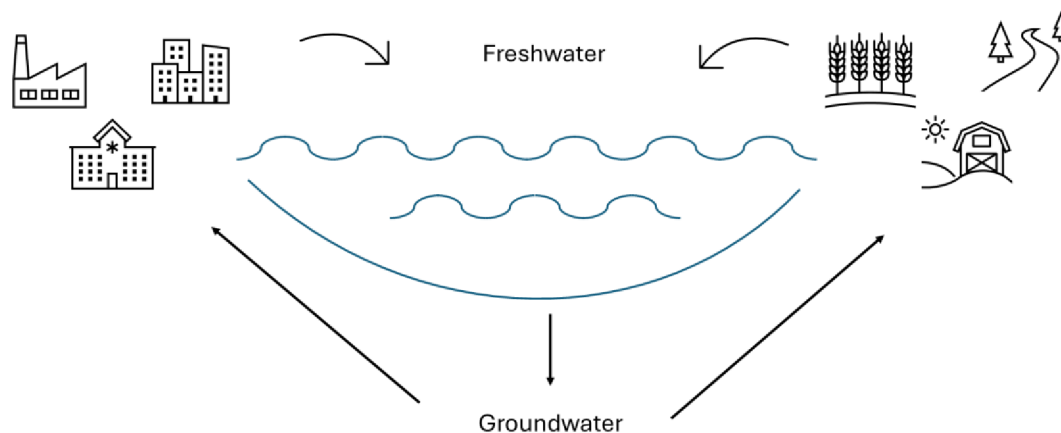

Figure 2.4: Sources of MPs pollution according to (Du et al., 2021; Wang et al., 2021b).

We distinguish two main ways MPs spread in water: horizontal and vertical transport. Horizontal transport occurs in the direction of the watercourse or marine current. Particle movement is influenced by flow velocity, changes in depth, water flow, or wind speed. Vertical movement is associated with sedimentation processes. In this type of movement, the adsorption property of the material is essential, which subsequently affects whether MPs sink to the bottom of the water due to their additional weight (Du et al., 2021).

In aquatic ecosystems, several degradation pathways for plastics exist. These encompass biodegradation facilitated by microorganisms, predominantly through hydrolysis and enzyme catalysis. Photodegradation and thermal degradation are also observed (Du et al., 2021). Throughout these processes, notable alterations in the properties of MPs occur. Specifically, modifications in colour, surface morphology, crystallinity, and density are observed. The density fluctuation within the aquatic environment is frequently attributed to microbial colonisation of MPs (Guo and Wang, 2019).

The colonisation of plastics by bacteria has been identified as the initial stage of biodegradation. Successful colonisation occurs within a few days after entry into freshwater or marine ecosystems (Nguyen et al., 2023). This biofilm type is called a *plastisphere* (Nguyen et al., 2021) or plastic ring. The formation of the biofilm depends on the properties of MPs. Still, generally, it is observed that the rougher the surface, the greater the hydrophobicity of the MPs, leading to increased adhesion of microorganisms (Du et al., 2021). According to the IUPAC, a biofilm is an aggregation of microorganisms. Cells are often embedded within a self-produced matrix of extracellular polymeric substances (EPS) and adhere to each other or a surface. It is a stable system capable of internal adaptation to environmental conditions by its inhabitants. EPS, also called "slime," is a polymeric conglomeration of extra-cellular biopolymers in various structural forms (Vert et al., 2012).

MPs can serve as a shelter for pathogens and act as vectors of diseases in animals and humans. They can absorb organic and inorganic pollutants, including toxic metals, which increases

their ability to transport these substances and affect the environment and human health. Furthermore, it has been found that MPs can carry ARGs and harmful organisms, thereby increasing the risk of exposure for plants, animals, and humans. These findings underscore the urgent need for further research and measures to protect the environment and human health from the negative impacts of MPs (González-Pleiter et al., 2021; Hale et al., 2020; Liu et al., 2021).

2.5 Antibiotics (ATBs)

Since the early 20th century, when the first ATB, Penicillin, was discovered, the use of these drugs has significantly expanded. The main reasons for this expansion are the increasing population and the need to feed it. ATBs are often used as growth promoters or preventive measures against livestock bacterial infections (Kovalakova et al., 2020). AMR is a naturally occurring phenomenon where microorganisms develop resistance to ATBs they were previously susceptible to, making infections more challenging or impossible to treat and increasing the risk of spreading serious infectious diseases and mortality (Mancuso et al., 2021).

The spread of ARBs and the transfer of ARGs among microorganisms pose a significant health concern. Specific populations are particularly vulnerable to infections and complications associated with AMR, such as organ transplant recipients, cancer patients, newborns, and the elderly. Resistant bacteria can disseminate into the environment and transfer their resistance among species and bacterial strains. The emergence of multidrug-resistant strains (MDR) can complicate treatment and require more aggressive forms of care. This phenomenon can potentially increase the burden on healthcare systems and worsen treatment outcomes for affected individuals (Ugoeze et al., 2024). With the increasing use, ATBs are becoming less effective. In 2019, globally, 1.27 million people died due to antibiotic failure. This resistance phenomenon is fueled by inappropriate prescribing of specific ATBs and excessive use of these drugs, even for mild infections (Hyun, 2024).

ATBs are classified into various categories based on their mechanisms of action. One such criterion is their bactericidal or bacteriostatic nature, which relates to their ability to kill bacteria or prevent further growth and multiplication (Kovalakova et al., 2020). Another distinction is their efficacy against gram-negative⁴ or gram-positive⁵ bacteria. There is also a division based on their ability to inhibit protein synthesis or disrupt various components of bacterial cell walls (Ugoeze et al., 2024).

The primary sources from which ATBs enter the environment are livestock farming, industry, community activities, and hospitals. Some ATBs do not fully degrade and may remain active or revert to their original form. Most ATBs administered to subjects (humans or animals) are incompletely metabolised. Thus, they can be excreted in their active form in faeces or urine. From livestock, these drugs can pass through excretory products directly into the environment, reaching wastewater or rivers (Manaiia et al., 2024). ATBs intended for human use are used

⁴ Gram-negative bacteria have thin cell walls surrounded by an outer membrane containing lipopolysaccharide, and they are named for their pink or red staining characteristic in the Gram stain test (Rogers, 2024a).

⁵ Gram-positive bacteria are characterized by a thick peptidoglycan cell wall and the absence of an outer membrane composed of lipopolysaccharides, and they typically stain purple in Gram staining (Rogers, 2024b).

outside hospitals in 80% of cases (Kovalakova et al., 2020). From hospitals and households, they can enter the environment through waste pathways or pass through WWTPs, from where they can escape and often remain uncaught (Manaia et al., 2024). Some studies suggest that up to 70-80% of antibiotics passing through wastewater systems remain unchanged (Kovalakova et al., 2020).

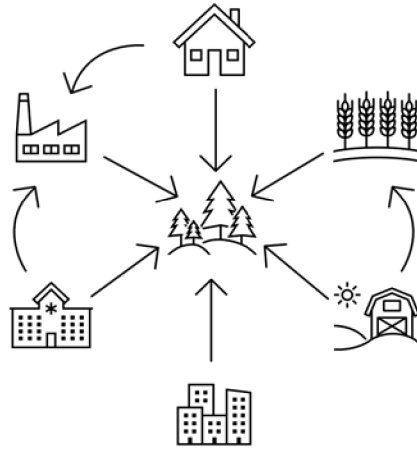

Figure 2.5: Pathways of ATBs to the environments according to (Manaia et al., 2024).

MPs act as vectors for transmitting ARGs. Some studies suggest that antibiotic concentrations around MPs can be up to 5000 times higher than in the surrounding water (Zhang et al., 2020). ATBs can directly influence the emergence and spread of ARGs (Liu et al., 2021). Bacteria naturally produce ATBs as a defence mechanism against other microorganisms or as signalling molecules. Through this mechanism, many species have developed resistance. Bacteria acquire resistance when they acquire plasmids⁶ containing ARGs. Due to the selective pressure created by the natural release of ATBs and their release as unwanted pollutants, plasmids containing ARGs are more common in nature, leading to the spread of ARBs and, in some cases, the emergence of MDR (Jian et al., 2021).

2.6 Horizontal gene transfer (HGT)

ATB resistance is one of the most well-known examples of HGT. This process occurs when bacteria survive exposure to ATBs due to mutations in their genetic material or acquire ARGs from other bacteria through horizontal transfer (Mancuso et al., 2021).

HGT is a significant mechanism enabling the spread of genetic material among organisms outside the traditional vertical transmission from parents to offspring (Burmeister, 2015). This process facilitates the dissemination of genetic information across different species and kingdoms, including bacteria, archaea, and eukaryotic organisms (Boto, 2009).

⁶ A plasmid is an extrachromosomal genetic element in bacteria, consisting of circular DNA that replicates independently from the bacterial chromosome, potentially providing selective advantages (Britannica, 2024d).

There are several mechanisms through which HGT occurs. Among the three basic processes are transformation, transduction, and conjugation. Transformation happens when bacteria uptake DNA from their surrounding environment. Conversely, transduction is mediated by bacteriophages⁷, which transfer DNA from one bacterium to another (Burmeister, 2015).

Conjugation, considered the primary mechanism of HGT, occurs through close cell-to-cell contact (Arias-Andres et al., 2018). In gram-positive bacteria, it is mediated by adhesins, whereas conjugative pili are utilised in gram-negative bacteria (Michealis and Grohmann, 2023). Genetic material is often transferred via plasmids, which can be either circular or linear and are transferred from donor to recipient (Brito, 2021). Following the transfer of genetic material, microorganisms continue to evolve, often resulting in increased resistance (Burmeister, 2015). Another issue is that when plasmids are transferred, not only a single resistant gene may be transferred, but multiple genes, leading to the development of multidrug-resistant bacteria (Abe et al., 2020).

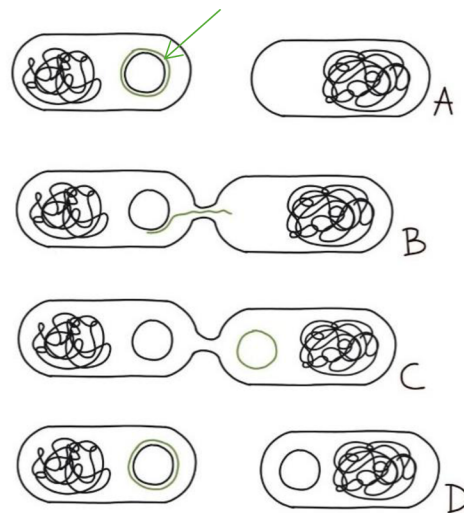

Figure 2.6: HGT conjugation mechanism. The donor cell carrying a plasmid with antibiotic resistance genes (green arrow) approaches the recipient bacterium (A). A conjugative pilus is formed, through which the duplicated genetic material in the form of the plasmid is transferred to the recipient bacterium (B,C). Subsequently, the bacteria are separated, and the donor cell synthesizes the duplicated genetic material (D). According to (Brito, 2021).

As mentioned earlier, bacteria tend to colonise MPs, where they form biofilms. Research indicates that up to 80% of all bacteria reside in biofilms. Due to the abundance of nutrients and proximity within these communities, this situation enhances the likelihood of HGT and the emergence of ARBs (Michealis and Grohmann, 2023). In a recent experiment, a higher frequency of HGT of ARGs among bacteria associated with MPs compared to surrounding water was demonstrated, with a transfer ratio of up to one recipient cell per 46 donor cells on MPs compared to one per 100,000 cells in the water. MPs biofilms are often called hotspots for forming ARGs (Arias-Andres et al., 2018). Another issue is the removal of such biofilms. Bacteria

⁷ Viruses that infect bacteria, and they can also infect single-celled prokaryotic organisms called archaea (Britannica, 2024b).

within biofilms may respond differently to antimicrobial agents, including ATBs, which can thwart therapeutic efforts (Michealis and Grohmann, 2023).

2.7 World ATB resistance

Bacterial resistance to ATBs represents a global challenge in public health with extensive implications for medical practice and healthcare systems. The main contributing factors to this situation include the overuse of ATB, a lack of new therapeutic agents, and inadequate hygiene in healthcare facilities. Resistance is not limited to individual drugs or types of bacteria, and thus, we are witnessing a concerning rise in MDR that withstands a broad spectrum of ATBs (Aslam et al., 2021).

In 2017, the World Health Organization (WHO) classified dangerous resistant pathogens into three categories. The first category with critical priority includes bacteria such as *Acinetobacter baumannii*, *Pseudomonas aeruginosa*, and *Enterobacteriaceae*. Bacteria like *Enterococcus faecium*, *Staphylococcus aureus* (*S. aureus*), and others are classified under high priority. Pathogens with medium priority include *Streptococcus pneumoniae*, *Shigella*, and others (Mancuso et al., 2021).

S. aureus is a gram-positive bacterium that causes damage ranging from minor skin infections to severe diseases such as endocarditis⁸, pneumonia, and sepsis⁹. It is commonly found on the skin of healthy individuals. *S. aureus* is a significant human pathogen, not only due to the diseases it causes but also because of its ability to develop resistance to both old and new ATBs. The first resistant strains emerged against penicillin as early as 1942. These genes are often transferred along with genes resistant to erythromycin and gentamicin. Since the 1950s, methicillin-resistant *S. aureus* (MRSA) has been known. MRSA emerged through HGT and is resistant to methicillin and other antibiotics such as oxacillin, cefazolin, cefotaxime, and others. The spread of this resistant pathogen has been observed worldwide. Various chemotherapeutic agents, radiation therapy, and drug delivery systems with nanocomponents are currently used for their treatment (Mancuso et al., 2021; Nandhini et al., 2022).

Enterococci are gram-positive bacteria, with over 80 species identified. They are among the most common nosocomial infections¹⁰. *Enterococci* are found in various ecosystems, such as soil, water, and human and animal gastrointestinal tract. Vancomycin was one of the primary drugs for *enterococcal* infections. Still, bacteria developed resistance to vancomycin in the 1980s, and since then, vancomycin-resistant *enterococci* (VRE) have spread worldwide, mainly in the form of nosocomial infections. In addition to VRE, other genes are resistant to antibiotics, such as ampicillin, cephalosporins, and aminoglycosides. Infections caused by VRE lead

⁸ Endocarditis is inflammation of the inner layer of the heart caused by microorganisms entering the bloodstream and becoming trapped in the heart (Britannica, 2024c).

⁹ Sepsis is a systemic inflammatory condition that arises as a complication of infection and may be associated with acute and life-threatening organ dysfunction (Rogers, 2024c).

¹⁰ Nosocomial infections are infections acquired during healthcare procedures and not present at the time of admission, encompassing various healthcare settings and including occupational risks for staff (Sikora and Zahra, 2024).

to higher mortality rates and more prolonged and expensive treatment costs (Azzam et al., 2023; Cimen et al., 2023).

3 Materials and Methods

3.1 MPs

Pristine granules and pellets were sourced from I'm Green™ SHA7260 from Brazil (HDPE), Ingeo 3001D from Nature Works in the USA (PLA), and Tianan ENMAT from China (PHBV) (Nguyen et al., 2023). PET was procured from a Coca-Cola bottle obtained from a local retailer, bioHDPE was derived from a yoghurt bottle purchased from a local store, and cup bio-PLA was obtained from commercially available drinking cups.

All MPs beads were generated by milling the granules or pellets in an A11 primary analytical mill manufactured by IKA in Sweden under dry ice (solid nitrogen). Subsequently, the resultant powder underwent sieving to yield samples ranging in size from 200 to 500 μm of HDPE, PHBV, PLA (granules and cups), PET, and bioHDPE (Nguyen et al., 2023).

Table 3.1: List of used MPs in this study.

| Cup PLA (cPLA) | Granule PLA (gPLA) | PHBV | bioHDPE | HDPE | PET |
|-------------------|-----------------------|------|---------|------|-----|
|-------------------|-----------------------|------|---------|------|-----|

3.2 Bacterial culture

In the experiments, *E. coli* was used as the donor of plasmids. This *E. coli* strain was identified with the green fluorescent plasmid pKJK5, which encodes resistance to TMP and KAN. This plasmid system was activated during the plasmid transfer. Specifically, *E. coli* was genetically modified using the gene cassette lacIq-Lpp-mCherry-kmR integrated at the chromosomal site attTn7. As a result, *E. coli* exhibited red fluorescence, and transconjugants exhibited green fluorescence (Arias-Andres et al., 2018).

Four bacteria: *Algoriella xinjiangensis* (*A. xinjiangensis*), *Glutamicibacter bergerei* (*G. bergerei*), *Acinetobacter bouvetii* (*A. bouvetii*), and *Rhodococcus zophii* (*R. zophii*) were isolated from the WWTPs in Liberec 460 01. These bacteria were isolated at the Department of Applied Biology (CXI).

All bacterial strains were incubated overnight in the desired volume of DEV. The cultivation medium consisted of DEV (10 g/L Meat Peptone, 10 g/L Meat Extract, 5 g/L NaCl).

E. coli was grown in a DEV medium supplemented with KAN (50 $\mu\text{g}/\text{mL}$) and TMP (30 $\mu\text{g}/\text{mL}$).

All bacterial incubations were carried out in an incubator at 30 °C on a shaker at 120 rpm (New Brunswick innova 42 incubator shaker, USA). All experiments were conducted within a flow box to prevent contamination (SafeFAST Classic).

3.3 ATB

All ATBs used during this experiment (AMP, AZM, CRX, CTX, GEN, KAN, PEN, SMX, STR, TET, and TMP) were ordered from Sigma-Aldrich® via the Merck website.

3.4 Growth curves of isolated bacteria

Precultures of four selected bacteria, specifically *A. xinjiangensis*, *G. bergerei*, *A. bouvetii* and *R. zophii*, were prepared. Overnight cultures were incubated at an optimal temperature of approximately 30 °C. Following the incubation, bacterial optical density (OD) was measured using a UV-vis spectrophotometer (Hach Lange DR6000, Germany) instrument with a wavelength of 600 nm throughout the whole experiment. The necessary volume to achieve a resulting concentration of 0.01 was calculated using the formula $c1 \times v1 = c2 \times v2$, with the remaining suspension consisting of liquid DEV. Triplicates were prepared for each bacterium.

Subsequently, after vortexing, 1 mL aliquots were withdrawn from each sample, and OD600 was remeasured. Sampling commenced 2 h after the start of the experiment, resulting in sampling times of 2 h, 4 h, 6 h, 8 h, 10 h, 24 h and 48 h.

The results were processed, and graphs were made using Excel.

3.5 Zone of inhibition (IZ)

Dilution series were prepared for 11 different ATBs. This dilution series was created to investigate the effectiveness of individual antibiotics against specific bacterial strains and to identify the minimum inhibitory concentration, which is the lowest concentration of antibiotic that still effectively inhibits bacterial growth. The series commenced with the highest working concentration (H.), and serial two-fold dilution was prepared. Each antibiotic was subsequently diluted in this manner four times. The subsequent and final concentrations are utilised as the respective ATB minimum inhibitory concentration (L.). The lowest concentration refers to minimum inhibitory concentration (MIC). It is the lowest concentration of ATB and completely prevents visible growth of the test strain of an organism under in vitro conditions. MIC is a standard method used to assess the susceptibility of bacteria to various antimicrobial agents and can be applied to a wide range of microorganisms (Kowalska-Krochmal and Dudek-Wicher, 2021).

Table 3.2: Table of used ATB concentrations.

| ATB | H. [$\mu\text{g/mL}$] | 1. [$\mu\text{g/mL}$] | 2. [$\mu\text{g/mL}$] | 3. [$\mu\text{g/mL}$] | 4. [$\mu\text{g/mL}$] |
|-----|-------------------------|-------------------------|-------------------------|-------------------------|-------------------------|
| AMP | 30 | 15 | 7.5 | 3.75 | 1.875 |
| CTX | 50 | 25 | 12.5 | 6.25 | 3.125 |
| STR | 25 | 12.5 | 6.25 | 3.125 | 1.5625 |
| GEN | 5 | 2.5 | 1.25 | 0.625 | 0.3125 |
| TET | 60 | 30 | 15 | 7.5 | 3.75 |
| SMX | 60 | 30 | 15 | 7.5 | 3.75 |
| PEN | 10 | 5 | 2.5 | 1.25 | 0.625 |
| CRX | 30 | 15 | 7.5 | 3.75 | 1.875 |
| AZM | 60 | 30 | 15 | 7.5 | 3.75 |
| KAN | 50 | 25 | 12.5 | 6.25 | 3.125 |
| TMP | 30 | 15 | 7.5 | 3.75 | 1.875 |

Agar plates were labelled with designated locations for each concentration. Four plates were prepared for each ATB, and bacteria *A. xinjiangensis*, *G. bergerei*, *A. bouvetii* and *R. zophii* were subsequently inoculated using cotton swabs. Various concentrations of ATB were pipetted onto specific spots, each in volume of 5 μL . All samples were placed in the NAME incubator at 30 °C overnight.

The following day, IZs were measured using a ruler. A commercial ruler with centimetre and millimetre scales was used, and the ruler's error was determined to be 0.05 cm.

Table 3.3: Example of measurement of IZs.

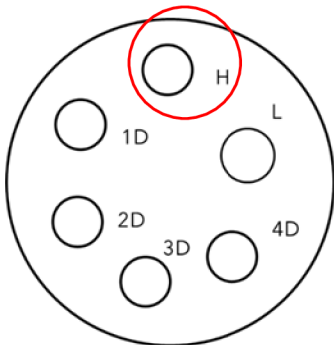
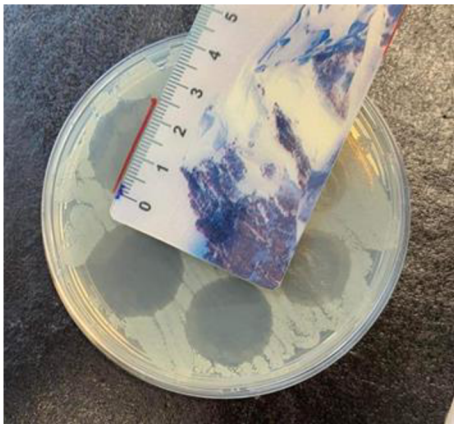
| Labels on agar plates | Measurement of IZs using a ruler |
|---|--|
|  |  |

3.6 Plastic characterisation using SEM

Part of the examined MPs were individually sterilised under a UV lamp for at least one hour. Subsequently, using a micro spatula, some samples were transferred onto discs. As part of the SEM accessories, these discs were equipped with double-sided adhesive tape to secure the particles.

The prepared samples were then placed into a vacuum chamber, an integral part of the SEM. They were coated with a thin layer of platinum film on tens of nm, and then transferred to the sample chamber.

Samples were photographed at various magnifications tailored to the distribution and size of individual MPs. The most common magnification was 100 times, except for cPLA particles, which required magnification up to 2500 times. Individual photographs were analysed using the ImageJ program.

Bacteria attached to MPs were observed under SEM, regularly operated by the expert Ing. Pavel Kejzlar, PhD in CXI. MPs were placed on discs and equipped with double-sided adhesive tape to secure the particles. The prepared samples were then placed into a vacuum chamber, an integral part of the SEM. They were coated with a thin layer of platinum film on tens of nm. Then, they were transferred to the sample chamber. Samples were photographed at various magnifications tailored to the distribution and size of individual MPs. The most common magnification was 100 times, except for cPLA particles, which required magnification up to 2500 times. Individual photographs were analysed using the ImageJ program.

3.7 HGT experiment

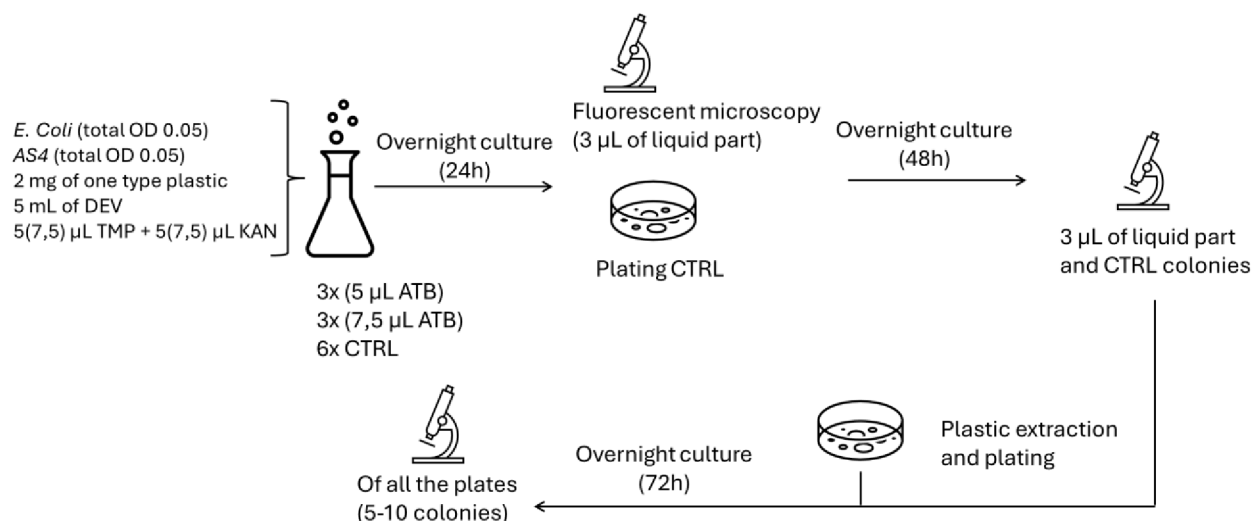

Figure 3.1: Scheme of HGT experiment.

Glass vials contained 2 mg of each type of MPs. The vials were sterilised by UV for 1h. Then, 5 mL of DEV medium was pipetted into each vial. The bacterial overnight cultures

E. coli and *R. zophii* were measured the OD600, then was calculated using the same formula above ($c_1v_1=c_2v_2$) to obtain an OD600 of 0.05 in the final working volume of 5 mL in the experiments.

After adding ATBs, 5 μ L of KAN and 5 μ L of TMP were added for low concentrations (50 μ g/mL KAN, 30 μ g/mL TMP), and 7.5 μ L of KAN and 7.5 μ L TMP were added for high concentrations (75 μ g/mL KAN, 45 μ g/mL TMP). All of these procedures were carried out within the flow box facility.

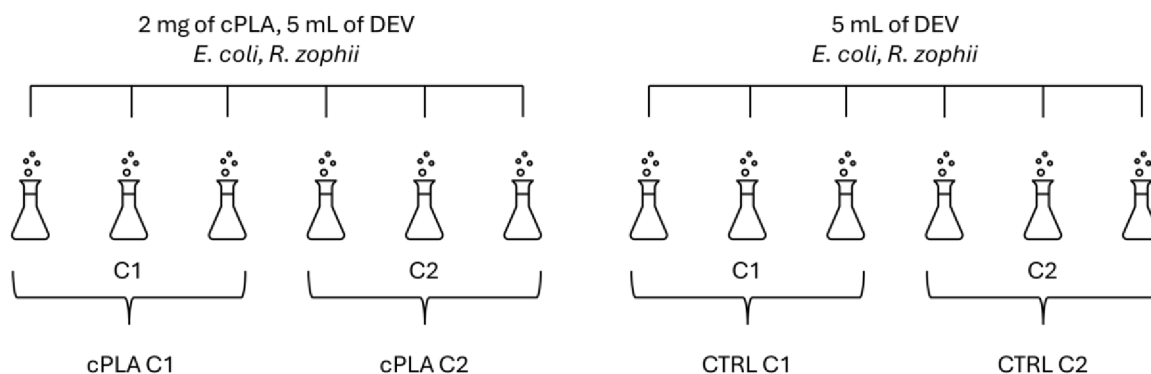

Figure 3.2: Sample illustration. On the left, a diagram for one selected plastic type. On the right, a diagram for the control sample. All samples were prepared in triplicates.

Similarly, control (CTRL) samples were prepared with low and high concentrations of ATBs without adding MPs. All samples were in triplicates.

All completed samples were incubated in (New Brunswick innova 42 incubator shaker, USA) for 48h at 30 °C.

Table 3.4: List of samples.

| BPs | | | | | Conventional plastics | |
|---------|---------|---------|------------|---------|-----------------------|---------|
| cPLA | gPLA | HDPE | bioHDPE | PHBV | PET | CTRL |
| cPLA C1 | gPLA C1 | HDPE C1 | bioHDPE C1 | PHBV C1 | PET C1 | CTRL C1 |
| cPLA C2 | gPLA C2 | HDPE C2 | bioHDPE C2 | PHBV C2 | PET C2 | CTRL C2 |

Example: cPLA C1 is the first replicate in triplicate of cPLA samples of low ATB concentration (50 μ g/mL of KAN + 30 μ g/mL of TMP) and C2 is for high concentration (75 μ g/mL of KAN + 45 μ g/mL of TMP).

3.7.1 Plating CTRL

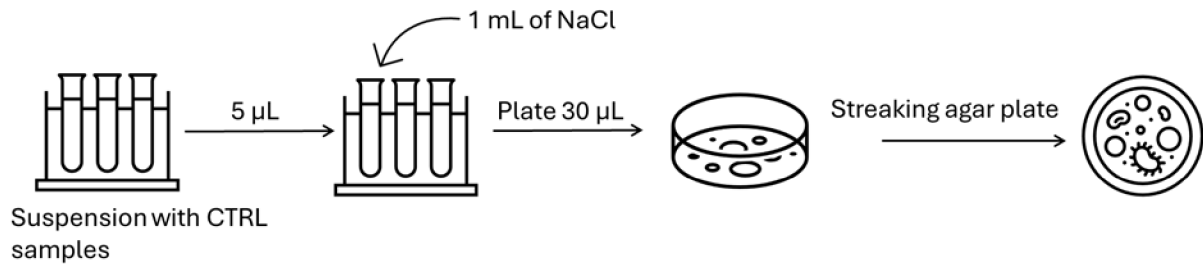

Figure 3.3: Scheme of plating CTRL.

After 48 h of incubation, the CTRL samples were inoculated onto agar plates NAME. The suspension was mixed using a vortex, and 5 μL was withdrawn into an Eppendorf tube. After that, 1 mL of physiological solution, serving for dilution, was added. The dilution was 200 times. So, the colonies could be countable on the plates (not so crowded).

Subsequently, the sample was vortexed again, and a volume of 30 μL was pipetted onto a Petri dish. The suspension was inoculated onto the plates using a sterile glass hockey stick. These samples were incubated for 24 h in an incubator (New Brunswick innova 42 incubator shaker, USA) at 30. Colonies were counted and calculated.

3.7.2 Extraction of bacteria on MPs

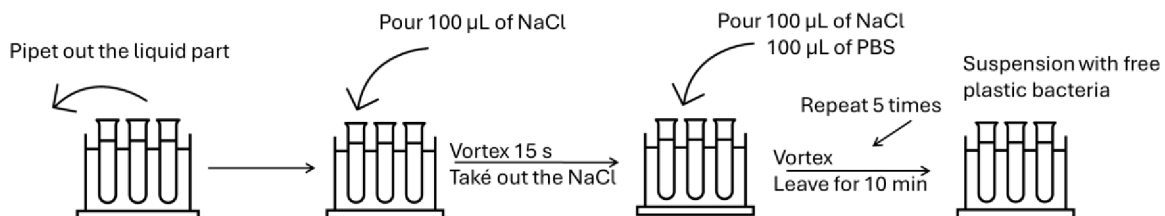

Figure 3.4: Scheme of extraction of bacteria on MPs.

After 48 h, MPs were carefully pipetted from the samples and transferred to clean Eppendorf tubes. Then, liquid medium phases were removed using a pipette to retain only MPs. Subsequently, 100 μL of 0.9 % NaCl was added to each sample to rinse the MPs and vortex.

The last step was to add 100 μL of 0.9 % NaCl and 100 μL sodium pyrophosphate solution (PBS). Samples were vortexed for approximately 20 s and then left for 5 min. This cycle was repeated 5 times to release bacteria from the biofilm.

3.7.3 Plating bacteria after extraction of bacteria on MPs

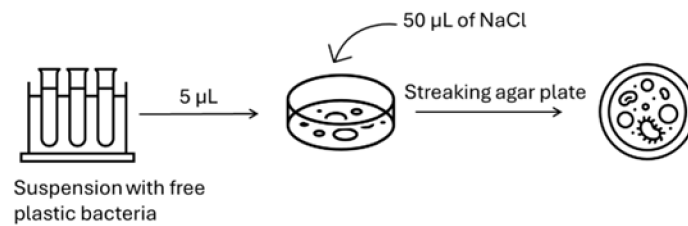

Figure 3.5: Scheme of plating extraction.

From the liquid phase of samples containing bacteria from the original biofilms, 5 μL was extracted and transferred onto an agar. 50 μL of 0.9 % NaCl was pipetted onto the same agar plate to prevent the sample from drying out. Plates were incubated in the same condition as the exposure at 30 C for 24 h, then (1) colonies were counted and calculated; (2) green fluorescent transconjugants were counted in colonies.

3.8 HGT under epifluorescence microscope

After 24 h incubation, a colony on each plate was scratched and placed onto a microscopic slide. Distilled water was utilised as the dilution medium. Several colonies were chosen to take pictures and count a number of transconjugants with green fluorescence.

The prepared slide was observed under the Axio Imager epifluorescence microscope (Zeiss, Germany). Two channels, the green AF488 and the red Cy3 channels, were employed for observation.

The plates were kept in a fridge, and transconjugants in colonies were taken and counted after 1.5 months. The reason was the persuasion that the bacteria could transfer ARGs more effectively in plates, where the assumption was that the bacteria could more effectively transfer ARGs on plates that were close to each other.

3.9 Flow cytometer (FCM)

As a bachelor's student, it was my first step in the research field. I was guided to go to the Leibniz Institute of Freshwater Ecology and Inland Fisheries (IGB) in the Forschungsverbund Berlin e.V. in March 2023 to learn the method and understand HGT. For this study, *E. coli* bacteria were selected as donors and *Pseudomonas* sp. as recipients, with *Pseudomonas* sp. isolated from Lake Stechlin in Germany by IGB researchers. A colleague, Ph.D. student Jaffer Yusuf from IGB, guided the FCM process.

The experimental procedure was designed analogously to the methodology used in studies of HGT. Bacteria were incubated in a suspension containing DEV medium and a mixture of specific types of MPs, with a donor-to-recipient ratio of 1:10. The types of plastics used included chitosan, PET, cPLA, gPLA, bioHDPE, HDPE, and PHBV. Every treatment was prepared in quintuplicate, including the CTRL, which contained only the medium and bacteria.

Each test tube was filled with 10 mL of DEV medium, 10 μ L of *E. coli*, and 100 μ L of *Pseudomonas*. Additionally, 2 mg of the selected type of MPs were added. Notably, no ATBs were added in this experiment.

These samples were then incubated for 48 h in an incubator at a stable temperature of 30 °C. After the incubation period, MP extraction was performed according to the procedure described in chapter 3.7.2, "Extraction of bacteria on MPs."

The samples were subsequently partitioned into sets delineated as the free-living bacteria (LR) and the attached bacteria on MPs (PR). All samples were then subjected to measurement using a flow cytometer.

From the resulting homogeneous suspension containing released bacteria from the biofilm, 300 μ L were transferred to a cuvette, to which 300 μ L of PBS was added. These filled cuvettes were then placed in a flow cytometer for further analysis. The number of events was set to 15,000.

Table 3.5: List of samples for a flow cytometer.

| CTRL | gPLA | cPLA | PHBV | bioHDPE | HDPE | PET | Chitosan |
|------------------|------------------|------------------|------------------|------------------|------------------|------------------|------------------|
| LR (5 \times) | LR (5 \times) | LR (5 \times) | LR (5 \times) | LR (5 \times) | LR (5 \times) | LR (5 \times) | LR (5 \times) |
| | PR (5 \times) | PR (5 \times) | PR (5 \times) | PR (5 \times) | PR (5 \times) | PR (5 \times) | PR (5 \times) |

3.10 DNA extraction

DNA extraction was performed after the extraction of MP plastics, at which point bacteria were released into the liquid environment in the Eppendorf tubes from the biofilm on the surface of MPs. For this purpose, the FastDNA™ SPIN Kit was used following the manufacturer's protocol.

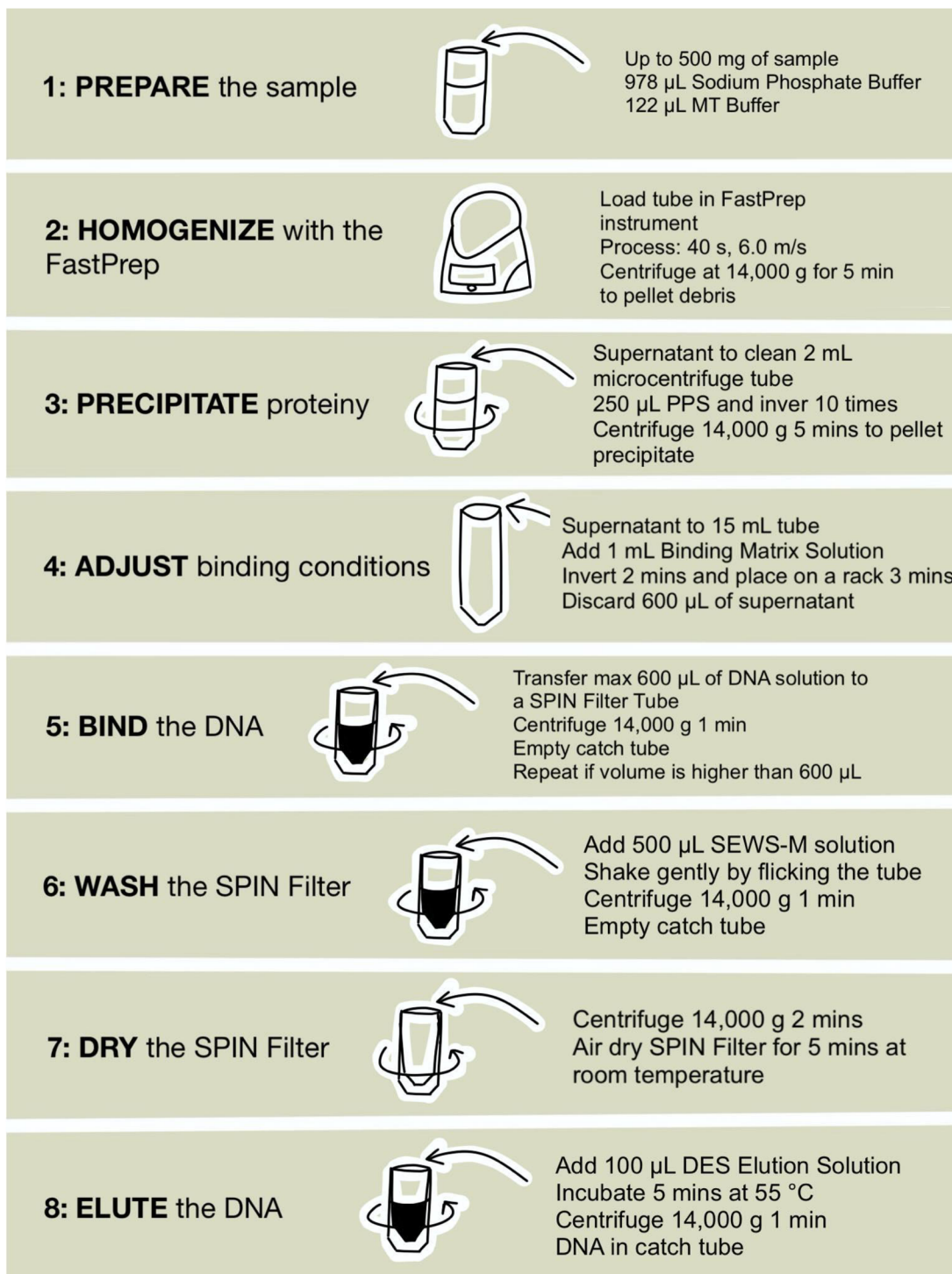

Figure 3.6: : Modified protocol from Manual of FastDNA™ SPIN Kit for Soil.

The extracted DNA from individual samples was measured in DNA concentration (DeNovix DS-11 Spectrophotometer/Fluorometer Series, USA). After selecting the program for DNA concentration measurement, 1 μL of each sample was applied to the respective location, and the instrument measured the concentration.

3.11 qPCR

All samples were diluted to achieve a DNA concentration of up to 4 ng/mL using dH_2O . Two primer pairs, 16S rRNA (F-5' CCTACGGGAGGCAGCAG, R-5' ATTACCGCGGCTGCTGG and OmpA (F-5' GGATGATAACGAGGCGCAA, R-5' CAACCAGATGTCTAC-GCTGAAG), were employed for qPCR analysis. A qPCR reaction mix was prepared for each primer. Each reaction for individual primer-sample combinations had a volume of 10 μL , comprising 3.6 μL of qPCR H_2O , 5 μL of Sybr Mix, 0.4 μL of primer (16S or OmpA), and 1 μL of the respective DNA sample.

The 16S rRNA primer pair was used as a reference gene, while OmpA is an outer membrane pore protein gene that plays an important role in controlling membrane permeability and membrane transport of ARGs (Mishra et al., 2020).

qPCR was conducted using a 96-well plate loaded into the LightCycler 480 instrument (Roche, Basel, Switzerland). A colleague from CXI, Ph.D. student Marlita Marlita, in collaboration with a colleague from IGB, Ph.D. student Jaffer Yusuf, optimized this specific type of analysis.

4 Result and discussion

The topic represents a largely underexplored area within environmental toxicology. While it is established that MPs exert significant ecological impacts, their specific interactions with microbial communities and potential role in HGT remain elusive. This study was devised to address this research gap and advance our understanding of this domain. The initial phase of the work involved experimental familiarisation with microbial cultures, followed by the main experiment to analyse the influence of bio-MPs on the HGT of ARGs.

4.1 DNA concentration and qPCR

Unfortunately, this methodology has been excluded from the experiment due to the lack of correspondence between these results and any previously examined outcomes, as it would require significant modifications for potential future use.

The tested primers often proved incompatible and were not easily modified for this type of experiment. Modifying and subsequently monitoring specific primers during qPCR would have been time-consuming.

Nevertheless, partial results are available, specifically regarding the quantity of extracted DNA from the samples and one set of qPCR data.

Table 4.1: Data for DNA concentration [ng/ μ L]. Average from triplicate.

| | | | |
|---------|----------------|---------|----------------|
| CTRL C1 | 132 \pm 53 | PHBV C1 | 18 \pm 4 |
| CTRL C2 | 144 \pm 9 | PHBV C2 | 18 \pm 5 |
| cPLA C1 | 8.9 \pm 0.5 | HDPE C1 | 15.1 \pm 1.2 |
| cPLA C2 | 8.1 \pm 0.3 | HDPE C2 | 17 \pm 0.7 |
| gPLA C1 | 10.3 \pm 0.5 | PET C1 | 10 \pm 0.7 |
| gPLA C2 | 9.7 \pm 0.5 | PET C2 | 9 \pm 3 |

The results of DNA extraction show that the control samples contained higher DNA concentrations. These higher results are attributed to the isolation of DNA from bacteria that were freely present in the aquatic environment, known as free-living bacteria, whereas other DNA concentrations were isolated from bacteria settled in biofilm on MPs.

Table 4.2: Results for qPCR.

| Name | Average Cp | Name | Average Cp |
|------------------|------------|------------------|------------|
| PET C1 (16S) | 18.65 | PET C1 (OmpA) | 6.22 |
| PET C2 (16S) | 20.06 | PET C2 (OmpA) | 6.69 |
| cPLA C1 (16S) | 20.45 | cPLA C1 (OmpA) | 10.23 |
| cPLA C2 (16S) | 27.36 | cPLA C2 (OmpA) | 13.68 |
| gPLA C1 (16S) | 18.73 | gPLA C1 (OmpA) | 9.37 |
| gPLA C2 (16S) | 22.15 | gPLA C2 (OmpA) | 11.08 |
| CTRL C1 (16S) | 13.48 | CTRL C1 (OmpA) | 1.93 |
| CTRL C2 (16S) | 13.37 | CTRL C2 (OmpA) | 1.91 |
| bioHDPE C1 (16S) | 23.99 | bioHDPE C1(OmpA) | 7.99 |
| bioHDPE C2 (16S) | 25 | bioHDPE C2(OmpA) | 8.33 |
| PHBV C1 (16S) | 21.67 | PHBV C1 (OmpA) | 7.22 |
| PHBV C2 (16S) | 21.57 | PHBV C2 (OmpA) | 7.19 |

The Crossing Point (CP) is the number of PCR cycles at which the fluorescence signal reaches a specified level, indicating the beginning of the exponential amplification phase. A higher CP value usually indicates a lower initial amount of target DNA in the sample.

Comparing CP values between different samples reveals significant differences in the expression of genes 16S and OmpA. Samples with higher CP values may indicate less genetic material, including transferred genetic material among bacteria.

Samples such as cPLA C2 exhibit significantly higher CP values for both examined genes compared to other samples. This may suggest a lower initial amount of target DNA and potentially a smaller amount of genetic material, including possible transferred genetic material.

4.2 Preliminary experiments

4.2.1 Growth curve

Based on the measured data, it is evident that bacteria *A. bouvetii*, *A. xinjiangensis*, *G. bergerei*, and *R. zophii* exhibit different growth dynamics over time. Bacterium *R. zophii* demonstrated the most significant growth activity, reaching significantly higher OD600 values than other cultures. This indicates a high capacity for this culture's growth and proliferation.

The results show that all bacteria had similar OD600 values of 0.1 after 6 h, except *A. bouvetii*. All bacterial growth continued increasing after 24 h with an OD600 of 0.4. Furthermore, *R. zophii* grew rapidly with the highest cell density of 1.3 after 48 h. Based on this high-growth activity, the bacterium *R. zophii* was selected for further analysis.

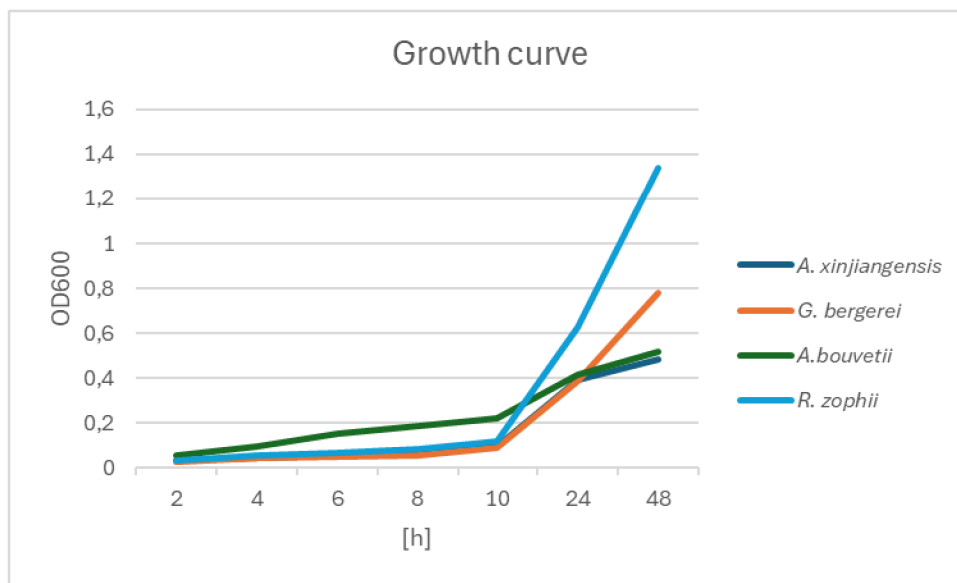

Figure 4.1: Bacterial growth curves by cell density by OD600.

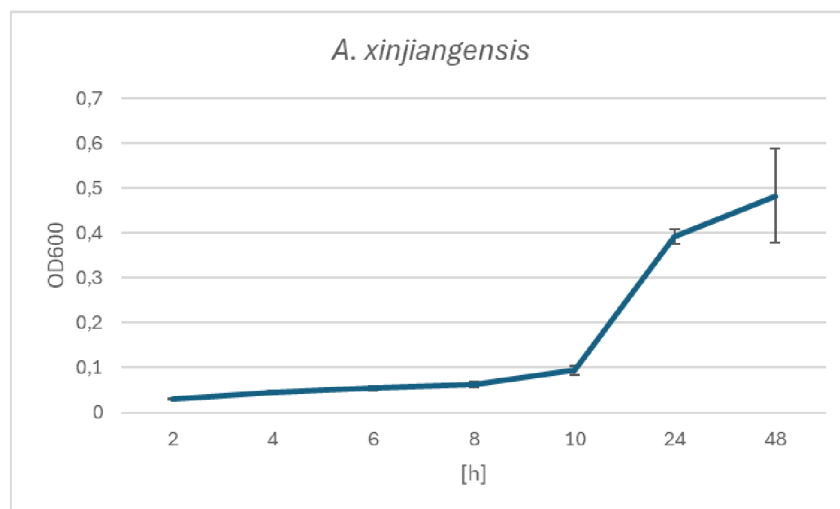

Figure 4.2: *A. xinjiangensis* growth curve by cell density by OD600.

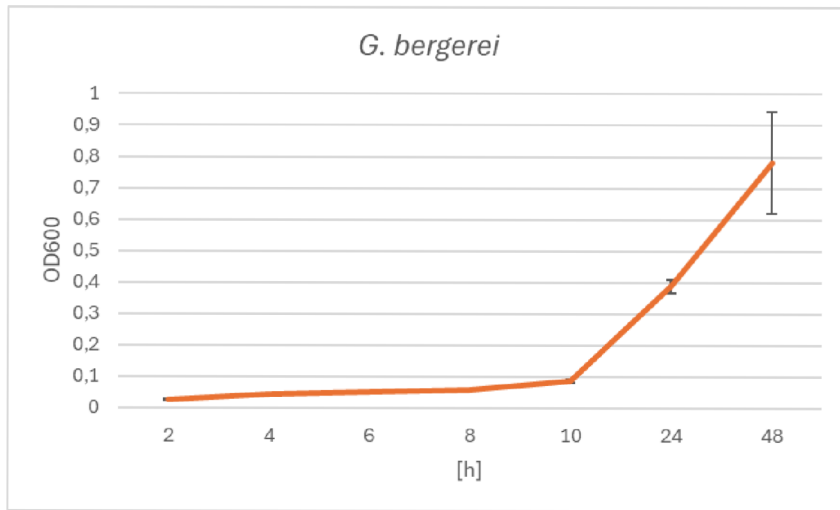

Figure 4.3: *G. bergerei* growth curve by cell density by OD600.

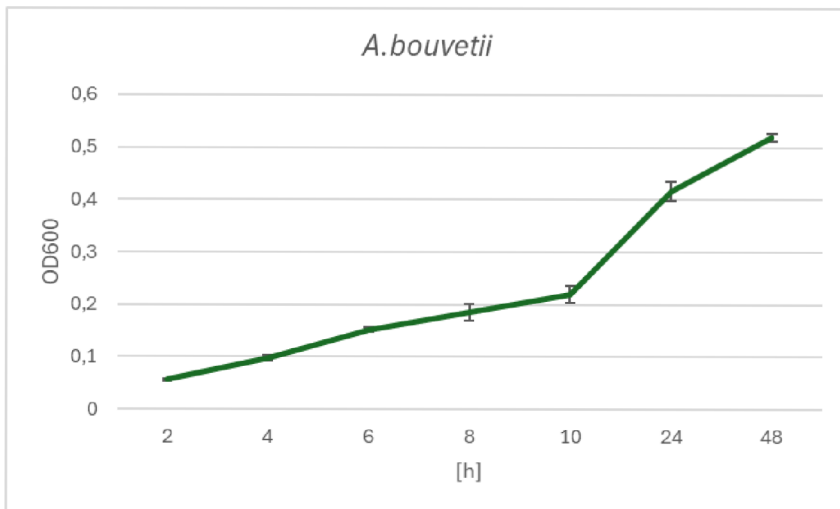

Figure 4.4: *A. bouvetii* growth curve by cell density by OD600.

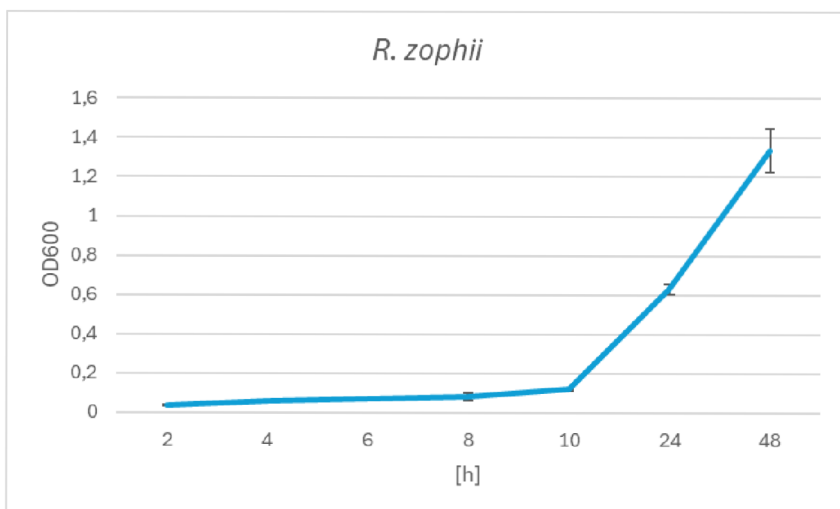

Figure 4.5: *R. zophii* growth curve by cell density by OD600.

4.2.2 IZ

This experiment was conducted to determine which bacterial cultures exhibit resistance to specific ATBs. The experimental procedure is detailed in Chapter 3.5, where the methods and procedures are thoroughly described. The results of an individual bacterium are presented in tables, where the symbol "X" indicates the absence of an inhibition zone, which means bacteria are resistant to ATBs. The symbol "∞" denotes the presence of a large inhibition zone in the tested ATB concentrations, which means bacteria were not resistant to ATBs. The large IZ could not be precisely measured in test conditions. This experiment should be redone on a larger plate. However, it was not the aim of this study. When bacteria resist many ATBs, they are considered multiple ATB-resistant (MAR) bacteria, as our results show for all bacteria.

All bacteria were MAR and resisted all tested ATBs (yellow lines) with different concentrations. Their resistance is in the order of *A. xinjiangensis* (fully: SMX, CRX, AZM; partially: GEN, TET, PEN, KAN, TMP) > *A. bouvetii* (fully: SMX, CRX, AZM; partially: AMP, TET, TMP) > *R. zophii* (fully: SMX, AZM; partially: PEN, TMP) > *G. bergerei* (fully: CRX, AZM; partially: SMX).

R. zophii exhibited low resistance to the antibiotics TMP and KAN. This factor, along with the high growth rate demonstrated by the growth curve results of this bacterium (figure 4.5), led to the selection of *R. zophii* as the recipient bacterium for donor *E. coli*.

Table 4.3: Results of IZ for *A. xinjiangensis*.

| ATB | H. [cm] | 1. [cm] | 2. [cm] | 3. [cm] | 4. [cm] |
|-----|------------|------------|------------|------------|------------|
| AMP | 2.5 ± 0.05 | 2 ± 0.05 | 1.3 ± 0.05 | 1.2 ± 0.05 | 0.9 ± 0.05 |
| CTX | 3.5 ± 0.05 | 2.5 ± 0.05 | 2.3 ± 0.05 | 2 ± 0.05 | 2 ± 0.05 |
| STR | 2.5 ± 0.05 | 1.7 ± 0.05 | 1.5 ± 0.05 | 1 ± 0.05 | 0.5 ± 0.05 |
| GEN | 1.5 ± 0.05 | 1 ± 0.05 | X | X | X |
| TET | 2 ± 0.05 | 1.5 ± 0.05 | 1.2 ± 0.05 | X | X |
| SMX | X | X | X | X | X |
| PEN | 3 | 2 | 1.5 | X | X |
| CRX | X | X | X | X | X |
| AZM | X | X | X | X | X |
| KAN | 1.8 ± 0.05 | 1.3 ± 0.05 | 0.9 ± 0.05 | X | X |
| TMP | 2.3 ± 0.05 | 0.8 ± 0.05 | 0.5 ± 0.05 | X | X |

Table 4.4: Results of IZ for *G. bergerei*.

| ATB | H. [cm] | 1. [cm] | 2. [cm] | 3. [cm] | 4. [cm] |
|-----|------------|------------|------------|------------|------------|
| AMP | 3 ± 0.05 | 3 ± 0.05 | 3 ± 0.05 | 3 ± 0.05 | 3 ± 0.05 |
| CTX | ∞ | ∞ | ∞ | ∞ | ∞ |
| STR | 3 ± 0.05 | 2.8 ± 0.05 | 2.5 ± 0.05 | 2.3 ± 0.05 | 2 ± 0.05 |
| GEN | 2.5 ± 0.05 | 2.2 ± 0.05 | 2 ± 0.05 | 1.8 ± 0.05 | 1.5 ± 0.05 |
| TET | 2.7 ± 0.05 | 2 ± 0.05 | 1.8 ± 0.05 | 1.5 ± 0.05 | 1 ± 0.05 |
| SMX | 0.5 ± 0.05 | X | X | X | X |
| PEN | ∞ | ∞ | ∞ | ∞ | ∞ |
| CRX | X | X | X | X | X |
| AZM | X | X | X | X | X |
| KAN | 3.5 ± 0.05 | 3 ± 0.05 | 2.8 ± 0.05 | 2.5 ± 0.05 | 2 ± 0.05 |
| TMP | ∞ | ∞ | ∞ | ∞ | ∞ |

Table 4.5: Results of IZ for *A. bouvetii*.

| ATB | H. [cm] | 1. [cm] | 2. [cm] | 3. [cm] | 4. [cm] |
|-----|------------|------------|------------|------------|------------|
| AMP | 1.8 ± 0.05 | 1.3 ± 0.05 | 0.7 ± 0.05 | 0.3 ± 0.05 | X |
| CTX | ∞ | ∞ | ∞ | ∞ | ∞ |
| STR | 3.5 ± 0.05 | 2.5 ± 0.05 | 2.5 ± 0.05 | 2.3 ± 0.05 | 2.2 ± 0.05 |
| GEN | 3 ± 0.05 | 2.5 ± 0.05 | 2 ± 0.05 | 1.8 ± 0.05 | 1.5 ± 0.05 |
| TET | 1.7 ± 0.05 | 1.5 ± 0.05 | 1.2 ± 0.05 | 0.5 ± 0.05 | X |
| SMX | X | X | X | X | X |
| PEN | 2 ± 0.05 | 1.5 ± 0.05 | 1 ± 0.05 | 0.7 ± 0.05 | 0.5 ± 0.05 |
| CRX | X | X | X | X | X |
| AZM | X | X | X | X | X |
| KAN | ∞ | ∞ | ∞ | ∞ | 2.5 ± 0.05 |
| TMP | 1.9 ± 0.05 | 1.5 ± 0.05 | 1.2 ± 0.05 | 0.6 ± 0.05 | X |

Table 4.6: Results of IZ for *R. zophii*.

| ATB | H. [cm] | 1. [cm] | 2. [cm] | 3. [cm] | 4. [cm] |
|-----|------------|------------|------------|------------|------------|
| AMP | ∞ | ∞ | ∞ | ∞ | ∞ |
| CTX | ∞ | ∞ | ∞ | ∞ | ∞ |
| STR | ∞ | ∞ | ∞ | ∞ | ∞ |
| GEN | ∞ | ∞ | ∞ | ∞ | ∞ |
| TET | 3 ± 0.05 | 2.7 ± 0.05 | 2 ± 0.05 | 1.5 ± 0.05 | 1.3 ± 0.05 |
| SMX | X | X | X | X | X |
| PEN | 1 ± 0.05 | X | X | X | X |
| CRX | ∞ | ∞ | ∞ | ∞ | ∞ |
| AZM | X | X | X | X | X |
| KAN | ∞ | ∞ | ∞ | ∞ | ∞ |
| TMP | 0.8 ± 0.05 | 0.6 ± 0.05 | 0.4 ± 0.05 | X | X |

4.2.3 FCM

As a beginner in my research path, I wanted to learn HGT and the FCM method with experts. Therefore, I went to IGB and got trained in the principles and methods from my colleague, Jaffer Yusuf from IGB, who evaluated the experiment conducted using an FCM. The measured data were subsequently recorded in tables, given the set number of events at 15000. The results are presented as a ratio of signals to the total number of 15000 events.

Table 4.7: List of results for flow cytometer [green signals / 15,000]. Transconjugants (green signal) received ARGs from the *E. coli* donor detected by FCM. LR is free-living bacteria (LR) and bacteria attached on MPs (PR) This experiment was not added ATBs.

| | CTRL | cPLA | gPLA | PHBV | bioHDPE | HDPE | PET | Chitosan |
|----------------------------------|------|------|------|------|---------|------|-----|----------|
| LR1 | 0 | 1 | 2 | 0 | 0 | 0 | 3 | 0 |
| LR2 | 0 | 0 | 1 | 0 | 0 | 0 | 0 | 0 |
| LR3 | 0 | 0 | 1 | 0 | 0 | 1 | 3 | 0 |
| LR4 | 0 | 0 | 1 | 1 | 0 | 0 | 0 | 0 |
| LR5 | 0 | 0 | 1 | 0 | 0 | 0 | 1 | 0 |
| PR1 | | 2 | 3 | 1 | 0 | 0 | 1 | 0 |
| PR2 | | 21 | 2 | 1 | 0 | 1 | 2 | 1 |
| PR3 | | 2 | 3 | 1 | 1 | 1 | 0 | 0 |
| PR4 | | 1 | 6 | 1 | 1 | 1 | 0 | 0 |
| PR5 | | 4 | 6 | 1 | 1 | 2 | 0 | 0 |
| Average [green signals / 15 000] | | | | | | | | |
| LR | 0 | 0.2 | 1.2 | 0.2 | 0 | 0.2 | 1.4 | 0 |
| PR | | 6 | 4 | 1 | 0.6 | 1 | 0.6 | 0.2 |

The results show that higher numbers of transferred genes occur in samples of the PR type, which are samples taken from bacteria on the surface of MPs. The gene transfer occurs with an 80% probability inside the biofilm. Specifically, the highest number of transfers was recorded on the surface of cPLA plastics 6 on average, followed by the second highest number on gPLA plastics 4 on average. The highest ARGs transferred signals were on the sample cPLA PR2, which was counted as 21 (Table 4.7).

In the liquid environment (LR), unlike the biofilm environment (PR), ARGs were not transferred as frequently. The question is how much to consider the influences of MPs on bacteria that are so-called free-living only in the liquid environment. Nevertheless, in this case, the highest number of transferred signals was observed in the sample with PET plastic (1.4).

Conversely, the lowest number was recorded for the chitosan type and also in the CTRL sample.

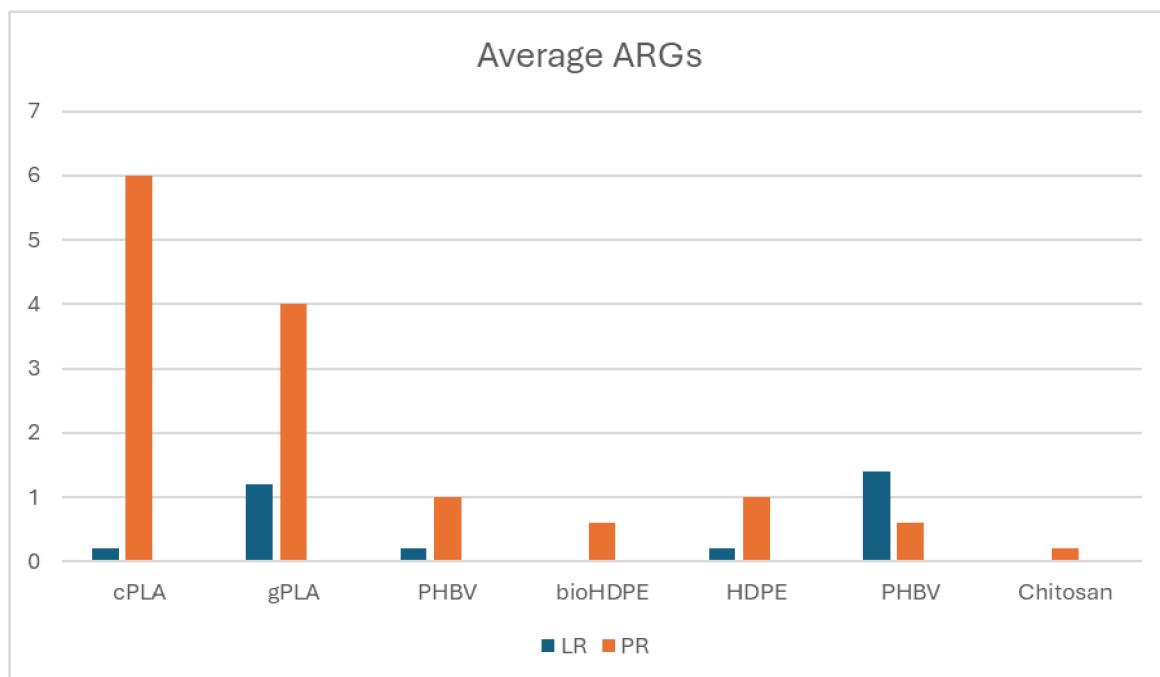

Figure 4.6: Number of transconjugants by HGT rate using FCM.

4.2.4 SEM

SEM was used to examine all types of MPs. Due to the diverse nature and distribution of individual MPs, capturing images with uniform magnification was impossible. Images of pure MPs were subsequently evaluated using the ImageJ software, where their average size and deviations were analysed.

Table 4.8: Measurement MP sizes using ImageJ presenting by width (W) and height (H).

| cPLA [W×H] [μm] | | | gPLA [W×H] [μm] | | | PHBV [W×H] [μm] | | |
|-----------------|--------|---------|--------------------|--------|---------|-----------------|--------|----------|
| Average | Min | Max | Average | Min | Max | Average | Min | Max |
| 206×305 | 98×36 | 509×682 | 18×21 | 11×12 | 26×38 | 46×55 | 7×23 | 111×153 |
| HDPE [W×H] [μm] | | | bioHDPE [W×H] [μm] | | | PET [W×H] [μm] | | |
| Average | Min | Max | Average | Min | Max | Average | Min | Max |
| 273×304 | 92×135 | 423×646 | 231×216 | 121×94 | 478×560 | 192×343 | 42×111 | 497×1051 |

The results of the MPs size analysis revealed differences in their sizes even though they were passed through sieve of 400 μm after grinding. For instance, bioHDPE exhibited greater variability in sizes compared to other bio-MPs. HDPE exhibited the largest detected particle with dimensions of 273 × 304 μm, while gPLA was identified as the material with the smallest particle measuring 12 × 21 μm. In the context of uniform size distribution, gPLA showed the best results with dimensions of 12 × 21 μm. These differences could have been caused by various physical and chemical properties of the individual plastic materials and variability in the processing methods.

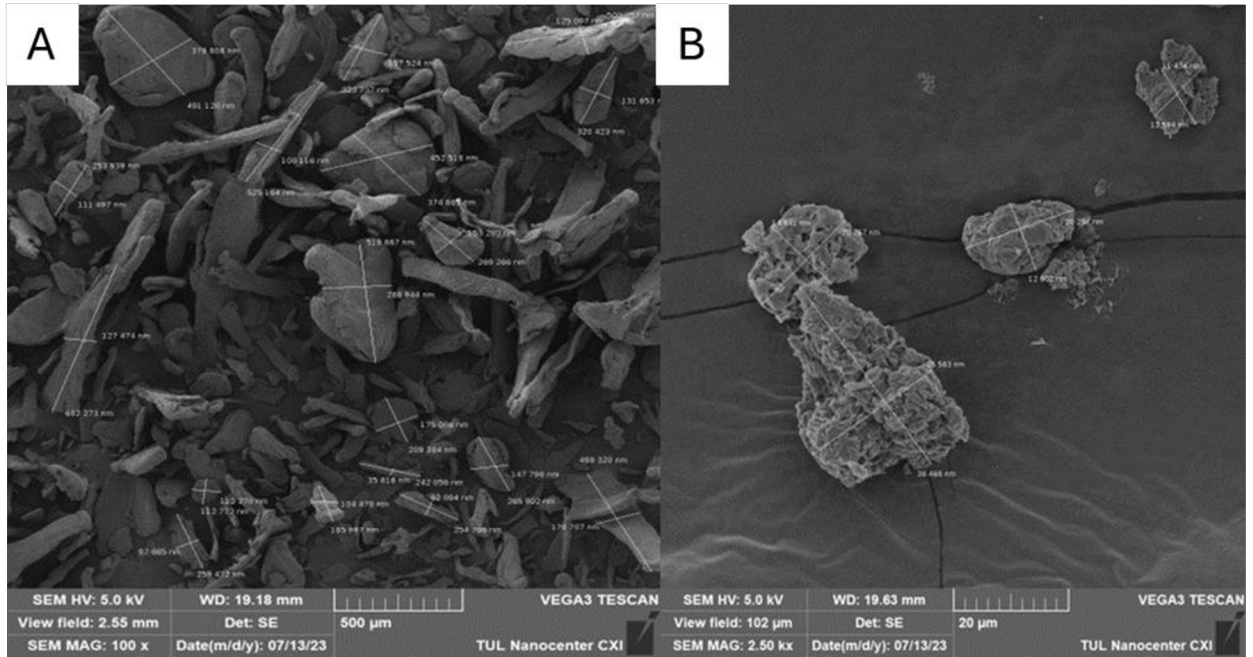

Figure 4.7: SEM and measurement from ImageJ, (A) cPLA, (B) gPLA.

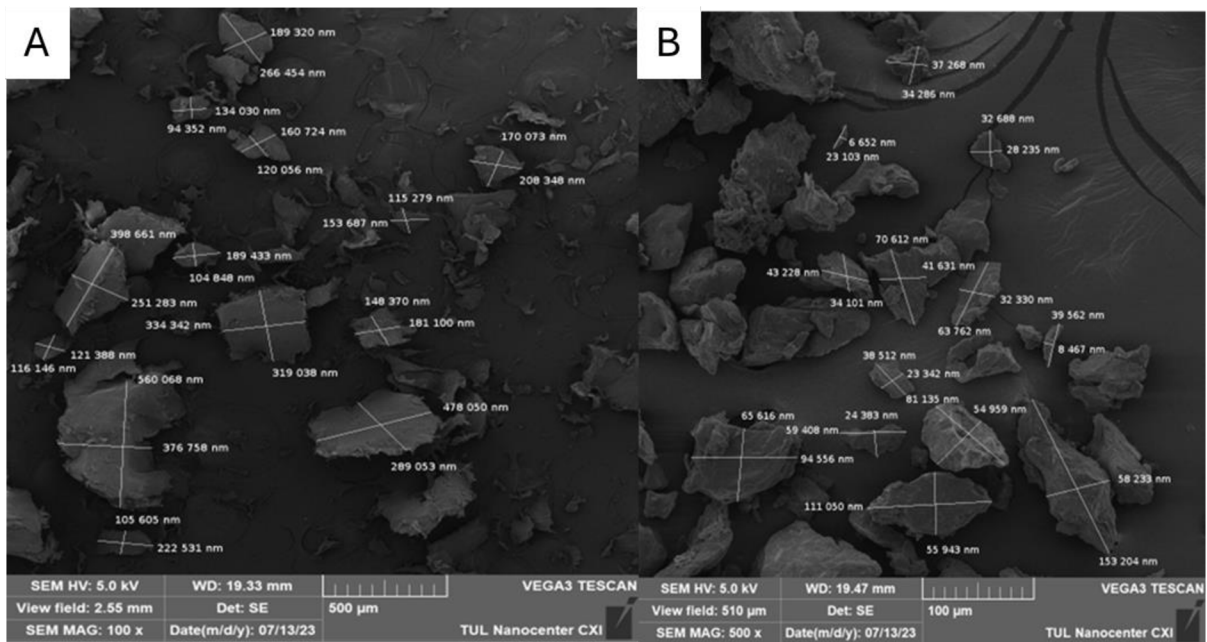

Figure 4.8: SEM and measurement from ImageJ, (A) bioHDPE, (B) PHBV.

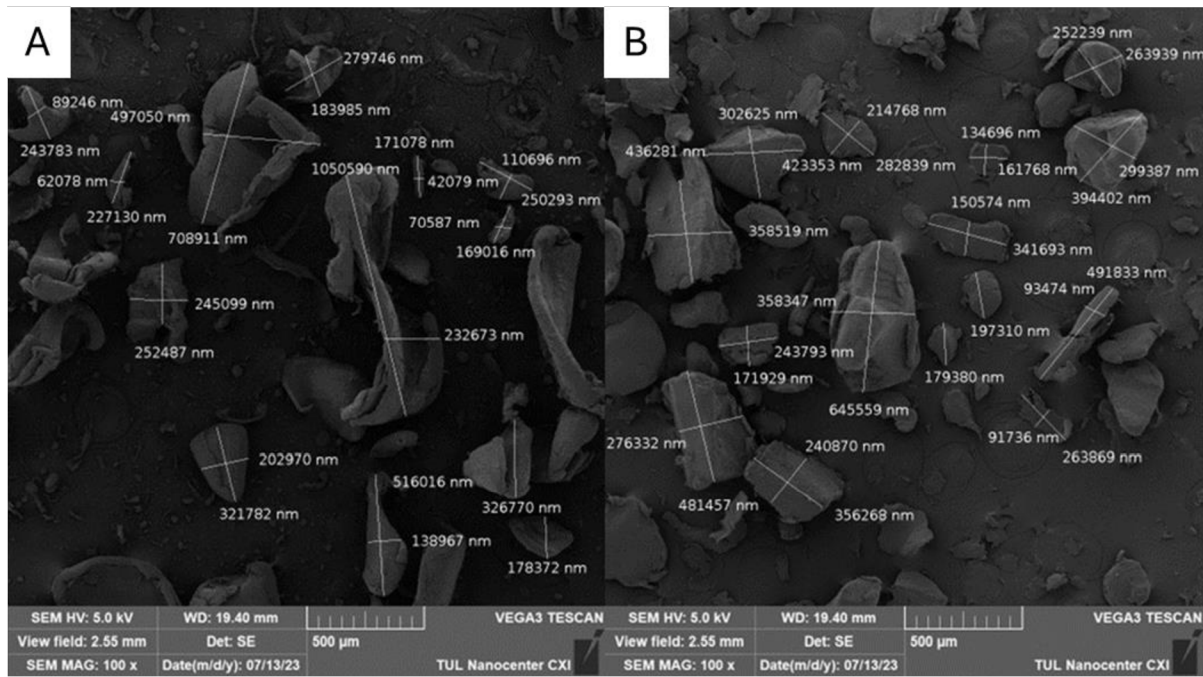

Figure 4.9: SEM and measurement from ImageJ, (A) PET, (B) HDPE.

Additional measurements were carried out using SEM, which included capturing images of MPs with bacteria in the biofilm. White arrows indicate bacteria attached to MPs.

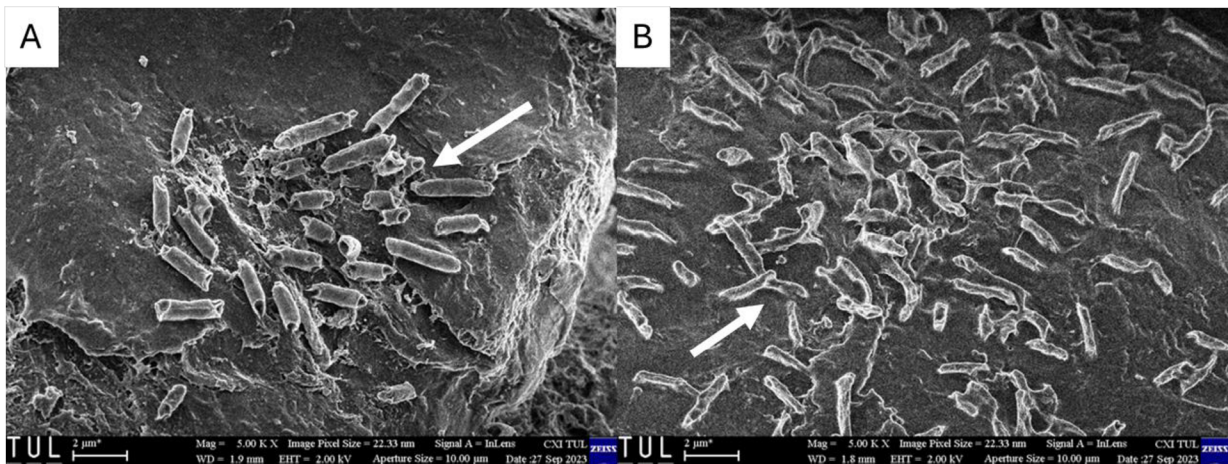

Figure 4.10: Results for SEM with bacteria. (A) cPLA, (B) gPLA. The white arrows indicate bacteria on MPs.

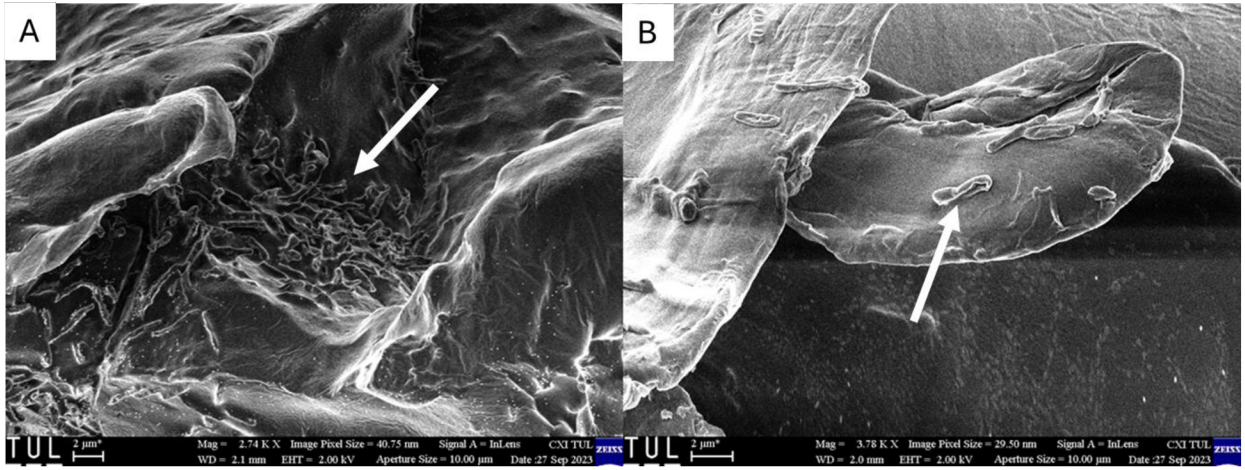

Figure 4.11: Results for SEM with bacteria. (A) PHBV, (B) bioHDPE. The white arrows indicate bacteria on MPs.

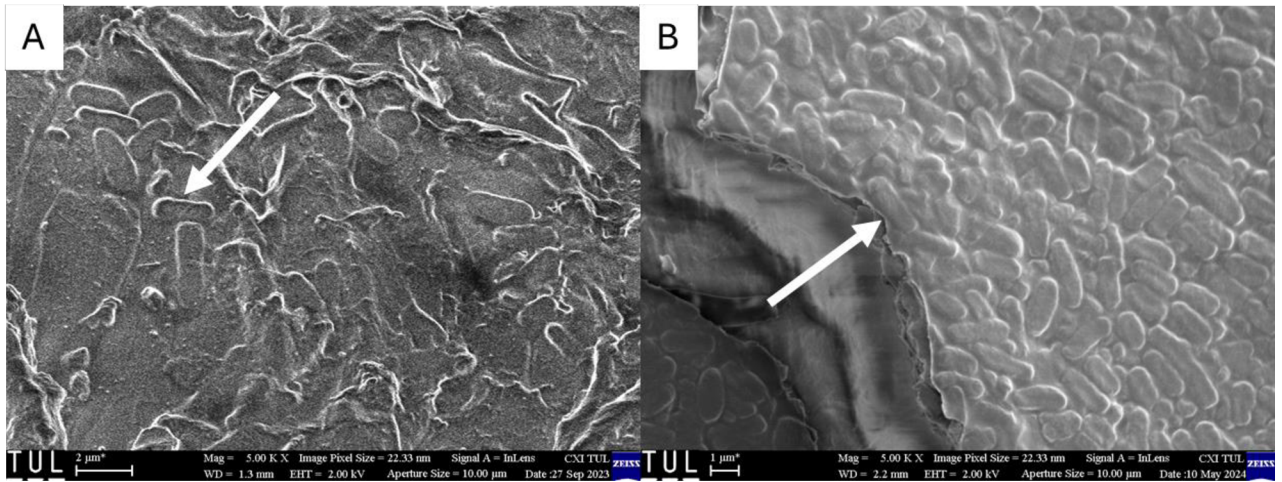

Figure 4.12: Results for SEM with bacteria. (A) PET, (B) HDPE. The white arrows indicate bacteria on MPs.

4.3 HGT experiment

4.3.1 Counting colonies

After the 24 h incubation, colonies were counted according to the samples listed in Table 3.3.

Table 4.9: The number of colonies in 30 μL of each sample, which was diluted 200 times.

| | | | |
|---------|------|------------|------|
| CTRL C1 | 4852 | PHBV C2 | 721 |
| CTRL C2 | 873 | bioHDPE C1 | 1575 |
| cPLA C1 | 5232 | bioHDPE C2 | 962 |
| cPLA C2 | 613 | HDPE C1 | 2404 |
| gPLA C1 | 1344 | HDPE C2 | 904 |
| gPLA C2 | 495 | PET C1 | 404 |
| PHBV C1 | 1026 | PET C2 | 452 |

Recalculation for CTRL C1 samples in 1mL as the following formula:

$$\begin{aligned}
 &4852 \text{ colonies } \dots 30 \mu\text{L} \\
 &X \text{ colonies } \dots \dots 1000 \mu\text{L} \\
 &X = \frac{4852 \times 1000}{30} \\
 &X = 161733
 \end{aligned}$$

Following that, the number of colonies recalculated in the starting/original samples in 1 mL. This is achieved by multiplying it by the dilution factor, which in this case (and for each CTRL) is 200.

$$Y = 200 \times 161733$$

Recalculation for cPLA C1 in 1 mL as the following formula:

$$\begin{aligned}
 &5232 \text{ colonies } \dots 55 \mu\text{L} \\
 &X \text{ colonies } \dots \dots 1000 \mu\text{L} \\
 &X = \frac{5232 \times 1000}{55} \\
 &X = 95127
 \end{aligned}$$

Following that, the number of colonies recalculated in the starting/original samples in 1 mL. This is achieved by multiplying it by the dilution factor, which in this case (and for each MP sample) is 10.

$$Y = 10 \times 95127$$

Table 4.10: Recalculation of CFU/mL in the starting/original samples.

| | | | |
|---------|--------------------|------------|--------------------|
| CTRL C1 | 3.23×10^7 | PHBV C2 | 1.31×10^5 |
| CTRL C2 | 5.82×10^6 | bioHDPE C1 | 2.86×10^5 |
| cPLA C1 | 9.51×10^5 | bioHDPE C2 | 1.74×10^5 |
| cPLA C2 | 1.11×10^5 | HDPE C1 | 4.37×10^5 |
| gPLA C1 | 2.44×10^5 | HDPE C2 | 1.64×10^5 |
| gPLA C2 | 9×10^4 | PET C1 | 7.34×10^4 |
| PHBV C1 | 1.87×10^5 | PET C2 | 8.22×10^4 |

From the analysis of the results presented above, it can be inferred that the highest number of colonies was observed in the CTRL samples. Among samples containing plastics, the highest colony counts were exhibited by samples cPLA C1 and HDPE C1. Conversely, the PET plastic sample appears to be the least conducive to bacterial growth.

A fascinating phenomenon observed is the tendency for colonies to predominantly form on media to which samples with lower concentrations of ATB were applied.

4.3.2 Counting bacteria green fluorescent signals

Subsequently, a portion of these colonies was examined under an epifluorescence microscope. One colony was placed on a microscope slide, and 2 μL of dH₂O were added to it. The channels used for imaging were set for the red Cy3 and green FITC fluorescence.

This procedure was conducted after a 24-hour incubation period and after 1.5 months from the sample collection, during which the samples were stored in the refrigerator at 4 °C.

The following images depict a comparison of transferred genes within 24 h and after a month and a half. These three samples represent the ones with the highest number of transferred genes over the month and a half period.

Following that, the counts of green signals were recalibrated using a formula to standardise the results as green signals per mL. This formula was retrieved from the microscopy laboratory archives at CXI TUL.

$$\begin{aligned}
 &4 \text{ cells ... } 0.1543139 \mu\text{L} \\
 &X \text{ cells ... } 1000 \mu\text{L} \\
 &X = \frac{5 \times 1000}{0.1543139} \\
 &X \cong 32401
 \end{aligned}$$

The data computed in this manner are presented in the following table.

Table 4.11: Counting of ARGs of green fluorescent bacteria and present number of cells/mL after 24 h and 1.5 months.

| Time: | 24 h | 1.5 months |
|------------|-----------------------------|-----------------------------|
| CTRL C1 | $(2.2 \pm 0.9) \times 10^4$ | $(6.6 \pm 3.1) \times 10^6$ |
| CTRL C2 | $(1.9 \pm 0.8) \times 10^4$ | $(3.3 \pm 0.7) \times 10^6$ |
| cPLA C1 | $(9.7 \pm 2.7) \times 10^3$ | $(6.1 \pm 1.3) \times 10^6$ |
| cPLA C2 | $(2.9 \pm 1.9) \times 10^4$ | $(1.4 \pm 0.3) \times 10^7$ |
| gPLA C1 | $(4.5 \pm 2.6) \times 10^4$ | $(1.1 \pm 0.5) \times 10^7$ |
| gPLA C2 | $(9.2 \pm 1.3) \times 10^2$ | $(1.2 \pm 0.4) \times 10^7$ |
| PHBV C1 | $(2.9 \pm 2.1) \times 10^4$ | $(9.1 \pm 2.9) \times 10^6$ |
| PHBV C2 | $(3.2 \pm 1.5) \times 10^4$ | $(5.1 \pm 2.1) \times 10^6$ |
| bioHDPE C1 | $(3.9 \pm 1.9) \times 10^4$ | $(6.7 \pm 2.4) \times 10^6$ |
| bioHDPE C2 | $(5.1 \pm 3.2) \times 10^4$ | $(1.1 \pm 0.3) \times 10^7$ |
| HDPE C1 | $(3.2 \pm 1.9) \times 10^4$ | $(6.8 \pm 2.4) \times 10^6$ |
| HDPE C2 | $(3.9 \pm 1.9) \times 10^4$ | $(3.6 \pm 0.8) \times 10^6$ |
| PET C1 | $(3.9 \pm 2.1) \times 10^4$ | $(6.1 \pm 4.1) \times 10^6$ |
| PET C2 | $(4.4 \pm 2.3) \times 10^4$ | $(4.1 \pm 1.8) \times 10^6$ |

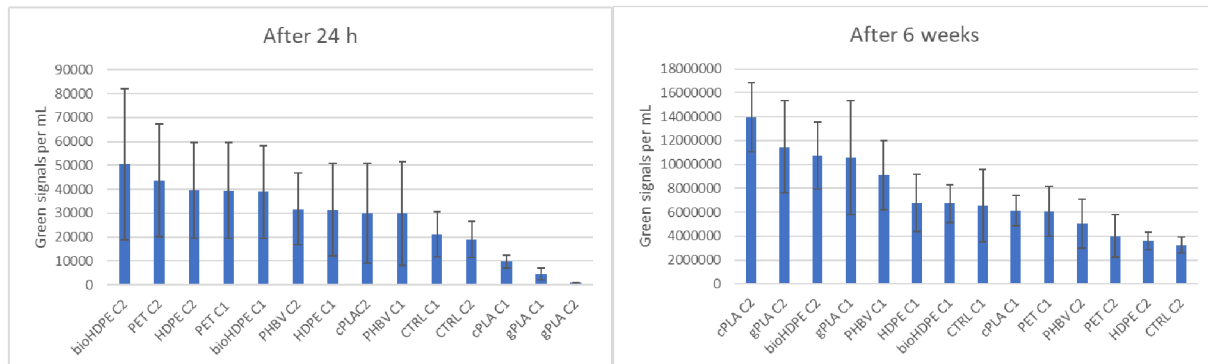
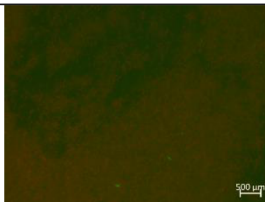
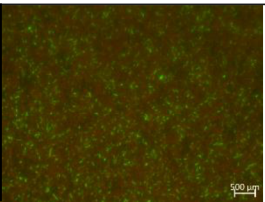

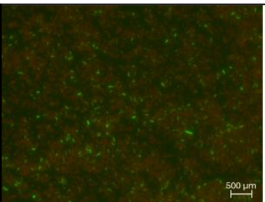
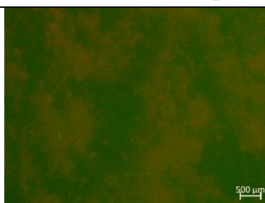
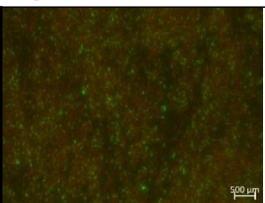
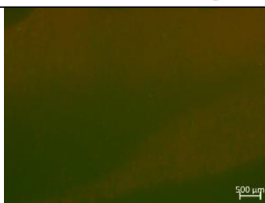
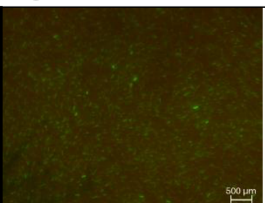
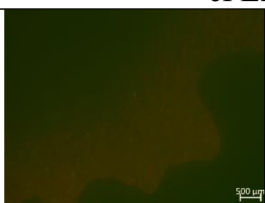
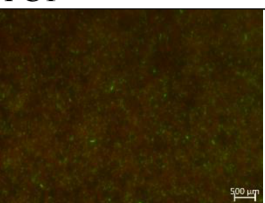

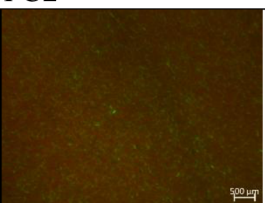
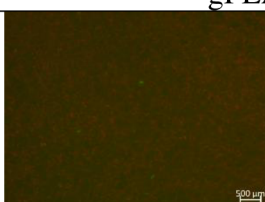
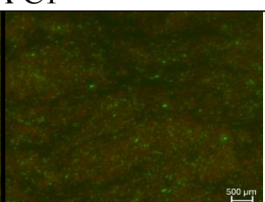

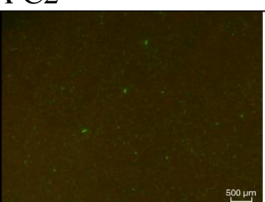
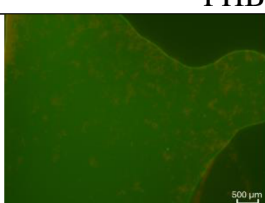
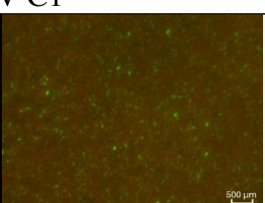
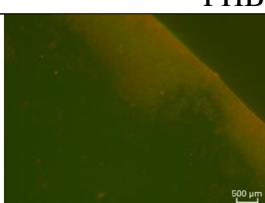
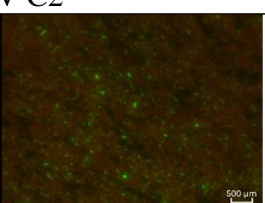
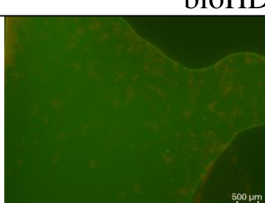
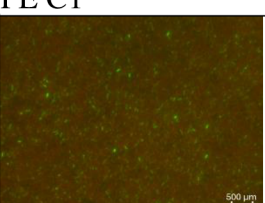
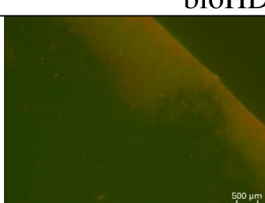
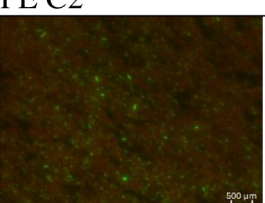
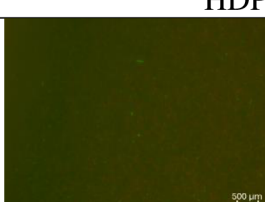
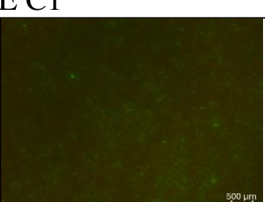

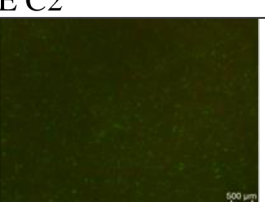

Figure 4.13: Graphical evaluation of data from counting ARGs from Table 4.11.

Table 4.12: Table of pictures of the recipient *R. zophii* having ARGs with the green fluorescence from the donor *E. coli* after 24 h and 6 weeks. Scale bar is 500 μm .

| 24 h | 6 weeks | 24 h | 6 weeks |
|---|---|--|---|
|  |  |  |  |
| CTRL C1 | | CTRL C2 | |
|  |  |  |  |
| cPLA C1 | | cPLA C2 | |
|  |  |  |  |
| gPLA C1 | | gPLA C2 | |
|  |  |  |  |
| PHBV C1 | | PHBV C2 | |
|  |  |  |  |
| bioHDPE C1 | | bioHDPE C2 | |
|  |  |  |  |
| HDPE C1 | | HDPE C2 | |
|  |  |  |  |
| PET C1 | | PET C2 | |

With the presence of ATBs and different concentrations, both bio- and conventional MPs alternated fairly evenly in the observed order from the highest to the lowest transfers of ARGs. The most significant transconjugant transfers occurred in the bioHDPE C2 (high ATB concentration) sample, with a difference in the number of transfers compared to other types of plastics being almost 10 thousand. The results indicated that adding ATBs increased the ARG transfer compared to not adding ATBs (Fig. 4.2).

Within the experiment, GHT was investigated by placing organisms in close proximity to agar plates under cold conditions. Subsequently, all plates were incubated at 4 °C for a duration of 6 weeks, and transconjugants were counted after 24 h. The decision for the extended 6-week incubation period was made as the transconjugant count and visual inspection were completed only after the initial 24 h. It was only after this period that the results were fully comprehended.

After 6 weeks, there was a dramatic change in the results, 62.5 % of used BPs samples occupied the top five places. Samples of cPLA and gPLA types, which originally occupied the last ranks, significantly increased the number of transferred ARGs and moved to the top positions in the order. Specifically, the cPLA C2 sample, which ranked first after a month and a half, recorded an increase in gene transfer of approximately 1.4×10^7 . Furthermore, after this longer period, we observed an increasing trend in BPs, which occupied the majority of the first half of the results, indicating that HGT was significantly more common on them than on conventional plastics.

After a longer incubation of 6 weeks, the number of transconjugants increased at the higher ATB concentration. That means the higher concentration could induce stressful conditions, promoting increased HGT frequency. The recipients of *R. zophii* received ATB genes from donor *E.coli* and consumed ATB as their nutrient.

5 Conclusion

The study focused on analysing four isolated bacterial resistances to ATBs and related HGTs. It examined the influences of different types of ATBs on the formation of IZ. It then continued by examining HGTs of KAN and TMP on isolated bacterial recipient *R. zophii* and donor *E. coli* by adding two concentrations of ATBs and bio- and conventional MPs, which were monitored for HGT over a period of 1.5 months.

It was demonstrated that each bacterium isolated from wastewater in Liberec exhibited overall resistance to at least two ATBs. The greatest resistance was observed in the bacterium *A. xijiangensis*, which showed complete resistance to three types of ATBs across their full concentrations, specifically SMX, CRX, and AZM, and partial resistance to five other types of antibiotics. Particularly, the lowest concentrations of TET, PEN, KAN, TMP, and, in the case of the three lowest concentrations, GEN, were observed.

Based on these results and the findings from growth curve experiments, where the highest growth rate was observed in the bacterium *R. zophii*, this bacterium was selected as the recipient organism for further projects. *E. coli* was chosen as the donor and was genetically modified to carry ARGs for TMP and KAN. The transfer of ARGs via HGT to the recipient bacterium *R. zophii* resulted in green flashes observable under an epifluorescence microscope.

Further modifications to the main experiment were made based on the results from flow cytometry experiments, which indicated a significant preference for ARG transfer in a biofilm environment commonly found on MPs, with a probability exceeding 80% of the total transferred genes. Therefore, additional modifications to the experiment primarily focused on the biofilm environment.

The main experiment investigated the impact of three bio-MPs compared to two conventional MPs and their effect on HGT. Furthermore, the effects of two different concentrations of ATBs on the overall dynamics of HGT were monitored. After 48h incubation, there was no trend of transconjugants being favoured by MPs. After 1.5 months of observation, there was a surprising bacterial selection, with a preference for bio-MPs. For example, cPLA C2, gPLA C2, bioHDPE C2, gPLA C1, and PHBV C1 showed the highest numbers of transconjugants. Additionally, the higher ATB concentration was interestingly impacting HGTs.

Nevertheless, a certain degree of caution is warranted in this consideration, as data from the analysis of transferred ARGs suggest that the HGT process was not entirely consistent. Findings indicate that samples taken after 48 h do not adhere to a consistent pattern in HGT frequency. The order that emerged from the measurements after 48 h drastically changed after 1.5 months. Therefore, discussion regarding the influence of plastic properties on this observed increase is necessary. However, data suggest that the frequency of HGT increased by 106 orders of transferred genes over one day to one and a half months.

It is crucial to consider to what extent this transfer is influenced by the specific transfer process between the donor *E. coli* and the recipient bacterium *R. zophii*. What proportion of the transfer

is attributed to the already transferred gene into recipient *R. zophii*, which then becomes another donor bacterium capable of further passing on this gene to its kind. Although genetic modification of the plasmid confirms the form of resistance acquired through HGT, it remains unclear what the specific and long-term impacts of different types of MPs on HGT are. While there is a likelihood that bacteria prefer bioplastics for this process, it is essential to continue investigating the influence of different concentrations of antibiotics on the surface of plastics in biofilm and how these factors affect the frequencies of HGT.

6 References

- ABE, Kimihiro; Nobuhiko NOMURA and Satoru SUZUKI, 2020. Biofilms: hot spots of horizontal gene transfer (HGT) in aquatic environments, focusing on a new HGT mechanism. online. *FEMS Microbiology Ecology*, vol. 96, no. 5, p. f1aa031. Available from: <https://doi.org/10.1093/femsec/f1aa031>.
- ARIAS-ANDRES, Maria; Uli KLÜMPER; Keilor ROJAS-JIMENEZ and Hans-Peter GROSSART, 2018. Microplastic pollution increases gene exchange in aquatic ecosystems. online. *Environmental Pollution*, vol. 237, pp. 253–261. Available from: <https://doi.org/10.1016/j.envpol.2018.02.058>.
- ASLAM, Bilal; Mohsin KHURSHID; Muhammad Imran ARSHAD; Saima MUZAMMIL; Maria RASOOL et al., 2021. Antibiotic Resistance: One Health One World Outlook. online. *Frontiers in Cellular and Infection Microbiology*, vol. 11. Available from: <https://doi.org/10.3389/fcimb.2021.771510>.
- ATIWESH, Ghada; Abanoub MIKHAEL; Christopher C. PARRISH; Joseph BANOUB and Tuyet-Anh T. LE, 2021. Environmental impact of bioplastic use: A review. online. *Heliyon*, vol. 7, no. 9, p. e07918. Available from: <https://doi.org/10.1016/j.heliyon.2021.e07918>.
- AZZAM, Ahmed; Hoda ELKAFAS; Heba KHALED; Ahmed ASHRAF; Mohammed YOUSEF et al., 2023. Prevalence of Vancomycin-resistant *enterococci* (VRE) in Egypt (2010–2022): a systematic review and meta-analysis. online. *Journal of the Egyptian Public Health Association*, vol. 98, no. 1, p. 8. Available from: <https://doi.org/10.1186/s42506-023-00133-9>.
- BERMÚDEZ, J. R. and P. W. SWARZENSKI, 2021. A microplastic size classification scheme aligned with universal plankton survey methods. online. *MethodsX*, vol. 8, p. 101516. Available from: <https://doi.org/10.1016/j.mex.2021.101516>.
- BEZIRHAN, Ezgi and H. Duygu BILGEN, 2015. A Review: Investigation of Bioplastics. online. *Journal of Civil Engineering and Architecture*, vol. 9, pp. 188–192. Available from: <https://doi.org/10.17265/1934-7359/2015.02.007>.
- BOTO, Luis, 2009. Horizontal gene transfer in evolution: facts and challenges. online. *Proceedings of the Royal Society B: Biological Sciences*, vol. 277, no. 1683, pp. 819–827. Available from: <https://doi.org/10.1098/rspb.2009.1679>.
- BRDLÍK, Pavel; Martin BORŮVKA; Luboš BĚHÁLEK and Petr LENFELD, 2022. The Influence of Additives and Environment on Biodegradation of PHBV Biocomposites. online. *Polymers*, vol. 14, no. 4, p. 838. Available from: <https://doi.org/10.3390/polym14040838>.
- BRITANNICA, T. Editors of Encyclopaedia, 2024a. *Polyester | Synthetic Fibers, Textiles, Clothing | Britannica*. Website. Available from: <https://www.britannica.com/science/polyester>. [viewed 2024-04-17].
- BRITANNICA, The Editors of Encyclopaedia, 2020. Polymerization | Definition, Classes, & Examples | Britannica. online. In: *Encyclopedia Britannica*. Available from: <https://www.britannica.com/science/polymerization>. [viewed 2024-04-18].

BRITANNICA, The Editors of Encyclopaedia, 2021. Copolymer | Synthesis, Polymerization, Blends | Britannica. online. In: *Encyclopedia Britannica*. Available from: <https://www.britannica.com/science/copolymer>. [viewed 2024-04-18].

BRITANNICA, The Editors of Encyclopaedia, 2024b. Bacteriophage | Definition, Life Cycle, & Research | Britannica. online. In: *Encyclopedia Britannica*. Available from: <https://www.britannica.com/science/bacteriophage>. [viewed 2024-04-18].

BRITANNICA, The Editors of Encyclopaedia, 2024c. Endocarditis | Description, Causes, Symptoms, & Treatment | Britannica. online. In: *Encyclopedia Britannica*. Available from: <https://www.britannica.com/science/endocarditis>. [viewed 2024-04-18].

BRITANNICA, The Editors of Encyclopaedia, 2024d. Plasmid | DNA replication, genetic engineering, cloning | Britannica. online. In: *Encyclopedia Britannica*. Available from: <https://www.britannica.com/science/plasmid>. [viewed 2024-04-18].

BRITO, Ilana Lauren, 2021. Examining horizontal gene transfer in microbial communities. online. *Nature Reviews Microbiology*, vol. 19, no. 7, pp. 442–453. Available from: <https://doi.org/10.1038/s41579-021-00534-7>.

BURELO, Manuel; Josué David HERNÁNDEZ-VARELA; Dora I. MEDINA and Cecilia D. TREVIÑO-QUINTANILLA, 2023. Recent developments in bio-based polyethylene: Degradation studies, waste management and recycling. online. *Heliyon*, vol. 9, no. 11, p. e21374. Available from: <https://doi.org/10.1016/j.heliyon.2023.e21374>.

BURMEISTER, Alita R., 2015. Horizontal Gene Transfer. online. *Evolution, Medicine, and Public Health*, vol. 2015, no. 1, pp. 193–194. Available from: <https://doi.org/10.1093/emph/eov018>.

CIMEN, Cansu; Matthijs S. BERENDS; Erik BATHOORN; Mariëtte LOKATE; Andreas VOSS et al., 2023. Vancomycin-resistant *enterococci* (VRE) in hospital settings across European borders: a scoping review comparing the epidemiology in the Netherlands and Germany. online. *Antimicrobial Resistance & Infection Control*, vol. 12, no. 1, p. 78. Available from: <https://doi.org/10.1186/s13756-023-01278-0>.

COX, Kieran D.; Garth A. COVERNTON; Hailey L. DAVIES; John F. DOWER; Francis JUANES et al., 2019. Human Consumption of Microplastics. online. *Environmental Science & Technology*, vol. 53, no. 12, pp. 7068–7074. Available from: <https://doi.org/10.1021/acs.est.9b01517>.

DHAKA, Vaishali; Simranjeet SINGH; Amith G. ANIL; T. S. SUNIL KUMAR NAIK; Shashank GARG et al., 2022. Occurrence, toxicity and remediation of polyethylene terephthalate plastics. A review. online. *Environmental Chemistry Letters*, vol. 20, no. 3, pp. 1777–1800. Available from: <https://doi.org/10.1007/s10311-021-01384-8>.

DONG, Han; Yuliang CHEN; Jun WANG; Yue ZHANG; Pan ZHANG et al., 2021. Interactions of microplastics and antibiotic resistance genes and their effects on the aquaculture environments. online. *Journal of Hazardous Materials*, vol. 403, p. 123961. Available from: <https://doi.org/10.1016/j.jhazmat.2020.123961>.

DU, Sen; Rongwen ZHU; Yujie CAI; Ning XU; Pow-Seng YAP et al., 2021. Environmental fate and impacts of microplastics in aquatic ecosystems: a review. online. *RSC Advances*, vol. 11, no. 26, pp. 15762–15784. Available from: <https://doi.org/10.1039/D1RA00880C>.

GAZAL, Abass A and Shabbir H GHEEWALA, 2020. Plastics, microplastics and other polymer materials – A threat to the environment. 2020.

GONZÁLEZ-PLEITER, Miguel; Alicia PEDROUZO-RODRÍGUEZ; Irene VERDÚ; Francisco LEGANÉS; Eduardo MARCO et al., 2021. Microplastics as vectors of the antibiotics azithromycin and clarithromycin: Effects towards freshwater microalgae. online. *Chemosphere*, vol. 268, p. 128824. Available from: <https://doi.org/10.1016/j.chemosphere.2020.128824>.

GUO, Xuan and Jianlong WANG, 2019. The chemical behaviors of microplastics in marine environment: A review. online. *Marine Pollution Bulletin*, vol. 142, pp. 1–14. Available from: <https://doi.org/10.1016/j.marpolbul.2019.03.019>.

GUPTA, A.P. and Vimal KUMAR, 2007. New emerging trends in synthetic biodegradable polymers – Polylactide: A critique. online. *European Polymer Journal*, vol. 43, no. 10, pp. 4053–4074. Available from: <https://doi.org/10.1016/j.eurpolymj.2007.06.045>.

HALE, Robert C.; Meredith E. SEELEY; Mark J. LA GUARDIA; Lei MAI and Eddy Y. ZENG, 2020. A Global Perspective on Microplastics. online. *Journal of Geophysical Research: Oceans*, vol. 125, no. 1, p. e2018JC014719. Available from: <https://doi.org/10.1029/2018JC014719>.

HYUN, David, 2024. *Antibiotic Resistant Bacteria is a Growing Threat, 2023* online. The Pew Charitable Trusts. Available from: <https://pew.org/3K5jb8C>. [viewed 2024-04-03].

JIAN, Zonghui; Li ZENG; Taojie XU; Shuai SUN; Shixiong YAN et al., 2021. Antibiotic resistance genes in bacteria: Occurrence, spread, and control. online. *Journal of Basic Microbiology*, vol. 61, no. 12, pp. 1049–1070. Available from: <https://doi.org/10.1002/jobm.202100201>.

KHANAM, P. Noorunnisa and Mariam Al Ali ALMAADEED, 2015. Processing and characterization of polyethylene-based composites. online. *Advanced Manufacturing: Polymer & Composites Science*, vol. 1, no. 2, pp. 63–79. Available from: <https://doi.org/10.1179/2055035915Y.0000000002>.

KOVALAKOVA, Pavla; Leslie CIZMAS; Thomas J. MCDONALD; Blahoslav MARSÁLEK; Mingbao FENG et al., 2020. Occurrence and toxicity of antibiotics in the aquatic environment: A review. online. *Chemosphere*, vol. 251, p. 126351. Available from: <https://doi.org/10.1016/j.chemosphere.2020.126351>.

KOWALSKA-KROCHMAL, Beata and Ruth DUDEK-WICHER, 2021. The Minimum Inhibitory Concentration of Antibiotics: Methods, Interpretation, Clinical Relevance. online. *Pathogens*, vol. 10, no. 2, p. 165. Available from: <https://doi.org/10.3390/pathogens10020165>.

KUMAR, Sachin; Achyut PANDA and Raghubansh Kumar SINGH, 2011. A review on tertiary recycling of high-density polyethylene to fuel. online. *Resources Conservation and Recycling - RESOUR CONSERV RECYCL*, vol. 55, pp. 893–910. Available from: <https://doi.org/10.1016/j.resconrec.2011.05.005>.

LIU, Yi; Wenzhi LIU; Xiaomei YANG; Jie WANG; Hui LIN et al., 2021. Microplastics are a hotspot for antibiotic resistance genes: Progress and perspective. online. *Science of The Total Environment*, vol. 773, p. 145643. Available from: <https://doi.org/10.1016/j.scitotenv.2021.145643>.

MANAIA, Célia M.; Diana S. AGA; Eddie CYTRYN; William H. GAZE; David W. GRAHAM et al., 2024. The Complex Interplay Between Antibiotic Resistance and Pharmaceutical and Personal Care Products in the Environment. online. *Environmental Toxicology and Chemistry*, vol. 43, no. 3, pp. 637–652. Available from: <https://doi.org/10.1002/etc.5555>.

MANALI SHAH; SANJUKTA RAJHANS; HIMANSHU A. PANDYA; and ARCHANA U. MANKAD, 2021. Bioplastic for future: A review then and now. online. *World Journal of Advanced Research and Reviews*, vol. 9, no. 2, pp. 056–067. Available from: <https://doi.org/10.30574/wjarr.2021.9.2.0054>.

MANCUSO, Giuseppe; Angelina MIDIRI; Elisabetta GERACE and Carmelo BIONDO, 2021. Pathogens | Free Full-Text | Bacterial Antibiotic Resistance: The Most Critical Pathogens. online. 2021-10. Available from: <https://www.mdpi.com/2076-0817/10/10/1310>.

MAZUR, Karolina; Raminder SINGH; Ralf P. FRIEDRICH; Hatice GENÇ; Harald UNTERWEGER et al., 2020. The Effect of Antibacterial Particle Incorporation on the Mechanical Properties, Biodegradability, and Biocompatibility of PLA and PHBV Composites. online. *Macromolecular Materials and Engineering*, vol. 305, no. 9, p. 2000244. Available from: <https://doi.org/10.1002/mame.202000244>.

MICHEALIS, Claudia and Elisabeth GROHMANN, 2023. *Antibiotics | Free Full-Text | Horizontal Gene Transfer of Antibiotic Resistance Genes in Biofilms*. Website. Available from: <https://www.mdpi.com/2079-6382/12/2/328>. [viewed 2024-04-13].

MISHRA, Mitali; Sasmita PANDA; Susmita BARIK; Arup SARKAR; Durg Vijai SINGH et al., 2020. Antibiotic Resistance Profile, Outer Membrane Proteins, Virulence Factors and Genome Sequence Analysis Reveal Clinical Isolates of Enterobacter Are Potential Pathogens Compared to Environmental Isolates. online. *Frontiers in Cellular and Infection Microbiology*, vol. 10. Available from: <https://doi.org/10.3389/fcimb.2020.00054>.

NAMPOOTHIRI, K. Madhavan; Nimisha NAIR and Rojan P JOHN, 2010. An overview of the recent developments in polylactide (PLA) research. online. *Bioresource technology*, vol. 101, pp. 8493–501. Available from: <https://doi.org/10.1016/j.biortech.2010.05.092>.

NANDHINI, Palanichamy; Pradeep KUMAR; Suresh MICKYMARAY; Abdulaziz S. ALOTHAIM; Jayaprakash SOMASUNDARAM et al., 2022. *Antibiotics | Free Full-Text | Recent Developments in Methicillin-Resistant Staphylococcus MRSA Treatment: A Review*. Website. Available from: <https://www.mdpi.com/2079-6382/11/5/606>. [viewed 2024-04-13].

NGUYEN, Nhung H. A.; Yehia S. EL-TEMSAH; Sebastien CAMBIER; Magdalena CALUSINSKA; Pavel HRABAK et al., 2021. Attached and planktonic bacterial communities on bio-based plastic granules and micro-debris in seawater and freshwater. online. *Science of The Total Environment*, vol. 785, p. 147413. Available from: <https://doi.org/10.1016/j.scitotenv.2021.147413>.

NGUYEN, Nhung H.A.; Marlita MARLITA; Yehia S. EL-TEMSAH; Pavel HRABAK; Jakub RIHA et al., 2023. Early stage biofilm formation on bio-based microplastics in a freshwater

reservoir. online. *Science of The Total Environment*, vol. 858, p. 159569. Available from: <https://doi.org/10.1016/j.scitotenv.2022.159569>.

PICCARDO, Manuela; Francesca PROVENZA; Eleonora GRAZIOLI; Andrea CAVALLO; Antonio TERLIZZI et al., 2020. PET microplastics toxicity on marine key species is influenced by pH, particle size and food variations. online. *Science of The Total Environment*, vol. 715, p. 136947. Available from: <https://doi.org/10.1016/j.scitotenv.2020.136947>.

PLASTICOVERSHOOT.EARTH, 2023. July 28th 2023: Plastic Waste now exceeds waste systems capacity. online. In: *Plastic Overshoot Day*. Available from: <https://plasticovershoot.earth/>. [viewed 2024-04-06].

PLASTICSEUROPE, 2023. Plastics – the fast Facts 2023 • Plastics Europe. In: *Plastics Europe*. 2023-. Available from: Plastics Europe, <https://plasticseurope.org/knowledge-hub/plastics-the-fast-facts-2023/>. [viewed 2024-04-06].

POLICASTRO, Grazia; Antonio PANICO and Massimiliano FABBRICINO, 2021. Improving biological production of poly(3-hydroxybutyrate-co-3-hydroxyvalerate) (PHBV) co-polymer: a critical review. online. *Reviews in Environmental Science and Bio/Technology*, vol. 20, no. 2, pp. 479–513. Available from: <https://doi.org/10.1007/s11157-021-09575-z>.

RIVERA-BRISO, Ariagna L. and Ángel SERRANO-AROCA, 2018. *Poly(3-Hydroxybutyrate-co-3-Hydroxyvalerate): Enhancement Strategies for Advanced Applications - PMC*. Website. Available from: <https://www.ncbi.nlm.nih.gov/pmc/articles/PMC6403723/>. [viewed 2024-02-28].

RODRIGUEZ, Ferdinand, 2024. Plastic | Composition, History, Uses, Types, & Facts | Britannica. online. In: *Britannica*. Available from: <https://www.britannica.com/science/plastic>. [viewed 2024-03-26].

ROGERS, Kara, 2024a. Gram-negative bacterium | Description, Characteristics, Examples, Infection, & Antibiotic Resistance | Britannica. online. In: *Encyclopedia Britannica*. Available from: <https://www.britannica.com/science/Gram-negative-bacterium>. [viewed 2024-04-18].

ROGERS, Kara, 2024b. Gram-positive bacterium | Description, Characteristics, & Examples | Britannica. online. In: *Encyclopedia Britannica*. Available from: <https://www.britannica.com/science/Gram-positive-bacterium>. [viewed 2024-04-18].

ROGERS, Kara, 2024c. Sepsis | Definition, Causes, Diagnosis, & Treatment | Britannica. online. In: *Encyclopedia Britannica*. Available from: <https://www.britannica.com/science/sepsis>. [viewed 2024-04-18].

RUDIN, Alfred and Phillip CHOI, 2013. *The elements of polymer science and engineering*. 3d edition. San Diego: Elsevier/AP. ISBN 978-0-12-382178-2.

RUMMEL, Christoph D.; Annika JAHNKE; Elena GOROKHOVA; Dana KÜHNEL and Mechthild SCHMITT-JANSEN, 2017. Impacts of Biofilm Formation on the Fate and Potential Effects of Microplastic in the Aquatic Environment. online. *Environmental Science & Technology Letters*, vol. 4, no. 7, pp. 258–267. Available from: <https://doi.org/10.1021/acs.estlett.7b00164>.

SIKORA, Anna and Farah ZAHRA, 2024. Nosocomial Infections. online. In: *StatPearls*. Treasure Island (FL): StatPearls Publishing. PMID 32644738. Available from: <http://www.ncbi.nlm.nih.gov/books/NBK559312/>.

SIRACUSA, Valentina and Ignazio BLANCO, 2020. Bio-Polyethylene (Bio-PE), Bio-Polypropylene (Bio-PP) and Bio-Poly(ethylene terephthalate) (Bio-PET): Recent Developments in Bio-Based Polymers Analogous to Petroleum-Derived Ones for Packaging and Engineering Applications. online. *Polymers*, vol. 12, no. 8, p. 1641. Available from: <https://doi.org/10.3390/polym12081641>.

UGOEZE, Kenneth; Christian ALALOR; Chidozie IBEZIM; Bruno CHINKO; Peter OWONARO et al., 2024. Environmental and Human Health Impact of Antibiotics Waste Mismanagement: A Review. online. *Advances in Environmental and Engineering Research*, vol. 5, no. 1, pp. 1–21. Available from: <https://doi.org/10.21926/aeer.2401005>.

VENKATACHALAM, Harsini and Radha PALANISWAMY, 2020. BIOPLASTIC WORLD: A REVIEW. *Journal of Advanced Scientific Research*, vol. 11, no. 03, pp. 43–53. ISSN 0976-9595.

VERT, Michel; Yoshiharu DOI; Karl-Heinz HELLWICH; Michael HESS; Philip HODGE et al., 2012. Terminology for biorelated polymers and applications (IUPAC Recommendations 2012). online. *Pure and Applied Chemistry*, vol. 84, no. 2, pp. 377–410. Available from: <https://doi.org/10.1351/PAC-REC-10-12-04>.

WANG, Chunhui; Jian ZHAO and Baoshan XING, 2021a. Environmental source, fate, and toxicity of microplastics. online. *Journal of Hazardous Materials*, vol. 407, p. 124357. Available from: <https://doi.org/10.1016/j.jhazmat.2020.124357>.

WANG, Xinjie; Nanthi BOLAN; Daniel C. W. TSANG; Binoy SARKAR; Lauren BRADNEY et al., 2021b. A review of microplastics aggregation in aquatic environment: Influence factors, analytical methods, and environmental implications. online. *Journal of Hazardous Materials*, vol. 402, p. 123496. Available from: <https://doi.org/10.1016/j.jhazmat.2020.123496>.

ZHANG, Kai; Amir Hossein HAMIDIAN; Aleksandra TUBIĆ; Yu ZHANG; James K. H. FANG et al., 2021. Understanding plastic degradation and microplastic formation in the environment: A review. online. *Environmental Pollution*, vol. 274, p. 116554. Available from: <https://doi.org/10.1016/j.envpol.2021.116554>.

ZHANG, Yuxuan; Juan LU and Jun WU, 2020. Potential risks of microplastics combined with superbugs: Enrichment of antibiotic resistant bacteria on the surface of microplastics in mariculture system - ScienceDirect. online. vol. 187. Available from: <https://www.sciencedirect.com/science/article/abs/pii/S0147651319311832>.