



**CZECH UNIVERSITY OF LIFE SCIENCES  
PRAGUE**

**FACULTY OF ENGINEERING**

**TECHNOLOGY AND ENVIRONMENTAL ENGINEERING**



**DIPLOMA THESIS**

**(Air-conditioning in the cabins of motor vehicles)**

**Author**



Bc. Surender Kumar

[Surenderduhan88@gmail.com](mailto:Surenderduhan88@gmail.com)

**Supervisor**



Prof. Ing. Pavel Kic, DrSc.

[kic@tf.czu.cz](mailto:kic@tf.czu.cz)

# CZECH UNIVERSITY OF LIFE SCIENCES PRAGUE

Faculty of Engineering

## DIPLOMA THESIS ASSIGNMENT

Surender Kumar

Technology and Environmental Engineering

Thesis title

Air-conditioning in the cabins of motor vehicles

---

### Objectives of thesis

The aim of the diploma thesis is to analyse the current state of design and function of air conditioning systems in cabins of motor vehicles. The attention should be focused on the assessment of main parameters, in particular on the thermal environment and quality of internal air from the driver's point of view. The assessment of influence of air conditioning on the internal environment in the vehicles should be based on knowledge from the literature and mainly supported by own measurements and considerations. The conclusions should summarize the obtained knowledge and recommend appropriate solutions suitable for practical applications.

### Methodology

Introduction

Aim of the thesis

Methods

State of the art

Results and discussion

Conclusions

References

Appendices

**The proposed extent of the thesis**

60 pages

**Keywords**

Clean air, drivers cabin, dust, microclimate, thermal state

---

**Recommended information sources**

ASHRAE Journal Modelling and Simulation in Engineering

Daly, S. Automotive air-conditioning and climate control systems. Elsevier, Oxford, 2006, 432 p., ISBN 07-506-6955-1.0

Haynes, J.: Haynes Automotive Heating and Air Conditioning Systems Manual. Haynes Manuals, ISBN-13: 978-1563929137

International Journal of Innovative Research in Science, Engineering and Technology

Miller, R., Miller, M. R.: Air Conditioning and Refrigeration. New York, McGraw-Hill, 2006, 591 p, ISBN 0-07-146788-2

Shan, K.W.: Handbook of air conditioning and refrigeration. McGraw-Hill, New Yours, 2000, ISBN 0-07-068167-8

---

**Expected date of thesis defence**

2017/18 SS – FE

**The Diploma Thesis Supervisor**

prof. Ing. Pavel Kic, DrSc.

**Supervising department**

Department of Technological Equipment of Buildings

Electronic approval: 29. 1. 2018

doc. Ing. Jan Malačák, Ph.D.

Head of department

Electronic approval: 30. 1. 2018

prof. Ing. Vladimír Jurča, CSc.

Dean

Prague on 21. 01. 2019

---

## **Declaration**

I declare my diploma thesis “Air-conditioning in the cabin of motor vehicles” I wrote independently under the supervision of Prof. Ing. Pavel Kic, DrSc. by using professional material (literature, scientific journals, etc.) and other sources of information. All sources cited at the end of the diploma thesis. As an author of this diploma thesis, I declare that I followed the all laws carefully regarding to copyright.

**In Prague on** \_\_\_\_\_

\_\_\_\_\_  
**(Surender Kumar)**

## **Acknowledgement**

I would like to say thank to Prof. Ing. Pavel Kic, DrSc. the supervisor of this diploma thesis for his valueable time and help in measurements and I would like to say thank to my family for support and motivation during my studies.



## Abstract

The main aim of this diploma thesis is to analyze the current state of design and function of Air-conditioning system in motor vehicle cabins. The focus of the diploma thesis is on basic parameters especially the thermal state of the internal environment and the purity of the internal air from the point of view of the driver. Diploma thesis has two parts. The first part of the diploma thesis contains general information about Air-conditioning like structure etc. This part completely based on literature, professional publications, magazines, Internet articles, research papers and other professional material.

The second part of the diploma thesis contains information about the actual measurements those measured by different kind of measuring equipments. Second part of diploma thesis is an experimental part. The measurements made with different operational modes of the air-conditioning system (without, minimum, medium and maximum). RH%, CO<sub>2</sub>%, Noise level L<sub>A</sub>(dB), Cabin air temperature (t<sub>i</sub>), Cabin globe temperature (t<sub>g</sub>) and Particulate matters were measured inside the vehicle cabin.

**Keywords:** Clean air, drivers cabin, dust, microclimate, thermal state.

## Abstrakt

Hlavním cílem této diplomové práce je provést analýzu současného stavu konstrukčního řešení a provozu klimatizačních zařízení v kabinách motorových vozidel. Zaměřit se na posouzení základních parametrů, zejména tepelného stavu prostředí a čistoty vnitřního vzduchu z hlediska řidiče. Diplomová práce má dvě části. První část diplomové práce obsahuje všeobecné informace o struktuře klimatizace apod. Tato část je kompletně založena na literatuře, odborných publikacích, časopisů, internetových článků, výzkumných zpráv a dalších odborných materiálu.

Druhá část diplomové práce obsahuje informace o vlastním měření dané problematiky klimatizačních zařízení motorových vozidel. Druhá část diplomové práce je experimentální. Měření provedená s různými provozními režimy klimatizačního systému (bez, minimálního, středního a maximálního). RH%, CO<sub>2</sub>%, hladina hluku L<sub>A</sub>(dB), teplota vzduch kabiny (t<sub>i</sub>), teplota globe kabiny (t<sub>g</sub>) a PM byly měřeny uvnitř kabiny vozidla.

**Klíčová slova:** Čistota vzduchu, kabina, prach, mikroklima, tepelný stav.

# Contents

1. Introduction .....	9
2. Objective of work .....	10
3. Methodology of work .....	10
3.1 Measuring instruments and Vehicle .....	12
3.1.1 Vehicle .....	12
3.1.2 Measuring instruments .....	13
3.2 Routes of Measurement .....	16
3.2.1 Route A .....	16
3.2.2 Route B .....	17
4. Description about air-conditioning system .....	17
4.1 Origin and history of air conditioning .....	17
4.2 Working principle of air-conditioning system .....	18
4.3 Components of air-conditioning systems .....	19
4.3.1 Compressor .....	19
4.3.2 Condenser .....	23
4.3.3 Evaporator .....	25
4.3.4 Accumulator .....	27
4.3.5 Cabin air filters .....	28
4.3.6 Receiver/Drier .....	29
4.3.7 Expansion valve .....	30
4.3.8 Orifice tube .....	31
4.3.9 Air vents inside the cabin .....	32
4.3.10 Blower motor .....	32
4.3.11 Condenser Fan .....	33
4.3.12 Sensors for the air-conditioning system .....	34
4.3.13 Connection elements of the air-conditioning system .....	35
4.4 Refrigerant .....	35
4.5 Types of an air-conditioning system according to the operating system .....	36

4.5.1 Manual air-conditioning system .....	37
4.5.2 Semi-automatic air-conditioning system.....	37
4.5.3 Automatic air-conditioning system.....	38
5. Results and discussions.....	39
5.1 Results of the first measurement .....	39
5.1.1 Effect of A/C system on CO <sub>2</sub> % .....	39
5.1.2 Effect of A/C system on RH% .....	41
5.1.3 Effect of A/C system on cabin temperature (t <sub>i</sub> ).....	42
5.1.4 Difference between vehicle cabin air temperature (t <sub>i</sub> ) and globe temperature (t <sub>g</sub> )....	43
5.1.5 Effect of A/C system on noise level L <sub>A</sub> (dB) inside the vehicle cabin .....	44
5.1.6 Effect of A/C system on Particulate matters (PM) inside the vehicle cabin .....	46
5.2 Results of the second measurement .....	51
5.2.1 Effect of A/C system on CO <sub>2</sub> % .....	51
5.2.2 Effect of A/C system on RH% .....	52
5.2.3 Effect of A/C system on cabin air temperature (t <sub>i</sub> ).....	53
5.2.4 Difference between vehicle cabin air temperature (t <sub>i</sub> ) and globe temperature (t <sub>g</sub> )....	54
5.2.5 Effect of A/C system on noise level L <sub>A</sub> (dB) inside the vehicle cabin .....	55
5.2.6 Effect of A/C system on Particulate matters (PM) inside the vehicle cabin .....	56
6. Detail of measurements .....	62
7. Conclusion .....	75
8. References .....	77
9. Abrivations.....	80
10. Pictures list.....	81
11. Charts list .....	82
12. Tables list .....	83



# 1. Introduction

The aim of the thesis is to analyze the current state of microclimate and operation of the air-conditioning system in the motor vehicle cabin. The Focus of the thesis is on basic parameters especially the thermal state of microclimate and cleanliness of the air inside the vehicle cabin from the point of view of the driver and passengers.

Based on the knowledge of the literature and other professional research materials (Scientific papers etc.) and Based on measurements (experimental part) find out the effect of air-conditioner on the underlying factors of the indoor environment.

No doubt, nowadays the air-conditioning facility avail by most of us. Nowadays we avail facilities of air-conditioner at home, during social or professional events, during traveling or drive motor vehicles. In simple words, the air-conditioner is quite common nowadays and very useful to create an appropriate microclimate for everyday activities.

The main work of air conditioners is providing air exchange, heating, cooling, dehumidification, dust filtration, impurities and odors from the air in some specific reason (It can be a house, vehicle, meeting hall, laboratory etc.) but the focus of the thesis is microclimate inside the vehicle cabin. Based on the theoretical part and measurement part it is quite confirmed appropriate microclimate conditions inside vehicles cabin are very important for passengers and drivers. Day by day the traffic is increasing on roads because of this number of accidents are also growing.

Suitable microclimate inside the vehicle help to reduce fatigue that's why it has positive effects for driver's attention serves as prevention of micro-sleep and a subsequent traffic accident. In other words, we can say that the air-conditioning system of motor vehicles plays a key role in active safety.

**The key indicators of a suitable microclimate inside the vehicles cabin are:**

1. Air temperature ( $t_i$ ) inside the cabin and globe temperature ( $t_g$ ).
2. Relative humidity.
3. O<sub>2</sub> concentration.
4. CO<sub>2</sub> concentration.
5. NO<sub>x</sub> concentration.
6. Dust particles (PM1 to PM10).
7. Noise level ( $L_A$ ).

## **2. Objective of work**

The main objective of the work is to describe the construction and operational state of air conditioning system of motor vehicles and the ability of air-conditioning system and role of the air-conditioner to create a suitable microclimate inside the vehicle cabin from the point of view of drivers and passengers. The main parameters of measurements are internal cleanliness of air and thermal state inside the cabin. The work performed based on theoretical knowledge (Scientific papers and other research professional materials etc.) and measurements.

## **3. Methodology of work**

All process of measurements and measuring instruments, routs of measurements comes under this content. Measurement part we divide into the following steps:-

1. Measurements during vehicle were parked at a sunny place.
  - a. Measurements without A/C with closed windows.
  - b. Measurements without A/C with open windows.
2. Measurements during driving outside town.
  - a. Measurements with minimum A/C.
  - b. Measurements with medium A/C.
  - c. Measurements with maximum A/C.
3. Measurements during vehicle park under a shadow.
  - a. Measurements with open windows without A/C.
4. Measurements during driving inside the town.
  - a. Measurements with minimum A/C.
  - b. Measurements with medium A/C.
  - c. Measurements with maximum A/C

*Table 1: Measurement number*

Measurement Number	Name of the vehicle	Route
1.	Kia Sportage	A
2.	Kia Sportage	B

Source: Author

*Table 2: Measured parameters*

Measured parameters:-	
Relative humidity	RH[%]
Temperature	$t_i$ & $t_g$ [°C]
CO <sub>2</sub> concentration	[%]
Dust Particles	[PM1 .....PM10]
Noise level	$L_A$ [dB]

Source: Author

The observed parameters were the dustiness or the number of particles of different sizes contained in the air in the space of the vehicle cabin. The PM1, PM2.5, PM4, PM10, as well as total dust in the vehicle cabin, were measured. Air temperature  $t_i$  [°C], CO<sub>2</sub> concentration [%] in cabin, relative air humidity RH [%] and noise level  $L_A$  [dB]. During measurements, driver and two crew members were inside the car. Dust particles were measured on the rear seat of the vehicle. With each particulate matter filter (1 $\mu$ m, 2.5 $\mu$ m, 4 $\mu$ m, 10 $\mu$ m) measurements took place 3 minutes with each. filter. So there were 4 values for each filter from each phase.

**Location of the measuring instruments:**

*Picture 1: Location of instruments*



Source: Author

Measuring instruments were placed in the cabin area of the car on the seat co-driver.

The temperature and relative humidity sensor together with CO<sub>2</sub> sensor were placed at some height on the headrest of co-driver seat.

### 3.1 Measuring instruments and Vehicle

#### 3.1.1 Vehicle

All measurements made with Kia Sportage car. The car was quite new and air-conditioning system was well functioning and equipped with sensors.

#### Description of vehicle

*Picture 2: Kia Sportage*



Source: Author

*Table 3: Technical Description of a car*

Technical Description of a car
Name of the vehicle: Kia Sportage.
Type of the vehicle: SUV.
Year of manufacturing: 2016.
The Color of the vehicle: Dark brown metal.
Type of AC system of the vehicle: Automatic.
Kilometer reading of the vehicle: 3424.
Type of engine of the vehicle: 1.7 LI4 (TD)
Seating capacity of the vehicle: 5 Persons including the driver.
Type of transmission of the vehicle: Manual.
The Steering system of the vehicle: Power steering.

The Material of seat covers: Synthetic rubber and mix nylon with cotton.

The Material of floor mats(Carpet): Rubber

Source: Author

### 3.1.2 Measuring instruments

#### 1. Dust Trak 8530 II Aerosol Monitor

*Picture 3: Dust Trak 8530 II Aerosol Monitor*



Source: Author

- Manufacturer: TSI Incorporated (USA).
- Principle: Reflection of the laser beam from the particles in the measuring cell.
- Measuring range: 0.001 to 150 mg.m<sup>-3</sup>.
- Particle size range: 0.1 to 15 µm.
- Measurement accuracy: ± 0.1% of the measured value.
- Airflow: 3.01 min<sup>-1</sup>.
- The time constant: 1 s to 60 s.
- Recording data: 45 days for one-minute samples.
- Recorded interval: 1 s to 1 hour.
- Operating temperature: 0 to 50°C.
- Operating humidity: 0 to 95 %.
- Weight: 2 kg with one battery and 2.5 kg with 2 batteries.
- Operating mode: The recording interval can be set from 1 s to 60 minutes.
- Battery type: Chargeable.

## 2. Metering panel ALMEMO 2590-9

- Manufacturer: Ahlborn.
- Universal data logger with 9 inputs.
- Serial number: Ho3100335Q.
- Type: Digital.
- Energy source: Chargeable battery.

*Picture 4: Metering panel ALMEMO 2590-9*



Source: Author

## 3. Temperature and relative humidity sensor ALMEMO

*Picture 5: Temperature and relative humidity sensor ALMEMO*

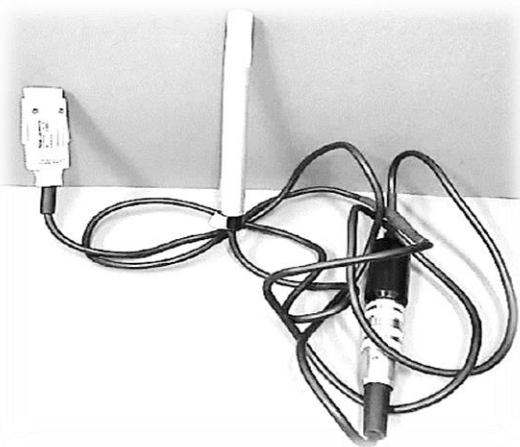

Source: Author

- Type: FH A 646-21.
- The operative range: -30 to +100 °C.
- Accuracy:  $\pm 0.01$  K.
- Operative range for air humidity: 5 to 98%.
- Accuracy for air humidity:  $\pm 2\%$ .

#### 4. ALMEMO CO<sub>2</sub> content measurement sensor

*Picture 6: ALMEMO CO<sub>2</sub> content measurement sensor*

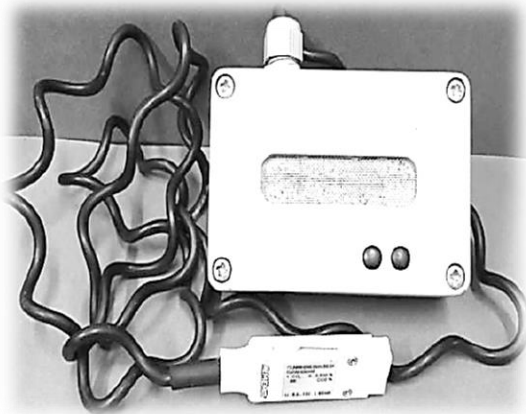

Source: Author

- Type: FY A600-CO<sub>2</sub>
- Operative range: 0 to 0.5%.
- Accuracy:  $\pm 0.01\%$ .

#### 5. BEHA 93411 noise measuring instrument

*Picture 7: BEHA 93411 noise measuring instrument*

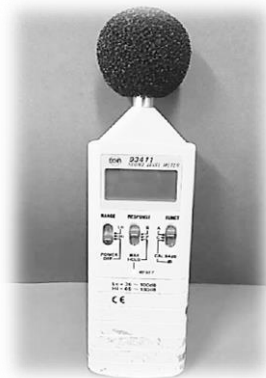

Source: Author

- Measuring range: 65 to 135 dB  $\pm$  2 dB.
- Frequency range: 30 Hz to 12 kHz
- Output signal: 10 mV DC/ dB.
- Impedance: 100  $\Omega$ .
- Energy source: Battery.

### 3.2 Routes of Measurement

Two identical routes were chosen for measurements. The first route was mostly outside the city it passed through villages. The second route passed through Prague.

#### 3.2.1 Route A

Route A started from Prague Suchdol and via Unetice and Tursko to Kralupy nad Vltavou and at last end up at Prague Suchdol. The total length of this route was 43 km. The map was similar like as under given in picture. Round colored circles on map show change of individual measurement phases.

Picture 8: Map for route A



Source: Google.com/maps



### 3.2.2 Route B

Route B also started from Prague Suchdol after passed through Hradčany, the North-South highway and at last end up at Prague Suchdol. The route was totally through the city and total length of the route was 23 km. The map was similar like as map under given in picture. Round colored circles on map show change of individual measurement phases.

Picture 9: Map for route B

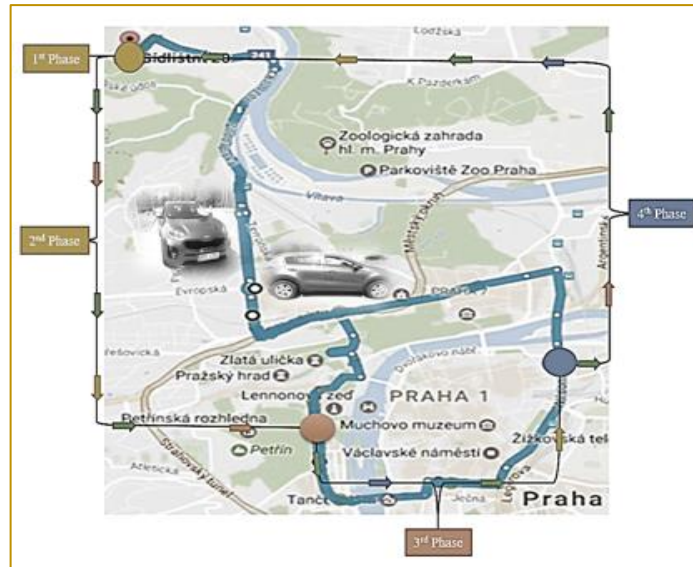

Source: Google.com/maps

## 4. Description about air-conditioning system

Automobile air conditioning is the science of controlling the temperature, humidity, motion, and cleanliness of the air within an automobile.

### 4.1 Origin and history of air conditioning

In past vehicles had no roof so the drivers and passengers had to wear clothes according to climate conditions but by the time automotive companies started to produce vehicles with doors and roof. The vehicles with door and roof were a little bit more comfortable for drivers and passengers. Insulation was the only way of heating. Ventilation was ensured by opening windows or windscreen. Vents were added for improving air circulation but airflow was difficult to control because it was very dependent on vehicle speed. The cooling system in past based on evaporation principle. In past cooling system inside vehicles had a problem of increment in moisture inside the cabin. By the time in 1939, the first A/C system installed on Packard car. But it had many problems and the most affecting one is the absence of compressor

clutch, therefore, a driver had to remove the engine belt from the compressor pulley each time he wanted to stop the A/C. A significant vehicular expansion of A/C systems in the United States was in 1969. Indeed, 50% of all new cars sold were equipped with A/C systems. For other industrialized countries such as the EU and Japan, A/C expansion took more time and 50% of new cars were not conditioned until 2000. The most worldwide expansion of A/C systems was in 2010 and more than 99% of new cars were conditioned in the US, Europe, and other countries. The first Czechoslovak vehicle with air conditioning system was Škoda VOS limousine. The boom of air conditioning system in cars in the Czech Republic came with Škoda car Felicia. [3], [23].

## 4.2 Working principle of air-conditioning system

Picture 10: Air-conditioning system & pressure-enthalpy diagram

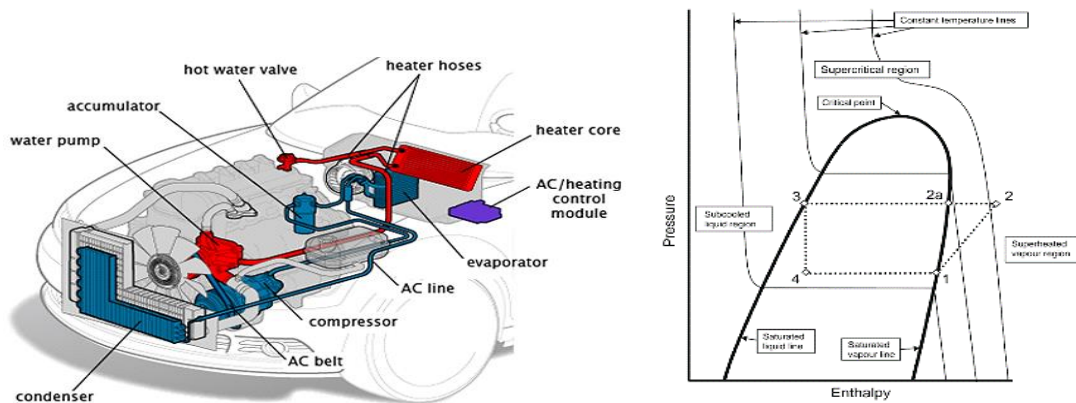

Source: [https://www.bing.com/image/search/car air-conditioning system, pressure-enthalpy diagram](https://www.bing.com/image/search/car+air-conditioning+system,+pressure-enthalpy+diagram)

Air-conditioning system works on the principle of exchange of air or in other words, we can say that it also works on the principle of heat transfer. “In automotive there are mainly two types of air-conditioners one is Thermal Expansion Valve system which regulates rate of refrigerant flow into evaporator as governed by evaporator outlet pipe temperatures sensed by the sensing bulb, and the other is Clutch Cycling Orifice tube system which controls evaporator temperature by turning the compressor on and off with a clutch cycling switch. This system includes a compressor, condenser, expansion device, evaporator, and an accumulator. Explanation of the working principle of an air-conditioning system according to the ideal vapor compression system. In the below-given diagram at point 1 refrigerant enters in the compressor and compressed adiabatically and become superheated vapor due to increase in temperature, pressure, and enthalpy as shown at point 2. The refrigerant by this point is above the temperature

of outside air. The refrigerant left the compressor and entered into the heat exchanger and then heat exchanger transferred the heat to outside air. At point 2a, the refrigerant converted into saturated vapor from the state of superheated vapor because of heat exchange. Now the refrigerant is a saturated vapor the pressure and temperature kept constant but heat is still being removed only the enthalpy continuous to decrease. The vapor begins to condense to liquid. Condensation continuous until the entire vapor is a saturated liquid point 3. The refrigerant leaves the condenser as a saturated liquid and travels towards expansion valve or fixed orifice tube. Now the refrigerant undergoes an expansion process. The process significantly reduces the temperature and pressure of the refrigerant while the enthalpy remains the same and then at point 4 most of the refrigerant is in a liquid state and from here cycle starts again. The performance of the air-conditioning system to create a suitable microclimate inside the vehicle cabin is depend on ventilation rate. [11], [3], [14].

### Equation for ventilation

$$V_c = M_p / (c_i - c_e) \dots\dots\dots (1)$$

(  $V_c$ = required air flow for ventilation( $m^3 h^{-1}$ ),  $M_p$ = Produced pollutant mass flow ( $kg h^{-1}$ ),  $c_e$ = pollutant concentration in inlet air but usually  $c_e$  is zero, because after passed through cabin air filter no pollutant remains,  $c_i$  = pollutant concentration in outlet air ( $kg m^{-3}$ ). [13].

## 4.3 Components of air-conditioning systems

Air-conditioning systems produced by assembling different components. They are given below:-

### 4.3.1 Compressor

A Compressor is the first component in the chain of the components of the air-conditioning system. In automotive vapor compression refrigeration system is used with some small variations. The refrigerant enters in the compressor and compressed adiabatically and become superheated vapor due to increase in temperature, pressure, and enthalpy. The refrigerant used in this type of compressors has a quality of absorbs a high quantity of heat from the air blown into the vehicle. They absorb heat when they change there State from liquid to vapor. They easily turn cars interior cool and dehumidify. A compressor works under extreme load conditions that's why proper lubrication is necessary. It runs by mechanical energy which provides by a drive unit of the engine with the help of V-belt. A compressor consume almost 75% of total energy used to drive the air-conditioning system that's why we can say that the efficiency of the air-conditioning system depends on the compressor

Picture 11: Compressor

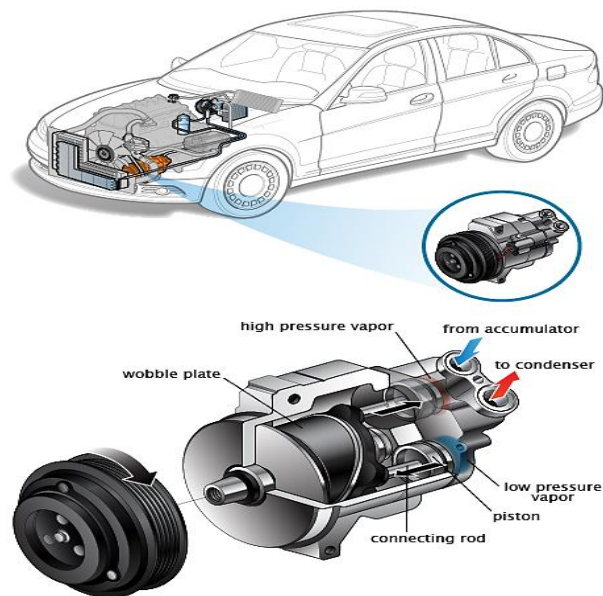

Source: <https://www.bing.com/image/search/car compressor>

.The range of pressure raises by compressor totally depends on the capacity of compressor or type of vehicle but it is usually between 200 kPa to around 2500 kPa. Lower the boiling point of refrigerant higher the capacity of heat absorbing. The speed of compressor also depends on capacity of compressor and type of vehicle it is usually between 800rpm to 2500rpm. [5], [6], [18].

### Types of compressors in automotive

#### Reciprocating compressor(Piston compressor)

Picture 12: Piston compressor

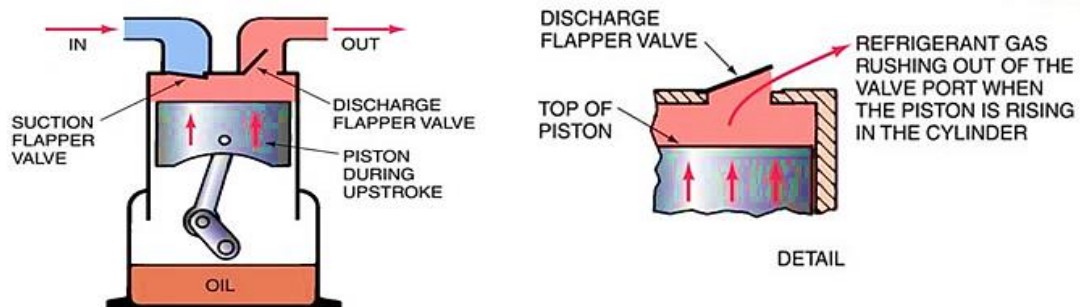

Source: <https://www.bing.com/images/search/piston compressor>

It is also known as a piston compressor. Crankshaft provides motion to the piston. Operation cycle has three steps suction, compression, and discharge. The reciprocating compressor is usually of two types single acting and double acting in single acting working fluid (refrigerant) acts only one side of the piston but in double acting, it acts both sides of the piston. The piston works same as a piston of the engine cylinder. It moves up and down in cylinder exist in a compressor. The moment of piston works by with the help of mechanical energy provided by some electric motor or engine. When the piston moves downward direction the intake valve feeds the piston cylinder and when piston goes upward direction it compresses the refrigerant and then exhausts valve allows refrigerant to pass through it. The compressor can be two cylinders or more it depends on the capacity of the compressor. [1], [6].

### Rotary compressor

Two types of the rotary compressor are used in the air-conditioning system. One type of rotary compressor has blades that rotate with the help of the shaft. Another type of rotary compressor has a fixed blade and which is part of the housing assembly. When blades rotate the trapped refrigerant vapors space ahead the blades compressed and then with the help of exhaust port discharge into the condenser. The rotary compressors have very smooth operation that's why friction losses are very less and no much vibration during operation. They have a long life because of smooth operation. [1], [14].

*Picture 13: Rotary blade & stationary blade compressor*

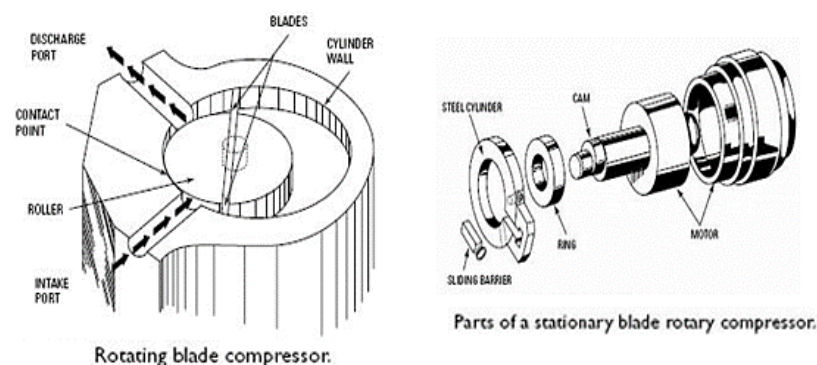

Source: [https://www.bing.com/images/search/diagram rotary compressor](https://www.bing.com/images/search/diagram+rotary+compressor)

## Scroll compressor

It has two scrolls one is fixed and another has free rotations. The moving scroll rotates through the use of a swing link. In working principle of a scroll compressor, the refrigerant between two scrolls goes under compression and pushed towards the center of the scrolls. By compression, the volume of gases forms of refrigerant decrease and by this pressure of refrigerant increase. At last refrigerant discharge through the center port towards the condenser. [1], [14].

*Picture 14: Scroll compressor*

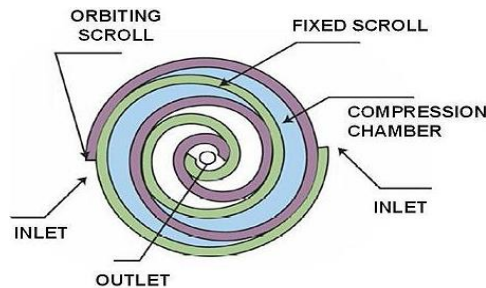

Source: [https://www.bing.com/images/search/diagram scroll compressor](https://www.bing.com/images/search/diagram+scroll+compressor)

### Advantage:

- It has a very simple construction.
- It has very few moving parts that's why very less vibration.
- Smooth operation.
- Less cost of maintenance.
- Low energy consumption.

## Electric compressor

As we know, the future of the automotive sector is hybrid or electric vehicles. Now these days also some hybrid and electric vehicles are available in the market and day by day, they are growing. Now, automotive companies they have their focus towards electric or hybrid vehicles. The electric compressor has a great application it can work with electric as well as combustion engine so it is perfect with electric vehicles (EV) and hybrid vehicles (HV). It is one kind of independent compressor. It requires DC voltage for a drive. The electric compressor has an almost the same size as a conventional compressor but has high efficiency than a conventional compressor. Electric compressor improves fuel consumption maximum by near 20% as

compared to the conventional compressor for a hybrid vehicle (HV). It has very low noise and vibration during operation. [8], [4].

*Picture 15: Electric compressor*

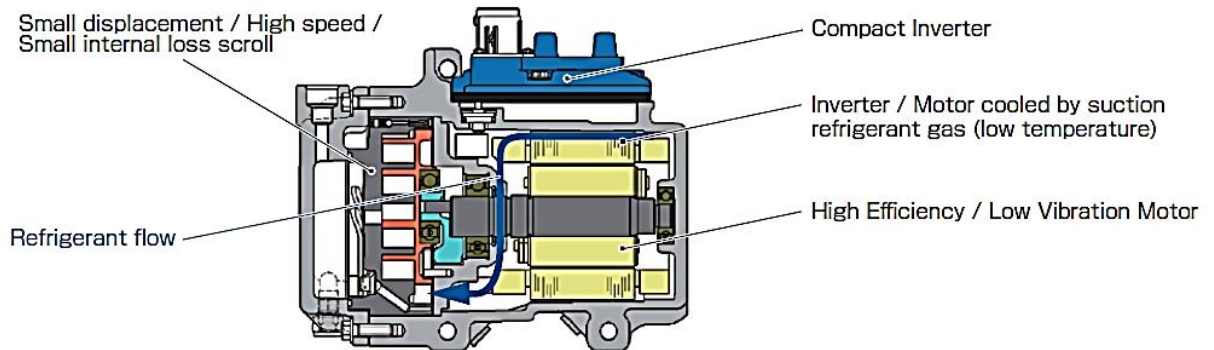

Source:

[http://www.globaldenso.com/en/newsreleases/events/globalmotorshows/2013/iaa13/files/IAA13\\_evhv.pdf](http://www.globaldenso.com/en/newsreleases/events/globalmotorshows/2013/iaa13/files/IAA13_evhv.pdf)

### 4.3.2 Condenser

In other words, we can say that condenser is a heat exchanger. The function of the condenser is to remove the heat of refrigerant discharged from the compressor. The heat from the refrigerant in a condenser is removed by (the universal nature of the heat as we know that heat always travel from hot medium to cold medium) transferring heat to the walls of the condenser tubes and then from tubes to conditioning medium (Surrounding). [18], [14].

*Picture 16: Condenser*

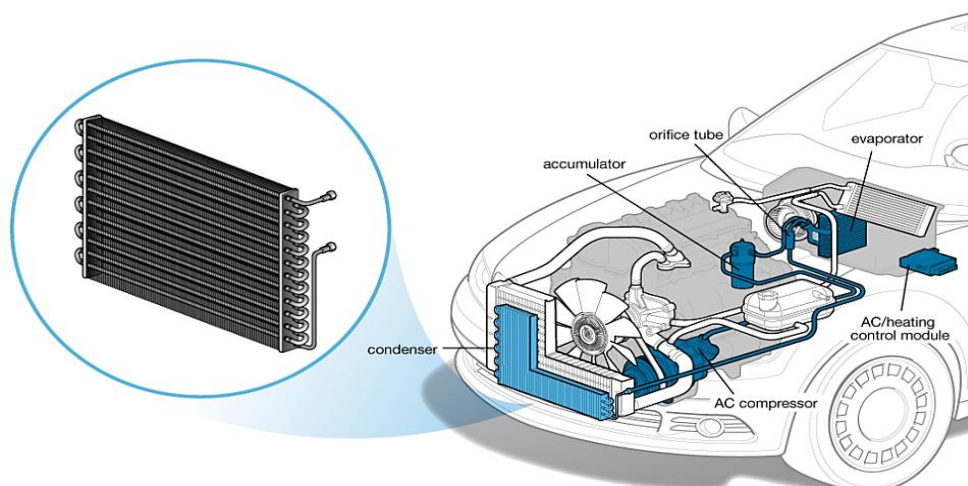

Source: <https://www.bing.com/images/search/car+condenser>

## The working principle of a condenser

According to a pressure-enthalpy diagram, the superheated vapor is cooled to saturation temperature corresponding to the pressure of the refrigerant. The line between points 3-4 shows it. This process also called as desuperheating. After that, the saturated vapor gives up latent heat and convert into saturated liquid. The name of this process is condensation. It is shown by line 4-5 in a pressure-enthalpy diagram. At last, the temperature of the refrigerant reduced more and this is a stage of subcooling. The line 5-6 in the below-given pressure-enthalpy diagram shows the process of subcooling

Picture 17: Pressure-enthalpy diagram

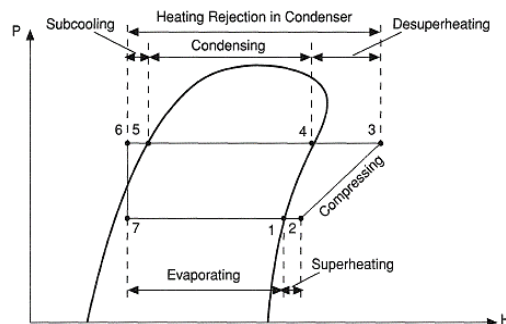

Source: [https://www.bing.com/images/search/diagram pressure-enthalpy](https://www.bing.com/images/search/diagram+pressure-enthalpy)

## Types of condensers

Mainly two types of condensers are used according to their applications.

### 1. Air cooled condensers.

- Natural convection air-cooled condensers.
- Forced convection air-cooled condensers.

### 2. Water cooled condensers

- Double tube condensers.
- Shell and coil condensers.
- Shell and tube condensers.

In air-cooled condensers, the medium of cooling is air.



In water-cooled condensers, the water is used as cooling medium.

### Heat transfer in condensers

$$Q = UA\Delta T = \Delta T/R \text{ J/s} \dots\dots\dots (2)$$

U = Heat transfer coefficient (W/m<sup>2</sup> °C).

A = Surface area of the condenser (m<sup>2</sup>).

ΔT = Temperature difference (°C).

R = Thermal resistance of the condenser.

**Note:** Air cooled condensers are used in the automotive industry. [18], [14].

### 4.3.3 Evaporator

It is an important part of an air-conditioning system. It is made with copper tubes and aluminum ribs. The function of an evaporator in air-conditioning system is to absorb heat from the medium, which we want to make colder. It is a device, which changes the state of refrigerant from liquid to vapor. The liquid refrigerant enters into the evaporator from the expansion valve where it boils. The temperature of the boiling refrigerant must be less than medium. If the temperature of the boiling refrigerant is more than medium, in this case, the heat will not flow from medium to refrigerant and system will not work. [18], [14].

Picture 18: Evaporator

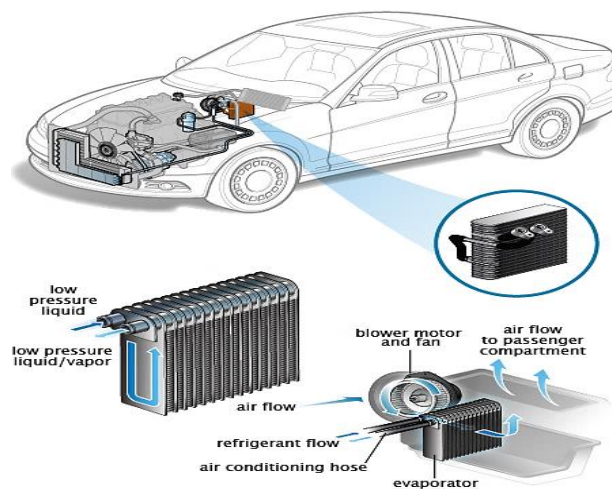

Source: [https://www.bing.com/images/search/car evaporator](https://www.bing.com/images/search/car+evaporator)

## The working principle of an evaporator

Picture 19: Pressure-enthalpy diagram

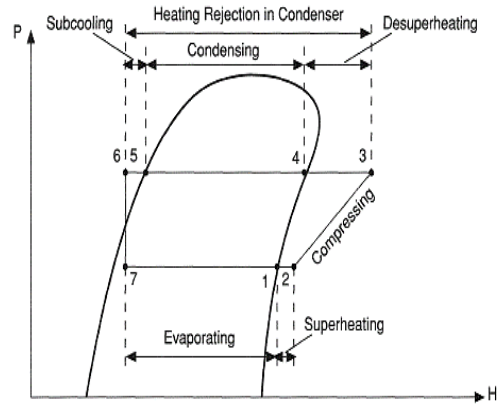

Source: [https://www.bing.com/images/search/diagram pressure-enthalpy](https://www.bing.com/images/search/diagram+pressure-enthalpy)

The working principle of an evaporator is very easy to understand with the help of a pressure-enthalpy diagram. In given above diagram point 6 represents the entry of liquid form of refrigerant into the expansion valve. As we can see in the above-given diagram, the expansion valve receives a pure liquid form of refrigerant with no vapor. At point 7 the liquid refrigerant enters into the evaporator and undergoes a process of boiling. During this boiling process, it continually absorbs heat from the medium, which we want to make colder. Finally, at point 1 all liquid refrigerant turned into vapor form and it is ready to leave the evaporator. In above-given diagram line 7-1 shows the process of evaporating. [18], [14].

### Evaporator capacity

The amount of heat absorbed by evaporator within a given time period is known as the capacity of an evaporator.

$$\text{Heat absorbed or transfer capacity } Q = UA (T_2 - T_1) \text{ J/s} \dots\dots\dots (3)$$

U = Heat transfer coefficient (W/m<sup>2</sup> °C)

A = Evaporator surface area (m<sup>2</sup>)

T<sub>2</sub> = Temperature of the medium supposed to be cooled (°C)

T<sub>1</sub> = Refrigerant saturation temperature (°C)

## Factors on which heat transfer capacity depends

- The Material of an evaporator coil.
- Temperature difference between refrigerant and medium.
- The Velocity of refrigerant inside the coil.
- Evaporator coils wall thickness.
- Contact surface area between evaporator coils and medium.

### 4.3.4 Accumulator

Picture 20: Accumulator

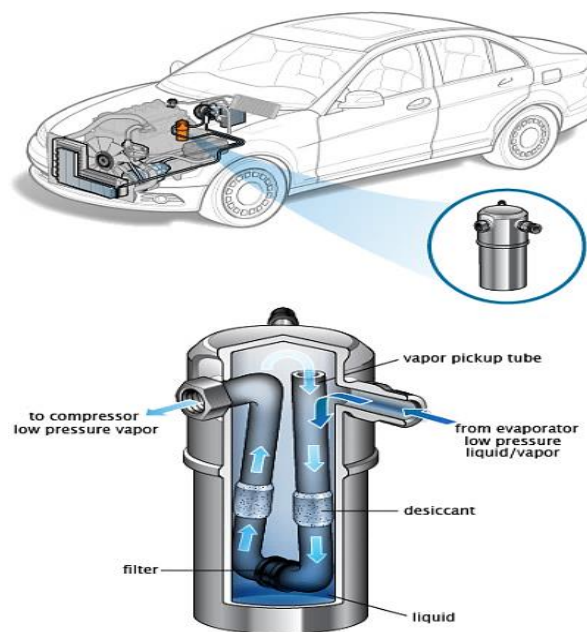

Source: [https://www.bing.com/images/search/car accumulator](https://www.bing.com/images/search/car+accumulator)

The accumulator is a device, which is located between the compressor and evaporator in the low-pressure section of the air-conditioning system. An accumulator is an alternate of receiver/drier and almost two times bigger than receiver/drier. The work of an accumulator is to store liquid refrigerant and ensure that no liquid form of refrigerant will go inside the compressor. According to its construction, the only gaseous form of the refrigerant can pass through it. It is one kind of protective equipment for the air-conditioning system. It removes moisture from the refrigerant, which can become the cause of corrosion inside the air-conditioning system and adds lubricant, which protects the components of the air-conditioning system and helps them for smooth operation. It makes a mixture of 3% lubricant and 97% gaseous refrigerant. [2], [14].

## Types of accumulator

### 1. Water accumulator

Water is used to pump refrigerant and lubricant. It has a quite simple construction and low maintenance. It works very well with water and other engine fluids.

### 2. Hydraulic accumulator

Hydraulic fluids are used to pump refrigerant and lubricant. Basically, it has three types:

- Bladder type.
- Piston type.
- Diaphragm type.

## 4.3.5 Cabin air filters

Picture 21: Cabin air filters

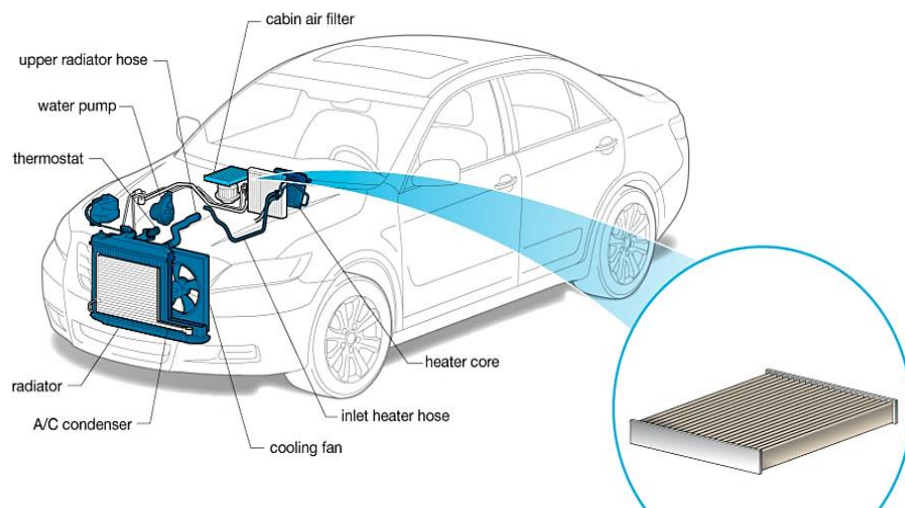

Source: [https://www.bing.com/images/search/car cabin air filters](https://www.bing.com/images/search/car+cabin+air+filters)

The cabin filters are one kind of filters that filtrate the air before entre inside the cabin of the vehicle. The cabin air filters are a very important component from the point of view of microclimate inside the vehicle compartment. They allow passing only the clean air. In other words, we can say that the purpose of air filters is to supply the clean air to the vehicle compartment and provide a healthy environment inside the compartment. They prevent the vehicle compartment from dust particles, different kinds of bacteria's, pollen and exhaust gases. The location of the cabin air filters inside the vehicle is under the windscreen as shown in above diagram. The quality filtration of the cabin air filter depends on its material. The replacement time period of cabin air filter depends on manufacturer recommendation. [3], [6], [23]

## Types of cabin air filters according to manufacturing material

- Paper filters.
- Carbon filters.

Carbon filters are more effective than paper filters. They have the ability to absorb organic odor as well as chemical odor and toxic gases like  $\text{NO}_2$ ,  $\text{C}_4\text{H}_{10}$ ,  $\text{C}_7\text{H}_8$ , and  $\text{O}_3$  etc.

### 4.3.6 Receiver/Drier

Picture 22: Receiver/Drier



Source: [https://www.bing.com/images/search/car receiver/drier](https://www.bing.com/images/search/car+receiver/drier)

The receiver/drier looks like a small metal cane with outlet inlet passes. The other names of the receiver/drier are filter/drier or receiver/dehydrator. The receiver/drier can only use with that air-conditioning system which equipped with expansion valve. It located in the high-pressure section of the air-conditioning system usually between condenser outlet and expansion valve inlet.

#### Main functions of receiver/drier

- Receiver/drier works as temporary storage of refrigerant and oil for the air-conditioning system when a system does not need them in case of low cooling.

- Receiver/drier has a filter that can trap debris. By this function, it works as a system cleaner.
- Receiver/drier contains desiccant. The desiccant is one kind of material, which has the ability of to absorb moisture. By this function, receiver/drier saves the system from the corrosion. [17]

#### 4.3.7 Expansion valve

Picture 23: Expansion valve

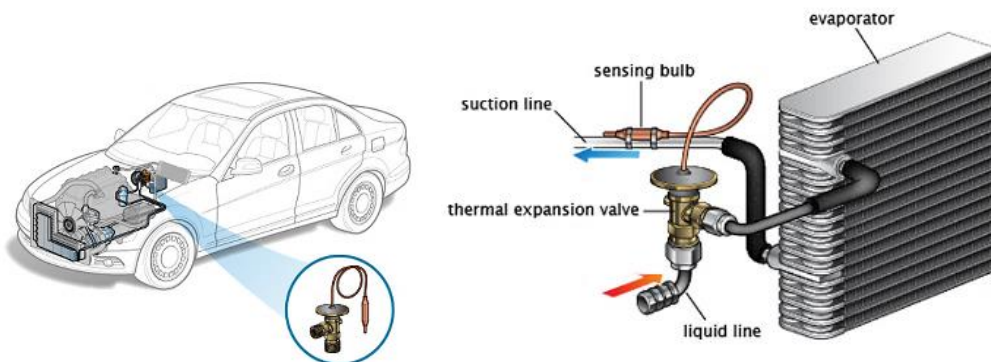

Source: [https://www.bing.com/images/search/car expansion valve](https://www.bing.com/images/search/car+expansion+valve)

The expansion valve is an expansion device. The expansion devices equipped with dry expansion evaporators known as expansion valve and expansion devices equipped with flooded evaporators called as float valves. The main function of the expansion valve is to control the refrigerant flow into the evaporator. It divides the low-pressure section and high-pressure section of the air-conditioning system. It is located between receiver/drier and evaporator.

#### Types of expansion valves

- Hand-operated expansion valve.
- Thermostatic expansion valve.
- Automatic expansion valve.
- Constant pressure expansion valve.

#### Main functions of the expansion valve

- Expansion valve reduces the pressure of the liquid refrigerant before being fed to the evaporator.

- It maintains the desired pressure difference between the low- and high-pressure sections of the air-conditioning system.
- It controls the refrigerant flow into the evaporator according to the situation of the load on the evaporator. [14], [18].

#### 4.3.8 Orifice tube

The orifice tube controls the amount of refrigerant before entering into the evaporator so we can say that the expansion valve and orifice tube do same work. It is located the high-pressure section of the air-conditioning system between condenser and evaporator core. It lowers the pressure and temperature of the refrigerant entering the evaporator. It is the latest technology than the expansion valve.

Picture 24: Orifice tube

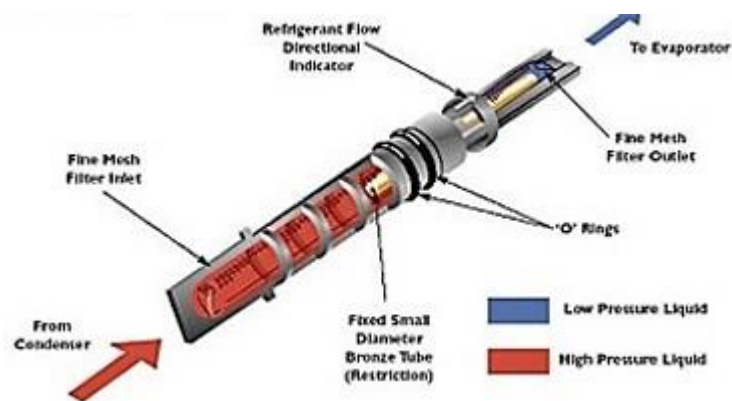

Source: [https://www.bing.com/images/search/orifice tube](https://www.bing.com/images/search/orifice+tube)

#### Working principle

High-pressure liquid refrigerant from the condenser enters into the tube and reach to expansion section (O Rings) of the tube and where it expands and by this expansion, the liquid refrigerant loses its pressure and temperature and after that from the outlet of the tube, the liquid refrigerant comes out with low pressure and low temperature.

#### Types of the orifice tube

- **Fixed orifice tube**  
It has constant flow or pressure of the refrigerant.
- **Variable orifice valve**

It has one fixed orifice tube and one another variable orifice tube controlled by temperature sensing spring. It looks like similar to regular fixed orifice tube from outside.

### **Fixed orifice tube color coding for size**

Size of orifice tube according to color depends on vehicle manufacturer. The color codes are green, orange, red, black and blue, white. [9], [14].

### **4.3.9 Air vents inside the cabin**

*Picture 25: Airflow inside the cabin through vents*

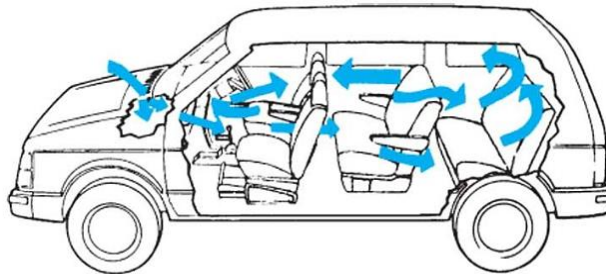

Source: [https://www.bing.com/images/search/car air vents](https://www.bing.com/images/search/car+air+vents)

Air vents play a very important role to get and keep desirable microclimate inside the cabin so they are a quite important part of an air-conditioning system. The number of air vents exists inside the cabin depending on the size of the vehicle. [19]

### **4.3.10 Blower motor**

*Picture 26: Blower motor*

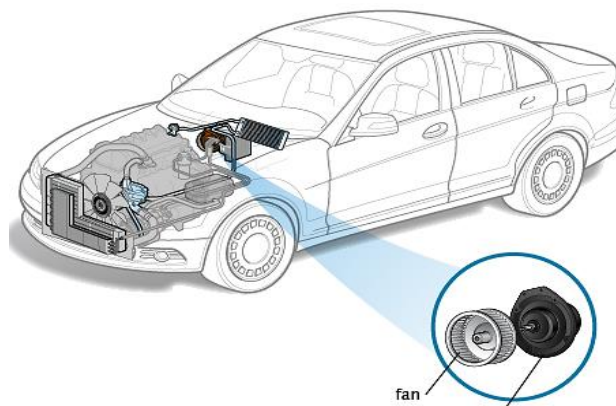

Source: [https://www.bing.com/images/search/car A/C blower motor](https://www.bing.com/images/search/car+A/C+blower+motor)



Blower motor is an electric motor with fan and it is used to deliver air from air-conditioning system to the vehicle compartment. Usually, it is located in heater box or separately under the dash. The working principle of the blower motor is quite simple, it works with DC voltage, whenever we supply DC voltage, the motor starts to spin, fan attached with the motor also spin with this and fan provides high velocity to air and push it towards the vehicle compartment. Speed selector controls the speed of the blower motor. Whenever air-conditioning is desire, the airflow from the blower motor is directed through the evaporator. The blower motor also works with heater core for heating. Some vehicles have two blower motors it depends on the size of the vehicle. [14], [15]

### **Components used in a blower motor**

- DC motor.
- The housing of the motor.
- One fan.
- Blower motor resistor and fan relay for speed control.

### **4.3.11 Condenser Fan**

*Picture 27: Condenser Fan*

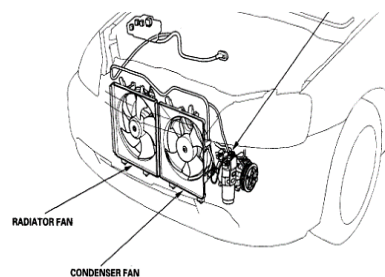

Source: [https://www.bing.com/images/search/car condenser fan](https://www.bing.com/images/search/car+condenser+fan)

Condenser fan is an important component of the air-conditioning system. It is located front side of the condenser and driven by DC voltage. It plays a quite big role in the performance of the air-conditioning system. The function of the condenser fan is to cool vapor refrigerant. It pulls the air through the condenser coils. In other words, we can say that if condenser fan is not working the air-conditioning system will not cool anything. The size of the condenser fan depends on the size of the condenser. [9], [14]

### **Components of the condenser fan**

- Waterproof DC motor.
- Plastic fan.
- A housing of the motor and fan.
- Wiring for voltage supply.

#### **4.3.12 Sensors for the air-conditioning system**

Now, these days most of automotive companies have their vehicles with a sensor-based air-conditioning system. The cabin of the vehicle has irregular temperature distribution because of windows and slops so it is quite difficult to create pleasant ambient conditions inside the cabin of the vehicle. The sensor-based air-conditioning system helps a lot to create pleasant ambient conditions inside the cabin. [7], [20]

#### **Types of air-conditioning sensors in automobiles**

##### **Evaporator temperature sensor**

The main function of the evaporator sensor is to control the temperature of the evaporator. It prevents to become temperature of evaporator near freezing point. The evaporator temperature sensor usually located on evaporator fins and in some vehicles it measures air temperature directly in front of the evaporator. It sends a signal to the system and on the behalf of the signal shutdown occur.

##### **Interior temperature sensors**

Interior temperature sensors are used to set sufficient temperature as required for the vehicle cabin. They are located inside the vehicle cabin and provide exact data of cooling. They help a lot to keep suitable cooling inside the cabin. The number of sensors used inside the vehicle compartment depends on the size of the vehicle.

##### **Solar sensors**

No one other temperature sensors can detect the temperature felt by passengers or drivers caused by direct sunlight on skin. Solar sensors can detect it and also they are able to evaluate the solar intensity and direction of the sun rays. They are very helpful in a dual zone air-conditioning system with the help of these sensors the system cools cabin more from the side of radiations than the shade.

## **External temperature sensors**

External temperature sensors are informed to drivers and passengers about the outside temperature. They also pass the necessary information to the air-conditioning system and control unit of the engine. They usually located behind the front bumper and on the side mirror and can be another part of the body. They are able to stand with moisture, heat, high pressure etc.

### **4.3.13 Connection elements of the air-conditioning system**

The connection elements are a very important part of the air-conditioning system. Connection pipes and hoses are used as a connection elements in the air-conditioning systems. The main purpose of hoses and connection pipes are to deliver and maintain the flow of refrigerant from one component to the other component of the air-conditioning system. Usually, they assemble with the help of clips. These clips are responsible for refrigerant leakage and pressure leakage. The material used to make these hoses and pipes are usually thermoplastic and metals like aluminum, copper and some other kind of metal alloys. The material of connection pipes also depends on the state of the fluid which will flow through them. Different sizes of connection pipes used in the air-conditioning system. [9], [6]

## **4.4 Refrigerant**

It is compound usually found in the gaseous or liquid state. It has the ability to absorb heat from the environment and can provide air-conditioning when it combines with components like compressors and evaporators and also has some important characteristics including good refrigeration performance, low flammability, and toxicity, compatibility with compressor lubricating oils and metals and good heat transfer characteristics. They usually identified by a number that relates to their molecular composition. [14], [18]

### **Types of refrigerants**

Most common refrigerants used in air-conditioning systems are:-

- Refrigerant R12 was used until early 1990 after that it banned because of its harmful impact on the environment. It has high ozone depleting potential(ODP). It is a colourless, odourless, non-toxic, non-corrosive, non-irritating, non-flammable liquid . It has boiling point  $-29^{\circ}\text{C}$  at ATP. It has a pressure of 0.82 bar at  $-15^{\circ}\text{C}$  and 6.4 bar at

30°C. The chemical formula of R12 refrigerant is  $\text{CCl}_2\text{F}_2$  and chemical name is Dichloro-difluoro-methane. Leakage is generally detected by a soap solution. [14], [18]

- Refrigerant R134 replaced the refrigerant R12. It has zero ozone depleting potential (ODP) and 74% less GWP than refrigerant R12 and not soluble in mineral oil. It has boiling point  $-26.15^\circ\text{C}$ . Leakage is generally detected by a sensitive leak detector. Refrigerant R134a used until the year 2016. It banned because of its global warming potential (GWP). It has 1300 GWP and according to new rule, it is not possible to register a vehicle with a GWP refrigerant more than 150. The chemical formula of refrigerant R134a is  $\text{CF}_3\text{CH}_2$  and chemical name is Tetrafluoro-ethane. [14], [18]
- R1234yf is the current refrigerant of the automotive sector. It has GWP value 4. It is very ecological and non-toxic. It has similar properties like refrigerant R134a. The disadvantage of refrigerant is mild flammability because of that it needs special storage and manipulation requirements. [21]

#### **Properties of an ideal refrigerant**

- It must have low boiling and freezing point.
- Non-corrosive, non-explosive, non-toxic, non-flammable in nature.
- High latent heat of vaporization, thermal conductivity, and coefficient of performance.
- Friendly with ozone ( $\text{O}_3$ ).
- Has easy availability.
- Low specific heat of liquid, the volume of vapor and high specific heat of vapor.
- Easy to find leakage.
- Reliable cost.

#### **4.5 Types of an air-conditioning system according to the operating system**

In automotive according to the operating system, we can divide the air-conditioning system into three types:

- Manual air-conditioning system.
- Semi-automatic air-conditioning system.
- Automatic air-conditioning system.

#### 4.5.1 Manual air-conditioning system

Picture 28: Operating control system of a manual air-conditioning system

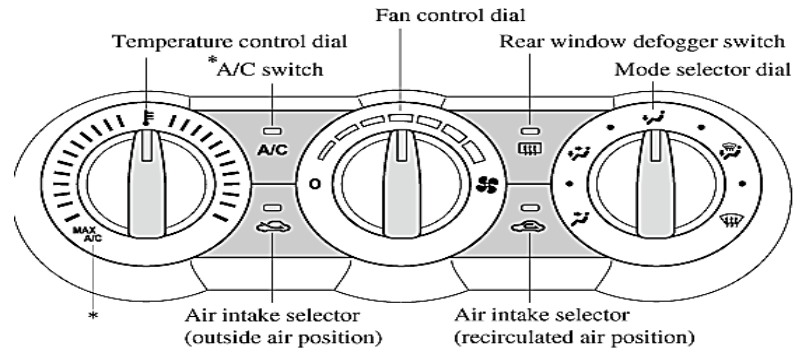

Source: <https://www.bing.com/images/search/car AC control system>

In manual type operating system everything is performed by the operator (driver) manually like the change of air velocity and temperature. In the above diagram it shows it has dials. Manual air-conditioning system has not any sensor to control. The microclimate of the cabin depends on outside temperature and speed of the vehicle and number of passengers inside the vehicle. To create comfortable zone inside the cabin the operators often need to change the air-conditioning settings. Whenever operator press the A/C button, the compressor starts work. The compressor works on full speed all the time. The operator cannot control the speed of the compressor. Manual air-conditioning put more load on vehicle engine and reduces engine power. [16]

#### 4.5.2 Semi-automatic air-conditioning system

Picture 29: Operating control system of the semi-automatic air-conditioning system

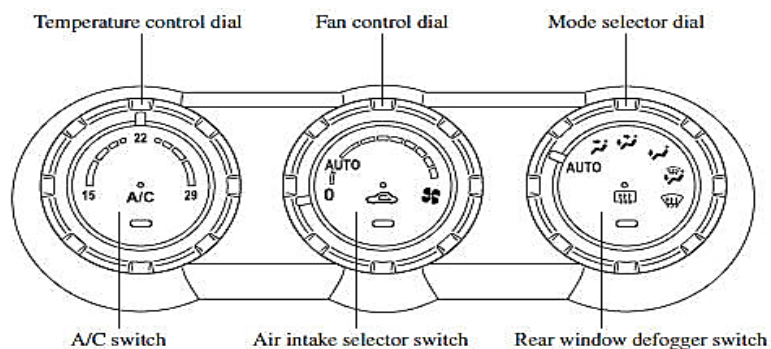

Source: <https://www.bing.com/images/search/car AC control system>

Semi-automatic air-conditioning system has some properties of the manual air-conditioning system and some properties of an automatic air-conditioning system. In other words, we can

say that it is the intermediate version of the air-conditioning system. It has an electronic control system and sensors for temperature. It has control dials same like as manual air-conditioning system. It can control the temperature inside the vehicle compartment according to the set temperature. It is not able to control the velocity of airflow automatically. The semi-automatic air-conditioning system is not able to distribute air inside the cabin automatically. [16]

### 4.5.3 Automatic air-conditioning system

Picture 30: Operating control system of the automatic air-conditioning system

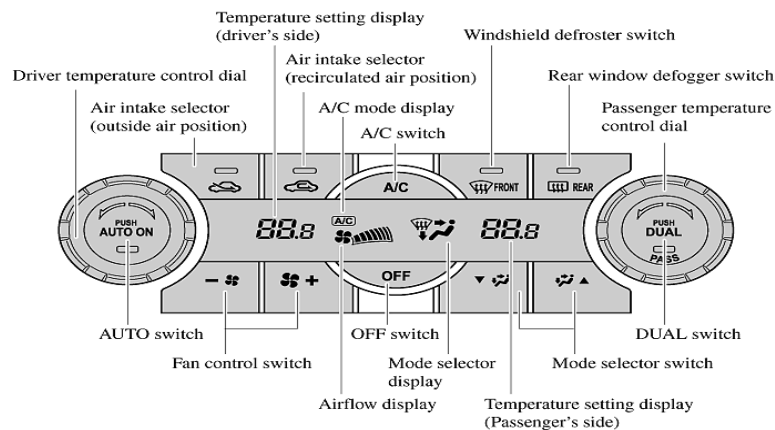

Source: <https://www.bing.com/images/search/car AC control system>

The automatic air-conditioning system operates by itself according to set temperature. It has its own control unit. It controls the temperature and velocity of airflow inside the cabin by using sensors. In this system, several sensors are located inside the cabin near to head, chest and legs of the passengers. The sensors compare measured temperature with a set temperature and then they decrease or increase the temperature to achieve set temperature. It has automatic air distribution with the help of sensors. The other name of the automatic air-conditioner is the multi-zone air conditioner. It is able to set up the different temperature in different parts of the vehicle compartment. [16]

### Types of automatic air-conditioning system

- **Dual-zone air-conditioning system**

It is able to set up the different temperature on the right or left side of the vehicle compartment.

- **Four-zone air-conditioning system**

It is able to set up the different temperature on each seat of the vehicle.

## 5. Results and discussions

During measurement CO<sub>2</sub>%, RH%, Temperature, Particulate matter( PM), Noise level L<sub>A</sub>(dB), were measured inside the vehicle cabin with the help of different measuring instruments. They were measured with without A/C on, with minimum A/C, with medium A/C, and with full A/C. The measuring instruments for CO<sub>2</sub>, RH%, Temperature, Noise level L<sub>A</sub>(dB) were set up on co-driver seat in the first compartment of the vehicle and particulate matters (PM) were measured in rear part of the vehicle compartment. All measurements were made during the summer season. The excess amount of these parameters have a very bad effect on drivers and passengers health. They have a very bad effect especially for allergic people and also sometimes they become the cause of an accident. The recommended level of these parameters is very important for healthy microclimate inside the vehicle cabin. The term phase used in given below tables the meaning of this phase is some time period for each measurement. The graphical explanation of each parameter with tables is given below.

### 5.1 Results of the first measurement

1<sup>st</sup> measurement outside town and during parking vehicle at Suchdol Prague.

#### 5.1.1 Effect of A/C system on CO<sub>2</sub>%

Chart 1: CO<sub>2</sub>% during 1st measurement

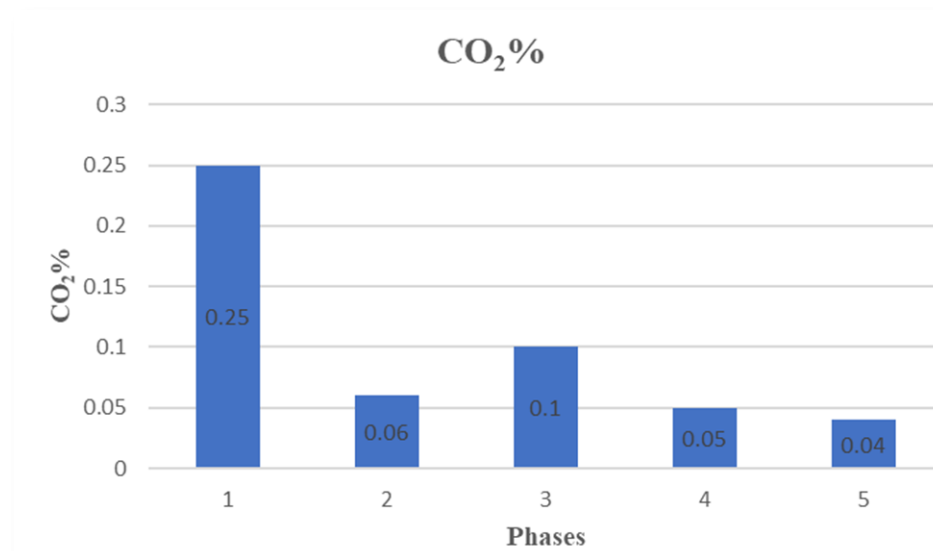

Source: Author

*Table 4: CO<sub>2</sub>% during 1st measurement*

<b>Phase</b>	<b>Conditions</b>	<b>CO<sub>2</sub> % mean value</b>
Phase: 1 (8 minutes)	During parking, AC off, Window closed.	0.25
Phase: 2 (14 minutes)	During parking, AC off, Open windows.	0.06
Phase: 3 (18 minutes)	During driving, A/C ON minimum.	0.1
Phase: 4 (18 minutes)	During driving, A/C ON medium.	0.05
Phase: 5 (20 minutes)	During driving , A/C ON maximum.	0.04

Source: Author

According to above-measured data, we can say that the A/C system is very effective in automobiles to maintain the level of CO<sub>2</sub>. In the above-given chart, it clearly shows when A/C system was off the level of CO<sub>2</sub> was very high inside the cabin. It measured highest 0.25% during phase 1. As soon as the air-conditioning system started work the level of the CO<sub>2</sub> started to drop rapidly. The lowest level of CO<sub>2</sub> 0.04% was with a maximum operation of the A/C system.



### 5.1.2 Effect of A/C system on RH%

Chart 2: RH% during 1st measurement

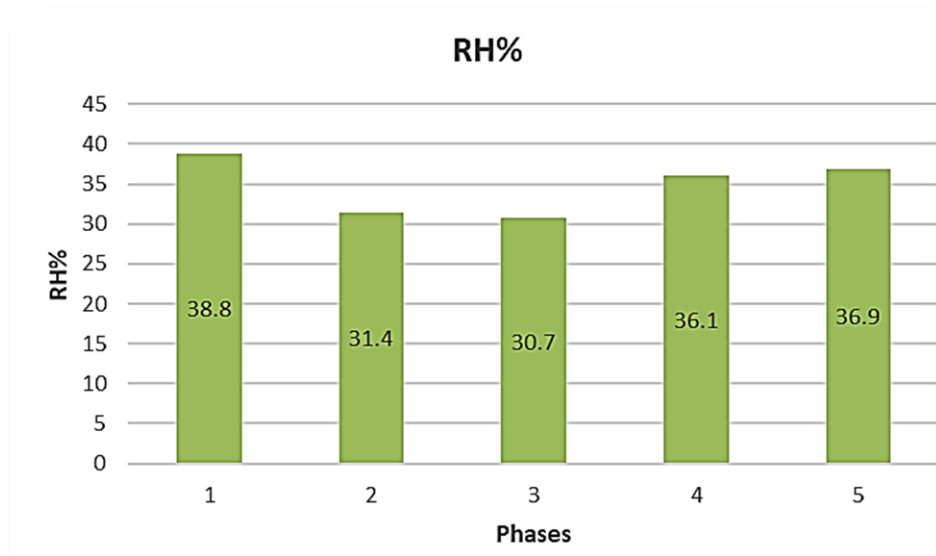

Source: Author

Table 5: RH% during 1st measurement

Phase	Conditions	RH% mean value
Phase: 1 (8 minutes)	During parking, AC off, Window closed.	38.8
Phase: 2 (14 minutes)	During parking, AC off, Open windows.	31.1
Phase: 3 (18 minutes)	During driving, A/C ON mini.	30.7
Phase: 4 (18 minutes)	During driving, A/C ON medium.	36.1
Phase: 5 (20 minutes)	During driving , A/C ON maximum.	36.9

Source: Author

According to the above measured data, we can say that A/C system is very effective to maintain a suitable level of RH. During the day of the measurement, the air was dry in the above-given

chart the measurement of phase: 2 (31.1%) clearly shows it. Relative humidity depends on external conditions. As soon as the air-conditioning system started work, the level of relative humidity increased rapidly and at last, it reached a suitable level, which we need for healthy microclimate inside the vehicle cabin.

### 5.1.3 Effect of A/C system on cabin temperature ( $t_i$ )

Chart 3: during 1st measurement

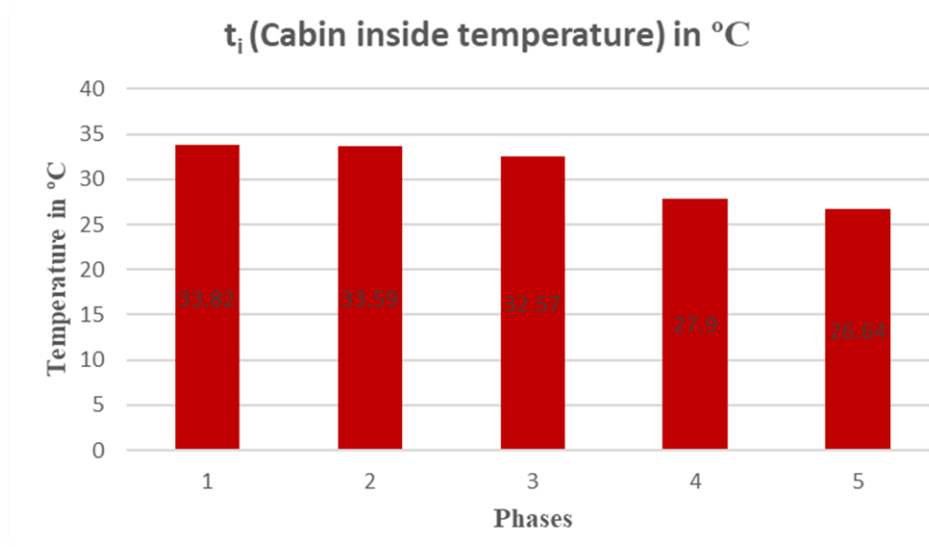

Source: Author

Table 6:  $t_i$  during 1st measurement

Phase	Conditions	$t_i$ mean value in °C
Phase: 1 (8 minutes)	During parking, AC off, Window closed.	33.82
Phase: 2 (14 minutes)	During parking, AC off, Open windows.	33.59
Phase: 3 (18 minutes)	During driving, A/C ON mini.	32.57
Phase: 4 (18 minutes)	During driving, A/C ON medium.	27.90
Phase: 5 (20 minutes)	During driving, A/C ON maximum.	26.64

Source: Author

According to the above-measured data, we can say that A/C system plays a very effective role to keep comfortable temperature ( $t_i$ ) inside the vehicle cabin. As shown in the above chart without the operation of A/C system the temperature of the vehicle cabin was high as soon as A/C system started work temperature of the cabin dropped rapidly. The set temperature of A/C system was 24°C. According to the above measurements, we can say that the A/C system is quite effective at its maximum operational condition to keep the desired temperature inside the vehicle cabin. Phase: 5 (26.64 °C) measurement, it clearly shows the temperature reached very near to the set temperature of the A/C system.

#### 5.1.4 Difference between vehicle cabin air temperature ( $t_i$ ) and globe temperature ( $t_g$ )

Table 7: Difference between  $t_i$  &  $t_g$  during 1st measurement

Phase	$t_g$ mean value in °C	$t_i$ mean value in °C
Phase: 1 (8 minutes)	33.14	33.82
Phase: 2 (14 minutes)	40.93	33.59
Phase: 3 (18 minutes)	37.85	32.57
Phase: 4 (18 minutes)	31.98	27.90
Phase: 5 (20 minutes)	32.57	26.90

Source: Author

Chart 4: Difference between  $t_i$  &  $t_g$  during 1st measurement

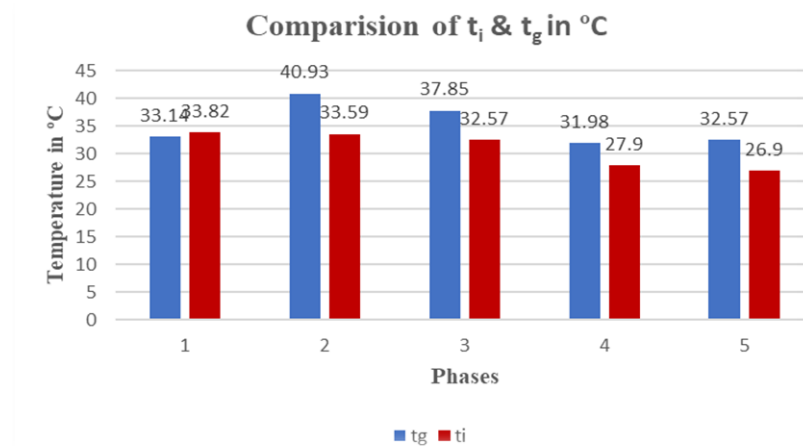

Source: Author

**Note:** Above table shows some big globe temperature ( $t_g$ ) difference between phases. The reason for this difference is that during measurements vehicle passed through different towns, villages and fields that's why solar radiations entered with different angles inside the vehicle.

### 5.1.5 Effect of A/C system on noise level $L_A$ (dB) inside the vehicle cabin

Table 8: Noise level  $L_A$ (dB) during 1st measurement

Phase	Conditions	Mean value noise $L_A$ (dB)
Phase: 1 (8 minutes)	During parking, AC off, Window closed.	54.70
Phase: 2 (14 minutes)	During parking, AC off, Open windows.	51.33
Phase: 3 (18 minutes)	During driving, A/C ON mini.	59.33
Phase: 4 (18 minutes)	During driving, A/C ON medium.	62.47
Phase: 5 (20 minutes)	During driving, A/C ON maximum.	66.49

Source: Author

Chart 5: Noise level  $L_A$ (dB) during 1st measurement

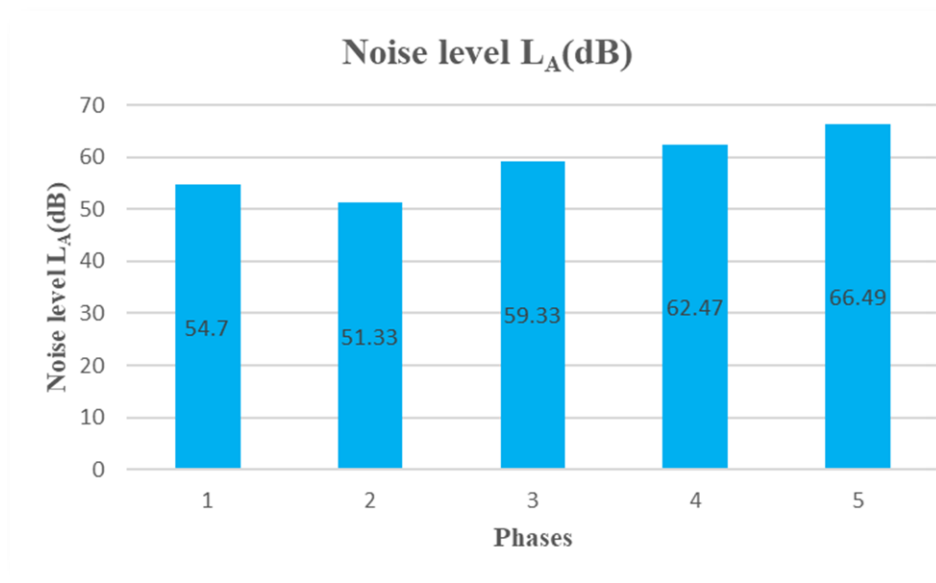

Source: Author

The noise level measured in decibel (dB) inside the vehicle cabin. The measuring instrument for noise level  $L_A$ (dB) was set up on co-driver seat in the first compartment of the vehicle cabin. According to the above-measured data, we can say that the A/C system increase noise level  $L_A$ (dB) inside the vehicle cabin. The reason for this increment in noise level  $L_A$ (dB) is noise generated by the air-conditioning system components and surrounding. The level of noise was not unpleasant inside the cabin so we can say that this noise level  $L_A$ (dB) has not any bad impact on the microclimate of the vehicle cabin.

### 5.1.6 Effect of A/C system on Particulate matters (PM) inside the vehicle cabin

#### PM 1

Table 9: PM 1 during 1st measurement

Phase	Conditions	Mean value PM1( $\mu\text{g.m}^{-3}$ )
Phase: 1&2 (8+14 minutes)	Parking, AC off, Window closed & window opened.	22.8
Phase: 3 (18 minutes)	Driving, A/C ON minimum	22.5
Phase: 4 (18 minutes)	Driving, A/C ON medium.	27.5
Phase: 5 (20 minutes)	Driving, A/C ON maximum.	17.7

Source: Author

Chart 6: PM 1 during 1st measurement

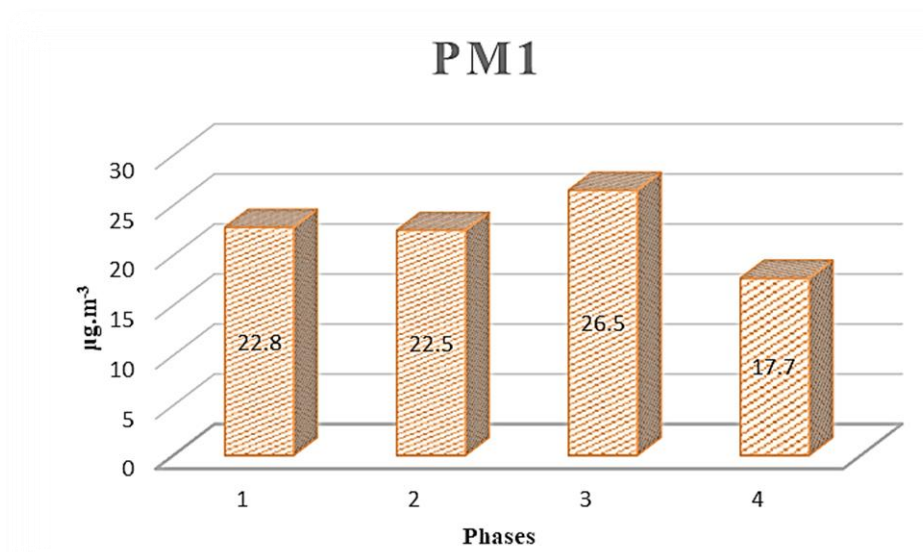

Source: Author

According to measurements shown in the above chart, we can say that the minimum operation of the A/C system is not effective for PM 1. A/C system started work with the medium operation then particles increased and reached its highest level  $26.5 \mu\text{g.m}^{-3}$  because of air-velocity.

Maximum operation of A/C system is quite effective on PM1 particles. Minimum particles 17.7  $\mu\text{g.m}^{-3}$  measured with the maximum operation of A/C system.

## PM 2.5

Table 10: PM 2.5 during 1st measurement

Phase	Conditions	Mean value of PM2.5 ( $\mu\text{g.m}^{-3}$ )
Phase: 1&2 (8+14 minutes)	Parking, AC off, Window closed & window opened.	22.8
Phase: 3 (18 minutes)	Driving, A/C ON minimum.	18
Phase: 4 (18 minutes)	Driving, A/C ON medium.	27.8
Phase: 5 (20 minutes)	Driving, A/C ON maximum.	14.7

Source: Author

Chart 7: PM 2.5 during 1st measurement

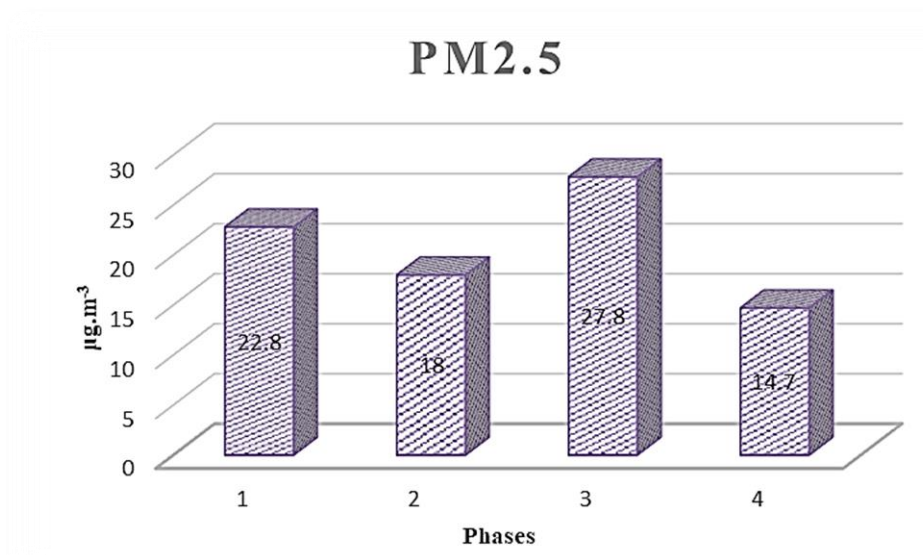

Source: Author

According to measurements shown in the above chart, we can say that the minimum operation of A/C system is effective for PM 2.5. A/C system started work with the medium operation

then particles increased and reached its highest level 27.8  $\mu\text{g.m}^{-3}$  because of air-velocity. Maximum operation of the A/C system is very effective on PM 2.5 particles. Minimum particles 14.7  $\mu\text{g.m}^{-3}$  measured with the maximum operation of the A/C system.

## PM 4

Table 11: PM 4 during 1st measurement

Phase	Conditions	Mean value PM4( $\mu\text{g.m}^{-3}$ )
Phase: 1&2 (8+14 minutes)	Parking, AC off, Window closed & window opened.	24
Phase: 3 (18 minutes)	Driving, A/C ON minimum	18
Phase: 4 (18 minutes)	Driving, A/C ON medium.	34.8
Phase: 5 (20 minutes)	Driving , A/C ON maximum.	18.5

Source: Author

Chart 8: PM 4 during 1st measurement

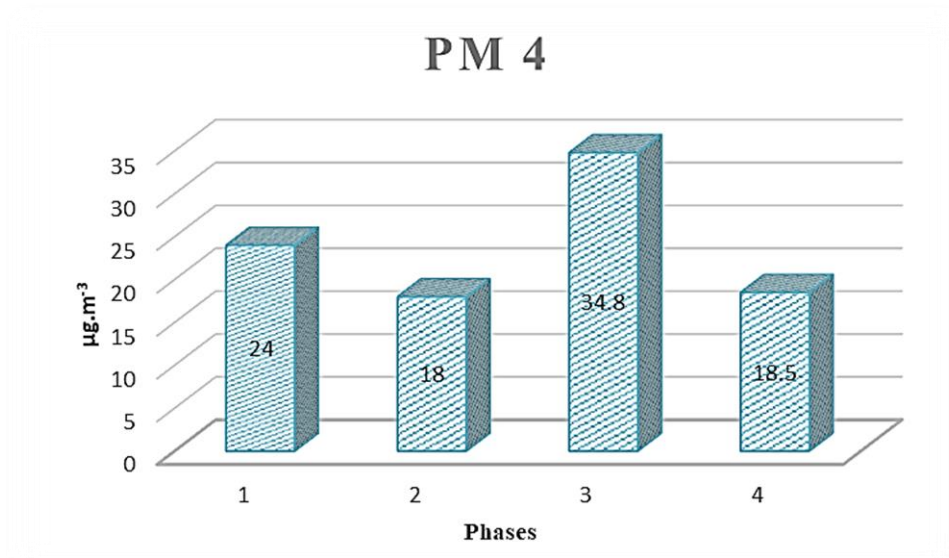

Source: Author

According to measurements shown in the above chart, we can say that the minimum operation of the A/C system is effective for PM4. A/C system started work with the medium operation



then particles increased and reached its highest level  $34.8 \mu\text{g.m}^{-3}$  because of air-velocity. Maximum operation of the A/C system is also effective on PM 4 particles. Minimum particles  $18 \mu\text{g.m}^{-3}$  measured with the minimum operation of the A/C system.

## PM 10

Table 12: PM 10 during 1st measurement

Phase	Conditions	Mean value PM10 ( $\mu\text{g.m}^{-3}$ )
Phase: 1&2 (8+14 minutes)	Parking, AC off, Window closed & window opened.	26.9
Phase: 3 (18 minutes)	Driving, A/C ON minimum.	19.8
Phase: 4 (18 minutes)	Driving, A/C ON medium.	28.9
Phase: 5 (20 minutes)	Driving , A/C ON maximum.	18.4

Source: Author

Chart 9: PM 10 during 1st measurement

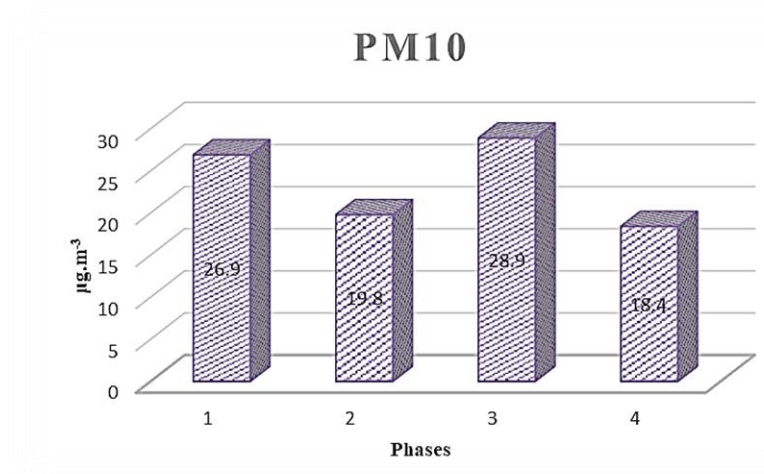

Source: Author

According to measurements shown in the above chart, we can say that the minimum operation of the A/C system is effective for PM 10. A/C system started work with the medium operation

then particles increased and reached its highest level 28.9  $\mu\text{g.m}^{-3}$  because of air-velocity. Maximum operation of the A/C system is also effective for PM 10 particles. Minimum particles 18.4  $\mu\text{g.m}^{-3}$  measured with the maximum operation of the A/C system.

### Total dust measured during the 1<sup>st</sup> measurement

Table 13: total dust during 1st measurement

Phase	Conditions	Mean value of total dust ( $\mu\text{g.m}^{-3}$ )
Phase: 1& 2 (8+14 minutes)	Parking, AC off, Windows closed & window opened.	48.3
Phase: 3 (18 minutes)	Driving, A/C ON minimum.	21.8
Phase: 4 (18 minutes)	Driving, A/C ON medium.	28.1
Phase: 5 (20 minutes)	Driving , A/C ON maximum.	23.8

Source: Author

Chart 10: total dust during 1st measurement

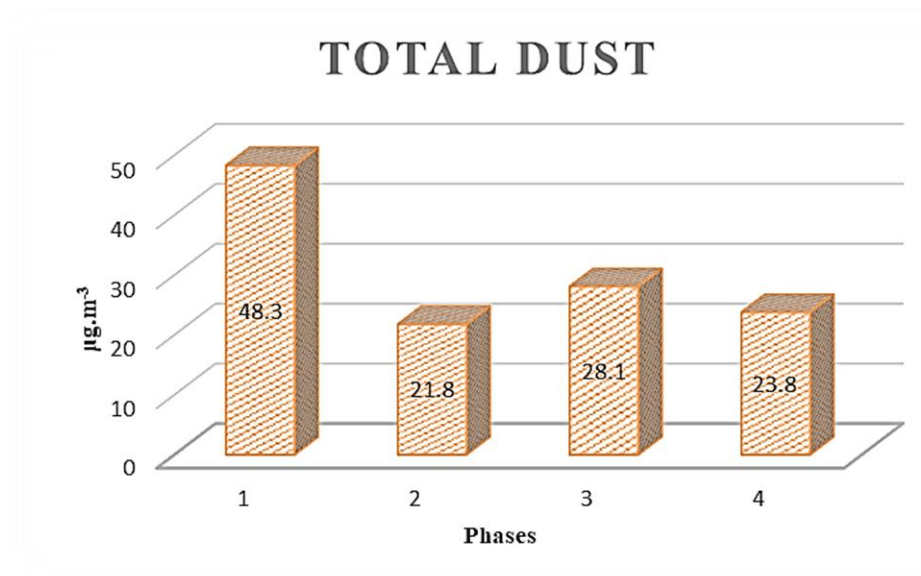

Source: Author

According to measurements shown in above chart the highest level of total dust inside the cabin  $48.3 \mu\text{g.m}^{-3}$  was without operation of the A/C system and lowest  $21.8 \mu\text{g.m}^{-3}$  was with the minimum operation of the A/C system.

## 5.2 Results of the second measurement

**2<sup>nd</sup> measurement inside the town and during parking vehicle under shadow at Suchdol Prague.**

### 5.2.1 Effect of A/C system on CO<sub>2</sub>%

*Chart 11: CO<sub>2</sub>% during 2nd measurement*

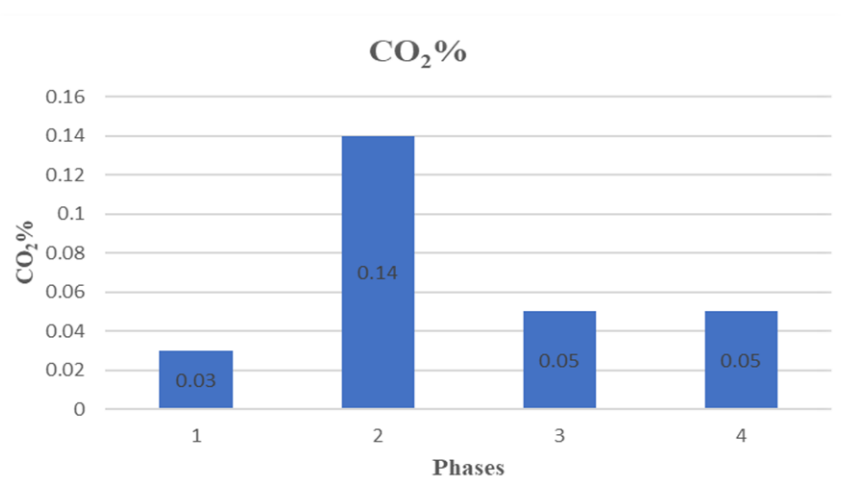

Source: Author

*Table 14: CO<sub>2</sub>% during 2nd measurement*

Phase	Conditions	Mean value of CO <sub>2</sub> %
Phase: 1 (19 minutes)	Parking under the shadow, A/C off, Opened windows.	0.03
Phase: 2 (17 minutes)	Driving, A/C ON minimum.	0.14
Phase: 3 (17 minutes)	Driving, A/C ON medium.	0.05
Phase: 4 (21 minutes)	Driving, A/C ON maximum.	0.05

Source: Author

According to above-measured data we can say that the A/C system is very effective in automobiles to maintain the level of CO<sub>2</sub>. In the above-given chart, it clearly shows when A/C system was off the level of CO<sub>2</sub> was lowest inside the cabin because of the open windows. It measured highest 0.14% during phase 2 with the minimum operation of the A/C system. The lowest level of CO<sub>2</sub> 0.03% was measured during without operation of the A/C system because of the fresh air.

### 5.2.2 Effect of A/C system on RH%

Chart 12: RH% during 2nd measurement

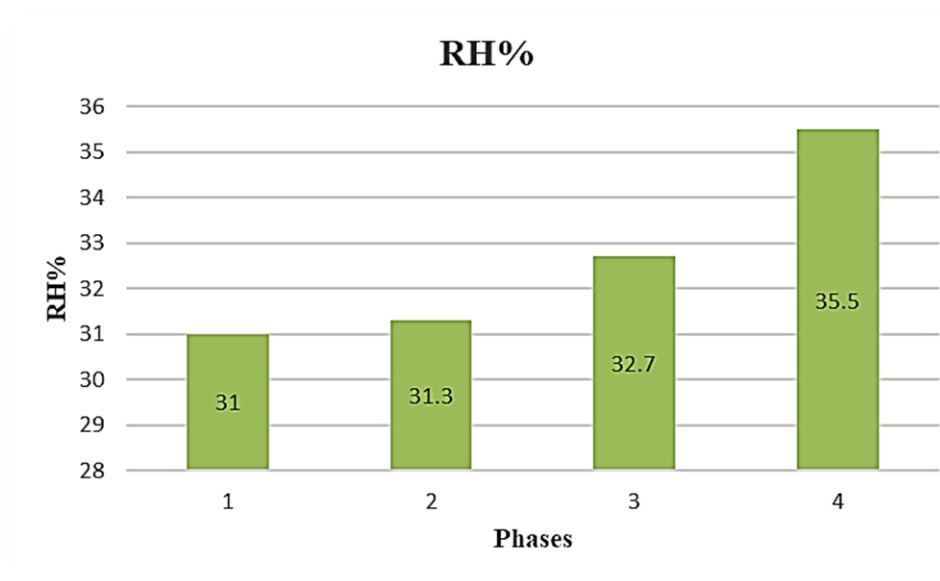

Source: Author

Table 15: RH% during 2nd measurement

Phase	Conditions	Mean value of RH%
Phase: 1 (19 minutes)	Parking under the shadow, A/C off, Opened windows.	31.0
Phase: 2 (17 minutes)	Driving, A/C ON minimum.	31.3
Phase: 3 (17 minutes)	Driving, A/C ON medium.	32.7
Phase: 4 (21 minutes)	Driving , A/C ON maximum.	35.5

Source: Author

According to above-measured data, we can say that A/C system is very effective to maintain a suitable level of RH. During the day of the measurement, the air was dry in above-given chart the measurement of phase – 1(31%) clearly shows it. Relative humidity depends on external conditions. As soon as the air-conditioning system started work, the level of relative humidity increased rapidly and at last, it reached a suitable level, which we need for healthy microclimate inside the vehicle cabin.

### 5.2.3 Effect of A/C system on cabin air temperature ( $t_i$ )

Chart 13:  $t_i$  during 2nd measurement

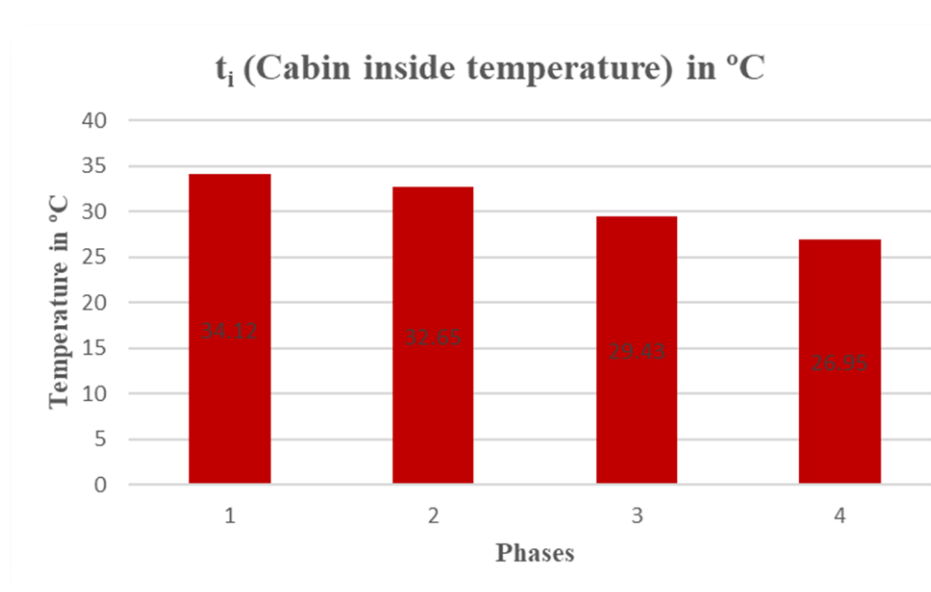

Source: Author

Table 16:  $t_i$  during 2nd measurement

Phase	Conditions	Mean value of $t_i$ in °C
Phase: 1 (19 minutes)	Parking under the shadow, A/C off, Opened windows.	34.12
Phase: 2 (17 minutes)	Driving, A/C ON minimum.	32.65
Phase: 3 (17 minutes)	Driving, A/C ON medium.	29.43
Phase: 4 (21 minutes)	Driving , A/C ON maximum.	26.95

Source: Author

According to above-measured data, we can say that A/C system plays a very effective role to keep comfortable temperature ( $t_i$ ) inside the vehicle cabin. As shown in the above chart without the operation of A/C system the temperature of the vehicle cabin was high as soon as A/C system started work temperature of the cabin dropped rapidly. The set temperature of A/C system was 24°C. According to the above measurements, we can say that the A/C system is quite effective at its maximum operational condition to keep the desired temperature inside the vehicle cabin. Phase – 4 (26.95 °C) measurement, it clearly shows the temperature reached very near to the set temperature of the A/C system.

#### 5.2.4 Difference between vehicle cabin air temperature ( $t_i$ ) and globe temperature ( $t_g$ )

Table 17: Difference between  $t_i$  &  $t_g$  during 2nd measurement

Phase	$t_g$ mean value in °C	$t_i$ mean value in °C
Phase: 1 (19 minutes)	36.91	34.12
Phase: 2 (17 minutes)	34.86	32.65
Phase: 3 (17 minutes)	34.02	29.43
Phase: 4 (21 minutes)	30.73	26.95

Source: Author

Chart 14: Difference between  $t_i$  &  $t_g$  during 2nd measurement

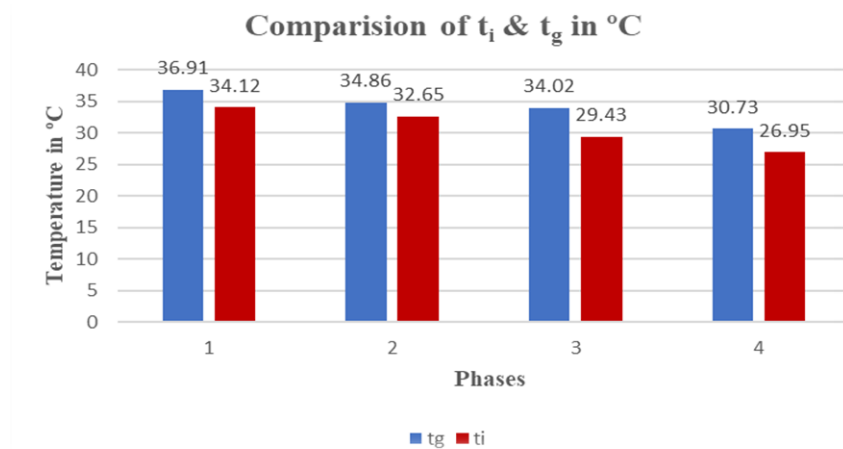

Source: Author

**Note:** Above table shows some globe temperature ( $t_g$ ) difference between phases. The reason for this difference is that during measurements vehicle passed through different locations of the town that's why solar radiations came with different angles inside the vehicle.

### 5.2.5 Effect of A/C system on noise level $L_A$ (dB) inside the vehicle cabin

Table 18: Noise level  $L_A$ (dB) during 2nd measurement

Phase	Conditions	Mean value of noise $L_A$ (dB)
Phase: 1 (19 minutes)	Parking under the shadow, A/C off, Opened windows.	54
Phase: 2 (17 minutes)	Driving, A/C ON minimum.	60.83
Phase: 3 (17 minutes)	Driving, A/C ON medium.	61.61
Phase: 4 (21 minutes)	Driving , A/C ON maximum.	64.35

Source: Author

Chart 15: Noise level  $L_A$ (dB) during 2nd measurement

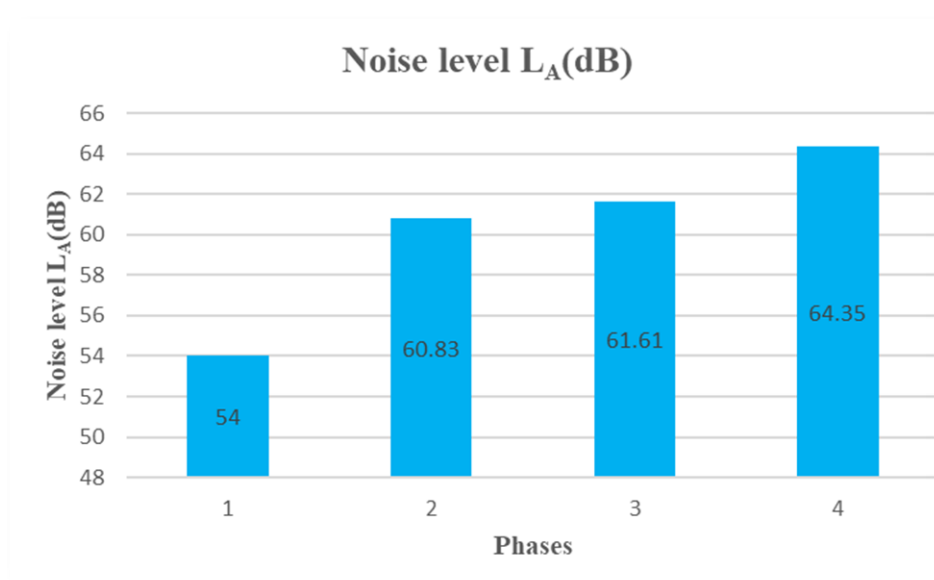

Source: Author

The noise level measured in decibel (dB) inside the vehicle cabin. The measuring instrument for noise level  $L_A$ (dB) was set up on co-driver seat in the first compartment of the vehicle cabin. According to the above-measured data, we can say that the A/C system increase noise level  $L_A$ (dB) inside the vehicle cabin. The reason for this increment in noise level  $L_A$ (dB) is noise generated by the air-conditioning system components and surrounding. The level of noise was not unpleasant inside the cabin so we can say that this noise level  $L_A$ (dB) has not any bad impact on the microclimate of the vehicle cabin.

### 5.2.6 Effect of A/C system on Particulate matters (PM) inside the vehicle cabin

#### PM 1

Table 19: PM 1 during 2nd measurement

Phase	Conditions	Mean value of PM1 ( $\mu\text{g}\cdot\text{m}^{-3}$ )
Phase: 1 (19 minutes)	Parking under the shadow, A/C off, Opened windows.	26.1
Phase: 2 (17 minutes)	Driving, A/C ON minimum.	20
Phase: 3 (17 minutes)	Driving, A/C ON medium.	20.7
Phase: 4 (21 minutes)	Driving , A/C ON maximum.	13.4

Source: Author



Chart 16: PM 1 during 2nd measurement

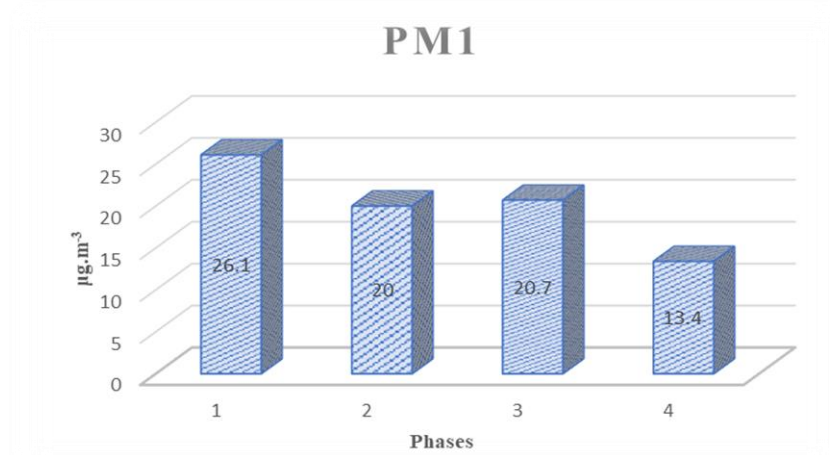

Source: Author

According to measurements shown in the above chart, we can say that the minimum operation of the A/C system decreased some amount of PM1 particles. A/C system started work with the medium operation then particles increased and reached 20.7 µg.m<sup>-3</sup> from 20 µg.m<sup>-3</sup> because of air-velocity. Maximum operation of A/C system is quite effective on PM1 particles. Minimum particles 13.4 µg.m<sup>-3</sup> measured with the maximum operation of A/C system.

## PM 2.5

Table 20: PM 2.5 during 2nd measurement

Phase	Conditions	Mean value of PM2.5 (µg.m <sup>-3</sup> )
Phase: 1 (19 minutes)	Parking under the shadow, A/C off, Opened windows.	27.4
Phase: 2 (17 minutes)	Driving, A/C ON minimum.	16.5
Phase: 3 (17 minutes)	Driving, A/C ON medium.	21.9
Phase: 4 (21 minutes)	Driving , A/C ON maximum.	16.6

Source: Author

Chart 17: PM 2.5 during 2nd measurement

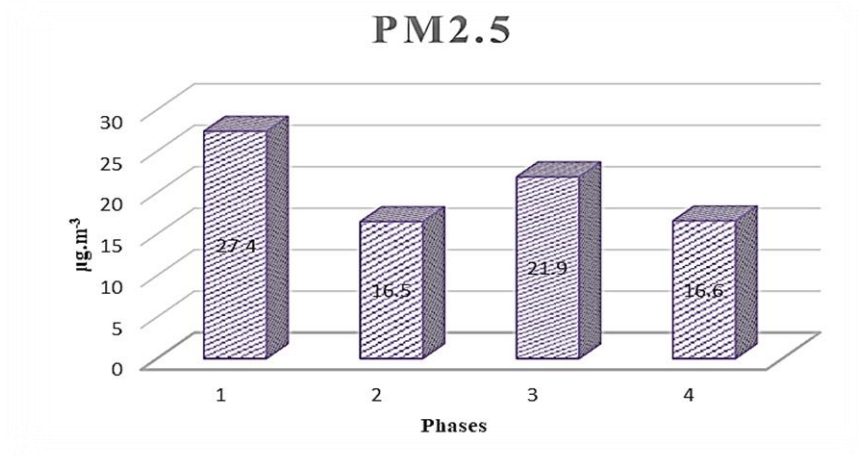

Source: Author

According to measurements shown in the above chart, we can say that the minimum operation of A/C system is effective for PM 2.5 particles. A/C system started work with the medium operation then particles increased and reached at 21.9 µg.m<sup>-3</sup> from 16.5 µg.m<sup>-3</sup> because of air-velocity. Maximum operation of the A/C system is also effective on PM 2.5 particles. Minimum particles 16.5 µg.m<sup>-3</sup> measured with the minimum operation of the A/C system.

#### PM 4

Table 21: PM 4 during 2nd measurement

Phase	Conditions	Mean value of PM4 (µg.m <sup>-3</sup> )
Phase: 1 (19 minutes)	Parking under the shadow, A/C off, Opened windows.	27.7
Phase: 2 (17 minutes)	Driving, A/C ON minimum.	12.2
Phase: 3 (17 minutes)	Driving, A/C ON medium.	27.5
Phase: 4 (21 minutes)	Driving , A/C ON maximum.	16.4

Source: Author

Chart 18: PM 4 during 2nd measurement

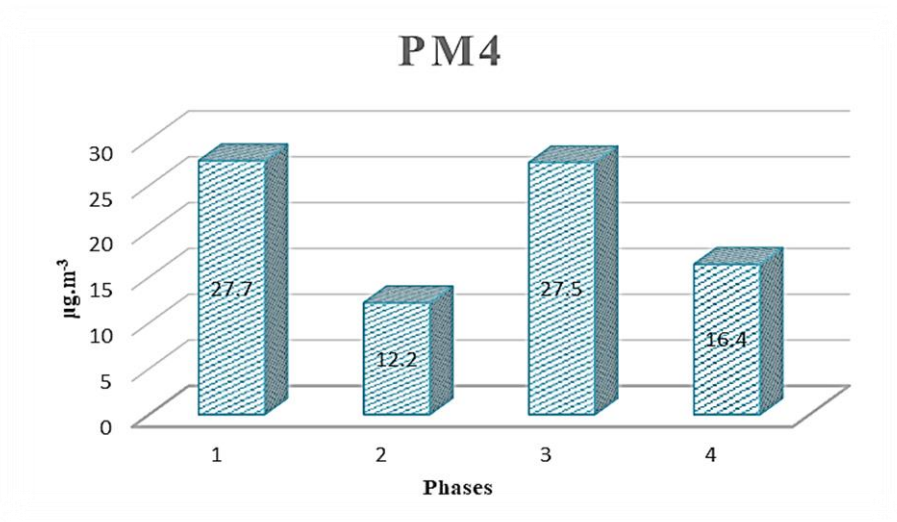

Source: Author

According to measurements shown in the above chart, we can say that the minimum operation of the A/C system is effective for PM4. A/C system started work with the medium operation then particles increased and reached at 27.5 µg.m<sup>-3</sup> from 12.2 µg.m<sup>-3</sup> because of air-velocity. Maximum operation of the A/C system is also effective on PM 4 particles. Minimum particles 12.2 µg.m<sup>-3</sup> measured with the minimum operation of the A/C system.

### PM 10

Table 22: PM 10 during 2nd measurement

Phase	Conditions	Mean value of PM10 (µg.m <sup>-3</sup> )
Phase: 1 (19 minutes)	Parking under the shadow, A/C off, Opened windows.	31.4
Phase: 2 (17 minutes)	Driving, A/C ON minimum.	18
Phase: 3 (17 minutes)	Driving, A/C ON medium.	41.2
Phase: 4 (21 minutes)	Driving , A/C ON maximum.	16.3

Source: Author

Chart 19: PM 10 during 2nd measurement

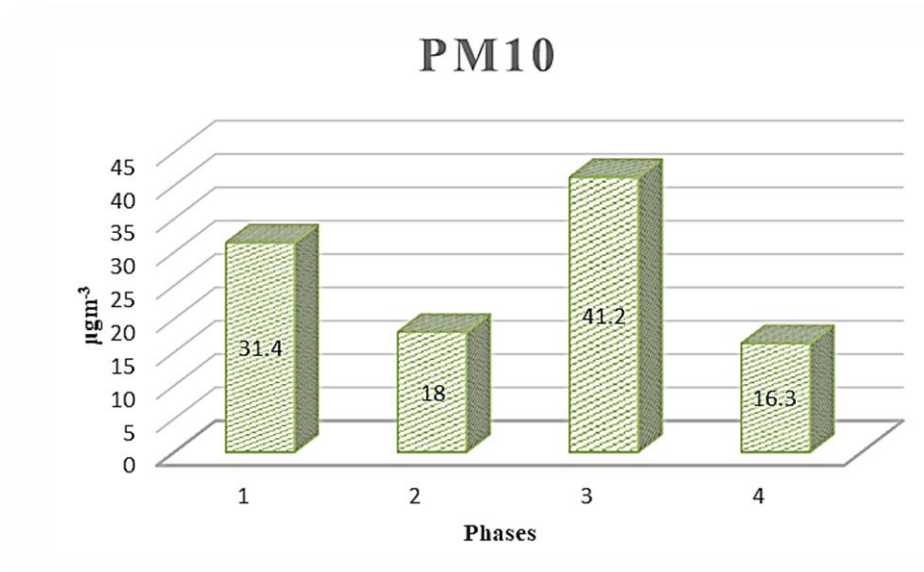

Source: Author

According to measurements shown in the above chart, we can say that the minimum operation of the A/C system is effective for PM 10. A/C system started work with the medium operation then particles increased and reached its highest level 41.2  $\mu\text{g.m}^{-3}$  because of air-velocity. Maximum operation of the A/C system is also effective for PM 10 particles. Minimum particles 16.3  $\mu\text{g.m}^{-3}$  measured with the maximum operation of the A/C system.

### Total dust measured during the 2<sup>nd</sup> measurement

Chart 20: Total dust during 2nd measurement

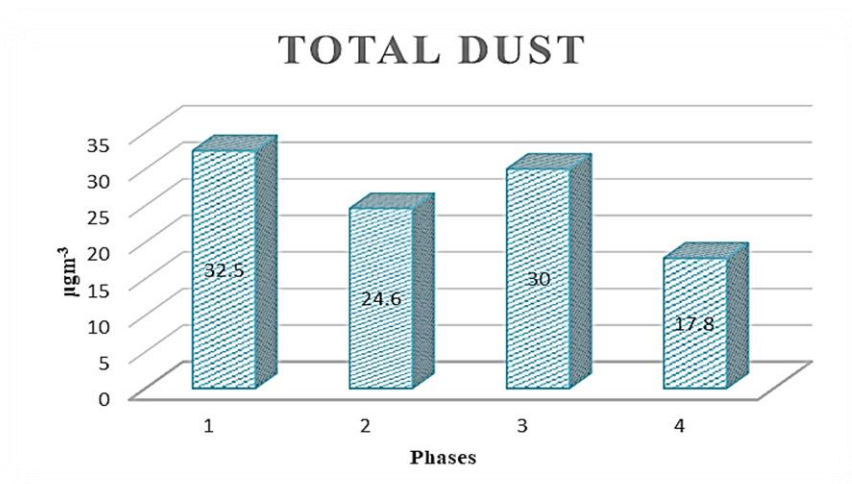

Source: Author

Table 23: Total dust during 2nd measurement

<b>Phase</b>	<b>Conditions</b>	<b>Mean value of total dust (<math>\mu\text{g.m}^{-3}</math>)</b>
Phase: 1 (19 minutes)	Parking under the shadow, A/C off, Opened windows.	32.5
Phase: 2 (17 minutes)	Driving, A/C ON minimum.	24.6
Phase: 3 (17 minutes)	Driving, A/C ON medium.	30
Phase: 4 (21 minutes)	Driving , A/C ON maximum.	17.8

Source: Author

According to measurements shown in above chart the highest level of total dust inside the cabin  $32.5 \mu\text{g.m}^{-3}$  was without operation of the A/C system and lowest  $17.8 \mu\text{g.m}^{-3}$  was with the maximum operation of the A/C system.

## 6. Detail of measurements

Table 24: Detail of measurements

Route	Location	AC mode	Time taken	CO <sub>2</sub>	t <sub>g</sub>	t <sub>i</sub>	RH	Noise Level L <sub>A</sub> (dB)
<b>Route 1st</b>								
<b>Phase 1</b>								
Parking	Suchdol	OFF	10:21:51	0.036	31.55	30.18	35.8	64.99
Parking	Suchdol	OFF	10:22:51	0.177	31.62	30.76	39.5	54.47
Parking	Suchdol	OFF	10:23:51	0.182	31.68	31.22	40.6	52.06
Parking	Suchdol	OFF	10:24:51	0.208	31.75	32.29	42.8	56.76
Parking	Suchdol	OFF	10:25:51	0.241	32.22	33.57	40.6	48.71
Parking	Suchdol	OFF	10:26:51	0.291	33.11	35.03	39.1	50.92
Parking	Suchdol	OFF	10:27:51	0.326	34.24	36.23	38.4	72.69
Parking	Suchdol	OFF	10:28:51	0.404	35.45	37.18	38.8	46.67
Parking	Suchdol	OFF	10:29:51	0.414	36.65	37.88	33.3	44.99
			<b>mean</b>	<b>0.253</b>	<b>33.14</b>	<b>33.82</b>	<b>38.8</b>	<b>54.70</b>
<b>Phase 2</b>								

Parkin g	Suchdol	OFF	10:30:51	0.244	37.73	35.84	30.5	48.14
Parkin g	Suchdol	OFF	10:31:51	0.161	38.64	34.61	29.7	48.73
Parkin g	Suchdol	OFF	10:32:51	0.109	39.46	34.58	31	53.38
Parkin g	Suchdol	OFF	10:33:51	0.069	40.02	32.84	30.9	48.4
Parkin g	Suchdol	OFF	10:34:51	0.052	40.47	32.61	33.2	55.9
Parkin g	Suchdol	OFF	10:35:51	0.035	40.85	32.14	31.9	50.98
Parkin g	Suchdol	OFF	10:36:51	0.035	41.11	32.17	32.2	54.32
Parkin g	Suchdol	OFF	10:37:51	0.035	41.33	31.98	32.7	53.84
Parkin g	Suchdol	OFF	10:38:51	0.035	41.54	33.49	31.5	50.79
Parkin g	Suchdol	OFF	10:39:51	0.035	41.76	32.57	30.9	55.23
Parkin g	Suchdol	OFF	10:40:51	0.035	41.92	33.86	32.2	50.45
Parkin g	Suchdol	OFF	10:41:51	0.035	42.09	34.85	30.6	46.33
Parkin g	Suchdol	OFF	10:42:51	0.035	42.26	34.19	29.5	51.62
Parkin g	Suchdol	OFF	10:43:51	0.035	42.31	33.68	31.9	46
Parkin g	Suchdol	OFF	10:44:51	0.035	42.4	34.44	32	55.82
			<b>mean</b>	<b>0.066</b>	<b>40.93</b>	<b>33.59</b>	<b>31.4</b>	<b>51.33</b>
<b>Phase 3</b>								

driving	outside the town	minimum	10:47:44	0.08	42.39	33.59	30.5	62.65
driving	outside the town	minimum	10:48:44	0.121	42.23	33.76	31.2	57.63
driving	outside the town	minimum	10:49:44	0.139	41.86	35.39	29.7	53.14
driving	outside the town	minimum	10:50:44	0.134	41.25	34.48	28.8	59.31
driving	outside the town	minimum	10:51:44	0.118	40.48	32.96	29.4	59.58
driving	outside the town	minimum	10:52:44	0.108	39.59	31.71	30.8	58.6
driving	outside the town	minimum	10:53:44	0.101	38.76	32.82	30.9	64.36
driving	outside the town	minimum	10:54:44	0.099	38.17	32.91	30.2	57.49
driving	outside the town	minimum	10:55:44	0.123	37.74	34.51	30.3	56.53
driving	outside the town	minimum	10:56:44	0.106	37.48	34.22	29.7	59.47
driving	outside the town	minimum	10:57:44	0.099	37.22	33.33	29.6	56.81
driving	outside the town	minimum	10:58:44	0.094	36.92	32.21	30.3	60.57
driving	outside the town	minimum	10:59:44	0.087	36.44	31.4	31	64.75
driving	outside the town	minimum	11:00:44	0.085	35.85	30.81	31.8	57.84
driving	outside the town	minimum	11:01:44	0.083	35.27	30.63	32.2	57.1
driving	outside the town	minimum	11:02:44	0.083	34.73	31.2	31.5	58.75



driving	outside the town	minimum	11:03:44	0.081	34.41	31.65	30.8	61.4
driving	outside the town	minimum	11:04:44	0.085	34.24	30.78	32.1	60.49
driving	outside the town	minimum	11:05:44	0.081	34.08	30.42	33.2	60.88
			<b>mean</b>	<b>0.100</b>	<b>37.85</b>	<b>32.57</b>	<b>30.7</b>	<b>59.33</b>
<b>Phase 4</b>								
driving	outside the town	medium	11:07:32	0.08	33.69	29.75	35.2	57.64
driving	outside the town	medium	11:08:32	0.068	33.3	29.3	34.8	70.22
driving	outside the town	medium	11:09:32	0.061	32.91	28.69	35.9	58.48
driving	outside the town	medium	11:10:32	0.059	32.64	28.37	36.9	64.93
driving	outside the town	medium	11:11:32	0.052	32.6	27.98	36.9	59.9
driving	outside the town	medium	11:12:32	0.052	32.61	28.01	36.5	64.34
driving	outside the town	medium	11:13:32	0.059	32.56	27.95	36.5	65.73
driving	outside the town	medium	11:14:32	0.055	32.37	27.72	37.1	58.55
driving	outside the town	medium	11:15:32	0.054	32.1	27.68	37.3	58.34
driving	outside the town	medium	11:16:32	0.055	31.78	27.65	36.1	55.74
driving	outside the town	medium	11:17:32	0.054	31.47	27.25	35.4	60.46
driving	outside the town	medium	11:18:32	0.05	31.27	27.56	34.9	62.85

driving	outside the town	medium	11:19:32	0.047	31.18	27.74	36.7	62.79
driving	outside the town	medium	11:20:32	0.049	31.2	27.98	35.4	62.04
driving	outside the town	medium	11:21:32	0.047	31.2	27.39	34.9	67.67
driving	outside the town	medium	11:22:32	0.052	31.09	27.39	36.3	68.5
driving	outside the town	medium	11:23:32	0.052	31.04	27.36	36.2	62.67
driving	outside the town	medium	11:24:32	0.052	31.1	27.3	36.2	63.36
driving	outside the town	medium	11:25:32	0.047	31.5	27.11	36.8	62.76
			<b>mean</b>	<b>0.055</b>	<b>31.98</b>	<b>27.90</b>	<b>36.1</b>	<b>62.47</b>
<b>Phase</b>								
<b>5</b>								
driving	outside the town	maximum	11:27:21	0.045	32.17	27.18	37.9	66.9
driving	outside the town	maximum	11:28:21	0.038	32.32	27.34	39.8	66.29
driving	outside the town	maximum	11:29:21	0.035	32.28	27.11	36.8	67.83
driving	outside the town	maximum	11:30:21	0.036	32.35	26.64	37.5	65.6
driving	outside the town	maximum	11:31:21	0.038	32.37	26.63	36.7	68.1
driving	outside the town	maximum	11:32:21	0.042	32.17	26.58	37.2	65.88
driving	outside the town	maximum	11:33:21	0.04	31.85	26.58	37	66.39
driving	outside the town	maximum	11:34:21	0.043	31.76	26.48	36.1	66.12

driving	outside the town	maximum	11:35:21	0.043	31.94	26.38	37.1	70.66
driving	outside the town	maximum	11:36:21	0.047	32.31	26.51	36.8	66.22
driving	outside the town	maximum	11:37:21	0.049	32.56	26.37	36.4	66.12
driving	outside the town	maximum	11:38:21	0.049	32.73	26.17	37.6	67.01
driving	outside the town	maximum	11:39:21	0.047	32.91	26.45	36.7	69.97
driving	outside the town	maximum	11:40:21	0.045	33	26.45	36.9	66.72
driving	outside the town	maximum	11:41:21	0.047	33.14	27.43	36.8	65.29
driving	outside the town	maximum	11:42:21	0.045	33.22	27.15	35.1	66.7
driving	outside the town	maximum	11:43:21	0.045	33.21	26.55	36.6	69.14
driving	outside the town	maximum	11:44:21	0.049	33.16	26.42	36.7	65.48
driving	outside the town	maximum	11:45:21	0.047	33.07	26.2	36.5	65.48
driving	outside the town	maximum	11:46:21	0.045	32.92	26.09	37.3	65.3
driving	outside the town	maximum	11:47:21	0.042	32.52	26.67	36.4	59.15
			<b>mean</b>	<b>0.044</b>	<b>32.57</b>	<b>26.64</b>	<b>36.9</b>	<b>66.49</b>
<b>Route</b>								
<b>2nd</b>								
<b>Phase</b>								
<b>1</b>								
Parking	Suchdol	OFF	14:48:46	0.043	38.5	35.1	32.1	56.08

Parkin g	Suchdol	OFF	14:49:46	0.038	38.83	35.05	30.3	52.46
Parkin g	Suchdol	OFF	14:50:46	0.03 6	38.92	34.89	29.9	54.89
Parkin g	Suchdol	OFF	14:51:46	0.035	38.81	34.95	30.3	58.24
Parkin g	Suchdol	OFF	14:52:46	0.035	38.6	34.65	29.7	51.49
Parkin g	Suchdol	OFF	14:53:46	0.035	38.32	34.47	30.7	53.91
Parkin g	Suchdol	OFF	14:54:46	0.035	38.01	34.42	30.7	58.51
Parkin g	Suchdol	OFF	14:55:46	0.035	37.7	34.54	31	56.51
Parkin g	Suchdol	OFF	14:56:46	0.035	37.42	34.42	30.6	60.3
Parkin g	Suchdol	OFF	14:57:46	0.035	37.08	33.89	30.4	51.7
Parkin g	Suchdol	OFF	14:58:46	0.035	36.71	33.44	31.2	53.11
Parkin g	Suchdol	OFF	14:59:46	0.035	36.35	33.47	31.6	46.72
Parkin g	Suchdol	OFF	15:00:46	0.035	36.06	33.54	31.4	55.32
Parkin g	Suchdol	OFF	15:01:46	0.035	35.8	33.64	31.3	58.23
Parkin g	Suchdol	OFF	15:02:46	0.035	35.57	33.54	31.7	57.35
Parkin g	Suchdol	OFF	15:03:46	0.035	35.37	33.6	31.8	53.41
Parkin g	Suchdol	OFF	15:04:46	0.035	35.24	33.74	31.5	53.84

Parking	Suchdol	OFF	15:05:46	0.035	35.09	33.73	31.5	48.02
Parking	Suchdol	OFF	15:06:46	0.035	34.98	33.63	31.6	45.54
Parking	Suchdol	OFF	15:07:46	0.035	34.88	33.68	31.1	54.54
Parking	Suchdol	OFF	<b>mean</b>	<b>0.036</b>	<b>36.91</b>	<b>34.12</b>	<b>31.0</b>	<b>54.01</b>
<b>Phase 2</b>								
driving	inside the town	minimum	15:08:32	0.035	34.78	33.67	32.1	56.42
driving	inside the town	minimum	15:09:32	0.047	34.66	33.52	30.3	60.54
driving	inside the town	minimum	15:10:32	0.078	34.64	32.92	30.4	59.9
driving	inside the town	minimum	15:11:32	0.111	34.59	32.02	31.5	66.71
driving	inside the town	minimum	15:12:32	0.125	34.47	31.49	32.4	65.65
driving	inside the town	minimum	15:13:32	0.139	34.49	31.27	32.3	65.17
driving	inside the town	minimum	15:14:32	0.14	34.7	31.95	31.7	66
driving	inside the town	minimum	15:15:32	0.151	34.78	32.02	31.3	57.93
driving	inside the town	minimum	15:16:32	0.165	34.77	32.08	31.6	55.03
driving	inside the town	minimum	15:17:32	0.182	34.82	32.94	30.6	60.3
driving	inside the town	minimum	15:18:32	0.199	35.04	33.39	30.6	66.05

driving	inside the town	minimum	15:19:32	0.218	35.29	34.11	30.7	60.68
driving	inside the town	minimum	15:20:32	0.217	35.52	34.54	29.8	62.97
driving	inside the town	minimum	15:21:32	0.199	35.58	33.42	30.6	61.72
driving	inside the town	minimum	15:22:32	0.18	35.39	32.53	31.9	56.89
driving	inside the town	minimum	15:23:32	0.161	35.08	32.17	32.3	55.34
driving	inside the town	minimum	15:24:32	0.147	34.7	32.03	31.8	58.24
driving	inside the town	minimum	15:25:32	0.135	34.28	31.76	31.7	59.42
driving	inside the town	minimum	<b>mean</b>	<b>0.146</b>	<b>34.87</b>	<b>32.66</b>	<b>31.3</b>	<b>60.83</b>
<b>Phase 3</b>								
driving	inside the town	medium	15:26:36	0.121	33.83	31.53	32.2	56.76
driving	inside the town	medium	15:27:36	0.102	33.45	31.48	33.6	61.53
driving	inside the town	medium	15:28:36	0.087	33.18	31.83	31.4	62.69
driving	inside the town	medium	15:29:36	0.073	33.15	31.61	31.6	54.47
driving	inside the town	medium	15:30:36	0.069	33.32	30.98	31.9	58.56
driving	inside the town	medium	15:31:36	0.071	33.61	30.49	32.2	62.22
driving	inside the town	medium	15:32:36	0.068	34.1	29.95	32.4	57.65

driving	inside the town	medium	15:33:36	0.068	34.61	29.54	32.5	61.65
driving	inside the town	medium	15:34:36	0.061	34.81	28.98	31.7	64.05
driving	inside the town	medium	15:35:36	0.049	34.78	28.5	33.1	58.98
driving	inside the town	medium	15:36:36	0.045	34.75	28.55	32.9	56.85
driving	inside the town	medium	15:37:36	0.042	34.88	28.46	32.6	53.97
driving	inside the town	medium	15:38:36	0.035	34.83	28.23	32.8	61.51
driving	inside the town	medium	15:39:36	0.035	34.61	28.07	33.8	74.04
driving	inside the town	medium	15:40:36	0.035	34.23	27.9	32.5	66.4
driving	inside the town	medium	15:41:36	0.035	33.83	27.86	33	68.21
driving	inside the town	medium	15:42:36	0.035	33.41	27.96	33.8	60.54
driving	inside the town	medium	15:43:36	0.035	33	27.92	33.7	69.05
driving	inside the town	medium	<b>mean</b>	<b>0.059</b>	<b>34.02</b>	<b>29.44</b>	<b>32.7</b>	<b>61.62</b>
<b>Phase 4</b>								
driving	inside the town	maximum	15:44:38	0.035	32.56	27.61	34.6	64.07
driving	inside the town	maximum	15:45:38	0.043	32.15	27.49	38.1	62.79
driving	inside the town	maximum	15:46:38	0.055	31.71	27.62	36	63.7

driving	inside the town	maximum	15:47:38	0.066	31.34	27.44	34.3	65.64
driving	inside the town	maximum	15:48:38	0.062	31.08	26.9	35.1	68.28
driving	inside the town	maximum	15:49:38	0.061	30.8	26.64	38.5	62.66
driving	inside the town	maximum	15:50:38	0.057	30.52	26.92	38.3	64.77
driving	inside the town	maximum	15:51:38	0.055	30.48	27.17	35.2	62.38
driving	inside the town	maximum	15:52:38	0.059	30.8	27.57	33.2	64.49
driving	inside the town	maximum	15:53:38	0.047	31.05	26.97	34.8	64.85
driving	inside the town	maximum	15:54:38	0.055	31.05	26.66	34.4	65.1
driving	inside the town	maximum	15:55:38	0.054	30.91	26.44	35.5	65.64
driving	inside the town	maximum	15:56:38	0.055	30.68	26.34	35.1	63.26
driving	inside the town	maximum	15:57:38	0.059	30.39	26.42	35.2	68.22
driving	inside the town	maximum	15:58:38	0.055	30.09	26.35	35.5	66.74
driving	inside the town	maximum	15:59:38	0.057	29.8	26.82	34.4	68.53
driving	inside the town	maximum	16:00:38	0.052	29.8	26.88	35.4	64.52
driving	inside the town	maximum	16:01:38	0.052	29.81	26.8	35.1	63.91
driving	inside the town	maximum	16:02:38	0.049	29.9	26.87	34.9	62.87



driving	inside the town	maximum	16:03:38	0.049	30.17	26.94	34.8	63.39
driving	inside the town	maximum	16:04:38	0.05	30.4	26.97	35.8	65.21
driving	inside the town	maximum	16:05:38	0.045	30.76	27.26	37.5	54.87
driving	inside the town	maximum	<b>mean</b>	<b>0.053</b>	<b>30.74</b>	<b>26.96</b>	<b>35.5</b>	<b>64.36</b>
<b>KIA Sportage</b>			<b>Dust concentration</b>					
20.6.2017, morning			Suchdol - Kralupy - Suchdol					
<b>Driving conditions</b>	<b>A/C mode</b>	<b>Total Dust <math>\mu\text{g}\cdot\text{m}^{-3}</math></b>	<b>PM10 <math>\mu\text{g}\cdot\text{m}^{-3}</math></b>	<b>PM4 <math>\mu\text{g}\cdot\text{m}^{-3}</math></b>	<b>PM2,5 <math>\mu\text{g}\cdot\text{m}^{-3}</math></b>	<b>PM1 <math>\mu\text{g}\cdot\text{m}^{-3}</math></b>		
Parking	OFF	48,3 ± 9	26,9 ± 2	24 ± 1	22,8 ± 1	22,8 ± 2		
driving 24°C	minimum	21,8 ± 6	19,8 ± 3	18 ± 0	18 ± 0	22,5 ± 1		
driving 24°C	medium	28,1 ± 5	28,9 ± 4	34,8 ± 6	27,8 ± 3	26,5 ± 2		
driving 24°C	maximum	23,8 ± 2	18,4 ± 3	18,5 ± 2	14,7 ± 1	17,7 ± 1		
20.6.2017, afternoon			Suchdol - Prague - Suchdol					
<b>Driving conditions</b>	<b>A/C mode</b>	<b>Total Dust <math>\mu\text{g}\cdot\text{m}^{-3}</math></b>	<b>PM10 <math>\mu\text{g}\cdot\text{m}^{-3}</math></b>	<b>PM4 <math>\mu\text{g}\cdot\text{m}^{-3}</math></b>	<b>PM2,5 <math>\mu\text{g}\cdot\text{m}^{-3}</math></b>	<b>PM1 <math>\mu\text{g}\cdot\text{m}^{-3}</math></b>		
Parking	OFF	32,5 ± 3	31,4 ± 2	27,7 ± 1	27,4 ± 1	26,1 ± 1		

driving 24°C	minimum	24,6 ± 5	18 ± 2	12,2 ± 2	16,5 ± 1	20 ± 2
driving 24°C	medium	30 ± 4	41,2 ± 6	27,5 ± 4	21,9 ± 1	20,7 ± 1
driving 24°C	maximu m	17,8 ± 2	16,3 ± 1	16,4 ± 1	16,6 ± 1	13,4 ± 1

## 7. Conclusion

The aim of the thesis was to analyze the current state of microclimate and operation of the air-conditioning system in the motor vehicle cabin. The focus of the diploma thesis was on basic parameters especially the thermal state of microclimate and cleanliness of the air from the point of view of the driver and passengers.

The first part of the diploma thesis is based on literature and other scientific publications related to the diploma thesis topic. In the first part of the thesis author described in detail all about the air-conditioning system, its working principle as well as the working principle of the individual components of the air-conditioning system. Every component of an air-conditioning system plays its unique role inside the air-conditioning system. The air-conditioning system is quite effective to create a suitable microclimate inside the vehicle cabin. The sensors of the air-conditioning system play a very big role to maintain suitable microclimate inside the cabin. Now, these days air-conditioning systems are very eco-friendly because of new refrigerant R1234yf.

The second part of the diploma thesis based on measurements. The measurements made with Kia Sportage car. The car was quite new, it had quite well functioning and sensor-based air-conditioning system. The type of the vehicle was SUV. Two identical routes were chosen for measurements. The first route was through villages and small towns (Prague Suchdol and via Unetice and Tursko to Kralup nad Vltavou and at last end up at Prague Suchdol). The second route was through Prague city (Prague Suchdol after passed through Hradčany, the North-South highway and at last end up at Prague Suchdol). The level of CO<sub>2</sub>%, RH%, Noise (dB), Particulate matters (PM) and  $t_i$  (cabin temperature in °C) was measured during both measurements. The excess amount of CO<sub>2</sub>, particulate matters (PM) inside the vehicle cabin have a very bad impact on drivers and passenger's health, and suitable  $t_i$  (cabin temperature) is necessary inside the cabin for relief from fatigue and stress.

Based on both parts of thesis it is quite confirmed that the air-conditioning system plays a big role to keep and maintain the suitable microclimate inside the vehicle cabin. Day by day technology is growing that is why in future the air-conditioning systems will be more reliable economically. The electric compressor is one of a suitable example of this. The electric compressor is very suitable with electric vehicles (EV) and hybrid vehicles (HV). Now these days because of the automatic air-conditioning system the driver of the vehicle can more

concentrate on driving, he/she does not need to perform manually to keep suitable microclimate inside the vehicle cabin.

According to the measurement part, we can say that the maximum operational condition of an air-conditioning system was very effective to keep the desired microclimate inside the vehicle cabin. The performance of the air-conditioning system depends on the ventilation rate. Solar radiations play a role to rise up cabin temperature  $t_i$  inside the cabin. The maximum operational condition of the A/C system showed best results during measurements. The noise level (dB) depends on the technical condition of the vehicle. The level of the dust inside the vehicle depends on the material and condition of accessories like mats, carpet and seat covers and take care of the vehicle.

At last, generalized conclusion is that the A/C system plays a very positive role to keep the desired microclimate inside the vehicle cabin.

## 8. References

- [1] Air conditioner compressor. [Online]. 2008 – 2019. [Cit 5-11-2018]. Available from: <https://www.airconditioning-systems.com/air-conditioner-compressor.html>
- [2] AUTO PARTS WAREHOUSE. A/C accumulator. [Online]. 1995-2019. [Cit 12-12-2018]. Available from: <https://www.autopartswarehouse.com/ac-accumulator>
- [3] Daly, Steven. *Automotive air-conditioning and climate control systems*. Science Direct, 2006. ISBN: 978-0-7506-6955-9.
- [4] Dahlan<sup>a</sup>, Afiq Aiman., Zulkifli<sup>a</sup>, Amirah Haziqah., Nasution<sup>b,\*</sup>, Henry., Aziz<sup>b</sup>, Azhar Abdul., Perang<sup>b</sup>, Mohd Rozi Mohd., Jamil<sup>b</sup>, Hishamuddin Mohd., Zulkifli<sup>a</sup>, Ahmad Ammar. 2014. Efficient and green vehicle air-conditioning system using electric compressor. *The 6<sup>th</sup> International conference on applied energy – ICAE 2014*. ScienceDirect.
- [5] Datta, Santanu Prasad., Das, Prasanta kumar., Mukhopadhyay, Siddharth. 2014. Effect of refrigerant charge, compressor speed and air flow through the evaporator on the performance of an automotive air-conditioning system. *International refrigeration and air-conditioning conference*. Paper 1470. [Online]. [Cit 10-1-2019]. Available from: <https://docs.lib.purdue.edu/cgi/viewcontent.cgi?article=2469&context=iracc>.
- [6] DENSO. *A/C compressors*. [Online]. 2018. [Cit 10-1-2019]. Available from: [https://www.denso-am.eu/media/631294/deac13uk10mm\\_uk\\_thermal\\_ac-compressor\\_leaflet\\_web.pdf](https://www.denso-am.eu/media/631294/deac13uk10mm_uk_thermal_ac-compressor_leaflet_web.pdf).
- [7] EPCOS. *Sensors for Air-conditioning in automobiles*. [Online]. 2007. [Cit. 30-11-2018]. Available from: <https://www.tdk-electronics.tdk.com/download/528068/647002b90bb6dbc8e9be4a0fe9242992/pdf-sensorsairconditioningautomotive-an1.pdf>. (Sensors for air-conditioning in automobiles, 2007)
- [8] GLOBAL DENSO. *Products for Electric and Hybrid vehicles*. [Online]. 2013. [Cit 25-12-2018] Available from: [http://www.globaldenso.com/en/newsreleases/events/globalmotorshows/2013/iaa13/files/IAA\\_13\\_evhy.pdf](http://www.globaldenso.com/en/newsreleases/events/globalmotorshows/2013/iaa13/files/IAA_13_evhy.pdf). (Products for Electric and Hybrid vehicles, 2013)
- [9] Haynes, J. *Haynes Automotive Heating and Air Conditioning System Manual*. Haynes Manuals. ISBN: 978-1563929137.

- [10] Hohls, S<sup>a</sup>., Becker, S<sup>b</sup>. 2018. *Modeling of HVAC noise in a simplified car model*. SAE Technical Papers. Scopus.
- [11] Imam, Md Shahid., Basha, Dr. M. Shameer., Azizuddin, Dr. Md., Reddy, Dr. K. Vijaya Kumar. 2013. *Design of air-conditioning system in automobiles*. IJRSET. ISSN: 2319-8753.
- [12] Jadhav, S.M<sup>a</sup>., Arulprakasajothi, M<sup>a</sup>., Chandrasekhar, U<sup>b</sup>., Devarajan, X<sup>a</sup>. 2019. *Experimental investigation of vapour absorption refrigeration cycle for automobile cabin cooling*. Scopus, pp. 41 – 51.
- [13] Kumar, S., Cerny, J., Kic, P. 2018. *Air conditioning in the cabins of passenger cars*. Agronomy Research 16, 2088-2096.
- [14] Khurmi, R.S., Gupta, J.K. *A textbook of Refrigeration and Air-conditioning*. Publisher S. Chand & Company PVT. LTD. ISBN: 978-81-219-2781-9.
- [15] Laukkonen, JD. What is Blower Motor? 2013. [Online]. [Cit 15-12-2018]. Available from: <http://www.crankshaft.com/blower-motor>
- [16] Munson, Cheryl. 2019. *Difference between Automatic air-conditioning vs. Manual*. Leaf Group Ltd. [Online]. [Cit 17-01-2019]. Available from: <https://www.hunker.com/12591346/difference-between-automatic-air-conditioning-vs-manual>
- [17] MACS Worldwide. Three important functions of the receiver/drier in your cars A/C system. 2010. [Online]. [Cit 20-12-2018]. Available from: <https://macsworldwide.wordpress.com/2010/07/13/three-important-functions-of-the-receiverdrier-in-your-cars-ac-system>
- [18] Miller, R., Miller, M.R. *Air conditioning and Refrigeration*. New York, McGraw-Hill, 2006, ISBN: 0-07-146788-2.
- [19] Szekyova, M., K. & Novy, R. 2006. *Ventilation and air-conditions*. Jaga, Bratislava, 359 pp.
- [20] Szczurek, A. & Maciejewska, M. 2015. Classification of air quality inside car cabin using sensor system. In: *International conference on sensor networks*, Sensor nets 2015, pp.211-219.
- [21] THE LINDE GROUP. R1234 yf – Opteon. [Online]. 2018. [Cit 10-12-2018]. *Automotive Refrigerant with low global warming potential*. Available from: <https://>

[/en/images/R1234yf%20-%20Opteon%20YF%20-%20brochure\\_tcm17-110818.pdf](#).

(R1234yf-Opteon, 2018)

[22] Viegas, C., Monteiro, A., dos Santos M., Lacombe, N., Viegas, S. 2018. *Filters from taxis air-conditioning system: A tool to characterize driver's occupational exposure to bioburden?* Environmental Research 164, Scopus, pp. 522 – 529.

[23] Vevrka, Lukas. 6 interesting fact about air-conditioning system. 2012. [Online]. [Cit 2-12-2018]. Available from: <http://www.auto.cz/klimatizace-69059>

[24] Zhou, X<sup>a</sup> ., Lai, D<sup>b</sup> ., Chen, Q<sup>c</sup> . 2019. *Experimental investigation of thermal comfort in a passenger car under driving conditions*. Scopus, pp. 109 – 119.

## **9. Abrivations**

1. A/C – Air-conditioning.
2. ATP – Atmospheric pressure.
3. DC – Direct current.
4. dB – Decibel
5. DT – Diploma thesis.
6. EV – Electric vehicles.
7. GPW – Global warming potential.
8. HV – Hybrid vehicles.
9. ODP – Ozone depleting potential.
10. PM – Particulate matter.
11. RH – Relative humidity.
12. TD – Turbo diesel.



## 10. Pictures list

<i>Picture 1: Location of instruments</i> .....	11
<i>Picture 2: Kia Sportage</i> .....	12
<i>Picture 3: Dust Trak 8530 II Aerosol Monitor</i> .....	13
<i>Picture 4: Metering panel ALMEMO 2590-9</i> .....	14
<i>Picture 5: Temperature and relative humidity sensor ALMEMO</i> .....	14
<i>Picture 6: ALMEMO CO<sub>2</sub> content measurement sensor</i> .....	15
<i>Picture 7: BEHA 93411 noise measuring instrument</i> .....	15
<i>Picture 8: Map for route A</i> .....	16
<i>Picture 9: Map for route B</i> .....	17
<i>Picture 10: Air-conditioning system &amp; pressure-enthalpy diagram</i> .....	18
<i>Picture 11: Compressor</i> .....	20
<i>Picture 12: Piston compressor</i> .....	20
<i>Picture 13: Rotary blade &amp; stationary blade compressor</i> .....	21
<i>Picture 14: Scroll compressor</i> .....	22
<i>Picture 15: Electric compressor</i> .....	23
<i>Picture 16: Condenser</i> .....	23
<i>Picture 17: Pressure-enthalpy diagram</i> .....	24
<i>Picture 18: Evaporator</i> .....	25
<i>Picture 19: Pressure-enthalpy diagram</i> .....	26
<i>Picture 20: Accumulator</i> .....	27
<i>Picture 21: Cabin air filters</i> .....	28
<i>Picture 22: Receiver/Drier</i> .....	29
<i>Picture 23: Expansion valve</i> .....	30
<i>Picture 24: Orifice tube</i> .....	31
<i>Picture 25: Airflow inside the cabin through vents</i> .....	32
<i>Picture 26: Blower motor</i> .....	32
<i>Picture 27: Condenser Fan</i> .....	33
<i>Picture 28: Operating control system of a manual air-conditioning system</i> .....	37
<i>Picture 29: Operating control system of the semi-automatic air-conditioning system</i> .....	37
<i>Picture 30: Operating control system of the automatic air-conditioning system</i> .....	38

## 11. Charts list

<i>Chart 1: CO<sub>2</sub>% during 1st measurement</i> .....	39
<i>Chart 2: RH% during 1st measurement</i> .....	41
<i>Chart 3: during 1st measurement</i> .....	42
<i>Chart 4: Difference between <math>t_i</math> &amp; <math>t_g</math> during 1st measurement</i> .....	44
<i>Chart 5: Noise level <math>L_A</math>(dB) during 1st measurement</i> .....	45
<i>Chart 6: PM 1 during 1st measurement</i> .....	46
<i>Chart 7: PM 2.5 during 1st measurement</i> .....	47
<i>Chart 8: PM 4 during 1st measurement</i> .....	48
<i>Chart 9: PM 10 during 1st measurement</i> .....	49
<i>Chart 10: total dust during 1st measurement</i> .....	50
<i>Chart 11: CO<sub>2</sub>% during 2nd measurement</i> .....	51
<i>Chart 12: RH% during 2nd measurement</i> .....	52
<i>Chart 13: <math>t_i</math> during 2nd measurement</i> .....	53
<i>Chart 14: Difference between <math>t_i</math> &amp; <math>t_g</math> during 2nd measurement</i> .....	54
<i>Chart 15: Noise level <math>L_A</math>(dB) during 2nd measurement</i> .....	55
<i>Chart 16: PM 1 during 2nd measurement</i> .....	57
<i>Chart 17: PM 2.5 during 2nd measurement</i> .....	58
<i>Chart 18: PM 4 during 2nd measurement</i> .....	59
<i>Chart 19: PM 10 during 2nd measurement</i> .....	60
<i>Chart 20: Total dust during 2nd measurement</i> .....	60

## 12. Tables list

<i>Table 1: Measurement number</i> .....	11
<i>Table 2: Measured parameters</i> .....	11
<i>Table 3: Technical Description of a car</i> .....	12
<i>Table 4: CO<sub>2</sub>% during 1st measurement</i> .....	40
<i>Table 5: RH% during 1st measurement</i> .....	41
<i>Table 6: t<sub>i</sub> during 1st measurement</i> .....	42
<i>Table 7: Difference between t<sub>i</sub> &amp; t<sub>g</sub> during 1st measurement</i> .....	43
<i>Table 8: Noise level L<sub>A</sub>(dB) during 1st measurement</i> .....	44
<i>Table 9: PM 1 during 1st measurement</i> .....	46
<i>Table 10: PM 2.5 during 1st measurement</i> .....	47
<i>Table 11: PM 4 during 1st measurement</i> .....	48
<i>Table 12: PM 10 during 1st measurement</i> .....	49
<i>Table 13: total dust during 1st measurement</i> .....	50
<i>Table 14: CO<sub>2</sub>% during 2nd measurement</i> .....	51
<i>Table 15: RH% during 2nd measurement</i> .....	52
<i>Table 16: t<sub>i</sub> during 2nd measurement</i> .....	53
<i>Table 17: Difference between t<sub>i</sub> &amp; t<sub>g</sub> during 2nd measurement</i> .....	54
<i>Table 18: Noise level L<sub>A</sub>(dB) during 2nd measurement</i> .....	55
<i>Table 19: PM 1 during 2nd measurement</i> .....	56
<i>Table 20: PM 2.5 during 2nd measurement</i> .....	57
<i>Table 21: PM 4 during 2nd measurement</i> .....	58
<i>Table 22: PM 10 during 2nd measurement</i> .....	59
<i>Table 23: Total dust during 2nd measurement</i> .....	61
<i>Table 24: Detail of measurements</i> .....	62