

10. PŘÍLOHY

- Tab. č. 4: Sortiment Zahradnictví Krulichovi
Tab. č. 5: Sortiment Pereny - Hlavenec
Tab. č. 6: Sortiment Školky Litomyšl
Tab. č. 7: Sortiment Spijker
Tab. č. 8: Sortiment Hogendoorn
Tab. č. 9: Sortiment Kurt Bluemel
Tab. č. 10: Sortiment Jelitto
Tab. č. 11: Průměrné měsíční teploty v Lednici na Moravě v letech 2014-2015 (ve °C)
Tab. č. 12: Průměrné měsíční srážky v Lednici na Moravě v letech 2014-2015 (v mm)
Tab. č. 13: Průměrná měsíční délka slunečního svitu v Lednici na Moravě v letech 2014-2015 (v hod)
Tab. č. 14: Seznam doporučených odrůd
Tab. č. 15: Seznam číselného označení hodnocených odrůd
Tab. č. 16: Seznam označení určitých znaků, které byly hodnoceny, pro jejich orientaci v popisném deskriptoru
Tab. č. 17: Popisný deskriptor pro rod *Symphyotrichum* Ness naměřený na pozemku ZF MENDELU
Tab. č. 18: Tabulka skutečných hodnot jednotlivých sledovaných znaků, které byly statisticky hodnoceny (hodnoty jsou zprůměrovány z 5 vybraných rostlin)
- Obr. č. 1: Příbuzenské vztahy *Symphyotrichae* (MORGAN & HOLLAND, 2012)
Obr. č. 10 - 81 Fotodokumentace sortimentu *Symphyotrichum* (KOMÁREK, 2015)
Obr. č. 82 - 83 Fotodokumentace sortimentu *Symphyotrichum* (KOMÁREK, 2013)

Tab. č. 4: Sortiment Zahradnictví Krulichovi

<i>Symphyotrichum novae-anglie</i> 'Septemberrubin'
<i>Symphyotrichum novae-anglie</i> 'Lachsglut'
<i>Symphyotrichum novae-anglie</i> 'Rudelsburg'
<i>Symphyotrichum novae-anglie</i> 'Violetta'
<i>Symphyotrichum novea-anglie</i> 'Purple Dome'
<i>Symphyotrichum novae-anglie</i> 'Haringston Pink'
<i>Symphyotrichum novae-anglie</i> 'Barr's Blue'
<i>Symphyotrichum nova-anglie</i> 'Andenken an Paul Gerber'
<i>Symphyotrichum ericoides</i> 'Pink Cloud'
<i>Symphyotrichum ericoides</i> 'Prostratum'
<i>Symphyotrichum ericoides</i> 'Lovely'
<i>Symphyotrichum ericoides</i> 'Weiser Zwerg'
<i>Symphyotrichum ericoides</i> 'Bluewonder'
<i>Symphyotrichum ericoides</i> 'Blues Star'
<i>Symphyotrichum ericoides</i> 'Yvette Richmonds'
<i>Symphyotrichum ericoides</i> 'Snow Flurry'
<i>Symphyotrichum ericoides</i> 'Schneetanne'
<i>Symphyotrichum pilosum</i> 'Monte Casino'
<i>Symphyotrichum lateriflorum</i> 'Lady in Black'
<i>Symphyotrichum lateriflorum</i> 'Horizontalis'
<i>Symphyotrichum lateriflorum</i> 'Prince'
<i>Symphyotrichum dumosum</i> 'Niobe'
<i>Symphyotrichum dumosum</i> 'Wachsenburg'
<i>Symphyotrichum dumosum</i> 'Jenny'
<i>Symphyotrichum dumosum</i> 'Kristina'
<i>Symphyotrichum dumosum</i> 'Apollo'
<i>Symphyotrichum dumosum</i> 'Herbstpuzel'
<i>Symphyotrichum dumosum</i> 'Blauer Zwerg'
<i>Symphyotrichum dumosum</i> 'Tina'
<i>Symphyotrichum dumosum</i> 'Lady in Blue'
<i>Symphyotrichum dumosum</i> 'Anneke'
<i>Symphyotrichum dumosum</i> 'Prof. A. Kippenberg'
<i>Symphyotrichum dumosum</i> 'Starlight'
<i>Symphyotrichum dumosum</i> 'Rosa Zwerg'
<i>Symphyotrichum dumosum</i> 'Aramis Rose'
<i>Symphyotrichum dumosum</i> 'Rosenwichtel'
<i>Symphyotrichum dumosum</i> 'Rosemarie Sallmann'
<i>Symphyotrichum dumosum</i> 'Countess of Dudley'
<i>Symphyotrichum dumosum</i> 'Alice Haslam'
<i>Symphyotrichum dumosum</i> 'Aramis Blue'
<i>Symphyotrichum dumosum</i> 'Blaue Lagune'
<i>Symphyotrichum dumosum</i> 'Silberteppich'
<i>Symphyotrichum dumosum</i> 'Aramis White'

<i>Symphytotrichum dumosum</i> 'Schneekissen'
<i>Symphytotrichum novi-belgii</i> 'Samona'
<i>Symphytotrichum novi-belgii</i> 'Blaugut'
<i>Symphytotrichum novi-belgii</i> 'Lassie'
<i>Symphytotrichum novi-belgii</i> 'Herbst. Vom Bressenhof'
<i>Symphytotrichum novi-belgii</i> 'Dauer Blau'
<i>Symphytotrichum novi-belgii</i> 'Tery's Pride'
<i>Symphytotrichum novi-belgii</i> 'Patricia Ballard'
<i>Symphytotrichum novi-belgii</i> 'Freda Ballard'
<i>Symphytotrichum novi-belgii</i> 'Strawberry and Cream'
<i>Symphytotrichum novi-belgii</i> 'Barbados'
<i>Symphytotrichum novi-belgii</i> 'Rosenquartz'
<i>Symphytotrichum novi-belgii</i> 'Bahamas'
<i>Symphytotrichum novi-belgii</i> 'Reintlingstar'
<i>Symphytotrichum novi-belgii</i> 'Dietgard Rose'
<i>Symphytotrichum novi-belgii</i> 'Carminkuppel'
<i>Symphytotrichum novi-belgii</i> 'Lady Frances'
<i>Symphytotrichum novi-belgii</i> 'Winston Churchil'
<i>Symphytotrichum novi-belgii</i> 'White Ladies'
<i>Symphytotrichum novi-belgii</i> 'Royal Velvet'
<i>Symphytotrichum novi-belgii</i> 'Sarah Ballard'
<i>Symphytotrichum novi-belgii</i> 'Crimson Brocade'
<i>Symphytotrichum novi-belgii</i> 'Fellowship'
<i>Symphytotrichum novi-belgii</i> 'Royal Ruby'
<i>Symphytotrichum novi-belgii</i> 'Sailor Boy'
<i>Symphytotrichum</i> 'Eleven purple'
<i>Symphytotrichum</i> 'Blaue Autumn'
<i>Symphytotrichum</i> 'Woods Lights'
<i>Symphytotrichum</i> 'New Star'
<i>Symphytotrichum</i> 'Final Touch'
<i>Symphytotrichum</i> 'Golden Spray'
<i>Symphytotrichum</i> 'Woods Pink'
<i>Symphytotrichum cordifolium</i> 'Photograph'
<i>Symphytotrichum x trefpunkt</i> 'Little Carlow'
<i>Symphytotrichum pringlei</i> 'Pink Star'

Tab. č. 5: Sortiment Pereny - Hlavenec

<i>Symphytotrichum dumosum</i> 'Apollo'
<i>Symphytotrichum dumosum</i> 'Azurro'
<i>Symphytotrichum dumosum</i> 'Blaue Lagune'
<i>Symphytotrichum dumosum</i> 'Blauer Zwerg'
<i>Symphytotrichum dumosum</i> 'Heinz Richard'
<i>Symphytotrichum dumosum</i> 'Herbstgruss vom Bress.'
<i>Symphytotrichum dumosum</i> 'Herbstpurzel'

<i>Symphiotrichum dumosum</i> 'Jenny'
<i>Symphiotrichum dumosum</i> 'Kassel'
<i>Symphiotrichum dumosum</i> 'Kristina'
<i>Symphiotrichum dumosum</i> 'Lady in Blue'
<i>Symphiotrichum dumosum</i> 'Mittelmeer'
<i>Symphiotrichum dumosum</i> Prof. A. Kippenberg'
<i>Symphiotrichum dumosum</i> 'Rosenwichtel'
<i>Symphiotrichum dumosum</i> 'Rozika'
<i>Symphiotrichum dumosum</i> 'Schneekissen'
<i>Symphiotrichum dumosum</i> 'Silberteppich'
<i>Symphiotrichum dumosum</i> 'Starlight'
<i>Symphiotrichum dumosum</i> 'Woods Pink'
<i>Symphiotrichum dumosum</i> 'Woods Purple'
<i>Symphiotrichum ericoides</i> 'Golden Spray'
<i>Symphiotrichum ericoides</i> 'Pink Cloud'
<i>Symphiotrichum ericoides</i> 'Schneetanne'
<i>Symphiotrichum ericoides</i> 'Snow Flurry'
<i>Symphiotrichum ericoides</i> 'Yvette Richardsonj'
<i>Symphiotrichum laeve</i> 'Caliope'
<i>Symphiotrichum laeve</i> 'Novemberblau'
<i>Symphiotrichum lateriflorum</i> var. <i>Horizontalis</i>
<i>Symphiotrichum lateriflorum</i> var. <i>Horizontalis</i> 'Chloe'
<i>Symphiotrichum lateriflorum</i> var. <i>Horizontalis</i> 'Lady in Black'
<i>Symphiotrichum lateriflorum</i> var. <i>Horizontalis</i> 'Prince'
<i>Symphiotrichum novae-angliae</i> 'Alma Potschke'
<i>Symphiotrichum novae-angliae</i> 'Barr's Blue'
<i>Symphiotrichum novae-angliae</i> 'Barr's Pink'
<i>Symphiotrichum novae-angliae</i> 'Herbschnee'
<i>Symphiotrichum novae-angliae</i> 'Purple Dome'
<i>Symphiotrichum novae-angliae</i> 'Rubinchartz'
<i>Symphiotrichum novae-angliae</i> 'Vibrant Dome'
<i>Symphiotrichum novae-angliae</i> 'Violetta'
<i>Symphiotrichum novi-belgii</i> 'Bewunderung'
<i>Symphiotrichum novi-belgii</i> 'Blutenmeer'
<i>Symphiotrichum novi-belgii</i> 'Dauerblau'
<i>Symphiotrichum novi-belgii</i> 'Karminkuppel'
<i>Symphiotrichum novi-belgii</i> 'Porzellan'
<i>Symphiotrichum novi-belgii</i> 'Rosa Perle'
<i>Symphiotrichum novi-belgii</i> 'Royal Ruby'
<i>Symphiotrichum novi-belgii</i> 'Schneeberg'
<i>Symphiotrichum novi-belgii</i> 'Schone von Dietlikon'
<i>Symphiotrichum novi-belgii</i> 'Terry's Pride'
<i>Symphiotrichum novi-belgii</i> 'Violetta'
<i>Symphiotrichum oblongifolium</i>

Tab. č. 6: Sortiment Školky Litomyšl

<i>Symphyotrichum dumosum</i> 'Blaue Lagune'
<i>Symphyotrichum dumosum</i> 'Heinz Richard'
<i>Symphyotrichum dumosum</i> 'Herbst. Vom Bressenhof'
<i>Symphyotrichum dumosum</i> 'Judith'
<i>Symphyotrichum dumosum</i> 'Kristina'
<i>Symphyotrichum dumosum</i> 'Rosemarie Salmann'
<i>Symphyotrichum dumosum</i> 'Rosenwichtel'
<i>Symphyotrichum dumosum</i> 'Schneekissen'
<i>Symphyotrichum dumosum</i> 'Silberteppich'
<i>Symphyotrichum ericoides</i> 'Pink Cloud'
<i>Symphyotrichum ericoides</i> 'Schneetanne'
<i>Symphyotrichum ericoides</i> 'Snow Flurry'
<i>Symphyotrichum novae-anglie</i> 'Abendsone'
<i>Symphyotrichum novae-angliae</i> 'Barr's Blue'
<i>Symphyotrichum novae-anglie</i> 'Herbschnee'
<i>Symphyotrichum novae-anglie</i> 'Maruška'
<i>Symphyotrichum novae-anglie</i> 'Rosa Sieger'
<i>Symphyotrichum novi-belgii</i> 'Bluttenmeer'
<i>Symphyotrichum novi-belgii</i> 'Bonningdale White'
<i>Symphyotrichum novi-belgii</i> 'Fellowship'
<i>Symphyotrichum novi-belgii</i> 'Fuldata'
<i>Symphyotrichum novi-belgii</i> 'Karminkuppel'
<i>Symphyotrichum novi-belgii</i> 'Marie Ballard'
<i>Symphyotrichum novi-belgii</i> 'Plenty'
<i>Symphyotrichum novi-belgii</i> 'Schone von Dietlikon'

Tab. č. 7: Sortiment Spijker

<i>Symphyotrichum dumosum</i> 'Anneke'
<i>Symphyotrichum dumosum</i> 'Apollo'
<i>Symphyotrichum dumosum</i> 'Early Blue'
<i>Symphyotrichum dumosum</i> 'Herbs. Vom Bresserhof'
<i>Symphyotrichum dumosum</i> 'Jenny'
<i>Symphyotrichum dumosum</i> 'Lady in Blue'
<i>Symphyotrichum dumosum</i> 'Peret Harrison'
<i>Symphyotrichum dumosum</i> 'Prof. Anton Kieppenbergh'
<i>Symphyotrichum dumosum</i> 'Rosenwichtel'
<i>Symphyotrichum dumosum</i> 'Schneekissen'
<i>Symphyotrichum dumosum</i> 'Starlight'
<i>Symphyotrichum cordifolium</i> 'Little Carlow'
<i>Symphyotrichum ericoides</i> 'Cecyle'
<i>Symphyotrichum lateriflorum</i> 'Horizontalis'
<i>Symphyotrichum lateriflorum</i> 'Lady in Black'

<i>Symphiotrichum laeve</i> 'Calliope'
<i>Symphiotrichum lateriflorum</i> 'Prince'
<i>Symphiotrichum novae-angliae</i> 'Purple Dome'
<i>Symphiotrichum novae-angliae</i> 'Alma Potschke'
<i>Symphiotrichum novi-belgii</i> 'Crimson Brocade'
<i>Symphiotrichum novi-belgii</i> 'Fellowship'
<i>Symphiotrichum novi-belgii</i> 'Maria Ballard'
<i>Symphiotrichum novi-belgii</i> 'Neron'
<i>Symphiotrichum novi-belgii</i> 'Patricia Ballard'
<i>Symphiotrichum novi-belgii</i> 'Sarah Ballard'
<i>Symphiotrichum novi-belgii</i> 'Schone von Dietlikon'
<i>Symphiotrichum novi-belgii</i> 'White Ladies'
<i>Symphiotrichum novi-belgii</i> 'Winston Churchill'
<i>Symphiotrichum</i> 'Pink Star'
<i>Symphiotrichum pringlei</i> 'Monte Cassino'

Tab. č. 8: Sortiment Hogendoorn

<i>Symphiotrichum</i> 'Ann Leys'
<i>Symphiotrichum</i> 'Blue Autumn'
<i>Symphiotrichum</i> 'Island Barbados'
<i>Symphiotrichum</i> 'Island Tonga'
<i>Symphiotrichum</i> 'Pink Star'
<i>Symphiotrichum</i> 'Light Blue'
<i>Symphiotrichum dumosum</i> 'Alice Haslam'
<i>Symphiotrichum dumosum</i> 'Anneke'
<i>Symphiotrichum dumosum</i> 'Apollo'
<i>Symphiotrichum dumosum</i> 'Bahamas'
<i>Symphiotrichum dumosum</i> 'Blaue Lagune'
<i>Symphiotrichum dumosum</i> 'Herbstgruss vom Bresserhof'
<i>Symphiotrichum dumosum</i> 'Jenny'
<i>Symphiotrichum dumosum</i> 'Kassel'
<i>Symphiotrichum dumosum</i> 'Kristina'
<i>Symphiotrichum dumosum</i> 'Lady in Blue'
<i>Symphiotrichum dumosum</i> 'Marjorie'
<i>Symphiotrichum dumosum</i> 'Mittelmeer'
<i>Symphiotrichum dumosum</i> 'Niobe'
<i>Symphiotrichum dumosum</i> 'Peter Harrison'
<i>Symphiotrichum dumosum</i> 'Peter Pan'
<i>Symphiotrichum dumosum</i> 'Pink Bouquet'
<i>Symphiotrichum dumosum</i> 'Prof. Anton Kieppenbergh'
<i>Symphiotrichum dumosum</i> 'Rosenwichtel'
<i>Symphiotrichum dumosum</i> 'Schneekissen'
<i>Symphiotrichum dumosum</i> 'Snowspire'
<i>Symphiotrichum dumosum</i> 'Starlight'

<i>Symphyotrichum dumosum</i> 'Wachsenburg'
<i>Symphyotrichum dumosum</i> 'Woods Pink'
<i>Symphyotrichum dumosum</i> 'Zwergenhimmel'
<i>Symphyotrichum cordifolium</i> 'Ideal'
<i>Symphyotrichum cordifolium</i> 'Little Carlow'
<i>Symphyotrichum cordifolium</i> 'Photograph'
<i>Symphyotrichum cordifolium</i> 'Silver Spray'
<i>Symphyotrichum ericoides</i> 'Blue Star'
<i>Symphyotrichum ericoides</i> 'Erlkoning'
<i>Symphyotrichum ericoides</i> 'Esthet'
<i>Symphyotrichum ericoides</i> 'Golden Spray'
<i>Symphyotrichum ericoides</i> 'Lovely'
<i>Symphyotrichum ericoides</i> 'Pink Cloud'
<i>Symphyotrichum ericoides</i> 'Prostrate Form'
<i>Symphyotrichum ericoides</i> 'Schneegitter'
<i>Symphyotrichum ericoides</i> 'Schneetanee'
<i>Symphyotrichum ericoides</i> 'Snow Flurry'
<i>Symphyotrichum laeve</i> 'Anneke Van Der Jeugd'
<i>Symphyotrichum laeve</i> 'Blauschleier'
<i>Symphyotrichum lateriflorum</i> 'Coombre Fishacre'
<i>Symphyotrichum lateriflorum</i> 'Horizontalis'
<i>Symphyotrichum lateriflorum</i> 'Lady in Black'
<i>Symphyotrichum lateriflorum</i> 'Prince'
<i>Symphyotrichum novae-angliae</i> 'And. An Alma Potschke'
<i>Symphyotrichum novae-angliae</i> 'Andenken an Paue Gerber'
<i>Symphyotrichum novae-angliae</i> 'Barr's Blue'
<i>Symphyotrichum novae-angliae</i> 'Barr's Pink'
<i>Symphyotrichum novae-angliae</i> 'Constance'
<i>Symphyotrichum novae-angliae</i> 'Herbschnee'
<i>Symphyotrichum novae-angliae</i> 'Maria Wolkonsky'
<i>Symphyotrichum novae-angliae</i> 'Purple Dome'
<i>Symphyotrichum novae-angliae</i> 'Rosa Sieger'
<i>Symphyotrichum novae-angliae</i> 'Rudelsburg'
<i>Symphyotrichum novae-angliae</i> 'Septemberrubin'
<i>Symphyotrichum novae-angliae</i> 'Vibrant Dome'
<i>Symphyotrichum novae-angliae</i> 'Violetta'
<i>Symphyotrichum novi-belgii</i> 'Brigitte'
<i>Symphyotrichum novi-belgii</i> 'Crimson Brocade'
<i>Symphyotrichum novi-belgii</i> 'Dauer Blau'
<i>Symphyotrichum novi-belgii</i> 'Elta'
<i>Symphyotrichum novi-belgii</i> 'Eventide'
<i>Symphyotrichum novi-belgii</i> 'Fellowship'
<i>Symphyotrichum novi-belgii</i> 'Marie Ballard'
<i>Symphyotrichum novi-belgii</i> 'Milka'
<i>Symphyotrichum novi-belgii</i> 'Patricia Ballard'

<i>Symphiotrichum novi-belgii</i> 'Royal Ruby'
<i>Symphiotrichum novi-belgii</i> 'Sarah Ballard'
<i>Symphiotrichum novi-belgii</i> 'Schone von Dietlikon'
<i>Symphiotrichum novi-belgii</i> 'White Ladies'
<i>Symphiotrichum novi-belgii</i> 'Winston Churchil'
<i>Symphiotrichum pringlei</i> 'Monte Casino'
<i>Symphiotrichum turbinellum</i>

Tab. č. 9: Sortiment Kurt Bluemel

<i>Symphiotrichum dumosum</i> 'Alert'
<i>Symphiotrichum dumosum</i> 'Blaue Lagune'
<i>Symphiotrichum dumosum</i> 'Nesthakchen'
<i>Symphiotrichum dumosum</i> 'Professor Anton Kippenberg'
<i>Symphiotrichum dumosum</i> 'Lady in Blue'
<i>Symphiotrichum ericoides</i>
<i>Symphiotrichum ericoides</i> 'Snow Flurry'
<i>Symphiotrichum laeve</i>
<i>Symphiotrichum laeve</i> 'Bluebird'
<i>Symphiotrichum lateriflorum</i> 'Horizontalis'
<i>Symphiotrichum lateriflorum</i> 'Lady in Black'
<i>Symphiotrichum novae-angliae</i>
<i>Symphiotrichum novae-angliae</i> 'Andenken an Alma Potschke'
<i>Symphiotrichum novae-angliae</i> 'Harrington Pink'
<i>Symphiotrichum novae-angliae</i> 'Purple Dome'
<i>Symphiotrichum novae-angliae</i> 'Rudelsburg'
<i>Symphiotrichum novi-belgii</i>
<i>Symphiotrichum novi-belgii</i> 'Blue Gown'
<i>Symphiotrichum novi-belgii</i> 'Marie Ballard'
<i>Symphiotrichum novi-belgii</i> 'Patricia Ballard'
<i>Symphiotrichum oblongifolium</i> 'October Sky'
<i>Symphiotrichum oblongifolium</i> 'Raydon's Favorit'
<i>Symphiotrichum pringlei</i> 'Monte Casino'

Tab. č. 10: Sortiment Jelitto

<i>Symphiotrichum azureus</i>
<i>Symphiotrichum ericoides</i>
<i>Symphiotrichum laevis</i>
<i>Symphiotrichum novae-angliae</i> 'Septemberrubin'
<i>Symphiotrichum novi-belgii</i>
<i>Symphiotrichum oblongifolium</i>
<i>Symphiotrichum puniceum</i>
<i>Symphiotrichum turbinellum</i>

Tab. č. 11: Průměrné měsíční teploty v Lednici na Moravě v letech 2014-2015 (ve °C)

Teplota	I.	II.	III.	IV.	V.	VI.	VII.	VIII.	IX.	X.	XI.	XII.
2014	1,5	3,2	8,1	11,6	14,6	18,8	21,3	17,9	15,4	11,0	7,4	2,9
2015	1,9	1,6	5,6	10,4	14,9	19,2	23,0	22,7	15,7	9,2	6,3	3,0

Tab. č. 12: Průměrné měsíční srážky v Lednici na Moravě v letech 2014-2015 (v mm)

Srážky	I.	II.	III.	IV.	V.	VI.	VII.	VIII.	IX.	X.	XI.	XII.
2014	6,3	6,3	4,0	20,6	46,2	31,4	69,6	146,0	166,0	30,1	25,2	20,7
2015	18,3	11,9	24,8	7,0	31,3	2,6	30,4	81,1	40,7	42,6	28,1	7,2

Tab. č. 13: Průměrná měsíční délka slunečního svitu v Lednici na Moravě v letech 2014-2015 (v hod)

Sluneční svit	I.	II.	III.	IV.	V.	VI.	VII.	VIII.	IX.	X.	XI.	XII.
2014	53,8	81,2	203,1	174,0	195,3	265,3	243,5	178,6	146,7	96,3	42,1	74,6
2015	43,8	112,1	138,4	241,3	153,9	274,9	295,9	274,6	166,1	76,8	95,6	41,9

Tab. č. 14: Seznam doporučených odrůd

Výborné:
<i>S. ericoides</i> všechny odrůdy
'Jizerka'
'Paleček'
'Strawberry and Cream'
'Vltava'
'Augenweide'
'Isis'
'Salabka'
Průměrné
'Schneekissen'
'Bahamas'
'Lilac Time'
'Niobe'
'Royal Velvet'
'Fuldatal'
Nevyhovující
'Boningham White'
'Blaubox'

Tab. č. 15: Seznam číselného označení hodnocených odrůd

1. Augenweide
2. Aramis White
3. Azurro
4. Blaubox
5. Blauerzweig
6. Heinz Richard
7. Herbstgruss von Bressenhlof
8. Isis
9. Jizerka
10. Judith
11. Kristina
12. Lady in Blue
13. Lights Blue
14. Lilac Time
15. Milena
16. Niobe
17. Paleček
18. Peter Harison
19. Petunia
20. Picasso
21. Rosemarie Sallman
22. Rosenwichtel
23. Rozika
24. Salabka
25. Schneekissen
26. Silberball
27. Silberblaukissen
28. Starlight
29. Tina
30. Vlatava
31. White Ladies
32. Winston churchil
33. Woods Purple
34. Alma Potschke
35. Fragstein
36. Haringston Pink
37. Hela Lacy
38. Herbschnee
39. Incomparabilis
40. Ivona
41. Lachst Glut
42. MRS S T Wright
43. Maruška

44. Purple Dome
45. Rudelsburg
46. Sayers Croft
47. September ruby
48. Violetta
49. Bahamas
50. Barbados
51. Boningale White
52. Crimson Brocade
53. Dauerblau
54. Fellowship
55. Fuldataal
56. Karminkuppel
57. Little Pink Beauty
58. Lomnice
59. Melbourne Bell
60. Porzellan
61. Rosenquartz
62. Royal Blue
63. Royal Velvet
64. Sailor Boy
65. Samoa
66. Sarah Ballard
67. Schneeberg
68. Schone von Dietlikon
69. Strawberry and Cream
70. Trudy Ann
71. Alester Freude
72. Finale
73. Horizontalis Snow
74. Little Carlow
75. Pink Cloud
76. Pink Star
77. Rosy Weil
78. Schneetanee
79. Snow Flurry
80. Symphyotrichum oblongifolium
81. x Kylie
82. 'Caliope'
83. 'Van der Jeugd'
84. 'Silver Spray'
85. 'Monte Cassino'

Tab. č. 16: Seznam označení určitých znaků, které byly hodnoceny, pro jejich orientaci v popisném deskriptoru

Z1	Výška rostliny[m]
Z2	Délka primárního obrostu[m]
Z3	Lokalizace větvení stonku[m]
Z4	Typ odnožování
Z5	Anthokyanové zbarvení
Z6	Odění stonku
Z7	Tvar listů
Z8	Odění listů
Z9	Barva listů
Z10	Okraj listů
Z11	Tvar zákrovních listenů
Z12	Počet řad zákrovních listenů
Z13	Odění zákrovních listenů
Z14	Průměr úboru[cm]
Z15	Počet květů v disku
Z16	Počet paprskovitých květů
Z17	Tvar paprskovitých květů
Z18	Délka paprskovitých květů[cm]
Z19	Šířka paprskovitých květů [cm]
Z20	Doba kvetení
Z21	Barva paprskovitých květů
Z22	Počet úborů na parakladiu
Z23	Rozmístění úborů na parakladiu
Z24	Délka parakladiu[m]
Z25	Druhotné větvení parakladií
Z26	Sklon k rozklesání
Z27	Sklon k zasychání listů v době kvetení

Tab. č. 17: Popisný deskriptor pro rod *Symphyotrichum* Ness naměřený na pozemku ZF MENDELU

	Z1	Z2	Z3	Z4	Z5	Z6	Z7	Z8	Z9	Z10	Z11	Z12	Z13	Z14	Z15	Z16	Z17	Z18	Z19	Z20	Z22	Z23	Z24	Z25	Z26	Z27	Z28	Z29
1	1	1	3	2	2	1	3	1	2	1	1	2	1	1	3	2	2	2	2	3	1	1	1	2	1	2	1	1
2	1	1	3	2	2	1	3	1	2	1	1	2	1	1	3	2	3	2	2	3	1	1	1	2	1	2	1	1
3	1	1	3	2	2	1	3	1	2	1	1	2	1	2	3	2	2	2	1	3	1	1	1	2	1	2	1	1
4	1	1	3	2	2	1	3	1	1	1	1	2	1	2	3	2	2	2	1	3	1	1	1	2	1	2	1	1
5	1	2	3	2	2	1	3	1	2	1	2	3	1	1	3	3	2	2	2	3	1	3	1	2	1	2	1	1
6	1	1	3	2	1	1	3	1	2	1	2	2	1	2	3	2	2	2	2	2	1	3	1	2	1	2	1	1
7	1	1	3	2	2	1	3	1	1	1	1	2	1	2	2	2	2	2	2	3	1	3	1	2	1	2	1	1
8	2	2	3	2	2	1	3	1	2	1	1	3	1	2	3	2	2	2	2	3	1	1	2	2	1	2	1	1
9	1	1	3	2	2	1	3	1	2	1	2	3	1	2	3	2	3	2	1	3	1	1	1	2	1	2	1	1
10	1	1	3	2	2	1	3	1	2	1	1	2	1	2	3	2	3	2	3	3	1	1	1	2	2	2	1	1
11	1	1	3	2	2	1	3	1	1	1	2	2	1	2	3	3	2	2	1	3	1	3	1	2	1	2	1	1
12	1	1	3	2	2	1	3	1	2	1	1	4	1	2	3	3	2	2	2	2	1	3	1	2	1	2	1	1
13	1	1	3	2	2	1	3	1	2	1	2	2	1	2	2	3	2	2	1	4	1	1	1	2	1	2	1	1
14	1	1	3	2	1	1	3	1	2	1	1	3	1	2	2	2	2	2	2	3	1	1	1	2	1	2	1	1
15	1	1	3	2	2	1	3	1	2	1	1	2	1	2	3	2	2	2	2	3	1	3	1	2	1	2	1	1
16	1	1	3	2	2	1	3	1	1	1	1	4	1	1	3	2	3	2	1	3	1	1	1	2	1	2	1	1
17	1	1	3	2	2	1	3	1	2	1	1	2	1	1	2	2	2	1	1	3	1	3	1	2	1	2	1	1
18	1	2	3	2	2	1	3	1	2	1	1	3	1	2	3	2	3	2	2	3	1	1	1	2	1	2	1	1
19	1	1	3	2	2	1	3	1	2	1	1	2	1	2	3	2	3	2	1	2	1	3	1	2	1	2	1	1
20	1	2	3	2	2	1	3	1	2	1	1	2	1	1	3	2	3	2	2	3	1	1	1	2	1	2	1	1
21	1	2	3	2	1	1	3	1	2	1	1	2	1	2	2	2	3	2	1	3	1	3	1	2	1	2	1	1
22	1	1	3	2	1	1	3	1	2	1	1	3	1	1	3	2	3	2	3	3	1	3	1	2	1	2	1	1
23	1	1	3	2	2	1	3	1	2	1	1	3	1	2	3	2	3	2	2	3	1	3	1	2	1	2	1	1
24	1	1	3	2	2	1	3	1	2	1	1	3	1	1	3	3	3	2	2	3	1	3	1	2	1	2	1	1
25	1	1	3	2	2	1	3	1	1	1	2	3	1	1	3	2	3	2	2	3	1	3	1	2	1	2	1	1
26	2	2	3	2	2	1	3	1	2	1	1	3	1	1	3	3	2	2	1	3	1	1	1	2	1	2	1	1
27	1	2	3	2	2	1	3	1	1	1	1	4	1	1	2	2	2	2	1	3	1	1	1	2	1	2	1	1
28	1	2	3	2	2	1	3	1	2	1	1	3	1	1	3	2	3	2	2	3	1	1	1	2	1	2	1	1

29	1	2	3	2	2	1	3	1	1	1	1	2	3	1	1	3	2	2	2	2	4	1	1	1	2	1	2	1	1
30	2	2	3	2	2	1	3	1	2	1	2	2	1	2	3	2	3	2	1	3	1	1	1	2	1	2	1	1	
31	3	2	3	2	2	1	3	1	2	1	1	3	1	2	3	3	2	3	2	3	1	1	1	2	1	2	1	1	
32	2	1	3	3	1	1	3	1	2	1	1	3	1	2	2	3	3	2	3	4	1	3	1	2	1	2	1	1	
33	1	1	5	3	2	1	3	1	2	1	2	3	1	1	2	2	2	2	2	3	1	1	1	2	1	2	1	1	
34	3	2	5	3	1	3	3	3	2	3	3	2	2	2	4	3	3	3	2	4	1	4	1	1	1	4	2	1	
35	3	2	5	3	1	3	3	3	2	3	3	2	2	2	4	4	2	3	1	3	1	4	1	1	1	4	2	1	
36	3	2	5	3	1	3	3	3	2	3	3	2	2	2	4	4	2	2	2	4	1	4	1	1	2	4	2	1	
37	3	2	5	3	1	3	3	3	2	3	3	2	2	2	4	3	3	2	1	4	1	3	2	1	1	5	1	1	
38	3	3	5	3	2	3	3	3	1	3	4	2	2	2	4	4	2	2	2	3	1	3	1	1	1	4	2	1	
39	3	3	5	3	1	3	3	3	2	3	4	2	2	2	4	3	2	2	2	4	1	4	1	1	1	5	1	1	
40	3	2	5	3	1	3	3	3	2	3	3	2	2	2	4	3	2	2	2	3	1	4	1	1	1	5	2	1	
41	3	3	5	3	1	3	3	3	2	3	3	2	2	2	3	3	2	2	2	4	1	4	1	1	1	5	1	1	
42	3	2	5	3	1	3	3	3	2	3	4	2	2	2	3	4	2	2	2	3	1	4	1	1	1	4	2	1	
43	3	3	4	3	1	3	3	3	2	3	3	2	2	2	4	4	2	2	2	4	1	4	1	1	1	4	1	1	
44	1	2	5	3	1	3	3	3	2	3	3	2	2	2	4	5	2	2	2	4	1	3	1	1	1	4	2	1	
45	3	3	5	3	1	3	3	3	2	3	3	2	2	1	4	4	2	2	2	4	1	3	1	1	1	4	2	1	
46	3	3	5	3	1	3	3	3	2	3	4	2	2	2	4	4	2	2	2	4	1	4	1	1	1	4	2	1	
47	3	3	5	3	1	3	3	3	2	3	4	2	2	2	3	4	2	2	2	4	1	3	1	1	2	4	2	1	
48	3	2	4	3	1	3	3	3	2	3	4	2	2	2	4	4	2	2	2	2	1	4	1	1	1	4	2	1	
49	1	1	4	2	2	1	3	1	2	1	2	3	1	2	2	3	2	2	2	3	1	3	1	2	1	2	1	1	
50	1	1	4	2	2	1	3	1	2	1	2	3	1	1	3	2	2	2	2	3	1	1	1	2	1	2	1	1	
51	3	2	4	2	1	1	3	1	1	1	2	3	1	2	3	2	2	2	2	2	1	1	1	2	3	2	1	1	
52	2	2	4	2	1	1	3	1	2	1	1	2	1	1	3	3	2	2	2	3	1	1	1	2	1	2	1	1	
53	3	3	4	2	2	1	3	1	2	1	1	3	1	2	3	2	3	2	2	3	1	1	1	2	1	2	1	1	
54	2	1	4	2	2	1	3	1	2	1	1	3	1	2	2	3	3	2	2	3	1	3	1	2	1	2	1	1	
55	3	3	4	2	2	1	3	1	2	1	1	4	1	2	2	3	2	2	3	3	1	1	1	2	2	2	1	1	
56	2	2	4	2	1	1	3	1	2	1	2	2	1	1	3	3	3	2	2	3	1	1	1	2	1	3	1	1	
57	1	1	3	2	1	1	3	1	2	1	2	3	1	2	3	2	2	2	2	3	1	1	1	2	1	3	1	1	

58	1	1	4	2	2	1	3	1	2	1	2	2	1	2	3	2	3	2	2	3	1	3	1	2	1	2	1	1
59	2	1	4	2	2	1	3	1	2	1	1	3	1	2	3	3	2	2	3	3	1	3	1	2	2	2	1	1
60	2	1	4	2	2	1	3	1	2	1	1	2	1	2	2	2	3	2	2	3	1	1	1	2	2	3	1	1
61	2	2	4	2	2	1	3	1	2	1	1	3	1	1	3	2	2	2	1	3	1	3	1	2	1	3	1	1
62	2	2	3	2	2	1	3	1	2	1	1	3	1	2	3	4	3	2	2	2	1	1	1	2	1	2	1	1
63	2	2	3	2	2	1	3	1	2	1	2	3	1	2	2	2	3	2	2	3	1	3	1	2	1	2	1	1
64	2	1	4	2	2	1	3	1	2	1	1	3	1	2	3	2	3	2	2	3	1	1	1	2	1	2	1	1
65	2	2	4	2	2	1	3	1	2	1	1	2	1	2	3	2	3	2	2	3	1	3	1	2	2	2	1	1
66	2	1	4	2	2	1	3	1	2	1	1	3	1	1	2	2	3	2	2	3	1	3	1	2	1	2	1	1
67	2	2	4	2	2	1	3	1	2	1	2	3	1	1	2	2	3	2	2	3	1	3	1	2	1	3	1	1
68	2	1	3	2	2	1	3	1	2	1	2	3	1	2	3	2	2	2	2	3	1	3	1	2	1	2	1	1
69	2	1	3	2	2	1	3	1	2	1	2	3	1	1	3	2	3	2	2	3	1	3	1	2	1	3	1	1
70	3	2	4	2	2	1	3	1	2	1	1	2	1	2	3	2	2	2	1	3	1	3	1	2	2	3	1	1
71	2	2	4	3	2	2	4	2	2	2	1	3	2	1	1	2	3	2	1	4	2	2	1	1	1	3	1	1
72	3	3	4	3	2	2	4	2	3	2	2	3	2	1	1	2	3	1	1	4	2	2	2	1	1	3	1	1
73	2	2	3	3	2	2	4	2	2	2	2	3	2	1	1	2	3	1	1	4	2	2	1	1	1	3	1	1
74	3	2	4	2	2	1	3	1	2	4	1	1	1	1	2	1	2	2	1	4	2	4	2	1	1	2	1	1
75	3	2	4	2	1	1	3	1	2	4	2	1	1	1	2	2	2	1	1	4	2	4	1	1	1	2	1	1
76	3	3	4	2	1	1	3	1	2	4	1	1	1	1	2	2	2	1	1	4	2	4	1	1	1	2	1	1
77	3	2	4	2	2	1	3	1	2	4	1	1	1	1	2	2	2	1	1	4	2	4	2	1	1	2	1	1
78	3	2	4	3	2	2	4	2	1	2	1	3	2	1	1	1	3	1	1	4	3	2	2	1	1	3	1	1
79	1	1	3	2	2	2	4	2	2	2	2	3	2	1	1	2	3	1	1	4	3	2	1	1	1	1	1	1
80	2	1	3	2	2	2	3	2	2	4	2	4	2	1	3	2	2	2	2	3	1	3	1	2	1	3	1	1
81	3	2	4	3	1	3	3	3	2	3	3	4	2	1	3	2	2	1	2	3	3	3	1	1	1	3	1	1
82	3	2	4	2	1	1	2	1	2	2	1	1	1	1	2	2	2	2	2	4	2	3	1	1	3	2	1	1
83	2	1	4	2	2	1	2	1	2	2	2	1	1	1	2	2	2	2	1	4	2	4	1	1	1	2	1	1
84	3	2	4	3	2	1	1	1	1	4	2	1	1	1	1	2	2	1	1	2	2	3	1	1	3	2	1	1
85	2	1	3	3	2	1	4	1	2	3	1	3	1	1	1	2	3	1	1	3	3	3	1	1	1	2	1	1

Tab. č. 18: Tabulka skutečných hodnot jednotlivých sledovaných znaků, které byly statisticky hodnoceny (hodnoty jsou zprůměrovány z 5 vybraných rostlin)

	Z1	Z3	Z14	Z16	Z18	Z19	Z22	Z24	Z26
1.	0,27	0,1	2,9	35	1	1,2	5	0,06	1
2.	0,28	0,09	2,8	40	2	1,2	5	0,06	1
3.	0,26	0,09	3,2	36	2	1,3	4	0,07	1
4.	0,41	0,12	3,5	35	2	1,3	7	0,1	1
5.	0,21	0,11	2,7	42	1	1,1	5	0,06	1
6.	0,25	0,1	3,6	32	2	1,4	3	0,07	1
7.	0,38	0,16	3,1	29	1	1,1	5	0,1	1
8.	0,52	0,21	3,3	34	1	1,2	8	0,11	1
9.	0,42	0,19	3,8	35	1	1,2	6	0,1	1
10.	0,3	0,15	3,5	38	2	1,1	4	0,09	1
11.	0,32	0,14	3,4	42	2	0,9	6	0,06	1
12.	0,34	0,16	3,6	41	1	1,1	4	0,07	1
13.	0,25	0,1	3,4	45	2	0,9	4	0,04	1
14.	0,32	0,18	3,2	40	2	0,8	4	0,05	1
15.	0,35	0,15	3,3	35	1	0,7	8	0,06	1
16.	0,15	0,05	2,7	35	1	0,8	4	0,03	1
17.	0,12	0,07	2,4	37	1	0,6	4	0,03	1
18.	0,28	0,1	3,1	33	1	1	6	0,04	1
19.	0,42	0,1	3,2	35	1	1,1	6	0,05	1
20.	0,35	0,12	2,9	35	1	0,9	6	0,05	1
21.	0,4	0,21	3,5	29	2	1,4	7	0,05	1
22.	0,28	0,15	3	36	2	1,2	6	0,02	1
23.	0,35	0,17	3,2	34	1	1,1	8	0,05	1
24.	0,24	0,1	2,5	41	2	0,9	6	0,03	1
25.	0,22	0,11	2,6	39	2	0,7	4	0,03	1
26.	0,65	0,25	2,3	43	1	0,9	8	0,07	1
27.	0,3	0,13	2,9	38	2	1	5	0,03	1
28.	0,28	0,12	0,7	35	2	0,9	5	0,05	1
29.	0,39	0,21	2,4	39	1	0,7	4	0,04	1
30.	0,59	0,2	3,4	35	2	1,2	7	0,05	1
31.	1,05	0,55	3,2	43	2	1,5	7	0,08	1
32.	0,61	0,23	3,2	41	2	1,2	5	0,06	1
33.	0,19	0,09	3,1	40	1	1,1	5	0,03	1
34.	1,2	0,7	4,8	67	1	1,5	5	0,08	1
35.	1,1	0,61	5,2	72	2	1,5	6	0,09	1
36.	1,19	0,72	4,5	75	1	1,4	8	0,1	1
37.	1,19	0,68	4,5	69	2	1,3	7	0,12	1
38.	1,25	0,8	4,4	71	1	1,3	7	0,1	1
39.	1,15	0,59	4,3	69	2	1,2	6	0,9	1
40.	1	0,5	4,5	69	2	1,3	8	0,1	1

41.	1,22	0,75	4,5	70	1	1,1	8	0,09	1
42.	1,08	0,6	4,7	75	2	1,3	5	0,08	1
43.	1,1	0,66	4,3	79	1	1,3	8	0,09	1
44.	0,32	0,2	4	91	2	1,2	5	0,05	1
45.	1,1	0,55	3	81	2	1,1	8	0,1	1
46.	1,27	0,69	4,7	85	1	1,4	8	0,1	1
47.	1,08	0,6	4,3	80	2	1,3	7	0,09	1
48.	1,2	0,6	4,7	75	1	1,2	7	0,09	1
49.	0,3	0,2	3,9	41	2	0,8	6	0,07	1
50.	0,4	0,2	2,7	39	1	0,9	4	0,06	1
51.	1,12	0,55	4	35	2	1,2	6	0,05	2
52.	0,84	0,36	3,1	58	1	1	5	0,07	1
53.	1,4	0,7	3,9	35	2	1,2	7	0,06	1
54.	0,79	0,3	5,5	52	1	1,4	5	0,07	1
55.	1	0,5	4,2	60	2	1	7	0,07	2
56.	0,85	0,32	3	57	2	0,8	6	0,09	1
57.	0,41	0,15	4,1	35	2	0,9	6	0,06	1
58.	0,43	0,16	4	34	1	0,9	7	0,08	1
59.	0,72	0,4	3,7	55	1	0,9	7	0,07	2
60.	0,8	0,38	3,5	29	1	1	5	0,07	2
61.	0,65	0,28	3,1	36	2	0,8	5	0,06	2
62.	0,96	0,59	3,5	60	2	1,2	7	0,09	2
63.	0,97	0,5	3,4	39	1	1,1	6	0,09	1
64.	0,95	0,6	3,5	35	2	1,1	6	0,08	1
65.	0,75	0,5	3,4	34	1	0,9	7	0,08	1
66.	0,8	0,35	3,1	28	1	0,9	5	0,08	1
67.	0,75	0,32	3,1	36	1	0,8	5	0,07	1
68.	0,8	0,4	3,4	32	2	0,9	5	0,08	1
69.	1	0,49	3,1	33	2	0,9	5	0,09	1
70.	0,56	0,27	4,6	35	1	1,3	4	0,08	1
71.	0,54	0,34	1,8	19	1	0,7	16	0,09	1
72.	1,52	0,95	1,7	17	1	0,6	20	0,12	1
73.	0,55	0,2	1,6	18	1	0,5	16	0,09	2
74.	1,15	0,66	1,9	15	1	0,7	18	0,11	1
75.	1,04	0,55	1,3	19	1	0,4	19	0,1	1
76.	1,17	0,7	1,4	17	1	0,4	14	0,1	1
77.	1,2	0,67	1,5	17	1	0,5	16	0,11	1
78.	1,15	0,72	1,3	13	1	0,5	21	0,11	2
79.	0,1	0,01	0,6	18	1	0,2	28	0,9	1
80.	0,67	0,45	2,6	30	1	1	8	0,8	2
81.	1,05	0,64	1,5	35	1	0,5	27	0,9	1
82.	1,1	0,65	2,9	22	1	0,9	16	0,1	2
83.	0,95	0,5	2,1	21	1	0,7	18	0,1	1
84.	1,12	0,57	1,1	19	1	0,4	19	0,1	1
85.	0,97	0,52	1	16	1	0,3	26	0,09	2

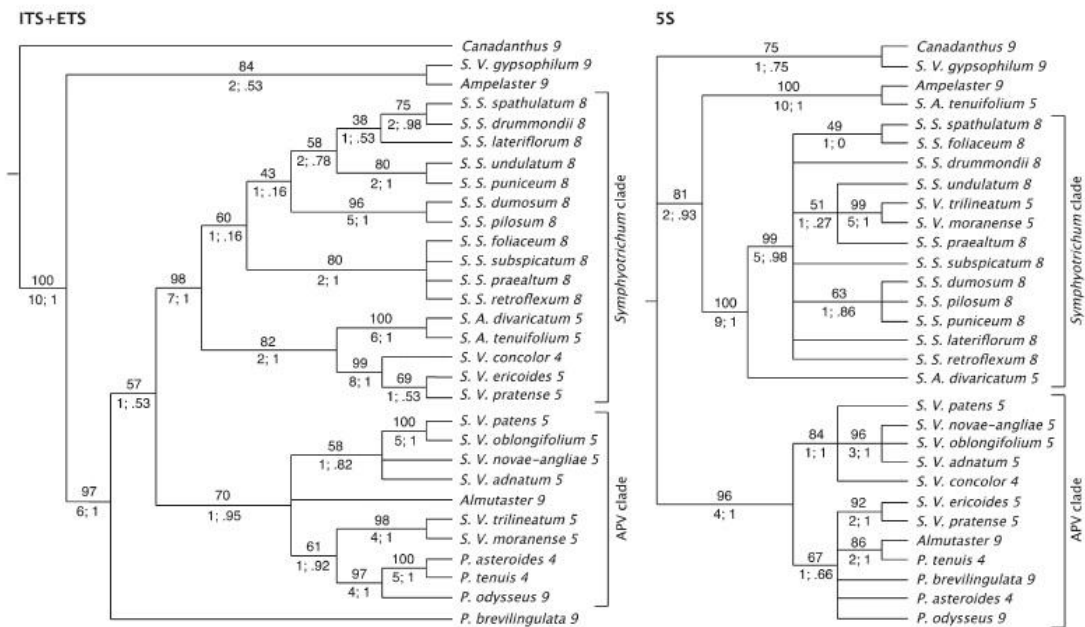

FIG. 2. Comparison of the results of analyses of ITS + ETS and 5S datasets. Bootstrap percentages are above the branches; decay and Bayesian posterior probability values are below the branches, respectively. Base chromosome numbers for each species are indicated after the names. The two primary clades are indicated by brackets. *S.* = *Symphyotrichum*; *P.* = *Psilactis*. For each species of *Symphyotrichum* the subgeneric classification of Semple (2005) is indicated: "S.", "A.", and "V." = subgenera *Symphyotrichum*, *Astropolium*, and *Virgulus*, respectively. Left: Strict consensus of nine trees resulting from analysis of the ITS + ETS dataset. Length = 523; consistency index excluding uninformative characters = 0.53; retention index = 0.74. Right: Strict consensus of 24 shortest trees resulting from analysis of the condensed 5S dataset. Length = 277; consistency index excluding uninformative characters = 0.72; retention index = 0.79.

Obr. č. 1: Příbuzenské vztahy *Symphytrichae* (MORGAN & HOLLAND, 2012)



Obr. č. 10: *Symphyotrichum laeve* 'Caliope'



Obr. č. 11: *Symphyotrichum cordifolium* 'Silver Spray'



Obr. č. 12: *Symphyotrichum ericoides* 'Horizontalis Snow'



Obr. č. 13: *Symphyotrichum ericoides* 'Finale'



Obr. č. 14: *Symphyotrichum* 'Royal Blue'

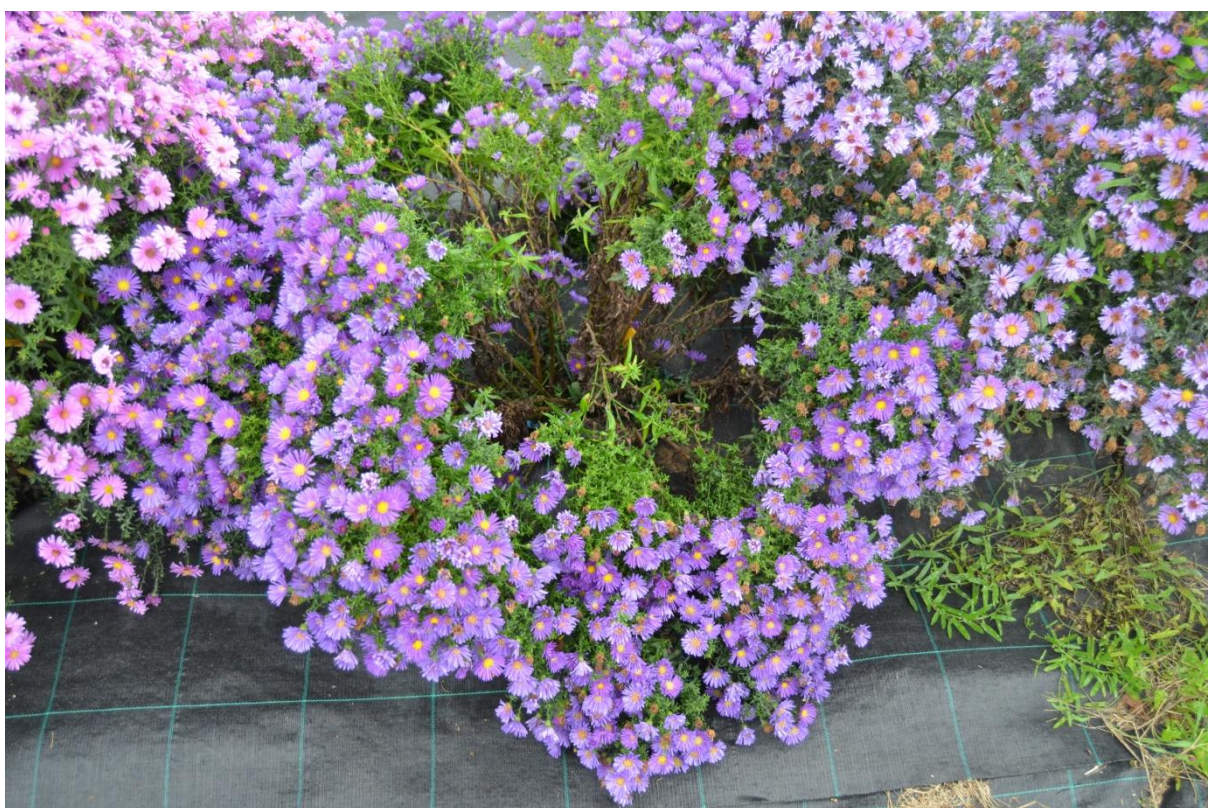

Obr. č. 15: *Symphyotrichum* 'Samoa'



Obr. č. 16: *Symphyotrichum* 'Little Pink Beauty'

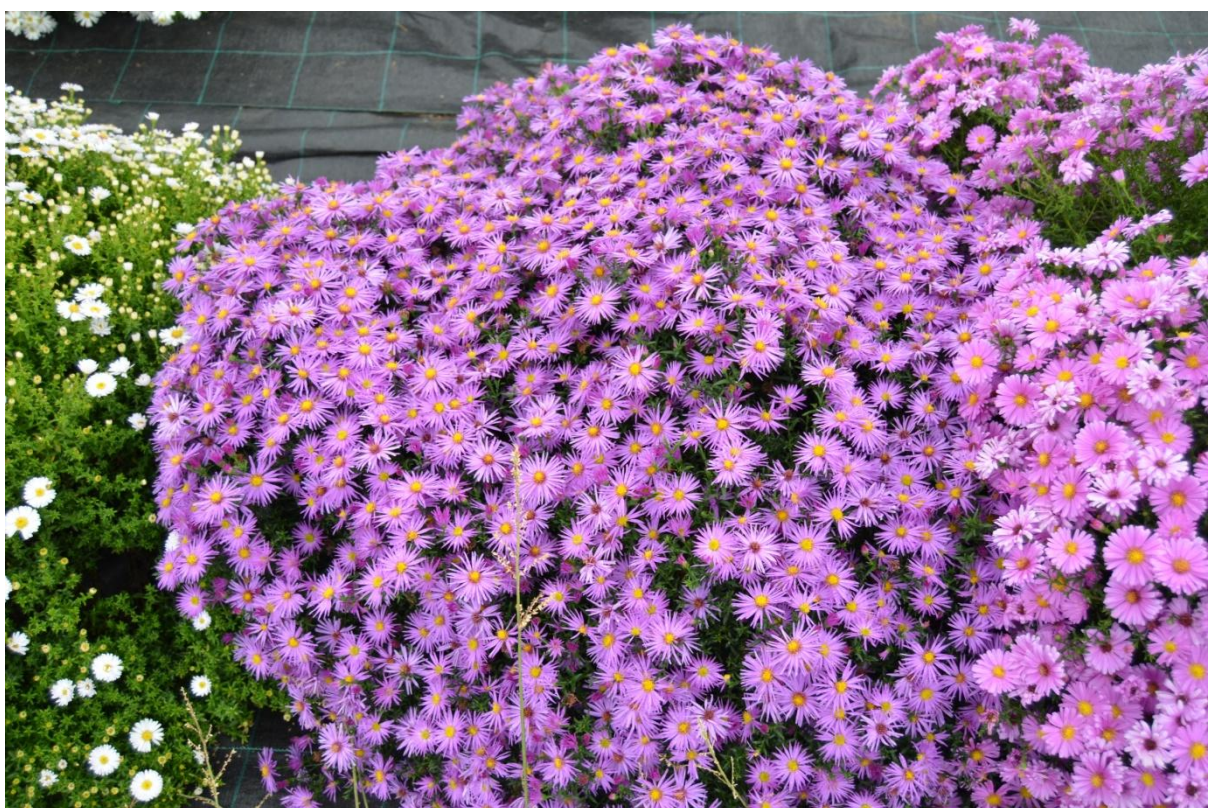

Obr. č. 17: *Symphyotrichum* 'Jizerka'



Obr. č. 18: *Symphyotrichum* 'Schneekissen'



Obr. č. 19: *Symphyotrichum* 'Paleček'

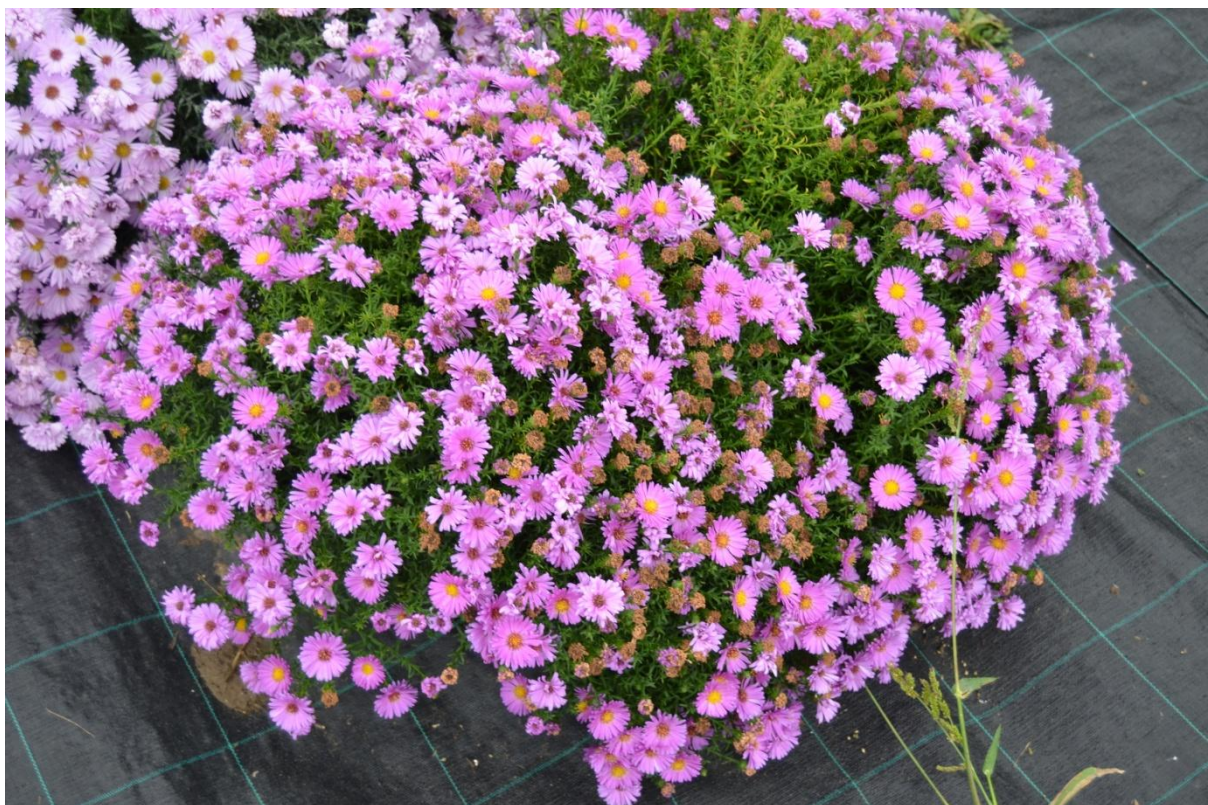

Obr. č. 20: *Symphyotrichum* 'Heinz Richard'



Obr. č. 21: *Symphyotrichum* 'Judith'

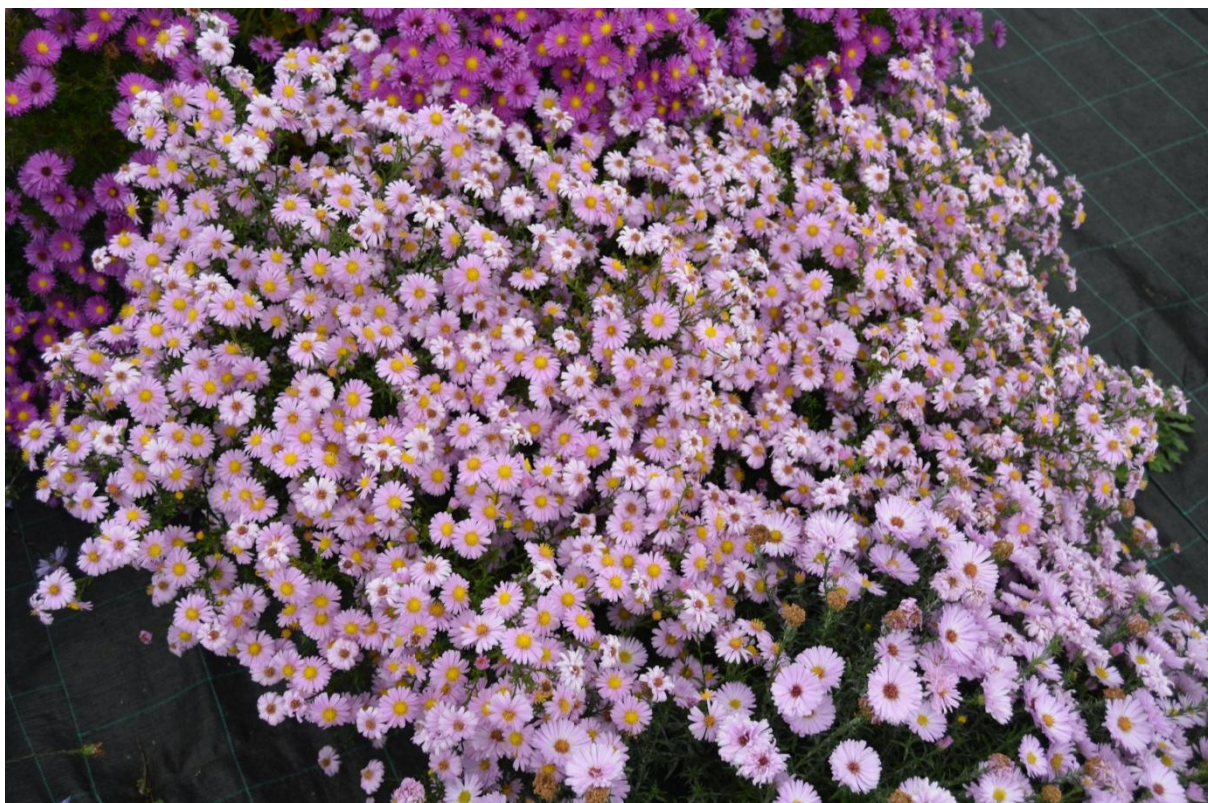

Obr. č. 22: *Symphyotrichum* 'Strawberry and Cream'

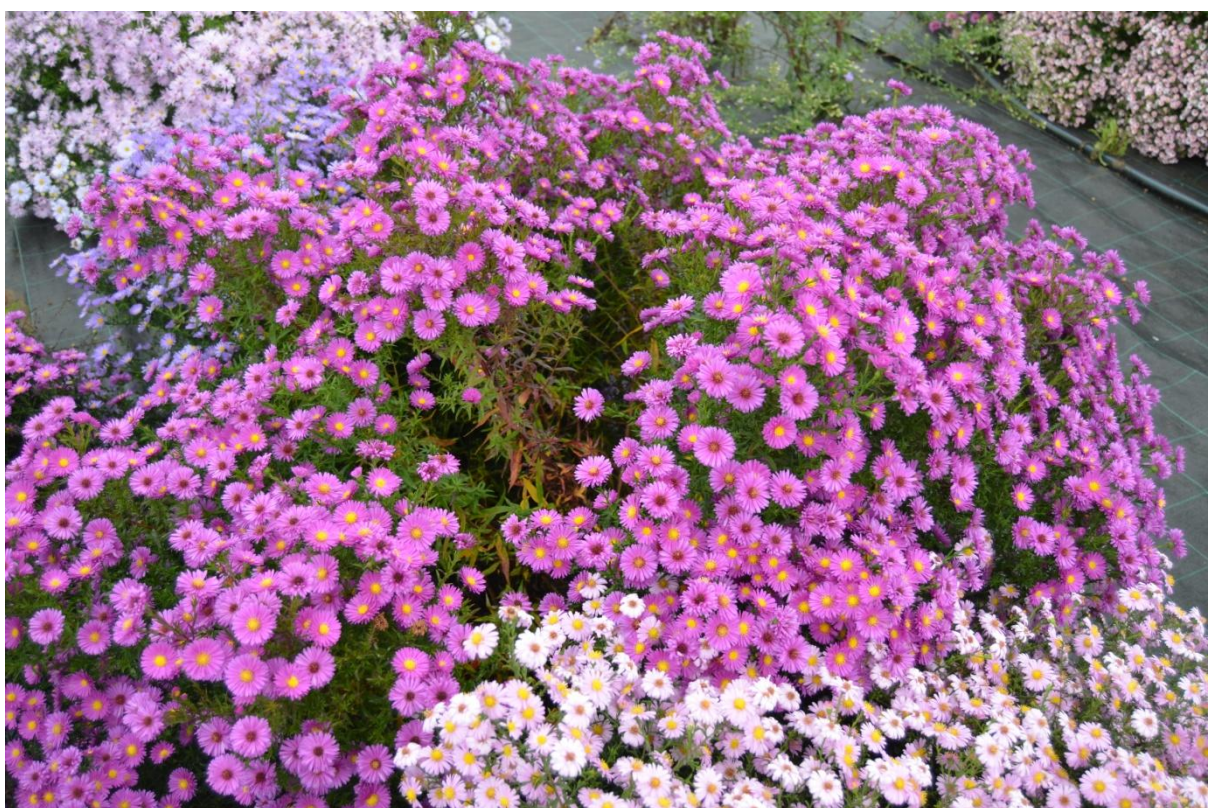

Obr. č. 23: *Symphyotrichum* 'Melbournebell'

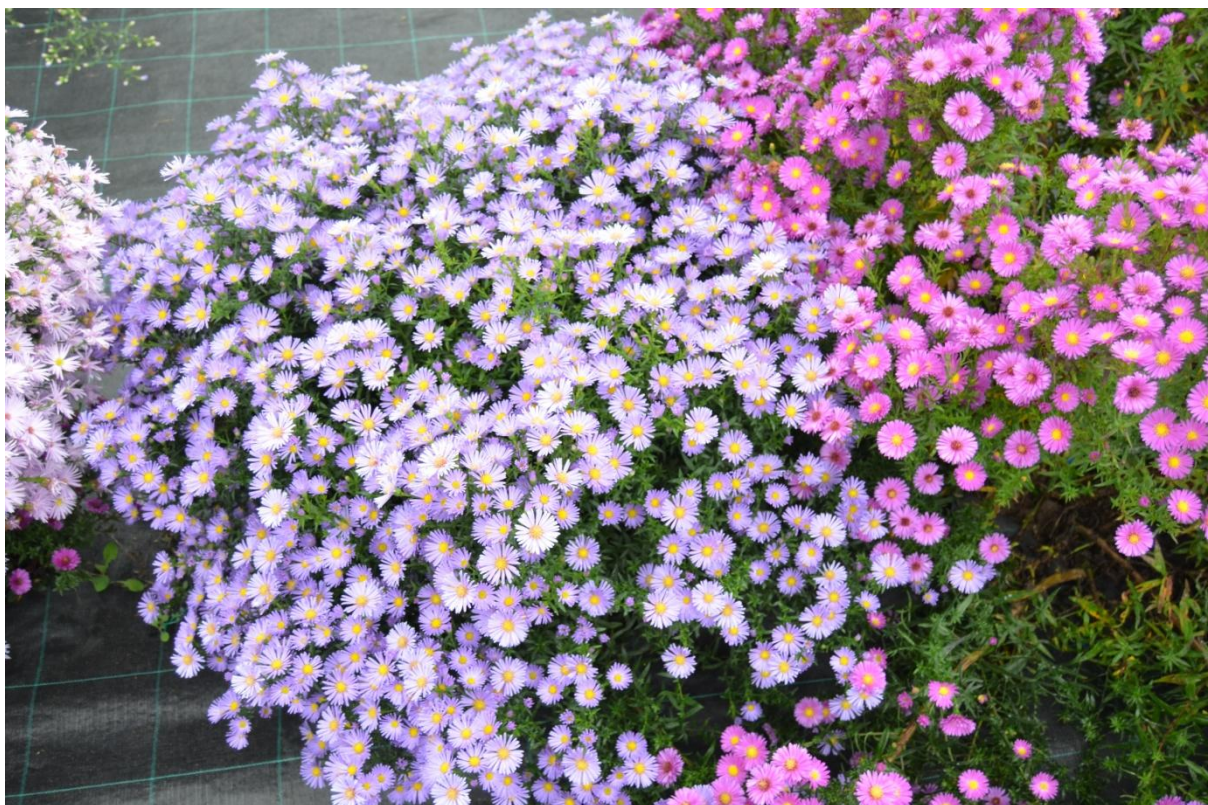

Obr. č. 24: *Symphyotrichum* 'Vltava'

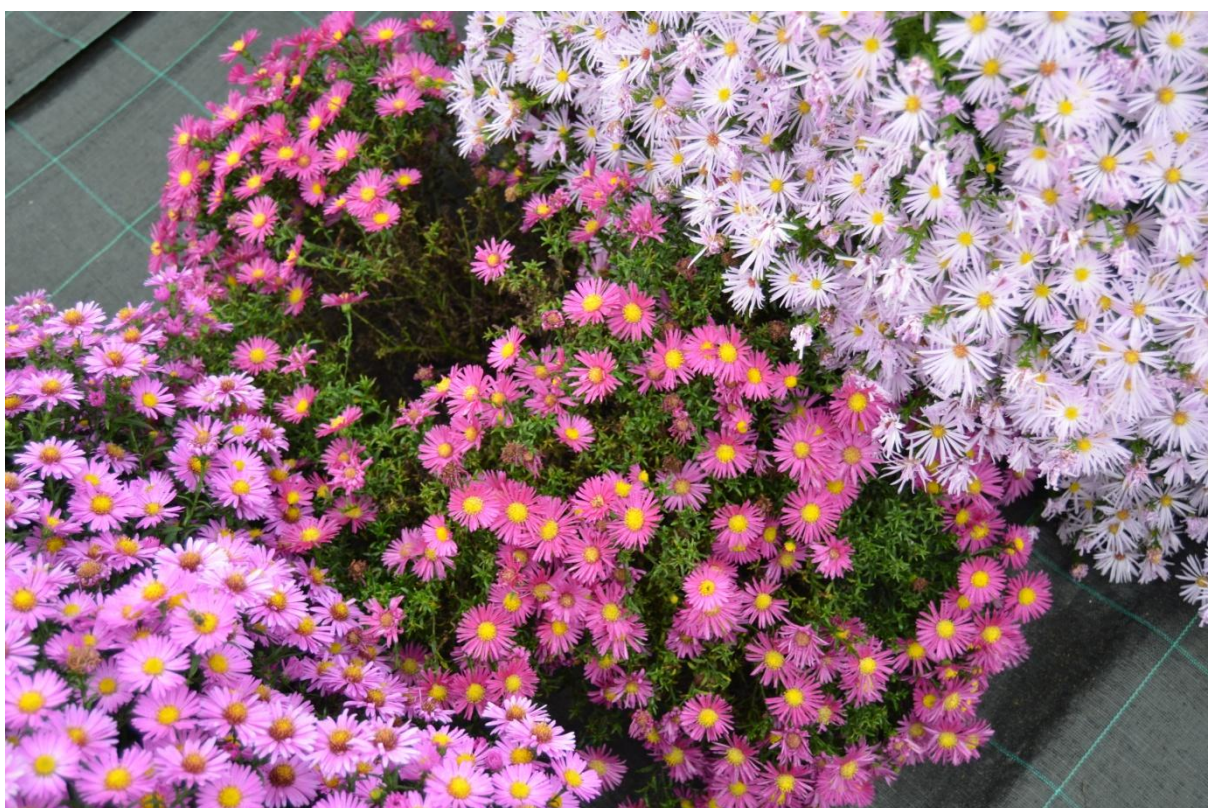

Obr. č. 25: *Symphyotrichum* 'Rosenquartz'

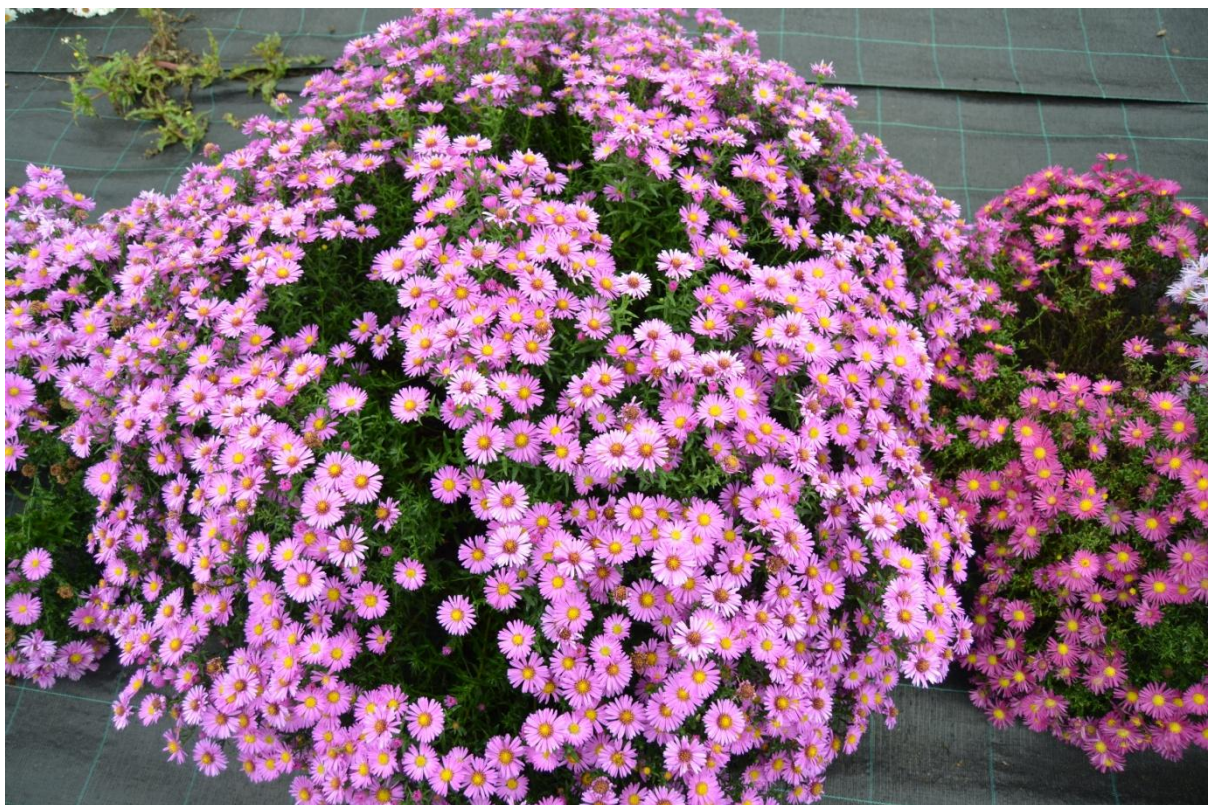

Obr. č. 26: *Symphyotrichum* 'Bahamas'

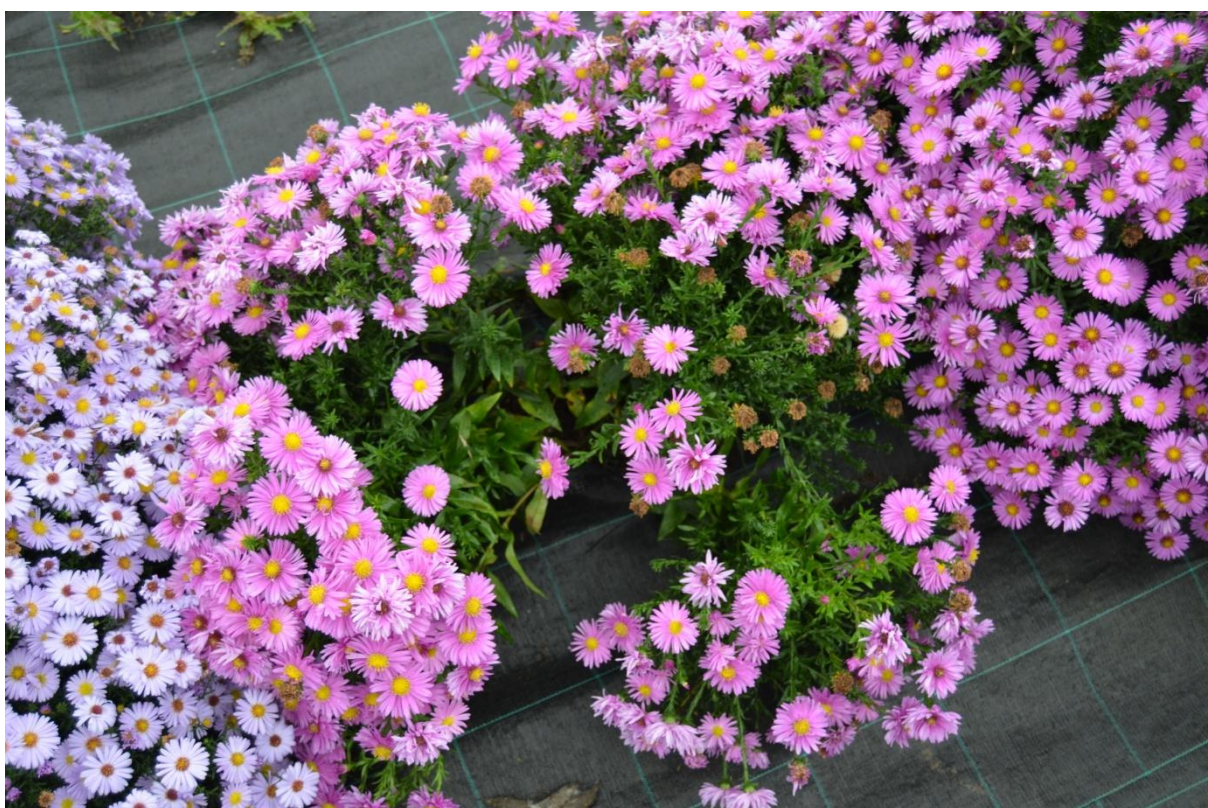

Obr. č. 27: *Symphyotrichum* 'Lomnice'



Obr. č. 28: *Symphyotrichum* 'Augenweide'

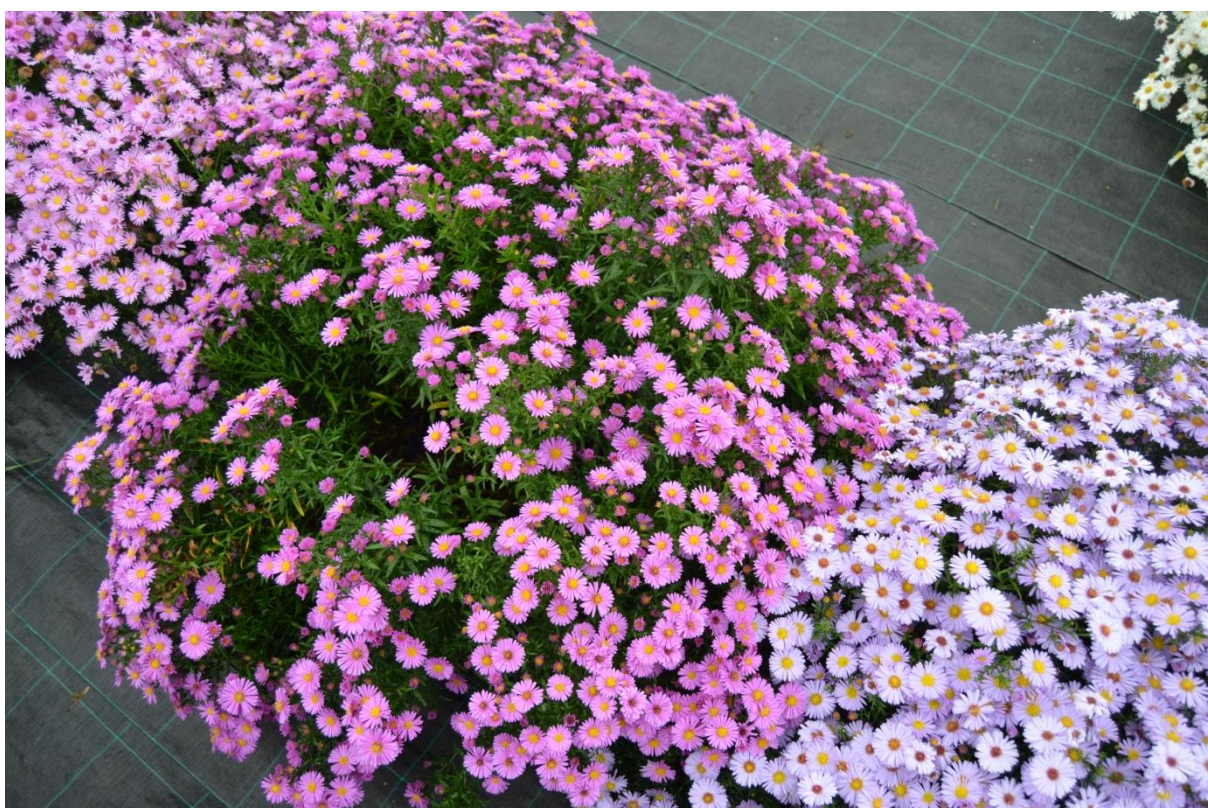

Obr. č. 29: *Symphyotrichum* 'Lilac Time'

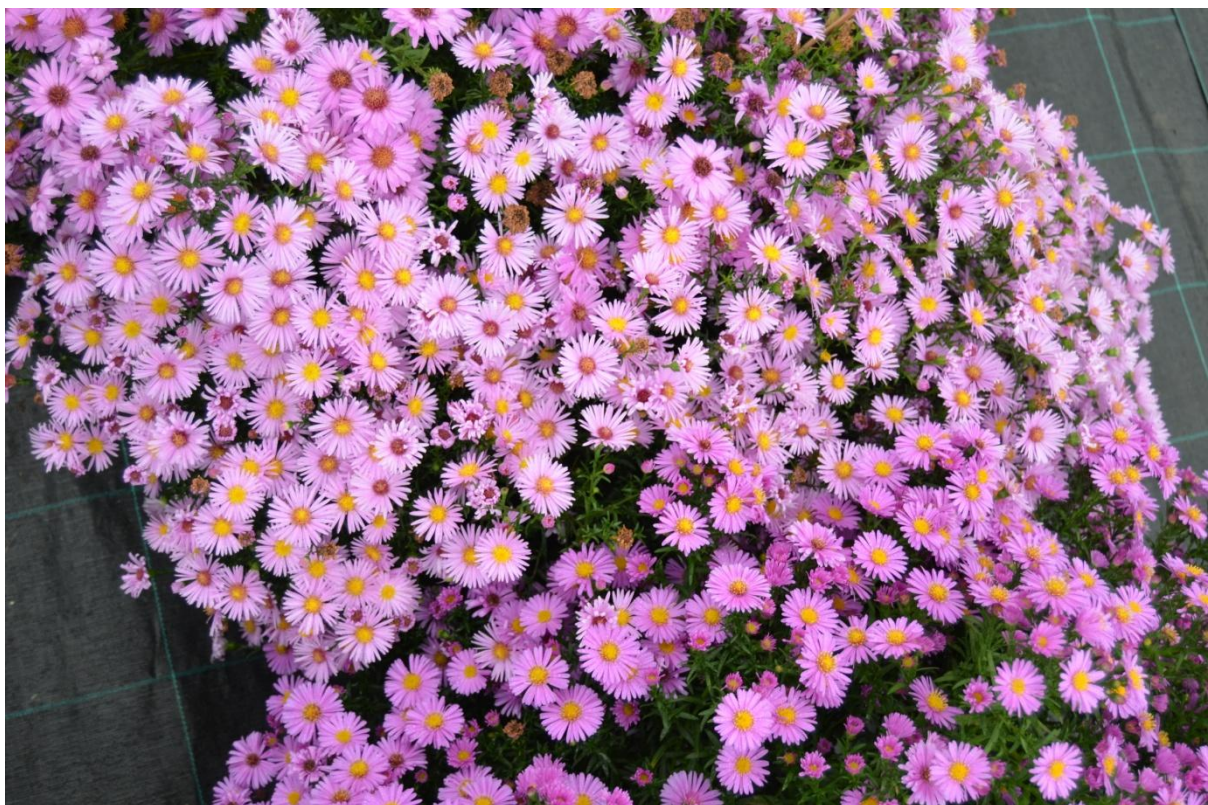

Obr. č. 30: *Symphyotrichum* 'Rosemarie Sallman'

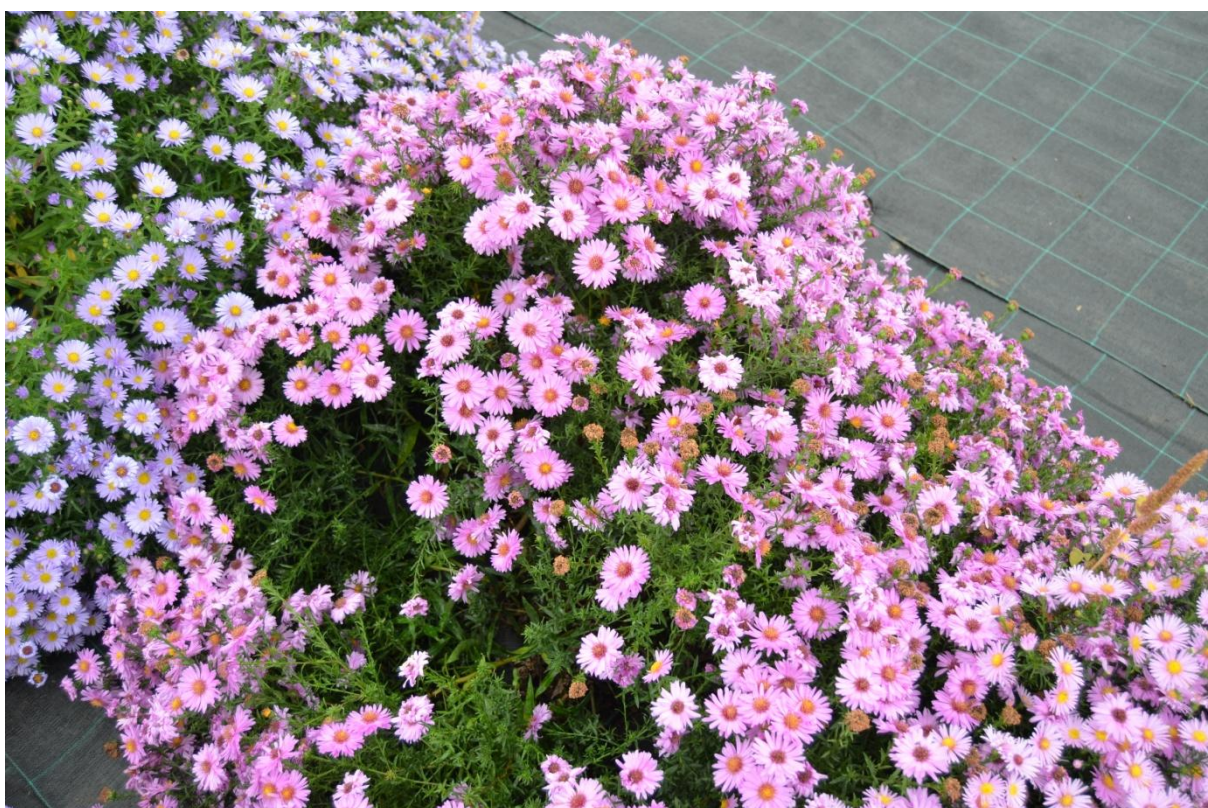

Obr. č. 31: *Symphyotrichum* 'Peter Harrison'

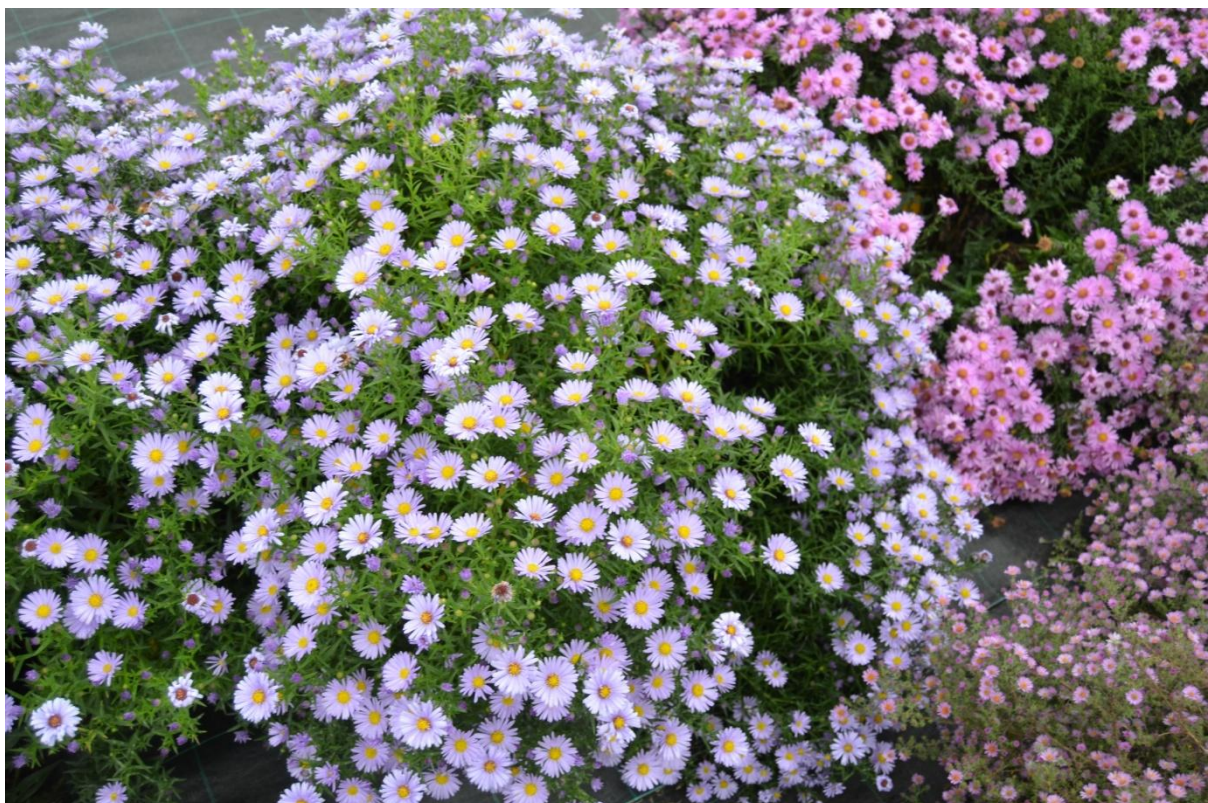

Obr. č. 32: *Symphyotrichum* 'Milena'

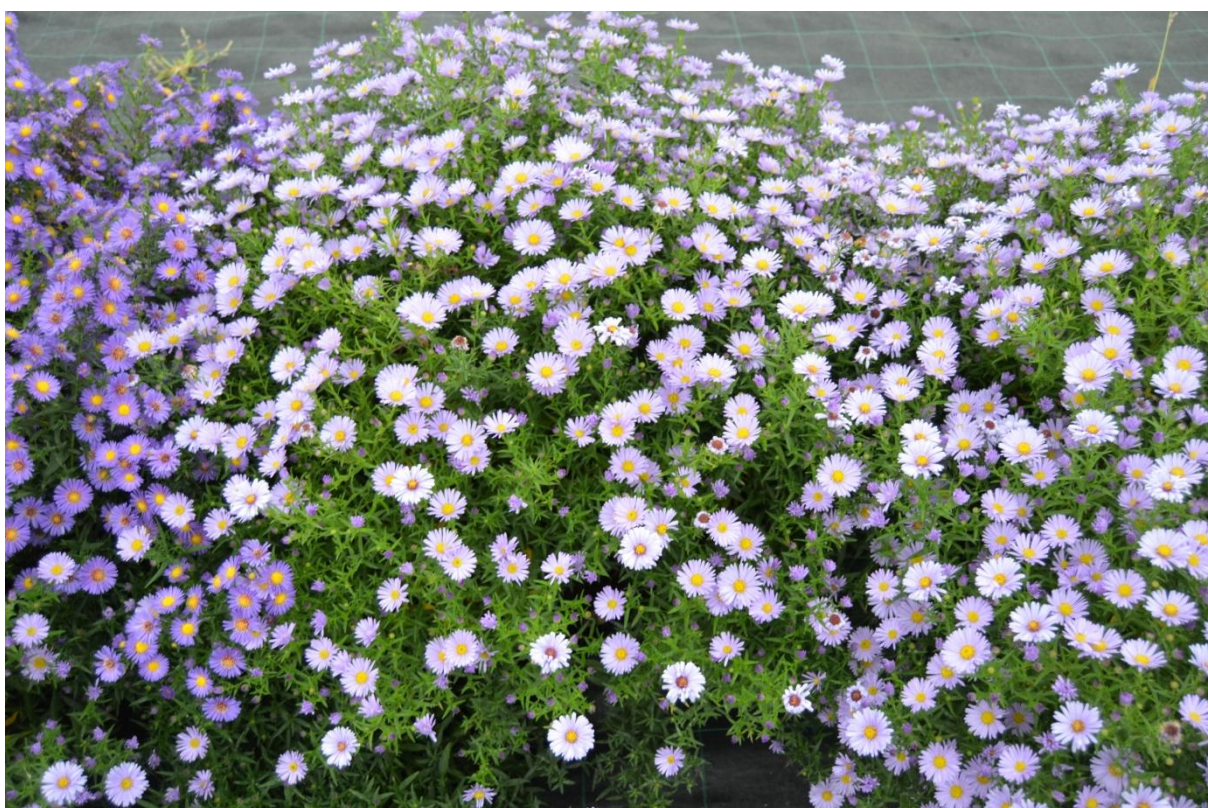

Obr. č. 33: *Symphyotrichum* 'Rozika'

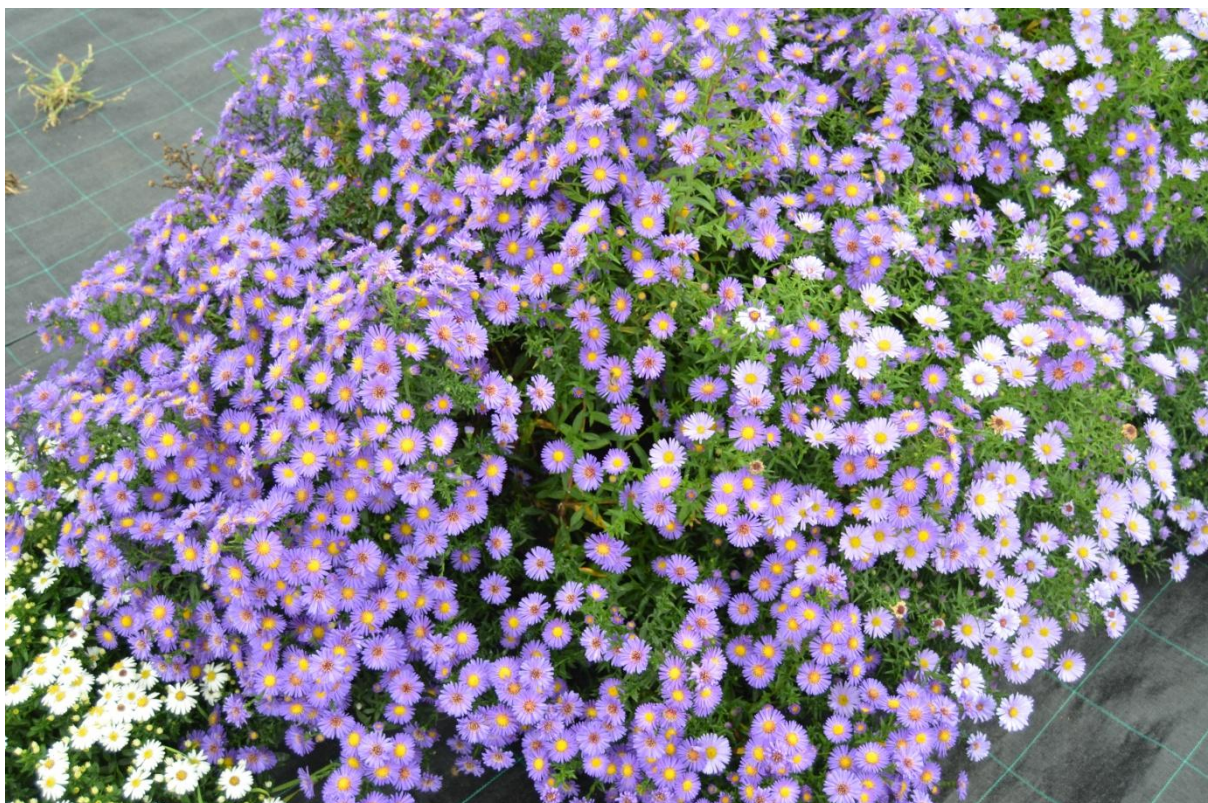

Obr. č. 34: *Symphyotrichum* 'Schone von Dietlikon'

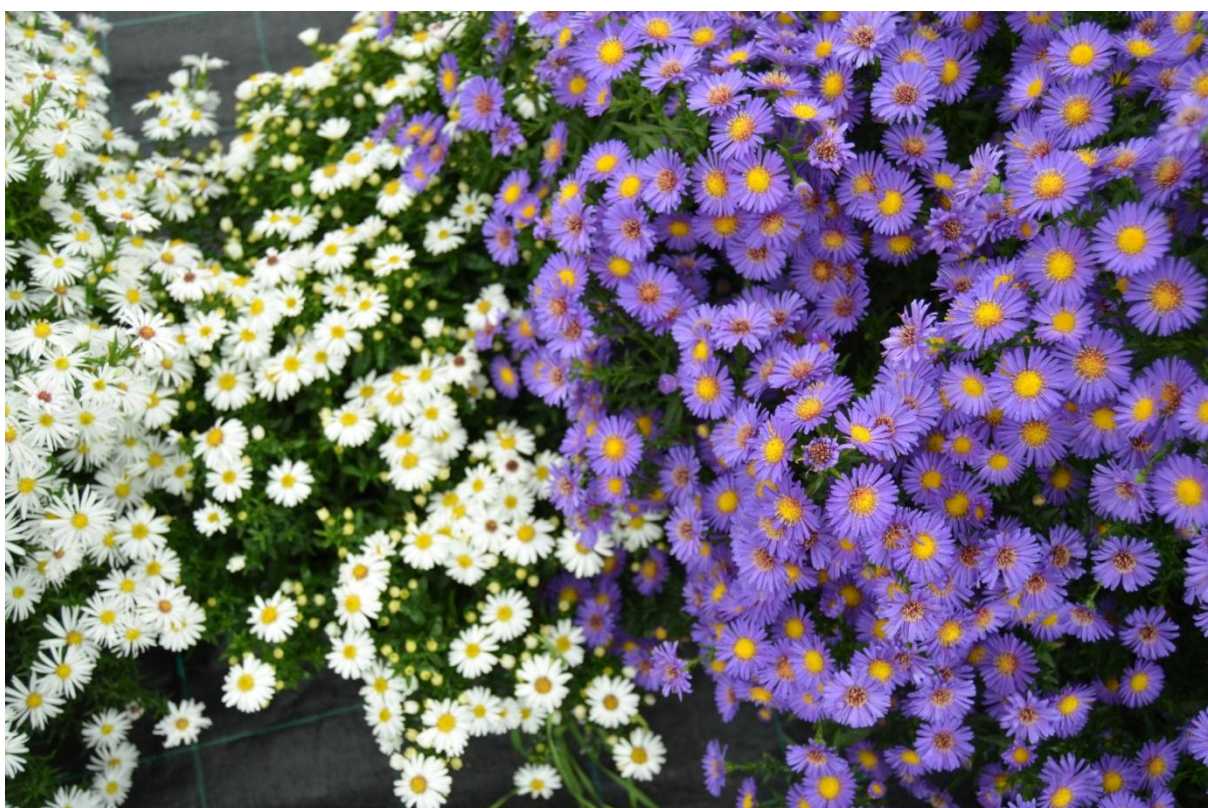

Obr. č. 35: *Symphyotrichum* 'Niobe (bílá uprostřed)



Obr. č. 36: *Symphyotrichum* 'Kristina'

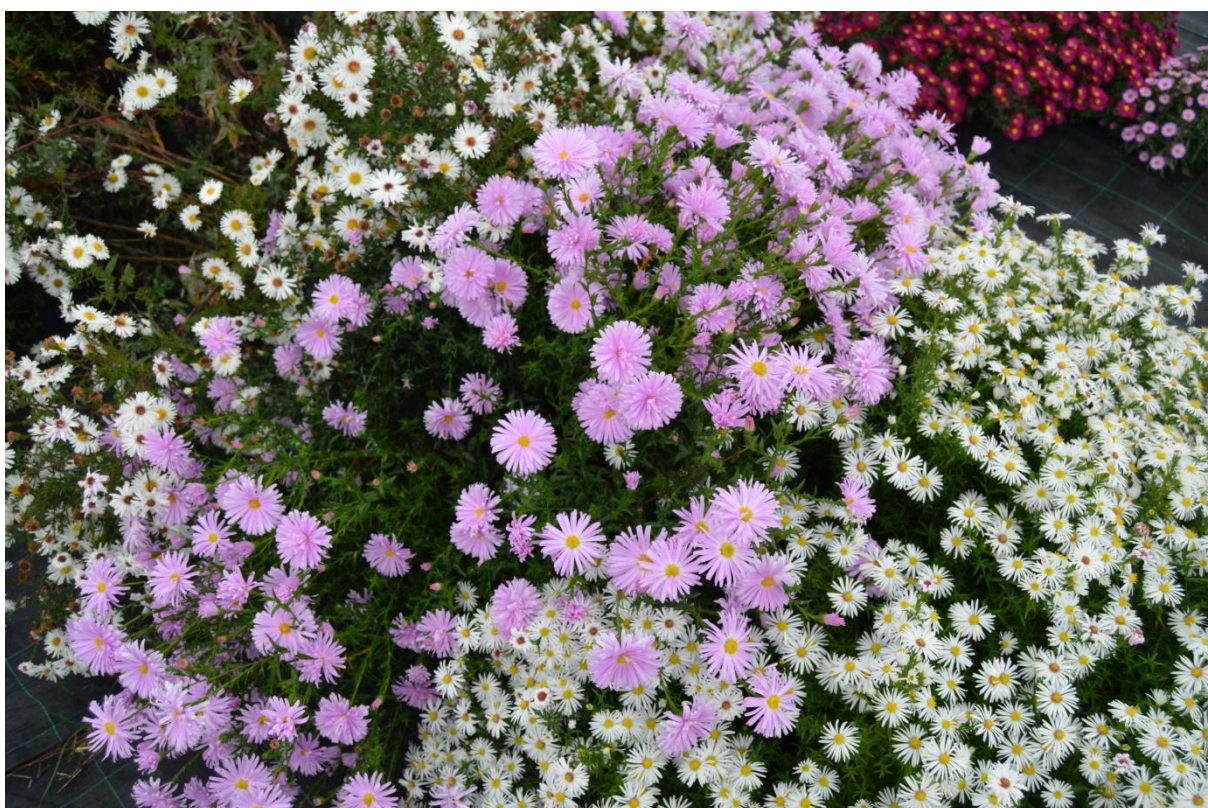

Obr. č. 37: *Symphyotrichum* 'Fellowship'



Obr. č. 38: *Symphyotrichum* 'Boningham White'

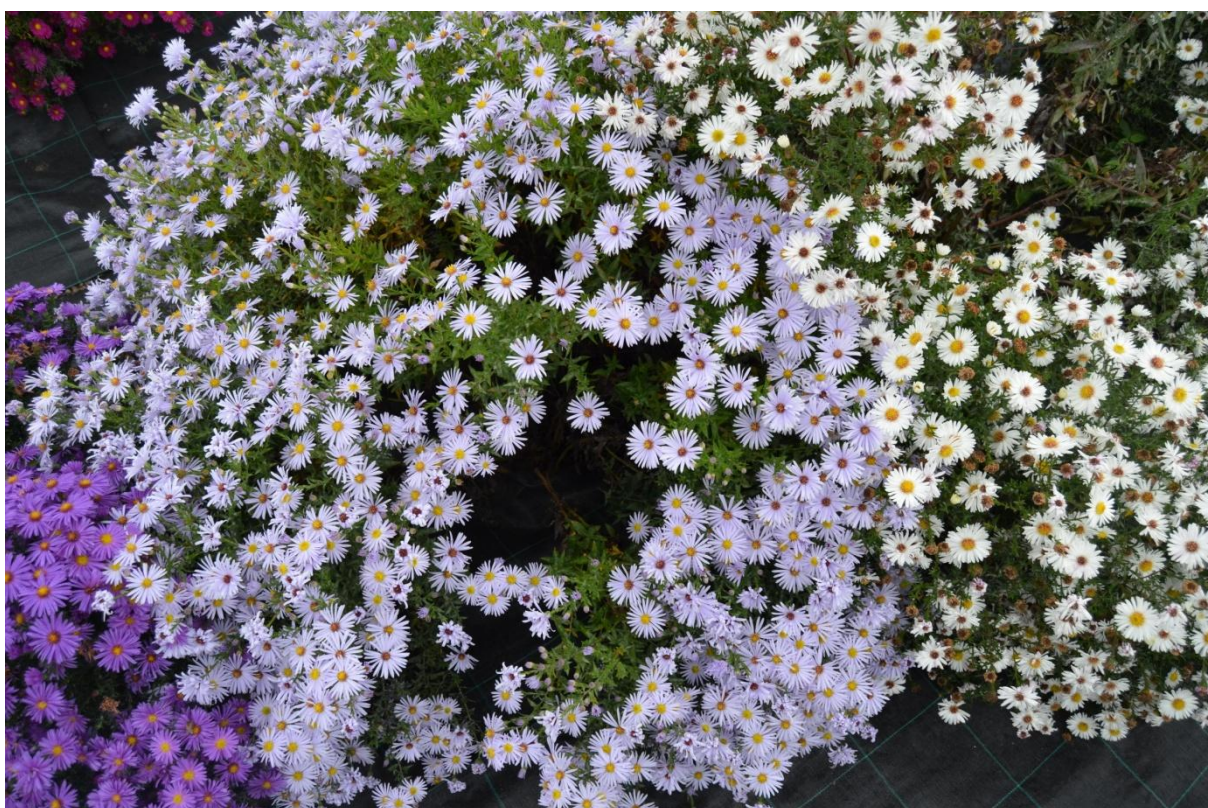

Obr. č. 39: *Symphyotrichum* 'Blaubox'

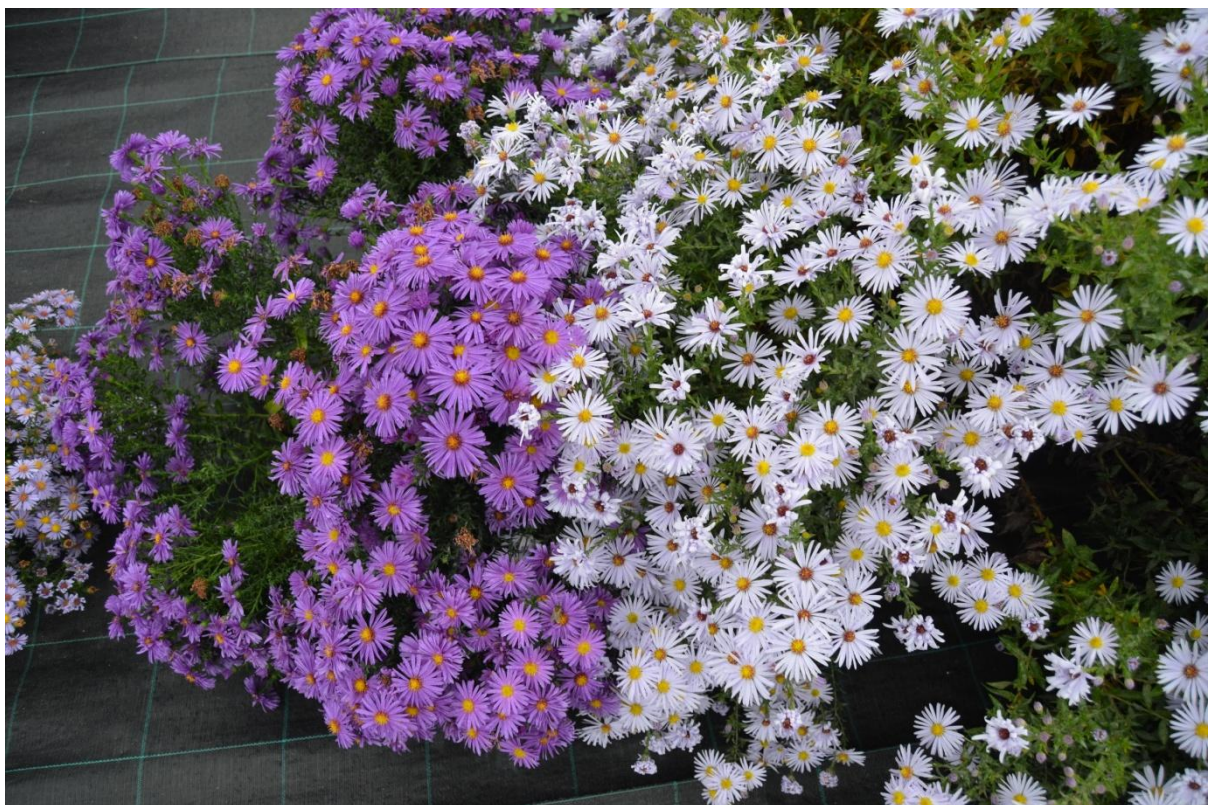

Obr. č. 40: *Symphyotrichum* 'Trudi Ann' (fialová)



Obr. č. 41: *Symphyotrichum* 'Silberblaukissen'

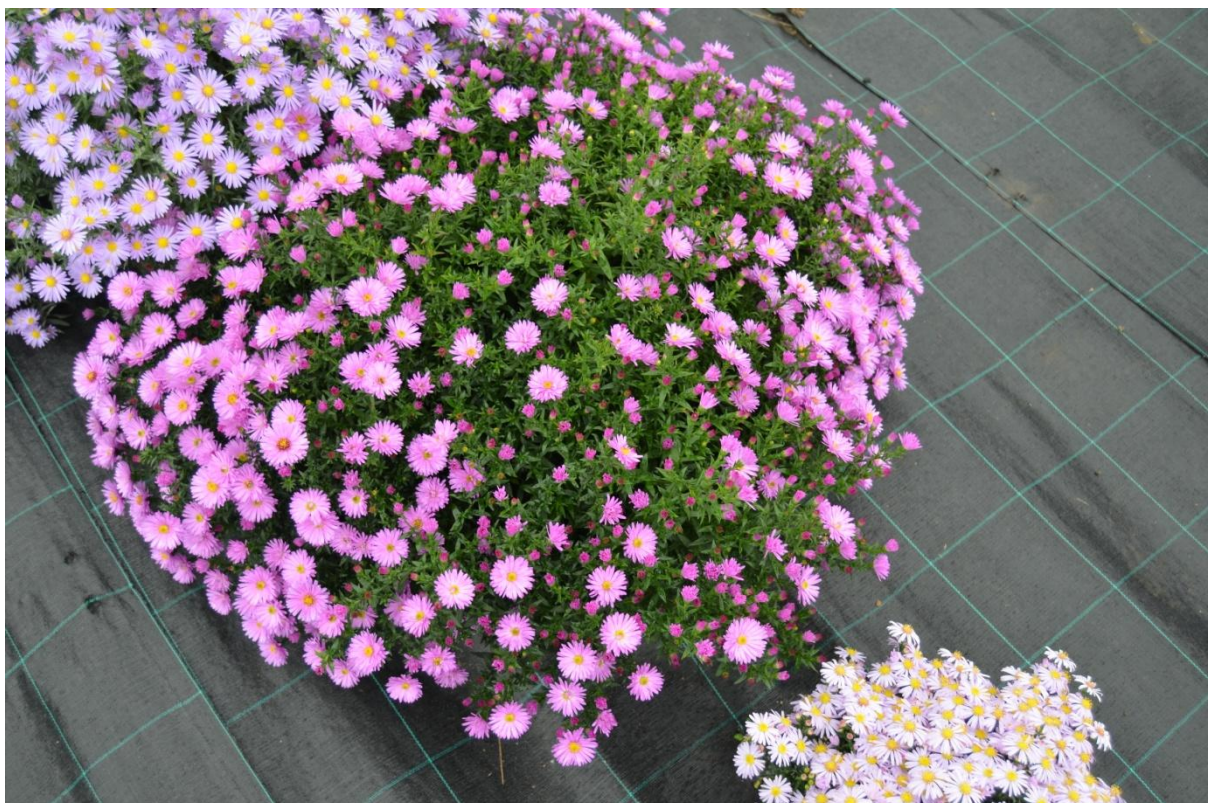

Obr. č. 42: *Symphyotrichum* 'Rosen Wichtel'



Obr. č. 43: *Symphyotrichum* 'Isis'



Obr. č. 44: *Symphyotrichum* 'Picasso'



Obr. č. 45: *Symphyotrichum* 'Royal Velvet'

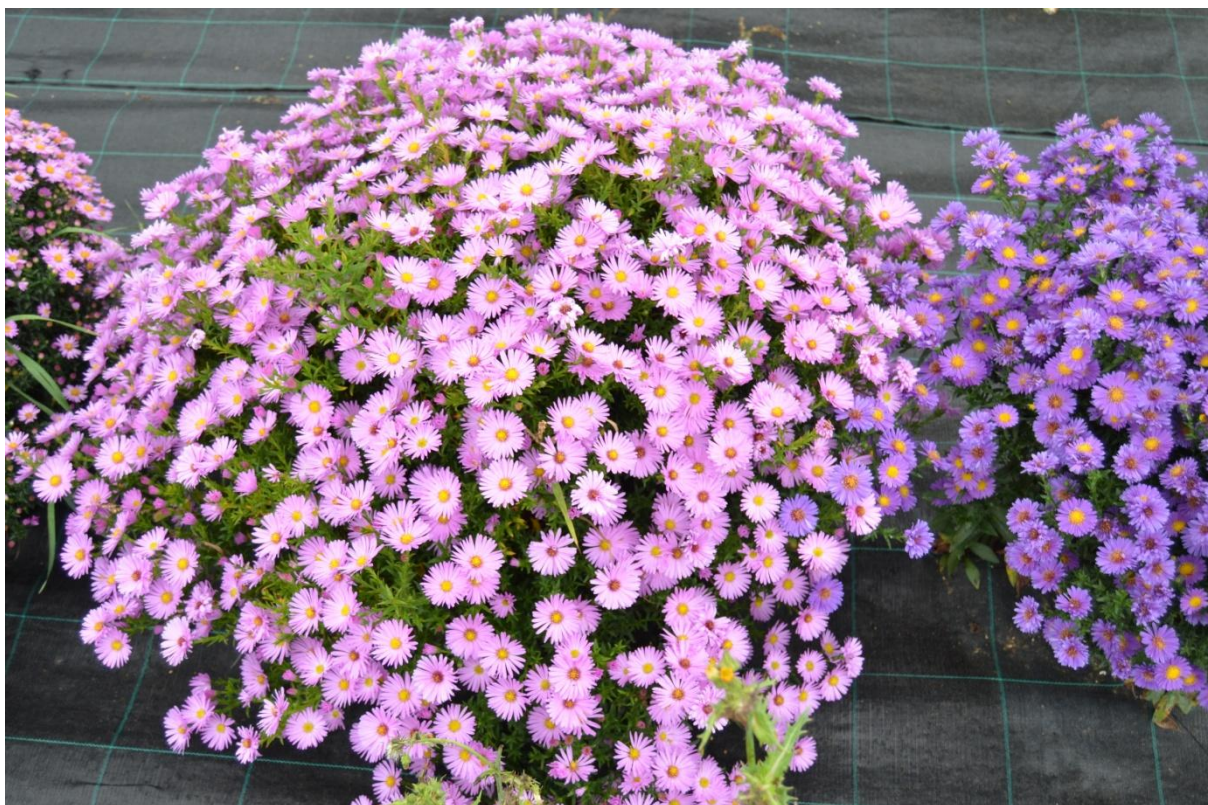

Obr. č. 46: *Symphyotrichum* 'Herbstgrus vom Bresserhof'



Obr. č. 47: *Symphyotrichum* 'Salabka'



Obr. č. 48: *Symphyotrichum* 'Blauer Zwerg' (modrá)

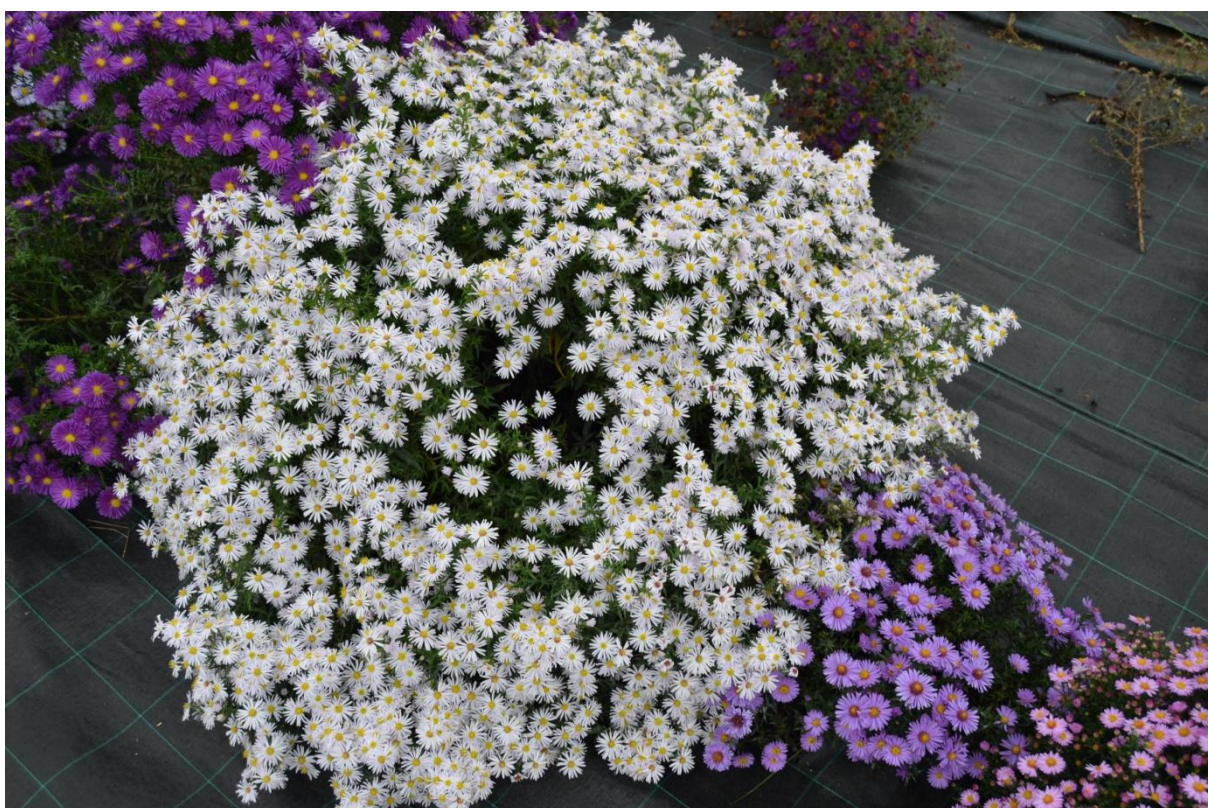

Obr. č. 49: *Symphyotrichum* 'Silberball'



Obr. č. 50: *Symphyotrichum* 'Fuldatal'



Obr. č. 51: *Symphyotrichum* 'Porzellan'



Obr. č. 52: *Symphotrichum* 'Petunia'



Obr. č. 53: *Symphotrichum* 'Lady in Blue'



Obr. č. 54: ;

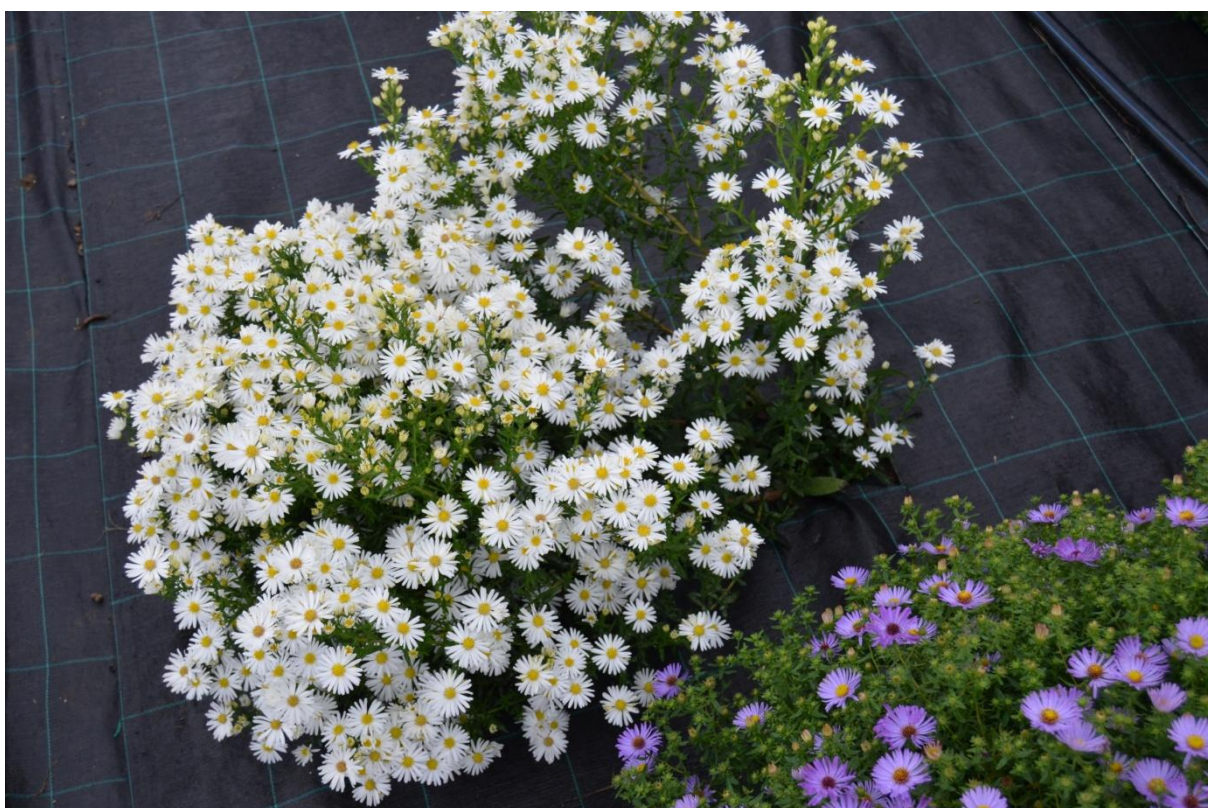

Obr. č. 55: *Symphyotrichum* 'Schneeberg'



Obr. č. 56: *Symphyotrichum lateriflorum* 'Van der Jeugd'



Obr. č. 57: *Symphyotrichum* 'Azurro'



Obr. č. 58: *Symphyotrichum* 'White Ladies'



Obr. č. 59: *Symphyotrichum* 'Aramis White'

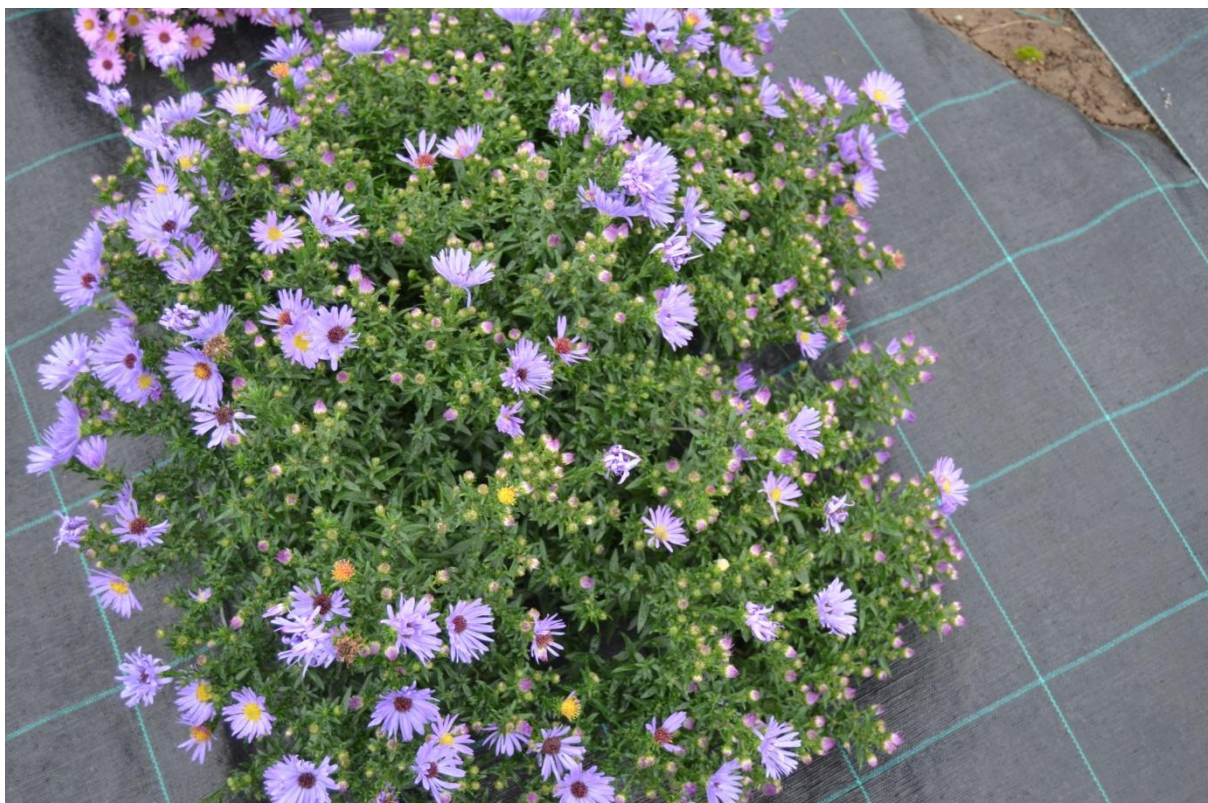

Obr. č. 60: *Symphyotrichum* 'Lights Blue'

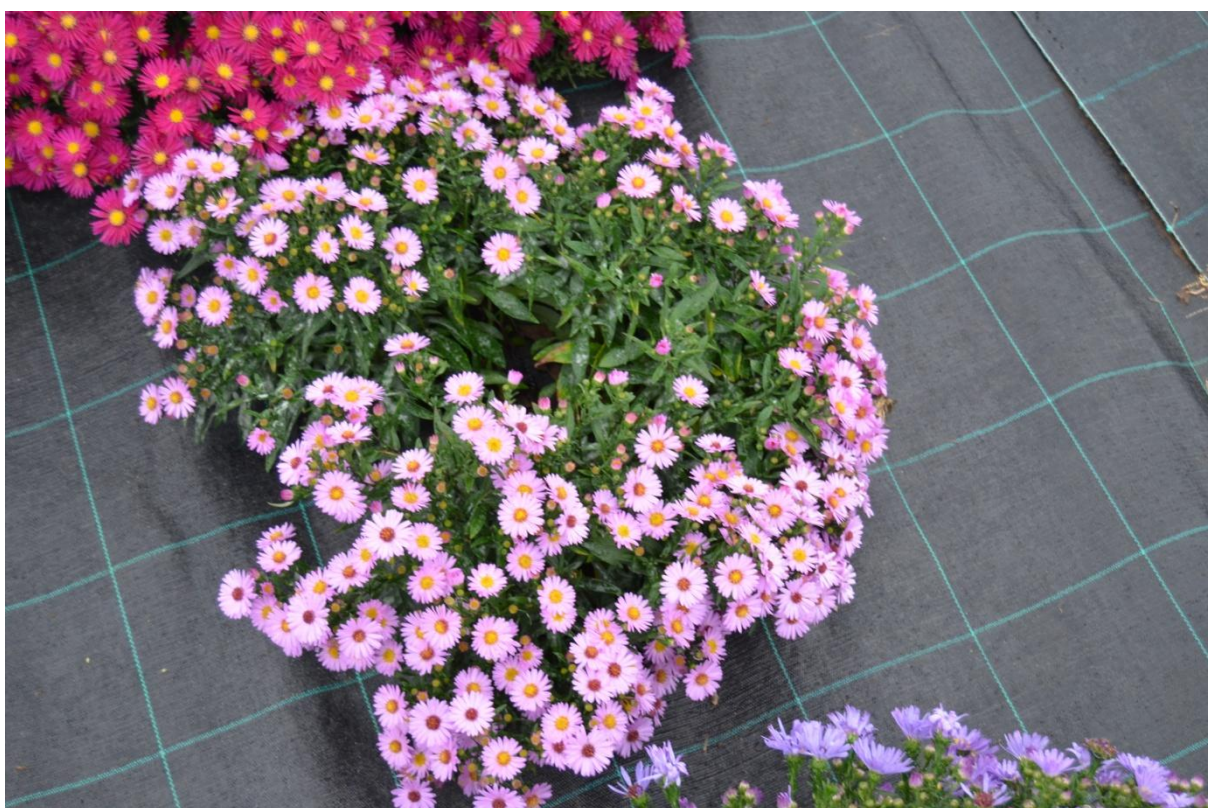

Obr. č. 61: *Symphyotrichum* 'Barbados'



Obr. č. 62: *Symphotrichum* 'Crimson Brocade'

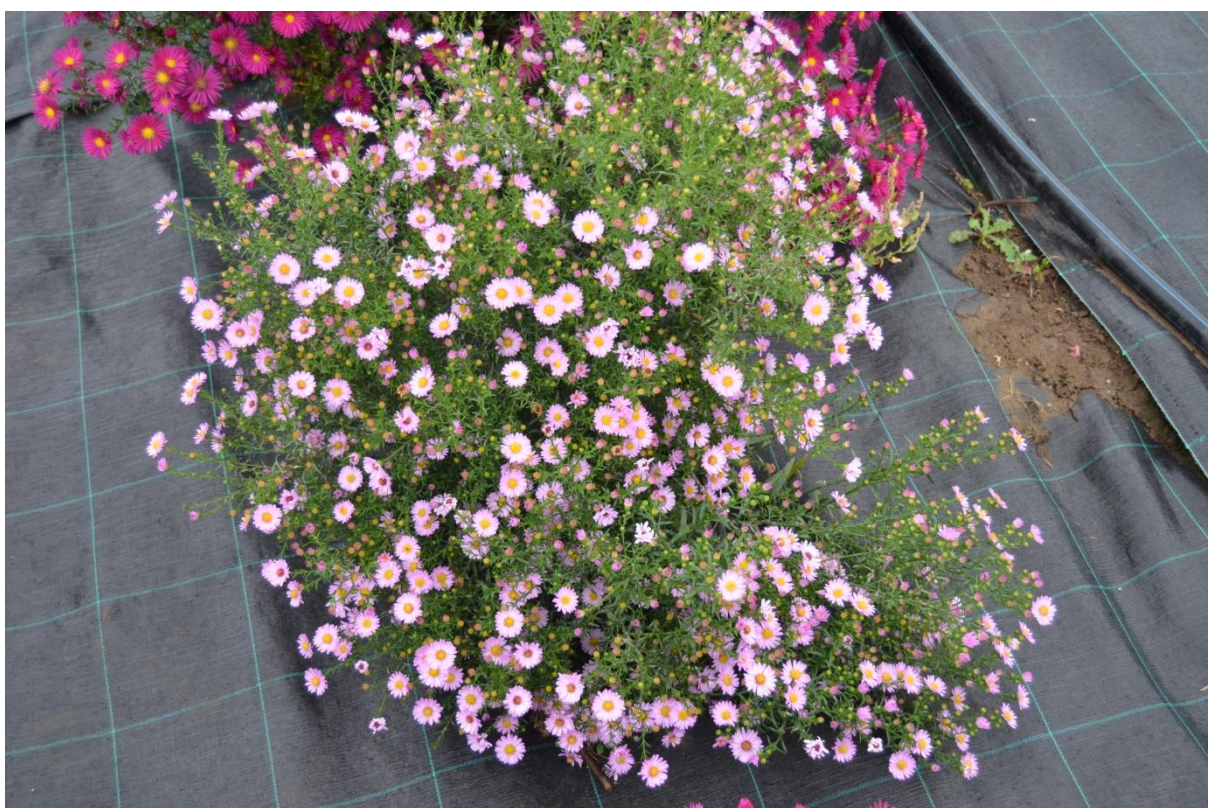

Obr. č. 63: *Symphotrichum* 'Tina'

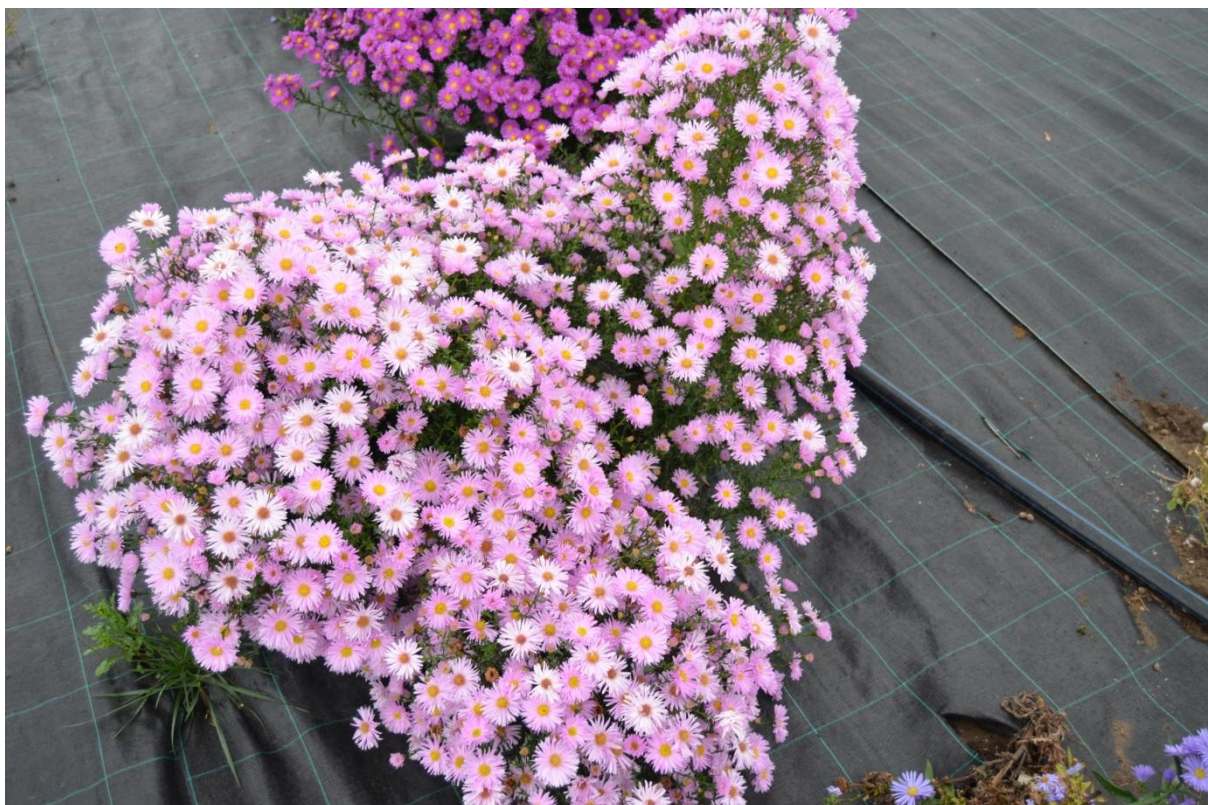

Obr. č. 64: *Symphyotrichum* 'Sarah Ballard'

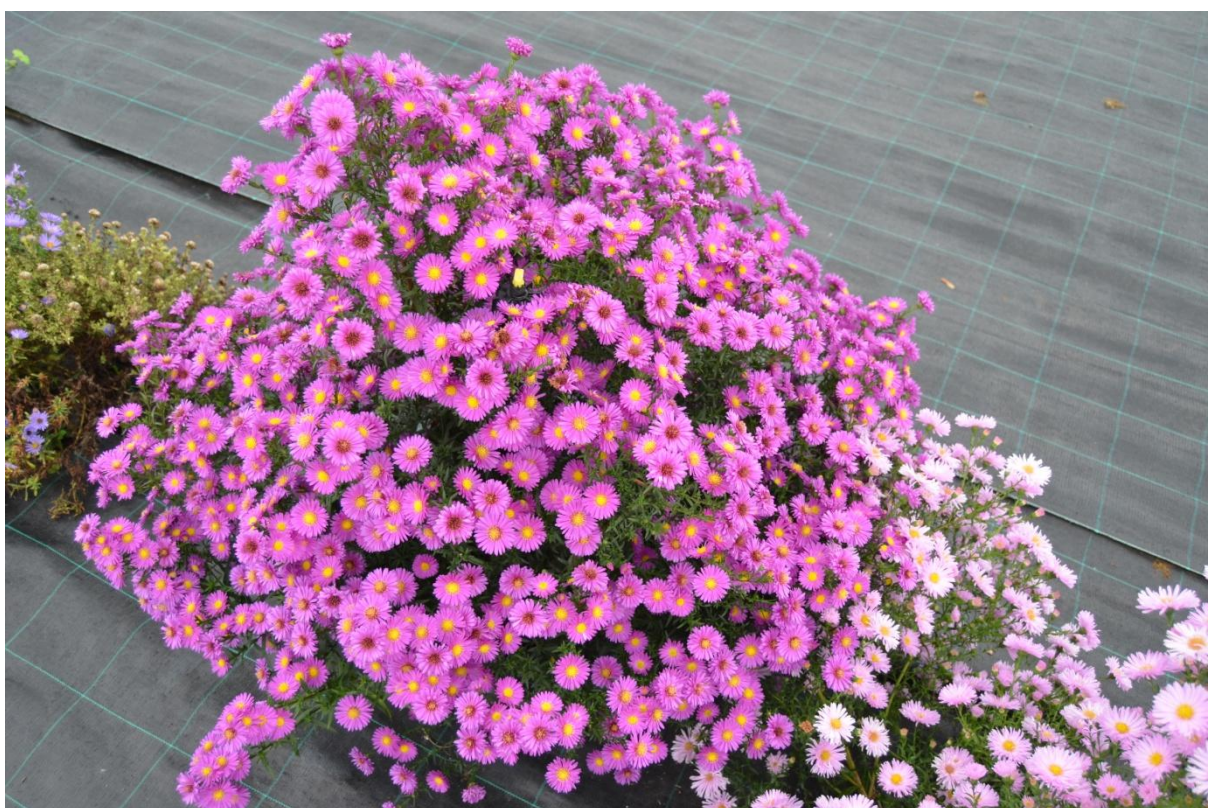

Obr. č. 65: *Symphyotrichum* 'Karminkuppel'



Obr. č. 66: *Symphyotrichum* 'Woods Purple'



Obr. č. 67: *Symphyotrichum* 'Winston Churchil'

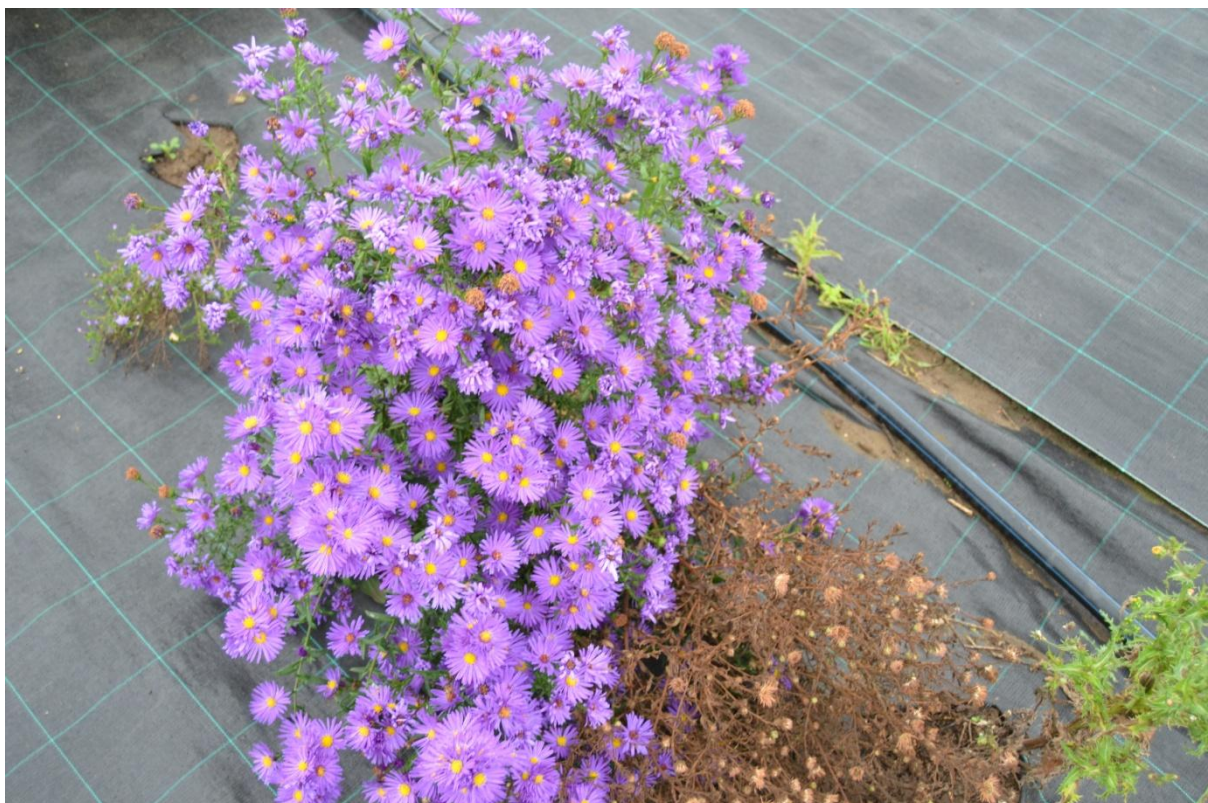

Obr. č. 68: *Symphyotrichum* 'Sailor Boy'



Obr. č. 69: *Symphyotrichum novae-angliae* 'Violetta'

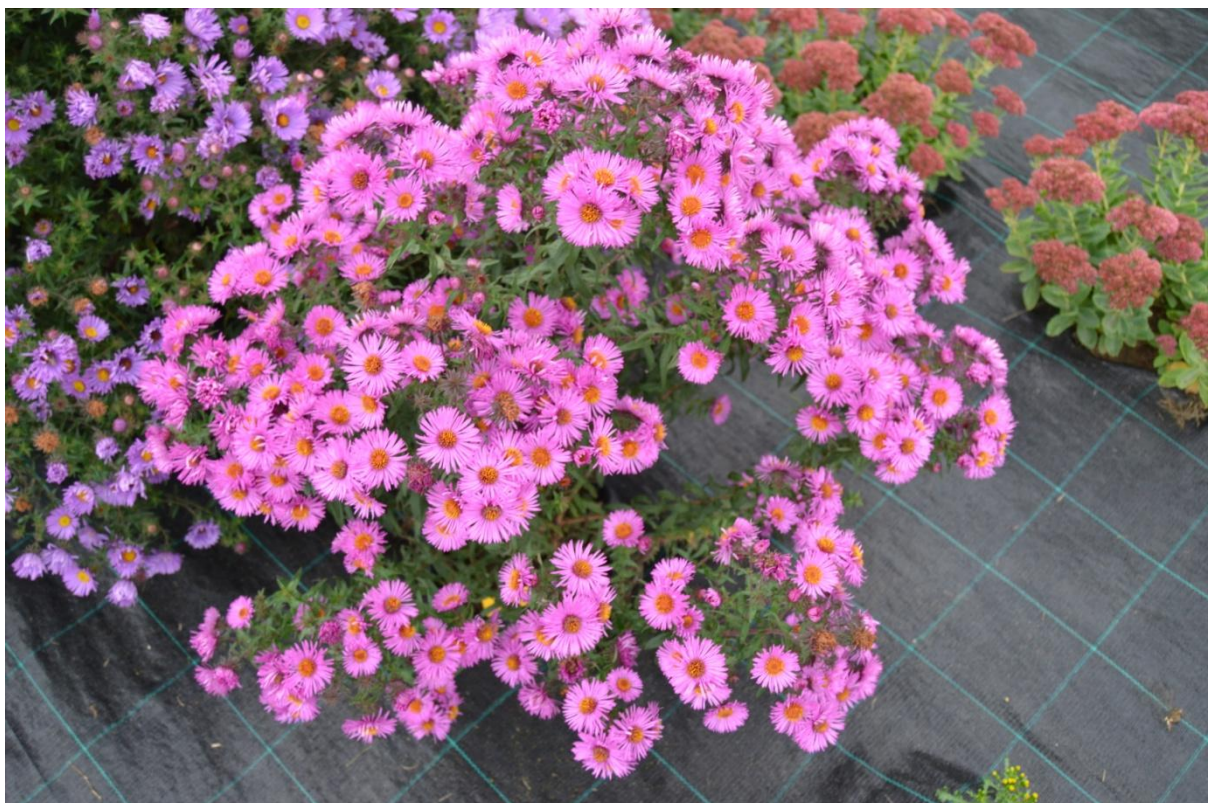

Obr. č. 70: *Symphyotrichum novae-angliae* 'Ivona'

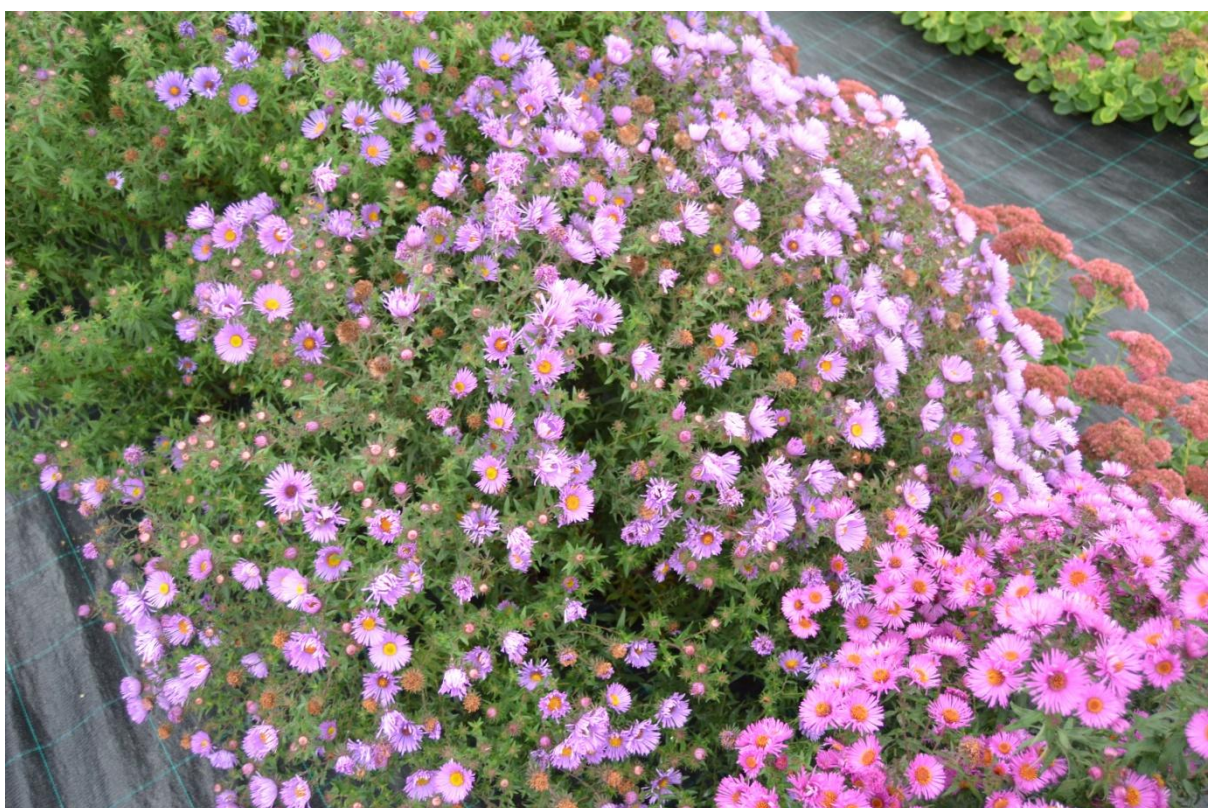

Obr. č. 71: *Symphyotrichum novae-angliae* 'Mrs. S. T. Wright'

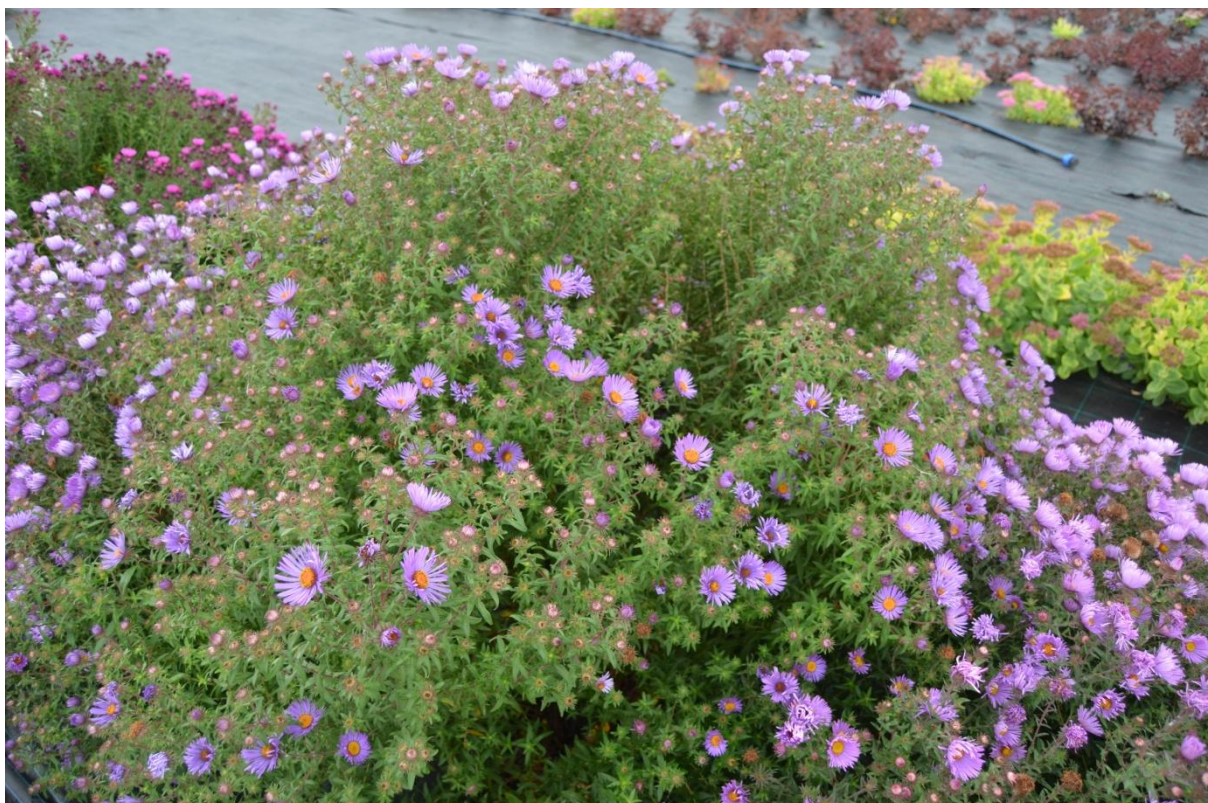

Obr. č. 72: *Symphotrichum novae-anglie* 'Hela Lacy'



Obr. č. 73: *Symphotrichum novae-anglie* 'Septemberruby'

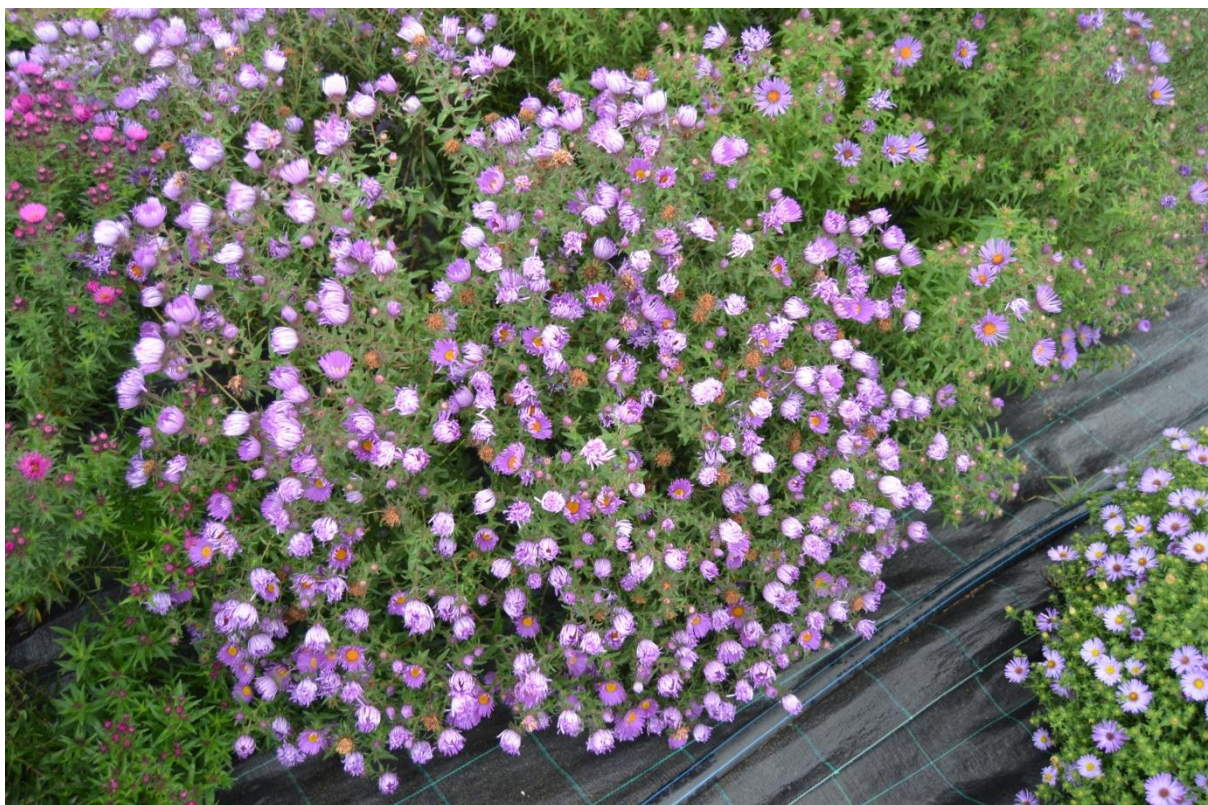

Obr. č. 74: *Symphyotrichum novae-anglie* 'Fragstein'



Obr. č. 75: *Symphyotrichum novae-anglie* 'Maruška'



Obr. č. 76: *Symphotrichum novae-anglie* 'Herbschnee'

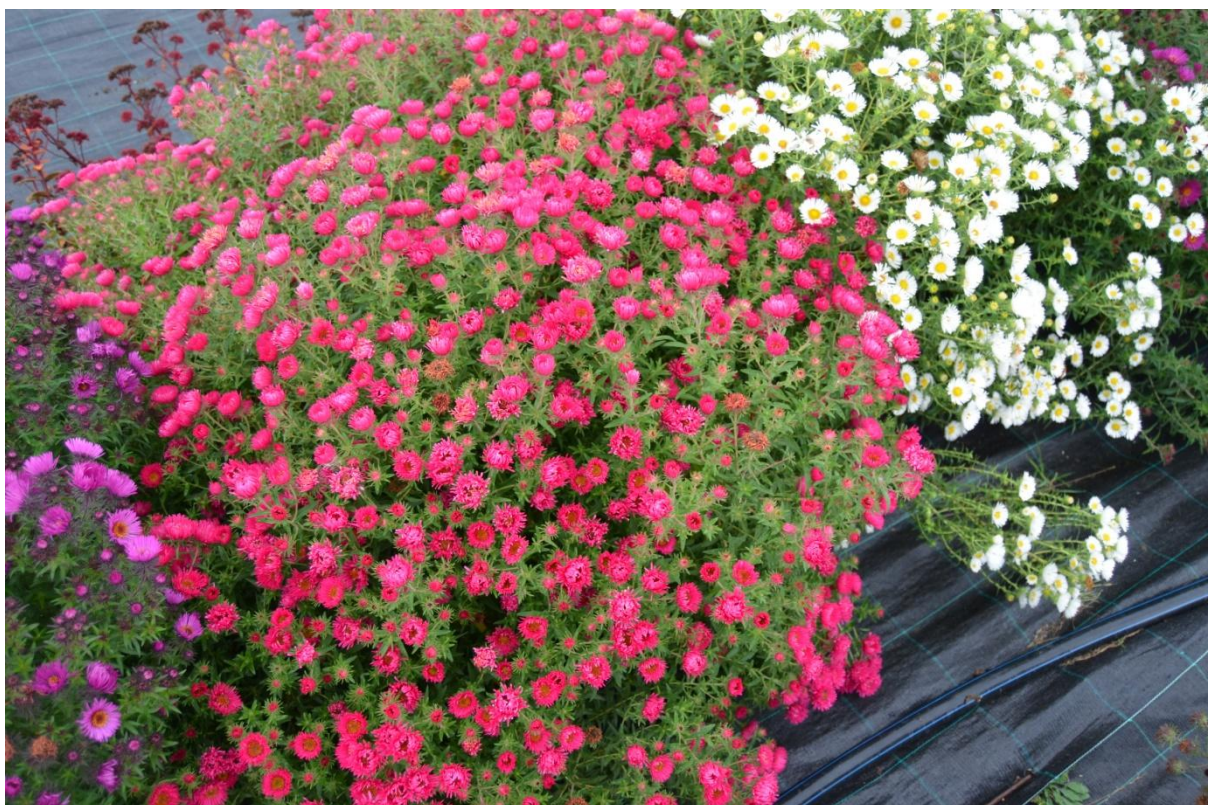

Obr. č. 77: *Symphotrichum novae-anglie* 'Alma Potschke'



Obr. č. 78: *Symphotrichum novae-angliae* 'Incomparabilis' (fialová)



Obr. č. 79: *Symphotrichum novae-angliae* 'Haringston Pink'

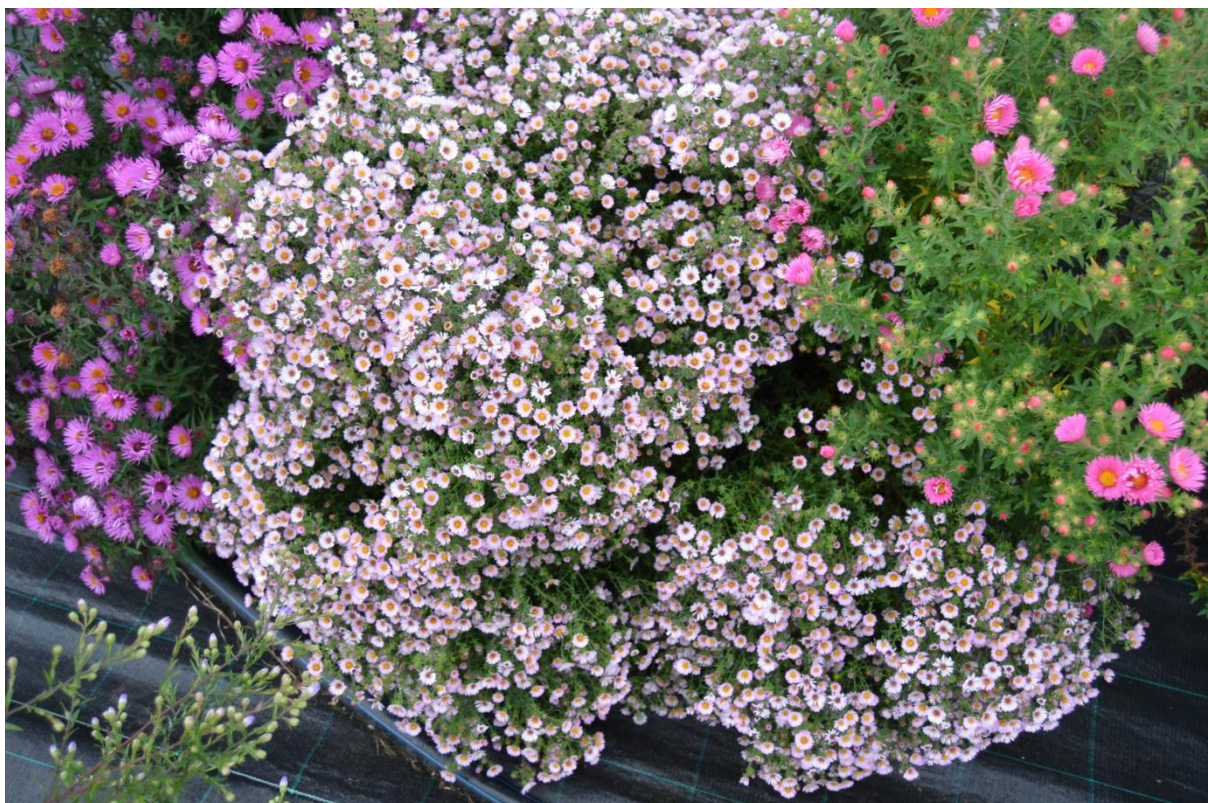

Obr. č. 80: *Symphyotrichum* x Kylie



Obr. č. 81: *Symphyotrichum novae-anglie* 'Summer Croft'

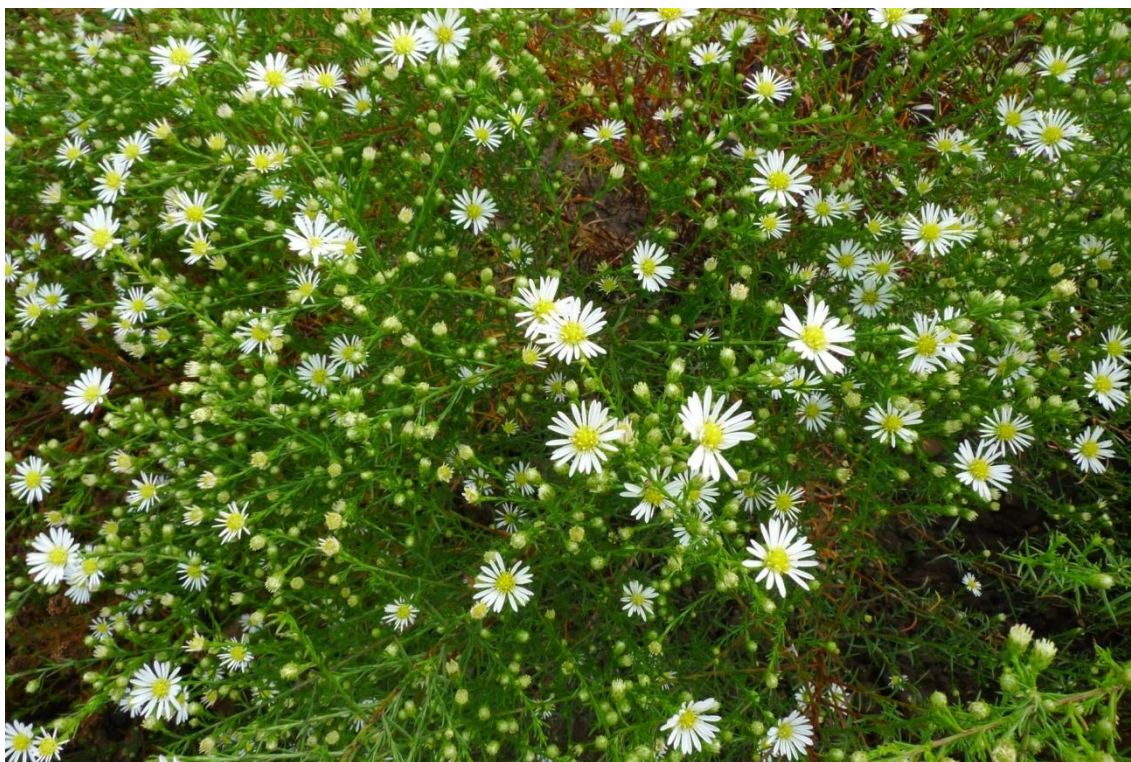

Obr. č. 82: *Symphyotrichum pilosum* 'Monte Casino'



Obr. č. 83: *Symphyotrichum ericoides* 'Alsterfreude'