

Příloha č. 1

DOBA PRŮCHODU JEDNOTLIVÉHO DÍLCE

Stavební projekt: 22038 Diplomová práce- Workoutové hřiště

stavební	dílec	kus	šířka	výška	délka	čas
1	Kleština	2	80	160	6819	0:01:40
2	Kleština	1	80	160	6265	0:01:58
3	Kleština	1	80	160	6265	0:01:58
4	Nárožna	4	140	200	5386	0:13:43
5	Námětková krokev lev	1	80	160	754	0:02:24
6	Námětková krokev lev	1	80	160	1577	0:03:25
7	Námětková krokev lev	1	80	160	2400	0:03:19
8	Námětková krokev lev	1	80	160	3224	0:03:19
9	Námětková krokev pra	1	120	160	3957	0:01:37
10	Námětková krokev pra	1	80	160	3224	0:02:09
11	Námětková krokev pra	1	80	160	2400	0:02:11
12	Námětková krokev pra	1	80	160	1577	0:02:18
13	Námětková krokev pra	1	80	160	754	0:03:27
14	Námětková krokev lev	1	80	160	754	0:02:24
15	Námětková krokev lev	1	80	160	1577	0:03:25
16	Námětková krokev lev	1	80	160	2400	0:03:19
17	Námětková krokev lev	1	80	160	3224	0:03:19
18	Námětková krokev pra	1	120	160	3957	0:01:37
19	Námětková krokev pra	1	80	160	3224	0:02:09
20	Námětková krokev pra	1	80	160	2400	0:02:11
21	Námětková krokev pra	1	80	160	1577	0:02:18
22	Námětková krokev pra	1	80	160	754	0:03:27
23	Námětková krokev lev	1	80	160	754	0:02:24
24	Námětková krokev lev	1	80	160	1577	0:03:25
25	Námětková krokev lev	1	80	160	2400	0:03:19
26	Námětková krokev lev	1	80	160	3224	0:03:19
27	Námětková krokev pra	1	120	160	3957	0:01:37
28	Námětková krokev pra	1	80	160	3224	0:02:09
29	Námětková krokev pra	1	80	160	2400	0:02:11
30	Námětková krokev pra	1	80	160	1577	0:02:18
31	Námětková krokev pra	1	80	160	754	0:03:27
32	Námětková krokev lev	1	80	160	754	0:02:24
33	Námětková krokev lev	1	80	160	1577	0:03:25
34	Námětková krokev lev	1	80	160	2400	0:03:19
35	Námětková krokev lev	1	80	160	3224	0:03:19
36	Námětková krokev pra	1	120	160	3957	0:01:37
37	Námětková krokev pra	1	80	160	3224	0:02:09
38	Námětková krokev pra	1	80	160	2400	0:02:11
39	Námětková krokev pra	1	80	160	1577	0:02:18
40	Námětková krokev	1	80	160	754	0:03:27
41	Sloupek- středová	1	140	140	2504	0:02:48
42	Sloupek- středová	1	140	140	2504	0:02:55

43	Sloupek- středová	1	140	140	2504	0:04:38
44	Sloupek- středová	1	140	140	2504	0:06:58
45	Vaznice- středová	1	140	160	6250	0:05:44
46	Pásek- středová část	1	140	140	1138	0:01:57
47	Pásek- středová část	1	140	140	1138	0:01:57
48	Sloupek- středová	1	140	140	2504	0:02:43
49	Sloupek hrazdy	1	140	140	2464	0:06:05
50	Sloupek hrazdy	1	140	140	2464	0:10:34
51	Sloupek hrazdy	1	140	140	2464	0:04:26
52	Sloupek hrazdy	1	140	140	2464	0:07:05
53	Sloupek hrazdy	1	140	140	2464	0:07:31
54	Sloupek- středová	1	140	140	2504	0:02:48
55	Sloupek- středová	1	140	140	2504	0:02:53
56	Sloupek- středová	1	140	140	2504	0:04:06
57	Sloupek- středová	2	140	140	2504	0:03:32
58	Vaznice- středová	1	140	160	6250	0:07:06
59	Pásek- středová část	1	140	140	1150	0:01:48
60	Pásek- středová část	1	140	140	1138	0:01:57
61	Paždík horní	1	140	140	2420	0:03:58
62	Paždík horní	1	140	140	2420	0:03:58
63	Sloupek- středová	1	140	140	2504	0:02:48
64	Sloupek- středová	1	140	140	2504	0:02:44
65	Sloupek- středová	1	140	140	2504	0:04:38
66	Sloupek- středová	1	140	140	2504	0:07:01
67	Vaznice- středová	1	140	160	6250	0:06:08
68	Pásek- středová část	1	140	140	1138	0:01:57
69	Pásek- středová část	1	140	140	1138	0:01:57
70	Sloupek- středová	1	140	140	2504	0:02:46
71	Sloupek- středová	2	140	140	2504	0:05:16
72	Vaznice- středová	1	140	160	6250	0:06:59
73	Pásek- středová část	1	140	140	1138	0:01:57
74	Pásek- středová část	1	140	140	1138	0:01:57
75	Vrcholový sloupek	1	140	140	1968	0:02:56
76	Sloupek hrazdy	1	140	140	2964	0:06:21
77	Sloupek hrazdy	1	140	140	2464	0:10:26
78	Sloupek hrazdy	1	140	140	2964	0:04:32
79	Sloupek hrazdy	1	140	140	2464	0:04:25
80	Sloupek hrazdy	1	140	140	2464	0:06:21
81	Sloupek hrazdy	1	140	140	2464	0:05:22
82	Šikmá vzpěra	1	140	140	2479	0:05:59
83	Šikmá vzpěra	1	140	140	2479	0:05:59
84	Šikmá vzpěra	1	140	140	2479	0:06:02
85	Šikmá vzpěra	1	140	140	2479	0:06:02
86	Sloupek hrazdy	1	140	140	2464	0:07:53
87	Sloupek hrazdy	1	140	140	2464	0:07:14
88	Sloupek hrazdy	1	140	140	2464	0:08:47
89	Sloupek hrazdy	1	140	140	2464	0:09:04
90	Sloupek hrazdy	1	140	140	2464	0:05:46
91	Sloupek hrazdy	1	140	140	1764	0:05:30
92	Sloupek hrazdy	2	140	140	1764	0:08:56

93	Paždík horn í	2	140	140	2440	0:05:05
95	Sloupek hrazdy	1	140	140	2059	0:08:48
96	Sloupek hrazdy	1	140	140	2964	0:04:54
97	Sloupek hrazdy	1	140	140	2059	0:05:35
98	Sloupek hrazdy	1	140	140	2059	0:05:32
99	Sloupek hrazdy	1	140	140	2964	0:04:10
100	Šikmá vzpěra	1	140	140	1410	0:03:46
101	Šikmá vzpěra	1	140	140	1410	0:03:46
102	Pásek	3	140	140	474	0:02:04
103	Pásek	3	140	140	474	0:02:04
104	Sloupek hrazdy	1	140	140	2059	0:08:51
105	Sloupek hrazdy	1	140	140	2059	0:07:06
106	Sloupek hrazdy	1	140	140	2964	0:05:03
107	Šikmá vzpěra	1	140	140	1410	0:05:44
108	Šikmá vzpěra	1	140	140	1399	0:05:44
109	Šikmá vzpěra	1	140	140	1410	0:03:46
110	Šikmá vzpěra	1	140	140	1410	0:03:52
111	Šikmá vzpěra	1	140	140	2538	0:08:03
112	Šikmá vzpěra	1	140	140	2538	0:07:55
113	Šikmá vzpěra	1	140	140	3009	0:05:47
114	Šikmá vzpěra	1	140	140	3009	0:07:16
115	Pásek	2	140	140	1772	0:01:41
116	Pásek	2	140	140	1772	0:01:41
117	Rozpěra mezi kleštin	2	120	160	500	0:00:34

běžný metr celkem :	322,90 bm	zaokrouhloeno :	330,40 bm
kubický metr celkem :	5,962 m ³	zaokrouhloeno :	6,095 m ³
běžný metr odřezky :	7,50 bm	v procentech :	2,3 %
čas [h] :	9:42:00		
počet stavebních dílců :	132		

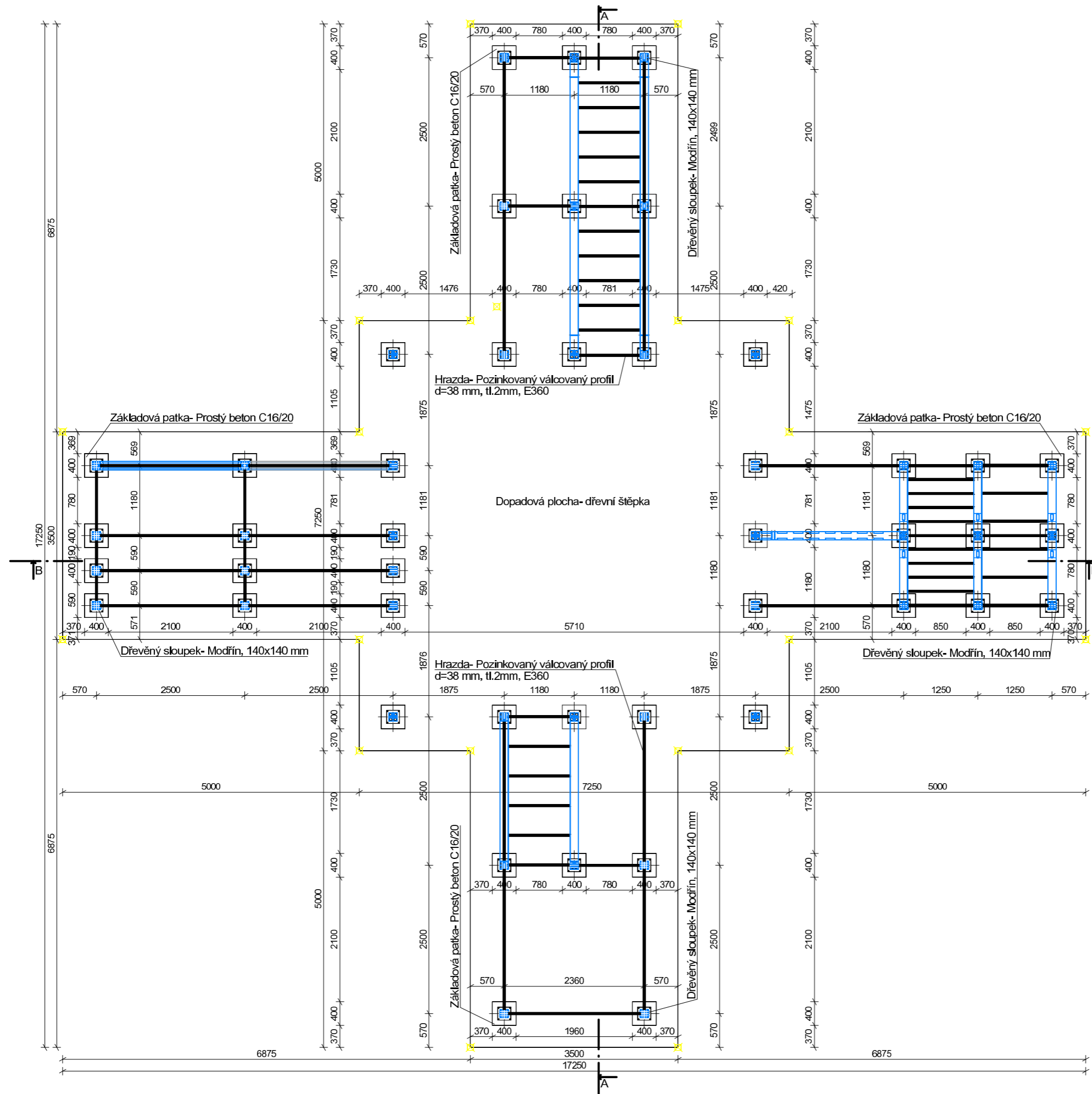

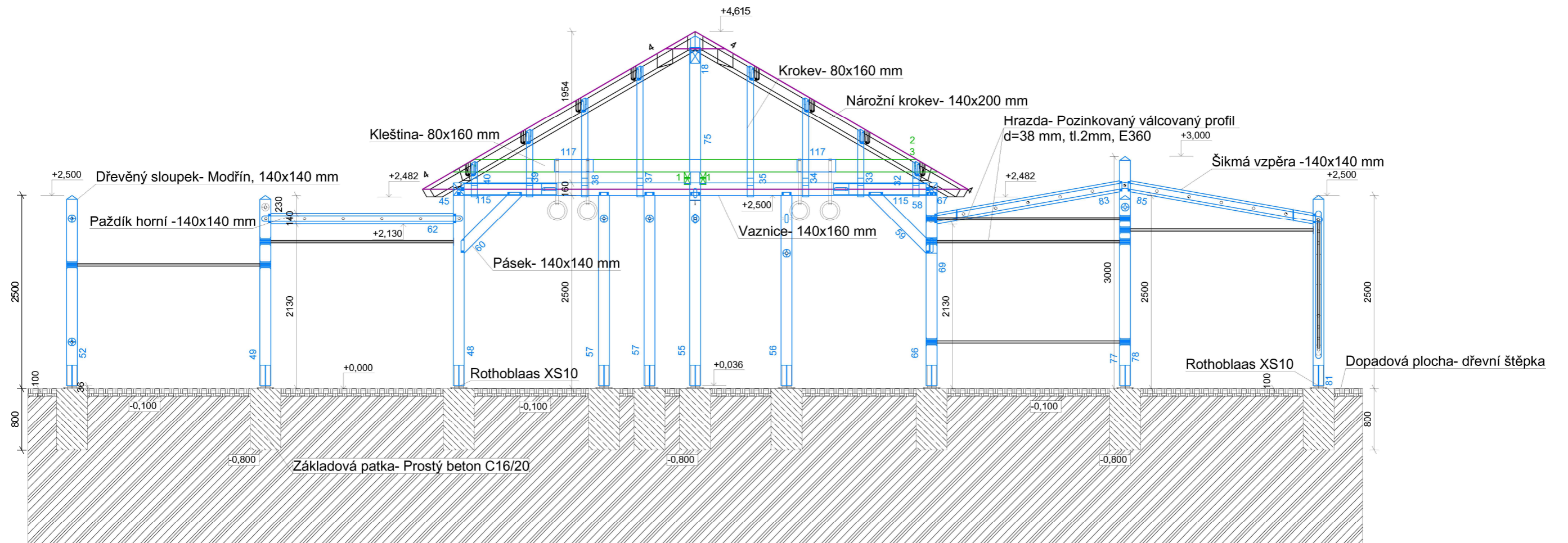

ČESKÁ
 ZEMĚDĚLSKÁ
 UNIVERZITA V PRAZE



DIPLOMOVÁ PRÁCE
 WORKOUTOVÉ HRISTĚ

14.04.2018

ZPRACOVAL: Bc.TOMÁŠ GIEBL, DiS.
 ŘEZ A-A

M : 1 : 55.00

SETA
 EXPERIENCE

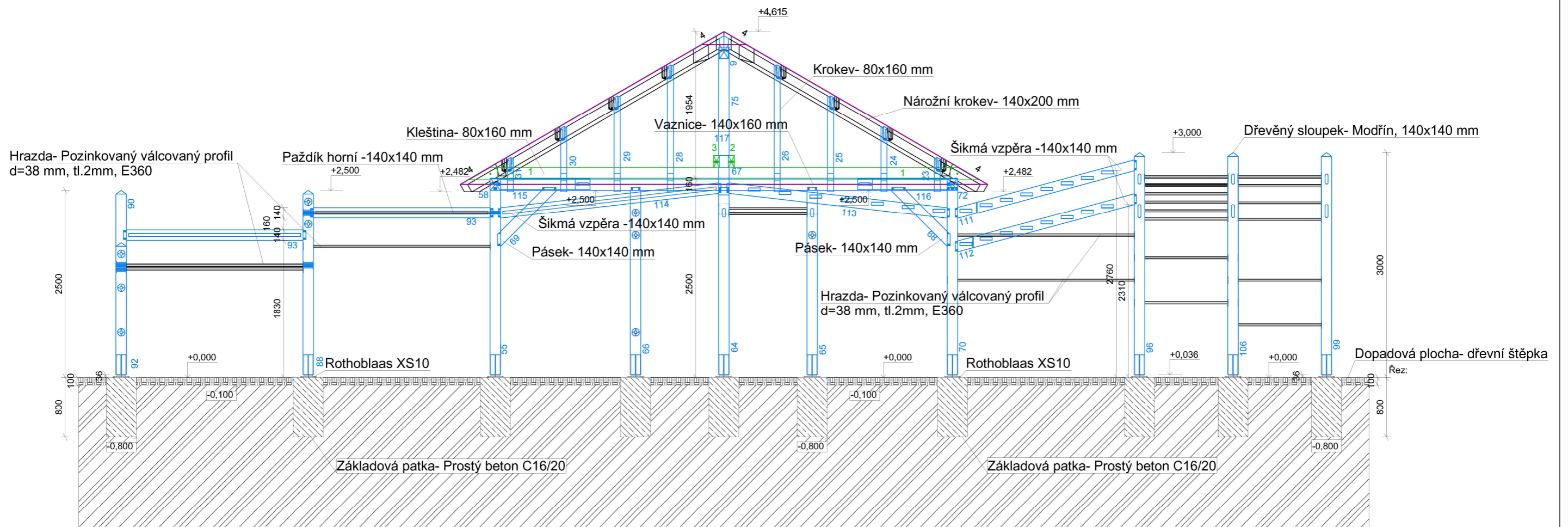

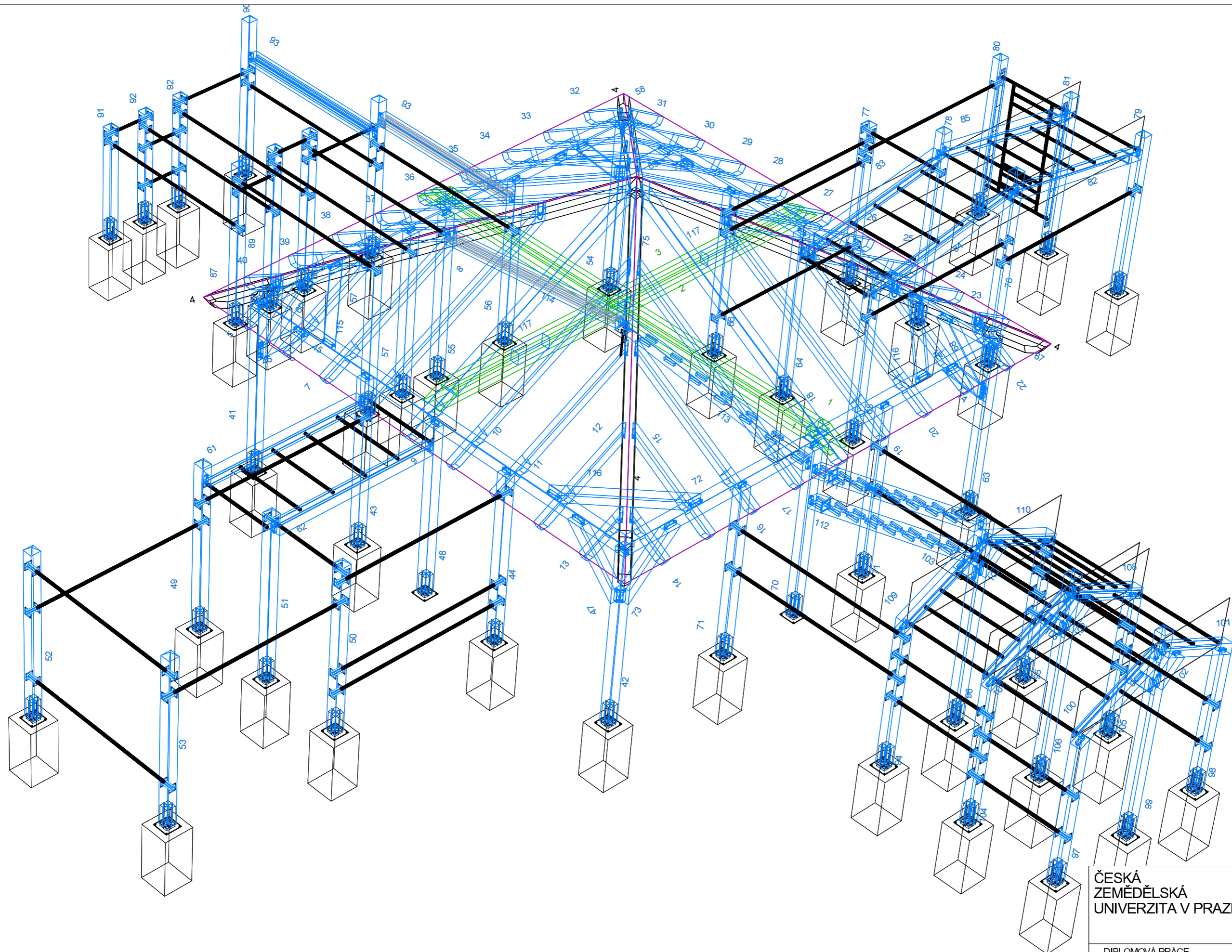

ČESKÁ ZEMĚDĚLSKÁ UNIVERZITA V PRAZE 	
DIPLOMOVÁ PRÁCE WORKOUTOVÉ HRŠTĚ	12.04.2018
ZPRACOVAL: Bc. TOMÁŠ GIEBL, DiS. Montážní výkres s čísly	
M : 1 : 45.00	

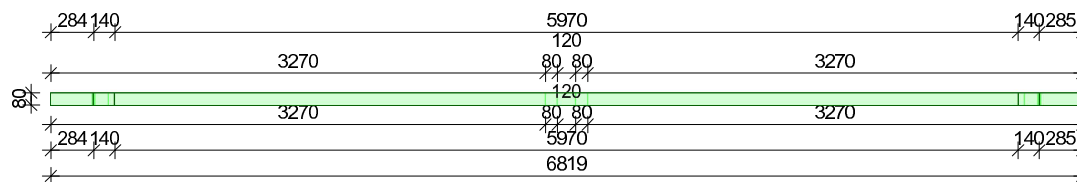
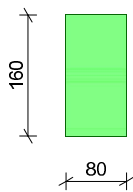
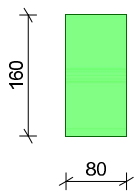
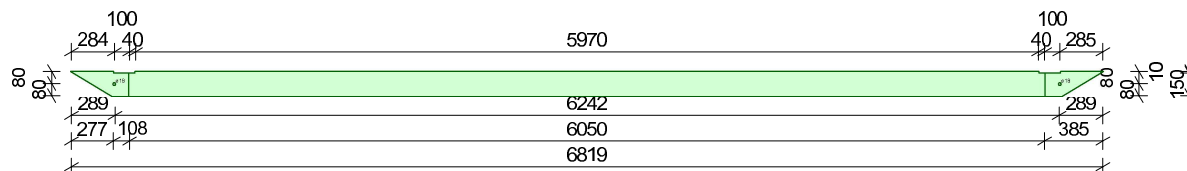
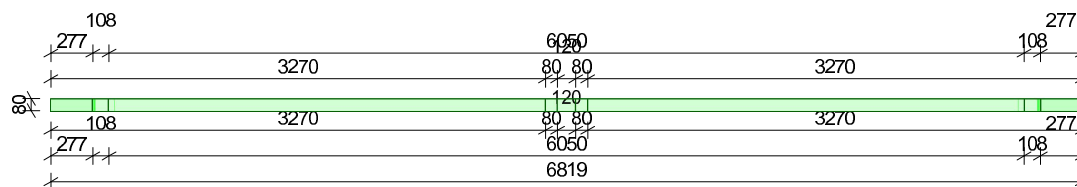
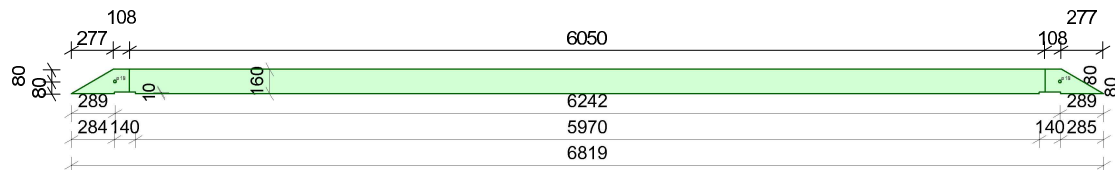
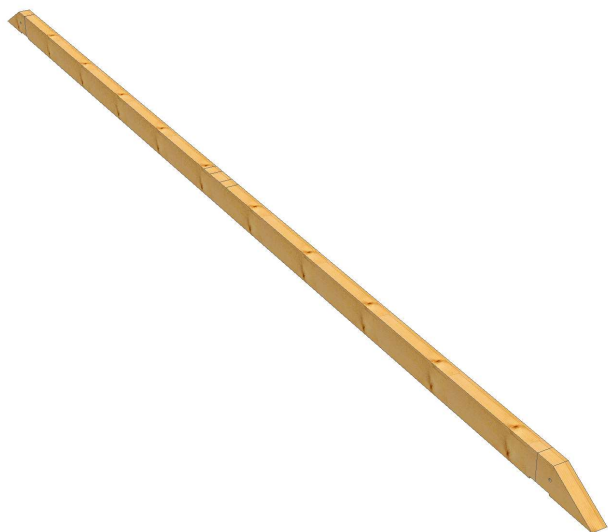

ČESKÁ
ZEMĚDĚLSKÁ
UNIVERZITA V PRAZE



DIPLOMOVÁ PRÁCE
WORKOUTOVÉ HRISTĚ 25.03.2018

ZPRACOVAL: Bc.TOMÁŠ GIEBL, DiS.
POZICE 1

M : 1 : 50.00

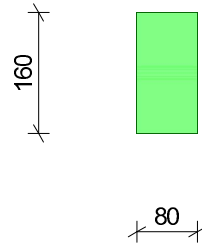
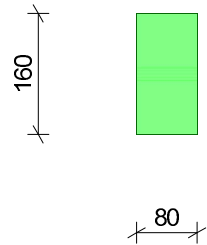
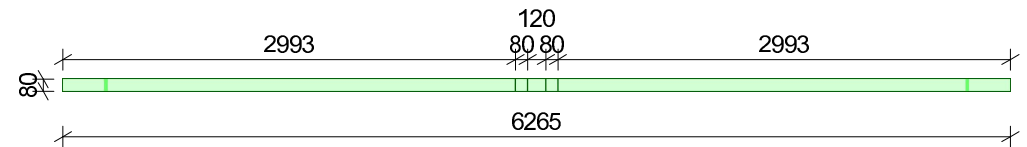
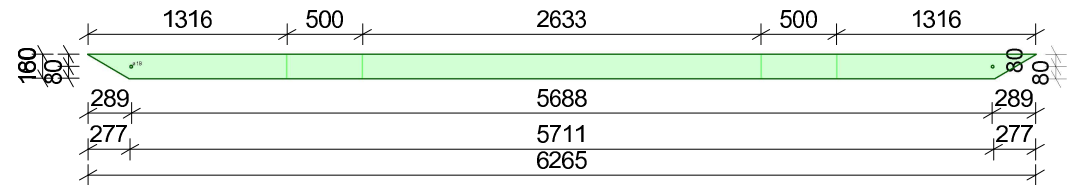
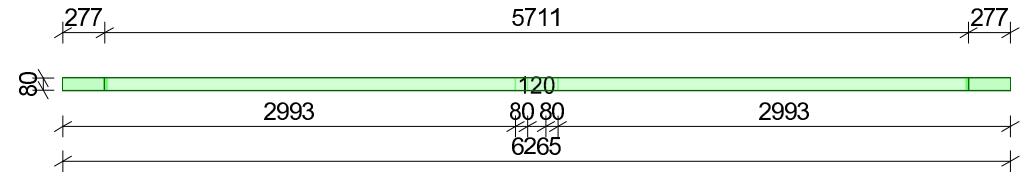
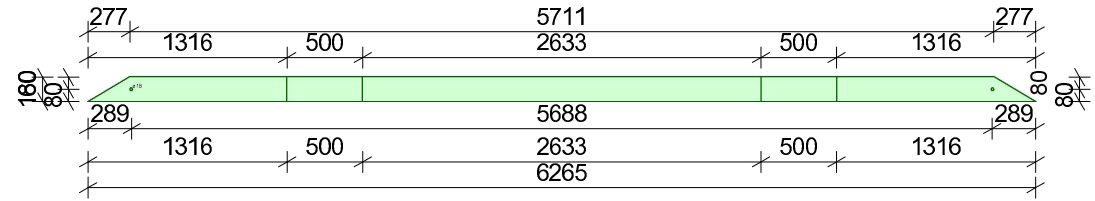

ČESKÁ
ZEMĚĚLSKÁ
UNIVERZITA V PRAZE



SEMA
EXPERIENCE
409 roků zkušeností

DIPLOMOVÁ PRÁCE
WORKOUTOVÉ HRISTĚ

25.03.2018

ZPRACOVAL: Bc.TOMÁŠ GIEBL, DiS.
POZICE 2, 3

M : 1 : 50.00

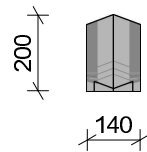
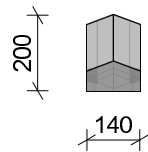
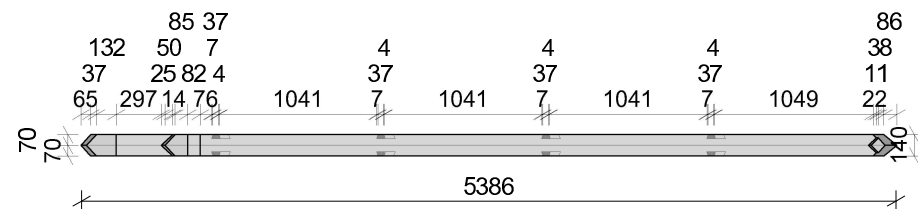
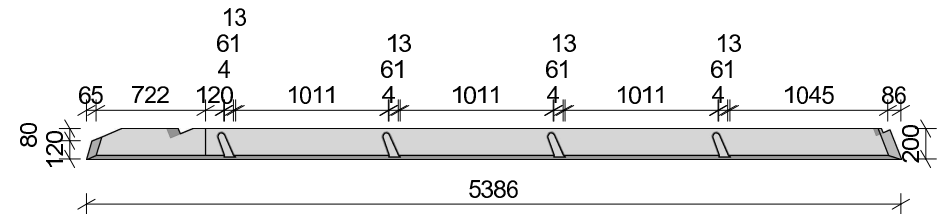
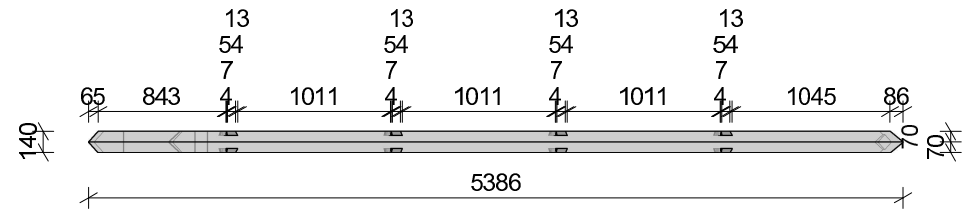
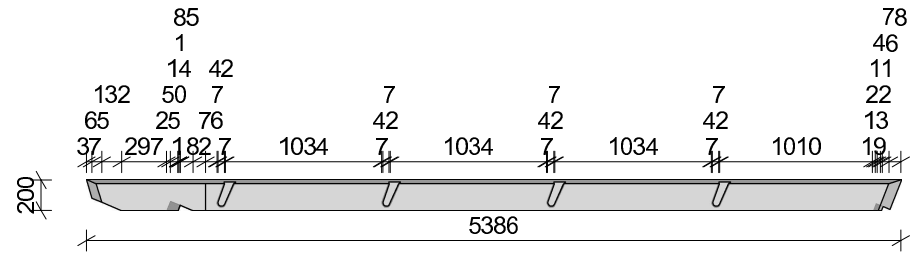

ČESKÁ
ZEMĚDĚLSKÁ
UNIVERZITA V PRAZE



SEMA
EXPERIENCE
Agrowood

DIPLOMOVÁ PRÁCE
WORKOUTOVÉ HRISTĚ

25.03.2018

ZPRACOVAL: Bc.TOMÁŠ GIEBL, DiS.
POZICE 4

M : 1 : 50.00

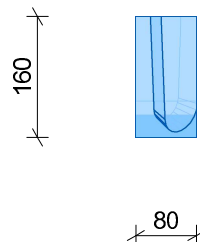
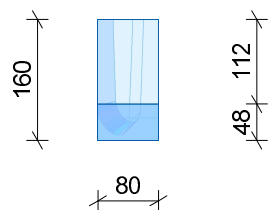
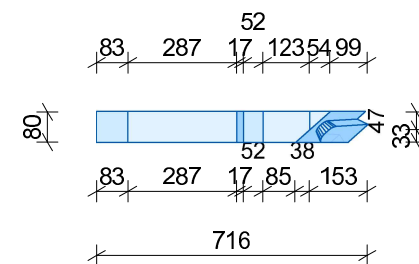
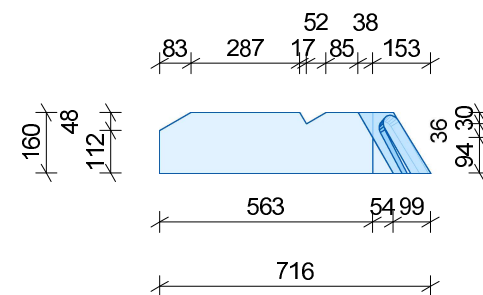
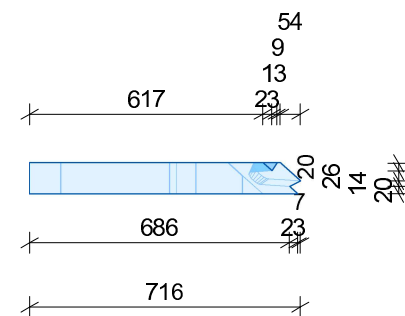
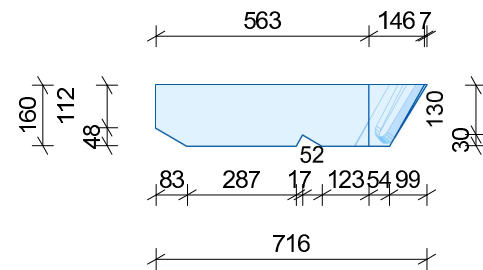

ČESKÁ
ZEMĚDĚLSKÁ
UNIVERZITA V PRAZE



SEMA
EXPERIENCE
400 rokov

DIPLOMOVÁ PRÁCE
WORKOUTOVÉ HRISTĚ

25.03.2018

ZPRACOVAL: Bc. TOMÁŠ GIEBL, DiS.
POZICE 5, 32, 23, 14

M : 1 : 20.00

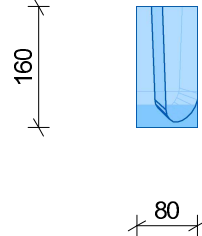
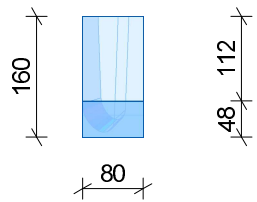
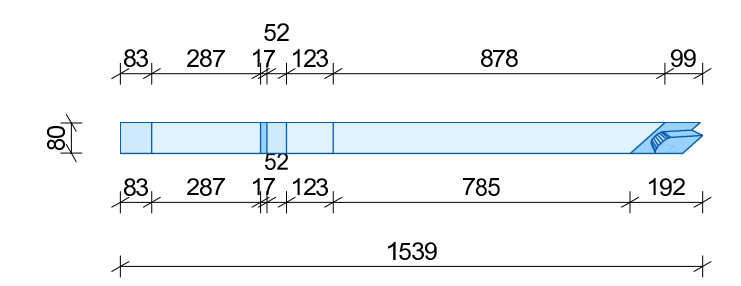
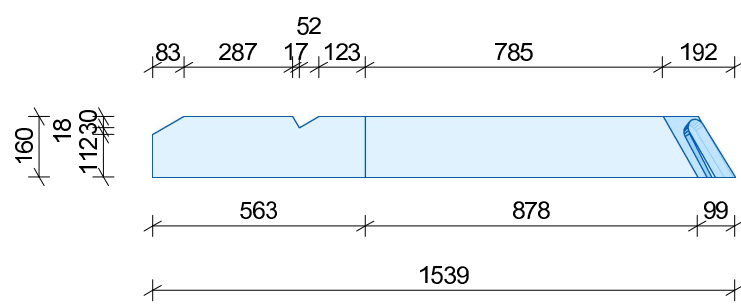
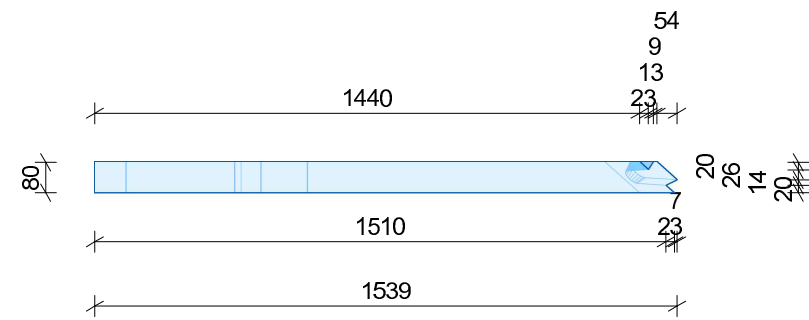
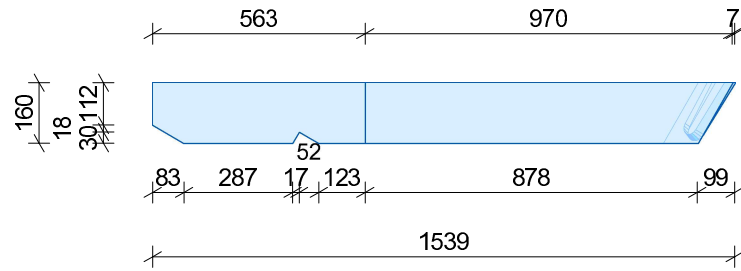

ČESKÁ
ZEMĚDĚLSKÁ
UNIVERZITA V PRAZE



SEMIA
EXPERIENCE
powered by

DIPLOMOVÁ PRÁCE
WORKOUTOVÉ HRISTĚ 25.03.2018

ZPRACOVAL: Bc. TOMÁŠ GIEBL, DiS.
POZICE 6, 33, 24, 15

M : 1 : 20.00

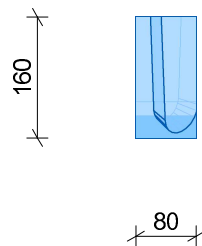
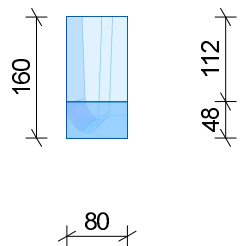
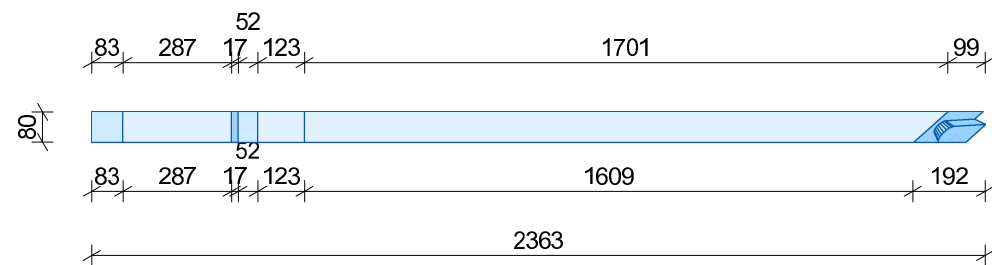
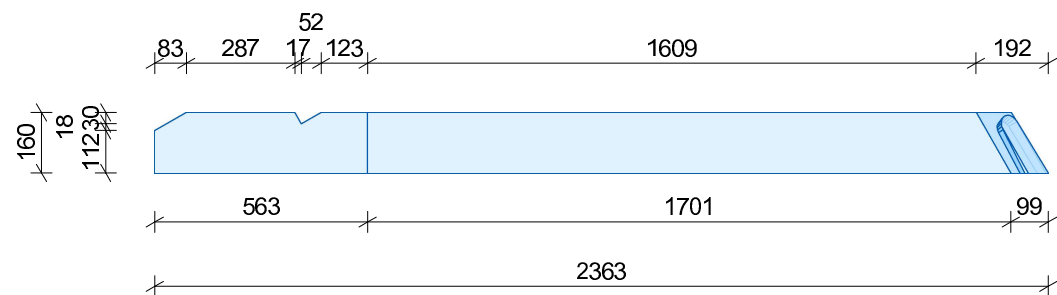
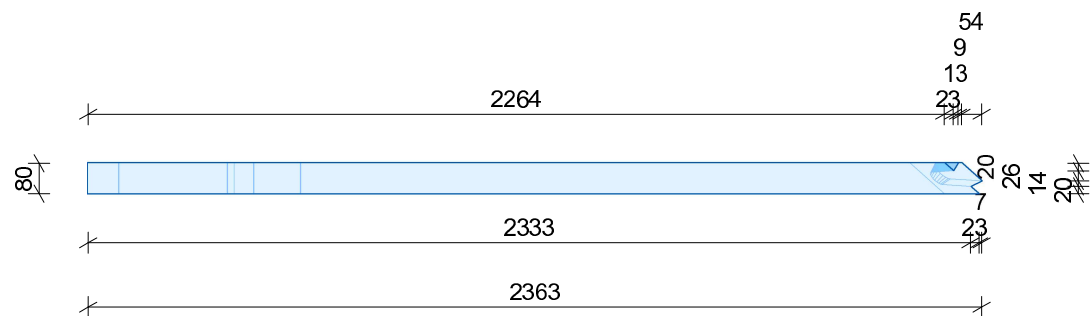
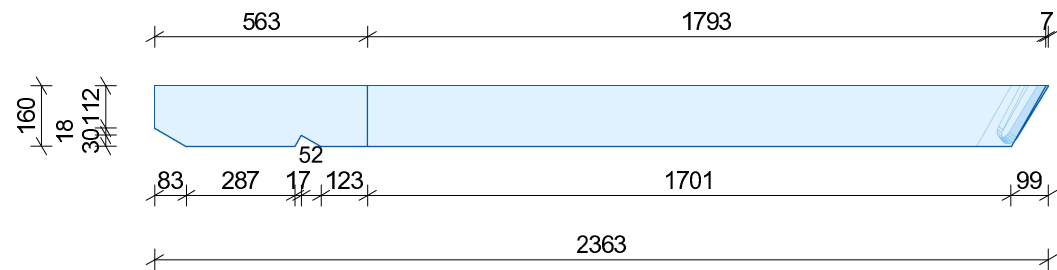

ČESKÁ
ZEMĚDĚLSKÁ
UNIVERZITA V PRAZE



SEMA
EXPERIENCE
409 paviláon

DIPLOMOVÁ PRÁCE
WORKOUTOVÉ HRISTĚ

25.03.2018

ZPRACOVAL: Bc. TOMÁŠ GIEBL, DiS.
POZICE 7, 34, 25, 16

M : 1 : 20.00

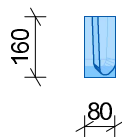
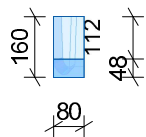
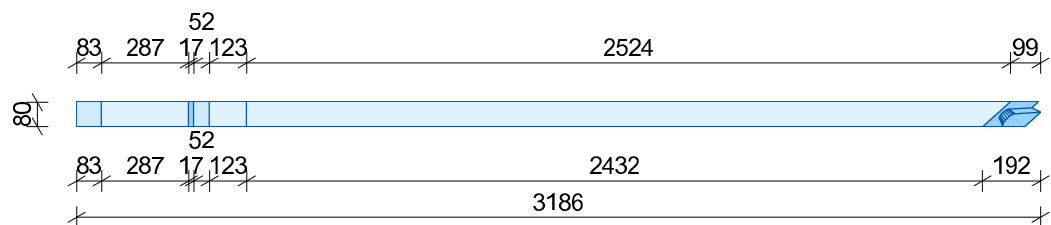
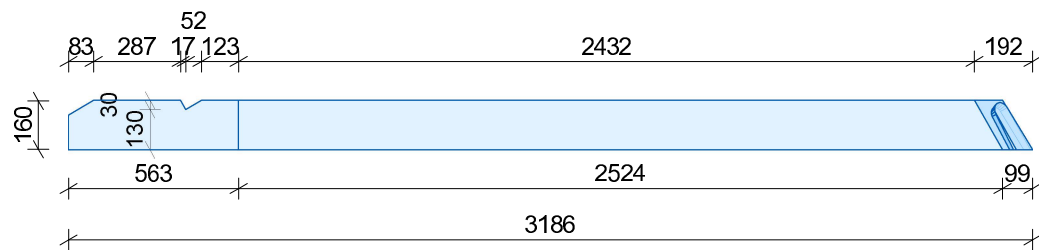
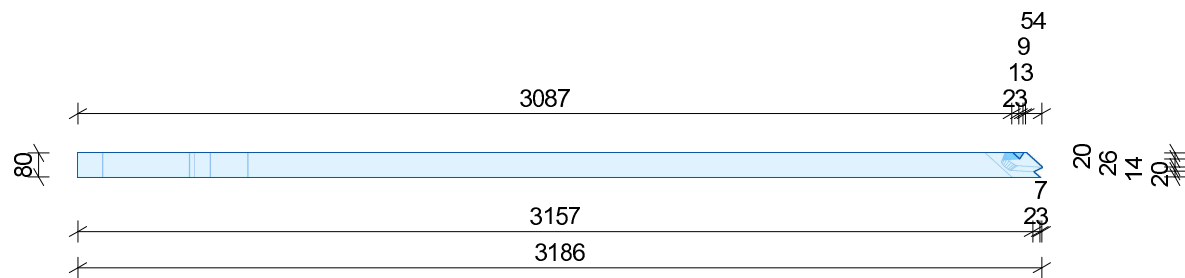
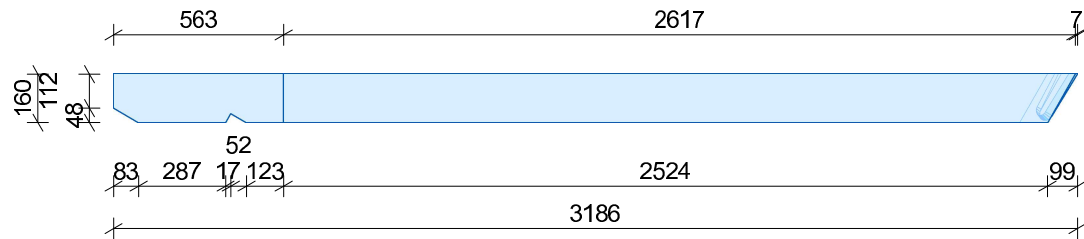

ČESKÁ
ZEMĚDĚLSKÁ
UNIVERZITA V PRAZE



DIPLOMOVÁ PRÁCE
WORKOUTOVÉ HRISTĚ 25.03.2018

ZPRACOVAL: Bc. TOMÁŠ GIEBL, DiS.
POZICE 8, 35, 26, 17

M : 1 : 25.00

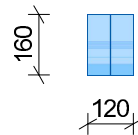
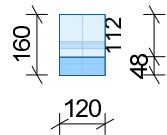
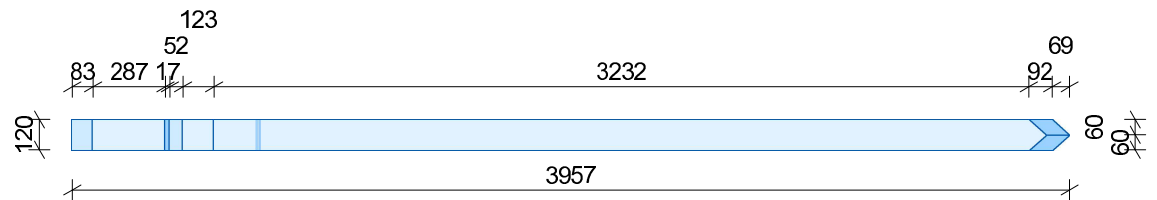
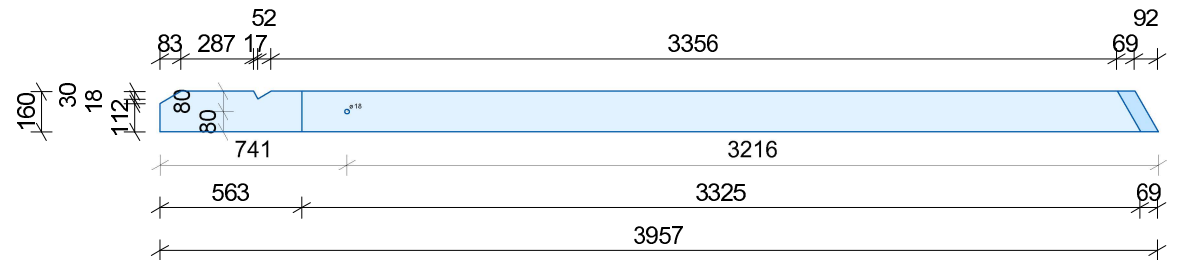
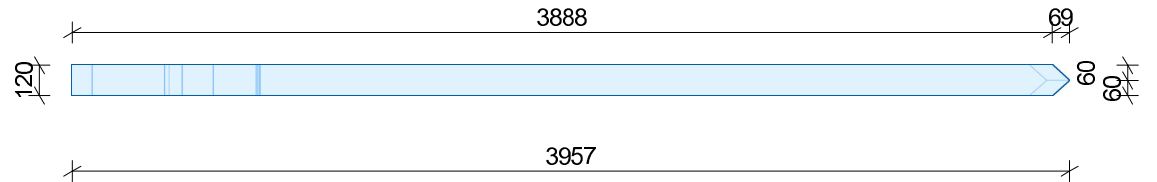
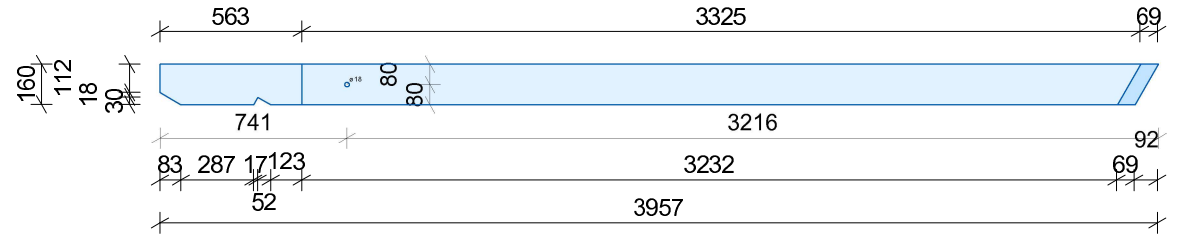

ČESKÁ
ZEMĚDĚLSKÁ
UNIVERZITA V PRAZE



SEMA
EXPERIENCE
404 PRAHA 04

DIPLOMOVÁ PRÁCE
WORKOUTOVÉ HRISTĚ

25.03.2018

ZPRACOVAL: Bc.TOMÁŠ GIEBL, DiS.
POZICE 9. 27

M : 1 : 30.00

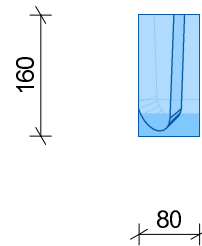
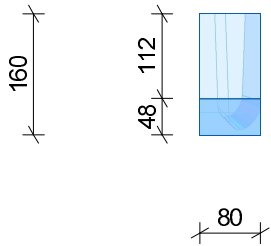
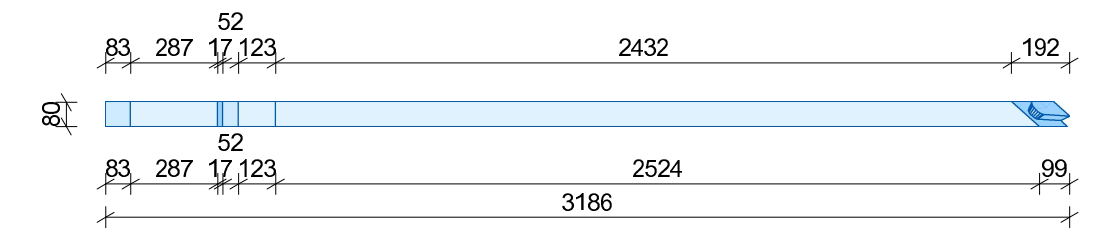
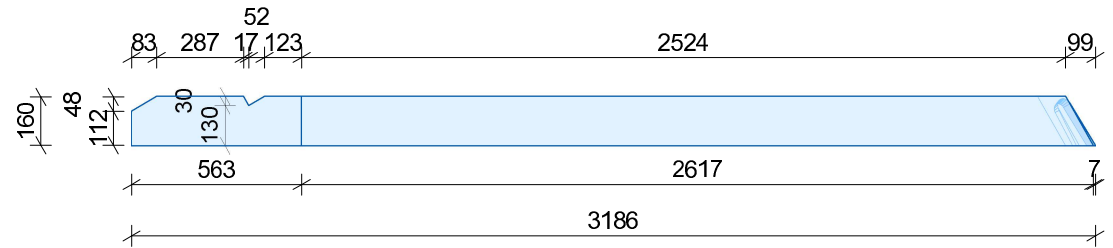
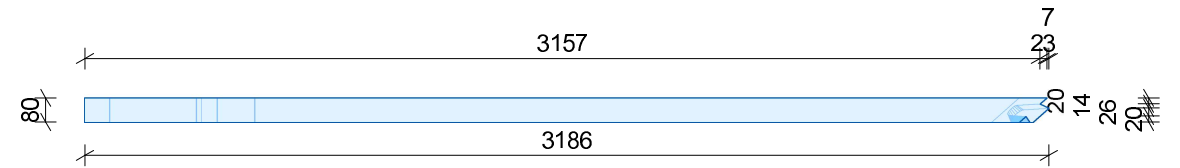
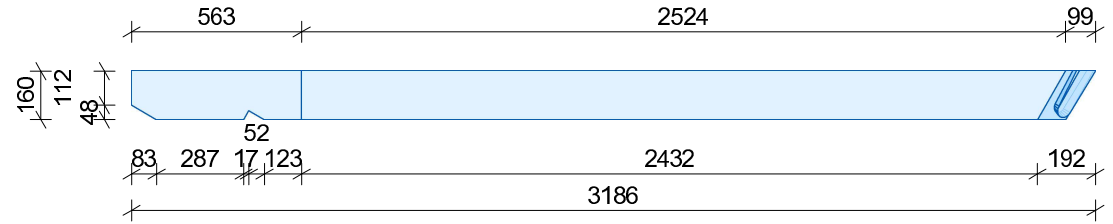

ČESKÁ
ZEMĚDĚLSKÁ
UNIVERZITA V PRAZE



SEMIA
EXPERIENCE
Agri research

DIPLOMOVÁ PRÁCE
WORKOUTOVÉ HRISTĚ 25.03.2018

ZPRACOVAL: Bc.TOMÁŠ GIEBL, DiS.
POZICE 10, 37, 28, 19

M : 1 : 25.00

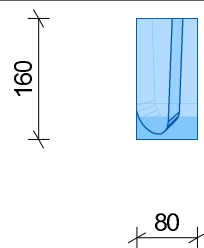
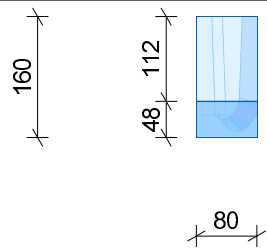
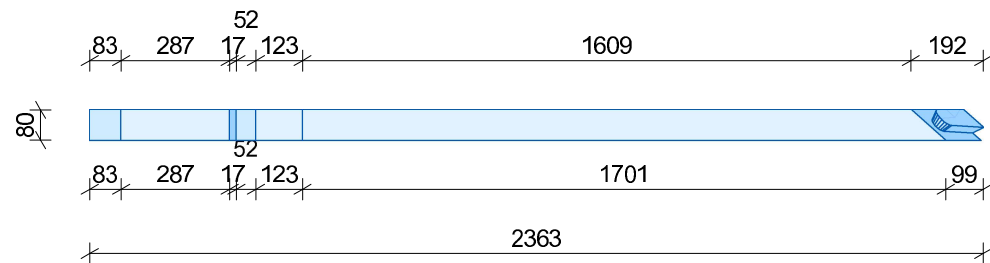
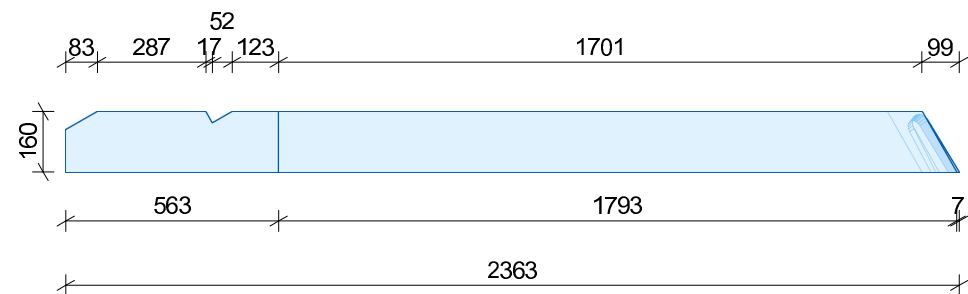
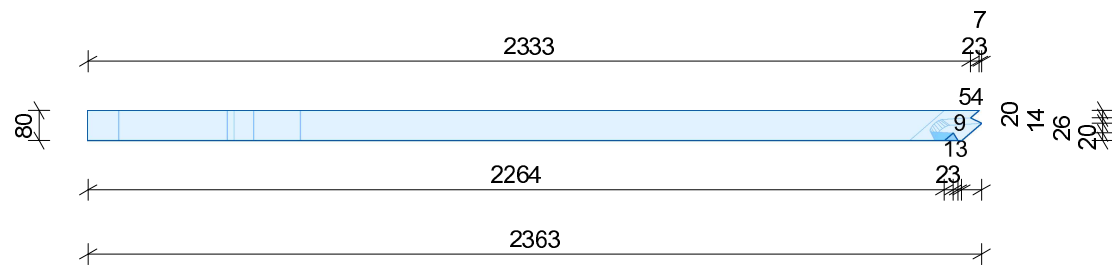
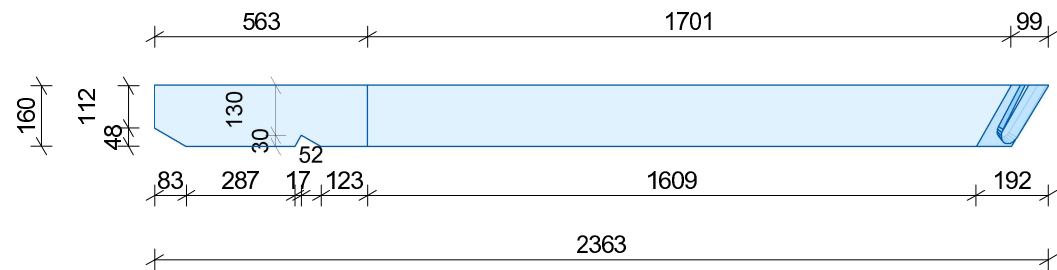

ČESKÁ
ZEMĚDĚLSKÁ
UNIVERZITA V PRAZE



SEMA
EXPERIENCE
Agri partner

DIPLOMOVÁ PRÁCE
WORKOUTOVÉ HRISTĚ

25.03.2018

ZPRACOVAL: Bc. TOMÁŠ GIEBL, DiS.
POZICE 11, 38, 29, 20

M : 1 : 20.00

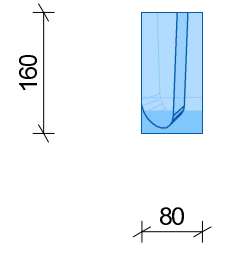
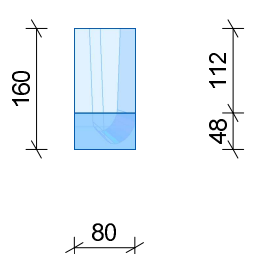
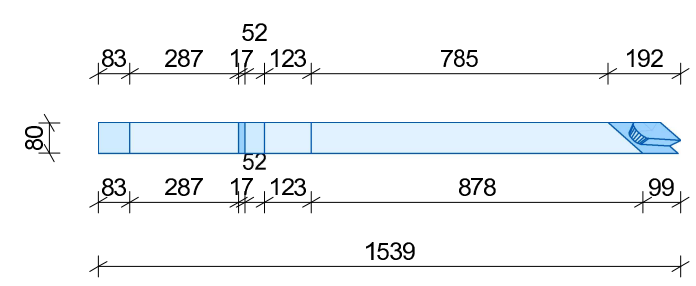
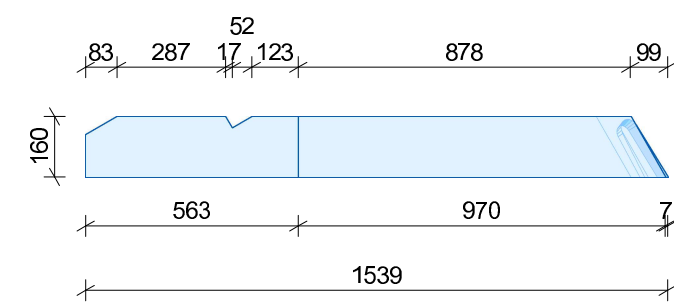
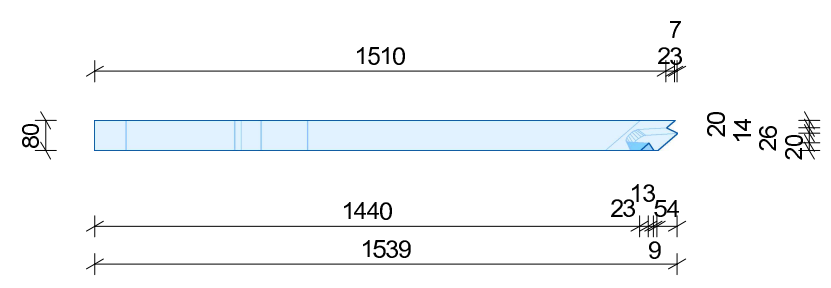
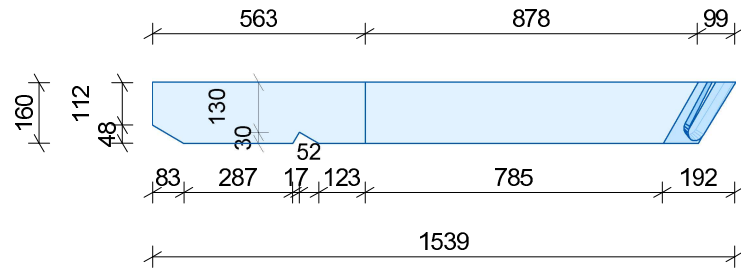

ČESKÁ
ZEMĚDĚLSKÁ
UNIVERZITA V PRAZE



SEMA
EXPERIENCE
Křídlo pavilón

DIPLOMOVÁ PRÁCE
WORKOUTOVÉ HRISTĚ

25.03.2018

ZPRACOVAL: Bc. TOMÁŠ GIEBL, DiS.
POZICE 12, 39, 30, 21

M : 1 : 20.00

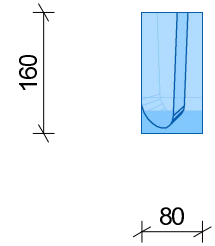
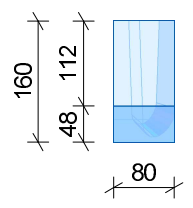
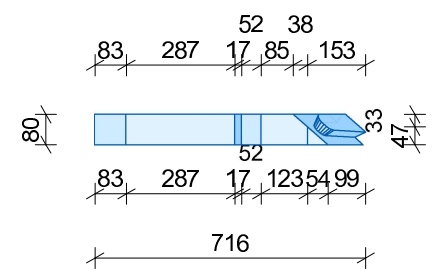
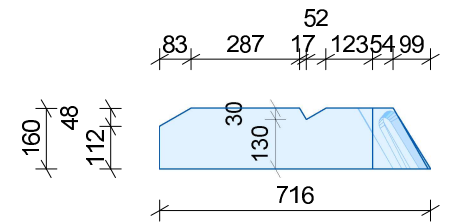
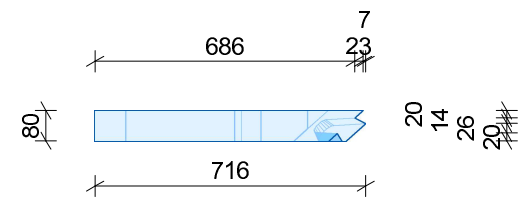
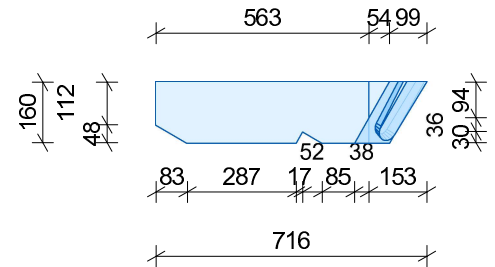

ČESKÁ
ZEMĚDĚLSKÁ
UNIVERZITA V PRAZE



SEMA
EXPERIENCE
Agri partners

DIPLOMOVÁ PRÁCE
WORKOUTOVÉ HRISTĚ 25.03.2018

ZPRACOVAL: Bc.TOMÁŠ GIEBL, DiS.
POZICE 13, 40, 31, 22

M : 1 : 20.00

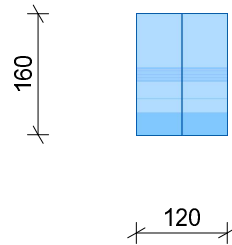
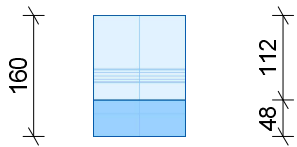
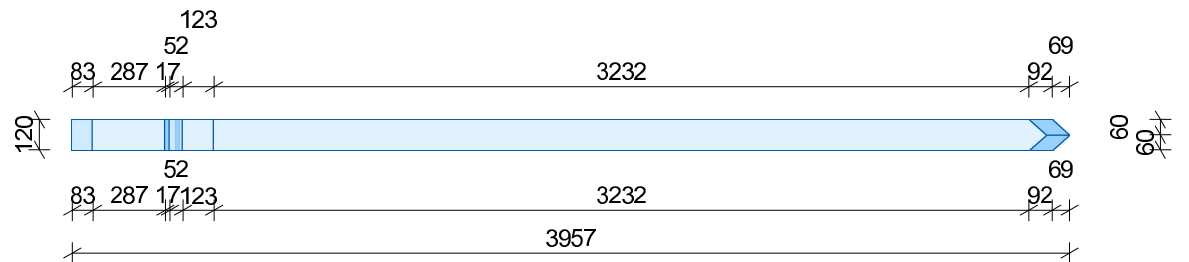
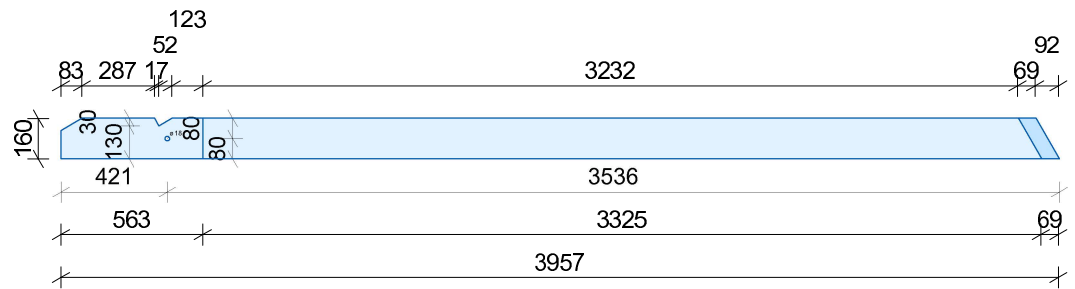
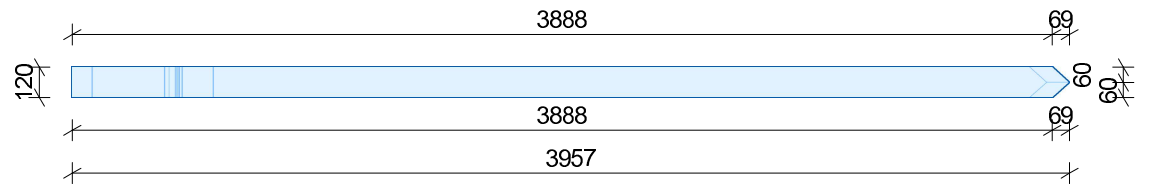
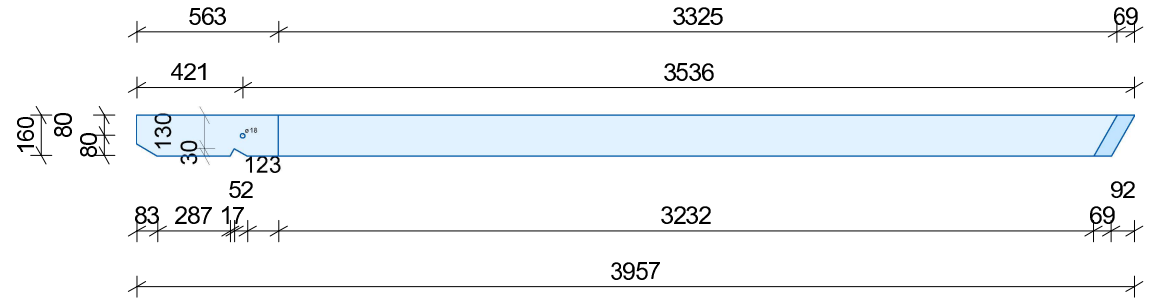
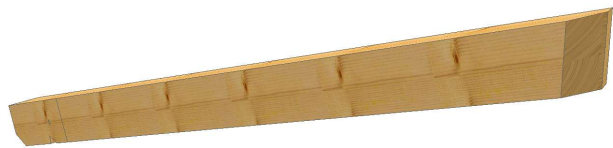

ČESKÁ
ZEMĚDĚLSKÁ
UNIVERZITA V PRAZE



DIPLOMOVÁ PRÁCE
WORKOUTOVÉ HRISTĚ 25.03.2018

ZPRACOVAL: Bc. TOMÁŠ GIEBL, DiS.
POZICE 18, 36

M : 1 : 30.00

powered by

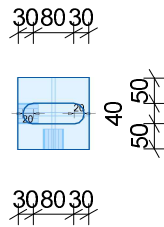
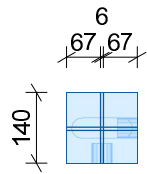
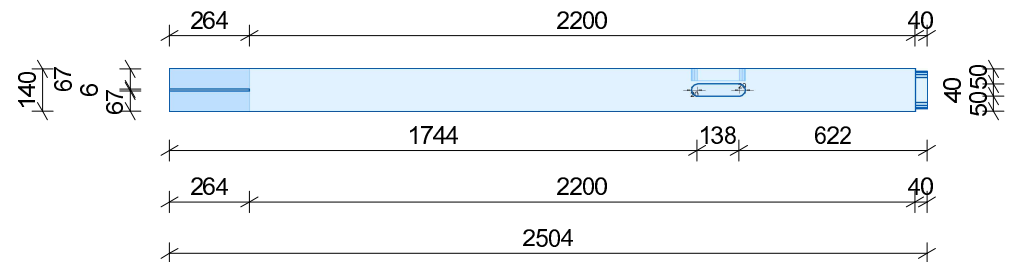
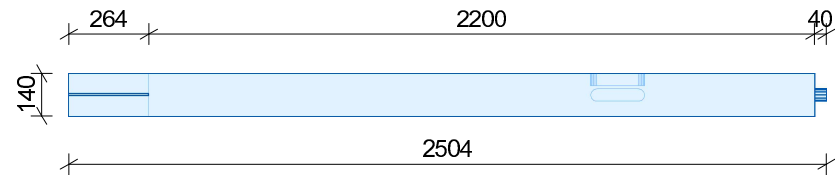
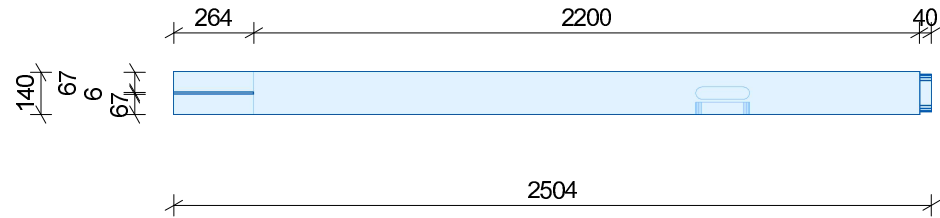
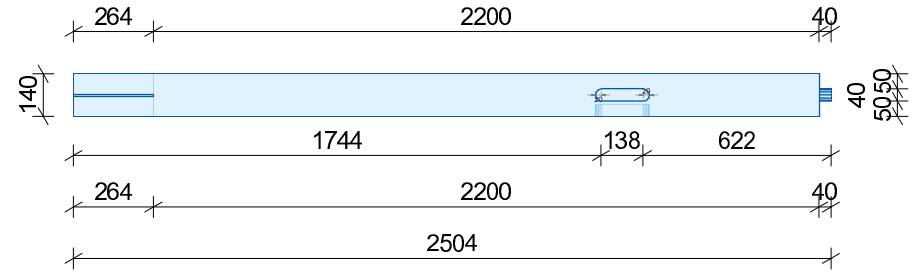

ČESKÁ
ZEMĚDĚLSKÁ
UNIVERZITA V PRAZE



SEMA
EXPERIENCE
149 PRAHA 4

DIPLOMOVÁ PRÁCE
WORKOUTOVÉ HRISTĚ

26.03.2018

ZPRACOVAL: Bc.TOMÁŠ GIEBL, DiS.
POZICE 41

M : 1 : 25.00

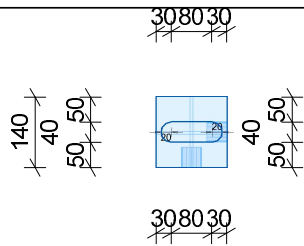
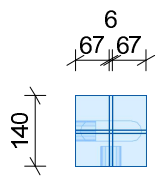
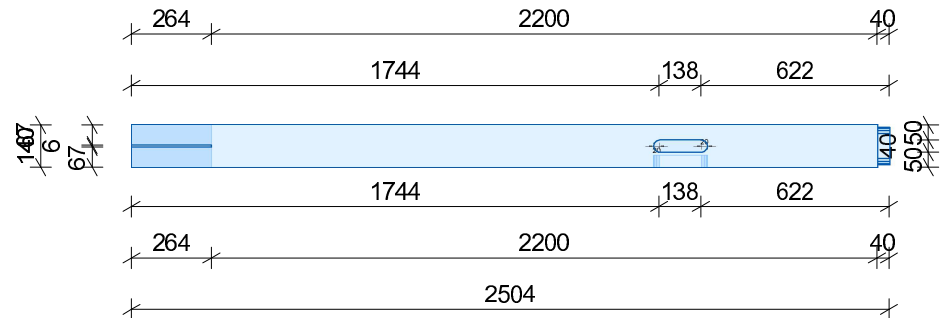
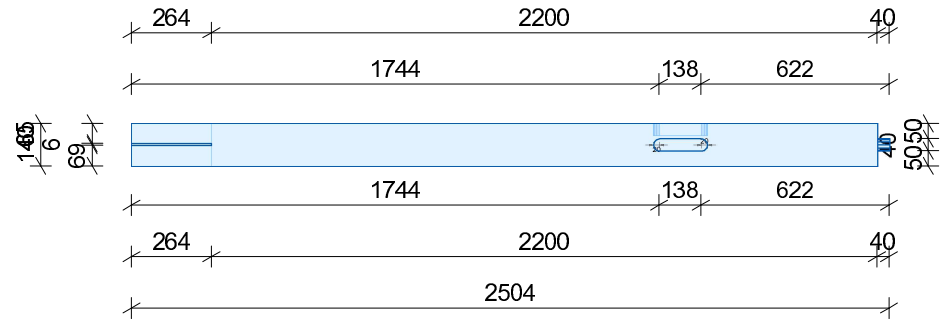
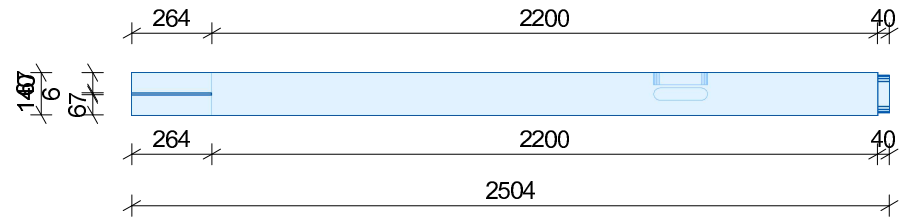
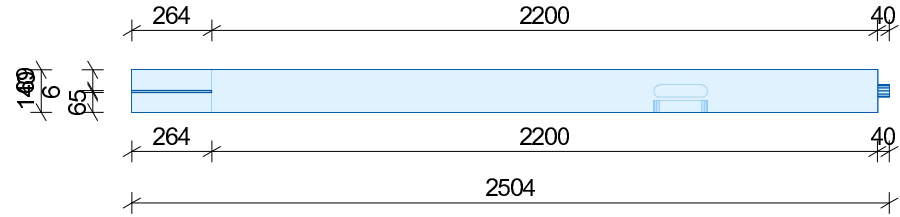

ČESKÁ
ZEMĚDĚLSKÁ
UNIVERZITA V PRAZE



DIPLOMOVÁ PRÁCE
WORKOUTOVÉ HRISTĚ 26.03.2018

ZPRACOVAL: Bc. TOMÁŠ GIEBL, DiS.
POZICE 42

M : 1 : 25.00

by reawood

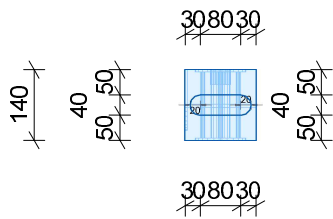
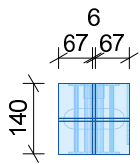
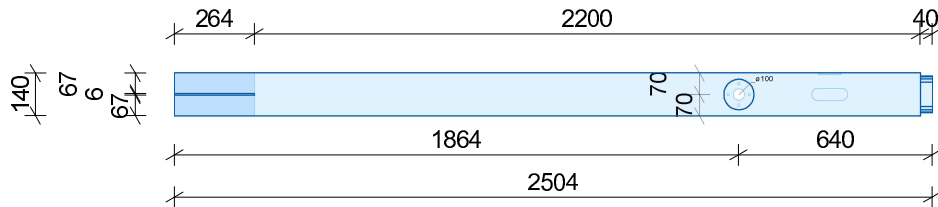
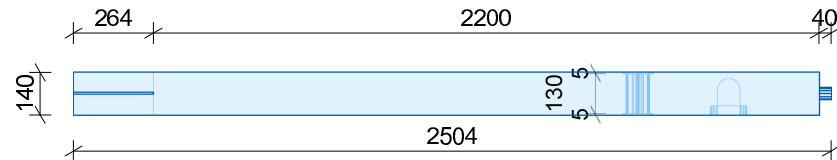
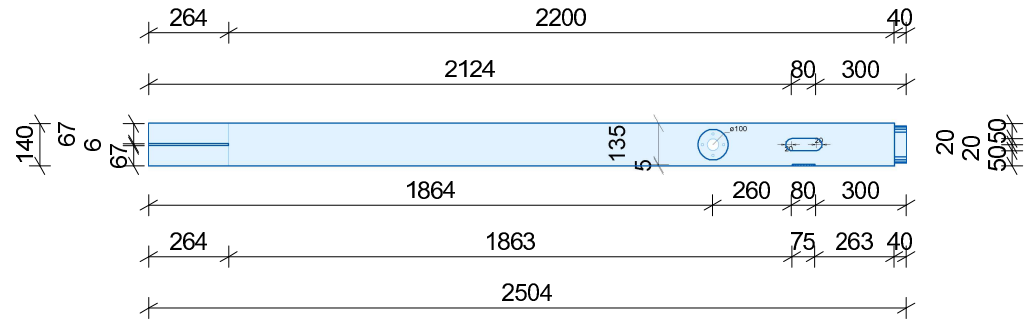
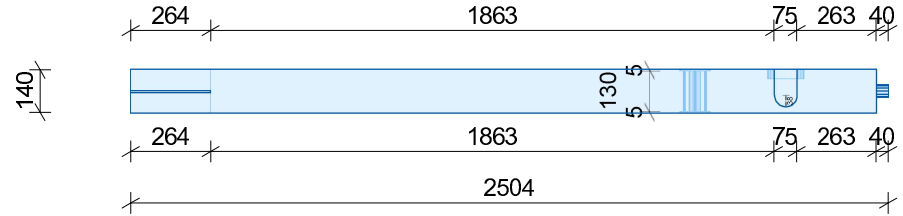

ČESKÁ
ZEMĚDĚLSKÁ
UNIVERZITA V PRAZE



SEMA
EXPERIENCE
4000000000

DIPLOMOVÁ PRÁCE
WORKOUTOVÉ HRISTĚ

26.03.2018

ZPRACOVAL: Bc.TOMÁŠ GIEBL, DiS.
POZICE 43

M : 1 : 25.00

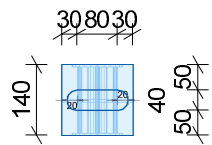
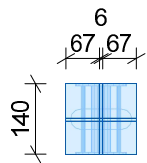
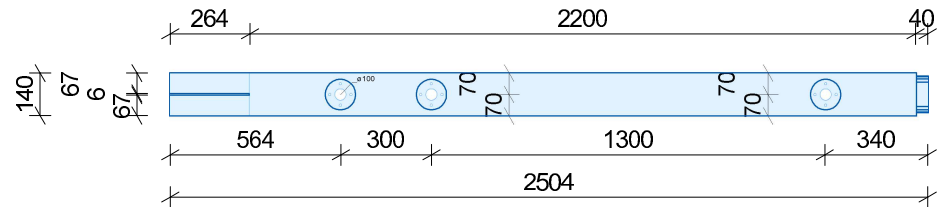
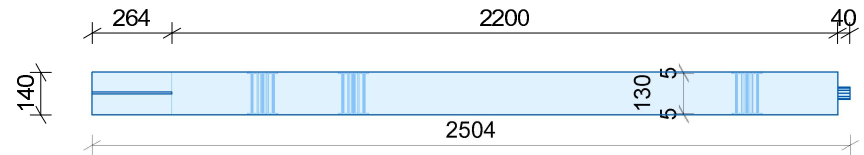
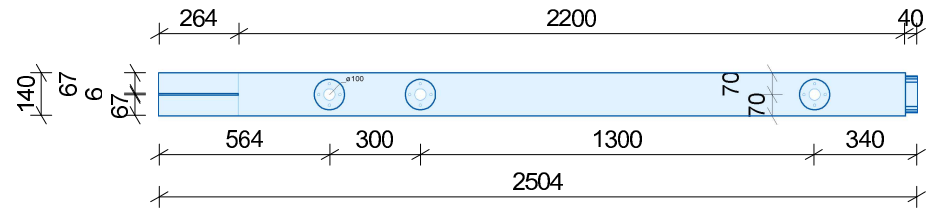
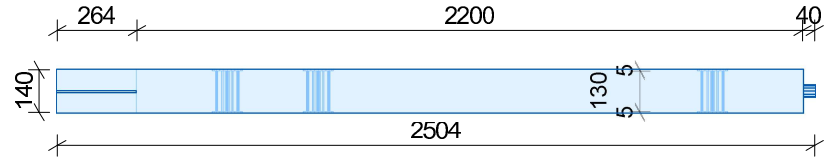

ČESKÁ
ZEMĚDĚLSKÁ
UNIVERZITA V PRAZE



SEMA
EXPERIENCE

DIPLOMOVÁ PRÁCE
WORKOUTOVÉ HRISTĚ

26.03.2018

ZPRACOVAL: Bc.TOMÁŠ GIEBL, DiS.
POZICE 44

M : 1 : 25.00

powered by

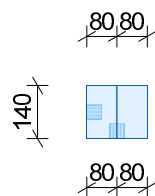
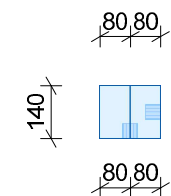
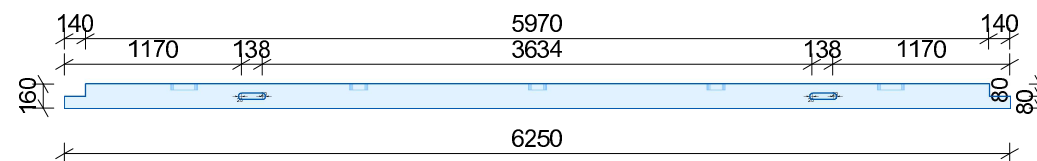
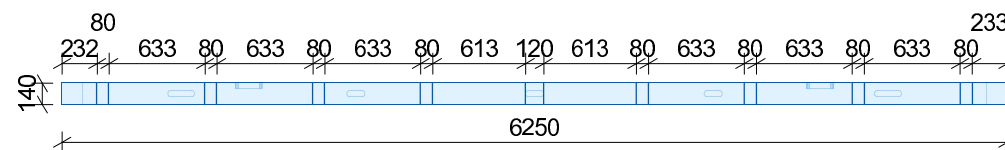
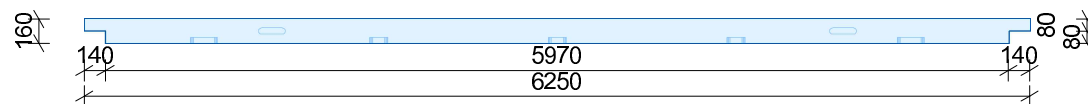
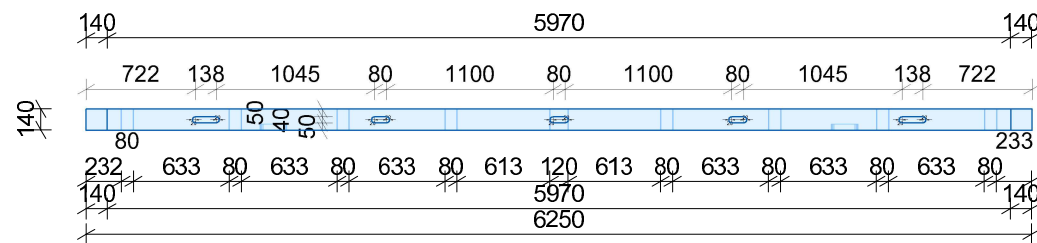
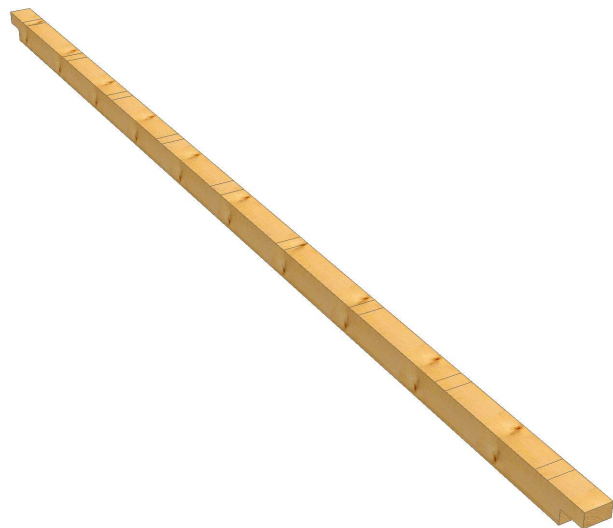

ČESKÁ
ZEMĚDĚLSKÁ
UNIVERZITA V PRAZE



SEMA
EXPERIENCE
149 pavlovod

DIPLOMOVÁ PRÁCE
WORKOUTOVÉ HRISTĚ

26.03.2018

ZPRACOVAL: Bc.TOMÁŠ GIEBL, DiS.
POZICE 45

M : 1 : 50.00

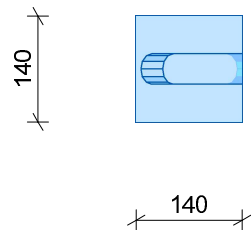
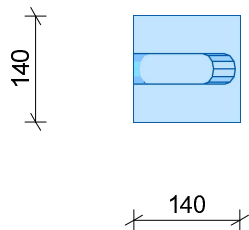
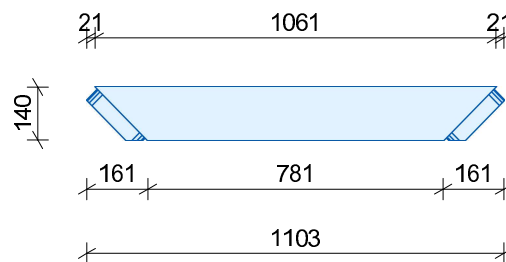
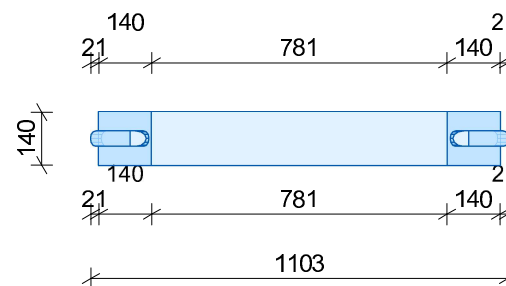
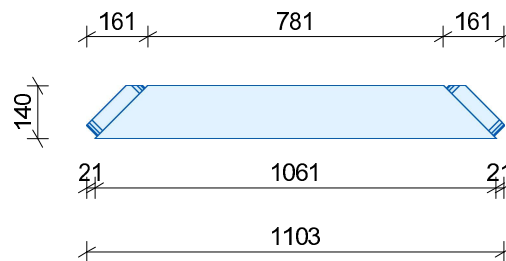
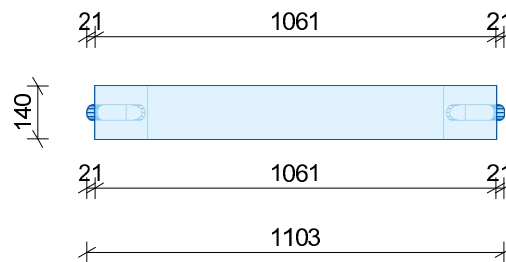

ČESKÁ
ZEMĚDĚLSKÁ
UNIVERZITA V PRAZE



SEMIA
EXPERIENCE
Agri research

DIPLOMOVÁ PRÁCE
WORKOUTOVÉ HRISTĚ 26.03.2018

ZPRACOVAL: Bc.TOMÁŠ GIEBL, DiS.
POZICE 46, 47,59, 60, 68, 69,73,74

M : 1 : 20.00

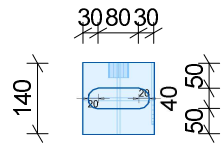
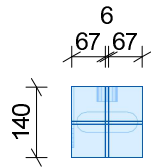
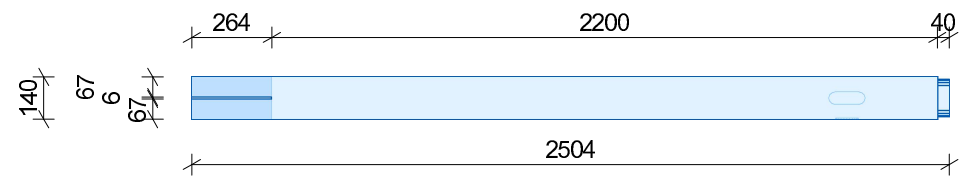
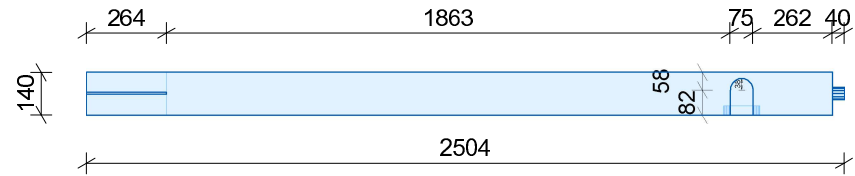
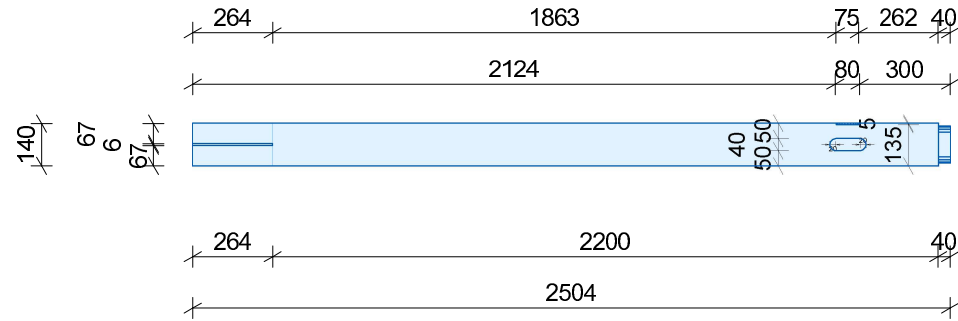
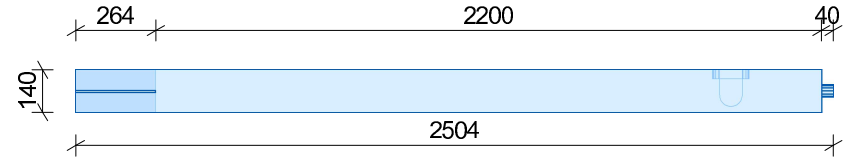

ČESKÁ
ZEMĚDĚLSKÁ
UNIVERZITA V PRAZE



SEMA
EXPERIENCE
Agri business

DIPLOMOVÁ PRÁCE
WORKOUTOVÉ HRISTĚ

26.03.2018

ZPRACOVAL: Bc. TOMÁŠ GIEBL, DiS.
POZICE 48

M : 1 : 25.00

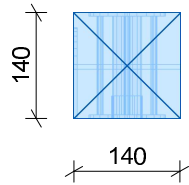
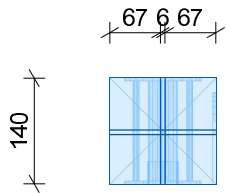
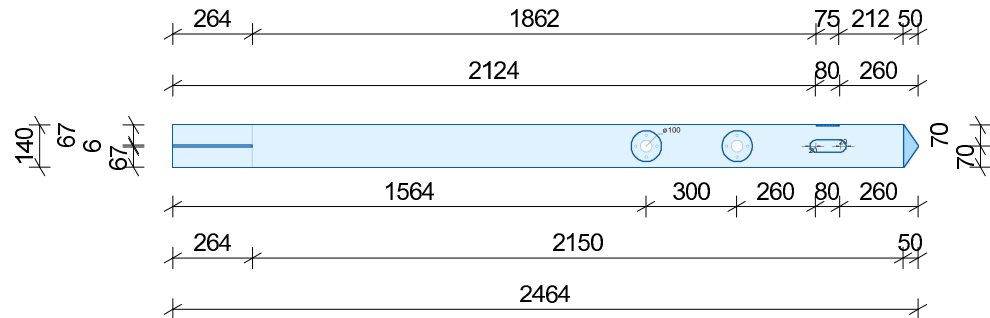
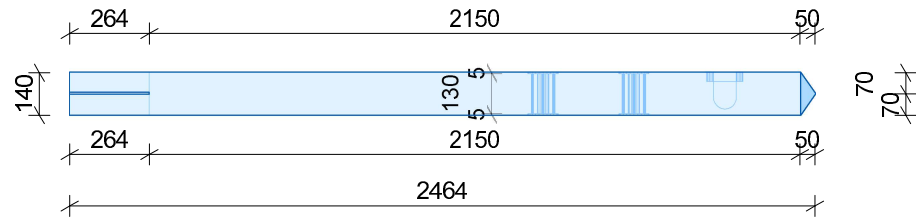
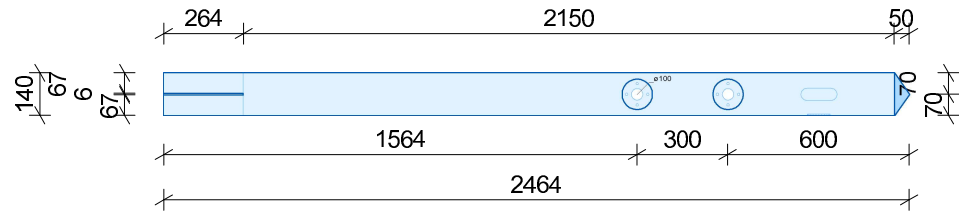
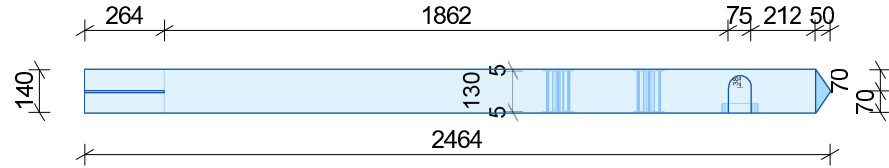

ČESKÁ
ZEMĚDĚLSKÁ
UNIVERZITA V PRAZE



DIPLOMOVÁ PRÁCE
WORKOUTOVÉ HRISTĚ 26.03.2018

ZPRACOVAL: Bc. TOMÁŠ GIEBL, DiS.
POZICE 49

M : 1 : 25.00

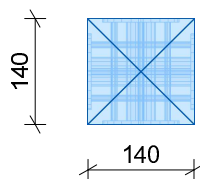
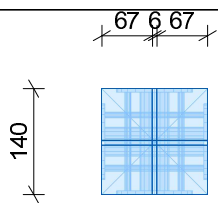
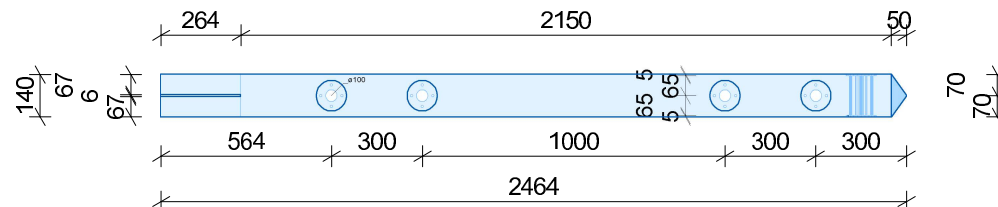
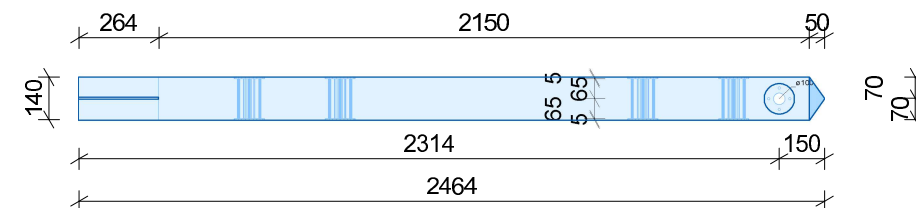
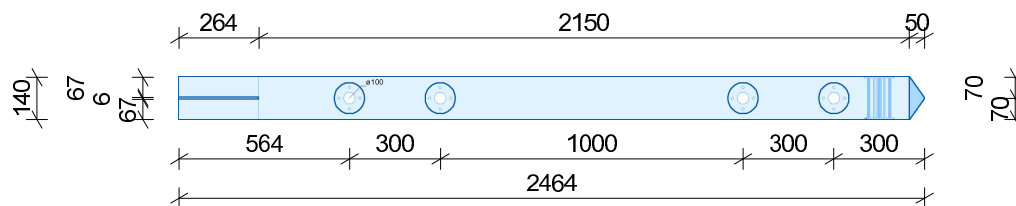
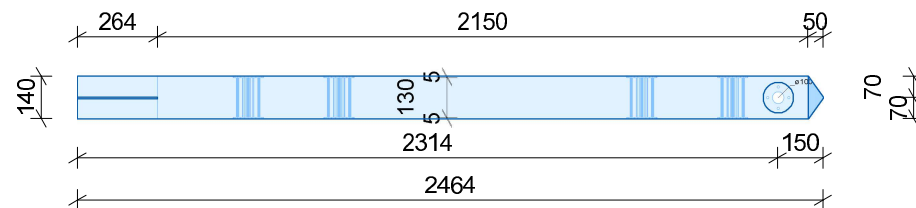

ČESKÁ
ZEMĚDĚLSKÁ
UNIVERZITA V PRAZE



SEMIA
EXPERIENCE
1400000000

DIPLOMOVÁ PRÁCE
WORKOUTOVÉ HRISTĚ

26.03.2018

ZPRACOVAL: Bc. TOMÁŠ GIEBL, DiS.
POZICE 50

M : 1 : 25.00

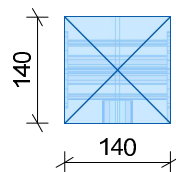
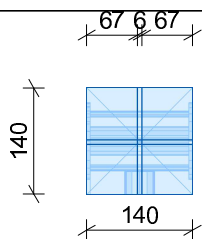
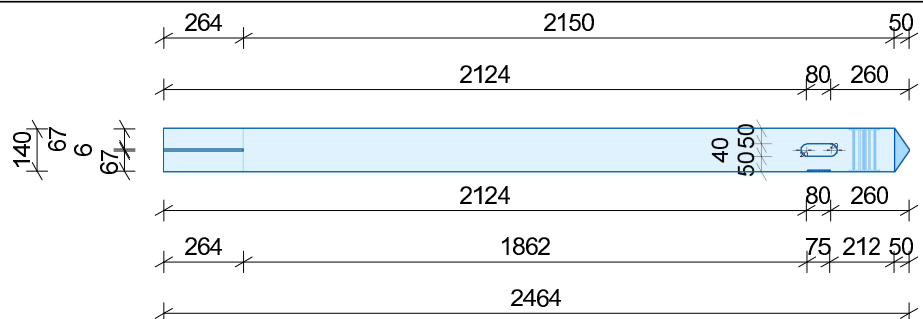
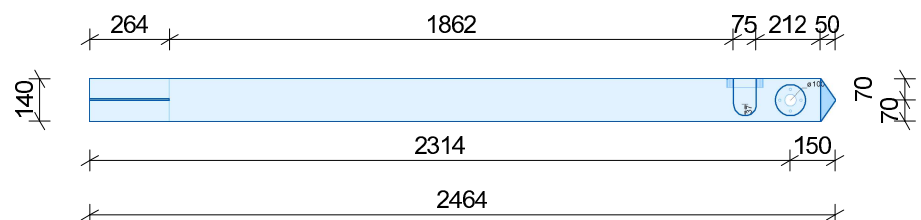
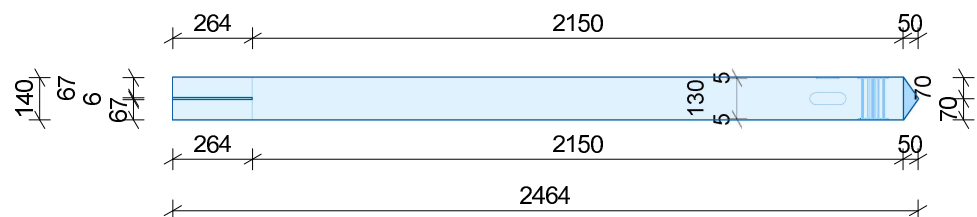
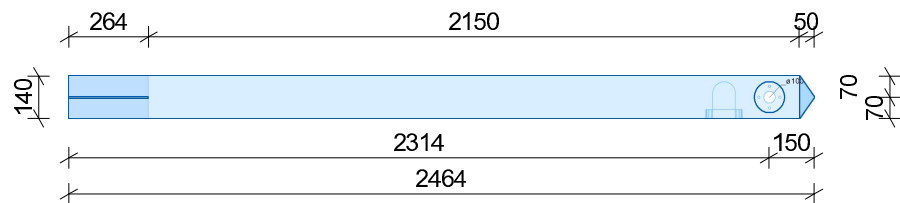

ČESKÁ
ZEMĚDĚLSKÁ
UNIVERZITA V PRAZE



SEMIA
EXPERIENCE
powered by

DIPLOMOVÁ PRÁCE
WORKOUTOVÉ HRISTĚ

26.03.2018

ZPRACOVAL: Bc. TOMÁŠ GIEBL, DiS.
POZICE 51

M : 1 : 25.00

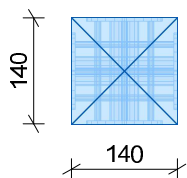
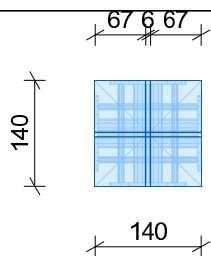
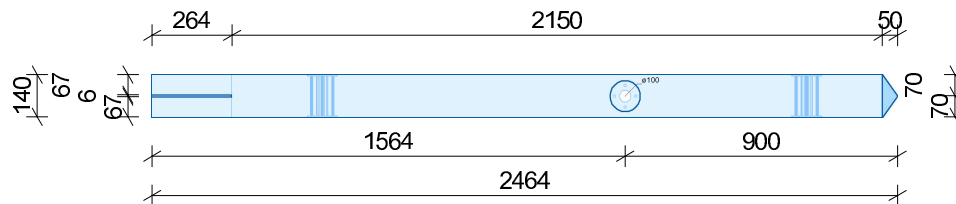
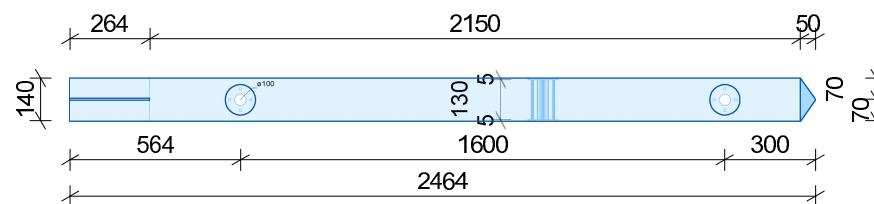
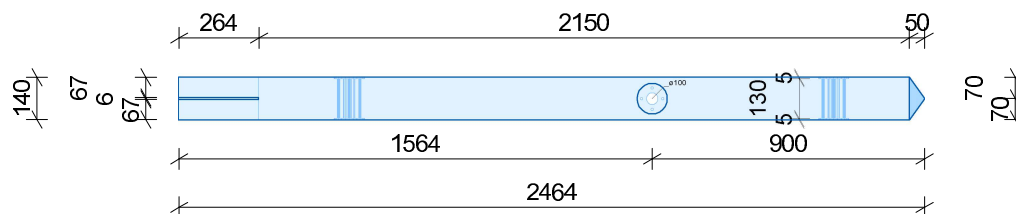
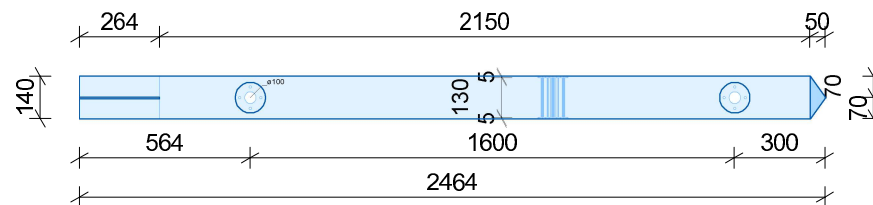

ČESKÁ
ZEMĚDĚLSKÁ
UNIVERZITA V PRAZE



SEMA
EXPERIENCE
409 000 000 000

DIPLOMOVÁ PRÁCE
WORKOUTOVÉ HRISTĚ

26.03.2018

ZPRACOVAL: Bc.TOMÁŠ GIEBL, DiS.
POZICE 52

M : 1 : 25.00

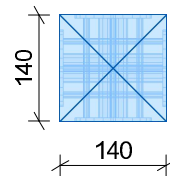
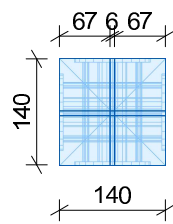
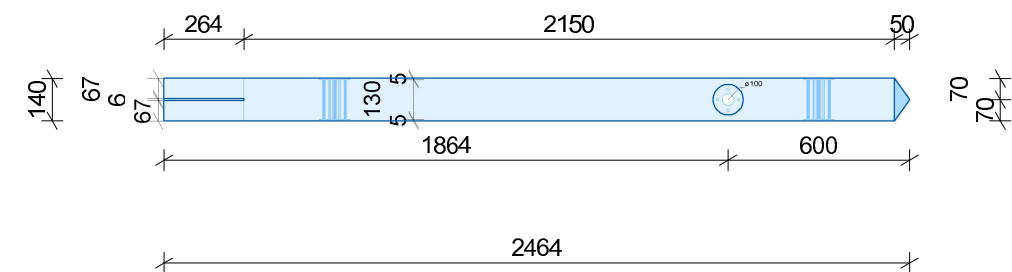
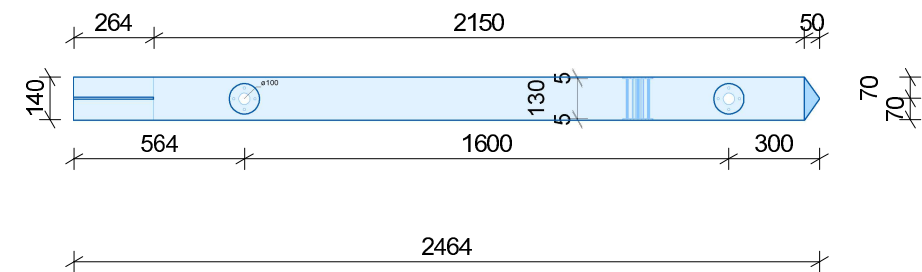
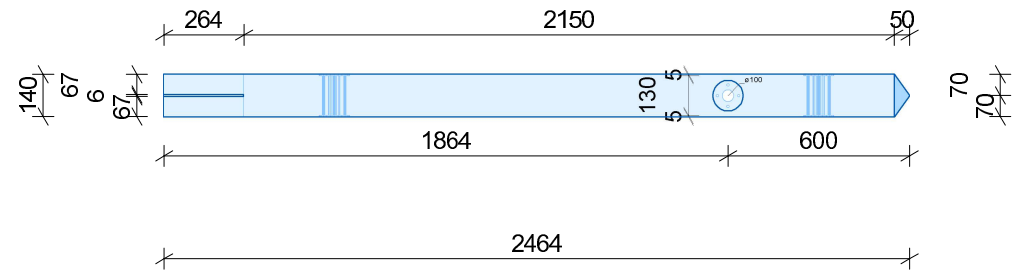
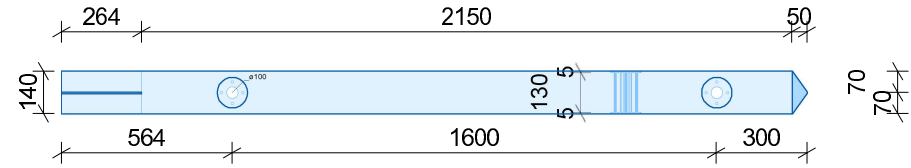

ČESKÁ
ZEMĚDĚLSKÁ
UNIVERZITA V PRAZE



DIPLOMOVÁ PRÁCE
WORKOUTOVÉ HRISTĚ 26.03.2018

ZPRACOVAL: Bc.TOMÁŠ GIEBL, DiS.
POZICE 53

M : 1 : 25.00

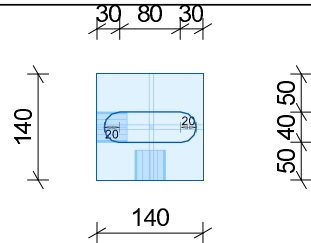
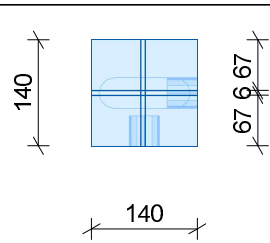
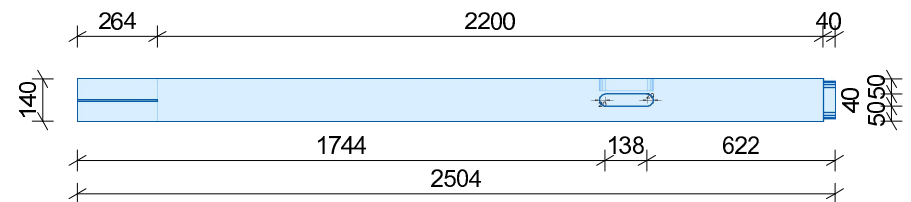
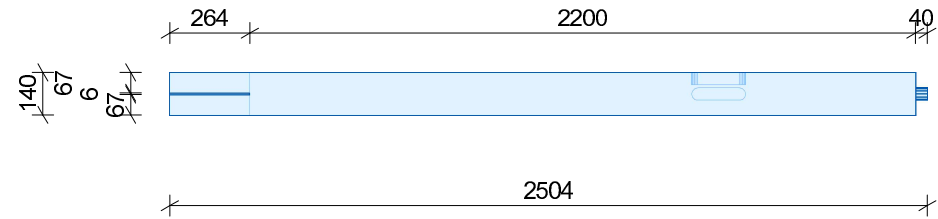
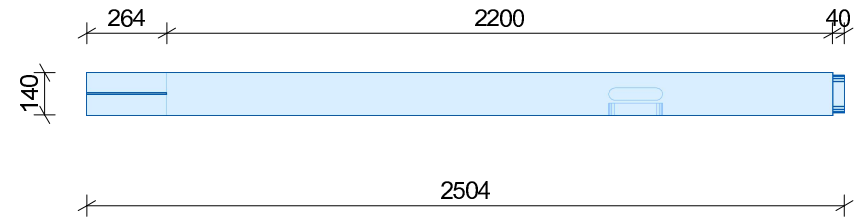
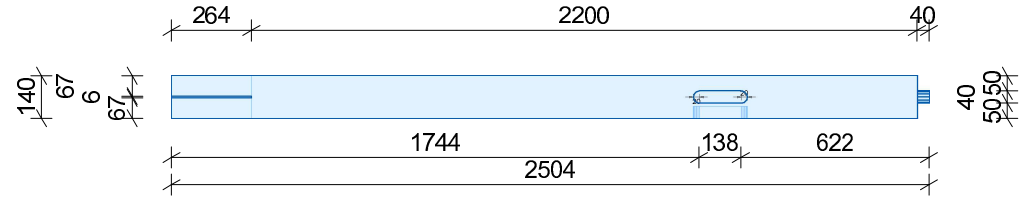

ČESKÁ
ZEMĚDĚLSKÁ
UNIVERZITA V PRAZE



SEMA
EXPERIENCE

DIPLOMOVÁ PRÁCE
WORKOUTOVÉ HRISTĚ 26.03.2018

ZPRACOVAL: Bc.TOMÁŠ GIEBL, DiS.
POZICE 54

M : 1 : 25.00

1/19 01/2018/01

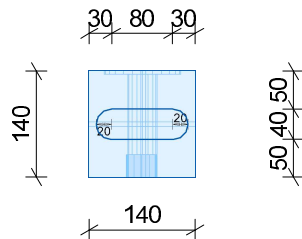
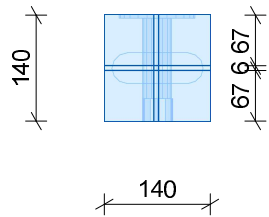
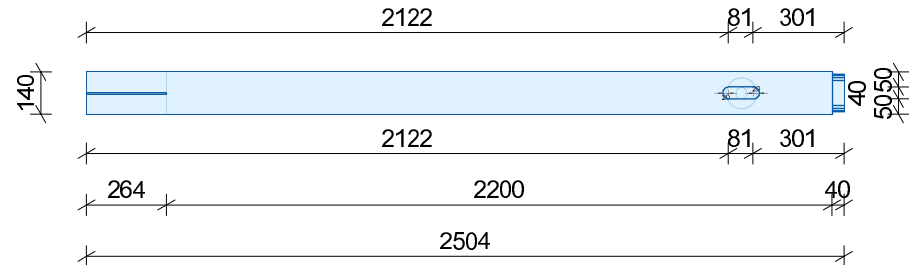
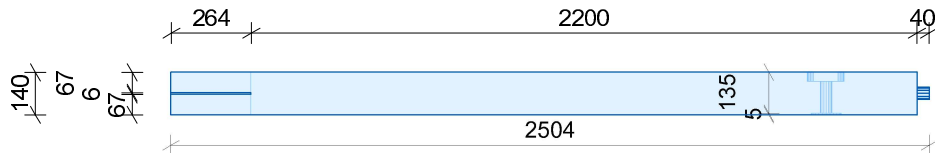
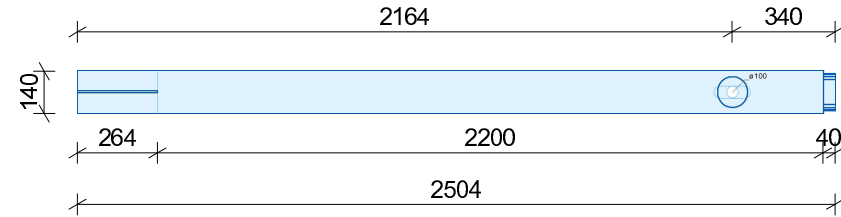
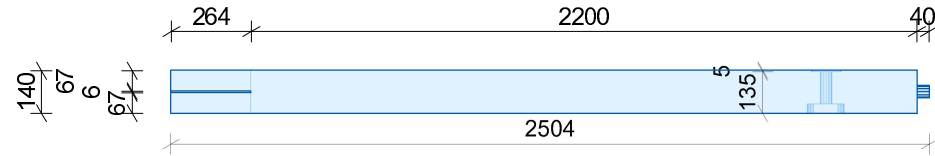

ČESKÁ
ZEMĚDĚLSKÁ
UNIVERZITA V PRAZE



SEMA
EXPERIENCE
Agri partner

DIPLOMOVÁ PRÁCE
WORKOUTOVÉ HRISTĚ 26.03.2018

ZPRACOVAL: Bc. TOMÁŠ GIEBL, DiS.
POZICE 55

M : 1 : 25.00

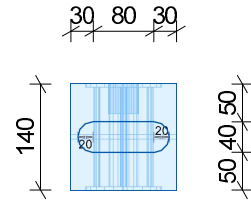
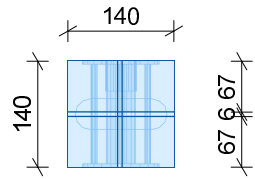
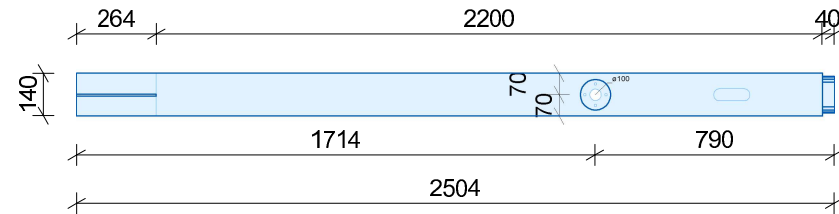
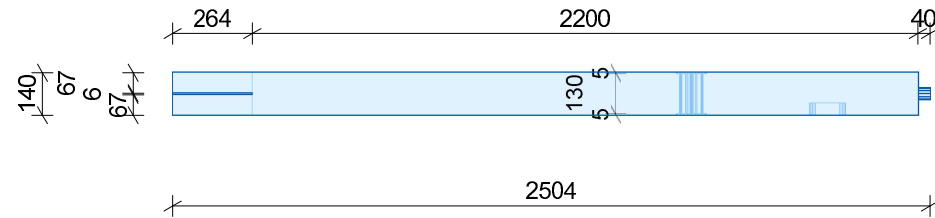
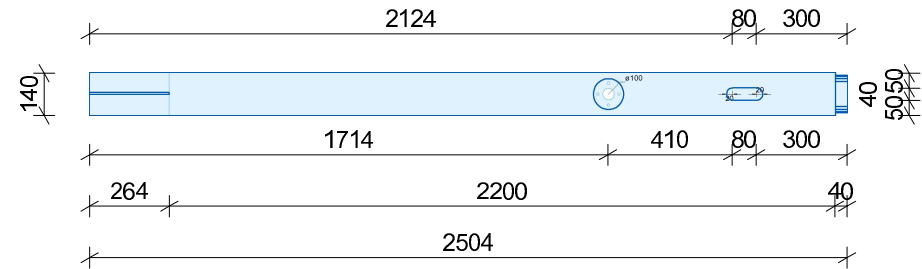
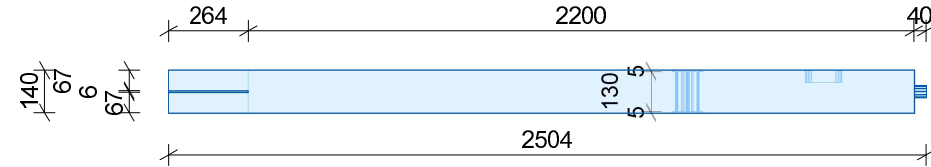

ČESKÁ
ZEMĚĚLSKÁ
UNIVERZITA V PRAZE



SEMA
EXPERIENCE
by reawood

DIPLOMOVÁ PRÁCE
WORKOUTOVÉ HRISTĚ

26.03.2018

ZPRACOVAL: Bc.TOMÁŠ GIEBL, DiS.
POZICE 56

M : 1 : 25.00

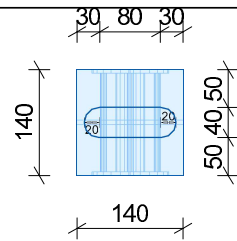
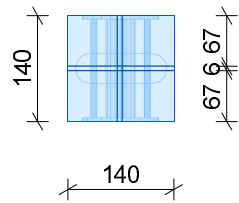
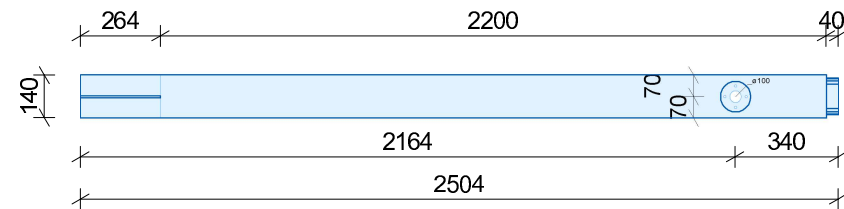
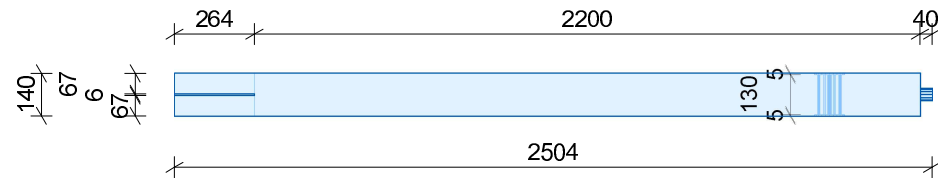
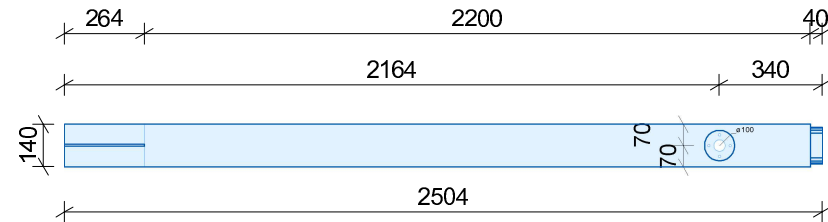
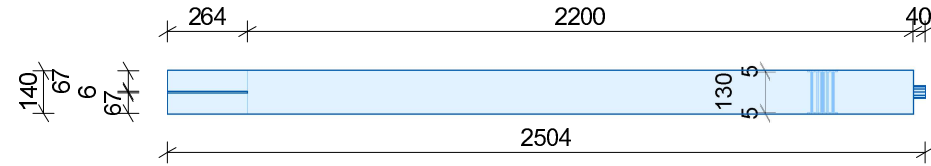

ČESKÁ
ZEMĚDĚLSKÁ
UNIVERZITA V PRAZE



SEMA
EXPERIENCE
powered by

DIPLOMOVÁ PRÁCE
WORKOUTOVÉ HRISTĚ 26.03.2018

ZPRACOVAL: Bc. TOMÁŠ GIEBL, DiS.
POZICE 57

M : 1 : 25.00

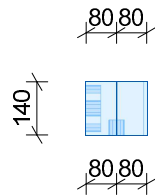
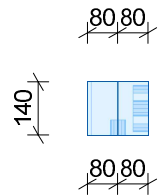
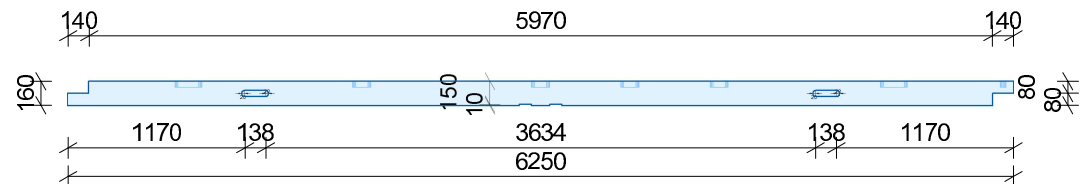
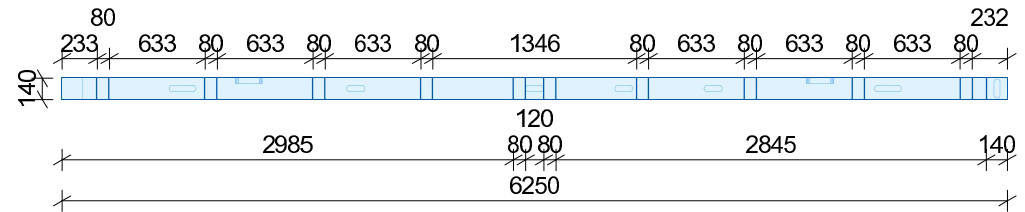
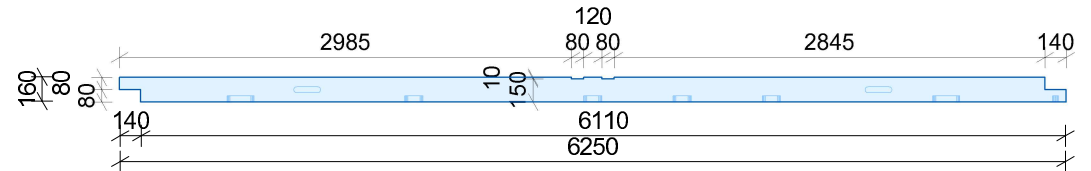
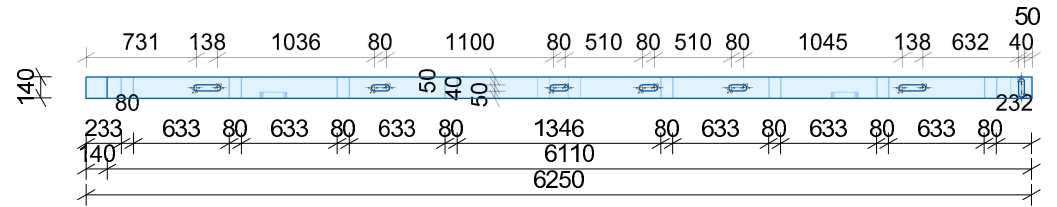

ČESKÁ
ZEMĚDĚLSKÁ
UNIVERZITA V PRAZE



DIPLOMOVÁ PRÁCE
WORKOUTOVÉ HRISTĚ 26.03.2018

ZPRACOVAL: Bc.TOMÁŠ GIEBL, DiS.
POZICE 58

M : 1 : 50.00

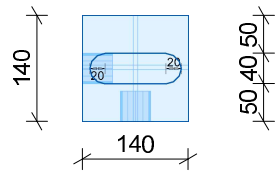
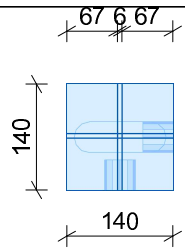
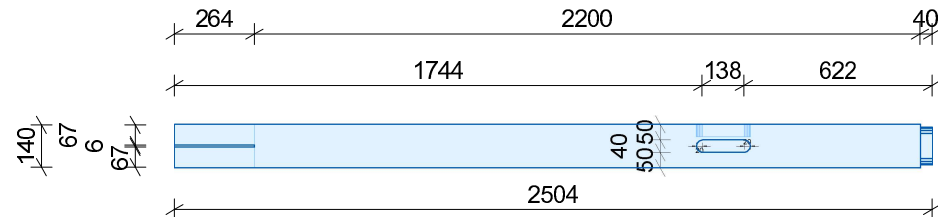
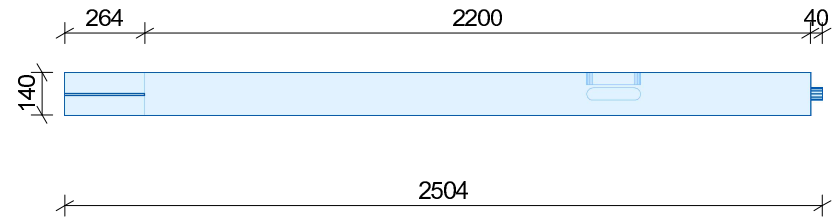
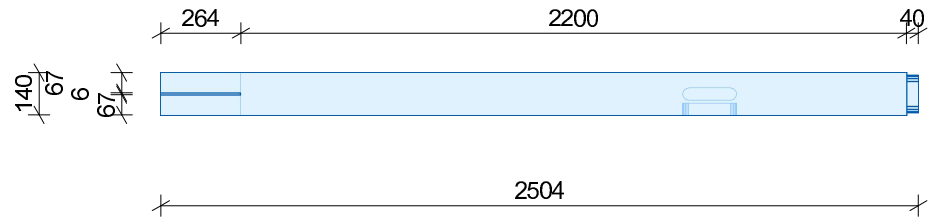
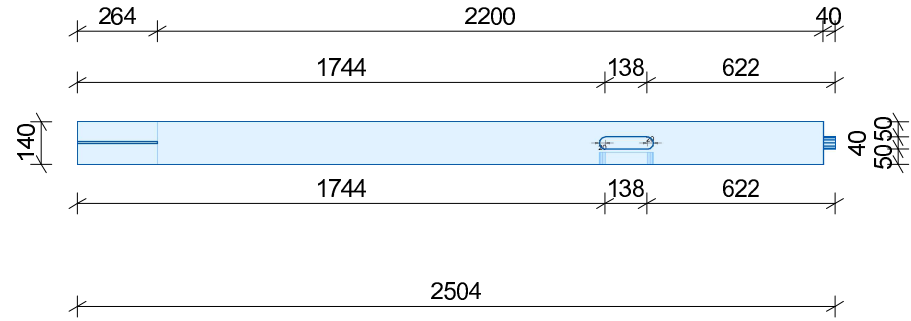

ČESKÁ
ZEMĚDĚLSKÁ
UNIVERZITA V PRAZE



SEMA
EXPERIENCE
Agri partner

DIPLOMOVÁ PRÁCE
WORKOUTOVÉ HRISTĚ

26.03.2018

ZPRACOVAL: Bc. TOMÁŠ GIEBL, DiS.
POZICE 63

M : 1 : 25.00

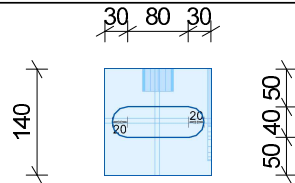
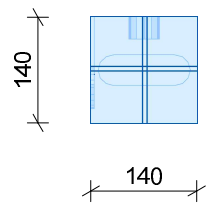
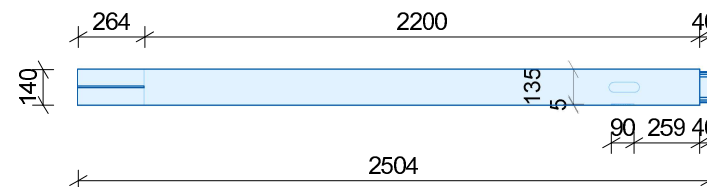
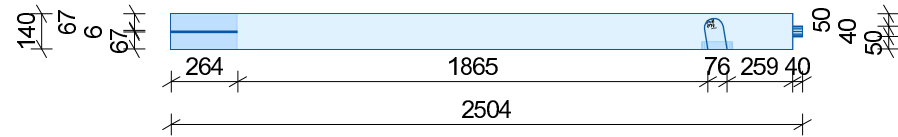
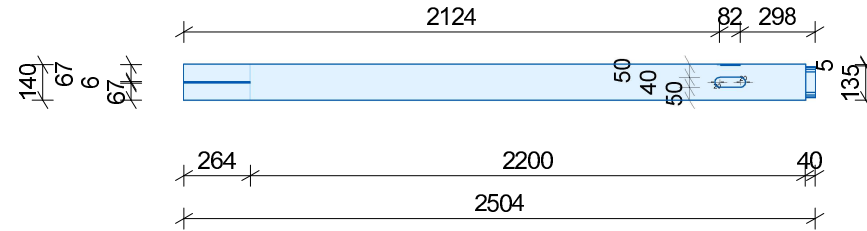
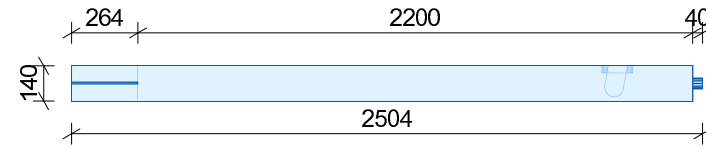

ČESKÁ
ZEMĚDĚLSKÁ
UNIVERZITA V PRAZE



SEMA
EXPERIENCE

DIPLOMOVÁ PRÁCE
WORKOUTOVÉ HRŠTĚ

26.03.2018

ZPRACOVAL: Bc.TOMÁŠ GIEBL, DIS.
POZICE 64

M : 1 : 30.00

powered by

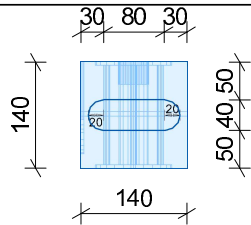
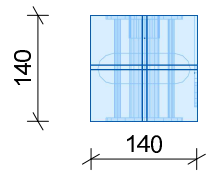
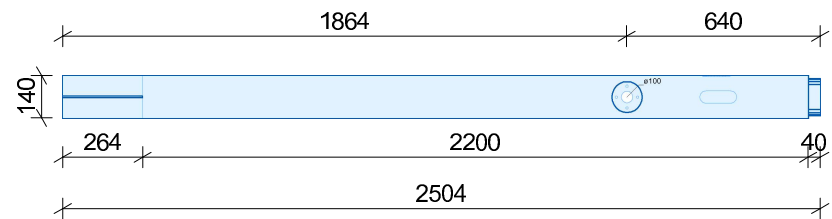
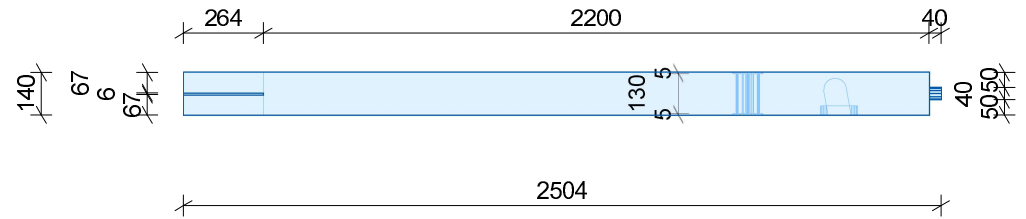
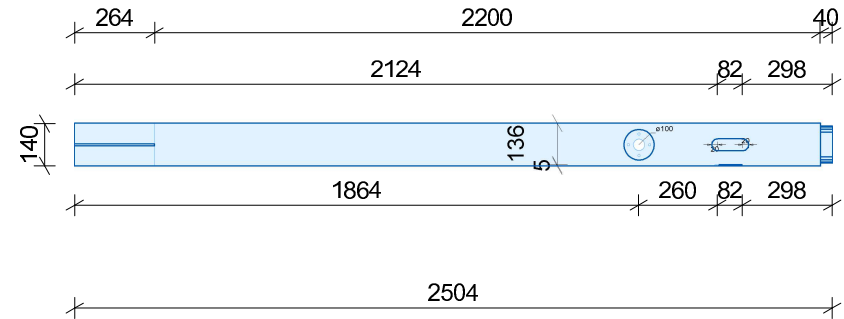
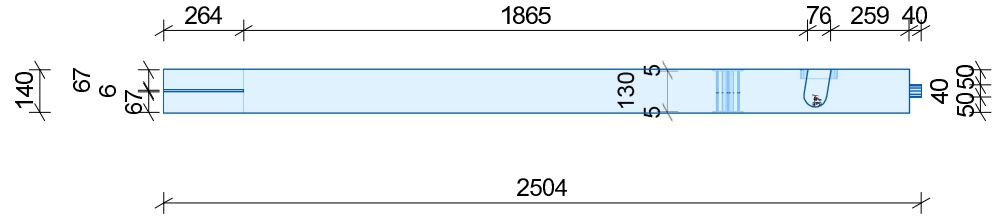

ČESKÁ
ZEMĚDĚLSKÁ
UNIVERZITA V PRAZE



SEMA
EXPERIENCE
429 PRAHA

DIPLOMOVÁ PRÁCE
WORKOUTOVÉ HRISTĚ 26.03.2018

ZPRACOVAL: Bc.TOMÁŠ GIEBL, DiS.
POZICE 65

M : 1 : 25.00

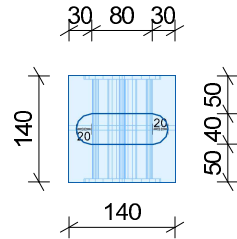
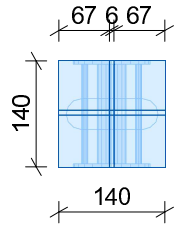
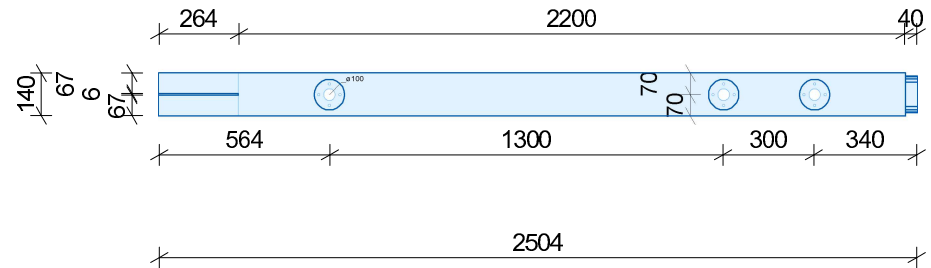
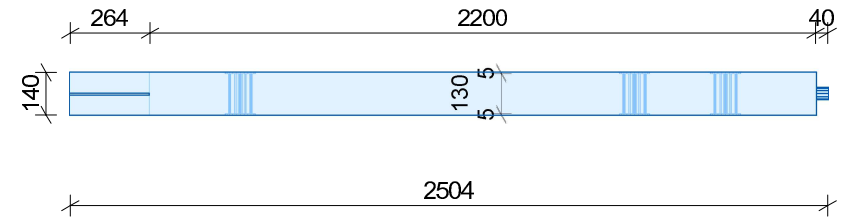
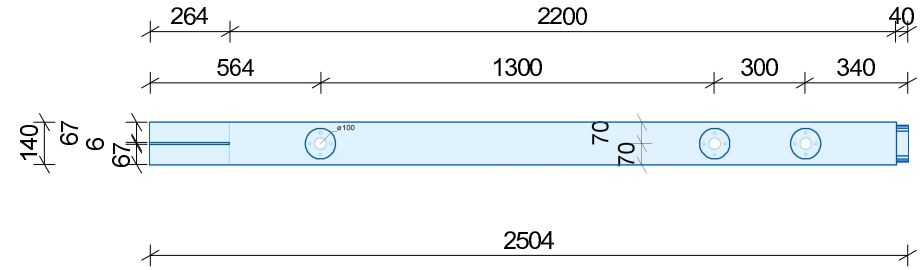
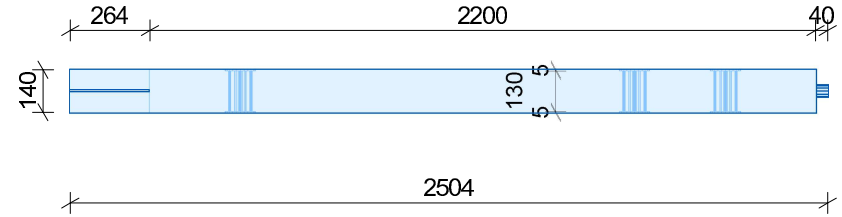

ČESKÁ
ZEMĚDĚLSKÁ
UNIVERZITA V PRAZE



SEMA
EXPERIENCE
414 PRAHA

DIPLOMOVÁ PRÁCE
WORKOUTOVÉ HRISTĚ

26.03.2018

ZPRACOVAL: Bc.TOMÁŠ GIEBL, DiS.
POZICE 66

M : 1 : 25.00

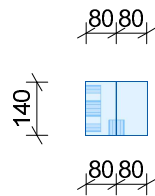
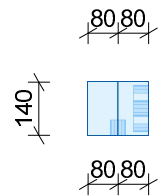
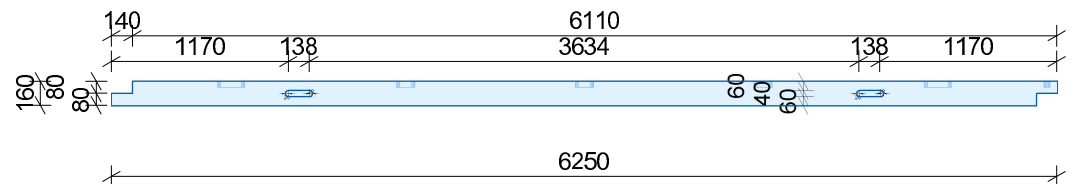
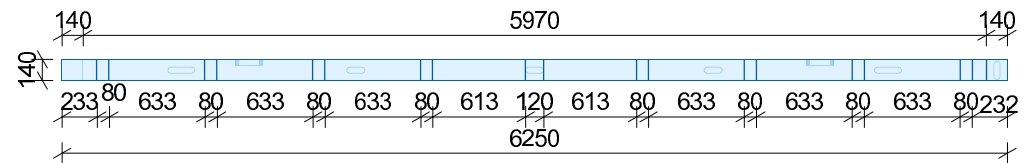
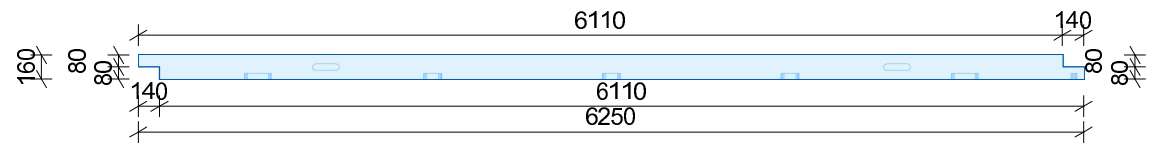
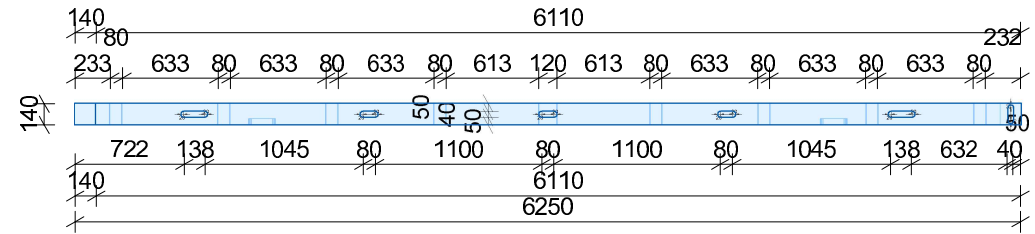
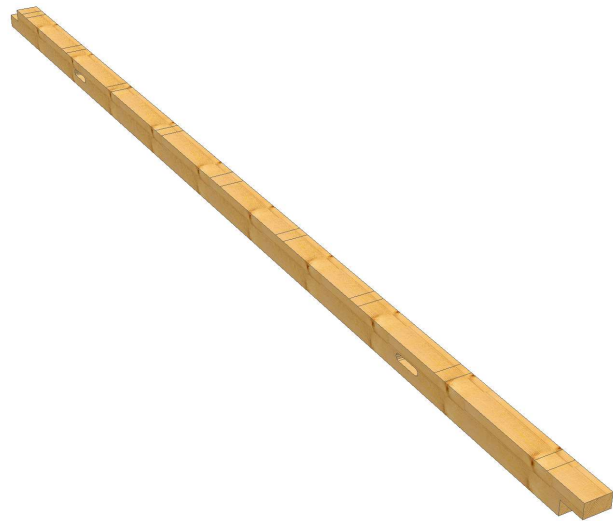

ČESKÁ
ZEMĚDĚLSKÁ
UNIVERZITA V PRAZE



SEMA
EXPERIENCE
149 pavlovod

DIPLOMOVÁ PRÁCE
WORKOUTOVÉ HRISTĚ

26.03.2018

ZPRACOVAL: Bc. TOMÁŠ GIEBL, DiS.
POZICE 67

M : 1 : 50.00

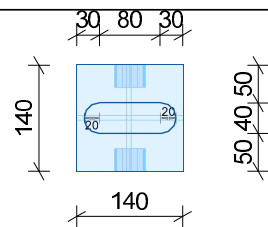
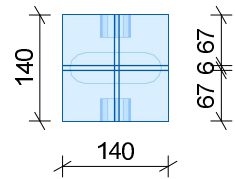
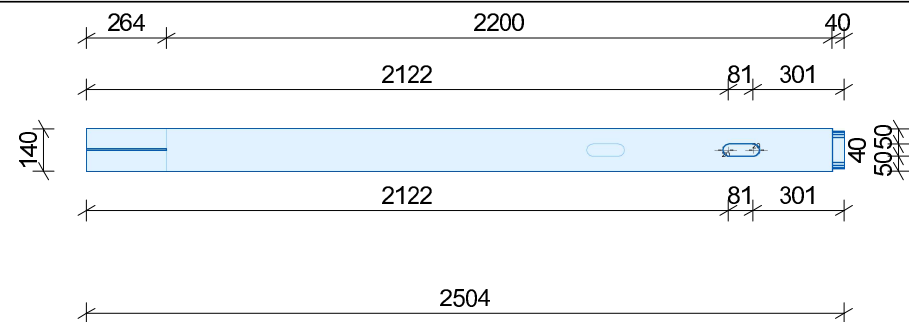
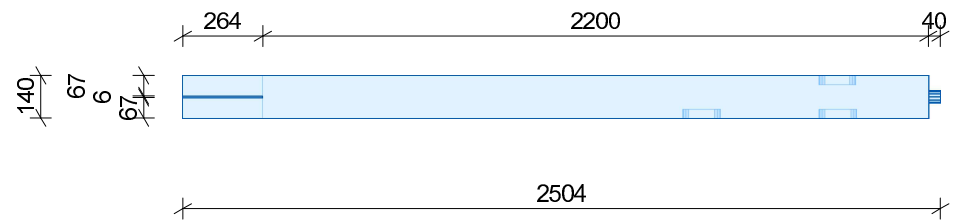
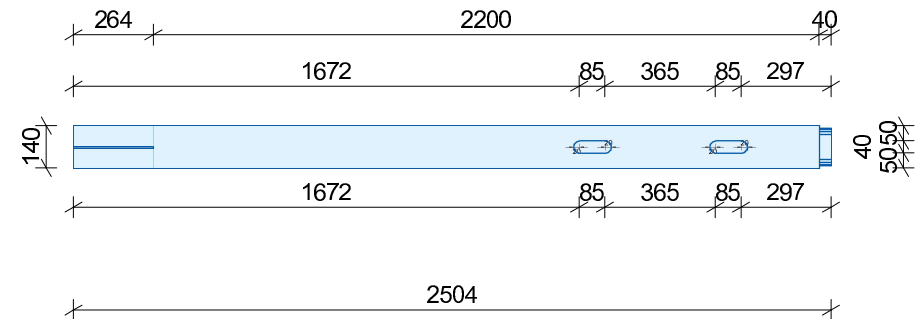
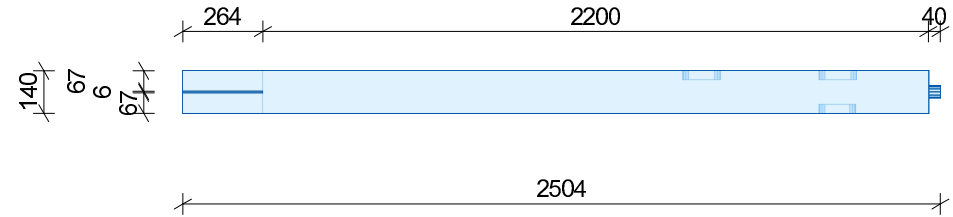

ČESKÁ
ZEMĚDĚLSKÁ
UNIVERZITA V PRAZE



SEMA
EXPERIENCE
powered by

DIPLOMOVÁ PRÁCE
WORKOUTOVÉ HRISTĚ

26.03.2018

ZPRACOVAL: Bc.TOMÁŠ GIEBL, DiS.
POZICE 70

M : 1 : 25.00

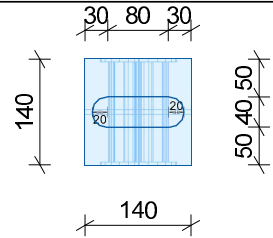
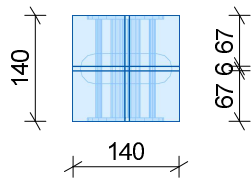
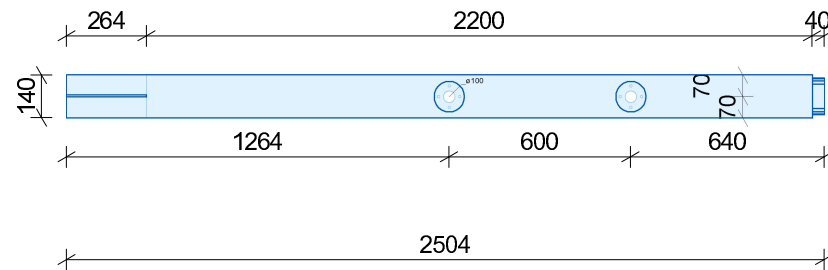
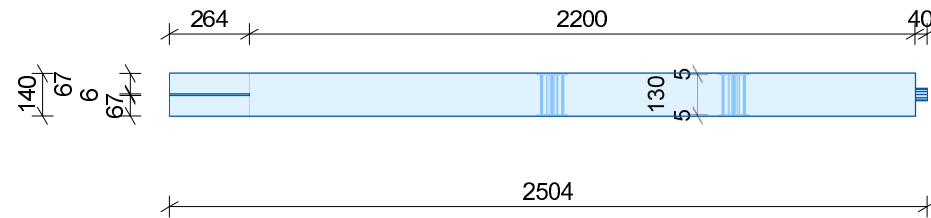
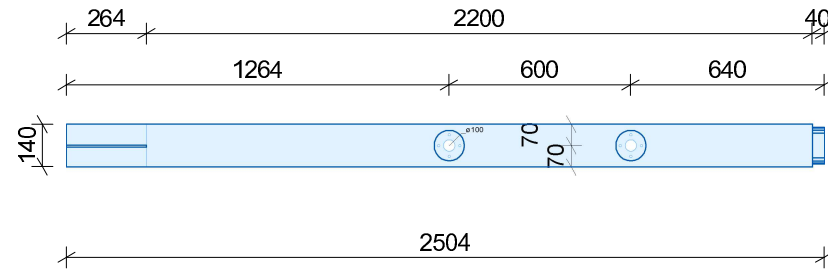
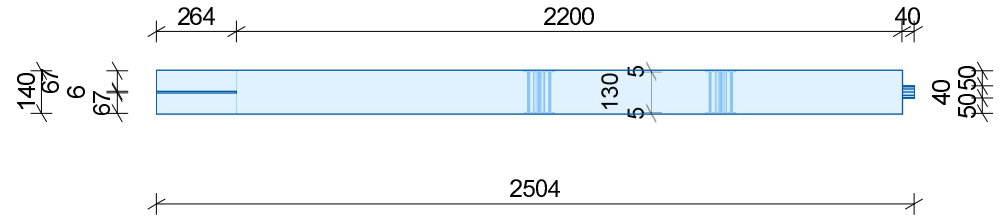

ČESKÁ
ZEMĚDĚLSKÁ
UNIVERZITA V PRAZE



DIPLOMOVÁ PRÁCE
WORKOUTOVÉ HRISTĚ

26.03.2018

ZPRACOVAL: Bc.TOMÁŠ GIEBL, DiS.
POZICE 71

M : 1 : 25.00

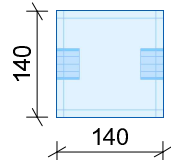
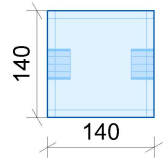
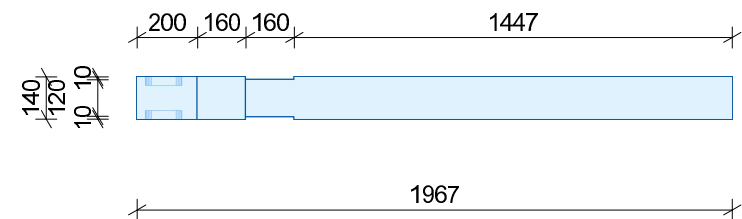
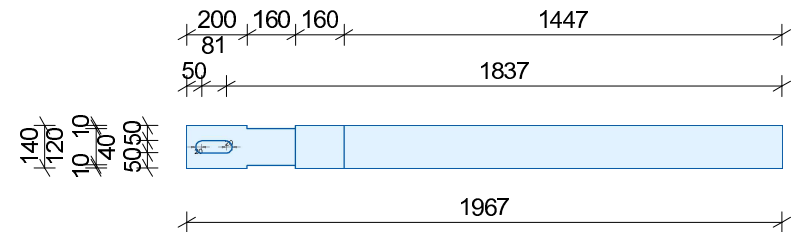
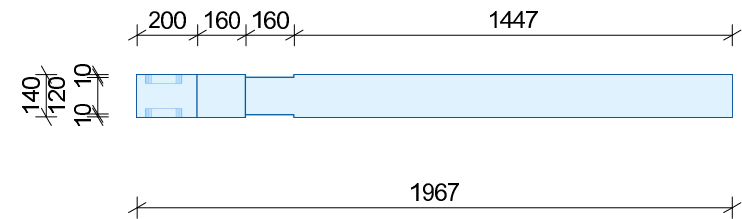
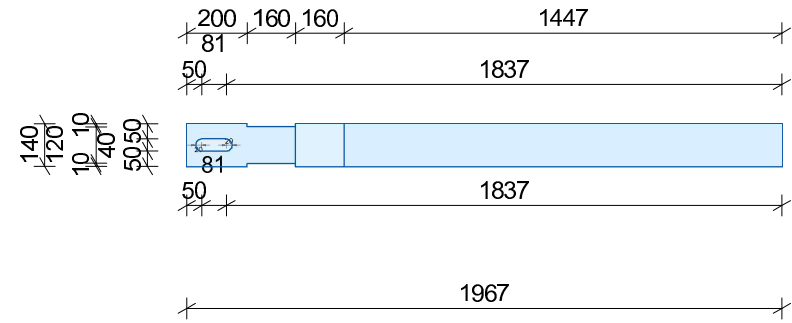

ČESKÁ
ZEMĚDĚLSKÁ
UNIVERZITA V PRAZE



SEMA
EXPERIENCE
Křídlo realizací

DIPLOMOVÁ PRÁCE
WORKOUTOVÉ HRISTĚ

26.03.2018

ZPRACOVAL: Bc. TOMÁŠ GIEBL, DiS.
POZICE 75

M : 1 : 25.00

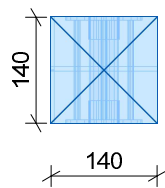
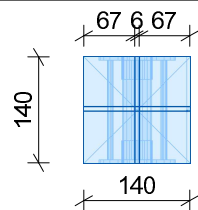
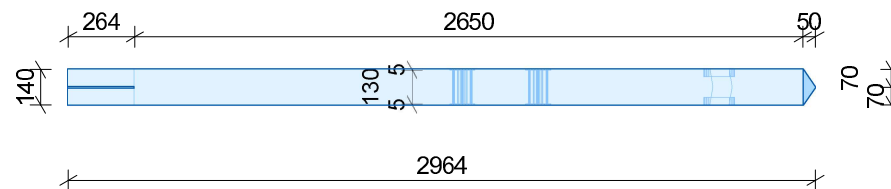
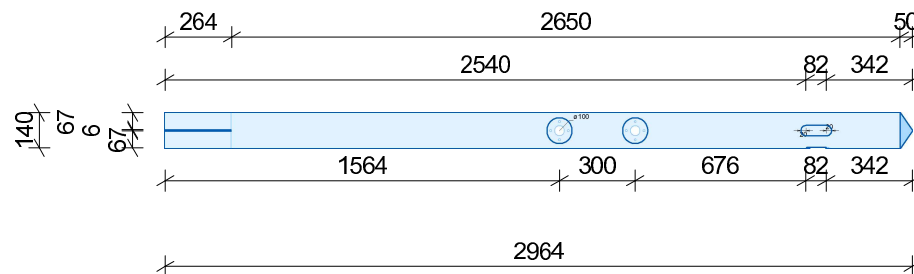
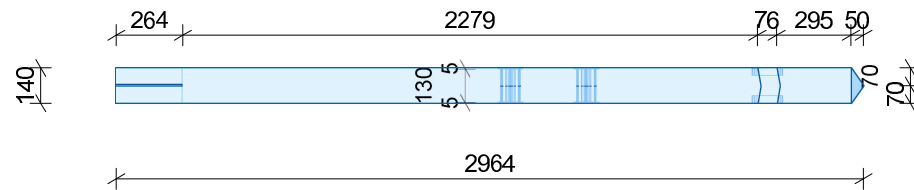

ČESKÁ
ZEMĚDĚLSKÁ
UNIVERZITA V PRAZE



DIPLOMOVÁ PRÁCE
WORKOUTOVÉ HRISTĚ

26.03.2018

ZPRACOVAL: Bc.TOMÁŠ GIEBL, DiS.
POZICE 76

M : 1 : 30.00

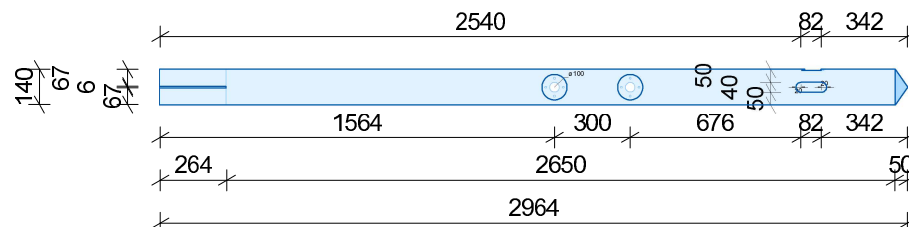

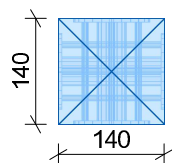
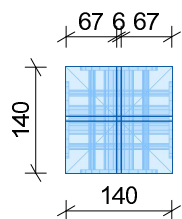
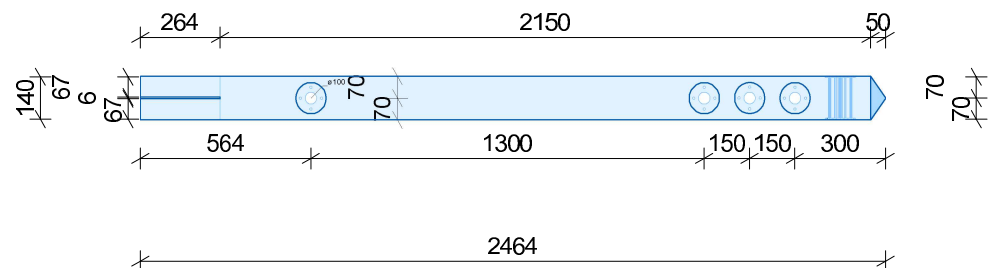
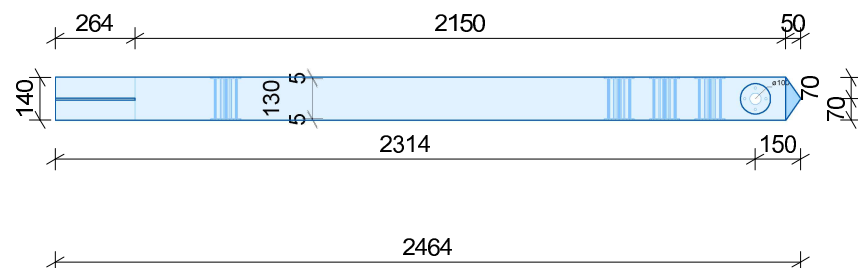
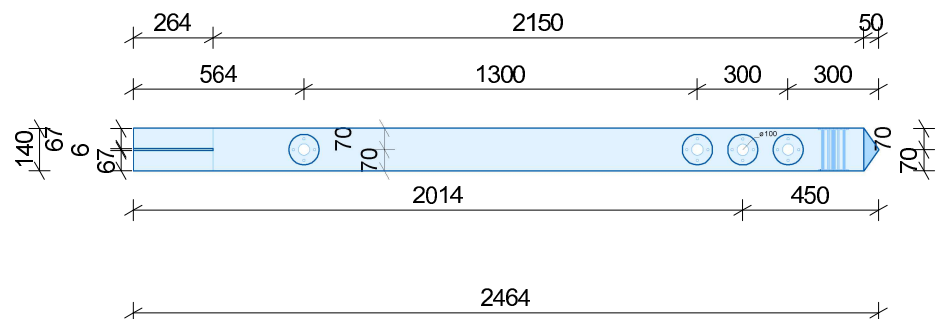
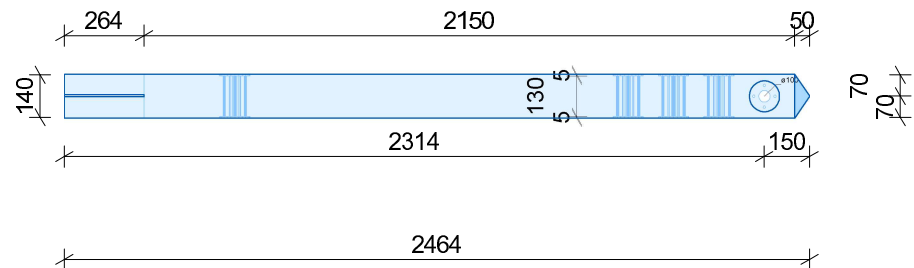

ČESKÁ
ZEMĚDĚLSKÁ
UNIVERZITA V PRAZE



SEMA
EXPERIENCE
by renowood

DIPLOMOVÁ PRÁCE
WORKOUTOVÉ HRISTĚ

26.03.2018

ZPRACOVAL: Bc. TOMÁŠ GIEBL, DiS.
POZICE 77

M : 1 : 25.00

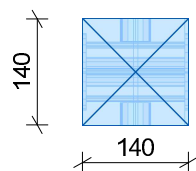
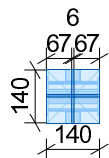
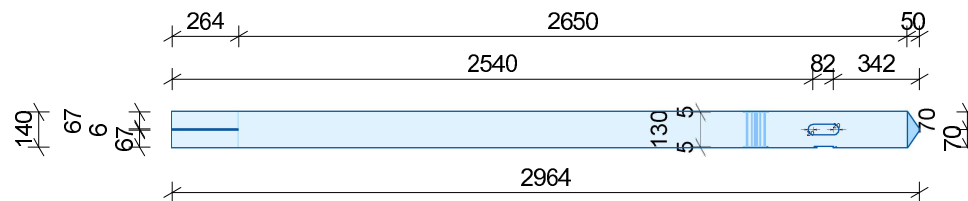
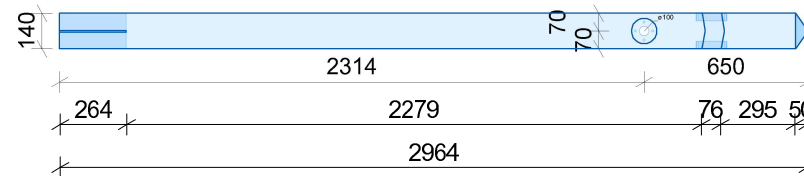
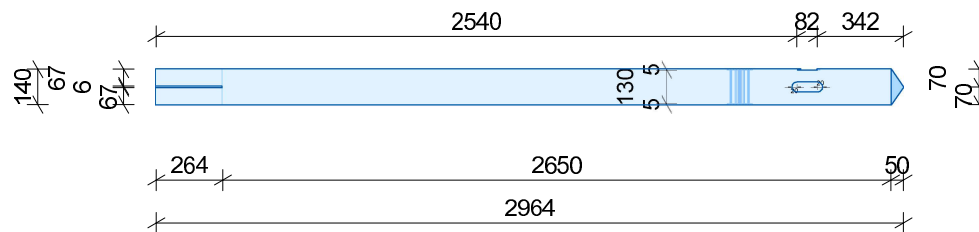
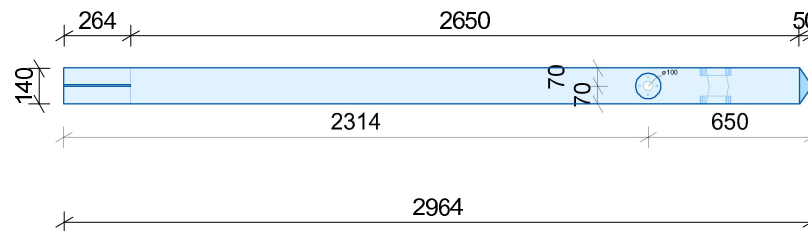

ČESKÁ
ZEMĚDĚLSKÁ
UNIVERZITA V PRAZE



SEMA
EXPERIENCE
149 pavlovod

DIPLOMOVÁ PRÁCE
WORKOUTOVÉ HRISTĚ

26.03.2018

ZPRACOVAL: Bc.TOMÁŠ GIEBL, DiS.
POZICE 78

M : 1 : 30.00

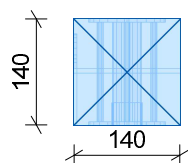
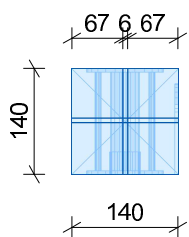
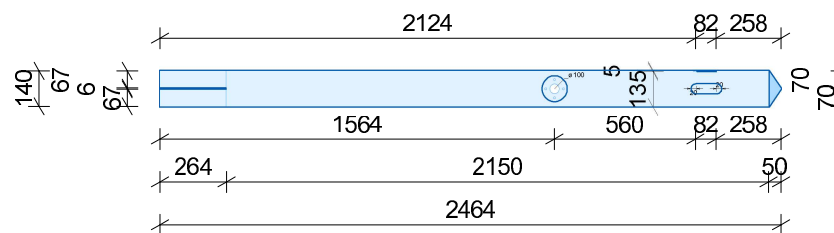
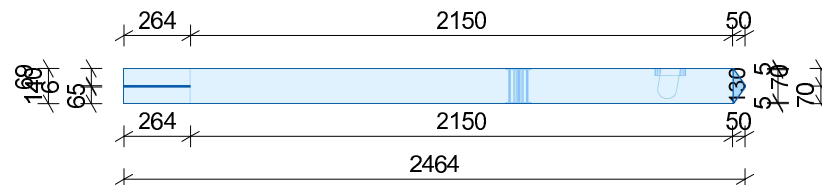
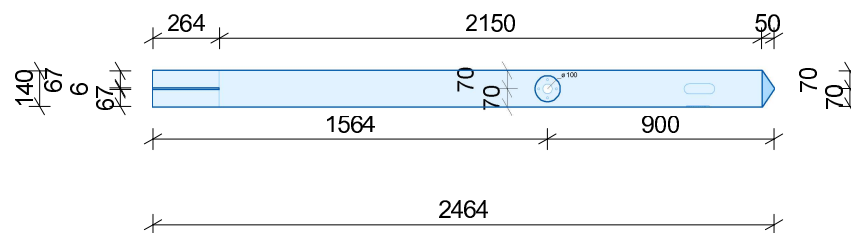
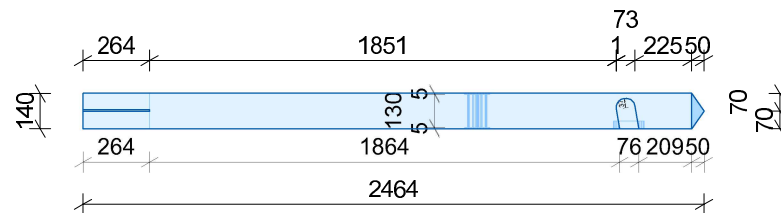

ČESKÁ
ZEMĚDĚLSKÁ
UNIVERZITA V PRAZE



SEMA
EXPERIENCE
AGRIUM

DIPLOMOVÁ PRÁCE
WORKOUTOVÉ HRISTĚ 26.03.2018

ZPRACOVAL: Bc.TOMÁŠ GIEBL, DiS.
POZICE 78

M : 1 : 30.00

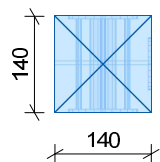
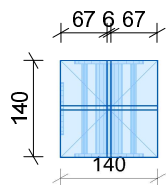
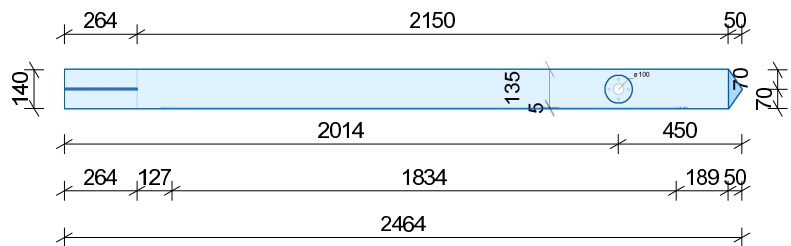
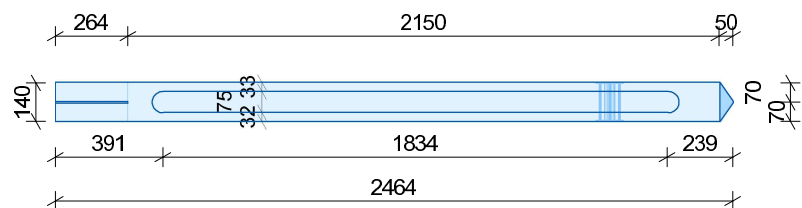
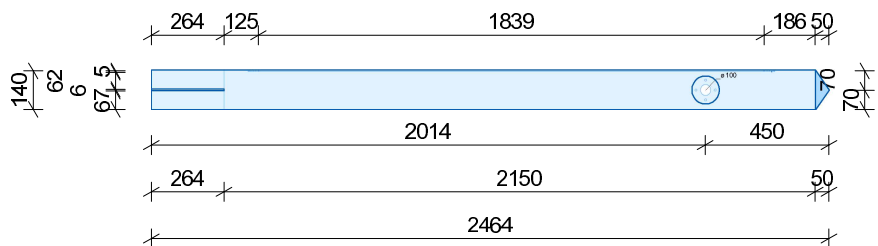
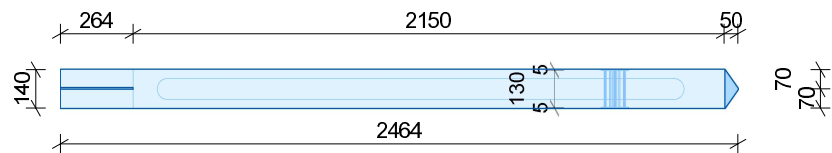

ČESKÁ
ZEMĚDĚLSKÁ
UNIVERZITA V PRAZE



SEMA
EXPERIENCE
Agri partner

DIPLOMOVÁ PRÁCE
WORKOUTOVÉ HRISTĚ

26.03.2018

ZPRACOVAL: Bc. TOMÁŠ GIEBL, DiS.
POZICE 80

M : 1 : 25,00

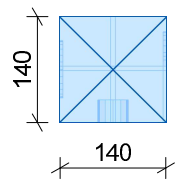
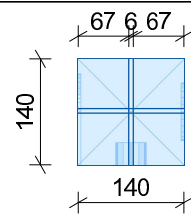
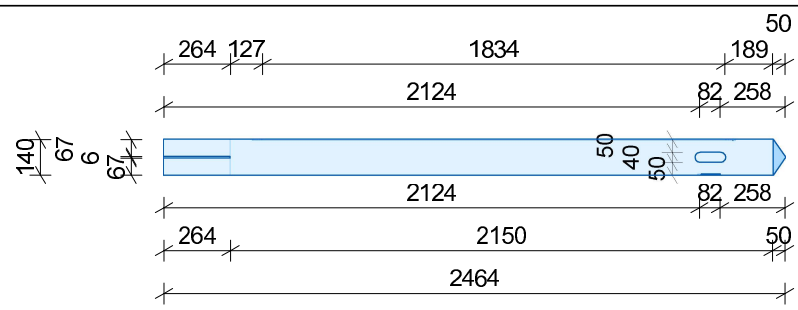
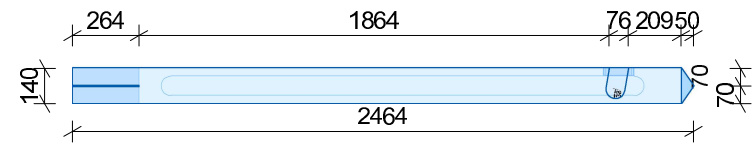
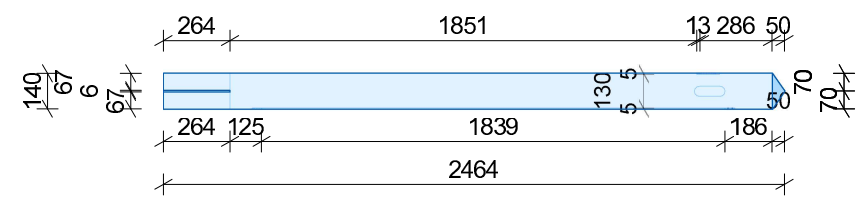
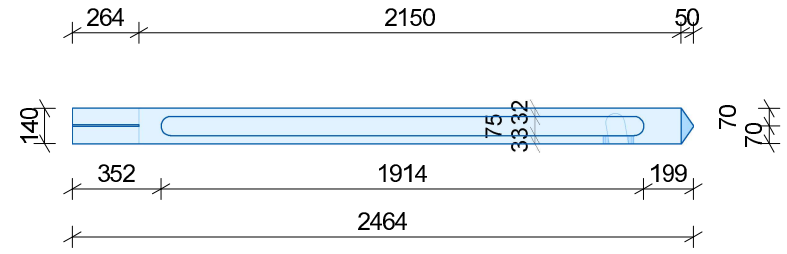

ČESKÁ ZEMĚDĚLSKÁ UNIVERZITA V PRAZE



DIPLOMOVÁ PRÁCE
WORKOUTOVÉ HRISTĚ 26.03.2018

ZPRACOVAL: Bc.TOMÁŠ GIEBL, DiS.
POZICE 81

M : 1 : 30.00

Logo of the Czech University of Agriculture in Prague.

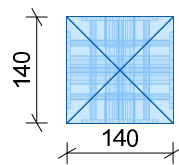
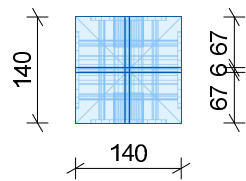
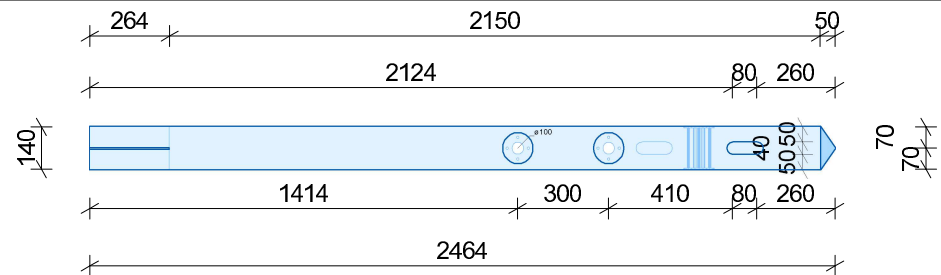
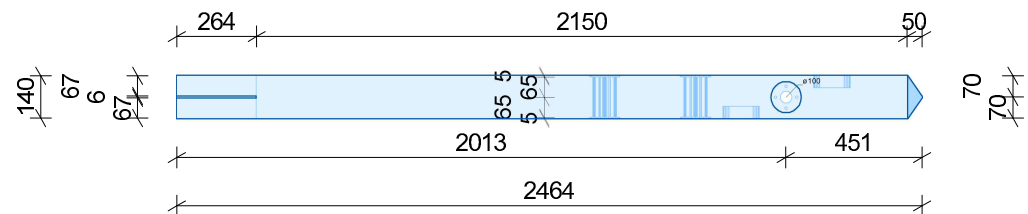
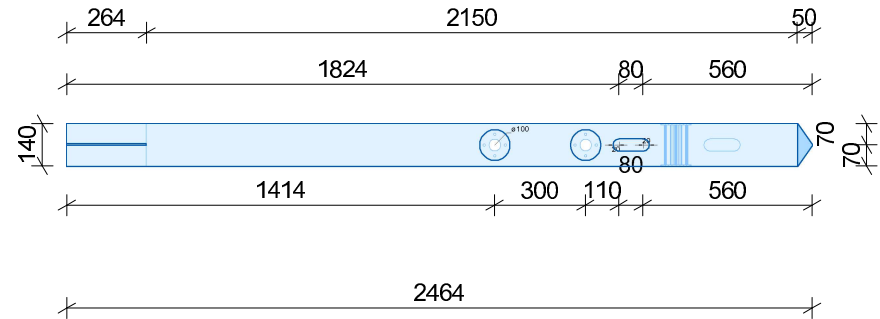
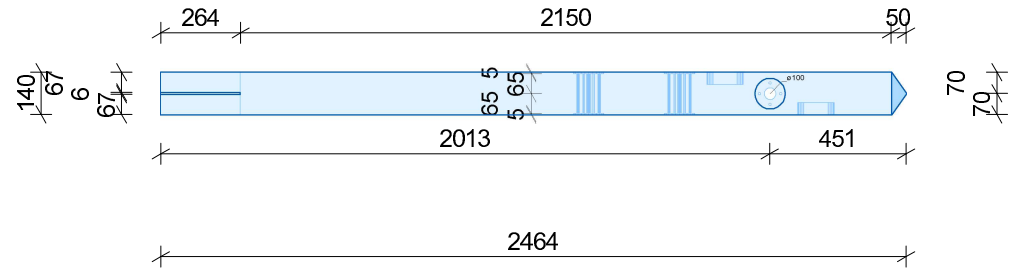

ČESKÁ
ZEMĚDĚLSKÁ
UNIVERZITA V PRAZE



DIPLOMOVÁ PRÁCE
WORKOUTOVÉ HRISTĚ 26.03.2018

ZPRACOVAL: Bc.TOMÁŠ GIEBL, DiS.
POZICE 86

M : 1 : 25.00

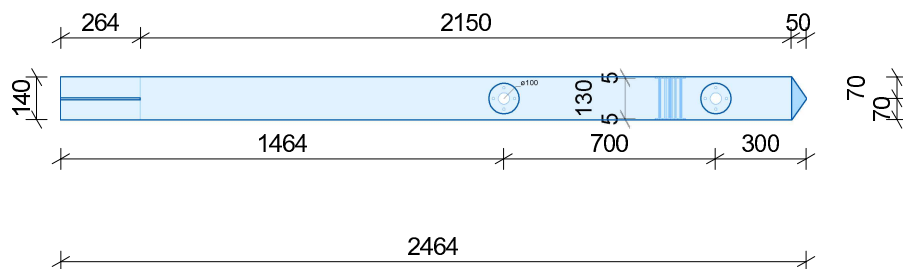
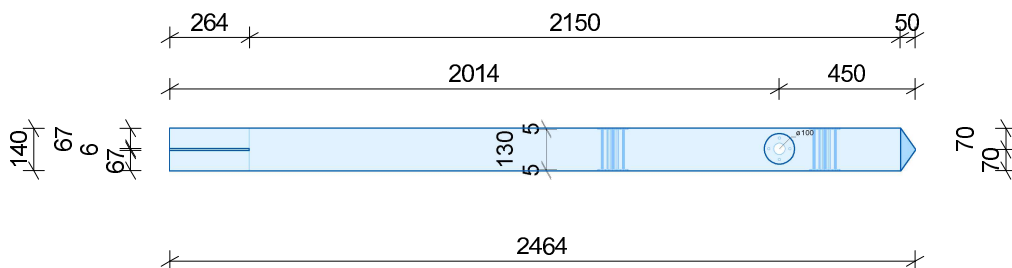
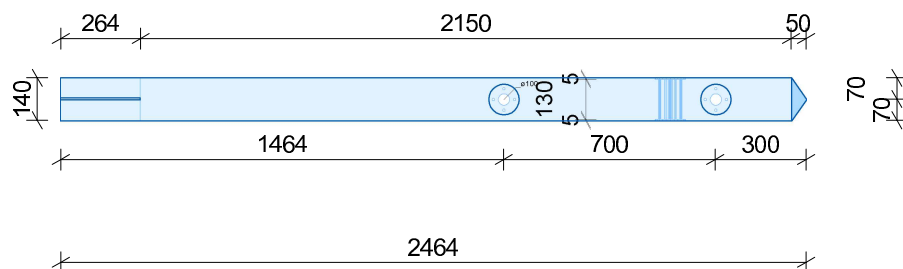
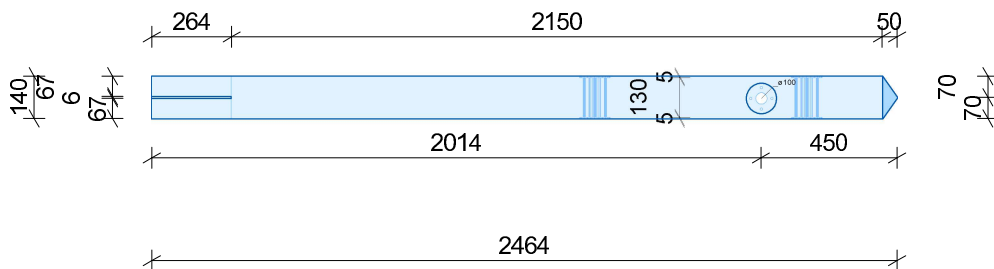
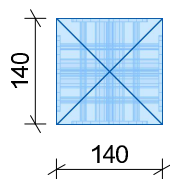
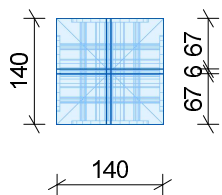

ČESKÁ
ZEMĚDĚLSKÁ
UNIVERZITA V PRAZE



SEMA
EXPERIENCE
Křídlo Pevnost

DIPLOMOVÁ PRÁCE
WORKOUTOVÉ HRISTĚ

26.03.2018

ZPRACOVAL: Bc.TOMÁŠ GIEBL, DiS.
POZICE 87

M : 1 : 25.00

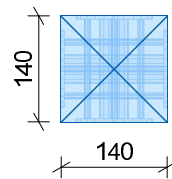
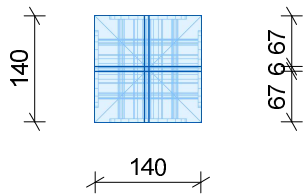
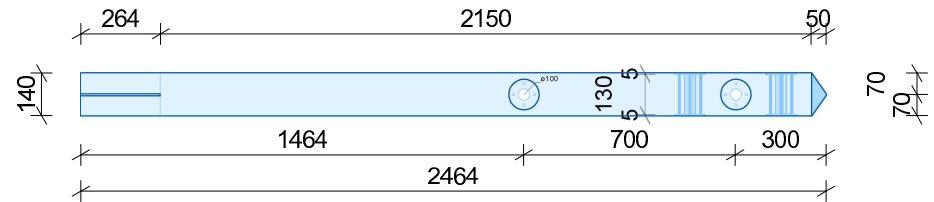
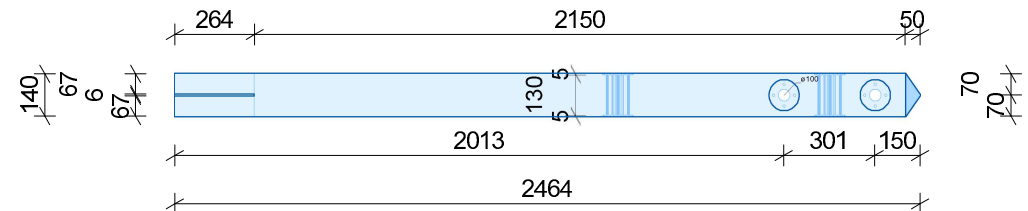
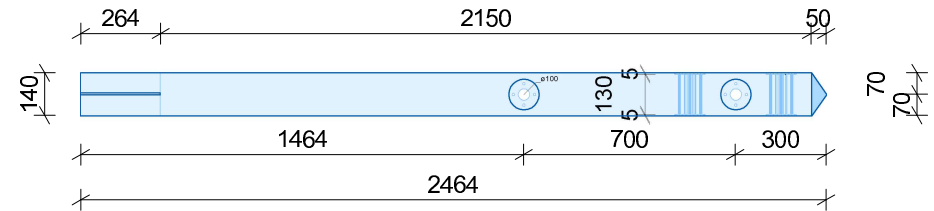
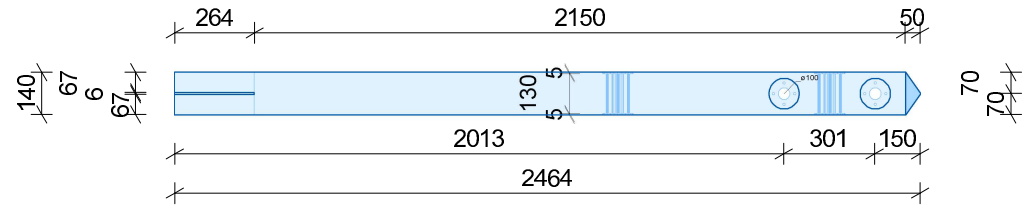

ČESKÁ
ZEMĚDĚLSKÁ
UNIVERZITA V PRAZE



SEMA
EXPERIENCE
Agri Research

DIPLOMOVÁ PRÁCE
WORKOUTOVÉ HRISTĚ 26.03.2018

ZPRACOVAL: Bc.TOMÁŠ GIEBL, DiS.
POZICE 88

M : 1 : 25.00

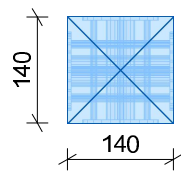
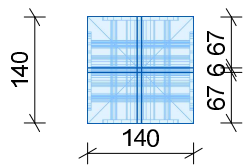
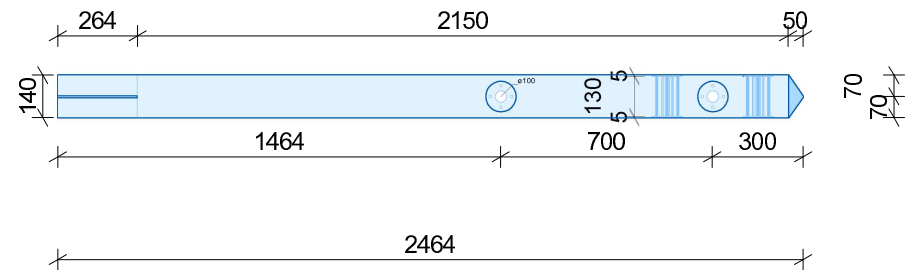
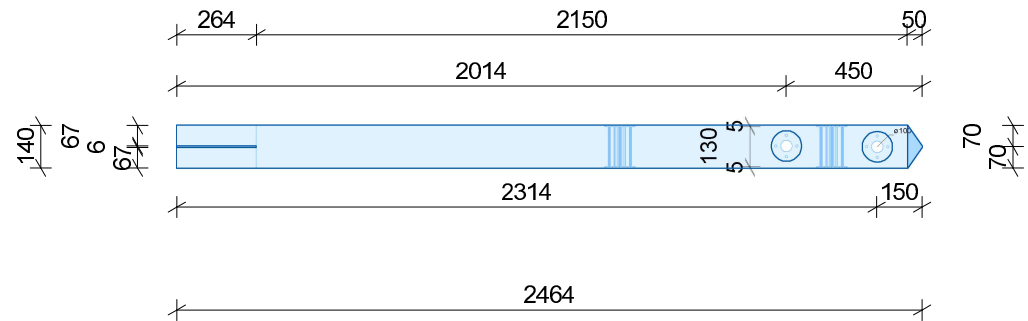
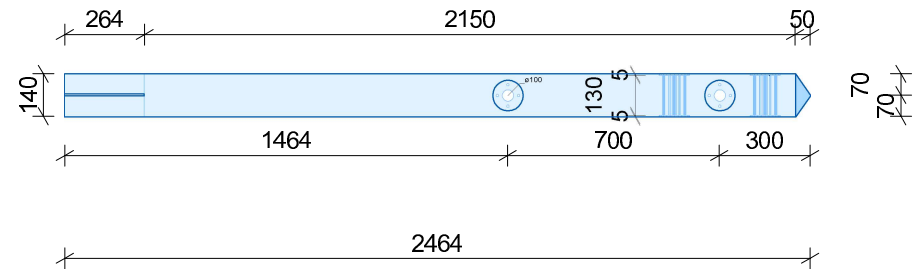
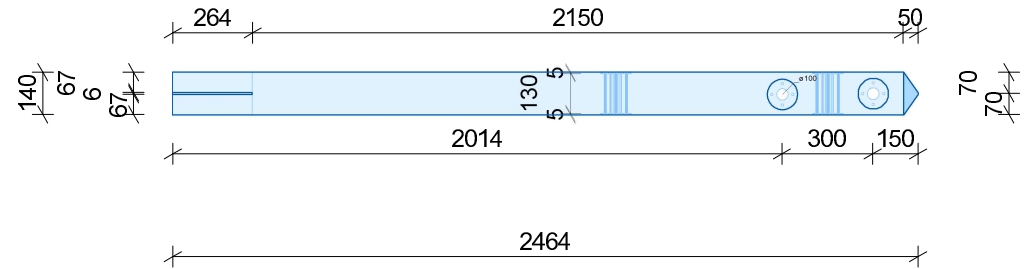

ČESKÁ
ZEMĚDĚLSKÁ
UNIVERZITA V PRAZE



SEMA
EXPERIENCE
Křídlo paravod

DIPLOMOVÁ PRÁCE
WORKOUTOVÉ HRISTĚ

26.03.2018

ZPRACOVAL: Bc. TOMÁŠ GIEBL, DiS.
POZICE 89

M : 1 : 25.00

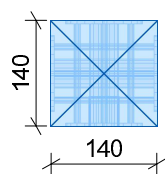
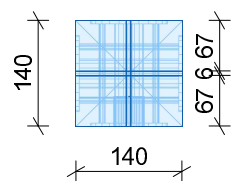
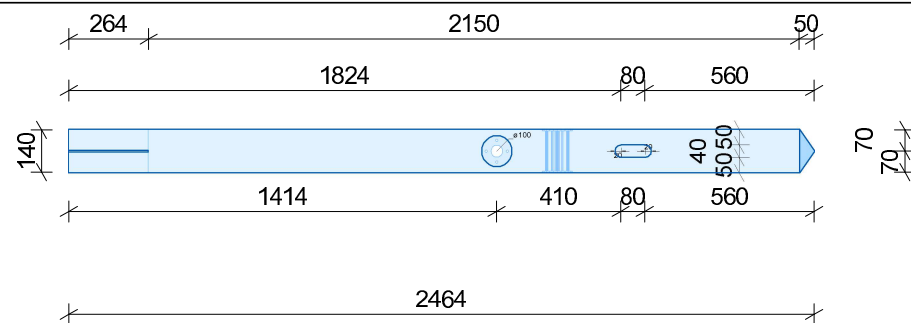
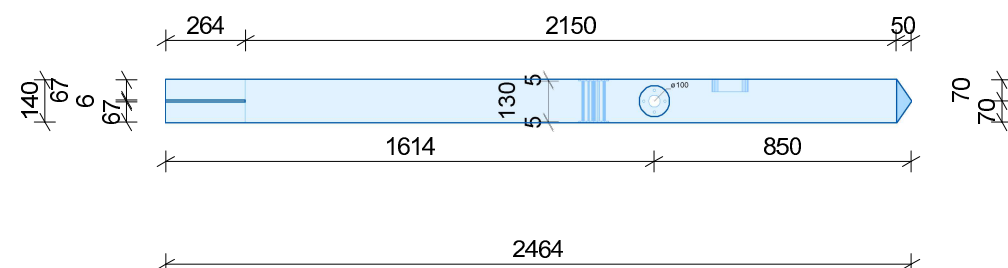
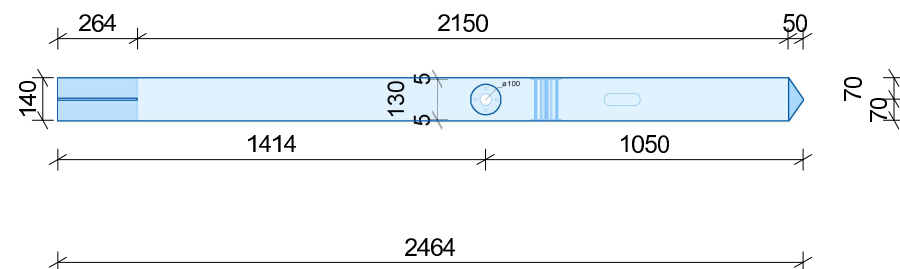
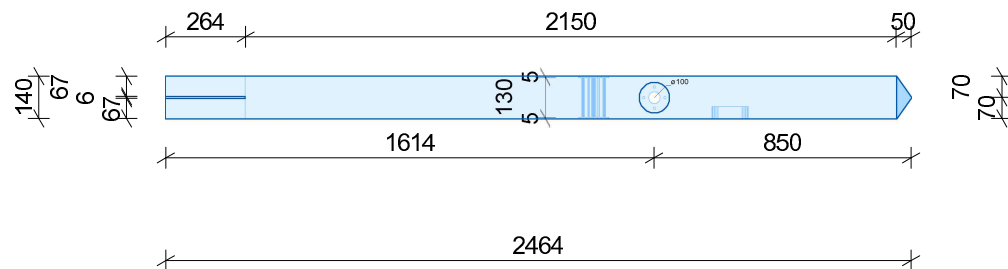

ČESKÁ
ZEMĚDĚLSKÁ
UNIVERZITA V PRAZE



DIPLOMOVÁ PRÁCE
WORKOUTOVÉ HRISTĚ

26.03.2018

ZPRACOVAL: Bc.TOMÁŠ GIEBL, DiS.
POZICE 90

M : 1 : 25.00

Logo rekonow

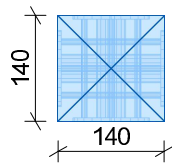
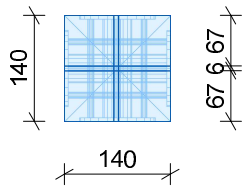

ČESKÁ
ZEMĚDĚLSKÁ
UNIVERZITA V PRAZE



SEMA
EXPERIENCE
404 PRAHA 4

DIPLOMOVÁ PRÁCE
WORKOUTOVÉ HRISTĚ

26.03.2018

ZPRACOVAL: Bc. TOMÁŠ GIEBL, DiS.
POZICE 91

M : 1 : 25.00

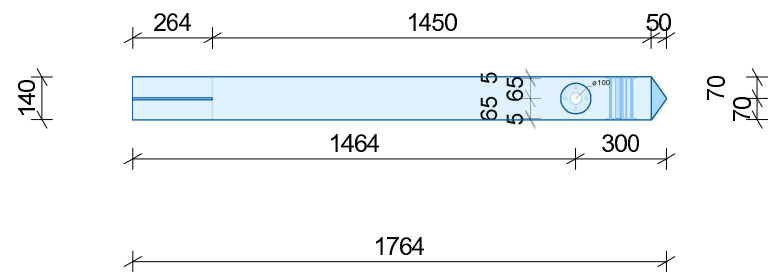
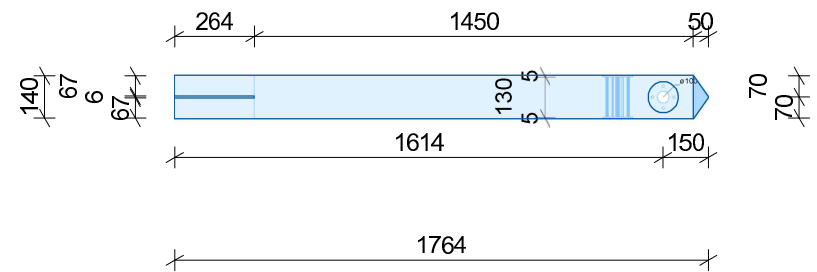
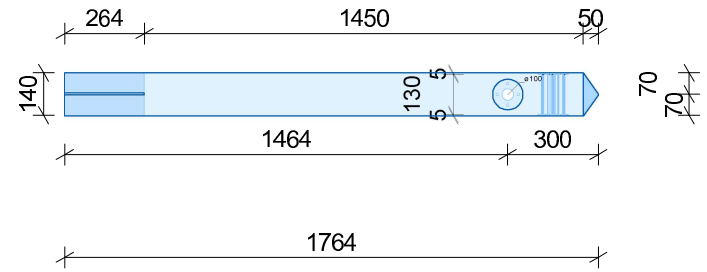
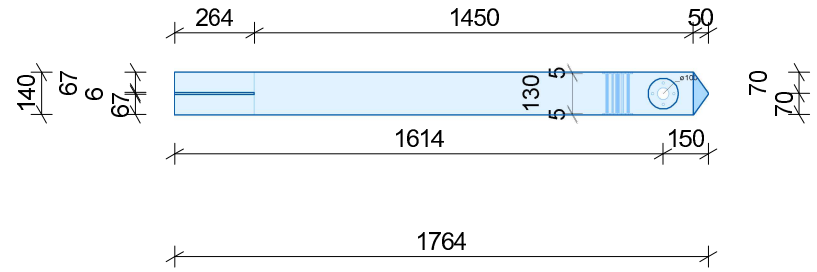

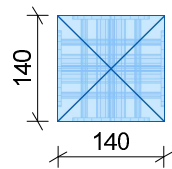
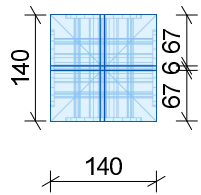
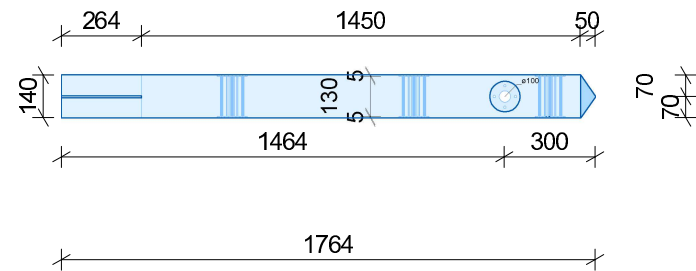
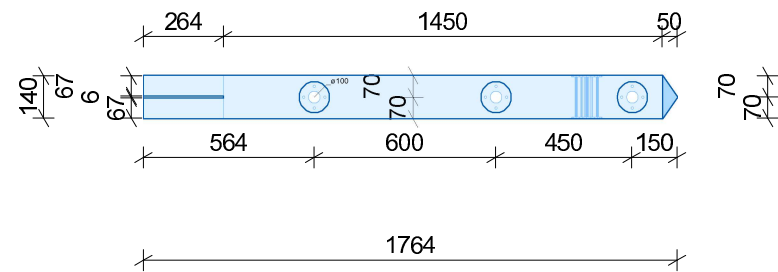
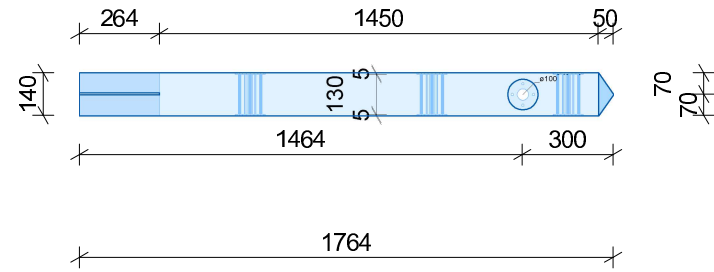
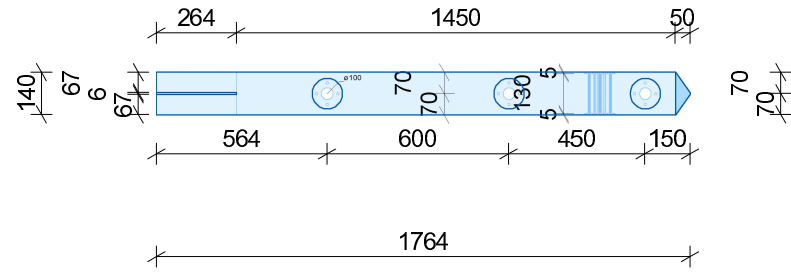

ČESKÁ
ZEMĚDĚLSKÁ
UNIVERZITA V PRAZE



SEMA
EXPERIENCE
149 PRAHA

DIPLOMOVÁ PRÁCE
WORKOUTOVÉ HRISTĚ

26.03.2018

ZPRACOVAL: Bc.TOMÁŠ GIEBL, DiS.
POZICE 92

M : 1 : 25.00

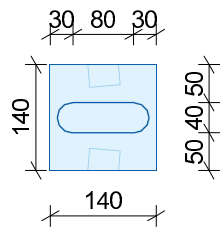
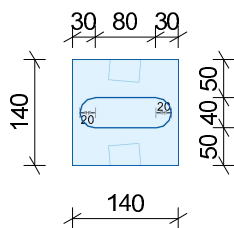
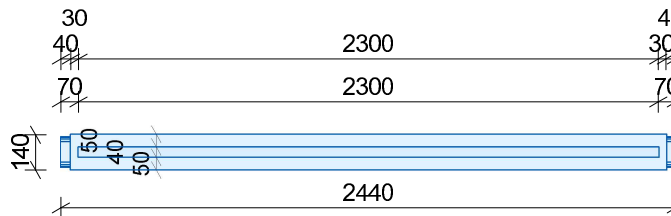
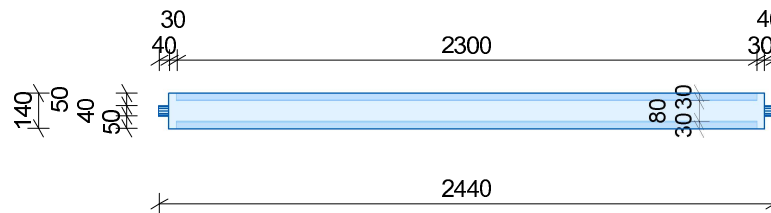
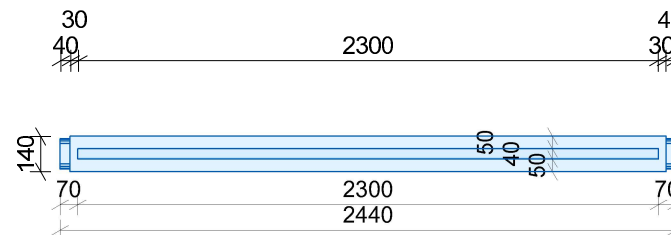
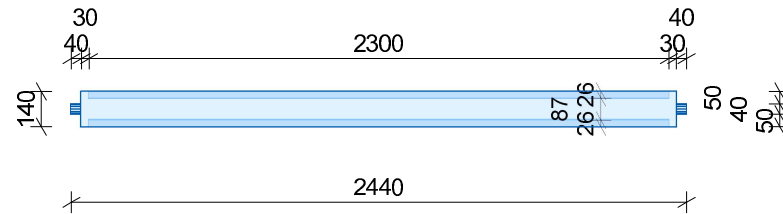
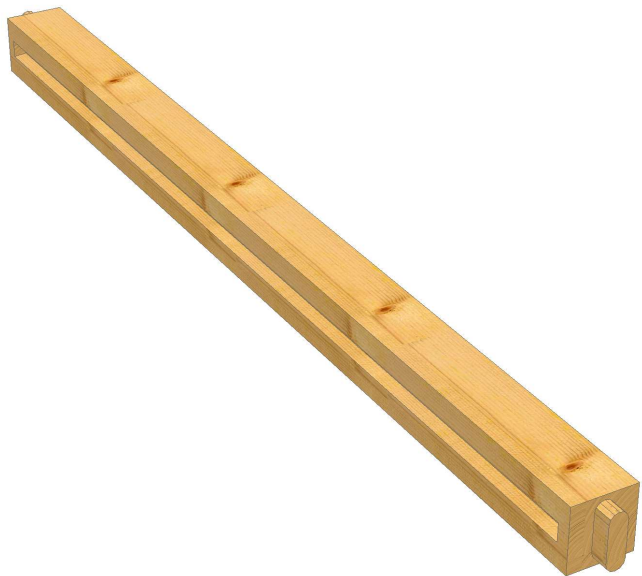

ČESKÁ
ZEMĚDĚLSKÁ
UNIVERZITA V PRAZE



SEMIA
EXPERIENCE
powered by

DIPLOMOVÁ PRÁCE
WORKOUTOVÉ HRISTĚ

26.03.2018

ZPRACOVAL: Bc.TOMÁŠ GIEBL, DiS.
POZICE 93

M : 1 : 30.00

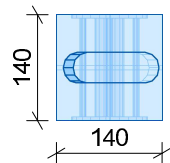
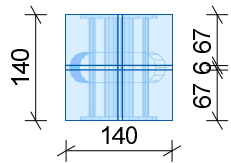
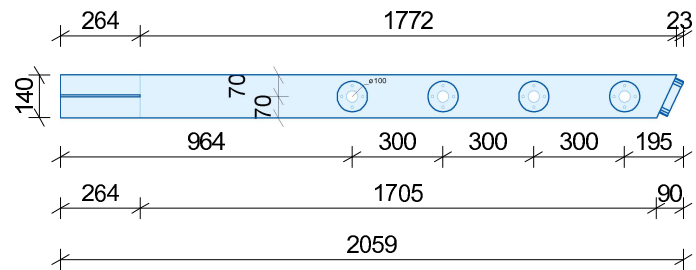
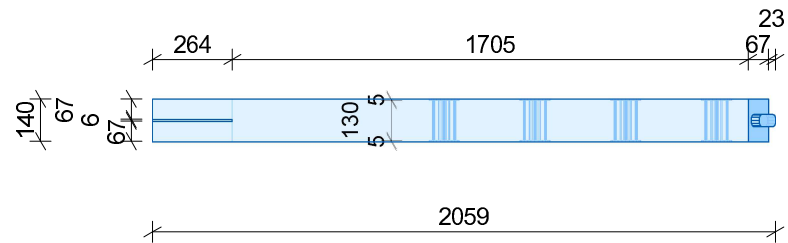
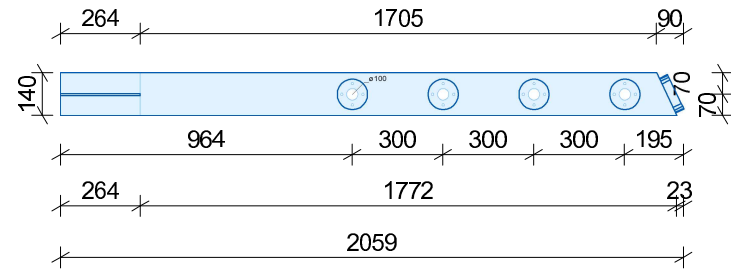
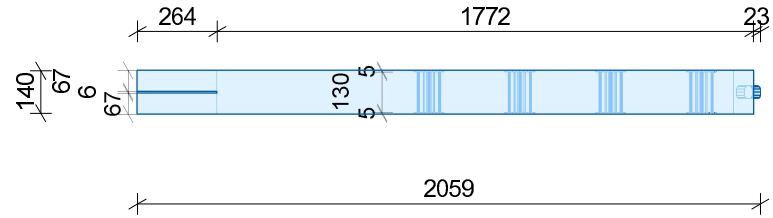

ČESKÁ
ZEMĚDĚLSKÁ
UNIVERZITA V PRAZE



SEMA
EXPERIENCE
Křídlo realizací

DIPLOMOVÁ PRÁCE
WORKOUTOVÉ HRISTĚ

26.03.2018

ZPRACOVAL: Bc. TOMÁŠ GIEBL, DiS.
POZICE 94

M : 1 : 25.00

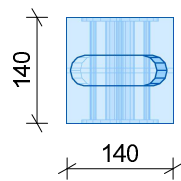
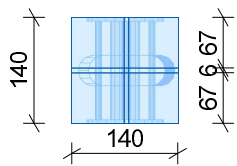
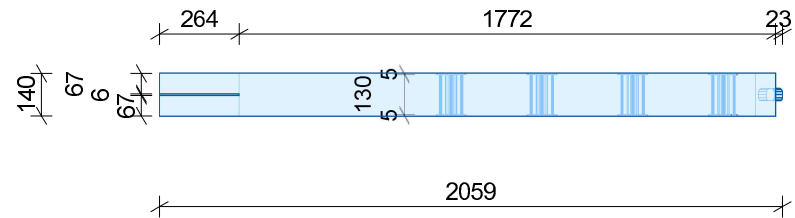
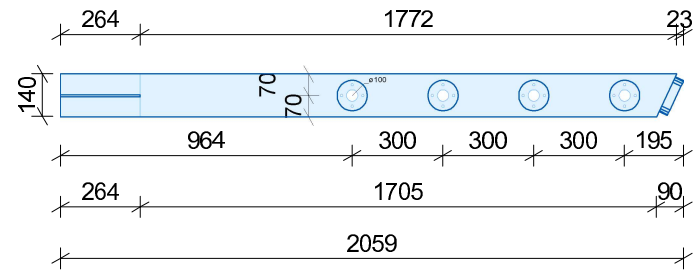
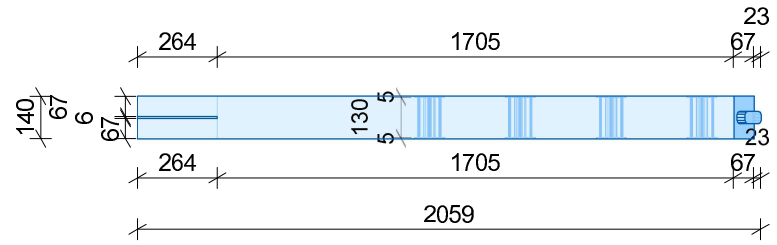

ČESKÁ
ZEMĚDĚLSKÁ
UNIVERZITA V PRAZE



SEMA
EXPERIENCE
powered by

DIPLOMOVÁ PRÁCE
WORKOUTOVÉ HRISTĚ

26.03.2018

ZPRACOVAL: Bc.TOMÁŠ GIEBL, DiS.
POZICE 95

M : 1 : 25.00

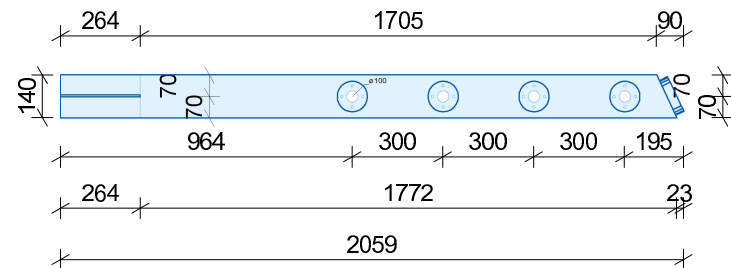

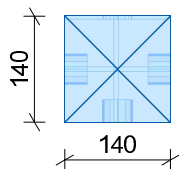
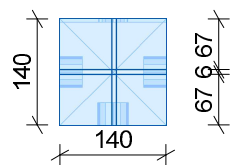
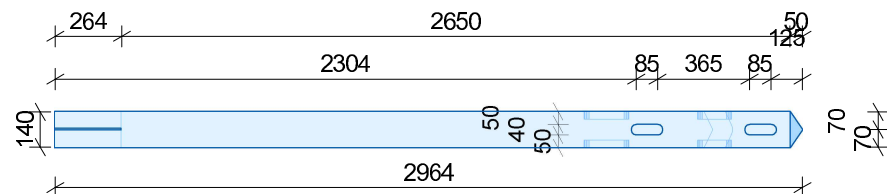
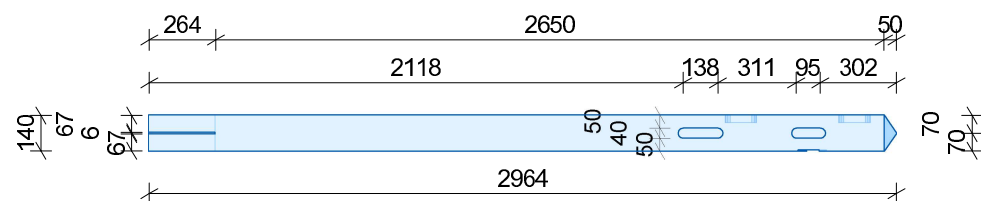
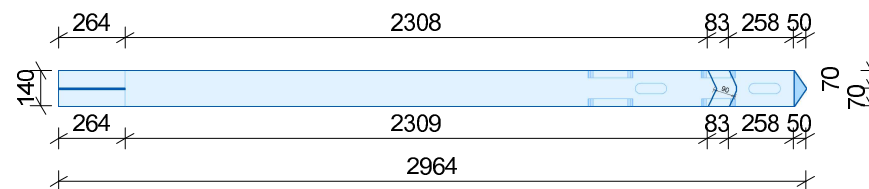
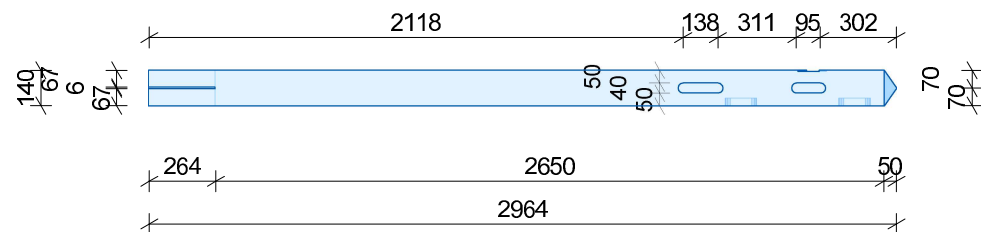

ČESKÁ
ZEMĚDĚLSKÁ
UNIVERZITA V PRAZE



SEMÁ
EXPERIENCE

DIPLOMOVÁ PRÁCE
WORKOUTOVÉ HRISTĚ

26.03.2018

ZPRACOVAL: Bc. TOMÁŠ GIEBL, DiS.
POZICE 96

M : 1 : 30.00

sq pavaaod

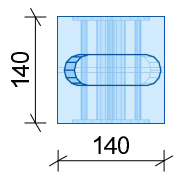
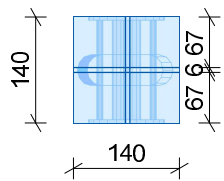
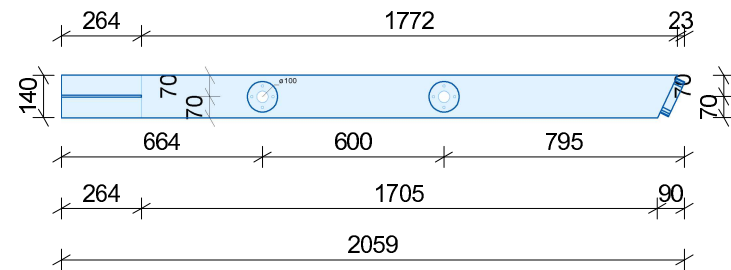
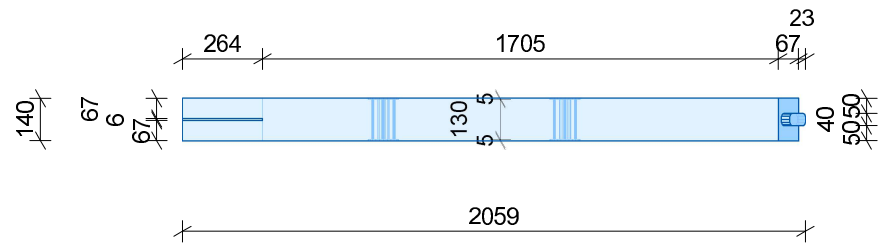
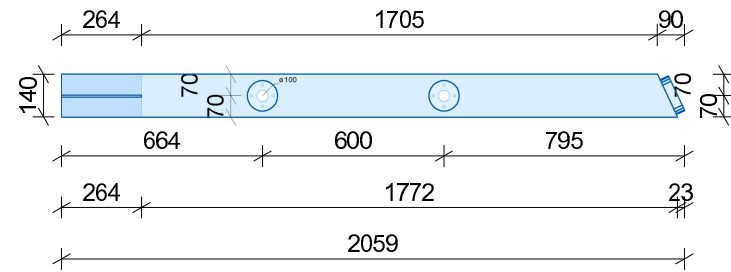
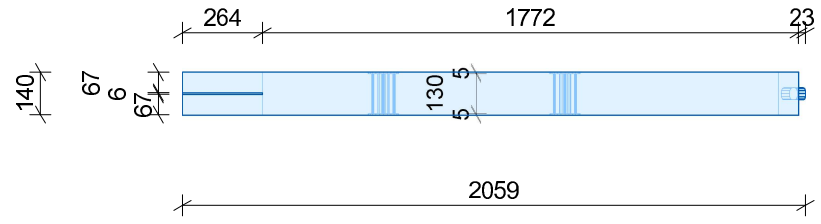

ČESKÁ
ZEMĚDĚLSKÁ
UNIVERZITA V PRAZE



SEMA
EXPERIENCE
Agrowood

DIPLOMOVÁ PRÁCE
WORKOUTOVÉ HRISTĚ

26.03.2018

ZPRACOVAL: Bc.TOMÁŠ GIEBL, DiS.
POZICE 97

M : 1 : 25.00

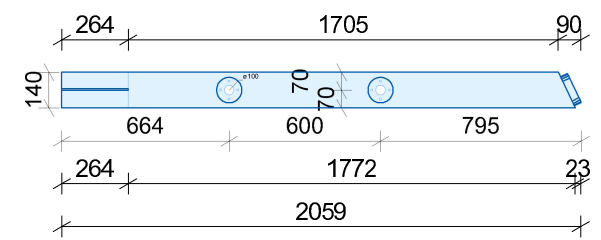
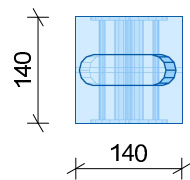
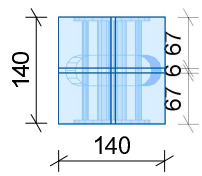
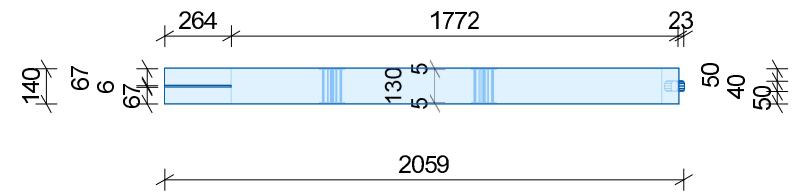
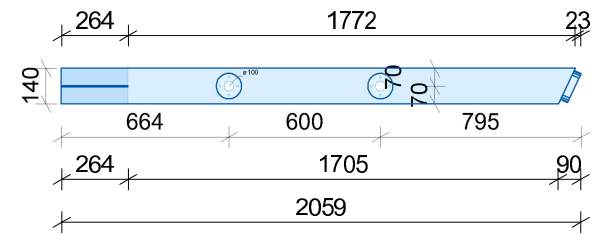
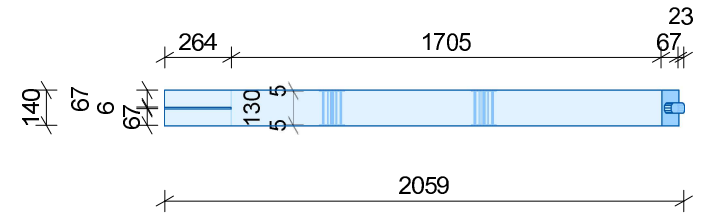

ČESKÁ
ZEMĚDĚLSKÁ
UNIVERZITA V PRAZE



SEMA
EXPERIENCE
Ag. partner

DIPLOMOVÁ PRÁCE
WORKOUTOVÉ HRISTĚ 26.03.2018

ZPRACOVAL: Bc.TOMÁŠ GIEBL, DiS.
POZICE 98

M : 1 : 30.00

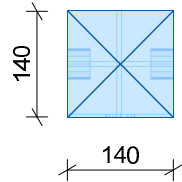
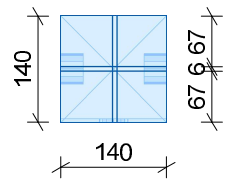
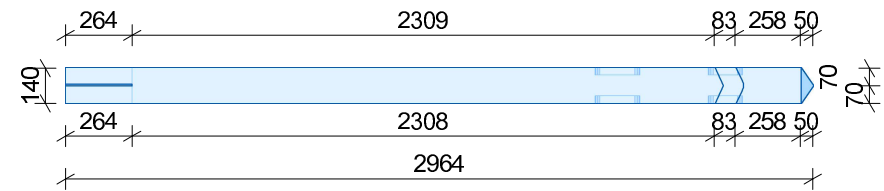
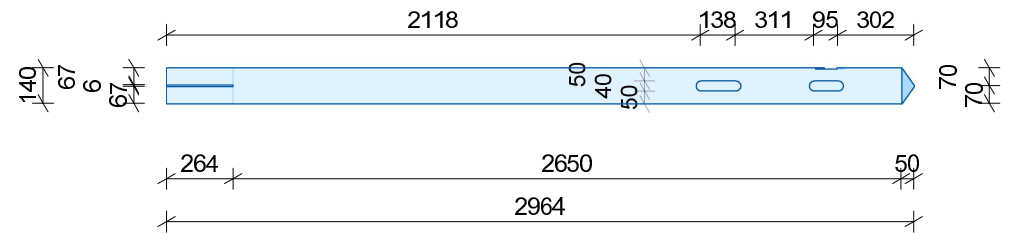
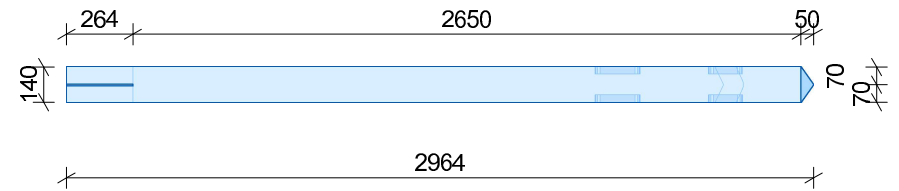
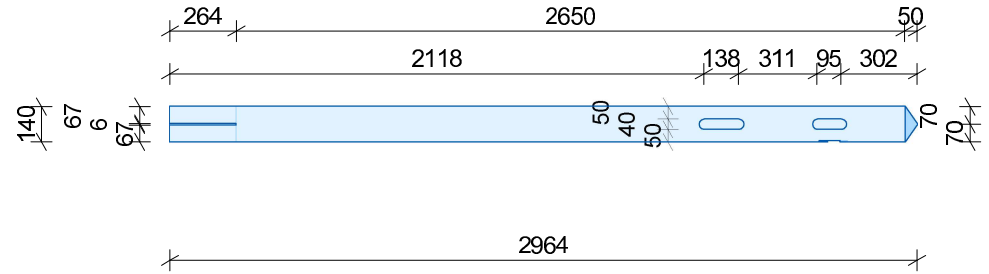

ČESKÁ
ZEMĚDĚLSKÁ
UNIVERZITA V PRAZE



SEMA
EXPERIENCE
149 PRAHA

DIPLOMOVÁ PRÁCE
WORKOUTOVÉ HRISTĚ 26.03.2018

ZPRACOVAL: Bc.TOMÁŠ GIEBL, DiS.
POZICE 99

M : 1 : 30.00

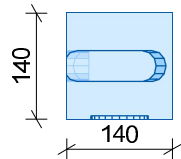
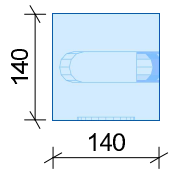
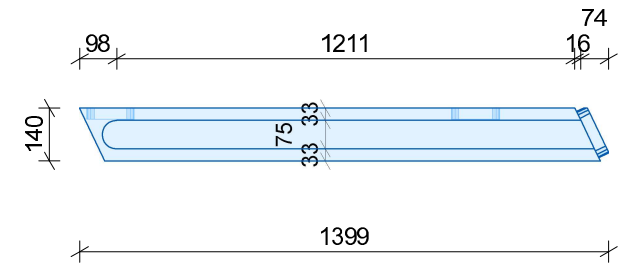
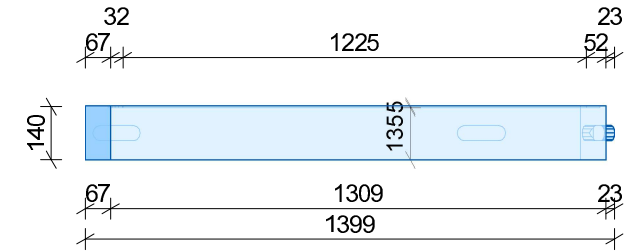
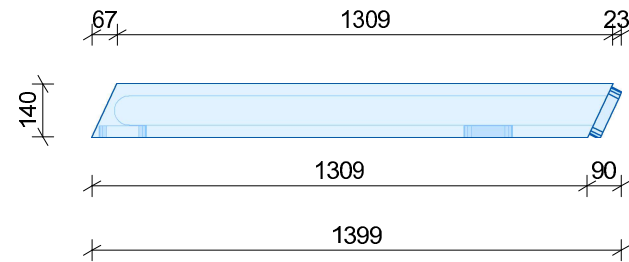
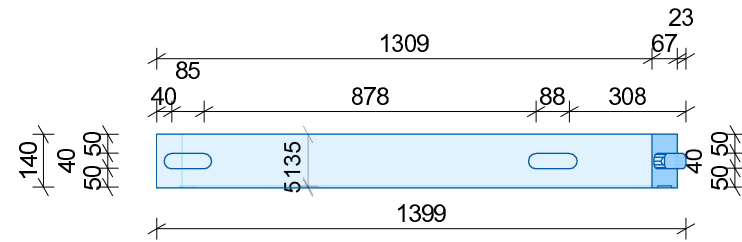

ČESKÁ
ZEMĚDĚLSKÁ
UNIVERZITA V PRAZE



SEMA
EXPERIENCE
Křídlo realizací

DIPLOMOVÁ PRÁCE
WORKOUTOVÉ HRISTĚ

27.03.2018

ZPRACOVAL: Bc.TOMÁŠ GIEBL, DiS.
POZICE 100, 110

M : 1 : 20.00

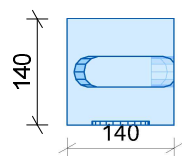
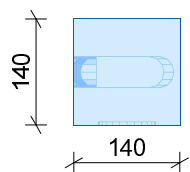
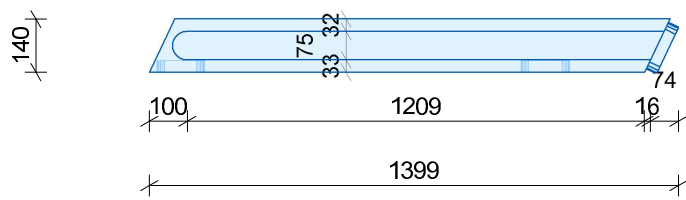
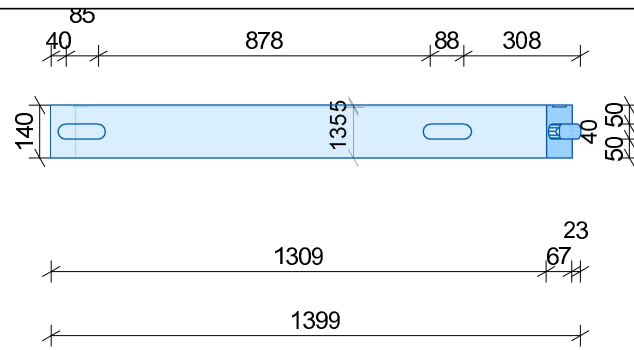
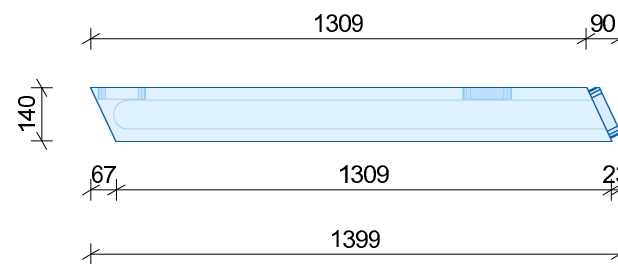
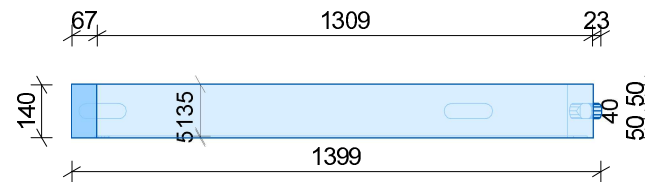
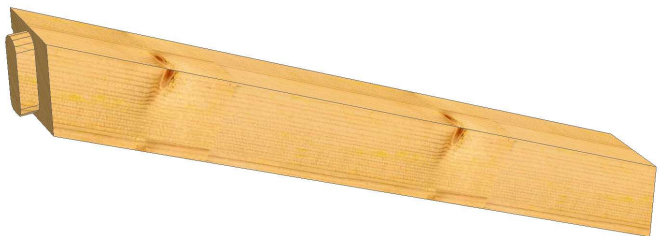

ČESKÁ
ZEMĚDĚLSKÁ
UNIVERZITA V PRAZE



SEMA
EXPERIENCE

DIPLOMOVÁ PRÁCE
WORKOUTOVÉ HRISTĚ 27.03.2018

ZPRACOVAL: Bc. TOMÁŠ GIEBL, DiS.
POZICE 101, 109

M : 1 : 20.00

by reawood

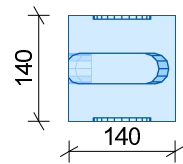
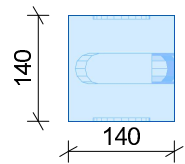
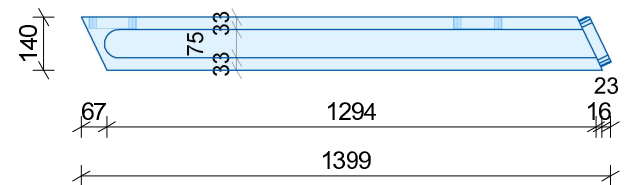
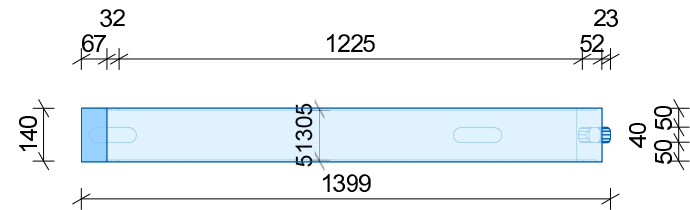
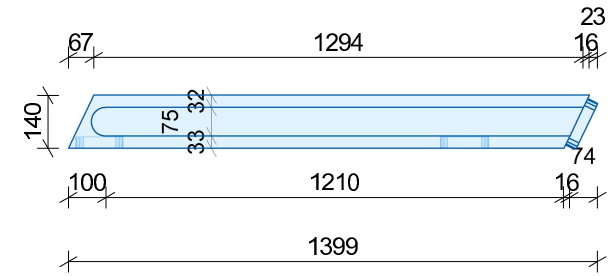
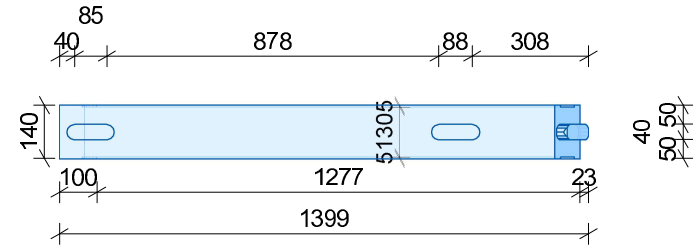

ČESKÁ
ZEMĚDĚLSKÁ
UNIVERZITA V PRAZE



DIPLOMOVÁ PRÁCE
WORKOUTOVÉ HRISTĚ

27.03.2018

ZPRACOVAL: Bc.TOMÁŠ GIEBL, DiS.
POZICE 107,108

M : 1 : 20.00

SEMA
EXPERIENCE
Křídlo realizací

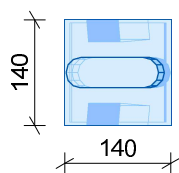
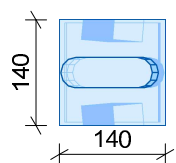
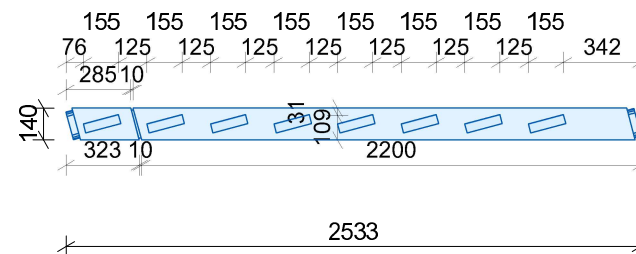
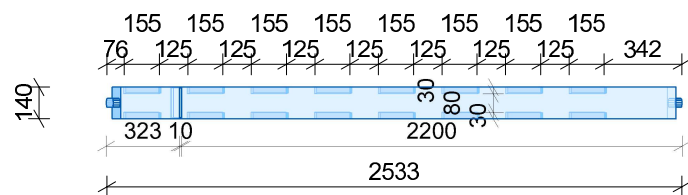
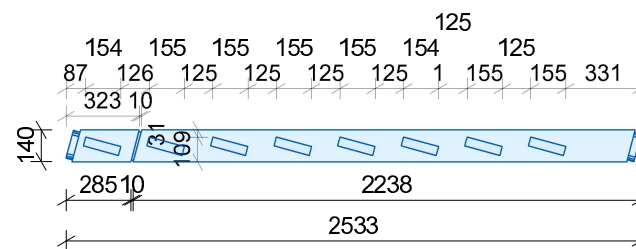
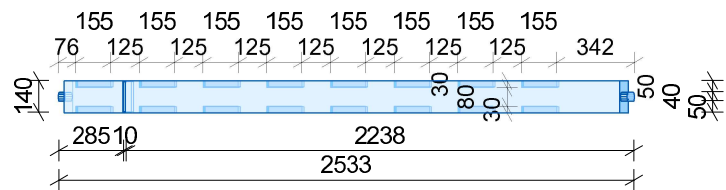

ČESKÁ
ZEMĚDĚLSKÁ
UNIVERZITA V PRAZE



SEMA
EXPERIENCE
Kdy rozumod

DIPLOMOVÁ PRÁCE
WORKOUTOVÉ HRISTĚ

27.03.2018

ZPRACOVAL: Bc.TOMÁŠ GIEBL, DiS.
POZICE 111

M : 1 : 33.33

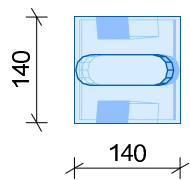
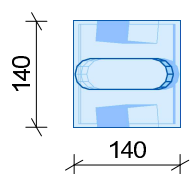
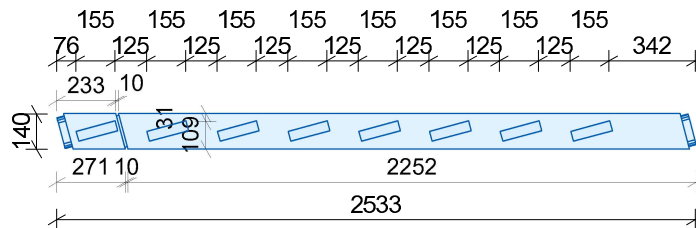
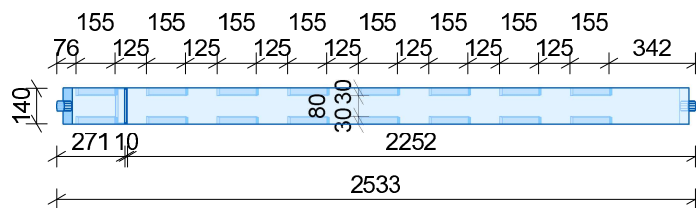
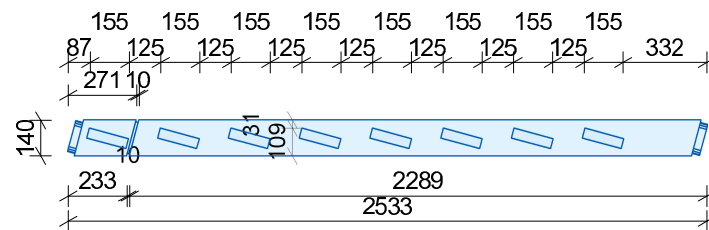
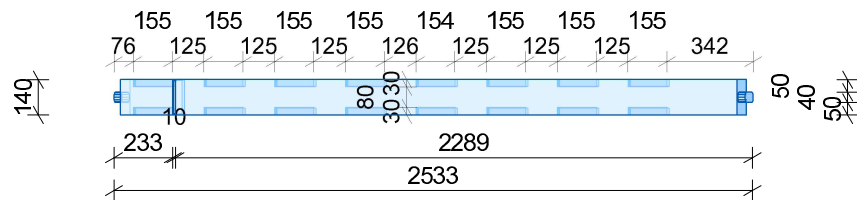

ČESKÁ
ZEMĚDĚLSKÁ
UNIVERZITA V PRAZE



SEMA
EXPERIENCE

DIPLOMOVÁ PRÁCE
WORKOUTOVÉ HRISTĚ

27.03.2018

ZPRACOVAL: Bc.TOMÁŠ GIEBL, DiS.
POZICE 112

M : 1 : 30.00

Logo of the company.

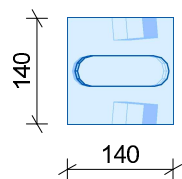
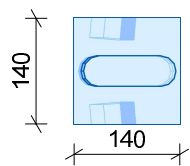
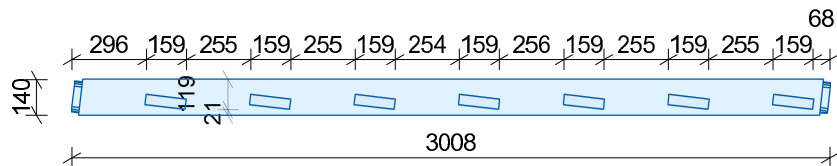
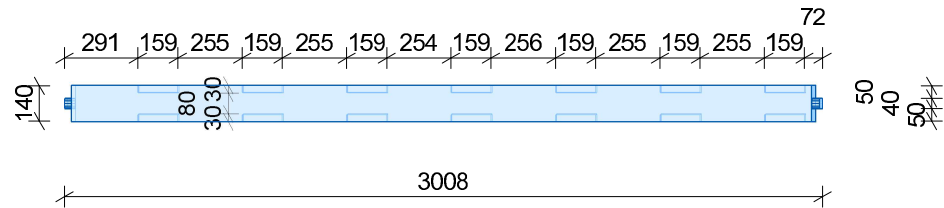
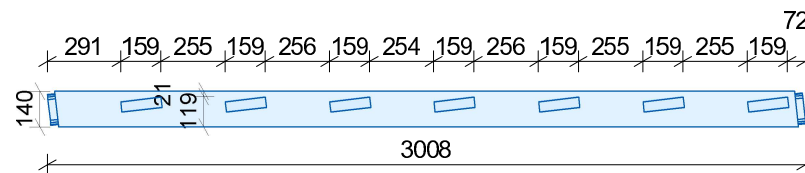
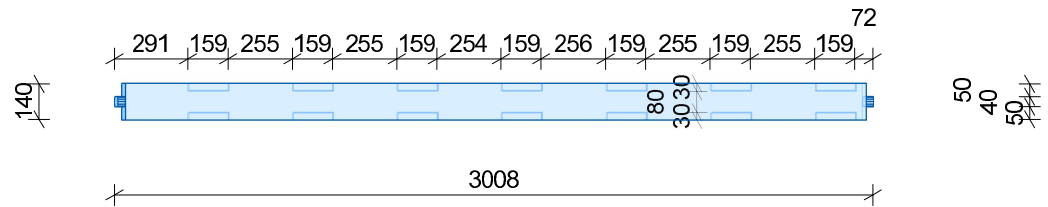

ČESKÁ ZEMĚDĚLSKÁ UNIVERZITA V PRAZE



DIPLOMOVÁ PRÁCE
WORKOUTOVÉ HRISTĚ 27.03.2018

ZPRACOVAL: Bc.TOMÁŠ GIEBL, DiS.
POZICE 113

M : 1 : 30.00

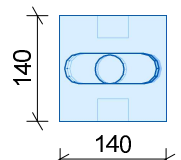
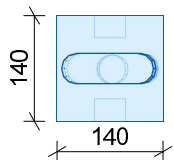
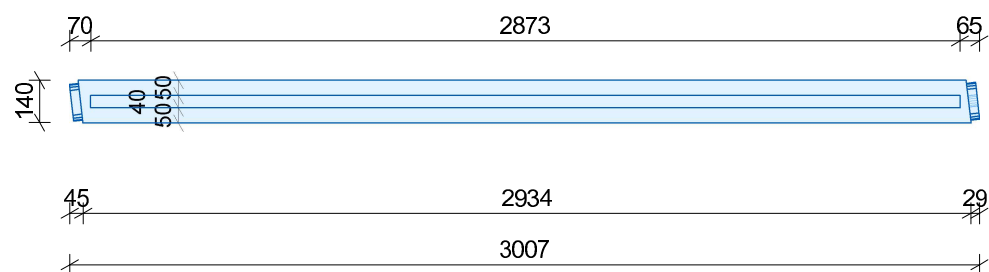
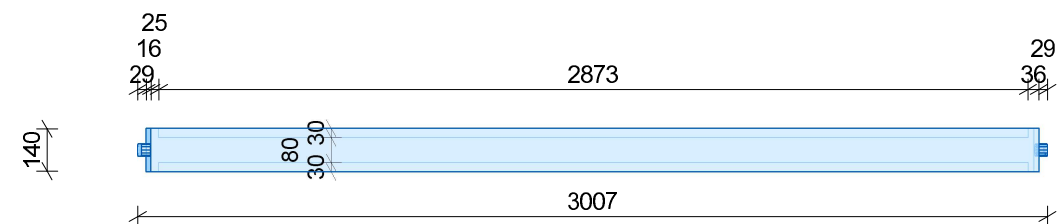
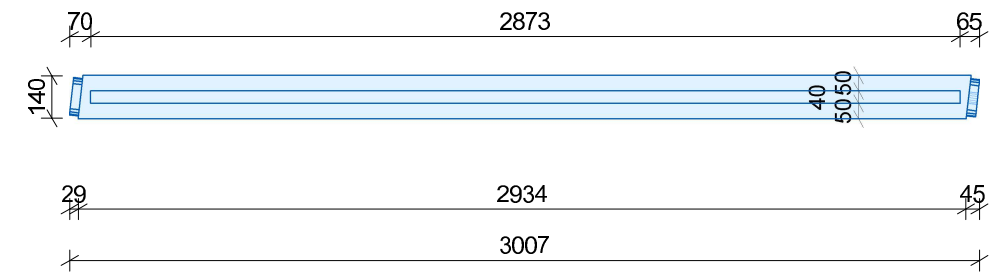
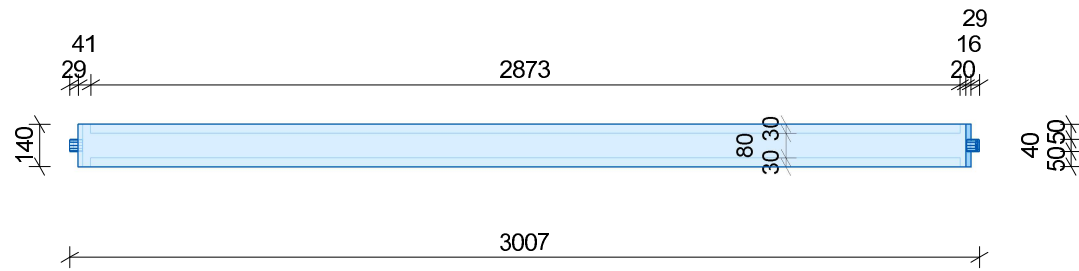
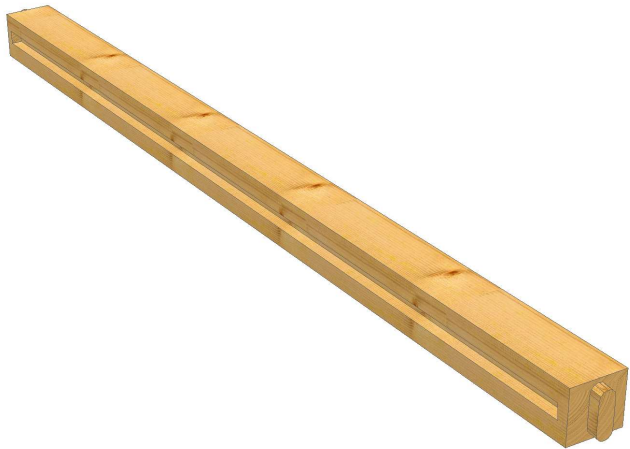

ČESKÁ
ZEMĚDĚLSKÁ
UNIVERZITA V PRAZE



SEMA
EXPERIENCE
149 pavlovod

DIPLOMOVÁ PRÁCE
WORKOUTOVÉ HRISTĚ 27.03.2018

ZPRACOVAL: Bc.TOMÁŠ GIEBL, DiS.
POZICE 114

M : 1 : 25.00

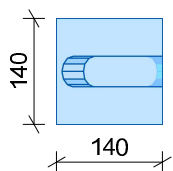
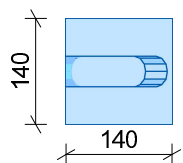
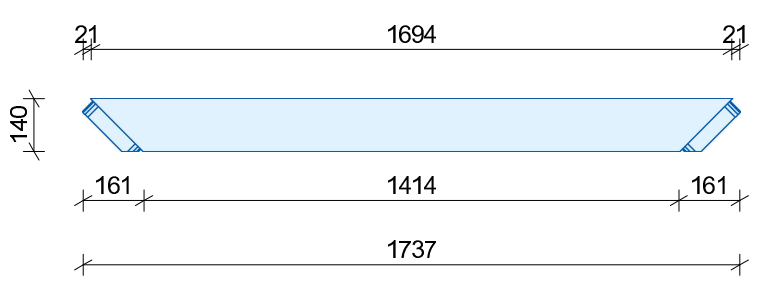
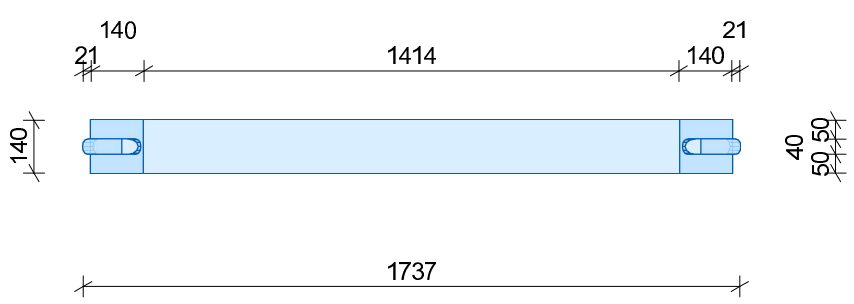
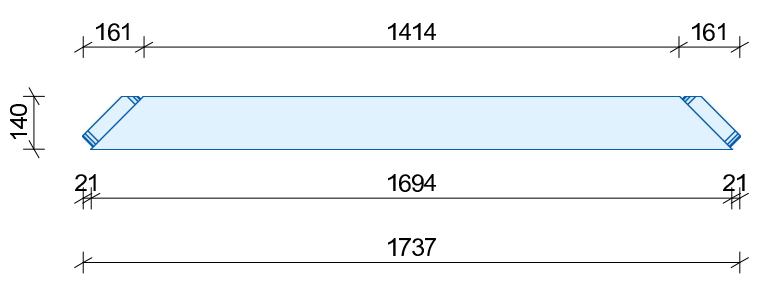
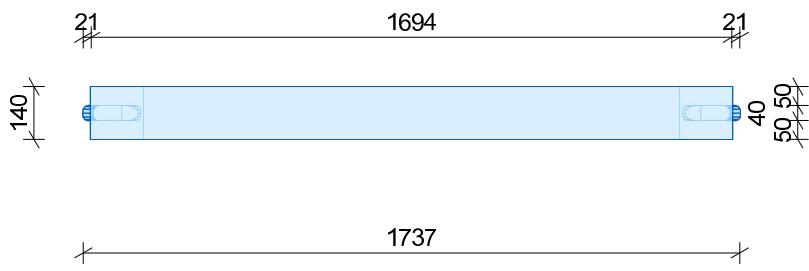

ČESKÁ
ZEMĚDĚLSKÁ
UNIVERZITA V PRAZE



SEMA
EXPERIENCE
409 PRAHA

DIPLOMOVÁ PRÁCE
WORKOUTOVÉ HRISTĚ

27.03.2018

ZPRACOVAL: Bc.TOMÁŠ GIEBL, DiS.
POZICE 115, 116

M : 1 : 20.00

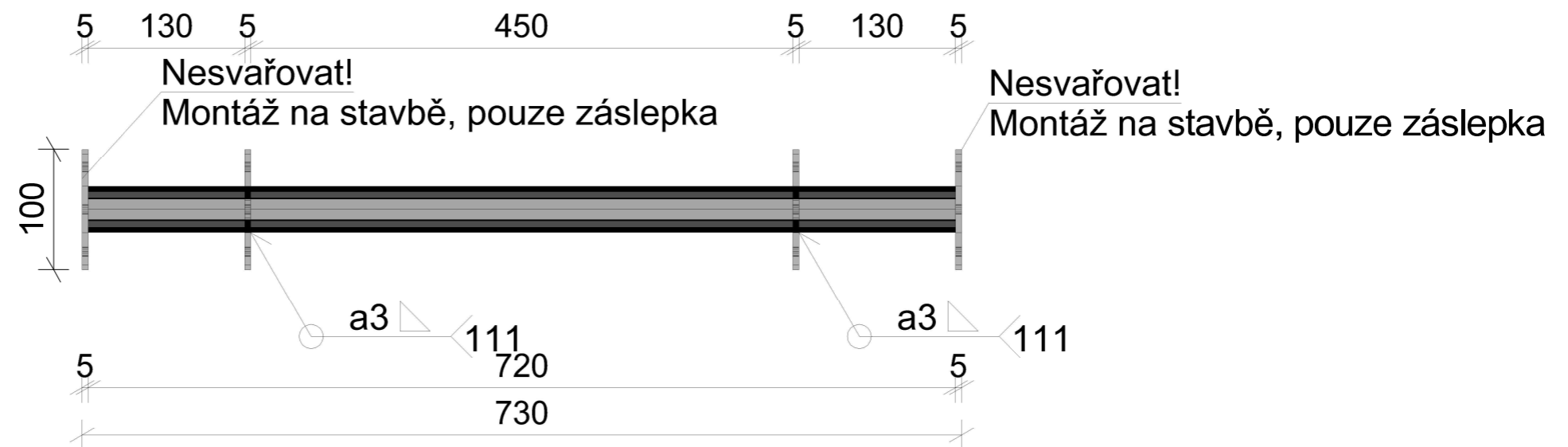
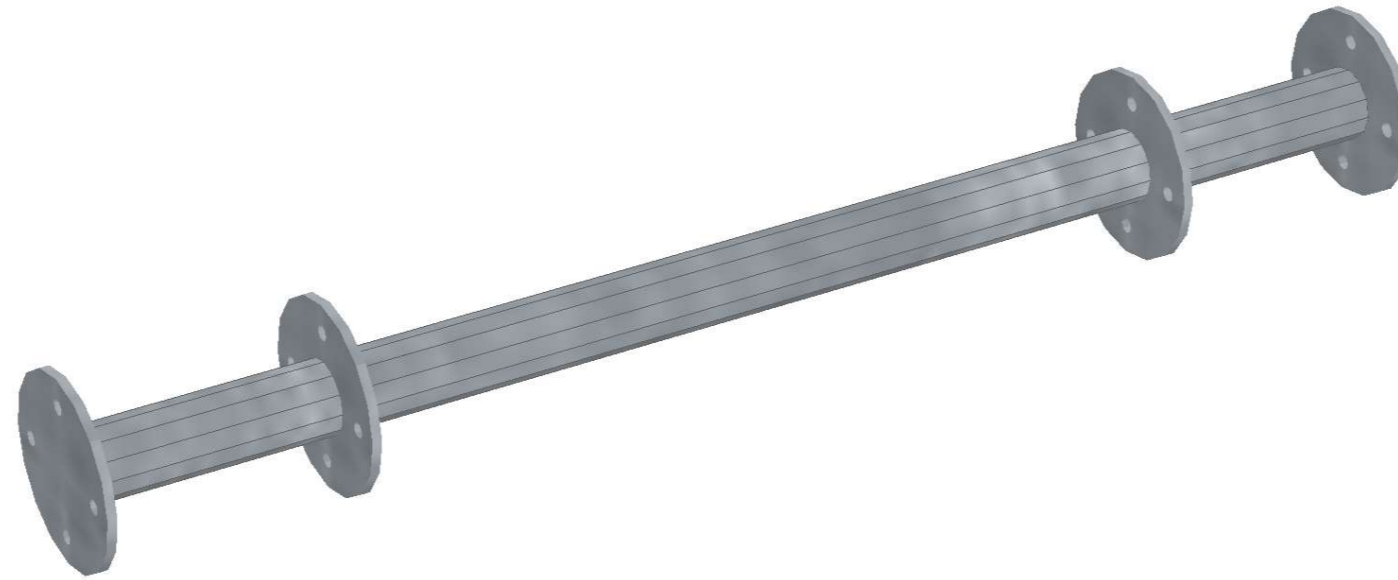

ČESKÁ
ZEMĚDĚLSKÁ
UNIVERZITA V PRAZE



SEMIA
EXPERIENCE
powered by

DIPLOMOVÁ PRÁCE
WORKOUTOVÉ HŘIŠTĚ

28.03.2018

ZPRACOVAL: Bc.TOMÁŠ GIEBL, DiS.
HRAZDA 730 MM
5 KS

M : 1 : 5.00

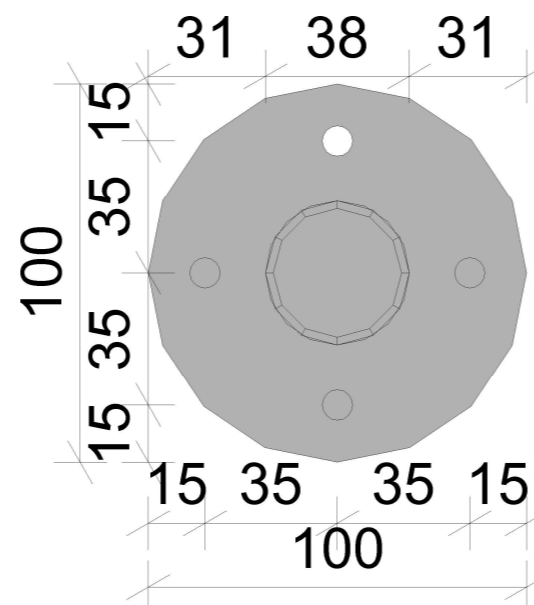

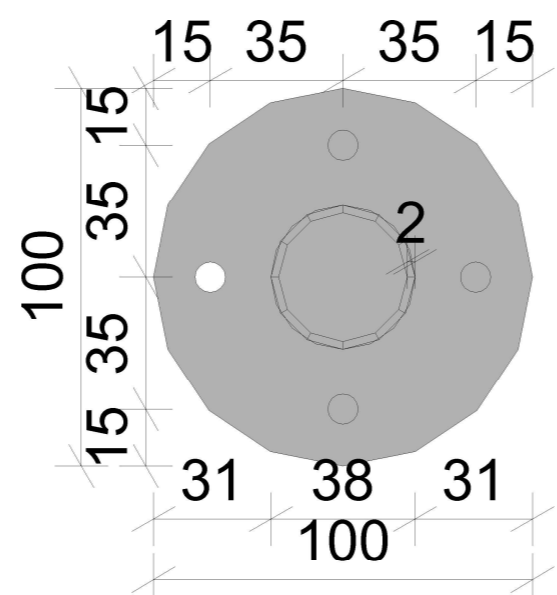
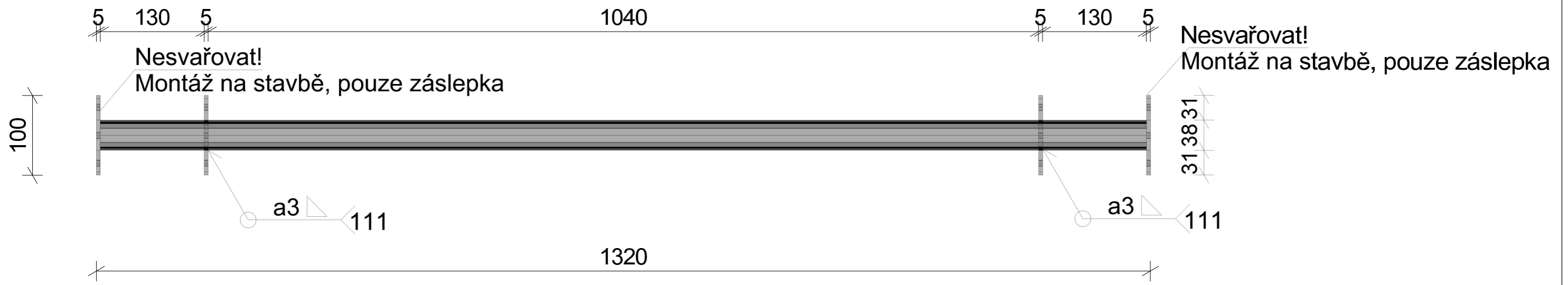

ČESKÁ ZEMĚDĚLSKÁ UNIVERZITA V PRAZE 		 EXPERIENCE powered by
DIPLOMOVÁ PRÁCE WORKOUTOVÉ HŘIŠTĚ		
ZPRACOVAL: Bc.TOMÁŠ GIEBL, DiS. HRAZDA 1320 MM 4 KS		
28.03.2018 M : 1 : 2.00		



ČESKÁ
ZEMĚDĚLSKÁ
UNIVERZITA V PRAZE



SEMA
EXPERIENCE
powered by

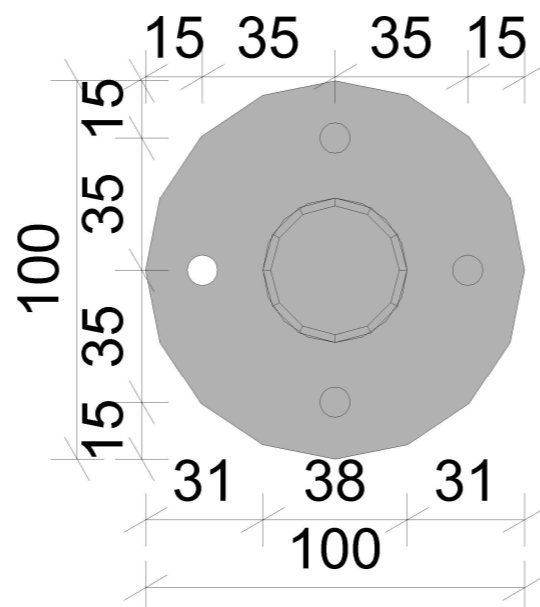

DIPLOMOVÁ PRÁCE
WORKOUTOVÉ HŘIŠTĚ

28.03.2018

ZPRACOVAL: Bc. TOMÁŠ GIEBL, DiS.
HRAZDA 1390 MM

M : 1 : 2.00

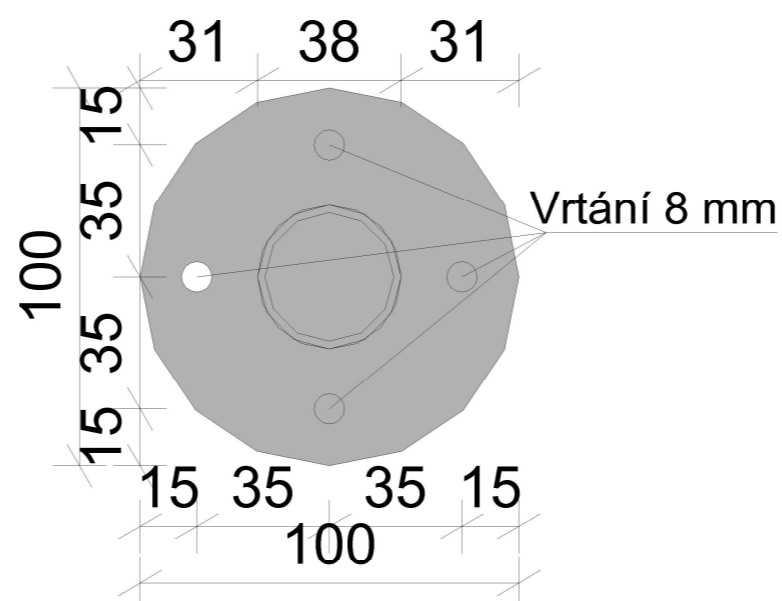
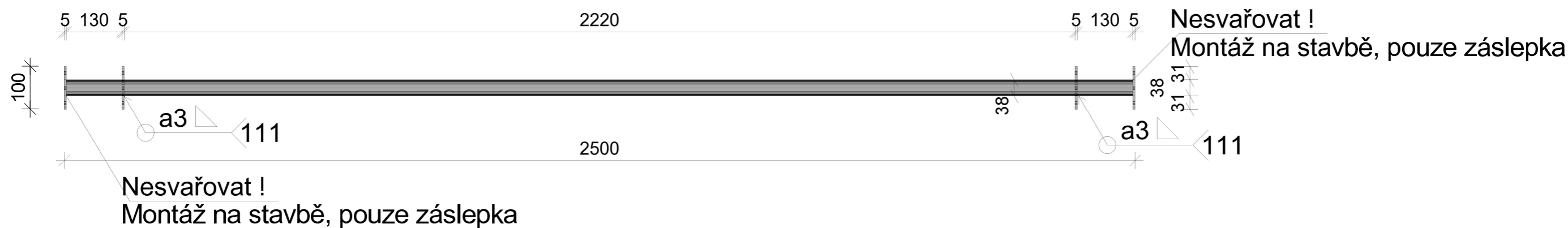
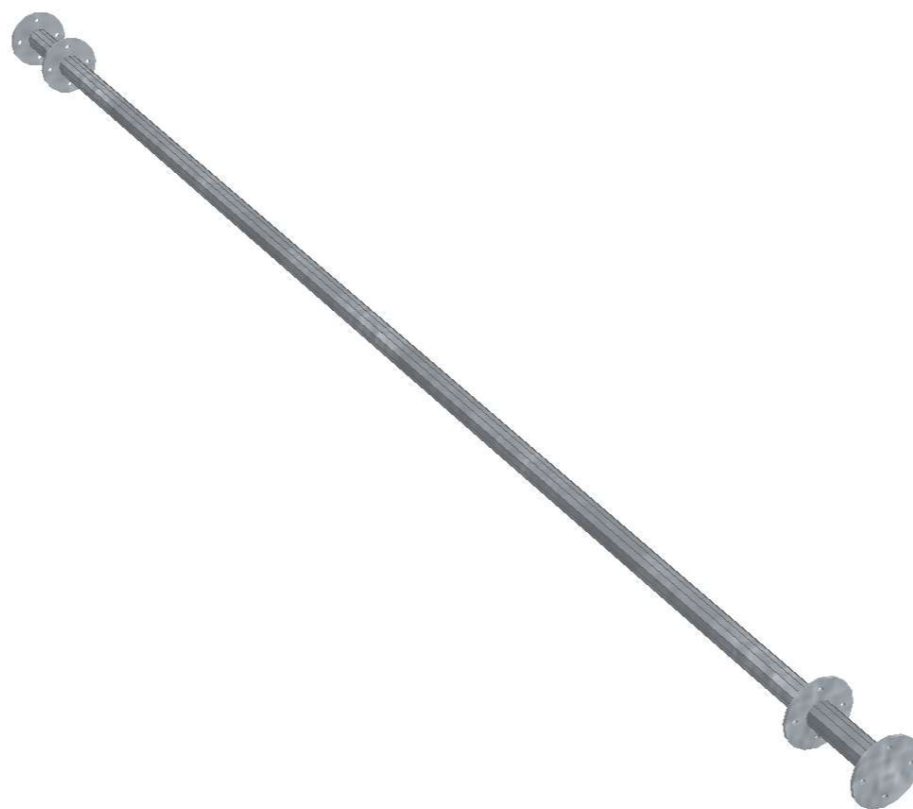

ČESKÁ
ZEMĚDĚLSKÁ
UNIVERZITA V PRAZE



SEMIA
EXPERIENCE
powered by

DIPLOMOVÁ PRÁCE
WORKOUTOVÉ HŘIŠTĚ

28.03.2018

ZPRACOVAL: Bc.TOMÁŠ GIEBL, DiS.
HRAZDA 2500 MM
2KS

M : 1 : 2.00

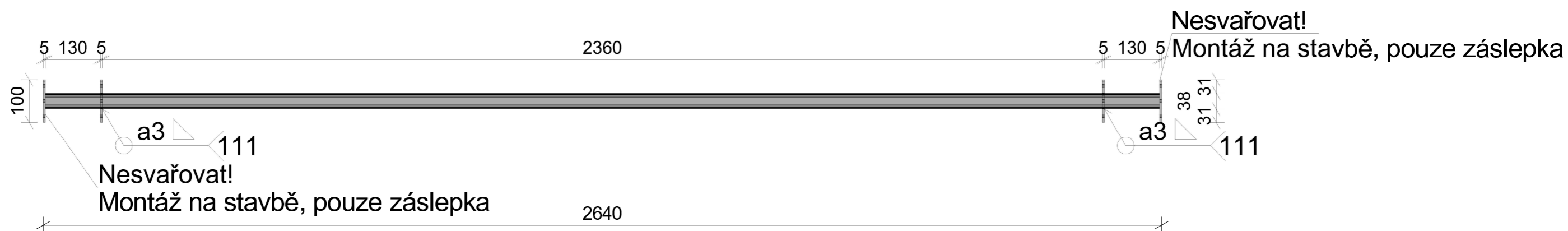
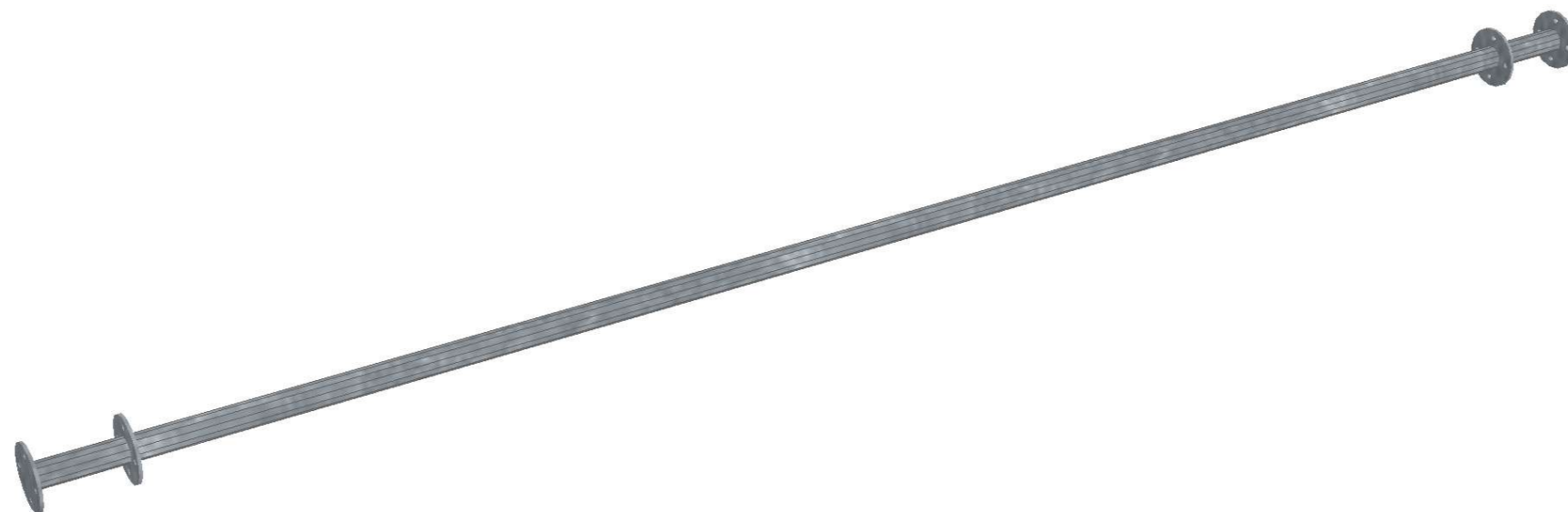

ČESKÁ
ZEMĚDĚLSKÁ
UNIVERZITA V PRAZE



powered by

DIPLOMOVÁ PRÁCE
WORKOUTOVÉ HŘIŠTĚ

28.03.2018

ZPRACOVAL: Bc. TOMÁŠ GIEBL, DiS.
HRAZDA 2640 MM
24 KS

M : 1 : 10.00

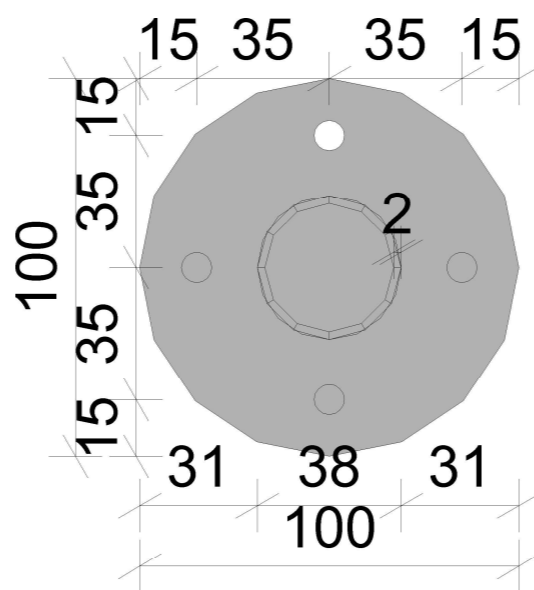

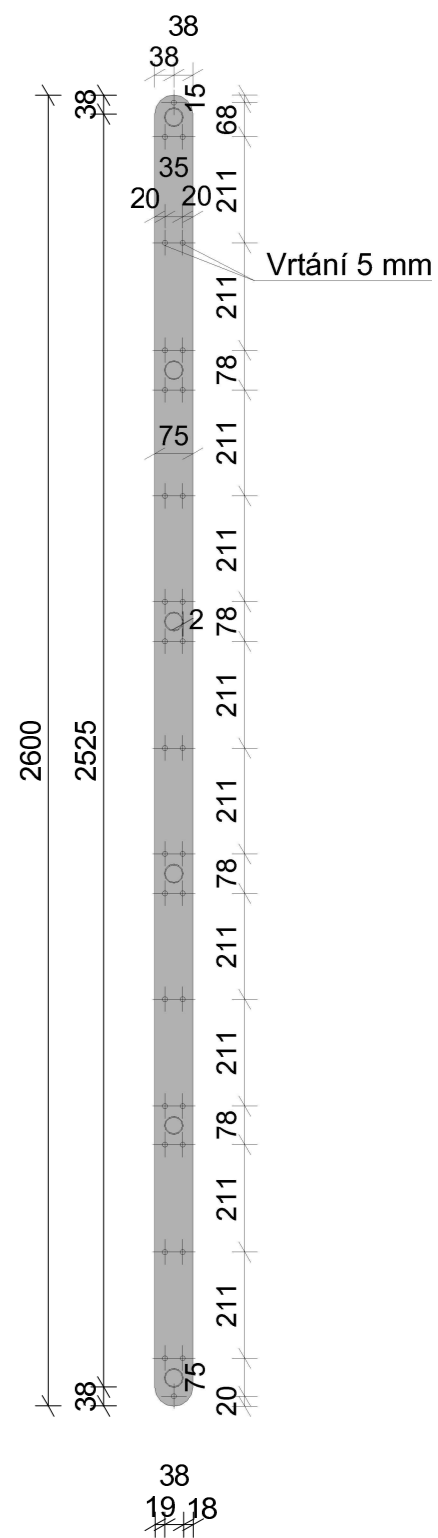
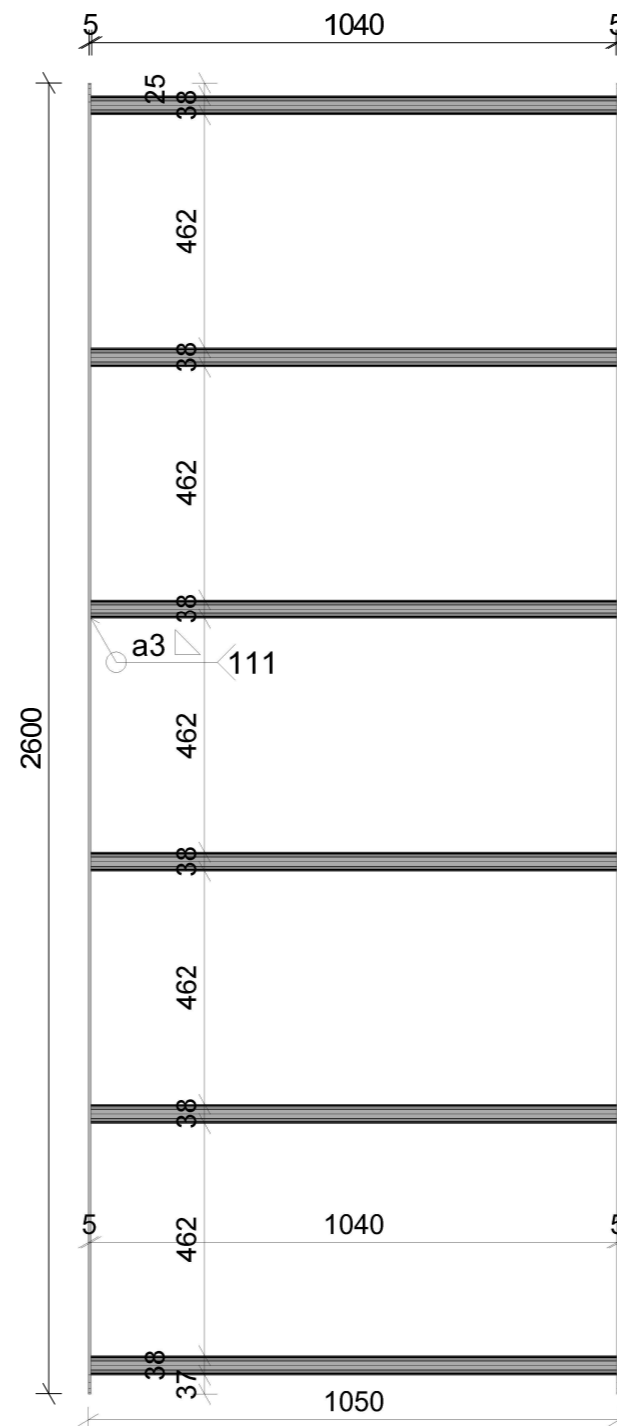
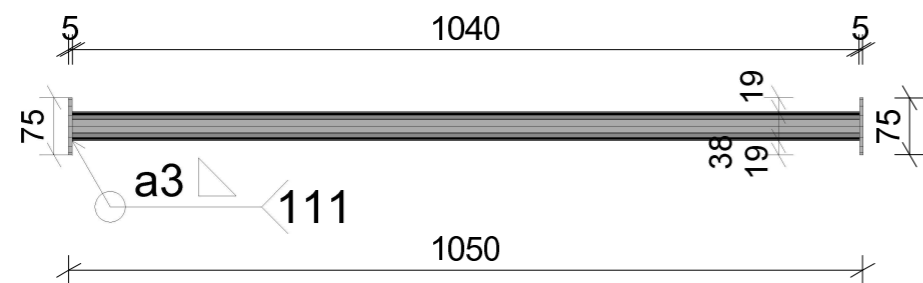
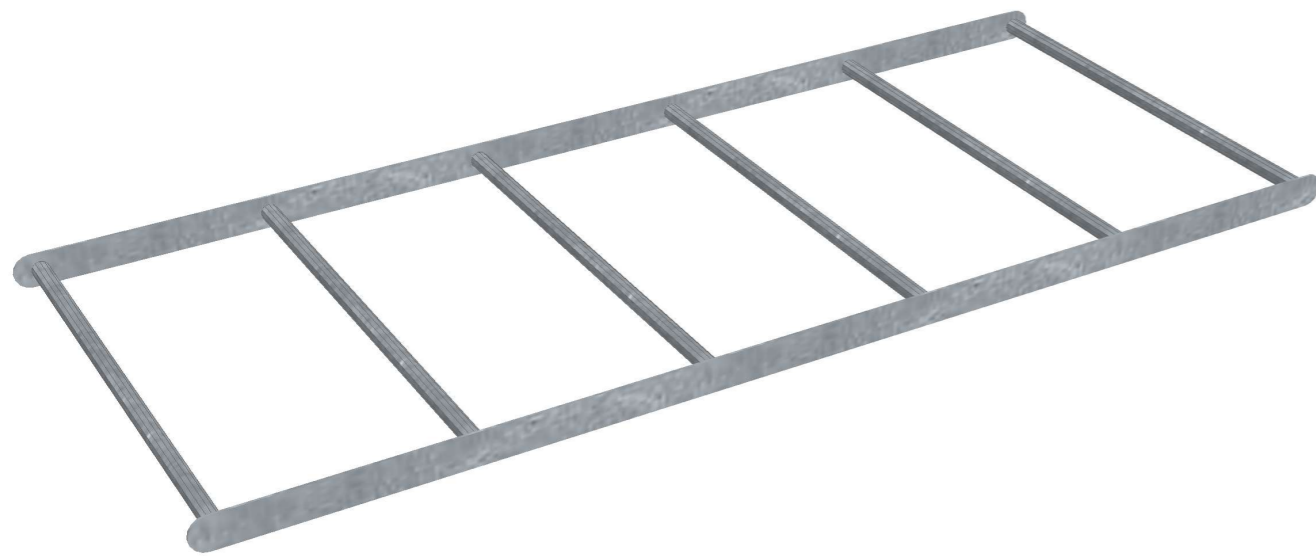

ČESKÁ
ZEMĚDĚLSKÁ
UNIVERZITA V PRAZE



DIPLOMOVÁ PRÁCE
WORKOUTOVÉ HŘIŠTĚ

27.03.2018

ZPRACOVAL: Bc. TOMÁŠ GIEBL, DiS.
ŽEBŘINY SVAŘENEC 1

M : 1 : 15.00

SEMIA
EXPERIENCE
powered by

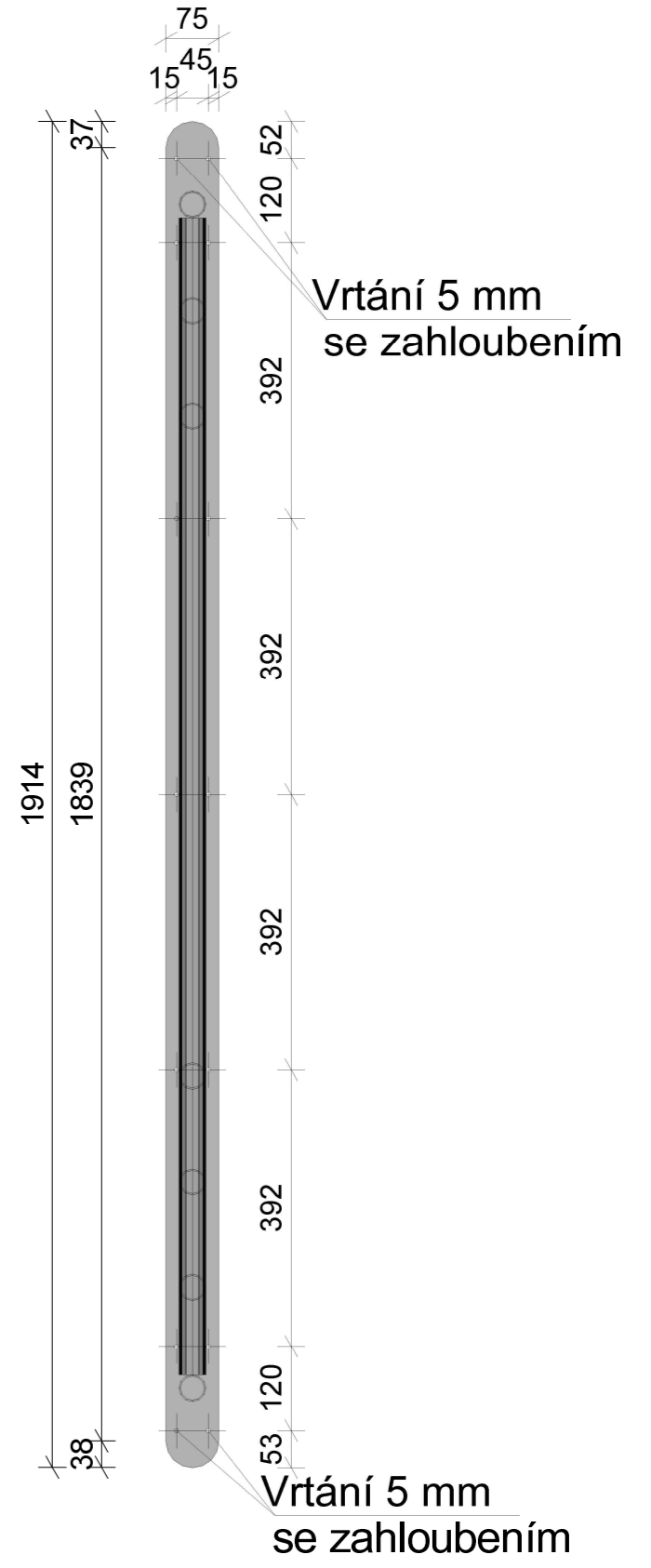
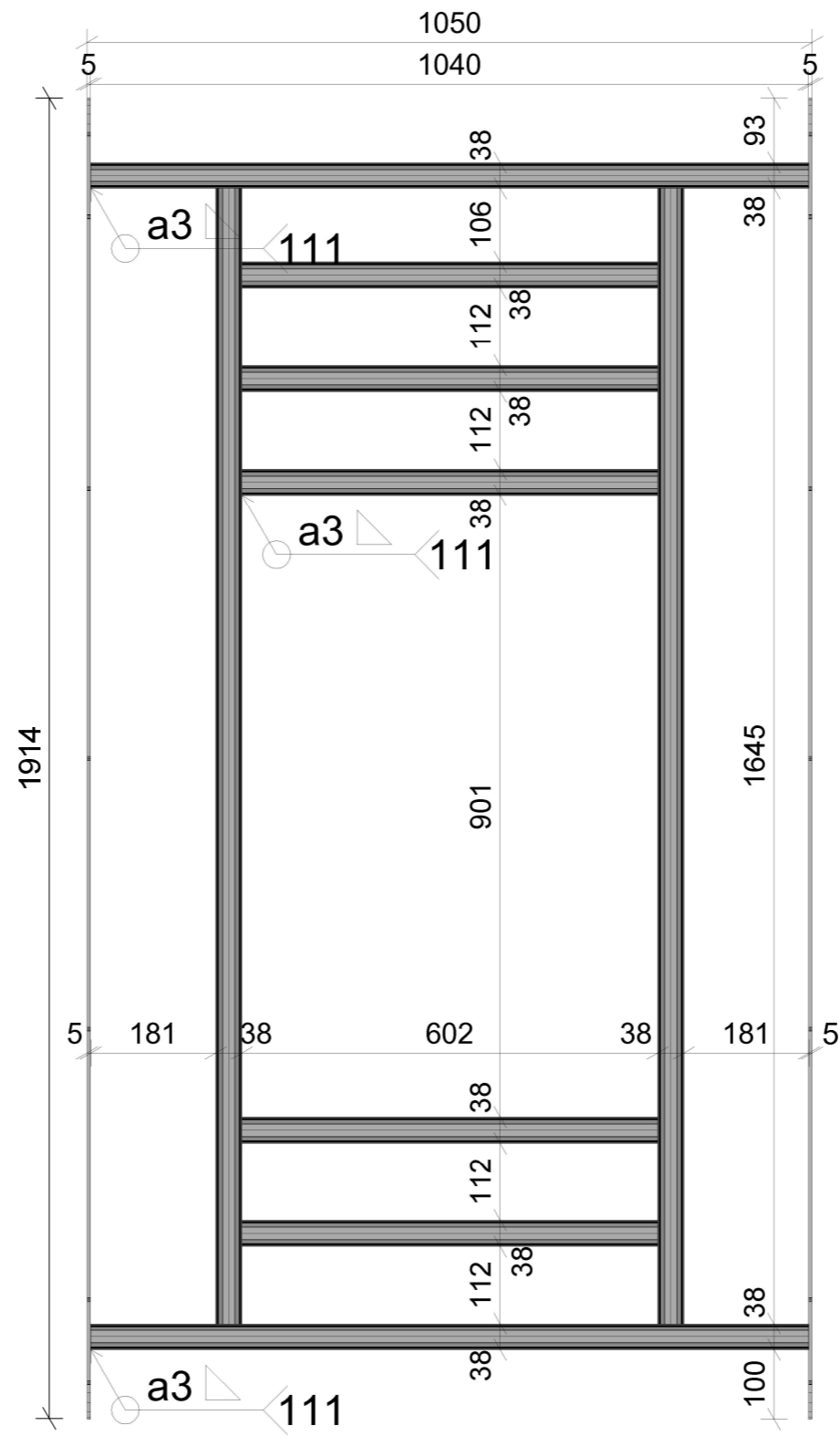
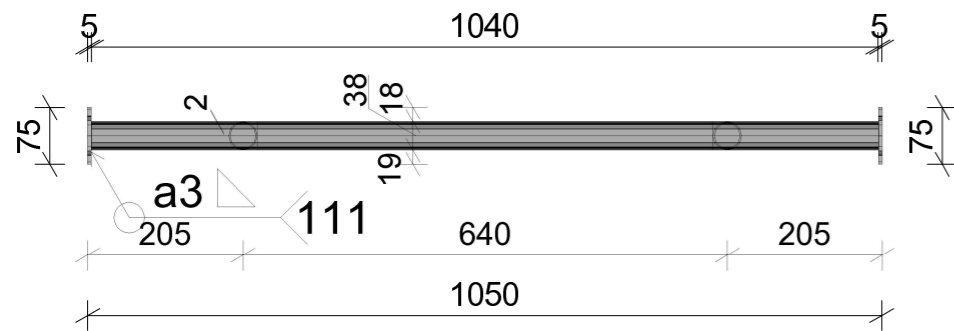
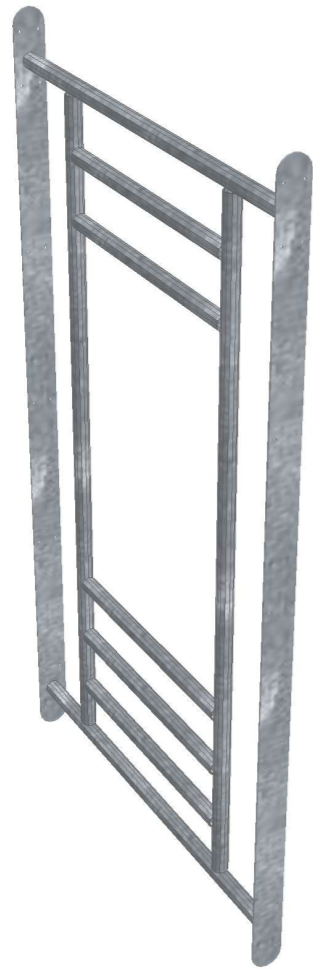

ČESKÁ
ZEMĚDĚLSKÁ
UNIVERZITA V PRAZE



DIPLOMOVÁ PRÁCE
WORKOUTOVÉ HŘIŠTĚ

27.03.2018

ZPRACOVAL: Bc. TOMÁŠ GIEBL, DiS.
Žebřiny svařenec 2

M : 1 : 10.00

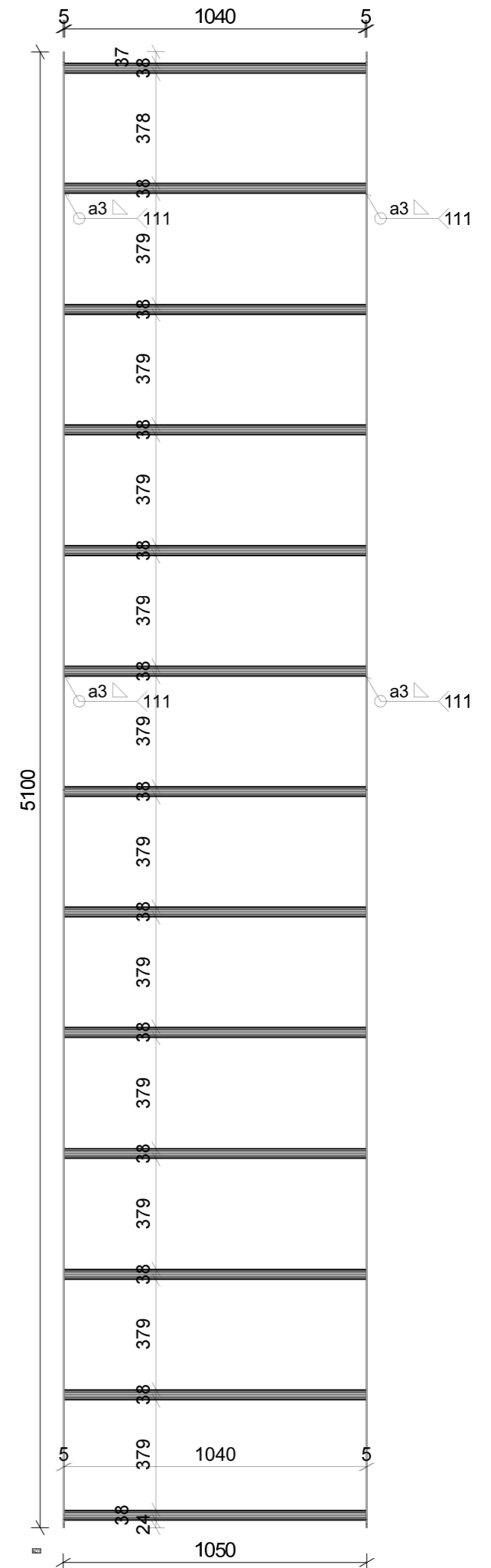
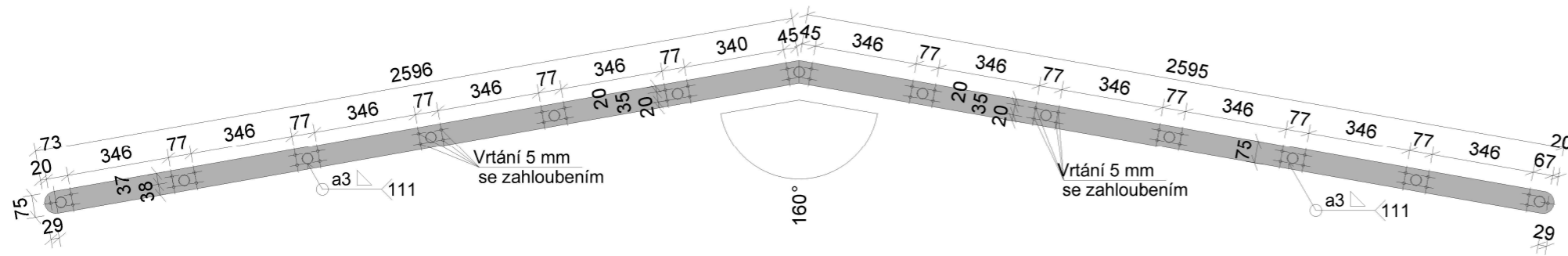
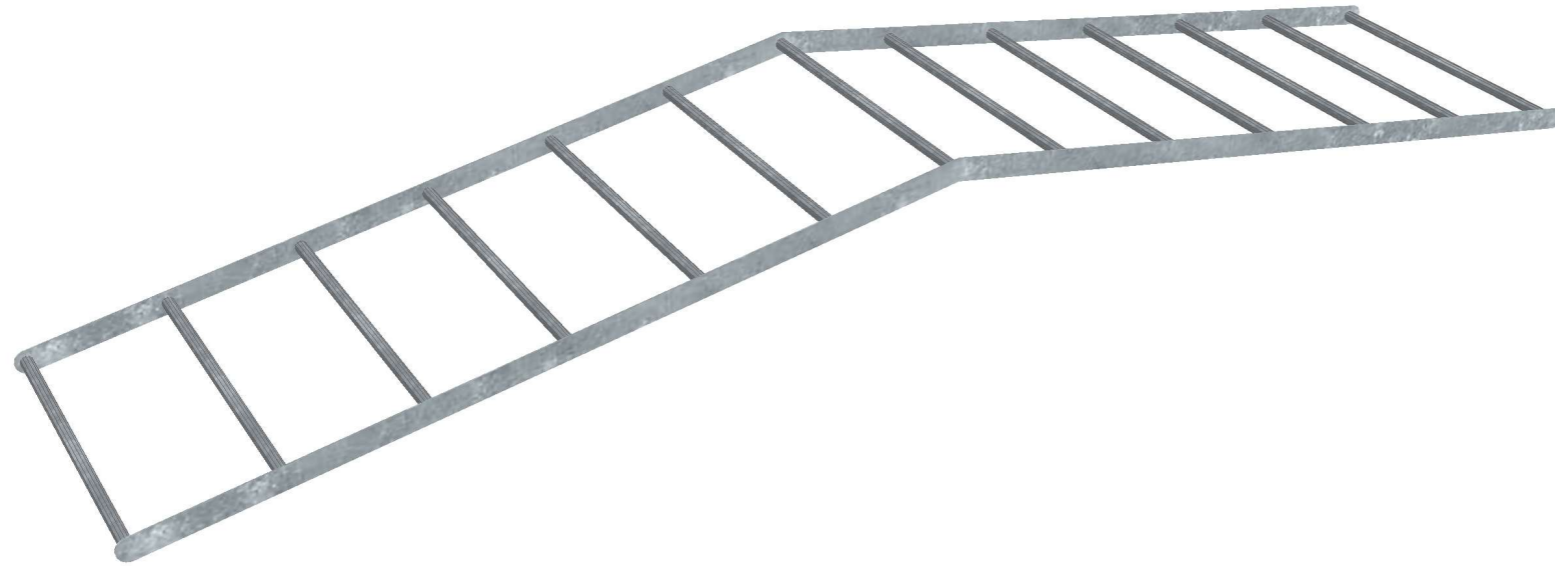

ČESKÁ
ZEMĚDĚLSKÁ
UNIVERZITA V PRAZE



ČESKÁ
ZEMĚDĚLSKÁ
UNIVERZITA V PRAZE



DIPLOMOVÁ PRÁCE
WORKOUTOVÉ HŘIŠTĚ

27.03.2018

ZPRACOVAL: Bc. TOMÁŠ GIEBL, DiS.
ŽEBŘINY SVARENEC 3

M : 1 : 20.00

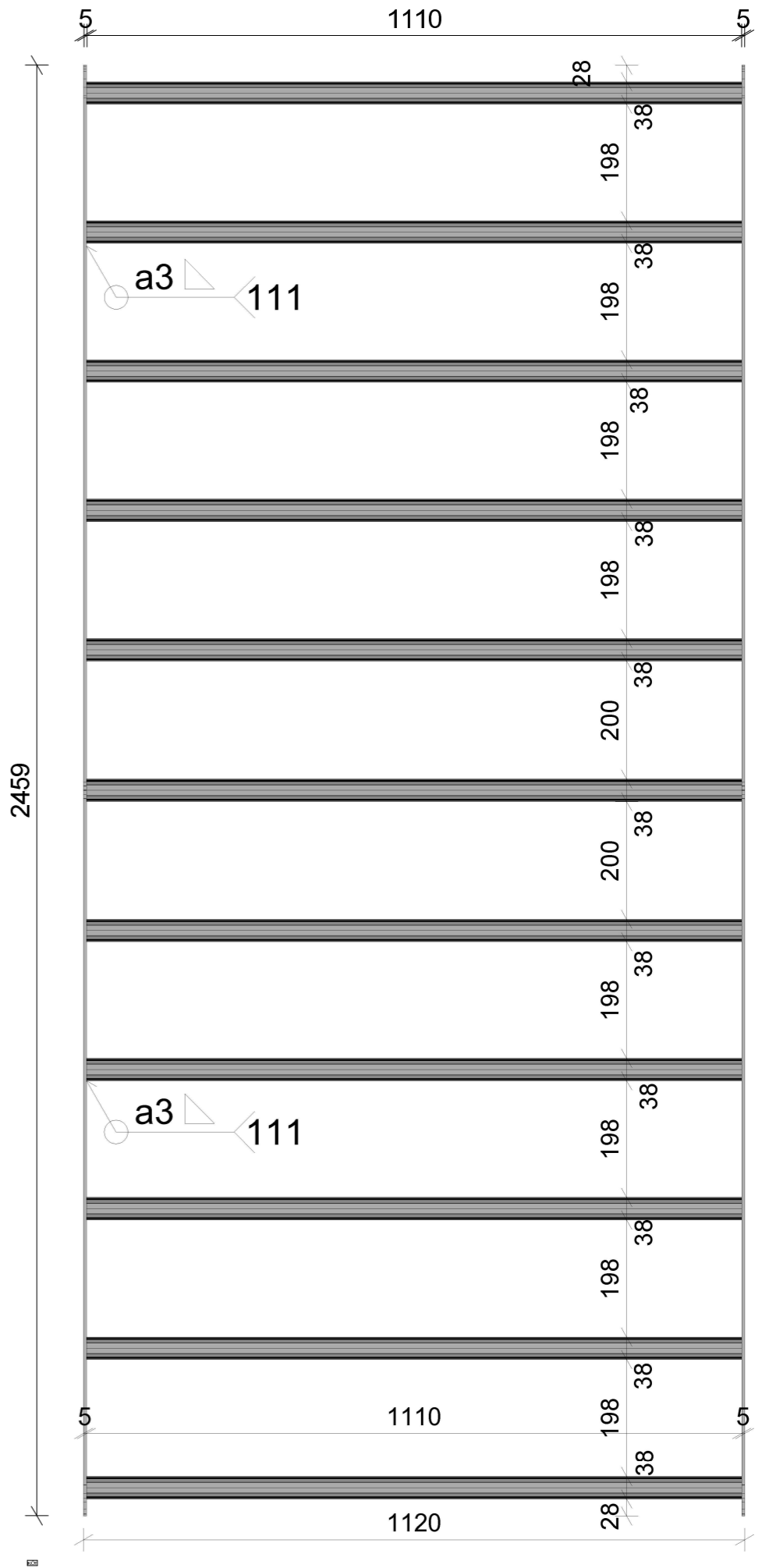
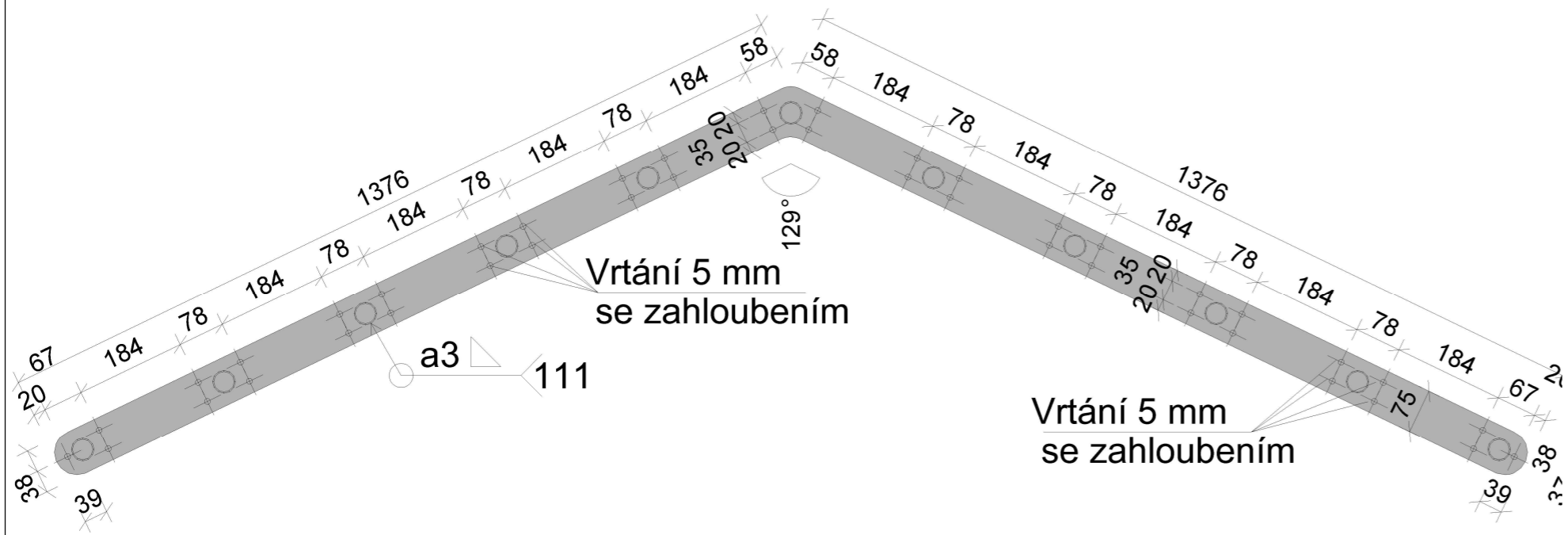
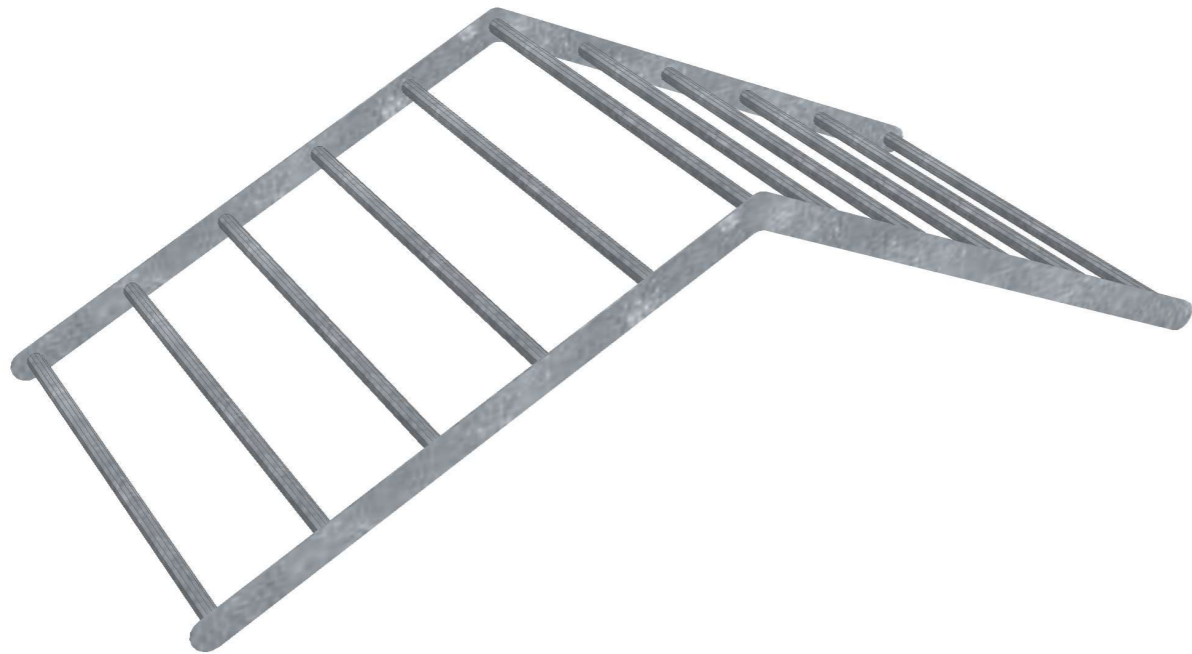

ČESKÁ ZEMĚDĚLSKÁ UNIVERZITA V PRAZE



DIPLOMOVÁ PRÁCE 27.03.2018
WORKOUTOVÉ HRÍŠTĚ

ZPRACOVAL: Bc. TOMÁŠ GIEBL, DiS.
ŽEBŘINY SVAŘENEC 4

M : 1 : 10.00

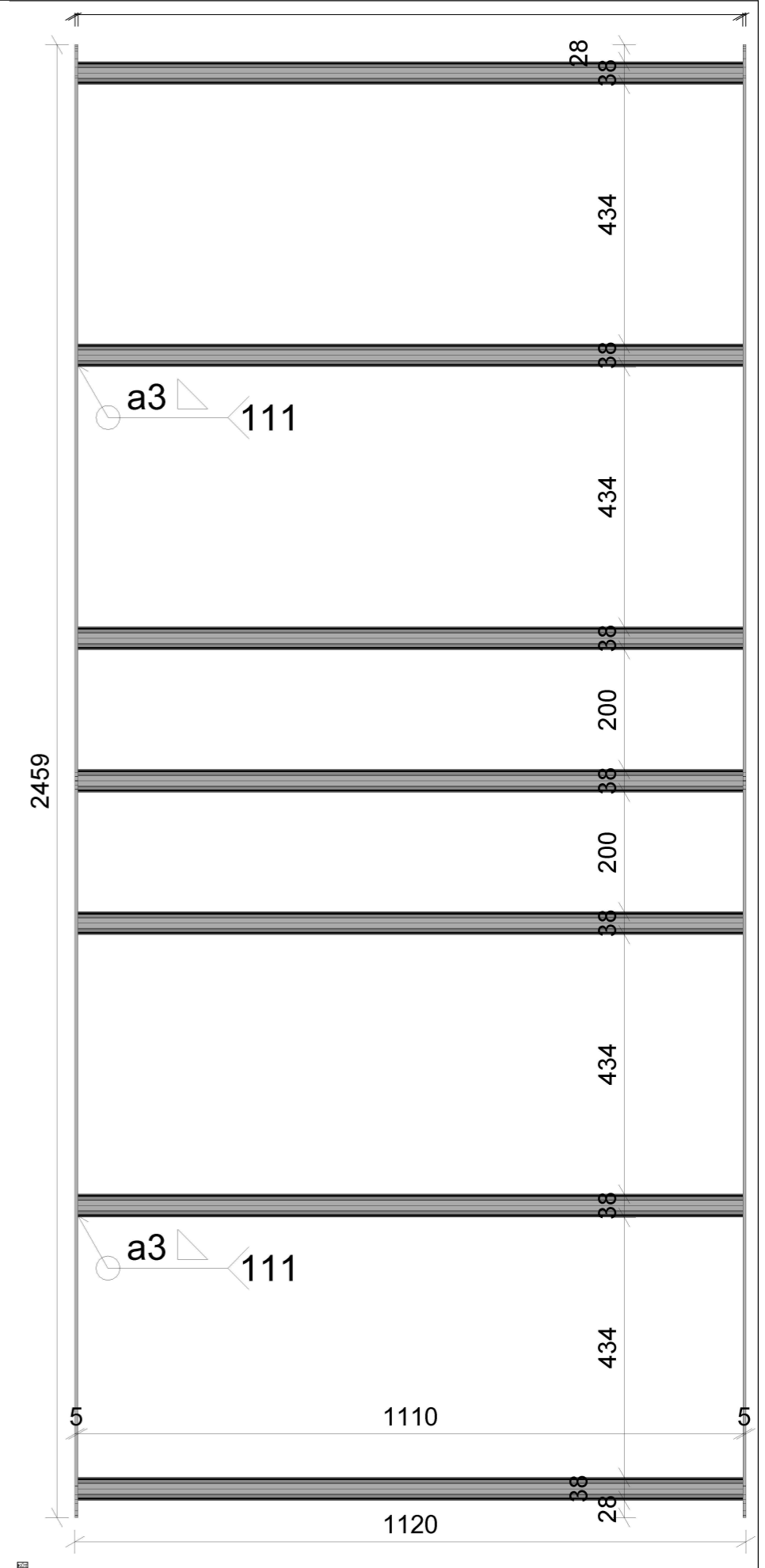
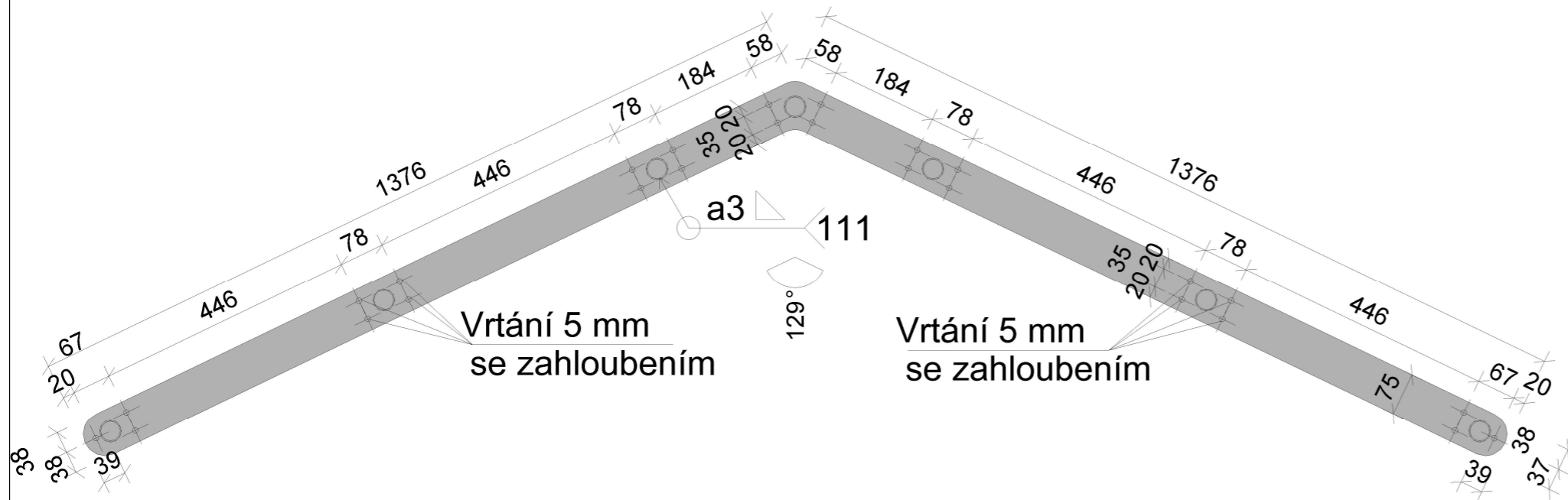
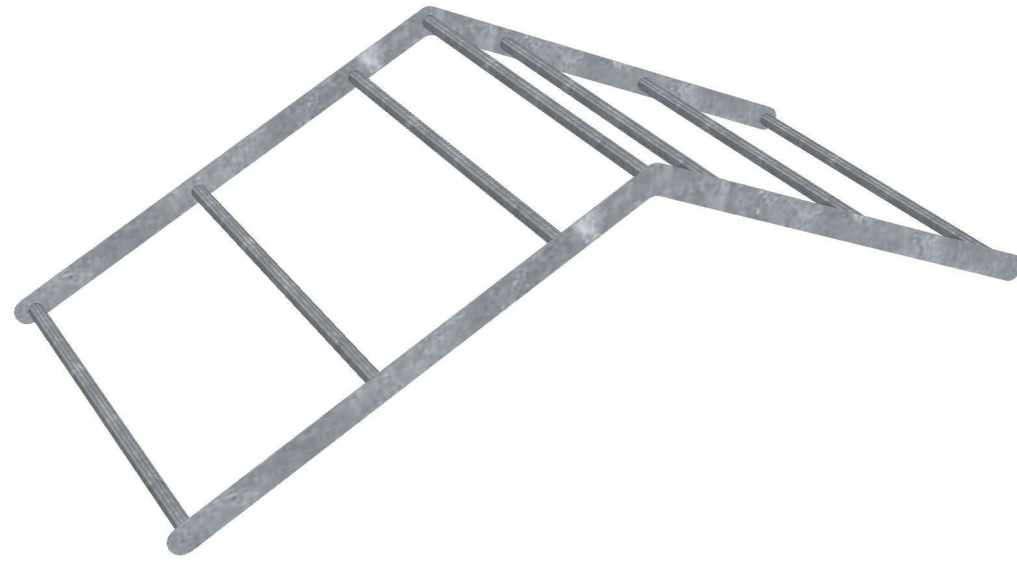

ČESKÁ
ZEMĚDĚLSKÁ
UNIVERZITA V PRAZE



SEMIA
EXPERIENCE
powered by

DIPLOMOVÁ PRÁCE
WORKOUTOVÉ HŘIŠTĚ

28.03.2018

ZPRACOVAL: Bc. TOMÁŠ GIEBL, DiS.
ŽEBŘINY SVAŘENEC 5

M : 1 : 10.00

Příloha č. 82

VÝPIS JEDNOTLIVÝCH PRVKŮ ZE DŘEVA

Seznam dílů : Seznam elementů

SMČ	Jedn Č.	K S	Označení	Sklon	Šířka [mm]	Výška [mm]	Délka [mm]
1	1	2	Kleština		80	160	6819
2	2	1	Kleština		80	160	6265
2	3	1	Kleština		80	160	6265
3	4	4	Nárožna		140	200	5386
24	41	1	Sloupek- středová část	90.0	140	140	2504
24	42	1	Sloupek- středová část	90.0	140	140	2504
24	43	1	Sloupek- středová část	90.0	140	140	2504
24	44	1	Sloupek- středová část	90.0	140	140	2504
25	45	1	Vaznice- středová část		160	140	6250
26	46	1	Pásek- středová část	45.0	140	140	1103
26	47	1	Pásek- středová část	45.0	140	140	1103
24	48	1	Sloupek- středová část	90.0	140	140	2504
4	5	1	Námětková krokev levá	30.0	80	160	716
5	6	1	Námětková krokev levá	30.0	80	160	1539
6	7	1	Námětková krokev levá	30.0	80	160	2363
7	8	1	Námětková krokev levá	30.0	80	160	3186
8	9	1	Námětková krokev pravá	30.0	120	160	3957
7	10	1	Námětková krokev pravá	30.0	80	160	3186
6	11	1	Námětková krokev pravá	30.0	80	160	2363
5	12	1	Námětková krokev pravá	30.0	80	160	1539
4	13	1	Námětková krokev pravá	30.0	80	160	716
27	49	1	Sloupek hrazdy	90.0	140	140	2464
27	50	1	Sloupek hrazdy	90.0	140	140	2464
27	51	1	Sloupek hrazdy	90.0	140	140	2464
9	14	1	Námětková krokev levá	30.0	80	160	716
10	15	1	Námětková krokev levá	30.0	80	160	1539
11	16	1	Námětková krokev levá	30.0	80	160	2363
12	17	1	Námětková krokev levá	30.0	80	160	3186
13	18	1	Námětková krokev pravá	30.0	120	160	3957
12	19	1	Námětková krokev pravá	30.0	80	160	3186
11	20	1	Námětková krokev pravá	30.0	80	160	2363
10	21	1	Námětková krokev pravá	30.0	80	160	1539
9	22	1	Námětková krokev pravá	30.0	80	160	716
28	52	1	Sloupek hrazdy	90.0	140	140	2464
28	53	1	Sloupek hrazdy	90.0	140	140	2464
14	23	1	Námětková krokev levá	30.0	80	160	716
15	24	1	Námětková krokev levá	30.0	80	160	1539
16	25	1	Námětková krokev levá	30.0	80	160	2363
17	26	1	Námětková krokev levá	30.0	80	160	3186
18	27	1	Námětková krokev pravá	30.0	120	160	3957
17	28	1	Námětková krokev pravá	30.0	80	160	3186
16	29	1	Námětková krokev pravá	30.0	80	160	2363
15	30	1	Námětková krokev pravá	30.0	80	160	1539

SMČ	Jedn Č.	K S	Označení	Sklon	Šířka [mm]	Výška [mm]	Délka [mm]
14	31	1	Námětková krokev pravá	30.0	80	160	716
29	54	1	Sloupek- středová část	90.0	140	140	2504
29	55	1	Sloupek- středová část	90.0	140	140	2504
29	56	1	Sloupek- středová část	90.0	140	140	2504
29	57	2	Sloupek- středová část	90.0	140	140	2504
30	58	1	Vaznice- středová část		160	140	6250
31	59	1	Pásek- středová část	45.0	140	140	1115
32	60	1	Pásek- středová část	45.0	140	140	1103
19	32	1	Námětková krokev levá	30.0	80	160	716
20	33	1	Námětková krokev levá	30.0	80	160	1539
21	34	1	Námětková krokev levá	30.0	80	160	2363
22	35	1	Námětková krokev levá	30.0	80	160	3186
23	36	1	Námětková krokev pravá	30.0	120	160	3957
22	37	1	Námětková krokev pravá	30.0	80	160	3186
21	38	1	Námětková krokev pravá	30.0	80	160	2363
20	39	1	Námětková krokev pravá	30.0	80	160	1539
19	40	1	Námětková krokev pravá	30.0	80	160	716
33	61	1	Paždík horní		140	140	2420
33	62	1	Paždík horní		140	140	2420
34	63	1	Sloupek- středová část	90.0	140	140	2504
34	64	1	Sloupek- středová část	90.0	140	140	2504
34	65	1	Sloupek- středová část	90.0	140	140	2504
34	66	1	Sloupek- středová část	90.0	140	140	2504
35	67	1	Vaznice- středová část		160	140	6250
36	68	1	Pásek- středová část	45.0	140	140	1103
36	69	1	Pásek- středová část	45.0	140	140	1103
37	70	1	Sloupek- středová část	90.0	140	140	2504
37	71	2	Sloupek- středová část	90.0	140	140	2504
38	72	1	Vaznice- středová část		160	140	6250
39	73	1	Pásek- středová část	45.0	140	140	1103
39	74	1	Pásek- středová část	45.0	140	140	1103
40	75	1	Vrcholový sloupek	90.0	140	140	1967
41	76	1	Sloupek hrazdy	90.0	140	140	2964
42	77	1	Sloupek hrazdy	90.0	140	140	2464
41	78	1	Sloupek hrazdy	90.0	140	140	2964
43	79	1	Sloupek hrazdy	90.0	140	140	2464
43	80	1	Sloupek hrazdy	90.0	140	140	2464
43	81	1	Sloupek hrazdy	90.0	140	140	2464
44	82	1	Šikmá vzpěra	10.0	140	140	2477
44	83	1	Šikmá vzpěra	10.0	140	140	2477
44	84	1	Šikmá vzpěra	10.0	140	140	2477
44	85	1	Šikmá vzpěra	10.0	140	140	2477
45	86	1	Sloupek hrazdy	90.0	140	140	2464
45	87	1	Sloupek hrazdy	90.0	140	140	2464
45	88	1	Sloupek hrazdy	90.0	140	140	2464
45	89	1	Sloupek hrazdy	90.0	140	140	2464
46	90	1	Sloupek hrazdy	90.0	140	140	2464
47	91	1	Sloupek hrazdy	90.0	140	140	1764
47	92	2	Sloupek hrazdy	90.0	140	140	1764

SMČ	Jedn Č.	K S	Označení	Sklon	Šířka [mm]	Výška [mm]	Délka [mm]
48	93	2	Paždík horní		140	140	2440
49	94	1	Sloupek hrazdy	90.0	140	140	2059
49	95	1	Sloupek hrazdy	90.0	140	140	2059
50	96	1	Sloupek hrazdy	90.0	140	140	2964
51	97	1	Sloupek hrazdy	90.0	140	140	2059
51	98	1	Sloupek hrazdy	90.0	140	140	2059
52	99	1	Sloupek hrazdy	90.0	140	140	2964
53	100	1	Šikmá vzpěra	25.7	140	140	1399
53	101	1	Šikmá vzpěra	25.7	140	140	1399
54	102	3	Pásek	45.0	140	140	468
54	103	3	Pásek	45.0	140	140	468
55	104	1	Sloupek hrazdy	90.0	140	140	2059
55	105	1	Sloupek hrazdy	90.0	140	140	2059
56	106	1	Sloupek hrazdy	90.0	140	140	2964
57	107	1	Šikmá vzpěra	25.7	140	140	1399
57	108	1	Šikmá vzpěra	25.7	140	140	1399
57	109	1	Šikmá vzpěra	25.7	140	140	1399
57	110	1	Šikmá vzpěra	25.7	140	140	1399
58	111	1	Šikmá vzpěra	15.0	140	140	2533
58	112	1	Šikmá vzpěra	15.0	140	140	2533
59	113	1	Šikmá vzpěra	-6.5	140	140	3008
60	114	1	Šikmá vzpěra	-6.5	140	140	3007
61	115	2	Pásek		140	140	1737
61	116	2	Pásek		140	140	1737
62	117	2	Rozpěra mezi kleštinami		120	160	500

Celková suma:

KS.....: 132
CelkL [mm].....: 321164
PIHobl [m2].....: 10,80
CelkovýO [m3].....: 5,933
CeláP [m2].....: 176,30
SHoblD [mm].....: 24954

Příloha č. 83

PRŮBĚH VNÍTRNÍCH SIL, NAPĚTÍ A DEFORMACE NA PRUTU HRAZDY

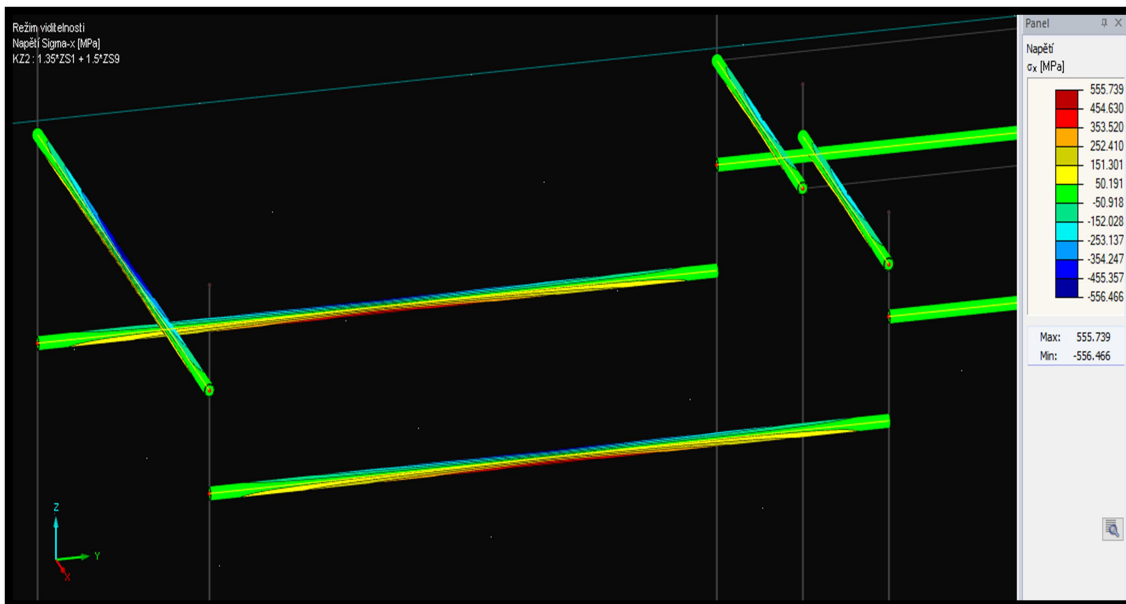
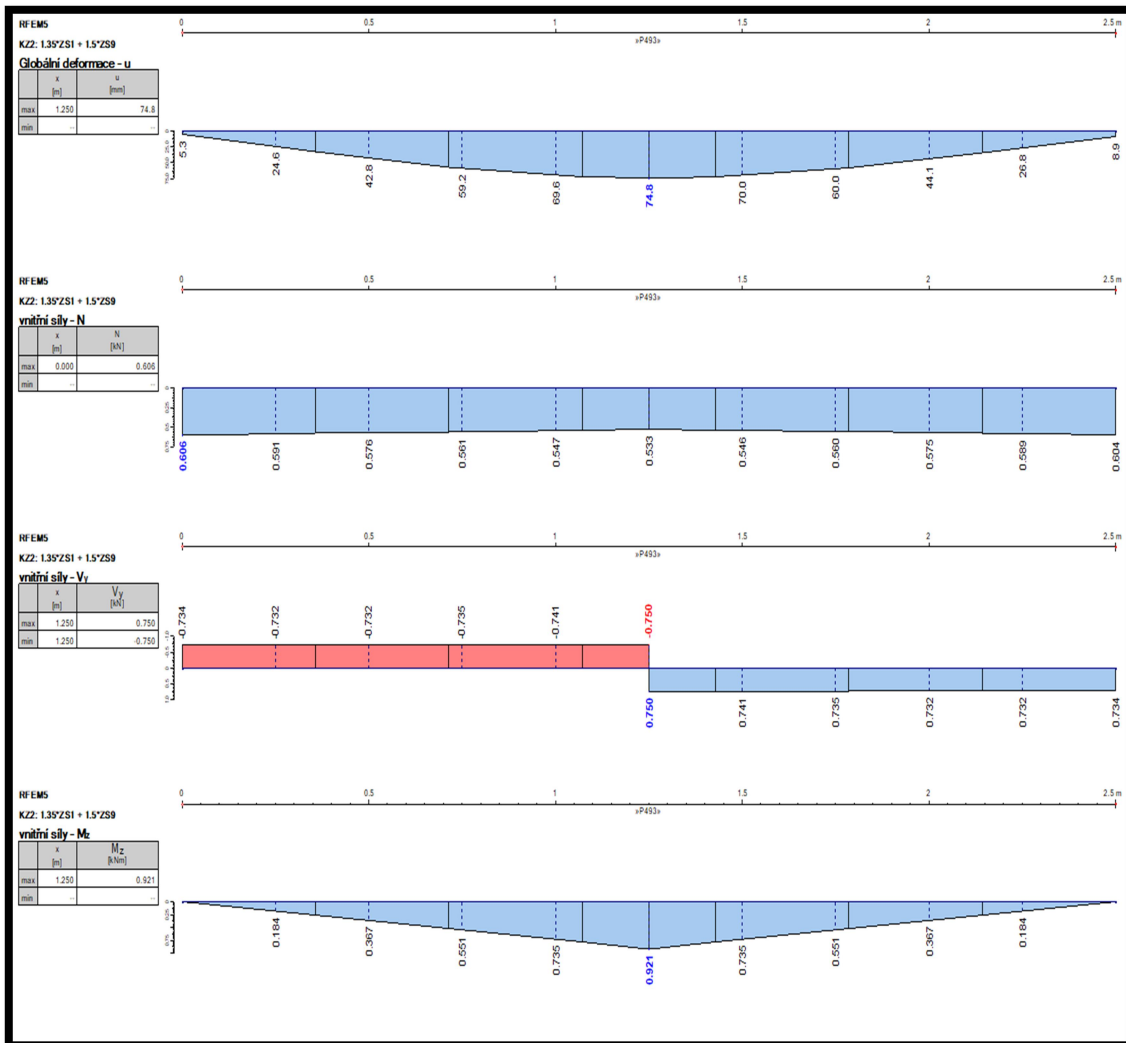

Příloha č. 84

PRŮBĚH VNÍTRNÍCH SIL, NAPĚTÍ A DEFORMACE SLOUPU

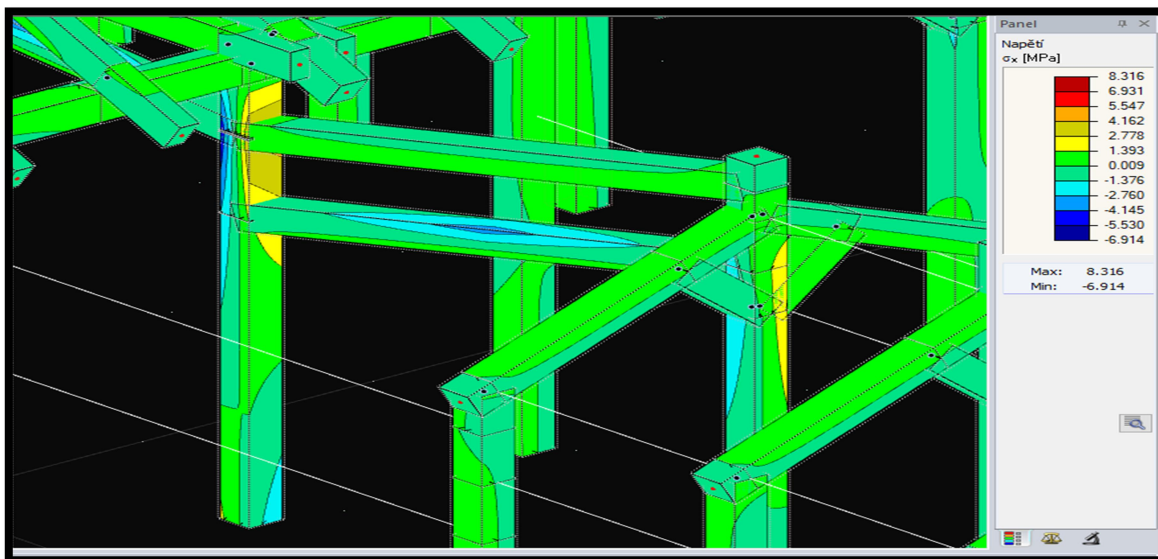
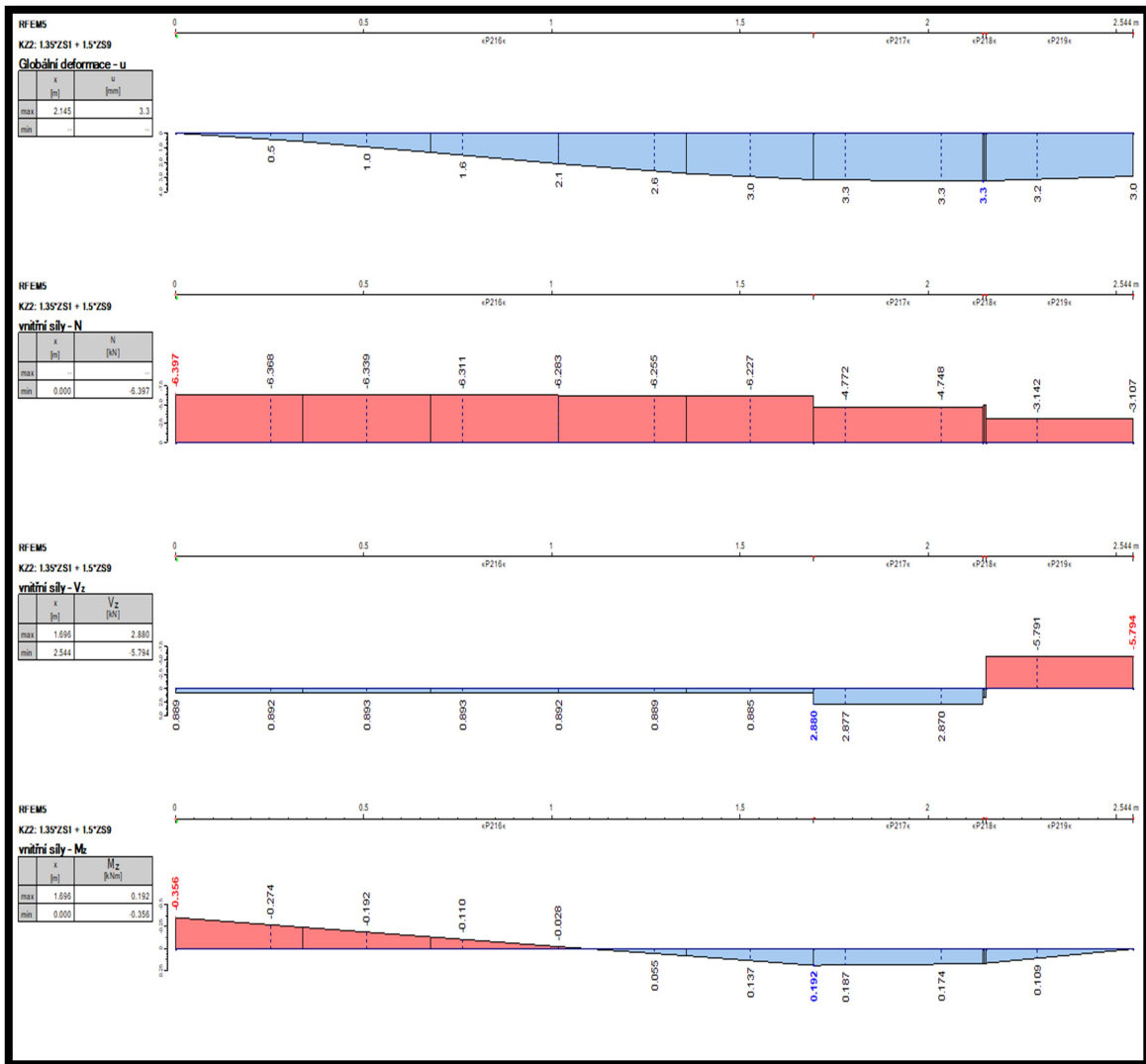

Příloha č. 85

PRŮBĚH VNÍTRNÍCH SIL, NAPĚTÍ A DEFORMACE NÁROŽNÍ KROKVE

