



# BRNO UNIVERSITY OF TECHNOLOGY

VYSOKÉ UČENÍ TECHNICKÉ V BRNĚ

FACULTY OF MECHANICAL ENGINEERING  
FAKULTA STROJNÍHO INŽENÝRSTVÍ

INSTITUTE OF AEROSPACE ENGINEERING  
LETECKÝ ÚSTAV

## ANALYSIS OF A SANDWICH PANEL UNDER SHEAR LOADING

ANALÝZA ÚNOSNOSTI SENDVIČOVÉHO PANELU PŘI SMYKOVÉM ZATÍŽENÍ

BACHELOR'S THESIS  
BAKALÁŘSKÁ PRÁCE

AUTHOR  
AUTOR PRÁCE

Gleb Kopylov

SUPERVISOR  
VEDOUCÍ PRÁCE

Ing. Michal Mališ, Ph.D.

BRNO 2016



# Bachelor's Thesis Assignment

Institut: Institute of Aerospace Engineering  
Student: **Gleb Kopylov**  
Degree program: Engineering  
Branch: Fundamentals of Mechanical Engineering  
Supervisor: **Ing. Michal Mališ, Ph.D.**  
Academic year: 2015/16

As provided for by the Act No. 111/98 Coll. on higher education institutions and the BUT Study and Examination Regulations, the director of the Institute hereby assigns the following topic of Bachelor's Thesis:

## **Analysis of a Sandwich panel under compressive loading**

### **Brief description:**

The work is focused on analysis of sandwich panel under shear loading using finite element method. Identify failure mode of sandwich panel and compare with analytical solution. Use standard tools implemented in commercial software package MSC. Patran/Nastran.

### **Bachelor's Thesis goals:**

1. Review of sandwich structure material components requirements
2. Simulation of the composite panels
3. Comparison with an analytical analysis
4. Comparison with a experiments

### **Bibliography:**

ASM Handbook, Volume 21, Composites, ASM International, The Material Information Company, 2001.

Niu, C. Y. M. (2005): Composite Airframe Structure, Hong Kong Conmilit Press Ltd., Brno, 664 stran.

Bush H. G. (1978): A Biaxial Method for Inplane Shear Testing, NASA Technical Mamorandum 74070.

Students are required to submit the thesis within the deadlines stated in the schedule of the academic year 2015/16.

In Brno, 30. 11. 2015

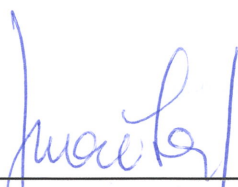
  
\_\_\_\_\_  
doc. Ing. Jaroslav Juračka, Ph.D.  
Director of the Institute



  
\_\_\_\_\_  
doc. Ing. Jaroslav Katolický, Ph.D.  
FME Dean

## Abstract

Main purpose of this bachelor's thesis was to design appropriate simulation of the in-plane shear test and confirm it. Types of the composite panel failures and approaches to sandwich tests were discussed. Several simulation designs were proposed. Best design has been chosen, based on important criterions. Six experiments were simulated with chosen simulation design. Results of simulations and analytical calculations were compared. Some findings about wrinkling coefficients and crimping equation validity have been taken, based on the results comparison.

## Keywords

Sandwich plate; composite laminate; shear load; Patran analysis; wrinkling; crimping; shear stress; uniaxial shear test

## Abstrakt

Hlavným cieľom tejto bakalárskej práce bolo navrhnúť vhodnú simulačnú metódu pre rovinnú šmykovú skúšku. Boli popísané rôzne typy porúch kompozitových panelov a rôzne prístupy k šmykovým skúškam. Boli navrhnuté rôzne simulačné metódy pre jednoosú šmykovú skúšku. Na základe najdôležitejších kritérií, bol zvolený najvhodnejší návrh. Šesť experimentov bolo nasimulovaných v súlade so zvoleným návrhom. Výsledky simulácií a výpočtov boli porovnané pre utvorenie korelácie medzi hodnotami a overenia správnosti simulačného návrhu. Na základe daného porovnania, takisto boli zistené skutočnosti ohľadom wrinkling kvocientov a platnosti rovníc pre výpočet crimpingu.

## Kľúčové slova

Sendvičová doska; kompozitné lamináty; šmykové zaťaženie; Patran analýzy; wrinkling; crimping; šmyková napätosť; jednoosá šmyková skúška

## Bibliographic citation

KOPYLOV, G. *Analysis of a sandwich panel under shear loading*. Brno: Brno University of Technology, Faculty of mechanical engineering, 2016. 83 p. Supervisor Ing. Michal Malíš, Ph.D..

## Declaration

I, Gleb Kopylov, declare that I have prepared this bachelor's thesis independently, under the supervision of my bachelor's thesis supervisor. I have used no other sources, except of those cited in the text and mentioned in references.

Brno, 26.05.2016

Gleb Kopylov

## Acknowledgment

I would like to thank to my supervisor Ing. Michal Mališ, Ph.D., especially for his guidance, support and encouragement through my bachelor thesis writing, which has been done with great willingness. He helped me with issues regarding my thesis topic, without any hesitation. I would like also to thank to my family and friends for their support during my studies.

Brno, 26.05.2016

Gleb Kopylov



# Contents

1	Introduction .....	11
1.1	Sandwich laminate – brief description .....	11
1.2	Wrinkling.....	11
1.3	Crimping.....	13
1.4	Uniaxial and biaxial in-plane shear testing.....	14
1.5	Objectives .....	17
2	Design approaches to simulations .....	18
2.1	First design approach – 2D surface with smaller surfaces .....	18
2.1.1	Model.....	18
2.1.2	Meshing .....	18
2.1.3	Materials specification and properties application .....	19
2.1.4	Loads and boundary conditions .....	20
2.2	Second design approach – 2D surface with rods.....	21
2.2.1	Model.....	21
2.2.2	Meshing .....	21
2.2.3	Material specification and properties application.....	21
2.2.4	Loads and boundary conditions .....	22
2.3	Third design approach – 3D model .....	23
2.3.1	Model.....	23
2.3.2	Meshing .....	23
2.3.3	Material specification and properties application.....	25
2.3.4	Loads and boundary conditions .....	25
2.4	Comparison of design approaches.....	26
3	Experiments.....	32
3.1	Sandwich plate compositions and experimental results .....	32
3.1.1	Experiment 1 .....	32
3.1.2	Experiment 2.....	33
3.1.3	Experiment 3.....	33
3.1.4	Experiment 4.....	34
3.1.5	Experiment 5.....	35
3.1.6	Experiment 6.....	36
3.2	Analytical solution.....	37
3.3	Simulations .....	40

3.3.1	Experiment 1 – simulation .....	41
3.3.2	Experiment 2 – simulation .....	44
3.3.3	Experiment 3 – simulation .....	47
3.3.4	Experiment 4 – simulation .....	51
3.3.5	Experiment 5 – simulation .....	54
3.3.6	Experiment 6 – simulation .....	57
3.4	Results comparison and assessment.....	60
3.4.1	Experiment 1 – results.....	60
3.4.2	Experiment 2 – results.....	62
3.4.3	Experiment 3 – results.....	64
3.4.4	Experiment 4 – results.....	66
3.4.5	Experiment 5 – results.....	68
3.4.6	Experiment 6 – results.....	70
3.5	Conclusion .....	72
3.5.1	Wrinkling.....	72
3.5.2	Crimping.....	73
4	Concluding remarks .....	74
5	Material characteristics .....	75
6	References.....	76
7	Nomenclature.....	78
8	List of figures.....	80
9	List of tables.....	82

# 1 Introduction

In this chapter I would like describe briefly some “sandwich composite plate” terminology, mention basic failure modes for sandwich laminates, methods used for shear testing and objectives of present bachelor’s thesis.

## 1.1 Sandwich laminate – brief description

Basic sandwich structure consists of light core – insert and two thin load-transferring facesheets usually made of carbon or fiberglass fabric. As material for light cores, foams are used often. Cores have isotropic properties and are suitable for load in every direction. Skin materials are orthotropic, so laminate designer should take into account orientation of layers in the sandwich laminate. Every laminate designed should not only be resistant to tension/compression type of failure, but also to other types failures.

## 1.2 Wrinkling

Facesheet wrinkling or just wrinkling is the most usual type of failure for the sandwiches. Such type of failure usually leads to catastrophic failure of the sandwich product; wrinkled laminate can barely transfer load. Wrinkling is described as a considerable loss of stiffness in sandwich, caused by the local instability phenomena such as buckling of the face layers at short wavelengths. [15] Consequently such type of buckling affects entire thickness of the laminate.

Most of the parts made from composite laminate materials are created by hand lay-up method. Even with the presence of modern techniques, laminating of the composites is not much different as it was fifty years ago.

In the present thesis I am particularly interested in symmetrical wrinkling and crimping of experimental laminates, because it can be calculated simple, so it is more suitable for in-class analysis.

Symmetrical wrinkling occurs if the core flatwise stiffness is sufficiently large, core insert material has isotropic properties and skin material is 2D orthotropic. Wrinkling is a length independent phenomenon, if tested panel have sufficient length. If the core of tested model is insufficient, it will rather behave like a column than a plate, which can lead to the global buckling. However, if these two conditions are fulfilled, wrinkling will be independent on the thickness of the model and on its size. [6] [7]

Several scientists studied the wrinkling phenomenon. First were Gough, Elam and de Bruyne. Their assumptions included fact that:

1. Facesheets are inextensible.
2. Core is attached directly to the middle surface of the facesheets.
3. Effects of the core compressive stresses can be neglected.

Core of the sandwich laminate should also fulfil the sufficient thickness condition.

$$\left(\frac{t_f}{t_c}\right) * \left(\frac{E_f}{E_c}\right)^{\frac{1}{3}} < 0,2$$

Then following equation is used for wrinkling calculation according to Gough, Elam and de Bruyne.

$$\sigma_{wr} = 0,794(E_f E_c G_c)^{\frac{1}{3}}$$

However, if the core is thinner  $\left(\frac{t_f}{t_c}\right) * \left(\frac{E_f}{E_c}\right)^{\frac{1}{3}} > 0,2$  equation with lower wrinkling coefficient  $k_1$  is used.

$$\sigma_{wr} = 0,630(E_f E_c G_c)^{\frac{1}{3}}$$

Williams, Legget and Hopkins were first who tried to solve antisymmetrical buckling and symmetrical wrinkling problem in more general way. Their theory accounted several factors which were neglected by Gough, Elam and de Bruyne. These factors included:

1. Transverse shear.
2. Through the thickness flexibility of the core.
3. Stretching of the facesheets.

More general model allowed Williams, Legget and Hopkins predict interaction between short wavelength wrinkling and long wavelength buckling of the strut. Cox and Ridell brought theoretical study based on the Williams, Legget and Hopkins approach, which is more suitable for design of sandwich plates. Following equation of facesheet wrinkling is derived by Cox and Riddel for sandwich struts with thick cores.

$$\sigma_{wr} = 0,760(E_f E_c G_c)^{\frac{1}{3}}$$

Hoff and Mautner tried to propose simpler models for symmetrical and antisymmetrical wrinkling. Sandwich strut with isotropic facesheets and solid cores is used for this prediction. They have also taken several assumptions:

1. Core deformations decay linearly to zero within a small zone of width, smaller than one half the thickness of the core.
2. Extensional strain energy of the facesheets, axial strain energy of the core, are neglected.

Following equation derived by Hoff and Maunter usually depend on the width to half core thickness ration. Generally, if this condition is fulfilled ( $w < \frac{t_c}{2}$ ) Hoff and Maunter equation works well in all cases. [9]

$$\sigma_{wr} = 0,910(E_f E_c G_c)^{\frac{1}{3}}$$

However, all previous equations are valid for the case of isotropic facesheets, whereas Carbon and Fiberglass material cloths are usually 2D orthotropic. Pearce and Webber were first to offer symmetric wrinkling stress equation for specially orthotropic facesheets. [9]

$$\sigma_{wr} = \frac{\pi}{t_f a^2} \left[ D_{11} m^2 + 2(D_{12} + 2D_{66}) \left(\frac{a}{b}\right)^2 + D_{22} \left(\frac{1}{m^2}\right) \left(\frac{a}{b}\right)^4 \right] + \frac{2E_c a^2}{m^2 \pi^2 t_f t_c}$$

Pearce and Webber equation is very complicated for fast and efficient design of sandwich plate, so generally derived equation for the axial compressive stress in the facesheet will be used.

$$\sigma_{wr} = k_1(E_f E_c G_c)^{\frac{1}{3}}$$

This equation is valid for the case of solid isotropic core (insert). Another main advantage of this equation is that it is independent on the thickness of the sandwich laminate (both core(insert) and facesheet(skin) thicknesses). To make this generalized equation suitable for orthotropic material  $E_f$  should be replaced by the following equation:

$$12(1 - \nu^2)D_f/t_f^3$$

Frequently, value of bending stiffness  $D_f$  is not available, so general wrinkling equation is adapted to orthotropic materials, changing its  $k_1$  coefficient (usually to lower values). [9]

All these predictions made by scientists cannot be generally adopted for all designs, because all of these equations are derived for isotropic facesheets. So, wrinkling coefficient will depend not only on the quality of the laminated material or amount of the epoxy, but mainly on the orientation of orthotropic skin material.

Usual procedure of sandwich structures wrinkling prediction includes calculation of the maximum principal facesheet stress with general equation, comparing it then to an allowable stress derived from uniaxially loaded model.

### 1.3 Crimping

Another type of laminate failure is shear crimping. It usually affects light core of the sandwich and is basically a short wavelength form of antisymmetric wrinkling. Shear crimping load can be calculated with the following equation. [4] [9]

$$\frac{1}{P_{cr}} = \frac{1}{P_E} + \frac{1}{tbG_c}$$

$$P_s = tbG_c$$

$$\frac{P_s}{b} = tG_c$$

In this thesis I will use third equation to calculate critical rated crimping load.

## 1.4 Uniaxial and biaxial in-plane shear testing

In this chapter, method used for the in-plane shear testing of sandwich plate is described. Basically two methods of the in-plane shear test can be used: uniaxial and biaxial. These two methods use the same specimen with same dimensions. Specimen is  $45^\circ$  rotated. The main difference is in the way load is distributed. If uniaxial method is used, pulling force is applied at two diagonally opposite corners of the frame. Frame is pinned at all corners, so members can rotate easily. Uniaxial load distribution is shown in the following figure.

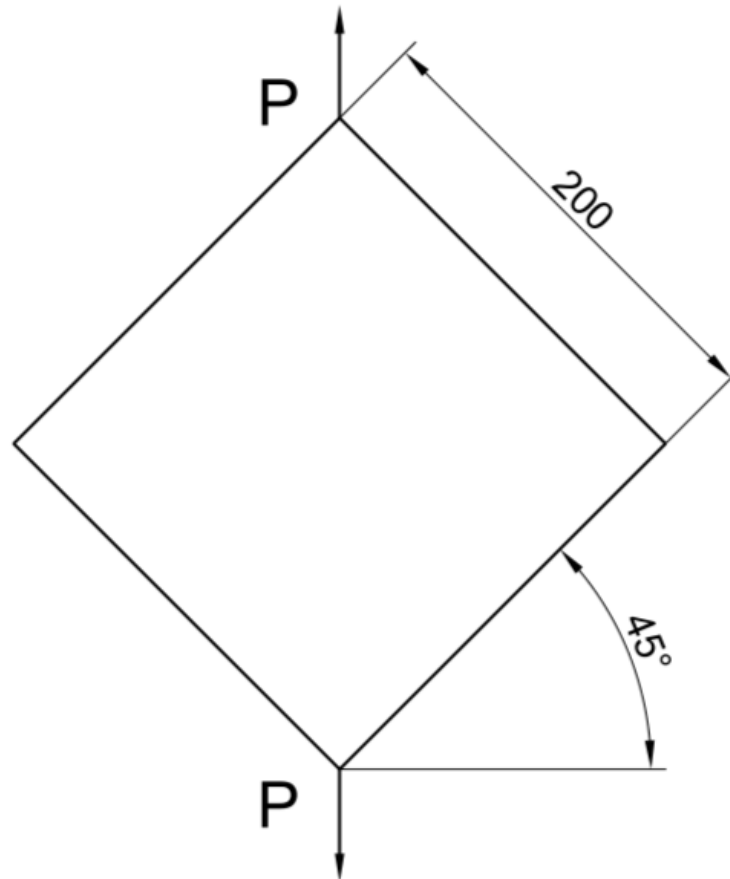

Figure 1. Schematic load distribution in uniaxial test method.

Tensile force is applied to pins in frame. Specimen is deformed into parallelogram shape with unchanged length of sides. However, not only specimen is deformed, edge members of frame are extended and bended. Even such extension and bending is not big compared to laminated specimen deformation (significant stiffness difference between frame material and laminated specimen) it can still affect experiment results. [4]

To eliminate these effects biaxial method of in-plane shear testing was invented. All four pins – corners of the frame are loaded, two with tensile force and two with compressive ones. Simplified drawing of biaxial load method is shown in the following figure.

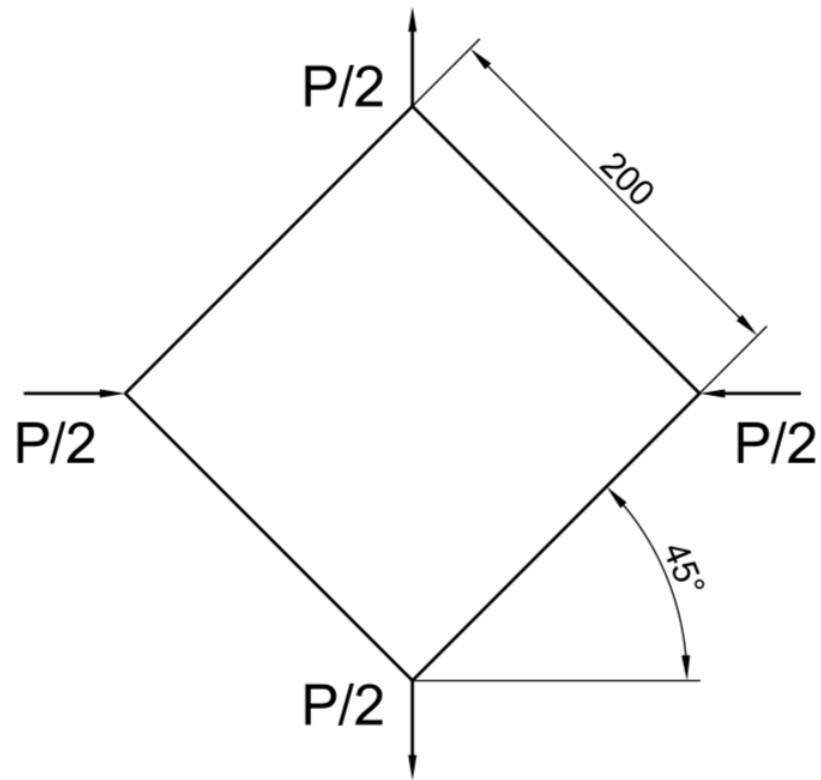

Figure 2. Schematic biaxial test method.

As shown in figure, every corner of frame is loaded with half of the pulling load ( $P/2$ ).

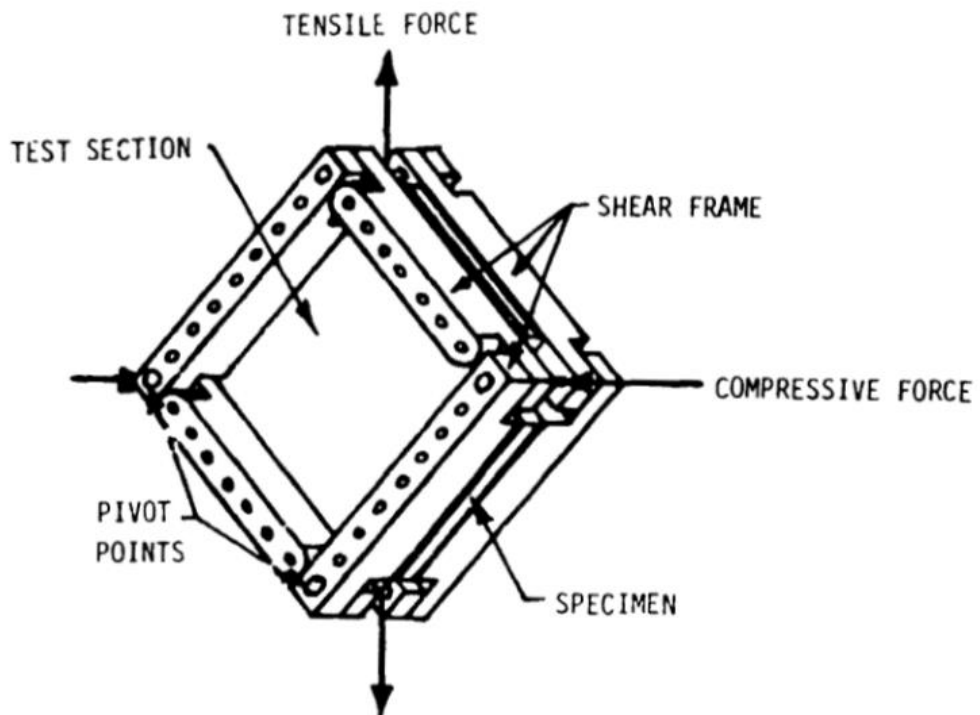

Figure 3. Biaxial shear frame and specimen [4].

Even this method of load test is more accurate, only uniaxial test machine was available for sandwich plate testing. However, I can assume that experiment results would not be affected significantly by simplified loading mode because stiffness difference between sandwich laminate and frame material is quite big. Uniaxial machine with frame and specimen used during experiments is shown in the following figure. [2] [4]

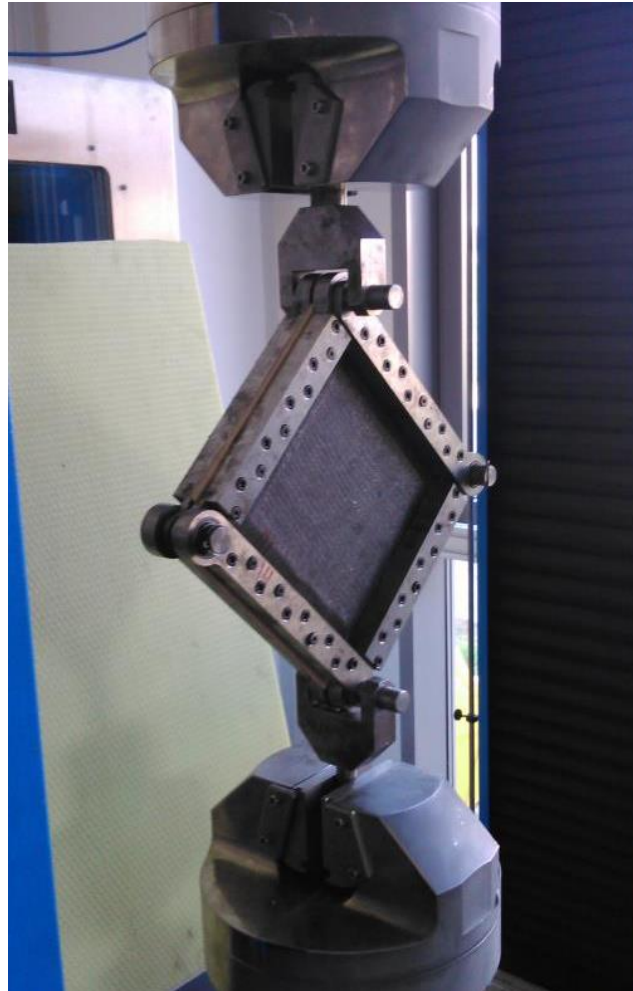

Figure 4. Uniaxial shear frame and specimen installed to pulling machine [13].

Specimen is fixed to frame with ten bolts on each side. To make such fixture possible, specimens are produced with reinforced offsets of enough stiffness to transfer load directly to the section of experiment interest (square central area of specimen). After specimen is fixed, frame is loaded with the pulling load until sandwich plate fails because of some failure mode. Main output from this experiment is load graph, which also shows the highest value of pulling load before failure. Getting these values, experiment results are further assessed with analytical calculations or with simulation.



## 1.5 Objectives

Problematics of sandwich laminate plates failure is very complex. It includes numerous failure modes both symmetric and antisymmetric. I decided to aim on the simplified symmetrical failures, particularly tension skin failure, symmetrical wrinkling and crimping. It will help me to use simplified simulations and calculations, so results of my bachelor's thesis can be used at school, particularly for simulation of sandwich plates during limited time available at laboratories.

My goal for this thesis is to design appropriate simulation of uniaxial in-plane shear test in MSC Patran finite elements analysis software. Simulation design has to be time-efficient, making possible for students to perform similar simulation during limited time of laboratory exercise. It also has to be accurate (compared to the analytical calculations) and provide graphical approximation of stress distribution.

Next goal of the present is to simulate students' experiments with chosen simulation approach, comparing simulation results with analytically calculated experiment results and analytical calculations. One of the reason for this comparison, is possible definition of correlation between simulation and analytics, proving of basic wrinkling and crimping equations for 2D orthotropic skin materials. In the couple of next chapters, I will try to fulfil all set goals clearly and accurately.

## 2 Design approaches to simulations

In this chapter three design approaches to simulation in MSC Patran software are presented. These simulation approaches include both 2D and 3D ways of sandwich plate representation. They also differ in the way load is applied. The task was to create the simulation which will be the most accurate and perform in the best possible way. After creation of all three designs, they are compared. As a result of comparison the best choice from view of performance, accuracy, time efficiency and overall practical value, was chosen.

### 2.1 First design approach – 2D surface with smaller surfaces

#### 2.1.1 Model

First step in the simulation design is to provide simulation software with the model of the analyzed object. In my case it would be composite laminate plate fixed into the pulling testing machine, 45 degrees rotated. For the first design approach I decided to use surface as the composite plate model and four surrounding smaller surfaces which represents test frame.

Firstly, I created surface with square dimensions of  $200 * 200 \text{ mm}$ . This surface would be used as the composite plate model. Next, I created four smaller surrounding surfaces with  $10 * 200 \text{ mm}$  dimension. These surfaces are attached by their longer side to each edge of the main surface – composite plate model. Next, all five surfaces were rotated, rotation angle 45 degrees. After geometric model creation, its meshing can be performed.

#### 2.1.2 Meshing

With the use of Mesh Control command, I divided all four edges of the main surface into thirty elements. Longer edges of the smaller surrounding surfaces were divided into thirty elements too. Shorter edges were divided into ten. Mesh command was used to create  $30 * 30$  mesh for the main surface (nine hundred elements). Another  $30 * 10$  meshes were created for four surrounding surfaces (three hundred elements each).

After creation of mesh for every surface in model, meshes were compiled together to provide accurate simulation results, so they will be not “teared off” under the load. Such compilation is made with the Equivalence command. Equivalence function is automatically picking up all meshes available in the model and compiles it into one continuous mesh, deleting excessive nodes based on the tolerance value.

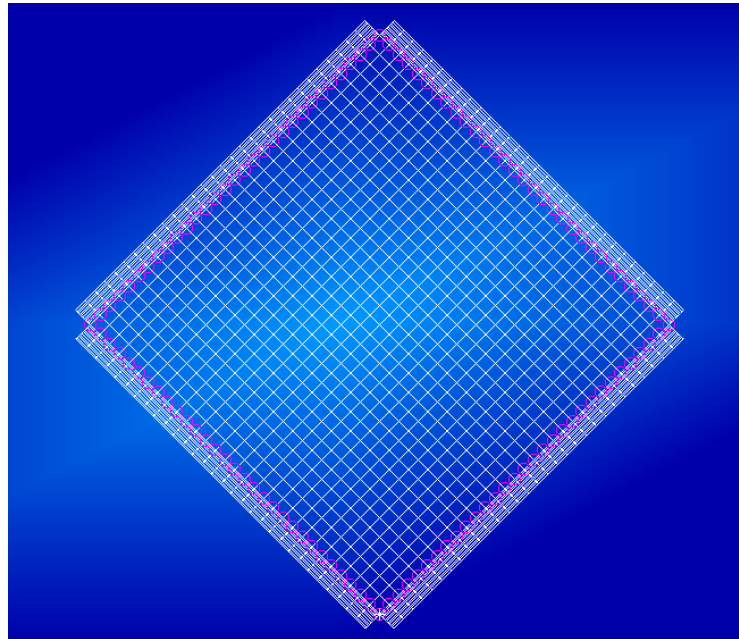

Figure 5. Meshing of the first approach model.

### 2.1.3 Materials specification and properties application

For this case I specified three types of the basic materials. These included: isotropic foam C70.55, orthotropic woven fabric Fiberglass 92125 and rigid material. All material specifications can be found in the IDAFLEG material lists. The rigid material is the ideal material with infinite strength and resistance, so it would not deform under the simulation loads.

Laminate is composed from two basic materials: C70.55 foam – insert and Fiberglass 92125 woven fabric – skin material. In the laminate composer menu materials were layered as in the following table.

Material	Type	Orientation	Thickness [mm]
Fiberglass 92125	Skin	45°	0.3
C70.55 (yellow)	Insert	–	5
Fiberglass 92125	Skin	45°	0.3

Table 1. Sandwich plate composition, first approach model.

After finishing input of material properties, they can be applied to the model. It was made in the Properties menu. Firstly, I applied “laminate” material properties to the 2D surface, creating 2D shell with the thickness specified by “laminate” itself. Secondly, I created four 2D shells applying the rigid material properties to the surrounding small surfaces. Thickness of these shells is the same as the thickness of the laminate, in this particular case 5,6 *mm*.

## 2.1.4 Loads and boundary conditions

### Displacements

Boundary conditions for model in all three axes (X, Y, Z) should be provided by displacements. All five surfaces were fixed against movement in the “Z” axis direction,  $Z_{fix} = [.,.,0]$  condition was used. As decision that composite panel would be loaded symmetrically was taken, I could use simple boundary conditions for “X” and “Y” axes directions. Upper and down edge intersection nodes of the main composite plate mesh were fixed in the “X” axis direction,  $X_{fix} = [0,.,.]$  condition was created. The furthest left and right nodes of the main composite plate mesh were fixed with  $Y_{fix} = [.,0,.]$  condition in the “Y” axis direction.

### Loads

According to the task, sandwich plate has to be loaded with 10000 N shear load. Making simple calculation, I determined pulling load value of 14142 N. As I have mentioned earlier, composite plate would be loaded symmetrically. I have chosen four nodes for load application. These nodes are the part of small surrounding surfaces and are situated on their shorter edges close to the symmetry axis. Consequently, load value for each of the node will be 7071 N. The following figure reflects loads and displacements placement.

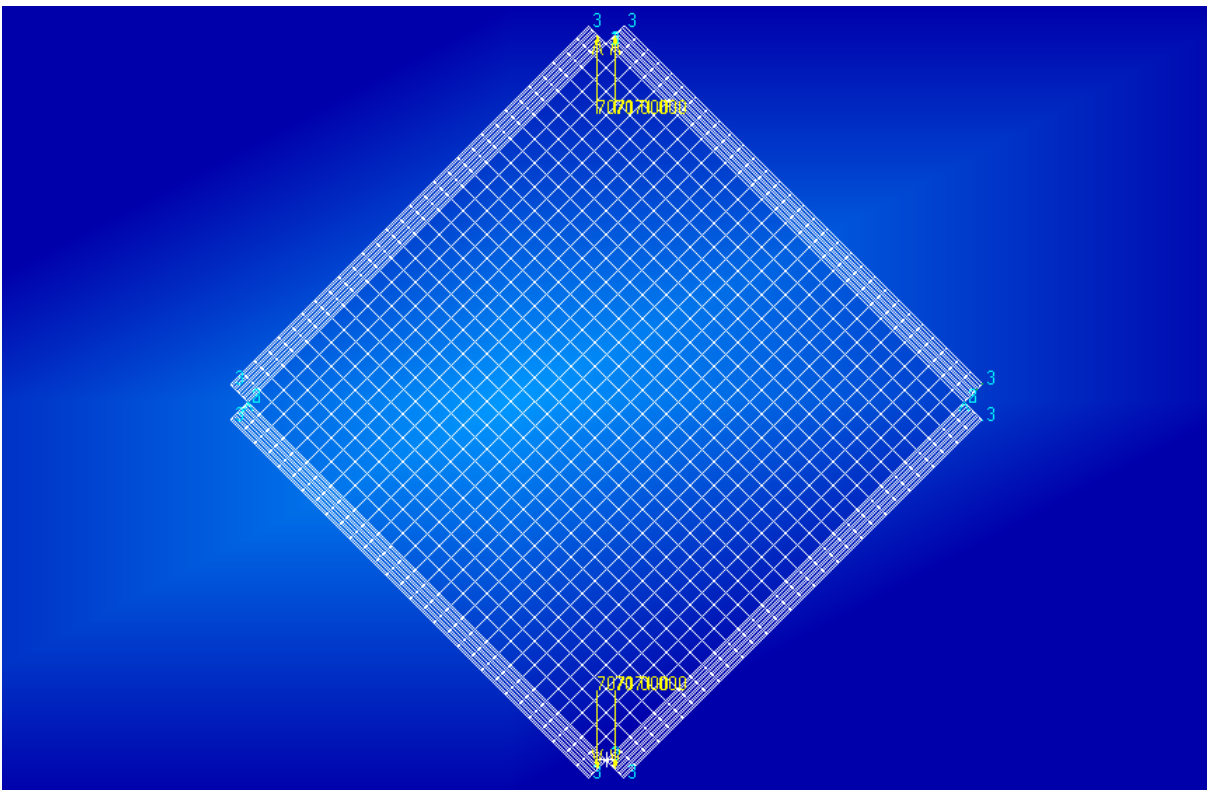

Figure 6. Loads and displacements representation for the first approach model.

This is the final step of design, so simulation can be performed now.

## 2.2 Second design approach – 2D surface with rods

### 2.2.1 Model

For the second design approach, I decided to use 2D surface as the composite plate model and four 1D rods as the frame in which composite plate is fixed in the real experiment.

Firstly, I created surface with square dimensions of  $200 * 200 \text{ mm}$ . This surface would be used as the composite plate model. Next, I created four curves which copied four edges of the surface. These curves would be later converted to the rods, made of “rigid” material. Afterwards, both surface and curves were rotated, rotation angle 45 degrees.

### 2.2.2 Meshing

With the use of Mesh Control command, I divided each of the surface edges and curves into thirty elements. Next, I used Mesh command for both surface and four curves. The  $30 * 30$  mesh for the surface was created (nine hundred elements) and each of the curves was divided into thirty bar elements.

After meshing of each geometrical form, meshes are compiled together to provide accurate simulation results, so meshes will be not “teared off” under the load. Such compilation was made with the Equivalence command.

### 2.2.3 Material specification and properties application

Material specification and laminate composition is the same as specified in first design approach, so all design approaches could be compared between easily.

Previously specified material properties are now applied to geometric model. It can be made in the Properties menu. Firstly, I applied created “laminate” material to the 2D surface, creating 2D shell with the thickness specified by “laminate” itself. Secondly, I created four 1D rods from four curves with the material sooner specified as “rigid” and cross-section area of  $1256 \text{ mm}^2$ .

## 2.2.4 Loads and boundary conditions

### Displacements

Boundary conditions in all three axes should be provided by displacements. Both surface and four curves have to be fixed in “Z” axis, with  $Z_{fix} = [ , , 0]$  condition. As model will be loaded symmetrically, upper and down curves intersection points are fixed in the “X” axis direction with  $X_{fix} = [0, , ]$  condition. Respectively, far left and far right intersection points are fixed in the “Y” axis direction with the  $Y_{fix} = [ , 0, ]$  condition.

### Loads

For this simulation, loads specification is quite simple. According to the task sandwich plate have to be loaded with 10000 N shear load, pulling load of 14142 N. There are two points where the load is applied. These two points are the upper and down intersection of curves loaded with specified pulling load. The following figure shows loads and displacements distribution.

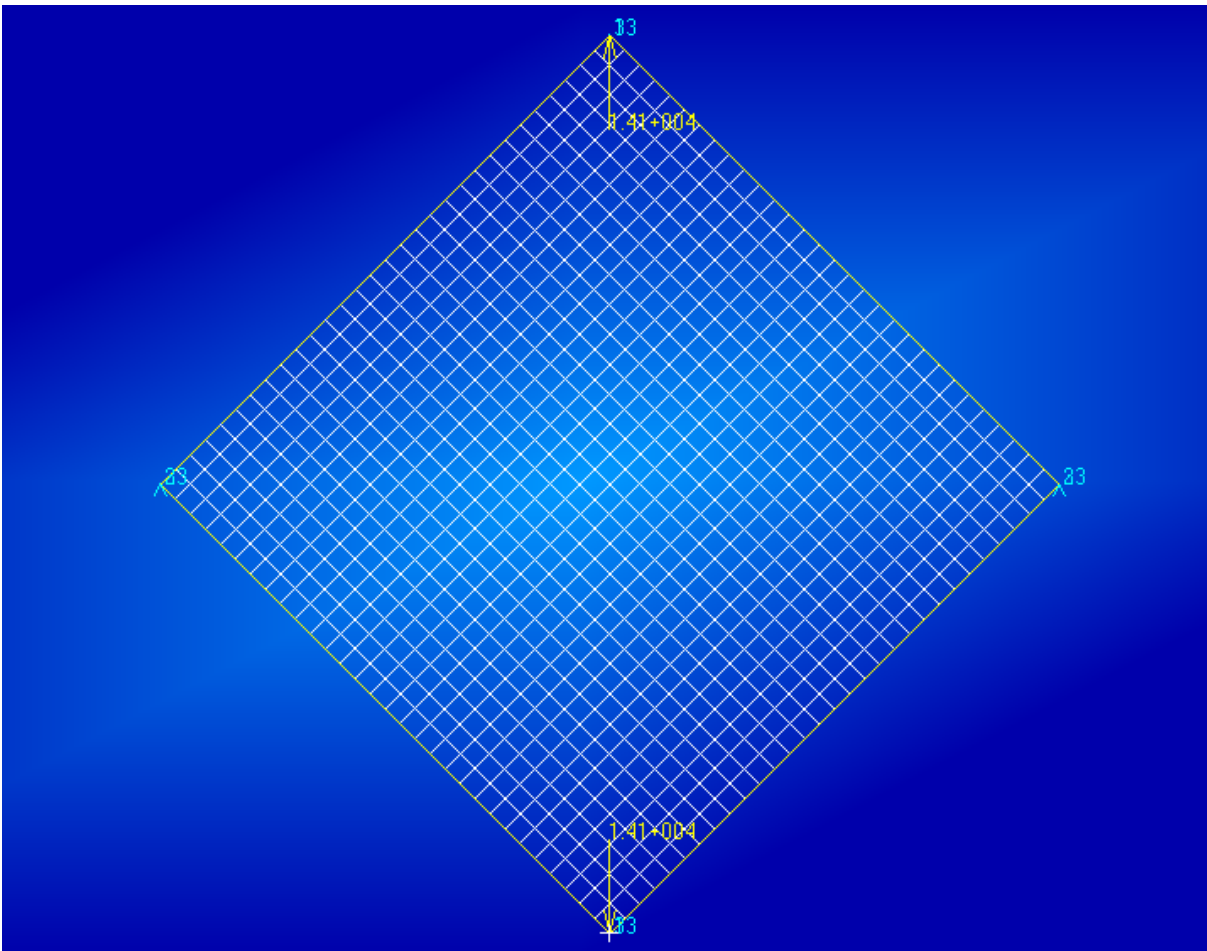

Figure 7. Meshing/loads/displacements representation for the second approach model.

This is the final step of design, so simulation can be performed now.

## 2.3 Third design approach – 3D model

### 2.3.1 Model

For the third design approach, I decided to use 3D model as the composite plate representation.

Firstly, I created surface with square dimensions of  $200 * 200 \text{ mm}$ . This surface would be used as the shear tested area of composite plate. Next, I created four smaller surfaces with dimensions of  $5 * 200 \text{ mm}$ . These smaller surfaces are attached by their longer edge to the main surface. Then, I created four curves  $210 \text{ mm}$  long. Curves are surrounding all mentioned surfaces (1+4), and later would be used as “rigid” material rods. Afterwards, both surface and curves were rotated, rotation angle 45 degrees.

3D form of the model will be created with use of meshing in the next chapter.

### 2.3.2 Meshing

With the use of Mesh Control command, each of the main surface edges were divided into forty elements. The  $5 * 200 \text{ mm}$  smaller surfaces' edges were divided into three and forty elements respectively. Four curves were divided into forty-two elements (to keep uniform width of mesh element). Mesh of 1600 elements was created on the main surface with Mesh command. Four meshes of 120 elements were created for smaller surfaces. Forty-two bar elements were created on each of curves. Next, meshes were compiled with equivalence command and driving geometry have been deleted.

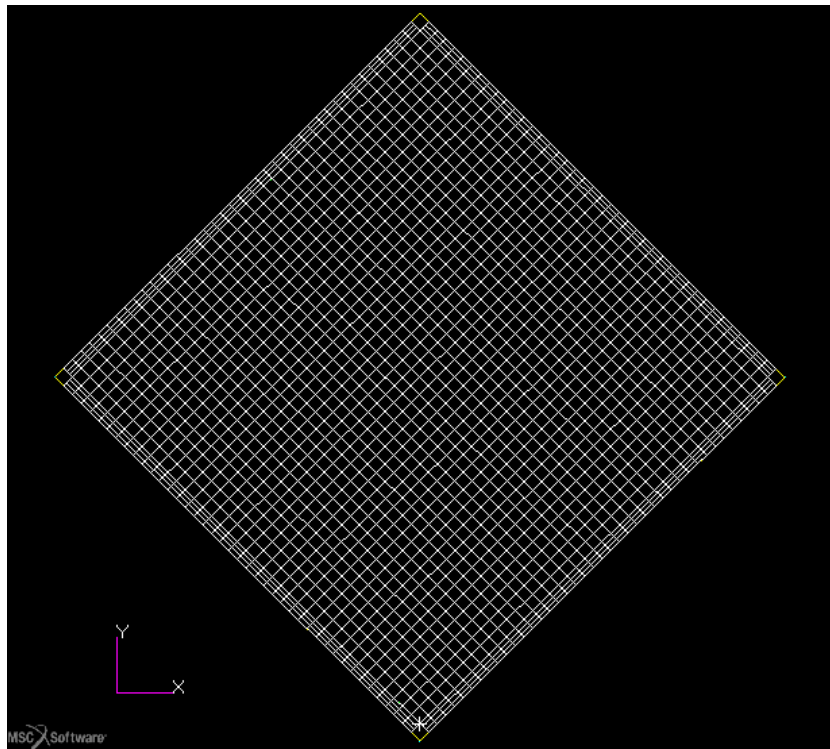

Figure 8. Meshing of 2D surfaces and curves in the third approach model.

Next, I could start with creation of 3D shape of model.

Firstly, element area of  $38 * 38$  elements was picked from the main plate mesh and extruded with sweep function. The height of extrusion was five elements, totaling  $5 \text{ mm}$ . On the top of this extrusion face elements were created. It was made with creating and meshing surface with same mesh dimensions as its 3D specimen.

Next step was to create four triangular transitions between upper surface and base. These triangular shaped (cross-section) transitions were created as thirty-eight 3D elements, with use of sweep extrusion. Such transition was created on each edge of the main surface. Last step was to create face elements on the longer (hypotenuse) side of triangle shaped transitions – bars. After finishing of meshing manipulations, equivalence command was used. All geometrical shapes used to create meshing were deleted.

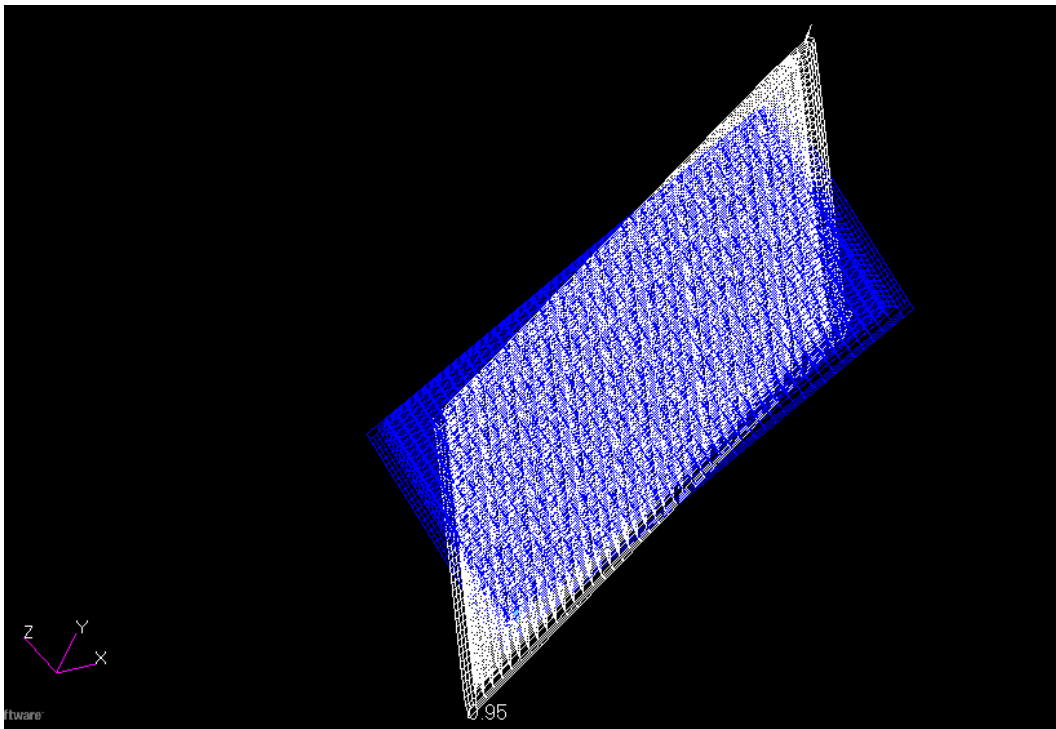

Figure 9. Meshing of 3D model, including mesh deformed under load.



### 2.3.3 Material specification and properties application

Material specification is the same as specified in first design approach, so all design approaches will be compared between easily. However, “laminated” material was not used for this approach.

Material properties application to mesh elements is made in the Properties menu. At first, I applied created Fiberglass 92125 material to all FEA quad and shell elements, except of elements which were part of smaller surfaces. Thickness of 2D shell was 0,3 *mm* according to task specification. Quad and Shell elements, which were part of smaller surfaces have been applied with the same material properties, but thickness of 2D shell was 3 *mm*. Material orientation of these properties is guided by Vector 1, which direction is positive direction of “Y” axis.

Next, 1D rods were created from bar elements which were part of four curves. 1D rod was specified with material called “rigid” and cross-section area of 1260 *mm*<sup>2</sup>.

Last step in material specification is definition of 3D solid property. This property includes all 3D mesh elements available; material choice is C70.55 foam.

### 2.3.4 Loads and boundary conditions

#### Displacements

Boundary conditions in all three axes should be provided by displacements. All mesh nodes of the model have to be fixed in “Z” axis, with  $Z_{fix} = [ , , 0]$  condition. As model is loaded symmetrically, upper and down curves’ intersection nodes were fixed in the “X” axis direction with  $X_{fix} = [0, , ]$  condition. Respectively, far left and far right intersection nodes are fixed in the “Y” axis direction with the  $Y_{fix} = [0, ]$  condition.

#### Loads

For this simulation design, loads specification is very similar to second design approach. Pulling load for the simulation will be 14142 *N*. This load will be applied to two mesh nodes, which are located on the upper and down intersection of curves. Basically location of loads application area is the same as for second approach.

This is the final step of design, so simulation can be performed now.

## 2.4 Comparison of design approaches

After simulation of every design approach was performed, I can compare results in terms of several important criterions.

First result representation figure is valid for the design made of surfaces (first design approach). Figure shows maximum shear stress amongst all three layers of laminate.

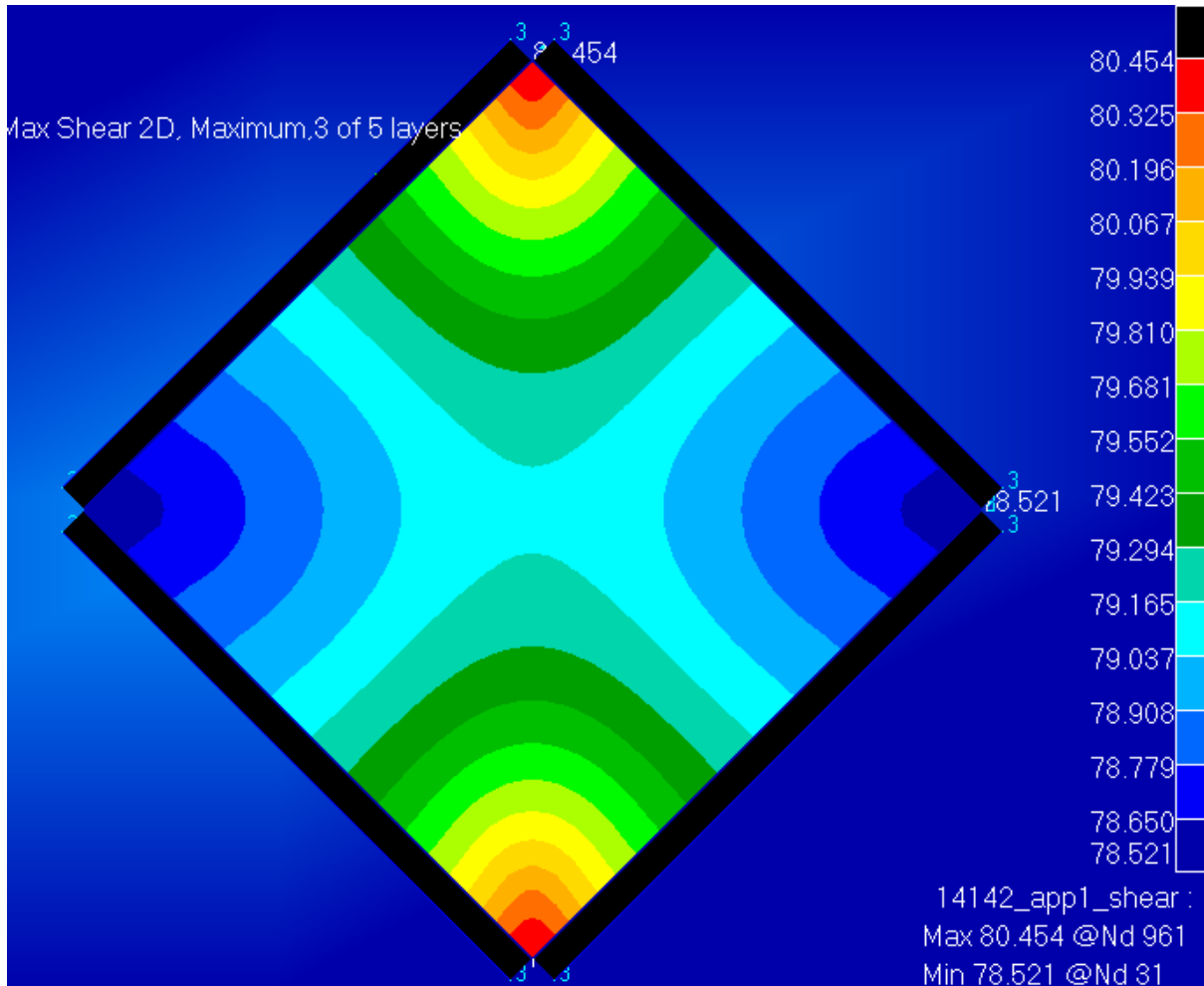

Figure 10. Graphic representation of shear stress in plate, first design approach.

Stress distribution for this approach is symmetrical, with values ranging from 78,521 MPa to 80,454 MPa. Such range is quite wide for this type of shear stress test.

Second result representation figure is valid for the design made of surface and four rods (second design approach). Figure shows maximum shear stress amongst all three layers of laminate.

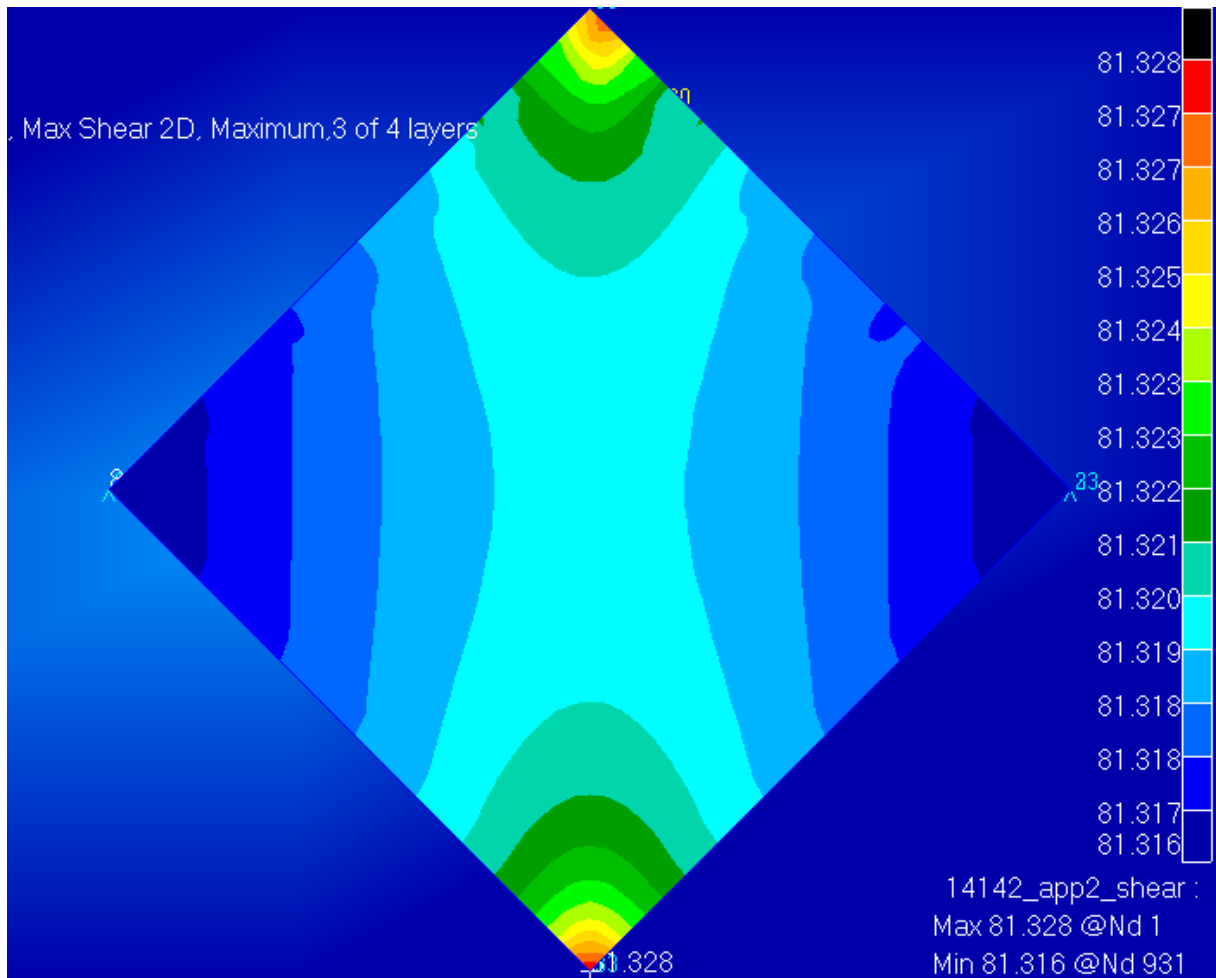

Figure 11. Graphic representation of shear stress in plate, second design approach.

Stress distribution for this approach is nearly symmetrical, with values ranging from  $81,316 \text{ MPa}$  to  $81,328 \text{ MPa}$ . This range is a lot smaller than the range of first design approach results. Graphical representation of stress distribution is also more accurate, than graph from the first approach (based on experience).

Results of the last simulation approach (3D) are presented the next three figures. All graphic representations were plotted with Max Shear function.

First figure shows maximum shear stress for front layer of skin in the sandwich plate. Distribution of shear stress seen on the figure, can be rated as quite symmetrical. This basically corresponds with stress distribution from second design approach. Values of stress in the interest area (squared specimen) are ranging from  $67,33 \text{ MPa}$  to  $85,26 \text{ MPa}$ . It is generally accepted that the most accurate values of shear stress are concentrated in the middle of squared specimen. In this case, it has light green color and range of stress values is from  $76,30 \text{ MPa}$  to  $85,26 \text{ MPa}$ . Averaged stress value of  $80,78 \text{ MPa}$ , is very close to the averaged result value from second design –  $81,322 \text{ MPa}$ .

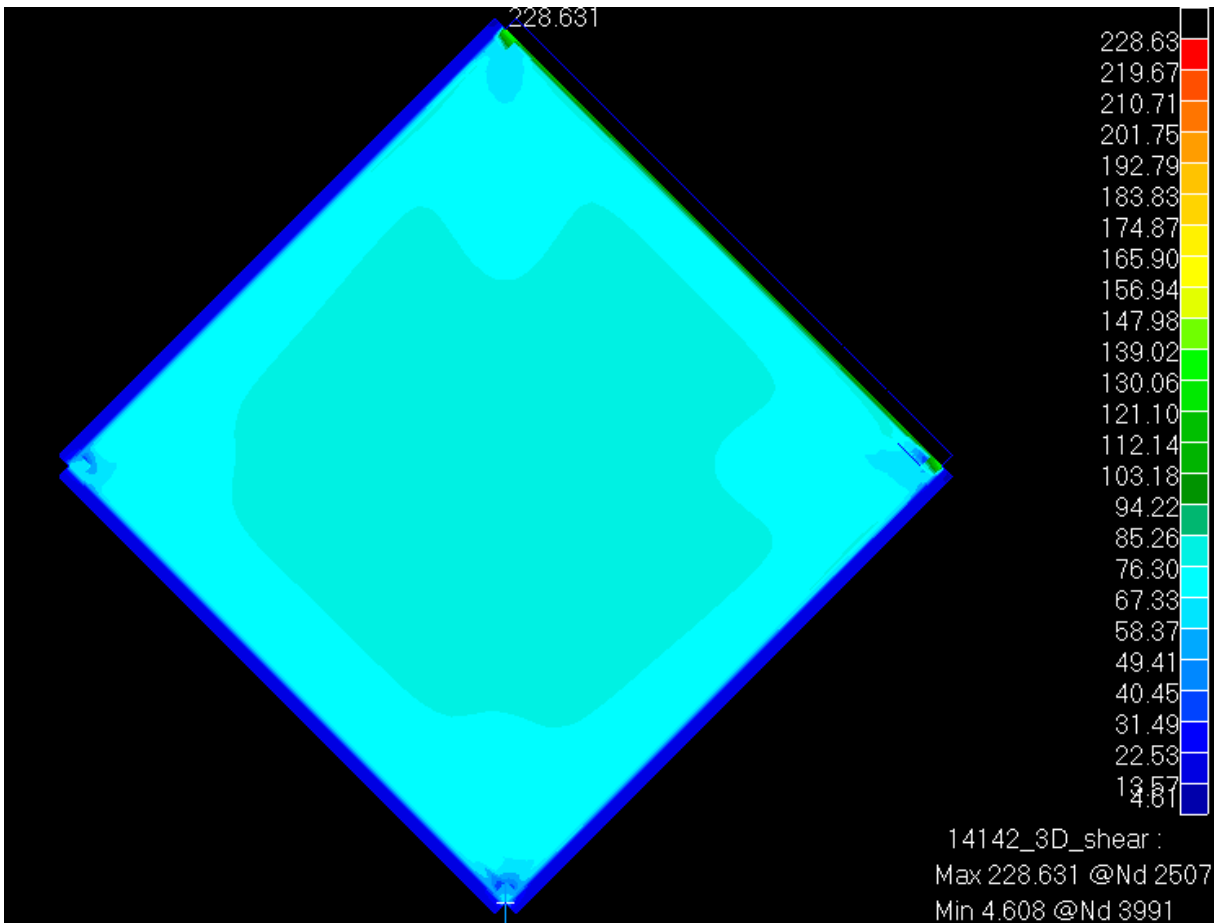

Figure 12. Front view of shear stress in sandwich plate, 3D approach.

Rear view of sandwich plate, shows even more uniform shear stress distribution. Almost all square area is filled with the light green color, representing stress range from 76,30 MPa to 85,26 MPa. However, area around left upper edge of squared specimen is seen to be stressed more than others. Area is darker green-colored which represents stress range from 85,26 MPa to 130,06 MPa. Even this stress value is higher than minimal material characteristic of Fiberglass 92125 material (95 MPa), I cannot predict skin failure. Material characteristic values of skin materials are too conservative and from experience tension failure of the skin is very rare. Usually failure modes like crimping or wrinkling occur sooner.

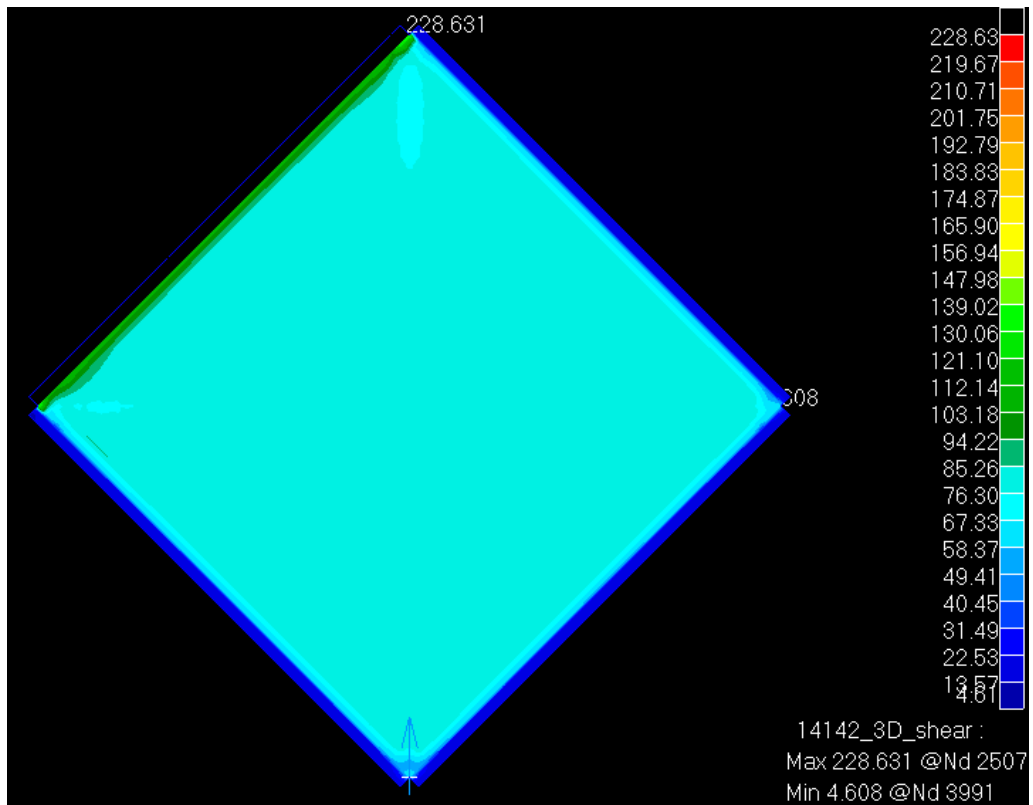

Figure 13. Rear view of shear stress in sandwich plate, 3D approach.

Edge view of sandwich plate in the next figure, proves that no special stress concentrations are situated on the transition edges of plate. Such simulation result allows me take an assumption that plane to plane transfer edges are not needed to be reinforced, when experimental specimen is produced for in-plane shear test.

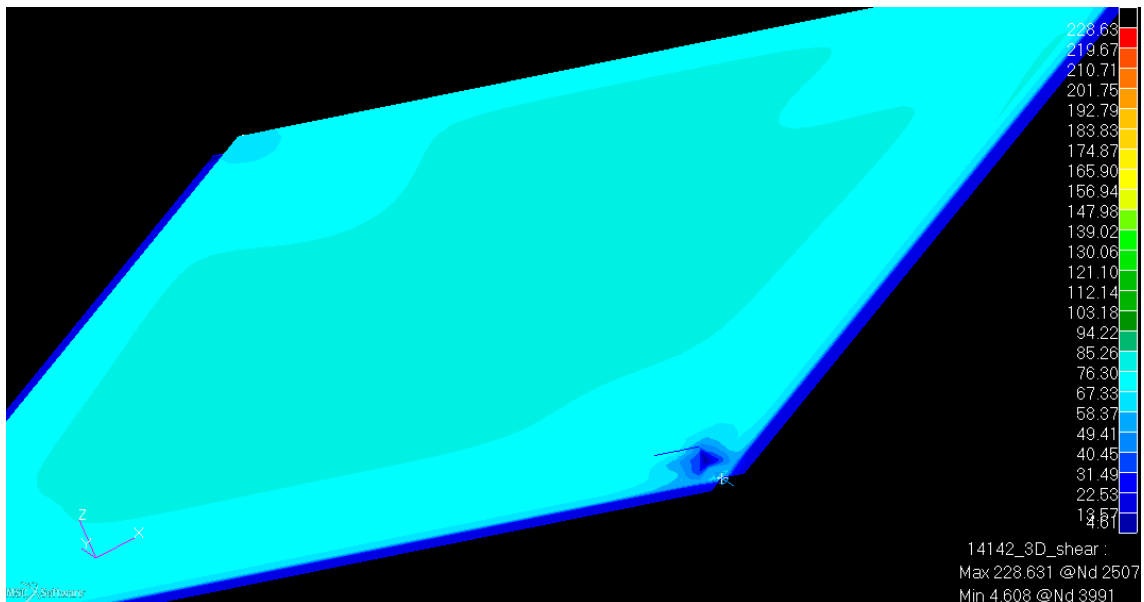

Figure 14. Edge view of shear stress in sandwich plate, 3D approach.

Next I would like to compare design approaches in terms of accuracy. I suppose that relevant comparison can be based on the value I can get calculating stress analytically. It is made with the following equation.

$$\sigma_p = \frac{S}{a * t_s} = \frac{10000 N}{200 mm * 0,6 mm} = 83,333 MPa$$

$S$  – shear load of sandwich plate

$a$  – side size of squared specimen

$t_s$  – thickness of skin

In the next table averaged stress values from three designs are compared with analytical calculation.

Design approach	Range of shear stress		Average shear stress value, [MPa]	Difference from 83,333 MPa, [%]
	From, [MPa]	To, [MPa]		
<b>2D Surfaces</b>	78,521	80,454	79,488	4,61
<b>2D Surface with rods</b>	81,316	81,328	81,322	2,41
<b>3D model</b>	76,30	85,26	80,78	3,06

Table 2. Averaged shear stress comparison, three simulation approaches.

According to comparison made in this table I can rank design approaches according percentage differences, with closest result ranking as first.

1. 2D Surface with rods
2. 3D Model
3. 2D Surface with smaller surfaces

Next, three design approaches are compared, taking into account several important criterions including design accuracy surveyed in previous table.

Parameter	2D surface with smaller surfaces	2D surface with rods	3D model
Design time	Short	Short	Longer
Representation accuracy	Poor	Better	Better
Computational time	Standard	Short	Longer
Overall practical value	Poor	Best	Better

Table 3. Important criterions comparison, three simulation approaches.

Based on this criterion comparison I have chosen 2D surface with rods (second) approach for following simulations. This approach fits perfectly to the objectives I defined in previous chapters. Simulation makes possible to predict load graph in plate accurately and efficiently. Its design is time-efficient and simple.

3D model (third) design approach provides some interesting results too but its design process is very time-consuming. Some practical value I can get from this design approach is even more accurate prediction of stress distribution, including stress distribution in corners and plane to plane transitions of the laminate skin.

2D surface with smaller surfaces (first) approach is not suitable my objectives. It does not provide accurate results (comparing to 2D surface with rods approach) nor produces a picture of factual stress distribution like 3D approach.

### 3 Experiments

In this chapter six experiments will be presented, including analytical solution, experiment (from reference protocols), simulation and comparison of results. The aim of such experiments' presentation is to check the correlation of chosen simulation model with analytical and experimental results. Also some conclusions about wrinkling and crimping will be made.

The main topic of these experiments was to design sandwich composite plate which will sustain specified shear load with use of analytical approach calculations. Then, designed plate had to be tested with laboratory load test machine, uniaxial in-plane shear test.

#### 3.1 Sandwich plate compositions and experimental results

Sandwich laminate plates tested during experiments, described in protocols, were made of different composite structures. Following tables show laminate structure of each experiment. This chapter also includes results for each experiment, like a failure load and value of stress in sandwich plate.

##### 3.1.1 Experiment 1

Experiment results and sandwich composition were used from protocol “Elaborát č. 4 – Kompozity” made by students Bilčík, Vaněk and Heczko. Sandwich structure is presented in the following table. [1]

Material	Type	Orientation	Thickness [mm]
Fiberglass 92125	Skin	45°	0,3
C70.55 (yellow)	Insert	–	5
Fiberglass 92125	Skin	45°	0,3

Table 4. Sandwich plate composition, Experiment 1.

Design shear load value for sandwich plate:  $S_1 = 10000 N$

Thickness of sandwich skin:  $t_{S1} = 0,6 mm$

Thickness of sandwich insert:  $t_{I1} = 5 mm$

According to experiment results, wrinkling mode failure lead to the damage of the composite plate. Measured load value at which failure occurred was  $14680 N$  ( $F_{F1} = 14680 N$ ). Analytically calculated failure stress in laminate skin is defined.

$$\sigma_{F1} = \frac{F_{F1}}{\sqrt{2} * a * t_{S1}}$$
$$\sigma_{F1} = \frac{14680 N}{\sqrt{2} * 200 mm * 0,6 mm} = 86,503 MPa$$



### 3.1.2 Experiment 2

Experiment results and sandwich composition were used from protocol “Kompozitní potah” made by students Čermák, Grim, Kolářová and Smékal. Sandwich structure is presented in the following table. [5]

Material	Type	Orientation	Thickness [mm]
Carbon 200	Skin	45°	0,32
C70.55 (yellow)	Insert	–	5
Carbon 200	Skin	45°	0,32

Table 5. Sandwich plate composition, Experiment 2.

Design shear load value for sandwich plate:  $S_2 = 10000 \text{ N}$

Thickness of sandwich skin:  $t_{S2} = 0,64 \text{ mm}$

Thickness of sandwich insert:  $t_{I2} = 5 \text{ mm}$

According to experiment results, wrinkling mode failure lead to the damage of the composite plate. Measured load value at which failure occurred was  $20865 \text{ N}$  ( $F_{F2} = 20865 \text{ N}$ ). Analytically calculated stress in laminate skin is defined.

$$\sigma_{F2} = \frac{F_{F2}}{\sqrt{2} * a * t_{S2}}$$

$$\sigma_{F2} = \frac{20865 \text{ N}}{\sqrt{2} * 200 \text{ mm} * 0,64 \text{ mm}} = 115,264 \text{ MPa}$$

### 3.1.3 Experiment 3

Experiment results and sandwich composition were used from protocol “Protokol č. 3. Technologie výroby letadel” made by students Monček, Kubo and Buben. Sandwich structure is presented in the following table. [13]

Material	Type	Orientation	Thickness [mm]
Carbon 200	Skin	45°	0,32
C70.55 (yellow)	Insert	–	5
Carbon 93	Skin	45°	0,15
Carbon 200	Skin	45°	0,32

Table 6. Sandwich plate composition, Experiment 3.

Design shear load value for sandwich plate:  $S_3 = 20000 \text{ N}$

Thickness of sandwich skin:  $t_{S3} = 0,79 \text{ mm}$

Thickness of sandwich insert:  $t_{I3} = 5 \text{ mm}$

According to experiment results, two-mode failure led to the damage of the composite plate. Measured load value at which crimping occurred was 26000 N ( $F_{F3c} = 26000 N$ ). Wrinkling failure occurred at load 28000 N ( $F_{F3w} = 28000 N$ ). Analytically calculated stress in laminate skin is defined.

$$\sigma_{F3c} = \frac{F_{F3c}}{\sqrt{2} * a * t_{S3}}$$

$$\sigma_{F3c} = \frac{26000 N}{\sqrt{2} * 200 mm * 0,79 mm} = 116,359 MPa$$

$$\sigma_{F3w} = \frac{F_{F3w}}{\sqrt{2} * a * t_{S3}}$$

$$\sigma_{F3w} = \frac{28000 N}{\sqrt{2} * 200 mm * 0,79 mm} = 125,310 MPa$$

### 3.1.4 Experiment 4

Experiment results and sandwich composition were used from protocol “Protokol: Kompozitní stojina” made by students Marcinko, Kacál and Fojtl. Sandwich structure is presented in the following table. [11]

Material	Type	Orientation	Thickness [mm]
Carbon 200	Skin	45°	0,32
C70.55 (yellow)	Insert	–	5
Carbon 200	Skin	45°	0,32

Table 7. Sandwich plate composition, Experiment 4.

Design shear load value for sandwich plate:  $S_4 = 10000 N$

Thickness of sandwich skin:  $t_{S4} = 0,64 mm$

Thickness of sandwich insert:  $t_{I4} = 5 mm$

According to experiment results wrinkling mode failure lead to the damage of the composite plate. Measured load value at which failure occurred was 27012,5 N ( $F_{F4} = 27012,5 N$ ). Analytically calculated stress in laminate skin is defined.

$$\sigma_{F4} = \frac{F_{F4}}{\sqrt{2} * a * t_{S4}}$$

$$\sigma_{F4} = \frac{27012,5 N}{\sqrt{2} * 200 mm * 0,64 mm} = 149,224 MPa$$

### 3.1.5 Experiment 5

Experiment results and sandwich composition were used from protocol “Kompozitní stojina” made by students Mikulášek, Jetela and Černota. Sandwich structure is presented in the following table. [12]

Material	Type	Orientation	Thickness [mm]
Fiberglass 92110	Skin	45°	0,17
Fiberglass 92110	Skin	45°	0,17
Fiberglass 92110	Skin	45°	0,17
C70.55 (yellow)	Insert	–	10
Fiberglass 92110	Skin	45°	0,17
Fiberglass 92110	Skin	45°	0,17
Fiberglass 92110	Skin	45°	0,17

Table 8. Sandwich plate composition, Experiment 5.

Design shear load value for sandwich plate:  $S_5 = 20000 N$

Thickness of sandwich skin:  $t_{S5} = 1,02 mm$

Thickness of sandwich insert:  $t_{I5} = 10 mm$

According to experiment results, wrinkling mode failure lead to the damage of the composite plate. Measured load value at which failure occurred was  $27012 N$  ( $F_{F5} = 27012 N$ ). Analytically calculated stress in laminate skin is defined.

$$\sigma_{F5} = \frac{F_{F5}}{\sqrt{2} * a * t_{S5}}$$

$$\sigma_{F5} = \frac{27012 N}{\sqrt{2} * 200 mm * 1,02 mm} = 93,629 MPa$$

### 3.1.6 Experiment 6

Experiment results and sandwich composition were used from protocol “Zkouška mechanických vlastností laminatu” made by students Bucňák, Častulík and Junas. Sandwich structure is presented in the following table. [3]

Material	Type	Orientation	Thickness [mm]
Fiberglass 92125	Skin	45°	0,3
Fiberglass 92125	Skin	45°	0,3
C70.75 (green)	Insert	–	5
Fiberglass 92125	Skin	45°	0,3
Fiberglass 92125	Skin	45°	0,3

Table 9. Sandwich plate composition, Experiment 6.

Design shear load value for sandwich plate:  $S_6 = 20000 \text{ N}$

Thickness of sandwich skin:  $t_{S6} = 1,2 \text{ mm}$

Thickness of sandwich insert:  $t_{I6} = 5 \text{ mm}$

According to experiment results, crimping mode failure lead to the damage of the composite plate. Soon after crimping failure, skin failed under the tension. Measured load value at which crimping failure occurred was  $42874 \text{ N}$  ( $F_{F6} = 42874 \text{ N}$ ). Analytically calculated stress in laminate skin is defined.

$$\sigma_{F6} = \frac{F_{F6}}{\sqrt{2} * a * t_{S6}}$$

$$\sigma_{F6} = \frac{42874 \text{ N}}{\sqrt{2} * 200 \text{ mm} * 1,2 \text{ mm}} = 126,319 \text{ MPa}$$

## 3.2 Analytical solution

Composite plate was designed with use of fabric as a skin and foam as an insert. All material characteristics are taken from the IDAFLEG material properties list. Several analytical calculations were made before the experiment was held and simulation task designed.

First step is to calculate stress in the sandwich skin. As the sandwich plate should be designed to sustain some specified amount of shear load, factual pulling load have to be calculated because of the experiment nature (composite plate is rotated by 45° in the test machine).

$$P_x = \sqrt{2} * S_x$$

Next, I can determine the minimal material characteristics value which will be used to calculate safety factors and limit load for particular material used in sandwich plate.  $\sigma_{cx}$  is the minimal value of four material characteristics.

$$\sigma_{cx} = \min\{X_t; X_c; Y_t; Y_c; \}$$

Then, calculation whether the chosen laminate structure will sustain applied load and which safety factors could be applied to design, is made. For the composite laminates it is common that in addition to the shear tense resistance, resistance of the laminate against wrinkling and crimping is taken into account. In previous chapters I have already discussed the way how these failure mechanisms work.

Shear stress in the laminate skin is calculated with the following equation.

$$\sigma_{px} = \frac{S_x}{a * t_{Sx}}$$
$$a = 200mm$$

Consequently, rated value of stress in the laminate skin will be calculated.

$$N_x = \sigma_{px} * t_{Sx}$$

The next step is to calculate maximum rated tension value for chosen insert layer. This value is used to calculate crimping safety of the laminate.

$$N_{cx} = G_{cx} * t_{Ix}$$

Critical wrinkling stress for the laminate is calculated with the following equation.

$$\sigma_{wx} = k_1 * \sqrt[3]{G_{cx} * E_{cx} * E_{fx}}$$

Equation input data are material characteristics of skin and insert. Values of these characteristics are taken from Table 44. for fabric cloths and Table 45. for foams. The  $k_1$  coefficient is a chosen value based on the experiments and experience in the laminate design. Common range for the  $k_1$  value is 0,4 to 0,8. Value of every  $k_1$  coefficient was predicted as the 0,5, because it is supposed that the quality of laminate could be lower, because of lack of lamination experience. Inserting all data to the equation, critical wrinkling pressure for sandwich plate is calculated.

## Safety factors

- Tension

Comparing critical tension which fiberglass fabric can sustain with the applied shear load, safety against tension failure can be determined.

$$v_{tenx} = \frac{t_{Sx} * \sigma_{cx} * a}{S_x}$$

- Crimping

Comparing critical rated tension and rated tension in the laminate, safety of the insert against crimping is determined.

$$v_{crx} = \frac{N_{cx}}{N_x}$$

- Wrinkling

Comparing critical wrinkling stress for sandwich plate with the factual stress, safety against wrinkling is determined.

$$v_{wrx} = \frac{\sigma_{wx}}{\sigma_{px}}$$

## Limit force equations

With the use of the safety coefficients I can determine the theoretical force limit, when the sandwich laminate will fail in certain failure modes.

First step is to calculate load of tension failure of the skin.

$$F_{tenx} = S_x * v_{tenx} * \sqrt{2}$$

Second step is to calculate load value of wrinkling failure.

$$F_{wrx} = S_x * v_{wrx} * \sqrt{2}$$

Third step is to calculate load value of crimping failure.

$$F_{crx} = S_x * v_{crx} * \sqrt{2}$$

$$\min(F_{tenx}, F_{wrx}, F_{crx})$$

These are the basic calculations which are made for the sandwich laminate design. "x" sign in listed variables is number of the experiment (from 1 to 6).

In the following tables analytical calculation results for all six experiments are presented. These results were calculated with use of sample equations mentioned sooner in this chapter.

Experiment number	Pulling load, $P_x$ [N]	Stress in the laminate skin, $\sigma_{px}$ [MPa]	Minimal material characteristic value, $\sigma_{cx}$ [MPa]	Stress in skin, $N_x$ [N/mm]	Critical crimping stress, $N_{cx}$ [N/mm]	Critical wrinkling stress, $\sigma_{wx}$ [MPa]
1	14142	83,333	95	50	90	103,865
2	14142	78,125	146	50	90	138,630
3	28284	126,582	146	100	90	138,630
4	14142	78,125	146	50	90	138,630
5	28284	98,039	95	100	180	103,865
6	28284	83,333	95	100	150	165,636

Table 10. Analytical solution results, Experiment 1 – 6.

Experiment number	Safety factors			Limit loads		
	Tension, $\nu_{tenx}$ [-]	Crimping, $\nu_{crx}$ [-]	Wrinkling, $\nu_{wrx}$ [-]	Tension failure, $F_{tenx}$ [N]	Crimping failure, $F_{crx}$ [N]	Wrinkling failure, $F_{wrx}$ [N]
1	1,14	1,8	1,246	16122	25456	17621
2	1,87	1,8	1,77	26446	25456	25032
3	1,15	0,9	1,095	32527	25456	30971
4	1,87	1,8	1,77	26446	25456	25032
5	0,97	1,8	1,06	27436	50912	29981
6	1,14	1,5	1,988	32244	42426	56229

Table 11. Analytical solution results, safety factors and critical loads, Experiment 1 – 6.

### 3.3 Simulations

Model for each simulation was designed according to the chosen specimen, described in Chapter 2.2.

Then laminate composite was created with materials specified in the task and used in the experiment. These laminate composite properties were applied to the model.

Last step of simulation design was to specify different load cases, which included chosen loads applied to the laminate plate according to both analytical design results and experiment.

All experiment results are assessed with Max Shear 2D function. Use of this function is possible because of  $45^\circ$  skin orientation of the laminate material. As skin material is orthotropic, tensile and compressive impact is transferred along the fibers in fabric cloths (both carbon and fiberglass). That is shown schematically in the following figure.

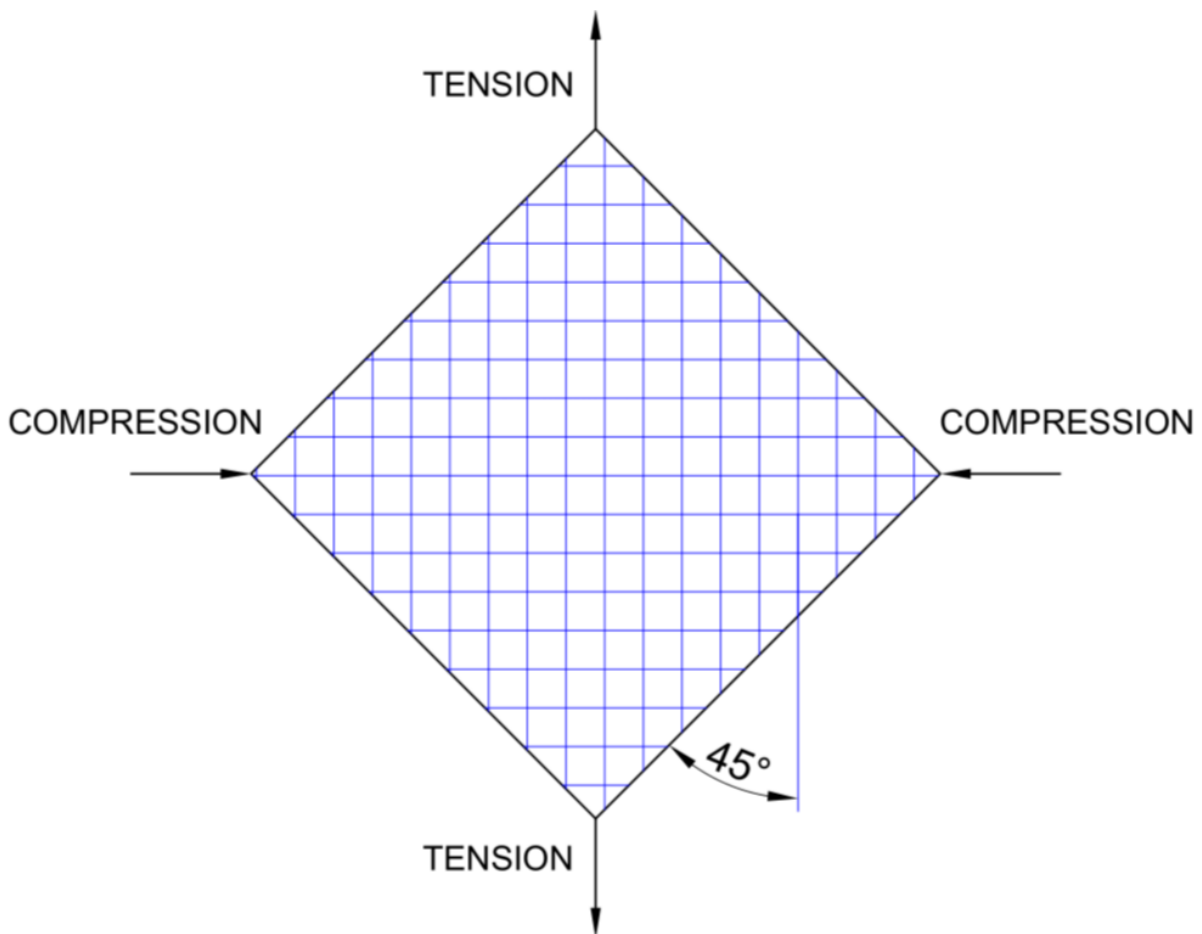

Figure 15. Schematic load distribution and orthotropic material orientation.



### 3.3.1 Experiment 1 – simulation

For this particular case, I have chosen three load cases:

- First load case was chosen according to design specification of the laminate plate –  $S_1 = 10000\text{ N}$  of shear load or  $F_{sim11} = 14142\text{ N}$  of pulling load.
- Second load case was chosen according to the results of experiment, particularly load value, when laminate plate failed because of wrinkling. Value of the pulling load was  $F_{sim12} = 14680\text{ N}$ .
- Third load case was based on the theoretical calculation of wrinkling load. Value of the pulling load was taken from limit force equations, particularly limit wrinkling failure load  $F_{sim13} = 17621\text{ N}$ .

In the following table all load cases used in the simulation for this experiment are presented.

Experiment 1, load cases for the simulation	
Load case name	Load value, [N]
$F_{sim11}$	14142
$F_{sim12}$	14680
$F_{sim13}$	17621

Table 12. List of load cases used for the simulation of Experiment 1.

The result of the first load case simulation ( $F_{sim11}$ ) is presented in the following figure. Max Shear 2D function was used to assess simulation results, stress values are maximum amongst all layers in the composite plate.

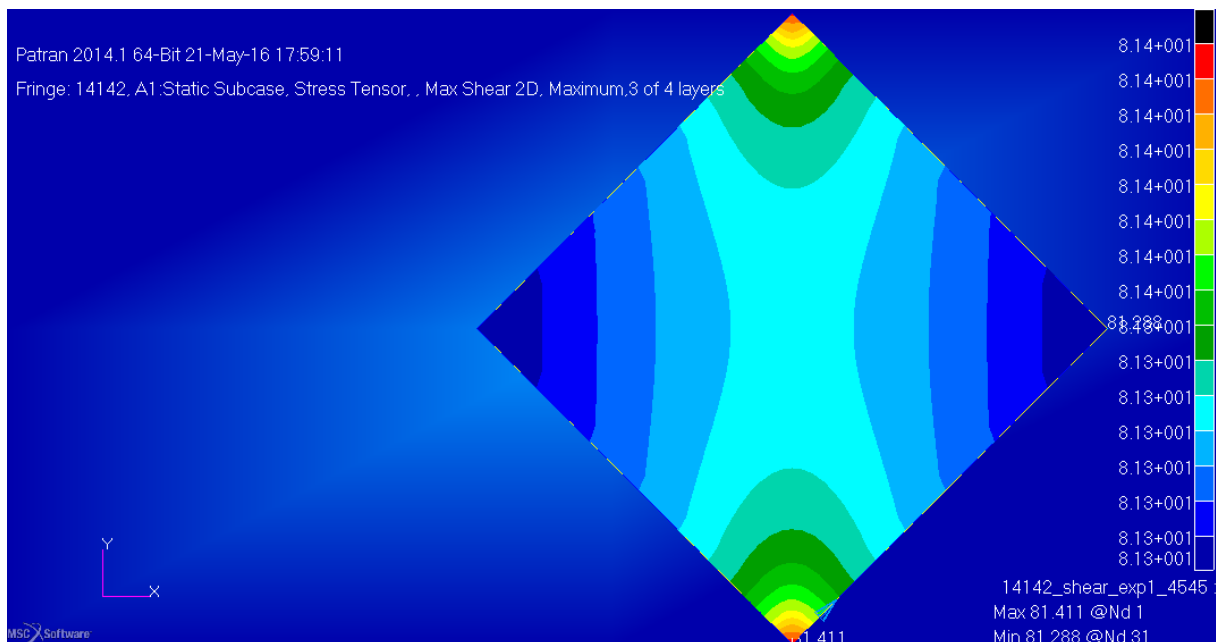

Figure 16. Graphic representation of stress in plate, load case  $F_{sim11}$ .

According to the simulation maximal shear stress in plate loaded with  $F_{sim11} = 14142\text{ N}$  is  $\sigma_{sim11X} = 81,411\text{ MPa}$ , minimal  $\sigma_{sim11N} = 81,288\text{ MPa}$ .

Next graphic representation of simulation results is valid for the second load case simulation ( $F_{sim12}$ ).

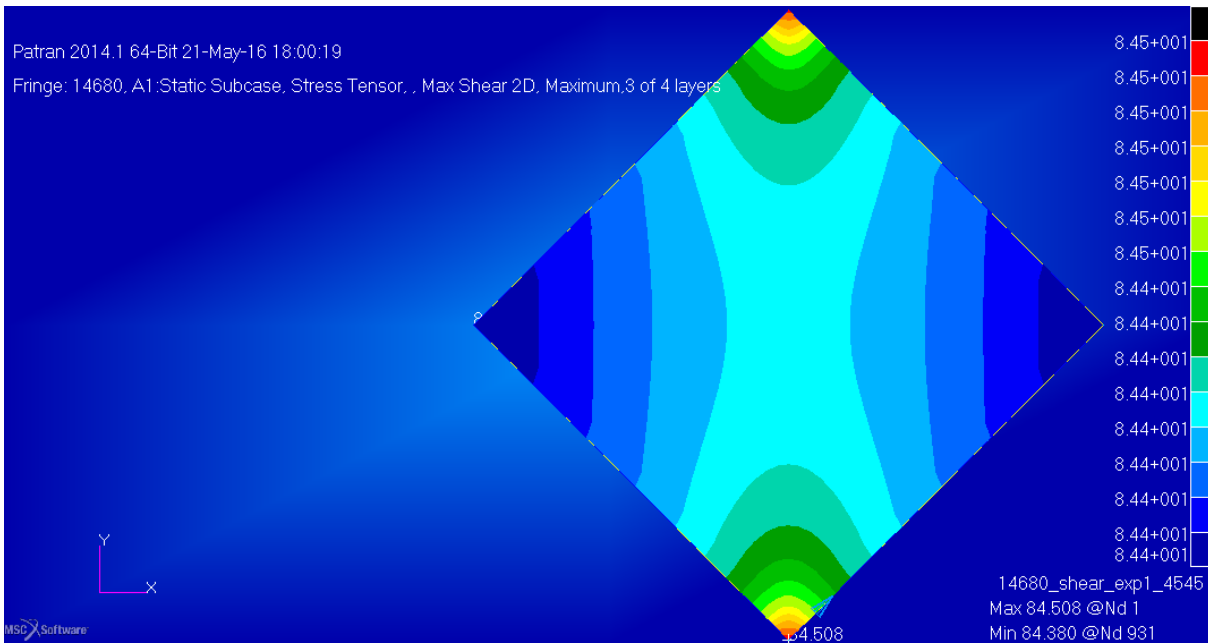

Figure 17. Graphic representation of stress in plate, load case  $F_{sim12}$ .

According to the simulation maximal shear stress of the plate loaded with  $F_{sim12} = 14680 N$  is  $\sigma_{sim12X} = 84,508 MPa$ , minimal  $\sigma_{sim12N} = 84,380 MPa$ .

Last load case simulation ( $F_{sim13}$ ) is presented in next figure. This figure represents maximum stress amongst laminate layers, at the moment it will collapse under theoretical wrinkling load.

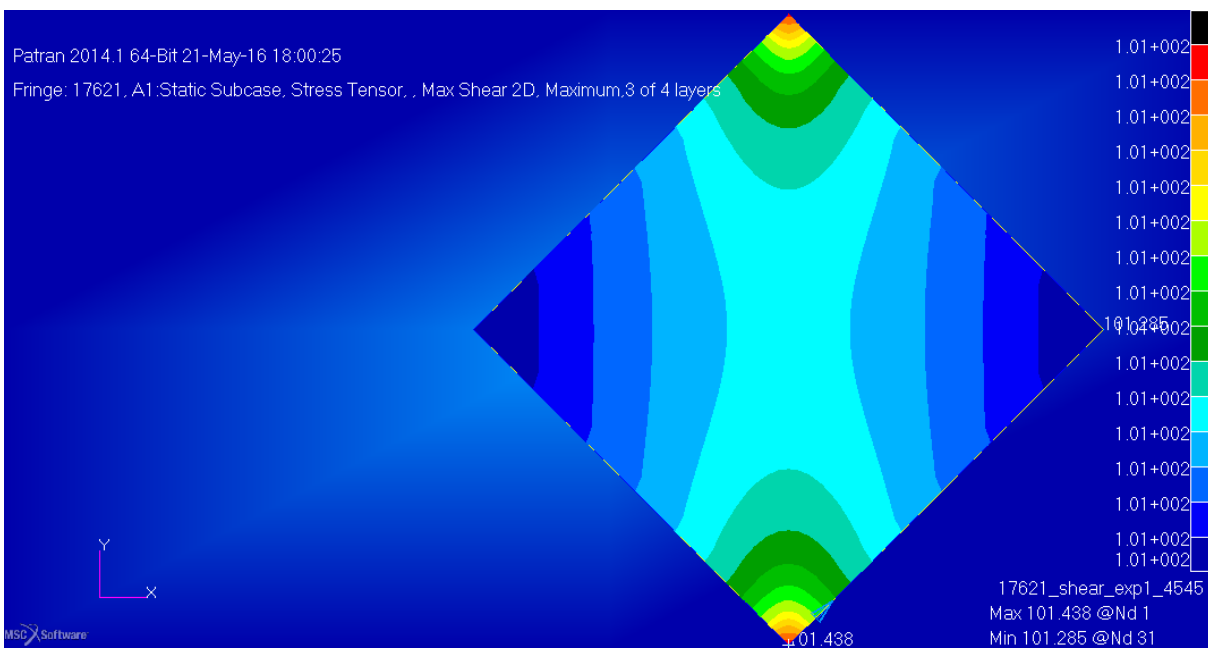

Figure 18. Graphic representation of stress in plate, load case  $F_{sim13}$ .

According to the simulation maximal shear stress of the plate loaded with  $F_{sim13} = 17621 N$  is  $\sigma_{sim13X} = 101,438 MPa$ , minimal  $\sigma_{sim13N} = 101,285 MPa$ .

The following table of simulation results represents shear stress for all three load cases. Averaged results will be later compared with analytically calculated values of stress.

Max Shear 2D value, MSC Patran simulation, Experiment 1			
Load case name	Shear stress, maximal [MPa]	Shear stress, minimal [MPa]	Shear stress, average [MPa]
$F_{sim11}$	81,411	81,288	81,350
$F_{sim12}$	84,508	84,380	84,444
$F_{sim13}$	101,438	101,285	101,362

Table 13. List of stress results for load cases, Experiment 1.

### 3.3.2 Experiment 2 – simulation

For this particular case, I have chosen three different load cases:

- First load case was chosen according to the design specification of the laminate plate –  $S_2 = 10000\text{ N}$  of shear load or  $F_{sim21} = 14142\text{ N}$  of pulling load.
- Second load case was chosen according to the results of experiment, particularly value of load when the laminate plate failed. Value of the pulling load was  $F_{sim22} = 20865\text{ N}$ .
- Third load case was based on theoretical calculation of wrinkling. Value of the pulling load was taken from limit force equations, particularly the wrinkling failure force  $F_{sim23} = 25032\text{ N}$ .

In the following table all load cases used in the simulation for this experiment are presented.

Experiment 2, load cases for the simulation	
Load case name	Load value, [N]
$F_{sim21}$	14142
$F_{sim22}$	20865
$F_{sim23}$	25032

Table 14. List of load cases used for the simulation of Experiment 2.

The result of the first load case simulation ( $F_{sim21}$ ) is presented in the following figure. Max Shear 2D function was used to assess simulation results, stress values are maximum amongst all layers in the composite plate.

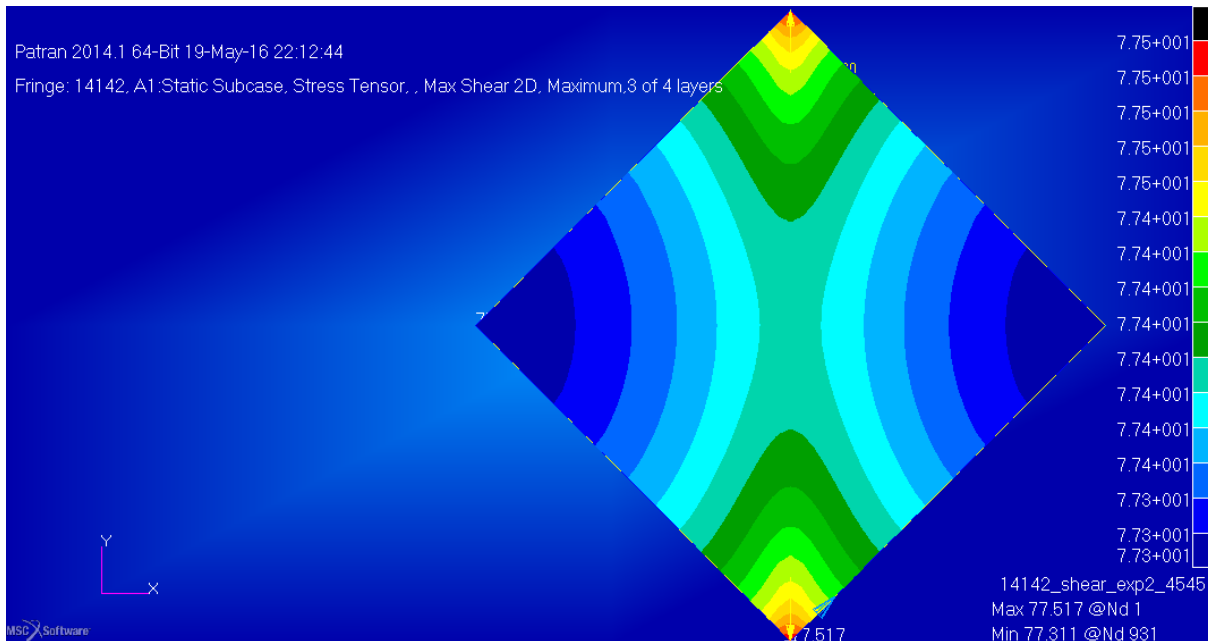

Figure 19. Graphic representation of stress in plate, load case  $F_{sim21}$ .

According to the simulation, maximal shear stress in plate loaded with  $F_{sim21} = 14142\text{ N}$  is  $\sigma_{sim21X} = 77,517\text{ MPa}$ , minimal  $\sigma_{sim21N} = 77,311\text{ MPa}$ .

Next graphic representation is valid for second load case simulation ( $F_{sim22}$ ).

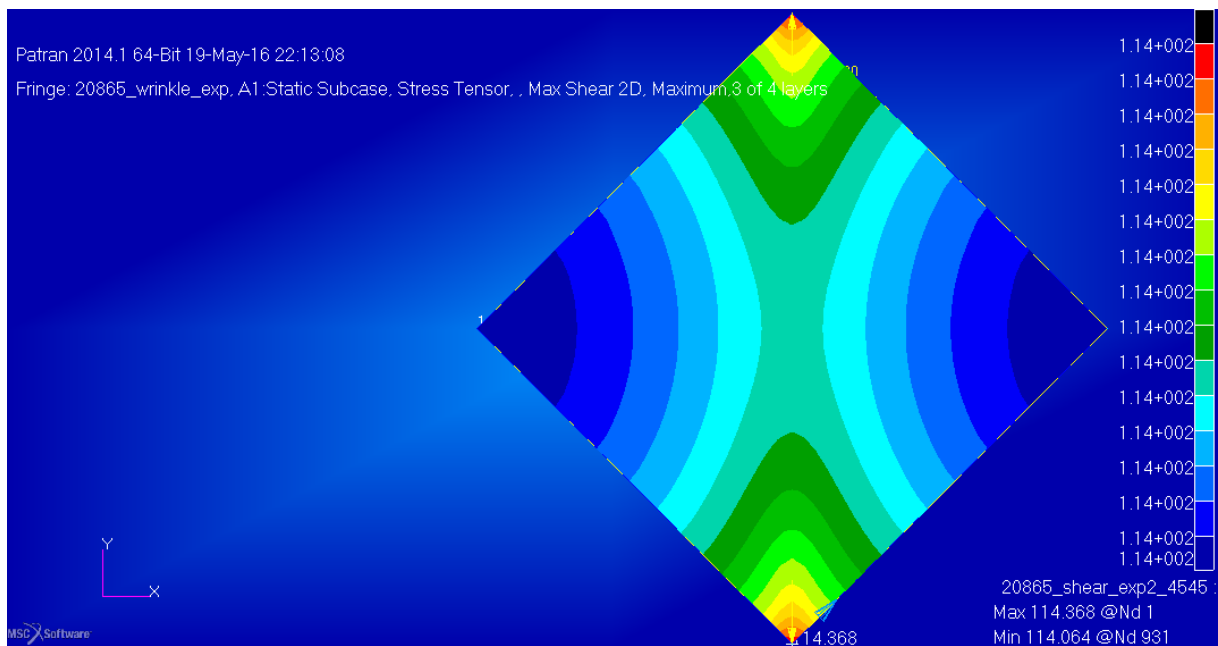

Figure 20. Graphic representation of stress in plate, load case  $F_{sim22}$ .

According to the simulation, maximal shear stress in plate loaded with the force  $F_{sim22} = 20865\text{ N}$  is  $\sigma_{sim22X} = 114,368\text{ MPa}$ , minimal  $\sigma_{sim22N} = 114,064\text{ MPa}$ .

Last graphic representation shows simulated results for the third load case ( $F_{sim23}$ ). This graph represents maximum stress values amongst all layers in the composite plate, under the load of wrinkling failure.

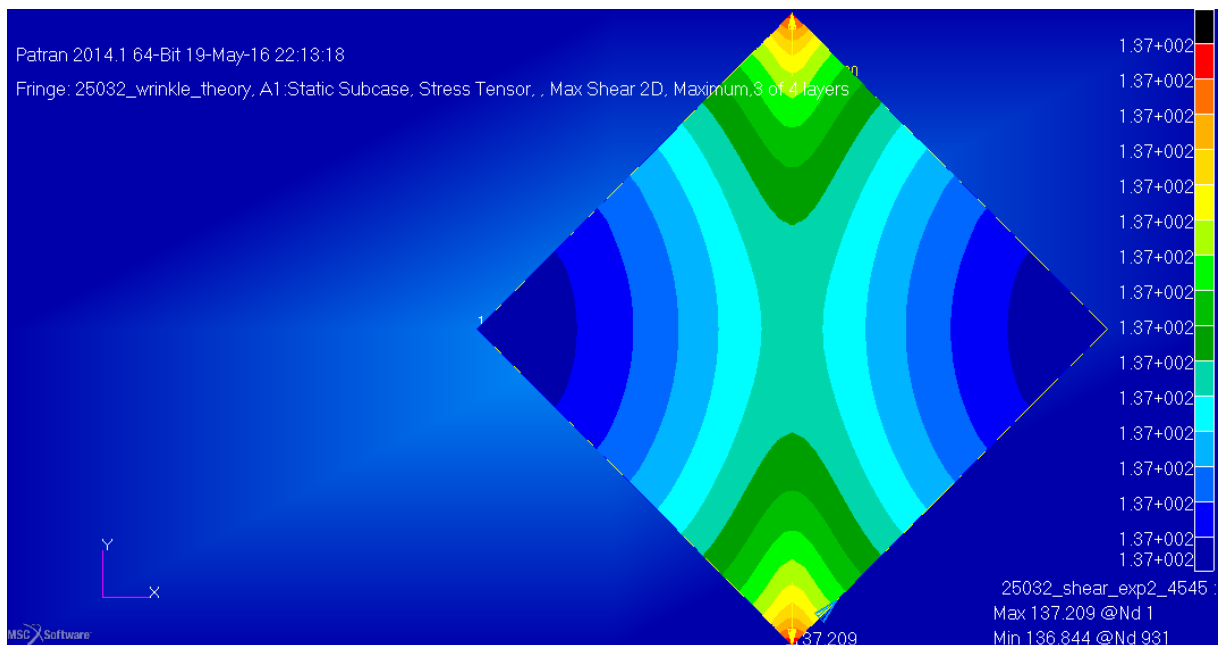

Figure 21. Graphic representation of stress in plate, load case  $F_{sim23}$ .

According to the simulation, maximal shear stress in plate loaded with the force  $F_{sim23} = 25032 N$  is  $\sigma_{sim23X} = 137,209 MPa$ , minimal  $\sigma_{sim23N} = 136,844 MPa$ .

The following table of simulation results represents shear stress for all three load cases. Averaged results will be later compared with analytically calculated values of stress.

Max Shear 2D value, MSC Patran simulation, Experiment 2			
Load case name	Shear stress, maximal [MPa]	Shear stress, minimal [MPa]	Shear stress, average [MPa]
$F_{sim21}$	77,517	77,311	77,414
$F_{sim22}$	114,368	114,064	114,216
$F_{sim23}$	137,209	136,844	137,027

Table 15. List of stress results for load cases simulation, Experiment 2.

### 3.3.3 Experiment 3 – simulation

For this particular case, I have chosen four different load cases:

- First load case was chosen according to the results of experiment, particularly value of load when the crimping in laminate plate occurred. Value of the pulling load was  $F_{sim31} = 26000 N$ .
- Second load case was chosen according to the results of experiment, particularly value of load when the laminate plate failed because of wrinkling. Value of the pulling load was  $F_{sim32} = 28000 N$ .
- Third load case was based on the theoretical calculation of crimping. Value of the pulling load was taken from limit force equations, particularly the crimping failure force  $F_{sim33} = 25456 N$ .
- Fourth load case was based on the theoretical calculation of wrinkling. Value of the pulling load was taken from limit force equations, particularly the wrinkling failure force  $F_{sim34} = 30971 N$ .

In the following table all load cases used in the simulation for this experiment are presented.

Experiment 3, load cases for the simulation	
Load case name	Load value, [N]
$F_{sim31}$	26000
$F_{sim32}$	28000
$F_{sim33}$	25456
$F_{sim34}$	30971

Table 16. List of load cases used for the simulation of Experiment 3.

The result of the first load case simulation ( $F_{sim31}$ ) is presented in the following figure. Max Shear 2D function was used to assess simulation results, stress values are maximum amongst all layers in the composite plate.

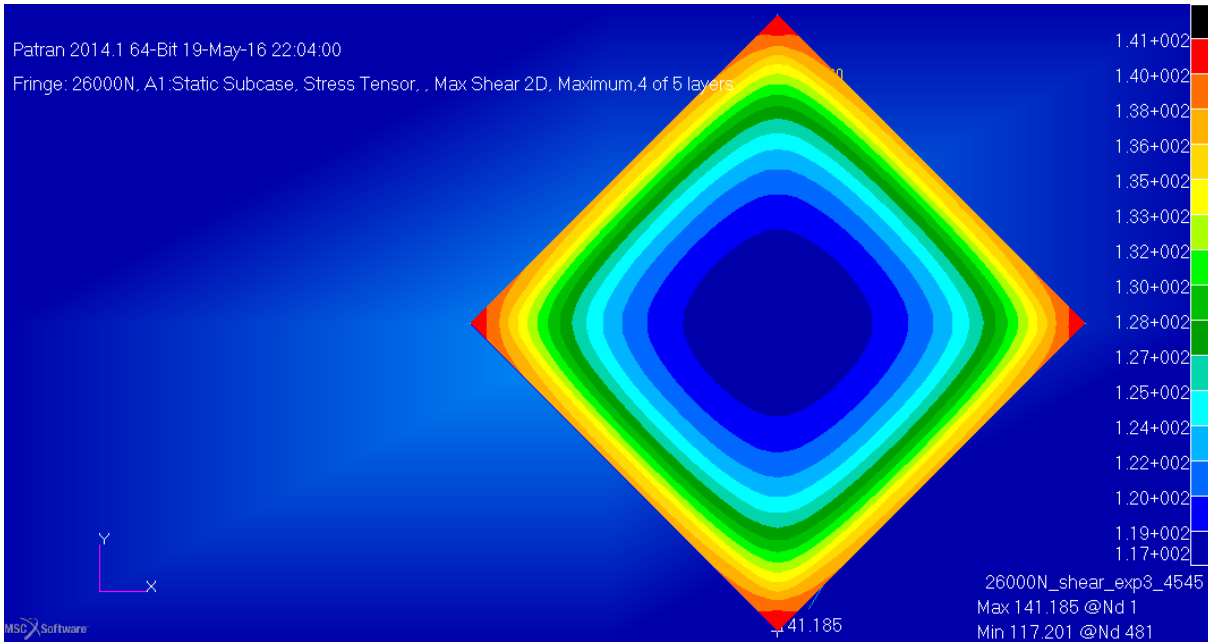

Figure 22. Graphic representation of stress in plate, load case  $F_{sim31}$ .

According to the simulation, maximal shear stress in plate loaded with  $F_{sim31} = 26000\text{ N}$  is  $\sigma_{sim31X} = 141,185\text{ MPa}$ , minimal  $\sigma_{sim31N} = 117,201\text{ MPa}$ .

Next graphic representation is valid for second load case simulation ( $F_{sim32}$ ).

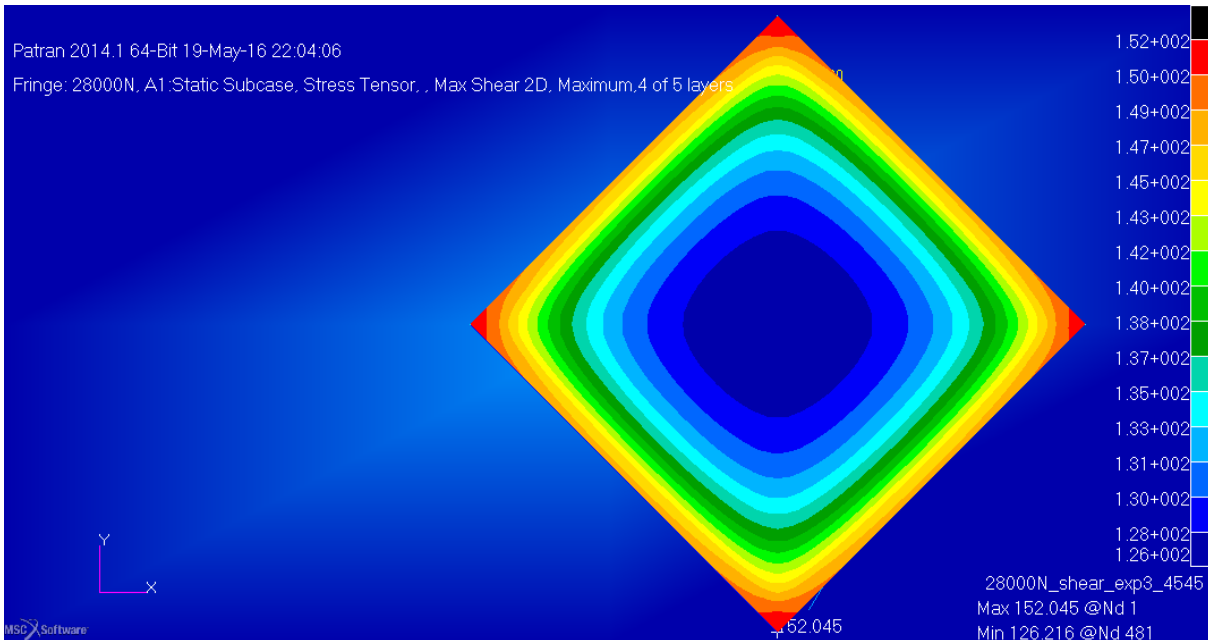

Figure 23. Graphic representation of stress in plate, load case  $F_{sim32}$ .



According to the simulation, maximal shear stress in plate loaded with  $F_{sim32} = 28000\text{ N}$  is  $\sigma_{sim32X} = 152,045\text{ MPa}$ , minimal  $\sigma_{sim32N} = 126,216\text{ MPa}$ .

Next graphic representation shows simulated results for the third load case ( $F_{sim33}$ ).

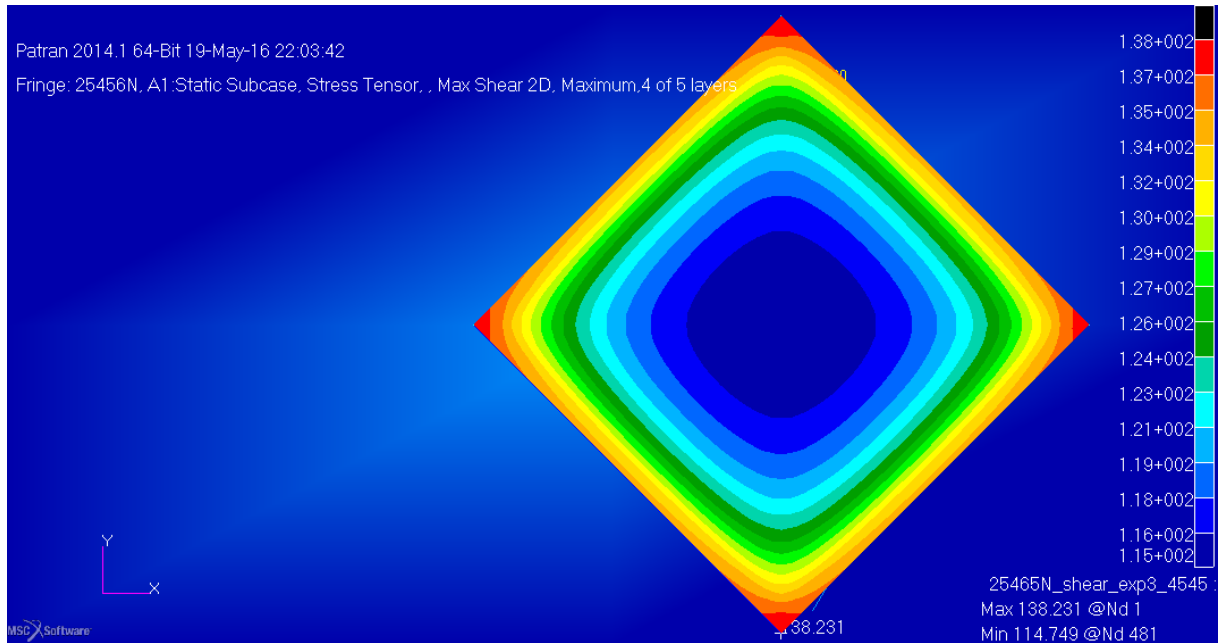

Figure 24. Graphic representation of stress in plate, load case  $F_{sim33}$ .

According to the simulation, maximal shear stress in plate loaded with  $F_{sim33} = 25456\text{ N}$  is  $\sigma_{sim33X} = 138,231\text{ MPa}$ , minimal  $\sigma_{sim33N} = 114,749\text{ MPa}$ .

Last graphic representation shows simulated results for the fourth load case ( $F_{sim34}$ ).

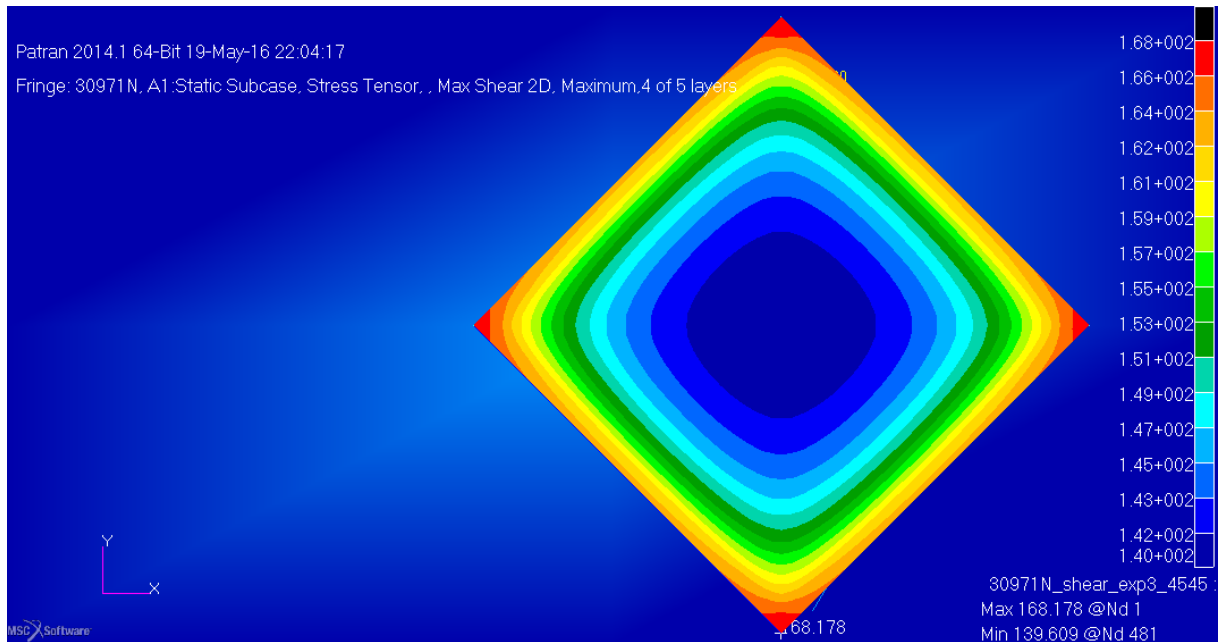

Figure 25. Graphic representation of stress in plate, load case  $F_{sim34}$ .

According to the simulation, maximal shear stress in plate loaded with  $F_{sim34} = 30971 N$  is  $\sigma_{sim34X} = 143,676 MPa$ , minimal  $\sigma_{sim34N} = 139,609 MPa$ .

The following table of simulation results represents shear stress for all four load cases. Because composite structure is not symmetric and central distribution of shear stress can be seen on figures, I used minimal values as results of shear stress in the laminate. These results will be later compared with analytically calculated values of stress.

Max Shear 2D value, MSC Patran simulation, Experiment 3		
Load case name	Shear stress, maximal [MPa]	Shear stress, minimal [MPa]
$F_{sim31}$	141,185	117,201
$F_{sim32}$	152,045	126,216
$F_{sim33}$	138,231	114,749
$F_{sim34}$	143,676	139,609

Table 17. List of stress results for load cases simulation, Experiment 3.

### 3.3.4 Experiment 4 – simulation

For this particular laminate plate, I have chosen three different load cases:

- First load case was chosen according to the design specification of the laminate plate –  $S_4 = 10000\text{ N}$  of shear load or  $F_{sim41} = 14142\text{ N}$  of pulling load.
- Second load case was chosen according to the results of experiment, particularly value of load when the laminate plate failed because of wrinkling. Value of the pulling load was  $F_{sim42} = 27012,5\text{ N}$ .
- Third load case was based on the theoretical calculation of wrinkling load. Value of the pulling load was taken from limit force equations, particularly the limit wrinkling failure force  $F_{sim43} = 25032\text{ N}$ .

In the following table all load cases used in the simulation for this experiment are presented.

Experiment 4, load cases for the simulation	
Load case name	Load value, [N]
$F_{sim41}$	14142
$F_{sim42}$	27012,5
$F_{sim43}$	25032

Table 18. List of load cases used for the simulation of Experiment 4.

First figure represents results of the first load case simulation ( $F_{sim41}$ ). Max Shear 2D function was used to assess simulation results, stress values are maximum amongst all layers in the composite plate.

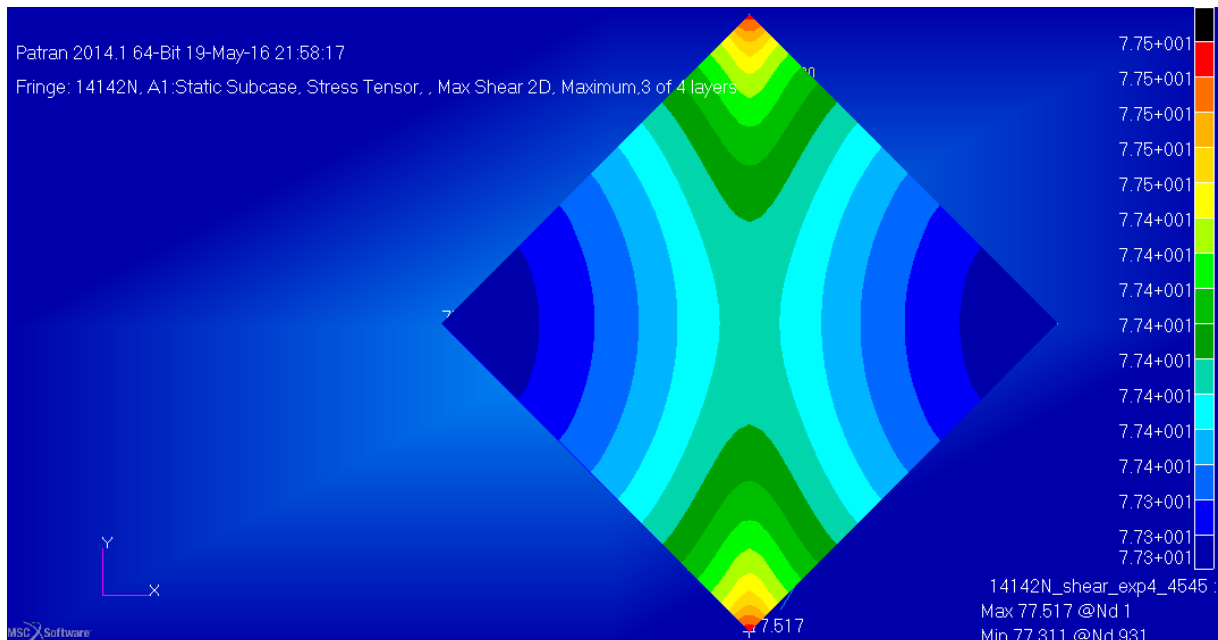

Figure 26. Graphic representation of stress in plate, load case  $F_{sim41}$ .

According to the simulation, maximal shear stress in the plate loaded with  $F_{sim41} = 14142\text{ N}$  is  $\sigma_{sim41X} = 77,517\text{ MPa}$ , minimal  $\sigma_{sim41N} = 77,311\text{ MPa}$ .

Next figure represents results of the second load case simulation ( $F_{sim42}$ ).

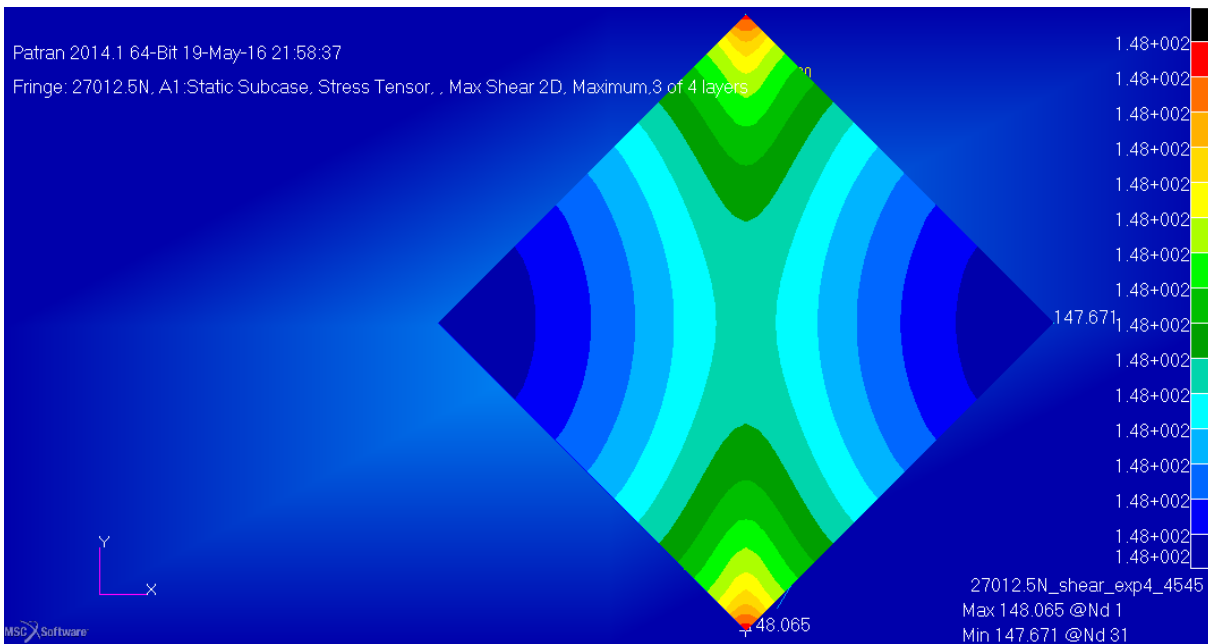

Figure 27. Graphic representation of stress in plate, load case  $F_{sim42}$ .

According to the simulation maximal shear stress of the plate loaded with  $F_{sim42} = 27012,5 N$  is  $\sigma_{sim42X} = 148,065 MPa$ , minimal  $\sigma_{sim42N} = 147,671 MPa$ .

Last load case of the simulation ( $F_{sim43}$ ) is presented in the next figure.

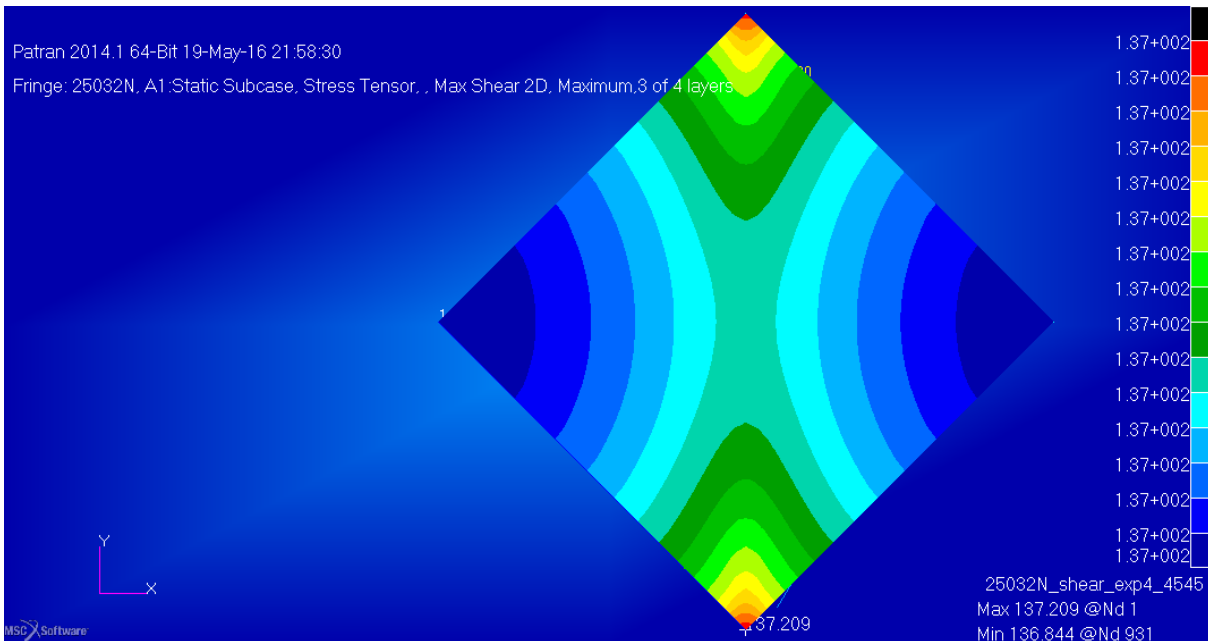

Figure 28. Graphic representation of stress in plate, load case  $F_{sim43}$ .

According to the simulation maximal shear stress of the plate loaded with  $F_{sim43} = 25032 N$  is  $\sigma_{sim43X} = 137,209 MPa$ , minimal  $\sigma_{sim43N} = 136,844 MPa$ .

The following table of simulation results represents shear stress for all three load cases. Averaged results will be later compared with analytically calculated values of stress.

<b>Max Shear 2D value, MSC Patran simulation, Experiment 4</b>			
<b>Load case name</b>	<b>Shear stress, maximal [MPa]</b>	<b>Shear stress, minimal [MPa]</b>	<b>Shear stress, average [MPa]</b>
<b><math>F_{sim41}</math></b>	77,517	77,311	77,414
<b><math>F_{sim42}</math></b>	148,065	147,671	147,868
<b><math>F_{sim43}</math></b>	137,209	136,844	137,027

Table 19. List of stress results for load cases simulation, Experiment 4.

### 3.3.5 Experiment 5 – simulation

For this particular laminate plate, I have chosen three different load cases.

- First load case was chosen according to the design specification of the laminate plate –  $S_5 = 20000 N$  of shear load or  $F_{sim51} = 28284 N$  of pulling load.
- Second load case was chosen according to the results of experiment, particularly value of load when the laminate plate failed because of wrinkling. Value of pulling load was  $F_{sim52} = 27012 N$ .
- Third load case was based on the theoretical calculation of wrinkling load. Value of the pulling load was taken from limit force equations, particularly the limit wrinkling failure force  $F_{sim53} = 29981 N$ .

In the following table all load cases used in the simulation for this experiment are presented.

Experiment 5, load cases for the simulation	
Load case name	Force value, [N]
$F_{sim51}$	28284
$F_{sim52}$	27012
$F_{sim53}$	29981

Table 20. List of load cases used for the simulation of Experiment 5.

First figure represents results of the first load case simulation ( $F_{sim51}$ ). Max Shear 2D function was used to assess simulation results, stress values are maximum amongst all layers in the composite plate.

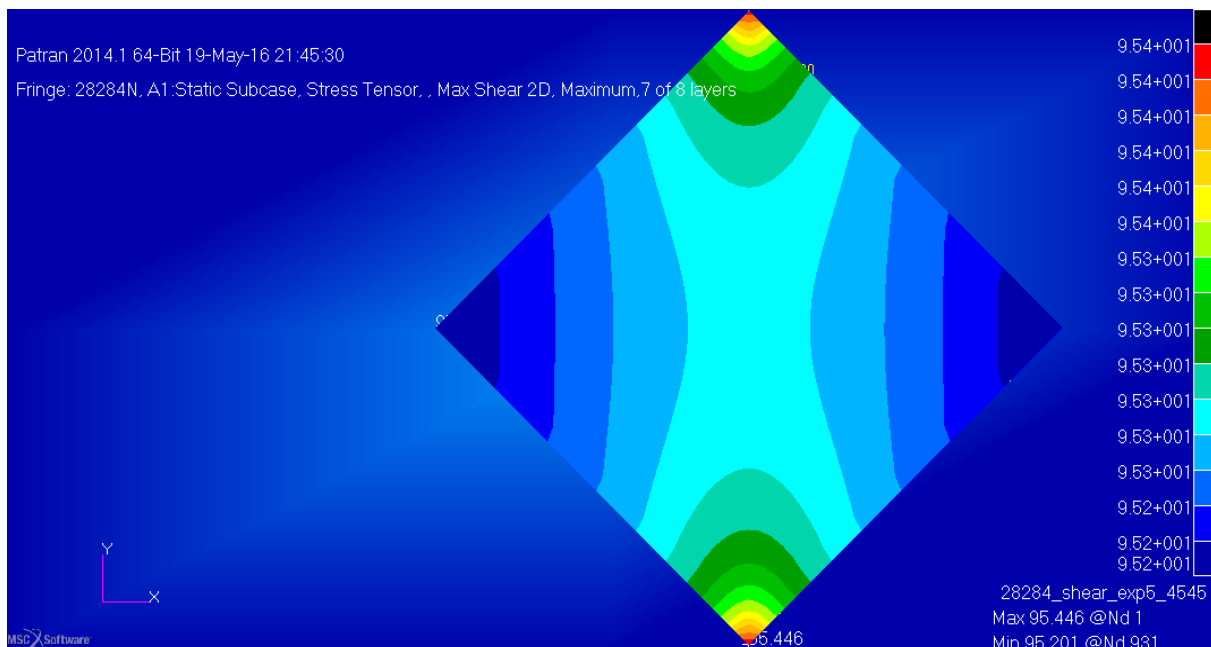

Figure 29. Graphic representation of stress in plate, load case  $F_{sim51}$ .

According to the simulation, maximal shear stress in the plate loaded with  $F_{sim51} = 28284 N$  is  $\sigma_{sim51X} = 95,446 MPa$ , minimal  $\sigma_{sim51N} = 95,201 MPa$ .

Next figure is valid for the second load case simulation ( $F_{sim52}$ ).

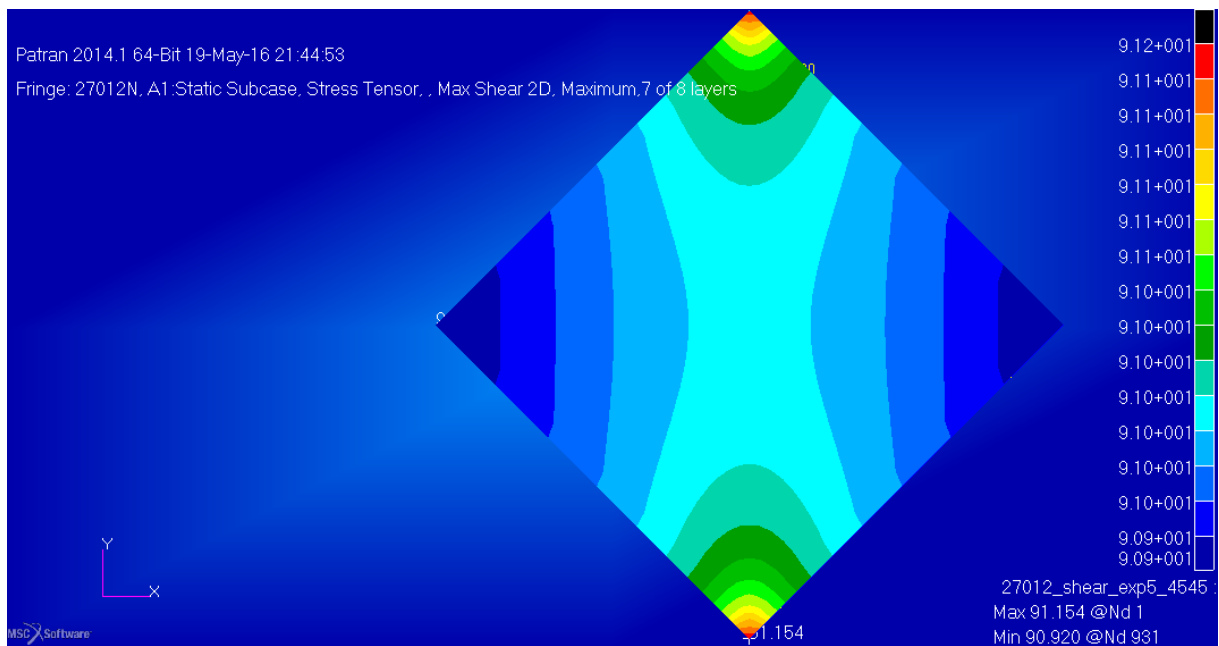

Figure 30. Graphic representation of stress in plate, load case  $F_{sim52}$ .

According to the simulation, maximal shear stress in the plate loaded with  $F_{sim52} = 27012 N$  is  $\sigma_{sim52X} = 91,154 MPa$ , minimal  $\sigma_{sim52N} = 90,920 MPa$ .

Last load case simulation ( $F_{sim53}$ ) is presented in the next figure.

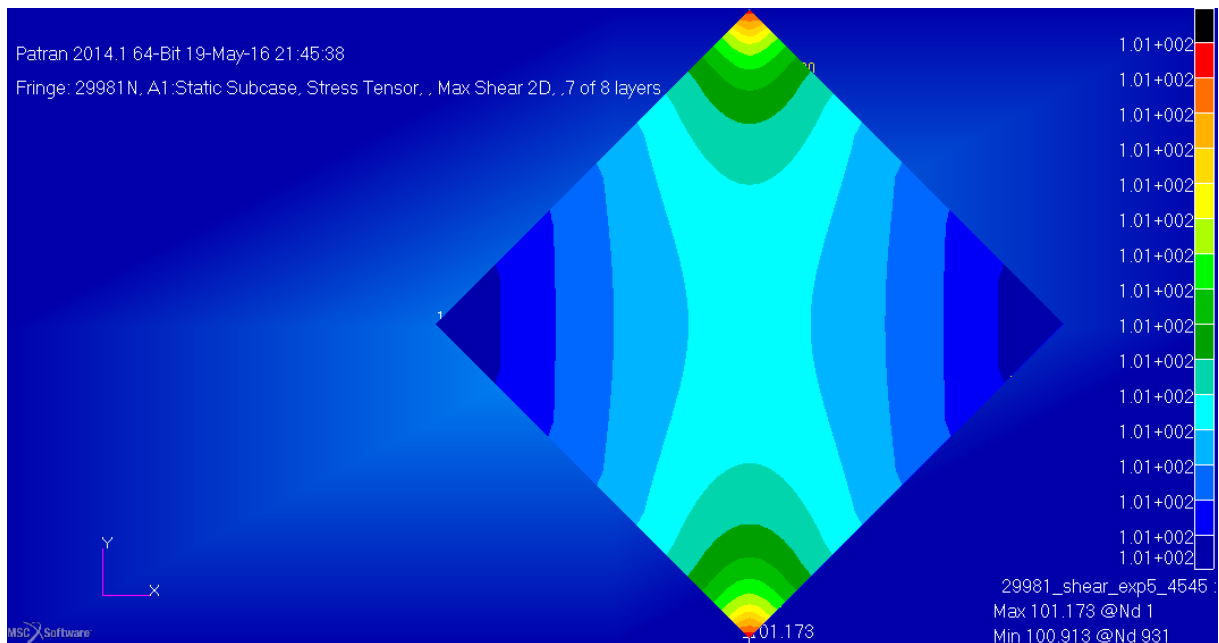

Figure 31. Graphic representation of stress in plate, load case  $F_{sim53}$ .

According to the simulation maximal shear stress in the plate loaded with  $F_{sim53} = 29981 N$  is  $\sigma_{sim53X} = 101,173 MPa$ , minimal  $\sigma_{sim53N} = 100,913 MPa$ .

The following table of simulation results represents shear stress for all three load cases. Averaged results will be later compared with analytically calculated values of stress.

<b>Max Shear 2D value, MSC Patran simulation, Experiment 5</b>			
<b>Load case name</b>	<b>Shear stress, maximal [MPa]</b>	<b>Shear stress, minimal [MPa]</b>	<b>Shear stress, average [MPa]</b>
<b><math>F_{sim51}</math></b>	95,446	95,201	95,324
<b><math>F_{sim52}</math></b>	91,154	90,920	91,037
<b><math>F_{sim53}</math></b>	101,173	100,913	101,043

Table 21. List of stress results for load cases simulation, Experiment 5.



### 3.3.6 Experiment 6 – simulation

For this experiment, I have chosen three different load cases:

- First load case was chosen according to design specification of the laminate plate –  $S_6 = 20000\text{ N}$  of shear load or  $F_{sim61} = 28284\text{ N}$  of pulling load.
- Second load case was chosen according to the results of experiment, particularly value of load when the laminate plate failed. Value of pulling load was  $F_{sim62} = 42874\text{ N}$ .
- Third load case was based on the theoretical calculation of crimping load. Value of the pulling load was taken from limit force equations, particularly the limit crimping failure force  $F_{sim63} = 42426\text{ N}$ .

In the following table all load cases used in the simulation for this experiment, are presented.

Experiment 6, load cases for the simulation	
Load case name	Load value, [N]
$F_{sim61}$	28284
$F_{sim62}$	42874
$F_{sim63}$	42426

Table 22. List of load cases used for the simulation of Experiment 6.

Result of first load case simulation ( $F_{sim61}$ ) is presented in the following figure. Max Shear 2D function was used to assess simulation results, stress values are maximum amongst all layers in the composite plate.

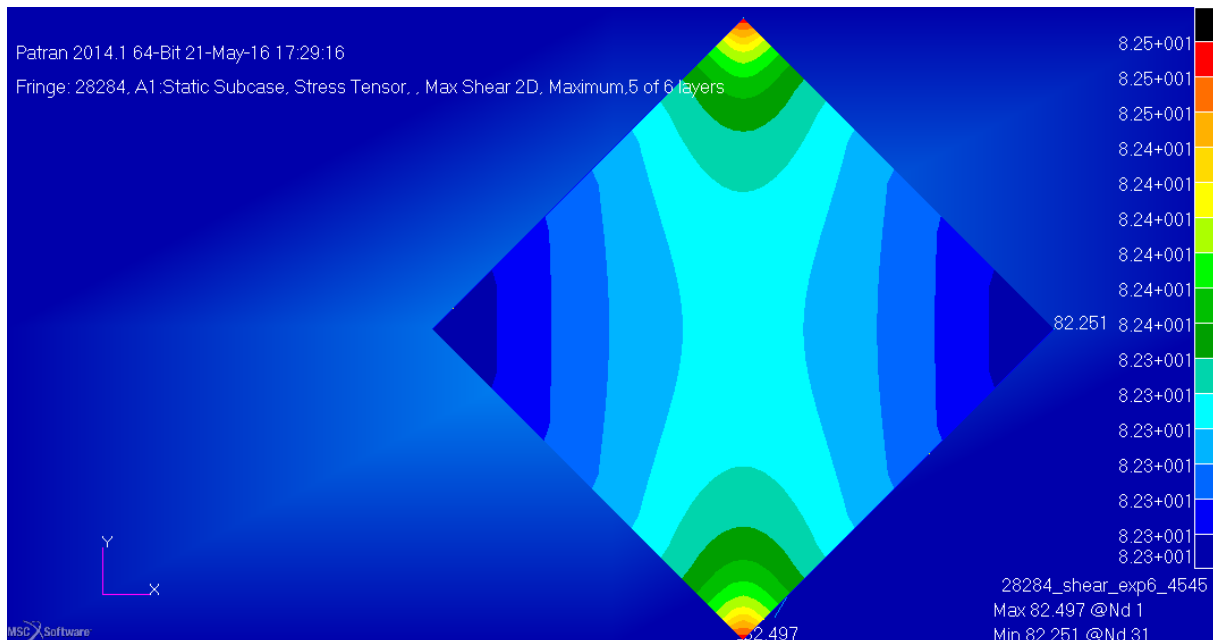

Figure 32. Graphic representation of stress in plate, load case  $F_{sim61}$ .

According to the simulation, maximal shear stress in plate loaded with  $F_{sim61} = 28284\text{ N}$  is  $\sigma_{sim61X} = 82,497\text{ MPa}$ , minimal  $\sigma_{sim61N} = 82,251\text{ MPa}$ .

Next graphic representation is valid for second load case simulation ( $F_{sim62}$ ).

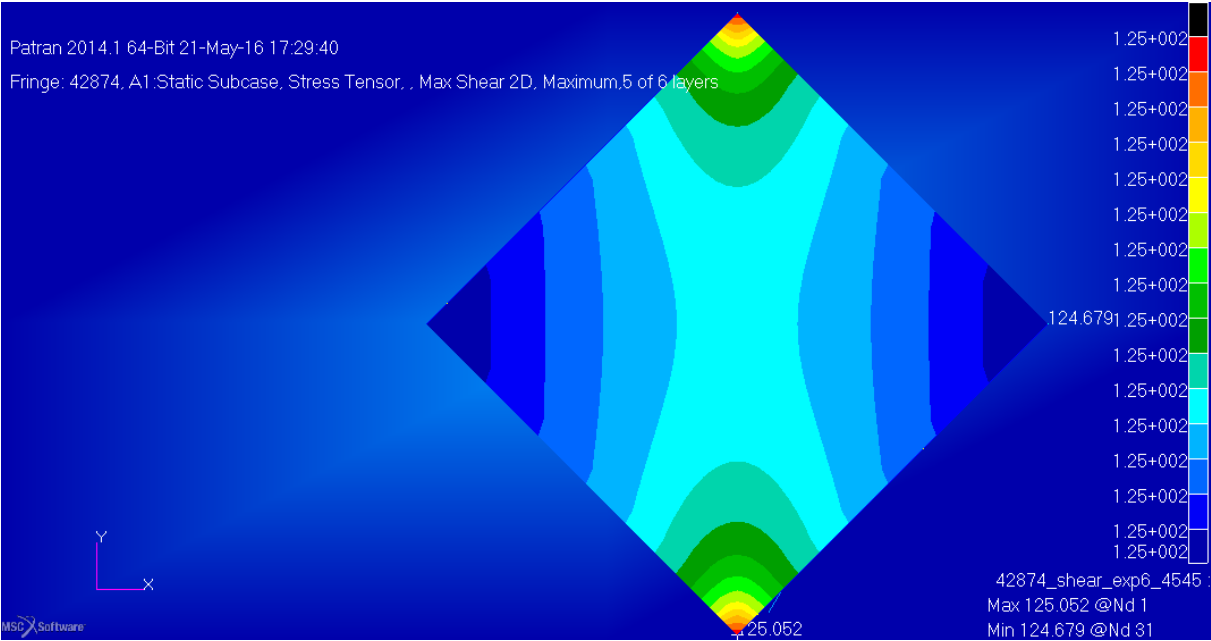

Figure 33. Graphic representation of stress in plate, load case  $F_{sim62}$ .

According to the simulation, maximal shear stress in plate loaded with  $F_{sim62} = 42874 N$  is  $\sigma_{sim62X} = 125,052 MPa$ , minimal  $\sigma_{sim62N} = 124,679 MPa$ .

Last graphic representation shows simulated results for the third load case ( $F_{sim63}$ ).

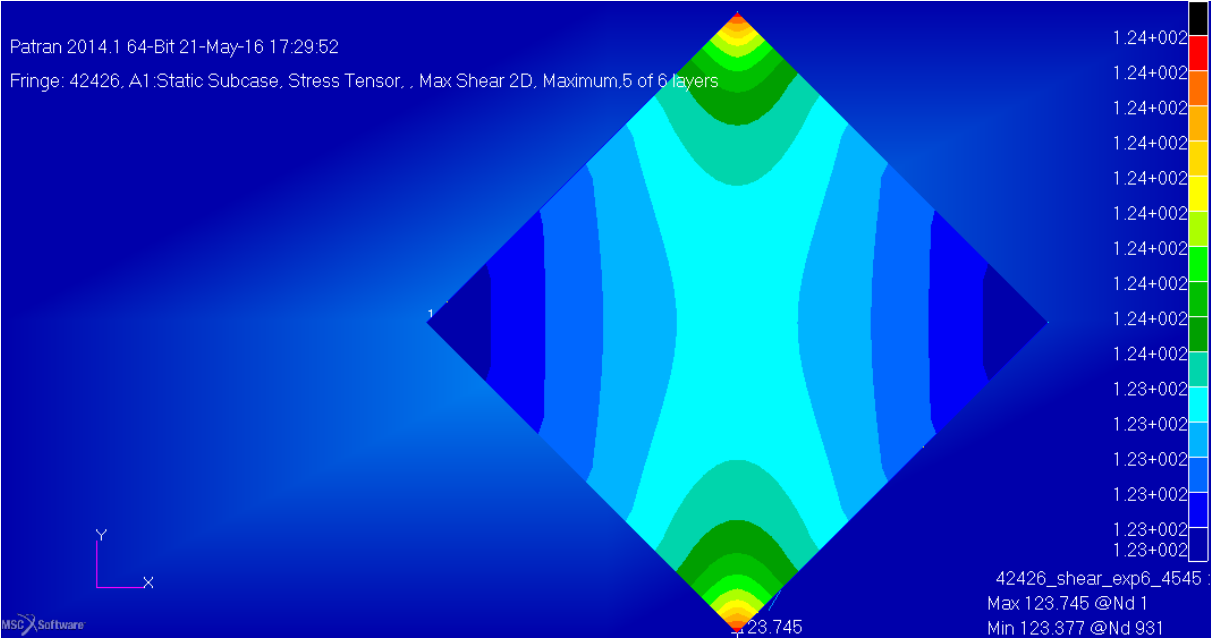

Figure 34. Graphic representation of stress in plate, load case  $F_{sim63}$ .

According to the simulation, maximal shear stress in plate loaded with  $F_{sim63} = 42426 N$  is  $\sigma_{sim63X} = 123,745 MPa$ , minimal  $\sigma_{sim63N} = 123,377 MPa$ .

The following table of simulation results represents shear stress for all three load cases. Averaged results will be later compared with analytically calculated values of stress.

Load case name	Max Shear 2D value, MSC Patran simulation, Experiment 6		
	Shear stress, maximal [MPa]	Shear stress, minimal [MPa]	Shear stress, average [MPa]
$F_{sim61}$	82,497	82,251	82,374
$F_{sim62}$	125,052	124,679	124,866
$F_{sim63}$	123,745	123,377	123,561

Table 23. List of stress results for load cases simulation, Experiment 6.

### 3.4 Results comparison and assessment

In this chapter, simulation results are compared with analytical calculations and experiment. Simulations are checked and correlation with analytical calculation is defined. Such correlation makes possible to confirm simulation appropriateness for each particular experiment.

#### 3.4.1 Experiment 1 – results

Experiment showed that laminate plate failed because of wrinkling, so stress results under wrinkling load values are presented in the following table.

Load value [N]	Type of result value	Shear stress, average [MPa]
14680	Simulation of experiment	84,444
	Experiment, analytically calculated stress value	86,503
17621	Simulation of theoretical wrinkling value	101,362
	Analytical calculation of theoretical wrinkling	103,865

Table 24. Chosen loads and respective stress values, Experiment 1.

Next, simulation results were compared between and analytically calculated results were compared too. These two comparisons were chosen to define correlation between simulation and analytically calculated results.

Type of calculation	Results of experiment simulation and simulated theoretical load value		Results of analytically calculated stress value from experimental and theoretical load values	
	Simulation, based on experimental value	Simulation, based on the theoretical load value	Experiment, analytically calculated stress	Analytical calculation of theoretical wrinkling
<b>Load value [N]</b>	14680	17621	14680	17621
<b>Shear stress, average [MPa]</b>	84,444	101,362	86,503	103,865
<b>Difference [%]</b>	20 %		20 %	

Table 25. Comparison of simulation/analytically calculated results, Experiment 1.

Difference between simulated theoretical and experimental values of stress is the same as difference of values which were analytically calculated. It is confirmed now that simulation represents experiment accurately.

Load value [N]	Simulated shear stress [MPa]	Analytically calculated shear stress [MPa]	Difference [%]
14680	84,444	86,503	2,44
17621	101,362	103,865	2,47

Table 26. Direct comparison of simulated and calculated stress, Experiment 1.

Difference of around 2,5% between simulated and calculated results can be explained by numerical approach to calculation in simulation software. Also, frame where specimen is fixed affects results of in-plane shear test. In uniaxial loading mode, frame elements can bend and extend a little.

### 3.4.2 Experiment 2 – results

Experiment showed that laminate plate failed because of wrinkling, so stress results under wrinkling load values are presented in the following table.

Load value [N]	Type of result value	Shear stress, average [MPa]
20865	Simulation of experiment	114,216
	Experiment, analytically calculated stress value	115,264
25032	Simulation of theoretical wrinkling value	137,027
	Analytical calculation of theoretical wrinkling	138,630

Table 27. Chosen load cases and respective stress values, Experiment 2.

Next, simulation results were compared between and analytically calculated results were compared too. These two comparisons were chosen to define correlation between simulation and analytically calculated results.

Type of the calculation	Results of experiment simulation and simulated theoretical load value		Results of analytically calculated stress value from experimental and theoretical load values	
	Simulation, based on experimental value	Simulation, based on the theoretical load value	Experiment, analytically calculated stress	Analytical calculation of theoretical wrinkling
Load value [N]	20865	25032	20865	25032
Shear stress, average [MPa]	114,216	137,027	115,264	138,630
Difference [%]	20		21	

Table 28. Comparison of simulation and analytically calculated results, Experiment 2.

Difference between simulated theoretical and experimental values of stress differs only by one percentage point from the difference of values which were analytically calculated. It is confirmed now that simulation represents experiment accurately.

Load value [N]	Simulated shear stress [MPa]	Analytically calculated shear stress [MPa]	Difference [%]
20865	114,216	115,264	0,92
25032	137,027	138,630	1,17

Table 29. Direct comparison of simulated and calculated stress, Experiment 2.

Small percentage difference between simulated and calculated results can be explained by the nature of calculation approach. Simulation software use numerical calculation instead of analytical calculations used for preliminary design.

### 3.4.3 Experiment 3 – results

Experiment showed that laminate plate failed because of crimping and following wrinkling, so stress results under crimping and wrinkling load values are presented in the following table.

Load value [N]	Type of result value	Shear stress, average [MPa]
26000	Simulation – crimping	117,201
	Experiment, analytically calculated stress – crimping	116,359
25456	Simulation of theoretical crimping value	114,749
	Analytical calculation – theoretical crimping	113,924
28000	Simulation – wrinkling	126,216
	Experiment, analytically calculated stress – wrinkling	125,310
30971	Simulation of theoretical wrinkling value	139,609
	Analytical calculation – theoretical wrinkling	138,630

Table 30. Chosen load cases and respective stress values, Experiment 3.

Next, simulation results for crimping were compared between and analytically calculated results of crimping were compared too. These two comparisons were chosen to define correlation between simulation and analytically calculated results.

Type of the calculation	Results of experiment simulation and simulated theoretical load value		Results of analytically calculated stress value from experimental and theoretical load values	
	Simulation, based on experimental value	Simulation, based on the theoretical load value	Experiment, analytically calculated stress	Analytical calculation of theoretical crimping
Load value [N]	26000	25456	26000	25456
Shear stress, average [MPa]	117,201	114,749	116,359	113,924
Difference [%]	-2,1		-2,1	

Table 31. Comparison of simulation/analytical calculation for crimping, Experiment 3.

Difference between simulated theoretical and experimental values of stress is same as the difference of values which were analytically calculated. It is confirmed now that simulation represents experiment accurately.



Load value [N]	Simulated shear stress [MPa]	Analytically calculated shear stress [MPa]	Difference [%]
26000	117,201	116,359	-0,72
28000	126,216	125,310	-0,72
25456	114,749	113,924	-0,72
30971	139,609	138,630	-0,7

Table 32. Comparison of stress – wrinkling and crimping, Experiment 3.

Small percentage difference between simulated and calculated results can be explained by the nature of calculation approach. Simulation software use numerical calculation instead of analytical calculations used for preliminary design. Another fact, which affects simulation results, is that composite structure is not symmetric, so I am limited to central square area of stress in resulting figure.

### 3.4.4 Experiment 4 – results

Experiment showed that laminate plate failed because of wrinkling, so stress results under wrinkling load values are presented in the following table.

Load value [N]	Type of result value	Shear stress, average [MPa]
27012,5	Simulation of experiment	147,868
	Experiment, analytically calculated stress value	149,224
25032	Simulation of theoretical wrinkling value	137,027
	Analytical calculation of theoretical wrinkling	138,630

Table 33. Chosen load cases and respective stress values, Experiment 4.

Next, simulation results were compared between and analytically calculated results were compared too. These two comparisons were chosen to define correlation between simulation and analytically calculated results.

Type of the calculation	Results of experiment simulation and simulated theoretical load value		Results of analytically calculated stress value from experimental and theoretical load values	
	Simulation, based on experimental value	Simulation, based on the theoretical load value	Experiment, analytically calculated stress	Analytical calculation of theoretical wrinkling
Load value [N]	27012,5	25032	27012,5	25032
Shear stress, average [MPa]	147,868	137,027	149,224	138,630
Difference [%]	-7,33		-7,1	

Table 34. Comparison of simulation and analytically calculated results, Experiment 4.

Difference between simulated theoretical and experimental values of stress differs only by two tenth of percentage point from the difference of values which were analytically calculated. It is confirmed now that simulation represents experiment accurately.

Load value [N]	Simulated shear stress [MPa]	Analytically calculated shear stress [MPa]	Difference [%]
27012,5	147,868	149,224	0,92
25032	137,027	138,630	1,17

Table 35. Direct comparison of simulated and calculated stress, Experiment 4.

Small percentage difference between simulated and calculated results can be explained by the nature of calculation approach. Simulation software use numerical calculation instead of analytical calculations used for preliminary design.

### 3.4.5 Experiment 5 – results

Experiment showed that laminate plate failed because of wrinkling, so stress results under wrinkling load values are presented in the following table.

Load value [N]	Type of result value	Shear stress, average [MPa]
27012	Simulation of experiment	91,037
	Experiment, analytically calculated stress value	93,629
29981	Simulation of theoretical wrinkling value	101,043
	Analytical calculation of theoretical wrinkling	103,865

Table 36. Chosen load cases and respective stress values, Experiment 5.

Next, simulation results were compared between and analytically calculated results were compared too. These two comparisons were chosen to define correlation between simulation and analytically calculated results. Such correlation can prove the validity of the simulation.

Type of the calculation	Results of experiment simulation and simulated theoretical load value		Results of analytically calculated stress value from experimental and theoretical load values	
	Simulation, based on experimental value	Simulation, based on the theoretical load value	Experiment, analytically calculated stress	Analytical calculation of theoretical wrinkling
Load value [N]	27012	29981	27012	29981
Shear stress, average [MPa]	91,037	101,043	93,629	103,865
Difference [%]	10,99		10,93	

Table 37. Comparison of simulation and analytically calculated results, Experiment 5.

Difference between simulated theoretical and experimental values of stress differs only by six hundredth of percentage point from the difference of values which were analytically calculated. This marginal difference confirms that simulation represents experiment accurately.

Load value [N]	Simulated shear stress [MPa]	Analytically calculated shear stress [MPa]	Difference [%]
27012	91,037	93,629	2,85
29981	101,043	103,865	2,79

Table 38. Direct comparison of simulated and calculated stress, Experiment 5.

Difference of around 3% between simulated and calculated results can be explained by numerical approach to calculation in simulation software. It is also possible that amount of layers affects simulation, so results are less corresponding with analytical solution, than in some previous experiments.

### 3.4.6 Experiment 6 – results

Experiment showed that laminate plate failed because of crimping, so stress results under crimping load values are presented in the following table.

Load value [N]	Type of result value	Shear stress, average [MPa]
42874	Simulation of experiment	124,876
	Experiment, analytically calculated stress value	126,319
42426	Analytical crimping value, simulation	123,561
	Analytical crimping value, calculation	124,999

Table 39. Chosen load cases and respective stress values, Experiment 6.

Next, simulation results were compared between and analytically calculated results were compared too. These two comparisons were chosen to define correlation between simulation and analytically calculated results. Such correlation can prove the validity of the simulation.

Type of the calculation	Results of experiment simulation and simulated theoretical load value		Results of analytically calculated stress value from experimental and theoretical load values	
	Simulation, based on experimental value	Simulation, based on the theoretical load value	Experiment, analytically calculated stress	Analytical calculation of theoretical crimping
Load value [N]	42874	42426	42874	42426
Shear stress, average [MPa]	124,876	123,561	126,319	124,999
Difference [%]	-1,05		-1,04	

Table 40. Comparison of simulation/analytical calculation for crimping, Experiment 6.

Difference between simulated theoretical and experimental values of stress differs only by one hundredth of percentage point from the difference of values which were analytically calculated. Such difference is negligible, so simulation represents experiment accurately.

Load value [N]	Simulated shear stress [MPa]	Analytically calculated shear stress [MPa]	Difference [%]
42426	123,561	124,999	1,16
42874	124,876	126,319	1,16

Table 41. Comparison of simulated and calculated stresses – crimping, Experiment 6.

Small percentage difference between simulated and calculated results can be explained by the nature of calculation approach. Simulation software use numerical calculation instead of analytical calculations used for preliminary design.

### 3.5 Conclusion

According to comparison of results for each of experiments, I can confirm that simulation approach I have chosen is suitable for design of the composite plate in-plane shear test. Simulation results differ from analytical calculation at most 3% with average of only 1%. Such small difference value is acceptable. These differences can be explained by the fact that frame elements are stressed with load too, consequently it affects results in a small manner. Also, simulation has the same kinematic mechanism of specimen deformation, as experiment (uniaxial in-plane shear testing). Graphical representations for experiments can be used by students to predict the area of failure and to confirm that stress distribution is not uniform.

#### 3.5.1 Wrinkling

Five of six tested sandwich laminates failed because of wrinkling failure. Such type of failure is hard to predict because it depends on the  $k_{1x}$  coefficient which range is quite wide and is surveyed experimentally. Even I have only five failure stress values available, I can define some correlation between these coefficients. Following equation is used to calculate  $k_{1x}$  coefficient, from value of the failure stress.

$$\sigma_{Fx} = k_{1x} * \sqrt[3]{G_{cx} * E_{cx} * E_{tx}}$$

$$k_{1x} = \frac{\sigma_{Fx}}{\sqrt[3]{G_{cx} * E_{cx} * E_{tx}}}$$

$x$  – experiment number

Following table includes calculated coefficients for all five experiments.

Experiment number	Theoretical wrinkling failure stress, $\sigma_{wx}$ [MPa]	Experimental wrinkling failure stress, $\sigma_{Fx}$ [MPa]	Percentage difference between wrinkling values, [%]	Experimental wrinkling coefficient, $k_{1x}$ [–]
1	101,362	84,444	–16,7	0,407
2	137,027	114,216	–16,3	0,412
3	139,609	126,216	–9,6	0,455
4	137,027	147,868	7,9	0,533
5	101,043	91,037	–9,9	0,438

Table 42. Wrinkling calculation for Experiments 1 – 5.

Based on results of the experimental wrinkling coefficient, conservative approach to wrinkling calculation should be used for future laminate designs. Four of five experiments failed sooner than it was predicted in calculation and their  $k_1$  value is quite similar. That means,  $k_1$  coefficient is from the range 0,4 – 0,45. I suppose that  $k_1$  coefficient from this range should be used for preliminary design, it will help to fit calculation into experiment better. It is also confirmed that wrinkling coefficient  $k_1$  does not depend on the skin material, but is more the



matter of the lamination quality, amount of the epoxy used in the laminate and other production conditions. [1] [5] [13] [11] [12] [3]

### 3.5.2 Crimping

Following table shows both theoretical and experimental crimping loads with percentage difference, for sandwich plates from experiments (3, 6, 7\*). Plates from these experiments are believed to fail because of crimping.

Experiment number	Theoretical crimping failure stress, $F_{crx}$ [N]	Experimental crimping failure load, [N]	Percentage difference between crimping values, [%]
3	25456	26000	2,1
6	42426	42874	1,1
7*	26582	28693,9	7,9

Table 43. Crimping comparison for Experiments 3, 6, 7\*.

Based on the crimping results, equation of crimping calculation ( $N_c = G_c * t_l$ ) can be accepted as accurate for preliminary sandwich panel design. Even only three sandwich plates failed because of crimping, development of results demonstrates that sandwich laminate resists crimping well, with positive percentage values for all three cases. That means, sandwich laminate is performing better than designed in every experiment. [13] [3] [8]

## 4 Concluding remarks

Problematics of composite sandwich failures and test design were introduced, in Chapter 1.

In Chapter 2, three types of design approach were proposed, including both 2D and 3D ways of design. These three approaches have been compared. Time-efficient and accurate design was achieved with 2D surface with rods approach. This approach was used in the following Chapter 3 for design of experiments simulation. As well, it can be used as specimen for simple simulation design during finite elements analysis of composite sandwich plates. It takes not more than 20 minutes to create simulation and receive simulation results including their graphic representation. Consequently, this simulation design can be helpful for the students of Institute of Aerospace Engineering, during their in-class activities connected with sandwich plates tests.

Six students' experiments were assessed, in Chapter 3. Assessment included analytical calculations, experiment description, simulation of experiment and comparison of results. After results have been compared, correlation between analytical calculated values and simulation has been set. Simulation was confirmed as appropriate and precise enough, to predict stress in the sandwich plate. Differences between analytically calculated values and simulated were at average about 1%, with highest difference around 3%. Also, theoretical and experimental values of wrinkling and crimping failures were compared. Some findings about wrinkling coefficients ( $k_1$ ) and crimping calculation equations validity have been made.

As conclusion, I may say that all objectives set in Chapter 1. have been fulfilled successfully in the present bachelor's thesis.

## 5 Material characteristics

Parameters	Dimension	Fiberglass 92110	Fiberglass 92125	Carbon 93	Carbon 200
$E_{11}$	[MPa]	16600		39470	
$E_{22}$	[MPa]	16600		39470	
$E_X$	[MPa]	10700		10170	
$\mu$	[-]	0,37			
$G_{12}$	[MPa]	3800		1620	
$G_X$	[MPa]	7700		15950	
$X_t$	[MPa]	95		146	
$X_c$	[MPa]	95		146	
$Y_t$	[MPa]	95		146	
$Y_c$	[MPa]	95		146	
$S_{12}$	[MPa]	-		35	
$S_X$	[MPa]	95		114	
$m_D$	[g/m <sup>2</sup> ]	163	280	93	200
$m_L$	[g/m <sup>2</sup> ]	291	500	200	438
$t_f$	[mm]	0,17	0,3	0,15	0,32
$P$	[CZK/m <sup>2</sup> ]	150	136	1800	584

Table 44. IDAFLEG characteristics of fabrics used for the laminate design(face).

Parameters	Dimension	C70.55	C70.75
$E$	[MPa]	21 – 50 (30)	73
$\mu$	[-]	[-]	
$G$	[MPa]	17 – 19 (18)	30
$X_c$	[MPa]	0,9	1,3
$S$	[MPa]	0,76	1,2
$\rho$	[kg/m <sup>3</sup> ]	60	80
<b>Color</b>	[-]	<i>yellow</i>	<i>green</i>
<b>Price – 5mm</b>	[CZK/m <sup>2</sup> ]	579	734
<b>Price – 10mm</b>	[CZK/m <sup>2</sup> ]	978	1178

Table 45. IDAFLEG characteristics of foams used for the laminate design(core).

“Rigid” material elastic and shear modulus are  $2 * 10^5$  MPa. Material used for frame specification.

## 6 References

- [1] BILČÍK, Adam, David VANĚK a Nikodem HECZKO. Elaborát č. 4 – Kompozity. Technická 2896/2, 616 69 Brno, CZ, 2015. Letecký ústav, Vysoké učení technické v Brně.
- [2] BIRMAN, V. a Charles W. BERT. Wrinkling of Composite-facing Sandwich Panels Under Biaxial Loading. *Journal of Sandwich Structures and Materials* [online]. 2004, 6(3), 217-237 [cit. 2016-05-23]. DOI: 10.1177/1099636204033643. ISBN 10.1177/1099636204033643. Dostupné z: <http://jasm.sagepub.com/cgi/doi/10.1177/1099636204033643>
- [3] BUCŇÁK, Ondřej a Milan JUNAS. Zkouška mechanických vlastností laminátového vzorku. Technická 2896/2, 616 69 Brno, CZ, 2015. Letecký ústav, Vysoké učení technické v Brně.
- [4] BUSH, Harold G. a Tanchum WELLER. A biaxial method for inplane shear testing. In: NASA Technical Reports Server [online]. Hampton, VA, United States: NASA Langley Research Center, 1978 [cit. 2016-05-21]. Dostupné z: <http://ntrs.nasa.gov/archive/nasa/casi.ntrs.nasa.gov/19780013546.pdf>
- [5] ČERMÁK, Jakub, Robert GRIM, Klára KOLÁŘOVÁ a Aleš SMÉKAL. Kompozitní potah. Technická 2896/2, 616 69 Brno, CZ, 2015. Letecký ústav, Vysoké učení technické v Brně.
- [6] GDOUTOS, E.E, I.M DANIEL a K.-A WANG. Compression facing wrinkling of composite sandwich structures. *Mechanics of Materials* [online]. 2003, 35(3-6), 511-522 [cit. 2016-05-25]. DOI: 10.1016/S0167-6636(02)00267-3. ISBN 10.1016/S0167-6636(02)00267-3. Dostupné z: <http://linkinghub.elsevier.com/retrieve/pii/S0167663602002673>
- [7] GRENESTEDT, Joachim L. a Jack REANY. Wrinkling of corrugated skin sandwich panels. *Composites Part A: Applied Science and Manufacturing* [online]. 2007, 38(2), 576-589 [cit. 2016-05-25]. DOI: 10.1016/j.compositesa.2006.02.007. ISSN 1359835x. Dostupné z: <http://linkinghub.elsevier.com/retrieve/pii/S1359835X06000911>
- [8] JÍLEK, Jan, Ondřej KÖVÉR a Matěj MALINOWSKI. Kompozitní konstrukce v letectví. Technická 2896/2, 616 69 Brno, CZ, 2016. Protokol. Letecký ústav, Vysoké učení technické v Brně.
- [9] LEY, Robert P., Weichuan LIN a Uy MBANEFO. Facesheet Wrinkling in Sandwich Structures. In: NASA Technical Reports Server [online]. Hampton, VA, United States: NASA Langley Research Center, 1999 [cit. 2016-05-23]. Dostupné z: <http://ntrs.nasa.gov/archive/nasa/casi.ntrs.nasa.gov/19990017863.pdf>
- [10] LOPATIN, A.V. a E.V. MOROZOV. Symmetrical Facing Wrinkling of Composite Sandwich Panels. *Journal of Sandwich Structures and Materials* [online]. 2008, 10(6), 475-497 [cit. 2016-05-23]. DOI: 10.1177/1099636208097196. ISBN 10.1177/1099636208097196. Dostupné z: <http://jasm.sagepub.com/cgi/doi/10.1177/1099636208097196>
- [11] MARCINKO, Peter, Jan KÁCAL a Michal FOJTL. Kompozitní stojina. Technická 2896/2, 616 69 Brno, CZ, 2015. Letecký ústav, Vysoké učení technické v Brně.
- [12] MIKULÁŠEK, Miloš, Václav JETELA a Jiří ČERNOTA. Kompozitní stojina. Technická 2896/2, 616 69 Brno, CZ, 2015. Letecký ústav, Vysoké učení technické v Brně.

- [13] MONČEK, Matej, Michal KUBO a Marek BUBEN. VÝROBA KOMPOZITNÝCH SENDVIČOV. Technická 2896/2, 616 69 Brno, CZ, 2015. Letecký ústav, Vysoké učení technické v Brně.
- [14] NIU, Michael Chun-Yung. Composite airframe structures: practical design information and data. 4th published. Hong Kong: Hong Kong Conmlit Press Ltd, 2005. ISBN 96-271-2806-6.
- [15] STIFTINGER, M.A. a F.G. RAMMERSTORFER. Face layer wrinkling in sandwich shells— theoretical and experimental investigations. *Thin-Walled Structures* [online]. 1997, 29(1-4), 113-127 [cit. 2016-05-25]. DOI: 10.1016/S0263-8231(97)00018-9. ISSN 02638231. Dostupné z: <http://linkinghub.elsevier.com/retrieve/pii/S0263823197000189>
- [16] ASM handbook. 10th editon. Materials Park, Ohio: ASM International, 2015. ISBN 16-150-3827-2.

## 7 Nomenclature

$t_c$	thickness of the core
$t_f$	thickness of the facesheet
$E_f$	Young's modulus of the facesheet
$E_c$	through-the-thickness Young's modulus of the core
$G_c$	core transverse shear modulus
$P_s$	shear crimping load
$P_E$	Euler buckling load
$P_{cr}$	buckling load
$t$	core thickness for crimping equation
$b$	length of squared specimen side (panel dimension transverse to the applied load)
$a$	length of squared specimen side (panel dimension in direction of the applied load)
$X_t; X_c; Y_t; Y_c$	minimal material characteristics for axis directions
$D_{11}; D_{12}; D_{22}; D_{66}$	facesheet laminate bending stiffness
$x$	<b>number of experiment 1 ... 6 (small <math>x</math> used as an experiment number for the following variables)</b>
$\sigma_{Fx}$	experimental failure stress
$F_{Fx}$	experimental failure load
$t_{Sx}$	sandwich skin thickness
$t_{Ix}$	sandwich insert thickness
$S_x$	design shear load
$P_x$	calculated pulling load
$\sigma_{cx}$	minimal material characteristics value
$\sigma_{px}$	stress in laminate skin
$N_x$	rated value of stress in laminate
$G_{cx}$	core transverse shear modulus
$N_{cx}$	maximum rated stress value
$E_{fx}$	Young's modulus of the facesheet material
$E_{cx}$	through-the-thickness Young's modulus of the core material

$\sigma_{wx}$	critical wrinkling stress for particular sandwich
$\nu_{tenx}$	safety factor against tension failure
$\nu_{crx}$	safety factor against crimping failure
$\nu_{wrx}$	safety factor against wrinkling failure
$F_{tenx}$	limit load for tension failure
$F_{crx}$	limit load for crimping failure
$F_{wrx}$	limit load for wrinkling failure
$F_{simx1}; F_{simx2}; F_{simx3}; F_{simx4}$	loads for simulation load cases
$\sigma_{simx1X}; \sigma_{simx2X}; \sigma_{simx3X}; \sigma_{simx4X}$	maximal shear stress in layer for load case
$\sigma_{simx1N}; \sigma_{simx2N}; \sigma_{simx3N}; \sigma_{simx4N}$	minimal shear stress in layer for load case

## 8 List of figures

Figure 1.	Schematic load distribution in uniaxial test method. ....	14
Figure 2.	Schematic biaxial test method.....	15
Figure 3.	Biaxial shear frame and specimen [4].....	15
Figure 4.	Uniaxial shear frame and specimen installed to pulling machine [13]. ....	16
Figure 5.	Meshing of the first approach model. ....	19
Figure 6.	Loads and displacements representation for the first approach model. ....	20
Figure 7.	Meshing/loads/displacements representation for the second approach model. ....	22
Figure 8.	Meshing of 2D surfaces and curves in the third approach model.....	23
Figure 9.	Meshing of 3D model, including mesh deformed under load.....	24
Figure 10.	Graphic representation of shear stress in plate, first design approach. ....	26
Figure 11.	Graphic representation of shear stress in plate, second design approach. ....	27
Figure 12.	Front view of shear stress in sandwich plate, 3D approach. ....	28
Figure 13.	Rear view of shear stress in sandwich plate, 3D approach. ....	29
Figure 14.	Edge view of shear stress in sandwich plate, 3D approach.....	29
Figure 15.	Schematic load distribution and orthotropic material orientation.....	40
Figure 16.	Graphic representation of stress in plate, load case <i>Fsim11</i> . ....	41
Figure 17.	Graphic representation of stress in plate, load case <i>Fsim12</i> . ....	42
Figure 18.	Graphic representation of stress in plate, load case <i>Fsim13</i> . ....	42
Figure 19.	Graphic representation of stress in plate, load case <i>Fsim21</i> . ....	44
Figure 20.	Graphic representation of stress in plate, load case <i>Fsim22</i> . ....	45
Figure 21.	Graphic representation of stress in plate, load case <i>Fsim23</i> . ....	45
Figure 22.	Graphic representation of stress in plate, load case <i>Fsim31</i> . ....	48
Figure 23.	Graphic representation of stress in plate, load case <i>Fsim32</i> . ....	48
Figure 24.	Graphic representation of stress in plate, load case <i>Fsim33</i> . ....	49
Figure 25.	Graphic representation of stress in plate, load case <i>Fsim34</i> . ....	49
Figure 26.	Graphic representation of stress in plate, load case <i>Fsim41</i> . ....	51
Figure 27.	Graphic representation of stress in plate, load case <i>Fsim42</i> . ....	52
Figure 28.	Graphic representation of stress in plate, load case <i>Fsim43</i> . ....	52
Figure 29.	Graphic representation of stress in plate, load case <i>Fsim51</i> . ....	54
Figure 30.	Graphic representation of stress in plate, load case <i>Fsim52</i> . ....	55
Figure 31.	Graphic representation of stress in plate, load case <i>Fsim53</i> . ....	55
Figure 32.	Graphic representation of stress in plate, load case <i>Fsim61</i> . ....	57
Figure 33.	Graphic representation of stress in plate, load case <i>Fsim62</i> . ....	58



Figure 34. Graphic representation of stress in plate, load case *Fsim63*. ..... 58

## 9 List of tables

Table 1.	Sandwich plate composition, first approach model. ....	19
Table 2.	Averaged shear stress comparison, three simulation approaches. ....	30
Table 3.	Important criterions comparison, three simulation approaches. ....	31
Table 4.	Sandwich plate composition, Experiment 1. ....	32
Table 5.	Sandwich plate composition, Experiment 2. ....	33
Table 6.	Sandwich plate composition, Experiment 3. ....	33
Table 7.	Sandwich plate composition, Experiment 4. ....	34
Table 8.	Sandwich plate composition, Experiment 5. ....	35
Table 9.	Sandwich plate composition, Experiment 6. ....	36
Table 10.	Analytical solution results, Experiment 1 – 6. ....	39
Table 11.	Analytical solution results, safety factors and critical loads, Experiment 1 – 6. ....	39
Table 12.	List of load cases used for the simulation of Experiment 1. ....	41
Table 13.	List of stress results for load cases, Experiment 1. ....	43
Table 14.	List of load cases used for the simulation of Experiment 2. ....	44
Table 15.	List of stress results for load cases simulation, Experiment 2. ....	46
Table 16.	List of load cases used for the simulation of Experiment 3. ....	47
Table 17.	List of stress results for load cases simulation, Experiment 3. ....	50
Table 18.	List of load cases used for the simulation of Experiment 4. ....	51
Table 19.	List of stress results for load cases simulation, Experiment 4. ....	53
Table 20.	List of load cases used for the simulation of Experiment 5. ....	54
Table 21.	List of stress results for load cases simulation, Experiment 5. ....	56
Table 22.	List of load cases used for the simulation of Experiment 6. ....	57
Table 23.	List of stress results for load cases simulation, Experiment 6. ....	59
Table 24.	Chosen loads and respective stress values, Experiment 1. ....	60
Table 25.	Comparison of simulation/analytically calculated results, Experiment 1. ....	60
Table 26.	Direct comparison of simulated and calculated stress, Experiment 1. ....	61
Table 27.	Chosen load cases and respective stress values, Experiment 2. ....	62
Table 28.	Comparison of simulation and analytically calculated results, Experiment 2. ....	62
Table 29.	Direct comparison of simulated and calculated stress, Experiment 2. ....	63
Table 30.	Chosen load cases and respective stress values, Experiment 3. ....	64
Table 31.	Comparison of simulation/analytical calculation for crimping, Experiment 3. ....	64
Table 32.	Comparison of stress – wrinkling and crimping, Experiment 3. ....	65
Table 33.	Chosen load cases and respective stress values, Experiment 4. ....	66

Table 34.	Comparison of simulation and analytically calculated results, Experiment 4.....	66
Table 35.	Direct comparison of simulated and calculated stress, Experiment 4. ....	67
Table 36.	Chosen load cases and respective stress values, Experiment 5. ....	68
Table 37.	Comparison of simulation and analytically calculated results, Experiment 5.....	68
Table 38.	Direct comparison of simulated and calculated stress, Experiment 5. ....	69
Table 39.	Chosen load cases and respective stress values, Experiment 6. ....	70
Table 40.	Comparison of simulation/analytical calculation for crimping, Experiment 6. ....	70
Table 41.	Comparison of simulated and calculated stresses – crimping, Experiment 6.....	71
Table 42.	Wrinkling calculation for Experiments 1 – 5. ....	72
Table 43.	Crimping comparison for Experiments 3, 6, 7*. ....	73
Table 44.	IDAFLEG characteristics of fabrics used for the laminate design(face). ....	75
Table 45.	IDAFLEG characteristics of foams used for the laminate design(core).....	75