

**CZECH UNIVERSITY OF LIFE SCIENCES PRAGUE**  
FACULTY OF ENVIRONMENTAL SCIENCES



**MASTER THESIS**

**Comparison of bird diversity within  
and outside protected areas (PA) of  
Central Italy: are PAs protecting  
better species richness, functional  
diversity or evolutionary  
uniqueness in bird communities?**

**Supervisor:** doc. Federico Morelli, Ph.D.  
**Diplomant:** Bc. Danielle Meyers

**Prague 2018**



**Czech University of Life Sciences Prague**  
**Faculty of Environmental Sciences**

**DIPLOMA THESIS TOPIC**

Author of thesis: B.Sc. Danielle Lee Meyers, BSc

Study programme: Engineering Ecology

Field of study: Nature Conservation

Thesis supervisor: Federico Morelli

Supervising department: Department of Applied Geoinformatics and Spatial Planning

Language of a thesis: English

Thesis title: **Comparison of bird diversity within and outside protected areas (PA) of Central Italy: are PAs protecting better species richness, functional diversity or evolutionary uniqueness in bird communities?**

Objectives of thesis: The aims of this study are to investigate if protected areas in the Marche Region (Central Italy) cover areas have higher bird diversity than non-protected areas. Then, to determine the efficiency of protected areas focused in this study, to protect different avian diversity components.

Methodology: Field data were collected from the central Marche Region, Italy from altitudes 0-1200m above sea level. Data on bird species occurrence were collected during the breeding season with a total of 453 point counts in different environments. Data were collected within and outside the protected areas. The point counts were uniformly spaced 200 m from each other. Environmental data was derived from the landcover map of the Marche Region (1:10 000). The Marche Region landcover map was used in order to consolidate the land-use into twelve land-use categories; undefined, urban areas, agricultural areas,

orchards and vineyards, forests, grasslands, riparian vegetation or reforestation, badlands, waterbodies, rivers, roads, and other.

In each species assemblage, different community metrics as the taxonomic diversity, functional diversity and evolutionary uniqueness were estimated. Three independent functional diversity indices were calculated, representing three key components of functional diversity: Functional Richness (FRic) is the amount of functional space occupied by species; Functional Evenness (FEve) measures regularity of abundance distribution along functional space; Functional Divergence (FDiv) measures how far high species abundances are from the center of the functional space. Additionally, evolutionary distinctiveness score (ED), max ED score, Rao's quadratic entropy (RaoQ), community evolutionary distinctiveness (CED), and bird species richness (BSR, number of species) were computed in each point count.

ESRI ArcMap was used for the spatial analysis of the data. In order to determine correlations between the diversity metrics, linear models were created and R squared values were calculated. For correlations between land uses, a correlogram was made using Pearson's linear correlation.

GLMs were constructed for the whole data set using the land use areas, spatial unit (inside or outside, 100m or 250m buffer size), and WED as independent variables and the diversity metrics as the dependent variables. GLMs were also created comparing the dominant land uses inside and outside protected areas with a 100m buffer using spatial unit, and WED. This shows the differences between the sites dominated by each land use inside compared to sites dominated by the same land use outside of the protected areas. Finally, a GLM was made to explore the interaction between spatial unit and dominant land use while still including WED for the 100m buffer.

The proposed extent of the thesis: 50

Keywords: Italy; Protected Areas Network; conservation; Natura2000; Avian diversity

Recommended information sources:

1. Devictor, V., Mouillot, D., Meynard, C.N., Jiguet, F., Thuiller, W., Mouquet, N., 2010. Spatial mismatch and congruence between taxonomic, phylogenetic and functional diversity: the need for integrative conservation strategies in a changing world. *Ecol. Lett.* 13, 1030–1040. doi:10.1111/j.1461-0248.2010.01493.x
2. Fuller, R.A., McDonald-Madden, E., Wilson, K.A., Carwardine, J., Grantham, H.S., Watson, J.E.M., Klein, C.J., Green, D.C., Possingham, H.P., 2010. Replacing underperforming protected areas achieves better conservation outcomes. *Nature* 466, 365–367. doi:10.1038/nature09180

3. Gaüzère, P., Jiguet, F., Devictor, V., 2015. Can protected areas mitigate the impacts of climate change on bird's species and communities? *Divers. Distrib.* in press. doi:10.1111/ddi.12426
4. Grodzińska-Jurczak, M., Cent, J., 2011. Expansion of nature conservation areas: problems with Natura 2000 implementation in Poland? *Environ. Manage.* 47, 11–27. doi:10.1007/s00267-010-9583-2
5. Morelli, F., Benedetti, Y., Su, T., Zhou, B., Moravec, D., Šímová, P., Liang, W., 2017. Taxonomic diversity, functional diversity and evolutionary uniqueness in bird communities of Beijing's urban parks: effects of land use and vegetation structure. *Urban For. Urban Green.* 23, 84–92. doi:10.1016/j.ufug.2017.03.009

Expected date of thesis defence: 2017/18 SS - FES

Electronically approved: 29. 3. 2018  
**doc. Ing. Petra Šímová, Ph.D.**  
Head of department

Electronically approved: 29. 3. 2018  
**prof. RNDr. Vladimír Bejček, CSc.**  
Dean

**Declaration:**

I hereby declare that I am the sole author of the thesis entitled: "Comparison of bird diversity within and outside protected areas (PA) of Central Italy: are PA protecting better species richness, functional diversity or evolutionary uniqueness in bird communities?". I duly marked out all quotations. The used literature and sources are stated in the attached list of references.

In Prague on

---

Danielle Meyers

## **ABSTRACT**

Diversity metrics estimated on species assemblages or communities are often used to measure and quantify the biodiversity in an area. Previously, it was common to only use indices such as species richness and abundance. However, in recent years popularity has increased using functional, taxonomic, and phylogenetic diversity metrics in order to determine the effectiveness of areas protecting biodiversity. A multi-facet approach can offer a better focus on the complexity of ecological systems. However, there is often discrepancy among the use of many diversity metrics, in that they can be redundant. There have been several studies showing that functional richness is positively correlated with species richness but functional evenness is uncorrelated.

Additionally, there are some studies showing how these metrics can be affected by land composition and landscape heterogeneity. In this study, the influence of land use composition on the diversity metrics estimated on bird communities are explored both inside and outside of protected areas in the central Marche Region of Italy. With this, the effectiveness of the protected areas protecting different facets of the avian diversity can be evaluated and where the focus of improvement needs to be.

Results of this study determined that sites outside of the protected areas were in general characterized by higher values of bird species richness and functional richness than inside. When comparing the avian diversity metrics across different types of land uses, the land use with the lower values in overall avian diversity metrics, especially in terms of bird species richness, was the grassland.

In conclusion, protected areas studied need to consider the many facets of avian diversity and community metrics, in order to be able to better conserve bird community biodiversity. There are numerous management techniques that can help to produce better results.

**Keywords:** Italy; Protected Areas Network; conservation; Natura2000; Avian diversity

## **ABSTRAKT**

Metriky diverzity jsou používány k měření biodiverzity druhů v oblasti. V Evropě je Natura 2000 hlavní síť chráněných území, které pokrývají celý kontinent. Existuje mnoho studií, které se zaměřují na efektivitu těchto chráněných území v různých zemích. Avšak nemnoho těchto studií ukazuje jak funkční, taxonomické a fylogenické metriky mohou být ovlivněny způsobem využití půdy. V této studii je zkoumán vliv využití půdy na metriku diverzity, uvnitř i mimo chráněná území, v regionu Marche ve střední Itálii. Z důvodu analýzy efektivnosti byly oblasti sběru dat rozděleny dle toho, zda se nachází uvnitř nebo mimo chráněné území. Prostorová analýza byla provedena za použití softwaru ArcGIS a modely pro statistickou analýzu byly vytvořeny v softwaru R Studio. Výsledky této studie ukazují, že metriky byly obecně vyšší v oblastech mimo chráněná území nežli uvnitř. Metriky bohatosti ptačích druhů a funkční bohatosti byly v tomto případě jedny z nejvíce zdrcujících objevů. Když porovnáme oblasti z hlediska využití půdy, je třeba nejvíce zlepšit oblasti luk. V těchto oblastech měli téměř všechny metriky diverzity negativní dopad.

Závěrem, zkoumaná chráněná území je třeba vylepšit za účelem zachování komunitní ptačí biodiverzity. Je mnoho možností plánování, které mohou zajistit lepší výsledky.

***Klíčová slova:*** Itálie; Síť chráněných oblastí; zachování; Natura2000; Ptačí rozmanitost

## **ACKNOWLEDGEMENTS**

I would like to take the time to thank my mentor, Federico Morelli, PhD. I appreciate the time you took to make this paper the best that it could be. And Yanina Benedetti, PhD for all of the advice you have given me on my thesis. A big thank you goes to Vítězslav Moudrý, PhD for all of your help with ArcGIS analysis. As well as Sean Hellingman for help with stastical analyses and help in R. Finally, I would like to thank Peter Kumble, PhD for all of your guidance throughout the program. I truly could not have done this without any of you. Thank you all.



## Table of Contents

Declaration.....	v
Abstract.....	vi
Abstrakt.....	vii
Acknowledgements.....	viii
Table of Contents.....	ix
<b>1. Introduction.....</b>	<b>1</b>
<b>2. Literature Review.....</b>	<b>2</b>
2.1 Biodiversity.....	2
2.2 Conservation strategies.....	5
2.3 Protected areas.....	6
<b>3. Aims of Study.....</b>	<b>10</b>
<b>4. Methods.....</b>	<b>11</b>
4.1 Study area and climate.....	11
4.2 Field work.....	12
4.3 Landscape and land use analyses in sampling sites.....	13
4.4 Dominant land use in each sampling site.....	14
4.5 Landscape metrics.....	14
4.6 Avian diversity and community metrics.....	15
4.7 Taxonomic diversity, functional diversity, and evolutionary uniqueness metrics calculations.....	15
4.6 GIS analysis and data visualization.....	17
4.7 Statistical analysis.....	17
4.8 Explanation of variables.....	18
<b>5. Results.....</b>	<b>21</b>
5.1 Landscape mapping.....	21

5.2 Spatial distribution of avian diversity: preliminary explorations using GIS mapping.....	21
5.3 Comparing avian diversity metrics inside an outside of protected areas.....	26
5.4 Effects of land use composition on each diversity metric.....	32
5.5 Exploring the interactions between land use composition inside and outside of protected areas.....	32
<b>6. Discussion.....</b>	<b>38</b>
6.1 Importance of protected areas and biodiversity.....	38
6.2 The role of landscape heterogeneity.....	38
6.3 Effectiveness of protected areas in the Marche Region (Italy).....	41
6.4 Management of different land uses.....	41
6.5 Future studies.....	42
<b>7. Conclusion.....</b>	<b>43</b>
<b>8. References.....</b>	<b>44</b>

## **INTRODUCTION**

In this thesis, we explored whether or not protected areas in the Marche Region (Central Italy) cover areas have higher bird diversity than non-protected areas. In order to determine the relative efficiency of protected areas focused in this study and which avian diversity components are being protected. These protected areas are being compared to areas outside in order to determine if they are able to protect against the loss of diversity better than areas with no protection.

In the literature review there is information to help better understand what biodiversity is, why it is important, as well as the difference between the main diversity metrics. There also contains information about different ways around the globe (focusing mostly within the EU) that biodiversity is being protected. Later, the management techniques within protected areas are investigated.

Italian protected areas were targeted due to the low amount of research of protected areas in this country. Protection of biological diversity is a fundamental key to contrast the current biodiversity loss. Additionally, it is also important to investigate the effectiveness of these areas as there are high funds required to maintain these areas. Birds were chosen in this study due to the ease of data collection (visual and acoustical), and because birds are also considered a biological indicator and can offer knowledge about the study area based on species found.

## LITERATURE REVIEW

### *Biodiversity*

Biodiversity is defined as the variety of life (Kierszniowska & Seiwert, 2009). Without variety, many species are more susceptible to disease and at risk of extinction. This can pose a problem for humans when it comes to the crops and other various foods that we consume on a daily basis. Since the evolution of humans, there has been destruction to the natural environment. Man has cut down trees for shelter, warmth, and agriculture ultimately cutting the forests. In Brazil, destruction of forests began as early as the 1500's (Mittermeier, Da Fonseca, Rylands, & Brandon, 2005). Today there continues to be losses of natural forests due to an increase in agricultural and urbanized areas to support the growth of the human population. Today, approximately 48% of the human population live in cities and is estimated to increase to nearly 60% by 2030 (Miller, 2005). This causes a large gap between humans and nature, resulting in individuals being blind to the severity of biodiversity loss. This has been supported from several survey studies coming from Australia and the USA where students were unable to identify local animals or where their milk and clothing come from (Adams, Leedy, & McComb, 2014).

Biodiversity can be broken down into categories of measurement and studied focusing different components or facets of the community diversity. Overall, diversity measurements can be referred to as functional, taxonomic diversity, and even phylogenetic diversity. Briefly, the taxonomic diversity refers to a measure of the number of taxa within an area (Magurran, 2004). Within this, the number (richness), distribution (evenness), and density of species can be calculated. Phylogenetic diversity allows for a relationship to be made based on evolutionary trees and can then provide a better understanding of how closely related different species are to each other. From the phylogenetic trees, evolutionary distinctiveness can be calculated. This is determined by the length between each node on the tree in order to measure how closely related individuals of different species are. An example of the calculation can be seen in Figure 7 (Isaac, Turvey, Collen, Waterman, & Baillie, 2007).

Additionally, there are three scale categories of biodiversity; alpha, beta, and gamma. Alpha, being the smallest, refers to diversity at a local level. This can be within a specific habitat type or site. Gamma represents the total number of species within a landscape. This is at a much larger scale than the alpha. Beta considers both local and regional diversity scales. In this way, the relationships between alpha and gamma can be measured (Whittaker & May, 1972). While these measures are interesting and provide information

about the species within the area, they fail to describe the species interactions and use of resources in the ecosystem.

Functional diversity is a relatively new term that has been growing in popularity amongst ecological research since the early 2000's. Functional diversity describes how organisms have different traits and can be measured through many indices such as evolutionary distinctiveness, functional divergence, functional evenness, and functional richness (Carmona, de Bello, Mason, & Lepš, 2016). Calculating functional diversity can be difficult since it can be measured over different spatial scales (Carmona et al., 2016). It is necessary to assess the functional metrics because basic diversity metrics (richness, evenness, etc.) assume that each individual has the same functioning role in the ecosystem (Mouchet, Villéger, Mason, & Mouillot, 2010). The use of several indices allows for all more aspects of biodiversity to be measured and each metric explores different functions a species has within a community. Between all of these indices, the distribution, abundance, and importance a species has in an ecosystem can be considered within a functional space. A comparison between the different functional metrics and how they fluctuate based the community structure (see Figure 1). Functional divergence is a relatively new index that has been used in the last decades. This term compares how far the abundances of a species are from the center of the functional space (Mouchet et al., 2010). In 2003, Mason et al. proposed functional divergence for the first time where the distribution and abundance of species were both used. This allows for the result to be weighted by abundance while also considering the evenness (Mason, Mouillot, Lee, & Wilson, 2005). When dealing with small samples in small communities, this can have a major effect on the functional divergence. Functional evenness estimates the distribution of the roles that a species has in ecosystems functions, in terms of the biomass distribution in the functional space (Ricotta, Bacaro, & Moretti, 2014). There are disadvantages of functional evenness, one of them being that the distribution of abundance only is measured for the species that are present in the current sample. However, this measurement also allows for weighted importance of species within the niche space (Petchey & Gaston, 2006). Functional richness refers to the niche space that is occupied by a species in a community (Mason et al., 2005). Functional diversity is sensitive to fluctuation in species richness. In the case of species richness and functional richness, many believe that species richness is an adequate surrogate for functional richness. However, this is only applicable when there is a linear increase in niche space. While there is typically a positive relationship for the two metrics, they are not always the same.

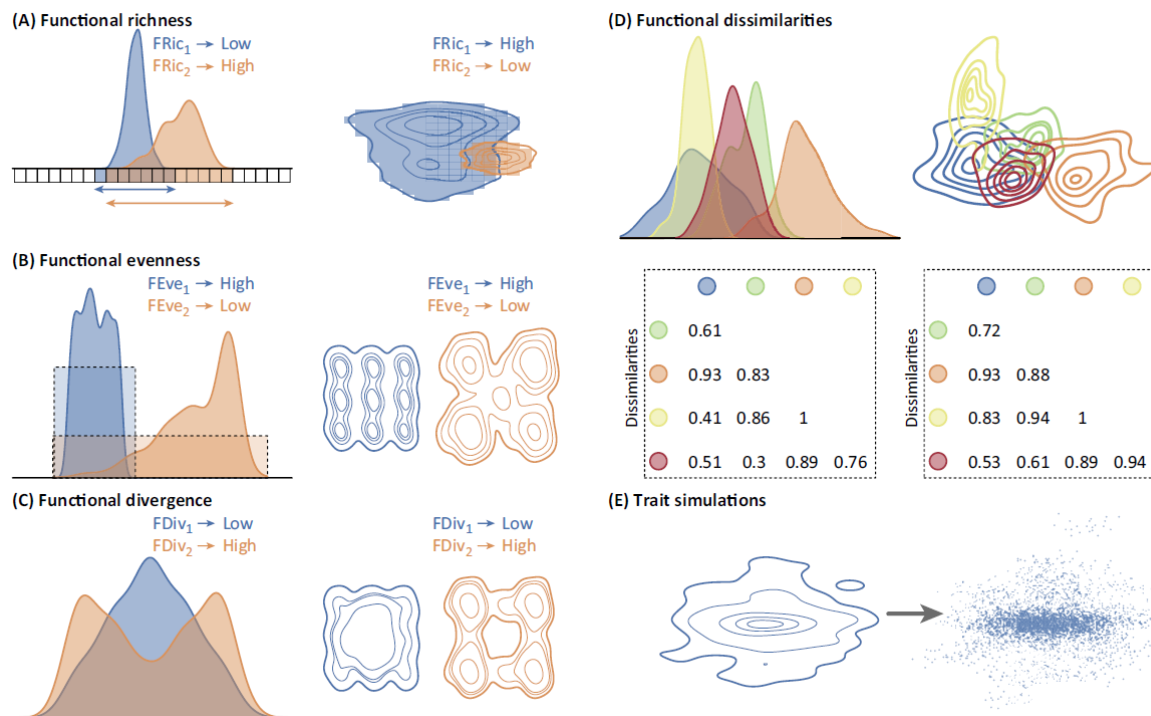

**Figure 1** shows the overlap and variations between three functional diversity metrics (A, B, C). In these figures, it is easy to visualize how the space looks with different values of the metrics. (D) Shows the differences between units and (E) shows how the functional traits can be used to simulate various traits of different scales. Reference: (Carmona et al., 2016)

An example of this can be seen in Figure 2 where (a) and (b) are mainly theoretical and (c) and (d) are closer to what occurs in nature. However, a review by (Díaz & Cabido, 2001) conclude that the species richness is not an adequate surrogate for functional richness since species richness doesn't allow for a better understanding of processes within the ecosystem. Therefore, it is important to calculate functional richness and species richness. With an increase in the number of traits, or species, there is a dramatic change in the overall functional diversity. This can be seen as a weakness of functional richness since there has to be a limitation on the number of traits in the population to prevent overestimation or underestimation of the functional diversity measure (Petchey & Gaston, 2006). A disadvantage of all of these diversity metrics is that there needs to be correct identification of the bird species. This can be difficult when identifying visually or acoustically similar individuals. With fewer samples, there is also the possibility of redundancy in the sample; however, with more diversity traits, redundancy can be limited (Petchey & Gaston, 2006).

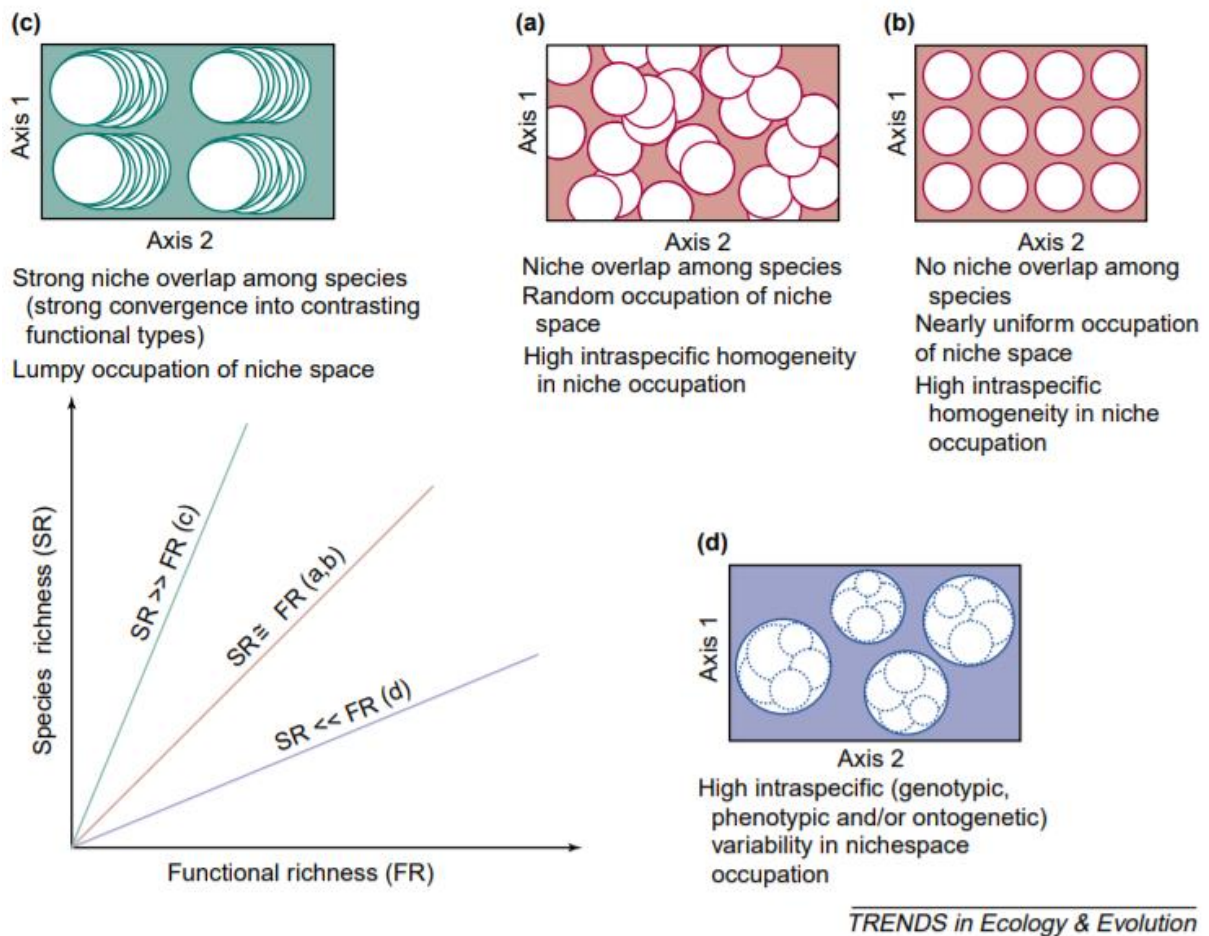

**Figure 2** the relationships between functional richness and species richness when occupying niche space differently. References: Altered by (Díaz & Cabido, 2001).

### Conservation & strategies

Conserving biodiversity is important for the health of the planet (Kareiva & Marvier, 2012). Increased biodiversity allows for natural stability, variety in crops, and sustainable living. However, biodiversity is being threatened every day. Negative human impact on the environment has been causing changes that are putting species at risk of extinction. For this reason, and several others, knowing different conservation strategies and how they work are important (Kareiva & Marvier, 2012).

There have been several conventions that protect different habitats. For example, the Ramsar Convention aims to reduce the loss of wetlands in the world (“The Ramsar Convention and its mission | Ramsar,” 2014). This is a worldwide effort as there are several areas protected under this convention across the globe. Mitigating the loss of wetlands is important as they are the most productive ecosystems in the world (“The Ramsar

Convention and its mission | Ramsar,” 2014). The most common reason for loss of wetlands is the conversion into farmland and infrastructure.

The European Union (EU) has two major directives in law that countries have to abide by. These are the Birds Directive and the Habitat Directive. Currently, 32% of birds in the EU are at an unfavorable conservation status (“Nature and biodiversity law - Environment - European Commission,” 2016). In order to help combat this loss in diversity, the objective of the Birds Directive is to protect all bird species within the EU by requiring the establishment of Special Protection Areas (SPAs) for birds. The directive was put in place in 1979 when there was a rapid decline in bird species due to loss of habitat and food from fragmentation and use of pesticides (“Nature and biodiversity law - Environment - European Commission,” 2016). The Habitat Directive was adopted in 1992 and aims to conserve rare, threatened, and endemic species within the EU (“Nature and biodiversity law - Environment - European Commission,” 2016). This directive calls for the establishment of Special Areas of Conservation (SACs) that protect more than just bird species. There are roughly 200 habitats that are protected under this directive (“Nature and biodiversity law - Environment - European Commission,” 2016). In combination, the SACs and SPAs make-up the Natura 2000 network.

There are different strategies based on what the purpose and goals of the conservation. There are six main targets set by the EU for conservation efforts. These are as follows: protect species and habitats, maintain and restore ecosystems, achieve more sustainable agriculture and forestry, more sustainable fishing and healthier seas, combat against invasive species, and help stop the loss of global biodiversity (“Biodiversity Strategy - Environment - European Commission,” 2016).

### ***Protected areas***

Approximately 10% of the earth’s surface is now covered with protected areas (Ervin, 2003). Therefore, determining whether protected areas are effective at conserving wildlife and its biodiversity is essential. When negative impacts on species and areas are minimized, we can say that they are successfully protected (Gaüzère, Jiguet, & Devictor, 2016). While it has been viewed since the 1900’s as an effective method of conservation, recently there have been disputes over the methodology protected areas. In several instances, exclusion of humans from these areas are part of the strategy causing social uproar (Nelson & Chomitz, 2011). In this case, multiple use protected areas can cause less conflict but may put at risk how successful the protected area is. For example, a study in Poland surveyed locals and found that they are more willing to consider environmental protection when it involved skiing resorts and other recreational areas. However, they are less likely to agree



with protected areas used for logging purposes (Grodzinska-Jurczak & Cent, 2011). Other obstacles also need to be crossed when implementing conservation areas. When protecting new areas, there are often arguments made about the economic loss it would have on the nation. Government officials in Poland opposed the introduction of protected areas for fear of economic losses for management and use of the land (Grodzinska-Jurczak & Cent, 2011).

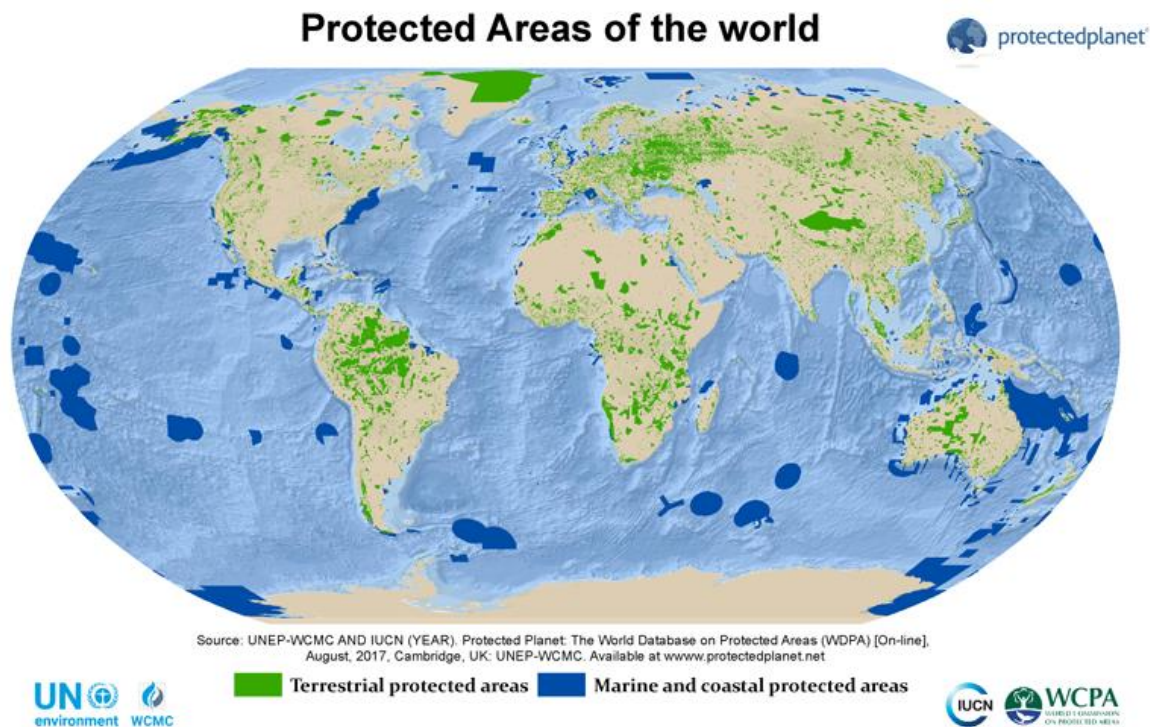

*Figure 3 highlighting protected areas from all over the globe at an international level. Photo: (“About | IUCN,” 2018)*

There are several types of protected areas and how they function in terms of conservation and human involvement. The categories are I-IV and range from strict nature reserves (I-III) to management of a nature area for the use of natural resources (IV-VI) (Naughton-Treves, Holland, & Brandon, 2005). Within each category, there are subcategories indicating whether the area is being used for biodiversity conservation or for the use of sustainable natural resources.

Protected areas can be created and maintained at different levels. The smallest is at a local scale and working all the way up to an international (“About - Protected Areas | IUCN,” 2018). There are protected areas in all human populated continents of the world. An image of the protected areas at the global level can be seen in Figure 3. Within each country, there can be areas placed under protection by the state but are not recognized at an international level. This can then be broken down further by locality. Individual regions of the country can

also protect specific areas at a local level (“About - Protected Areas | IUCN,” 2018).

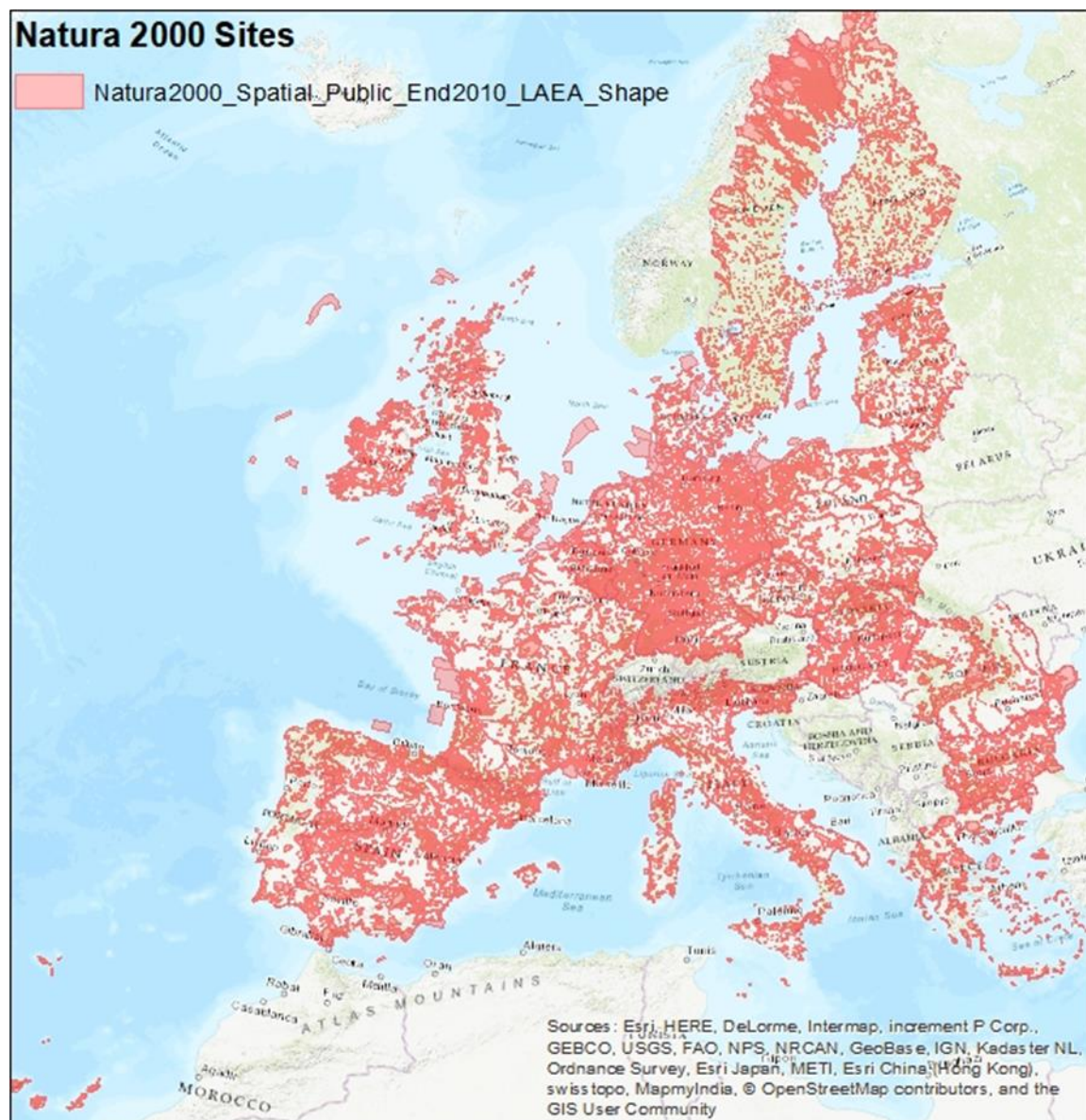

Figure 4 showing the Natura 2000 sites across the European continent. The sites are indicated in red.

In the EU, Natura 2000 is a conservation strategy that is made up of a network of protected areas across the continent (Figure 4). These networks make up 18% of terrestrial area and approximately 6% of marine areas (“Biodiversity Strategy - Environment - European Commission,” 2016). The focus of Natura 2000 is to protect breeding and resting areas for threatened species and habitats. In 1992, the European Communities adopted the Natura 2000 network and protected the most endangered species and rarest habitats.

Sites under the protection of Natura 2000 must come up with a management plan that is stated in either the Birds Directive or the Habitats Directive. This management technique must take into consideration economic, social, cultural, regional, and recreational

requirements of the area under protection (“Management of Natura 2000 sites - Environment - European Commission,” 2017). An example of management techniques for Italian protected areas can be seen in Figure 5 (European Commission, 2005). Though these areas are protected areas, this does not exclude human involvement. In some areas, there is strict protection without human accessibility, while in others there is farmland or even urbanized areas being protected under Natura 2000 (“Natura 2000 - Environment - European Commission,” 2017).

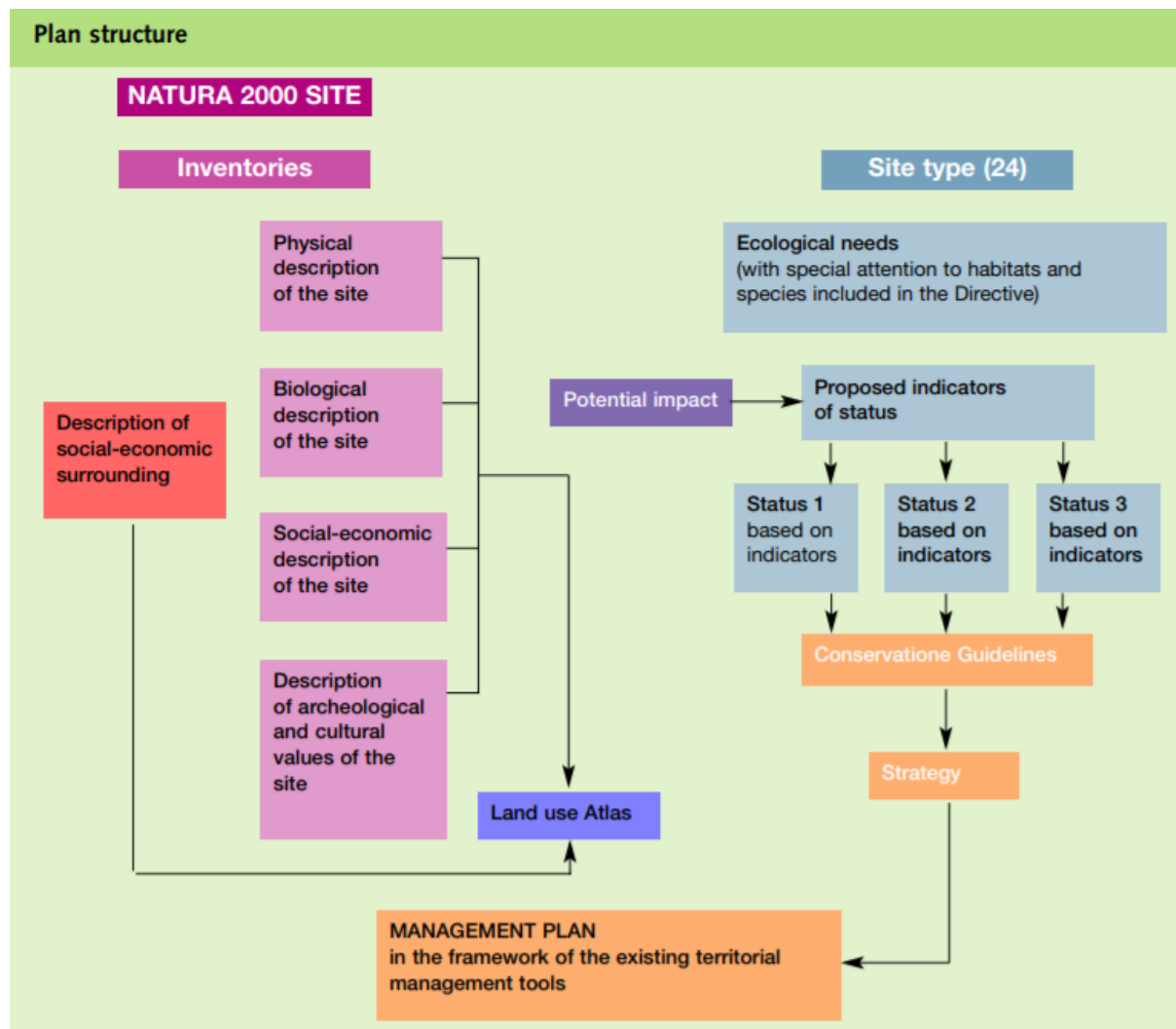

Figure 5 Natura 2000 management plan in Italy. Reference: (European Commission, 2005)

Since Italy is within the EU, there are Natura 2000 sites as well as national and regional protected areas. In total, Italy has 3,882 protected areas including both terrestrial and marine environments (“About - Protected Areas | IUCN,” 2018). Of the 3,882 protected areas, 69 are internationally protected, 871 are protected nationally, and 2,942 are protected at the regional level. Terrestrial area covered by protected areas consist of approximately

22% of the total land area while marine area covers roughly 9% of the total marine area (“About - Protected Areas | IUCN,” 2018).

While Natura 2000 is meant to help preserve biodiversity, there have been several studies indicating that there is room for improvement: Albuquerque et al. (2013), found that while there is in fact bird diversity in these protected areas, there were also a high number of threatened species found in protected area gaps. Therefore, these areas can be expanded to include the threatened species. A similar study in Italy indicating similar results where eleven different species were not protected in protected areas due to gaps (Maiorano, Falcucci, Garton, & Boitani, 2007). A Romanian study showed that due to the poor management and implementation of Natura 2000 sites, species diversity actually decreased (Iojă et al., 2010). Thus, it is important to further study the effectiveness of Natura 2000 to suggest possible improvements.

Central areas and boundaries of protected area networks are determined using endemic species, rare species, and species richness of different environments (Barnard et al. 1998; Lombard 2011; Lascelles et al. 2012). Protected areas aim to maintain biodiversity and provide a safe zone from threatening processes (Margules & Pressey, 2000). The most recent conservation strategy that has been introduced in Europe is the UE Ecological Network Natura 2000. Natura 2000 aims to prevent further loss of biodiversity and protecting natural habitat types, not only those that are unique to the continent (Grodzinska-Jurczak & Cent, 2011).

## **AIMS**

The aims of this study are to:

- a) investigate if protected areas in the Marche Region (Central Italy) cover areas have higher bird diversity than non-protected areas
- b) determine the efficiency of protected areas focused in this study, to protect different avian diversity components

## **METHODS**

### ***Study area and climate***

The Marche Region occupies an area of 9694 square meters with a coastal area on the Adriatic Sea in central Italy. The region is hilly and with the largest mountains in the area not exceeding 2400 meters (Lorenzini, Calzati, & Giudici, 2011). The coastal areas are flat in comparison to the inland areas with the exception of a small mountain area in the North. The climate is temperate with the more inland areas having a continental climate with relatively snowy winters in the mountains ("Climate Marche: Temperature, Climograph, Climate table for Marche - Climate-Data.org," n.d.). Temperate climate in this region is characterized by dry, hot summers (Tomaselli et al. 1972; Pesaresi, Galdenzi, Biondi, & Casavecchia, 2014). Precipitation in the area varies depending on locality. Inland sees a precipitation between 1000-1500mm per year and the coast 600-800mm per year ("Climate Marche: Temperature, Climograph, Climate table for Marche - Climate-Data.org," n.d.). Within the Marche Region, there are 109 Natura 2000 sites, two national parks, and four regional parks. The Natura 2000 areas cover approximately 14% of the surface in the region (Lorenzini et al., 2011).

Environmental data was derived from the landcover map of the Marche Region (1:10 000) (AA.VV. 2010). The Marche Region landcover map was used in order to consolidate the land-use into twelve land-use categories; undefined, urban areas, agricultural areas, orchards and vineyards, forests, grasslands, riparian vegetation or reforestation, badlands, waterbodies, rivers, roads, and other.

The land cover in the study consist of agricultural areas (41.3%), roads (3.8%), forests (39.9%), urban areas (2%), grasslands (7.4%), riparian vegetation or reforestation (2.2%), orchards or vineyards (1.5%), rivers (1.2%), badlands (0.6 %), and water bodies (2.1%). A visualization of the study area landscape makeup by average percentage of each land use can be seen below (Figure 6).



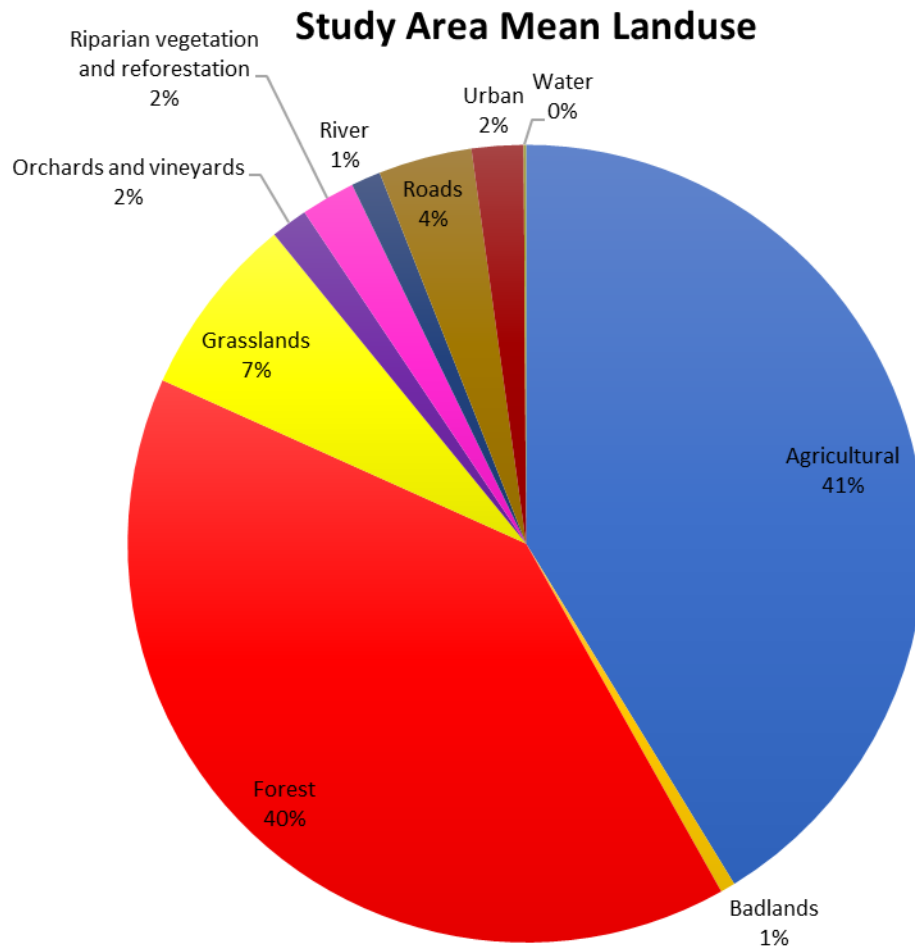

*Figure 6* visualization of landscape makeup in the study area. Forests and agricultural land uses make up a majority of the study area.

### **Field work**

Field data were collected from altitudes 0-1200m above sea level. Birds were observed between mid-April and the end of July 2012 with a total of 453 sampling sites in different environments. The sampling sites (Bibby et al., 1992) were uniformly spaced 200 m from each other. Counts were collected between 0600 and 1000 hours for ten minutes on sunny days; all sites were visited one time for 10' by expert ornithologists. Birds were identified visually and acoustically within a 100m radius around the observer. All nocturnal species were omitted from the data analyses. Bird species richness was calculated at each sample site as the sum of different species from all visits. There were 30 protected areas included in this study. These protected areas, along with outside areas, and number of sampling sites showed in the Table 1 below.

PROTECTED AREA	# OF SITES
Alpe Della Luna - Bocca Trabaria	10
Bocca Serriola	4
Calanchi E Praterie Aride Della Media Valle Del Foglia	16
Faggeto Di San Silvestro	1
Furlo	36
Gola Del Furlo	34
Gola Della Rossa	2
Gola Della Rossa E Di Frasassi	5
Gola Di Pioraco	1
Macchia Delle Tassinete	1
Macchia Di Montenero	2
Mombaroccio	1
Mombaroccio E Beato Sante	1
Monte Catria, Monte Acuto	13
Monte Catria, Monte Acuto E Monte Della Strega	13
Monte Cucco E Monte Columeo	1
Monte Giuoco Del Pallone	9
Monte Giuoco Del Pallone - Monte Cafaggio	1
Monte Lo Spicchio - Monte Columeo - Valle Di S. Pietro	1
Monte Maggio - Valle Dell'Abbadia	2
Monte Nero E Serra Santa	3
Monte Nerone - Gola Di Gorgo A Cerbara	10
Monte Nerone E Monti Di Montiego	10
Monte Puro - Rogedano - Valleremita	11
Monte S. Vicino	4
Monte San Vicino E Monte Canfaieto	14
Montecalvo In Foglia	7
Piana Di Pioraco	1
Serre Del Burano	10
Valle Scappuccia	11
Valle Scurosa, Piano Di Montelago E Gola Di Pioraco	1
Valle Vite - Valle Dell'Acquarella	3
<b>OUTSIDE</b>	<b>602</b>

*Table 1 The number of sites located within each Protected Area and the number of sites outside of the Protected Areas.*

### ***Landscape and land use analyses in sampling sites***

In order to assess the landcover composition in the areas where bird communities were recorded, buffers were made around each sampling site. First, a 100m buffer as was used in previous literature (Hostetler & Knowles-Yanez, 2003). Secondly, there was a 250m buffer added to each sampling site in order to determine if larger areas around each point had more significance (Hostetler & Knowles-Yanez, 2003). All buffer areas were then intersected with the landcover map of the Marche Region to analyze the landcover metrics.

To compare landcover composition, proportions of the different land uses in the all sampling site buffer were calculated. To do this, the buffer area and total land use areas were calculated using the calculate geometry tool in ESRI ArcMap. The land use areas were then divided by the total buffer areas in order to get a proportion (100m and 250m buffer for radius).

### ***Dominant land use in each sampling site***

Total landcover of the study area was then calculated using each land-use area divided by total area (buffer 100m and 250m). In order to analyze the landcover in the area, the landcover map was intersected with the sample sites and their buffers. Each site land-use was then calculated using the same method and model builder to make individual tables for each site and sum the total proportion of sites with duplicate land-uses. These tables were then merged together and dominant land-use was calculated. Land-uses with values greater than or equal to 60% was determined as the dominant land-use excluding areas where urban areas were equal to or exceeded 30%, in this case, 'urban area' is dominant. Sites where neither of these rules applied were given a 'mixed' dominant land-use. Edge density was also calculated by dividing the area by the perimeter.

### ***Landscape metrics***

Shannon and Simpson indices were also calculated to estimate the landcover composition and heterogeneity. This is important so that species diversity indices can be compared to the landcover. This has been performed in previous studies with significant results (Norderhaug, Ihse, & Pedersen, 2000). R Studio was used to calculate these values using the "vegan" package. The Shannon index looks at the number of different land uses and how evenly distributed the land uses are throughout sampling site (Nagendra, 2002). Meanwhile, the Simpson index focuses on richness over evenness. Simpson index is also used in samples where there are 'rare' typologies of land use in the data since the index is more weighted compared to the Shannon index. Simpson index is also used to compare similarity and differences in the land use composition (Nagendra, 2002). This is able to compare the number of land uses and the overlap of different land uses between the sampling sites. Shannon focuses on the richness and relative abundance of each land use in the sampling sites. Therefore, when the Simpson index of diversity value is high, there is less diversity. On the contrary, Shannon index values increase with increased diversity in the sampling site (Nagendra, 2002).

Another landcover metric was calculated in order to compare the different sampling sites. Edge density compares the heterogeneity of the sampling sites or how fragmented the area in the buffers are. In order to do this, the perimeters and the areas of each land use within



the buffer areas were calculated using the calculate geometry tool. The perimeter was then divided by the area in order to get an edge density value. This takes the number of edges in the sampling site and divides it by the maximum number of edges. In this way, it is easy to compare the fragmentation, or heterogeneity, of the sampling site landcovers.

### ***Avian diversity and community metrics***

Comparisons of bird species metrics were then calculated for each sampling site. In this study, evolutionary distinctiveness score (ED), maximum value of ED (henceforth called “max\_ED”), Rao’s quadratic entropy (RaoQ), community evolutionary distinctiveness (CED), and bird species richness (BSR) were used. Evolutionary distinctiveness shows how separated a species is in its family tree (Cadotte & Jonathan Davies, 2010). In other words, it shows how long ago the species split from its closest living ancestor (see Figure 7).

Distance from the closest living ancestor has an ED score that is calculated from timespan (in millions of years) that the species split and is divided by the number of species from the newly formed subtree (Cadotte & Davies, 2010). RaoQ combines relative abundance with pairwise functional differences between species. In this way, it is able to take into account the distinctiveness of the species as well as the relative abundance (Zoltan, 2005). CED is calculated the same way as the max\_ED; however, the CED considers all species in the community instead of each individual species (Cadotte & Jonathan Davies, 2010). BSR is calculated as a count of the number of different species within the community at each sampling site (Pino, Rodà, Ribas, & Pons, 2000).

### ***Taxonomic diversity, functional diversity, and evolutionary uniqueness metrics calculations***

Taxonomic diversity was determined using bird species richness (BSR) in all sample sites (Magurran, 2004). Species richness was calculated as the number of different species at each site.

Functional diversity is focused on traits species have that influence how the ecosystem or community is operating. This index allows for more in-depth analyses to traditional taxonomic approaches (de Bello et al., 2010). This diversity index was measured for each sample site using avian niche traits supplied by Pearman et al. (2014), based on feeding and breeding ecological traits. Seventy-three variables were used to describe each bird species niche, including 1) body mass, 2) food types (13 variables), 3) behavior used for acquiring food (9 variables), 4) substrate from which food is taken (9 variables), 5) time of day that the species forages (3 variables), 6) foraging habitats (20 variables), and 7) nesting habitats (18 variables) (Pearman et al., 2014). Body mass variables is in grams and the rest of variables are binomial (0 or 1).

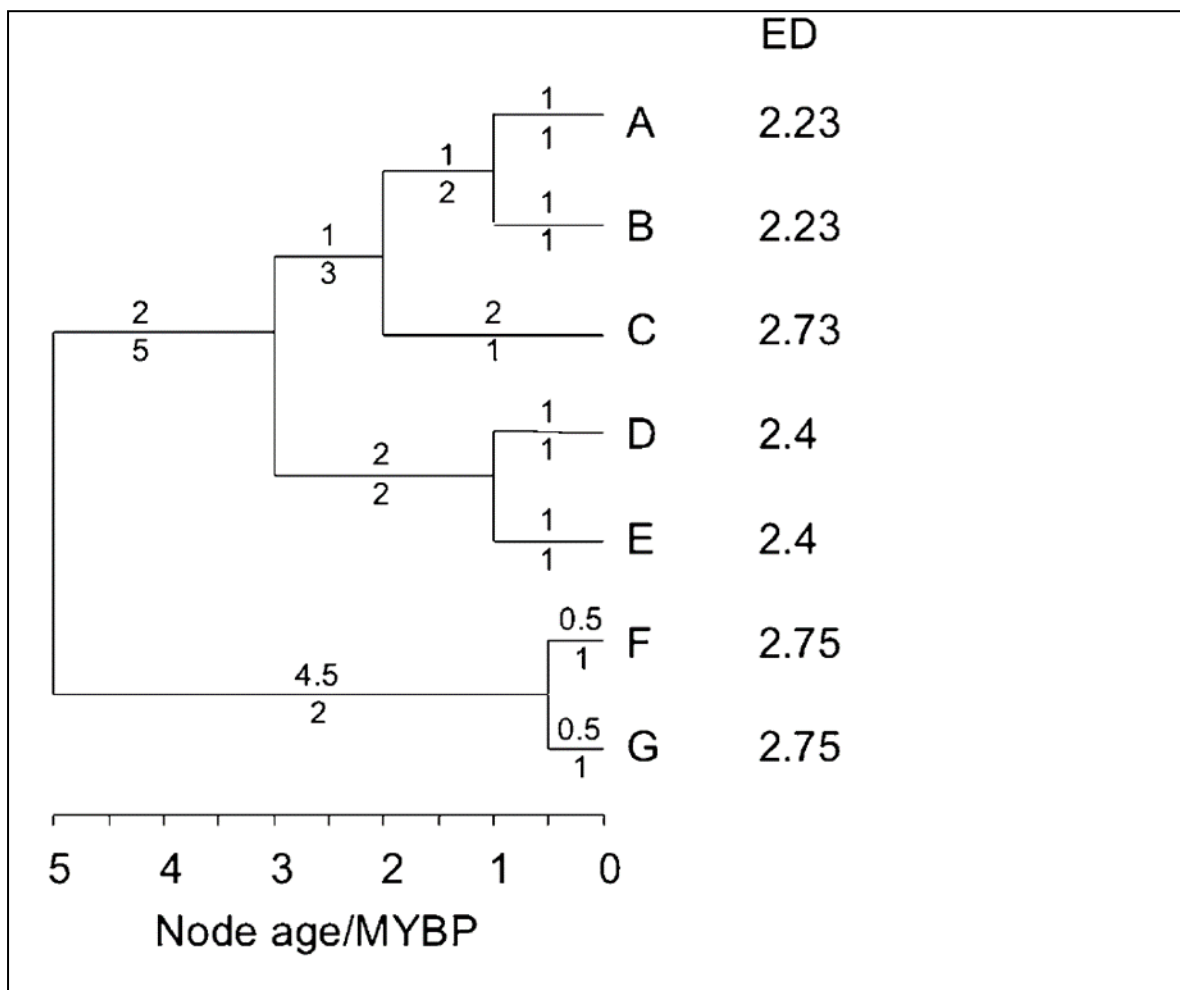

**Figure 7** an example of how evolutionary distinctiveness scores are calculated using the distance between each node.  
Reference: (Isaac et al., 2007).

Multidimensional FD indices were used in order to prevent difficulties with strong positive correlations between widely used functional diversity indices and species richness (Villéger, Mason, & Moullot, 2008). Three different functional diversity measures were used to describe overall functional diversity:

- Functional Richness (FRic) is the amount of functional space inhabited by a species community;
- Functional Evenness (FEve) represents how regular the degree of the biomass of the species community is spread in the niche space to allow for equal consumption of available resources;
- Functional Divergence (FDiv) is how far the species abundances differ from the center of the functional space.

This break up of functional diversity shows the distribution of taxa (or individuals) in a functional space (Mouchet et al., 2010). This study utilized the 'FD' package (Laliberté, Legendre, Shipley, & Laliberté, 2014) to determine the functional diversity indices (FRic, FEve, FDiv).

Variations in bird communities' phylogenetic diversity were quantified using the Evolutionary Distinctiveness (ED) score (Jetz et al., 2014) as a measure of uniqueness. Lengths of branches were summed to estimate the phylogenetic diversity. The total phylogenetic diversity of a clade was divided amongst its members to determine the ED score for each species. To do this, each branch was given a value equal to its length and divided by the total number of species within each branch (Isaac, Turvey, Collen, Waterman, & Baillie, 2007; "EDGE of Existence :: Evolutionarily Distinct & Globally Endangered," 2015). This score was then used to quantify the community evolutionary distinctiveness (CED) as an average ED of all species within the community (Morelli et al., 2016).

### ***GIS analysis and data visualization***

ESRI ArcMap ("ArcMap | ArcGIS Desktop," 2018) was used for the spatial analysis of the data. Sites were separated into two layers; inside protected areas and outside. The two layers were then able to show the difference of the diversity and taxonomic metrics of inside and outside. This was done using the symbology section of each layer and setting each metric to as the value field under the graduated symbols tab and allowing for five different classes. This shows the difference of each metric both inside and outside by illustrating larger values with larger circles and smaller values with smaller circles. In this way, it is evident the difference between inside and outside for each diversity and taxonomic index.

Diversity metrics were visually evaluated in ArcMap. By separating the sample sites into two groups (inside and outside of protected areas), it is possible to compare the preservation of biodiversity in the protected areas. Seven of the diversity indices were analyzed; BSR, CED, FRic, RaoQ, FDiv, FEve, max\_ED, and weighted edge density (WED).

### ***Statistical analyses***

All data were imported to R Studio and R Markdown. R Markdown was used in order for the ability to detail exact steps taken in the R script. In order to determine the type of distribution of each diversity metric, histograms and Cullen and Frey graphs were created. When data fell near two distributions on the Cullen and Frey graph, both distributions were tested in generalized linear models (GLM) and the model with the lowest Akaike information criterion (AIC) was used to ensure the best model was made. The AIC number estimates the amount of data that is lost when using different models. Therefore, data with the least amount of data lost is the better fitting model (Akaike, 1974). Since there is only one parameter in poisson distribution, it is essential to test for overdispersion. When testing for overdispersion, the model was found to be quadratically overdispersed. Therefore, the negative binomial model was chosen over the Quasi-Poisson model since it is comparable to the rest of the models in this study because it uses the maximum likelihood and not the

Quasi likelihood. GLMs were used since the data was of non-normal distribution and showed heteroskedasticity (Hardin & Hilbe, 2012). GLMs were constructed for the whole data set using the land use areas, spatial unit (inside or outside, 100m or 250m buffer size), and WED as independent variables and the diversity metrics as the dependent variables. Each diversity and community metric were modeled separately. All models included WED (EDGE.W) over the Shannon index since the WED allows for more detailed analysis of the landscape. While it is possible to include all landscape heterogeneity metrics, it was avoided due to redundancy.

### ***Explanation of variables***

All of the GLMs combined different variables that can be briefly explained. The dependent variable CED indicates community evolutionary distinctiveness. The explanatory variables are that are a percentage of land use coverage of the sampling site are: Agricultural.a (Agricultural areas), Badlands.a (Badland areas), Forest.a (Forests areas), Grasslands.a (Grasslands areas), Orchards.a (Orchards and vineyards areas), River.a (Rivers areas), Roads.a (Road areas), Urban.a (Urban areas), Water.a (Water bodies). EDGE.W indicated the weighted edge density and Spatial.unit represents whether the site is located inside or outside of the protected areas. Models using the data.full, used the dataset containing information about both 100m and 250m buffers while the data.100 uses data only from the 100m buffer.

*Example R script with full dataset GLM using CED:*

```
glmCED <- glm(formula = CED~ Agricultural.a + Badlands.a + Forest.a + Grasslands.a + Orchards.a + Riparian.Veg.Ref.a + River.a + Roads.a + Urban.a + Water.a + EDGE.W + Spatial.unit, family = Gamma(link="log"), data=data.full)
```

After the whole dataset was run, it was broken down into data containing only 100m data and only 250m data. Then the separate datasets were put into the original GLM in order to test for significance in each buffer size.

*Example of R script for 100m dataset GLM using CED:*

```
glmCED100 <- glm(formula = CED~ Agricultural.a + Badlands.a + Forest.a + Grasslands.a + Orchards.a + Riparian.Veg.Ref.a + River.a + Roads.a + Urban.a + Water.a + EDGE.W + Spatial.unit, family = Gamma(link="log"), data=data.100)}
```

For further analysis, GLMs were created using one land use at a time with spatial unit, WED, and 100m data. This allows for comparison of each land use areas inside and outside of the protected areas. This was done using the following dominant environments: grasslands, agricultural areas, forests, and mixed areas. These were variables were chosen since they occupy the most area in the study.

*Example of R script for single dominant land use (forest, in the example) GLM using CED:*

```
glmFORced<-glm(formula=CED~EDGE.W + Spatial.unit, family=Gamma(link="log"), data=data.domFOR)
```

GLMs were also created comparing the dominant land uses inside and outside protected areas with a 100m buffer using spatial unit, and WED. This shows the differences between the sites dominated by each land use inside compared to sites dominated by the same land use outside of the protected areas.

*Example of R script for dominant land use GLM using CED:*

```
glmCEDLU <- glm(formula = CED~ DOM.LU + EDGE.W + Spatial.unit, family = Gamma(link="log"), data=data.100)}
```

Finally, a GLM was made to explore the interaction between spatial unit and dominant land use while still including WED for the 100m buffer.

*Example of R script for interaction between dominant land use and spatial unit GLM using CED:*

```
glmCEDLU2 <- glm(formula = CED~ DOM.LU*Spatial.unit + EDGE.W, family = Gamma(link="log"), data=data.100)}
```

Correlations between variables were also explored. In order to determine correlations between the diversity metrics, linear models were created and R squared values were calculated (Figures S1-S6). For correlations between land uses, a correlogram was made using Pearson's linear correlation (Table T1 and T2).

For visual assessment of the data, ggplots were constructed in R Studio. Each diversity metric was explored with the dominant land use for both 100m and 250m. Using these various statistical and visual tools allows for the comparison of inside and outside of protected areas for each land use and diversity metric.

## RESULTS

### ***Landscape analysis***

In this study, edge density (weighted), Shannon index, and Simpson's index were calculated to determine the heterogeneity of the landscape. After analysis, it was determined that weighted edge density allowed for more detailed conclusions about the heterogeneity of land uses. Therefore, the Shannon and Simpson indices were not used in the final analysis.

### ***Spatial distribution of avian diversity: preliminary explorations using GIS mapping***

Maps were generated in ArcMap in order to display the study area visually. Below, maps about the protected areas and sampling sites can be seen. In Figure 9, the heterogeneity of the region along with the sampling sites can be seen. It is easy to see that there is high heterogeneity of the environment in the area. In Figure 10, the comparison land use inside and outside of protected areas can be seen. Protected areas have a higher concentration of forested areas than those outside of the protected areas. Outside of protected areas have larger areas of agriculture and urbanized areas.

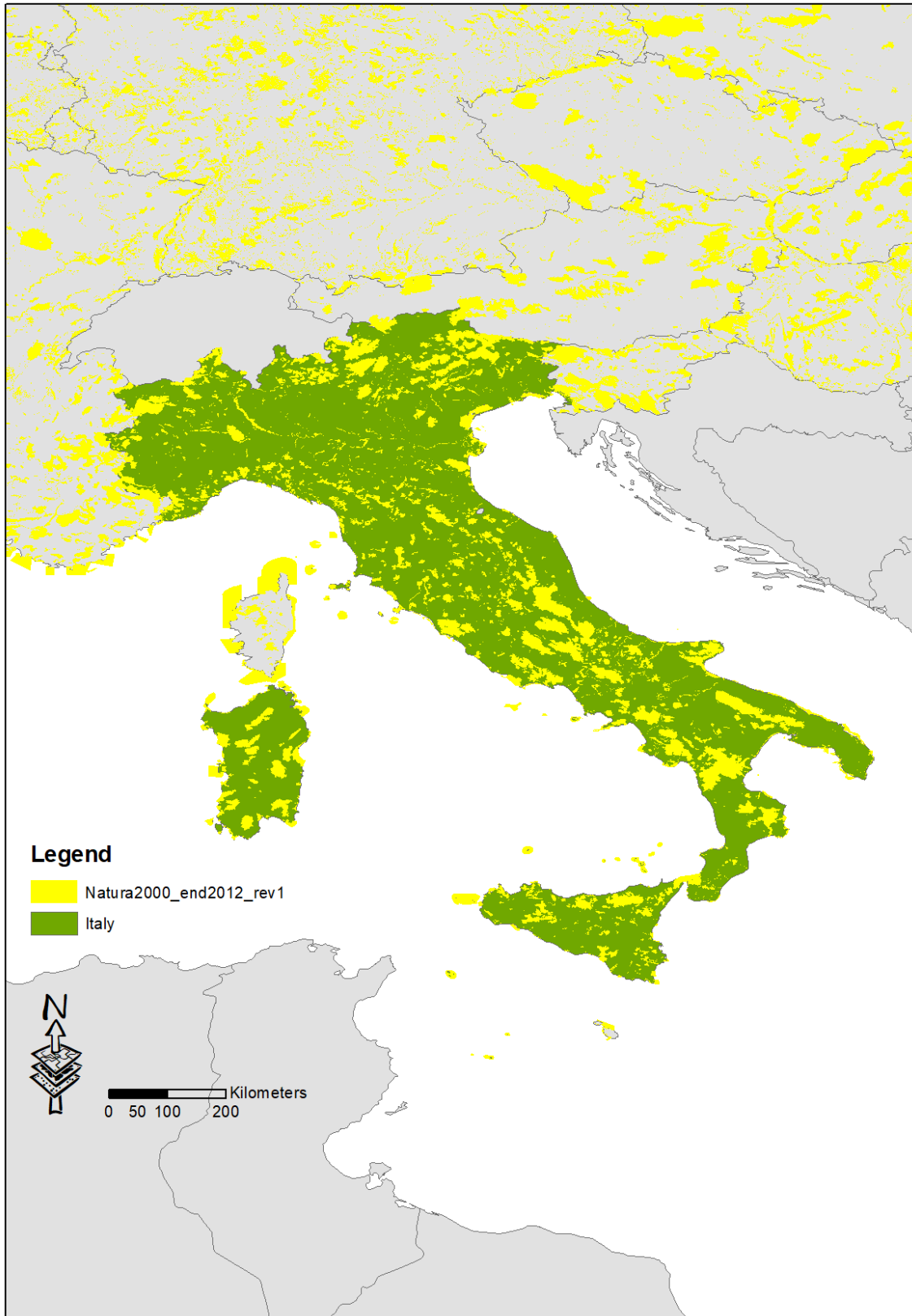

*Figure 8* protected areas in the whole Italian country.



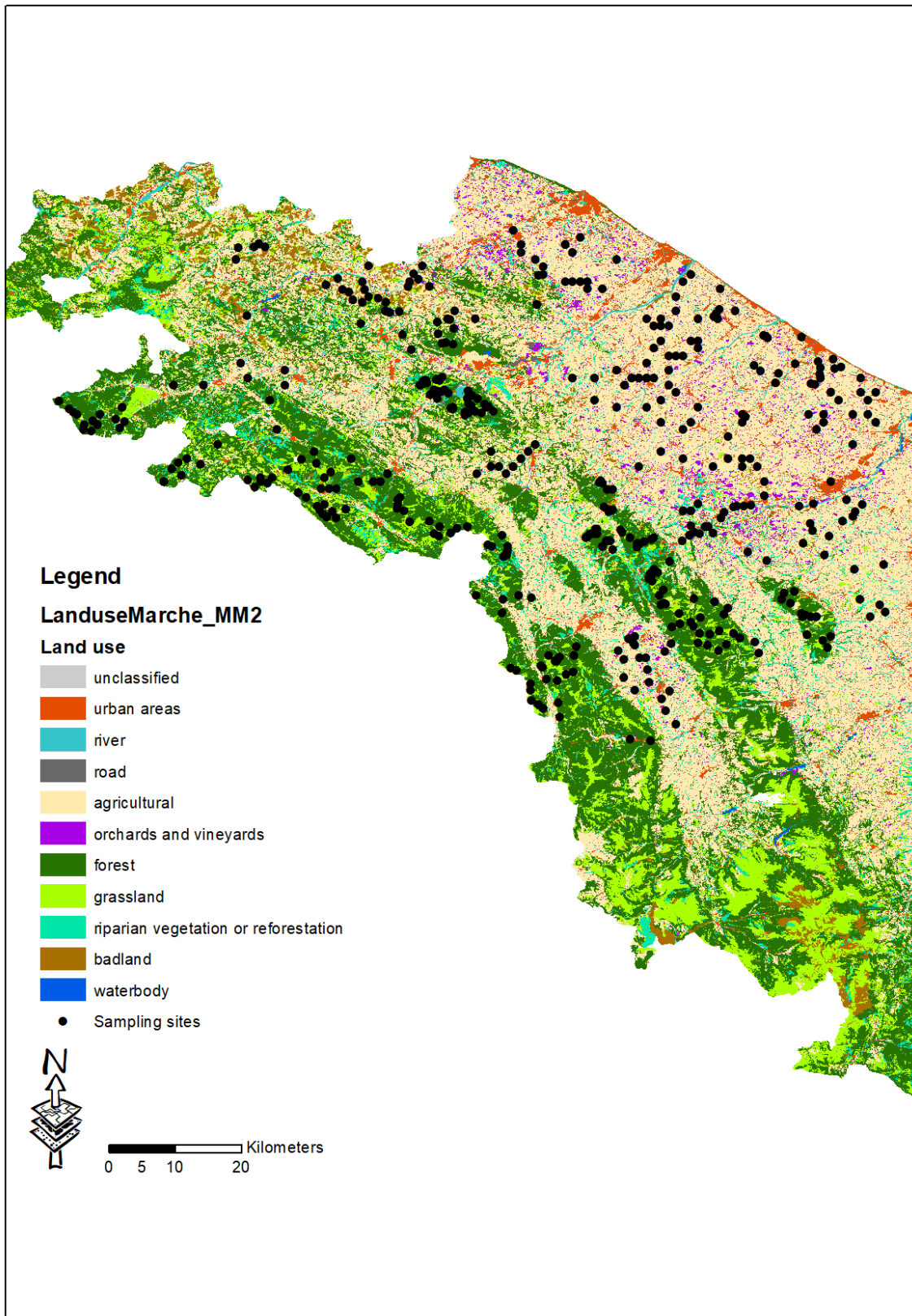

*Figure 9 land use map with sampling sites in the Marche Region (Central Italy).*

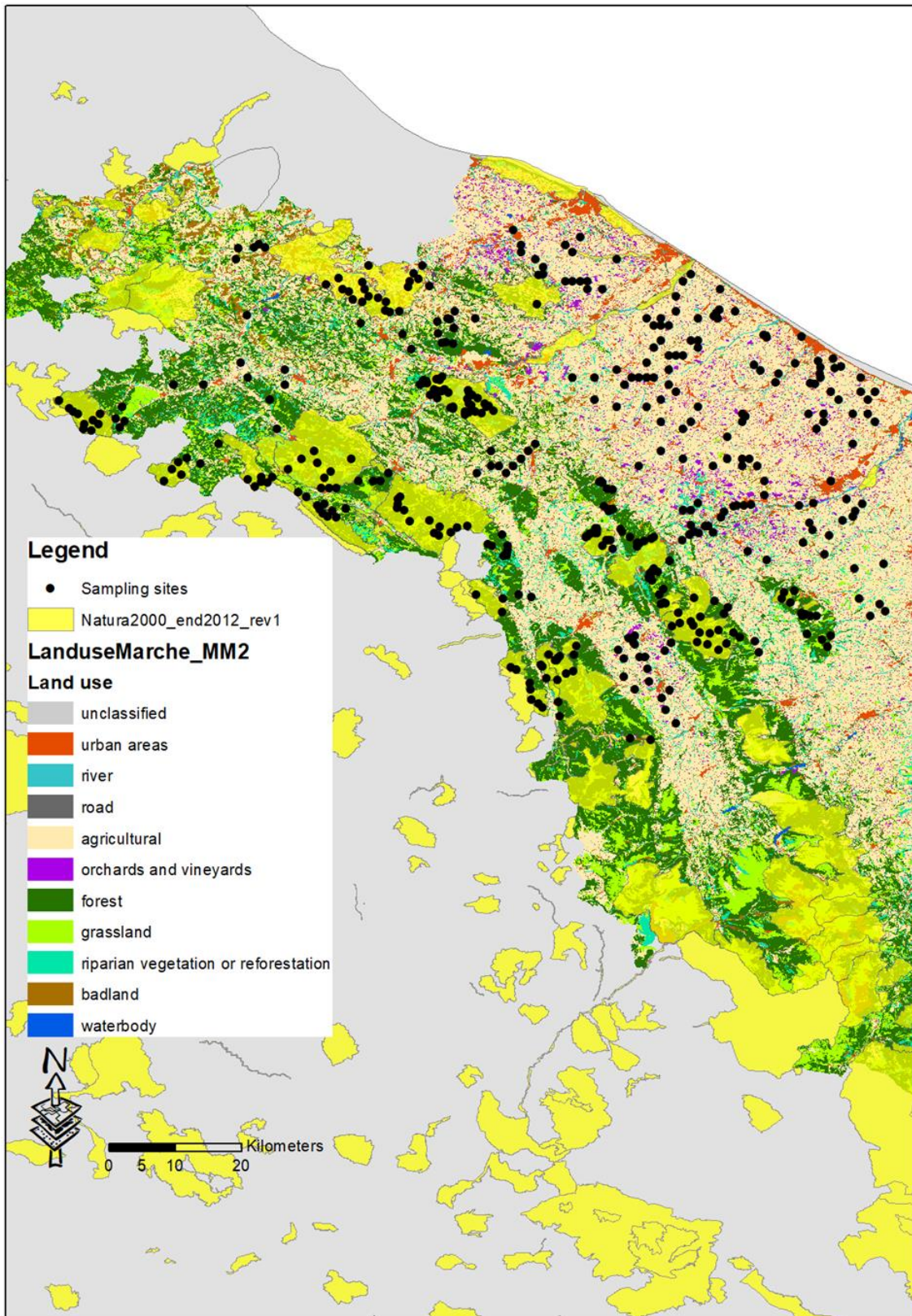
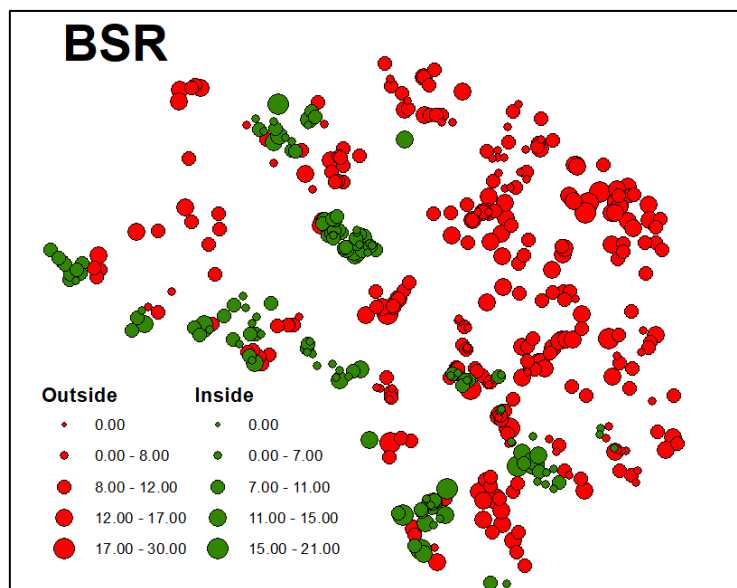

Figure 10 map including land use, sampling sites, and protected areas in the Marche Region of Italy.

A visual comparison can be seen below in Figures 11, 12, and 13. With this, a preliminary comparison can be made of inside and outside protected area sites for each diversity metric. While definitive conclusions cannot be drawn from these maps, it is possible to see some differences. There appears to be higher BSR outside of protected areas than inside of protected areas (Figure 11). This is indicated by larger circular plots in the outside sites. Similar results can be seen when comparing inside and outside of protected areas with FRic and RaoQ (Figure 12). However, the other diversity metrics seem to be similar both inside and outside of protected areas (Figures 12 & 13). Therefore, more conclusions can be made when comparing them in the GLM statistical analysis.



*Figure 11 comparison of inside and outside of Protected Areas for BSR.*



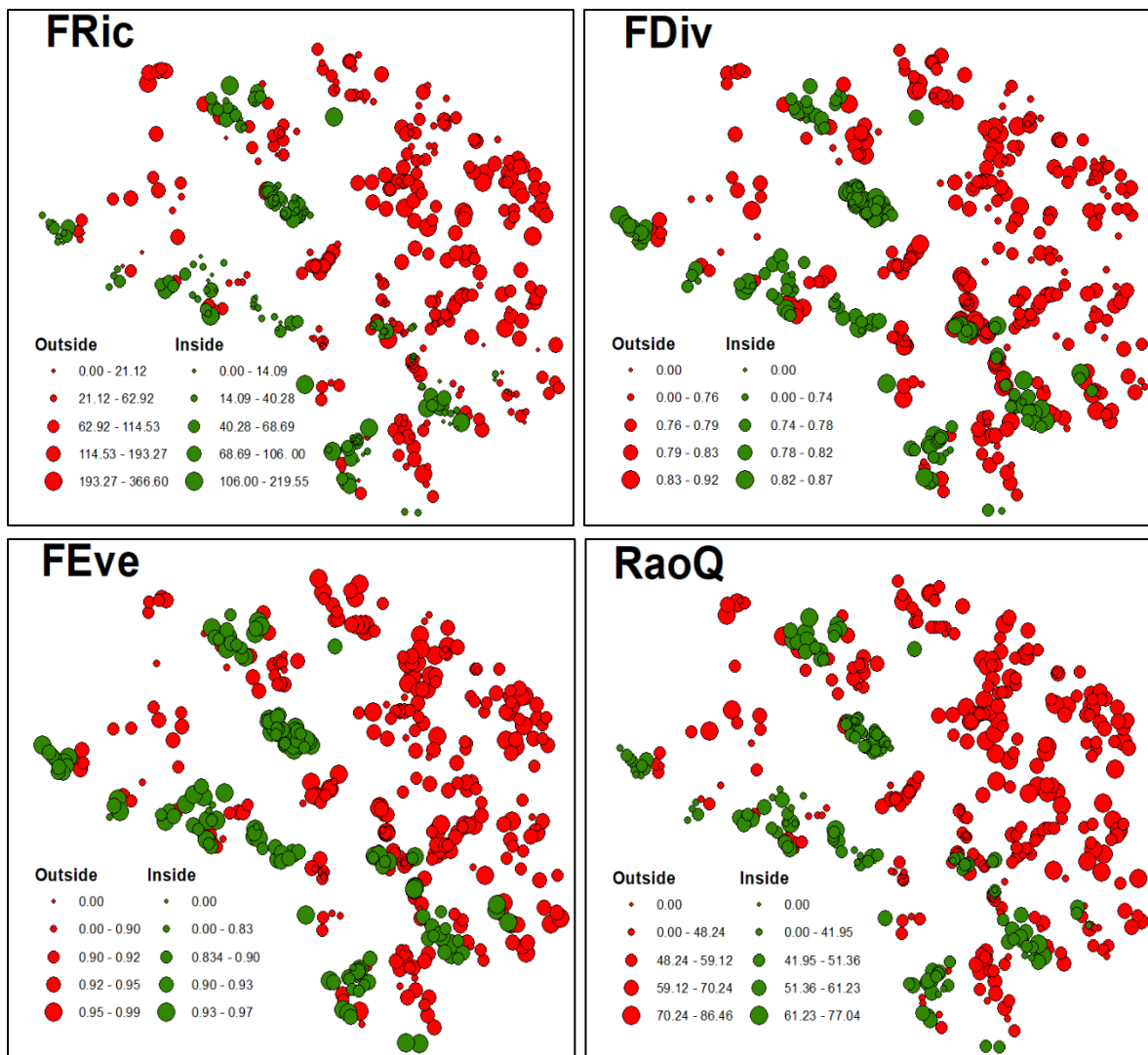

Figure 12 visualization of functional diversity metrics inside and outside of protected areas.

### Comparing avian diversity metrics inside and outside protected areas

The use of ggplots allows for deeper analysis of land use and diversity metrics. In the case of BSR, in each dominant land use, the values are higher outside of the protected areas than inside. However, no assumptions can be made when comparing urban areas and BSR values since there are no observations inside of the protected areas. This indicates that the protected areas are not properly conserving BSR in the study area (Figure 14). For FRic, outside of protected areas we found higher values in all dominant land uses. Forests have the most similar values both inside and outside; however, the outside appears to support bird communities characterized by high FRic, slightly better than inside. When comparing FEve, areas dominated by agriculture, grasslands, and riparian land uses have higher

values outside of protected areas than inside. On the other hand, when comparing mixed dominant land uses the FEve seems slightly higher inside of protected areas than outside.

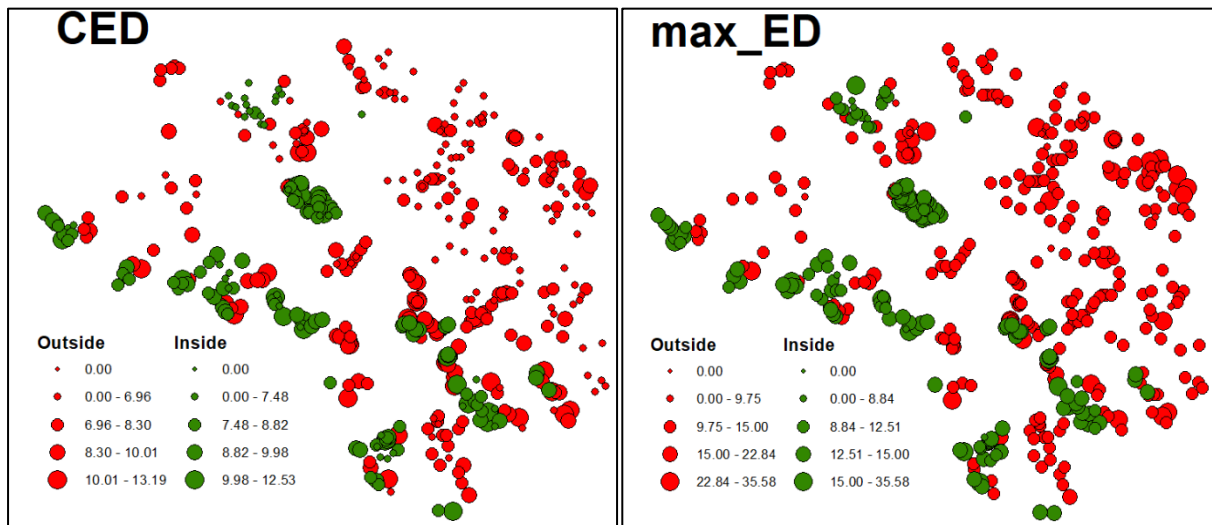
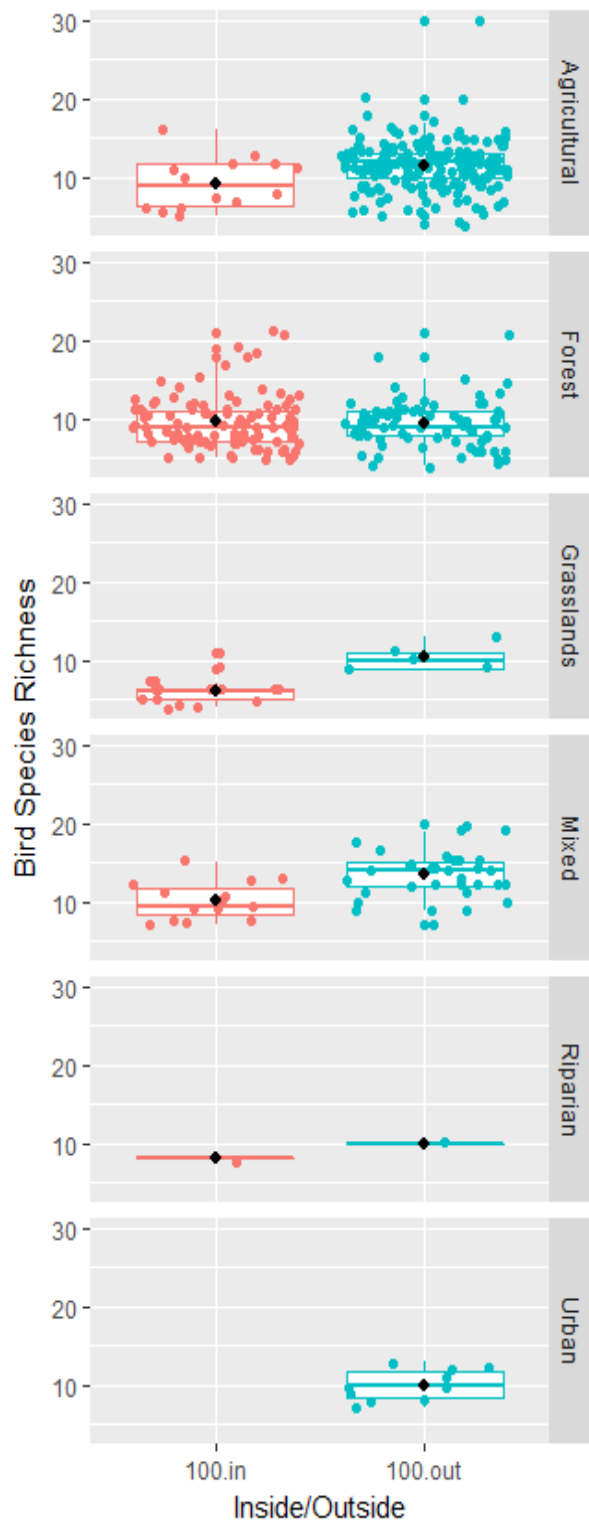

Figure 13 visualization of CED and max\_ED inside and outside of protected areas.

As for forests, FEve appears to be similar both inside and outside. However, it is important to note that in the forests dominated sites there are outliers, outside plot that have much higher values than those forests inside of the protected areas (Figure 15). The FDiv plot indicated that forest, grassland, mixed, and riparian (slight) dominated areas are also higher outside of protected areas than inside. When comparing RaoQ the agricultural and mixed land uses have higher values outside than inside. While forests also appear to have higher values outside than insides, it is not as clear to conclude as the agricultural and mixed areas. However, grassland dominated sites have higher values inside of the protected areas than outside (Figure 16). When comparing CED, sites dominated by grasslands and agricultural areas have higher CED values outside than inside of the protected areas. However, in sites where the landscape is dominated by mixed and riparian areas, protected areas appear to support bird communities with higher CED, so protecting better than outside. When comparing sites characterized by forest, it is difficult to conclude which sites have higher CED (Figure 17). Agricultural areas in this plots are similar but again there are outliers outside of protected areas with much higher values than any of those inside. Finally, when comparing the bird communities by their max\_ED, all of the land uses appear to be relatively similar. However, it seems that grasslands have slightly higher values outside than inside while riparian areas appear to be the opposite. Again, in agricultural and mixed land uses there are outliers outside of protected areas with higher values than any inside (Figure 17).



**Figure 14** BSR with dominant land uses for the 100m buffer. Average values are indicated with a black circle in each plot.

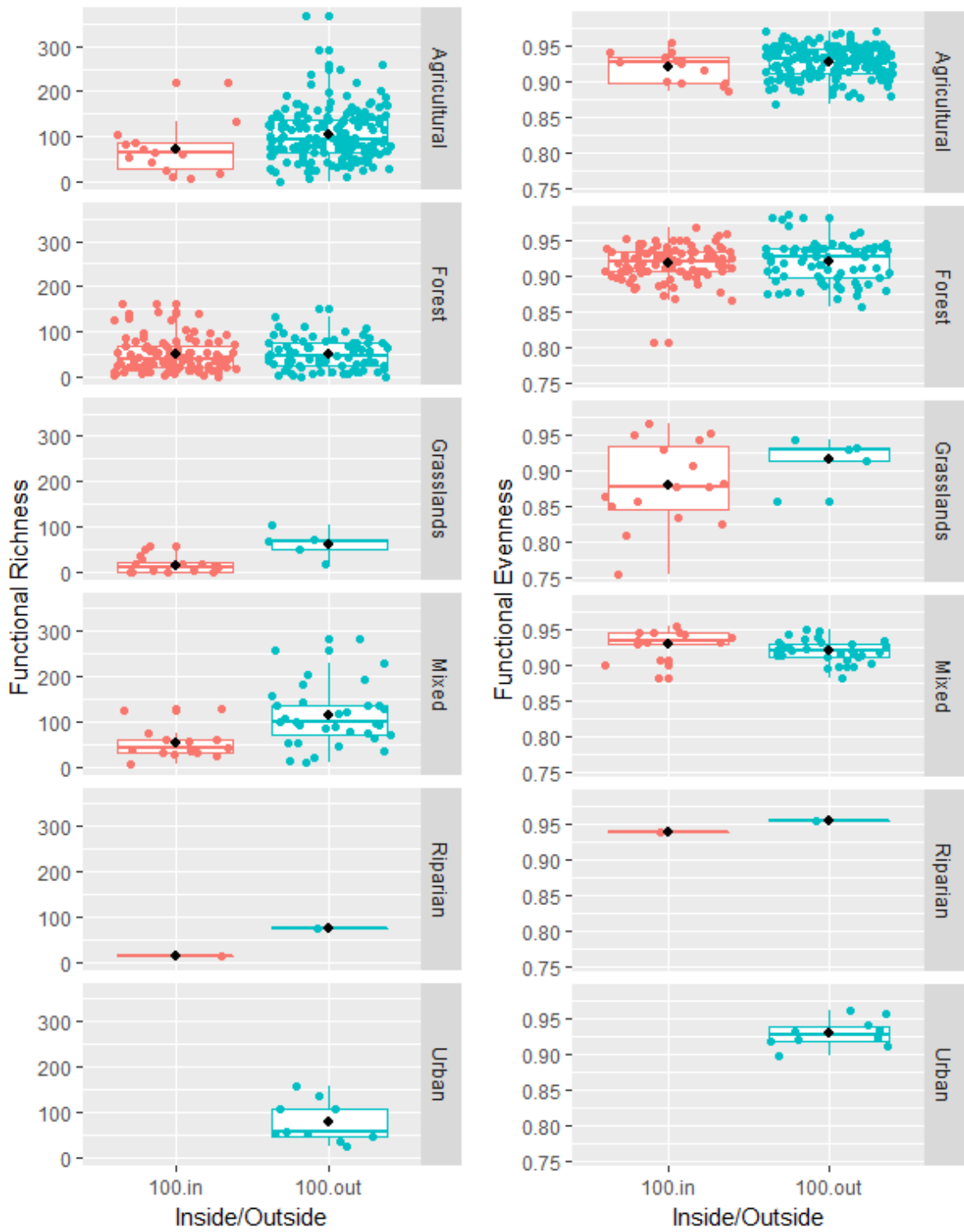

Figure 15 FRic and FEve visualized across dominant land uses. Average values are indicated by a black circle.

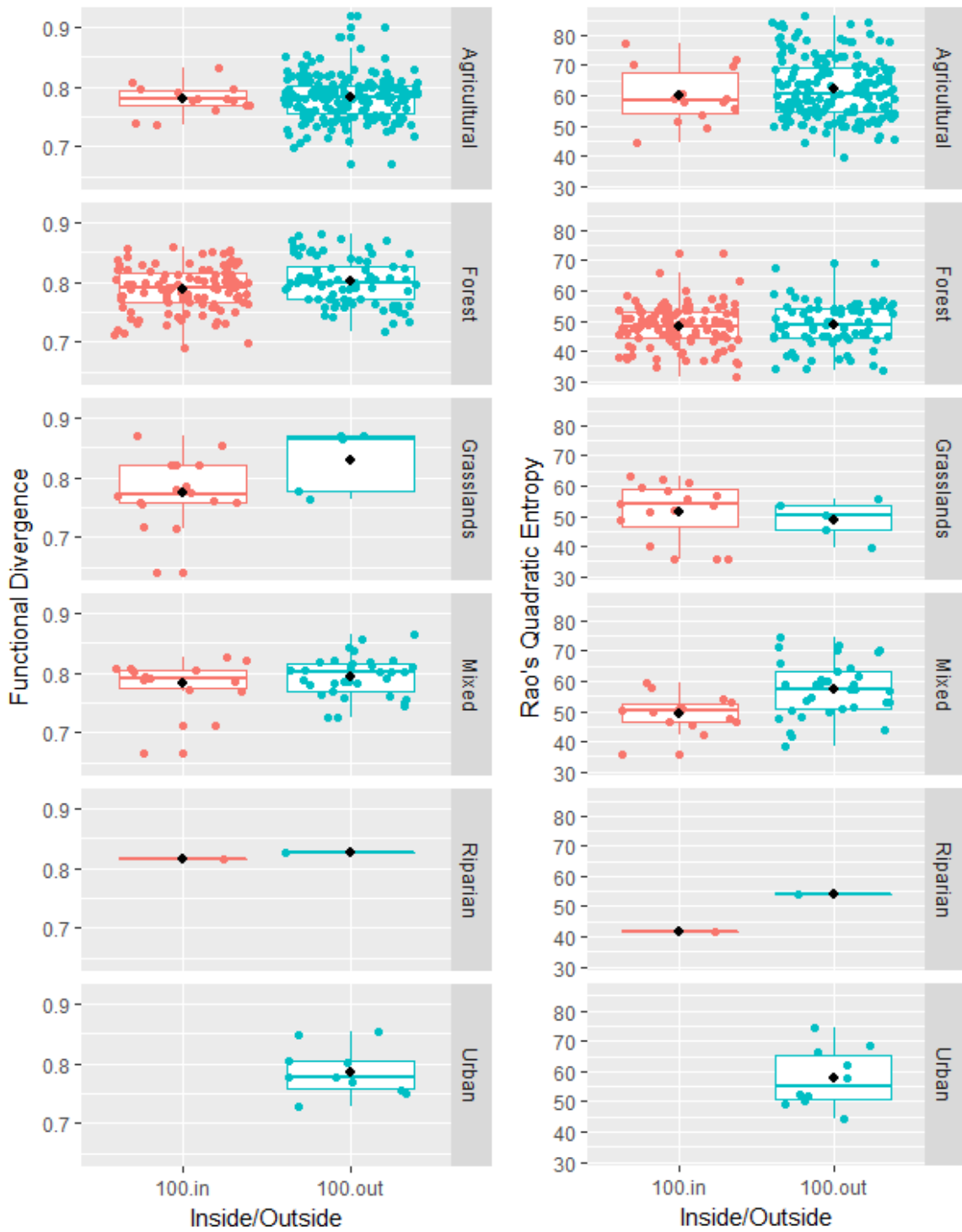
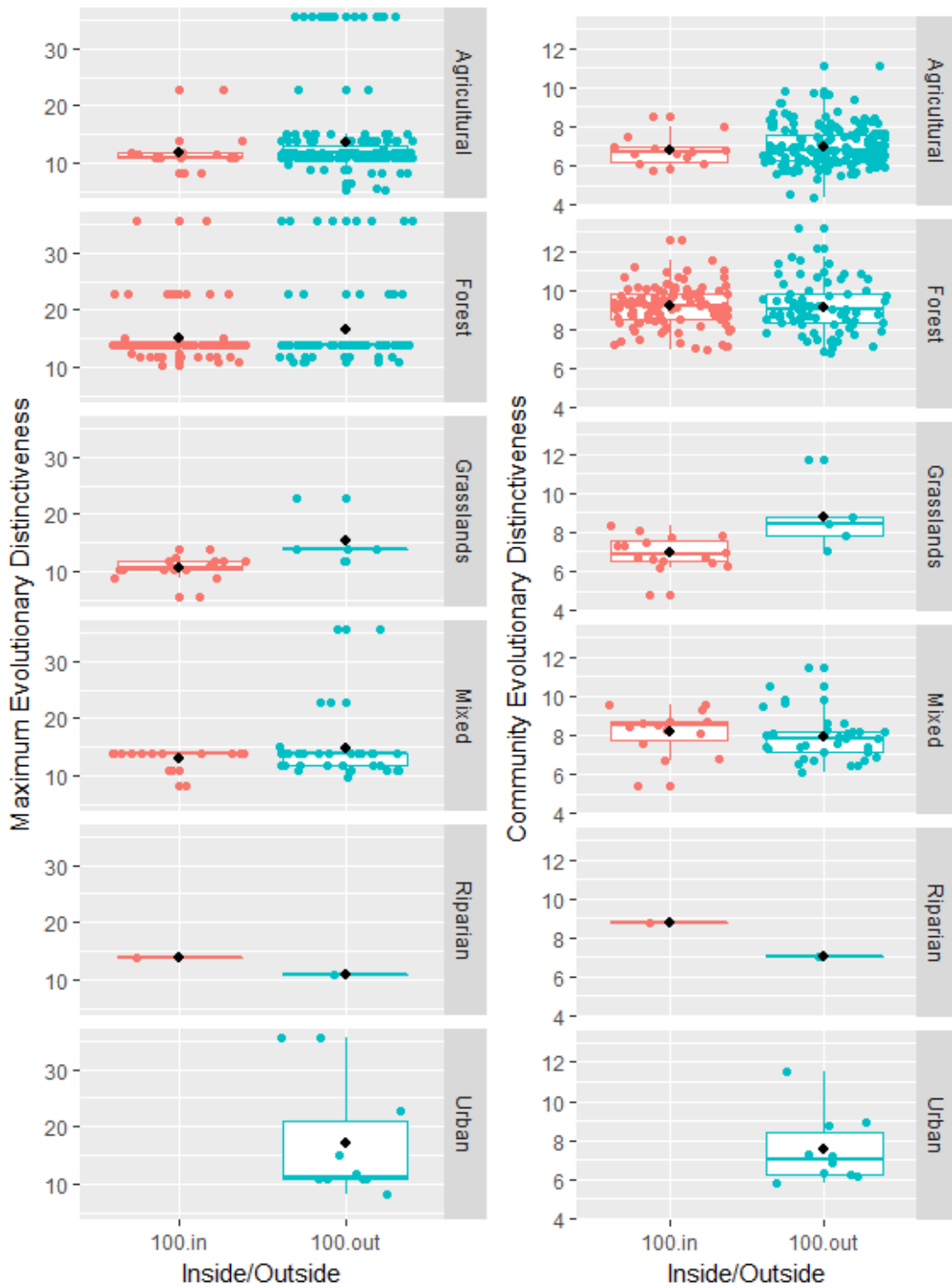

Figure 16 FDiv and RaoQ variation across dominant land uses. Average values are indicated by a black circle on each plot.





**Figure 17** CED and max\_ED variation across dominant land uses. Average values are indicated by a black circle on each plot.

In conclusion, it is possible to say that protected areas as a whole are not protecting in the same way each facet of the avian diversity in the Marche region, Central Italy. We found some variations related to the type of dominant environment, that were explored in the next section, looking for statistical support to the preliminary graphical explorations provided in the last section.

### ***Effects of land use composition on each diversity metric***

Six GLMs were created in order to look further into how well the protected areas in the Marche Region are at supporting the different avian diversity metrics.

The first comparison was performed on whole dataset, focusing the main effects of land use composition on each diversity metric separately. Table 2 below shows how the diversity indices fluctuate based on the different land use areas. In general, it can be seen that in areas that were classified as grasslands have lower bird diversity with all metrics decreasing when entering grassland areas with significant results. A similar trend is seen in badlands, forests, orchards, water, and urban areas where four or more diversity metrics decrease when entering areas classified in one of the aforementioned land uses. Forest coverage have a significantly positive impact on CED and negative impacts on one measure of functional diversity of bird communities as RaoQ. However, areas of agriculture, riparian vegetation and reforestation, rivers, and roads have three or less diversity metrics that increase when leaving these land use areas in the models. Agricultural areas have positive results with BSR, FRic, and RaoQ. However, CED, FDiv, and max\_ED are negatively impacted with an increase in agricultural area (Table 2).

It is also interesting to note the effect of weighted edge density on the diversity metrics. In the case of the Marche Region, it appears that when edge density is increased, the bird diversity decreases (Table 2).

### **Comparing diversity metrics inside and outside the protected areas**

When controlling by dominant land use or environment, we found that in comparison with other diversity metrics, BSR and FDiv have the most significant results. These two metrics indicate that when moving from inside to outside of the areas, there is an increase in the diversity ( $p < .01$ ). FRic and max\_ED also show significant results when moving from inside to outside of protected areas ( $p < .05$ ). When comparing areas inside and outside of protected areas, all diversity metrics tend to increase outside. However, not all diversity metrics present significant results. This result indicates that in some areas the avian diversity is higher outside than inside the network of protected areas in central Italy.

*Dependent variable:*

	BSR		CED		FDiv		FRic		FEve		max_ED		RaoQ	
	<i>negative binomial</i>	<i>glm: Gamma link = log</i>	<i>glm: Gamma link = log</i>	<i>glm: Gamma link = log</i>	<i>glm: Gamma link = log</i>	<i>glm: Gamma link = log</i>	<i>glm: Gamma link = log</i>	<i>glm: Gamma link = log</i>	<i>glm: Gamma link = log</i>	<i>glm: Gamma link = log</i>	<i>glm: Gamma link = log</i>	<i>glm: Gamma link = log</i>	<i>glm: Gamma link = log</i>	
Agricultural	4.642e-06** (2.171e-06)	-7.564e-06*** (9.180e-07)	-7.604e-07** (3.336e-07)	1.310e-05*** (4.528e-06)	2.062e-07 (1.929e-07)	-7.431e-06*** (2.812e-06)	6.022e-06*** (1.053e-06)							
Badlands	-1.380e-06 (1.023e-05)	-3.512e-06 (4.316e-06)	-8.339e-07 (1.568e-06)	1.689e-05 (2.129e-05)	7.425e-08 (9.070e-07)	-7.662e-06 (1.322e-05)	6.586e-06 (4.952e-06)							
Forest	9.813e-07 (1.839e-06)	1.762e-06** (7.593e-07)	-6.721e-09 (2.759e-07)	-5.119e-06 (3.746e-06)	4.687e-08 (1.596e-07)	-3.599e-07 (2.326e-06)	-2.063e-06** (8.712e-07)							
Grasslands	-4.208e-06* (2.331e-06)	-3.369e-06*** (9.034e-07)	-7.735e-08 (3.283e-07)	-1.735e-05*** (4.457e-06)	-5.095e-07*** (1.899e-07)	-6.863e-06*** (2.768e-06)	-1.008e-06 (1.037e-06)							
Orchards	9.567e-06 (6.678e-06)	-5.875e-06* (3.136e-06)	-3.756e-07 (1.140e-06)	2.682e-05* (1.547e-05)	-1.513e-07 (6.591e-07)	-1.213e-05 (9.608e-06)	3.100e-06 (3.599e-06)							
Riparian_Veg.Ref	1.060e-05** (4.931e-06)	2.970e-06 (2.310e-06)	-1.469e-06* (8.393e-07)	5.685e-06 (1.139e-05)	-2.698e-07 (4.854e-07)	4.946e-06 (7.076e-06)	-2.164e-06 (2.650e-06)							
River	1.688e-05** (6.896e-06)	-6.487e-06* (3.319e-06)	-1.689e-07 (1.206e-06)	2.735e-05* (1.637e-05)	7.407e-07 (6.976e-07)	-1.870e-05* (1.017e-05)	5.923e-06 (3.809e-06)							
Roads	1.927e-06 (1.395e-05)	5.775e-06 (6.043e-06)	-2.539e-06 (2.196e-06)	4.035e-05 (2.981e-05)	-3.916e-07 (1.270e-06)	2.438e-05 (1.851e-05)	1.501e-05** (6.933e-06)							
Urban	-7.994e-06 (8.474e-06)	-5.871e-06 (3.652e-06)	-2.667e-06** (1.327e-06)	-1.555e-05 (1.801e-05)	8.457e-07 (7.675e-07)	-2.587e-06 (1.119e-05)	1.670e-06 (4.190e-06)							
Water	-2.132e-04*** (7.095e-05)	-1.684e-05 (2.308e-05)	2.667e-06 (8.387e-06)	-4.942e-04*** (1.138e-04)	1.003e-05** (4.850e-06)	-6.113e-05 (7.070e-05)	-7.225e-05*** (2.648e-05)							
Edge Weight	-2.839e-02* (1.646e-02)	-8.497e-03 (7.005e-03)	-8.553e-04 (2.546e-03)	-2.342e-03 (3.456e-02)	1.598e-03 (1.472e-03)	-8.180e-03 (2.146e-02)	1.438e-02* (8.038e-03)							
Outside 100	1.030e-01** (4.769e-02)	1.697e-02 (1.992e-02)	1.462e-02** (7.237e-03)	1.901e-01* (9.824e-02)	5.174e-03 (4.185e-03)	1.083e-01* (6.101e-02)	1.384e-02 (2.285e-02)							
Constant	2.266*** (9.650e-02)	2.163*** (3.983e-02)	-2.281e-01*** (1.447e-02)	4.038*** (1.965e-01)	-9.095e-02*** (8.370e-03)	2.716*** (1.220e-01)	3.890*** (4.570e-02)							
Observations	453	453	453	453	453	453	453							

Note: **Table 2** difference in all diversity metrics based on land uses. Standard error can be seen in parentheses. \*p<0.1; \*\*p<0.05; \*\*\*p<0.01  
All data used were from the 100m buffer.

### **Avian diversity metrics compared across dominant land uses**

In order to compare the avian diversity and community metrics inside and outside the network of protected areas while controlling by the dominant type of environment, GLM's focusing on four dominant land uses were created. In Table 3, it is clear that agricultural, grasslands, and mixed dominant land uses supports bird communities with higher BSR values outside of the protected areas than inside. No significant differences in terms of WED were found among dominant land uses.

<i>Dependent variable:</i>				
BSR				
<i>negative binomial</i>				
	Forest	Agricultural	Grasslands	Mixed
Edge Weighted	-0.013 (0.018)	-0.026 (0.019)	-0.063 (0.070)	0.085 (0.078)
Outside 100	-0.024 (0.050)	0.225** (0.091)	0.451** (0.196)	0.259*** (0.098)
Constant	2.298*** (0.062)	2.274*** (0.094)	2.019*** (0.257)	2.182*** (0.151)
Observations	183	190	21	47

*Note:* \*p<0.1; \*\*p<0.05; \*\*\*p<0.01

**Table 3** bird species richness across four dominant land uses. All data used were for 100m buffer. Standard error is indicated in parentheses.

When comparing FRic, higher values can be seen outside of protected areas in sites dominated by agricultural, grasslands, and mixed land uses (Table 4) but not in sites dominated by forests. Bird communities with high FDiv were found outside the protected areas network in both forest and grassland dominated environments. No significant differences on FDiv values were found between inside and outside protected areas for agricultural and mixed environments. FEve was significantly higher inside than outside of the protected areas only in the mixed environments. When comparing RaoQ in mixed land uses, inside of protected areas have significantly lower values than outside (Table 5). However, there were no significant differences between inside and outside of protected areas in sites dominated by forests, agriculture, or grasslands.

<i>Dependent variable:</i>								
	FEve				FRic			
	<i>glm: Gamma link = log</i>				<i>glm: Gamma link = log</i>			
	Forest	Agricultural	Grasslands	Mixed	Forest	Agricultural	Grasslands	Mixed
Edge Weighted	0.004** (0.001)	0.002 (0.001)	-0.001 (0.011)	-0.003 (0.005)	-0.030 (0.037)	0.017 (0.035)	-0.107 (0.180)	0.032 (0.173)
Outside 100	0.003 (0.004)	0.008 (0.007)	0.037 (0.037)	-0.011* (0.006)	0.034 (0.105)	0.357** (0.159)	1.189* (0.596)	0.720*** (0.199)
Constant	-0.096*** (0.005)	-0.088*** (0.007)	-0.124*** (0.042)	-0.068*** (0.010)	3.998*** (0.129)	4.241*** (0.163)	3.192*** (0.680)	3.956*** (0.321)
Observations	183	190	21	47	183	190	21	47

*Note:* \*p<0.1; \*\*p<0.05; \*\*\*p<0.01

**Table 4** changes in FEve and FRic in four dominant land uses. Data used were from the 100m buffer. Standard error is indicated in parentheses

<i>Dependent variable:</i>								
	FDiv				RaoQ			
	Forest	Agricultural	Grasslands	Mixed	Forest	Agricultural	Grasslands	Mixed
Edge Weighted	0.003 (0.003)	0.001 (0.003)	0.019 (0.012)	-0.010 (0.013)	-0.002 (0.008)	0.012 (0.010)	-0.028 (0.031)	0.018 (0.044)
Outside 100	0.016** (0.007)	0.003 (0.013)	0.095** (0.039)	0.017 (0.015)	0.009 (0.022)	0.031 (0.045)	-0.092 (0.101)	0.145*** (0.050)
Constant	-0.245*** (0.009)	-0.251*** (0.014)	-0.322*** (0.045)	-0.231*** (0.025)	3.880*** (0.027)	4.070*** (0.047)	4.037*** (0.116)	3.871*** (0.081)
Observations	183	190	21	47	183	190	21	47

*Note:* \*p<0.1; \*\*p<0.05; \*\*\*p<0.01

**Table 5** FDiv and RaoQ fluctuations across four dominant land uses. All data used were for 100m buffer. Standard error is indicated in parentheses.

In forest, agricultural or mixed environments CED was not significantly associated to the position inside or outside the network of protected areas. This avian diversity metric was, instead, higher outside the protected areas when focusing the areas dominated by grasslands (Table 6). The values of max\_ED of bird communities were higher outside of protected areas in areas dominated by forests and grassland environments, while these values were similar between inside and outside the protected areas network in agricultural and mixed environments (Table 6). WED as a whole, appears to play a role in the changes in diversity metrics across different land uses only in some dominant environments (Table 4 and 6). The results of the GLM statistical analyses supported the preliminary explorations performed by using the ggplots. However, it is clear that the variations in diversity metrics between inside and outside of protected areas is relative to the different dominant land uses.

	<i>Dependent variable:</i>							
	CED				max_ED			
	Forest	Agricultural	Grasslands	Mixed	Forest	Agricultural	Grasslands	Mixed
Edge Weighted	-0.002 (0.007)	-0.024*** (0.009)	0.001 (0.026)	-0.031 (0.043)	-0.012 (0.019)	-0.042 (0.031)	-0.036 (0.035)	0.011 (0.102)
Outside 100	-0.004 (0.019)	0.047 (0.040)	0.232** (0.085)	-0.029 (0.049)	0.100* (0.053)	0.170 (0.137)	0.312** (0.116)	0.118 (0.117)
Constant	2.223*** (0.023)	1.954*** (0.041)	1.935*** (0.097)	2.147*** (0.080)	2.738*** (0.065)	2.536*** (0.141)	2.485*** (0.132)	2.550*** (0.188)
Observations	183	190	21	47	183	190	21	47

*Note:* \*p<0.1; \*\*p<0.05; \*\*\*p<0.01

**Table 6** differences in CED and max\_ED across four dominant land uses. Only the 100m buffer was used. Standard error is indicated in parentheses.

### **Exploring the interactions between land use composition and inside and outside of protected area**

Dominant land uses were compared as seen in Table 7 where agricultural area was used as the reference category for the factor ‘dominant land use’. In comparison to agricultural areas, BSR is significantly lower in forests while mixed land uses have higher BSR. In areas dominated by grasslands, BSR significantly decreases if compared with agricultural land uses. FRic shows higher values in agricultural areas than in forests and grasslands. FEve has higher values inside sites dominated with agriculture than forests and also decrease in grasslands. Bird communities in mixed and riparian environments have higher FDiv values than those found in agricultural areas. RaoQ increases when moving into agricultural areas over those dominated by forests and grasslands. RaoQ also has much lower values in sites with mixed land uses. Additionally, RaoQ is negatively impacted by areas dominated by riparian land uses than the agricultural areas. CED and max\_ED have significantly higher values in forest than agricultural areas, where this was the opposite for all other metrics. A similar result is seen when comparing grasslands and agricultural areas, where CED rises significantly in grassland areas. Mixed areas positively impact CED over those areas dominated by agriculture. Results also show that urban areas have significantly higher max\_ED values than agricultural areas. When comparing areas inside and outside of protected areas, all diversity metrics are increased outside. FDiv and FRic have the most significant values with a p-value less than one percent. Not far behind are RaoQ, BSR, and max\_ED with p-values less than ten percent, five percent, and five percent respectively. All other diversity indices show increased values outside as well, however their values are insignificant (Table 7).

*Dependent variable:*

	BSR	CED	FDiv	FEve	FRic	max_ED	RaoQ
	<i>negative</i>	<i>glm: Gamma</i>	<i>glm: Gamma</i>	<i>glm: Gamma</i>	<i>glm: Gamma</i>	<i>glm: Gamma</i>	<i>glm: Gamma</i>
	<i>binomial</i>	<i>link = log</i>	<i>link = log</i>	<i>link = log</i>	<i>link = log</i>	<i>link = log</i>	<i>link = log</i>
Forest	-0.114*** (0.038)	0.286*** (0.017)	0.022*** (0.006)	-0.008** (0.003)	-0.531*** (0.081)	0.230*** (0.051)	-0.234*** (0.019)
Grasslands	-0.384*** (0.089)	0.073** (0.035)	0.017 (0.012)	-0.042*** (0.007)	-1.152*** (0.163)	-0.039 (0.102)	-0.178*** (0.039)
Mixed	0.107** (0.048)	0.126*** (0.024)	0.015* (0.008)	-0.003 (0.005)	-0.023 (0.111)	0.071 (0.069)	-0.113*** (0.026)
Riparian.Veg.Ref	-0.206 (0.238)	0.115 (0.101)	0.058* (0.035)	0.025 (0.020)	-0.756 (0.474)	-0.050 (0.297)	-0.245** (0.112)
Urban	-0.136 (0.103)	0.069 (0.046)	0.005 (0.016)	0.003 (0.009)	-0.275 (0.216)	0.225* (0.135)	-0.073 (0.051)
Edge Weighted	-0.018 (0.012)	-0.013** (0.005)	0.002 (0.002)	0.002** (0.001)	-0.016 (0.026)	-0.027* (0.016)	0.003 (0.006)
Outside 100	0.095** (0.037)	0.010 (0.017)	0.016*** (0.006)	0.004 (0.003)	0.281*** (0.078)	0.124** (0.049)	0.032* (0.019)
Constant	2.377*** (0.050)	1.962*** (0.022)	-0.265*** (0.008)	-0.085*** (0.004)	4.392*** (0.106)	2.542*** (0.066)	4.090*** (0.025)
Observations	453	453	453	453	453	453	453

*Note: Table 7 statistical analysis of the interaction between 3 dominant land uses and spatial unit for the 100m buffer. Standard error is indicated by parentheses. \*p<0.1; \*\*p<0.05; \*\*\*p<0.01*

## **DISCUSSION**

### ***Importance of protected areas and biodiversity***

Protected areas have been implemented all over the globe in order to conserve species and habitat diversity. In Europe, the Natura 2000 network was introduced 1992 and has increased the number of protected areas on the continent. The network consists of areas protected under the Birds Directives and the Habitat Directives (“Nature and biodiversity law - Environment - European Commission,” 2016). Areas can be placed under protection because of one of the directive or can be protected under both. Protected areas can be protected on many levels ranging from human involvement to no human access. They can also be managed at different scales; international, national, and regional (“Management of Natura 2000 sites - Environment - European Commission,” 2017). It is important to take in to account the management of these areas as well as the landscapes. Previous studies have shown that the management of the areas and the land use have significant effects on bird species diversity in Europe (Batáry, Báldi, & Erdos, 2007). The protection of these areas is important to conserve the biodiversity on the planet. Especially considering that due to climate change, many species and habitats are becoming rarer. In this regard, Pimm et al. (1995) estimated extinction rate to be 100 to 1000 times higher now than they were naturally before humans. Therefore, it is essential to protect species and habitats when possible.

### ***The role of landscape heterogeneity***

While edge density played a minimal role in the variance in of diversity metrics in this study, several studies shown that it can help to increase diversity. In France, due to the homogeneity of the landscape, bird diversity was significantly low (Devictor et al., 2010). These results came from the analysis of functional diversity as well as phylogenetic analysis (evolutionary distinctiveness scores). However, the preference of habitat fragmentation can be species specific. Some species can prefer a continuous landscape while other like high fragmentations (Diffendorfer, Gaines, & Holt, 1995). Therefore, it is a possibility that some diversity metrics were low due to the species that were present. In the results of this study, the interpretation is not so clear. The landscape heterogeneity measured by mean of the edge density weighted was negatively associated with both community evolutionary distinctiveness (CED) and max ED. This could be associated to the fact that other studies in the same region found bird species characterized by higher ED scores (more evolutionary unique species) in large forest patches, that are also characterized by lower landscape heterogeneity (Morelli et al. 2018a, 2018b). Finally, the areas with high edge density weighted presented also significantly higher FEve in Central Italy.



### ***Effectiveness of protected areas in Marche region (Italy)***

This study examined the effectiveness of protected areas in the Marche Region of Italy, by comparing different avian diversity metrics inside and outside the network of protected areas while controlling for the dominant type of environment. Our results indicate that the coverage of hotspots of avian diversity by the protected areas could be improved. Nearly all diversity metrics decreased inside of the protected areas when compared with the same type of environment outside.

The number of bird species (species richness) was significantly higher outside than inside the network of protected areas in agricultural lands, grasslands and mixed environment, while this diversity metric was similar in forest environments. Considering separately the multidimensional indices of functional diversity, we can highlight how the FRic was higher outside the network of protected areas in Agricultural, grassland and mixed environments, while FRic was unrelated to the fact to be inside or outside the protected areas in the forest environments. From this point of view, we can highlight that protected areas covering forest areas are better protecting the taxonomic diversity (the number of species) and functional richness of avian communities than in other type of environments. The bird communities showed very similar values of FEve inside and outside the protected areas network in almost all types of dominant environments (forest, agricultural and grassland), while the FEve was significantly higher inside the PA's network in mixed environments. This fact can suggest that the potential resilience of bird communities (Villéger et al., 2008) inside and outside the main protected areas of Marche region is equal.

There are ways to explain the greater values of these diversity metrics outside of the protected areas. For example, there are studies showing that species richness can have a positive response to intermediate disturbances (Connell, Series, & Mar, 1978). Intermediate disturbances occur frequently but not so much so that the species or habitats are unable to recover. Examples of these disturbances can be intraspecific competition or deforestation at a small scale. Previous studies have also shown that intermediate disturbances can increase the functional diversity in a community (Hector, Joshi, Lawler, Spehn, & Wilby, 2001, Weithoff et al., 2016). A study conducted in Canada, indicated that vegetation in areas of low stability (riparian lowland) benefited more from moderate disturbances than low or high disturbances (Biswas & Mallik, 2010). It is important to note that our findings also showed that when moving from areas of moderate disturbance to areas of high disturbance that species richness and abundance increase while functional diversity metrics decreased (Biswas & Mallik, 2010). Small and frequent disturbances influenced species richness and

the species and habitats were still able to recover without detrimental damages (Thiollay, 1997). However, according to Kondoh (2001), it is important to understand the productivity of the environment. A study on plants indicated that intermediate disturbances only have positive effects when the productivity of the ecosystem is high. Alternatively, ecosystems of low productivity suffer from these disturbances (Kondoh, 2001).

FDiv of bird communities in Marche protected areas have relatively lower values inside of protected areas than outside in forest and grasslands. However, the values of FDiv between inside and outside were similar in both agricultural and mixed environments. FDiv refers to the niche differentiation of the community. Results indicates that FDiv in protected areas was lower in forest and grasslands environments, meaning that possibly there is more niche overlap within the protected areas (Mason et al., 2005).

RaoQ accounts for the pairwise differences between species and their relative abundance. When comparing inside and outside of protected areas, areas of grasslands and water had higher values outside of protected areas than inside. This indicates that there is higher niche overlap within the protected areas causing the lower values. However, agricultural areas had a positive influence on RaoQ inside of protected areas. This can be due to the fact that there are stricter regulations for farming in protected areas than outside. In sites with a mixed dominant land use, protected areas also failed to conserve RaoQ more than those outside of protected areas.

CED is considered a measure about the community uniqueness, in terms of evolutionary heritage. Species that are more unique tend to be rarer in nature (Cadotte & Jonathan Davies, 2010). It is important to identify the species with the higher ED scores and selectively protect these species. In this study, we did not focus on individual species but looked at the overall community diversity. These findings highlighted that the values of mean evolutionary distinctiveness (CED) in bird communities were similar inside and outside the network of protected areas in almost all the types of environments, with the only exception of the grasslands, where CED was significantly higher outside the protected areas network. This fact can suggest that ecological planning of future protected areas in that region of Central Italy need to pay more attention to the presence of bird species evolutionary unique, in order to increase the overall evolutionary heritage of the species assemblages protected by that network.

The bird within the community that is the most evolutionarily unique gives the max\_ED score. In areas of agriculture, grasslands, and rivers, there were lower scores inside of protected areas than outside of protected areas. Agricultural areas may have lower max\_ED

scores since they are a 'newer' land use. When comparing forest and grassland dominant land uses where the max\_ED rises significantly outside of the protected areas than inside.

### ***Management of different land uses***

Bird diversity was compared across dominant land uses and the interaction between inside and outside of protected areas. Overall, areas dominated by agriculture showed a significant increase in some of the diversity indices, especially if compared with forest and grassland areas. It is well known that farmlands that use organic practices have positive effects on bird diversity over those with conventional practices (Europäische Kommission, 2014). Furthermore, previous research shows that farmland birds prefer semi-natural areas. As a result, in landscapes where semi-natural areas are scarce, increased hedge length helped to increase BSR (Batáry, Matthiesen, & Tschardtke, 2010). This is due to the increased amount of crop cover. Many farmland bird species prefer to have the crop cover since they typically have nests on the ground. Unfortunately, this also means that disturbances to help increase diversity metrics have to be done carefully. Large machinery or high amounts of disturbances can destroy nests and kill offspring. Minimal disturbances such as grazing or hand cutting of crops (Society & Ecology, 2010). In the particular case of agricultural areas visited in this study for the collection of data, we can confirm that large proportion of areas were very heterogeneous farmlands, characterized by the presence of semi-natural patches and marginal vegetation, then increasing the availability of niches for more bird species (Kisel et al. 2011).

Grasslands have the most significant results with a decrease in several diversity metrics when grasslands are dominant inside of protected areas. FRic has lower value in areas inside of grasslands in protected areas indicating that there are niches that are being unused in these areas (Mason et al., 2005). With values of lower FDiv, this can suggest that some species are using habitats that they would not normally use due to an increase in competition of resources (Morelli, Benedetti, Perna, & Santolini, 2018). Some examples about the management of grasslands areas come from United States of America and Europe. North American studies have shown that a combination of fires and grazing can increase the mosaic of grasslands. This can have a positive impact on the bird species in these areas. These fires are contained and not meant to destroy entire habitats (Fuhlendorf et al., 2006). In a study, the prairie grouse was seen to have a positive response to these disturbances. This study not only showed that grassland vegetation benefited from the burning and grazing, but so did bird species. Dependent on time after burning, different bird species were seen in the treated areas (Fuhlendorf et al., 2006). However, in general it has been shown that grazing has negative effects on bird species richness and abundance

(Dobkin, Rich, & Pyle, 1998; Fuller & Gough, 1999; Verhulst, Báldi, & Kleijn, 2004; Maron & Lill, 2005). Alternatively, a study conducted by Batáry, Báldi, & Erdős, (2007) shows that grassland species suffer from extensive grazing while non-grassland species had no effects from the grazing. They indicated that this is most likely due to the fact that grassland species are specialists with their nests in the area that are more likely to be affected by grazing than those that only feed in grasslands (Batáry et al., 2007). Thus, it can be important to determine the species in which there is more need for protection in these areas. While grazing can help benefit some bird species, it can negatively impact others.

Forests have the highest values of CED. This can be due to the fact that forests are older landscapes than agricultural or grassland areas for avian species. Most bird ancestor assemblages came from forested areas and until human alterations to the landscape had no need to move to these less suitable land uses (Morelli et al., 2018). Therefore, forests can be considered the older environment and hold more unique resources required by these species. As stated previously, management techniques cutting the forest canopy at the local level can help to increase the diversity of bird species in forests (Le Saout et al., 2013).

### ***Future studies***

In this study, diversity metrics and the land uses were used to determine if protected areas in the Marche Region were effective at conserving bird diversity. Further studies should take into account 3D spatial analysis. This can help to determine if protected elevations are better at protecting species diversity than lowland protected areas, as seen in Canada. Future research can also focus on the sizes of the protected areas. Canadian research indicated that sizes of protected areas didn't make a difference as they were placed in areas where few humans inhabited. However, in Italy where there is a higher density of humans, it can prove informational to include this type of data. Furthermore, it can be interesting to compare the specific sites to determine which protected areas are more effective than others. In this way, management techniques and habitat compositions can be used to improve protected areas with lower diversity. Additionally, it can be beneficial to include analysis of the bird species as well in order to determine whether some indices are skewed by different species present. Future studies should also work with a dataset collected over a longer time-scale. While there was still a large amount of data collected, the time span was over one year can it can be argued that the turnover of species cannot properly be represented.

## **CONCLUSIONS**

While Natura 2000 is implemented to conserve biodiversity, it is important to consider areas where it is lacking. The sites in this study indicate that protected areas in the Marche Region are not conserving bird diversity as well as it should, because offering support mainly to bird communities not characterized by higher values of avian diversity metrics, even assessing different diversity facets as taxonomic diversity, functional diversity and evolutionary uniqueness. Therefore, it is proposed that different management techniques should be used in order to increase the overall diversity in these areas. Additionally, our findings provide a first attempt to elaborate a multidimensional assessment of the level of protection offered by the protected areas network to the bird communities in the Marche region. However, more studies need to be done in order to determine which management techniques can work the best in these areas. Different management techniques can help to conserve various diversity metrics and therefore the metrics need to be prioritized.

## REFERENCES

1. About - Protected Areas | IUCN. (n.d.). Retrieved April 9, 2018, from <https://www.iucn.org/theme/protected-areas/about>
2. About | IUCN. (2018). Retrieved April 14, 2018, from <https://www.iucn.org/about>
3. Adams, L. W., Leedy, D. L., & McComb, W. C. (2014). Urban Wildlife Research and Education in North American Colleges and Universities ', *15*(4), 591–595.
4. Akaike, H. (1974). A New Look at the Statistical Model Identification. *IEEE Transactions on Automatic Control*, *19*(6), 716–723. <https://doi.org/10.1109/TAC.1974.1100705>
5. ArcMap | ArcGIS Desktop. (n.d.). Retrieved March 5, 2018, from <http://desktop.arcgis.com/en/arcmap/>
6. Batáry, P., Báldi, A., & Erdos, S. (2007). Grassland versus non-grassland bird abundance and diversity in managed grasslands: Local, landscape and regional scale effects. *Biodiversity and Conservation*, *16*(4), 871–881. <https://doi.org/10.1007/s10531-006-9135-5>
7. Batáry, P., Matthiesen, T., & Tschardtke, T. (2010). Landscape-moderated importance of hedges in conserving farmland bird diversity of organic vs. conventional croplands and grasslands. *Biological Conservation*, *143*(9), 2020–2027. <https://doi.org/10.1016/j.biocon.2010.05.005>
8. Biodiversity Strategy - Environment - European Commission. (2016). Retrieved April 14, 2018, from [http://ec.europa.eu/environment/nature/biodiversity/strategy/index\\_en.htm](http://ec.europa.eu/environment/nature/biodiversity/strategy/index_en.htm)
9. Biswas, S. R., & Mallik, A. U. (2010). in Riparian and Upland Plant Communities. *Ecology*, *91*(1), 28–35. <https://doi.org/10.1890/08-0887.1>
10. Cadotte, M. W., & Jonathan Davies, T. (2010). Rarest of the rare: Advances in combining evolutionary distinctiveness and scarcity to inform conservation at biogeographical scales. *Diversity and Distributions*, *16*(3), 376–385. <https://doi.org/10.1111/j.1472-4642.2010.00650.x>
11. Carmona, C. P., de Bello, F., Mason, N. W. H., & Lepš, J. (2016). Traits Without Borders: Integrating Functional Diversity Across Scales. *Trends in Ecology and Evolution*, *31*(5), 382–394. <https://doi.org/10.1016/j.tree.2016.02.003>
12. Climate Marche: Temperature, Climograph, Climate table for Marche - Climate-Data.org. (n.d.). Retrieved March 5, 2018, from <https://en.climate-data.org/region/433/>
13. Connell, J. H., Series, N., & Mar, N. (1978). Diversity in Tropical Rain Forests and Coral Reefs High diversity of trees and corals is maintained. *Science*, *199*(4335),

- 1302–1310. <https://doi.org/10.2307/1745369>
14. de Bello, F., Lavorel, S., Díaz, S., Harrington, R., Cornelissen, J. H. C., Bardgett, R. D., ... Harrison, P. A. (2010). Towards an assessment of multiple ecosystem processes and services via functional traits. *Biodiversity and Conservation*, *19*(10), 2873–2893. <https://doi.org/10.1007/s10531-010-9850-9>
  15. Devictor, V., Mouillot, D., Meynard, C., Jiguet, F., Thuiller, W., & Mouquet, N. (2010). Spatial mismatch and congruence between taxonomic, phylogenetic and functional diversity: The need for integrative conservation strategies in a changing world. *Ecology Letters*, *13*(8), 1030–1040. <https://doi.org/10.1111/j.1461-0248.2010.01493.x>
  16. Díaz, S., & Cabido, M. (2001). Vive la différence: Plant functional diversity matters to ecosystem processes. *Trends in Ecology and Evolution*, *16*(11), 646–655. [https://doi.org/10.1016/S0169-5347\(01\)02283-2](https://doi.org/10.1016/S0169-5347(01)02283-2)
  17. Diffendorfer, J. E., Gaines, M. S., & Holt, R. D. (1995). Habitat fragmentation and movements of three small mammals (*Sigmodon*, *Microtus*, and *Peromyscus*). *Ecology*, *76*(3), 827–839. <https://doi.org/10.2307/1939348>
  18. Dobkin, D. S., Rich, A. C., & Pyle, W. H. (1998). Habitat Grazing and in Avifaunal a Riparian Recovery Meadow Basin from System Livestock of the Northwestern Great. *Conservation Biology*, *12*(1), 209–221. <https://doi.org/10.1111/j.1523-1739.1998.96349.x>
  19. EDGE of Existence :: Evolutionarily Distinct & Globally Endangered. (2015). Retrieved April 15, 2018, from <https://www.edgeofexistence.org/>
  20. Ervin, J. (2003). Protected area assessments in perspective. *Bioscience*, *53*(9), 819–822. [https://doi.org/10.1641/0006-3568\(2003\)053\[0819:PAAIP\]2.0.CO;2](https://doi.org/10.1641/0006-3568(2003)053[0819:PAAIP]2.0.CO;2)
  21. Europäische Kommission. (2014). Farming for Natura 2000, 145 Seiten.
  22. European Commission. (2005). *LIFE Focus / Integrated management of Natura 2000 sites. The contribution of LIFE projects.*
  23. Fuhlendorf, S. D., Harrell, W. C., Engle, D. M., Hamilton, R. G., Davis, C. A., & Leslie Jr., D. M. (2006). Should heterogeneity be the basis fo conservation? Grassland bird response to fore and grazing. *Ecological Applications*, *16*(5), 1706–1716.
  24. Fuller, R. J., & Gough, S. J. (1999). Changes in sheep numbers in Britain: Implications for bird populations. *Biological Conservation*, *91*(1), 73–89. [https://doi.org/10.1016/S0006-3207\(99\)00039-7](https://doi.org/10.1016/S0006-3207(99)00039-7)
  25. Gaüzère, P., Jiguet, F., & Devictor, V. (2016). Can protected areas mitigate the impacts of climate change on bird's species and communities? *Diversity and Distributions*, *22*(6), 625–637. <https://doi.org/10.1111/ddi.12426>
  26. Grodzinska-Jurczak, M., & Cent, J. (2011). Expansion of nature conservation areas: Problems with natura 2000 implementation in Poland? *Environmental Management*,

- 47(1), 11–27. <https://doi.org/10.1007/s00267-010-9583-2>
27. Hardin, J. W., & Hilbe, J. W. (2012). *Generalized Linear Models and Extensions* (3rd ed.). StataCorp LP.
28. Hector, A., Joshi, J., Lawler, S., Spehn, E. M., & Wilby, A. (2001). Conservation implications of the link between biodiversity and ecosystem functioning. *Oecologia*, *129*(4), 624–628. <https://doi.org/10.1007/s004420100759>
29. Hostetler, M., & Knowles-Yanez, K. (2003). Land use, scale, and bird distributions in the Phoenix metropolitan area. *Landscape and Urban Planning*, *62*(2), 55–68. [https://doi.org/10.1016/S0169-2046\(02\)00096-8](https://doi.org/10.1016/S0169-2046(02)00096-8)
30. Iojă, C. I., Pătroescu, M., Rozyłowicz, L., Popescu, V. D., Vergheș, M., Zotta, M. I., & Felciuc, M. (2010). The efficacy of Romania's protected areas network in conserving biodiversity. *Biological Conservation*, *143*(11), 2468–2476. <https://doi.org/10.1016/j.biocon.2010.06.013>
31. Isaac, N. J. B., Turvey, S. T., Collen, B., Waterman, C., & Baillie, J. E. M. (2007). Mammals on the EDGE: Conservation priorities based on threat and phylogeny. *PLoS ONE*, *2*(3). <https://doi.org/10.1371/journal.pone.0000296>
32. Jetz, W., Thomas, G. H., Joy, J. B., Redding, D. W., Hartmann, K., & Mooers, A. O. (2014). Global Distribution and Conservation of Evolutionary Distinctness in Birds. *Current Biology*, *24*(9), 919–930. <https://doi.org/10.1016/j.cub.2014.03.011>
33. Kareiva, P., & Marvier, M. (2012). What Is Conservation Science? *BioScience*, *62*(11), 962–969. <https://doi.org/10.1525/bio.2012.62.11.5>
34. Kierszniowska, S., & Seiwert, B. (2009). Definition of. *The Dictionary of Forestry*, *2008*(x), 612–623. <https://doi.org/10.1074/mcp.M800346-MCP200>
35. Kisel, Y., McInnes, L., Toomey, N.H., Orme, C.D.L., 2011. How diversification rates and diversity limits combine to create large-scale species-area relationships. *Philos. Trans. R. Soc. London B - Biol. Sci.* *366*, 2514–2525. doi:10.1098/rstb.2011.0022
36. Kondoh, M. (2001). Unifying the relationships of species richness to productivity and disturbance. *Proceedings of the Royal Society B: Biological Sciences*, *268*(1464), 269–271. <https://doi.org/10.1098/rspb.2000.1384>
37. Laliberté, A. E., Legendre, P., Shipley, B., & Laliberté, M. E. (2014). Package 'FD.'
38. Le Saout, S., Hoffmann, M., Shi, Y., Hughes, A., Bernard, C., Brooks, T. M., ... Rodrigues, A. S. L. (2013). Protected areas and effective biodiversity conservation. Supplementary Material. *Science*, *342*(6160), 803–805. <https://doi.org/10.1126/science.1239268>
39. Lorenzini, E., Calzati, V., & Giudici, P. (2011). Territorial brands for tourism development: A statistical analysis on the Marche region. *Annals of Tourism Research*, *38*(2), 540–560. <https://doi.org/10.1016/j.annals.2010.10.008>



40. Magurran, A. E. (2004). Measuring biological diversity, 256.
41. Maiorano, L., Falcucci, A., Garton, E. O., & Boitani, L. (2007). Contribution of the Natura 2000 network to biodiversity conservation in Italy. *Conservation Biology*, 21(6), 1433–1444. <https://doi.org/10.1111/j.1523-1739.2007.00831.x>
42. Management of Natura 2000 sites - Environment - European Commission. (2017). Retrieved April 14, 2018, from [http://ec.europa.eu/environment/nature/natura2000/management/index\\_en.htm](http://ec.europa.eu/environment/nature/natura2000/management/index_en.htm)
43. Margules, C. R., & Pressey, R. (2000). Systematic conservation planning. *Nature (London)*, 405(6783), 243–253. <https://doi.org/10.1038/35012251>
44. Maron, M., & Lill, A. (2005). The influence of livestock grazing and weed invasion on habitat use by birds in grassy woodland remnants. *Biological Conservation*, 124(4), 439–450. <https://doi.org/10.1016/j.biocon.2005.02.002>
45. Mason, N. W. H., Mouillot, D., Lee, W. G., & Wilson, J. B. (2005). Functional richness, functional evenness and functional divergence: The primary components of functional diversity. *Oikos*, 111(1), 112–118. <https://doi.org/10.1111/j.0030-1299.2005.13886.x>
46. Miller, J. R. (2005). Biodiversity conservation and the extinction of experience. *Trends in Ecology and Evolution*, 20(8), 430–434. <https://doi.org/10.1016/j.tree.2005.05.013>
47. Mittermeier, R. a., Da Fonseca, G. a. B. B., Rylands, A. B., & Brandon, K. (2005). A Brief History of Biodiversity Conservation in Brazil [doi:10.1111/j.1523-1739.2005.00709.x](https://doi.org/10.1111/j.1523-1739.2005.00709.x). *Conservation Biology*, 19(3), 601–607. <https://doi.org/10.1111/j.1523-1739.2005.00709.x>
48. Morelli, F., Benedetti, Y., Ibáñez-Álamo, J. D., Jokimäki, J., Mänd, R., Tryjanowski, P., & Møller, A. P. (2016). Evidence of evolutionary homogenization of bird communities in urban environments across Europe. *Global Ecology and Biogeography*, 25(11), 1284–1293. <https://doi.org/10.1111/geb.12486>
49. Morelli, F., 2018. High nature value farmland increases taxonomic diversity, functional richness and evolutionary uniqueness of bird communities. *Ecol. Indic.* 90, 540–546. [doi:10.1016/j.ecolind.2018.03.035](https://doi.org/10.1016/j.ecolind.2018.03.035)
50. Morelli, F., Benedetti, Y., Perna, P., & Santolini, R. (2018). Associations among taxonomic diversity, functional diversity and evolutionary distinctiveness vary among environments. *Ecological Indicators*, 88(February), 8–16. <https://doi.org/10.1016/j.ecolind.2018.01.022>
51. Mouchet, M. A., Villéger, S., Mason, N. W. H., & Mouillot, D. (2010). Functional diversity measures: An overview of their redundancy and their ability to discriminate community assembly rules. *Functional Ecology*, 24(4), 867–876.

- <https://doi.org/10.1111/j.1365-2435.2010.01695.x>
52. Nagendra, H. (2002). Opposite trends in response for the Shannon and Simpson indices of landscape diversity. *Applied Geography*, 22(2), 175–186.  
[https://doi.org/10.1016/S0143-6228\(02\)00002-4](https://doi.org/10.1016/S0143-6228(02)00002-4)
53. Natura 2000 - Environment - European Commission. (2017). Retrieved April 14, 2018, from [http://ec.europa.eu/environment/nature/natura2000/index\\_en.htm](http://ec.europa.eu/environment/nature/natura2000/index_en.htm)
54. Nature and biodiversity law - Environment - European Commission. (2016). Retrieved April 14, 2018, from [http://ec.europa.eu/environment/nature/legislation/index\\_en.htm](http://ec.europa.eu/environment/nature/legislation/index_en.htm)
55. Naughton-Treves, L., Holland, M. B., & Brandon, K. (2005). The Role of Protected Areas in Conserving Biodiversity and Sustaining Local Livelihoods. *Annual Review of Environment and Resources*, 30(1), 219–252.  
<https://doi.org/10.1146/annurev.energy.30.050504.164507>
56. Nelson, A., & Chomitz, K. M. (2011). Effectiveness of strict vs. multiple use protected areas in reducing tropical forest fires: A global analysis using matching methods. *PLoS ONE*, 6(8). <https://doi.org/10.1371/journal.pone.0022722>
57. Norderhaug, A., Ihse, M., & Pedersen, O. (2000). Biotope patterns and abundance of meadow plant species in a Norwegian rural landscape. *Landscape Ecology*, 15(3), 201–218. <https://doi.org/10.1023/A:1008141400166>
58. Pearman, P. B., Lavergne, S., Roquet, C., Wüest, R., Zimmermann, N. E., & Thuiller, W. (2014). Phylogenetic patterns of climatic, habitat and trophic niches in a European avian assemblage. *Global Ecology and Biogeography*, 23(4), 414–424.  
<https://doi.org/10.1111/geb.12127>
59. Pesaresi, S., Galdenzi, D., Biondi, E., & Casavecchia, S. (2014). Bioclimate of Italy: Application of the worldwide bioclimatic classification system. *Journal of Maps*, 10(4), 538–553. <https://doi.org/10.1080/17445647.2014.891472>
60. Petchey, O. L., & Gaston, K. J. (2006). Functional diversity: Back to basics and looking forward. *Ecology Letters*, 9(6), 741–758. <https://doi.org/10.1111/j.1461-0248.2006.00924.x>
61. Pino, J., Rodà, F., Ribas, J., & Pons, X. (2000). Landscape structure and bird species richness: Implications for conservation in rural areas between natural parks. *Landscape and Urban Planning*, 49(1–2), 35–48. [https://doi.org/10.1016/S0169-2046\(00\)00053-0](https://doi.org/10.1016/S0169-2046(00)00053-0)
62. Ricotta, C., Bacaro, G., & Moretti, M. (2014). A new measure of functional evenness and some of its properties. *PLoS ONE*, 9(8).  
<https://doi.org/10.1371/journal.pone.0104060>
63. Society, B. E., & Ecology, A. (2010). Territory Distribution and Breeding Success of

- Skylarks *Alauda arvensis* on Organic and Intensive Farmland in Southern England  
 Author ( s ): Jeremy D . Wilson , Julianne Evans , Stephen J . Browne , Jon R . King  
 Published by : British Ecological Society St. *Society*, 34(6), 1462–1478.
64. The Ramsar Convention and its mission | Ramsar. (n.d.). Retrieved April 14, 2018,  
 from <https://www.ramsar.org/about/the-ramsar-convention-and-its-mission>
65. Thiollay, J. M. (1997). Disturbance, selective logging and bird diversity:a Neotropical  
 forest study. *Biodiversity and Conservation*, 6\_ \_(8), 1155–1173.  
<https://doi.org/10.1023/a:1018388202698>
66. Tomaselli R, Balduzzi A, Filipello S (1972) Carta Bioclimatica d'Italia. Scala  
 1:2.000.000
67. Verhulst, J., Báldi, A., & Kleijn, D. (2004). Relationship between land-use intensity  
 and species richness and abundance of birds in Hungary. *Agriculture, Ecosystems  
 and Environment*, 104(3), 465–473. <https://doi.org/10.1016/j.agee.2004.01.043>
68. Villéger, S., Mason, H., & Mouillot, D. (2008). New Multidimensional Functional  
 Diversity Indices for a Multifaceted Framework in Functional Ecology Author ( s ):  
 Sébastien Villéger , Norman W . H . Mason , David Mouillot Published by : Ecological  
 Society of America content in a trusted digital archive. *Ecology*, 89(8), 2290–2301.  
<https://doi.org/10.1890/07-1206.1>
69. Weithoff, G., Laakmann, S., Auel, H., Kochzius, M., Salmaso, N., Naselli-Flores, L.,  
 ... Ebert, D. (2016). Global patterns and drivers of species and trait composition in  
 diatoms. *Estuarine, Coastal and Shelf Science*, 16(1), 217–227.  
<https://doi.org/10.1016/j.ecolind.2014.08.033>
70. Whittaker, A. R. H., & May, I. (1972). Evolution and Measurement of Species  
 Diversity Published by : International Association for Plant Taxonomy ( IAPT ) Stable  
 URL : <http://www.jstor.org/stable/1218190> REFERENCES Linked references are  
 available on JSTOR for this article : You may need to log. *Taxon*, 21(2), 213–251.
71. Zoltan, B.-D. (2005). Rao' s quadratic entropy as a measure of functional diversity  
 based on multiple traits. *Journal of Vegetation Science*, 16, 533–540.  
[https://doi.org/10.1658/1100-9233\(2005\)16\[533:RQEAAM\]2.0.CO;2](https://doi.org/10.1658/1100-9233(2005)16[533:RQEAAM]2.0.CO;2)