

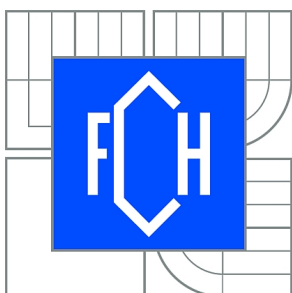

VYSOKÉ UČENÍ TECHNICKÉ V BRNĚ

BRNO UNIVERSITY OF TECHNOLOGY



FAKULTA CHEMICKÁ

ÚSTAV CHEMIE POTRAVIN A BIOTECHNOLOGIÍ

FACULTY OF CHEMISTRY

INSTITUTE OF FOOD SCIENCE AND BIOTECHNOLOGY

# HEMOGLOBIN-MEDIATED OXIDATION OF MARINE LIPOSOMES

HEMOGLOBIN-MEDIATED OXIDATION OF MARINE LIPOSOMES

DIPLOMOVÁ PRÁCE

MASTER'S THESIS

AUTOR PRÁCE

AUTHOR

Bc. LADA ŠKRABALOVÁ

VEDOUCÍ PRÁCE

SUPERVISOR

Turid Rustad

BRNO 2011



Vysoké učení technické v Brně  
**Fakulta chemická**  
Purkyňova 464/118, 61200 Brno 12

## Zadání diplomové práce

Číslo diplomové práce: **FCH-DIP0547/2010** Akademický rok: **2010/2011**  
Ústav: Ústav chemie potravin a biotechnologií  
Student(ka): **Bc. Lada Škrabalová**  
Studijní program: Chemie a technologie potravin (N2901)  
Studijní obor: Potravinářská chemie a biotechnologie (2901T010)  
Vedoucí práce: **Turid Rustad**  
Konzultanti: RNDr. Milena Vespalcová, Ph.D.

### Název diplomové práce:

Hemoglobin-mediated oxidation of marine liposomes

### Zadání diplomové práce:

Theoretical part:

- 1) basic lipid oxidation principles
- 2) physical and chemical factors affecting lipid oxidation
- 3) literature search on hemoglobin as a singlet oxygen generator
- 4) summary of mechanisms by which hemoglobin promotes oxidation of lipids
- 5) hemoglobin as a pro-oxidant in different matrices
- 6) physical and chemical factors affecting hemoglobin mediated lipid oxidation

Experimental part:

- 1) isolation and characterization of phospholipids from cod roe
- 2) study of the pro-oxidant effect of hemoglobin(s) in a liposome model system made of cod roe phospholipids measuring oxygen uptake
- 3) effect of the environmental conditions (temperature, pH, added compounds, light) and the state of denaturation on the pro-oxidant effect
- 4) assessment of good experimental conditions for this assay

### Termín odevzdání diplomové práce: 13.5.2011

Diplomová práce se odevzdává ve třech exemplářích na sekretariát ústavu a v elektronické formě vedoucímu diplomové práce. Toto zadání je přílohou diplomové práce.

-----  
Bc. Lada Škrabalová  
Student(ka)

-----  
Turid Rustad  
Vedoucí práce

-----  
doc. Ing. Jiřina Omelková, CSc.  
Ředitel ústavu

V Brně, dne 15.1.2011

-----  
prof. Ing. Jaromír Havlica, DrSc.  
Děkan fakulty

## **ABSTRACT**

The objective of this work was to study the kinetics of lipid oxidation catalyzed by bovine methemoglobin and to evaluate the effects of different experimental conditions and different antioxidants (EDTA, ascorbic acid, caffeic acid,  $\alpha$ -tocopherol,  $\delta$ -tocopherol, astaxanthin and L-ascorbic acid-6-palmitate) on the methemoglobin-mediated lipid oxidation in a marine phospholipid liposome model system. The oxygen uptake was used for monitoring lipid oxidation at pH 5.5 and 30 °C.

The type of prooxidant and the concentration of both prooxidant and antioxidant (AOX) were found to be very important factors in the evaluation of the antioxidant activity in the liposome model system. Another important factors are the structure of the antioxidant molecule, its hydrophilicity/lipophilicity and its location in the system. All antioxidants, except 0.1 % of astaxanthin and 0.1 % of ascorbyl palmitate, inhibited metHb-induced lipid oxidation in all tested concentrations of the AOX. The efficiency of the AOX increased with their increasing concentration. 0.1 % of astaxanthin had no effect on the oxidation of liposomes. 0.1 % of ascorbyl palmitate had a prooxidative effect which can be explained by the prooxidative action of ascorbyl radical, which could promote hydroperoxide scission. Free iron released from metHb contributed little to metHb-mediated lipid oxidation in liposomes, whereas part of the prooxidant activity of metHb was attributed to the formation of singlet oxygen (metHb as a photosensitizer). The antioxidative activity of astaxanthin, ascorbyl palmitate, and tocopherol can be partly attributed to their singlet oxygen quenching ability. However, the main prooxidative mechanisms of metHb are suggested to be decomposition of lipid hydroperoxides, generating free radicals, and formation of hypervalent forms of Hb. EDTA inhibited oxidation of liposomes by chelating transition metals in liposomes and chelating free iron from the metHb solution. The reduction of hypervalent forms of Hb seems to be a very important antioxidant mechanism and was found to be attributed to ascorbyl palmitate, ascorbic acid (AsA) and caffeic acid (CaA). AsA, CaA, tocopherols and astaxanthin inhibit metHb-mediated lipid oxidation by scavenging of lipid radicals. No significant effect of hydrogen peroxide on the oxidation of liposomes was observed. The oxidation was slightly inhibited due to thermal treatment of metHb solution. A significant inhibition of oxygen uptake rate was observed in liposomes containing TPP (triphenylphosphine), which suggests that the heme-mediated lipid oxidation in liposomes is dependent on the presence of pre-existing lipid peroxides.

The outcomes of this work can be used for the study of oxidation of liposome solutions, cell membranes and oil-in-water emulsions stabilized by phospholipids; the results contribute to understanding the prooxidant and antioxidant mechanisms and factors that influence oxidation in these systems.

## **KEYWORDS**

Liposomes, phospholipids, lipid oxidation, hemoglobin, iron, oxygen uptake, antioxidants

## ABSTRAKT

Cílem této práce bylo studium mechanismu oxidace lipidů katalyzované hovězím methemoglobinem a zhodnocení účinků různých experimentálních podmínek a antioxidantů (EDTA, askorbová kyselina, kávová kyselina,  $\alpha$ -tokoferol,  $\delta$ -tokoferol, astaxanthin a L-askorbyl-6-palmitát) na methemoglobinem zprostředkovanou oxidaci lipidů v modelovém systému liposomů připravených z fosfolipidů. K monitorování oxidace lipidů při pH 5,5 a teplotě 30 °C bylo použito spotřeby kyslíku.

Pro zhodnocení antioxidační aktivity v modelovém systému liposomů se ukázaly být důležitými faktory typ prooxidantu a koncentrace prooxidantu a antioxidantu. Dalšími důležitými faktory jsou struktura molekuly antioxidantu, jeho hydrofilita/lipofilita a umístění v systému. Všechny testované antioxidanty ve všech koncentracích (kromě koncentrace 0.1 % astaxanthinu a 0.1 % askorbyl palmitátu) inhibovaly oxidaci vyvolanou methemoglobinem. Účinnost antioxidantu stoupala s jeho zvyšující se koncentrací. Koncentrace 0.1 % astaxanthinu neměla žádný vliv na oxidaci liposomů. Koncentrace 0.1 % askorbyl palmitátu měla prooxidační efekt, který lze vysvětlit prooxidačním působením radikálu askorbylu, který může urychlit štěpení hydroperoxidů. Volné železo uvolněné z methemoglobinu se podílelo jen velmi málo na oxidaci liposomů, zatímco část prooxidační aktivity methemoglobinu byla přisouzena tvorbě singletového kyslíku (methemoglobin jako fotosenzitizátor). Antioxidační aktivita astaxanthinu, askorbyl palmitátu a tokoferolu byla z části přisouzena schopnosti zhaset singletový kyslík. Ovšem hlavním prooxidačním mechanismem methemoglobinu se ukázal být rozklad lipidových hydroperoxidů, tvorba volných radikálů a hypervalentních forem hemoglobinu. EDTA utlumila oxidaci liposomů díky chelataci přechodných kovů obsažených v liposomech a chelataci volného železa přítomného v methemoglobinovém roztoku. Velmi důležitým antioxidačním mechanismem (který vykazují askorbyl palmitát, askorbová a kávová kyselina) se ukázala být redukce hypervalentních forem hemoglobinu. Askorbová kyselina, kávová kyselina, tokoferoly a astaxanthin inhibovaly methemoglobinem zprostředkovanou oxidaci lipidů odstraňováním volných radikálů. Při použití peroxidu vodíku nebyl pozorován žádný vliv na oxidaci liposomů vyvolanou methemoglobinem. Působení vysoké teploty (tepelná denaturace) mírně utlumilo oxidaci. Významná inhibice oxidace byla pozorována u liposomů obsahujících TPP (triphenylphosphin), což značí, že je methemoglobinem vyvolaná oxidace liposomů závislá na přítomnosti již vzniklých lipidových peroxidů.

Výsledky této práce přispívají k hlubšímu pochopení prooxidačních a antioxidačních mechanismů a faktorů, které ovlivňují oxidaci liposomálních roztoků, buněčných membrán a emulzí typu olej ve vodě stabilizovaných fosfolipidy.

## KLÍČOVÁ SLOVA

Liposomy, fosfolipidy, oxidace lipidů, hemoglobin, železo, spotřeba kyslíku, antioxidanty

ŠKRABALOVÁ, L. *Hemoglobin-mediated oxidation of marine liposomes*. Brno: Brno University of Technology, Faculty of Chemistry, 2011. 115 s. Supervisor of the diploma thesis: Dr. Ing. Turid Rustad.

The experimental part of the thesis had been carried out at the Department of Biotechnology of the Norwegian University of Science and Technology (NTNU) in Trondheim and in SINTEF Fisheries and Aquaculture in Trondheim, Norway.

## DECLARATION

I hereby declare that the diploma thesis has been worked out by myself and that all the quotations from the used literary sources are accurate and complete. The content of the diploma thesis is the property of the Faculty of Chemistry of Brno University of Technology and all commercial uses are allowed only if approved by both the supervisor and the dean of the Faculty of Chemistry, BUT.

.....  
signature

## *Acknowledgements*

I would like to express my gratitude to my supervisor, Prof. Turid Rustad, for her guidance and supervision of the thesis and for the opportunity to work on the thesis in the laboratories of NTNU and SINTEF Fisheries and Aquaculture.

I am very grateful to Ing. Věra Kristinová for her advice, readiness, professional help in the laboratories, very valuable discussions and for introducing me to the field of lipid oxidation.

My thanks also belong to the researchers at SINTEF, Dr. Revilija Mozuraityte and Dr. Ivar Storrø for their advice and discussions.

I would also like to thank to my family for their encouragement and support.

# CONTENTS

<b>1</b>	<b>INTRODUCTION .....</b>	<b>9</b>
<b>2</b>	<b>THEORY .....</b>	<b>11</b>
2.1	LIPIDS .....	11
2.1.1	<i>Phospholipids and membranes</i> .....	13
2.1.2	<i>Marine phospholipids</i> .....	14
2.2	LIPID OXIDATION .....	15
2.2.1	<i>Enzyme-initiated lipid oxidation</i> .....	15
2.2.2	<i>Autoxidation</i> .....	16
2.2.3	<i>Photosensitized oxidation</i> .....	17
2.2.4	<i>Model systems in oxidation studies</i> .....	18
2.2.4.1	Emulsions .....	19
2.2.4.2	Washed fish mince .....	19
2.2.4.3	Liposomes .....	19
2.2.5	<i>Physical and chemical factors affecting lipid oxidation</i> .....	20
2.2.5.1	Metals .....	21
2.2.5.2	Moisture content .....	21
2.2.5.3	Emulsifiers .....	22
2.2.5.4	Proteins .....	22
2.2.5.5	pH .....	22
2.2.5.6	Temperature .....	23
2.3	PROOXIDANTS .....	23
2.3.1	<i>Hemoglobin</i> .....	23
2.3.1.1	Heme-iron catalysis .....	24
2.3.2	<i>Iron</i> .....	28
2.4	ANTIOXIDANTS .....	30
2.4.1	<i>Primary antioxidants</i> .....	30
2.4.2	<i>Secondary antioxidants</i> .....	32
2.4.2.1	Chelators .....	33
2.4.2.2	Oxygen scavengers and reducing agents .....	34
2.4.2.3	Singlet oxygen quenchers .....	35
2.4.3	<i>Natural antioxidants</i> .....	37
2.4.3.1	Ascorbic acid .....	37
2.4.3.2	Carotenoids .....	38
2.4.3.3	Phenolic compounds .....	39
2.4.3.4	Tocopherols .....	42
2.4.4	<i>Synthetic antioxidants</i> .....	45
2.4.4.1	Ascorbyl palmitate .....	46
2.4.5	<i>Antioxidants in lipid systems</i> .....	46
2.4.5.1	Interfacial phenomena in the evaluation of antioxidants .....	47
<b>3</b>	<b>EXPERIMENTAL .....</b>	<b>48</b>
3.1	ISOLATION OF PHOSPHOLIPIDS .....	48
3.1.1	<i>Isolation of cod roe oil</i> .....	48

3.1.2	<i>Isolation of phospholipids</i>	48
3.2	LIPOSOME PREPARATION	49
3.3	ANALYSIS OF ISOLATION PRODUCTS	50
3.3.1	<i>Characterisation of isolation products</i>	50
3.3.2	<i>Composition of PL2 determined by HPLC-CAD</i>	51
3.3.3	<i>Fatty acid profile of OIL and PL2 determined by GC</i>	51
3.3.4	<i>Peroxide value</i>	51
3.3.5	<i>Thiobarbituric acid reactive substances</i>	52
3.3.6	<i>p-anisidine value</i>	52
3.3.7	<i>Total carotenoids</i>	53
3.4	OXIDATION EXPERIMENTS – OXYGEN UPTAKE MEASUREMENT	53
3.4.1	<i>Oxygraph</i>	53
3.4.2	<i>Reaction conditions</i>	54
3.4.2.1	Reactants	55
3.4.2.2	Hemoglobin	55
3.4.2.3	EDTA	55
3.4.2.4	Thermal denaturation	56
3.4.2.5	TPP (triphenylphosphine)	57
3.4.2.6	Water-soluble antioxidants	57
3.4.2.7	Lipid-soluble antioxidants	57
3.4.2.8	Experiments without the presence of light	57
3.4.2.9	Reaction with hydrogen peroxide (H <sub>2</sub> O <sub>2</sub> )	57
3.4.3	<i>OUR measurement</i>	57
3.4.4	<i>Graph processing</i>	58
3.5	LIST OF CHEMICALS	60
3.6	LIST OF INSTRUMENTS	61
<b>4</b>	<b>RESULTS AND DISCUSSION</b>	<b>63</b>
4.1	ANALYSIS OF ISOLATION PRODUCTS	63
4.1.1	<i>Composition of the isolation products, purity of final phospholipids</i>	63
4.1.2	<i>Composition of PL2 determined by HPLC-CAD</i>	64
4.1.3	<i>Fatty acid profile of OIL and PL2</i>	65
4.1.4	<i>Peroxide value, TBARS and anisidine value</i>	67
4.1.5	<i>Total carotenoids</i>	68
4.2	OXIDATION EXPERIMENTS IN A LIPOSOME SYSTEM	69
4.2.1	<i>Control experiments without liposomes</i>	70
4.2.2	<i>Oxidation of liposomes, addition of Fe<sup>2+</sup>, Fe<sup>3+</sup> and Hb</i>	70
4.2.3	<i>Influence of EDTA on liposomes</i>	72
4.2.4	<i>Addition of EDTA</i>	72
4.2.5	<i>Thermal denaturation of hemoglobin solution</i>	74
4.2.6	<i>TPP (triphenylphosphine)</i>	77
4.2.7	<i>Ascorbic acid (AsA)</i>	78
4.2.8	<i>Caffeic acid (CaA)</i>	80
4.2.9	<i>Astaxanthin</i>	83
4.2.10	<i>α-tocopherol, δ-tocopherol</i>	89
4.2.11	<i>Ascorbyl palmitate</i>	94

4.2.12	<i>Experiments without the presence of light</i> .....	96
4.2.13	<i>Reaction with hydrogen peroxide (H<sub>2</sub>O<sub>2</sub>)</i> .....	98
4.2.14	<i>Absorption curve of metHb</i> .....	101
<b>5</b>	<b>CONCLUSION</b> .....	<b>103</b>
<b>6</b>	<b>LITERATURE</b> .....	<b>105</b>
<b>7</b>	<b>LIST OF ABBREVIATIONS</b> .....	<b>114</b>



# 1 INTRODUCTION

Marine phospholipids contain high amounts of n-3 polyunsaturated fatty acids (n-3 PUFA). Among these the most important ones are eicosapentaenoic acid (EPA, 20:5 n-3) and docosahexaenoic acid (DHA, 22:6 n-3) [1]. These fatty acids have beneficial health effects, such as reduced risk of coronary heart diseases [2] and of inflammatory diseases [3] and they are important for proper development and function of brain and retina [4].

Therefore there is a growing interest for incorporation of these fatty acids into food products, including meat products such as pates, meat minces and sausages. Marine phospholipids can also be used as a delivery system for drugs and in pharmacology [5]. Marine phospholipids are rich in PUFA, therefore they are susceptible to oxidation, which causes damage to biological systems, leads to undesirable flavour, rancid odour and loss of nutritional value in foods. Some oxidation products might even be toxic.

The degree of n-3 PUFA degradation increases during processing of fish, because lipids are exposed to prooxidants such as transition metals, enzymes as well as to atmospheric oxygen [6].

Lipid oxidation therefore limits the use of marine phospholipids both in food products and as nutritional supplements. This highlights the need to get more knowledge about oxidation of marine phospholipids – to choose suitable processing and storage conditions for matrices containing marine phospholipids, especially when hemoglobin is present as a natural component in meat.

Heme-proteins hemoglobin (Hb) and myoglobin (Mb) can act as promoters of lipid oxidation and can be responsible for the onset of lipid oxidation [7, 8]. Under certain conditions such as depletion of oxygen, pH decrease or intensely fluctuating oxygen supply in tissues, heme pigments may become catalytic [9]. Hemoglobin is naturally present in muscle foods, even after bleeding of muscle tissue [8]. It is therefore important to know how its activity can be influenced by different conditions and antioxidants in different model systems.

Foods are multicomponent systems. To avoid complexity of real food matrices and for clearer interpretation of experimental results, several different model systems can be used for lipid oxidation studies. These model systems simulate foods or biological systems. In these simplified models, different variables can be modified and controlled, therefore they provide good conditions for the study of lipid oxidation mechanisms, the effects of different prooxidants and antioxidants [7, 10]. Lipid oxidation can be prevented by addition of antioxidants, but their efficiency is dependent on the type of food system, the type and concentration of antioxidants and prooxidants [7].

Liposomes were chosen as the model system for oxidation studies. They are frequently used as a model system for the study of lipid peroxidation. Liposomes are microscopic structures containing one or more concentric lipid bilayers [11]. It is well known that the major site of oxidative damage to tissues is in the membrane systems of cells. The advantage of liposomes is that they provide oxidizable substrate containing LC-PUFA and also simulate biological membranes and food emulsions stabilized by phospholipids and they allow manipulation of lipid composition, pH, temperature and addition of various agents [12].

The two essential reactants in lipid oxidation are the unsaturated fatty acids and oxygen. A large number of different products are formed during lipid oxidation. These can be determined by different methods. Measuring oxidation is a challenge also because some of these products have low threshold value and have different stability. Therefore one solution

might be to determine the disappearance of reaction products as marker of lipid oxidation. As a method to study lipid oxidation, measurement of oxygen uptake using polarographic oxygen electrode was employed. It is a fast and simple method and allows determination of the lipid oxidation rate and is very useful for kinetic studies of lipid oxidation [7].

The aim of this work is to study the kinetics of lipid oxidation catalyzed by bovine methemoglobin and to evaluate the effects of different antioxidants (EDTA, ascorbic acid, caffeic acid,  $\alpha$ -tocopherol,  $\delta$ -tocopherol, astaxanthin, and ascorbyl palmitate) on the methemoglobin-mediated lipid oxidation in a marine phospholipid liposome model system at pH 5.5 and 30 °C.

## 2 THEORY

### 2.1 Lipids

Lipids are a large group of naturally occurring chemical compounds. In living organisms lipids are responsible for various functions: they are used as energy storage, some lipids work as signalling molecules and messengers in signal-transduction pathways (e. g. hormones) and as structural components in cell membranes (phospholipids) [13].

No strict definition of lipids exists. According to Gunstone [14] lipids are compounds which are based on fatty acids or closely related compounds such as the corresponding alcohols and the sphingosine bases. According to Kates [15] lipids are substances that are not soluble in water, but are soluble in organic solvents (e. g. benzene, ether, chloroform and acetone), their molecule contains long-chain hydrocarbon groups and they can be found in living organisms or are derived from living organisms.

Classes of lipids include fatty acids and their derivatives, triacylglycerols, waxes, sterols, isoprenoids, phospholipids, glycolipids and sphingolipids [13].







Lipids can be classified into two groups: hydrophobic lipids (e. g. triacylglycerols) and amphiphilic lipids (e. g. phospholipids). Amphiphilic nature means that these lipids contain a hydrophilic part (a polar „head“) with affinity for water and a lipophilic part (a „tail“) with affinity for oil. Due to this amphiphilic nature they are able to form special structures such as liposomes and membranes in an aqueous environment [15]. This will be discussed later in sections 2.1.1 and 2.2.4.3.

The key components of lipids are fatty acids. They are long hydrocarbon chains that are of varying length and can be either saturated or unsaturated. One end of the fatty acid molecule is a carboxylic acid group. The majority of plant and animal fatty acids are esterified to a glycerol molecule and triacylglycerol is the most common form of lipids [13].

There are about one thousand natural fatty acids known, but only 20 – 50 from these are of a common concern. Fatty acids have usually an even number of carbon atoms (mostly 12 – 22 carbon atoms), are unbranched and monocarboxylic. The double bonds in unsaturated fatty acids are almost exclusively *cis* configuration. Fatty acids rarely have functional groups other than carboxyl group, however some contain functional groups such as fluoro-, hydroxy-, keto- or epoxygroup [1].

Fatty acid carbon atoms can be numbered starting from the carboxylic acid end. Carbon atoms number 2 and 3 are then called  $\alpha$  and  $\beta$ , respectively. This numbering is used in the IUPAC system, where the position of a double bond is represented by the symbol  $\Delta$  (which indicates the position of the double bonds from the carboxyl group). The methyl carbon at the other end is called  $\omega$ -carbon. Accordingly, the position of a double bond can be represented by the symbol  $\omega$  (or  $n$ ), which indicates the position of the double bond from the  $\omega$ -carbon [1, 16].

n-3 and n-6 polyunsaturated fatty acids (long-chain polyunsaturated fatty acids, LC-PUFAs) belong to those fatty acids that are essential for human. Animals cannot make linoleic acid or  $\alpha$ -linolenic acid for themselves, nor can they interconvert n-3 and n-6 fatty acids. These PUFA must be obtained from the diet – LC-PUFA present in the diet by eating fish and meat originally come from plants. Fish oils and some vegetable oils such as soybean, rapeseed and linseed oil are rich in long-chain PUFA [1]. Figure 1 shows some of the n-3 and n-6 fatty acids, the two at the top are essential fatty acids.

Omega-6 polyunsaturated FAs	Omega-3 polyunsaturated FAs
 Linoleic acid 18:2n-6	 $\alpha$ -Linolenic acid 18:3n-3
 $\gamma$ -Linolenic acid 18:3n-6	 Eicosapentaenoic acid 20:5n-3
 Arachidonic acid 20:4n-6	 Docosahexaenoic acid 22:6n-3

**Figure 1:** Examples of omega-6 and omega-3 polyunsaturated fatty acids [17]

Several beneficial human health effects of n-3 fatty acids have been documented. Some of these physiological functions are influenced by n-3 fatty acids: growth and development of the central nervous system and retina, proper function of the cardiovascular system, prevention and treatment of some diseases such as cardiovascular disease (CVD), reduced risk for CVD (e. g. by influencing the blood pressure, thrombogenic mechanism). n-6 fatty acids are derived from linoleic acid, whereas n-3 fatty acids are derived from  $\alpha$ -linolenic acid. Polyene acids are biosynthesized by combination of elongation and desaturation processes starting with an unsaturated acid. Figure 2 shows the spatial structure of some PUFAs [1].

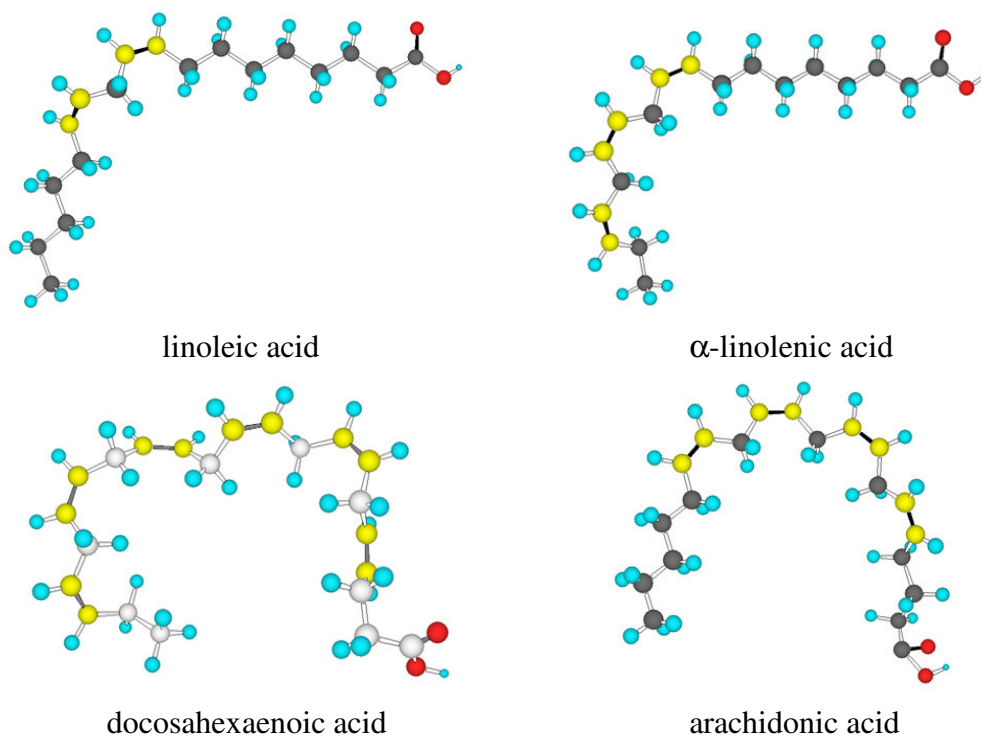

**Figure 2:** Spatial arrangement of some PUFAs [12]

### 2.1.1 Phospholipids and membranes

There are two major classes of phospholipids: glycerophospholipids and sphingomyelins (SM). The first group contains glycerol molecule as the backbone, the second contains sphingosine [18].

A phospholipid molecule is composed of four components: one or more fatty acids, a part to which the fatty acid is attached, a phosphate and an alcohol molecule that is attached to phosphate [13].

Describing phospholipids derived from glycerol (glycerophospholipids), one of the fatty acid chains is replaced by a phosphate group. So they are composed of glycerol, fatty acids, phosphate and an organic base or polyhydroxy compound. The phosphate is almost always joined to the *sn*-3 position of the glycerol molecule [18]. Figure 3 shows some common classes of phospholipids.

Phospholipids, glycolipids and cholesterol are the major lipid classes in membranes [13].

Although membranes are diverse both in their structure and in their function, they have several properties in common: membranes are structures that are only two molecules thick, they form boundaries between compartments, and they contain mainly proteins and lipids (with their mass ratio ranging from 4:1 to 1:4). Another part of membranes are carbohydrates – they are joined to proteins and lipids. Another property that membranes have in common is the presence of specific protein molecules which are responsible for special functions of the membrane – some of these proteins work as pumps, channels, enzymes or receptors. Membranes are dynamic and fluid structures [13].

Above a critical concentration (which is in the range of  $10^{-5}$  –  $10^{-10}$  mol/L) and in the presence of water, phospholipids form various macromolecular structures. The main structure is a bilayer, where the polar regions are oriented towards the aqueous phase and the hydrophobic regions are “isolated” from the water environment. Sphingomyelins (SM) and phosphatidylcholine (PC) form primarily bilayers, but other phospholipids can form a variety of other structures.

Membrane degradation can occur in animals and plants after slaughter and harvest and this is probably a factor responsible for quality deterioration of animal and plant tissues. In food tissues there are two main pathways of this breakdown: free radical lipid oxidation and loss of plasma and organelle membrane integrity. Some of the effects and changes of the lipid peroxidation in membranes are uncoupling of oxidative phosphorylation in mitochondria, inactivation of membrane-bound enzymes, increased permeability and others [18].

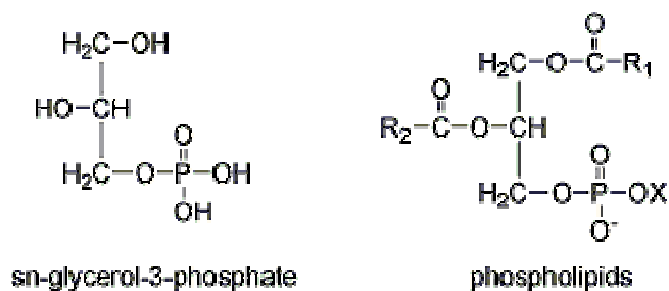

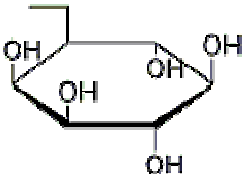
name of X-OH	formula of X	name of phospholipid
water	—H	phosphatidic acid
ethanolamine	—CH <sub>2</sub> CH <sub>2</sub> NH <sub>3</sub> <sup>+</sup>	phosphatidylethanolamine
choline	—CH <sub>2</sub> CH <sub>2</sub> N(CH <sub>3</sub> ) <sub>3</sub> <sup>+</sup>	phosphatidylcholine
mycinositol		phosphatidylinositol
glycerol	—CH <sub>2</sub> CH(OH)CH <sub>2</sub> OH	phosphatidylglycerol

**Figure 3:** Types of glycerophospholipids [19]

### 2.1.2 Marine phospholipids

Marine phospholipids contain high amounts of n-3 PUFA. The most important are eicosapentaenoic acid (EPA, 20:5 n-3) and docosahexaenoic acid (DHA, 22:6 n-3) [1]. It has been observed that n-3 fatty acids in phospholipids are more easily obtainable for catabolic processes than n-3 fatty acids present in triacylglycerols [5]. This is the reason for the growing interest for marine phospholipids containing n-3 PUFA themselves and for incorporating fats rich in n-3 PUFA into food products.

Fish muscle is not the only raw material rich in marine phospholipids. Other important sources are fish roe and Antarctic krill (*Euphausia superba*). Following are examples of lipid composition of Antarctic krill and fish roe. In a study of Pond et al. [20] Antarctic krill (at South Georgia, southern Atlantic ocean) contained between 12.5 and 0.7 % lipids (of the wet mass) and phosphatidylcholine made up around 38 – 14 % of the total lipids. There was a large variability in the lipid content and composition. There were differences among female, male and immature krill and also differences due to catching area (site differences). According to Phleger et al. [21] the polar lipid content made up 56 – 81 % of the total lipids in Antarctic krill from Elephant Island region. In the study of Kaitaranta and Ackman [22] lipids comprised 9.2 – 2.4 % of the roe weight. The major lipids in the mature roe of Baltic herring and roach were polar lipids that made up to 90 – 75 % of the total lipids.

Phospholipids in cod roe and milt constitute around 70 % of the total lipid fraction [23].

Phospholipids are used as emulsifiers in food, because of their emulsification properties. The most widely known is lecithin from egg yolk and soybean oil. Marine phospholipids can also be used for this purpose, but as they contain high amount of polyunsaturated fatty acids, they are susceptible to oxidation, which causes damage to the biological and food system and reduces the quality of food. Some of the effects caused to membranes by oxidation are mentioned above in section 2.1.1. It also leads to formation of off-flavours and loss of antioxidant compounds. In addition, some of the oxidation products were found to be toxic. Because of all these drawbacks utilization of marine phospholipids as a part of processed foods and as nutritional supplement is limited. Therefore it is necessary to get deeper understanding about phospholipid oxidation [1].

## 2.2 Lipid oxidation

Lipid oxidation, one of the major causes of quality deterioration in food systems, is a general term that describes a sequence of chemical reactions between unsaturated fatty acids and reactive oxygen species (ROS) [24, 25].

Lipid oxidation negatively affects flavour, colour and texture; it destroys essential fatty acids and causes an overall decrease in nutritional quality of foods. Oxidation also reduces shelf-life and may produce toxic compounds [7].

Reactive oxygen species is a term used for a group of oxygen radicals and nonradical oxygen derivatives. Superoxide anion radical ( $O_2^{\bullet-}$ ), hydroxy radical ( $OH^{\bullet}$ ), peroxy radical ( $ROO^{\bullet}$ ), alkoxy radical ( $RO^{\bullet}$ ) and hydroperoxy radical ( $HOO^{\bullet}$ ) are the oxygen radicals, whereas hydrogen peroxide ( $H_2O_2$ ), ozone ( $O_3$ ) and singlet oxygen ( $^1O_2$ ) belong to the nonradical oxygen derivatives [25].

Reactive oxygen species can be formed enzymatically, chemically, photochemically, by irradiation of food and also by decomposition of ROS and by inter-reactions of ROS. The most reactive ROS is hydroxy radical followed by singlet oxygen. Lipid oxidation by ROS results in formation of low-molecular-weight volatile compounds such as aldehydes, ketones, alcohols and hydrocarbons. Some vitamins are easily oxidized by ROS (especially by singlet oxygen) [25].

Lipid oxidation can take place in three different pathways:

- a) enzymatic oxidation
- b) nonenzymatic chain autoxidation with free radicals
- c) nonenzymatic photosensitized oxidation (without free radicals).

### 2.2.1 Enzyme-initiated lipid oxidation

Endogenous enzymes liberated from the tissue itself can be a source of initiating species (lipid hydroperoxides). Kanner and Kinsella [26] have shown that tissue peroxidase was able to initiate lipid peroxidation. Lipoxygenase, an iron containing enzyme, from various animal tissues catalyzes the inset of oxygen ( $^3O_2$ ) into unsaturated fatty acid resulting in formation of reactive hydroperoxides. Lipoxygenase has been found to be present in skin [27], gills [28] and muscle [29] of various fish.

The action of lipoxygenase involves oxidation of fatty acids with a 1-*cis*, 4-*cis* pentadiene system, abstraction of hydrogen on methyl group, formation of a conjugated diene, consumption of oxygen, reduction of peroxy radical and addition of a proton before the lipid hydroperoxide leaves the active site. For initiation of lipid oxidation by lipoxygenase-like

system the enzymes have to be activated by previously formed hydroperoxides and fatty acids have to be in their free form [30, 31].

### 2.2.2 Autoxidation

Autoxidation is a free radical chain reaction. It includes initiation, propagation and termination phases.

Triplet oxygen ( $^3O_2$ ) is involved in autoxidation. It is the most stable and abundant form of oxygen; it is the oxygen found in air. Triplet oxygen has got two unpaired electrons. It is a diradical and cannot react with food components, unless these food components are radical compounds. It means that direct oxidation of unsaturated fatty acid (which are in their nonradical singlet states) in lipids by this low-energy ground state oxygen is not possible; this reaction is spin-forbidden. Autoxidation requires radical form of fatty acids or acylglycerols. [32].

The spin restriction can be overcome in several ways, allowing the ground state oxygen to react with lipids and other biological substrates. Examples of the possible initiators are: singlet oxygen, superoxide radical, hydroxy radical, ferryl and perferryl radical, ferrous-dioxygen-ferric complex [30].

During initiation, a hydrogen atom is removed from the fatty acid or acylglycerol to form a lipid alkyl radical. This radical formation can be accelerated by heat, metal catalysts and ultraviolet and visible light [32].

Initiation:

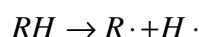

Propagation:

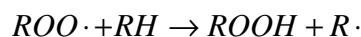
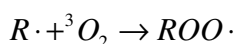

Termination:

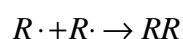
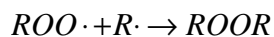

In the propagation step the lipid alkyl radical reacts with triplet oxygen to form lipid peroxy radical. The lipid peroxy radical abstracts hydrogen from another lipid molecule forming hydroperoxide and another lipid alkyl radical. These radicals catalyze the oxidation reaction. The autoxidation is called a free radical chain reaction.

In the termination step radicals react with each other to form nonradical species.

Hydroperoxides are the primary oxidation products. They are relatively stable, but in the presence of metals or at high temperatures they are decomposed to alkoxy and hydroxy radicals (the homolytic cleavage of the oxygen-oxygen bond is the major pathway of hydroperoxide decomposition). Alkoxy radical formed from hydroperoxide is then decomposed by homolytic  $\beta$ -scission of carbon-carbon bond. Two oxo compounds are formed: alkyl and alkenyl radical. The homolytic  $\beta$ -scission is an important reaction in which volatile compounds are produced during oxidation. Then secondary oxidation products are formed: aldehydes, ketones, alcohols, acids, esters and short-chain hydrocarbons [32]. Several secondary products can react further – e. g. with protein amino groups, giving tertiary products called Schiff's bases. Proteins can be reactants in other reactions – they can react with oxygen or lipid radicals, yielding cross-linked proteins or protein-lipid complexes. One of the consequences can be reduced solubility of proteins [7].



### 2.2.3 Photosensitized oxidation

Photosensitized oxidation is a type of oxidation initiation (as will be explained later in this section). This type of oxidation is accelerated by light in the presence of sensitizer such as chlorophylls, pheophytins, heme proteins, riboflavin.

A sensitizer in its singlet state ( $^1S$ ) absorbs energy from light and becomes excited. Excited singlet sensitizer ( $^1S^*$ ) can return to its ground state via emission of light (where fluorescence is produced), internal conversion (heat is produced) or intersystem crossing. The last action results in the formation of excited triplet state of the sensitizer ( $^3S^*$ ). The excited triplet state of the sensitizer can abstract a hydrogen atom from a substrate or donate an electron to a substrate. This substrate may be a fatty acid or a phenol compound. This is Type I sensitizer. Type II sensitizers in their triplet state can transfer their energy to low-energy triplet oxygen to form superoxide anion or singlet oxygen. Superoxide anion produces hydrogen peroxide by a spontaneous dismutation and reaction of hydrogen peroxide with superoxide anion results in the formation of singlet oxygen (Haber-Weiss reaction). The Haber-Weiss reaction occurs in the presence of transition metals, e. g. iron and copper. The sensitizer returns to its ground single state.

Formation of the excited triplet state of sensitizer:

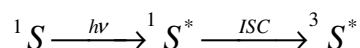

Type I sensitizer:

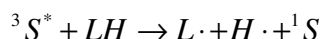

Type II sensitizer:

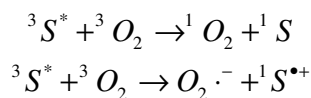

Dismutation:

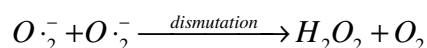

Haber-Weiss reaction:

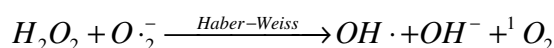

The shift from Type I to Type II reaction or vice versa is dependent on the oxygen concentration and types and concentration of compounds present in the system. The shift between Type I and Type II reactions is dependent on oxygen concentration and types and concentrations of compounds present in the (food) system [18].

Readily oxidizable compounds such as phenols favor reaction of Type I sensitizer.

More than 99 % of the reaction between triplet sensitizer and triplet oxygen results in formation of singlet oxygen. Sensitizers may produce  $10^3 - 10^5$  molecules of singlet oxygen before they become inactive [33].

The rate of Type II pathway is dependent mainly on solubility and concentration of oxygen in the food system. When all the oxygen is used up the reaction shifts from Type II to Type I [18].

Singlet oxygen is electrophilic and can react directly with double bonds with high electron density. Subsequently hydroperoxides are formed and can be decomposed by the same

mechanism as hydroperoxides formed by triplet oxygen in autoxidation. The radicals formed in the decomposition of hydroperoxides can initiate autoxidation (with  $^3\text{O}_2$ ) [32].

Singlet oxygen is able to rapidly increase the oxidation rate of foods even at very low temperatures [34].

Therefore, it can be concluded that photosensitized oxidation is a type of oxidation initiation. Singlet oxygen is suggested to be involved in the initiation of lipid oxidation, because the nonradical and electrophilic singlet oxygen can directly react with double bonds of food components without the formation of free radicals. The rate of singlet oxygen oxidation is much greater than that of triplet oxygen oxidation [18].

Photosensitization is an important mechanism for the formation of singlet oxygen. However, singlet oxygen can be also formed chemically and enzymatically, see Figure 4 [18].

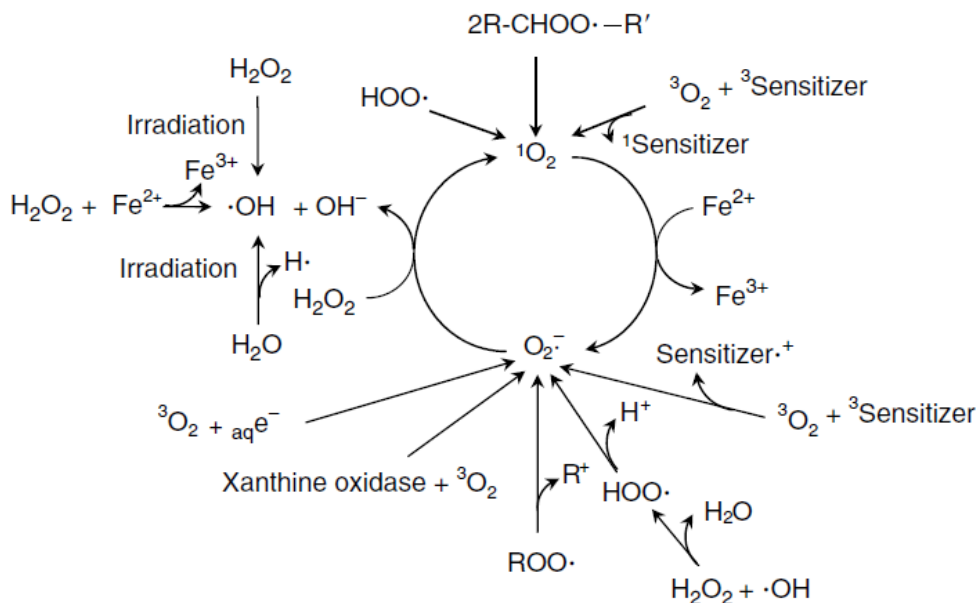

**Figure 4:** Singlet oxygen formation by biological, chemical and photochemical methods [25]

#### 2.2.4 Model systems in oxidation studies

Foods are multicomponent systems, where the interface is a crucial site – oxygen diffuses inside with different rates and interacts with unsaturated lipids, metal initiators and other components.

For lipid oxidation studies several different model systems have been used. These model systems simulate foods or biological systems, but are simplified versions of these. The oxidation substrate, the surrounding environment and storage conditions should be as similar to the real system as possible. However, results obtained with a model system should be interpreted carefully and conclusions should be confirmed in real food systems. The results might be misleading, because model systems are simplified systems and might oversimplify the real interfacial interactions of the food components. On the other hand, model systems should be simple enough to let scientists draw clear conclusions.

Real food systems, such as meat minces, tissue homogenates, mayonnaise, are natural model systems. However, they are very complex systems and it is not advisable to use them

for the study of influence of different factors on lipid oxidation in foods. On the other hand, these systems are suitable for the study of antioxidant utilization.

The following model systems have been used in marine research for the study of lipid oxidation:

- bulk fish oils,
- emulsions,
- isolated membrane (bilayer) structures such as microsomes and marine phospholipid liposomes,
- minced fish,
- washed minced fish [7, 10]

#### **2.2.4.1 Emulsions**

Oil-in-water (o/w) emulsions are widely used as model systems representing food systems with water and lipids. However they are not very good models for fish muscle.

In oil-in-water emulsions oil droplets are dispersed in continuous aqueous phase.

Oil-in-water emulsions consist of buffer that is emulsified in oil with the help of surfactants such as SDS or Tween or with more complex emulsifiers such as whey protein or sodium caseinate.

In studies in oil-in-water emulsions the effect of emulsifier is important, but also the effect of the interaction between emulsifier and antioxidants has to be investigated. The emulsifier is important for the efficiency of an antioxidant, because antioxidants partition in the interface and may react with the emulsifier [7].

#### **2.2.4.2 Washed fish mince**

This model system is very useful and has been used in fish muscle research. It is a matrix with the structure of muscle – it has got intact myofibrillar proteins and membranes, but has no endogenous triacylglycerols, prooxidants and antioxidants. Washing process removes aqueous antioxidants and pro-oxidants. These compounds can be added to the model system in known and controlled amounts (often in physiological levels) and their influence on lipid oxidation under different conditions (e. g. pH, moisture) can be studied [7, 35].

White muscle from cod has been used in most trials, because it contains low levels of both lipids and catalysts. Cod muscle has low mitochondria content. Mitochondria are sources of reactive oxygen species which could disturb lipid oxidation reactions [7, 35].

#### **2.2.4.3 Liposomes**

In general, lipids can adopt different macroscopic structures on hydration – e. g. micellar, hexagonal or bilayer.

Liposomes are microscopic structures containing one or more concentric lipid bilayers. And polar lipids (phospholipids) as amphiphilic molecules, are able to form such bilayer structures (Figure 5). They may even form these structures spontaneously when in contact with excess water. These structures have dimensions of several hundred angstroms (Å) to fractions of a millimeter. Liposomes can consist of one or more lipid lamellae depending on the preparation procedure. The preparation method used also influences the encapsulation efficiency, captured volume, particle size and size heterogeneity. Properties of liposomes are also influenced by the chemical composition of the lipids and liposomes containing cholesterol are more stable for longer storage periods [11].

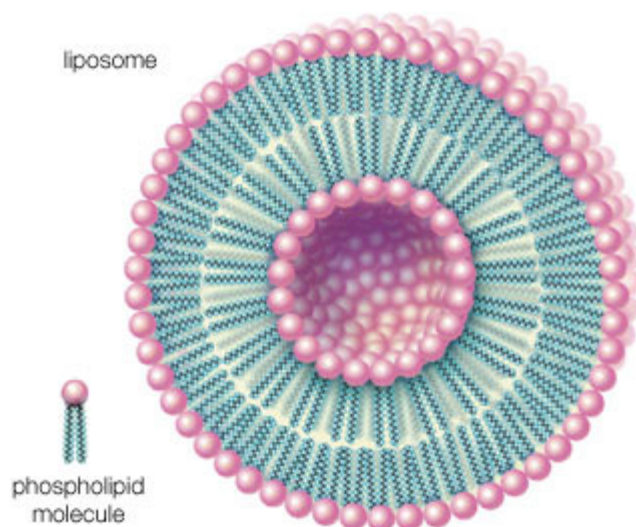

**Figure 5:** A phospholipid molecule and structure of liposome [36]

Liposomes have been used extensively as model membranes. It is possible to entrap various solutes into them during formation of liposomes. Liposomes containing protein components have been used in the study of lipid-protein interaction in biological membranes. Liposomes can also be used as carriers of drugs and macromolecules in vivo [37].

Liposomes made from marine phospholipids have a high potential as an oral supplement for PUFA.

Hydrophilic and/or hydrophobic substances are protected inside liposomes made by encapsulation. In a concept of liposomes as an oral dosage form, liposomes protect the substances from digestive degradation and they can also improve absorption of weakly absorbed drugs in the gastrointestinal tract [37, 38].

Liposomes can also be used as a model system to study lipid peroxidation. The advantages of their use are given in the Introduction to the thesis. It is well known that the major site of oxidative damage to tissues is in the membrane systems of cells. The use of liposomes in the study of lipid peroxidation has several advantages: there is no complication of a possible interference of other cell components; free radicals can be studied in the absence of a chemical free radical generating system; it is possible to handle the lipid composition, manipulate pH, temperature and add various components [11].

Concretely, liposomes can be used for study of effects of metals in lipid oxidation, oxidative interaction of hemoglobin and cell membrane and effects of different antioxidants. Marine phospholipids can be used for the study of oxidation of fish meat, because it has been found that phospholipids of cell membranes make up most of the lipids present in fish lean muscle [7, 10].

### **2.2.5 Physical and chemical factors affecting lipid oxidation**

Food systems are complex matrices. In food systems, lipids are dispersed in heterogenous environments – e. g. muscle tissue or emulsions. Susceptibility to oxidation is therefore influenced by many factors such as the form of lipids in the food system and interaction of lipids with other components. These components might be antioxidants and prooxidants. There is often greater focus on antioxidants than on pro-oxidants. However pro-oxidants are

also an issue of a great importance. Temperature, light, metals, metalloproteins, enzymes and microorganisms are catalytic systems that can oxidize food lipids. These reactions involve free radicals and/or oxygen species [39].

When lipids with polyunsaturated fatty acids are present in the form of bilayers, the lipid oxidation occurs to a greater extent.

In some organelles (such as mitochondria), Fe(III)-ADP and NADH play a pivotal role for enzyme-catalyzed lipid oxidation by oxygen free radical generation [39].

#### **2.2.5.1 Metals**

Lipids in food systems naturally contain trace amounts of metals. Heavy metals, especially those that have two or more valency states, are able to promote lipid oxidation. Among these metals are for example: Fe, Cu, Ni, Zn, Cr, Al. By an electron transfer these metals can change their state between the oxidized and reduced form. This process catalyzes the breakdown of peroxides.

Iron is probably the most important for lipid oxidation. The mechanisms by which iron promotes lipid oxidation is described in section 2.3.2. Iron is commonly present in food – it can be added with some food ingredients such as impurities in salts. Crude oils contain transition metals such as iron and copper, but refining process reduces their contents [32].

Muscle foods contain high amounts of iron. More than 95 % of iron in muscle is bound to protein – as ferritin, myoglobin and hemoglobin. Iron can be released from ferritin and non-enzymatic oxygen activation occurs via Haber-Weiss reaction [39].

Iron is an essential chemical element for humans. It plays role in oxygen transport, respiration and is a part of some enzymes [13].

Due to iron deficiency some foods (e.g. bread, breakfast cereals) have been fortified with iron to prevent this common nutritional deficiency [40]. However this may entail a difficulty – iron in these matrices can cause oxidation of lipids, rancidity, and another negative changes.

Transition metals reduce activation energy of the initiation step in autoxidation therefore metals increase the rate of oxidation. Metals are able to react directly with unsaturated lipids to produce lipid alkyl radicals, but this reaction occurs slowly. That is why this reaction is not believed to be important in lipid oxidation promotion. Metals also produce reactive oxygen species such as singlet oxygen and hydroxy radical [41]. Metal-catalyzed decomposition of pre-formed lipid hydroperoxides is a very important initiator in lipid oxidation. Decomposition of lipid hydroperoxides produces radicals that are able to initiate further oxidation, but also leads to formation of secondary oxidation products which cause off-flavour [32].

#### **2.2.5.2 Moisture content**

There is a relationship between moisture content and lipid oxidation rate. For prediction of stability against oxidation the following factors have to be taken into account: water activity, moisture composition and the state of water. Water is a medium which dissolves hydrophilic antioxidants and pro-oxidants (e. g. metals). Generally, if water is removed from a food system, lipid oxidation decreases. This is because of lower mobility of reactants such as transition metals and oxygen. Water activity of food is a physical state that protects lipids from oxidation deterioration by a type of microencapsulation. Proteins and polysaccharides undergo glass transitions giving this protection. In some foods, removal of water will lead to

increase in lipid oxidation. The reason is probably the loss of a protective water solvation layer surrounding lipid hydroperoxides [16, 39].

### **2.2.5.3 Emulsifiers**

There are two groups of emulsifiers – macromolecules such as proteins and the second group consists of small amphiphilic molecules such as phospholipids, free fatty acids, monoacylglycerols, diacylglycerols and surfactants.

Proteins are absorbed to the oil droplets' surface, they facilitate the formation of oil/water droplets and they increase the stability of the emulsion. They act by lowering the surface tension. They prevent fusion of the droplets.

Emulsifiers may affect the oxidative stability via their surface charge - positively charged droplets may repel positively charged metal ions which results in decrease of oxidation. In contrast, if the surface charge is negative, the metal ions will be attracted to the surface. It is believed that lipid oxidation is initiated on the oil-water interface. Here, if the metal ions are attracted to the interface, the water soluble metal ions can come in contact with less polar lipid hydroperoxides. Therefore the ability of metal ions to promote oxidation is high. The surface charge can be influenced by pH. As for proteins, they give positive or negative charge to the droplets when the pH is below or above their isoelectric point (pI), respectively. Actually all the droplets will either have a positive or negative charge, so they will repel each other and they themselves will contribute to the stability of the emulsion by preventing the coalescence [7].

The oxidation rate of an emulsion can also be influenced by the amino acid composition of protein, because the amino acid composition affects its antioxidative activity [42].

Some emulsifiers have the ability to chelate metals or have free radical properties, which inhibits the oxidation reaction [7].

### **2.2.5.4 Proteins**

Polypeptides are susceptible to an attack by free radicals and therefore polypeptides are susceptible to oxidation. Some proteins can be directly affected by free radicals while others can be affected secondarily by these reactions. Oxidation reactions are responsible for changes in functionality of some proteins, protein solubility and distribution of water in muscle foods. In addition to lipid oxidation it is important to prevent protein oxidation as well to keep high nutritional and sensory quality of food. Little is known about protein oxidation compared to lipid oxidation and the products and off-flavour formed [7, 39].

### **2.2.5.5 pH**

pH plays a crucial role in the process of lipid oxidation. pH affects solubility, reactivity, interactions and partitioning of many compounds that are parts of the food system both for lipid oxidation and antioxidant reactions [7].

As already mentioned in part 2.1.3.3., pH influences the surface charge of emulsion droplets with protein emulsifiers (and thereby the interaction with metal ions).

pH also influences the rate of lipid oxidation caused by hemoglobin (Hb) [43]. Binding of oxygen by acidic hemoglobins is dependent on pH [44]. Formation of methemoglobin by autoxidation of ferrous oxyhemoglobin was found to occur more rapidly at reduced pH [45]. Acidic pH enhances hemoglobin subunit formation as compared to higher pH. Hb subunits undergo autoxidation more rapidly than tetramers [46].

Metal ions are more soluble at low pH than at high pH. According to this fact, lipid oxidation is promoted at low pH. Mozuraityte [10] studied lipid oxidation of marine phospholipid liposomes induced by ferric/ferrous ions and found that the oxygen uptake rate was dependent on pH with a maximum at pH 4 – 5. The influence of pH was explained by iron availability and changes in Zeta potential.

However in complex food systems different factors may be influenced by pH in a different way than when they are present alone [7].

#### **2.2.5.6 Temperature**

Generally, increased temperature leads to increased reaction between molecular oxygen and food lipids. Therefore, food (including muscle foods) should be stored at refrigeration or freezer temperatures. But lower temperatures may not always ensure reduced susceptibility to lipid oxidation, because the amount of dissolved oxygen is higher at low temperatures [46].

If singlet oxygen is involved in oxidation, it rapidly increases the rate of oxidation of foods even at very low temperatures [18].

Cooking causes dramatic increase in lipid oxidation in muscle. During the cooking process cellular compartments are broken, lipids in membranes become exposed to prooxidants, antioxidants are degraded, volatilize, and antioxidant enzymes become thermally inactivated through denaturation. On the other hand, relatively higher temperatures favor the formation of Maillard products, which have antioxidant properties and can retard lipid oxidation [30, 39].

### **2.3 Prooxidants**

#### **2.3.1 Hemoglobin**

A brief introduction for the role of hemoglobin as a promoter of lipid oxidation is given in the Introduction to the thesis (section 1) and its role as a photosensitizer is mentioned in section 2.2.3.

Heme pigments (hemoglobin and myoglobin) are responsible for the colour of meat. Hemoglobin (Hb), the main pigment of red blood cells, is an iron-containing metalloprotein. Hb consists of four polypeptide chains (globins) with each chain containing one heme group. Heme is a chromophore component responsible for light absorption and colour. Heme group consists of a porphyrin ring with a central iron atom. The porphyrine ring is formed by four pyrrole rings joined together and linked to the iron atom (see Figure 6). The central iron atom possesses six coordination sites, four of which are occupied by the nitrogen atoms within the tetrapyrrole ring. The fifth coordination site is bound by the histidine residue of globin; the sixth site is available to complex with electronegative atoms donated by various ligands. Hb forms reversible complexes with oxygen in lungs; the heme group is responsible for binding molecular oxygen. This complex is then distributed via the blood to various tissues throughout the body where oxygen is absorbed [16].

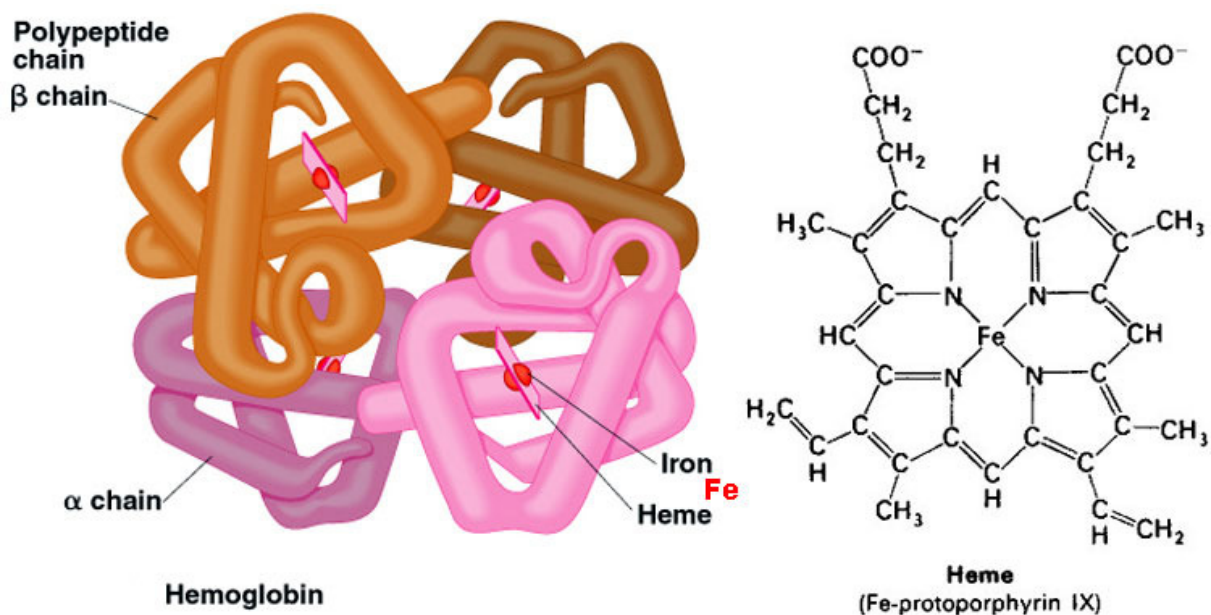

**Figure 6:** Model of hemoglobin and the structure of heme-group [47]

The heme iron within the porphyrin ring may exist in several forms (more of them are described in section 2.3.1.1):

In the reduced form ( $\text{Fe}^{2+}$ ), oxygen molecule can be bound to iron. This binding is stabilized by hydrogen bonds to the distal histidine. When molecular oxygen binds to Hb, oxyhemoglobin is formed (red  $\text{HbO}_2$ ) and this process is called oxygenation. Another situation occurs at low pH or at low oxygen tension - oxygen is not bound (blue deoxyhemoglobin) [13].

When oxidation of Hb occurs, the iron atom is converted to its oxidized state ( $\text{Fe}^{3+}$ ), forming methemoglobin (brown colour). Methemoglobin is not able to bind oxygen [8].

### 2.3.1.1 Heme-iron catalysis

Hemoglobin can be found in raw fish material and in a variety of seafood products. Considering meat, a *post mortem* system, which is different from a living tissue, the metabolism gradually changes after death, when muscles are no longer supplied with oxygen. As the oxidative metabolism changes to glycolytic metabolism, lactic acid is accumulated in the muscle, which results in a pH drop – from 7.4 to approximately 6.0 – 5.5. Furthermore, the compartmentalisation of the muscle is destroyed, which comprises the processes such as protein denaturation and potential reactants are mixed [12, 48].

Under conditions such as depletion of oxygen, pH decrease or fluctuating oxygen supply in tissues, heme pigments may become catalytic. Similar changes occur during the conversion of muscles to meat [9]. Values of pH below neutrality are typical for *post mortem* muscle systems. Therefore knowledge about the effect of pH below neutrality is important for understanding lipid oxidation in *post mortem* meat and fish [45].

Several studies have reported that Hb is an effective promoter of lipid oxidation [8, 35, 49–52]. Nowadays it is believed that Hb is the major catalyst (possibly with Mb) of lipid oxidation in fish. Hb might be responsible for the different rates of lipid oxidation between lean and dark-muscle fish (dark-muscle fish contain higher amounts of hemoglobin than lean fish) [51, 53].



There are several potential mechanisms by which Hb can promote lipid oxidation:

Hemoglobin can act as a **photosensitizer**, because it possesses the ability to absorb energy from light. This energy is then transferred to triplet oxygen to form singlet oxygen, which can then react with fatty acids, thus initiating lipid oxidation [54].

In **autoxidation**, process in which Hb is converted to metHb, hydroperoxy radical ( $\text{HOO}\bullet$ ) or superoxide anion radical ( $\text{O}_2\bullet^-$ ) is liberated. These two radicals can be readily converted to  $\text{H}_2\text{O}_2$ , which promotes the lipid-oxidation ability of Hb, because the reaction of metHb with  $\text{H}_2\text{O}_2$  causes formation of hypervalent iron species (perferrylhemoglobin and ferrylhemoglobin). Perferrylhemoglobin rapidly transforms to ferryl hemoglobin, which is an initiator of lipid oxidation [55]. Besides  $\text{H}_2\text{O}_2$ , hemoglobins have the ability to decompose other strong oxidizing agents - preformed lipid hydroperoxides. The reaction of metHb with peroxides also yields ferrylhemoglobin ( $\text{Fe}^{4+}=\text{O}$ ), more precisely ferryl heme protein radical. This ferrylhemoglobin is also known as the activated metHb. Although this ferryl radical has a short half-life, it is able to abstract a proton from a lipid (LH), leaving lipid alkyl radical  $\text{L}\bullet$ , which can form lipid peroxy radical  $\text{LOO}\bullet$  in the presence of oxygen. This radical can react with another lipid molecule, which causes further oxidation – a free radical circle is formed. It is important to say that, more precisely, it is actually the transition metal associated with proteins which can promote hydroperoxide decomposition [16, 18, 55].

The prooxidative activity of Hb is highly dependent on **pH**. Lipid oxidation is accelerated by pH reduction probably because the autoxidation of Hb is enhanced at reduced pH [56]. At low pH (2.5 – 3.5), the more unfolded the Hb is the more exposed is its heme group, which increases its prooxidative activity [57]. On the other hand, autoxidation reaction is reduced at an alkaline pH, because interactions with distal histidine become stronger; the conformation of Hb is more stable at high pH [58]. The enhanced autoxidation at low pH can be partly explained by the increased dissociation of the tetramer to dimers (for mammalian hemoglobins [56]) and probably full dissociation to monomers (for fish hemoglobins [59]). The dissociated form of Hb is more prooxidative and it is more likely to lose its heme [60]. Many fish species contain multiple Hb components – acidic and basic hemoglobins. Binding of oxygen by acidic hemoglobins is dependent on pH, whereas basic hemoglobins bind oxygen independent of pH. Deoxygenation of acidic Hb is favored at low pH, which could promote lipid oxidation via acceleration of Hb autoxidation [44]. Some hemoglobins (e. g. trout Hb) are known to have exaggerated Bohr effects. The Bohr effect is explained as an increase in deoxyHb content due to decreasing pH. Relatively minimal Bohr effects occur in mammalian hemoglobins [59, 61]. Thus, typically, low deoxyHb content is associated with low autoxidation rate. However, Richards and Dettman found that the autoxidation rate of perch Hb was more rapid than trout Hb, although perch Hb had low deoxyHb content. Perch Hb was a better catalyst of lipid oxidation than trout Hb in washed cod muscle. This indicates that autoxidation rate is not always higher with increasing deoxyHb content and that the heme crevice characteristics have to be considered [62]. The crevice and its heme are hydrophobic and are thought to play a major role in aggregation of Hb [57]. This suggests a mechanism other than deoxyHb-mediated metHb formation and that autoxidation might not be dependent only on the  $\text{O}_2$  affinity. Using various Mb mutants it has been found that decreasing the size of amino acid residues near the heme crevice facilitates the access of ligands (e. g.  $\text{H}_2\text{O}$ ; coordinated  $\text{H}_2\text{O}$  in the heme crevice is a reactant in Hb autoxidation) to the heme crevice and promotes autoxidation [63, 64].

**Thermal denaturation** of these proteins can increase their prooxidative activity presumably by increased exposure of the heme iron that is able to more effectively interact with hydroperoxides. Denaturation of Mb is one of the factors that accelerate lipid oxidation in cooked meats, a problem known as warmed-over flavor [16].

Not only metHb, but also deoxyHb, heme and hemin are able to **break down preformed lipid hydroperoxides** forming lipid radicals. Alternatively, displaced hemin or released iron can promote lipid oxidation. Iron can be released from hemoglobin (e. g. during storage). Therefore it is difficult to find whether the released iron, dissociated heme or the intact heme protein is responsible for lipid oxidation. The difficulty is that the heme protein autoxidation, heme dissociation, heme destruction and iron release can all take place in a very short period of time and simultaneously [8, 65, 66].

The following physical and chemical properties have to be taken into account when evaluating the prooxidative role of the heme protein: oxygen affinity, subunit formation, autoxidation rate, heme affinity and heme destruction [35, 67]. In their comparative analysis of different hemoglobins [62] Richards and Dettmann conclude that among other factors, their study suggests that rates of lipid oxidation in various muscle foods may be dependent on the relative ability of Hb from different animal species to promote lipid oxidation.

Heme-iron catalysis potentially comprises both one-electron and two-electron transfer processes. Heme pigments may leak iron, which can be transformed to simpler iron species that may bind to the negatively charged phospholipids and catalyze (e. g. Fenton-type) reactions in membranes [68]. In solution, heme is mainly found as hematin. Heme, hemin, and hematin are used interchangeably to express the presence of non-protein bound heme-iron (or “free heme-iron”). Hemin is a form that readily transforms into hematin in aqueous solution [12].

In the **Fenton-like mechanism** of catalysis, a hydroxyl radical (or in the case of LOOH reduction LO• radical), is formed in the first reaction of the cycle, see Figure 7. This reaction is thermodynamically favorable. As the second reaction of the catalytic cycle, the reduction of heme-Fe(III) by H<sub>2</sub>O<sub>2</sub> is proposed. This reaction is slower than the first one. There can be other reductants than H<sub>2</sub>O<sub>2</sub> (e. g. ascorbate). The catalysis through the Fenton-like mechanism is influenced by the high oxygen affinity of Mb and Hb, which leads to rapid oxygenation of Mb-Fe(II) and Hb-Fe(II) at normal physiological oxygen concentrations. Therefore deoxyheme-Fe(II) proteins available for the Fenton-like reactions is dependent on the rate constant of oxygen dissociation of the heme-Fe(II)O<sub>2</sub> protein [69].

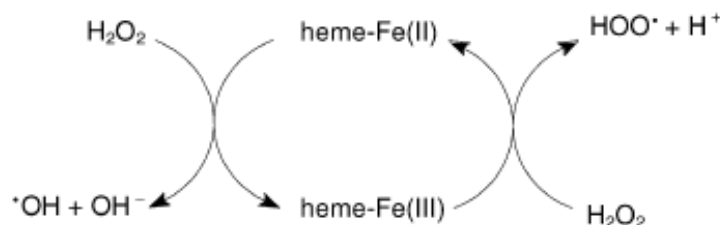

**Figure 7:** Proposed mechanism of heme-Fe(II)/heme-Fe(III) catalysis (a Fenton-like mechanism) [12]

**Heme-Fe(III)/heme-Fe(IV) mechanism:** Oxidation of heme-Fe(III) to iron species with higher oxidation states (hypervalent species) is known to occur in reaction with peroxides.

Hypervalent forms of Hb and Mb have characteristic visible absorption spectra [70]. As can be seen in Figure 8, one-electron transfer takes place between heme-Fe(III) and LOOH.

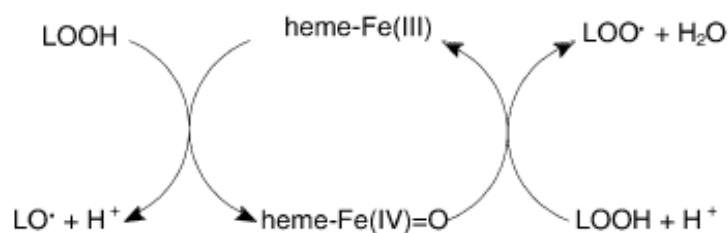

**Figure 8:** Proposed mechanism of heme-Fe(III)/heme-Fe(IV)=O catalysis [12]

In the initial reaction one electron and oxygen atom are transferred from a peroxide to the heme group and the last electron for the iron-oxygen bond comes formally from Fe(III), which is oxidized to Fe(IV) [71]. The heme-Fe(IV)=O species is strongly oxidizing, therefore the regeneration of heme-Fe(III) (in the second reaction of the cycle) is possible. Oxidative cleavage of LOOH to LOO• by ferrylmyoglobin is favorable [55]. Also another compounds such as plant phenols (and other antioxidants) can efficiently react with ferrylmyoglobin to regenerate MbFe(III) [72]. The regeneration of MbFe(III) can also occur due to autoreduction of MbFe(IV)=O (that means, regeneration of MbFe(III) occurs even in the absence of a reducing compound). However, the rate of autoreduction is probably too slow for an efficient catalysis. The LO• radical formed in the first reaction of the cycle along with heme-Fe(IV)=O have the potential to accelerate oxidation reactions. In model systems containing both LOOH and H<sub>2</sub>O<sub>2</sub>, MbFe(IV)=O has been detected. However, detection of heme-Fe(IV)=O species does not necessarily mean that the cyclic reactions shown in Fig. 8 represent the actual mechanism [12, 73].

**Pseudoperoxidase mechanism:** The reactions of the pseudoperoxidase cycle (see Figure 9 – pseudoperoxidase cycle with Mb as the heme-Fe catalyst and H<sub>2</sub>O<sub>2</sub> as the peroxide) are generally the same as reactions in which true heme peroxidases are present. However, Mb and Hb react slower with peroxides than real peroxidases, and moreover their peptide chains might be oxidatively altered during repeated peroxidase cycling. Thus, peroxidase cycling of Mb and Hb can be best described as a pseudoperoxidase cycling. In this mechanism, a two-electron transfer from heme-Fe(III) takes place. Subsequently, heme-Fe(III) is regenerated by getting an electron from two electron donors. These donors may be lipids or proteins therefore this cycle may both initiate and propagate oxidation. If the donors are antioxidants, almost unreactive radicals are formed, and the overall result is the antioxidative cycle [74]. In the reaction an oxygen atom (from peroxide) binds to the heme-iron and the two electrons needed for the iron-oxygen bond are originating from the heme-iron species. One electron formally comes from Fe(III) which is oxidized to Fe(IV) and the second electron comes from the porphyrin ring (which is oxidized to a porphyrin radical cation). In Mb and Hb, this radical cation oxidizes an amino acid residue of the surrounding peptide chain, resulting in formation of perferryl species as a protein radical with iron in the oxidation state +4 [71, 75].

Structural differences between heme pockets of Mb and classical peroxidases are suggested to be responsible for the observed difference in peroxidase activity. The Fe(III) state of peroxidases is pentacoordinated, i. e. the sixth site does not have any ligand, whereas Fe(III) state of Mb is hexacoordinated – the sixth ligand is a water molecule. Therefore

a water molecule must leave the heme of MbFe(III) before it is oxidized to hypervalent states. Charged amino acid residues close to the heme group in the heme pocket (which most peroxidases contain, but Mb does not) are believed to favour the reactions of the peroxidase cycle [76, 77].

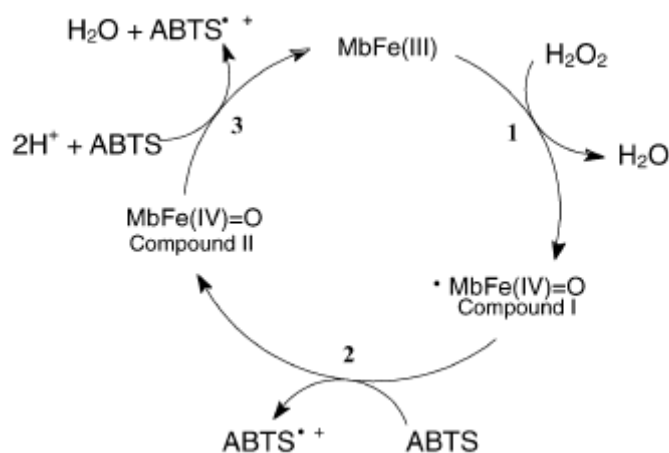

**Figure 9:** Pseudoperoxidase cycle of myoglobin. H<sub>2</sub>O<sub>2</sub> and ABTS are substrates [12]

**Heme-Fe(II)/heme-Fe(IV) mechanism:** Heme-Fe(II) species can be oxidized by two-electron transfer when mixed with peroxides, as can be seen by the detection of MbFe(IV)=O in reaction mixtures containing MbFe(II) and H<sub>2</sub>O<sub>2</sub> [78]. The oxygenated forms of heme pigments have also been shown to form the ferryl states in the reaction with H<sub>2</sub>O<sub>2</sub> [79], but results from the study by Yusa and Shikama suggest that MbFe(II)O<sub>2</sub> seems to be deoxygenated before it reacts with H<sub>2</sub>O<sub>2</sub> [78]. MbFe(II)/HbFe(II) must be regenerated from MbFe(IV)=O or HbFe(IV)=O, respectively, if the catalytic reaction cycle should be working. However, as the ferryl states preferentially reduce to ferric states (in one-electron transfer system), the regeneration above does not seem to take place. It can be concluded that the catalytic heme-Fe(II)/heme-Fe(IV) mechanism does not seem to operate, because heme-Fe(II) is not regenerated when the heme-Fe(III) is the “end-product”. This does not mean that the heme-iron catalysis is prevented, because Mb-Fe(III) can exert catalytic activity through mechanisms described in Fig. 7 and 8. MbFe(IV)=O radical is not formed in the reaction between MbFe(II)O<sub>2</sub> and H<sub>2</sub>O<sub>2</sub>, but only in reaction between MbFe(III) and H<sub>2</sub>O<sub>2</sub>. However, increasing amounts of H<sub>2</sub>O<sub>2</sub> leads to higher formation of MbFe(IV)=O radical also in the MbFe(II)O<sub>2</sub>-solution [78, 80].

In conclusion, the above described mechanisms of the prooxidative activity are classified into four groups and each of the mechanisms alone or combinations of these mechanisms may work depending upon the specific conditions in biological systems [12].

### 2.3.2 Iron

An introduction about the presence and the role of iron is given in part 2.2.5.1.

Three mechanisms are known by which metals promote oxidation (examples of reactions are shown with iron).

a) In the first mechanism (mentioned in 2.1.3.1.) transition metals can directly react with unsaturated lipids and break them down into lipid alkyl radicals (L•):

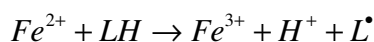

However this reaction occurs slowly, there are spin barriers and thermodynamic limitations and therefore this reaction is not believed to play an important role in lipid oxidation promotion.

b) The second mechanism is the lipid hydroperoxide-dependent mechanism. Two possible pathways have been proposed:

➤ LOOH breakdown by  $Fe^{2+}$ :

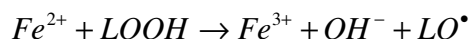

and subsequent abstraction of hydrogen atom by  $LO^{\bullet}$  radical:

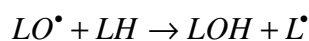

➤ LOOH breakdown by  $Fe^{3+}$ :

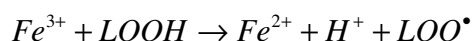

and subsequent abstraction of hydrogen atom by  $LOO^{\bullet}$  radical:

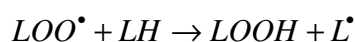

c) In the third mechanism ground state oxygen can be activated in the presence of transition metals and the initiation of oxidation occurs either by hydroperoxy radical or singlet oxygen formed:

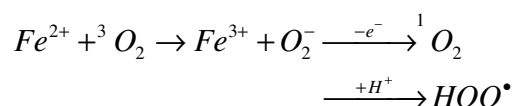

Metal-catalyzed decomposition of lipid hydroperoxides is believed to be the most important mechanism. Even trace amounts of these transition metals can promote the shift of electrons from lipid hydroperoxides because reactions of  $Fe^{2+}$  and  $Fe^{3+}$  with lipid hydroperoxides (LOOH) can run in cycles, so the lower oxidation state of metal is regenerated. Metals in lower oxidation state are better and faster promoters of hydroperoxide decomposition than metals in their higher oxidation state.  $Fe^{2+}$  has been reported to decompose peroxides at a higher rate than  $Fe^{3+}$  [10, 18]. This could be due to the fact that the activation energy that is needed for the cleavage of O-O bond is lower than activation energy required for the cleavage of O-H bond, which is 184kJ/mol and 377kJ/mol, respectively [18].

In Figure 10 the proposed mechanism of lipid peroxidation catalyzed by metals is shown.

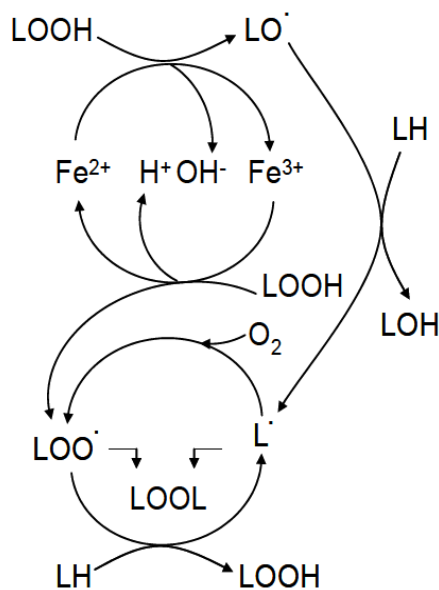

**Figure 10:** Proposed mechanism of transition metals-catalyzed lipid peroxidation [10]

## 2.4 Antioxidants

An antioxidant can be defined as any substrate that significantly delays or prevents oxidation of an oxidizable substrate when present at low concentrations compared with those of the oxidizable substrate. The term “oxidizable substrate” refers to every type of molecule found *in vivo*, which includes proteins, lipids, sugars, nucleic acids etc. The oxidative damage to the substrate is caused by reactive oxygen species (ROS). Many substances can act as antioxidants, but their relative importance and efficiency depends upon the type of ROS generated, the type of substrate as a target of the oxidative damage and where this damage takes place [81].

The inhibition by antioxidant can occur in two ways: it reduces the rate at which maximal level of oxidation is reached and reduces the maximal level of oxidation [18].

In foods, antioxidants help maintain food quality and increase shelf life. Antioxidants used in food processing have to fulfill several requirements, such as: they must be relatively cheap, effective at low concentrations, stable (also during food processing steps), nontoxic and their influence on flavour, odour and colour should be minimal [18].

Antioxidants can be classified according to the mechanism of action as primary and secondary antioxidants. Some antioxidants are multiple-function antioxidants, which means, that they exhibit more than one type of mechanism of activity. Antioxidants can also be classified according to their origin as natural and synthetic antioxidants [18].

### 2.4.1 Primary antioxidants

Primary (Type I) antioxidants are chain-breaking antioxidants that act as free radical acceptors. They are often called free radical scavengers (FRS). These antioxidants delay or inhibit the initiation step or interrupt the propagation step of autoxidation. The mechanism of primary antioxidants action is the donation of antioxidant’s hydrogen atom to the radicals [18].

There are two reaction mechanisms by which hydrogen atoms can be transferred to a free radical: hydrogen atom transfer (HAT) and single-electron transfer (SET). In the HAT

mechanism, a whole hydrogen atom is transferred (abstracted) from an antioxidant to a free radical using the same sets of orbitals. The antioxidant becomes a radical in the reaction:

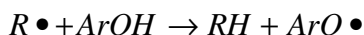

In the HAT mechanism, the main parameter determining the antioxidant efficacy is the bond dissociation enthalpy of the O-H bonds – the weaker the bond, the easier the hydrogen transfer and the easier the free radical inactivation.

In the SET mechanism, the hydrogen atom is transferred as a proton ( $H^+$ ) and an electron and different sets of orbitals are used. After the hydrogen transfer, the radical becomes an anion and the antioxidant becomes a radical cation ( $ArO \bullet^+$ ). The most important parameter for evaluation of the scavenging ability for this mechanism is the ionization potential: the lower the ionization potential, the easier the electron abstraction.

Primary antioxidants can react with lipid, peroxy and alkoxy radicals and convert them to more stable, nonradical products. They can slow down oxidation in the initiation phase, where antioxidants scavenge lipid radicals ( $L \bullet$ ), or in the propagation phase of lipid peroxidation, where they scavenge lipid peroxy radicals ( $LOO \bullet$ ) and/or lipid alkoxy radicals ( $LO \bullet$ ) [18].

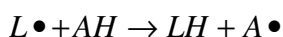
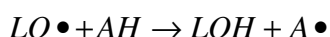
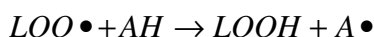

The antioxidant radicals and lipid derivatives that are formed after hydrogen donation are more stable and they are less readily available for further oxidation. The antioxidant radical has a very low reactivity with lipids. The antioxidant radical is stabilized by delocalization of the unpaired electron in the phenol ring and forms stable resonance structures [18].

FRS primarily reacts with peroxy radicals because the propagation phase is a slow step in lipid oxidation therefore there is a high concentration of this radical. Another reason is that peroxy radical has lower energy than other radicals (such as alkoxy radical or hydroxy radical, which are so reactive, that they react with molecules that are in the closest proximity). FRS competes more effectively with other compounds (mainly with unsaturated fatty acids) for peroxy radicals and is therefore not likely to react with high-energy free radicals [18].

The antioxidant efficiency is influenced by the ability of FRS to donate hydrogen to the free radical. The lower the hydrogen bond energy of the FRS the faster the transfer of the hydrogen atom to the free radical. This ability of an FRS to donate hydrogen can be predicted according to the standard one-electron potentials. The higher the reduction potential of a compound (e. g. ROS) the greater the oxidizing ability of this compound. For example, the hydroxy radical has a very high standard reduction potential (2310 mV) and is one of the most reactive species known [18, 25]. The standard reduction potentials of reactive oxygen species are shown in Table 1.

Any compound that has a reduction potential lower than the reduction potential of a free radical is able to donate hydrogen to this free radical. ROS, which has a reduction potential greater than 1000 mV, is thermodynamically capable of oxidizing PUFA, which has a reduction potential of 600 mV [25]. For example, FRS  $\alpha$ -tocopherol has reduction potential of 500 mV and is therefore capable of donating hydrogen to peroxy radical (mentioned above) which has 1000 mV. The hydrogen of the hydroxyl group on  $\alpha$ -tocopherol has lower

reduction potential than the methylene-interrupted hydrogen in PUFA molecule (600 mV). Therefore  $\alpha$ -tocopherol can react with peroxy radicals more rapidly than unsaturated fatty acids [18].

**Table 1:** Standard reduction potentials of reactive oxygen species [18]:

Reactive oxygen species (half-cell)	Standard reduction potential (mV)
$O_2, H^+ / HO_2\bullet$	- 460
$O_2 / O_2\bullet^-$	- 330
$H_2O_2, H^+ / H_2O, HO\bullet$	320
$O_2\bullet^-, H^+ / H_2O_2$	940
$ROO\bullet, H^+ / ROOH$	1000
$HO_2\bullet, H^+ / H_2O_2$	1060 ~ 1500
$RO\bullet, H^+ / ROH$	1600
$HO\bullet, H^+ / H_2O$	2310

The efficiency of a FRS is also dependent on the energy of the resulting FRS radical (FRS $\bullet$ ). If the FRS radical is a low-energy radical, it is not likely that it will catalyze oxidation of other compounds. Very efficient FRS form low-energy radicals thanks to the resonance delocalization of the unpaired electron. Moreover, efficient FRS form radicals that do not react rapidly with oxygen resulting in peroxide formation. These hydroperoxides could be decomposed producing other free radicals [18].

Antioxidant radicals can participate in termination reactions with peroxy, alkoxy or antioxidant radicals forming nonradical species [18]:

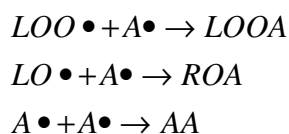

Primary antioxidants can reduce hydroperoxides to hydroxy compounds, but the main antioxidative mechanism of primary antioxidants is radical scavenging [18].

Ascorbic acid (vitamin C) is active as a radical scavenger in aqueous media, but only at higher concentrations ( $\sim 10^{-3}$  M). A prooxidant activity of ascorbic acid has been observed at lower concentrations ( $10^{-5}$  M), especially in the presence of metals and/or at high oxygen pressures. This may occur by ascorbate-mediated generation of hydroxy radicals [16, 82].

Effective primary antioxidants are mono- or polyhydroxy phenols. From this point of view, phenolic compounds will be discussed in section 2.4.3.3, as well as tocopherols (section 2.4.3.4) and carotenoids (section 2.4.3.2), which are also compounds with primary antioxidant activity. There are also primary antioxidants of a synthetic origin, such as butylated hydroxyanisole (BHA), butylated hydroxytoluene (BHT), propyl gallate (PG) and tertiary butylhydroquinone (TBHQ) [18]. These will be discussed briefly in section 2.4.4.

## 2.4.2 Secondary antioxidants

Secondary (preventive, Type II) antioxidants slow down the rate of oxidation by several different mechanisms, but they do not convert radicals to more stable products. Secondary antioxidants can:



- Chelate prooxidant metals and deactivate them
- Replenish hydrogen to primary antioxidants
- Decompose hydroperoxides to nonradical products
- Deactivate singlet oxygen
- Absorb ultraviolet radiation
- Act as oxygen scavengers

These antioxidants are often called synergists, because they promote the antioxidant action of primary antioxidants [18].

#### **2.4.2.1 Chelators**

Several heavy metals with two or more valence states (Fe, Cu, Mn, Ni, Zn, Cr, V, Al) promote oxidation, because they act as catalysts of free radical reactions. They transfer single electrons during changes of oxidation state [18]. See section 2.2.5.1 for the introduction for metals. Mechanisms of oxidation promotion by transition metals are discussed in section 2.3.2.

The prooxidative activity of metals can be altered by chelators or sequestering agents. Chelators inhibit the activity of prooxidant metals by one or more of these mechanisms:

- Prevention of metal redox cycling
- Occupation of all coordination sites of the metal
- Formation of insoluble metal complexes
- Steric hindrance of interactions between metals and lipids or oxidation intermediates (e. g. hydroperoxides)

The main metal chelators found in foods contain multiple carboxylic acid (e. g. EDTA, citric acid) or phosphate groups (e. g. polyphosphate, phytate). The efficiency of oligophosphates increases with increasing number of phosphate groups up to six residues [16, 18].

Chelators must be ionized to be active – their activity decreases if the pH value is below the  $pK_a$  of the ionizable groups [16].

Chelators are typically water-soluble, but some are soluble in lipids (e. g. citric acid) and therefore the chelator is able to inactivate metals in the lipid phase [18].

A chelating ligand (also called a chelating agent) must contain at least two functional groups capable of donating electrons. These groups have to be spatially arranged so that a ring containing the metal ion can be formed. Chelates are more thermodynamically stable than similar complexes that are not chelates [16].

Some metal chelators can increase the oxidative reactions by increasing the solubility of the metal and/or modify the redox potential. The chelating activity can be decreased by the presence of other chelatable ions, such as calcium, because these ions compete with the prooxidative metals for binding sites [18].

#### ***EDTA (ethylenediamine tetraacetic acid)***

EDTA is a hexadentate ligand. When EDTA forms a chelate with a metal ion in solution, it displaces six water molecules from the metal ion. This, together with the fact that EDTA chelates contain five rings, enhances the stability of the complex. EDTA forms stable chelates with many metal ions [16]. One example is given in Figure 11.

Whether the chelator will inhibit or accelerate the prooxidant activity is dependent on the metal-to-chelator ratio. EDTA is a typical example for this: EDTA is ineffective or prooxidative when the EDTA:iron ratio is  $\leq 1$  and antioxidative when the EDTA:iron ratio is  $> 1$  [16].

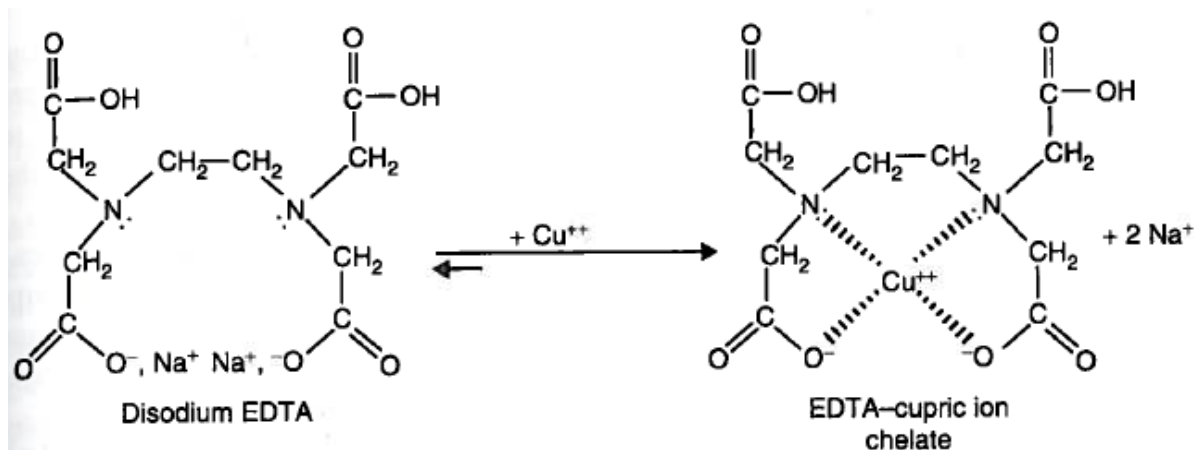

**Figure 11:** Schematic representation of chelation of cupric cation by disodium EDTA [16]

Prooxidant metals can also be controlled by metal binding proteins, such as transferrin, ovotransferrin, lactoferrin, ferritin, albumin. Transferrin and lactoferrin bind two ferric ions apiece, ovotransferrin has been reported to bind three. Ferritin is a multisubunit protein that is able to store up to 4500 ferric ions. Transferrin, ovotransferrin, lactoferrin and ferritin inhibit iron-catalyzed lipid oxidation by binding iron in its ferric state (inactive state) and possibly by sterically hindering interactions between metal and peroxides. Combination of a presence of some reducing agents (e. g. ascorbate, cystein) and low pH can cause release of iron from the proteins, and therefore acceleration of the oxidation reactions [18].

#### 2.4.2.2 Oxygen scavengers and reducing agents

To this group of secondary antioxidants belong ascorbic acid, ascorbyl palmitate, erythorbic acid, sodium erythorbate and sulfites. Oxygen scavengers and reducing agents act by donating hydrogen atoms. Oxygen scavenging activity is useful in products with dissolved oxygen [18].

Ascorbic acid and sulfites react directly with oxygen and are able to eliminate it from the food product. L-ascorbic acid is a strong reductant and it is able to oxidize through one- or two-electron transfers. One-electron reactions involve an L-ascorbic acid radical, whereas two-electron transfer occurs when transition metals are present. These metals catalyze ascorbate autoxidation. During this reaction, L-ascorbate and oxygen form a ternary complex with the metal catalyst and two  $\pi$  electrons are shifted from ascorbate to oxygen through the transition metal yielding water and an oxidized, more stable form of ascorbic acid (dehydroascorbic acid) [18].

In a number of different muscle tissues, it has been shown that exogenous addition of ascorbic acid and its derivatives controls rancidity [83-85]. Within these tissues, ascorbic acid may act as an antioxidant by several mechanisms: it may function as an oxygen scavenger, it may scavenge free radicals generated in the aqueous phase, it may maintain heme compounds in their reduced noncatalytic state and it may regenerate tocopherol. On the other hand, ascorbic acid can act as a prooxidant by maintaining Fe<sup>2+</sup> in its reduced state [18].

Ascorbic acid (vitamin C) is active as a radical scavenger in aqueous media, but only at higher concentrations ( $\sim 10^{-3}$  M). A prooxidant activity of ascorbic acid has been observed at lower levels ( $10^{-5}$  M), especially in the presence of metals [82].

Ascorbic acid is a synergist with tocopherols. It helps to inhibit oxidation by regenerating tocopherol from tocopheroxy radical or oxidation products [18].

Ascorbic acid (as a natural antioxidant) is also discussed in section 2.4.3.1.

Ascorbyl palmitate (AP) is a fat-soluble ester of palmitic acid and ascorbic acid (Figure 12). Ascorbic acid is soluble in water therefore AP as a fat-soluble analogue of ascorbic acid can be used in oils or oil-containing food. AP has been shown to be also an effective singlet oxygen quencher. Carotenoids also act as singlet oxygen quenchers, but their use can be limited because they provide yellow to red colour to the products. Thus, there was a need for a novel fat-soluble antioxidant that is able to reduce the photooxidation of oils and other photolabile oil-soluble compounds [86].

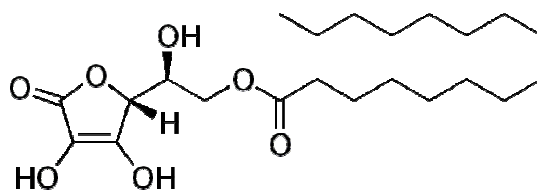

**Figure 12:** Ascorbyl palmitate [87]

### 2.4.2.3 Singlet oxygen quenchers

Singlet oxygen is a high-energy molecule responsible for photooxidation of unsaturated fats. Carotenoids (including  $\beta$ -carotene, lycopene, lutein, astaxanthin, etc.) are active singlet oxygen quenchers at low oxygen partial pressure. Singlet oxygen quenchers exhaust the excess amount of energy of singlet oxygen and dissipate this energy in the form of heat [18].

There are three possible steps where a quencher can act:

- Quenching of the excited triplet sensitizer
- Chemical quenching of singlet oxygen
- Physical quenching of singlet oxygen

Generally, chemical quenching involves the reaction of singlet oxygen with the quencher to produce an oxidized product, whereas physical quenching leads to the return of singlet oxygen to triplet oxygen without the consumption of oxygen or the formation of oxidized products by energy transfer or charge transfer [18].

$\beta$ -carotene is able to chemically quench singlet oxygen – it runs by an attack of singlet oxygen to the double bonds of carotenoid. This will lead to formation of carotenoid breakdown products containing aldehyde and ketone functional groups as well as  $\beta$ -carotene-5,8-endoperoxide, the last being a unique marker of singlet oxygen quenching ability of  $\beta$ -carotene. Tocopherols can also chemically quench singlet oxygen, and this reaction will result in formation of tocopherol peroxides and epoxides. Also other compounds, such as proteins, peptides, amino acids, phenolics or ascorbate, can chemically quench singlet oxygen, but the resulting oxidation products are not well known [16, 18].

Chemical inactivation of singlet oxygen by carotenoids causes carotenoid autoxidation, which results in loss of its antioxidant activity. Therefore, the predominant mechanism of singlet oxygen quenching by carotenoids is physical quenching: the energy of singlet oxygen ( $^1\text{O}_2$ ) is transferred to singlet state carotenoid ( $^1\text{car}$ ) and the products are the excited state of

carotenoid ( $^3car$ ) and the ground state of oxygen, triplet oxygen. This is called singlet oxygen quenching. Energy can be transferred from the excited triplet sensitizer ( $^3Sen^*$ ) to the singlet state carotenoid ( $^1car$ ), which is called triplet sensitizer quenching. Then, the triplet state carotenoid returns to its ground state by dissipating its energy by vibrational and rotational interactions with the surrounding solvent [18]:

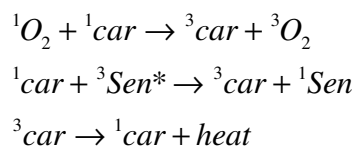

Carotenoids are very efficient singlet oxygen quenchers – for example, one molecule of  $\beta$ -carotene is able to quench up to 1000 molecules of singlet oxygen. The rate of singlet oxygen quenching by carotenoids depends on the number of conjugated double bonds and the type and number of functional groups. Carotenoids with nine or more conjugated double bonds are effective singlet oxygen quenchers. Xanthophylls are not efficient in scavenging singlet oxygen because of addition of functional groups to the hydrocarbon structure [18]. For example, Lee and Min [88] investigated the effectiveness of five different carotenoids (lutein, zeaxanthin, isozeaxanthin, lycopene and astaxanthin) in quenching chlorophyll-photosensitized oxidation of soybean oil and concluded that the efficiency increased with increasing number of double bonds in carotenoid and the concentration of carotenoid.

Hirayama *et al.* [89] examined the singlet oxygen quenching ability of various naturally occurring carotenoids by measuring toluidine blue-sensitized photooxidation of linoleic acid. They reported that the  $^1O_2$  quenching ability increased with increasing number of conjugated double bonds, but this ability varied with chain structure and functional groups. They stated that the number of conjugated double bonds was the most effective parameter for assessing the  $^1O_2$  quenching ability. The open chain had a higher quenching ability than the  $\beta$ -inone ring, the hydroxy group had a positive effect but was less effective as quencher, while epoxy and methoxy groups had lower effects. This indicates that carotenoids with some functional groups attached to the hydrocarbon structure are less effective  $^1O_2$  quenchers.

Ascorbic acid is an example of a chemical quencher of the excited sensitizer. Tocopherols and amines can physically quench singlet oxygen by the charge transfer mechanism – the quencher is the electron donor in this interaction. Tocopherols are primarily studied as free radical scavengers, but when present in systems susceptible to singlet oxygen oxidation, tocopherols inhibit oxidation. Tocopherol can form a complex with singlet oxygen and tocopherol donates an electron to singlet oxygen [18]:

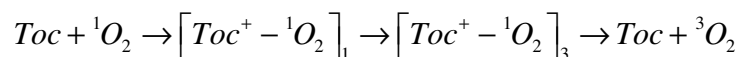

In addition to physical quenching, tocopherol can quench singlet oxygen by reacting irreversibly with singlet oxygen, which is called chemical quenching. This reaction produces oxidized compounds.  $\alpha$ -tocopherol reacts with singlet oxygen at the highest rate, followed by  $\beta$ -,  $\gamma$ -, and  $\delta$ -tocopherols. This can result in the prooxidative activity of  $\alpha$ -tocopherol [18].

### 2.4.3 Natural antioxidants

The consumers are concerned about synthetic food additives, and therefore utilization of natural antioxidants is preferred. Some natural preservatives are a part of foods, while others can be added to the product or are formed as a result of cooking and processing steps. Recent research has been focused on isolation and identification of effective antioxidants from various natural sources. Important natural antioxidants are ascorbic acid, tocopherols, carotenoids, phenolic compounds; others are for example: amino acids, proteins, protein hydrolysates, phospholipids. Recently, spices (e. g. rosemary) have been used as sources of commercially exploited antioxidants – the active compounds in the extracts are mainly polyphenolic substances [16, 18].

The safety of natural antioxidants should not be taken for granted. Some natural products are potential carcinogens, mutagens or teratogens.

#### 2.4.3.1 Ascorbic acid

Ascorbic acid (AsA), or vitamin C, (see Figure 13) is a component of plant tissues and is produced synthetically in large amounts. Ascorbic acid acts as a primary or secondary antioxidant. In vivo, AsA is a primary antioxidant, whereas in foods it is a multifunctional antioxidant and can act by following mechanisms:

- Quenching of singlet oxygen (see section 2.4.2.3)
- Scavenging of oxygen in the presence of metal ions (see section 2.4.2.2)
- Reduction of free radicals (see section 2.4.1)
- Reduction of primary antioxidant radicals

In the last mechanism, ascorbic acid is a synergist with tocopherols. Synergism is a phenomenon in which the net antioxidant effect is higher than the sum of the individual antioxidant effects. Synergism between antioxidants has been observed mainly in the co-occurrence of metal chelator and free radical scavengers, because metal chelators mostly operate in the initiation step of lipid oxidation and radical scavengers in the propagation step. The synergistic antioxidant effects have been studied mostly with tocopherols [18], but the following study [90] involves carotenoids.

Jørgensen and Skibsted [90] investigated carotenoid scavenging of free radicals and suggested a mechanism for trapping of an alkoxyl radical by astaxanthin in the central hydrophobic region of a cell membrane. The trapping of this radical is followed by a “transport” of the unpaired electron by the conjugated system to the lipid-water interface, where the astaxanthin radical reacts with ascorbate anion ( $\text{AH}^-$ ) in the aqueous phase, resulting in non-radical product and ascorbyl radical.

Ascorbic acid (AsA) occurs naturally in fruits and vegetables and, in smaller amounts, also in animal tissues and animal-derived products. Ascorbic acid and its salts are widely used as food ingredients for their reducing and antioxidative activities (e. g. in meats, for inhibiting of enzymatic browning in fruits and vegetables, for inhibition of nitrosamine formation in cured meats). Fatty acid esters (e. g. ascorbyl palmitate) and AsA acetals are lipid-soluble compounds used for protection in lipid environments. AsA is very susceptible to oxidation, especially when catalyzed by transition metal ions such as  $\text{Cu}^{2+}$  and  $\text{Fe}^{3+}$  [16].

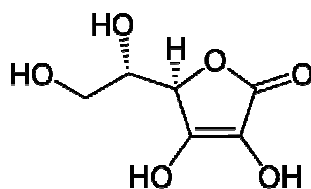

**Figure 13:** *L-Ascorbic acid* [67]

### 2.4.3.2 Carotenoids

Carotenoids are a family of more than 600 natural compounds. Carotenoids are yellow, orange and red lipid-soluble pigments that can be found in plants, fruits and vegetables. They consist of a class of hydrocarbons called carotenes (e. g.  $\beta$ -carotene, lycopene) and their oxygenated derivatives called xanthophylls (e. g. astaxanthin, canthaxanthin). From the structural point of view, carotenoids are 40-carbon isoprenoids or tetraterpenes with different structural characteristics.

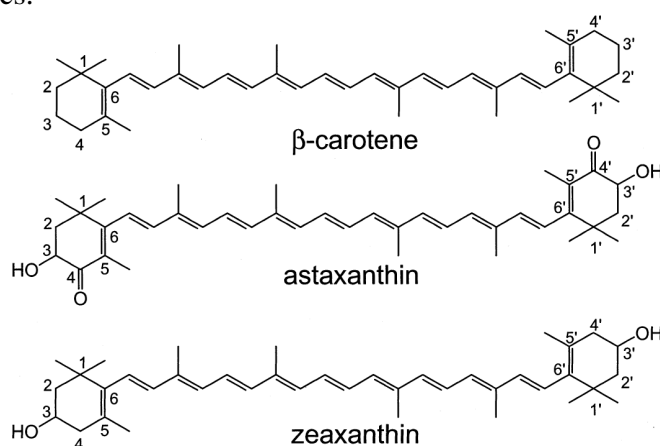

**Figure 14:** *Chemical structures of  $\beta$ -carotene, astaxanthin and zeaxanthin* [91]

Carotenoids have a typical linear, long-chain polyene structure (Figure 14). In this conjugated system, the electrons are delocalized or shared evenly in the whole chain. The antioxidant capacity is directly related to polyene chain length and number of conjugated double bonds. These double bonds are chemically stable and can undergo specific redox chemical reactions. For example, when a carotenoid loses one electron and becomes a radical cation, the resulting +1 charge is distributed over the electron-rich chain and this compound is much more stable than a compound in which the charge is situated at a single location [18, 92].

Carotenoids have dual antioxidant capacity, they are:

- Singlet oxygen quenchers
- Scavengers of free radicals (mainly peroxy radicals)

The ability of carotenoids to quench singlet oxygen is described in section 2.4.2.3.

The knowledge of the mechanism by which carotenoids react with radicals in lipid oxidation and perform an antioxidative effect has been rather limited until lately. Carotenoids

seem to scavenge peroxy radicals by a mechanism in which the radical is added to the conjugated polyene system:

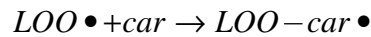

The resulting carbon-centered radical is stabilized by resonance. When the oxygen concentration is low, a second peroxy radical can be added to the carbon-centered radical and a nonradical polar product is formed:

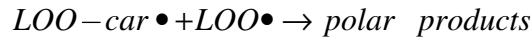

At high oxygen pressures, carotenoids become prooxidants, because oxygen can be added to the carbon-centered radical in a reversible reaction resulting in an unstable chain-carrying peroxy radical:

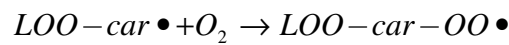

This radical can be degraded to radicals and non-radical polar products, resulting in no net inhibition of oxidation [90]:



Other radicals from lipid oxidation processes can react in these reactions. The relative reactivity of carotenoids towards radicals and the relative stability of the resulting carbon-centered radical are the important factors for the antioxidative capacity of carotenoids [90]. Carotenoids are very unstable, and their addition to processed foods has to be done carefully. Carotenoid stability is affected by pH, heat, oxygen, light and the presence of metals [18].

#### 2.4.3.3 Phenolic compounds

Phenolic compounds (phenolics) are naturally occurring compounds found in plants. Phenolic compounds have one structural feature in common – a phenol, an aromatic ring with one or more hydroxyl groups. These compounds have been considered as important parts of plant foods because of their impact on flavour and colour; there is also an interest in their potential health benefits and antimicrobial effects. Several phenolics have shown potential for use as antioxidants in foods and some are already utilized as such. However, the antioxidant activity of these compounds varies greatly, and some even act as prooxidants. Many factors influence the antioxidant activity – number and position of hydroxyl groups, polarity, solubility, reducing potential, stability to food processing and stability of the phenolic radical. Metal chelation properties, in addition to high reducing potentials, can accelerate metal-catalyzed oxidative reactions, which results in the prooxidative activity of the compound under certain conditions. Research on plant phenolics has been very intensive recently. The list of plant material sources of antioxidant compounds is still growing. Plants containing phenolics with antioxidant activity are for example: apples, citrus fruits, sesame seeds, rice, barley, peppers, soybean, mustard, rapeseed, tea leaves, wine, olive oil, berry fruits, coffee and cocoa bean and others [16, 18, 93].

Flavonoids are secondary products of plant metabolism consisting of more than 4000 individual compounds classified to six subclasses: flavones, flavonols, flavanols, flavonones, isoflavones and anthocyanins. Several are able to chelate metals, therefore they can act as

antioxidants. Flavonoids also can act as primary antioxidants and superoxide anion scavengers [18].

In studies with membrane model systems, antioxidant efficiency of flavonoids has been discovered to be dependent not only on their redox properties but also on their ability to interact with biomembranes [94].

Phenolic acids also belong to the large group of phenolics. Phenolic acids are structurally related to flavonoids – they serve as precursors of flavonoid biosynthesis. Phenolic acids are phenols with one carboxylic acid group. Phenolic acids include:

- Hydroxycinnamic acids (caffeic, *p*-coumaric, ferulic, sinapic acids)
- Hydroxybenzoic acids (4-hydroxybenzoic, ellagic, gallic, gentisic, protocatechuic, salicylic, vanillic acids)
- Hydroxycoumarin (scopoletin)

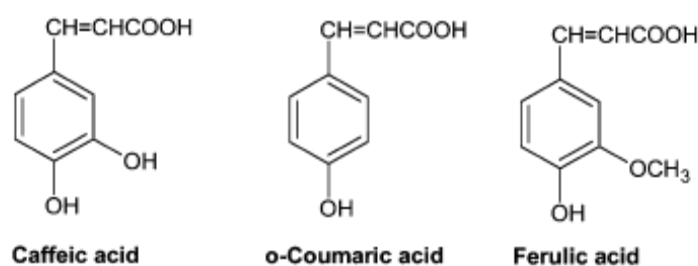

**Figure 15:** Structures of some phenolic acids [95]

Some phenolic acids are able to retard lipid oxidation. This is a feature related to their metal-chelating capacity as well as the ability to scavenge free radicals. Phenolic compounds are able to donate a hydrogen atom from their hydroxyl group forming a stable phenolic radical. This radical has low energy due to delocalization of the unpaired electron throughout the phenolic ring (for caffeic acid, the lateral double bond is conjugated with the catechol ring), see Figure 16. If there are some substitution groups on the phenolic ring, the antioxidant activity is often increased. This is because these substitutions result in increased stability of the phenolic radical and/or increased ability to donate hydrogen atom [18, 95, 96].



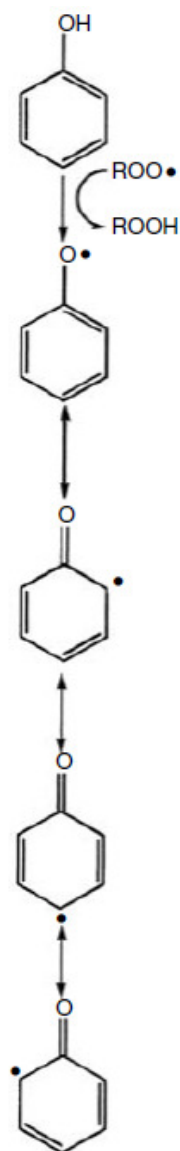

**Figure 16:** Resonance stabilization of a free radical by a phenolic [18]

However, the antioxidant activity of phenolic acids varies greatly and is dependent on their structure and the food system [18, 94]. For example, a higher activity in scavenging AAPH-derived peroxy radicals was observed by caffeic acid in comparison with monohydroxycinnamic acid derivatives, ferulic acid and *p*-coumaric acid [96]. A similar trend in their antioxidant capacities has also been observed in other studies [97, 98].

Substitution of hydrogen atoms on phenol in the *ortho*- and *para*-positions with alkyl groups increases electron density of the OH moiety and enhances its reactivity toward lipid radical. Addition of a second hydroxy group, so that there are two OH groups (in the *ortho*- and *para*-positions), increases the antioxidative activity of the compound. Such compounds, e. g. caffeic acid, can form intramolecular hydrogen bond that increases the stability of the phenoxyl radical (see Figure 17) [95, 96].

The redox potentials and bond dissociation enthalpies (BDE) of the O-H bond are the important physicochemical characteristics that control the thermodynamic ability for electron transfer and hydrogen atom transfer of phenolic compounds [95, 96].

It has been shown, that ascorbic acid can regenerate phenolic antioxidants by supplying hydrogen to the phenoxy radical formed by providing hydrogen atoms in the chain reaction of lipid oxidation. For this action, ascorbic acid must be less polar, so that it will dissolve in fat. This is achieved by esterification to fatty acids to form e. g. ascorbyl palmitate [18, 95].

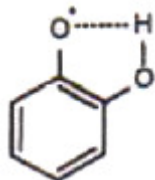
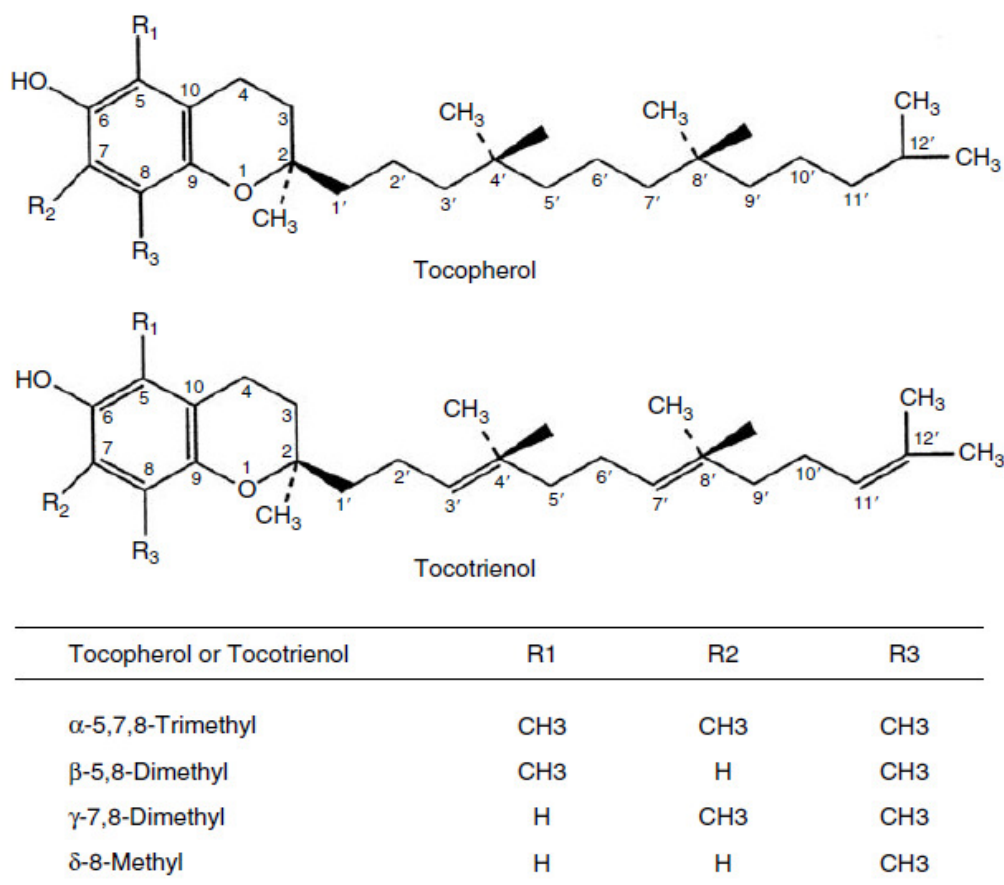

**Figure 17:** Stabilization of the phenoxy radical by intramolecular hydrogen bonding [18]

#### 2.4.3.4 Tocopherols

Tocopherols and tocotrienols are groups of chromanol homologues with vitamin E activity in the diet. They are widely distributed in the plant kingdom, with vegetable oils being the richest vitamin E sources. Tocotrienols are less common. For example, palm oil has a unique vitamin E profile, having tocotrienols in higher concentrations than other food sources. During isolation of oil from plants, tocopherols and tocotrienols are also isolated. Even after refining, a sufficient level of tocopherols and tocotrienols is retained, although there is some loss during deodorization step. Thus, they secure the stability of the oil end-product. Worldwide, the main commercial source of natural tocopherols is in the soybean oil refining industry [18, 82].

Tocopherols and tocotrienols are monophenolic compounds with varying antioxidant activities. The vitamin E group consists of eight naturally occurring homologues. They are fat-soluble 6-hydroxychroman compounds.  $\alpha$ -,  $\beta$ -,  $\gamma$ -, and  $\delta$ -tocopherols contain saturated side chain consisting of three isoprenoid units, whereas the corresponding  $\alpha$ -,  $\beta$ -,  $\gamma$ -, and  $\delta$ -tocotrienols have double bonds at the 3', 7' and 11' positions of the side chain (see Figure 18). Only *RRR* isomers are found in nature. Biologically, *RRR*- $\alpha$ -tocopherol has the highest vitamin E activity [18].

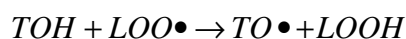

**Figure 18:** Structure of tocopherols and tocotrienols [18]

Tocopherols can act as antioxidants by the following mechanisms:

- Free radical scavenging (mainly peroxy radicals, but carbon-centered and hydrogen radicals as well)
- Scavenging of singlet oxygen (see section 2.4.2.3)
- Complexation of iron in the presence of ascorbate

Tocopherols inhibit lipid oxidation by scavenging free radicals. Tocopherols have a standard reduction potential of 0.5 V, and can donate hydrogen atoms to alkyl, alkoxy and peroxy radicals of lipids whose standard reduction potentials are 0.6, 1.6, and 1.0 V, respectively. Tocopherol (TOH) donates its phenolic hydrogen to peroxy radical (LOO•) to produce tocopheroxy radical (TO•) and lipid hydroperoxide:



The rate of this reaction is higher ( $10^4 - 10^9 \text{ M}^{-1}\text{s}^{-1}$ ) than that of reaction between lipid peroxy radical and lipids ( $10 - 60 \text{ M}^{-1}\text{s}^{-1}$ ) [18, 99].

The tocopheroxy radical may then scavenge another radical to produce a stable nonradical product, or may react with reducing agent (e. g. ascorbic acid) to regenerate TOH, or may attack lipids producing new reactive lipid radicals capable of initiating a new oxidation chain reaction. The relative importance of these reactions of tocopheroxy radical influences the total antioxidant capacity of TOH. If there are not enough lipid peroxy radicals (which is at a low

lipid oxidation rate in lipid membrane systems), tocopheroxy radicals react with each other producing tocopheryl quinone and TOH [18, 99]:



At a higher lipid oxidation rate, tocopheroxy radical reacts with lipid peroxy radicals and produce TOH-lipid peroxy complex, which then undergoes hydrolysis giving tocopheryl quinone and lipid hydroperoxide (or, generally, tocopheroxy radical undergoes radical-radical coupling with other radicals producing adducts) [18, 99]:

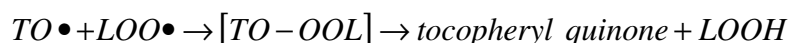

Each tocopherol molecule is therefore able to neutralize two peroxy radicals. Since lipid peroxy radicals react with tocopherols several orders of magnitude faster than with acyl lipids, one tocopherol molecule can protect about  $10^3 - 10^8$  PUFA molecules at low peroxide values [99].

Tocopherols also can react with alkoxy radicals, formed in the propagation step, or undergo self-coupling to form dimers and/or trimers [18, 99]:

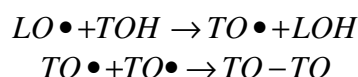

In a very special case, when oxygen is present in trace amounts and hydroperoxides are present in negligible concentrations, tocopherols can react directly with alkyl radicals:

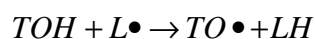

The antioxidant activity of TOH differs among the isomers. In vivo, the relative antioxidant activity of tocopherols decreases in the order  $\alpha$ -TOH >  $\beta$ -TOH >  $\gamma$ -TOH >  $\delta$ -TOH. However, in foods the antioxidant activity of tocopherols is reverse:  $\delta$ -TOH >  $\gamma$ -TOH >  $\beta$ -TOH >  $\alpha$ -TOH. A possible explanation can be the following [82]:

- $\alpha$ -TOH reacts with radicals as shown in Figure 19. Product I is stable, whereas product II is a radical capable of initiating autoxidation reaction; formation of product II may be suppressed in vivo
- In aqueous media  $\delta$ -TOH is the most effective in protecting hydroperoxides from decomposition. Higher stability of hydroperoxides can prolong the induction phase of lipid autoxidation. In vivo, the hydroperoxides are rapidly converted into other compounds (e. g. by enzymatic reduction producing hydroxy fatty acids which cannot degrade to radicals)
- $\alpha$ -TOH easily undergoes oxidation by gaseous oxygen (which leads to radical formation), while  $\gamma$ -TOH and especially  $\delta$ -TOH are stable.

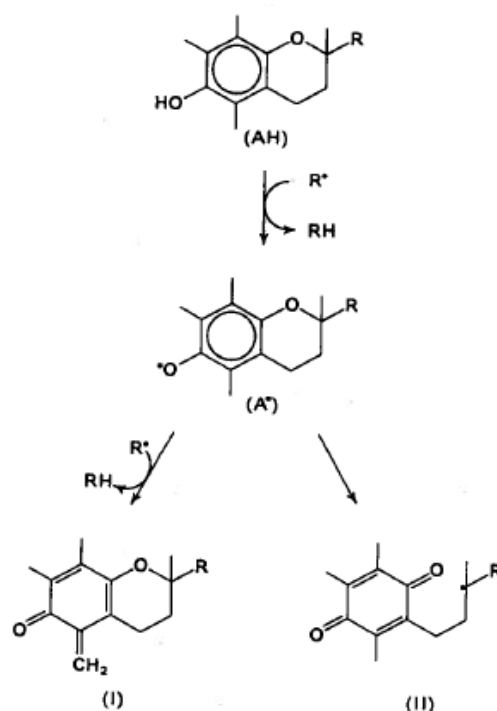

**Figure 19:** Reaction of  $\alpha$ -TOH with radicals [82]

$\delta$ -TOH generally has the highest free radical-scavenging activity. The optimal concentration of TOH is dependent on their oxidative stability; isomer that has lower oxidative stability generally shows lower optimal concentration for the maximal antioxidative activity. TOH, particularly  $\alpha$ -TOH, exhibit prooxidative activity when present at high concentrations in oil and it is even more obvious, when the concentration of lipid peroxy radicals is very low. Tocopheroxy radical can abstract hydrogen atom from the lipid and produces TOH and lipid alkyl radical, although the reaction is very slow. This so called TOH-mediated peroxidation can be prevented by addition of ascorbic acid, which provides hydrogen to tocopheroxy radical [18, 99].

#### 2.4.4 Synthetic antioxidants

Despite their high efficiency, low cost and good stability, synthetic antioxidants (AOX) are not widely used in foods, because of consumers' suspicion that their consumption might promote carcinogenicity. Synthetic AOX are intentionally added to foods to inhibit lipid oxidation, and they are very effective in this function. The following synthetic AOX are approved for use in food: butylated hydroxyanisole (BHA), butylated hydroxytoluene (BHT), propyl gallate (PG), octyl gallate (OG), dodecyl gallate (DG), tertiary butylhydroquinone (TBHQ), 4-hexylresorcinol and erythorbic acid. Development of new synthetic AOX is rather limited by the costs of research, costs related to evaluation of their safety as well as by the time needed for the whole process – up to obtaining approval for an additive [18].

BHA is a waxy, monophenolic compound. It is soluble in fat and used as AOX in animal fats, but is not effective in vegetable oils. BHA and BHT are fairly heat stable, therefore they are used in heat-processed foods. BHT is a widely used monophenolic AOX. TBHQ is a biphenolic AOX. It is heat-stable and is used in frying applications [18].

PG, OG and DG are, respectively, the *n*-propyl, *n*-octyl and *n*-dodecyl esters of 3,4,5-trihydroxybenzoic acid. PG is slightly water-soluble, whereas OG and DG are more lipid-soluble [18].

#### **2.4.4.1 Ascorbyl palmitate**

Ascorbyl palmitate (AP) and ascorbyl stearate are synthetic derivatives of ascorbic acid (AsA). AP is an ester of ascorbic acid and palmitic acid. It is a fat-soluble analogue of AsA. However, it is still only slightly soluble and requires the help of magnets and/or higher temperatures. AP acts as oxygen quencher and a reductant and has been shown to be an effective singlet oxygen quencher (see section 2.4.2.2) [18, 86].

AP has been shown to be a synergist with  $\alpha$ -tocopherol and phenolic antioxidants [16]. AP has a GRAS (Generally Recognized as Safe) status; in the digestive system, AP is hydrolyzed to nutritionally available ascorbic acid and palmitic acid [18].

### **2.4.5 Antioxidants in lipid systems**

Many studies have been made comparing the effectiveness of antioxidants with different lipid substrates, model systems, oxidation conditions and methods to follow lipid oxidation. This variability has led to large confusion. This is because it depends whether the oxidation is carried out in bulk oil or in emulsion and which analytical method is used to determine the extent and end point of oxidation. Therefore the methodology for evaluation of antioxidants must be carefully interpreted [100].

The relative antioxidant effectiveness in lipid systems is dependent on numerous factors [7, 18, 100]:

- The type of the lipid matrix (e. g. triacylglycerols, phospholipids, free fatty acids)
- The type of the lipid system (bulk oil, emulsion, minces, LDL, membrane systems: e. g. liposomes, microsomes)
- The type and the structure of antioxidant (e. g. number of conjugated double bonds, number of OH groups)
- The concentration of antioxidant
- The presence of prooxidants, their type and concentration (transition metals, metalloproteins, photosensitizers)
- The ratio of prooxidant vs. antioxidant concentrations
- The presence of other substances (e. g. proteins, emulsifiers, enzymes, endogenous antioxidants)
- Reaction conditions (e. g. pH, temperature, oxygen concentration, light)

Many foods and biological systems are complex, multicomponent, and heterogenous systems, where lipids are present with other components in aqueous medium. In emulsions, the membranes that surround the emulsion droplet consist of surface-active substances such as emulsifiers and/or proteins. They form a protective barrier against penetration and diffusion of metals or radicals that initiate lipid oxidation. The chemical and physical characteristics of an emulsifier are important factors for protection of PUFA against oxidation in aqueous phase. Antioxidants behave differently in bulk phase and emulsion systems. In bulk phase, the relative oxidative stability of PUFA increases with decreasing the degree of unsaturation. The reverse has been shown in micelles and in PC liposomes (which suggests that the degree of

unsaturation is not the main factor affecting the oxidative stability of PC in liposomes). The differences in relative oxidative stability of PUFA between in bulk phase and in aqueous phases such as food and biological systems, is significant [18].

#### ***2.4.5.1 Interfacial phenomena in the evaluation of antioxidants***

Antioxidant efficacy depends on many factors. In multiphase systems, partitioning of the antioxidant into different phases of the system appears to be one of the most important factors. It is due to the so-called polar paradox. According to this phenomenon, polar (hydrophilic) antioxidants such as ascorbic acid or Trolox will be more effective in non-polar media like bulk oil than their non-polar (or more non-polar) counterparts ascorbyl palmitate and tocopherol, respectively. And lipophilic antioxidants will be more effective in polar media (like emulsions) [7, 100].

The differences in the efficacy of antioxidants in emulsion and bulk oils, is due to their physical location in these two systems. Polar antioxidants are more effective in bulk oil, because they are located at the air-oil interface where oxidation is taking place (due to high concentrations of oxygen and prooxidants). Lipophilic antioxidants will be less protective by remaining in solution in the oil. In contrast, non-polar antioxidants are more effective in emulsions because they are located in the oil phase (in the oil droplets) and/or are accumulated at the oil-water interface. These are the locations where oxidation propagates, because the interactions between hydroperoxides at the droplet surface and prooxidants in the aqueous phase take place here. In emulsions, hydrophilic antioxidants move to the aqueous phase where they cannot adequately protect the lipid [16, 100].

The study of antioxidant efficiency in dispersed systems is more complex compared to evaluation of AOX efficacy in bulk oils, because much more variables can affect lipid oxidation (e. g. pH, emulsifiers).

It can be concluded that there is no ideal (or universal) lipid model system. Each system is specific and the efficiency of an antioxidant is different in each system. Therefore the choice of a lipid model system has to be made according to the purpose of a study (e. g. which prooxidant and/or antioxidant is investigated) [7, 16].

## 3 EXPERIMENTAL

### 3.1 Isolation of phospholipids

The isolation procedure consisted of extraction of total lipids from the raw material and isolation of phospholipids from the total lipids.

#### 3.1.1 Isolation of cod roe oil

The marine phospholipids used for the experiments were isolated from cod (*Gadus morhua*) roe. Separated frozen cod roe was obtained from HOPEN DRIFT AS, Kabelvåg, Norway. The production date was 17 March 2008. Before isolation, the roe was kept in dark at -40 °C.

The extraction of total lipids (OIL) from the roe was performed according to the method of Bligh and Dyer [101]. A portion of the roe (approximately 150 g) was homogenized by an Ultra Turrax homogenizer in 100 mL of distilled water, 400 mL of methanol and 200 mL of chloroform for 2 min. Then, 200 mL of chloroform was added and the mixture was homogenized for another 1 min. After that, 200 mL of distilled water was added and the mixture was homogenized for another 1 min. The mixture was then divided into centrifugal bottles and was centrifuged for 15 min at 9000 rpm at 4 °C. After centrifugation, the chloroform (bottom) phase containing lipids was pipetted out, filtered through glass wool to remove protein particles, collected into dark bottles and stored in a freezer (-20 °C) until further processing. The whole procedure was carried out on ice. Total lipids in chloroform were concentrated by evaporation of chloroform with a rotor evaporator under the following conditions: water bath at 30 °C, max. 60 rpm speed, vacuum 200 mbar. Concentrated lipids were stored in chloroform at -20°C.

#### 3.1.2 Isolation of phospholipids

Phospholipids were isolated from the total lipids by the acetone precipitation method described by Kates [15] with modifications made by Mozuraityte [10]. The acetone precipitation method is based on the fact that phospholipids are insoluble in cold acetone.

An aliquot of total lipids dissolved in chloroform, 4 g in 10 mL, was mixed with 200 mL of acetone and kept at -20 °C overnight. The acetone phase (OIL1) was poured off and the precipitated phospholipids (PL1) were dissolved in chloroform and collected. Phospholipids in chloroform were concentrated by evaporation of chloroform using a rotor evaporator. Then, the precipitation procedure was repeated once again and combined to give resulting in obtaining the acetone phase containing OIL2 and chloroform phase containing final phospholipids PL2. Phospholipids in chloroform were concentrated by evaporation of chloroform using a rotor evaporator. The final phospholipids in chloroform (ca. 0.4 g in 1 mL of chloroform) were stored at -20 °C. The evaporation was not carried out to dryness because chloroform protects phospholipids against oxidation.

The scheme of phospholipid isolation is shown in Figure 20.



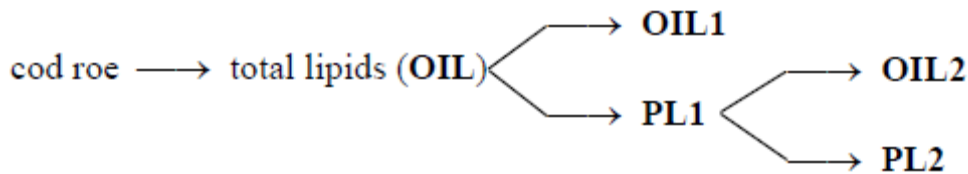

**Figure 20:** Scheme of phospholipid isolation from total lipids extracted from cod roe

During the whole isolation procedure five products were obtained – OIL (total lipids), OIL1, OIL2, PL1, PL2 (final phospholipids), see Figure 21. These fractions were then analysed in terms of their degree of oxidation (PV, TBARS, AV), the carotenoid content and their purity (TLC). In addition, the fatty acid composition was determined for OIL and PL2. Final phospholipids were used for the preparation of liposomes used in the oxidation experiments.

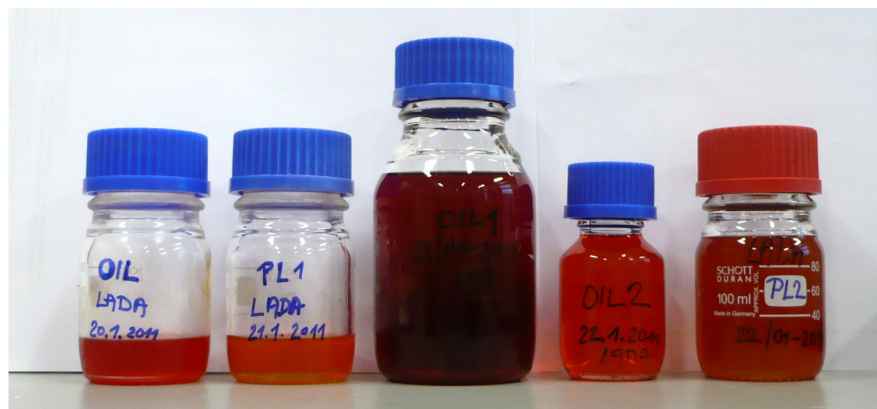

**Figure 21:** Five products obtained from the isolation procedure, from left OIL, PL1, OIL1, OIL2 and PL2

### 3.2 Liposome preparation

The liposome solution was prepared according to Mozuraityte [10]. An aliquot (1 mL) of final phospholipids was pipetted into a test tube and the solvent (chloroform) was evaporated by a stream of nitrogen gas (99.99%). After that, phospholipids were kept under vacuum for ca. 1.5 hours to evaporate the solvent completely, leaving a dried mass of phospholipids. Dried phospholipids were dispersed in a 5 mM MES (2-morpholinoethanesulfonic acid) solution to a concentration of 30 mg/mL. MES buffer was chosen because of some of its useful properties. These are: MES buffer does not bind iron as for example phosphate buffers, has low solubility in nonpolar solvents and its functional pH range 5.5 – 6.4 is suitable for the oxidation experiments (that were carried out at pH  $\approx$  5.5). Liposomes were prepared by sonication (Figure 22). The solution was sonicated at 50% amplitude 30 times with a 5 s pulse (total sonication time: 2.5 min.) using Vibra Cell sonicator (Sonics & Materials Inc., USA). Both during and after the sonication the solution was kept on ice to prevent increase in temperature and oxidation.

Liposomes for experiments with TPP (triphenylphosphine) and lipid-soluble antioxidants (astaxanthin,  $\alpha$ -tocopherol,  $\delta$ -tocopherol and L-ascorbic acid-6-palmitate) were prepared by addition of appropriate amount of triphenylphosphine (TPP) solution or particular antioxidant solution to dried phospholipids. After mixing the dried PL with that solution, chloroform was

evaporated by a stream of nitrogen gas and after that, PL were kept under vacuum for 1 hour to evaporate chloroform completely. After that, PL were dissolved in the MES solution and sonicated as described above. If the pH of the liposomes decreased after the sonication, the pH 5.5 was restored by a few drops of 1 M NaOH.

Before each set of experiments fresh liposome solution was prepared (i.e. it was prepared daily). For the experiment itself, the liposome concentration of 15 mg/mL (1.5%) was used, which was achieved by diluting the 3% liposome solution with the MES solution in a 1:1 ratio (v/v).

pH verification: the pH of solutions was measured by a TitraLab90 station (Radiometer analytical, Denmark) coupled with a combined glass electrode (LIQ-GLASS 238000/08, Hamilton Co., Reno, USA). The electrode was calibrated with a set of commercial buffers, pH 4.0 and 7.0.

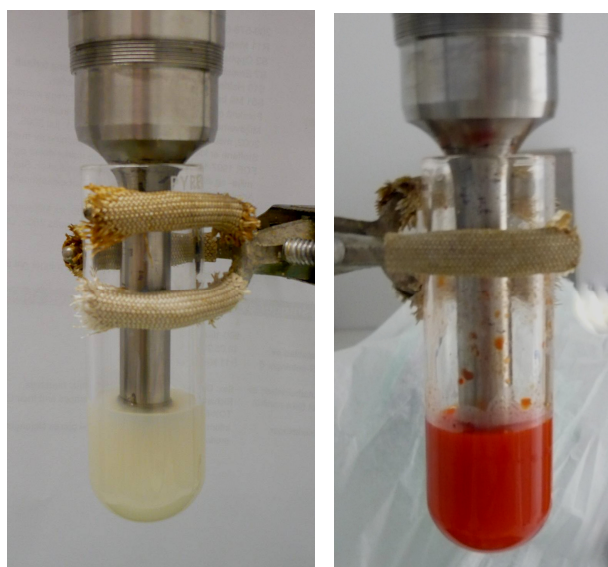

*Figure 22: Liposome preparation by sonication of phospholipids, from left: ordinary liposomes, liposomes containing antioxidant astaxanthin*

### 3.3 Analysis of isolation products

#### 3.3.1 Characterisation of isolation products

The composition of total lipids (OIL), intermediate products (OIL1, OIL2, PL1) and the final phospholipids (PL2) was analyzed using the Iatroscan analyzer, principle of which is thin layer chromatography with flame ionization detector system (TLC-FID analyzer TH-10 MK-6, Iatron Laboratories, Inc., Tokyo, Japan).

Standards and samples dissolved in chloroform to a concentration of approximately 20 mg/3 mL were spotted by means of a 10  $\mu$ L Hamilton syringe bit by bit on the starting part of chromarods. Each spot was dried gently with a stream of nitrogen gas. The holder with chromarods was placed into a tank with saturated NaCl solution for 8 min. After that, the holder with chromarods was placed into a development tank for separation for 27 min. The solvent mixture consisted of *n*-hexane – diethylether – formic acid (85:15:0.04). Then, the holder was taken out and allowed to dry in air for 3 min. The holder with chromarods was placed into Iatroscan and the analysis was run. The components in the samples were identified by comparison of their retention times with those of standard solution. The results were expressed as area (%) as the mean value  $\pm$  standard deviation.

### 3.3.2 Composition of PL2 determined by HPLC-CAD

Another method for determination of PL2 composition was employed: HPLC-CAD (High Pressure Liquid Chromatography with Charged Aerosol Detection). It was an assisted analysis.

The classes of phospholipids in the lipid samples (1 mg/mL) were analyzed by the Waters 2695 Separations Module (Waters, Milford, MA, USA) coupled to the ESA Corona Charged aerosol detector (ESA Biosciences Inc., Chelmsford, USA). The samples were separated on Agilent Prep-SIL Scalar 10  $\mu\text{m}$  column, 4.6  $\times$  150 mm (packed by Agilent Technologies, Santa Clara, CA, USA) kept at ambient temperature ( $22 \pm 1$  °C). For the isocratic elution a ternary gradient having a constant flow rate of 1.25 mL/min and consisting of degassed solvents A = n-hexane, B = 2-propanol, and C = deionised water (MiliQ) was used with the following timetable: at 0.01 min 40:59:1 (%A:%B:%C); at 3 min 40:54:6; at 17 min 40:48:12; at 17.01 min 40:59:1; and at 20 min 40:59:1. The sample temperature was 4 °C and the injected volume was 10  $\mu\text{L}$ . Different components of PL2 (the phospholipid classes) were identified by a comparison to the retention times of commercial standards (only four standards were available at the time of the analysis: PE, PC, lysoPE and lysoPC) and the amounts were calculated from area %.

### 3.3.3 Fatty acid profile of OIL and PL2 determined by GC

Fatty acid composition of extracted oil (OIL) and final phospholipids (PL2) was determined by gas chromatography (GC) of their fatty acid methyl esters (FAMES) according to the method described by Dauksas *et al.* [102].

The lipids were transesterified with boron trifluoride-methanol and 0.5 M methanolic sodium hydroxide, and then the FAMES were extracted into hexane according to the AOCS method Ce 2-66 [103].

FAMES were analysed on a Fison 8160 capillary gas chromatograph equipped with a capillary cold on-column injector, a fused silica capillary column, Omegawax 320 (30 m, 0.32 mm i.d., 0.25  $\mu\text{m}$  film thickness) connected to a flame ionisation detector (FID). The FID was connected to a computer implemented with Chrom-cart for Windows 1.21 software. The gas chromatograph was provided with an AS800 auto-sampler. The oven temperature was increased from 80 to 180 °C at 25 °C  $\text{min}^{-1}$  and held for 2 min. The temperature of the oven was then increased by 2.5 °C  $\text{min}^{-1}$  to 205 °C (held for 8 min) and up to 215 °C and held for 3 min. The temperature of the detector was 250 °C. Hydrogen was used as carrier gas at a flow rate of 1.6  $\text{ml}\cdot\text{min}^{-1}$ .

Free fatty acid methyl esters were identified by the comparison of their retention times with those of a reference solution chromatographed at identical GC conditions.

The analysis was performed in duplicate and the results were expressed in GC area % as a mean value  $\pm$  standard deviation.

### 3.3.4 Peroxide value

Peroxide value (PV) is a method for determination of the primary oxidation products. PV of extracted oil (OIL, OIL1, and OIL2) and phospholipids (PL1, PL2) was determined using the official ferric thiocyanate method of the International Dairy Federation (IDF) [104] with modifications according to Ueda *et al.* [105] and Undeland *et al.* [106]. Chloroform was evaporated from an aliquot of each sample by a stream of nitrogen gas and the sample was redissolved in iso-hexane to a concentration of  $20 \pm 1$  mg/mL.

The principle of the method is based on the oxidation of ferrous ion ( $Fe^{2+}$ ) to ferric ion ( $Fe^{3+}$ ) by lipid hydroperoxides in an acidic medium. Ferric ion then reacts with thiocyanate forming a pink complex:

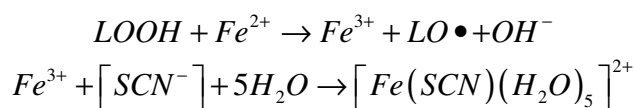

This pink complex shows strong absorption at 500 nm and is determined spectrophotometrically. Standard curve is based on  $Fe^{3+}$  solution.

Each product was analysed in triplicate and the results were expressed in meq peroxide  $O_2$ /kg fat as the mean value  $\pm$  standard deviation.

### 3.3.5 Thiobarbituric acid reactive substances

Thiobarbituric acid reactive substances (TBARS) evaluate the secondary oxidation products. TBARS of the isolation products were analyzed according to the spectrophotometric method described by Ke et al. [107]. The amounts of the solutions used were reduced to half compared to the original method.

The principle of the method is the reaction between one molecule of malonaldehyde (oxidation product) and two molecules of thiobarbituric acid forming a pink complex [18] (see Figure 23):

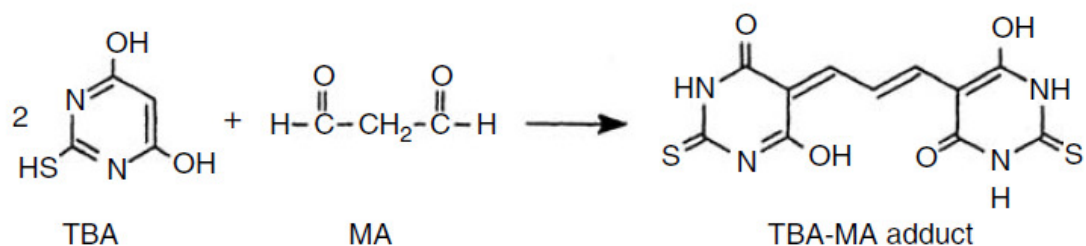

**Figure 23:** Reaction between thiobarbituric acid and malonaldehyde [18]

The intensity of this complex is measured at 530 nm.

The amount of TBARS in samples was determined by comparison of absorbance values for samples with absorbance values for the standard curve prepared for 1,1,3,3-tetraethoxypropane (TEP).

The sample analysis was performed in triplicate. The amount of TBARS was expressed as  $\mu$ M TBARS/g fat as the means value  $\pm$  standard deviation.

### 3.3.6 *p*-anisidine value

*p*-anisidine value (AV) measures secondary oxidation products – reactive aldehydes. AV of the isolation products was determined according to AOCS Official method Cd 18-90 [108]. This method measures the amount of aldehydes (mainly 2-alkenals and 2, 4-alkadienals) in fats and oils, by the reaction of aldehydic compounds in a sample and the *p*-anisidine. Absorbance of the final yellowish reaction product mixture is measured at 350 nm.

The sample analysis was performed in triplicate. AV was expressed as AV/g fat as the mean value  $\pm$  standard deviation.

### 3.3.7 Total carotenoids

The isolation products were analyzed for a total carotenoid content as described by Tolasa et al. [109]. The recommended concentration of oil/phospholipids in n-hexane (for the solution to be analyzed) was 50 mg/mL. To avoid too high colour intensity and therefore too high absorbance (because the samples contained different amount of carotenoids), solutions with lower concentrations were prepared directly by taking smaller (than recommended) amounts of samples. This means, that PL1 and PL2 were dissolved to a 50 mg/mL concentration, OIL and OIL1 were dissolved to a 12.5 mg/mL concentration and OIL2 was dissolved to a 16.67 mg/mL concentration. The absorbance was measured at 472 nm.

The content of carotenoids (as astaxanthin and canthaxanthin) was calculated using the absorption coefficient  $E = 2100$ . The samples were analyzed in triplicate. The carotenoid content was expressed as  $\mu\text{g}$  of carotenoids/g fat as the mean value  $\pm$  standard deviation.

Another method, by Sachindra et al. [110], was employed for carotenoids determination, using petroleum ether as a solvent. However, the results are not shown, which will be explained in part Results and discussion.

### 3.4 Oxidation experiments – oxygen uptake measurement

As a method to study lipid oxidation, measurement of oxygen uptake was employed. Concentration of dissolved oxygen in liposomes was measured continuously by a polarographic oxygen electrode. The fact that the measurements can be done continuously, makes this technique very advantageous.

In this system, the catalytic activity of different pro-oxidants can be studied alongside with effects of antioxidants (both hydrophilic and lipophilic), different salts and/or different pH [7].

When a promoter or an antioxidant is added to the system, its effect can be seen immediately – the oxygen uptake will alter (increase or decrease) or will remain the same.

The consumption of the dissolved oxygen is then used to calculate the oxygen uptake rate (OUR) that reflects the rate of lipid oxidation.

#### 3.4.1 Oxygraph

The oxygraph system (Figure 24) consists of an electrode (a) which is mounted on a control unit (b). The electrode disk (c) forms the bottom of the whole reaction cell (d) into which liposomes (or different reaction mixtures) can be pipetted. A magnet (e) is put into the reaction cell to stir the reaction mixture and to facilitate equal distribution of oxygen in the whole volume of the reaction mixture. A plunger (f) is employed to prevent oxygen diffusion from the atmosphere. A capillary canal (g) in the plunger serves for injection of different reactants into the mixture during measurements. The reaction cell is water-jacketed, so it is possible to adjust the temperature at which the experiment is run. The water is circulated in hoses which connect the jacket with a water bath [10].

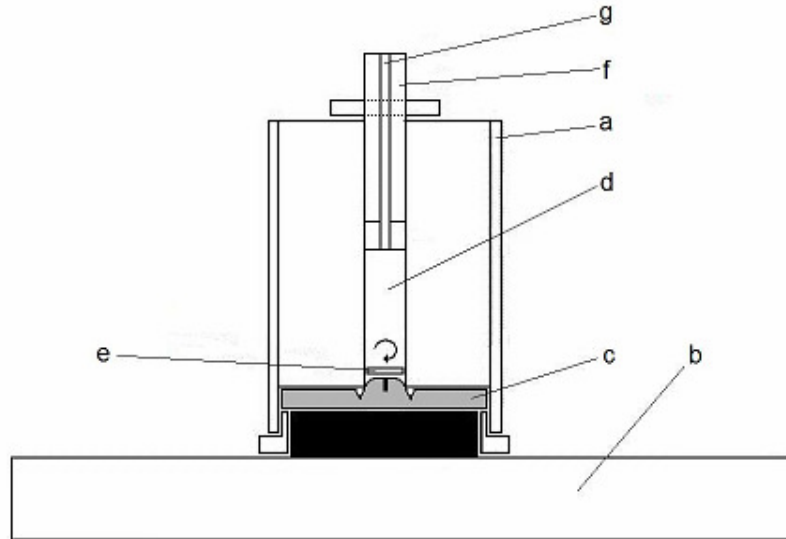

**Figure 24:** Scheme of the oxygraph system [10]

The oxygen electrode (Figure 25) consists of a platinum cathode and a silver anode. The electrodes are connected by an electrolyte bridge which is made by pouring a small volume of the electrolyte solution (3M KCl) on the dome part of the electrode which is held by a paper spacer and a polytetrafluoroethylene membrane. Then, a stable polarizing voltage from the control box is applied on the electrodes. This causes ionization of the electrolyte; and current flows through the electrolyte. The magnitude of this current flow is proportional to the concentration of oxygen dissolved in the electrolyte, which is in turn proportional to the oxygen concentration in the surrounding reaction mixture (solution in the cell) [10].



**Figure 25:** Electrode disc [111]

### 3.4.2 Reaction conditions

All the experiments were performed at 30°C and pH 5.3 – 5.6. At pH ~ 5.5 a maximum OUR was observed for Hb- and free iron-mediated oxidation in liposomes [43] and therefore this value was chosen as a working pH in this study. The pH value of the reaction mixture was verified after the experiments.

The concentration of the liposome solution was 1.5 % (1.5 mg/mL).

The volume of the reaction mixture was 1 mL.

MES solution (5 mM) was prepared by diluting appropriate amount of MES in distilled water and adjusting pH at 5.5 by a few drops of 1 M NaOH.

### 3.4.2.1 Reactants

TPP solution (250 mM) was prepared by diluting appropriate amount of TPP in chloroform. TPP solution was stored in a refrigerator.

Stock solutions (0.02 M) of  $\text{Fe}^{2+}$  ( $\text{FeCl}_2 \cdot 4\text{H}_2\text{O}$ ) and  $\text{Fe}^{3+}$  ( $\text{FeCl}_3$ ) in 0.5 M HCl were prepared monthly. Because of possible autoxidation of  $\text{Fe}^{2+}$  at higher pH, acidic solutions were made. The working solutions (0.5 mM) of  $\text{Fe}^{2+}$  and  $\text{Fe}^{3+}$  were prepared daily by diluting appropriate amount of stock solution with MES solution.

Working solution of bovine hemoglobin (0.001 g/mL corresponding to 15.5  $\mu\text{M}$ ) was prepared daily by dissolving appropriate amount of bovine hemoglobin in MES solution.

EDTA (ethylenediamine tetraacetic acid) solution (1.71 mM) was prepared by diluting appropriate amount of EDTA in MES solution.

Stock solution of ascorbic acid (AsA) (100 mM) was prepared in MES solution, stock solution of caffeic acid (CaA) (100 mM) was prepared in 96% ethanol. These solutions were kept refrigerated. Working solutions (5 mM) of these reactants were prepared freshly before running the experiments by diluting appropriate volume of the stock solution in MES solution.

Stock solutions of lipid-soluble antioxidants astaxanthin (0.2 mM, 2 mM),  $\alpha$ -tocopherol (4.6 mM),  $\delta$ -tocopherol (5.1 mM) and L-ascorbic acid-6-palmitate (4.8 mM) were prepared by dissolving appropriate amount of the substance in chloroform.

Concentrations of prooxidants and water-soluble antioxidants used in experiments were calculated and expressed as a final concentration of the compound in the reaction mixture (1 mL), see **Table 2** and **Table 3**. The concentration of lipid-soluble AOX was expressed as the AOX concentration in phospholipids (because of the type of their solubility), and was 0.1% and 1.0%.

Stock solution of  $\text{H}_2\text{O}_2$  (0.001 mol/L) was prepared by diluting appropriate amount of the concentrated solution (30%  $\text{H}_2\text{O}_2$ ). Working solutions (0.062  $\mu\text{mol/L}$ ) were prepared freshly before experiments.

During measurements of dissolved oxygen concentration, background oxygen uptake rate (OUR) was observed for first 2 – 4 minutes ( $r_0$ ). This was the oxygen uptake rate for liposome solution itself.

### 3.4.2.2 Hemoglobin

After that, for the first set of measurements, hemoglobin was added in five different amounts/concentrations – 10  $\mu\text{L}$ , 20  $\mu\text{L}$ , 40  $\mu\text{L}$ , 60  $\mu\text{L}$  and 80  $\mu\text{L}$  of Hb solution, corresponding to a certain amount of Hb-iron (see **Table 2**).

After Hb addition, a fast decrease of dissolved oxygen concentration was observed. This decrease was characteristic for each Hb concentration (and for each antioxidant and each concentration in other experiments).

### 3.4.2.3 EDTA

Concerning EDTA, double the amount of EDTA relative to the Hb-Fe amount (see **Table 2**) was added to the reaction mixture at different stages – it was added before Hb or after addition of Hb. Based on these experiments (discussed in section 4.2.4), it has been decided to add EDTA to the liposome solution before addition of any other reactant. Therefore, after observing the background oxygen uptake rate for liposomes, EDTA was

added and a background OUR ( $r_1$ ) was observed again until it was constant. Then, Hb was added and the OUR was observed ( $r_2$ ).

**Table 2:** Amounts of hemoglobin and EDTA used in the experiments

V (Hb solution) ( $\mu\text{L}$ )	c (Hb) in reaction cell ( $\mu\text{M}$ )	c (Hb-Fe) in reaction cell ( $\mu\text{M}$ )	c (Hb-Fe) (ppm)	V (EDTA solution) ( $\mu\text{L}$ )
10	0.16	0.62	0.03	7
20	0.31	1.24	0.07	15
40	0.62	2.48	0.14	30
60	0.93	3.72	0.21	45
80	1.24	4.96	0.28	60

**Table 3:** Amounts of antioxidants and TPP used in the experiments

	c (AOX) in reaction cell ( $\mu\text{M}$ )	c (TPP) in 1.5% liposomes ( $\mu\text{M}$ )	c (Hb) in reaction cell ( $\mu\text{M}$ )	c (Hb-Fe) in reaction cell ( $\mu\text{M}$ )
AsA	25	-	0.62	2.48
	50	-	0.62	2.48
CaA	50	-	0.62	2.48
	100	-	0.62	2.48
TPP	-	200	0.62	2.48
	-	200	1.24	4.96
Astaxanthin 0.1 %	-	-	0.62	2.48
			0.93	3.72
Astaxanthin 1.0 %	-	-	0.62	2.48
			0.93	3.72
Ascorbyl palmitate 0.1 %	-	-	0.62	2.48
			0.93	3.72
Ascorbyl palmitate 1.0 %	-	-	0.62	2.48
			0.93	3.72
$\alpha$ -tocopherol 0.1 %	-	-	0.62	2.48
$\delta$ -tocopherol 0.1 %	-	-	0.62	2.48
$\alpha$ -tocopherol 1.0 %	-	-	0.62	2.48
			0.93	3.72
$\delta$ -tocopherol 1.0 %	-	-	0.62	2.48
			0.93	3.72

#### 3.4.2.4 Thermal denaturation

In subsequent experiments the influence of thermal denaturation of Hb on its pro-oxidant activity was investigated. Hb solution was heated in a boiling water bath for 10 minutes. After it cooled down, it was used for the experiments.



#### **3.4.2.5 TPP (triphenylphosphine)**

Liposomes prepared with TPP were prepared from phospholipids that had been mixed with TPP in chloroform. The preparation procedure is described in section 3.2 Liposome preparation. Final concentration of TPP in the 1.5% liposome solution was 200  $\mu\text{M}$ . TPP was used in the experiment where the influence of this peroxide scavenger was studied. TPP was added to PL to reduce the amount of pre-existing lipid peroxides. TPP is known to break down peroxides to alcohols and has been reported to be an effective scavenger of pre-existing lipid peroxides in liposomes [112]. The reason for utilizing TPP was the assumption that metHb needs to be activated by  $\text{H}_2\text{O}_2$  or lipid peroxides to be an effective prooxidant, therefore the oxidation reaction would be dependent on the concentration of pre-existing lipid hydroperoxides.

#### **3.4.2.6 Water-soluble antioxidants**

For experiments with water-soluble antioxidants (CaA, AsA), the order of addition of reactants was as follows: liposomes and their background OUR was observed ( $r_0$ ). Then, EDTA was added and background OUR was observed again until it became constant. Then, the antioxidant was added to the system and the background OUR was observed again. When a constant background OUR was reached ( $r_1$ ), Hb was added.

#### **3.4.2.7 Lipid-soluble antioxidants**

For experiments with lipid-soluble antioxidants, a calculated appropriate amount of an antioxidant stock solution was added to the concentrated phospholipids so that the final concentration of the AOX in phospholipids was 0.1% and 1.0%. The solvent was evaporated by a stream of nitrogen gas and then, the PL were kept under vacuum for 1 hour. Then the procedure of liposomes preparation was the same as described in part 3.2 Liposome preparation. The order of addition of reactants was as follows: liposomes containing a lipid-soluble antioxidant, then EDTA and then Hb.

#### **3.4.2.8 Experiments without the presence of light**

To study the the role of hemoglobin as a photosensitizer and therefore the influence of singlet oxygen on oxidation of marine liposomes, several experiments without the presence of light were carried out. The reaction cells were covered with aluminium foil during the reactions. For these experiments liposomes were prepared as usual.

#### **3.4.2.9 Reaction with hydrogen peroxide ( $\text{H}_2\text{O}_2$ )**

The reaction of metHb with  $\text{H}_2\text{O}_2$  leads to formation of hypervalent iron species (perferrylhemoglobin and ferrylhemoglobin). Perferrylhemoglobin rapidly transforms to ferryl hemoglobin, which is an initiator of lipid oxidation [55]. In our experiments reactions between metHb with  $\text{H}_2\text{O}_2$  were carried out to see if the rate of oxidation is enhanced by formation of the hypervalent iron species in our model system.

### **3.4.3 OUR measurement**

The OUR of the overall oxidation ( $r_2$ ) was measured after the addition of Hb as pro-oxidant.

An example of an OUR measurement is shown in Figure 26.

For evaluation of Hb prooxidative activity, the rate of catalyzed oxidation was compared with the rate of non-catalyzed oxidation. To evaluate the effect of an antioxidant, the rate of oxidation of liposomes containing an antioxidant was compared with the rate of oxidation of liposome solution without AOX.

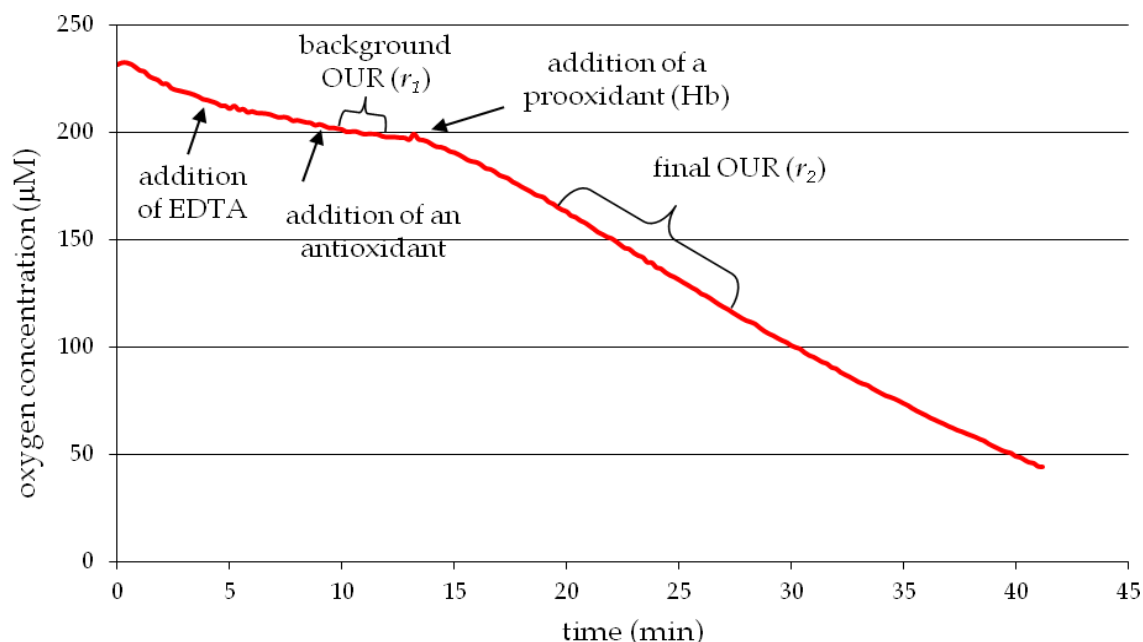
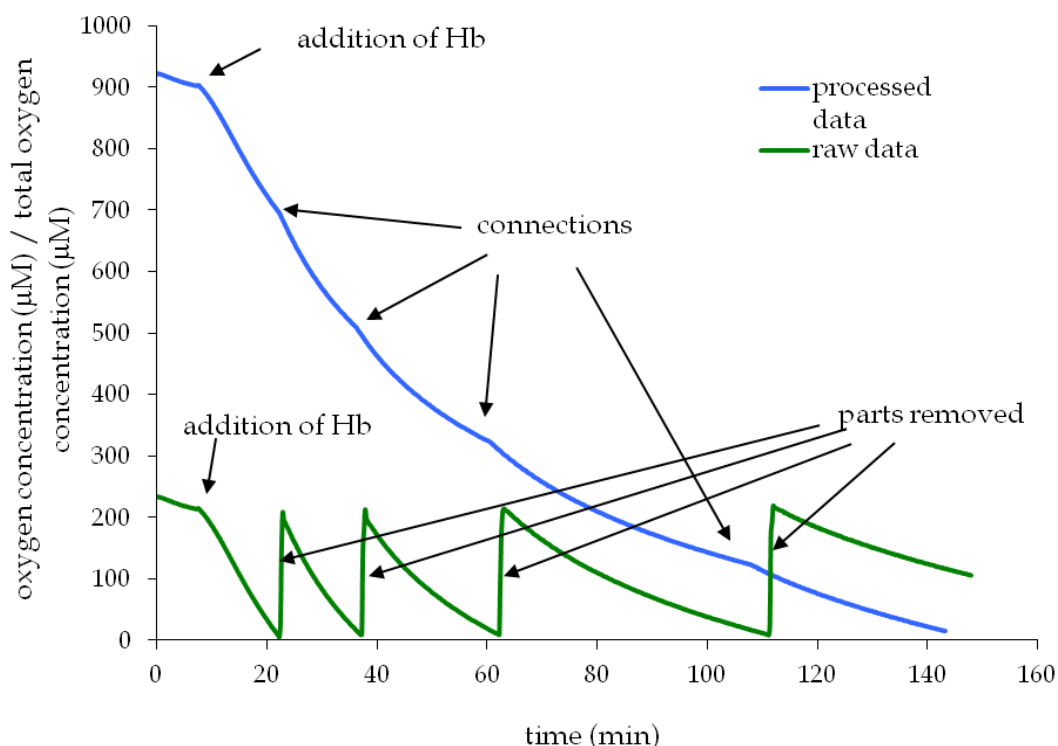

**Figure 26:** Example of an oxygen uptake rate measurement

Three parallel measurements were run for each type of experiment. Oxygraph software “oxy32” and MS Excel were used for data and graphs processing and statistical analysis.

### 3.4.4 Graph processing

Figure 27 (green curve) shows an oxygen uptake rate measurement as recorded by the Oxygraph software. In the experiments, where the oxygen concentration reached zero, the plunger was removed and the mixture was bubbled with a Pasteur pipette to replenish the dissolved oxygen. This bubbling can be seen as a rapid increase of oxygen concentration. Then, the reaction proceeded further and was observed for a longer period of time.



**Figure 27:** An example of the original and processed graph of an oxygen uptake rate measurement in a liposome solution with added Hb as a prooxidant. The processed graph is made by connecting the parts before and after the addition of oxygen and removing the parts in between

A file from each measurement was saved as ASCII file using the Oxygraph software and the curve was processed in MS Excel. In the next step, parts of the curve when bubbling was done were connected to give one continuous graph. Therefore the continuous graph is made by connecting the parts before and after the addition of oxygen and removing the parts in between. The y-values were shifted so that the whole curve is situated in the first quadrant of the field. Therefore the oxygen concentration was termed *total (sum) oxygen concentration*. The original and processed graph with Hb as a prooxidant is shown in Figure 27.

In the third step the so called *functional region* of the curve was chosen, which is the main part of the curve beginning at the moment of Hb addition and ending when the oxygen uptake rate reached the background OUR (apparently the oxidation is not catalyzed anymore in this phase). The moment of Hb addition was set as a zero time (x-axis shift). Exponential function was chosen (see Figure 28) as the most suitable function:

$$Y = A \cdot e^{-bx}$$

Parameter  $b$  was used for calculating the average value, which was named  $k$  – a rate constant. This constant was divided by the concentration of Hb in the cell ( $\mu\text{M}$ ), and this number was called *specific rate*. The specific rate then served for comparison with the specific rates  $k$  of individual experiments, evaluation of the prooxidant or antioxidant activity of the compounds employed and evaluation of effects of various reaction conditions. If the difference between the  $k$  values was lower than 5 %, it was concluded that no effect on the

control curve was observed. The other two conclusions are: the specific rate  $k$  was either inhibited (i. e. the changed conditions have an antioxidative effect) or increased (i. e. the changed conditions have a prooxidative effect).

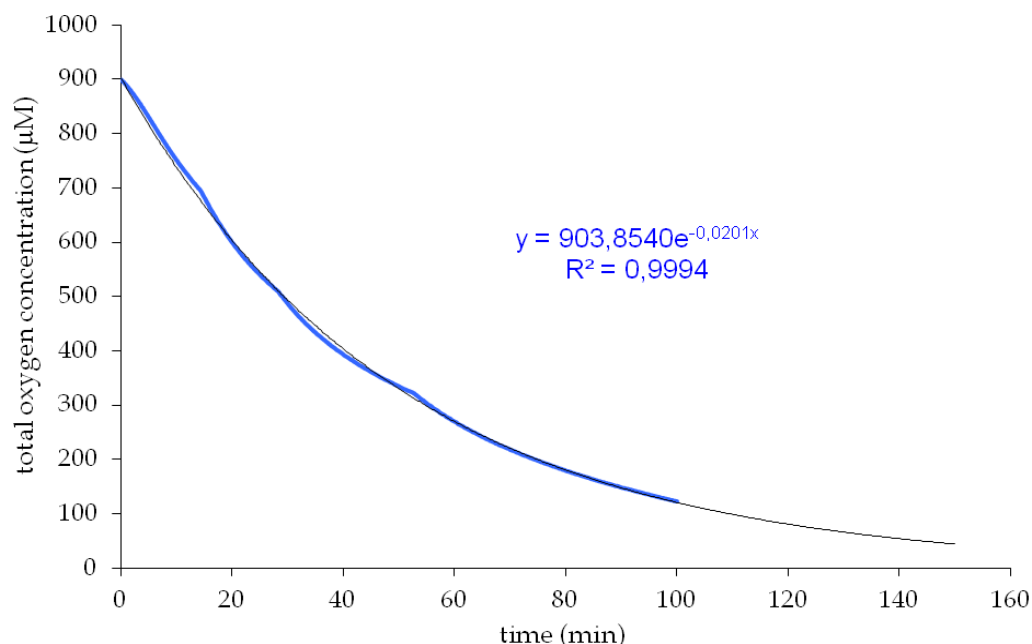

**Figure 28:** An example of a processed curve with a suitable trendline and its equation

### 3.5 List of chemicals

The following chemicals were supplied by Sigma-Aldrich Chemie GmbH (Steinheim, Germany):

- Caffeic acid
- Astaxanthin,  $\geq 92\%$
- $\delta$ -tocopherol, 90%
- Hemoglobin from bovine blood – methemoglobin
- L-ascorbic acid-6-palmitate, 94,6%
- 2-methyl-pentane
- 2-(N-morpholino)ethanesulfonic acid (MES),  $\geq 99,5\%$
- Sodium dithionite ( $\text{Na}_2\text{S}_2\text{O}_4$ )
- 1,1,3,3-tetraethoxypropane (TEP)
- 2-thiobarbituric acid (TBA)
- Trichloroacetic acid (TCA)
- Sodium sulphite ( $\text{Na}_2\text{SO}_3$ )

The following chemicals were supplied by Merck KGaA (Darmstadt, Germany):

- Acetic acid
- Acetone
- Ammonium thiocyanate ( $\text{NH}_4\text{SCN}$ )
- DL- $\alpha$ -tocopherol, 98,2%
- Chloroform, p.a.

- Ethanol
- Ferrous chloride tetrahydrate ( $\text{FeCl}_2 \cdot 4\text{H}_2\text{O}$ ), >99%
- Hydrochloric acid (HCl) (37%)
- Hydrogen peroxide, >30%
- Methanol
- *n*-hexane, p. a.
- Potassium chloride (KCl)
- Sodium hydroxide (NaOH), >99,98%

The following chemicals were supplied by Riedel de Haën (Seelze, Germany):

- Ferric chloride anhydrous ( $\text{FeCl}_3$ ), p. a.

The following chemicals were supplied by Fluka Chemie (Buchs, Germany):

- IDRANAL II (ethylenediaminetetraacetic acid, EDTA),  $\geq 99,5\%$

Nitrogen ( $\text{N}_2$ ) gas was supplied by ASA AS, Oslo, Norway.

### 3.6 List of instruments

The following instrumental devices were used:

- Mettler AE200 electronic balance (Mettler – Toledo International, Inc., USA)
- PRECISA 1000C – 3000D electronic balance (PAG Oerlikon AG, Zürich, Switzerland)
- Mettler AG204 Delta Range analytical balance (Mettler – Toledo International, Inc., USA)
- Ultra Turrax homogenizer (IKA Works, Inc., Staufen, Germany)
- Heidolph LABOROTA 4000 rotavapor (Heidolph Instruments, GmbH & Co., KG, Schwabach, Germany)
- Büchi Rotavapor R-200 (Büchi Labortechnik AG, Switzerland)
- Büchi Heating Bath B-490 (Büchi Labortechnik AG, Switzerland)
- Heto Heating Bath (Birkerød, Denmark)
- Sorvall RC5C centrifuge (Thermo Fisher Scientific Inc., Waltham, MA, USA)
- Sorvall RC5B PLUS centrifuge (Thermo Fisher Scientific Inc., Waltham, MA, USA)
- Vibra Cell sonicator (Sonics & Materials Inc., USA)
- MS2 Minishaker vortex (IKA Works, Inc., USA)
- Magnetic stirrer VMS-A (VWR Inc., SAS, France)
- TitrLab station TIM90 Titration Manager (Radiometer analytical SAS, Denmark)
- Glass electrode LIQ-GLASS 238000/08 (Hamilton Co., Reno, USA)
- pH meter pH3110 (WTW, Weilheim, Germany)
- pH-electrode SenTix41 (WTW, Weilheim, Germany)
- Oxygraph system (Hansatech Instruments Ltd., Norfolk, UK)
- Ultrospec 2000 UV/Visible spectrophotometer (Amersham Pharmacia Biotech Inc., Sweden)
- VARIAN 50 Bio UV-Visible spectrophotometer (Varian Inc., The Netherlands)
- Fison 8160 capillary gas chromatograph (Fisons Instruments S.p.A., Milan, Italy)

- fused silica capillary column Omegawax 320 (Supelco Inc., Bellefonte, Pennsylvania, USA)
- Iatroscan TLC-FID analyzer TH-10 MK-IV, Iatron Laboratories Inc., Tokyo, Japan)
- Finnpiette pipettes (Thermo Fisher Scientific Inc., Waltham, MA, USA)
- Finnpiette pipettes (Thermo LabSystems Inc., Beverly, MA, USA)
- Microliter syringe #705 (Hamilton, Bonaduz, Switzerland)

## 4 RESULTS AND DISCUSSION

### 4.1 Analysis of isolation products

#### 4.1.1 Composition of the isolation products, purity of final phospholipids

The oil (total lipids) was extracted from cod roe. The marine phospholipids that were used for preparation of liposomes were isolated from the total lipids. Two precipitation steps were employed to obtain phospholipids with as high purity as possible. The precipitation steps removed triacylglycerols (TAG), diacylglycerols (DAG), monoacylglycerols (MAG), free fatty acids, cholesterol and a substantial portion of carotenoids.

The mass balance of the isolation and extraction processes is given in Table 4. From the total amount of 6156 g of the roe, 218.3 g of oil (total lipids) was obtained, which is 35.5 g of oil per kg of cod roe; and this is 3.55 % of the cod roe mass. From the cod roe, the yield of 59.4 g of final phospholipids (PL2) was obtained, which is 9.64 g of PL2 per kg of cod roe, and this is 0.96 % of PL2 of the cod roe weight.

The main constituents of fish roe are proteins, lipids and water. They show considerable differences in their relative proportions among various fish species. Lipids in our isolation comprised 3.55 % of the cod roe mass. For example, Kaitaranta and Ackman [22] have reported lipid content of various fish roe in the range 2.4 – 9.2 % of the roe weight (on a wet weight basis), whereas Falch et al. [113] reported lipid content of roe from saithe (*Pollachius virens*) to be 5.7 %.

**Table 4:** Mass balance of the isolation and extraction processes

	<b>OIL</b>	<b>OIL1</b>	<b>OIL2</b>	<b>PL1</b>	<b>PL2</b>
<b>Yield in g/kg of cod roe</b>	35.5	22.3	3.2	12.4	9.6
<b>Yield in % of cod roe weight</b>	3.55	2.23	0.32	1.24	0.96

The composition of the total lipids (OIL), intermediate products (OIL1, OIL2, PL1) and final phospholipids (PL2) were determined using the Iatroscan TLC-FID analyzer.

The composition of the isolation products is shown in Table 5. The extracted oil contained  $75 \pm 8$  % of phospholipids. The final phospholipids contained  $96.4 \pm 0.3$  % of phospholipids (which is in agreement with analysis of cod roe PL carried out by Mozuraityte et al. [10], who reported that the phospholipid content in final PL ranged from 96 to 99.4 %). The final phospholipids also contained small amounts of free fatty acids, diacylglycerols and cholesterol. Other compounds (cholesterol esters, triacylglycerols, monoacylglycerols) were not detected in PL2. High amount of phospholipids was lost during the isolation procedure and the acetone precipitation steps, because OIL1 and especially OIL2 contain high amounts of PL,  $44 \pm 4$  % and  $76 \pm 1$  %, respectively. Phospholipids were not further isolated from OIL1 and OIL2.

Falch et al. [113] analyzed the chemical composition of roe from saithe (*Pollachius virens*) and found out that PL made 84.5 % of total lipids.

Figure 29 shows an example of an Iatroscan chromatogram.

**Table 5:** Composition of the isolation products gained during the isolation of phospholipids

Lipids \ %	Cholesterol esters	Triacylglycerols	Free fatty acids	Diacylglycerols	Cholesterol	Monoacylglycerols	Phospholipids
<b>OIL</b>	1.3	8 ± 2	6 ± 2	nd	10 ± 2	2.6	75 ± 8
<b>OIL1</b>	2.9 ± 0.2	25 ± 1	11 ± 3	nd	15.9 ± 0.6	nd	44 ± 4
<b>PL1</b>	nd*	1.4	2.7	nd	9.7	nd	86.3
<b>OIL2</b>	0.604 ± 0.003	4.40 ± 0.06	6.51 ± 0.02	nd	12.6 ± 0.9	nd	76 ± 1
<b>PL2 (final PL)</b>	nd	nd	1.6 ± 0.4	1.2 ± 0.2	0.9 ± 0.3	nd	96.4 ± 0.3

Results are expressed in % as the mean value ± standard deviation; \* not detected.

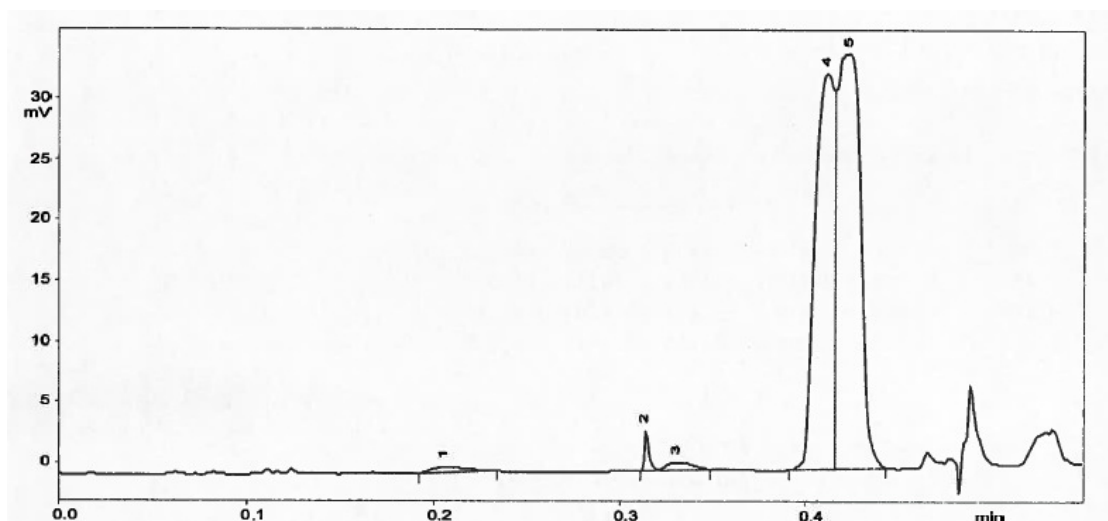

**Figure 29:** Iatroscan chromatogram of PL2, from left free fatty acids peak (1), diacylglycerol peak (2), cholesterol peak (3) and phospholipid peaks (4, 5)

As can be seen from this chromatogram, the phospholipid peak was separated into two peaks indicating that the phospholipids comprise two classes of PL – probably phosphatidylcholine (PC) and phosphatidylethanolamine (PE).

#### 4.1.2 Composition of PL2 determined by HPLC-CAD

The composition of PL2 was determined also by HPLC-CAD analysis. The composition of PL2 is shown in Table 6.

The isolated PL2 contained 22.9 % of phosphatidylethanolamine (PE) and 3.2 % of lysophosphatidylethanolamine (lysoPE), 59.9 % of phosphatidylcholine (PC) and 2.9 % of lysophosphatidylcholine (lysoPC).



**Table 6:** Composition of PL2 analyzed by HPLC-CAD

$\%$ Lipids	PE	lysoPE	PC	lysoPC
<b>PL2</b>	22.9	3.2	59.9	2.9

Figure 30 shows the HPLC-CAD chromatogram of PL2. Besides PE, lysoPE, PC and lysoPC, three other peaks (11.1 % in total) can be seen on the chromatogram. These substances are unknown, because only four standards were available at the time of analysis. However, these peaks might represent (from left) cholesterol, TAG and astaxanthin.

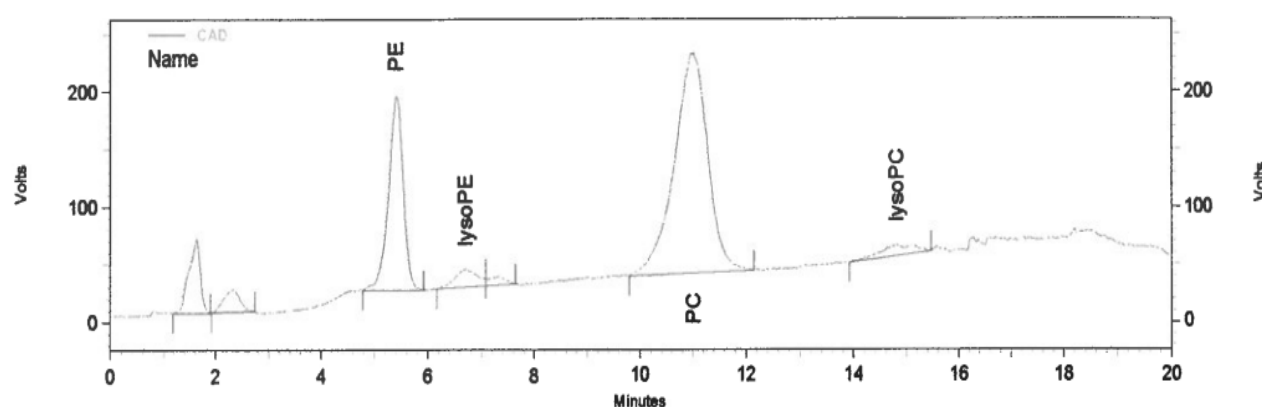

**Figure 30:** HPLC-CAD chromatogram of PL2 analysis, from left: two unknown peaks, PE peak, lysoPE peak, unknown peak, PC peak and lysoPC peak

When comparing Iatroscan analysis versus HPLC-CAD analysis, it can be concluded that each method has different limit of detection, e. g. in Iatroscan determination, TAG were not detected in PL2. HPLC-CAD is a very suitable method for phospholipid separation.

#### 4.1.3 Fatty acid profile of OIL and PL2

Fatty acid composition of extracted oil (OIL) and final phospholipids (PL2) was determined by gas chromatography (GC) of their fatty acid methyl esters (FAMES).

The fatty acid composition of OIL and PL2 is given in Table 7 and presented in detail in Figure 31.

The main fatty acid both in OIL and PL2 was DHA (docosahexaenoic acid, C22:6 *n*-3) followed by palmitic acid (C16:0). For OIL, the third and fourth most abundant fatty acid was EPA and oleic acid, respectively; for PL2 it was oleic acid and EPA, respectively. The content of PUFA was  $48.6 \pm 0.5$  % in OIL and  $46.0 \pm 0.3$  % in PL2 (in % of the total fatty acids). Among PUFA, EPA and DHA were the main constituents. As comparison, Cervera *et al.* [114] have reported, that PUFA from cod roe (*Gadus morhua*) made up to  $36.1 \pm 0.8$  % of total saponifiable oil. In contrast to our analysis, Cervera *et al.* [114] have reported, that linoleic acid (18:2 *n*-6) was the main PUFA (and made up  $11.8 \pm 0.2$  % of total saponifiable oil), but closely followed by DHA, which made up to  $10.3 \pm 0.3$  % of total saponifiable oil. The disagreement for the main PUFA being linoleic acid, can be explained by different origin of the cod roe.

**Table 7: Fatty acid composition of OIL and PL2**

Lipids	OIL	PL2
<b>Saturated</b>	21.9 ± 0.9	26.6 ± 0.4
- palmitic acid	18.3 ± 0.7	21.0 ± 0.2
<b>Monounsaturated</b>	24.6 ± 0.3	23.11 ± 0.07
- oleic acid	13.0 ± 0.1	12.81 ± 0.08
<b>Diunsaturated</b>	1.03 ± 0.03	0.71 ± 0.04
<b>Polyunsaturated:</b>	48.6 ± 0.5	46.0 ± 0.3
- DHA	30.5 ± 0.1	30.53 ± 0.02
- EPA	14.44 ± 0.08	12.25 ± 0.02
<b>unknown</b>	3.9 ± 0.1	3.55 ± 0.03

Results are expressed in % as the mean value ± standard deviation.

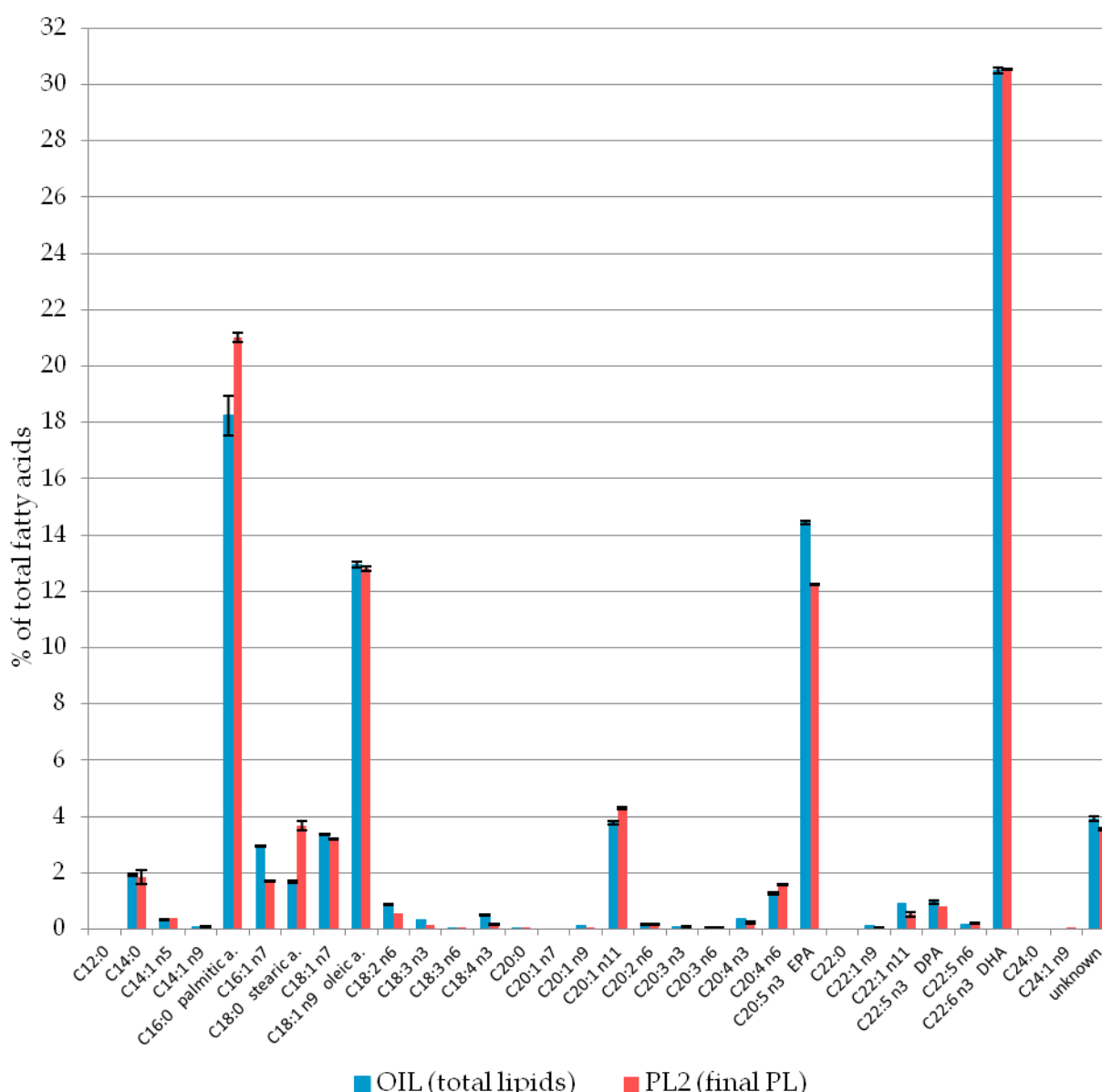

**Figure 31: Fatty acid composition of OIL and PL2**

Values similar to this study, have been reported by Mozuraityte *et al.* [115], who made different phospholipid preparations from five batches of cod roe – the content of saturated fatty acids ranged 24.8 – 35.5 %, monounsaturated fatty acids ranged 22.3 – 35.1 %, and PUFA ranged 31.5 – 52.9 % of the total fatty acids in phospholipids.

Falch *et al.* [113] analyzed the chemical composition of roe from saithe (*Pollachius virens*) and reported the following percentages of fatty acids (as % of total fatty acids) – saturated FA: 25.6 %, monounsaturated FA: 48.4 %, PUFA: 26.0 %, DHA: 31.7 %, EPA: 12.0 %. In comparison with our study the amounts of monounsaturated FA and PUFA are quite different, but the results for saturated FA, DHA and EPA are very similar. The differences are probably due to different species analyzed.

#### 4.1.4 Peroxide value, TBARS and anisidine value

Peroxide value (PV), TBARS and anisidine value (AV) show the degree of oxidation of the extracted oil and the isolation products. These tests enable estimation of how the isolation procedure and storage conditions influenced the degree of oxidation of the lipid matrix.

Table 8 shows peroxide values, TBARS and AV of the isolation products.

**Table 8:** Peroxide values, TBARS and AV of the isolation products (OIL, OIL1, OIL2, PL1 and PL2)

	OIL	OIL1	OIL2	PL1	PL2
<b>PV (meq peroxide O<sub>2</sub>/kg fat)</b>	8.4 ± 0.3	9.3 ± 0.2	10.6 ± 0.7	7.5 ± 0.3	4.9 ± 0.4
<b>TBARS (µmol/g fat)</b>	0.27 ± 0.01	0.22 ± 0.03	0.22 ± 0.03	0.21 ± 0.01	0.47 ± 0.05
<b>AV</b>	1.9 ± 0.7	5.0 ± 0.9	3.2 ± 0.3	9.5 ± 0.3	13.3 ± 1.0

Results are expressed as the mean value ± standard deviation.

The peroxide values of the isolation products differed. The PVs of PL1 and PL2 were significantly lower than PVs of the OIL fractions. This is surprising because PL1 and PL2 contain less carotenoids than the OIL fractions. Carotenoids, which act as antioxidants, were partly removed from PL during the acetone precipitation procedure. A possible explanation can be that molecules with peroxide groups concentrated in the OIL fractions. As peroxides are polar compounds, it is likely that they have better solubility in acetone and therefore most of them did not precipitate.

Peroxide content is the net result of the rate of peroxide formation and the rate of their decomposition. The decomposition pathways of peroxides are numerous and lipid oxidation gives many end products from one peroxide molecule. Therefore analyzing only one or few oxidation products might be misleading.

TBARS, characterizing the secondary oxidation products (volatile aldehydes) were very low (comparison can be done with Mozuraityte [10] and Kristinova [48]). This indicates that keeping the phospholipids dissolved in chloroform and stored at low temperatures (in a freezer) provides suitable conditions for protection against significant oxidation development.

However, TBARS of final phospholipids (PL2) were higher, which might indicate, that the second precipitation negatively influenced the quality of PL2. This is probably because of

further manipulation with the fraction – contact with surrounding oxygen and exposure to higher (than in the freezer) temperatures.

Anisidine value determines the content of non-volatile aldehydes and was highest for PL2. This is consistent with the TBARS for PL2 from the point of view of the secondary oxidation development.

The primary oxidation products are normally measured with the peroxide value test (PV) and the secondary products with p-Anisidine test. Anisidine value (AV) represents the level of non-volatile aldehydes, primarily 2-alkenals and 2, 4-alkadienals present in the fat. On the contrary, other tests (TBARS) consider the volatile portion of aldehydes and, due to their intrinsic variable nature, give results that are less reliable. We can say that peroxide value indicates the actual oxidative status in fat matrix but anisidine value indicates its history from the oxidative point of view. These two values can be combined into the so-called total oxidation or TOTOX value:

$$\text{Totox} = \text{AV} + (2 \times \text{PV})$$

The TOTOX number is commonly used in the industry to describe the oxidative state of oil. It has the advantage of combining evidence of both the history of oil and its present state. However, the TOTOX value does not have any sound scientific bases, because it combines variables with different dimensions [18].

#### 4.1.5 Total carotenoids

The isolation products were analyzed for a total carotenoid content. Carotenoids are a group of fat-soluble pigments distributed widely in nature, and among aquatic animals, carotenoids are responsible for the orange colour of fish meat. Carotenoids also act as antioxidants. The carotenoid content of isolation products is given in Table 9.

**Table 9:** Content of carotenoids in the isolation products (OIL, OIL1, OIL2, PL1 and PL2)

	OIL	OIL1	OIL2	PL1	PL2
<b>µg of carotenoids/g fat</b>	68 ± 4	117 ± 3	42.3 ± 0.7	22.6 ± 0.3	15 ± 1

Results are expressed as the mean value ± standard deviation.

As discussed in section 4.1.1, a large portion of carotenoids was removed by the acetone precipitation of OIL and later, by the second acetone precipitation of PL1. It can be seen from the method by Tolasa et al. [109] and another method [110] (where the qualitative and quantitative distribution of carotenoids in different body components of four species of shrimp was assessed) that in both methods, carotenoids were extracted from the homogenized samples using acetone. During the precipitation steps in our procedure, a large portion of carotenoids was present in the acetone extracts. This is in agreement with the carotenoid content in different isolation products – during the first precipitation, most carotenoids from OIL were extracted into acetone, which is OIL1 fraction. PL1 fraction contains lower amount of carotenoids than OIL1. Also for the second precipitation, larger portion of carotenoids from PL1 was extracted into acetone and is therefore present in OIL2 fraction. OIL2 contains higher amount of carotenoids than PL2.

Nevertheless, calculating the mass balance of carotenoids revealed that the mass balance did not fit. The sum of carotenoid content in OIL1 and PL1 should give the carotenoid content

in OIL; and the sum of carotenoid content in OIL2 and PL2 should give carotenoid content of PL. Another method for carotenoid determination was therefore employed [110], using petroleum ether as a solvent. However, data for carotenoid content are not shown because of an imprecise weighing of samples. Despite of this, the carotenoid content was calculated and gave lower amounts of carotenoids than the first method. But the tendency of the data was the same (see Figure 32), the first method with *n*-hexane as a solvent gave results that were decreased by 33 – 47 % compared to the method using petroleum ether. A possible explanation for these discrepancies might be that different types of carotenoids accumulate in different fractions or different types of carotenoids are present in our samples (detailed carotenoid composition of our samples is not known) - in method using *n*-hexane, astaxanthin and canthaxanthin were determined, whereas in the method using petroleum ether, the carotenoids were: astaxanthin and its mono- and diesters,  $\beta$ -carotene and zeaxanthin.

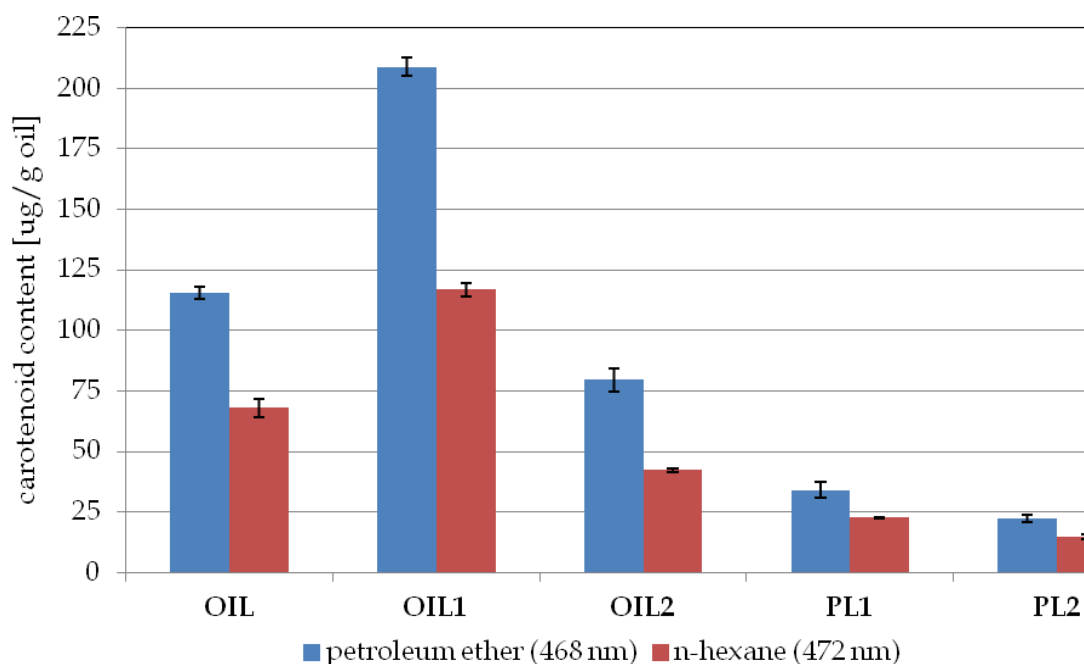

**Figure 32:** Comparison of two methods for carotenoid determination

## 4.2 Oxidation experiments in a liposome system

Liposomes have been used extensively as model membranes. The advantages of using liposomes are partly described in section 2.2.4.3, the reason for choosing hemoglobin as a lipid oxidation catalyst is given in the Introduction to the thesis. Advantages of using liposomes as a model system for study of lipid peroxidation are: due to the bilayer vesicular structure, liposomes resemble cell membranes; they can also imitate emulsions stabilized by phospholipids. In the liposome system, manipulation with the lipid composition, pH, temperature and addition of various reactants is possible. It has been found that the only lipids in lean fish muscle are phospholipids of cell membranes, therefore marine phospholipids can be used for study of oxidation of fish meat matrices [10, 116].

#### 4.2.1 Control experiments without liposomes

Control experiments without liposomes were performed (graphs not shown) to prove that liposomes are the oxidizable substrate in the reactions. The amounts of the substances used in these control experiments were those used in the other experiments.

In the first experiment 0.5 mL of MES solution and 0.5 mL of Hb solution were put into the reaction cell and when the OUR became constant, 45  $\mu$ L of EDTA was added. After the addition of EDTA no change in the consumption of dissolved oxygen was observed.

In the second experiment 1 mL of MES solution was put into the reaction cell and when the OUR became constant, 45  $\mu$ L of EDTA was added. After the addition of EDTA no change in the consumption of dissolved oxygen was observed.

In the third experiment 1 mL of MES solution was put into the reaction cell and when the OUR became constant, 60  $\mu$ L of Hb was added. After the addition of Hb no change in the consumption of dissolved oxygen was observed. This means that Hb had no substrate to oxidize.

In the fourth control experiment 1 mL of MES solution was put into the reaction cell and when the OUR became constant, 60  $\mu$ L of Hb was added and then 45  $\mu$ L of EDTA was added. No change in the consumption of dissolved oxygen was observed. This means that Hb had no substrate to oxidize.

After these outcomes it can be concluded that liposomes is the oxidizable substrate in the reactions investigated in our study and that neither MES solution, nor EDTA nor Hb have influence in the absence of liposomes.

#### 4.2.2 Oxidation of liposomes, addition of $Fe^{2+}$ , $Fe^{3+}$ and Hb

Iron ( $Fe^{2+}$  and  $Fe^{3+}$ ) and bovine methemoglobin (metHb) were used as prooxidants in lipid oxidation in liposomes, whereas metHb was the main catalyst investigated.  $Fe^{2+}$  and  $Fe^{3+}$  were used for some comparison experiments, because Hb contains iron atoms. Oxygen consumption by liposomes themselves and after addition of prooxidants is shown in Figure 33 and 34.

Before addition of any reactant, a slow and linear decrease in concentration of dissolved oxygen was observed. This is consumption of oxygen by liposomes themselves and the oxygen uptake rate (OUR) of liposomes is referred to as the *background OUR*. This initial activity of liposomes can be explained by the presence of pre-formed peroxides and/or the presence of endogenous transition metals (e. g. Fe, Cr). Traces of these metals can contaminate liposome solution during sonication of phospholipids or might be present as contaminants in chemicals.

When  $Fe^{2+}$  was added to liposomes an initial drop in concentration of dissolved oxygen was observed, which was followed by a slower, linear decrease in oxygen concentration. When  $Fe^{3+}$  was added to liposomes, no fast decrease in oxygen concentration was observed. The oxygen concentration decreased slowly a linearly. Mozuraityte et al. [10] explain that the fast decrease in oxygen concentration after addition of  $Fe^{2+}$  is due to oxidation of  $Fe^{2+}$  to  $Fe^{3+}$  by peroxides (via peroxide breakdown). This reaction is accompanied by production of alkoxy radicals which further propagate lipid peroxidation by chain branching leading to production of peroxides, which is accompanied by oxygen consumption. When equilibrium between  $Fe^{2+}$  and  $Fe^{3+}$  is achieved, a constant oxygen uptake rate is observed. Later, EDTA was added to the reaction mixture (in amount 2-times higher than the concentration of added

iron) resulting in a slower linear oxygen concentration decrease. This experiment confirmed the chelating properties of EDTA.

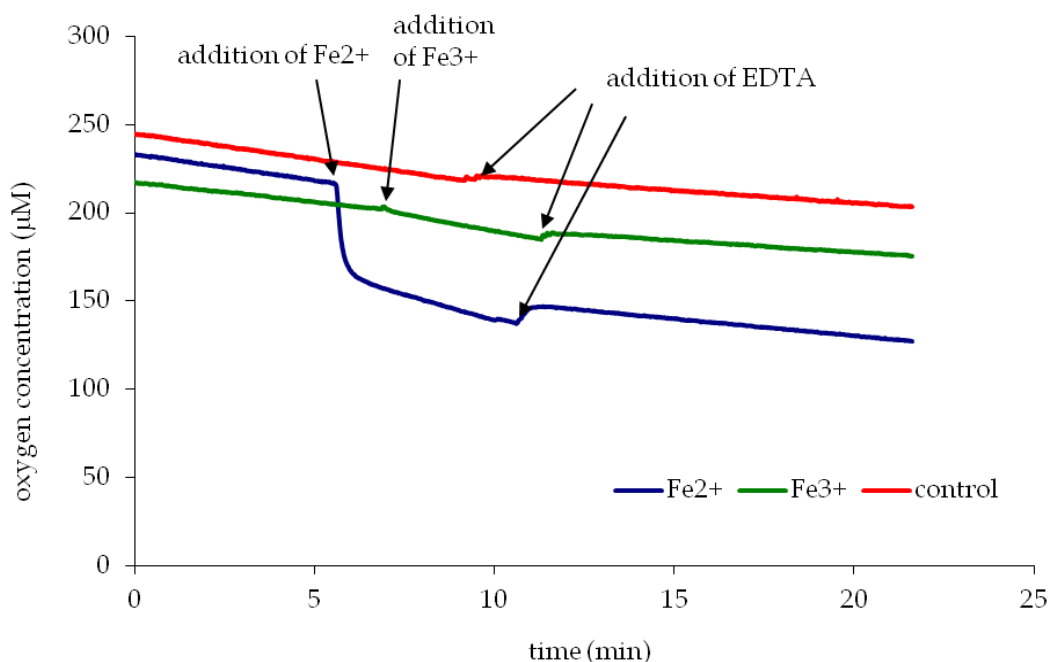

**Figure 33:** Oxygen consumption of a 1.5% liposome solution; oxidation was catalyzed by  $\text{Fe}^{2+}$  ( $10 \mu\text{M}$ ) and  $\text{Fe}^{3+}$  ( $10 \mu\text{M}$ ); and inhibited by addition of EDTA ( $120 \mu\text{L}$ )

When Hb was added to liposomes, no initial drop in concentration of dissolved oxygen was observed (see Figure 34). This might be explained by the met-form of Hb, where iron is present in the  $\text{Fe}^{3+}$  state and also by the different and more complex pro-oxidant activity mechanisms of Hb (as described in section 2.3.1) compared to Fe. The oxygen consumption after addition of Hb was not constant. The fastest OUR was observed immediately after Hb addition. Then the oxygen concentration decreased slowly. As can be seen from Figure 14, the higher the concentration of Hb added, the faster the OUR.

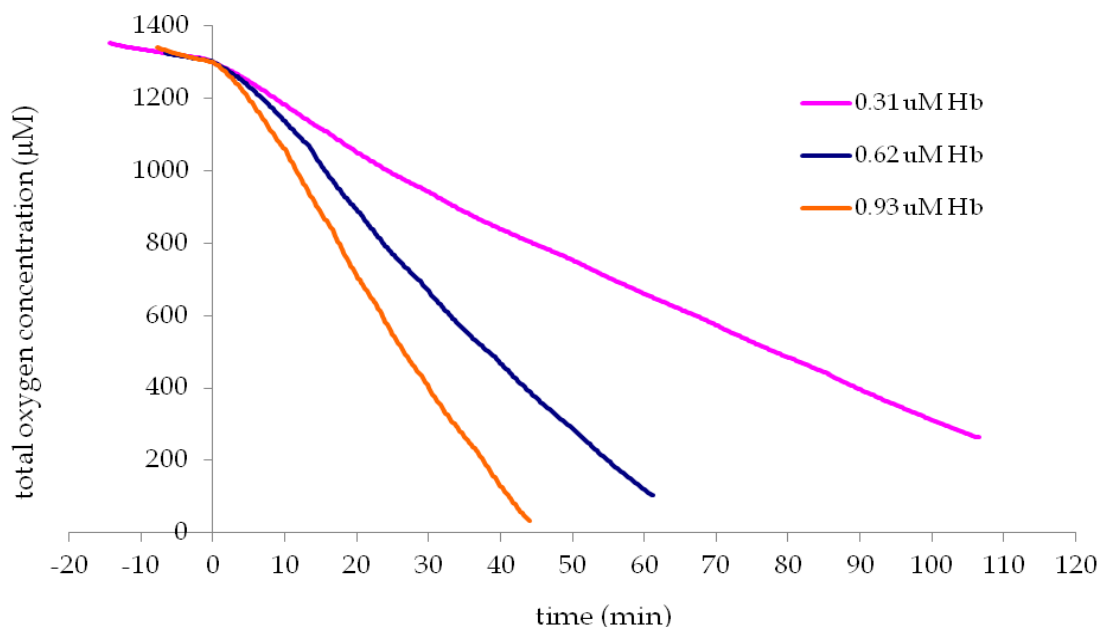

**Figure 34:** Oxygen consumption of a 1.5% liposome solution; oxidation was catalyzed by metHb added in three different amounts (giving 0.31, 0.62 and 0.93  $\mu\text{M}$  concentration in the reaction cell)

#### 4.2.3 Influence of EDTA on liposomes

The influence of EDTA on the consumption of oxygen by liposomes was investigated and is also shown in Figure 33. In this control experiment only liposome solution was present in the reactions cells and EDTA was added later to the liposome solution. After addition of EDTA the OUR decreased and then was constant for the period of the experiment. This means that EDTA improves the background OUR of liposomes by chelating endogenous metals which are present in liposomes owing to sonication or as contaminants in chemicals (as already explained above in section 4.2.2).

#### 4.2.4 Addition of EDTA

In subsequent experiments, EDTA was added to the liposome solution. EDTA was added in different stages – before addition of Hb (0.62  $\mu\text{M}$ ), shortly after addition of Hb and later after addition of Hb (i. e. in the second phase, after first bubbling), see Figure 35. It can be observed that EDTA slowed down the rate of oxygen consumption. In experiment when EDTA was added to the liposome solution prior to Hb, it has been observed that EDTA decreased the background OUR of liposomes. This can be attributed to the chelating function of EDTA, as liposomes contained endogenous transition metals (as discussed in section 4.2.2). When all the curves with added EDTA are compared, it can be seen, that they become parallel in the end.

After these experiments it has been decided to always add EDTA into the liposome solution prior to addition of Hb (or any other reactant) to eliminate the pro-oxidant effect of free iron.



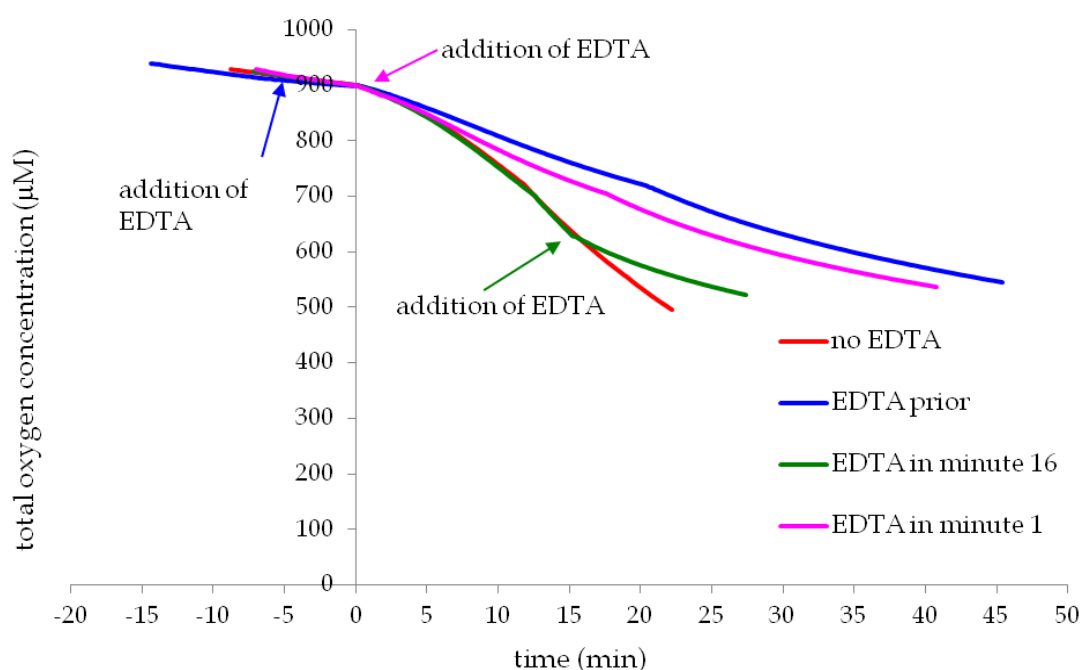

**Figure 35:** Influence of EDTA added in different stages on the OUR when metHb was added as a pro-oxidant ( $0.62 \mu\text{M}$ )

The observed effect is in contrast with the results obtained by Grunwald and Richards [8]. They found that EDTA had little effect on the overall pattern of Mb-mediated TBARS formation. In their study, addition of EDTA did not significantly affect Mb-mediated lipid peroxide formation. This contrast can be explained by the different methods used to study lipid oxidation and also by the different systems used. Grunwald and Richards studied mechanisms of heme protein-mediated lipid oxidation in washed cod muscle. The mechanism by which lipid oxidation proceeds in liposomes is probably different compared to that in washed cod muscle. Washed cod muscle contains myofibrillar and membrane proteins that may provide a docking site for heme, while liposomes are devoid of protein. Another, and probably the most important explanation, might be that in our liposomes, traces of transition metals were present because of impurities in chemicals and as a consequence of sonication. Grunwald and Richards conclude that the inability of excess EDTA to inhibit Mb-mediated lipid oxidation in cooked washed cod suggests that released iron due to heating does not stimulate lipid oxidation. This might not be the case when explaining differences in action of EDTA with a study of Carvajal et al. [43], who added EDTA to the reaction mixture (liposomes) after injection of Hb. They reported no inhibition of the oxidation reaction. The oxygen uptake curve is not shown, so maybe the reaction was not run long enough for EDTA to exert its function. They concluded that it is not the free low-molecular-weight iron itself that promotes heme-mediated lipid oxidation but rather that the whole protein or the heme group is the pro-oxidant. Therefore it can be concluded that our results provide additional information to the study by Carvajal et al. and the following study of Richards and Li [35].

Richards and Li [35] examined effectors and mechanisms of Hb-mediated lipid oxidation. They found that approximately 7 % of the iron associated with Hb was released from the heme protein during 2 °C storage in washed cod muscle and that EDTA neither accelerated nor inhibited Hb-mediated lipid oxidation measured by the formation of lipid peroxides and

TBARS. They concluded that the released iron contributed little to Hb-mediated lipid oxidation in washed cod muscle. In comparison to our study, Richards and Li utilized washed cod muscle which contains proteins that may act as a docking site. EDTA in our experiments decreased the oxygen consumption mainly thanks to its chelation of endogenous transition metals which originated in the liposome solution and chelation of free iron which is stated to be present in the metHb powder in amount of 0.25 – 0.35 % [117].

Figure 36 shows curves for five tested concentrations of Hb. EDTA was added to the liposome solution prior to addition of Hb.

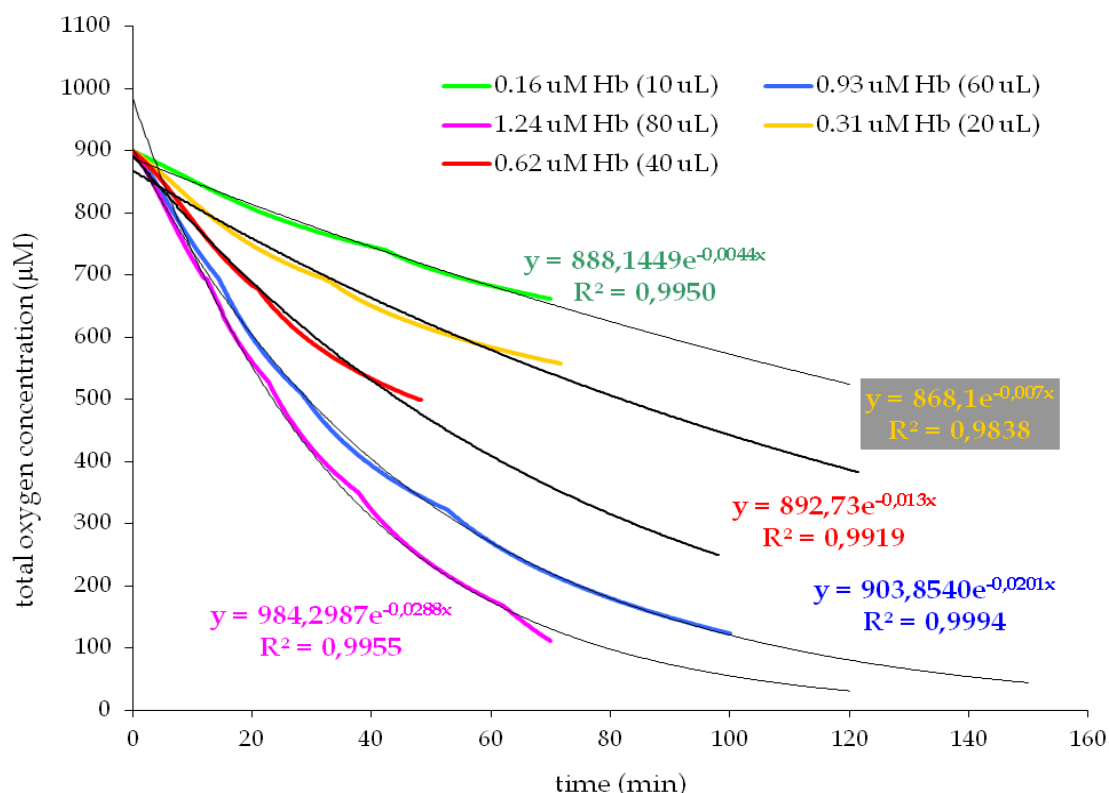
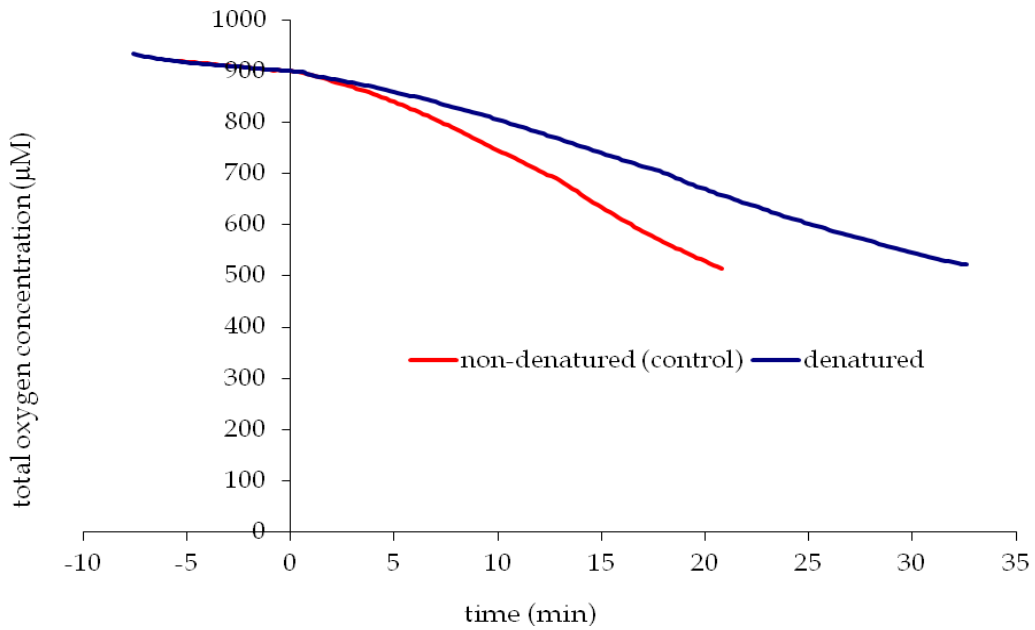

**Figure 36:** Oxygen consumption of a 1.5% liposome solution; oxidation was catalyzed by metHb added in five different amounts (giving 0.16, 0.31, 0.62, 0.93 and 1.24 µM concentration in the reaction cell). EDTA was added prior to metHb. Trendlines were constructed for each curve

#### 4.2.5 Thermal denaturation of hemoglobin solution

In subsequent experiments, the influence of thermal denaturation of Hb on its pro-oxidant activity was investigated. The Hb solution was heated in a boiling water bath and used after it cooled down. One concentration of added Hb was used (0.62 µM).

Figure 37 shows the oxygen consumption by a liposome solution; oxidation was catalyzed by non-denatured (natural, fresh) and denatured Hb. The denatured Hb acted as a pro-oxidant, but was less pro-oxidative than non-denatured Hb.



**Figure 37:** Oxygen consumption of a 1.5% liposome solution; oxidation was catalyzed by non-denatured and denatured metHb ( $0.62 \mu\text{M}$ )

Figure 38 shows the oxygen consumption by a liposome solution; oxidation was catalyzed by non-denatured and denatured Hb. EDTA was added prior to Hb. Exponential trendline was added to the curves. The  $k$  coefficients of both curves were compared. Due to denaturation of Hb solution, the oxidation was inhibited by 16 % (see also section 4.2.12 and Figure 63, where a summary graph is shown).

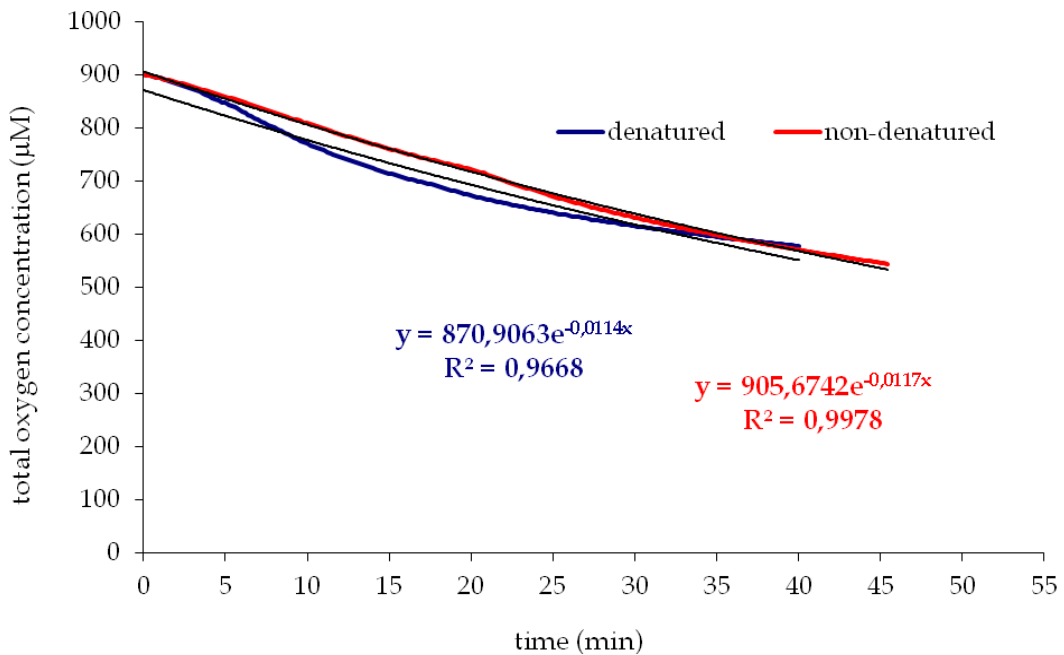

**Figure 38:** Oxygen consumption of a 1.5% liposome solution; oxidation was catalyzed by non-denatured and denatured metHb ( $0.62 \mu\text{M}$ ); EDTA was added prior to metHb. The exponential trendlines and their equations are shown

The cooking temperatures denature the globin and induce the release of heme reactant. Upon denaturation both Mb and Hb can release lipid-soluble heme, which has been reported to promote lipid oxidation [50, 66].

The inhibition of oxidation (in comparison with unheated Hb) when heated Hb was used in the experiments is in accordance with the results of study by Grunwald and Richards [8], who concluded that the extent of lipid oxidation (determined by TBARS formation) mediated by sperm whale Mb appeared to be greater in the unheated washed cod as compared to that in the heated washed cod. Heating might rapidly dissociate heme, which is able to promote lipid oxidation, albeit less effectively than the globin chains can deliver heme into the lipid phase.

Several researchers have suggested that iron released from heme-proteins during heating is a major factor in promoting lipid oxidation in cooked meats [118-120]. However some researchers believe that iron originating from Mb is not an important promoter in lipid oxidation in cooked meat because the cleavage of the porphyrine ring is difficult. In addition it has been proposed that the released iron may bind to different compounds such as the denatured heme-protein itself or other proteins [121].

Berisha et al. [122] showed that heating Mb solution to 100 °C released only 1.42 % of iron from horse heart Mb, which suggested that released iron had a small role in the lipid oxidation observed. They also observed that heating to 100 °C decreased the prooxidant activity as compared with the unheated Mb.

Kristensen and Andersen [121] studied the effect of heat denaturation on the prooxidative activity of metMb. Their results showed that temperatures immediately below thermal denaturation of metMb-induced structural changes in the heme protein which subsequently increased the prooxidative activity of the molecule. In contrast, temperatures above the denaturation temperature of metMb decreased the prooxidative activity of the resulting species compared to native metMb, which is consistent with our results. The decrease in prooxidative activity was found to be related to hemichrome formation. Moreover, the amount of free iron released during heat denaturation of metMb was found to be of an order where it would not be expected to play any significant role in lipid peroxidation (coexisting with other pro-oxidative species formed during heat denaturation of metMb).

The decrease in the prooxidative activity of metHb after heating in our experiments is similar to results of Bou et al. [67] who studied the effect of heating oxyMb and metMb on the oxidation of muscle microsomes and found out that metMb promoted lipid oxidation in both its native and denatured states. The prooxidative activity of metMb increased at moderate thermal treatments, but decreased with higher heating temperatures. The reason for the decrease in the prooxidant activity (in comparison to native protein) may be the loss of protein solubility, which could decrease the ability of the heme groups in oxyMb and metMb to interact with microsomes. OxyMb became antioxidative when heated to temperatures above 75 °C. This was likely due to a decrease in its prooxidative activity due to loss of solubility of oxyMb. In their experiments the solubility of oxyMb and metMb decreased dramatically at temperatures above 85 °C, which indicates that the protein denatures and aggregates at these temperatures. However aggregation was not observed in our experiments.

Pazos et al. [123] found out that the free radical generating-activity of Hb (from rainbow trout, cod and herring) was not affected by heating these fish hemoglobins at 70 °C for 10 and 45 minutes in aqueous solution. This temperature is lower than that in our experiments but the time of the treatment is quite long. Thus it can be concluded that in our study the observed

prooxidant activity of heated metHb was maintained (although decreased) also due to the free radical generating-activity of metHb.

Another reason why there is not a big difference in the prooxidative activity of metHb in our experiments might be, that the metHb has been treated variously because of its production and therefore it might be partly denatured in a way. Therefore the degree of denaturation caused by the cooking process might not be so significant.

#### 4.2.6 TPP (triphenylphosphine)

The reason for utilizing TPP in the experiment was the assumption that metHb needs to be activated by H<sub>2</sub>O<sub>2</sub> or lipid peroxides to be an effective prooxidant, therefore the oxidation reaction will be dependent on the concentration of pre-existing lipid hydroperoxides. TPP is known to break down peroxides to alcohols and has been reported to be an effective scavenger of pre-existing lipid peroxides in liposomes [112].

Final concentration of TPP in the 1.5% liposome solution was 200 μM. The peroxide value of PL2 was found to be 4.9 meq/kg. It has been calculated that TPP is at a 54-fold excess compared to peroxides. Such excess is therefore likely to cover the pre-existing peroxides and possibly also peroxides formed during sonication.

The inhibition of oxygen uptake rate was observed in liposomes containing TPP, see Figure 39. Compared to the control experiment (liposomes without TPP, 0.62 μM Hb) the inhibition was 79 %. Even the OUR in liposomes with higher concentration of Hb (1.24 μM) was substantially inhibited - by 92 %. The effect of TPP on metHb-mediated oxidation of liposomes is also presented in a summary graph in section 4.2.12.

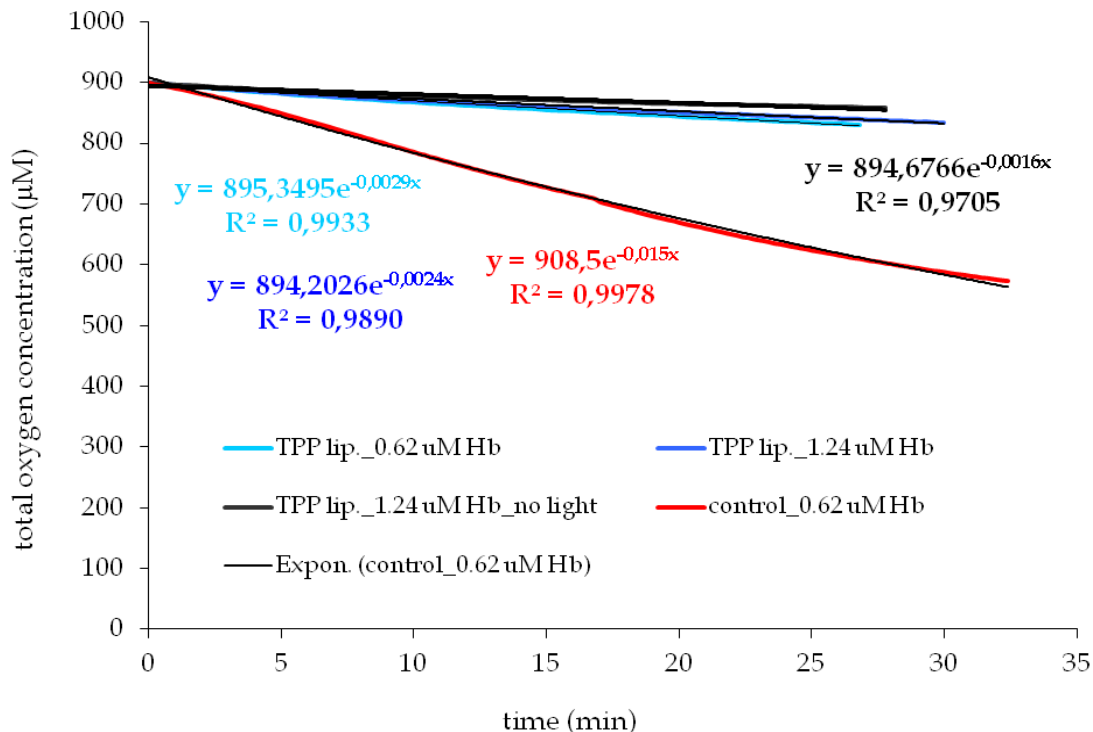

**Figure 39:** Changes in concentration of dissolved oxygen in liposome solution with two concentrations of metHb (0.62 and 1.24 μM) as the catalyzer. The concentration of TPP was 200 μM. The exponential trendlines and their equations are shown

These results suggest that peroxides take part in the reaction and that the heme-mediated lipid oxidation in liposomes is dependent on the presence of pre-existing lipid peroxides, which is consistent with outcomes of Carvajal et al. [43]. Mozuraityte et al. [112] studied the effect of TPP (added to phospholipids) on  $\text{Fe}^{2+}$ -catalyzed lipid oxidation in liposomes. They determined the effectiveness of TPP in reduction of peroxides in PL (extracted from liposomes) by analyzing the peroxide value of PL. They found out there were peroxides present in PL and, moreover, peroxides were measured in liposomes prepared with the highest concentration of TPP. This can be explained by selective decomposition of peroxides by TPP. Other explanation (also for our results) might be that some peroxides are produced during sonication.

It was observed that the background OUR in liposomes treated with TPP was higher than that of liposomes without TPP. The reason is probably the fact that TPP undergoes slow oxidation during which  $\text{O}_2$  is consumed to give triphenylphosphine oxide [124]:

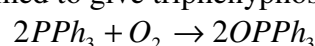

#### 4.2.7 Ascorbic acid (AsA)

Ascorbic acid (AsA), or vitamin C, is an important component of living systems and is a natural component in various food and food products. It is one of the two water-soluble compounds tested in our study. Ascorbic acid acts as a primary or secondary antioxidant. In vivo, AsA is a primary antioxidant, whereas in foods it is a multifunctional antioxidant and can act by following mechanisms: quenching singlet oxygen, scavenging of oxygen in the presence of metal ions, reduction of free radicals and reduction of primary AOX radicals [18].

Two concentrations of AsA (25 and 50  $\mu\text{M}$ ) and one concentration of Hb (0.62  $\mu\text{M}$ ) were used in the experiments. When AsA was added to liposomes, a decrease in OUR was observed, see Figures 40 and 41.

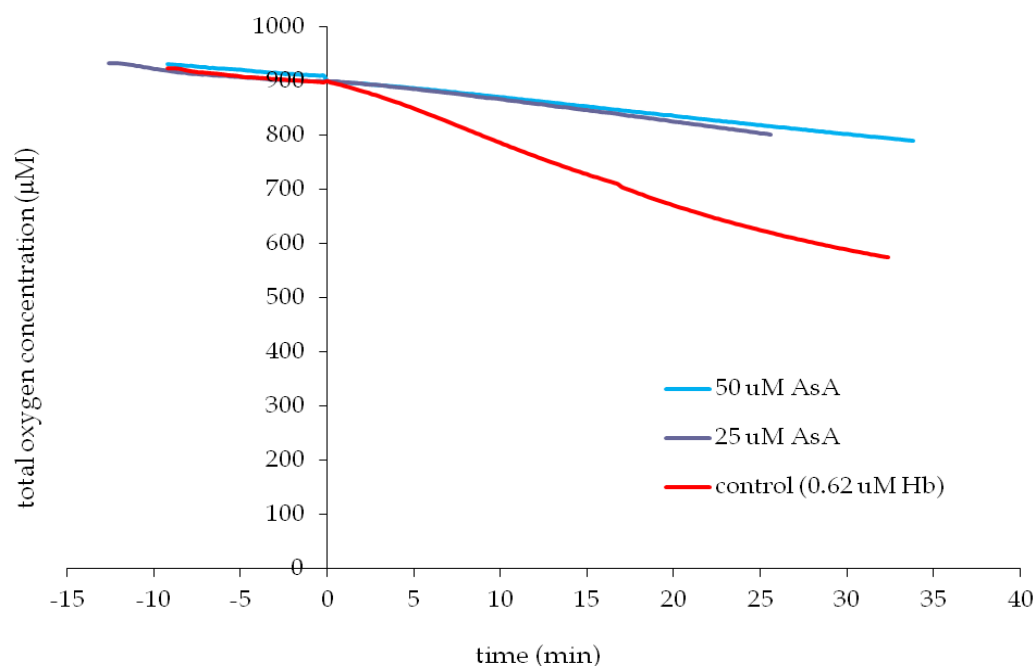

**Figure 40:** Changes in concentration of dissolved oxygen in liposome solution with two concentrations of AsA (25 and 50  $\mu\text{M}$ ). The concentration of metHb (as the prooxidant) was 0.62  $\mu\text{M}$ . The red curve represents non-inhibited catalysis

At the higher concentration of AsA, higher decrease in OUR was observed. The consumption of dissolved oxygen decreased linearly after addition of AsA. The inhibition for 25  $\mu\text{M}$  AsA was 66 %, for the concentration 50  $\mu\text{M}$  AsA, the inhibition was 71 %. The observed effect of AsA in our system was antioxidative.

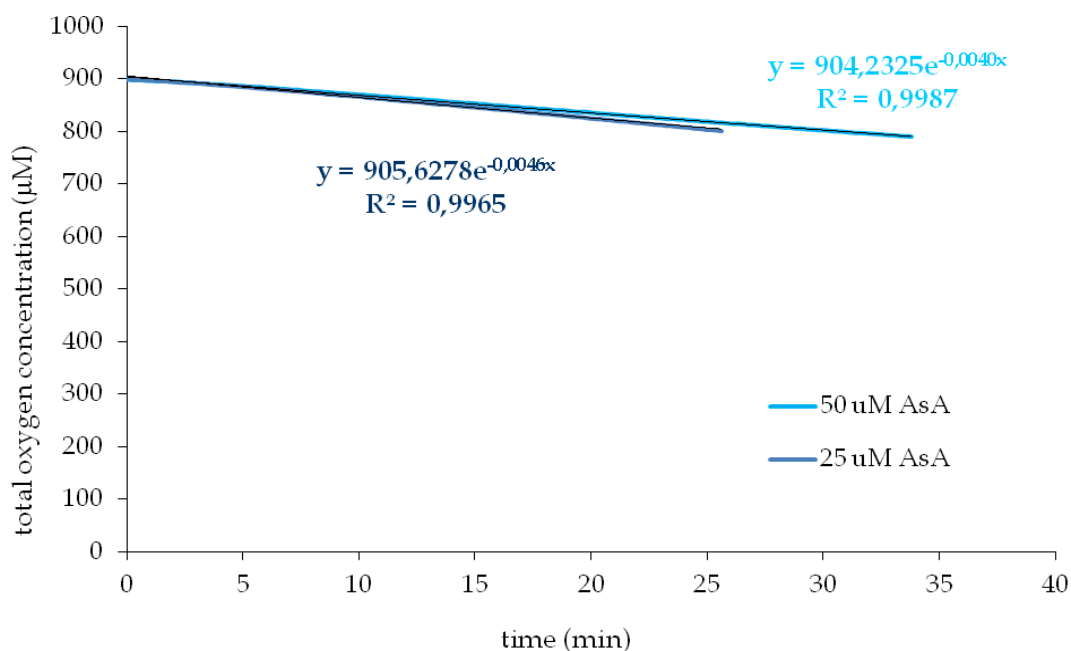

**Figure 41:** Changes in concentration of dissolved oxygen in liposome solution with two concentrations of AsA (25 and 50  $\mu\text{M}$ ). The concentration of metHb (as the prooxidant) was 0.62  $\mu\text{M}$ . The exponential trendlines and their equations are shown

AsA can have both antioxidative and prooxidative effects depending on the factors such as the presence of LMW metals and lipid hydroperoxides and the concentration of AsA. The ability of AsA to inhibit lipid oxidation in our study is attributable to reducing hypervalent forms of Hb and scavenging of lipid radicals. Possible prooxidant effects of AsA include the ability to reduce  $\text{Fe}^{3+}$ , therefore maintaining  $\text{Fe}^{2+}$  in its reduced state. Prooxidative effects of AsA are also dependent on the level of preformed lipid hydroperoxides, which can be decomposed by AsA [18, 35]. No prooxidative effects were observed. This was probably thanks to chelation of free iron by EDTA, which was added to liposomes prior to addition of AsA and Hb.

Our findings meet the observations of Richards and Li [35], who examined the effectors and mechanisms of Hb-mediated lipid oxidation. The Hb concentration used was 13.3  $\mu\text{M}$ . Ascorbate (2.2 mM) was a modest to highly effective inhibitor of Hb-mediated lipid oxidation determined by TBARS formation. The inhibition was due to the free radical scavenging ability of ascorbate and its ability to reduce hypervalent forms of Hb. However, lower concentrations of ascorbate (20 and 200  $\mu\text{M}$ ) had a small inhibitory effect. When comparing different washed cod preparations, the ability of ascorbate to inhibit Hb-mediated lipid oxidation varied. This was due to variation in preformed lipid peroxide content among cod fillets used for the preparation of the washed cod muscle. Ascorbate is an effective inhibitor at

low levels of preformed lipid hydroperoxides. Thus, the action of AsA is concentration dependent.

Also Maestre et al. [111], who studied the effect of reductants and iron chelators on lipid oxidation catalyzed by fish Hb, concluded, that reducing compounds (among them the ascorbic acid) had greater capacity to prevent lipid oxidation catalyzed by fish Hb in comparison with iron chelators. They suggested that the free radical scavenging and/or reduction of ferrylHb species are crucial to avoid the prooxidative activity of fish Hb.

#### **4.2.8 Caffeic acid (CaA)**

Among the natural substances with antioxidant properties, CaA belonging to hydroxycinnamic acids, has attracted attention as a food antioxidant. CaA can be found naturally in various agricultural products.

Caffeic acid was efficient in inhibiting Hb-mediated lipid oxidation in both tested concentrations 50 and 100  $\mu\text{M}$ , see Figure 42 and 43. The concentration of Hb was 0.62  $\mu\text{M}$ . After addition of CaA to liposomes, a decrease in OUR was observed. The decrease in concentration of dissolved oxygen was linear for the tested period.

The concentration 50  $\mu\text{M}$  inhibited the oxidation by 49 %, the concentration of 100  $\mu\text{M}$  caused inhibition by 57 %.

These observations are consistent with the results of the study by Kristinová et al. [48], who studied the antioxidant activity of phenolic acids in Hb-mediated lipid oxidation in liposomes. CaA inhibited Hb-mediated oxidation in concentrations above 0.1  $\mu\text{M}$ . At the concentration of 0.1  $\mu\text{M}$  it was inactive. The inhibition ranged from 30 to 57 %. They observed no distinctive dependence between the degree of inhibition and the concentration of CaA. However, higher concentrations of CaA resulted in better inhibition of oxidation than lower concentrations. CaA can protect lipid by scavenging free radicals and chelating transition metals. It has been concluded in section 4.2.4 that free iron released from Hb played a minor role in the prooxidative activity of Hb, thus the antioxidant effect of CaA can be attributed to its ability to scavenge free radicals.



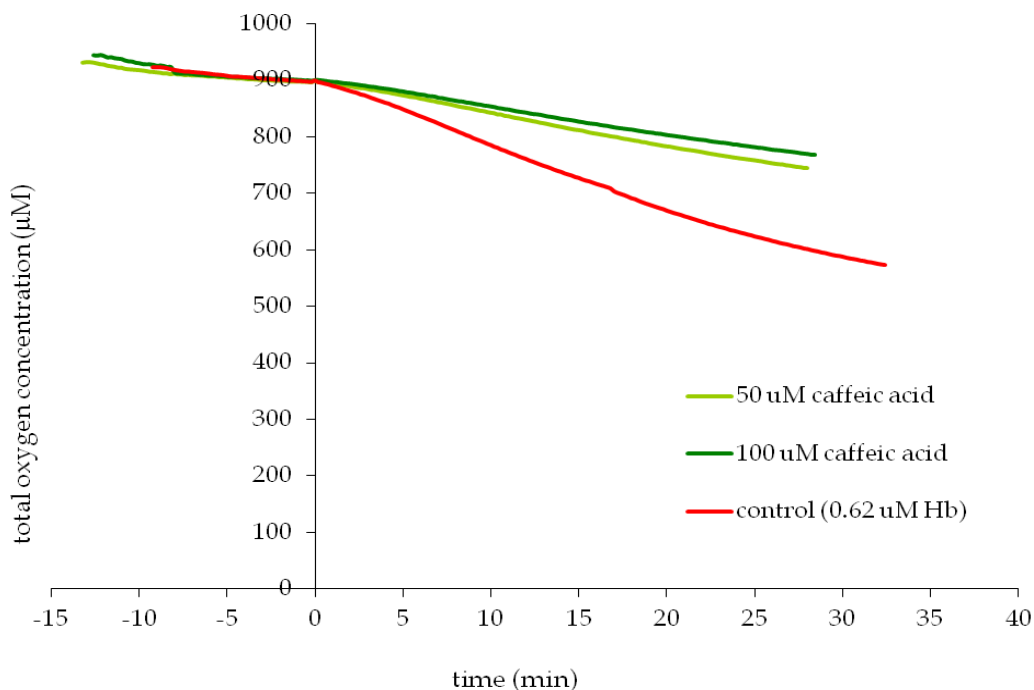

**Figure 42:** Changes in concentration of dissolved oxygen in liposome solution with two concentrations of CaA (50 and 100 µM). The concentration of metHb (as the prooxidant) was 0.62 µM. The red curve represents non-inhibited catalysis.

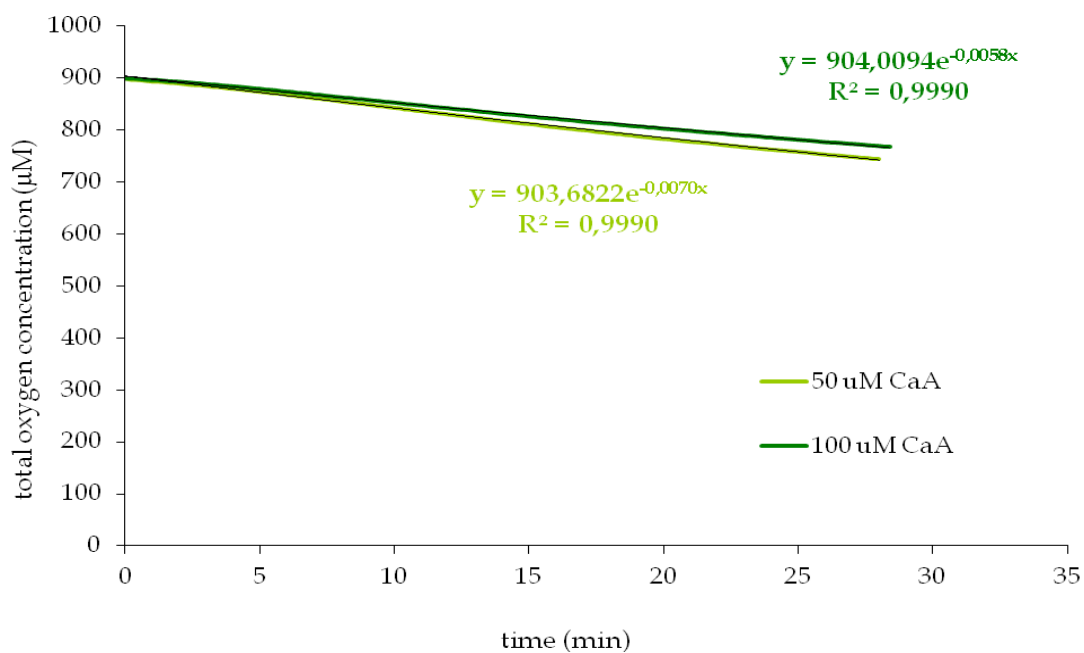

**Figure 43:** Changes in concentration of dissolved oxygen in liposome solution with two concentrations of CaA (50 and 100 µM). The concentration of metHb (as the prooxidant) was 0.62 µM. The exponential trendlines and their equations are shown.

The activity of CaA towards Hb-mediated lipid oxidation has been studied in different model systems [125] and it has been concluded, that CaA can significantly prevent Hb-

mediated lipid oxidation in fish muscle foods. However, its activity in food emulsion and liposomes is dependent on the pH, the type of emulsifier used and the prooxidants present. The molecular structure of hydroxycinnamic acids is a key determinant for their radical scavenging and metal chelating abilities. CaA contains a catechol group with  $\alpha$ ,  $\beta$ -unsaturated carboxylic acid chain responsible for the interaction with different radicals. The double bond conjugated with the catechol group lead to electron delocalisation, which increases the stability of the *o*-semichinone radical and the AOX activity of CaA.

Due to the two vicinal hydroxyl groups CaA is one of the most active compounds among hydroxycinnamic acids. Pino et al. [96] evaluated the capacity of hydroxycinnamic acid derivatives to trap peroxy radicals. They conclude that the reactivity of the compound is determined by the bond dissociation energy of the hydrogen atom of the phenolic moiety. However, their experiments were performed in solution of the tested cinnamic acids in phosphate buffer.

Phenolic compounds are capable of binding to proteins by noncovalent bonds [126]. Carlsen et al. [127] studied the kinetics of reduction of iron(IV) in ferrylMb by chlorogenate (derivative of chlorogenic acid) and reported that binding of chlorogenate to the reactive ferrylMb results in reduction of the oxoferryl moiety to ferric iron ( $\text{Fe}^{3+}$ ). This can also be the explanation for the inhibitory effect of CaA in the Hb-mediated lipid oxidation in liposomes. Kristinová et al. [48] assumed that CaA in the aqueous phase of the liposome solution can enter the heme crevice of Hb and/or bind to ferrylHb reducing the oxoferryl moiety to metHb. Another characteristics that has to be taken into account is the polarity of the phenolic molecule, because it influences the location of the phenolic molecule in the lipid system. In emulsion systems, the affinity of the antioxidant towards the interface, is a key parameter. The affinity is dependent on pH. According to Mozuraityte et al. [115] the zeta potential of cod roe liposomes at pH 5.5 is negative. Although the zeta potential is not the same as surface charge, it can be considered giving information about the net charge of the particles. At pH 5.5, CaA is an anion. Therefore there is probably a repulsion of CaA into the aqueous phase by the negatively charged liposomes, and the amount of CaA molecules available for radical scavenging is decreased in the bilayer [11, 48, 115].

Pazos et al. [94] tested natural phenolics in their inhibition of Hb- and iron-promoted oxidation in fish microsomes. They stated that the inhibitory efficiency of phenolics was related to their polarity, affinity for being incorporated into the microsomes, reducing capacity, chelating activity, and inhibitory activity against Hb autoxidation. However, according to their results, they stressed the importance of incorporating the exogenous AOXs into the membranes where the key substances for lipid oxidation are located. Phenolic compounds were not effective at inhibiting autoxidation of Hb. However, for comparison to our study, their results might be misleading in a way, because microsomes contain iron-reducing enzymatic system and endogenous  $\alpha$ -tocopherol. For this model system, a more efficient inhibition of lipid oxidation can be reached when phenolics are introduced into the membranes, where the chain-propagating lipid radicals and ferrous-generating enzymatic systems are present. This greater inhibition occurs due to the fact that endogenous  $\alpha$ -tocopherol can be regenerated by phenolics.

We assume that the reducing ability of CaA and, in a lesser degree, radical scavenging ability, are responsible for the observed inhibition of Hb-mediated lipid oxidation in liposomes. CaA is more likely to be present in the aqueous phase, which is also the location

of Hb, therefore the interaction of CaA with Hb is probably more important than its interaction with free radicals.

#### 4.2.9 Astaxanthin

Carotenoids (among them also astaxanthin) are excellent singlet oxygen quenchers as well as lipid peroxidation chain-breakers. This ability is generally attributed to the activity of polyene chain and increases with increasing number of conjugated double bonds along the polyene chain. The linear, long-chain polyene structure is typical for carotenoids. In this conjugated system, the electrons are delocalized or shared evenly in the whole chain [18, 90, 92].

Two concentrations of astaxanthin were tested in our study: 0.1 % and 1.0 %. Astaxanthin was added to phospholipids before preparation of liposomes. Two concentrations of Hb were applied: 0.62 and 0.93  $\mu\text{M}$ . Also reaction without the presence of light was carried out (for 0.62  $\mu\text{M}$  Hb concentration). Figures 44 and 47 show curves from all the experiments using 0.1 % of astaxanthin in PL and 1.0 % of astaxanthin in PL, respectively.

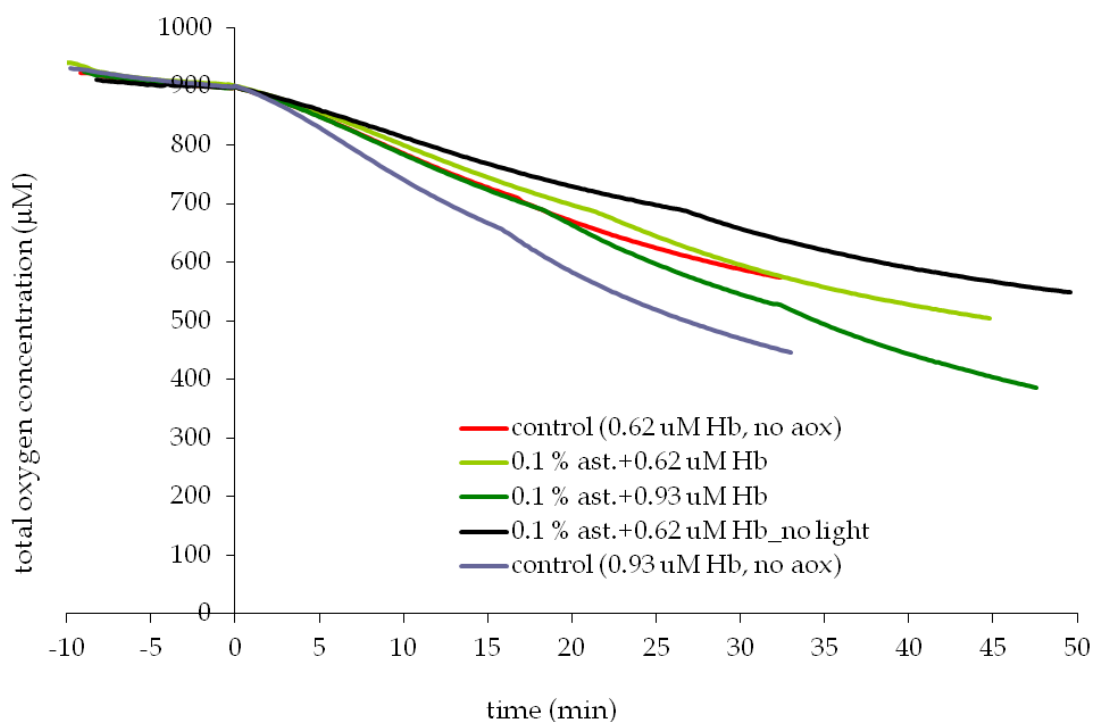

**Figure 44:** Oxygen consumption by a liposome solution made from PL containing 0.1 % astaxanthin. The oxidation was catalyzed by 0.62 and 0.93  $\mu\text{M}$  metHb. The red and grey curves represent non-inhibited reactions

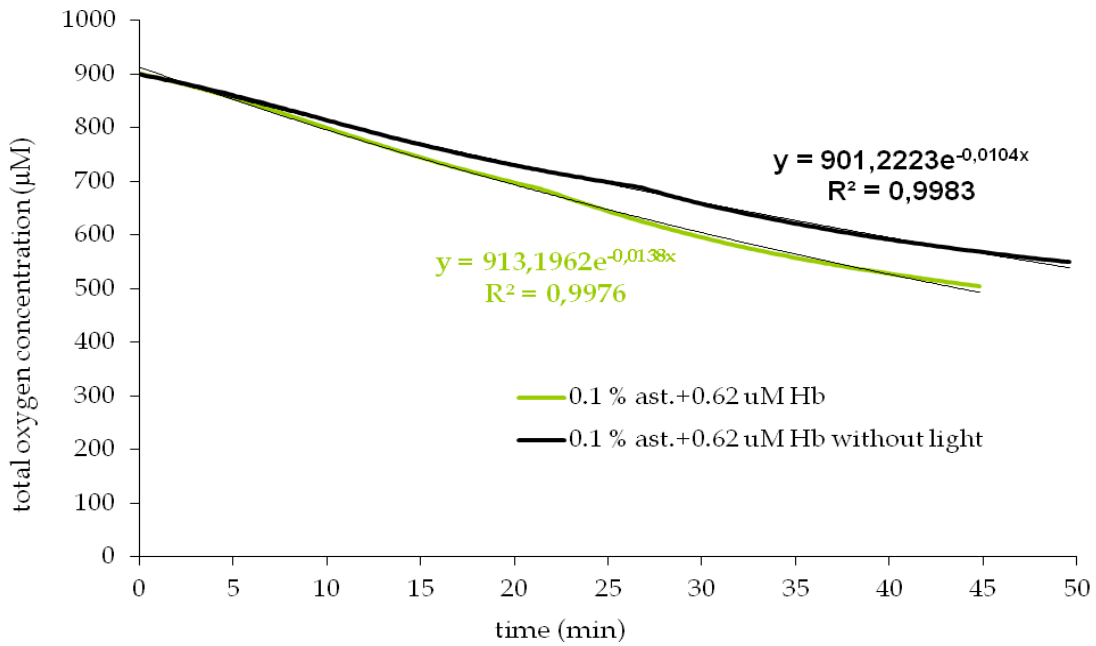

**Figure 45:** Oxygen consumption by a liposome solution made from PL containing 0.1 % of astaxanthin. The oxidation was catalyzed by 0.62 µM metHb. The grey curve represents the same reaction, but without the presence of light. Exponential trendlines and their equations are shown

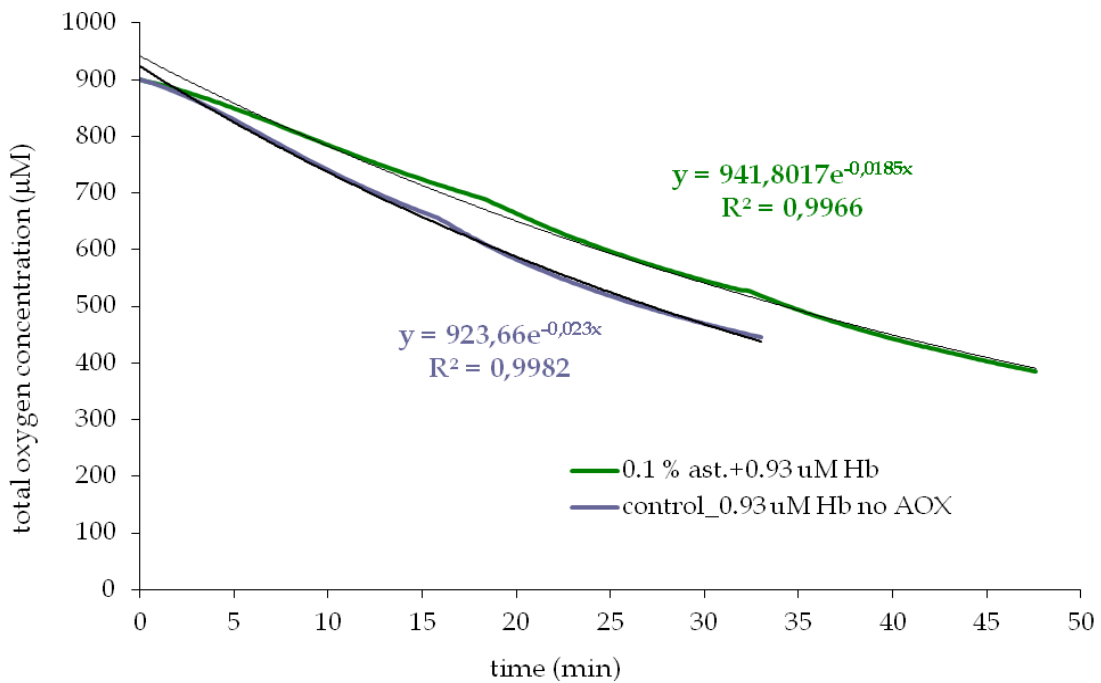

**Figure 46:** Oxygen consumption by a liposome solution made from PL containing 0.1 % of astaxanthin. The oxidation was catalyzed by 0.93 µM metHb. The green curve is non-inhibited reaction. Exponential trendlines and their equations are shown

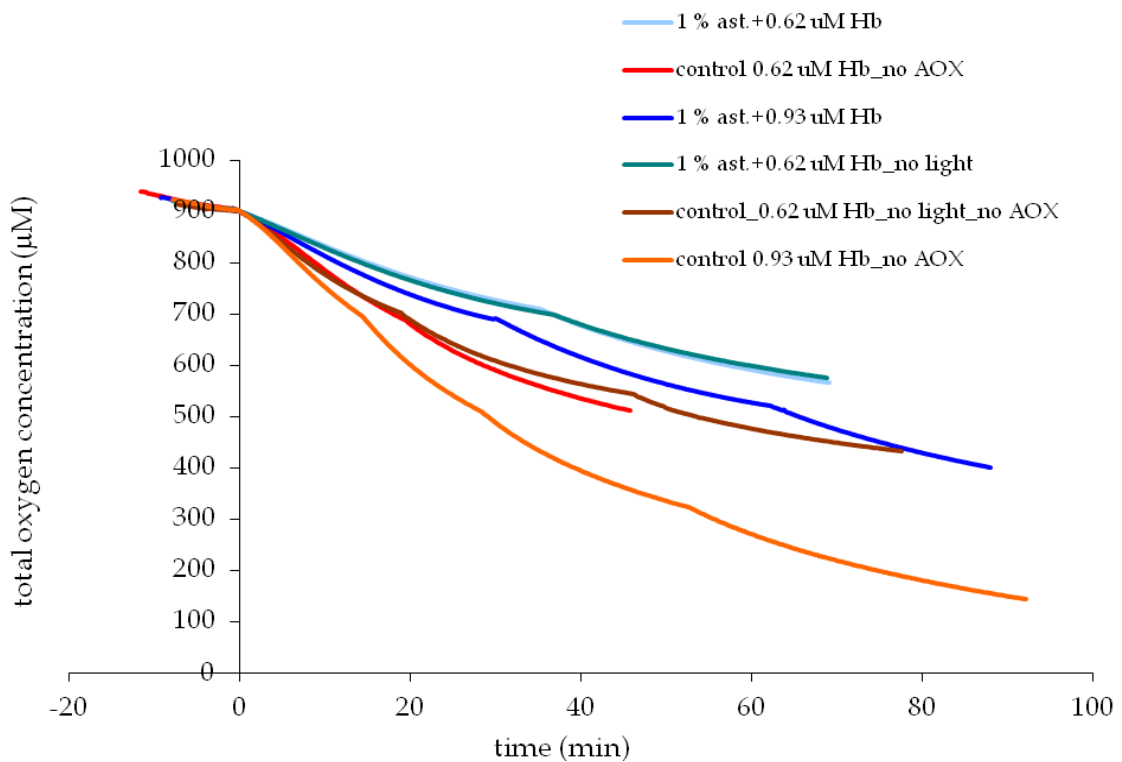

**Figure 47:** Oxygen consumption by a liposome solution made from PL containing 1.0 % of astaxanthin. The oxidation was catalyzed by 0.62 and 0.93  $\mu\text{M}$  metHb. The red and orange curves represent non-inhibited reactions (for 0.62 and 0.93  $\mu\text{M}$  Hb, respectively)

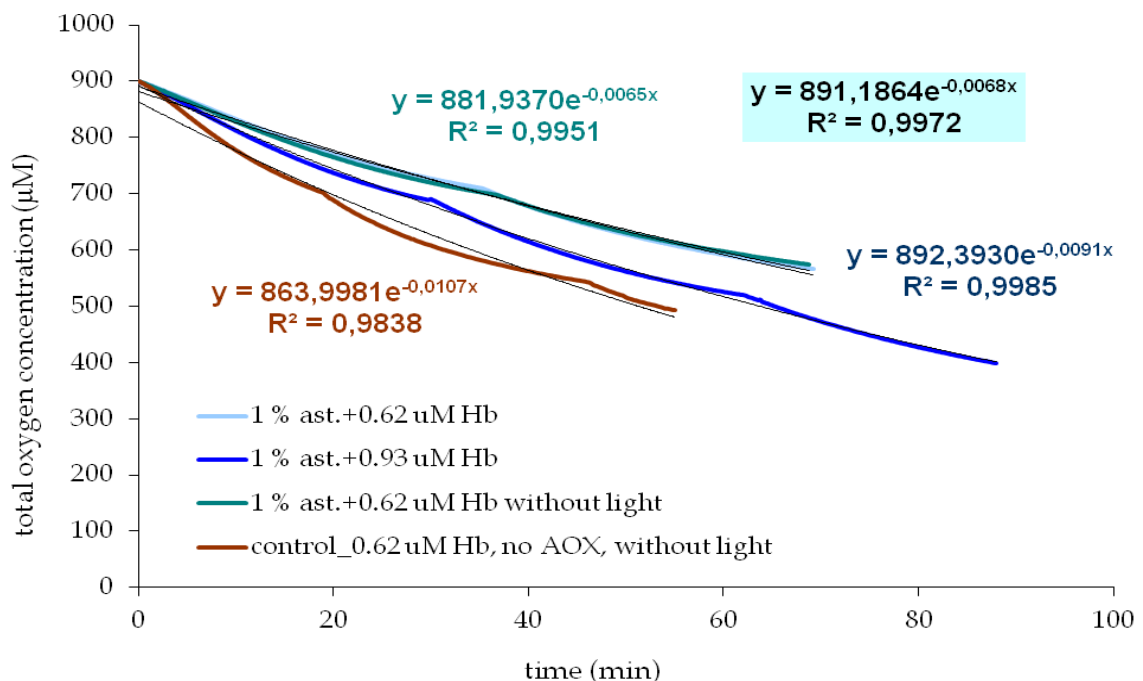

**Figure 48:** Oxygen consumption by a liposome solution made from PL containing 1.0 % of astaxanthin. The oxidation was catalyzed by 0.62 and 0.93  $\mu\text{M}$  metHb. The brown curve is a control experiment (non-inhibited reaction in the absence of light) for experiments without light. Exponential trendlines and their equations are shown

In Figure 48, the brown curve represents non-inhibited reaction run in the absence of light. This curve and its  $k$  value serve as the control for the other experiments run without light.

For the lower concentration of Hb ( $0.62 \mu\text{M}$ ) the addition of 0.1 % of astaxanthin did not have any effect on the OUR of the liposome solution (see Figure 45). For  $0.93 \mu\text{M}$  concentration of Hb, this concentration of astaxanthin inhibited the OUR by 13.3 % (see Figure 46). The effect of astaxanthin was therefore concentration dependent. No effect was observed for the reaction run in the absence of light catalyzed by  $0.62 \mu\text{M}$  Hb in liposomes containing 0.1 % of astaxanthin.

For the lower concentration of Hb ( $0.62 \mu\text{M}$ ) the addition of 1.0 % of astaxanthin in PL resulted in decrease in the OUR by 50 % (see Figure 48). For  $0.93 \mu\text{M}$  concentration of Hb, this concentration of astaxanthin inhibited the OUR by 57.4 % (see Figure 48). The OUR of the reaction run in the absence of light catalyzed by  $0.62 \mu\text{M}$  Hb in liposomes containing 1.0 % of astaxanthin was decreased by 39.3 % (compared to reaction with the same concentration of Hb, without astaxanthin, in the absence of light), see Figure 48.

Hb is known to be a photosensitizer of lipid oxidation and can form singlet oxygen. The effect of light is presented in section 4.2.12. The observed inhibition of OUR of the liposome solution in the reaction run in the absence of light was 21 %. Therefore, the antioxidative activity of astaxanthin can be partly attributed to its singlet oxygen quenching ability.

Carvajal et al. [43] added 5.4 and  $54 \mu\text{M}$  astaxanthin to the phospholipids and observed inhibition of lipid oxidation rate by 25.5 % and 62.2 %, respectively. They used a final concentration of  $1.55 \mu\text{M}$  Hb in the experiments. Carvajal et al. found out that light did not have any significant effect on lipid oxidation, therefore they concluded that it is more likely that the formation of free radicals is the primary reaction leading to lipid oxidation.

In our study, we also conclude that free radicals scavenging is the primary antioxidant ability of astaxanthin in our system.

As described in part 2.4.3.2, carotenoids seem to scavenge peroxy radicals by a mechanism in which the radical is added to the conjugated polyene system. The resulting carbon-centered radical is stabilized by resonance. When the oxygen concentration is low, a second peroxy radical can be added to the carbon-centered radical and a nonradical polar product is formed. However, at high oxygen pressures, carotenoids become prooxidants, because oxygen can be added to the carbon-centered radical in a reversible reaction resulting in an unstable chain-carrying peroxy radical. This radical can be degraded to radicals and non-radical polar products, resulting in no net inhibition of oxidation [90]. This might be the explanation why no effect was observed at 0.1 % astaxanthin in PL. The concentrations of both astaxanthin and Hb were probably too low in comparison with oxygen concentration, so that no effect on OUR was observed.

Jørgensen and Skibsted [90] who studied carotenoid scavenging of radicals using two different systems. One of the systems used metMb as the free-radical initiator in a heterogenous lipid/water system. For this system they found out that each of the four carotenoids astaxanthin,  $\beta$ -carotene, canthaxanthin, and zeaxanthin protects the methyl esters against oxidation. Their antioxidative effect increased with increasing carotenoid concentration, increased with decreasing oxygen partial pressure and was found to be only little dependent on the structure of the carotenoid. They suggest that carotenoids might have a special importance as alkoxyl radical scavengers in biological systems. In living cells

carotenoids are associated with the cell membrane, and it has been proposed that carotenoids are oriented perpendicular to the plane of the lipid bilayer. They also say that the balance between hydrophilic groups and the hydrophobic polyene chain is an important factor for incorporation in the bilayer. The hydroxy and carbonyl groups in the cyclohexenyl group (as in astaxanthin) facilitate embedding of the carotenoid at the water/lipid interface. They suggest a mechanism for the antioxidant function of carotenoids in cell membranes (see Figure 49). Astaxanthin traps an alkoxy radical in the central hydrophobic region of the bilayer and the polyene structure „transports“ the unpaired electron to the lipid-water interface, where the astaxanthin radical reacts with a water soluble reductant (e. g. ascorbic acid). They also state that a hydroxy group in the 3-position provides further stabilisation by intermolecular hydrogen bonding to the aqueous phase and by intramolecular hydrogen bonding to the carbonyl oxygen.

Similar outcomes can be seen in study of Goto et al. [91] who examined the effects of  $\beta$ -carotene and astaxanthin on the peroxidation of phospholipid liposomes induced by ADP and  $\text{Fe}^{2+}$ . They found out that astaxanthin was about 2-fold more effective than  $\beta$ -carotene. They suggested that the conjugated polyene moiety and the terminal ring moieties of the more potent astaxanthin trapped radicals in the membrane and both in the membrane and at the membrane surface, respectively. Only the conjugated polyene chain of  $\beta$ -carotene was responsible for radical trapping near the membrane surface and in the interior of the membrane. They also suggested that intramolecular hydrogen bonding is readily formed in astaxanthin. Thanks to equivalent amounts of the hydrophobic intramolecular hydrogen-bonded ring and intermolecular hydrogen bonding with polar heads of PL, and the interconversion between the two hydrogen bond formations, the terminal ring of astaxanthin can scavenge radicals both at the surface and in the interior of the PL membrane (see Figure 50).

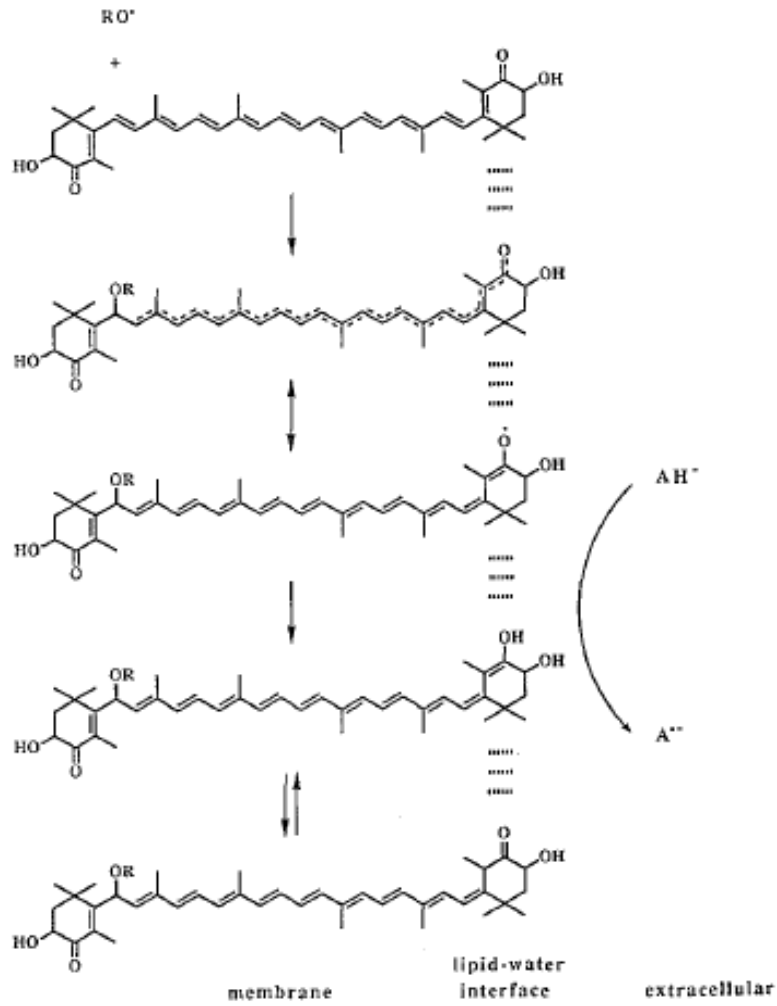

**Figure 49:** Suggested mechanism for trapping of alkoxyl radical by astaxanthin in the central hydrophobic region of a cell membrane, followed by „transport“ of the unpaired electron by the conjugated system to the lipid-water interface, where astaxanthin radicals reacts with an ascorbate anion [90]

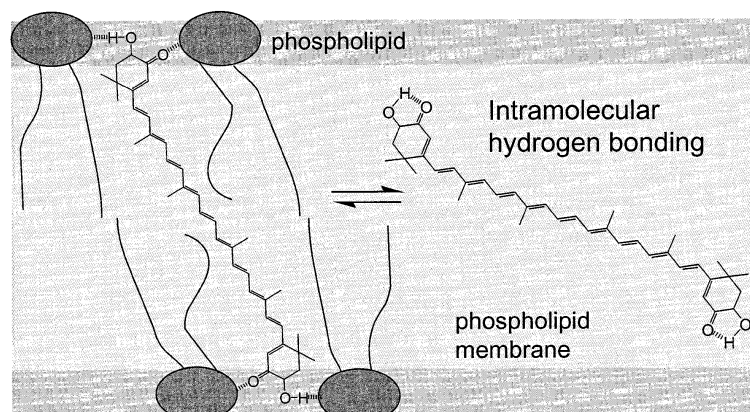

**Figure 50:** Schematic representation of the possible locations of astaxanthin molecules having inter- and intramolecular hydrogen bonds in the PL membrane [91]



#### 4.2.10 $\alpha$ -tocopherol, $\delta$ -tocopherol

Tocopherols can act as antioxidants by scavenging free radicals, scavenging singlet oxygen and by complexation of iron in the presence of ascorbate. Tocopherols scavenge free radicals by donating hydrogen atom to alkyl, alkoxy and peroxy radicals of lipids.

Two concentrations of  $\alpha$ - and  $\delta$ -tocopherols were tested in our study: 0.1 % and 1.0 %. Tocopherol was added to phospholipids before preparation of liposomes. For the 0.1 % of tocopherol, only one concentration of Hb was used: 0.62  $\mu$ M.

For the 1.0 % of tocopherol in PL, two concentrations of Hb were applied: 0.62 and 0.93  $\mu$ M. Reactions without the presence of light were carried out for both tocopherols and for 0.62  $\mu$ M Hb concentration.

For the lower concentration of  $\alpha$ -tocopherol and  $\delta$ -tocopherol, the OUR was inhibited by 49 % and 13 %, respectively (see Figures 51 and 52).

For the higher concentration of  $\alpha$ -tocopherol, the OUR of liposomes with added 0.62  $\mu$ M Hb and 0.93  $\mu$ M Hb was inhibited by 70 % and 77 %, respectively (see Figures 53 - 56). The OUR of liposomes in the reaction run in the absence of light, containing 1.0 % of  $\alpha$ -tocopherol and 0.62  $\mu$ M Hb was inhibited by 50 %, see Figures 57 and 58. This inhibition is lower than that of the reaction in the presence of light (69.6 %).

For the higher concentration of  $\delta$ -tocopherol, the OUR of liposomes with added 0.62  $\mu$ M Hb and 0.93  $\mu$ M Hb was inhibited by 85 % and 90 %, respectively (see Figures 53 - 56). The OUR of liposomes in the reaction run in the absence of light, containing 1.0 % of  $\delta$ -tocopherol and 0.62  $\mu$ M Hb was inhibited by 87 %, see Figures 57 and 58. Unlike  $\alpha$ -tocopherol, here the inhibition of oxidation was almost the same for reactions in the presence of light and without light.

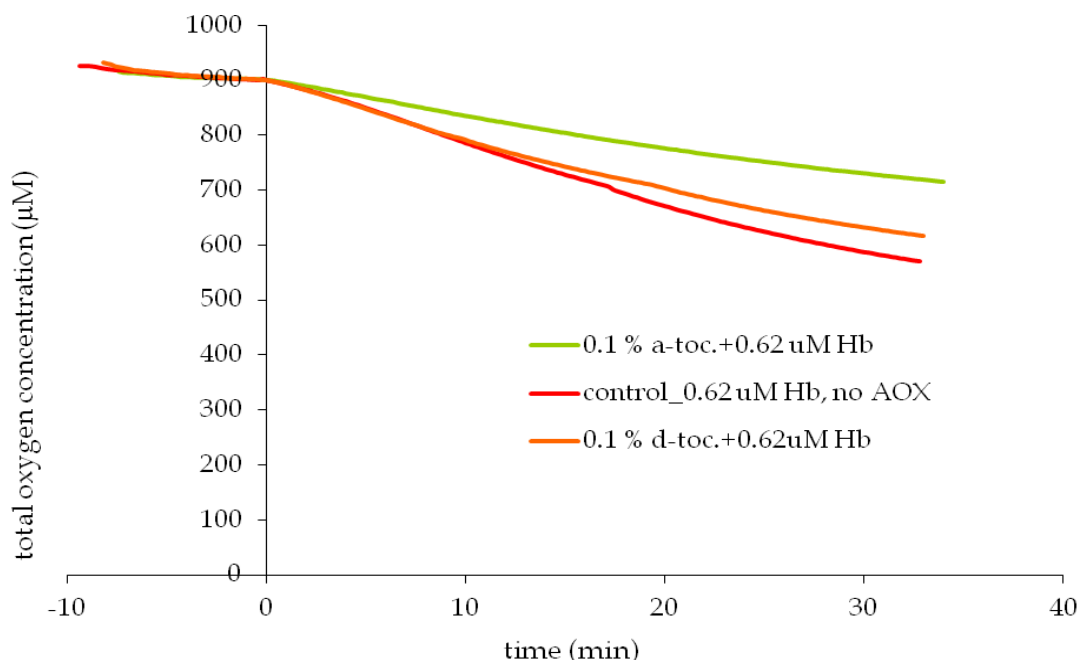

**Figure 51:** Effect of 0.1 % of  $\alpha$ - and  $\delta$ -tocopherols on lipid oxidation induced by metHb (0.62  $\mu$ M). The red curve represents control experiment (without AOX)

It can be summarized that (except for the reactions utilising 0.1 % of tocopherols) for the concentration 1.0 % of tocopherols,  $\delta$ -tocopherol was more efficient antioxidant in inhibiting

Hb-mediated lipid oxidation in liposomes than  $\alpha$ -tocopherol. Both tocopherols acted as antioxidants.

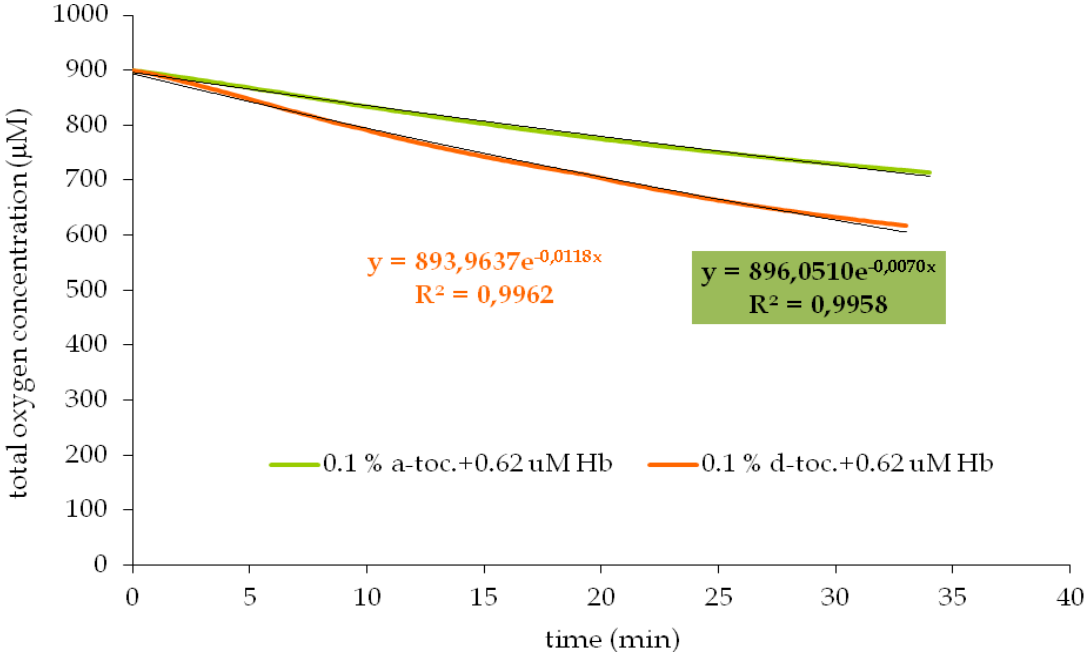

**Figure 52:** Effect of 0.1 % of  $\alpha$ - and  $\delta$ -tocopherols on lipid oxidation induced by metHb (0.62  $\mu$ M). The exponential trendlines and their equations are shown

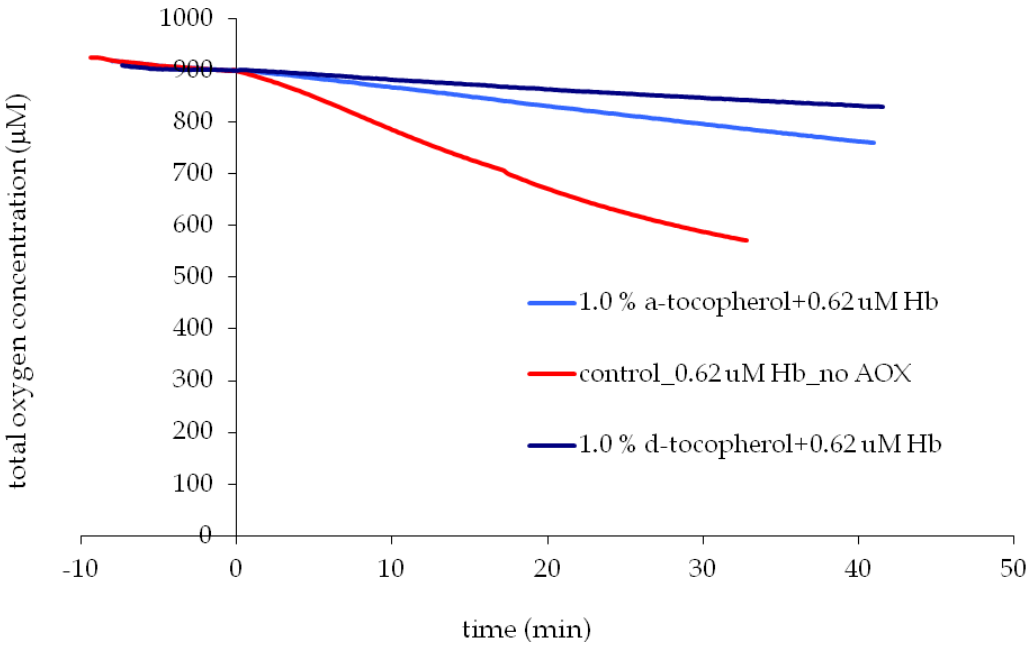

**Figure 53:** Effect of 1.0 % of  $\alpha$ - and  $\delta$ -tocopherols on lipid oxidation induced by metHb (0.62  $\mu$ M). The red curve represents control experiment (without AOX)

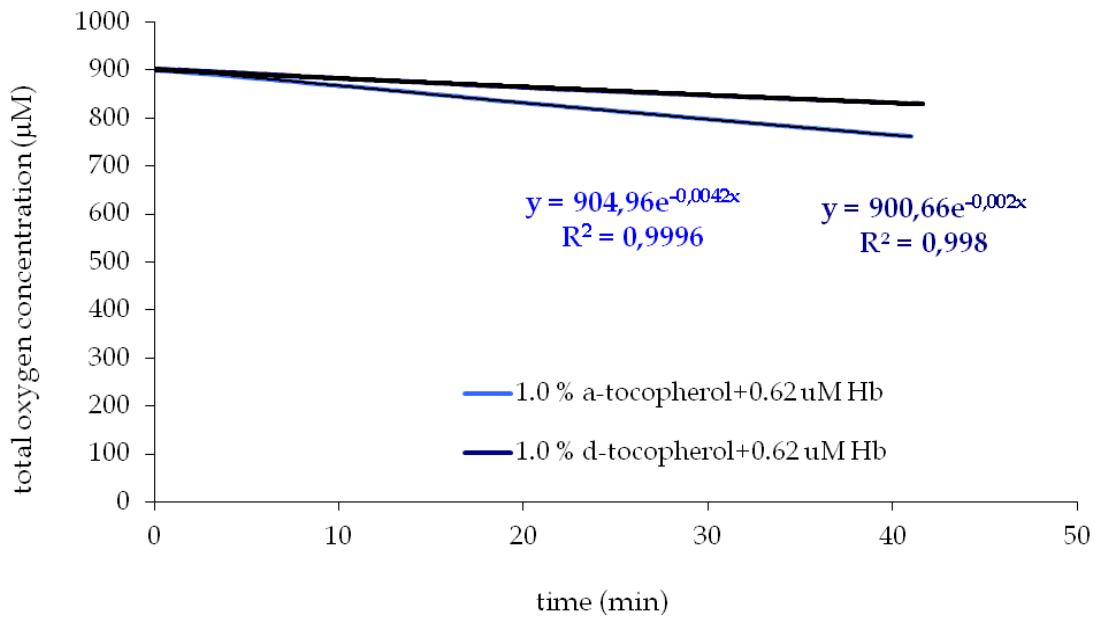

**Figure 54:** Effect of 1.0 % of  $\alpha$ - and  $\delta$ -tocopherols on lipid oxidation induced by metHb (0.62  $\mu$ M). The exponential trendlines and their equations are shown

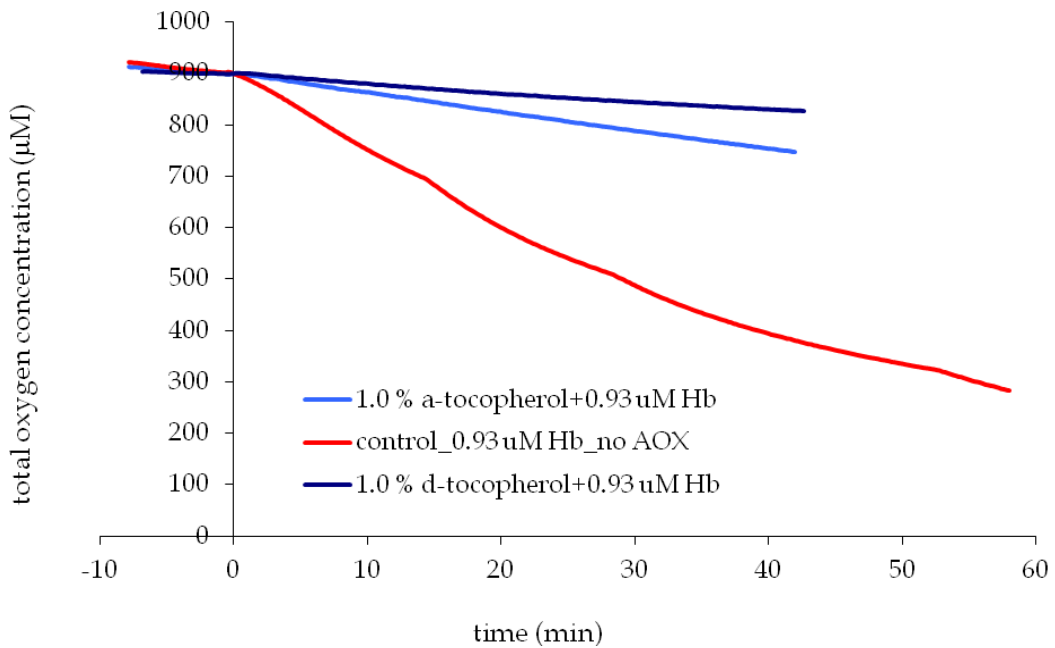

**Figure 55:** Effect of 1.0 % of  $\alpha$ - and  $\delta$ -tocopherols on lipid oxidation induced by metHb (0.93  $\mu$ M). The red curve represents control experiment (without AOX)

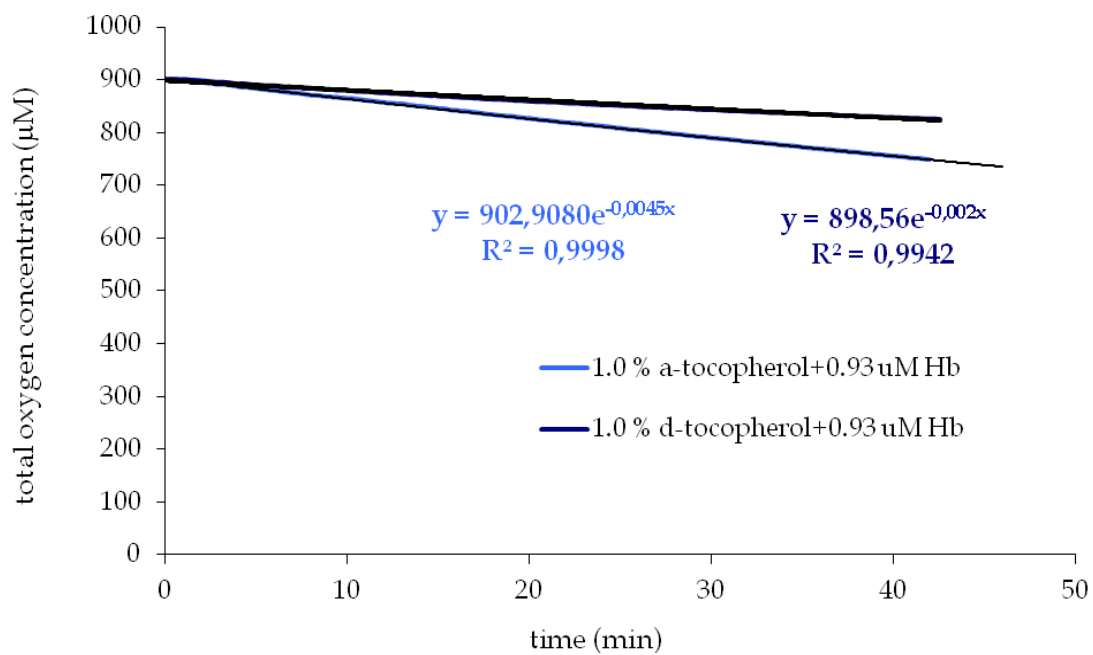

**Figure 56:** Effect of 1.0 % of  $\alpha$ - and  $\delta$ -tocopherol on lipid oxidation induced by metHb (0.93  $\mu\text{M}$ ). The exponential trendlines and their equations are shown

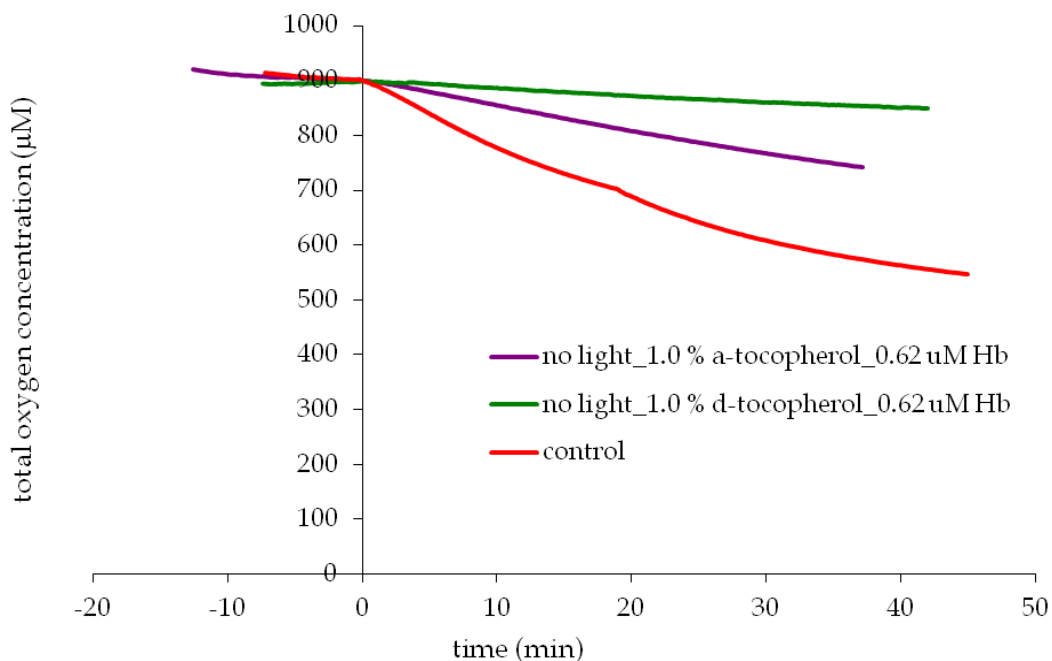

**Figure 57:** Effect of tocopherols on lipid oxidation of liposomes containing 1.0 % of  $\alpha$ - and  $\delta$ -tocopherol. The oxidation was induced by metHb (0.62  $\mu\text{M}$ ). The reaction was run in the absence of light. The red curve represents control experiment (without AOX, without light)

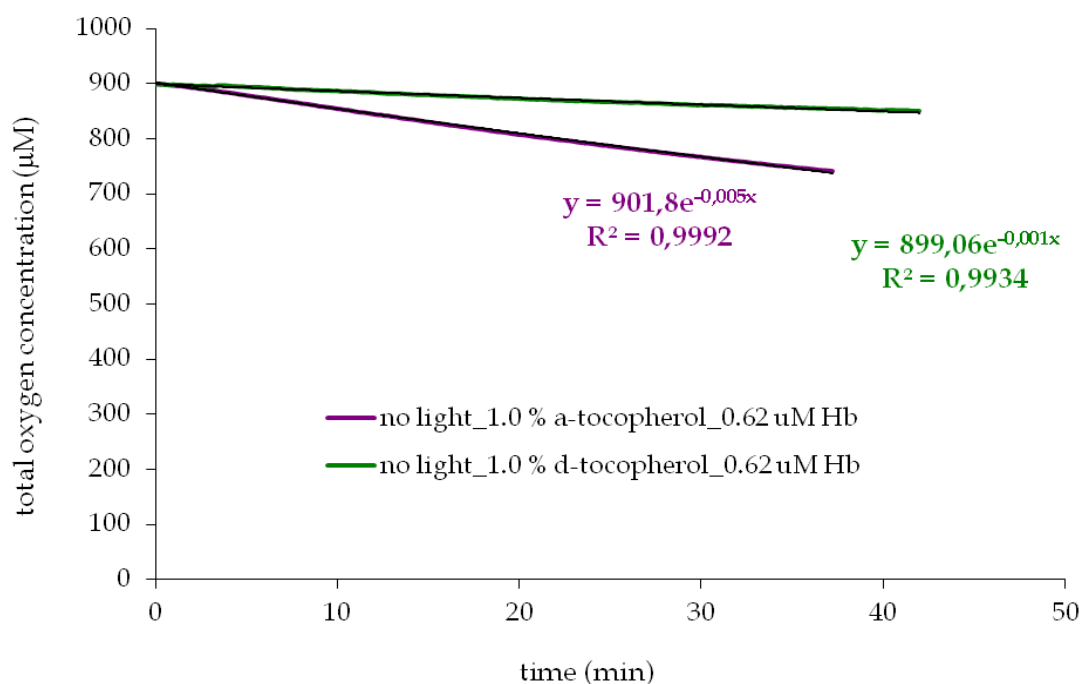

**Figure 58:** Effect of tocopherols on lipid oxidation of liposomes containing 1.0 % of  $\alpha$ - and  $\delta$ -tocopherol. The oxidation was induced by metHb (0.62  $\mu$ M). The reaction was run in the absence of light. The exponential trendlines and their equations are shown

Carvajal et al. [43] examined the effect of  $\alpha$ -tocopherol on lipid oxidation initiated by bovine Hb and observed a significant inhibitory effect for both concentrations of  $\alpha$ -tocopherol (5.4 and 54  $\mu$ M). They concluded that the inhibition effect was due to radical scavenging by  $\alpha$ -tocopherol.

Yin and Cheng [128] studied OxyMb and lipid oxidation in phosphatidylcholine liposomes and reported that 10  $\mu$ M  $\alpha$ -tocopherol delayed both lipid and oxyMb oxidations. They hypothesized that  $\alpha$ -tocopherol retarded lipid oxidation directly, and oxyMb oxidation indirectly. In our study we used metHb (not oxyHb) therefore there is only agreement with the inhibitory effect of  $\alpha$ -tocopherol on lipid oxidation directly.

Yoshida et al. [129] studied the oxidation of soybean phosphatidylcholine (PC) liposomes and low density lipoprotein in aqueous dispersion induced by hemolysate and metHb. They examined the effect of pentamethylchromanol (PMC), a vitamin E analogue. The oxidation was suppressed by the addition of PCM into the liposomal membrane. They also found out that when the phosphatidylcholine was treated beforehand with ebselen (which decomposes hydroperoxides), the oxidation did not proceed. These data suggest that the initiation reaction of the oxidation of the PC liposomes induced by hemolysate and metHb takes place by radicals which are produced in the reaction between hydroperoxides in liposomes and the heme protein species. These results indicate that tocopherols inhibit lipid oxidation in liposomes by radical scavenging. Part of the antioxidant activity might be attributed to singlet oxygen quenching, as some effect of light has been observed in our experiments. However, the possibility to incorporate this lipid-soluble AOX in the liposome membrane (where it scavenges free radicals) favours the explanation by the radical scavenging ability of tocopherols.

The observation, that for the concentration 1.0 % of tocopherols,  $\delta$ -tocopherol was more efficient antioxidant in inhibiting Hb-mediated lipid oxidation in liposomes than  $\alpha$ -tocopherol, can be explained by the different antioxidant activity of TOH among the isomers (see part 2.4.3.4). *In vivo*, the relative antioxidant activity of tocopherols decreases in the order  $\alpha$ -TOH >  $\beta$ -TOH >  $\gamma$ -TOH >  $\delta$ -TOH. The presence of more methyl substituents in the phenolic ring of the tocopherol does not only enhance its antioxidants activity, but also increases its lipophilic properties, making the  $\alpha$ -homologue the most soluble tocopherol in lipid substrates [99]. However, in foods the antioxidant activity of tocopherols is reverse:  $\delta$ -TOH >  $\gamma$ -TOH >  $\beta$ -TOH >  $\alpha$ -TOH, and this is in agreement with our observations. Generally,  $\delta$ -TOH has the highest free radical-scavenging activity. While the *in vitro* antioxidant activity is highly dependent on the varying physical states and chemical compositions of the *in vitro* models (systems), the *in vivo* vitamin E activity seems to be highly related to the lipophilicity of the vitamin. The described differences between the *in vitro* and *in vivo* systems also may be due to differences in the relative importance of lipid oxidation mechanisms (radical scavenging and singlet oxygen quenching).

#### 4.2.11 Ascorbyl palmitate

Ascorbyl palmitate (AP) is a fat-soluble analogue of ascorbic acid. AP acts as oxygen quencher and a reductant and has been shown to be an effective singlet oxygen quencher [18, 86].

Two concentrations of ascorbyl palmitate were tested in our study: 0.1 % and 1.0 %. AP was added to phospholipids before preparation of liposomes. For both concentrations of AP, two concentration of Hb were used: 0.62 and 0.93  $\mu$ M.

For the lower concentration of AP, a prooxidative effect was observed. The OUR of liposomes with added 0.62 $\mu$ M Hb and 0.93 $\mu$ M Hb increased by 12 % and 9 %, respectively (see Figures 59 and 60).

However, for the higher concentration of AP (1.0 %), an antioxidative effect was observed. The OUR of liposomes with added 0.62 $\mu$ M Hb and 0.93 $\mu$ M Hb decreased by 86.0 % and 90.2 %, respectively, see Figures 61 and 62.

The prooxidative effect at the low concentration can be explained by the action of ascorbyl radical - Hamilton et al. [130] studied effects of tocopherols, ascorbyl palmitate, and lecithin on autoxidation of fish oil for single antioxidants, binary, and ternary mixtures. They observed a slight prooxidative effect when ascorbyl palmitate was used alone at a concentration 0.1 %. They suggested that ascorbyl palmitate, or more precisely the ascorbyl radical, could promote hydroperoxide scissions.

Different results are presented by Let et al. [131], who investigated the ability of  $\gamma$ -tocopherol, EDTA, and ascorbyl palmitate to protect fish oil enriched salad dressing against oxidation during a 6 week storage period at room temperature. They observed prooxidant effects with a high concentration of ascorbyl palmitate (300  $\mu$ g/g of fish oil), whereas a low concentration was slightly antioxidative (50  $\mu$ g/g of fish oil).

As the absence of light decreased the OUR in our study by 21 %, a possible explanation of the antioxidative effect of AP is its singlet oxygen quenching ability. Lee et al. [86] investigated quenching mechanisms and kinetics of ascorbyl palmitate for the reduction of the photosensitized oxidation of oils and found out that AP was extremely effective at minimizing both methylene-blue- and chlorophyll-sensitized photooxidations of linoleic acid and soybean oil, and its effectiveness was concentration-dependent.

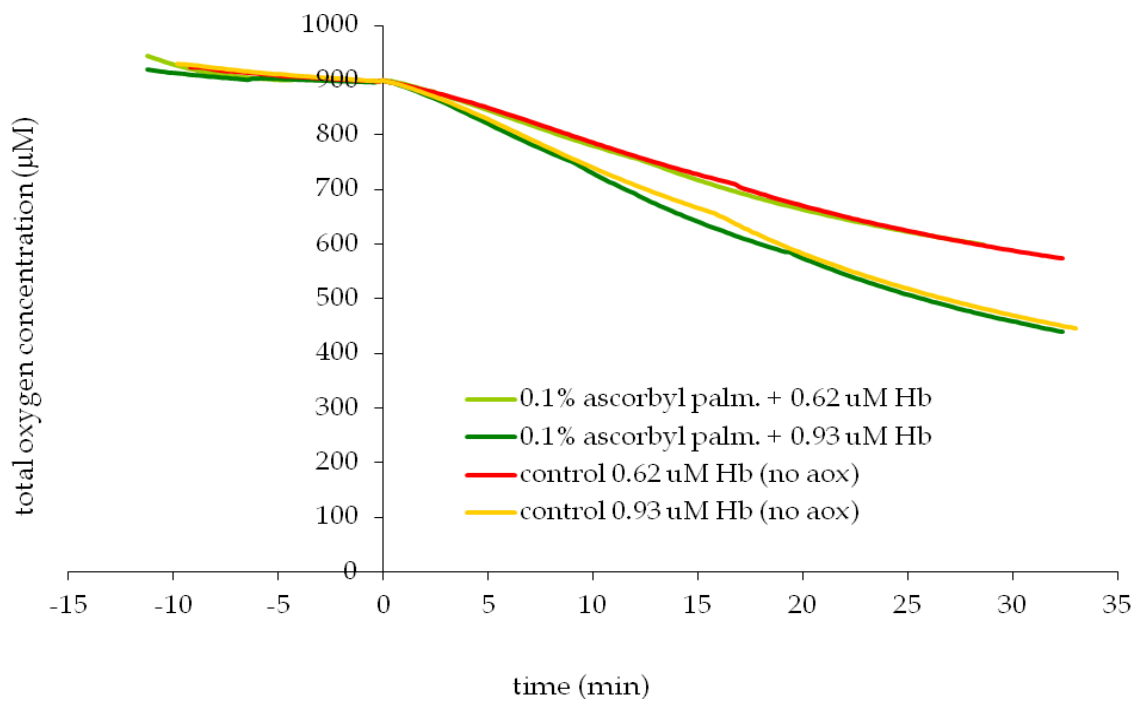

**Figure 59:** Effect of 0.1 % of ascorbyl palmitate on lipid oxidation induced by metHb (0.62 and 0.93  $\mu\text{M}$ ). The red and orange curves represent control experiments (without AOX)

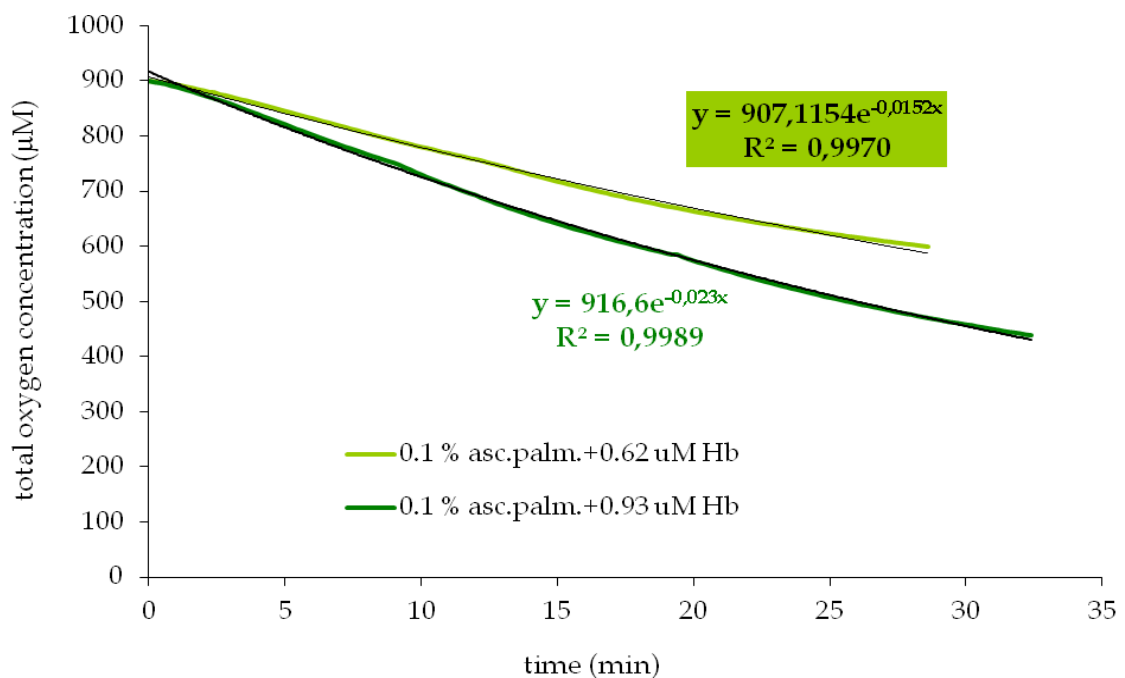

**Figure 60:** Effect of 0.1 % of ascorbyl palmitate on lipid oxidation induced by metHb (0.62 and 0.93  $\mu\text{M}$ ). The exponential trendlines and their equations are shown

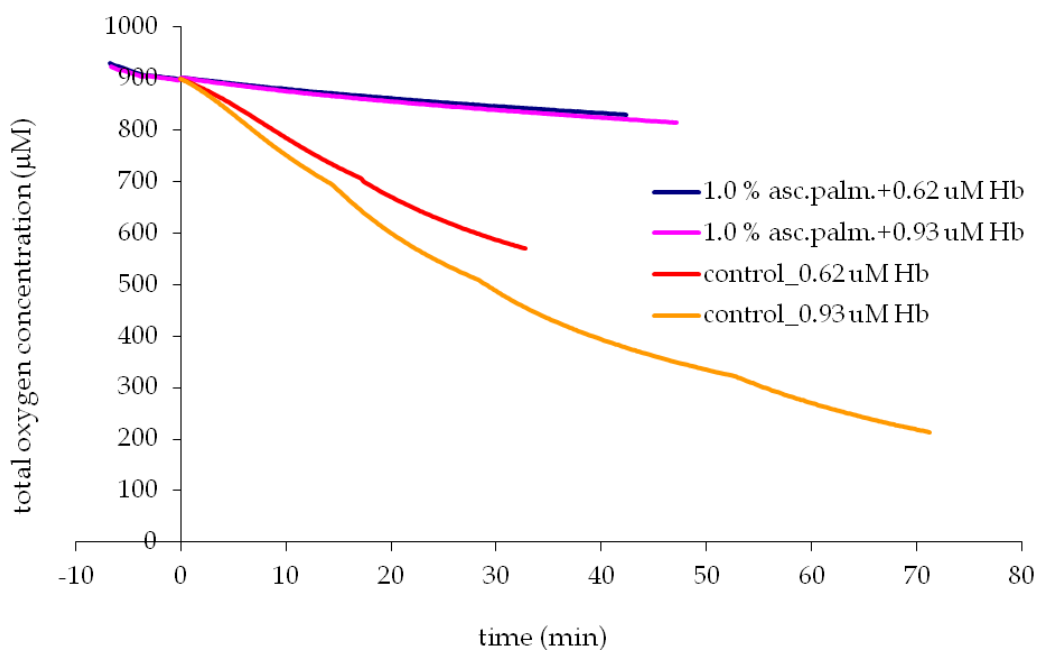

**Figure 61:** Effect of 1.0 % of ascorbyl palmitate on lipid oxidation induced by metHb (0.62 and 0.93  $\mu\text{M}$ ). The red and orange curves represent control experiments (without AOX)

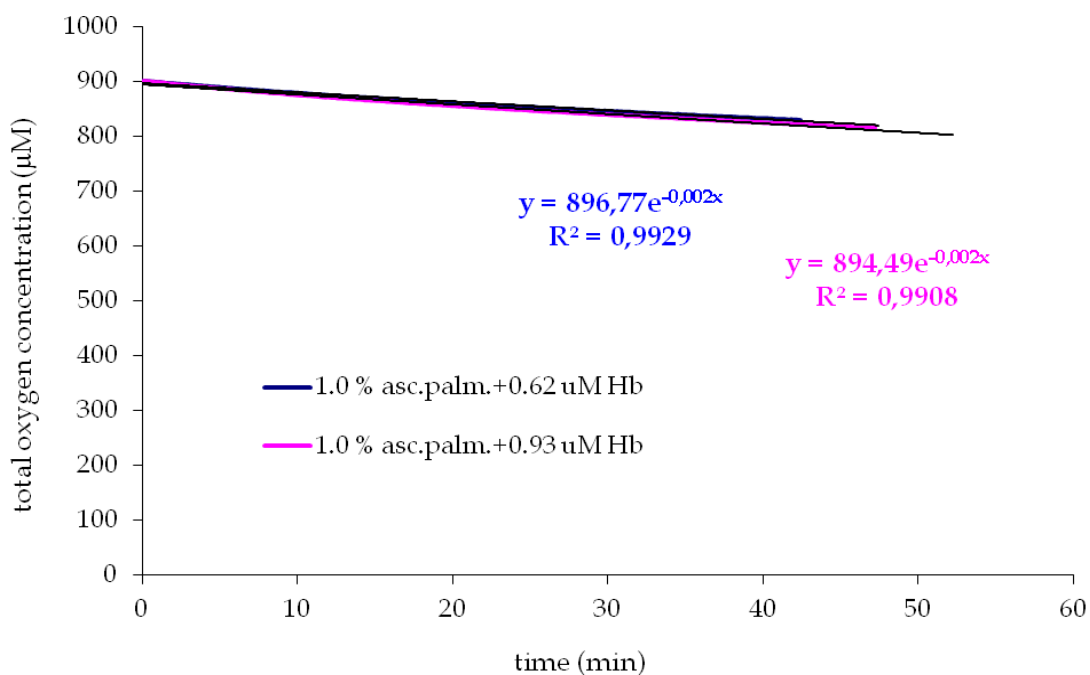

**Figure 62:** Effect of 1.0 % of ascorbyl palmitate on lipid oxidation induced by metHb (0.62 and 0.93  $\mu\text{M}$ ). The exponential trendlines and their equations are shown

#### 4.2.12 Experiments without the presence of light

To study the the role of hemoglobin as a photosensitizer and therefore the influence of singlet oxygen on oxidation of marine liposomes, several experiments without the presence of



light were carried out. The reaction cells were covered with aluminium foil during the reactions. The individual experiments are specified in the individual sections above. Here, the overall effect of the absence of light on metHb-mediated oxidation of liposomes is presented. It was found out, that the absence of light resulted in inhibition of the OUR of liposomes. The decrease in OUR was 21 %, see Figure 63.

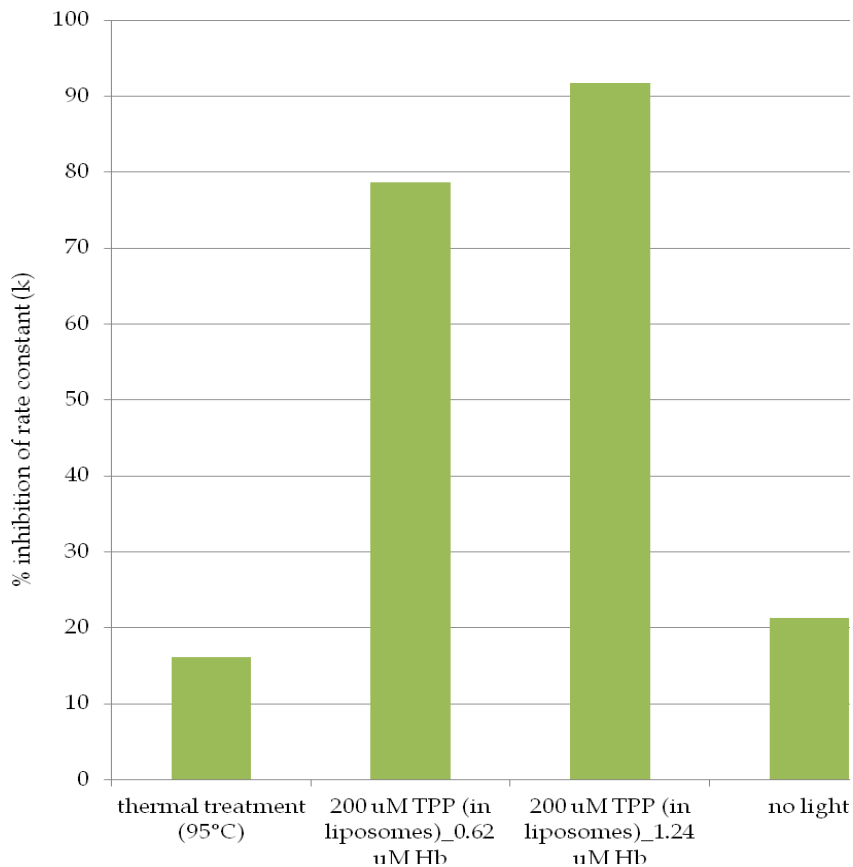

**Figure 63:** Effect of thermal treatment, TPP and absence of light on the prooxidant activity of metHb (0.62 µM)

Mb and Hb are known to act as photosensitizers of lipid oxidation on meat. They possess the ability to absorb energy from light. This energy is then transferred to triplet oxygen to form singlet oxygen, which can then react with fatty acids, thus initiating lipid oxidation [54]. As a decrease in OUR of liposomes in the absence of light was observed in our experiments, it can be concluded, that a smaller part of the prooxidative activity of metHb is attributed to the photosensitizing properties of metHb.

These results are not in agreement with the results reported by Carvajal et al. [43] who found out that there was no significant difference in OUR of liposomes (with metHb as the prooxidant) between the reaction performed with and without light. Their explanation was that most of the Hb used for the experiments was in the oxidized state, thereby leading to a low formation of singlet oxygen.

Generally, porphyrins are known to act as photosensitizers [54]. On the other hand, according to King [132] both Mb and oxyMb have the ability to absorb light energy, resulting in the formation of metMb through a photooxidative reaction. Whang and Peng [133] reported

that peroxide values for pork and turkey meat exposed to light were significantly higher than those stored in the dark. They also found that myoglobin and its derivatives functioned as photosensitizers in model systems for the formation of singlet oxygen. Therefore it is not clear which forms of heme proteins can act as photosensitizers. The disagreement between our results and the results of Carvajal et al. [43] can be explained by different processing of the data.

#### **4.2.13 Reaction with hydrogen peroxide (H<sub>2</sub>O<sub>2</sub>)**

The reaction of metHb with H<sub>2</sub>O<sub>2</sub> leads to formation of hypervalent iron species (perferrylhemoglobin and ferrylhemoglobin). Perferrylhemoglobin rapidly transforms to ferryl hemoglobin, which is an initiator of lipid oxidation [55, 134].

Before the experiments of metHb with H<sub>2</sub>O<sub>2</sub> in liposomes, several control experiments without metHb were carried out to check if single H<sub>2</sub>O<sub>2</sub> or EDTA with H<sub>2</sub>O<sub>2</sub> influence the oxidation of liposomes. In the first experiment, only H<sub>2</sub>O<sub>2</sub> working solution was present in the cell, oxygen was removed by bubbling the solution with N<sub>2</sub>. It was observed that the oxygen concentration did not increase, which indicates that H<sub>2</sub>O<sub>2</sub> is not decomposed to H<sub>2</sub>O and O<sub>2</sub>, see dark blue curve in Figure 64. No effect on oxidation of liposomes was observed in the presence of 10 μL or 40 μL of H<sub>2</sub>O<sub>2</sub> alone, see the light blue and pink curves in Figure 64. No effect on oxidation of liposomes was observed in the presence of 30 μL of EDTA and 10 μL of H<sub>2</sub>O<sub>2</sub>, no effect was observed in the presence of 30 μL of EDTA and 40 μL of H<sub>2</sub>O<sub>2</sub>, see the red and green curves in Figure 64. Actually, the expected decrease in the background OUR of liposomes was observed after addition of EDTA.

In the first experiment, 30 μL of EDTA was added to liposomes and later, 40 μL of H<sub>2</sub>O<sub>2</sub> was added and then 40 μL of metHb solution (corresponding to 0.62 μM concentration of metHb in the reaction mixture) was added to the reaction mixture. These amounts of metHb and H<sub>2</sub>O<sub>2</sub> correspond to the ratio between heme groups and H<sub>2</sub>O<sub>2</sub> 1:1. In the second experiment, the reactants were added in the same order, only the amount of H<sub>2</sub>O<sub>2</sub> was different: 10 μL. These amounts correspond to the ratio between heme groups and H<sub>2</sub>O<sub>2</sub> 4:1 (i.e. heme protein to H<sub>2</sub>O<sub>2</sub> ratio is 1:1).

In the second set of experiments, the same amounts of reactants were used except H<sub>2</sub>O<sub>2</sub>. Only one concentration of H<sub>2</sub>O<sub>2</sub> was used: 40 μL. The appropriate amounts of metHb solution and H<sub>2</sub>O<sub>2</sub> solution were mixed before and this mixture was then added to liposomes containing EDTA. The moments of addition were: 1 minute and 10 minutes after mixing the solutions.

The resulting curves are shown in Figures 65 and 66. No significant effect of hydrogen peroxide on the OUR of liposomes was observed.

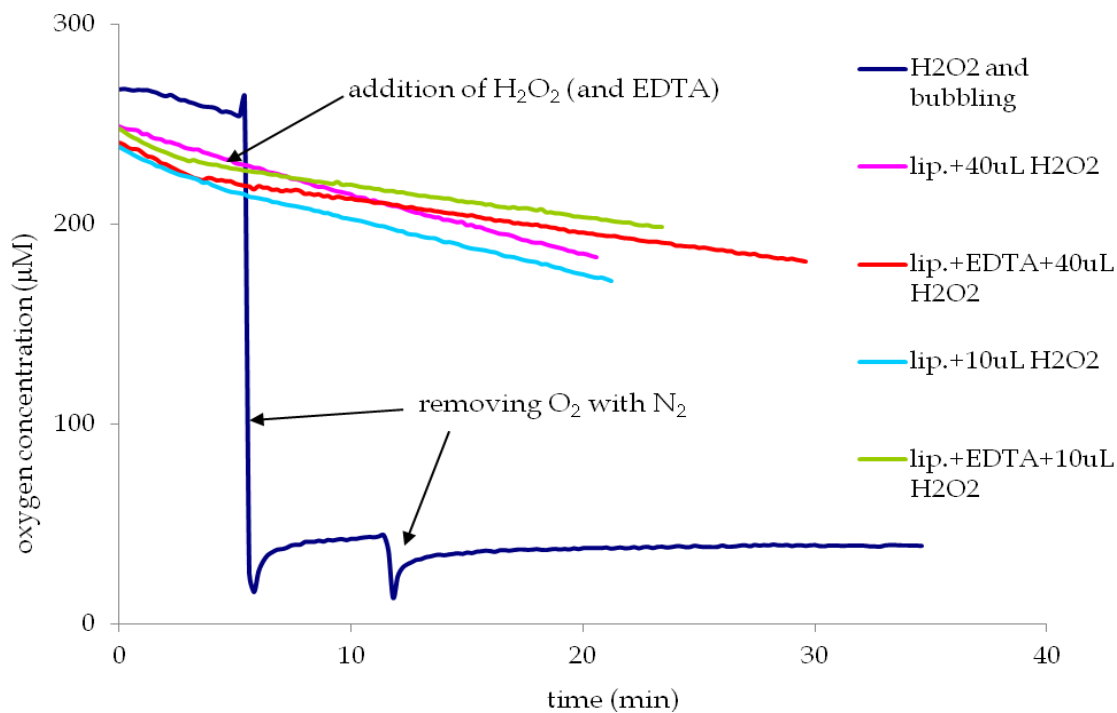

**Figure 64:** Control experiments for experiments with H<sub>2</sub>O<sub>2</sub>

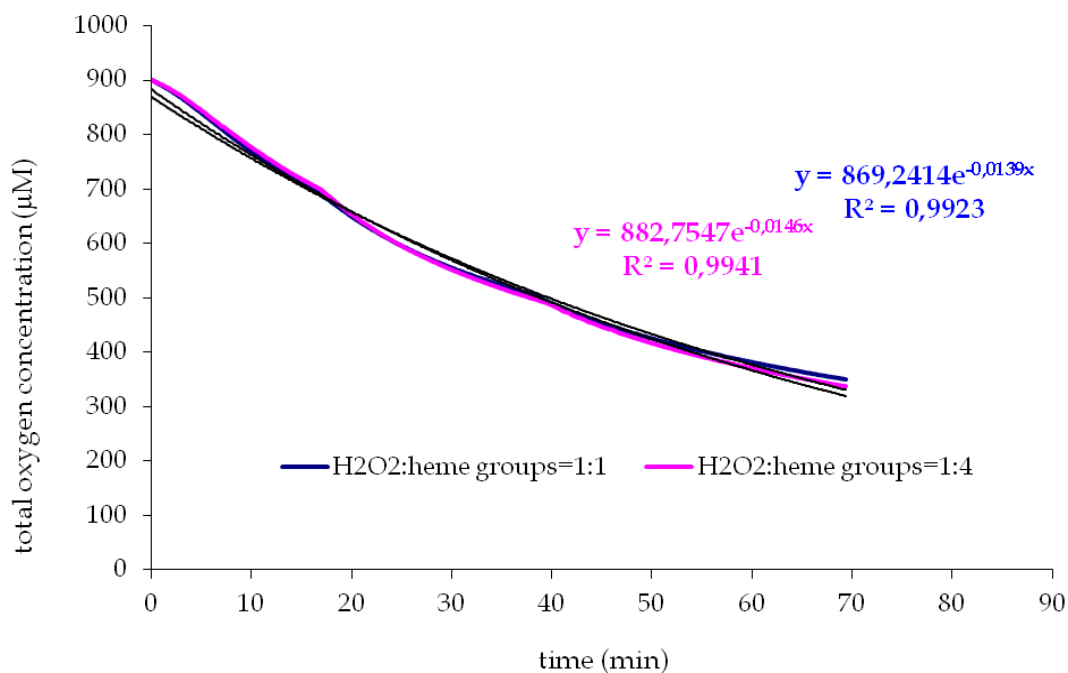

**Figure 65:** The effect of hydrogen peroxide on the OUR of metHb-mediated oxidation of liposomes. The exponential trendlines are shown. H<sub>2</sub>O<sub>2</sub> and metHb were added separately to liposomes

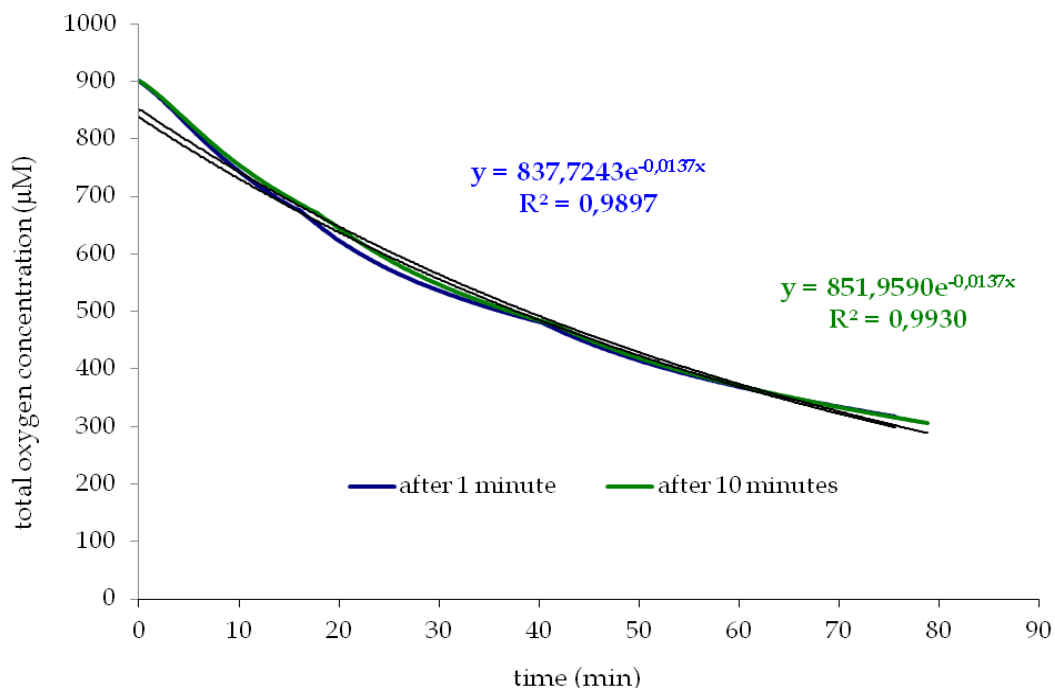
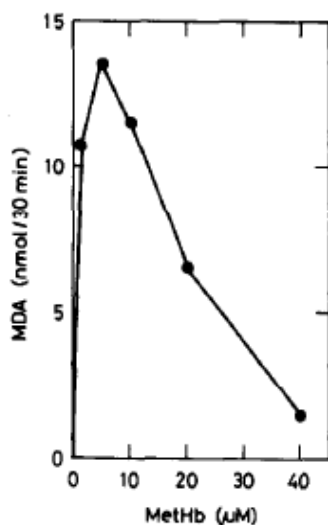

**Figure 66:** The effect of hydrogen peroxide on the OUR of metHb-mediated oxidation of liposomes. The exponential trendlines are shown.  $H_2O_2$  and metHb were mixed before and then added to the reaction mixture

Our results are not in agreement with findings in literature about the reaction of metHb with  $H_2O_2$ . Kanner and Harel [55] studied the interaction of  $H_2O_2$  with metMb and found out that this reaction led very rapidly to generation of an active species which could initiate lipid peroxidation. Their results show that maximum initiation by activated metMb occurred 10 – 30 s after addition of  $H_2O_2$ . They also found out that the activity of the activated metMb decreased rapidly to 50 % during the first 10 minutes, but this level of activity remained stable for more than 30 min. They found out, that small amounts of  $H_2O_2$  (1 – 10  $\mu M$ ) could activate metMb for a significant oxidation. MetHb was also found to be activated by  $H_2O_2$  and to initiate lipid peroxidation. In experiments with metHb they found out that the maximum was reached at the concentration 5 – 7  $\mu M$ , with a rapid decline with further increase of metHb concentration (see Figure 67). As the metHb molecule contains four heme groups, they suggested it seems that the prooxidant effect is obtained when the ratio between heme groups and  $H_2O_2$  is almost 1:1. Maximum oxygen absorption was found during incubation of activated metMb with 30 - 40  $\mu M$   $H_2O_2$ .

King and Winfield [135] studied the oxidation by  $H_2O_2$  of horse heart metMb in the pH range from 6 to 8. At the lower pH a high proportion of the metMb was in a free radical state a few seconds after  $H_2O_2$  was added. The ferryl Mb reverts to the ferric state. They found out that at least eight oxidations can occur before the hemoprotein loses its reactivity toward  $H_2O_2$ . After one or two oxidation-reduction cycles the metMb is modified and is noticeably slower to react with  $H_2O_2$  and faster to return to the ferric state. They recorded isosbestic points in the spectra of a mixture of metMb and  $H_2O_2$  and found evidence for the extensive formation of modified metMb during an oxidation-reduction cycle – the absorption curve for

metMb does not pass the four isosbestic points of the reaction mixture, observed several minutes after addition of H<sub>2</sub>O<sub>2</sub>.

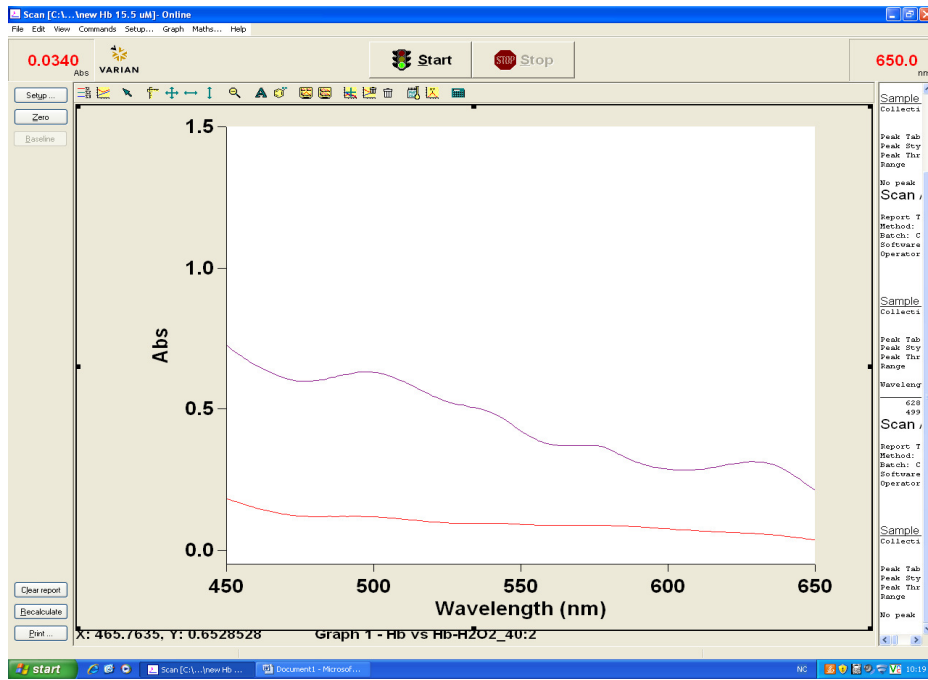

**Figure 67:** Membranal lipid peroxidation by activated methHb with H<sub>2</sub>O<sub>2</sub> (30 μM) [55]

A possible explanation for the disagreements is the state of our metHb. As has been mentioned in section 4.2.5, the metHb that we use has been treated variously because of its production and therefore might be denatured to some extent. It is likely that the main prooxidative activity of our metHb was the decomposition of preformed lipid hydroperoxides, which generates free radicals, and the oxidation of liposomes proceeds. Thereby the effect of H<sub>2</sub>O<sub>2</sub> might be hidden. The reaction of metHb with peroxides also yields ferrylhemoglobin (Fe<sup>4+</sup>=O).

#### 4.2.14 Absorption curve of metHb

The absorption spectra of the Hb solution were scanned to check, which form of Hb we work with. The absorption scan was performed in the 450 – 650 nm wavelength range at room temperature (see Figure 68). The spectra were compared with measurement by Olsen and Elvevoll [136] (see Figures 69 and 70) and it was found out that our hemoglobin is in the form of methemoglobin.



**Figure 68:** Absorption curve of bovine metHb (the upper curve)

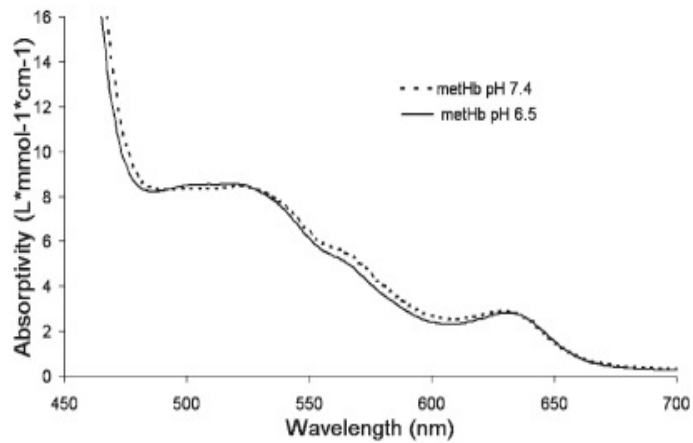

**Figure 69:** The absorption curve of Atlantic cod metHb [136]

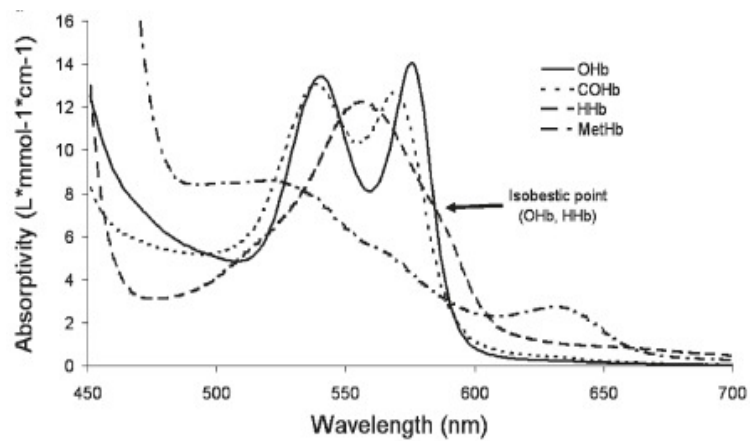

**Figure 70:** Absorption curves of the four common Hb derivatives of Atlantic cod (OHb stands for oxyHb, COHb stands for carboxyHb, HHb stands for deoxyHb) [136]

## 5 CONCLUSION

The kinetics of lipid oxidation catalyzed by bovine methemoglobin and the antioxidant capacity of different compounds were studied in a liposome model system. The effects of temperature (thermal denaturation), light, TPP and H<sub>2</sub>O<sub>2</sub> on the prooxidant activity of metHb were also evaluated.

EDTA, an iron chelator, was added to the liposome solution before any other reactant in all the experiments. EDTA decreased the background OUR of liposomes due to its chelating function, because liposomes contained endogenous transition metals and the methemoglobin solution contained free iron. EDTA therefore eliminated the prooxidant effect of free iron. When metHb was added to liposomes, the fastest decrease in OUR was observed shortly after metHb addition and then the OUR decreased slowly. As the OUR decreased slowly even after replenishing the dissolved oxygen in the liposome solution, it can be suggested that metHb is a reactant in this reaction rather than a catalyst or a prooxidant, because it seems that metHb is consumed during the reaction.

It has been concluded that the free iron released from metHb contributed little to metHb-mediated lipid oxidation in liposomes.

The type of prooxidant and the concentration of both prooxidant and antioxidants are important factors in evaluation of the antioxidant activity.

It was found out, that the absence of light resulted in inhibition of the OUR of liposomes. The decrease in OUR was 21 %. Therefore, metHb acted as a photosensitizer forming singlet oxygen, and the antioxidative activity of astaxanthin, ascorbyl palmitate, and tocopherol can be partly attributed to their singlet oxygen quenching ability.

However, the main prooxidative mechanisms of metHb are suggested to be decomposition of lipid hydroperoxides, generating free radicals, and formation of hypervalent forms of Hb.

The efficiency of the antioxidants increased with their increasing concentration. All the antioxidants exhibited antioxidative activity in the higher concentration. 0.1 % of astaxanthin had no effect on the oxidation of liposomes. 0.1 % of ascorbyl palmitate (AP) had a prooxidative effect which can be explained by the prooxidative action of ascorbyl radical, which could promote hydroperoxide scission.

The antioxidative effect of AP can be explained by its singlet oxygen quenching ability and its role as a reductant. The reduction of hypervalent forms of Hb seems to be a very important antioxidant mechanism. Besides ascorbyl palmitate, this is also the case for ascorbic acid (AsA) and caffeic acid (CaA). These water-soluble AOX exhibited antioxidative activity in both tested concentrations. However, AsA was more efficient than CaA. The ability of AsA and CaA to inhibit metHb-mediated lipid oxidation is also attributable to scavenging of lipid radicals. CaA in the aqueous phase of the liposome solution can enter the heme crevice of Hb and/or bind to ferrylHb reducing the oxoferryl moiety to metHb. Due to the two vicinal hydroxyl groups CaA is an active antioxidative compound. Our results indicate that tocopherols inhibit lipid oxidation in liposomes mainly by radical scavenging. Part of the antioxidant activity is attributed to singlet oxygen quenching. Free radicals scavenging is the primary antioxidant ability of astaxanthin in our system. Astaxanthin is a very potent antioxidant. The conjugated polyene moiety and the terminal ring moieties of astaxanthin probably trap radicals in the membrane and both in the membrane and at the membrane surface, respectively.

No significant effect of hydrogen peroxide on the OUR of liposomes was observed. However, it was expected that H<sub>2</sub>O<sub>2</sub> could activate metMb for a significant oxidation. Probably the lipid hydroperoxides decomposition is a more important prooxidant mechanism of metHb in our system.

The influence of thermal denaturation of metHb on its pro-oxidant activity was investigated. Due to thermal treatment of metHb solution, the oxidation was inhibited by 16 %. The reason for the decrease in the prooxidant activity may be the loss of protein solubility. As the metHb has been treated variously because of its production, it might be partly denatured in a way. Therefore the degree of denaturation caused by the thermal treatment might not be so significant.

A significant inhibition of oxygen uptake rate was observed in liposomes containing TPP (triphenylphosphine). TPP is known to break down peroxides to alcohols. These results suggest that lipid peroxides take part in the oxidation reaction and that the heme-mediated lipid oxidation in liposomes is dependent on the presence of pre-existing lipid peroxides.

The mechanism of Hb-induced lipid oxidation is very complex. Also the evaluation of efficiency of different antioxidants is a very complex issue, even when a simplified model system is used for the study of lipid oxidation. Further investigations are needed to determine the antioxidant efficacy, mainly with focus on natural antioxidants for the use in food products.



## 6 LITERATURE

1. Breivik, H., *Long-chain omega-3 specialty oils*. 2007, Bridgwater, England: The Oily Press. p. 312. ISBN 978-0-9552512-1-4.
2. Kris-Etherton, P.M., W.S. Harris, and L.J. Appel, *Fish consumption, fish oil, omega-3 fatty acids, and cardiovascular disease*. *Circulation*, 2002. 106(21): p. 2747-2757. ISSN 0009-7322.
3. Calder, P.C., *n-3 Fatty acids, inflammation, and immunity – relevance to postsurgical and critically ill patients*. *Lipids*, 2004. 39: p. 1147-1161. ISSN 0024-4201.
4. Innis, S.M., *Essential fatty acids in growth and development*. *Progress in Lipid research*, 1991. 30(1): p. 39 -103. ISSN 0163-7827.
5. Løvaas, E., *Marine phospholipids (MPL): resources, applications and markets.*, in *Seafood research from fish to dish: quality, safety and processing of wild and farmed fish.*, J.B. Luten, Jacobsen, C., Bekaert, K., Sæbø, A., Oehlenschläger, J., Wageningen, Editor. 2006, Academic Publishers: The Netherlands. ISBN 90-8686-005-2.
6. Undeland, I., B. Ekstrand, and H. Lingnert, *Lipid oxidation in herring (*Clupea harengus*) light muscle, dark muscle, and skin, stored separately or as intact fillets*. *Journal of the American Oil Chemists' Society*, 1998. 75(5): p. 581-590. ISSN 0003-021X.
7. Jacobsen, C., et al., *Preventing lipid oxidation in seafood.*, in *Improving seafood products for the consumer*, T. Brresen, Editor. 2008, Woodhead Publishing in Food Science, Technology and Nutrition p. 426-460. ISBN 978-1-84569-019-9.
8. Grunwald, E.W. and M.P. Richards, *Mechanisms of Heme Protein-Mediated Lipid Oxidation Using Hemoglobin and Myoglobin Variants in Raw and Heated Washed Muscle*. *Journal of Agricultural and Food Chemistry*, 2006. 54(21): p. 8271-8280. ISSN 0021-8561.
9. Carlsen, C.U. and L.H. Skibsted, *Myoglobin Species with Enhanced Prooxidative Activity Is Formed during Mild Proteolysis by Pepsin*. *Journal of Agricultural and Food Chemistry*, 2004. 52(6): p. 1675-1681. ISSN 0021-8561.
10. Mozuraityte, R., *Oxidation of marine phospholipids in liposomes*. *Doctoral Thesis*, in *Faculty of Natural Science and Technology in Trondheim, Department of Biotechnology*. 2007, NTNU: Trondheim. p. 143. ISBN 978-82-471-3134-3.
11. Chatterjee, S.N. and S. Agarwal, *Liposomes as membrane model for study of lipid peroxidation*. *Free Radical Biology and Medicine*, 1988. 4(1): p. 51-72. ISSN 0891-5849.
12. Carlsen, C.U., J.K.S. Møller, and L.H. Skibsted, *Heme-iron in lipid oxidation*. *Coordination Chemistry Reviews*, 2005. 249(3-4): p. 485-498. ISSN 0010-8545.
13. Berg, J.M., J.L. Tymoczko, and L. Stryer, *Biochemistry*. 6th ed. 2007, New York: W. H. Freeman and Company. p. 1046. ISBN 0-7167-8724-5.
14. Gunstone, F.D., *Fatty acids and lipid chemistry*. 1st ed. 1996, Springer Netherlands: Blackie Academic & Professional. p. 268. ISBN 0751402532.
15. Kates, M., *Techniques of Lipidology: Isolation, analysis and identification of lipids*. 2nd revised ed. 1991: Elsevier Science Publisher: Amsterdam, The Netherlands. 186-278. ISBN 0-444-80737-3.
16. Damodaran S., P.K.L., Fennema O. R., *Fennema's Food Chemistry*. 4th ed. 2008, Boca Raton: Taylor & Francis group. p. 1144. ISBN: 978-0-8493-9272-6.

17. *Prescription Omega-3 Fatty Acids for the Treatment of Hypertriglyceridemia: Chemistry*. © 1994-2011 by WebMD LLC [cited 21. 02. 2011]; Available from: [http://www.medscape.com/viewarticle/555607\\_2](http://www.medscape.com/viewarticle/555607_2).
18. Akoh, C.C. and D.B. Min, *Food Lipids: Chemistry, Nutrition and Biotechnology*. 3rd ed. 2008: CRC Press, Taylor & Francis Group. p. 930. ISBN 978-1-4200-4663-2
19. Chan, W.K.M., et al., *Lipid oxidation induced by oxymyoglobin and metmyoglobin with involvement of H<sub>2</sub>O<sub>2</sub> and superoxide anion*. *Meat Science*, 1997. 46(2): p. 181-190. ISSN 0309-1740.
20. Pond, D., et al., *Variation in the lipid content and composition of Antarctic krill Euphausia superba at South Georgia*. *Marine Ecology Progress Series*, 1995. 117: p. 49-57. ISSN 0171-8630.
21. Phleger, C.F., et al., *Interannual and between species comparison of the lipids, fatty acids and sterols of Antarctic krill from the US AMLR Elephant Island survey area*. *Comparative Biochemistry and Physiology Part B: Biochemistry and Molecular Biology*, 2002. 131(4): p. 733-747. ISSN 1096-4959
22. Kaitaranta, J.K. and R.G. Ackman, *Total lipids and lipid classes of fish roe*. *Comparative Biochemistry and Physiology Part B: Comparative Biochemistry*, 1981. 69(4): p. 725-729. ISSN 1096-4959.
23. Tocher, D.R. and J.R. Sargent, *Analyses of lipids and fatty acids in ripe roes of some northwest European marine fish*. *Lipids*, 1984. 19(7): p. 492-499. ISSN 0024-4201.
24. Shahidi, F. and Y. Zhong, *Lipid Oxidation: Measurement Methods*, in *Bailey's Industrial Oil and Fat Products*, F. Shahidi, Editor. 2005, John Wiley & Sons, Inc. p. 357-385. ISBN 0-471-38460-7.
25. Choe, E. and D.B. Min, *Chemistry and Reactions of Reactive Oxygen Species in Foods*. *Journal of Food Science*, 2005. 70(9): p. R142-R159. ISSN 0022-1147.
26. Kanner, J. and J.E. Kinsella, *Lipid deterioration initiated by phagocytic cells in muscle foods: beta-carotene destruction of a myeloperoxidase-hydrogen peroxide-halide system*. *Journal of Agricultural and Food Chemistry*, 1983. 31(2): p. 370-376. ISSN 0021-8561.
27. Mohri, S., et al., *Prooxidant Activities in Fish Skin Extracts and Effects of Some Antioxidants and Inhibitors on Their Activities*. *Fisheries Science*, 1999. 65(2): p. 269 - 273. ISSN 0919-9268.
28. Liu, Y.J. and B.S. Pan, *Inhibition of Fish Gill Lipoxygenase and Blood Thinning Effects of Green Tea Extract*. *Journal of Agricultural and Food Chemistry*, 2004. 52(15): p. 4860-4864. ISSN 0021-8561.
29. Stodolnik, L., et al., *Rancidity inhibition study in frozen whole mackerel (Scomber scombrus) following flaxseed (Linum usitatissimum) extract treatment*. *Grasas y Aceites*, 2005. 56(3): p. 198-204. ISSN 1988-4214.
30. Monahan, F.J., *Oxidation of Lipids in Muscle Foods: Fundamental and Applied Concerns*, in *Antioxidants in Muscle Foods: Nutritional Strategies to Improve Quality*, E. Decker, C. Faustman, and C.J. Lopez-Bote, Editors. 2000, John Wiley & Sons, Inc. p. 3-24. ISBN 0-471-31454-4.
31. German, J.B., S.E. Chen, and J.E. Kinsella, *Lipid oxidation in fish tissue. Enzymic initiation via lipoxygenase*. *Journal of Agricultural and Food Chemistry*, 1985. 33(4): p. 680-683. ISSN 0021-8561.
32. Choe, E. and D.B. Min, *Mechanisms and Factors for Edible Oil Oxidation*. *Comprehensive Reviews in Food Science and Food Safety*, 2006. 5(4): p. 169-186. ISSN 1541-4337
33. Kochevar, I.E., R.W. Redmond, and H.S. Lester Packer, *Photosensitized production of singlet oxygen*. *Methods in Enzymology*, 2000. 319: p. 20-28. ISSN 0076-6879.

34. Rawls, H.R. and P.J. Van Santen, *A possible role for singlet oxygen in the initiation of fatty acid autoxidation*. Journal of the American Oil Chemists' Society, 1970. 47(4): p. 121-125. ISSN 0003-021X.
35. Richards, M.P. and R. Li, *Effects of Released Iron, Lipid Peroxides, and Ascorbate in Trout Hemoglobin-Mediated Lipid Oxidation of Washed Cod Muscle*. Journal of Agricultural and Food Chemistry, 2004. 52(13): p. 4323-4329. ISSN 0021-8561.
36. *Liposome* -- *Britannica Online Encyclopedia*. ©2011 Encyclopædia Britannica, Inc. [cited 22. 2. 2011]; Available from: <http://www.britannica.com/EBchecked/media/92244/Phospholipids-can-be-used-to-form-artificial-structures-called-liposomes>.
37. Lasic, D.D., *Novel applications of liposomes*. Trends in Biotechnology, 1998. 16(7): p. 307-321. ISSN 0167-7799.
38. Nacka, F., et al., *Physical and chemical stability of marine lipid-based liposomes under acid conditions*. Colloids and Surfaces B: Biointerfaces, 2001. 20(3): p. 257-266. ISSN 0927-7765.
39. Vercellotti, J.R., A.J. St. Angelo, and A.M. Spanier, *Lipid Oxidation in Foods*, in *Lipid Oxidation in Food*, A.J. St. Angelo, Editor. 1992, American Chemical Society. p. 1-11. ISBN 9780841224612.
40. *Iron deficiency* - *Wikipedia, the free encyclopedia*. [cited 7. 3. 2011]; Available from: [http://en.wikipedia.org/wiki/Iron\\_deficiency\\_\(medicine\)](http://en.wikipedia.org/wiki/Iron_deficiency_(medicine)).
41. Andersson, K., *Influence of reduced oxygen concentrations on lipid oxidation in food during storage*. Doctoral thesis, in *Chalmers University of Technology and the Swedish Institute for Food and Biotechnology*. 1998: Sweden. Chalmers Reproservice.
42. Hu, M., D.J. McClements, and E.A. Decker, *Lipid Oxidation in Corn Oil-in-Water Emulsions Stabilized by Casein, Whey Protein Isolate, and Soy Protein Isolate*. Journal of Agricultural and Food Chemistry, 2003. 51(6): p. 1696-1700. ISSN 0021-8561.
43. Carvajal, A.K., et al., *Kinetic Studies of Lipid Oxidation Induced by Hemoglobin Measured by Consumption of Dissolved Oxygen in a Liposome Model System*. Journal of Agricultural and Food Chemistry, 2009. 57(17): p. 7826-7833. ISSN 0021-8561.
44. Zolse, G., et al., *Steady-state fluorescence and circular dichroism of trout hemoglobins I and IV interacting with tributyltin*. Proteins: Structure, Function, and Bioinformatics, 1999. 34(4): p. 443-452. ISSN 0887-3585.
45. Richards, M.P. and H.O. Hultin, *Effect of pH on Lipid Oxidation Using Trout Hemolysate as a Catalyst: A Possible Role for Deoxyhemoglobin*. Journal of Agricultural and Food Chemistry, 2000. 48(8): p. 3141-3147. ISSN 0021-8561.
46. Hultin, H.O., *Oxidation of lipids in seafood*, in *Seafoods: chemistry, processing, technology and quality*, F. Shahidi and J.R. Botta, Editors. 1994, Blackie Academic and Professional: London. p. 49-74. ISBN 9780751402186.
47. *Hemoglobin.jpg*. 2011. GSCChemistryBP - Element Information: [cited 28. 11. 2011]; Available from: <http://chemistry.wiki.elanco.net/file/view/hemoglobin.jpg/120238735/hemoglobin.jpg>.
48. Kristinova, V., et al., *Antioxidant Activity of Phenolic Acids in Lipid Oxidation Catalyzed by Different Prooxidants*. Journal of Agricultural and Food Chemistry, 2009. 57(21): p. 10377-10385. ISSN 0021-8561.
49. Richards, M.P. and H.O. Hultin, *Contributions of Blood and Blood Components to Lipid Oxidation in Fish Muscle*. Journal of Agricultural and Food Chemistry, 2002. 50(3): p. 555-564. ISSN 0021-8561.
50. Richards, M.P., M.A. Dettmann, and E.W. Grunwald, *Pro-oxidative Characteristics of Trout Hemoglobin and Myoglobin: A Role for Released Heme in Oxidation of Lipids*.

- Journal of Agricultural and Food Chemistry, 2005. 53(26): p. 10231-10238. ISSN 0021-8561.
51. Pazos, M., I. Medina, and H.O. Hultin, *Effect of pH on Hemoglobin-Catalyzed Lipid Oxidation in Cod Muscle Membranes in Vitro and in Situ*. Journal of Agricultural and Food Chemistry, 2005. 53(9): p. 3605-3612. ISSN 0021-8561.
  52. Undeland, I., H.G. Kristinsson, and H.O. Hultin, *Hemoglobin-Mediated Oxidation of Washed Minced Cod Muscle Phospholipids: Effect of pH and Hemoglobin Source*. Journal of Agricultural and Food Chemistry, 2004. 52(14): p. 4444-4451. ISSN 0021-8561.
  53. Venugopal, V. and F. Shahidi, *Structure and composition of fish muscle*. Food Reviews International, 1996. 12(2): p. 175-197. ISSN 1525-6103.
  54. Min, D.B. and J.M. Boff, *Chemistry and Reaction of Singlet Oxygen in Foods*. Comprehensive Reviews in Food Science and Food Safety, 2002. 1(2): p. 58-72. ISSN 1541-4337.
  55. Kanner, J. and S. Harel, *Initiation of membranal lipid peroxidation by activated metmyoglobin and methemoglobin*. Archives of Biochemistry and Biophysics, 1985. 237(2): p. 314-321. ISSN 0003-9861.
  56. Tsuruga, M., et al., *The Molecular Mechanism of Autoxidation for Human Oxyhemoglobin*. Journal of Biological Chemistry, 1998. 273(15): p. 8607-8615. ISSN 0021-9258.
  57. Kristinsson, H.G. and H.O. Hultin, *The Effect of Acid and Alkali Unfolding and Subsequent Refolding on the Pro-oxidative Activity of Trout Hemoglobin*. Journal of Agricultural and Food Chemistry, 2004. 52(17): p. 5482-5490. ISSN 0021-8561.
  58. Hargrove, M.S., A.J. Wilkinson, and J.S. Olson, *Structural Factors Governing Hemin Dissociation from Metmyoglobin*. Biochemistry, 1996. 35(35): p. 11300-11309. ISSN 1520-4995.
  59. Manning, J.M., et al., *Normal and Abnormal Protein Subunit Interactions in Hemoglobins*. Journal of Biological Chemistry, 1998. 273(31): p. 19359-19362. ISSN 0021-9258.
  60. Benesch, R.E. and S. Kwong, *Coupled Reactions in Hemoglobin*. J. Biol. Chem., 1995. 270(23): p. 13785-13786. ISSN 0021-9258.
  61. Binotti, I., et al., *Studies on the functional properties of fish hemoglobins: II. The oxygen equilibrium of the isolated hemoglobin components from trout blood*. Archives of Biochemistry and Biophysics, 1971. 142(1): p. 274-280. ISSN 0003-9861.
  62. Richards, M.P. and M.A. Dettmann, *Comparative Analysis of Different Hemoglobins: Autoxidation, Reaction with Peroxide, and Lipid Oxidation*. Journal of Agricultural and Food Chemistry, 2003. 51(13): p. 3886-3891. ISSN 0021-8561.
  63. Richards, M.P., et al., *Effects of Fish Heme Protein Structure and Lipid Substrate Composition on Hemoglobin-Mediated Lipid Oxidation*. Journal of Agricultural and Food Chemistry, 2007. 55(9): p. 3643-3654. ISSN 0021-8561.
  64. Scott, E.E., Q.H. Gibson, and J.S. Olson, *Mapping the Pathways for O<sub>2</sub> Entry Into and Exit from Myoglobin*. Journal of Biological Chemistry, 2001. 276(7): p. 5177-5188. ISSN 1083-351X.
  65. Chiu, D.T.-Y., et al., *Correlation of membrane lipid peroxidation with oxidation of hemoglobin variants: Possibly related to the rates of heme release*. Free Radical Biology and Medicine, 1996. 21(1): p. 89-95. ISSN 0891-5849.
  66. Tappel, A.L., *UNSATURATED LIPIDE OXIDATION CATALYZED BY HEMATIN COMPOUNDS*. Journal of Biological Chemistry, 1955. 217(2): p. 721-734. ISSN 0021-9258.

67. Bou, R., et al., *Effect of Heating Oxymyoglobin and Metmyoglobin on the Oxidation of Muscle Microsomes*. Journal of Agricultural and Food Chemistry, 2008. 56(20): p. 9612-9620. ISSN 0021-8561.
68. Jacobsen, C., et al., *Lipid Oxidation in Fish Oil Enriched Mayonnaise:  $\alpha$ -Tocopherol, Calcium Disodium Ethylenediaminetetraacetate, but Not Gallic Acid, Strongly Inhibited Oxidative Deterioration*. Journal of Agricultural and Food Chemistry, 2001. 49(2): p. 1009-1019. ISSN 0021-8561.
69. Antonini, E. and M. Brunori, in: *Hemoglobin and Myoglobin in Their Reactions with Ligands*. 1971, Amsterdam: North-Holland Publishing Company. p. 436.
70. King, N.K. and M.E. Winfield, *The Mechanism of Metmyoglobin Oxidation*. Journal of Biological Chemistry, 1963. 238(4): p. 1520-1528. ISSN 0021-9258.
71. Everse, J., *The Structure of Heme Proteins Compounds I and II: Some Misconceptions*. Free Radical Biology and Medicine, 1998. 24(7-8): p. 1338-1346. ISSN 0891-5849.
72. Carlsen, C.U., et al., *Protein Binding in Deactivation of Ferrylmyoglobin by Chlorogenate and Ascorbate*. Journal of Agricultural and Food Chemistry, 2000. 48(2): p. 204-212. ISSN 0021-8561.
73. Mikkelsen, A. and L.H. Skibsted, *Kinetics of enzymatic reduction of metmyoglobin in relation to oxygen activation in meat products*. Zeitschrift für Lebensmitteluntersuchung und -Forschung A, 1992. 194(1): p. 9-16. ISSN 00443026.
74. Kröger-Ohlsen Maiken, V., et al., *Pseudoperoxidase Activity of Myoglobin: Pigment Catalyzed Formation of Radicals in Meat Systems*, in *Free Radicals in Food*. 2002, American Chemical Society. p. 138-150. ISBN 9780841218949.
75. Egawa, T., H. Shimada, and Y. Ishimura, *Formation of Compound I in the Reaction of Native Myoglobins with Hydrogen Peroxide*. Journal of Biological Chemistry, 2000. 275(45): p. 34858-34866. ISSN 0021-9258.
76. Modi, S., et al., *Coordination geometry of haem in cyanogen bromide modified myoglobin and its effect on the formation of compound I*. Journal of the Chemical Society, Chemical Communications, 1991(12): p. 830-831. ISSN 0022-4936.
77. Matsui, T., S.-i. Ozaki, and Y. Watanabe, *Formation and Catalytic Roles of Compound I in the Hydrogen Peroxide-Dependent Oxidations by His64 Myoglobin Mutants*. Journal of the American Chemical Society, 1999. 121(43): p. 9952-9957. ISSN 0002-7863.
78. Yusa, K. and S. Keiji, *Oxidation of oxymyoglobin to metmyoglobin with hydrogen peroxide: involvement of ferryl intermediate*. Biochemistry, 1987. 26(21): p. 6684-6688. ISSN 1520-4995.
79. Kevin D, W., *The interaction of oxymyoglobin with hydrogen peroxide: The formation of ferrylmyoglobin at moderate excesses of hydrogen peroxide*. Archives of Biochemistry and Biophysics, 1987. 253(2): p. 419-430. ISSN 0003-9861.
80. Reeder, B.J., et al., *Characteristics and Mechanism of Formation of Peroxide-Induced Heme to Protein Cross-Linking in Myoglobin*. Biochemistry, 2001. 41(1): p. 367-375. ISSN 1520-4995.
81. Halliwell, B., *Antioxidant characterization. Methodology and Mechanism*. Biochemical Pharmacology, 1995. 44(10): p. 1341-1348. ISSN 0006-2952.
82. Belitz, H.-D., W. Grosch, and P. Schieberle, *Food Chemistry*. translation from the second German edition by D. Hadziyev ed. 1987, Heidelberg: Springer Verlag Berlin. p. 774. ISBN 3-540-15043-9.
83. Dirinck, P., et al., *Studies on Vitamin E and Meat Quality. 1. Effect of Feeding High Vitamin E Levels on Time-Related Pork Quality*. Journal of Agricultural and Food Chemistry, 1996. 44(1): p. 65-68. ISSN 0021-8561.

84. Lin, C.F., et al., *Effects of Dietary Oils and  $\alpha$ -Tocopherol Supplementation on Lipid Composition and Stability of Broiler Meat*. Journal of Food Science, 1989. 54(6): p. 1457-1460. ISSN 0022-1147.
85. Engeseth, N.J., et al., *Improved oxidative stability of veal lipids and cholesterol through dietary vitamin E supplementation*. Meat Science, 1993. 35(1): p. 1-15. ISSN 0309-1740.
86. Lee, K., M. Jung, and S. Kim, *Quenching mechanism and kinetics of ascorbyl palmitate for the reduction of the photosensitized oxidation of oils*. Journal of the American Oil Chemists' Society, 1997. 74(9): p. 1053-1057. ISSN 0003-021X.
87. *Ascorbyl palmitate - Wikipedia, the free encyclopedia*. Last Update Date 10. 4. 2011 [cited 21. 4. 2011]; Available from: [http://en.wikipedia.org/wiki/Ascorbyl\\_palmitate](http://en.wikipedia.org/wiki/Ascorbyl_palmitate).
88. Lee, S.H. and D.B. Min, *Effects, quenching mechanisms, and kinetics of carotenoids in chlorophyll-sensitized photooxidation of soybean oil*. Journal of Agricultural and Food Chemistry, 1990. 38(8): p. 1630-1634. ISSN 0021-8561.
89. Hirayama, O., et al., *Singlet oxygen quenching ability of naturally occurring carotenoids*. Lipids, 1994. 29(2): p. 149-150. ISSN 0024-4201.
90. Jørgensen, K. and L.H. Skibsted, *Carotenoid scavenging of radicals*. Zeitschrift für Lebensmitteluntersuchung und -Forschung A, 1993. 196(5): p. 423-429. ISSN 00443026.
91. Goto, S., et al., *Efficient radical trapping at the surface and inside the phospholipid membrane is responsible for highly potent antiperoxidative activity of the carotenoid astaxanthin*. Biochimica et Biophysica Acta (BBA) - Biomembranes, 2001. 1512(2): p. 251-258. ISSN 0005-2736.
92. Cardounel, A.J., et al., *Direct superoxide anion scavenging by a disodium disuccinate astaxanthin derivative: relative efficacy of individual stereoisomers versus the statistical mixture of stereoisomers by electron paramagnetic resonance imaging*. Biochemical and Biophysical Research Communications, 2003. 307(3): p. 704-712. ISSN 0006-291X.
93. Dimitrios, B., *Sources of natural phenolic antioxidants*. Trends in Food Science & Technology, 2006. 17(9): p. 505-512. ISSN 0924-2244.
94. Pazos, M., et al., *Inhibition of Hemoglobin- and Iron-Promoted Oxidation in Fish Microsomes by Natural Phenolics*. Journal of Agricultural and Food Chemistry, 2006. 54(12): p. 4417-4423. ISSN 0021-8561.
95. Iglesias, J., et al., *Caffeic Acid as Antioxidant in Fish Muscle: Mechanism of Synergism with Endogenous Ascorbic Acid and  $\alpha$ -Tocopherol*. Journal of Agricultural and Food Chemistry, 2008. 57(2): p. 675-681. ISSN 0021-8561.
96. Pino, E., et al., *Free radical scavenging capacity of hydroxycinnamic acids and related compounds*. Journal of Physical Organic Chemistry, 2006. 19(11): p. 759-764. ISSN 0894-3230.
97. Cheng, J.-C., et al., *Antioxidant activity of hydroxycinnamic acid derivatives in human low density lipoprotein: Mechanism and structure-activity relationship*. Food Chemistry, 2007. 104(1): p. 132-139. ISSN 0308-8146.
98. Medina, I., et al., *Effect of Molecular Structure of Phenolic Families as Hydroxycinnamic Acids and Catechins on Their Antioxidant Effectiveness in Minced Fish Muscle*. Journal of Agricultural and Food Chemistry, 2007. 55(10): p. 3889-3895. ISSN 0021-8561.
99. Kamal-Eldin, A. and L.-Å. Appelqvist, *The chemistry and antioxidant properties of tocopherols and tocotrienols*. Lipids, 1996. 31(7): p. 671-701. ISSN 0024-4201.

100. Frankel, E.N., et al., *Interfacial Phenomena in the Evaluation of Antioxidants: Bulk Oils vs Emulsions*. Journal of Agricultural and Food Chemistry, 1994. 42(5): p. 1054-1059. ISSN 0021-8561.
101. Bligh, E.G. and W.J. Dyer, *A rapid method of total lipid extraction and purification*. Canadian J. of Biochemistry and Physiology, 1959. 37(8): p. 911-917. ISSN 0576-5544.
102. Dauksas, E., et al., *Composition of fatty acids and lipid classes in bulk products generated during enzymic hydrolysis of cod (Gadus morhua) by-products*. Process Biochemistry, 2005. 40(8): p. 2659-2670. ISSN 1359-5113.
103. *Method Ce 2-66*. AOCS: Official Methods and Recommended Practices of the American Oil Chemists' Society. 4th Edn. AOCS Press, Champaign, IL (USA), 1989.
104. *Anhydrous Fat, Determination of Peroxide Value*. International Dairy Federation. IDF Standard 74A. IDF: Brussels, Belgium, 1991.
105. Ueda, S., T. Hayashi, and M. Namiki, *Effect of Ascorbic Acid on Lipid Autoxidation in a Model Food System*. Agricultural and Biological Chemistry, 1986. 50(1): p. 1-7. ISSN 0002-1369.
106. Undeland, I., M. Stading, and H. Lingnert, *Influence of skinning on lipid oxidation in different horizontal layers of herring (Clupea harengus) during frozen storage*. Journal of the Science of Food and Agriculture, 1998. 78(3): p. 441-450. ISSN 0022-5142.
107. Ke, P.J. and A.D. Woyewoda, *Microdetermination of thiobarbituric acid values in marine lipids by a direct spectrophotometric method with a monophasic reaction system*. Analytica Chimica Acta, 1979. 106(2): p. 279-284. ISSN 0003-2670.
108. *Official Method Cd 18-90. p-Anisidine Value*. American Oil Chemists' Society. AOCS Press, 1993.
109. Tolasa, S., S. Cakli, and U. Ostermeyer, *Determination of astaxanthin and canthaxanthin in salmonid*. European Food Research and Technology, 2005. 221(6): p. 787-791. ISSN 1438-2385.
110. Sachindra, N.M., N. Bhaskar, and N.S. Mahendrakar, *Carotenoids in different body components of Indian shrimps*. Journal of the Science of Food and Agriculture, 2005. 85(1): p. 167-172. ISSN 0022-5142.
111. Maestre, R., et al., *Capacity of Reductants and Chelators To Prevent Lipid Oxidation Catalyzed by Fish Hemoglobin*. Journal of Agricultural and Food Chemistry, 2009. 57(19): p. 9190-9196. ISSN 0021-8561.
112. Mozuraityte, R., T. Rustad, and I. Storrø, *The Role of Iron in Peroxidation of Polyunsaturated Fatty Acids in Liposomes*. Journal of Agricultural and Food Chemistry, 2007. 56(2): p. 537-543. ISSN 0021-8561.
113. Falch, E., T. Rustad, and M. Aursand, *By-products from gadiform species as raw material for production of marine lipids as ingredients in food or feed*. Process Biochemistry, 2006. 41(3): p. 666-674. ISSN 1359-5113.
114. Rincón-Cervera, M.Á., M.D. Suárez-Medina, and J.L. Guil-Guerrero, *Fatty acid composition of selected roes from some marine species*. European Journal of Lipid Science and Technology, 2009. 111(9): p. 920-925. ISSN 1438-9312.
115. Mozuraityte, R., T. Rustad, and I. Storrø, *Pro-oxidant activity of Fe<sup>2+</sup> in oxidation of cod phospholipids in liposomes*. European Journal of Lipid Science and Technology, 2006. 108(3): p. 218-226. ISSN 1438-9312.
116. Lúcio, M., et al., *Use of liposomes to evaluate the role of membrane interactions on antioxidant activity*. Analytica Chimica Acta, 2007. 597(1): p. 163-170. ISSN 0003-2670.

117. *Certificate Of Analysis*. [cited 26. 11. 2011]; Available from: <http://www.sigmaaldrich.com/catalog/CertOfAnalysisPage.do?symbol=H2625&LotNo=067K7001&brandTest=SIGMA>.
118. Shahidi, F. and C. Hong, *Role of metal ions and heme pigments in autoxidation of heat-processed meat products*. *Food Chemistry*, 1991. 42(3): p. 339-346. ISSN 0308-8146.
119. Love, J.D. and A.M. Pearson, *Metmyoglobin and nonheme iron as prooxidants in cooked meat*. *Journal of Agricultural and Food Chemistry*, 1974. 22(6): p. 1032-1034. ISSN 0021-8561.
120. Igene, J.O., et al., *Influence of heme pigments, nitrite, and nonheme iron on development of warmed-over flavor (WOF) in cooked meat*. *Journal of Agricultural and Food Chemistry*, 1979. 27(4): p. 838-842. ISSN 0021-8561.
121. Kristensen, L. and H.J. Andersen, *Effect of Heat Denaturation on the Pro-oxidative Activity of Metmyoglobin in Linoleic Acid Emulsions*. *Journal of Agricultural and Food Chemistry*, 1997. 45(1): p. 7-13. ISSN 0021-8561.
122. Berisha, A., Y. Endo, and K. Fujimoto, *The Effect of Heating Temperature on the Prooxidant and Hydroperoxide Decomposition Activity of Myoglobin*. *Food Science and Technology Research*, 2000. 6(4): p. 257-262. ISSN 1881-3984.
123. Pazos, M., M.L. Andersen, and L.H. Skibsted, *Efficiency of Hemoglobin from Rainbow Trout, Cod, and Herring in Promotion of Hydroperoxide-Derived Free Radicals*. *Journal of Agricultural and Food Chemistry*, 2009. 57(18): p. 8661-8667. ISSN 0021-8561.
124. Di Mascio, P., M.E. Murphy, and H. Sies, *Antioxidant defense systems: the role of carotenoids, tocopherols, and thiols*. *The American Journal of Clinical Nutrition*, 1991. 53(1): p. 194S-200S. ISSN 0002-9165.
125. Medina, I., et al., *Activity of caffeic acid in different fish lipid matrices: A review*. *Food Chemistry*, 2012. 131(3): p. 730-740. ISSN 0308-8146.
126. Rawel, H.M., K. Meidtner, and J. Kroll, *Binding of Selected Phenolic Compounds to Proteins*. *Journal of Agricultural and Food Chemistry*, 2005. 53(10): p. 4228-4235. ISSN 0021-8561.
127. Carlsen, C.U., et al., *Protein Binding in Deactivation of Ferrylmyoglobin by Chlorogenate and Ascorbate*. *Journal of Agricultural and Food Chemistry*, 2000. 48(2): p. 204-212. ISSN 0021-8561.
128. Yin, M.-C. and W.-S. Cheng, *Oxymyoglobin and Lipid Oxidation in Phosphatidylcholine Liposomes Retarded by  $\alpha$ -tocopherol and  $\beta$ -carotene*. *Journal of Food Science*, 1997. 62(6): p. 1095-1097. ISSN 1750-3841.
129. Yoshida, Y., K. Kashiba, and E. Niki, *Free radical-mediated oxidation of lipids induced by hemoglobin in aqueous dispersions*. *Biochimica et Biophysica Acta (BBA) - General Subjects*, 1994. 1201(2): p. 165-172. ISSN 0304-4165.
130. Hamilton, R., et al., *Effects of tocopherols, ascorbyl palmitate, and lecithin on autoxidation of fish oil*. *Journal of the American Oil Chemists' Society*, 1998. 75(7): p. 813-822. ISSN 0003-021X.
131. Let, M.B., C. Jacobsen, and A.S. Meyer, *Ascorbyl Palmitate,  $\gamma$ -Tocopherol, and EDTA Affect Lipid Oxidation in Fish Oil Enriched Salad Dressing Differently*. *Journal of Agricultural and Food Chemistry*, 2007. 55(6): p. 2369-2375. ISSN 0021-8561.
132. King, J.M., *Riboflavin photosensitized singlet oxygen oxidation of vitamin D*. [PhD dissertation]. 1996, The Ohio State University: Ohio. p. 65-105.
133. Whang, K. and I.C. Peng, *Electron Paramagnetic Resonance Studies of the Effectiveness of Myoglobin and Its Derivatives as Photosensitizers in Singlet Oxygen Generation*. *Journal of Food Science*, 1988. 53(6): p. 1863-1865. ISSN 1750-3841.



134. George, P. and D.H. Irvine, *The reaction between metmyoglobin and hydrogen peroxide*. *Biochem. J.*, 1952. 52: p. 511-517. ISSN 0264-6021.
135. King, N.K. and M.E. Winfield, *The Mechanism of Metmyoglobin Oxidation*. *The Journal of Biological Chemistry*, 1962. 238(4): p. 1520-1528. ISSN 0021-9258.
136. Olsen, S.H. and E.O. Elvevoll, *pH-Induced Shift in Hemoglobin Spectra: A Spectrophotometric Comparison of Atlantic Cod (*Gadus morhua*) and Mammalian Hemoglobin*. *Journal of Agricultural and Food Chemistry*. 59(4): p. 1415-1422. ISSN 0021-8561.

## 7 LIST OF ABBREVIATIONS

A•	antioxidant radical
ABTS	2-azino-bis(3-ethylbenzthiazoline-6-sulfonate)
AOX	antioxidant
AAPH	2,2'-azobis-2-methyl-propanimidamide, dihydrochloride
AsA	ascorbic acid
AV	<i>p</i> -anisidine value
Å	angstrom
BDE	bond dissociation enthalpy
CaA	caffeic acid
CVD	cardiovascular disease
DAG	diacylglycerol
DHA	docosahexaenoic acid
EDTA	ethylenediamine tetraacetic acid
EPA	eicosapentaenoic acid
FAME	fatty acid methyl ester
FID	flame ionization detector
FRS	free radical scavenger
GC	gas chromatography
GRAS	Generally Recognized as Safe
HAT	hydrogen-atom transfer
Hb	hemoglobin
HO•	hydroxy radical
HOO•	hydroperoxy radical
IDF	International Dairy Federation
L•	lipid alkyl radical
LC-PUFA	long-chain polyunsaturated fatty acid
LDL	low-density-lipoprotein
LMW	low molecular weight
LO•	lipid alkoxy radical
LOO•	lipid peroxy radical
LOOH	lipid hydroperoxide
MAG	monoacylglycerol
Mb	myoglobin
meq	milliequivalents
MES	2-morpholinoethanesulfonic acid
O <sub>2</sub> • <sup>-</sup>	superoxide anion radical
OPPh <sub>3</sub>	triphenylphosphine oxide
OUR	oxygen uptake rate
PC	phosphatidylcholine
pI	isoelectric point
PL	phospholipids
PPh <sub>3</sub>	triphenylphosphine
PV	peroxide value

ROS	reactive oxygen species
SET	single-electron transfer
SM	sphingomyelin
TAG	triacylglycerol
TBARS	thiobarbituric acid reactive substances
TEP	1,1,3,3-tetraethoxypropane
TLC	thin layer chromatography
TO•	tocopheroxy radical
TOH	tocopherol
TOTOX	total oxidation value
TPP	triphenylphosphine