

**UNIVERSITY OF SOUTH BOHEMIA**

FACULTY OF SCIENCE

**Molecular and biochemical characterization of serine  
protease SmSP1 in *Schistosoma mansoni***



**Bc. David Opavský**

Master Thesis

Supervisor: RNDr. Jan Dvořák Ph.D. – Institute of Molecular Genetics, Prague

**České Budějovice**

**2013**

Opavský, D., 2013: Molecular and biochemical characterization of serine protease SmSP1 in *Schistosoma mansoni*. Mgr.Thesis, in English - 59 p., Faculty of Science, University of South Bohemia, České Budějovice, Czech Republic.

Anntation: SmSP1 is a chimerical serine protease consisted of three domains (cub, LDLa and trypsin-like) and found in *Schistosoma mansoni*. Its characterization was performed by molecular techniques such as PCR screen, qRT-PCR and RNA interference (RNAi) to gain information about expression profile, level expression and susceptibility to RNAi. Further, protein expression was carried out to gain an antigen for immunization and recombinant for biochemical studies. Results of PCR screen and qRT-PCR suggested possible function of SmSP1 in egg and adult stages but SmSP1 gene was not found susceptible to RNAi in NTS. Recombinant from *E. coli* was successfully used for immunization. Active recombinant was likely expressed in *Pichia pastoris* but expression conditions are unstable and expression optimization is necessary.

I hereby declare that this thesis is based on my own work and all other sources of information have been acknowledged.

I hereby declare that, in accordance with Article 47b of Act No. 111/1998 in the valid wording, I agree with the publication of my master thesis, in full to be kept in the Faculty of Science archive, in electronic form in publicly accessible part of the STAG database operated by the University of South Bohemia in České Budějovice accessible through its web pages.

Further, I agree to the electronic publication of the comments of my supervisor and thesis opponents and the record of the proceedings and results of the thesis defence in accordance with aforementioned Act No. 111/1998. I also agree to the comparison of the text of my thesis with the Theses.cz thesis database operated by the National Registry of University Theses and a plagiarism detection system.

Date .....

Signature .....

## Acknowledgements

I'd like to thank Jan Dvořák for giving me opportunity to work in his lab, for everything he learnt me and finally for his help during writing up. I'd like to thank also Dan Sojka for his help with everything I needed and Zdenek Franta for his help with qRT-PCR. Next thank belongs to Conor Caffrey and Brain Suzuki for their help during my stay at UCSF.

## **1. Introduction**

1.1 Schistosomiasis.....	1
1.2 Life cycle.....	2
1.3 Genetics of <i>Schistosoma mansoni</i> .....	8
1.4 Host-parasite interaction.....	9
1.4.1 Gut and tegument.....	9
1.4.2 Necessity of immune response for <i>Schistosoma mansoni</i> development.....	10
1.5 Immune response and pathological consequences.....	11
1.6 Current treatment.....	12
1.7 Proteases.....	13
1.7.1. Classification of proteases.....	13
1.7.2 Proteases of <i>Schistosoma mansoni</i> .....	13
1.7.3 Serine proteases.....	15
1.7.4 Serine proteases of <i>Schistosoma mansoni</i> .....	16
1.7.5 Studied serine proteases.....	16

## **2.Methods.....21**

Abbreviations.....	21
Solutionsolutions.....	22
Life stage maintenance.....	22
<b>2.1 Transcriptomic study.....</b>	<b>22</b>
2.1.1 PCR screen.....	22
2.1.2 Quantitative RT-PCR.....	24
2.1.3 RNA interference.....	24
2.1.3.1 RNAi using dsRNA (double-stranded RNA).....	25
2.1.3.2 siRNA (short interfering RNA) interference.....	26
2.1.3.3 Quantitative RT-PCR of RNAi NTS.....	27
<b>2.2 Proteomic study.....</b>	<b>28</b>
2.2.1 Expression in <i>Escherichia coli</i> BL 21.....	28
2.2.1.1 Amplification, cloning and transformation.....	28

2.2.1.2 SmSP1 trypsin expression.....	28
2.2.1.3 Purification by FPLC (Fast protein liquid chromatography).....	28
2.2.1.4 Protein refolding.....	29
2.2.1.5 Protein activation.....	29
2.2.2 Expression in <i>Pichia pastoris</i> .....	30
2.2.3 Expression in SHuffle® BL 21 Express Competent <i>Escherichia coli</i> .....	31
2.2.4 Autoinduction of Protein Expression in the T7 System.....	31
<b><u>3. Results.....</u></b>	<b><u>32</u></b>
<b>3.1 Bioinformatic study .....</b>	<b>32</b>
<b>3.2 Transcriptomic study.....</b>	<b>36</b>
3.2.1. PCR screen.....	36
3.2.2. Quantitative RT-PCR.....	37
3.2.3. RNA interference (RNAi).....	38
<b>3.3 Proteomic study.....</b>	<b>40</b>
3.3.1 Expression in pET system.....	40
3.3.2 Expression in <i>Pichia pastoris</i> .....	42
3.3.3 Expression in SHuffle <i>Escherichia coli</i> and autoinduction media.....	44
<b><u>4. Discussion.....</u></b>	<b><u>44</u></b>
<b><u>5. Conclusion.....</u></b>	<b><u>50</u></b>
<b><u>6. Literature.....</u></b>	<b><u>51</u></b>

## **Introduction**

### 1.1. Schistosomiasis

Schistosomiasis (bilharziasis) is a tropical disease caused by helminths of the genus *Schistosoma* (family Schistosomatidae, order Digenea, class Trematoda, phylum Platyhelminths and kingdom Animalia) (Webster, 2006). This disease affects at least 240 million people worldwide, and more than 700 million people are in risk in the endemic areas (Gryseels et al., 2006). The number of identified *Schistosoma* species is now 17 and are grouped according to their morphology of egg, intermediate host specificity, occurrence and genetics (McCutchan et al., 1983; Bowles et al., 1995; Lockyer et al., 2000). There are three species which cause majority of infection disease, *Schistosoma mansoni*, *Schistosoma haematobium* and *Schistosoma japonicum*. Immunopathological reactions against schistosome eggs trapped in the tissues lead to inflammatory and obstructive disease in the urinary system (*S. haematobium*) or intestinal lesions, hepatosplenic inflammation, and liver fibrosis (*S. mansoni*, *S. japonicum*) (Webster et al., 2006). *Schistosoma mansoni* was documented in Africa, the Middle East, Caribbean, Brazil, Venezuela; *Schistosoma haematobium* in Africa and the Middle East; and *S. japonicum* in China, Indonesia, the Philippines (WHO, 2013). This thesis is focused on a group of serine proteases in *S. mansoni* therefore introduction is for that reason mostly about *S. mansoni*.

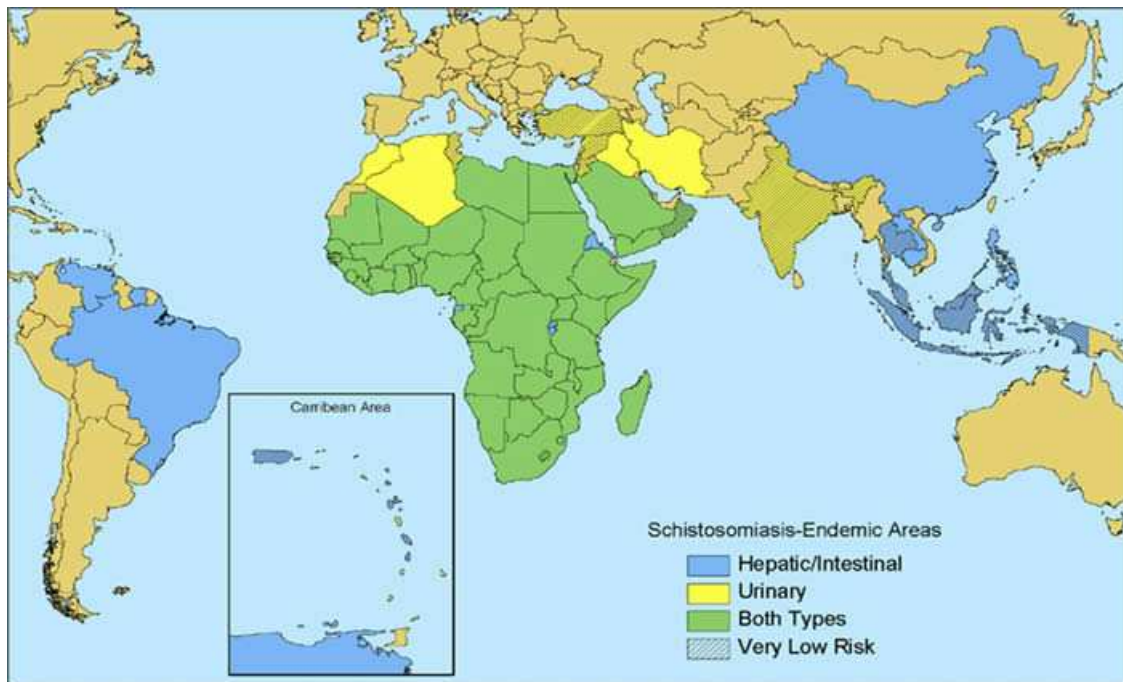

**Figure 1. Map showing the occurrence of schistosomiasis in the world**  
 (<http://www.nathnac.org>)

## 1.2 Life cycle

*S. mansoni* has a complex life cycle requiring passage through an intermediate host, a fresh-water snail *Biomphalaria* spp., and through a definitive host. *Schistosoma* eggs must move through tissues of the intestine to escape from the host. Escape mechanism from host tissues is facilitated by secretion of immuno-reactive molecules by eggs and the formation of host intense strong granulomatous response by the host which acts to exclude the egg into gut (Jones et al., 2008). The eggs are then excreted from definitive hosts with the feces.

Miracidia (invasive larvae) hatch from egg after contact with water to infect snail host. Process is initiated by osmotic change in water, light and decrease of temperature (Mahmoud et al., 2001). Macromolecular glycoconjugates with fatty acids on the snail surface are cues for miracidial host-finding which are involved in both the induction and fixation processes of the larva (Kalbe et al., 1996). The miracidium after penetration of the snail develops into the mother sporocyst (Schutte, 1974).

Mother sporocysts asexually produce daughter sporocysts which migrate to hepatopancreas of snails where they produce invasive larvae, cercariae. The entire development process of cercariae within the mother sporocyst usually takes up to a week (Boyle et al., 2005). The cercariae leave the snail host under light stimulus (Asch, 1972). The cercariae react specifically to chemical compounds on the surface of host skin (free fatty acids, free L-arginin and small peptides with terminally located L-arginin) by increasing the frequency of shifts in swimming direction (Haeberlein and Haas, 2008). Entry into host skin has three distinct phases: (1) attachment, (2) crawling over surface exploring for an entry site; and (3) penetration into the epidermis (Haas and Schmidt, 1982). They transform to schistosomula after a penetration the host skin.

The transformation includes shedding tails, loss of cercaria surface glycocalyx and development of double layer outer tegumental membrane (Samuelson et al., 1985; Skelly et al.,

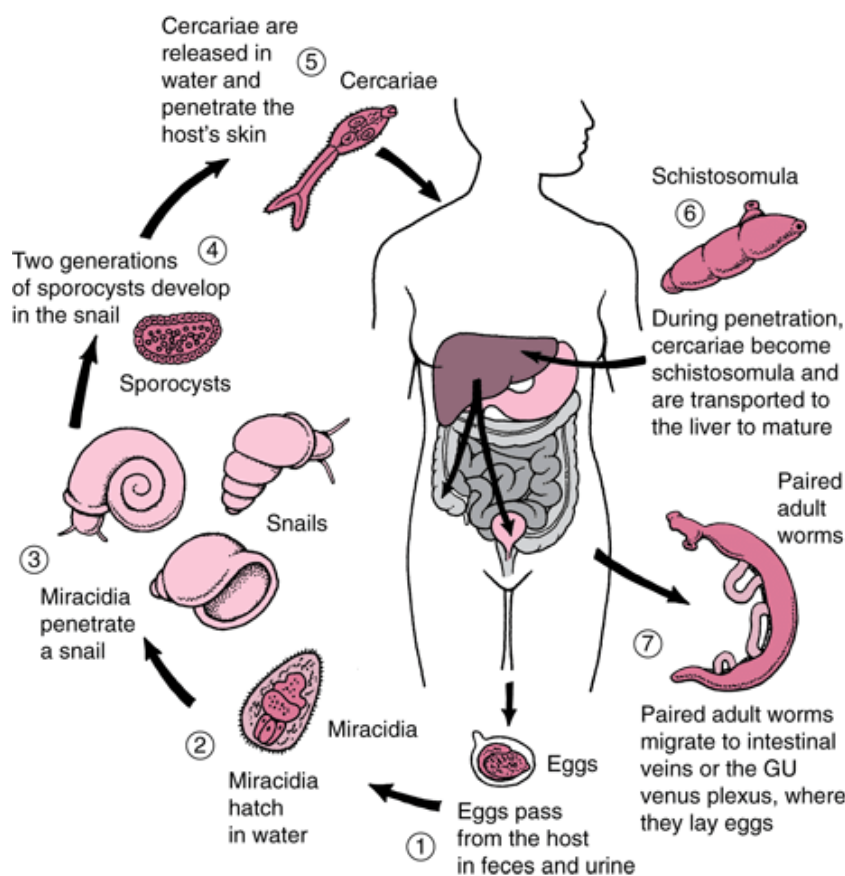

1996; Dorsey et al., 2002). The schistosomula are then carried by the flow of blood to the lungs, via the pulmonary artery. To develop further, the schistosomula must migrate the blood vessels via the left side of the heart to the hepatic portal vein (Haas et al., 1982) where they start to reproduce 28 and 35 days post-infection. Adult schistosome

worms reside in the

**Figure 2.**Life cycle of *S. mansoni* (<http://www.malevolentdesign.org/schistosomiasis/>)



portal and mesenteric veins as male/female pairs, and survive for many years producing hundreds of fertilized eggs per day. They lay eggs in the mesenteric or rectal veins while male carrying a female in its gynaecophoric canal (Sulaiman et al., 1982).

### Egg

*S. mansoni* adult females produce about 200-300 eggs per day (Loker et al., 1983). The process of egg maturation takes about seven days from laying to extraction and only matured eggs are extracted. The maturation takes place only defined medium plus serum which proves that host's signals are necessary for maturation (Michaels and Prata, 1968). The size of *S. mansoni* eggs is 114 to 180  $\mu\text{m}$  long by 45-70  $\mu\text{m}$  wide. The egg shell consists of three layers, an outer microspinus, middle intermediately dense and inner dense layer. Three layers are located between the shell and miracidium, Lechman's lacuna containing lipid bodies surrounds miracidium, intermediate von Lichtenberg's thin epithelium and outer acellular Reynold's layer (Neill et al., 1988). The Lichtenberg's layer contains multiple nuclei, rough endoplasmatic reticulum, lysosomes, mitochondria and  $\alpha$ -glycogen rosettes. The Reynold's layer contains matrix forming interlocking filaments under the shell pores (Jones et al., 2008).



These pores secrete various proteins and glycans (Cass et al., 2007; Jang Lee et al, 2007). Extracted eggs contain matured miracidium (Methieson et al, 2010; <http://rgmg.cebio.org/>).

**Figure 3. Image of egg, containing miracidium, with prominent lateral spine next to the posterior end (SRG ,[www.path.cam.ac.uk](http://www.path.cam.ac.uk))**

### Miracidium stage

Miracidium starts hatching from the egg after the contact with the water. When miracidium is hatched, it starts immediately locating snail host by chemotaxis, negative geotropy and phototaxis. The size of *S. mansoni* miracidium is 150 to 180  $\mu\text{m}$  long by 70 - 80  $\mu\text{m}$  wide (Ghaffar et al., 2010; <http://www.path.cam.ac.uk/~schisto/index.html>, SRG Cambridge). The numerous cilia on the surface together with well-developed musculature under the cilia enable

miracidium to move towards the intermediate-host snail (Bahia et al., 2006). Endogenous glycogen reserves are utilized as an energy source for aerobic energy metabolism in

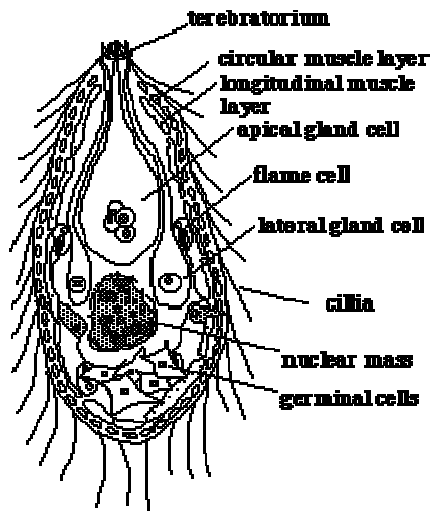

By Dr T. Stewart

miracidium (Tielens et al., 1992). Flame cells for extraction are located on both posterior and anterior (Sato et al., 2002). The nervous system consists of centrally located neural mass which innervates peripheral sensory papillae and muscular fibres (Rollinson et al., 1985). The anterior possesses a group of gland cells and a number of membrane folds, altogether called terebratorium, carrying sensory organs at the anterior extremity (Eklun-Natey et al., 1985).

**Figure 4. Miracidium picture (ALCOM,**

<http://www.fao.org/docrep/005/AD002E/AD002E00.htm#TOC>)

Mother sporocyst stage

The development of mother sporocyst starts short time after the miracidium penetration into the fibromuscular tissue of the host's cephalopodal region, near the penetration point (Jourdan et al., 1982). The development includes following morphological changes. Epidermal ciliated cells are lost and replaced by new tegument with increasing number of vesicles which prevent amoebocytes to attach to parasite tegument. Extensive microvilli are formed on the surface. Neural mass and excretory system slowly degenerates and the whole sporocyst is gradually shaped like long sac and bounds closely to snail tissues (Schutte, 1975; Pan, 1996).

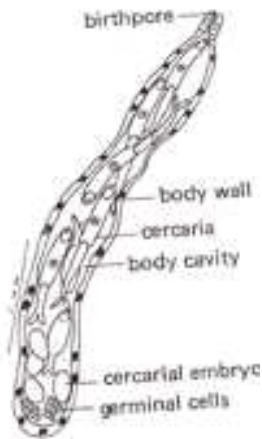

**Figure 5. Sporocyst inside a snail (Bayne et al., 2009)**

### Daughter sporocyst

Daughter sporocysts are developed from germinal cells of mother sporocyst and are enveloped by the tegumental structure of mother sporocyst. This tegumental structure rapidly degenerates and is replaced by somatic cells which create future outer layer of daughter sporocyst. Then the outer layer forms a surface coat, spines and basement membrane (Meuleman et al., 1980). After 2-3 weeks of miracidium penetration, such young daughter sporocyst is developed and migrates to a digestive gland. In the gland cells, daughter sporocyst

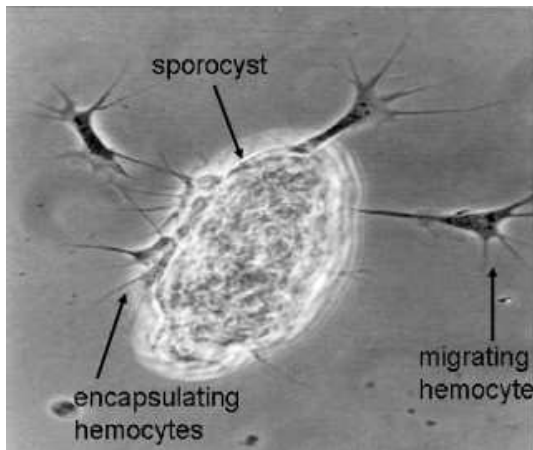

increase in size and cercariogenesis is started.

Daughter sporocyst has typical syncytial trematode tegument and is densely covered by microvilli.

Subtegument, surrounding the cavity with cerariae and organs, contains cellular elements like tegumentary, parenchymatous, muscular and excretory cells. Anterior part has nerve cells with acetylcholinesterase activity (Pan et al., 1985).

**Figure 6. Daughter sporocyst (Bayne et al, 2009)**

### Cercaria

When the daughter sporocyst, carrying the cercarial germinal cells, reaches snail's digestive gland-hepatopancreas, the cercariogenesis starts and takes up to a week prior cercariae shedding (Nuttman, 1971). Germinal cells rapidly form morula stage which develops into a germ balls. Germ balls are unequally divided into two parts, body and tail of the cercariae. Body contains five pairs of glands, two pairs of pre-acetabular penetration glands and three pairs of post-acetabular adhesive glands. The tail facilitates movement in the water. Both divided parts are covered by tegument developed from primeval epithelium. Several thousands of cercariae are released from host snail per day (He e al., 1985). The body of cercaria is covered by tegument which is protected by glycocalyx containig of 18% of amino acid and 82% of carbohydrate. Glycocalyx protects cercaria against osmotic shock in water. Basal lamina and circular muscle fibres are located beneath the tegument. Metabolism of cercariae is

aerobic and is supplied by glycogen reserves which provide energy for two days (McKerrow and Salter, 2002; <http://rgmg.cebio.org/>).

#### Diagram of *Schistosoma mansoni* cercaria

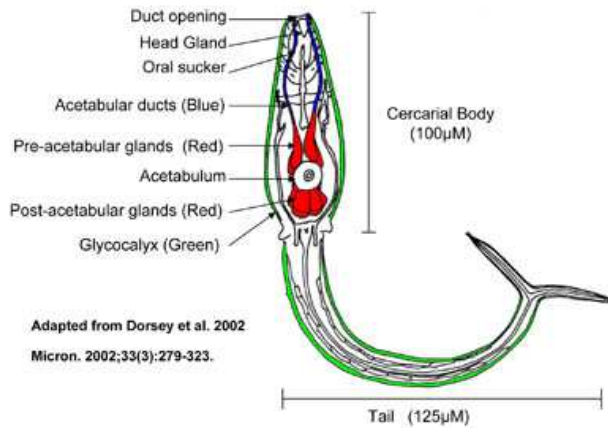

**Figure 7. Description of *S. mansoni* cercaria**

#### Schistosomula

Schistosomula stage starts after the cercariae penetration into the definitive host. First step is loss of tail and shedding of cercarial tegument with glycocalyx. Adult tegument is made by fusion of membrane vesicles of subtegument cells and outer membrane cells until 3 hours after



penetration (McLaren et al., 1980). Another change is swift from aerobic to anaerobic metabolism and blood feeding (El-Ansary, 2003). Further step is migration to liver veins via heart and lung. The development and maturation takes place in the liver (Wilson et al., 1986).

**Figure 8. SEM (Scanning electron microscopy) of schistosomula ([www.path.cam.ac.uk/](http://www.path.cam.ac.uk/))**

## Adults

Five weeks after cercarie penetration, worms complete their maturation. Female and male mate, mature to form reproductive pair and migrate to mesenteric vein. Both male and female have two suckers, oral and ventral, which helps to maintain their position in mesenteric vein. The oral sucker is surrounded by sensory papillae assisting by blood feeding. Female lives on



male's ridged gynaecophoric canal covered by small spines. The female is slender, cylindrical and longer than the male is (Hockley et al., 1973). Male is approximately 5-11mm long and 1mm wide, female is approximately 16mm long and 0.2 mm wide. Both male and female are covered by syncytial tegument covered by two lipid bilayers (Skelly et al., 1996). Female produce about 300 eggs every day. Such high production is connected with ingest of high number of red cells, 330 000 per hour. Male ingests only about 39 000 red cells per hour (Loker, 1983).

**Figure 9.** Male and female, female lives in the gynaecophoric canal of male (Stanford.edu)

### 1.3. Genetics of *Schistosoma mansoni*

*S. mansoni* is a diploid organism containing seven pairs of autosomes and one pair of heteromorphic chromosome. Female is heterogametic (ZW) and male is homogametic (ZZ) (Criscione et al., 2009). The GC content is 34.7% (Young et al., 2012). The sequencing project of 363 megabases (Mb) *S. mansoni* genome identified 11,807 potential genes (Berriman et al, 2009). This number of genes was reduced to 10,852 genes by further Sanger and Illumina sequencing (Protasio et al., 2012). The average size of genes is 4.7 kb with introns (the average is 1692bp) and exon (the average is 217bp). Unusual intron distribution in multi-exon genes was with very small (26bp) introns located near 5' end while when more far introns are from 5' end the larger they are, resulting in very large introns (33.8 kb) near 3' end. Such introns

distribution was not found in any other eukaryotes and its function is not clear. Variation of proteins is increased by alternative splicing and also by alternative splicing of unusual micro-exon structures found in 45 genes (Berriman et al., 2009). Pre-matured RNA of 11% genes is edited by RNA *trans*-splicing mechanism (Potasio et al., 2012). Approximately 40 % of genome consists of repetitive sequences and 60% represents single copy or small gene families. Mobile genetic elements made up 20% of genome, 15% LTR transposons (Gypsy/Ty3 and Blade clades) and 5% non-LTR transposons (RTE, CR1 and R2 clades) (Berriman et al., 2009). Mitochondrial genome contains 36 genes, 12 protein-encoding genes, 2 ribosomal RNAs and 22 tRNA genes (Thanh et al., 2001).

#### 1.4. Host-parasite interaction

Co-evolution of *S. mansoni* and its host has taken for millions of years. During this period many host-parasite interactions were developed. These interactions are necessary for survival and proper development in the host. Most of parasite interactions with the host are via gut and tegument.

##### 1.4.1. Gut and tegument

Gut is covered by syncytial epithelium, gastrodermis, Main component of gastrodermis are gastrodermal cells which serve for both secretion of digesting enzymes and absorption of digested nutrient (Dalton et al., 2004). These enzymes digest hemoglobin and serum proteins to provide enough building material for egg production in the female parasite and general metabolic requirements in both male and female (Bogitsh, 1982).

The whole body of adults is covered by an outer layer. This outer layer consists of outer tegument layer, intermediate peripheral muscle layers and inner cell bodies (cytons). The tegument layer is covered by double lipid layer, called membranocalyx, and apical plasma membrane cover the tegument surface. Tegument cytoplasm and cell body cytoplasm are connected by slender, numerous, microtubule-lined cytoplasmic channels and contain mitochondria, multilaminar vesicles and discoid bodies. The discoid bodies are surrounded by a single bilayer with dense granular mucopolysaccharide content (Wilson and Barnes, 1974).

Secreted proteins are produced in cyton's Golgi bodies, packed into secretory inclusions and transport to tegument.

First tegument function is uptake of low-molecular weight solutes such as glucose, nucleotides and aminoacids. Glucose is transported by schistosome glucose transporter SGTs (Peterson, 2010), nucleotides and aminoacids by diffusion (Levy and Read, 1975).

Second tegument function is parasite protection against surrounding environment, especially immune system. One of the protection strategies is binding host molecules on the parasite surface such as MHC (major histocompatibility complex), protease inhibitor  $\alpha$ -2-macroglobulin, complement activation inhibitor DAF (decay accelerating factor, cholesterol transporting molecule LDL (low density lipoprotein) or Fc portion of antibodies (Sher et al., 1978; Pearce et al., 1990; Rumjanek et al., 1988). This process makes the parasite less accessible and recognizable for immune system.

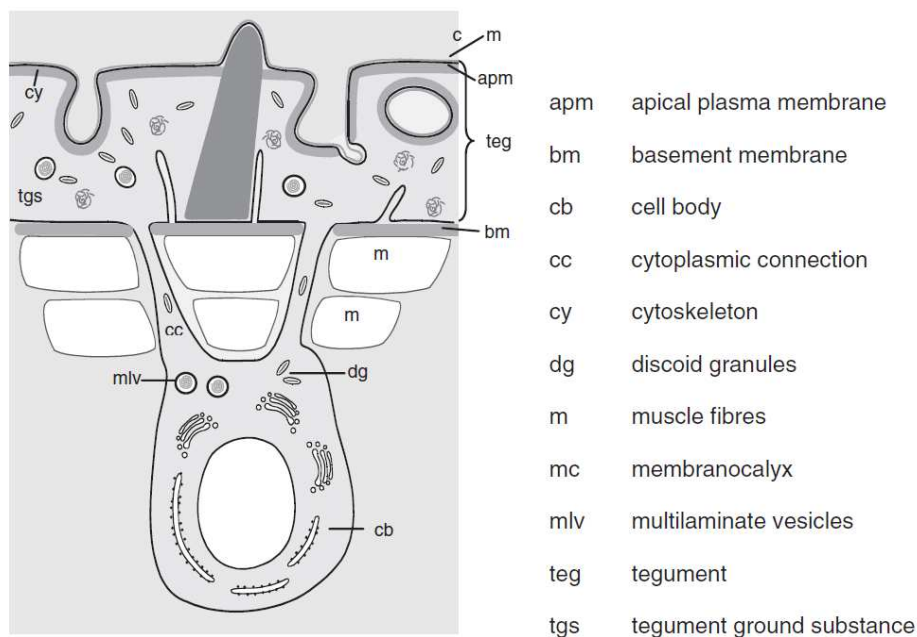

**Figure 10. Diagram of *S. mansoni* surface (Skelly et al., 2003)**

#### 1.4.2. Necessity of immune response for development

Surprisingly, the co-evolution of host and parasite caused that immune response is not only harmful for *S. mansoni* but it is even necessary for proper *S. mansoni* development. Small and less fecund adult is developed, if it grew up in immunodeficient host (Davies et al., 2001).

Correct development of *S. mansoni* is also dependent on host hormones. Increased thyroid hormone level produces bigger worms but decreased thyroid level produces smaller worms (Wahab et al., 1971; Saule et al., 2002).

#### 1.5. Immune response and pathological consequences

Three symptoms are typical for *S. mansoni* infection 1) Cercarial dermatitis 2) Acute schistosomiasis (Katayama fever) and 3) Chronic schistosomiasis.

Itchies and papular rash are symptoms which can appear around penetration site and are caused by cercariae penetration into the host (Stuiver et al., 1984).

Acute schistosomiasis takes during schistosomula migration in the definitive host up to 10 week after the infection. In 3-5 weeks, parasites migrate and T helper 1 (Th1) response is dominant. In 5-6 weeks, parasites mature, mate and start producing eggs, the response changes, the Th1 response decreases and Th2 response strongly increases (Rabello et al., 1995). Decrease of Th1 response can be explained by soluble egg antigens (SEA) which inhibit Dendritic Cells (DC) to produce IL-12 (Pearce et al., 2004). Activation of Th2 response is also initiated by SEA. IPSE/alpha-1 and peroxiredoxin secreted from eggs were shown to initiate the IL-4 production in basophiles (Schramm et al., 2007). Acute phase is manifested by fever, malaise, hepatosplenomegaly, eosinophilia and diarrhea (Boros, 1989).

The pathology of chronic schistosomiasis is mainly a consequence of immune response against their eggs. Most of eggs pass through the intestine wall and leave the host with feces. The rest of eggs are distributed mainly into liver and intestine but also into the kidney, lung or central nervous system where they induce a granulomatous response. Granulomatous reaction evoked by the soluble egg antigens (SEAs) that are released through ultramicroscopic pores in the eggshell (Ross et al., 2002). Recent proteomic study identified 188 proteins secreted from the egg to the environment. Secreted proteins were very variable in function and some of them are immunomodulating or hepatotoxic (Cass et al., 2007). The granulomas surround the eggs and consist of eosinophils, macrophages, lymphocytes, neutrophils, mast cells, and fibroblasts (Kaplan et al., 1998). These granulomas, impairing blood flow in the liver, cause portal hypertension. Fibrosis of the liver and hepatosplenomegaly can also occur. Later, eggs can migrate into the lung, where granulomas are developed and induce pulmonary arthritis



(Mentink-Kane et al., 2004). Seriousness of symptoms depends on the number and location of the adult's pair inside the host, duration of infection and overall health conditions of the host.

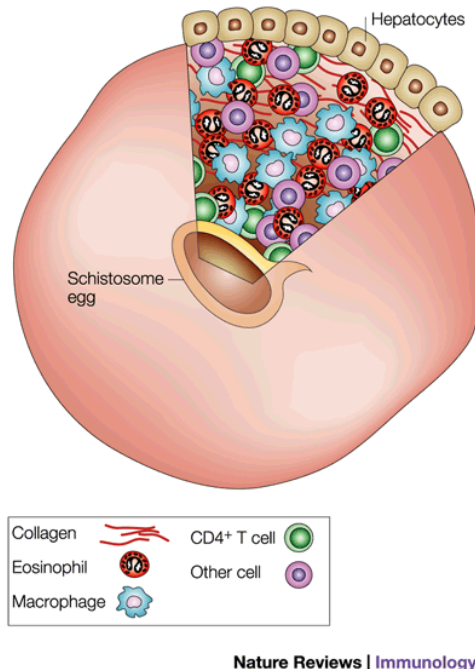

**Figure 11. Egg of *S. mansoni* surrounded by granuloma which is made up of various host cells (Pearce et al., 2002)**

### 1.6. Current treatment

Praziquantel (PZQ; 2-cyclohexylcarbonyl-1,3,4,6,7,11b-hexahydro-2H-pyrazino (2,1-a)isoquinoline-4-one) is highly effective against all schistosome species that are known to infect humans and well-tolerated (Melman et al., 2009). In addition, the market competition reduced the cost to US \$ 0.2 for a person treatment after the Merck patent expired (Fenwick et al., 2003). All these facts together make PZQ perfect for mass distribution.

The risk of mass treatment is development of resistance to PZQ if we consider antibacterial and antimalarial chemotherapy experience. Laboratory experiments prove that partial but inherited resistance to PZQ may develop and also a few cases of decreased drug sensitivity were reported. Studies of infected patients, not cured by multiple doses of praziquantel, suggested that resistance to the drug may be present (Botros et al., 2007).

Schistosomicidal antihelmintics, such as hycanthone and oxamniquine, have been used. However, these former treatments are withdrawn due to hepatotoxicity (Caffrey et al., 2007).

*S. mansoni* genome project makes a more target-based approach to drug discovery feasible, and some promising leads have already emerged. In the context of drug discovery, potential areas of vulnerability were explored, including: lipid metabolism, GPCRs, ligand- and voltage-gated ion channels, kinases, proteases and neuropeptides (Berriman et al., 2009).

## **1.7. Proteases**

### 1.7.1. Classification of proteases

#### Numerical classification

Enzyme Commission number (EC) is a numerical classification which groups enzymes according to the chemical reaction they catalyze. Peptidases (E.C. 3.4) is group of hydrolases which catalyze hydrolyses of peptide bonds. Endopeptidases (E.C. 3.4.2) are group of proteases which are classified according to their functional amino acids in active site. This classification provides five mechanistic classes of proteases: the serine proteases (E.C. 3.4.21), cystein proteases (E.C. 3.4.22), aspartic acid proteases (E.C. 3.4.23), metalloproteases (E.C. 3.4.24) and threonine protease (E.C. 3.4.25).

#### MEROPS

MEROPS database provides another protease classification derived from system developed by Rawlings and Barrett (Rawlings and Barrett, 1993). Proteases are grouped into Families and Clans based on their structural and functional similarities (Rawlings and Barrett, 2012). Families categorize proteases according to similarities in amino acid sequence of active site. Names of families are abbreviated to a single letter representing catalytic type of a protease. Clans divide proteases according to their evolutionary similarities and their names are shortened into two letter abbreviation (Rawling and Barrett, 2012).

### 1.7.2. Proteases of *Schistosoma mansoni*

Proteases (a.k.a. peptidases, proteolytic enzymes) represent approximately 2% of the total number of proteins present in all types of organisms (Barrett et al., 2001). Proteases are very important in many biological processes in general, but they also play an important role in

parasitism which includes processes such as hatching, excystment, tissue/cell invasion, nutrient acquisition and immune evasion (McKerrow et al., 2009). For trematode parasites causing diseases of medical and veterinary importance, proteases operate at the host-parasite interface facilitating migration, digestion of host proteins and probably immune evasion (Donnelly et al., 2006). For this reason, proteases have been intensively studied as targets for vaccine and drug therapies (Bos et al., 2009).

Most studied and characterized proteases are gut proteases. Both male and female of *S. mansoni* adults consume huge amount of blood, containing red cells and serum proteins. Red cells are hemolysed in esophagus and gained hemoglobin digested in the gut. This digestion is performed by a various number of proteolytic enzymes, mainly cysteine and aspartic proteases. These gut proteases are expressed as zymogens with low pH optimum typical for schistosoma gut. Several of them were expressed in various expression systems, biochemically characterized and immunohistochemically localized. Study carried out by Delcroix et al. (2006) investigated to the proteolytic network to find out their common cooperation in the digestive process. It concluded cathepsin B1 (SmCB1), cathepsin L1 (SmL1), cathepsin D (SmCD), cathepsin C (SmCC), asparaginyl endopeptidase (SmAE) and aminopeptidase. Results suggested possible way of proteases cooperation. Possibly SmCB1, SmCL1, SmAE, and SmCC cooperate to initiate host protein degradation. Cathepsin D cleaves hemoglobin with result of two peptides which are subsequently cleaved SmCB1 and SmCL. Albumin is cleaved by cysteine proteases ( Cathepsin B1, L1) or Cathepsin D, the resulted peptide are then degraded by Cathepsin D or (Cathepsin B1, L1) metallo aminopeptidase (Delcroix et al., 2006). There is a brief introduction of main players of digesting which were mentioned above.

*S. mansoni* Cathepsin B1 (SmCB1) contains Cys/His/Asn catalytic triad typical for cysteine proteases. SmCB1 was first sequenced protease of *S. mansoni* and is the most abundant cysteine protease in gastrointestinal region. There are isoforms of SmCB1, both share specific motif (YWLANSWxxDWGE) which is thought to be necessary for hemoglobin digestion (Baig et al., 2002). Another Cathepsin B, Cathepsin B2, was located on the surface of *S. mansoni* tegument.

*S. mansoni* asparaginyl endopeptidase (SmAE, legumain) is Clan CD cysteine peptidases with peptide sequence at P1-P2-P3 is Thr-Ala-Asn (Mathieu et al., 2002). SmAE Ortholog works as a protease for zymogen activation in plants (Okamoto et al., 1999).

*S. mansoni* cathepsin L1 (SmCL1, SmCF1) and *S. mansoni* cathepsin CL2 were both localized in gastrodermis. They share 44% similarity and preference for substrate with hydrophobic AA at P2 position (Phe, Trp, Tyr) (Brady et al., 2000).

*S. mansoni* cathepsin D (SmCD) is autoactivated aspartic endopeptidases weighing 40kDa. SmCD expressed in insect cells degraded both peptidyl substrates and hemoglobin at acid pH.

*S. mansoni* cathepsin C (SmCC) is cysteine exopeptidase which gradually removes dipeptide from the N-terminal end of substrate.

### 1.7.3. Serine proteases

Serine protease class uses the classical Ser/His/Asp (sequence of triad can vary) catalytic triad mechanism, in which serine is the nucleophile, histidine is the general base and acid, and the aspartate helps orient the histidine residue and neutralize the charge from the histidine during the transition states (Ekici et al., 2008). The active site is surrounded with substrate binding pocket which allows the protease to bind its substrates and determines the substrate specificity of the enzyme (Schechter and Berger, 1967).

Serine peptidases are synthesized as inactive precursors (zymogens) because of their specific and precise usage, thereby their usage corresponds to their structure which consists of three domains: catalytic, substrate binding and zymogen activation domains (Barrett et al., 2004). Zymogens of proteolytic enzymes consist of the intact protease with an N-terminal extension. Proteolysis of this N-terminal extension results in transformation from inactive zymogen to active protease (Neurath, 1957).

#### 1.7.4 Serine proteases of *Schistosoma mansoni*

##### Cercarial elastase

The best characterized serine protease in *S. mansoni* is *S. mansoni* cercarial elastase (SmCE, clan PA(S) family S1) with typical serine triad His68/Asp126/Ser218. It was named according to the elastin substrate which digests (Dvořák et al., 2008). SmCE has chemotrypsin activity with hydrophobic AA at P1 position, Phe at P2, Trp and Ser at P3 or P4 (Salter, 2002) and is fully inhibited by 10 $\mu$ M inhibitor Z-Ala-Ala-Pro-Phe-CMK (Dvořák et al., 2008). Five genes, encoding various isoforms of cercarial elastase, were identified in *S. mansoni* but only two of them are responsible for 90% of cercarial elastase activity (Salter et al., 2002). Elastase is secreted from acetabular glands of cercaria to degrade host skin connective-tissue macromolecules such as elastin, type IV collagen, fibronectin, laminin and keratin (Hansell et al., 2008; Curwen et al., 2006).

##### Further serine proteases of *Schistosoma mansoni*

Even though *S. mansoni* elastase and SmSP1 (mentioned below) are the only studied serine proteases in this parasite, several other enzymes with serine protease activity were found. Such enzymes are kallikrein-like protease found in *S. mansoni* homogenate (Karvalho et al., 1998), serine protease modulating IgE synthesis (Verwaerde et al., 1988) and serine protease found on the surface transformed schistosomula cleaving complement proteins (Marikovsky et al., 1990). Presence of these serine proteases in these processes implying their ability to influence immune and physiological processes of definitive host.

#### 1.7.5 Studied serine proteases

Many molecules of *S. mansoni* are intensively studied as putative drug targets against schistosomiasis. Serine proteases were so far neglected for a long time. Our group has been trying to fill this gap. Serine proteases, which were chosen for our research, share high

similarity with human regulatory molecules. According to our hypothesis, these proteases could play important roles in host-parasite interaction. Our research is focused on molecular and biochemical characterization of these five serine proteases. My thesis is focused on biochemical and molecular characterization of SmSP1. My effort was focused on expression of SmSP1 trypsin recombinant for immunization and biochemical studies. Other experiments were carried out to determinate expression profile, expression level and susceptibility to RNAi. Some experiments were carried out together with some other studied proteases for comparative reason. The first is SmSP2 which share high similarity with *C. sinensis* trypsinogen. The second is SmSP3 (Smp\_103680) which is consisted of cub and trypsin domains and has certain similarities to transmembrane serine protease from *S. japonicum*. Both cub and trypsin domains are expressed separately in all *S. mansoni* life stages except from egg. The third is SmSP4 (smp\_129230) which is a protease with similarity to mammalian regulatory factors such as C-anticoagulation factor and shares high similarity with so called *C. sinensis* transmembrane serine peptidases. The last is SmSP5 (smp\_141450) which is most likely chymotrypsin.

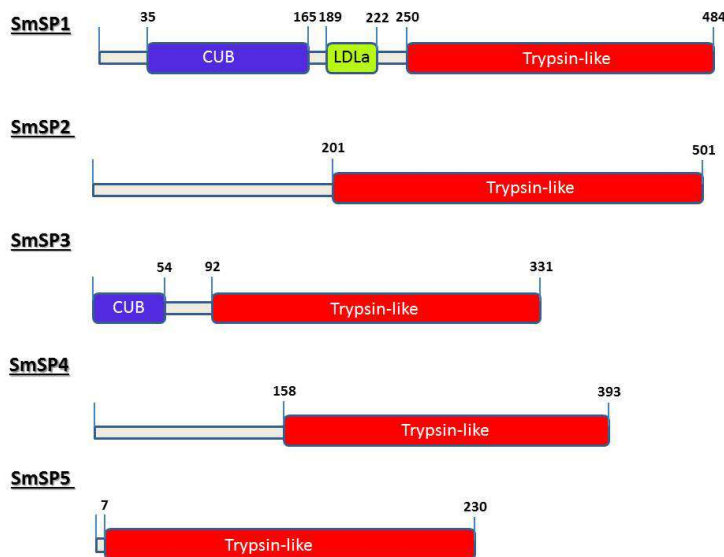

**Figure 12. Domain scheme of studied proteases** SmSP1 contains cub, LDLa and trypsin-like domains and SmSP3 contains cub and trypsin-like domains.

## SmSP1

SmSP1 (*Schistosoma mansoni* Serine protease 1, GenbankAJ011561) is a chimerical molecule matriptase-like protease and is compounded of three domains, extracellular cub, LDL binding receptor and trypsin domain.

## Cub domain

Cub domain is an extracellular domain that was found especially in developmental and proteins with the function in the immunity (Bork et al., 1993). These proteins are involved in a diverse range of functions, including complement activation, developmental patterning, tissue repair, axon guidance and angiogenesis, cell signaling, fertilization, haemostasis, inflammation, neurotransmission, receptor-mediated endocytosis, and tumour suppression (Perry et al., 2007). Mammalian complement subcomponents C1s/C1r, which form the calcium-dependent complex C1, are the first component of the classical pathway of the complement system (Major et al., 2010).

## LDL (Low density lipoprotein) receptor class A

The low-density lipoprotein (LDL) is the major cholesterol-carrying lipoprotein of plasma, acting to regulate cholesterol homeostasis in mammalian cells. The LDL receptor binds LDL and transports it into cells by acidic endocytosis. In order to be internalized, the receptor-ligand complex must first cluster into clathrin-coated pits. Once inside the cell, the LDLr separates from its ligand, which is degraded in the lysosomes, while the receptor returns to the cell surface (Brown et al., 1986). LDLr is closely related in structure to several other receptors, including LRP1, LRP1b, megalin/LRP2, VLDL receptor, lipoprotein receptor, MEGF7/LRP4, and LRP8/apolipoprotein E receptor2). These proteins participate in a wide range of physiological processes, including the regulation of lipid metabolism, protection against atherosclerosis, neurodevelopment, and transport of nutrients and vitamins (May et al., 2007).

## Trypsin domain

SmSP1 trypsin domain is a serine protease which belongs to clan PA, S1 trypsin-like family (MEROPS, <http://merops.sanger.ac.uk/>). This trypsin domain of SmSP1 was partially studied several years ago by Cocude et al. This study was focused on 468bp region of SmSP1

which is 42% identical to vampire bat tissue plasminogen, 36% identical to human protein C precursor and 35% identical to mouse mouse plasma kallikrein. This sequence was cloned and expressed 21kDa protein was used for rat immunization. Using antibodies SmSP1 has been identified as 30kDa protein from soluble antigens from *S. mansoni*. Claimed SmSP1 and kallikrein identity was confirmed by immunocrossreactivity (Cocude et al., 1997). Second Cocude's study was focused on 248aa sequence of SmSP1 light chain showed significant homology with mammalian plasma kallikrein and human factor I. This sequence was cloned, expressed and gained antibodies were used for immunolocalization which detected SmSP1 on the surface of *S. mansoni* (Cocude et al., 1998).



Aims of my master's thesis:

Transcriptomic part:

- 1) Expression profile of SmSP1 domains by PCR screen
- 2) SmSP1 expression profile of all developmental stages using qRT-PCR
- 3) Gene expression knockdown by RNAi

Proteomic part:

- 1) SmSP1 expression in *E. coli*
- 2) SmSP1 expression in *P. pastoris*
- 3) Autoinduction and *E. coli* SHuffle expression of SmSP1

## **2.Methods and material**

### **Abbreviations**

cDNA	complementary DNA
dsRNA	double stranded RNA
EDTA	ethylenediaminetetraacetic acid
E-64	( <i>trans</i> -Epoxy succinyl-L-leucylamido(4-guanidino)butane)
FPLC	fast protein liquid chromatography
IDT	Integrated DNA technology
IPTG	isopropylthio- $\beta$ -galactoside
LDL	Low density lipoprotein
NTS	Newly transformed schistosomula
PMSF	phenylmethylsulfonyl fluoride
qRT-PCR	Quantitative Reverse Transcription Polymerase Chain Reaction
RISC	RNA-induced silencing complex
RNAi	RNA interference
RT	room temperature
SEM	scanning electron microscope
siRNA	short interfering RNA
Z- Phe-Arg-AMC	benzyloxycarbonyl-phenylalanylarginine-7-amido-4-methylcoumarin

## Solutions

Elution buffer (FPLC)	8M urea, 20mM Tris, 0,5M imimidazole, pH=8
Isolation buffer	8M Urea, 20mM Tris/HCl, pH=8
Lysis buffer	20mM Tris/HCl, pH=8
Refolding buffer 1	50mM Tris, 150mM NaCl, pH=8
Refolding buffer 2	20% Glycerol, 50mM Tris/HCl, 150mM NaCl, pH=8
Refolding buffer 3	100mM Tris; 1mM EDTA; 250mM L-Arg; 7,5% Sucrosa; 7,5% Glycerol; 1mM BME; 0,02% Triton X-100, pH=8
Wash buffer (FPLC)	8M urea, 20mM Tris, 10mM imimidazole, pH=8

## Life stage maintenance

*S. mansoni* parasites were maintained by cycling between in *Biomphalaria glabrata* snail host and outbred laboratory mouse strain CD-1 in the animal facilities of the institute. NTS (Newly Transformed Schistosomula) is *in vitro* transformed and cultivated schistosomula from cercariae. NTS were kindly provided by Brian Suzuki (University of California San Francisco, USA) and were prepared according to Ramalho-Pinto's protocol (Ramanlho-Pinto et al., 1974).

## **2.1 Transcriptomic part**

### 2.1.1 PCR screen

Total RNA was isolated from all developmental stages (adults, eggs, miracidium, sporocyst, cercariae, NTS) using Total RNA purification Kit (Norgen, Biotek) and transcribed into single strand cDNA by SuperScript III Reverse Transcriptase. Primers for single SmSP1 domains were used in following combinations to cover these regions (SmSP1 cub region, SmSP1 cub and LDL, SmSP1 trypsin, SmSP1 trypsin and SmSP1 LDL region, the whole SmSP1 region). All primer combinations were used with cDNA from all developmental stages. The amplification reaction consisted of 40 cycles (94°C for 30 s, 55°C for 1 min and 72°C for 2 min) using *Taq* polymerase.

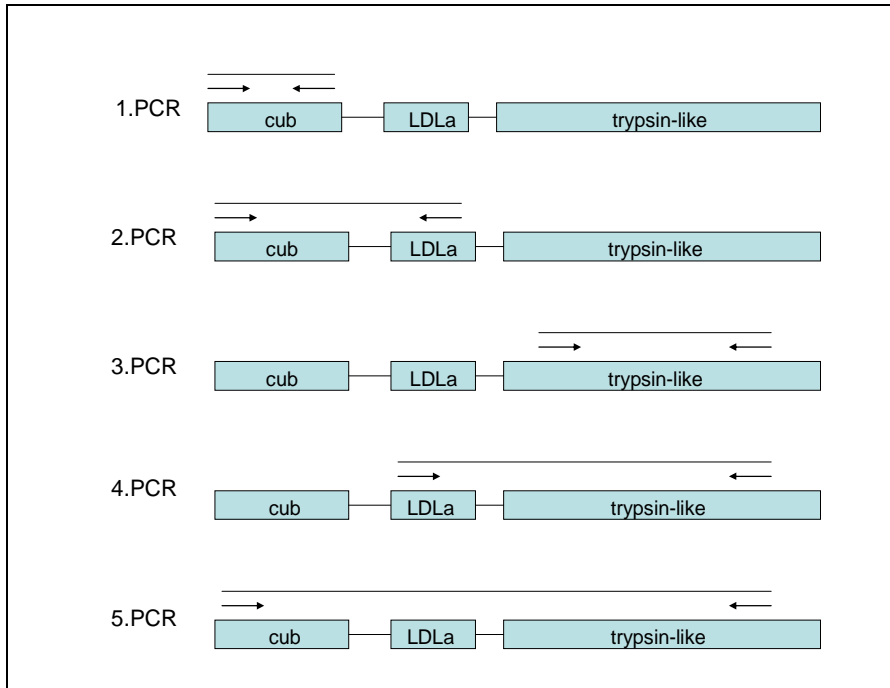

**Figure 13. Scheme of 5 PCR reactions** 1. PCR covered cub domain, 2. PCR covered cub and LDLa domains, 3. PCR covered trypsin-like domains, 4. PCR covered LDLa and trypsin domain, 5. PCR covered cub, LDLa and trypsin domains

Primer combinations for SmSP1 PCR screen		
Covering region	Forward	Reverse
SmSP1 cub	SmSP1 cub FRD 5'-CAATTGGCATATGATGGATTGA-3'	SmSP1 cub REV 5'-TTGTGTTTTCCAGCTGATCG-3'
SmSP1 cub-LDLr	SmSP1 cub LDLr FRD 5'-CACCATTTATATTCAGTCCTAATGGA-3'	SmSP1 cub LDLr REV 5'-TCTGAACCTGAGCAATCAGAAA-3'
SmSP1 trypsin	SmSP1 trypsin FRD 5'-CGCACAATGGGTAATGACAG-3'	SmSP1 trypsin REV 5'-ACCTTGGAAGCATCAATTC-3'
SmSP1 trypsin-LDLr	SmSP1 LDLr FRD 5'-TTTCTGATTGCTCAGGTTTCAGA-3'	SmSP1 trypsin REV 5'-ACCTTGGAAGCATCAATTC-3'
SmSP1 cub-LDLr-trypsin	SmSP1 cub FRD 5'-CAATTGGCATATGATGGATTGA-3'	SmSP1 trypsin REV 5'-ACCTTGGAAGCATCAATTC-3'

**Tab. 1 List of primer combination used for PCR screen of SmSP1**

### 2.1.2 Quantitative RT-PCR

Analysis of mRNA expression using quantitative RT-PCR (qRT-PCR) was done in order to determine expression levels in the particular life stages. Results of this method may indicate the function during the life cycle of the parasite and should provide the relative comparison with other trypsin-like proteases. As well as, due to alternative splicing, primers were designed to determine differences in the expression of particular domains in the cases of multi-domain genes.

Sets of primers were designed to achieve 150-200bp product size and 55°C annealing temperature. Triplicate reactions were carried out in a final volume 12.5µl in 96 black well plates. PCR profile consisted of 35 cycles (94°C for 30 s, 55°C for 30 sec and 72°C for 1 min) using MESA Green kit qRT-PCR Master Mix for SYBR Green (Eurogentec). Cytochrome oxidase subunit 1B (SmCOX) was used due to stable expression as a reference gene (Stefanic et al., 2010). Relative expression was calculated according to Nolan (Nolan et al., 2006).

#### List of primers used for qRT-PCR

##### SmSP1 LDLa domain

5'-TCGAATGGAAATGTCCAACA-3'

5'-GCCCCAGTTTTCTTCGTTATC-3'

##### SmSP1 cub domain

5'-TTTCCAATCTTTGATACTGAATGTG-3'

5'-ACGATCTTGTGGATTAACATGAATTA-3'

##### SmSP1 trypsin domain

5'-CGCACAATGGGTAATGACAG-3'

5'-CGTGGAAGTGGAGAAAGTCG-3'

### 2.1.3 RNA interference

Studies were performed on NTS (Newly Transformed Schistosomula) in 24-well plate. Each well contained 400 NTS and approximately 1 ml Complete Medium 169 (100 U/ml of penicillin and 100 µg/ml of streptomycin). Cultivation took 6 days at 37°C and 5% CO<sub>2</sub>. All

manipulation with NTS was performed under the sterile conditions to avoid contamination. Another protease SmPEP, studied by our collaborating lab, was included in these experiments for comparative reasons.

#### 2.1.3.1. RNAi using dsRNA (double-stranded RNA)

Constructs for dsRNA were prepared in order to knockdown selected serine proteases of *S. mansoni* (SmSP1-cub and trypsin domains, SmSP2 (Smp\_141450), SmSP3 (Smp\_103680), SmSP4 (Smp\_129230), and SmPEP. dsRNA was synthesized from two corresponding PCR products (each carrying T7 promotor at opposite end, figure 14.), using T7 Ribomax Express RNAi kit (Promega). PCR reaction consisted of incubation step at 98°C for 3 min; followed with 35 cycles of 30 s at 98°C, 30 s at 55°C and 30 s at 72°C; and finally incubation at 72°C for 7 min using *Taq* polymerase. Each PCR product was mixed with T7 Express Ribomax RNA polymerase and Ribomax T7 buffer to transcribe PCR products into RNA. After incubation at 37°C for 1 hour and at 42 °C for 1 hour., corresponding ssRNA products were mixed and incubate at 70°C for 10 minutes to give rise to dsRNA. Solution with dsRNA was treated by DNase and RNase. To purified dsRNA, sodium acetate and 95% Ethanol were added. Mixture was placed on ice for 20 minutes and spined down at top speed for 10 minutes. Supernatant was poured away and pellet was washed by 70% Ethanol. Pellet was subsequently resuspended in dH<sub>2</sub>O. Resultant dsRNA in 500 bp of size was added to Basch medium 169 with NTS (Newly Transformed Schistosomula) in the final concentration 30µg/ml and subsequently the dsRNA was delivered into NTS by soaking (Stefanic et al., 2010).

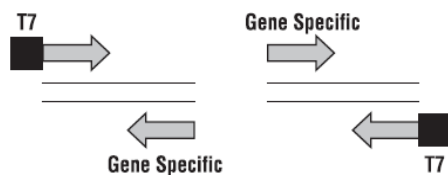

**Figure 14. Scheme of production of PCR products with T7 promotor**

Primers used for preparation of dsRNA for RNAi experiments

SmSP4 (Smp\_12930)

5'-GGATCCTAATACGACTCACTATAGGTAGATATGTGAACATTGCTTG-3'

5'-TTAAAATGTGAACACTTCAGC-3'

5'-GGTAGATATGTGAACATTGCTTG-3'

5'-GGATCCTAATACGACTCACTATAGGTAAAATGTGAACACTTCAGC-3'

SmSP5 (Smp\_141450)

5'-CCTAGGTAATACGACTCACTATAGGAAATTAGAATATCGTATACAAAATGG-3'

5'-GACATTTCAATTGATTTATCTTCAC-3'

5'-GAAATTAGAATATCGTATACAAAATGG-3'

5'-GGATCCTAATACGACTCACTATAGGACATTTCAATTGATTTATCTTCAC-3'

SmPEP

5'-CCTAGGTAATACGACTCACTATAGGAGCATACCAGTATCAACTATC-3'

5'-GGAAGATCTTCGCCCGATTAC-3'

5'-GGAGCATACCAGTATCAACTATC-3'

5'-CCTAGGTAATACGACTCACTATAGGAAGATCTTCGCCCGATTAC-3'

SmSP1

5'-CCTAGGTAATACGACTCACTATAGGTGGTCAATGGCCAACCGGCTCCA-3'

5'-GCTTTATTAAGATATTGATACCATG-3'

5'-GTGGTCAATGGCCAACCGGCTCCA-3'

5'-GGATCCTAATACGACTCACTATAGGCTTTATTAAGATATTGATACCATG-3'

#### 2.1.3.2. siRNA (short interfering RNA) interference

Commercial service provided by Integrated DNA technology (IDT) was used for synthesis of siRNA. As a control siRNA derived from cDNA mCherry fluorescent protein was used.

Experiments were carried out under the conditions that had been optimized by previous studies

(Štefanić et al., 2010 and Krautz-Peterson et al., 2007) for NTS. NTS in Basch medium 169 were transferred into cuvette and electroporated with 2µg siRNA (125 V, 20ms).

### 2.1.3.3 Quantitative RT-PCR analysis of expression knockdowns in RNAi treated NTS

Newly transformed schistosomula treated with siRNA, dsRNA and treated/untreated controls were collected by quick pulse centrifugation and washed 3 times with Basch medium 169 after a week incubation. Total RNA was isolated using Total RNA purification Kit (Norgen, Biotek) and transcribed into single strand cDNA using SuperScript III Reverse Transcriptase (Invitrogen). Knockdown efficiency was evaluated by quantitative RT-PCR with specific primers listed below. Triplicate reactions were carried out in final volume of 12.5µl in 96 well plates. Reaction was carried out as described in the chapter 2.3.2 (Stefanic, 2010).

Primers for qRT-PCR of RNAi treated NTS:

Smp\_12930

5'-ATAAGTGTCGGTTGGGGACA-3'

5'-GCATGTCCAGCACAAATGAC-3'

Smp\_141450

5'-TGTC AATGGGTCAATTACGTTT-3'

5'-CCAACCATTTCCAGCTATTGA-3'

SmSP1

5'-GGACAGTCCACATTGGTGATT-3'

5'-CCCATCCTGCAACATAACAA-3'

SmPEP

5'-CATTCGTGGTGGAGGAGAAT-3'

5'-CGCATACTGGA ACTTGAGCA-3'



## **2.2 Proteomic study**

### 2.2.1 Expression in *Escherichia coli* BL 21

#### 2.2.1.1 Amplification, cloning and transformation

*E. coli* expression system was used for production of SmSP1 trypsin domain. SmSP1 trypsin domain was amplified by PCR using *S. mansoni* adult cDNA as a template and Phusion polymerase (Finnzymes) with primers SmSP1spFRD 5'-CACCGTGGTCAATGGCCAACCGGCT-3' and SmSP1spREV 5'-TTACAAAAA ACTTGAATACC-3'. PCR consisted of incubation at 98°C for 3 min; followed with 35 cycles of 30 s at 98°C, 30 s at 55°C and 30 s at 72°C; and finally incubation at 72°C for 7 min. PCR reaction was analyzed by 1% agarose gel. Expected 700bp band was cut out and isolated by Gel Extraction kit (Geneaid). PCR product was cloned into pET100 Directional TOPO®Expression Kit (Invitrogen) containing Histidine-tag at the N-terminus and transformed to *E. coli* DH5 alpha (Invitrogen). Transformed bacteria culture was grown in 5ml LB medium (100µg/ml ampicilin) at 37°C overnight. Plasmid was isolated by Plasmid isolation kit (Geneaid). Plasmid verified by sequencing analysis was transformed into *E. coli* expression strain BL 21 (Invitrogen) containing T7 polymerase.

#### 2.2.1.2 SmSP1 trypsin expression

Overnight inoculum was poured into the 200ml LB media (100µg/ml ampicillin, 20mM glucose) and grew at 37°C for 4 hours until it reached OD<sub>600</sub>= 0.7. Grown bacteria culture was spinned down by centrifugation at 3000g for 10 min. Pellet was resuspended in LB medium (100µg/ml ampicillin, 1mM IPTG) and grown overnight at 37°C. The culture was centrifuged at 3000g for 10 min and resuspended in lysis buffer (20mM tris/HCl, pH=8). Resuspended culture was sonicated and centrifuged at 12 000g for 10 min at 4°C. Resultant pellet was twice sonicated in isolation buffer (8M Urea, 20mM Tris/HCl, pH=8) and centrifuged at 12 000g for 10 min at 4°C.

#### 2.2.1.3 Purification by FPLC (Fast protein liquid chromatography)

HiTrap (GE Healthcare) column, charged with 20mM CoCl<sub>2</sub>, was equilibrated with the isolation buffer. Samples were consequently washed by the wash buffer (8M urea, 20mM Tris,

10mM imidazole, pH=8) and eluted by the elution buffer (8M urea, 20mM Tris, 0,5M imidazole, pH=8). Protein isolation was verified by SDS-PAGE.

#### 2.2.1.4 Protein refolding

Recombinant and purified SmSP1 trypsin domain were subjected to refold in several refolding buffers. First, it was dialyzed against buffer (3M Urea, 20mM Tris, pH=8) and then against (20mM Tris, pH=8) refolding buffer. Purified protein was gradually dialyzed against three refolding buffers 1) 50mM Tris/HCl, 150mM NaCl, pH=8, 2) 20% Glycerol, 50mM Tris/HCl, 150mM NaCl, pH=8 and 3) 100mM Tris/HCl; 1mM EDTA; 250mM L-Arg; 7,5% Sucrosa; 7,5% Glycerol; 1mM BME; 0,02% Triton X-100. All refolding reactions were performed overnight in 5L volume. Recombinant was also dialyzed into the PBS and used for immunization.

#### 2.2.1.5 Protein activation

Different proteases (thrombin, trypsin, matriptase, factor XII) were chosen according to amino acid sequence code in the prodomain of SmSP1 and preference and biological role of potential activating proteases. After protein attempts soluble and inactive recombinant SmSP1 was used for activation experiments. This soluble SmSP1 was incubated with each of these proteases for 1 hour, 2 hours, 4 hours and overnight at 37°C. Two different buffers were used in this experiment. Incubation with Trombin and trypsin was conducted in buffer containing (50mM Tris, 50mM NaCl, 20mM CaCl<sub>2</sub>; 0,001% Triton X-100, pH=8) and incubation with matriptase and factor XII was conducted in buffer containing (20mM Tris, 150mM NaCl; 0,02 Triton-X 100, pH=8,5). SDS-PAGE and fluorometric assays were performed to monitor potential activation. Fluorometric assays were carried out in 20mM Tris buffer with 20µM of synthetic peptidyl substrate Z- Phe-Arg-AMC (benzyloxycarbonyl-phenylalanylarginine-7-amido-4-methylcoumarin) and serine protease inhibitor PMSF (Phenylmethylsulfonyl fluoride, Sigma-Aldrich) was used to verify possible serine protease activity. The assay was run on an Infinitive M200 PRO (TECAN).

### 2.2.2 Expression in *Pichia pastoris*

Different variants of SmSP1 (whole SmSP1 molecule, SmSP1 trypsin domain and both with/without his-tag) were tested. Egg cDNA was used as template for PCR in order to obtain whole SmSP1 protein, otherwise for other variants cDNA from adults was used instead. All four PCR products were cloned into pPICZ $\alpha$  B vector (Invitrogen). Vectors with cloned PCR products were sequenced, propagated in *E. coli* strain DH5 $\alpha$  in 200ml volume and isolated by Maxi Plasmid Kit (Geneaid). These constructs were successfully transformed into *P. pastoris* strain X-33 by electroporation and spread on YPD plates containing 100 $\mu$ g/ml Zeocin. After 3 days incubation at 30°C, 25 colonies were selected and transferred on new YPD plates containing 100 $\mu$ g/ml Zeocin. Each of them was transferred into test-tube with 5ml YPD media containing 100 $\mu$ g/ml Zeocin. They were incubated in horizontal shaker at 30°C for 5 days. Methanol up to 1% methanol was added several times per day into the media to maintain concentration necessary for protein expression. After 5 days, all samples were centrifuged and supernatant was lyophilised, desalted and resuspended in PBS. SDS-PAGE and fluorimetric assays were used to verify expression and activity. The activity assay was carried out with 40 $\mu$ M Z-Phe-Arg-AMC substrate in two different buffers (50mM Tris and 50mM Citrate Phosphate, both with/without CaCl<sub>2</sub>) in the pH from 6.5 to 8.0. As a control, assay was also tested with 1mM serine protease inhibitor PMSF (Phenylmethylsulfonyl fluoride, Sigma-Aldrich) and 10 $\mu$ M cysteine protease inhibitor E-64 (*trans*-Epoxy succinyl-L-leucylamido(4-guanidino)butane, Sigma-Aldrich).

Combination of PCR primers for four desired PCR products:

Whole SmSP1 molecule with his tag

5'-CTCGAGAAAAGAGAGAAACGGTCAGTTTATGATAACGAAGAAAAC-3'

5'-TAAGCGGCCGCTCAATGATGATGATGATGATGCAAAACACTTGAATACCAGT  
CAGAAAACATAG-3'

Whole SmSP1 molecule without histag

5'-CTCGAGAAAAGAGAGAAACGGTCAGTTTATGATAACGAAGAAAAC-3'

5'-TAAGCGGCCGCTTACAAAACACTTGAATACCAGTCAGAAAACATAG-3'

SmSP1 trypsin molecule with histag

5'-CACCGTGGTCAATGGCCAACCGGCT-3'

5'-TAAGCGGCCGCTCAATGATGATGATGATGATGCAAAACACTTGAATACCAGT  
CAGAAAACATAG-3'

SmSP1 trypsin molecule without histag

5'-CACCGTGGTCAATGGCCAACCGGCT-3'

5'-TAAGCGGCCGCTTACAAAACACTTGAATACCAGTCAGAAAACATAG-3'

### 2.2.3 Expression in SHuffle® BL 21 Express Competent *Escherichia coli*

Plasmid with SmSP1 trypsin construct used for expression in (odkaz na podkapitolu) was transformed into the SHuffle® T7 Express Competent *E. coli* cells (Biolabs) and place on LB plate containing 100µg/ml ampicillin. Selected colonies were propagated in 5ml LB (100µg/ml ampicillin, 20mM glucose) at 30°C overnight. Later, 200ml LB media (containing 100µg/ml ampicillin) was inoculated with overnight culture and incubated at 30°C for 7 hours and then temperature of media was cooled down to 18°C and IPTG was added to a final concentration 0,2mM. The culture grew overnight at 18°C. Grown culture was centrifuged at 3000g for 10 min at 4°C. Pellet was resuspended in isolation buffer (20mM Tris, 300mM NaCl, pH=8), sonicated and centrifuged at 10 000g for 10 min at 4°C. Supernatant was purified by FPLC HiTrap (GE Healthcare) colon charged with 20mM CoCl<sub>2</sub>. The eluted samples were tested by SDS-PAGE and fluorometric assays for protein activity. Fluorometric assays were carried out in 20mM Tris/HCl buffer with 20µM Z-Phe-Arg-AMC substrate. As a control, assay was also tested with serine protease inhibitor PMSF (Phenylmethylsulfonyl fluoride, Sigma-Aldrich). The assays were analyzed using an Infinitive M200 PRO fluoremetre (TECAN).

### 2.2.4 Autoinduction of protein expression in the T7 system

Plasmids used for expression in *E. coli* BL 21 and *E. coli* Shuffle (sections 2.1.2 and 2.1.3) were transformed into the *E. coli* BL 21 (Invitrogen) and spread on LB plate containing 100µg/ml Ampicilin. Selected colonies was transferred into 2 ml of ZYP-0.8G media (Studier

et al., 1990) and shaken at 300RPM at 37°C for 6 hours. Grown culture was inoculated into 400ml ZYP-5052 media (50µg/ml Ampicilin) (Studier et al., 1990) and shaken at 18°C for 2 days. Culture was centrifuged at 3000g for 10 min at 4°C. Then, centrifuged pellet was resuspended in 4 ml of lyses buffer (20mM HCl, pH=8), sonicated and centrifuged again at 12 000g/10min. The supernatant, containing cytoplasmatic fraction, was purified by FPLC HiTrap (GE Healthcare) column charged with 20mM CoCl<sub>2</sub>. The eluted samples were tested by SDS-PAGE and fluorometric assays for protein activity. Fluorometric assays were carried out in 20mM Tris buffer (pH=7,5;8,0;8,5) with 20µM Z- Phe-Arg-AMC substrate. Another assay also tested the samples with serine protease inhibitor PMSF (Phenylmethylsulfonyl fluoride, Sigma-Aldrich). Assays were analyzed by Infinitive M200 PRO (TECAN).

### **3. Results**

#### **3.1 Bioinformatic part**

##### Nucleotide and protein sequence of SmSP1

Nucleotide sequence of SmSP1 consists of 1455 bp was translated into protein sequence (484 aminoacid residues) at server Expassy (<http://web.expasy.org/translate/>). Predicted signal sequence, identified by SignalIP program (<http://www.cbs.dtu.dk/services/SignalP/>), is probably cut off at position between 27 and 28 aminoacid (p=0.336). Two N-glycosylation sites were predicted at positions 111 (p=0.7959) and 184 (p=0.6942) by NetNGlyc 1.0 Server (<http://www.cbs.dtu.dk/services/NetNGlyc/>) but no O-glycosylation site was predicted by NetOGlyc 3.1 Server (<http://www.cbs.dtu.dk/services/NetOGlyc/>). Server BILAB (<http://biomedical.ctust.edu.tw/edbcp/>) for prediction of disulfide bonds between cysteines predicted four disulfide bonds between cysteines at these positions (277-293, p= 0.76894), (379-443, p=0.86582), (409-422, p=0.81247), (433-461, p=0.54911). Server SMART ([http://smart.embl-heidelberg.de/smart/show\\_motifs.pl](http://smart.embl-heidelberg.de/smart/show_motifs.pl)) predicted three domains cub (range from 35 to 166), LDLa (range from 186 to 224) and trypsin-like serine protease (range from 249 to 480).

```
atgttgtggtataataacagatacaaaaatagtttgtctattattgtactagtattatgt
M L W Y N I Q I Q N S L S I I V L V L C
agatttcattgtttaatatgttttccaatctttgatactgaatgtggttctacaccattt
```

**R F H C L I C** F P I F D T E **C G S T P F**  
 atattcagtcctaataaggaaatatttattcacataaagggttatgaaaaacaattggcatat  
**I F S P N G N I Y S H K G Y E K Q L A Y**  
 gatggattgattcaatggttttggtaattcatgttaatccacaagatcgtattattatt  
**D G L I Q C F W L I H V N P Q D R I I I**  
 caatcagttgattttgatctagctgggtgattcaattcaatgtgatgaagatagtttaact  
**Q S V D F D L A G D S I Q C D E D S L T**  
 gtttatgaaccagaagattatcaagttgacaatataacatcttcagaaattgatacattc  
**V Y E P E D Y Q V D** **I T S S E I D T F**  
 acgaaaagaattggtaaatatccatattgtggattgacaagtttttagagtattatctagt  
**T K R I G K Y P Y C G L T S F R V L S S**  
 tccaatcagttatttctagttttaaggctcgatcaactggaaaacacaatgggtttta  
**S N Q L F L V F K A R S T G K H N G F N**  
 ctacgttattcagctataaacaataaacttggcaaagatagtagaatcttcacacagctc  
**L R Y S A** I N N N L A K I V E S S S Q S  
 attacagtgaacaggacatgtgactcatcattcgaatggaaatgtccaacatcccaatgt  
**I T V** **R T C D S S F E W K C P T S Q C**  
 atattgaaaataggagatgtgatggattttctgattgctcaggttcagaagatgaaata  
**I L K I W R C D G F S D C S G S E D E I**  
 aactgtttaagtccactttcaaaaatctcgtttacatagtagacaaaaacggtcagtt  
**N C L S P L S** K I S R L H S R Q K R S V  
 tatgataacgaagaaaactggggccgtgtgggtcaatggccaaccggctccaaaagggtgct  
 Y D N E E N W G **R V V N G Q P A P K G A**  
 tgggcttttatagtttctttacgtttctccggaacggaggacatgtttgtgcaggtagc  
**W A F I V S L R F S G N G G H V** **C A G S**  
 ttaattagcgcacaatgggtaatgacagctgcacactgtattcaaccaatgccagatcca  
**L I S A Q W V M T A A** **H C** **I Q P M P D P**  
 aagcagatggttttagtagcgttgggaagatactatagaaacttgggtggctcctgaagttcaa  
**K R W F V D V G R Y Y R N F G G P E V Q**  
 agaataaaactttcacaaattgttatacacccatcttacaataaaaaaatttacgcaat  
**R I K L S Q I V I H P S Y N K K I Y A N**  
 gacatagcactgttacgtctacaaaactccagctaatattagataatcgctcaggtacgact  
**D I A L L R L Q T P A N L D N R Q V R L**  
 tctccagttccacgtaatcctcatttatccgatttattaacagataatgttcagtgcatg  
**S P V P R N P H L S D L L T D N V Q** **C M**  
 gtcgctgggtggggagatacacataatacaggttcaaataatgatgttctaagacaagcagtt  
**V A G W G D T H N T G S N D V L R Q A V**  
 cttcctgtcattaattatgatctttgcaaatcatgggtatcaatatcttaataaagcaagc  
**L P V I N Y D L** **C** **K S W Y Q Y L N K A S**  
 ttttggctggatacaacaaggaggaattgatgcttgccaaggatagtgggggctcct  
**F C** **A G Y K Q G G I D A** **C** **Q G D** **S** **G G P**  
 ctattgtgttacgttgggggtcaaacagttcaagctggaattgtatcatggggcaacgat  
**L L C** **Y V G G Q T V Q A G I V S W G N D**  
 tgtgcaaaaccaaggaatccgggagtttataactaatgtggctatgttttctgactggat  
**C** **A K P R N P G V Y T N V A M F S D W Y**  
 tcaagtgttttgtaa  
 S S V L -

**Figure 15.** Nucleotide and protein sequence of SmSP1 show predicted **signal sequence**, **N-glycosylation sites**, **catalytic triad**, **cysteines forming disulfide bonds** and three domains **cup**, **LDLa** and **trypsin-like serine protease**.

Protein alignment of SmSP1, SmSP2, SmSP3, SmSP4, SmSP5, cercarial elastase, trypsin and chymotrypsin

	190	200	210	220	230	240
SmSP1	ITVNRTCDS	FEWKCPTSQCILKIWRCDG	FSDCSGSEDEIN	LSPLSKISR	LHSRQKRSV	
Chymotrypsin	-----VLSGLS-----					
Trypsin	-----VDDDD-----					
SmSP3	-----DIQMES-----					
SmSP4	-----EEELEFLDEINK-----					
SmSP2	YAEKRTCLNKTQCN	-----EYTG			QIKNLTNTCG	-----IR
SmSP5	-----MKLEY-----					
Elastasa	-----FERVS-----					
Prim.cons.	2222RTC222222CPTSQCILKIWRCDG	FSDCSG2E3E335L38LSK222LHSRQKR22				
	250	260	270	280	290	300
SmSP1	YDNEENWGRVVNGQPAPK	-GAWAFIVSLRFSG	---NGGHV	LAGSLISAQWVMTAAH	IQP	
Chymotrypsin	-----RIVNGEEAVP	-GSWPQVSLQDK	---TGFHF	CGSLINENWVVTAAH	IGVT	
Trypsin	-----KIVGGYTCGA	-NTVPYQVSLNSG	---YHF	CGSLINSQWVVSAAH	YKS	
SmSP3	-----RIIGGEISRP	-GQWPWMVSVREN	---DQFR	GASLISSQWLLTAAH	FPK	
SmSP4	-----NEEILEEIDSF	-IPPSLVYNYPDGS	---RRFHL	GGTLIHPQWIMTAAH	FFP	
SmSP2	KSDNQIMEKILGGKAVEP	-HSWPWAVRLSVKLP	RRRSVTF	GGTLIAPQWILTAAH	VLV	
SmSP5	-----RIQNGYPVNL	-GEFPMIVLLLGN	---THL	TGTIIAPDKILTAAH	ACG	
Elastasa	-----TWLVRKGEPEVQDRTEFPYIAFVRTER	-----T-M	GTGSLVSTRAVLTAAGH	ACG		
Prim.cons.	22222234RIV2GEPV8PRG2WPWIVSLRD34PRRRG2HFCG	GGSLISPQWVLTAAHC2C2				
	310	320	330	340	350	360
SmSP1	MPDP	-----KRWFVDVGRY	YRNFGGPEVQRIKLSQ	VIHPSYN	-----	
Chymotrypsin	TSD	-----VVVAGEFDQGS	SSEKIQKLI	AKVFNKSKYN	-----	
Trypsin	GIQ	-----VRLGEDNIN	VVEGNEQFISAKS	IVHPSYN	-----	
SmSP3	NINL	-----DNWTVHIGD	SYLDWTDSEEILMNI	SSILTHPNYRL	-----	
SmSP4	NPFYPHL	-----SANPSSWXV	RIGEHDMLNESMEHYDMSVAHVYVHPQYQS	-----		
SmSP2	ENKHIPVGGKPVMLADHMKSTIYAHLGDH	DRYKQEAQAIDHRVTVAILHPNYHR	-----			
SmSP5	DPTY	-----EVDIFDYVNGS	ISNHDELGGSPDISILMLNKKFH	-----		
Elastasa	PMP	-----VVQVSFLT	LRNGDQQGIHHQPSGVKVAPEYMP	SCTASRQ		
Prim.cons.	NPDY222GKPVMLA2222S5WVV33GEHD3NNGD	E22D32ISKVIVHP3YN4SCTASRQ				
	370	380	390	400	410	420
SmSP1	----KKIYANDIAL	LRLQTPANLDNRQVRLSPVPRNPHLSDLLTDNVQ	IMVAGWGDTHN			
Chymotrypsin	----SLTINNDITL	LKLSTAAFSQT	---VSAV-CLPSASDDFAAGTT	VT	TGWLTRY	
Trypsin	----SNTLNNDIML	LKLKSAASLNSR	---VA-SISLPTSCASAGTQ	ELISGWGNTKS		
SmSP3	----HKLYDYDYAL	LKIVSPIQYTSK	---RRPICILD	TTLMNTNELDR	YVAGWGSSED	
SmSP4	----ASSSGYDIAL	LKLTKPVKLGRY	---VNIACLPSAGEEIQPGQE	ISVGVGSEID		
SmSP2	----KLQTDGYDIAL	LRLSEPVKTTPE	---IDFACLPSKNL	KLTSNKKYAVGVG	SNKG	
SmSP5	----LSKGWIEIGL	LNYNYSMNDTQE	-----KEKNTDF	FVLF	GFEDKS	
Elastasa	RRRIRQTLSGFDIATVMLAQMVNLQSG	-----IRVISLPQASDIPTPGTDVFIVGYGRDDN				
Prim.cons.	RRRI222T2G2DIAL	LKLS2P2NLTS2QVR32PVACLPSASDKLT2GT2C2VVGWGSTK3				

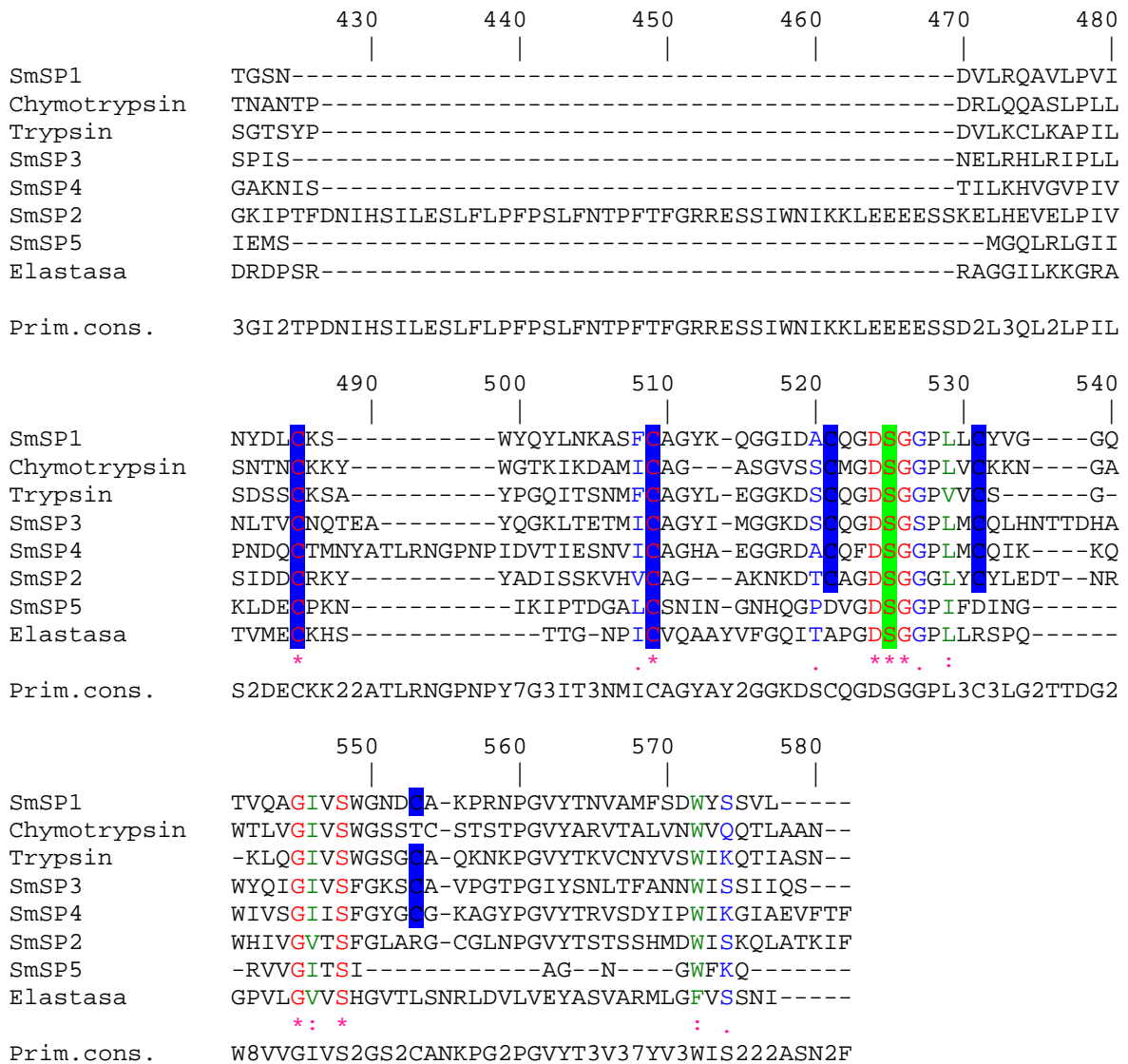

**Figure 16.** Protein alignment of SmSP1 with other studied proteases, cercarial elastase, trypsin and chymotrypsin (CLUSTALW multiple alignment, [http://npsa-pbil.ibcp.fr/cgi-bin/align\\_clustalw.pl](http://npsa-pbil.ibcp.fr/cgi-bin/align_clustalw.pl)) Alignment show homology in catalytic triad H,D,S (except for SmSP5 in which D is substituted by E), cysteines which form disulphide bonds, N-glycosylation sites do not occur in trypsin domain therefore not shown.



### 3.2 Transcriptomic study

#### 3.2.1. PCR screen

SmSP1 is consisted of three domains (cub, LDLr and trypsin). PCR screens revealed that differential expression of SmSP1 gene and it implies most probable splicing of cub and trypsin domains which are expressed separately in every stage. Whole SmSP1 mRNA transcript has been found in the eggs.

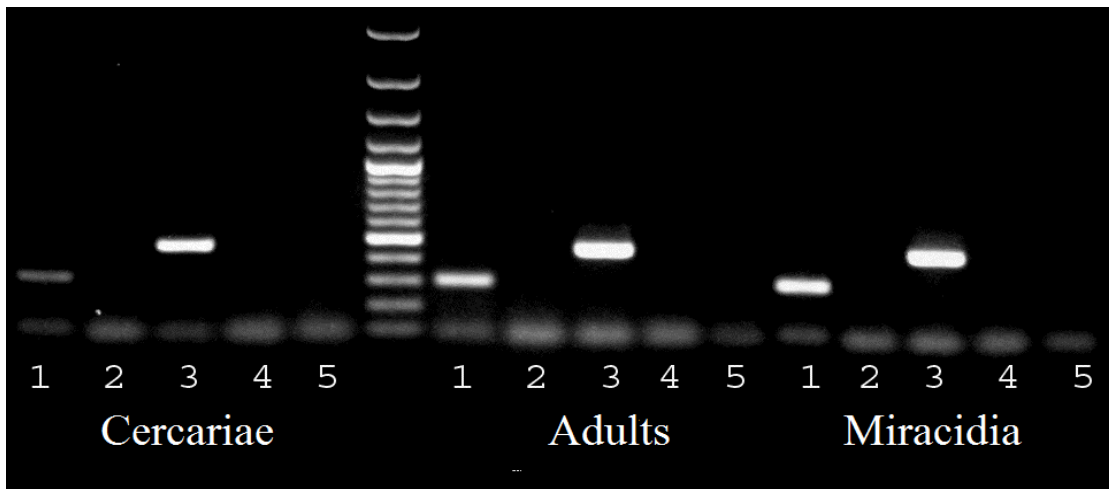

**Figure 17.** PCR screen of SmSP1 for cercariae, adults and miracidia 1.cub region, 2. cub-LDLa region, 3. trypsin region, 4. trypsin-LDLa region, 5. cub-LDLr-trypsin region. PCR was positive only separate cub and trypsin domain.

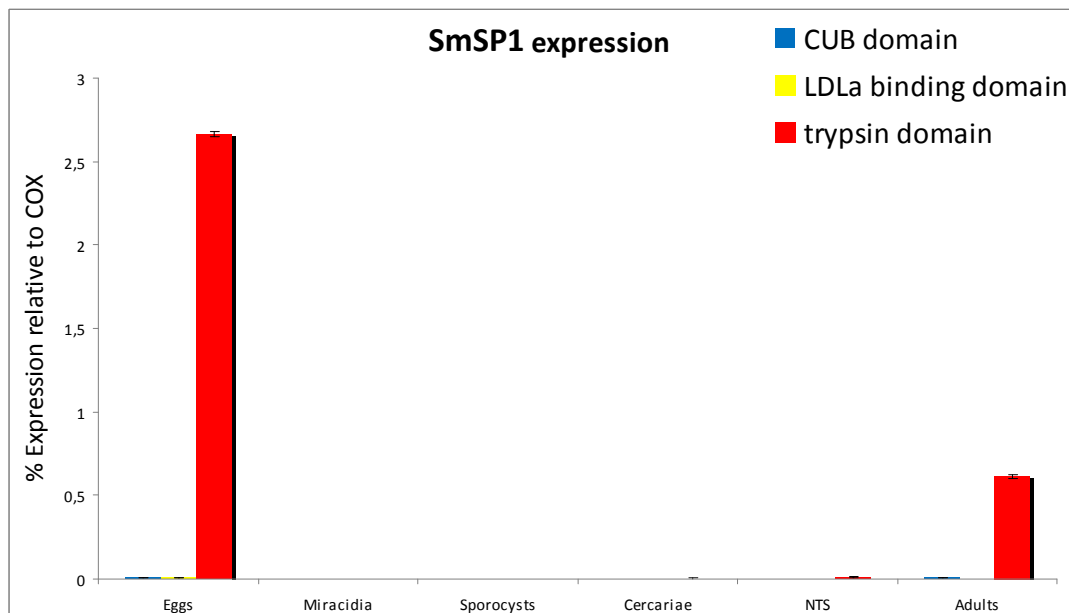

**Figure 18.** PCR screen of SmSP1 1. cub region, 2. cub-LDLa region, 3. trypsin region, 4. trypsin-LDLa region, 5. cub-LDLr-trypsin region. PCR products of NTS and sporocysts show

only expression of cub domain and trypsin domain. Only egg stage shows expression of all expression patterns – arrow indicates weak band representing the whole transcript.

### 3.2.2. Quantitative RT-PCR

The highest relative expression of trypsin domain is in egg stage and five times lower expression is in adult stage. In other stages, trypsin domain was barely expressed. Expression of cub and LDLa binding domain is also very low and in comparison with trypsin expression in egg or adult stage is negligible. Considered that high expression was identified only in egg stage, a specific function of SmSP1 is possible in this stage. Very similar results were obtained from qRT-PCR of other proteases. All studied protease showed high expression in egg stage. SmSP3 consists of cub and trypsin domain. Trypsin domain is highly expressed in egg stage, same as cub but cub expression is much lower than trypsin expression is in egg stage. SmSP5 has high expression in egg stage and low in adult stage. SmSP4 has high expression only in egg stage. In comparison, SmSP2 possess very high expression in the worms during mammalian infection, the highest during migration stage of schistosomula, more than 100% of highly expressed SmCOX.



**Figure 19.**qRT-PCR results of three domains of SmSP1 relative expression.

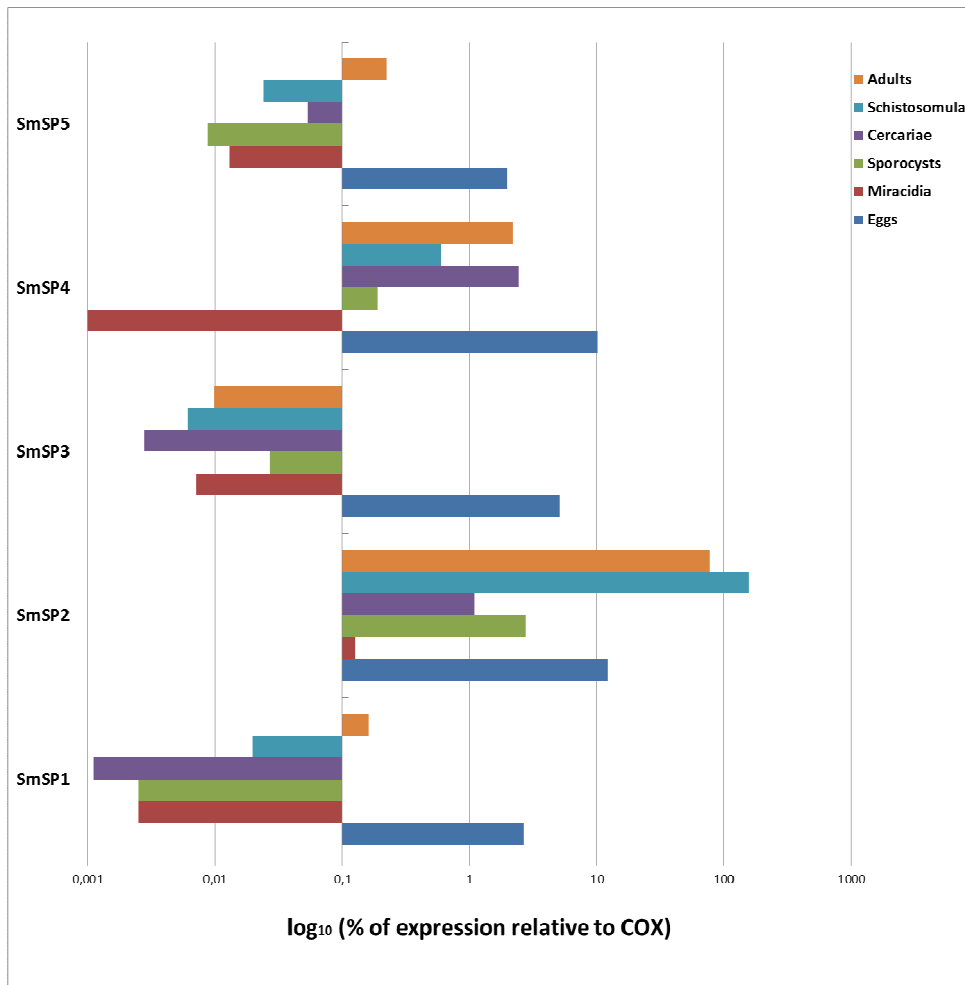

**Figure 20. Comparison of relative expression of SmSP1, SmSP2, SmSP3, SmSP4 and SmSP5 in all developmental stages.** Expression of SmSP1 in egg is average in comparison with other proteases but very low in other stage. These results imply that SmSP1 has a very specific function in egg stage. Similar function may have SmSP3 and SmSP5. SmSP2 and SmSP4 show high expression in almost all stages which imply they function is more general, maybe in metabolism. (Dvořák, Franta, Areola, unpublished data)

### 3.1.3. RNA interference (RNAi)

RNAi functioned best for SmPEP, expression knockdown was achieved with both dsRNA and siRNA. Another protease which was susceptible to RNAi is Smp\_141450 (SmSP5). SmSP1 did not respond for neither dsRNA nor siRNA.

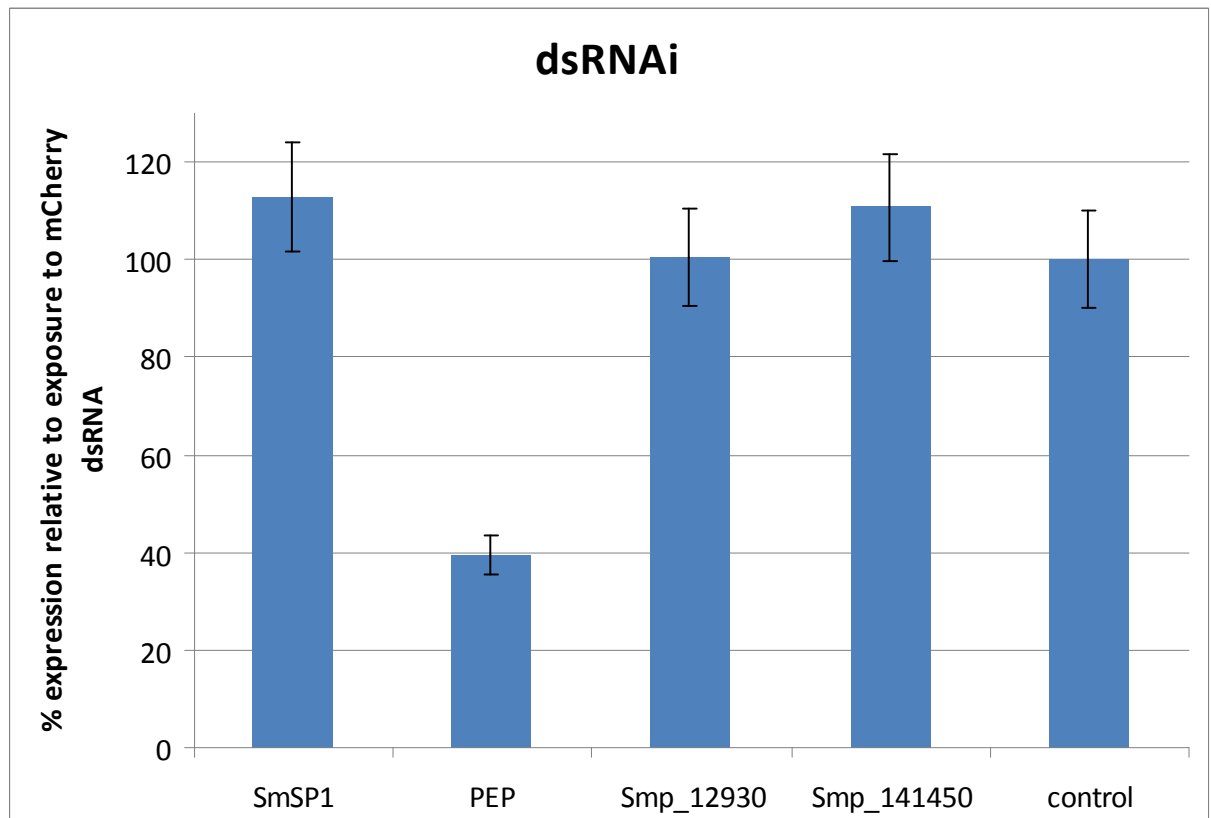

**Figure 21.** Results of dsRNAi against SmSP1, PEP, Smp\_12930 and Smp\_141450. The only significant knockdown, 60%, was achieved for PEP. mCherry was used as a control.

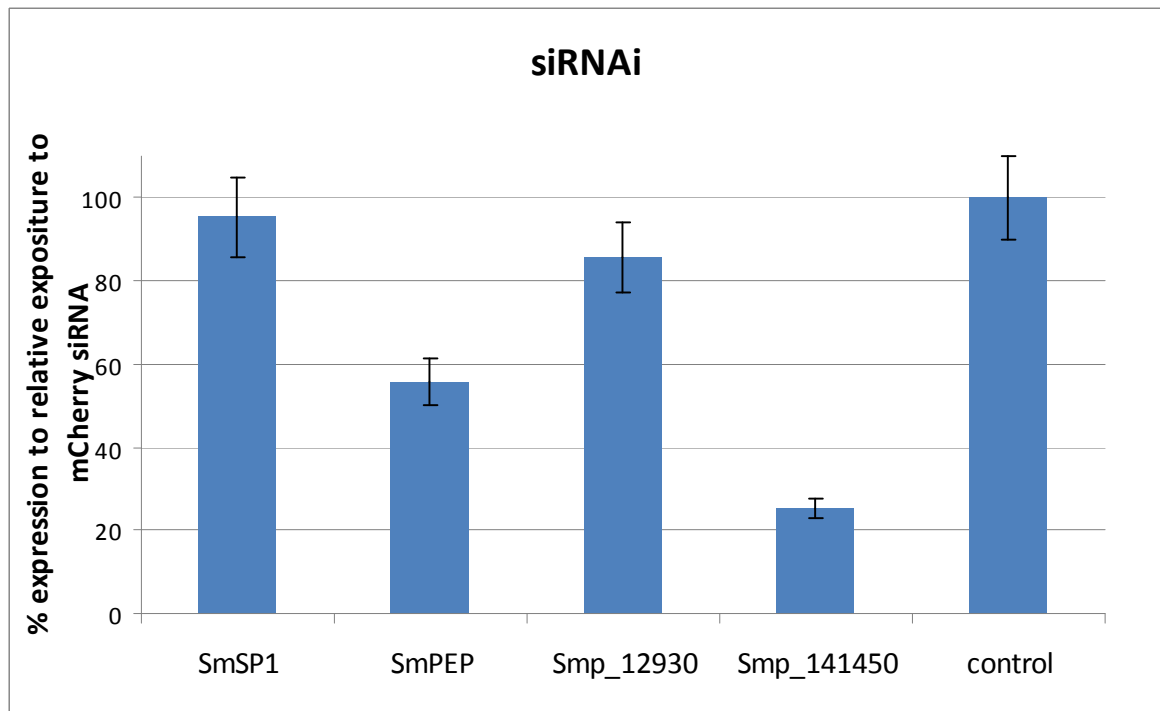
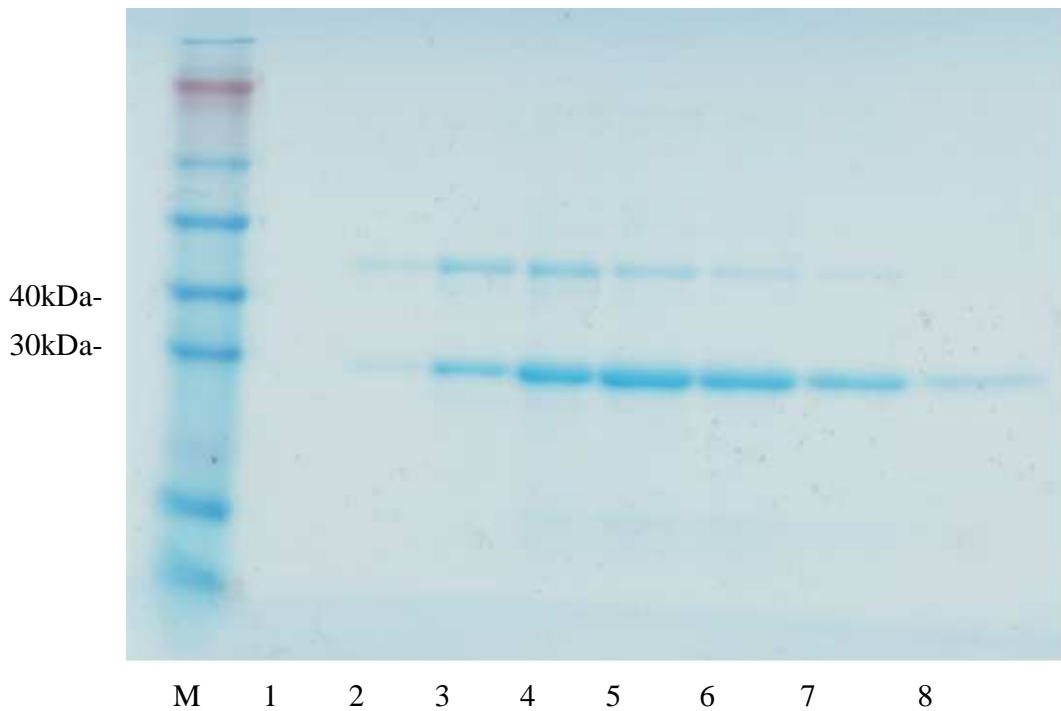

**Figure 22. siRNAi results of SmSP1, PEP, Smp\_12930 and Smp\_141450.** Significant knockdown was achieved only for PEP and Smp\_141450. mCherry was used as a control.

### 3.3. Proteomic part

#### 3.3.1 Expression in pET system

SmSP1 trypsin domain was successfully amplified, cloned into pET100 Directional TOPO® Expression Kit (Invitrogen) and transformed into DH5 $\alpha$  cells. SDS-PAGE confirmed that expressed protein has relevant weight 30kDa and Maldi TOF confirmed SmSP1 as a purified recombinant.



**Figure 23.4-12% SDS-PAGE (Invitrogen) analysis of SmSP1 elution from FCLP.** 1,2,3,4,5,6,7,8- purified SmSP1 recombinant in varying in amount. Lower band is expressed SmSP1. These results were later confirmed by MALDI TOF.

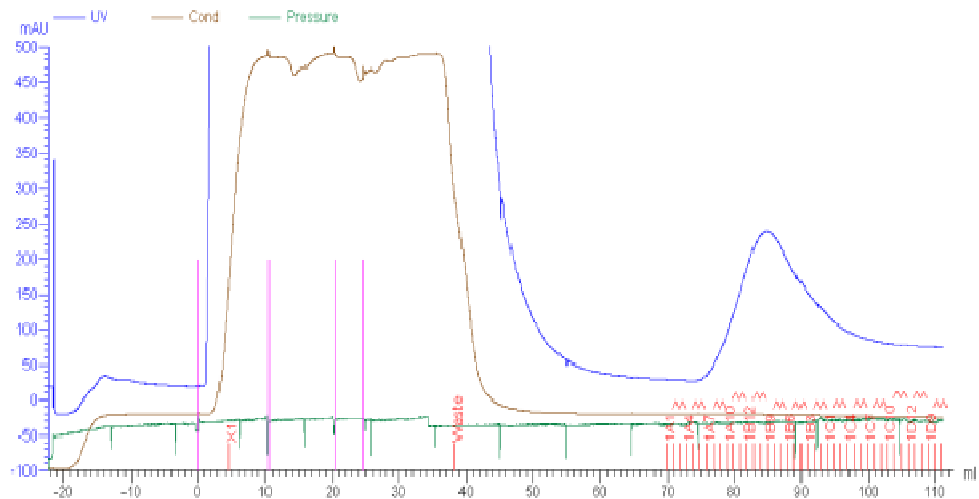

**Figure 24.FPLC purification of SmSP1 trypsin recombinant.** Blue line is absorption curve relevant to protein concentration and brown line is salt concentration. Elution phase is the blue peak on right side.

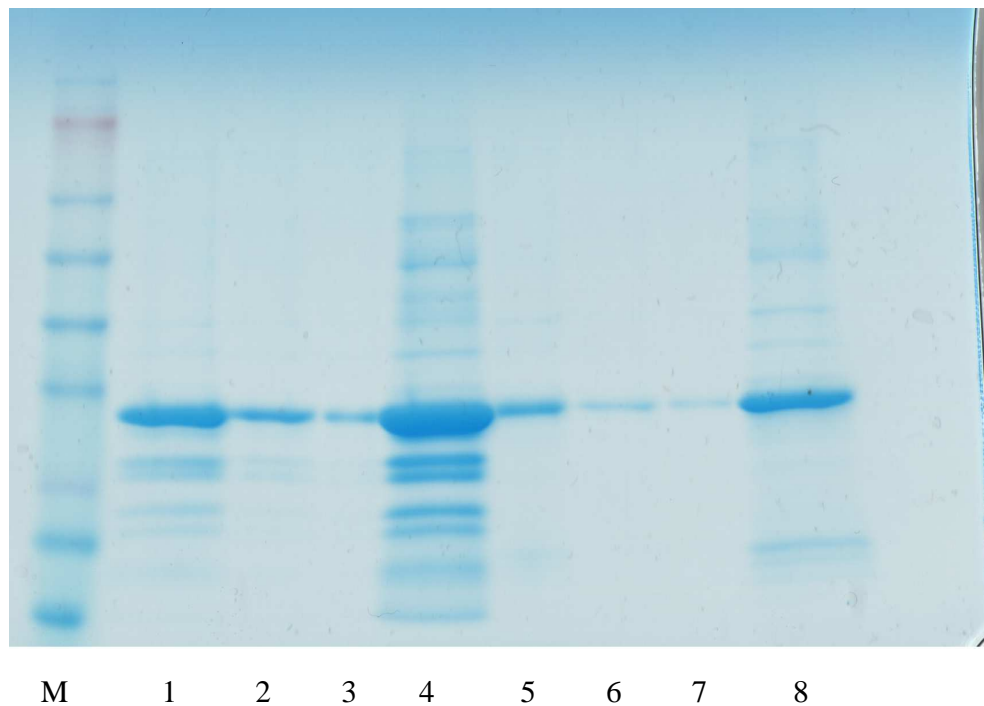
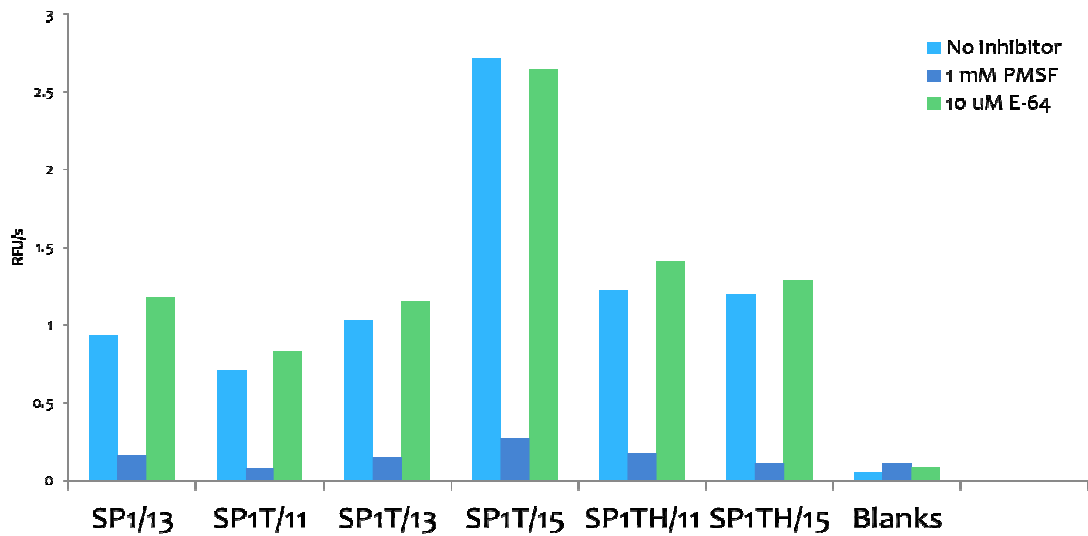

**Figure 25.4-12% SDS-PAGE (Invitrogen) of refolding of SmSP1 in 3.refolding buffer**

1,5-refolded recombinant 30 minutes time point; 2,6-refolded recombinant 60 minutes time point; 3,7-refolded recombinant 90 minutes; 4,8-recombinant which was not purified or refolded;

### 3.3.2 Expression in *Pichia pastoris*

SDS-PAGE and fluorimetric assay imply that expression of SmSP1 was successful in *Pichia pastoris* but the expression provides very low amount of active protein. The lack of active protein enables to confirm expression by Maldi TOF.



**Figure 26. Fluorimetric assay.** Selected colonies of *P. pastoris* which express active recombinant SmSP1. SP1 represent whole SmSP1, SP1T represent SmSP1 trypsin and SP1TH represent SmSP1 trypsin with his-tag. Fluorogenic peptidyl substrate, Z-Phe-Arg-AMC, was used as a substrate for activity measuring of secreted proteases. PMSF, serine protease inhibitor, and E-64, cysteine protease inhibitor, were employed to determine secreted proteases.

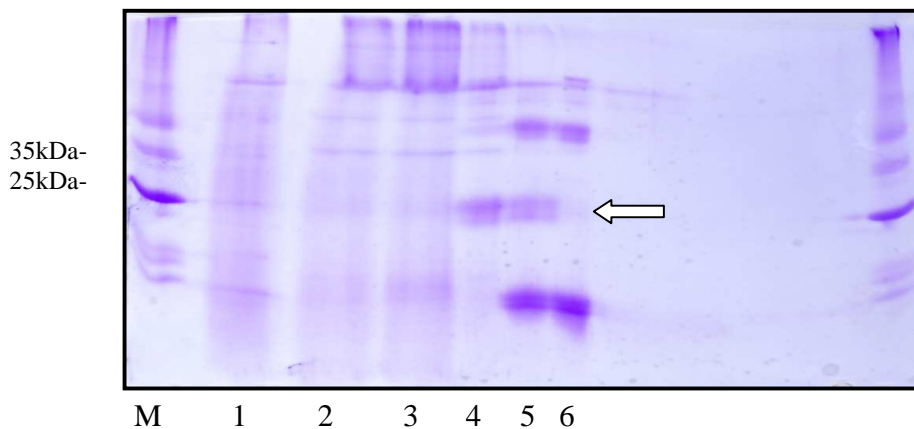

**Figure 27. SDS-PAGE of FPLC purified SmSP1 trypsin recombinant in *P. pastoris***  
 1-not purified recombinant, 2-wash, 3-second wash, 4-elution (125mM imidazole), 5-elution (250mM Imidazole), 6-elution (500mM imidazole)



### 3.3.3 Expression in SHuffle *Escherichia coli* and autoinduction media

Both expression experiments were supposed to provide refolded and proteolytically active protein located in their cytoplasm. Cytoplasm of both experiments were isolated and tested by SDS-PAGE and fluorimetric assay. Neither of them provided any evidence which proved that desired protease had been successfully expressed.

## **4. Discussion**

This thesis was planned as a part of bigger research project which aims to characterize a group of serine proteases of *S. mansoni*. The aim of this thesis was a complete characterization of SmSP1 and partial characterization of several chosen serine proteases involved in the research project. Apart from SmSP1 other SmSP proteases were never really investigated. SmSP1 was first studied in past by Cocude et al. In other study, trypsin domain of SmSP1 was expressed in *E. coli* and used as an antigen for immunization to gain antibodies for SmSP1 immunolocalization. This immunolocalization revealed that SmSP1 is located in schistosomula tegument and parenchyma of adult worms and schistosomula which suggested possible role of this enzyme in host-parasite interaction (Cocude et al., 1998). First part of my SmSP1 characterization is confirmation the previous experiments to SmSP1 expression, immunization and immunolocalization were successfully carried out and confirmed previous findings. Sequence alignment of 101 other serine proteases by ML analysis helped us categorize studied proteases according to their homology with the aim to determine common ancestors and their nearest relatives. It was found out that SmSP1 is an ortholog of plasminogen of *C. sinensis*, and their common ancestor is derived from vertebrates. This is in contrast with previous study in which SmSP1 most identical enzyme was determinate vampire plasminogen (42% identity, Cocude, 1997). Comparison of qRT-PCR results of SmSP1 with results of other proteases implies that SmSP1 (and also SmSP3 and SmSP5) is a protease with specific function especially in egg. Egg is protected by a shell to avoid damaging by immune system and nutrition are provided from energy sources inside the egg and the only aim of egg is an elicitation of inflammation. This inflammation helps the egg trap through the intestine to be excreted with feces so most of molecules secreted from egg should help stimulate immune response to evoke inflammation. Potentially, SmSP1 could be involved in this process. PCR screen revealed information that the whole SmSP1 protein is expressed solely in the egg stage.

The fact that SmSP1 contains LDL receptor could have a connection with the finding that eggs of *S. mansoni* secrete specific molecules with cholesterol lowering effect (Stanley et al., 2009). Such molecule is expressed only in egg stage because cholesterol lowering effect was observed only in mice exposed to *S. mansoni* egg (Stanley et al., 2009). This molecule is consisted of three specific domains 1) a domain with extracellular signal 2) a domain which specifically binds cholesterol transporting molecules and 3) a domain with proteolytic activity. Studied SmSP1 is a proper candidate for such cholesterol lowering molecule because fulfilled all mentioned requirements. It is expressed in egg stage and possesses an extracellular cub domain, LDL receptor and serine protease domain. The reason, why egg lowering concentration of LDL, could be to accelerate the creation of inflammation. Several types of immune cells are involved in inflammatory process such as macrophages and T lymphocytes. Macrophages and T lymphocytes ingest LDL with help of LDLa receptor on their surface (Boisvert et al., 1998). Macrophages with enhanced ability of uptake of LDL were found in mice exposed to *S. mansoni* eggs (Flamme et al., 2007) which is a consequence decreased LDL level in serum. If we consider that oxidized LDL enhances pro-inflammatory response of macrophages (Tits et al., 2011) so enhanced uptake of LDL into macrophages could contribute to acceleration of inflammatory response and help the egg to be released faster. On the other hand, it is hard to say if low expression of this protease could have so massive effect and decrease LDL level in the host.

Explanation of different transcript structure of SmSP1 in egg and other stages can be explained that SmSP1 transcript is processed by alternative splicing. Programs, which determinate type of alternative splicing (AL), were developed mainly for a few organisms such as human or mouse (Wang et al., 2005). To date, *C. elegans* is the only worm for which such software was constructed (Ramani et al., 2011). This fact makes impossible determinate whether or not SmSP1 is really processed by AL or what type of AL process SmSP1. Therefore RACE and similar experiments have potential to determinate exact expression and splice variants for particular domains.

RNA interference is a tool of specific gene silencing discovered in *C. elegans* with a wide range of organism, found in invertebrate, vertebrate and plants (Paddison et al., 2004). All compartments (Dicer, RISC or RNAase H enzyme Argonaute) involved in RNAi pathway

were found in Schistosome genome and transcriptome (Krauty-Peterson et al., 2008). These findings confirm that RNAi is functional in *S. mansoni* and can be applied in research under optimized conditions. During last decade, conditions under which RNAi works best were determined (Stefanic et al., 2010). This does not mean that RNAi works for every gene. RNAi efficiency varies from gene to gene in *S. mansoni* and every gene must be tested individually for RNAi effect (Stefanic et al., 2010). RNAi knockdown provides a few utilities. For fundamental research, RNAi can help to determine gene function if interesting and informative phenotype is provided. For applied research, the necessity of gene function for studied parasite can help to select potential targets for drug or vaccine. Another RNAi utility is potential development of RNAi-based drug (Pecot et al., 2011), even though RNAi therapy was experimentally used only against mice infected by *S. japonicum* (Pereira et al., 2008). RNAi experiments mentioned above were pilot studies to select which studied serine proteases are susceptible to RNAi. Proteases susceptible to RNAi turned out to be SmPEP, SmSP4 (Smp\_129230) and SmSP5 (Smp\_141450). The reason of failure of RNAi for SmSP1 could be a very low expression at NTS stage. NTS were used for RNAi experiments because RNAi is perfectly optimized their use and also because of their ease availability. Possible solution of SmSP1 testing for RNAi is to carry out experiments again with adults or with egg (Rinaldi et al., 2009) because of high expression in these stages.

Second part of my work was focused on protein expression. Expression of trypsin domain of SmSP1 was carried out to obtain expressed protein for two following applications, immunization and biochemical studies. SmSP1 trypsin domain was successfully expressed in *E. coli*, purified, solubilized and used for immunization. Refolding process which led to solubilized recombinant was carried out in three buffers but successful was in the last one which contained high amount of sucrose and L-Arginine. High amount of sucrose and L-arginin increased the osmotic pressure of the buffer and probably caused at least partial folding of the recombinant and led to the fact that the recombinant was soluble. SmSP1 trypsin domain possesses four cysteine bonds near to each other (Chapter 3.1). This fact could have led to a misfolding of recombinant and could also be the cause of impossibility to gain perfectly folded recombinant. To activate soluble recombinant, it was treated by four proteases which were supposed to digest pro-domain to activate recombinant because proteases are expressed as zymogens. Failure of this experiment could have been that recombinant was only partially

folded and activation was impossible. Another reason of failure might have been that buffer used for the assay was not optimal for this recombinant. Solution would be produced several mutants and optimization of refolding conditions.

Another approach to get correctly refolded and active protein was the use of autoinduction media and *E. coli* Shuffle. Shuffle *E. coli* is engineered K12 strain expresses disulfide bond isomerase DsbC. DsbC works as a chaperon which assists in the folding of proteins and also promotes correction of mis-oxidized proteins into their correct form (Chen et al., 1999). Autoinduction media were developed by Studier lab (Studier et al., 1990) to gain correctly folded protein in *E. coli*. This is supposed to be achieved by diauxic growth of *E. coli* under low temperature. These conditions result in slow and gradual protein production which should provide enough time for correct protein folding. Both expressions were carried out under low temperature for two days but SDS-PAGE and activity assay revealed that protein expression was not successful. There are several possible explanations for failure of these expressions. The first is that produced protein was not stable in *E. coli*. After folded protein is created, it could be degraded by *E. coli*. Second, produced protein needs eukaryotic refolding system components (Golgi apparatus, Endoplasmic reticulum) and even chaperone presence in Shuffle *E. coli* was not sufficient for correct folding. Absence of these components in bacterial cells makes production of eukaryotic folded protein difficult. Third, produced protein is immediately aggregated into inclusion bodies so there is not enough time for protein folding.

In case of the cause of activation failure was the absence of eukaryotic components, eukaryotic system was employed. Eukaryotic yeast *Pichia pastoris* could have provided active protease because it possesses cellular components necessary for correct protein folding and activation. This expression was designed to *P. pastoris* secrete expressed recombinant into medium. Such medium was lyophilized, purified and tested by SDS-PAGE and fluorimetric assay. SDS-PAGE of purified recombinant proved protein with relevant molecular weight and fluorimetric assay detected activity. Activity was inhibited by serine protease inhibitor but no inhibition was detected when cysteine protease inhibitor was used. These findings suggest that recombinant expression was successful but shortage of recombinant makes impossible to test recombinant by MALDI TOF. Optimization of expression conditions will be necessary step for confirmation of this recombinant and also for any further recombinant use. After enough

amount of active SmSP1 protease is gained, SmSP1 will be undergone by various biochemical analyses which should determinate functional features. Such analyses include PS-SCL (Positional scanning-synthetic combinatorial libraries) which is able to determinate % amino acid preference of P1-P4 position. Next important analyses are various assays which help to determinate pH optimum, substrate, kinetic and inhibition constants. Results of these experiments will help determinate protein function.

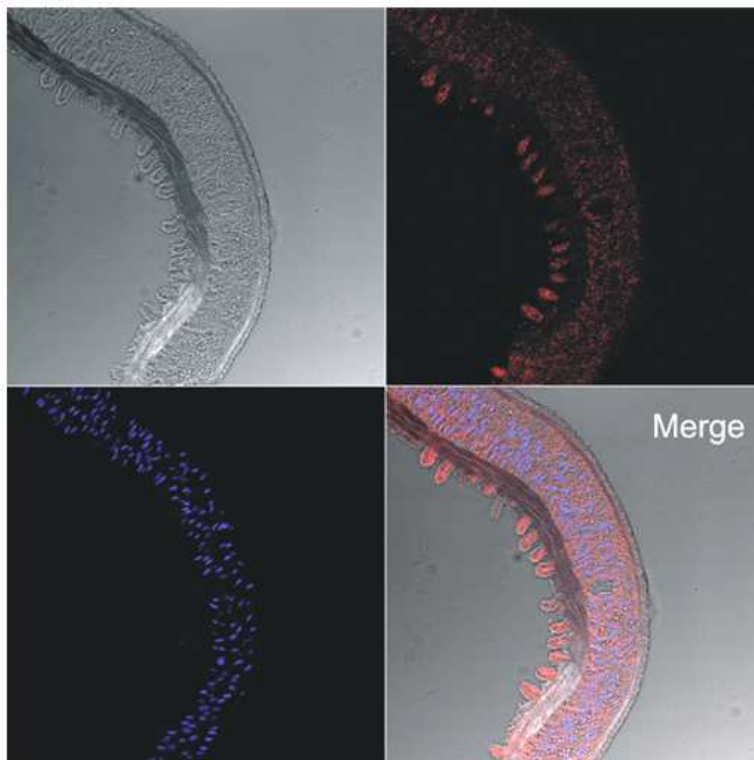

**Figure 28. Immunocalization of SmSP1 trypsin in *S. mansoni* adults** Anti-chickenSmSP1 (1/500) localized native SmSP1 using DAPI show positive signal in cuticle and parenchyma. This respond to Cocude's results (Cocude et al., 1998).

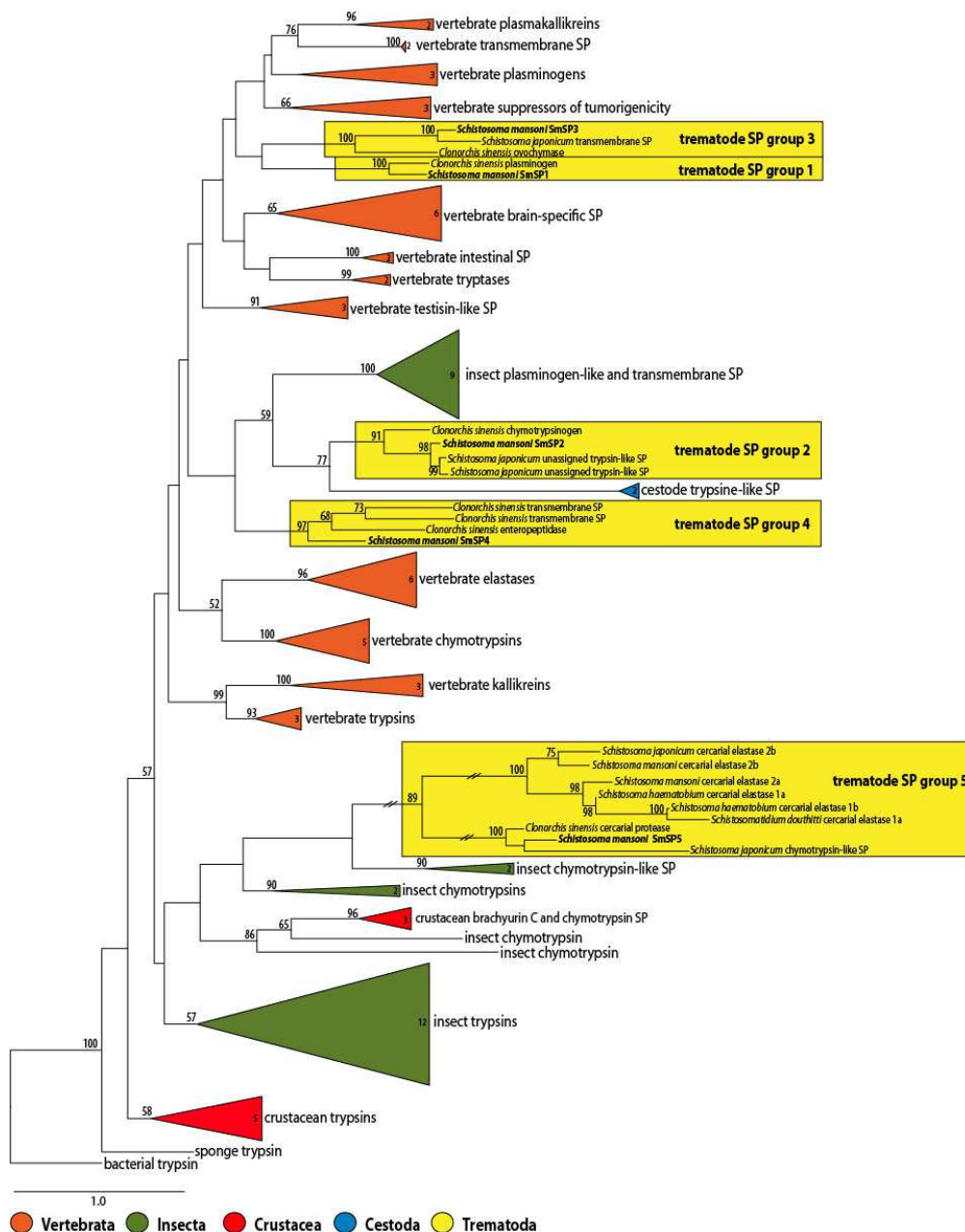

Fig. x. Maximum likelihood phylogenetic tree of 101 trypsin-like serine proteases (SP) with the emphasis on trematode serine proteases. Numbers in the collapsed branches (triangles) indicate number of included taxa. Nodal supports, calculated from 500 bootstrap replicates, shown at nodes. Bootstrap percentages with <50% support are not shown. Branches in the trematode SP group 5 marked by two diagonal lines shortened to one third of their original length. Bacterial trypsin (*Streptomyces griseus*) used as outgroup.

### Figure 29. ML analysis (Maximum Likelihood Analysis of Phylogenetic tree) of 101 serine proteases (Bartošová, Dvořák, unpublished data)

These data indicate that SmSP1 is an ortholog of plasminogen of *Clonorchis sinensis* and that they share the same ancestor from vertebrate.

## **5. Conclusion**

The aim of this thesis was a partial characterization of SmSP1. This characterization was performed by expression of recombinant and several molecular methods. SmSP1 was expressed in *E. coli*, purified, refolded used as an antigen for immunization. Several other expression systems were tested but only *P. pastoris* provided probably active protein. PCR screen revealed that the whole SmSP1 is expressed only in egg stage and the other stages produce only separated cub and trypsin domain. qRT-PCR revealed that highest expression of SmSP1 trypsin is in egg stage and lower expression is in adult stage. RNAi experiments gave us information that SmSP1 is not susceptible for RNAi in NTS. Main contribution of thesis was to lay the foundations for further follow-up research which could reveal actual function of SmSP1.

## **6.Literature**

- Aragon, A. D., Imani, R. A., Blackburn, V. R., Cupit, P. M., Melman, S. D., Goronga, T., ... & Cunningham, C. (2009). Towards an understanding of the mechanism of action of praziquantel. *Molecular and biochemical parasitology*, 164(1), 57-65.
- Asch, H. L. (1972). Rhythmic emergence of *Schistosoma mansoni* cercariae from *Biomphalaria glabrata*: Control by illumination. *Experimental Parasitology*, 31(3), 350-355.
- Bahia, D., Avelar, L. G. A., Vigorosi, F., Cioli, D., Oliveira, G. C., & Mortara, R. A. (2006). The distribution of motor proteins in the muscles and flame cells of the *Schistosoma mansoni* miracidium and primary sporocyst. *Parasitology*, 133(03), 321-32
- Baig, S., Damian, R. T., & Peterson, D. S. (2002). A novel cathepsin B active site motif is shared by helminth bloodfeeders. *Experimental parasitology*, 101(2), 83-89.
- Barrett AJ. Proteases. *Curr Protoc Protein Sci*. 2001; 21(21.1)
- Barrett, D. S., Chen, L., Litterman, N. K., & Walker, S. (2004). Expression and characterization of the isolated glycosyltransferase module of *Escherichia coli* PBP1b. *Biochemistry*, 43(38), 12375-12381.
- Bayne, C. J. (2009). Successful parasitism of vector snail *Biomphalaria glabrata* by the human blood fluke (trematode) *Schistosoma mansoni*: A 2009 assessment. *Molecular and biochemical parasitology*, 165(1), 8-18.
- Berriman, M., Haas, B. J., LoVerde, P. T., Wilson, R. A., Dillon, G. P., Cerqueira, G. C., ... & Wortman, J. (2009). The genome of the blood fluke *Schistosoma mansoni*. *Nature*, 460(7253), 352-358.
- Bogitsh, B. J. (1982). *Schistosoma mansoni*: Cytochemistry and morphology of the gastrodermal Golgi apparatus. *Experimental Parasitology*, 53(1), 57-67.
- Boisvert, W. A., Santiago, R., Curtiss, L. K., & Terkeltaub, R. A. (1998). A leukocyte homologue of the IL-8 receptor CXCR-2 mediates the accumulation of macrophages in atherosclerotic lesions of LDL receptor-deficient mice. *Journal of Clinical Investigation*, 101(2), 353.
- Boros, D. L. (1989). Immunopathology of *Schistosoma mansoni* infection. *Clinical Microbiology Reviews*, 2(3), 250-269.
- Bos, D., Mayfield, C., & Minchella, D. (2009). Analysis of regulatory protease sequences identified through bioinformatic data mining of the *Schistosoma mansoni* genome. *BMC genomics*, 10(1), 488.
- Botros, S. S., Seif el-Din, S. H., El-Lakkany, N. M., Sabra, A. N. A., & Ebeid, F. A. (2006). Drug-metabolizing enzymes and praziquantel bioavailability in mice harboring *Schistosoma mansoni* isolates of different drug susceptibilities. *Journal of Parasitology*, 92(6), 1344-1349.



Bowles, J., Blair, D., & McManus, D. P. (1995). A molecular phylogeny of the human schistosomes. *Molecular Phylogenetics and Evolution*, 4(2), 103-109.

Boyle, J. P., & Yoshino, T. P. (2005). Serotonin-induced muscular activity in *Schistosoma mansoni* larval stages: importance of 5-HT transport and role in daughter sporocyst production. *Journal of Parasitology*, 91(3), 542-550.

Brady, C. P., Brindley, P. J., Dowd, A. J., & Dalton, J. P. (2000). *Schistosoma mansoni*: Differential Expression of Cathepsins L1 and L2 Suggests Discrete Biological Functions for Each Enzyme. *Experimental parasitology*, 94(2), 75-83.

Brown, W. V., Dujovne, C. A., Farquhar, J. W., Feldman, E. B., Grundy, S. M., Knopp, R. H., ... & Samuel, P. (1986). Effects of fenofibrate on plasma lipids. Double-blind, multicenter study in patients with type IIA or IIB hyperlipidemia. *Arteriosclerosis, Thrombosis, and Vascular Biology*, 6(6), 670-678.

Cass, C. L., Johnson, J. R., Califf, L. L., Xu, T., Hernandez, H. J., Stadecker, M. J., ... & Williams, D. L. (2007). Proteomic analysis of *Schistosoma mansoni* egg secretions. *Molecular and biochemical parasitology*, 155(2), 84-93.

Caffrey, C. R., Steverding, D., Swenerton, R. K., Kelly, B., Walshe, D., Debnath, A., ... & May, B. C. (2007). Bis-acridines as lead antiparasitic agents: structure-activity analysis of a discrete compound library in vitro. *Antimicrobial agents and chemotherapy*, 51(6), 2164-2172.

Carvalho, O. S., Massara, C. L., Guerra, H. L., Campos, Y. R., Caldeira, R. L., Chaves, A., & Katz, N. (1998). Re-evaluation of schistosomiasis mansoni in Minas Gerais, Brazil. III. "Noroeste de Minas" mesoregion. *Revista do Instituto de Medicina Tropical de São Paulo*, 40(5).

Cass, C. L., Johnson, J. R., Califf, L. L., Xu, T., Hernandez, H. J., Stadecker, M. J., ... & Williams, D. L. (2007). Proteomic analysis of *Schistosoma mansoni* egg secretions. *Molecular and biochemical parasitology*, 155(2), 84-93.

Cetre, C., Cocude, C., Pierrot, C., Godin, C., Capron, A., Capron, M., & Khalife, J. (1998). In vivo expression of cytokine mRNA in rats infected with *Schistosoma mansoni*. *Parasite immunology*, 20(3), 135-142.

Chen, J., Song, J. L., Zhang, S., Wang, Y., Cui, D. F., & Wang, C. C. (1999). Chaperone activity of DsbC. *Journal of Biological Chemistry*, 274(28), 19601-19605.

Cocude, C., Pierrot, C., Cetre, C., Godin, C., Capron, A., & Khalife, J. (1997). Molecular characterization of a partial sequence encoding a novel *Schistosoma mansoni* serine protease. *Parasitology*, 115(04), 395-402.

- Cocude C, Pierrot C, Cêtre C, Fontaine J, Godin C, Capron A, Khalife J. (1998). Identification of a developmentally regulated *Schistosoma mansoni* serine protease homologous to mouse plasma kallikrein and human factor I. *Parasitology*, *118*, 389-396.
- Criscione, C. D., Valentim, C. L., Hirai, H., LoVerde, P. T., & Anderson, T. J. (2009). Genomic linkage map of the human blood fluke *Schistosoma mansoni*. *Genome biology*, *10*(6), R71.
- Curwen, R. S., Ashton, P. D., Sundaralingam, S., & Wilson, R. A. (2006). Identification of novel proteases and immunomodulators in the secretions of schistosome cercariae that facilitate host entry. *Molecular & Cellular Proteomics*, *5*(5), 835-844.
- Dalton, J. P., Skelly, P., & Halton, D. W. (2004). Role of the tegument and gut in nutrient uptake by parasitic platyhelminths. *Canadian journal of zoology*, *82*(2), 211-232.
- Davies, S. J., Grogan, J. L., Blank, R. B., Lim, K. C., Locksley, R. M., & McKerrow, J. H. (2001). Modulation of blood fluke development in the liver by hepatic CD4+ lymphocytes. *Science*, *294*(5545), 1358-1361.
- Delcroix, M., Sajid, M., Caffrey, C. R., Lim, K. C., Dvořák, J., Hsieh, I., ... & McKerrow, J. H. (2006). A multienzyme network functions in intestinal protein digestion by a platyhelminth parasite. *Journal of Biological Chemistry*, *281*(51), 39316-39329.
- Donnelly, S., Dalton, J., & Loukas, A. (2005). Proteases in helminth-and allergen-induced inflammatory responses.
- Dorsey, C. H., Cousin, C. E., Lewis, F. A., & Stirewalt, M. A. (2002). Ultrastructure of the *Schistosoma mansoni* cercaria. *Micron*, *33*(3), 279-323.
- Dvořák, J., Mashiyama, S. T., Braschi, S., Sajid, M., Knudsen, G. M., Hansell, E., ... & McKerrow, J. H. (2008). Differential use of protease families for invasion by schistosome cercariae. *Biochimie*, *90*(2), 345-358.
- Ekici, Ö. D., Paetzel, M., & Dalbey, R. E. (2008). Unconventional serine proteases: variations on the catalytic Ser/His/Asp triad configuration. *Protein Science*, *17*(12), 2023-2037.
- El-Ansary, A. (2003). Biochemical and immunological adaptation in schistosome parasitism. *Comparative Biochemistry and Physiology Part B: Biochemistry and Molecular Biology*, *136*(2), 227-243.
- Fenwick, A., Savioli, L., Engels, D., Robert Bergquist, N., & Todd, M. H. (2003). Drugs for the control of parasitic diseases: current status and development in schistosomiasis. *Trends in parasitology*, *19*(11), 509-515.
- La Flamme, A. C., Harvie, M., Kenwright, D., Cameron, K., Rawlence, N., Low, Y. S., & McKenzie, S. (2007). Chronic exposure to schistosome eggs reduces serum cholesterol but has no effect on atherosclerotic lesion development. *Parasite immunology*, *29*(5), 259-266.

Ghaffar, Abdul and Gregory Brower. "Parasitology – Chapter Six: Trematodes (Flukes)." Microbiology and Immunology Online. University of South Carolina School of Medicine, 15 Apr 2010

Gryseels, B., Polman, K., Clerinx, J., & Kestens, L. (2006). Human schistosomiasis. *The Lancet*, 368(9541), 1106-1118.

Haas, W., & Schmitt, R. (1982). Characterization of chemical stimuli for the penetration of *Schistosoma mansoni* cercariae. *Zeitschrift für Parasitenkunde*, 66(3), 293-307.

Haeberlein, S., & Haas, W. (2008). Chemical attractants of human skin for swimming *Schistosoma mansoni* cercariae. *Parasitology research*, 102(4), 657-662.

Hansell, E., Braschi, S., Medzihradsky, K. F., Sajid, M., Debnath, M., Ingram, J., ... & McKerrow, J. H. (2008). Proteomic analysis of skin invasion by blood fluke larvae. *PLoS neglected tropical diseases*, 2(7), e262.

He YX, Hsu SY, Hsu HF, Clarke WR (1984) [Immunogenicity of secretion materials of the acetabular glands of *Schistosoma mansoni* cercariae]. *Ji Sheng Chong Xue Yu Ji Sheng Chong Bing Za Zhi* 2(3):176-8

Hockley, D. J. (1973). Ultrastructure of the tegument of *Schistosoma*. *Adv Parasitol*, 11(0), 233-305.

Jang-Lee, J., Curwen, R. S., Ashton, P. D., Tissot, B., Mathieson, W., Panico, M., ... & Haslam, S. M. (2007). Glycomics analysis of *Schistosoma mansoni* egg and cercarial secretions. *Molecular & Cellular Proteomics*, 6(9), 1485-1499.

Jones, M. K., Bong, S. H., Green, K. M., Holmes, P., Duke, M., Loukas, A., & McManus, D. P. (2008). Correlative and dynamic imaging of the hatching biology of *Schistosoma japonicum* from eggs prepared by high pressure freezing. *PLoS neglected tropical diseases*, 2(11), e334.

Jourdane, J. (1982). Study of the mechanisms of rejection in incompatible mollusk-schistosome pairs from infestations by means of a natural route or by microsurgical transplantations of parasitic stages]. *Acta tropica*, 39(4), 325.

Kalbe, M., Haberl, B., & Haas, W. (1996). *Schistosoma mansoni* miracidial host-finding: species specificity of an Egyptian strain. *Parasitology research*, 82(1), 8-13.

Krautz-Peterson, G., & Skelly, P. J. (2008). *Schistosoma mansoni*: The dicer gene and its expression. *Experimental parasitology*, 118(1), 122-128.

Le, T. H., Humair, P. F., Blair, D., Agatsuma, T., Littlewood, D. T., & McManus, D. P. (2001). Mitochondrial gene content, arrangement and composition compared in African and Asian schistosomes. *Molecular and biochemical parasitology*, 117(1), 61.

Levy, M. G., & Read, C. P. (1975). Purine and pyrimidine transport in *Schistosoma mansoni*. *The Journal of parasitology*, 627-632.

Lockyer, A. E., Jones, C. S., Noble, L. R., & Rollinson, D. (2000). Use of differential display to detect changes in gene expression in the intermediate snail host *Biomphalaria glabrata* upon infection with *Schistosoma mansoni*. *Parasitology*, *120*(04), 399-407.

Loker, E. S. (1983). A comparative study of the life-histories of mammalian schistosomes. *Parasitology*, *87*(Pt 2), 343-369.

Mahmoud, K. M., Sobh, M. A., El - Agroudy, A. E., Mostafa, F. E., El Baz, M., Shokeir, A. A., & Ghoneim, M. A. (2001). Impact of schistosomiasis on patient and graft outcome after renal transplantation: 10 years' follow - up. *Nephrology Dialysis Transplantation*, *16*(11), 2214-2221.

Major, B., Kardos, J., Kékesi, K. A., Lőrincz, Z., Závodszy, P., & Gál, P. (2010). Calcium-dependent conformational flexibility of a CUB domain controls activation of the complement serine protease C1r. *Journal of Biological Chemistry*, *285*(16), 11863-11869.

Marikovsky, M., Arnon, R., & Fishelson, Z. (1990). *Schistosoma mansoni*: localization of the 28 kDa secreted protease in cercaria. *Parasite immunology*, *12*(4 - 5), 389-401.

Mathieson, W., Castro-Borges, W., & Wilson, R. A. (2011). The proteasome-ubiquitin pathway in the *Schistosoma mansoni* egg has development-and morphology-specific characteristics. *Molecular and biochemical parasitology*, *175*(2), 118-125.

Mathieu, A. P., Lavigne, P., & LeHoux, J. G. (2002). Molecular modeling and structure-based thermodynamic analysis of the StAR protein. *Endocrine research*, *28*(4), 419-423.

May, P., Woldt, E., Matz, R. L., & Boucher, P. (2007). The LDL receptor-related protein (LRP) family: an old family of proteins with new physiological functions. *Annals of medicine*, *39*(3), 219-228.

McKerrow, J., & Salter, J. (2002). Invasion of skin by *Schistosoma cercariae*. *Trends in parasitology*, *18*(5), 193-195.

McKerrow, J. H., Doyle, P. S., Engel, J. C., Podust, L. M., Robertson, S. A., Ferreira, R., ... & Craik, C. S. (2009). Two approaches to discovering and developing new drugs for Chagas disease. *Memórias do Instituto Oswaldo Cruz*, *104*, 263-269.

McLaren, M. L., Long, E. G., Goodgame, R. W., & Lillywhite, J. E. (1979). Application of the enzyme linked immunosorbent assay (ELISA) for the serodiagnosis of *Schistosoma mansoni* infections in St. Lucia. *Transactions of the Royal Society of Tropical Medicine and Hygiene*, *73*(6), 636-639.

Mentink-Kane, M. M., Cheever, A. W., Thompson, R. W., Hari, D. M., Kabatereine, N. B., Vennervald, B. J., ... & Wynn, T. A. (2004). IL-13 receptor  $\alpha$  2 down-modulates granulomatous inflammation and prolongs host survival in schistosomiasis. *Proceedings of the National Academy of Sciences of the United States of America*, *101*(2), 586-590.

- Meuleman, E. A., Holzmann, P. J., & Peet, R. C. (1980). The development of daughter sporocysts inside the mother sporocyst of *Schistosoma mansoni* with special reference to the ultrastructure of the body wall. *Zeitschrift für Parasitenkunde*, 61(3), 201-212.
- Michaels, R. M., & Prata, A. (1968). Evolution and characteristics of *Schistosoma mansoni* eggs laid in vitro. *The Journal of parasitology*, 921-930.
- Neill, P. J., Smith, J. H., Doughty, B. L., & Kemp, M. (1988). The ultrastructure of the *Schistosoma mansoni* egg. *The American journal of tropical medicine and hygiene*, 39(1), 52.
- Neurath, H. (1957). Some considerations of the multiple specificity of proteolytic enzymes. *Annals of the New York Academy of Sciences*, 68(1), 11-24.
- Nuttman, C. J. (1971). The fine structure of ciliated nerve endings in the cercaria of *Schistosoma mansoni*. *The Journal of Parasitology*, 855-859.
- Okamoto, T., & Minamikawa, T. (1999). Molecular cloning and characterization of Vigna mungo processing enzyme 1 (VmPE-1), an asparaginyl endopeptidase possibly involved in post-translational processing of a vacuolar cysteine endopeptidase (SH-EP). *Plant molecular biology*, 39(1), 63-73.
- Paddison, P. J., Cleary, M., Silva, J. M., Chang, K., Sheth, N., Sachidanandam, R., & Hannon, G. J. (2004). Cloning of short hairpin RNAs for gene knockdown in mammalian cells. *Nature methods*, 1(2), 163-167.
- Pan, S. C. (1996). *Schistosoma mansoni*: the ultrastructure of larval morphogenesis in *Biomphalaria glabrata* and of associated host-parasite interactions. *Japanese journal of medical science & biology*, 49(4), 129.
- Pan, X. Q., & Gou, Q. (1985). Ornithine metabolism in *Schistosoma japonicum*: synthesis of polyamines and proline]. *Ji sheng chong xue yu ji sheng chong bing za zhi= Journal of parasitology & parasitic diseases*, 3(2), 107.
- Pearce, E. J., Hall, B. F., & Sher, A. L. A. N. (1990). Host-specific evasion of the alternative complement pathway by schistosomes correlates with the presence of a phospholipase C-sensitive surface molecule resembling human decay accelerating factor. *The Journal of Immunology*, 144(7), 2751-2756.
- Pearce, E. J., M Kane, C., Sun, J., J Taylor, J., McKee, A. S., & Cervi, L. (2004). Th2 response polarization during infection with the helminth parasite *Schistosoma mansoni*. *Immunological reviews*, 201(1), 117-126
- Pereira, T. C., Pascoal, V. D. B., Marchesini, R. B., Maia, I. G., Magalhaes, L. A., Zanotti-Magalhaes, E. M., & Lopes-Cendes, I. (2008). < i> *Schistosoma mansoni*</i>: Evaluation of an RNAi-based treatment targeting HGPRTase gene. *Experimental parasitology*, 118(4), 619-623.
- Perry, S. E., Robinson, P., Melcher, A., Quirke, P., Bühring, H. J., Cook, G. P., & Blair, G. E. (2007). Expression of the CUB domain containing protein 1 (CDCP1) gene in colorectal tumour cells. *FEBS letters*, 581(6), 1137-1142.

- Protasio, A. V., Tsai, I. J., Babbage, A., Nichol, S., Hunt, M., Aslett, M. A., ... & Berriman, M. (2012). A systematically improved high quality genome and transcriptome of the human blood fluke *Schistosoma mansoni*. *PLoS neglected tropical diseases*, 6(1), e1455.
- Rabello, A. L., Garcia, M. M. A., da Silva, R. A. P., Rocha, R. S., Chaves, A., & Katz, N. (1995). Humoral immune responses in acute schistosomiasis mansoni: relation to morbidity. *Clinical infectious diseases*, 21(3), 608-615.
- Howells, R. E., Ramalho-Pinto, F. J., Gazzinelli, G., De Oliveira, C. C., Figueiredo, E. A., & Pellegrino, J. (1974). *Schistosoma mansoni*: Mechanism of cercarial tail loss and its significance to host penetration. *Experimental Parasitology*, 36(3), 373-385.
- Rawlings, N. D., & Barrett, A. J. (1993). Evolutionary families of peptidases. *Biochemical Journal*, 290(Pt 1), 205.
- Rawlings, N. D., Barrett, A. J., & Bateman, A. (2012). MEROPS: the database of proteolytic enzymes, their substrates and inhibitors. *Nucleic acids research*, 40(D1), D343-D350.
- Rinaldi, G., Morales, M. E., Alrefaei, Y. N., Cancela, M., Castillo, E., Dalton, J. P., ... & Brindley, P. J. (2009). RNA interference targeting leucine aminopeptidase blocks hatching of *Schistosoma mansoni* eggs. *Molecular and biochemical parasitology*, 167(2), 118-126.
- Rollinson, D. (1985). Biochemical genetics in the study of schistosomes and their intermediate hosts. *Parassitologia*, 27(1-2), 123.
- A.G. Ross, P.B. Bartley, A.C. Sleight, G.R. Olds, Y. Li, G.M. Williams, D.P. McManus (2002). Schistosomiasis *N. Engl. J. Med.*, 346, 1212–1220.
- Rumjanek, F. D., Campos, E. G., & Luis Carlos, C. A. (1988). Evidence for the occurrence of LDL receptors in extracts of schistomula of *Schistosoma mansoni*. *Molecular and biochemical parasitology*, 28(2), 145-152.
- Saule, P., Adriaenssens, E., Delacre, M., Chassande, O., Bossu, M., Auriault, C., & Wolowczuk, I. (2009). Early variations of host thyroxine and interleukin-7 favor *Schistosoma mansoni* development. *J Parasitol.*, 88(5):849-55.
- Schechter, I., & Berger, A. (1967). On the size of the active site in proteases. I. Papain. *Biochemical and biophysical research communications*, 27(2), 157.
- Schramm, G., Mohrs, K., Wodrich, M., Doenhoff, M. J., Pearce, E. J., Haas, H., & Mohrs, M. (2007). Cutting edge: IPSE/alpha-1, a glycoprotein from *Schistosoma mansoni* eggs, induces IgE-dependent, antigen-independent IL-4 production by murine basophils in vivo. *The Journal of Immunology*, 178(10), 6023-6027.
- Salter, J. P., Choe, Y., Albrecht, H., Franklin, C., Lim, K. C., Craik, C. S., & McKerrow, J. H. (2002). Cercarial elastase is encoded by a functionally conserved gene family across multiple species of schistosomes. *Journal of Biological Chemistry*, 277(27), 24618-24624.

- Samuelson, J. C., & Caulfield, J. P. (1985). The cercarial glycocalyx of *Schistosoma mansoni*. *The Journal of cell biology*, 100(5), 1423-1434.
- Sato, H., Kusel, J. R., & Thornhill, J. (2002). Functional visualization of the excretory system of adult *Schistosoma mansoni* by the fluorescent marker resorufin. *Parasitology*, 125(06), 527-535.
- Schutte, C.H.J., (1974). Studies on the South African strain of *Schistosoma mansoni*. Part 2. The intra-molluscan larval stages. *South African J. Sci.*, 70: 327-46
- Schutte, C.H.J., (1975). Studies on the South African strain of *Schistosoma mansoni*. Part 3. Notes on certain host-parasite relationships between intra-molluscan larvae and intermediate host. *South African J. Sci.*, 71: 8-20
- Sher, A., Hall, B. F., & Vadas, M. A. (1978). Acquisition of murine major histocompatibility complex gene products by schistosomula of *Schistosoma mansoni*. *The Journal of experimental medicine*, 148(1), 46-57.
- Skelly, P. J., & Shoemaker, C. B. (1996). Rapid appearance and asymmetric distribution of glucose transporter SGTP4 at the apical surface of intramammalian-stage *Schistosoma mansoni*. *Proceedings of the National Academy of Sciences*, 93(8), 3642-3646.
- Skelly, P. J., & Alan Wilson, R. (2006). Making sense of the schistosome surface. *Advances in parasitology*, 63, 185-284.
- Stanley, R. G., Jackson, C. L., Griffiths, K., & Doenhoff, M. J. (2009). Effects of *Schistosoma mansoni* worms and eggs on circulating cholesterol and liver lipids in mice. *Atherosclerosis*, 207(1), 131-138.
- Štefanić, S., Dvořák, J., Horn, M., Braschi, S., Sojka, D., Ruelas, D. S., ... & Caffrey, C. R. (2010). RNA interference in *Schistosoma mansoni* schistosomula: selectivity, sensitivity and operation for larger-scale screening. *PLoS neglected tropical diseases*, 4(10), e850.
- Studier, F. W., Rosenberg, A. H., Dunn, J., & Dubendorff, J. W. (1990). Use of T7 RNA polymerase to direct expression of cloned genes. *Methods in enzymology*, 185, 60-89.
- Stuiver, P. C. (1984). Acute schistosomiasis (Katayama fever). *British Medical Journal (Clinical research ed.)*, 288(6412), 221.
- Tielens, A. G., Horemans, A., Dunnewijk, R., van der Meer, P., & van den Bergh, S. G. (1992). The facultative anaerobic energy metabolism of *Schistosoma mansoni* sporocysts. *Molecular and biochemical parasitology*, 56(1), 49-57.
- Le, T. H., Humair, P. F., Blair, D., Agatsuma, T., Littlewood, D. T., & McManus, D. P. (2001). Mitochondrial gene content, arrangement and composition compared in African and Asian schistosomes. *Molecular and biochemical parasitology*, 117(1), 61.
- Sulaiman SM, Hakim MA, Amin MA. (1982) The location of *Schistosoma haematobium* (Gezira strain, Sudan) in three experimental animal hosts. *Trans R Soc Trop Med Hyg.*, 76(1):129.

Verwaerde, C., Auriault, C., Neyrinck, J. L., & Capron, A. (1988). Properties of serine proteases of *Schistosoma mansoni* schistosomula involved in the regulation of IgE synthesis. *Scandinavian journal of immunology*, 27(1), 17-24.

Wahab, M. A., Warren, K. S., & Levy, R. P. (1971). Function of the thyroid and the host-parasite relation in murine schistosomiasis mansoni. *Journal of Infectious Diseases*, 124(2), 161-171.

Webster, B. L., Southgate, V. R., & Littlewood, D. T. J. (2006). A revision of the interrelationships of *Schistosoma* including the recently described *Schistosoma guineensis*. *International journal for parasitology*, 36(8), 947-955.

Wilson, R. A., & Coulson, P. S. (1986). *Schistosoma mansoni*: dynamics of migration through the vascular system of the mouse. *Parasitology*, 92(01), 83-100.

Wilson, R. A., & Barnes, P. E. (1974). An in vitro investigation of dynamic processes occurring in the schistosome tegument, using compounds known to disrupt secretory processes. *Parasitology*, 68(2), 259-270.

Wright, C. A., & Bennett, M. S. (1967). Studies on *Schistosoma haematobium* in the laboratory I.A strain from Durban, Natal, South Africa. *Transactions of the Royal Society of Tropical Medicine and Hygiene*, 61(2), 221-227.