

**CZECH UNIVERSITY OF LIFE SCIENCES PRAGUE**

**FACULTY OF ENVIRONMENTAL SCIENCES**



**MASTER OF SCIENCE (M.Sc.) THESIS**

**Application of Urban Stormwater Drainage Design and Modelling  
Based on High Resolution Satellite Technology**

**SUPERVISOR:** Doc. Ing. Jakub Štibinger, CSc.

**AUTHOR:** Kashif Hussain

**PRAGUE, 2016**

# CZECH UNIVERSITY OF LIFE SCIENCES PRAGUE

Faculty of Environmental Sciences

## DIPLOMA THESIS ASSIGNMENT

Kashif Hussain

Land and Water Management

Thesis title

**Application of Urban Stormwater Drainage Design & Modelling Based on High Resolution Satellite Technology.**

---

### Objectives of thesis

1. Improvement the quality of Urban Drainage Modelling and Simulation using High Resolution Satellite Image and Topographic Maps.
2. IDF curve derivation for short duration rainfall from daily data
3. Peak flow assessment using Hydraulic Toolbox and SWMM
4. To Use the Hydrological Simulation Model for Estimation or assessing the hydraulic capacity of the Urban Drainage System

### Methodology

The Satellite Technology combining with ArcGIS is used for determination of the following component,

1. Landuse Classification of the Study Area
2. Demarcation and computation Drainage Area, Slope and catchment physical parameter.
3. Flow Pattern

The detailed methodology for urban hydrological modelling and hydraulic capacity based gevin below,

1. Calculation of the Surface Runoff by HEC-HMS or Epa-SWMM
2. Design of Drains Hydraulic Capacity, its bottom slope profile by HEC-RAS

**The proposed extent of the thesis**

40 – 60 pages

**Keywords**

Flow carrying capacity, GIS, Maximum Likelihood Classification, Parameters, QuickBird, Rational Method,

---

**Recommended information sources**

- I. Chow & V. T., "Handbook of Applied Hydrology". McGraw-Hill, New York, 1964.
- II. Paul Meylan, Anne-Catherine Favre and Andre Musy., "Text Book Predictive Hydrology A Frequency Analysis Approach", 2012. <https://books.google.cz/books?id=MjvOBQAAQBAJ&pg> (2015)
- III. Bhaskar, J., & Suribabu, C. (2014). Estimation of Surface Run-off for Urban Area Using Integrated Remote Sensing and GIS Approach. Jordan Journal of Civil Engineering, Volume 8, No. 1, pp70-80.
- IV. Akan, A., & Houghtalen, R. (2003). Urban Hydrology, Hydraulics, and Stormwater Quality. John Wiley & Sons Inc.

---

**Expected date of thesis defence**

2015/16 SS – FES

**The Diploma Thesis Supervisor**

doc. Ing. Jakub Štibinger, CSc.

**Supervising department**

Department of Land Use and Improvement

**Advisor of thesis**

prof. Pavel Kovář

Electronic approval: 15. 4. 2015

**prof. Ing. Petr Sklenička, CSc.**

Dean

Prague on 12. 04. 2016

## **Declaration**

It is truly declared that this thesis is the requirement of Master degree with specialization in Land and Water Management, Faculty of Environmental Sciences Czech University of Life Science, Prague Czech Republic. It is furthermore stated that the thesis is purely based on my own research and no material was plagiarized from previously published work.

Prague, 2016

.....  
Kashif Hussain

## **Acknowledgement**

I could find no words to express my deepest sense of gratitude to Almighty “*ALLAH*” whose blessings cannot be even counted. He is the most compassionate and merciful. Who knows what was there in the universe, what is and what will be. He has enabled me to elucidate a drop from existing ocean of knowledge. Millions of blessings and mercies of ALLAH are upon *Holy Prophet Muhammad (Peace Be Upon Him)*, the city of knowledge, who guided the humanity from darkness of ignorance to the light of awareness.

I feel highly privileged in taking this opportunity to express my sincerest thanks to my supervisor Professor Doc. Ing. Jakub Štibinger, CSc. This thesis was not possible without his inspiration, enthusiasm, encouragement, constant help and support. I also express my sincere gratitude to him for always been available for detail discussion in conducive environment of learning.

I am highly indebted to Inj. Lukáš Pospíšil for study guidance, motivational financial support arrangement and preparation of supporting documents on demand for training, scientific workshop and visa.

The study period in Faculty of Environmental Sciences is most wonderful part of my life which was not possible without prayers of family and their encouragement. There were number of ups and down during my whole study period but unaccounted support from my father, brothers and wife has given me strength to fulfill this piece of work.

I cannot forget my school teachers for the support and motivation of study carrier. Finally I thank on directly and indirectly supports of preparation thesis of my all friends in Pakistan and also in Czech Republic.

Finally, I pray to Almighty ALLAH for the development of Pakistan and enhancement of humanity values.

## **Abstract**

The urban stormwater runoff and water quantity management issues could not be resolvable without identification of drainage area and accurate flow networks. Therefore, the urban watersheds hydrology is totally different when compared with natural environments and it requires advance evaluation techniques. In the absence of high resolution rainfall data, empirical reduction formula is used for daily rainfall data conversion into short duration rainfall data sets. Extreme type-1 distribution method is used for frequency analysis, and derivation intensity duration frequency (IDF) curve. In this study the catchment delineation was performed by combining ArcGIS core application (including geoprocessing surface modeling and Spatial Analyst extension), high resolution remote sensing data and field observations. Due to area extent limitation for Rational Method, the selected catchments were divided into sub-catchments of area less than 80.9 ha or equal. The GIS and RS methodology was developed for determination of Rational Method and stormwater management model (SWMM) parameterization in a large urban catchment. The calculation of low resolution sub-catchment parameterization is the more challenging part and has many uncertainties factor involved. Few parameters such as runoff coefficient 'C' Curve Number 'CN' overland flow manning's roughness 'n' and imperviousness is directly related to land use type. Thus, land use type classification was performed using Quick Bird satellite image adopting the Maximum Likelihood Classification (MLC) method and determined seven land use types of each catchment. For surface runoff modelling this study consist of two models, first Rational Method is used to estimate the surface runoff of selected catchments. In second part Stormwater Management Model (SWMM) is also used to estimate the surface runoff. The SWMM model runoff results are compared to Rational Method. Comparatively surface runoff values calculated by Rational Method are much higher than calculated surface runoff values by SWMM. The Hydraulic Flow carrying capacity was determined by continuity equation and compared with surface runoff values calculated by above described methods. The Shahi Katha drain has much higher flow carrying capacity. The Airport Tehkal Payain and University Road Tehkal Bala drains flow carrying capacity was very low in comparison to calculated flow values with some bottle necks because of bridge and irregular section shapes presence. Thus, both drains are causing flood hazards in urban area. The flood hazards might be controlled or managed by

increasing the drains size and replacement of irregular sections into rectangular proper sections.

**Keywords:** Flow carrying capacity, GIS, Maximum Likelihood Classification, Parameters, QuickBird, Rational Method, Stormwater, SWMM,

## Anotace

Řešení problematiky odtoku vody z přívalových dešťů a regulace množství vody by nebyly možné bez správné identifikace drenážního území a sítě toků. Z tohoto důvodu je tzv. urbánní hydrologie zcela odlišná od řešení hydrologických otázek v přírodním prostředí a vyžaduje pokročilé metody hodnocení. V případě, že chybějí data o srážkách s vysokým rozlišením, je obvyklé použít empirický vzorec pro konverzi dat s denním časovým krokem do podrobnějšího časového rozlišení. Pro frekvenční analýzu a odvození IDF křivek (intenzita, doba trvání a frekvence opakování) se používá metoda založená na extrémálním rozdělení 1.typu. V této studii bylo vymezení povodí provedeno pomocí aplikace ArcGIS (včetně modelování povrchu za použití geoprocessingu a rozšíření Spatial Analyst), dat z dálkového průzkumu Země s vysokým rozlišením a terénních pozorování. Vybraná povodí byla rozdělena do dílčích povodí o ploše 80,9 ha nebo menší kvůli omezení prostorového rozsahu racionální metody. Byla vyvinuta metodika pro určení parametrů racionální metody a modelu Stormwater Management Model (SWMM) ve velkém urbanizovaném povodí. Výpočet parametrů dílčích povodí s nízkým rozlišením je náročnější částí a zahrnuje v sobě mnoho nejistot. Několik parametrů jako koeficient odtoku "C", číslo CN křivky (Curve Number) "CN", Manningův součinitel drsnosti pro plošný odtok "n" a nepropustnost přímo souvisí s typem využití území. Proto byla provedena klasifikace za využití satalitních snímků QuickBird. Byla použita metoda založená na klasifikaci podle maximální podobnosti (MLC) a výsledkem je rozlišení sedmi typů využití území pro každé povodí. Pro modelování povrchového odtoku byly v této studii použity dva modely: racionální metoda se používá pro odhad povrchového odtoku z vybraných povodí a model SWMM je také použit pro odhad povrchového odtoku. Výstupy modelu SWMM jsou porovnávány s výsledky racionální metody. Srovnatelné hodnoty získané racionální metodou jsou mnohem vyšší než hodnoty povrchového odtoku získané z modelu SWMM. Hydraulická unášecí kapacita toku byla získaná z rovnice kontinuity a porovnána s hodnotami vypočítanými výše uvedenými metodami. Tok z Shahi Katha má mnohem vyšší unášecí kapacitu toku. Toky z letiště Tehkal Payain a univerzity Road Tehkal Bala mají velmi nízkou unášecí kapacitu ve srovnání s vypočtenými hodnotami toku (za použití "bottlenecks"). Důvodem je přítomnost mostu a nepravidelné profily koryta. Obě drenážní území tedy způsobují povodňové riziko v urbanizované oblasti.



Povodňová rizika mohou být snížena či řízena pomocí zvýšení odvodnění a nahrazení nepravidelných profilů patřičnými pravidelnými profily.

**Klíčová slova:** unášecí kapacita toku, GIS, klasifikace podle maximální podobnosti, parametry, QuickBird, racionální metoda, přívalová voda, SWMM,

## Table of Content

<b>DECLARATION.....</b>	<b>I</b>
<b>ACKNOWLEDGEMENT.....</b>	<b>II</b>
<b>ABSTRACT .....</b>	<b>III</b>
<b>ANOTACE.....</b>	<b>V</b>
<b>1. CHAPTER ONE INTRODUCTION .....</b>	<b>1</b>
1.1 GENERAL INTRODUCTION .....	1
1.2 PROBLEM STATEMENT .....	3
1.3 OBJECTIVE OF THE STUDY.....	4
<b>2. CHAPTER TWO LITERATURE REVIEW .....</b>	<b>5</b>
2.1 GENERAL CONCEPTS OF STORMWATER AND MANAGEMENT.....	5
2.2 THE CATCHMENT AND THE REGIONAL WATER BALANCE.....	6
2.3 PRECIPITATION MEASUREMENT .....	7
2.4 EFFECTS OF URBAN DEVELOPMENT.....	8
2.5 EVAPOTRANSPIRATION ON URBAN AREAS.....	10
2.6 INFILTRATION REDUCTION CAUSED BY IMPERVIOUS SURFACES .....	10
2.7 SURFACE AND SUB-SURFACE FLOW.....	11
2.8 PREVENTIVE AND CORRECTIVE ACTION.....	12
2.9 STRUCTURAL COMPONENTS OF DRAINAGE SYSTEM .....	12
2.10 ENVIRONMENTS AND ECOLOGY .....	13
2.11 URBAN RAINFALL-RUNOFF MODELLING.....	14
2.12 URBAN DRAINAGE HISTORY AND DESIGN APPROACH.....	15
2.13 STORMWATER MANAGEMENT COMPUTER MODEL SWMM .....	16
2.13.1 Environment compartment .....	16
2.13.2 Hydrologic soil groups.....	18
2.13.3 SWMM surface runoff simulation process .....	20
2.14.4 Parameters sub-catchment and calibrating SWMM .....	20
<b>3. CHAPTER THREE METHODOLOGY.....</b>	<b>22</b>
3.1 DESCRIPTION OF THE STUDY AREA.....	22
3.1.1 Study area boundary .....	22
3.1.2 Existing stormwater drainage and sanitation system.....	23

3.2 DATA COLLECTION AND INSTITUTION .....	24
3.3 GEOGRAPHIC INFORMATION SYSTEM (GIS) APPROACH .....	27
3.3.1 Image classification tools .....	27
3.3.2 Maximum likelihood classification .....	28
3.4 DAILY RAINFALL CONVERSION AND DATA ANALYSIS .....	29
3.4.1 Empirical equation for Intensity duration frequency (IDF) curve.....	30
3.4.2 Statistical probability distribution fitting and frequency analysis .....	30
3.5 SURFACE PEAK DISCHARGE MODELLING .....	32
3.5.1 Rational method characteristics .....	33
3.5.2 Rational method limitations:.....	34
3.5.3 Use of the Rational Method.....	34
3.5.3.1 Runoff coefficient .....	34
3.6 CURVE NUMBER INFILTRATION METHOD.....	36
3.6.1 CN METHOD PARAMETERS.....	40
3.7 DRAINAGE CAPACITY MEASUREMENT & DESIGN METHOD .....	41
3.7.1 Continuity equation.....	41
3.7.2 Manning's equation .....	41
<b>4. CHAPTER FOUR RESULTS.....</b>	<b>43</b>
4.1 DETAILED CATCHMENTS DELINEATION.....	43
4.2 CATCHMENT SUBDIVISION .....	44
4.3 LAND USE CLASSIFICATION.....	47
4.4 INTENSITY DURATION FREQUENCY (IDF) CURVES .....	49
4.4.1 Design rainfall and frequency analysis .....	49
4.4.2 IDF curves derivation .....	50
4.5 PEAK SURFACE RUNOFF ASSESSMENT RATIONAL METHOD.....	53
4.6 PEAK RUNOFF SIMULATION USING SWMM .....	59
4.6.1 Sub-catchment parameterization.....	60
4.6.1.1 Flow Width .....	60
4.6.1.2 Sub-catchment slope .....	63
4.6.1.3 Sub-catchment imperviousness.....	65
4.6.1.4 Manning's roughness coefficient for overland flow .....	68
4.6.1.5 Depression storage .....	69
4.6.1.6 Infiltration .....	69

4.6.2 SWMM simulation .....	70
4.6.3 Detail summary GIS and surface flow peak simulations.....	74
4.7 HYDRAULIC FLOW CAPACITY ANALYSIS .....	75
<b>5. CHAPTER FIVE DISCUSSION .....</b>	<b>81</b>
<b>6. CHAPTER SIX CONCLUSIONS .....</b>	<b>82</b>
<b>REFERENCES.....</b>	<b>86</b>
<b>APPENDIX-I .....</b>	<b>96</b>

## **Abbreviations**

BMPS- Best Management Practices

CDOT- Colorado Department of Transportation

DEM- Digital Elevation Model

EPA SWMM- Environment Protection Agency Stormwater Management Model

FHWA-Federal Highway Administration's

GIS-Geographic Information System

GPS-Global Position System

GSP- Geological Survey of Pakistan

IDF- Intensity Duration Frequency

IDP- Internally Displaced People

KP- Khyber Pakhtunkhwa

NDC-National Development Consultant

NRCS- Natural Resources Conservation Service

MLC- Maximum Likelihood Classification

PMD-Pakistan Meteorological Department

RS-Remote Sensing

SMADA-Storm water Management and Design Aid

SUDAS- Statewide Urban Design and Specifications

TMA- Tehsil Municipal Administration

UCs-Union Council's

USDA-United States Department of Agriculture

USGS- United States Geological Survey

WWTP- Waste Water Treatment Plants

## List of Figure

Figure 1: Serious flooding in Peshawar (2013). .....	3
Figure 2: Effects of imperviousness on urban water cycle (Bernard and Tuttle, 1998). .....	7
Figure 3: Urbanization effect on peak rate of runoff (Butler & Davies , 2011). .....	9
Figure 4: Conceptual view of surface runoff in SWMM (Rossman & Huber, 2016). .....	11
Figure 5: USDA standard soil triangle, with Hydrologic Soil Groups for distributives soil texture.....	19
Figure 6: Location of Study Area.....	22
Figure 7: Condition of Stormwater drainage network system. ....	24
Figure 8: Daily maximum rainfall of study area.....	25
Figure 9: Annual maximum accumulative rainfall of study area.....	25
Figure 10: QuickBird image of study area.....	26
Figure 11: A flowchart of the methodology GIS work of the study. ....	27
Figure 12: Initial abstraction, continuing abstraction and direct surface scheme. ....	37
Figure 13: Selected drains network and catchments in the study area.....	44
Figure 14: Sub-catchments, flow routes and pour point. ....	46
Figure 15: Size distribution of the sub-catchment of selected drains. ....	47
Figure 16: Land use classification Shahi Katha drain (image on the left), Airport Tehkal Payain drain (image in centre) and University Road Tehkal Bala drain (image one right). .....	48
Figure 17: Rainfall intensity duration log-log graph.....	51
Figure 18: Log-log graph for determination of Sherman Equation constant ‘b’. ....	51
Figure 19: IDF curves for study area .....	52
Figure 20: Shahi Katha drains sub-catchment flow length and flow width.....	62
Figure 21: Airport Tehkal Payain drains sub-catchment flow length and flow width. .....	62
Figure 22: University Road Tehkal Bala drain sub-catchment flow length and flow width.....	63
Figure 23: Mean hydrologic slope of sub-catchment (a) Shahi Katha drain, (b) Airport Tehkal Payain drain and (c) University Road Tehkal Bala drain.....	65
Figure 24: Shahi Katha drain sub-catchment imperviousness values uses in SWMM model.....	66

Figure 25: Airport Tehkal Payain drain sub-catchment imperviousness values used in SWMM model.....	67
Figure 26: University Road Tehkal Bala drain sub-catchment imperviousness values used in SWMM model. ....	67
Figure 27: Overland flow roughness Shahi Katha drain (right), Airport Tehkal Payain drain (centre) and University Road Tehkal Bala drain (left). ....	68
Figure 28: Shahi Katha drain structure of the SWMM model. ....	71
Figure 29: Airport Tehkal Payain drain structure of the SWMM model. ....	71
Figure 30: University Road Tehkal Bala drain structure of the SWMM model. ....	72
Figure 31: Shahi Katha drain surface runoff hydrograph generated by SWMM routing techniques for 2 hour design storm of 2-yr and 5-yr return period. ....	73
Figure 32: Airport Tehkal Payain drain surface runoff hydrograph generated by SWMM routing techniques for 2 hour design storm of 2-yr and 5-yr return period. ....	73
Figure 33: University Road Tehkal Bala drain surface runoff hydrograph generated by SWMM routing techniques for 2 hour design storm of 2-yr and 5-yr return period. ....	74
Figure 34: Bottle neck cross section for bridge. ....	77
Figure 35: Bottle neck cross section for bridge. ....	79

## List of Table

Table 1: The preventive and corrective action plane (Sheafer et al. 1982).....	12
Table 2: Hydrologic Soil Groups and meaning (NRCS, 2009 Chapter, 7).....	19
Table 3: Generalized design criteria return period for urban flood control structure (CDOT, drainage design Manuals, chapter-7 hydrology, 2004).....	32
Table 4: Typical Recommended Runoff Coefficient (CDOT, drainage design Manuals, chapter-7 hydrology, 2004). .....	36
Table 5: Geometric elements of hydraulic efficient sections without freeboard. ....	42
Table 6: Area of land use .....	48
Table 7: The design rainfall intensity (mm/hr) for different durations by Extreme Type-I distribution .....	50
Table 8: Calculated surface peak flow of Shahi Katha drain for 2-yr and 5-yr recurrence intervals. ....	54
Table 9: Calculated surface peak flow of Airport Tehkal Payain drain for 2-yr and 5-yr recurrence intervals.....	56
Table 10: Calculated surface peak flow of University Road Tehkal Bala drain for 2-yr and 5-yr recurrence intervals. ....	58
Table 11: Calculated, weighted Curve Number and soil drying time.....	70
Table 12: Detail summary GIS and surface flow peak simulations.....	75
Table 13: Shahi Katha drains calculated flow velocity, hydraulic flow capacity and Surface flow peak results comparisons.....	76
Table 14: Airport Tehkal Payain drain calculated flow velocity, hydraulic flow capacity and Surface flow peak results comparisons.....	78
Table 15: University Road Tehkal Bala drains calculated flow velocity, hydraulic flow capacity and Surface flow peak results comparisons.....	80



## **1. Chapter One Introduction**

### **1.1 General Introduction**

Geographic information system and high resolution satellite image are widely using tools in urban drainage modeling. The calculation of weighted coefficients using high resolution satellite image is easier than manual land cover survey. The Construction of stormwater drains and its capacity of carrying storm rain in urban area are affected by human activities. Watershed boundary which was produced by ground surveys in an urban area is totally different as to natural watershed because changes of impervious surfaces. The field survey in large especially unplanned urban areas can be rather complex or costly and tumultuous to daily human activities (Tammy & James, 2014). The urban stormwater and sewerage water contain many particles which need treatment before disposing in receiving elements, it depend on many different raw water source at initial stage such as, water transportation and distribution network to purification plant, and there drainage systems can be found throughout world (Schütze et al, 2003).

Due to grievous storm flood urban areas bear property damage and financial losses; because urban area has vital opportunity for best life and it is also the mid-point of population movement, property and many other resources. There was in past and recent years, many cities, villages have been submerged by storm flood (Zhifeng Li et al, 2014). Surface flow, surface retention physical process and transportation of surface along discriminately tract are crucial elements for urban flood modeling. Such urban flood modeling required terrain data of high quality (Boonya-aroonnet, 2008). The hydrological rendition Digital elevation model (DEM) is a particular term for flow direction and it is code in each raster DEM cell which represents stream order route of water flow. The limitation every cell of raster DEM is conterminous with surrounding cells in eight directions. The distance between a given and neighbors cell used estimation relief which represent flow direction (Pourali et al., 2014).

An effectual functioning drainage system design contempt exploitation over the year which remains a substantial challenge. Change of climate and urbanization by

specific impacts has been vast acknowledged which could increase in the frequency implicated substantive and urban floods magnitude in vast regions of the world (Zhou, 2014). There are set of empirical parameters which is important tools for hydrological models or conceptual models and used calibration filed measured urban surface runoff could not provide the permission to modular regurgitate runoff hydrodynamic behavior and used in drainage network model as input (Henonin et al., 2010).

The calculation of precise urban runoff for urban planning and water resources management is very critical at all stages. There was used of Geographic Information System (GIS) and remote sensing technologies during over past increasing the care of worth monitoring estimation runoff from urban watershed (Bhaskar & Suribabu, 2014). An environment is complicated in nature due to efficiency of drainage network. This complex nature solution and control of drainage network efficiency requires enough planning engineer experience, skill and reliable data. In general many complicated problem particularly terrain related problems dealing which could be easy to used Geographical information system (GIS) tools (Mohan Rao et al., 2013). Stream vestige adopts the slope as proper flowing direction. Direction of main channel is demark using both elevation and accumulation of flow which was easily measured to Digital elevation model (DEM) because it is better and more easy than previous traditional approaches of steepest slope measuring method. Remote sensing and GIS application shared some several directions in the calculation of slope for stream direction (Jasiewicz & Metz, 2011). Classification of routing procedures divides into two subjects such as hydrologic and hydraulic. The solutions of equation have a closed relation to hydrologic models, while numerical integration of difference approaches with a finite element require usually for hydrological models. There were continuity equation practices and many other mathematical relationships between stream discharge and storage solved by common hydrological models. The relationship between discharge and storage can be either linear or nonlinear (Akram et al., 2014).

## 1.2 Problem statement

The urban and rivers flooding in Pakistan is a major social and economic problem caused by heavy rainfall fall during monsoon but Peshawar city is not situated in monsoon region. The major flood is generated in Peshawar city (figure 1) from hill torrents and western rainfall storm. Due to rapid increasing urbanization, population and climate change Peshawar city is divulge to increased magnitude flooding events every year. The existing stormwatre drainage systems typically do not have an enough flow carrying capacity due to unplanned urban expansion and isolated construction, especially along the main stormwater channel bank sides. The number of small drains has also been engulfed during the elaboration of built up area and it have bad impacts on pervious surface which cause infiltration capacity reduction. Therefore, this unplanned urban development also had serious impacts on the water quality, environment and urban ecology.



**Figure 1:** Serious flooding in Peshawar (2013).

Department responsible for urban stormwater, wastewater, water supply and solid waste management Tehsil Municipal Administration (TMA) also have problem or gaps in areas such as better delivery service financial performance, capacity management, quality institutional set-up and tariff structure in study place. Storm water drainage and urban flood risk management control system need improvement could not improve without amelioration of present condition of TMA. This study may help stakeholder to improving the existing surface flood conveyance system or how they should design exceeded flood water convey and stormwater storage system.

### **1.3 Objective of the study**

- I. Improvement the quality of urban drainage modelling and simulation using high resolution satellite image and topographic maps.
- II. IDF curve derivation for short duration rainfall from daily data.
- III. Peak flow assessment using Hydraulic Toolbox and SWMM.
- IV. To use the hydrological Simulation model for estimation or assessing the hydraulic capacity of the urban drainage system.

## **2. Chapter Two Literature Review**

### **2.1 General concepts of stormwater and management**

The amount of water originating from rainfall, melting snow, glacier or ice and flow on the surface of land is called stormwater (Durrans, 2003). The stormwater in impervious surface generate massive runoff volume which cause urban flooding and quickly transfer to stream (Vallet et al., 2014). The urban areas where conveyance systems exist is strongly related to the concept of the stormwater. Urban flood have high magnitude it causing precise damage in the urban area almost the worth of urban damage in millions of euro or dollar (Aaltonen et al., 2008). Moreover inauspicious particle directly transport into downstream water system (river, dam, pound & irrigation canal) through stormwater form urban surfaces and cause degrading the quality of water (Scalenghe and Marsan, 2009; Göbel et al., 2007 and Tikkanen, 2013).

The best management practices (BMPs) is better control of quality and quantity of urban storm water using reliable technique. There is storm water managerial technique and method for structural and non-structural element which are distinguished between point source and non-point source pollution reduction to elevate quality of storm water and environment protection (Clary et al., 2002). There is a little attention required for management of stormwater as compared management of river water resources or management of wastewater. The apace elimination of stormwater away from urban areas is aim of traditional stormwater system. Stormwater was considering less polluted compared to wastewater for long period (Chouli et al., 2007).

The urban water management system requires advance technique and technology for mitigation urban flood, water quality, public health issues and environment protection. For this purpose urban hydrology science, including environmental science, public health and sociology developed to improve the management of urban stormwater and other urban water quality issues (Fletcher et al., 2013). The most important index of water management is one of the subsurface drainage discharge the encroachment of the drainage systems (M.Valipour, 2012). The sediment or contaminated solid particle removal in stormwater is ordinarily measured

management. The consciousness is most important about sediment size range and it removed by different treatment technique. Suspended solids act as a mobile substrate for pollutants such as heavy metals and polycyclic aromatic hydrocarbons (PAHs) (Hoffman et al., 1982; Sartor and Boyd, 1972; Shinya et al., 2000; Tai, 1991 and Goonetilleke et al, 2004).

## 2.2 The catchment and the regional water balance

The basic knowledge of watershed dynamic is a crucial step calculation morphometric of a catchment. The water channel flowing pattern and drainage network system evaluation over space and time are connected by few variables such as watershed geology and geomorphology, drainage system structural component, soil properties and vegetation of the watershed which contributes surface runoff at a single point (Kumar et.al, 2015). Catchment (drainage basin) is considered as basic component in natural hydrological or urban hydrological modeling and also design of hydraulic structure. There is the catchment should be defined as the accumulation of stream flow from connected cross-section. Delineation of each catchment depends on the selected area topography (contour). The catchment divide is the line where one or more stream water enter in a catchment. The stream cross section drain all flow into a catchment is known as a pour point. There is a pour point location in stream network at any part and it base on the study area size (Dingman, 1994).

$$P+G_{in} - (Q+ET+G_{out}) = \Delta S \quad 1$$

Water balance for urban area according to (Sahely et al., 2003) can be written as

$$P + D + A + W = E + R_S + S \quad 2$$

Where

P = precipitation

G<sub>in</sub>= groundwater inflow

Q = stream outflow

ET or E = evapotranspiration

G<sub>out</sub>=groundwater outflow (mm/day)

ΔS = change of water storage

D = Dew or hoar frost

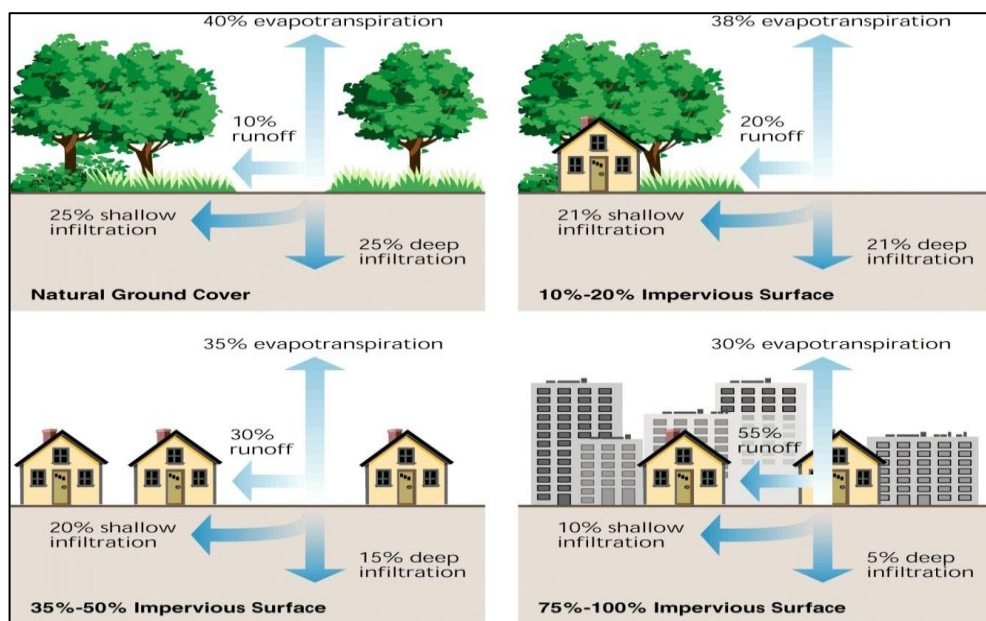
A = amount of water released from anthropogenic resources

W = piped water

$R_s$  = natural and piped surface and sun-surface flow out of city

S = change of water storage in urban fabric

Catchment delineation from contoured topographic maps shows in study area was used in past traditionally. But computer software ARC GIS and remote sensing data digital elevation model (DEMs) from last few decades become main catchment delineation and analyzed source such as slope and many other parameters (Dingman, 1994). There were water cycle categorized in different landscape is shows in figure 2 which clearly represent the water balance and water distribution in land class.



**Figure 2:** Effects of imperviousness on urban water cycle (Bernard and Tuttle, 1998).

The urban water cycle processes has become more complex due to rapid urbanization, because changing land use has an impacts on hydrological processes in a watershed. The quality of water and water utility demand are increasing which basically depend on urban economic capacity and setting function (Wu , Zhan, & Güneralp, 2015).

### 2.3 Precipitation measurement

Urban stormwater study and modeling base on precise precipitation measurement that would be appendage in selected catchment. Degree of incertitude is always subject to input rainfall data. This incertitude is stimulated for observing

precipitation and generalizing method cover whole area measurement of the studied basin system (Dingman, 1994).

The single point is simple and traditional method of measuring of precipitation. For considering this method a vessel placing on an open field and measured water amount using scale or some automated metering system which graphically marked continuously observed precipitation. But some time automated metering system is disturbed technically or human activities to show error in data. There are a few different types of precipitation gages have been design to minimize error originated by different sources. There are any known systematic error would be used for correction of usually observed precipitation (Dingman, 1994; Kuusisto, 1986a). In case of missing and unavailable information of precipitation in selected study area many empirical methods available of precipitation calculation.

#### **2.4 Effects of urban development**

The change in land for high intensity new development that would be relate with the growth of population and economy is a substantial land-use and particularly conversion of land cover for present demand of human history requirement. Urbanization is reckoning an encroachment on hydrological term such as natural water flow influence and also many other hydrological parameters, transporting pollutants to water regime and erosion rates control (Arthur, 2010).

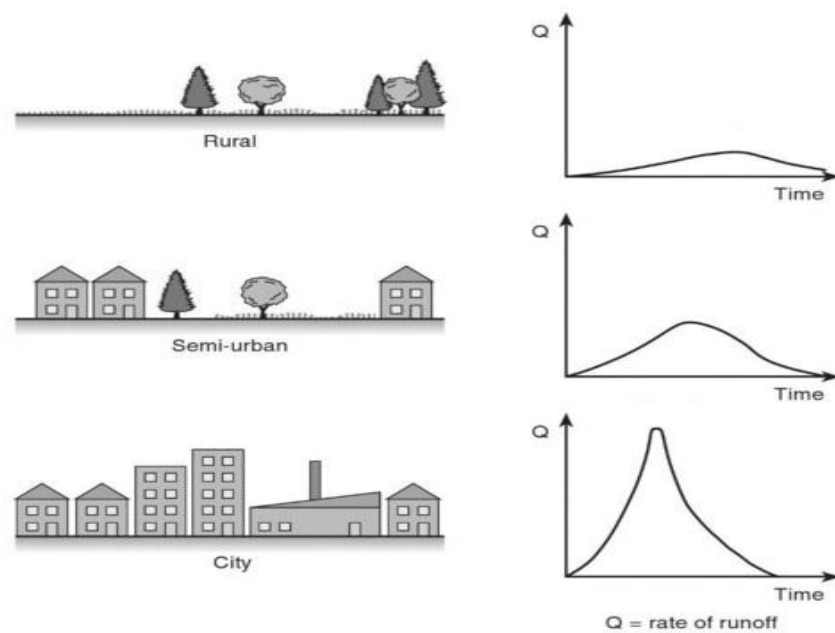
The peak discharge of floods is affected by land use and human activates influence so need skill and technique for modification rainfall and snowmelt how store on surface of land and runoff the surface land into streams. The rainfall and snowmelt are infiltrating on vegetation in the soil column or in low surface areas almost in forests and grassland catchments. When this catchments is full saturated runoff flow as subsurface flow. The land surface changes in urban areas have less storage capacity of rainfall and snowmelt due to concentration of roads and buildings (Konard , 2003).

Earth imperviousness is increasing by construction of residential, commercial and industrial buildings which caused to reduction time of concentration of surface flow and produced higher peak in basin after massive rainfall. The runoff volume and



urban flood magnitude is badly increasing. Moreover runoff is also increasing due to the sewers and storm installation (Goudie, 1990 and Weng, 2001). There was the vast change in ecological structure and function of stream, including increment algal biomass, increased ascendance of eutrophic algal species and ecosystem change processes which is connected with species loss because of urbanization difference easily clear if it is compared with catchments of undeveloped or forested streams (Walsh et al., 2005 and Matthew et al., 2012).

The world is facing serious issues of water demand which is affected due to increasing urban population it is basic need of any nation. Water management strategy may be helpful to reducing water demand in present and also for future (Khan et al., 2013). The surface runoff quantity increase in artificial surface with respect in relation to infiltration and therefore, it cause high peak total volume of water in receiving water bodies during and after the rain event. The surface runoff flow is faster overhead artificial surface and through stormwater sewer even that it is not over neutral surface. This mean flow amount is generated on artificial surface faster and have flow peak greater as usual natural surface (Butler & Davies , 2011). The urbanization effect on runoff peak rate is presented in figure 3.



**Figure 3:** Urbanization effect on peak rate of runoff (Butler & Davies , 2011).

## **2.5 Evapotranspiration on urban areas**

“Evapotranspiration is the flux that link the energy and water balance” (Bryan Ellis, 1999) therefore micro-meteorological and hydrological framework can be used for estimation or analyzing evapotranspiration, because in urban environments some component such as, building, road, trees, car parking produced their individual micro-climate (Bryan Ellis, 1999). Urbanization increases the land imperviousness, decrease the quantity of vegetation and decrease the rate of evapotranspiration (Haase, 2009). The quantity of evapotranspiration in urban area is decrease because due to vegetation reduction (Fletcher et al, 2013). The evapotranspiration impact almost considered negligible in case of urban storm water study because of short rain fall event in urban area. In general case urban regional water balances compared with rural area evapotranspiration have less impact. There is a unique largest output in urban catchment especially for long term is evapotranspiration and it is an essential component of water equilibrium. In many cases evapotranspiration process for an urban catchment is more complicated than in a natural catchment or rural setting due to high variation of microclimate (Mitchell et al., 2001).

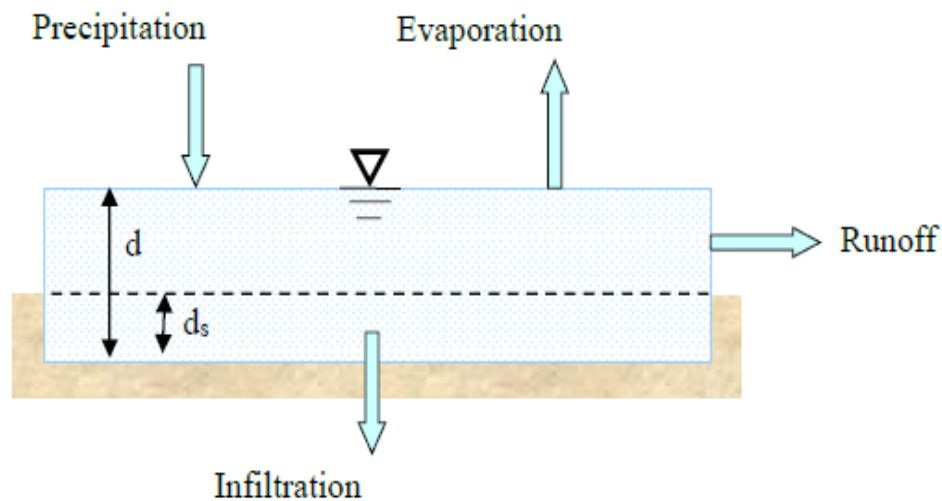
## **2.6 Infiltration reduction caused by impervious surfaces**

There was the combat construction on natural and agriculture land converted into urban area becoming infiltration elimination source. These urban land impervious surface increase runoff surface (Fletcher et al, 2013). The main parameter of groundwater recharge is infiltration, but due to infiltration reduction groundwater level going low and also water quality effected. The study area groundwater recharge from rain, irrigation canal, surface water stream and stormwater drains. Groundwater level effected because of domestic and industrial used and concrete construction of urban stream and other groundwater recharge source (Tikkanen, 2013). The rainfall water division into water flow on land surface such as runoff and that which infiltrates is most important phenomena in hydrological processes. The amount of water which infiltrate recharges groundwater but, urbanization have significant impact on infiltration rate (Woltemade, 2010). The natural landscape is disturbed due to replacement of agriculture land and vegetation-covered land with impervious surface a dramatic urbanization. The hydraulic efficiency raised in the response of increases impervious surface which cause high runoff flow in urban catchment in the

absence of high infiltration. Therefore, low infiltration capacities in impervious surface are induce urban flooding and cause economic losses, urban water pollution and also health issues (Yao et al., 2016).

## 2.7 Surface and sub-surface flow

The amount of precipitation water flow on the top of earth crest after evaporation, interception and saturation dry soil is known as surface runoff. The essential component of the hydrological cycle is surface and sub-surface flow interaction, which predicts soil moisture states and echo-hydrological processes response in conceptual model (Le et al., 2015). The surface runoff generated by rainfall over a sub-catchment of nonlinear reservoir to estimates using SWMM model was first publish by Chen and Shubinski (1971). The figure 4, presentation experiences are showing the surface inflow in sub-catchment after massive precipitation and evaporation and infiltration losses.



**Figure 4:** Conceptual view of surface runoff in SWMM (Rossman & Huber, 2016).

The sub-catchment surface to a depth  $d$  stops the net excess ponds and runoff outflow start from ponded water above depression storage depth  $d_s$ . The abstraction such as surface ponding, interception by flat roof and vegetation, and surface wetting from initial rainfall are normally accounted in depression storage  $d_s$  (Rossman & Huber, 2016).

## 2.8 Preventive and corrective Action

The existing built-up areas development of a strategy most important for designer must be focused on both preventive and corrective measures. Structural corrective action impacts and storm runoff flow control and surrounding flood water directly dispose through inlets of storm sewer, interceptor lines, section of channelized stream and receiving reservoir. The neighborhood storm runoff or flood plains in river which is effect of limit activities by non-structural corrective action. They also include land use adjustment or modification and flood validation (Sheafer et al. 1982). There is key point of preventive and corrective actions summarized in table-1 below.

**Table 1:** The preventive and corrective action plane (Sheafer et al. 1982)

#	Preventive Action	Corrective Action
1	Control of flood-prone land uses.	Construction of storm sewers, Storm storage and water quality best management practice (BMPs).
2	Flood plain regulation.	Land Use Adjustments.
3	Flood-prone land acquisition.	Channelization to enlarge streams.
4	Subdivision regulation.	Enlarging bridge and culverts openings.
5	Building code provision.	Modifying bridge and culverts approaches, entrance, and discharge transitions.
6	Control of water and sewer extension.	Designation of nonconforming uses.
7	Flood-prone area information and education.	Flood Proofing of Building.
8	Measure to reduce the runoff rate.	
9	Measure to reduced erosion.	
10	Flood proofing.	

## 2.9 Structural components of drainage system

The list of structural components, design and consideration of present circumstance is not comprehensives intended, nor is complete process of design beginning to end expressly described in short word.

- I. Major Drainage ways.

- a. Information geomorphologic characteristic of Catchments.
  - b. Behave of different floods.
  - c. Existing channel improvements.
  - d. Extension of basin area.
  - e. Conveyance of flood.
- II. Streets
  - a. Slope Information.
  - b. Depth and velocity of drain.
  - c. Size of drain and flow capacity.
- III. Storm sewers
  - a. Necessary element of storm sewer.
  - b. Design of storm sewer for pressure flow or open channel flow.
  - c. Trash racks cleaning during major storm runoff.
- IV. Storm inlets
  - a. Capacity flow bypass through inlets.
  - b. Storm sewer design for design runoff system
- V. Intersections
- VI. Flow Controls Devices
- VII. Safety Racks
- VIII. Detentions Facilities
- IX. Water Quality Mitigation Measure
- X. Other Special Structure

## **2.10 Environments and ecology**

In recent year human activities directly associated with permanently urban development and in the results changed original states of urban water quality or ecology and natural waters hydrology (Pei et al., 2013). The biological, chemical and physical processes are complicated zones in and around the urbanized city aggregated due to human action for better life and built environments. There was in earlier decades research on urban ecology distinguished better ecological processes in urban area built an environment which is distribution and organisms copiousness, as well as budgets of biogeochemical (Pickett et al. 2011 and Porse, 2014).

Environments issues is growing in Peshawar city generally last few decade due to urbanization, growth of rapid population, Deformation of natural resources, urban flooding, dust storm, deforestation, water and air pollution etc. After America-Afghan War Millions Afghan refugee's influx and internally displaced people (IDP) from northern part of the Pakistan due to some terrorist activities has further destroying the peace situation by putting huge pressure on economy, historical infrastructure and ecology (Izhar, 2012). The most substantial environment problem of the city highly construction using traditional method producing dust particle, industrial smoke causing air pollution, noise pollution surface water degradation and quality of groundwater, poor solid waste management. The quality of surface and groundwater is going retrograde.

### **2.11 Urban rainfall-runoff modelling**

The urban flooding limits can be controlled or minimized in stormwater drainage system by real time rainfall-runoff modelling technique (Hutton et al., 2014). The water resources management in urban area is an important task in response of heavy rainfall, therefore a number of rainfall-runoff models play an important role in urban rainfall-runoff modeling. These models physically have been distinguished as a potent tool for simulation of accurate runoff and prognostication discharge of urban system; it totally base on detailed GIS calculated parameters (Dongquan et al, 2009). The rainfall-runoff relationship modeling in large or small urban catchment is not a big challenge for urban hydrologist for flood transport system acknowledgement. Therefore, in design and modeling urban stormwater drainage network rainfall-runoff knowledge is considered a most crucial tool (Previdi, Lovera, & Mambretti, 1999). The stormwater management in urban catchment is a main component during heavy rainfall, because the behavior of rainfall-runoff in urban catchment is communally different as natural catchment (Ouyang et al, 2012). The land use change is representing significant impacts on the rainfall-runoff process because housing society and commercial development increasing the soil compaction and decreasing the agriculture land. This urban growth, including building and road construction is well understood thing increases runoff quantity (Woltemade, 2010).

## **2.12 Urban drainage history and design approach**

The history of the drainage system is directly connected to old Indus civilization (i.e. the Mohenjo-Daro and the Harappa) which was formed in 2500 B.C. the rainfall and flood water was used cultivation, wheat, dates and cotton (Ritzema , 2006). Generally urban drainage system is design for fast removing surface runoff from urban area during consistent storm event. However, in some cases stormwater exceeding the drainage design capacity which cause economic loss, traffic interruption, urban water pollution and health issues due to high intensity urban flooding. Thus in that situation need to reduce flood magnitude in urban area is to improving drainage capacity (Qin, Li, & Fu. , 2013). In cities across the world urban drainage systems have been constructed of removing the runoff from urban areas. Therefore stormwater and wastewater combined drainage system were also used for similar purpose in some part of the world (Yazdanfar & Sharma, 2015). The system which used runoff collection in urban area and quickly transport to receiving water bodies is generally defined as separate urban stormwater drainage system. Such stormwater drainage systems are widely used in Australia and North America (Vymazal, 2010; Yazdanfar & Sharma, 2015). For urban drainage design rational method widely preferred by hydraulic engineering or urban hydrologist because it is empirical relation between rainfall intensity and peak flow. It is typically considered very simple of calculation peak discharge for urban drainage design (Yazdanfar & Sharma, 2015). The rational method is most widely used technique worldwide for urban drainage structures designing, including drainage components, such as roadside drainage, storm drains inlets, open storm channel and also closed storm sewer etc. (Pilgrim, 1986; Linsley, 1986 and Froehlich, 2010). For urban drainage systems planning, designing and stormwater management purpose numerous urban drainage model used in many studies, thus hydrologic/hydraulic simulation processes in selected urban area rational method (Mulaney, 1851) and SWMM 5.1 (Rossman & Huber, 2016) chosen to simulate surface runoff and designing drainage hydraulic capacity. The SWMM is a complete urban drainage system planning, analysis and designing model which widely used throughout the world and in past a considerable research work carried out on such case study (Di Pierro et al., 2006; Lee et al., 2010; Burszta-Adamiak & Mrowiec, 2013; Sun et al., 2013; Ning et al., 2014 & Yu et al., 2014)

## **2.13 Stormwater management computer model SWMM**

One of the best stormwater management computer model SWMM was first developed in 1969-1971. It had been upgraded continually and used widely throughout the world for urban planning, analysis and available urban stormwater runoff, combine sewer system and many other drainage systems (Rossman & Huber, 2016).

SWMM is dynamic rainfall runoff, hydrology and hydraulic simulation computer engine used for estimation of runoff quantity and quality in each modeled sub-catchment in response input parameters. The precipitation, evapotranspiration, infiltration and groundwater are included in model hydrological processes generate runoff. The SWMM routing portion transports the calculated surface runoff and pollutant load in receiving point through open channels, pipes system, pumps and regulator (Rossman & Huber, 2016).

EPA SWMM was used for large urban stormwater, combined sewers system, sanitary sewer and many other drainage systems in built up areas and also many applications as well as used in non urban areas for planning, designing and analysis. The current modified version of EPA SWMM is 5.1.

### **2.13.1 Environment compartment**

The series flow of water and particles systems between environment compartments is conceptual part in SWMM model which is according to Rossman and Huber (2016).

#### **I. The Atmosphere compartment**

The precipitation originates in this compartment and supports the pollutants deposits onto the compartment of the land surface.

#### **II. The land surface compartment**

It is the most crucial part of the SWMM which is occurred on land surface and received the precipitation from atmosphere in both condition rainfall and snow. The land surface compartment commonly divided into small homogeneous sub-catchment for runoff modeling and each sub-catchment has its own sets of input parameters such as, imperviousness, manning's



roughness coefficient for overland flow and depression storage. The amount of water move back to the compartment of atmosphere, into the sub-surface compartment as infiltration and surface runoff transports through land surface compartment towards conveyance objects is the form of accounted outflows.

### **III. The sub-surface compartment**

Due to imperviousness parameters which define in sub-catchment produced infiltration on the previous fraction of the land surface and transport in sub-surface compartments. The process in which rainfall is penetrates the ground surface and fills the pores of the underlying soil layer is represents infiltration relationship (Akan & Houghtalen, 2003). Theoretically, Richards's equation is governed for infiltration (Richards, 1931), which based the relationship between soil moisture content function, pore water tension and soil permeability. According to (Rossman & Huber, 2016) highly nonlinear partial differential equation solution is more difficult for use in model like, SWMM and unsuitable for general purpose especially for continuous simulation for long-term. Therefore, several infiltration models base on simple algebraic relationship have developed by engineers, which capture infiltration capacity depend on soil characteristics and previously infiltrated water volume during the storm event track. For surface runoff simulation which model is a best, are not universal agreements. Four different infiltration models are coded in SWMM 5.1 such as:

- i. The Horton Method (Horton, 1933)
- ii. Modified Horton Method (Akan. 1992)
- iii. The Green-and-Ampt method (Green and Ampt. 1911)
- iv. The Curve Number method

The Curve Number infiltration method is selected for this study, being infiltrated method, it highly depended on soil conditions and types.

### **IV. The conveyance compartment**

The most major SWMM part is conveyance compartment which consists on different hydraulics routing components for surface runoff such as, open channels, pipes network, pumps, node, flow divider, flow outlets and regulator. The inflow in this part comes from remote sub-catchments

generated surface runoff, dry weather flow sanitary and inputs defined time series from users, through conduits of the drainage networks linkage which is connected to each other with nodes. The calculated surface runoff results accuracy depend on routing method choice and running simulations time.

### **2.13.2 Hydrologic soil groups**

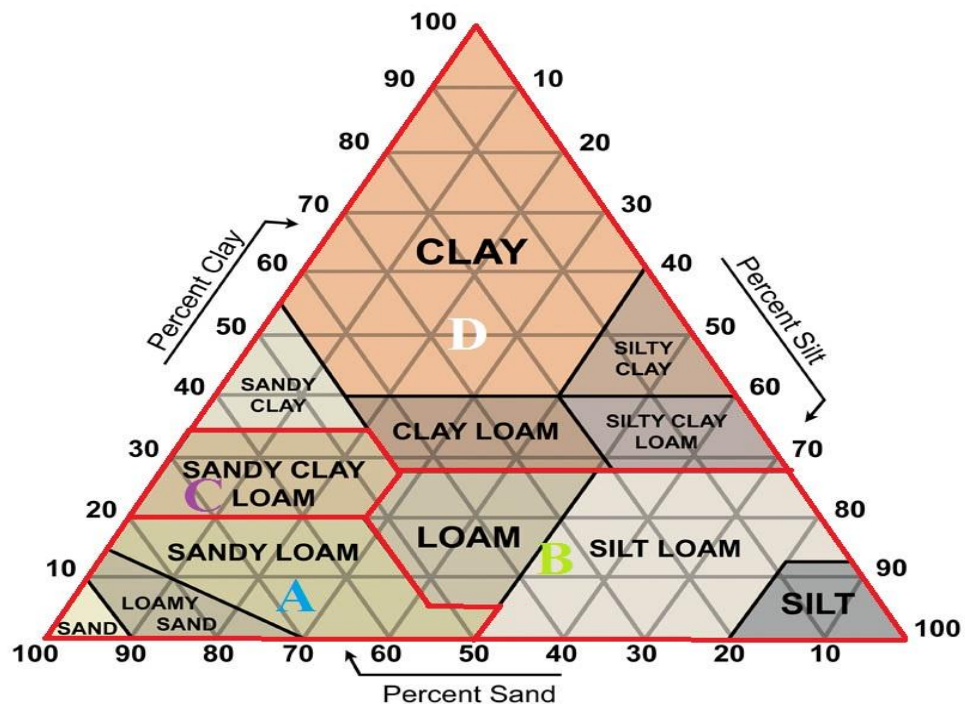
The Curve Number infiltration method is directly related hydrologic soil groups. The soils were originally associated with Hydrologic Soil Groups, which basically depended on field measured data such as rainfall, runoff and infil-trometer (Musgrave, 1955). Initially on the judgment of soil Scientist hydrological soil groups was established. The unclassified soil profiles characteristics with profiles of soil already presented into Hydrologic Soil Groups a comparison assignment was made. These soil groups are based on the premise that soil determined within a climate region which are similar in depth to a soil restrictive layer or water table, water transmission rate, soil texture, soil structure, and degree of swelling when soil saturated and also have similar runoff responses (NRCS, 2009). The soil classes are based on given below factors:

- i. Intake and water transmission under the yearly maximum witness conditions (thoroughly wet).
- ii. Soil not frozen
- iii. Bare soil surface
- iv. Expansive clays maximum swelling

But during assigning the Hydrologic Soil Groups soil surface slope is not considered (NRCS, 2009). Therefore, most classified HSG are A, B, C, and D which have different runoff and infiltration limitation, where runoff potential in soil group A is very low and runoff potential in group D is very high (NRCS, 2009). Table 2 illustrates the classification and meaning of these groups and figures 5 representing the USDA soil triangle, with HSG with distributed soil.

**Table 2:** Hydrologic Soil Groups and meaning (NRCS, 2009 Chapter, 7)

Groups	Meanings
A	In this group runoff potential very low when soil thoroughly wet. The infiltration rates very high and water freely transmitted through the soil structure.
B	The runoff potential in this group moderately low when soil thoroughly wet and due to water transmission through unimpeded soil, infiltration rates is moderate.
C	In this group soil have low infiltration rate when thoroughly wetted. Due to transmission of water through somewhat restricted soil, runoff potential moderately high.
D	Runoff potential very high. The rate of infiltration in this group very low due to transmission of water through in very restricted soil structure.



**Figure 5:** USDA standard soil triangle, with Hydrologic Soil Groups for distributes soil texture.

### 2.13.3 SWMM surface runoff simulation process

SWMM is a distributed distinct time simulation computer model and used simulation surface runoff for nonlinear reservoir produced in response of precipitation over sub-catchments. The flow calculation over sub-catchment mathematically equation according to (Park et al, 2008) is given below.

$$Q = \frac{W}{n} (d - d_p)^{\frac{5}{3}} (S_o)^{\frac{1}{2}} \quad 3$$

Where

Q = Outflow (m<sup>3</sup>/s) over the sub-catchment

W = Sub-catchment width (m)

n = Manning's roughness coefficient for overland flow

d = water depth (m)

d<sub>p</sub> = depth of depression (m)

S<sub>o</sub> = Sub-catchment slope (%)

Surface runoff generated after the response of missive rainfall at the source areas is defined to flow either into another sub-catchment or into a drainage system entry point (Rossman & Huber, 2016).

### 2.14.4 Parameters sub-catchment and calibrating SWMM

The SWMM application is consists on numerous initial sensitive measured and inferred parameters which vary from sub-catchment to sub-catchment. A few measured sub-catchments parameters are classified into area of sub-catchment, channel length, channel shape, bed slope, soil types, land-use type and rainfall depth. The inferred parameters is not measured which can be classified to depression storage, manning's roughness coefficient for overland flow of channel and sub-catchment flow width (Choi & Ball , 2002). The inferred parameters are usually needed to calibrated, while measured parameters easier to obtain from watershed delineation and land-use classification.

For urban catchments detailed spatial data which directly connected land cover types and drainage network is important for calibrating model, especially SWMM

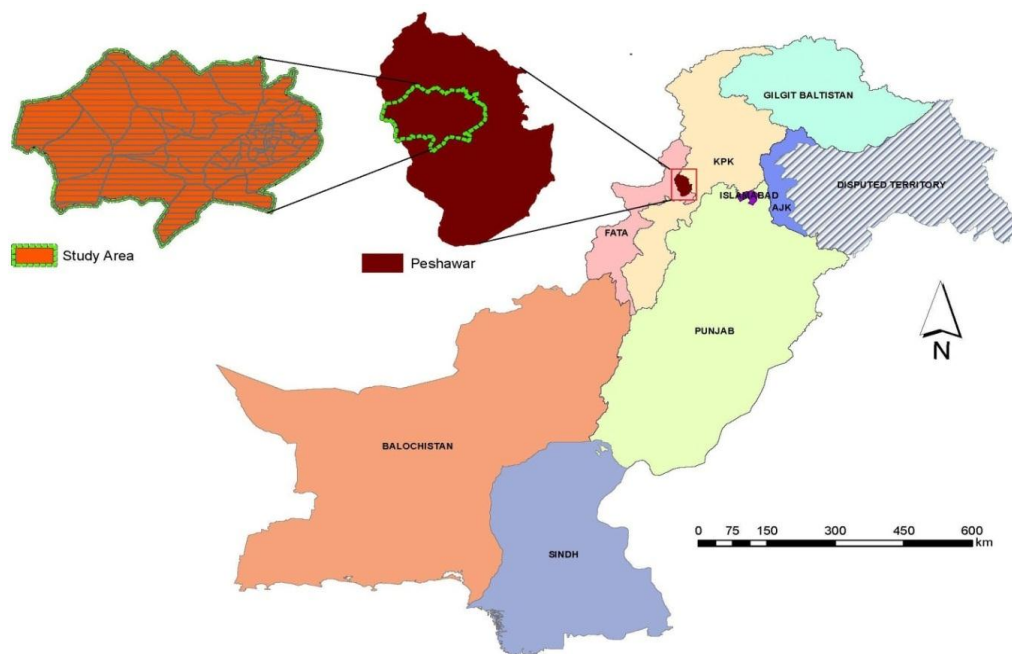
applications (Jacobson, 2011). The land use related data is not easily available, but hydrological and physical weighted parameters calculated with linkage of GIS and remote sensing data in this study which may be reduce calibration process complexity. Among numerous variety of techniques for model calibration purposes, trial and error method are considered more simple and easy. But urban surface runoff modeling for urban drainage design and planning, SWMM model required some parameters a few research relevant parameters estimation procedure was published. For single event and continuous simulation purposes, SWMM model calibration procedure was designed by (Maalel & Huber, 1984). The GIS and remote sensing technologies in recent period became large and vital tools in spatial development science due to rapid development and it was used in numerous parameters calibration model's researches (Shen & Zhang, 2014). For the optimization technique in SWMM model an automatic calibration method was developed by (Janet et al., 2008), which based on GIS applications and had some benefits of large urban catchment. The SWMM model parameters estimations by traditional methods are usually depended on urban catchment measured topography and hydrological data (Krebs et al., 2013).

### 3. Chapter Three Methodology

#### 3.1 Description of the study area

##### 3.1.1 Study area boundary

The study was conducted Peshawar which is the presiding bishop province city of Khyber Pakhtunkhwa (KP) and also the provincial capital. Geographically location of the Peshawar, situated close to Pak-Afghan border between latitude  $33^{\circ} 44'$  to  $34^{\circ} 15'$  N and longitude  $71^{\circ} 22'$  to  $71^{\circ} 42'$  E of elevation above mean sea level 359 m. Peshawar valley located from Federal capital (Islamabad), Pakistan of distance by road about 160 km and about 48 km distance from old famous historical Khyber Pass which lead Pak-Afghan border. The location of the study area is shown in figure 6. Climatically Peshawar city is situated in semi-arid region of the country, summer season very hot and winter very cold. The maximum temperature in summer is more than  $40^{\circ}\text{C}$  and the average annual precipitation is 480 mm measured by Pakistan Meteorological Department (PMD).



**Figure 6:** Location of Study Area.

The topography of the study area which had maximum elevation on western side was 480 m above mean sea level and on the North eastern of study area maximum elevation was 305 m above mean sea level. So there was surrounded mountainous

area on Western, North-West and South-West side form Peshawar valley. Western part of the study area had extreme steep slope and mild to flat toward Eastern part of the study area, which was toward North-East. Peshawar valley lies under surrounding three sides highest mountain range mostly part of the city flat with normal steep slope. This range of mountains formed a complicate Peshawar city from west, southwest and southeast sides and structurally distorted sedimentary and metamorphic rocks. The aerial distribution of the rock principal in the study area shows in geological map which was created by Geological Survey of Pakistan (GSP). The formation of sandy silt alluvial deposit in the study area was changing path of the river and flow of the river brought sheet wash. Middle Pleistocene had been realized of some erosion cycle. Metamorphic rock with violation of igneous was the part of North West of Peshawar valley. The erosion product which is consists alluvial deposits such as sand, gravel, boulders and clay transported by the river from surrounding rocks. The coarse alluvial deposits by river or stream were found along the mountain fronts. Quadruplet age of alluvial sediments which was filled Peshawar Catchment with a few hundred meters thick layer of alluvial sediments. In the nearest mountainous area piedmont deposit which was formed by rock weathering conveyance from shorter distance are present (Bundschuh , 1992).

### **3.1.2 Existing stormwater drainage and sanitation system**

The study area had a combined storm and sanitation system. Mostly drains collect the domestic, commercial and industrial waste water and also rainfall surface runoff. During field assessment it was found that most parts of the city connect with open surface and subsurface drainage network system in bad condition. Few underground sewers also found but mostly under construction or indirectly connect with existing drains. In the study area three waste water treatment plants (WWTP) which was found functional because energy crisis is the big issue in the study area and all drainage waste and storm water need to pump in waste water treatment plant. Due to this waste water treatment plants none operation both types of flows direct disposed into open field, agriculture lands, river, irrigation canals and non-perennial stream which were contributing the flood hazard, environmental impact and public health problem. The condition of major drains is shown in figure 7.



**Figure 7:** Condition of Stormwater drainage network system.

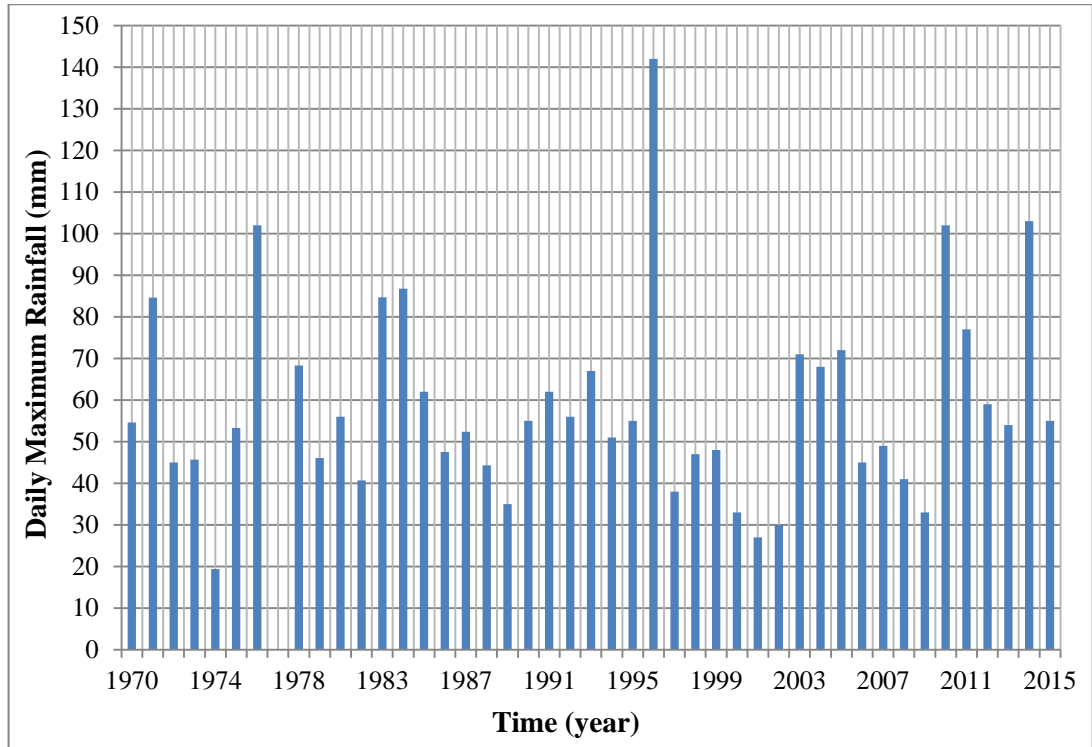
There was in the low area where land had high depression construct the three water pump station which was not properly designed. There was existing sewer and drains discharge disposal point did not had proper structure design and linked with receiving water bodies through unconditional section. There was the main receiving both types of water Bara River, Shah Alam River, Budhni River (almost collect major and minor storm water of the study area including industrials waste water) and five irrigation canals. Most of them collect minor disposal point of the study area. These studies focus only stormwater modelling and drainage capacity.

### **3.2 Data collection and institution**

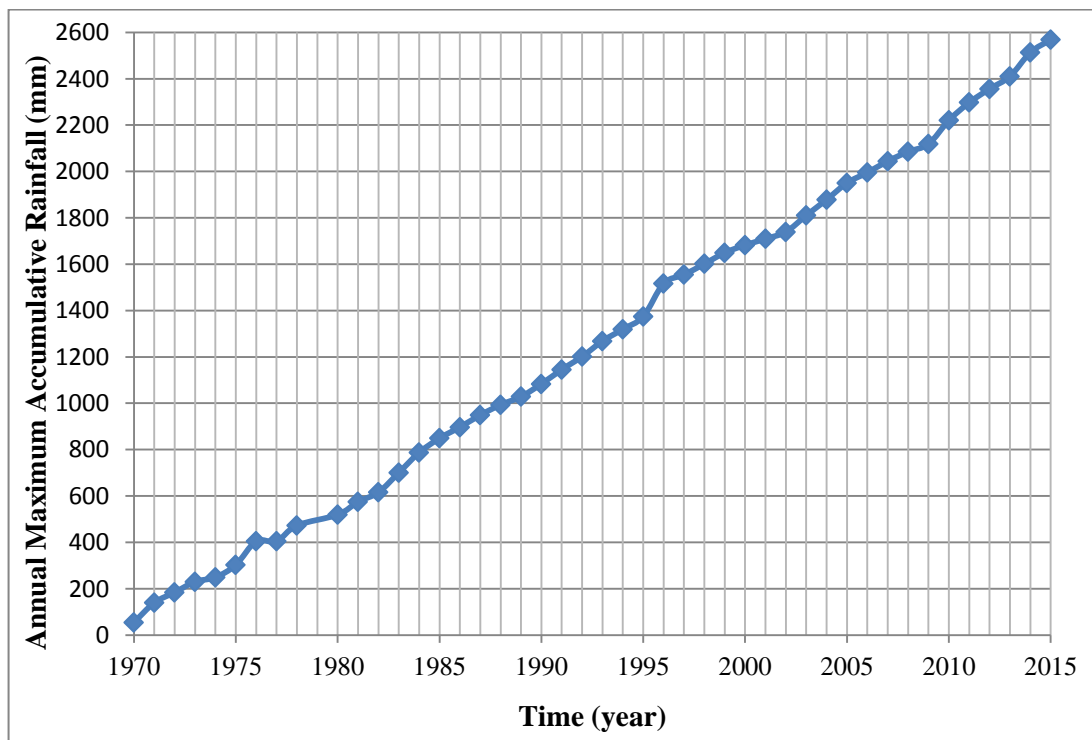
Hydrological analysis was a main part of this study evaluation IDF curve from recorded rainfall analysis and surface peak flow calculation for stormwater management. For the evolution stormwater runoff modeling in the absence of short duration, daily rainfall data was collected from Pakistan Meteorological Department, Peshawar varying from 1970 to 2015. There was recorded rainfall 1977 is missing which could not use in this study. The daily maximum and accumulative annual rainfall data are shown in figure-8 and figure-9. For this study high resolution rainfall data required which was not available in study area meteorological station, due to



part of the Kabul River basin and similarity of hydrology hourly rainfall data obtained from available nearest catchment study reports.



**Figure 8:** Daily maximum rainfall of study area.

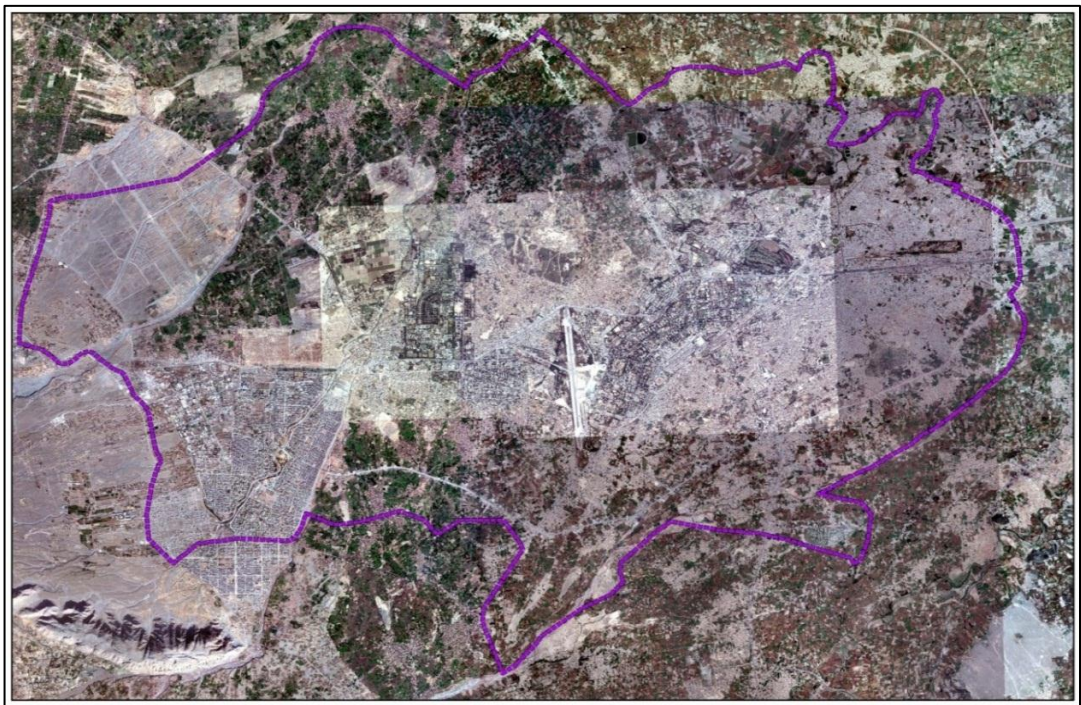


**Figure 9:** Annual maximum accumulative rainfall of study area.

The recorded one hour's interval rainfall data Mardan climatological station (2000 to 2009) was collected from annual reports of river and climatological data of Pakistan, WAPDA (Water and Power Development Authority), and three hours intervals rainfall data (1961 to 1991) were collected from pehur high level canal project, WAPDA, Working paper no. 01, hydrology studies (final), Risalpur meteorological station. The daily maximum rainfall data of both meteorological stations was also collected in support calculation parameters for calibration and validation IDF curves. The daily and hourly data was used calculation of empirical formula parameters.

For the calculation of hydraulic flow carrying capacity of main drain, bathymetric survey data was also collected from NDC (National Development Consultant private Ltd.), survey section. GPS (Global Position System) point data was collected by author own effort at each drain final disposal point, drains junction, drains flowing under shops or houses, and bridge etc.

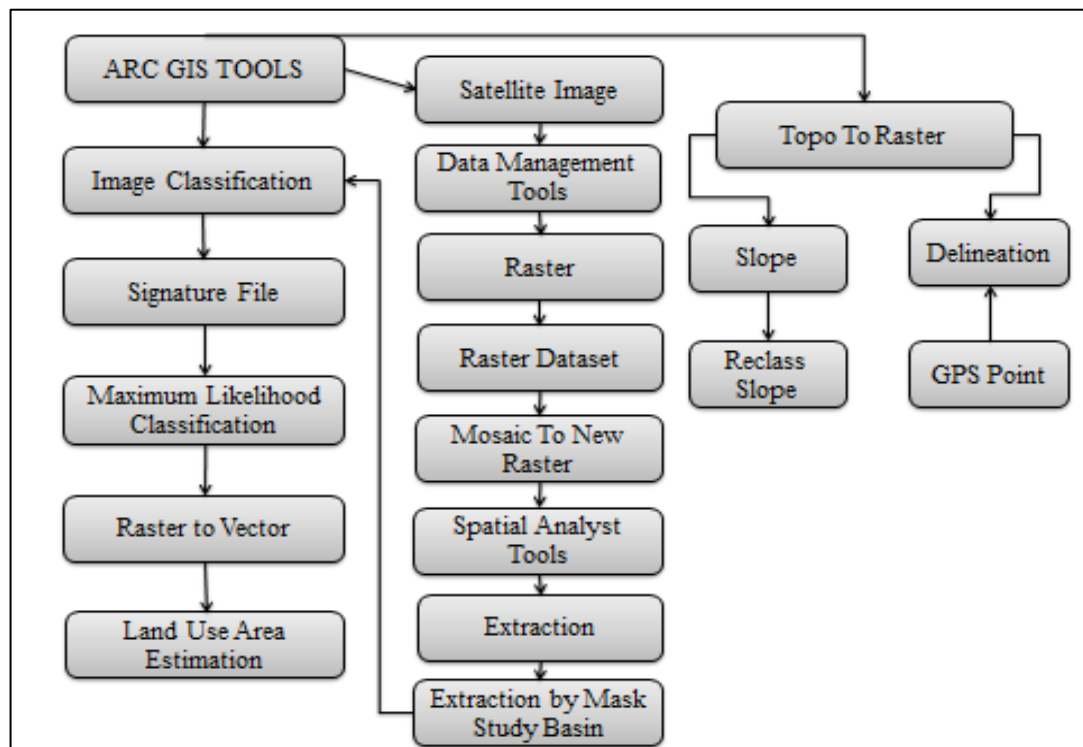
The estimation geomorphological parameters 5 meter contour shape file was collected from NDC for development digital elevation model. The drainage demarcation and land use classification required high resolution satellite image. The QuickBird image of resolution 0.65 m was obtained from NDC GIS section and presented in figure 10.



**Figure 10:** QuickBird image of study area.

### 3.3 Geographic Information System (GIS) Approach

There were many different tools of ArcGIS 10.2 applied in this study, methodology of GIS work as flowchart shows in figure-11. GIS tools applied in order for study area selection, selected catchment delineation and divide in sub-catchment, slope and slope reclassification, land use classification and catchment runoff parameters. These parameters were used for simulation of stormwater runoff as initial input data for SWMM.



**Figure 11:** A flowchart of the methodology GIS work of the study.

#### 3.3.1 Image classification tools

An image classification tool was used for extracting the different class information from a raster image of multiband which was most commonly based on some reference point. The thematic maps of land use were also created by using resulted raster from classified image. There was generally image classification tools had two types supervised and unsupervised. For supervise and unsupervised classification needed the signature files for determinations of the references point class types were also imported.

### 3.3.2 Maximum likelihood classification

The Maximum Likelihood Classification (MLC) tools are design on to principles bases which are described as:

- The multidimensional space being normally distributed for cell in each class sample
- Bayes theorem

There are Maximum Likelihood Classification (MLC) is a method supervised and derived from Bayes theorem, which was distributed in many different mathematical parameters and states as the posteriori distribution  $P(i/\omega)$  the feature vector for each pixel related to probability  $\omega$  directly related to class  $i$  which is mathematically written as (Ahmad & Quegan, 2012).

$$P(i/\omega) = \frac{P(i/\omega)P(i)}{P(\omega)} \quad 4$$

Where,

$P(i/\omega)$  = likelihood function

$P(i)$  = Information Priori for class  $i$  probability which occurs in selected study area

$P(\omega)$  = Probability that  $\omega$  observed which is written as

$$P(i/\omega) = \sum_{i=1}^M P(i/\omega)P(i) \quad 5$$

Where  $M$  is representing the number of class,  $P(\omega)$  is use as normalization.

Variation and covariance signature class tools of in each cell in the signature file it is represented of each land used class. The distribution of a normal sample class supposition would be characterized by vector mean and matrix covariance. According each cell value under consideration of two characteristics to be determined the cells to the class membership is computed by statistical probability. The priori probability weighting is used for default which is equal for each specified cell and assigned for each class member as highest probability (Esri, 2013).

There was the input priori probability file option is used for occurrence of some likelihood classes which was appeared in every condition such as higher, lower and

then the average of both class. The special probabilities for weighted class in the priori file are specified. Under this condition priori file help in the of cells location that would be overlap between specified two classes. This priori probability statistically approach assigned harmonious class for each cell with complete accuracy. After completion of signature file Maximum Likelihood Classification (MLC) tools completely able for operation of land use classification and produces resulted output raster and represent confidence level of classification (Esri, 2013).

### 3.4 Daily rainfall conversion and data analysis

In the absence of high resolution rainfall data (minute or hours) the daily rainfall data was obtained from Pakistan Meteorology Department (PMD) of Peshawar. Two empirical methods are selected for daily rainfall data conversion into hours, such as one is Halcrow formula written as:

$$P_T = P_{24} \times \left(\frac{T}{24}\right)^{0.2} \quad 6$$

Where,

$P_T$  = rainfall at required time T

$P_{24}$  = 24 hours total rainfall

T = time at which we want to find the required rainfall

The second method is recommended by Indian Meteorological Department (IMD) for rainfall intensity derivation duration in hours from maximum rainfall. The IMD reduction formula according to Ahmed et al. (2012) written as:

$$P = \left(\frac{t}{24}\right)^{\frac{1}{3}} \times P_{Ta-24} \quad 7$$

Where,

t = time in hours

P T a-24 = total 24 Hour rainfall

### 3.4.1 Empirical equation for Intensity duration frequency (IDF) curve

The above stated method only used daily rainfall data conversion into hour, but for urban stormwater drainage modeling required very short duration rainfall such as in minutes. There was studying different hydrology book (Chow et al., 1988) and research paper found several most common used empirical methods. Two IDF curves empirical equations which are mathematical connected rainfall intensity, duration and return period is adopted for derivation of IDF curves in this study. The development of IDF curves, selected empirical equations generally written as:

Bernard Equation: 
$$i = \frac{a}{d^e} \quad 8$$

Sherman Equation: 
$$i = \frac{a}{(d+b)^e} \quad 9$$

Where I was representing intensity of the rainfall (mm/hr), d duration is time duration of rainfall event (minute), a, b and e meteorological station related parameters. For estimation of selected equations parameters frequency analysis are considered crucial.

### 3.4.2 Statistical probability distribution fitting and frequency analysis

The frequency analysis considered crucial method of calculation Bernard and Sherman equations parameters such as 'a', 'b' and 'e' development short duration IDF curves. For statistical probability distribution, SMADA (Stormwater Management and Design Aid) hydrological model is selected, which was developed by University of Florida in 1984. The DISTRIB (Statistical Distribution Analysis) tool was specially designed for frequency analysis. Extreme Value Types-I distribution method highly recommend distribution in various statistic hydrological modeling literature. The storm frequency analysis was performed by using Extreme Type-I distribution Chow (1955) and Tomlinson (1980). The Depth-duration-frequency was performed using Extreme Value Type-1 distribution, Hershfield (1961). The mathematical probability density function Extreme Value Type-1 written as:

$$P_x(X) = \frac{1}{\alpha} \exp\left(\pm \frac{x-\beta}{\alpha} - \exp\left[\pm \frac{x-\beta}{\alpha}\right]\right) \quad 10$$

$$-\infty < X < \infty; -\infty < \beta < \infty; \alpha > 0$$

The Extreme Value Type-I Distribution equation derived by Chow (1953) given below:

$$K_T = \frac{\sqrt{6}}{\pi} \left( 0.5772 + \ln \left\{ \ln \left[ \frac{T_x(X)}{T_x(X)-1} \right] \right\} \right) \quad 11$$

Derivation of T from above equation can be written as:

$$T = \frac{1}{1 - \exp \left\{ - \exp \left[ - \left( \gamma + \frac{\pi K_T}{\sqrt{6}} \right) \right] \right\}} \quad 12$$

$T_x(x)$  = Design Return period (Years) of Rainfall data

Calculation of rainfall intensities from design return period express of given equation:

$$P_{(i,T)} = \bar{P} + K_T S_P \quad 13$$

Where as

$P_{(i,T)}$  = Rainfall intensity of design return period (mm/hours)

$\bar{P}$  = Mean of recoded rainfall data

$S_P$  = Standard deviation of rainfall record

Drainage design return period should be depending on an economic valuation which compared with derived benefits to drainage works providing costs. However historical urban flood impairment is normally not available for better analysis of cost- benefit. A general determination of policy depended on such circumstance as used of land, jeopardy to safety of public and public hope is more advantageous (storm water drainage design manual, 2013). Design return period based on levels of flood recommended in table 3 given below.

**Table 3:** Generalized design criteria return period for urban flood control structure (CDOT, drainage design Manuals, chapter-7 hydrology, 2004).

<b>Type of Structures</b>	<b>Return Period</b>
<b>Highway culverts</b>	
Low traffic	5 – 10
Intermediate traffic	10 – 25
High traffic	50 – 100
<b>Highway bridges</b>	
Secondary system	10 – 50
Primary system	50 – 100
<b>Farm drainage</b>	
Culverts	5 – 50
Ditches	5 – 50
<b>Urban drainage</b>	
Storm sewer in small cities	2 – 25
Storm sewer in large cities	25 – 50
<b>Airfield</b>	
Low traffic	5 – 10
Intermediate traffic	10 – 25
High traffic	50 – 100
<b>Levees</b>	
On farms	2 – 50
Around cities	50 – 200
Dams (small –large)	50 – 1000

### 3.5 Surface peak discharge modelling

There were two hydrological models used in this study for simulation surface runoff peak of selected drainage areas. The Hydraulic Toolbox which was developed by Aquaveo Inc. of FHWA (Federal Highway Administration's). Rational Calculator tools are used for surface runoff peak discharge calculation stormwater drainage watershed. The calculation surface runoff peak of the selected catchments under given assumption using originally developed traditional Rational method, that the frequency of the both precipitation, infiltration and continuously distributed in and space. There was the traditional rational formula according (Mulvaney 185; Turazza, 1880; Chow, 1964 and Wang et al., 2012) may be expressed as:

$$Q = 0.00278 C i A$$

14



If infiltration rate consider over the impervious area the Rational Equation according to (Rossman & Huber, 2016) can be written as.

$$Q = 0.00278 [C I + (1-C) \max (0, i-f)] A \quad 15$$

Whereas

Q = Peak discharge in m<sup>3</sup>/s of define catchment due to its geomorphological characteristics

C = dimension less peak runoff coefficient depend on the land use type of selected catchment

i = Rainfall intensity (mm/hr) in term of time of concentration for design rainfall of selected return period

A = Catchment area (ha) of the selected storm water drains

f = rate of infiltration (m/s)

For time of concentration Kirpich equation used in this study

$$T_c = 0.0195 \left[ \frac{L}{S} \right]^{0.77} \quad 16$$

Where

T<sub>c</sub> = Time of concentration (Minutes)

L = the horizontal projection of the channel length from most distant point to the catchment outlet (m).

S = the slope between the two points

### 3.5.1 Rational method characteristics

There was some assumption of Rational method was made rate of maximum runoff generated by constant rainfall storm event, which was managed for time concentration of surface runoff starts from catchment remote part to disposal point. Many other assumptions according SUDAS (2013), for Rational Method which would be described below;

- The uniform rainfall in space at selected drainage catchments would be adopted for runoff simulation.
- The constant intensity of rainfall should be designed during time period which was equal to time of concentration.

- The frequency curve of the rainfall is parallel to the frequency of the surface runoff. There was used of rational runoff coefficient same for all rainfall return periods.
- The catchment area of the drains including the total area of other tributaries to the point of drain design.

### **3.5.2 Rational method limitations:**

There several limitation of rational formula:

- Most common limitation, rational method used only for peak flow of the catchment.
- The simulation of peak flows from average rainfall intensities did not have some time order as actual storm.
- The rational coefficient (C) for runoff usually adopt from table it depend on land types, but selection of coefficient always depend different land use types in the study areas catchments.
- Time of concentration including flow time from overland also open/closed channels flow time remote area to design point.
- Rational Method used only for small catchment of limited area range 80.9 ha.

### **3.5.3 Use of the Rational Method**

#### **3.5.3.1 Runoff coefficient**

Rational method runoff coefficient dominate the some rainfall loss parameters, such as infiltration integrated effect, evapotranspiration, soil retention, channel flow routing, and interception, Peak flow rate and time distribution of channels flows always effect by these parameters. Rational runoff coefficient was most adjusted variable for designing of small and large urban storm water managements and structure design of open or covered drains and combine sewer systems. Engineers and Hydro Engineers found common coefficient for different land use classification which was with details description explained in table 3. Due to given Rational coefficient for runoff used to derived individuals drains catchment using catchment land use classification which extract using ARC GIS 10.2 land classification likely hood method. There was in table-4 runoff coefficient values is average estimate

values for selected catchment but this information was used in this study for weighted C values it based on catchment area and land use associated with runoff coefficient (C) values and it would be calculated by given below equation.

$$C_w = \frac{A_1 C_1 + A_2 C_2 + \dots + C_i A_i}{A_1 + A_2 + \dots + A_i} \quad 17$$

$$C_w = \frac{\sum C_i A_i}{\sum A_i} \quad 18$$

Where,

$C_w$  = Weighted runoff coefficient

$C_1, C_2 + \dots + C_i$  = Different land used coefficient

$A_1, A_2 + \dots + A_i$  = Area of land used with respect runoff coefficient

**Table 4:** Typical Recommended Runoff Coefficient (CDOT, drainage design Manuals, chapter-7 hydrology, 2004).

Land Use or Surface Characteristics	Percent Impervious	Frequency			
		2-yr	5-yr	10-yr	100-yr
Business:					
Commercial Areas	95	0.87	0.87	0.88	0.89
Neighborhood Areas	70	0.60	0.65	0.70	0.80
Residential:					
Single-Family		0.40	0.45	0.50	0.60
Multi-Unit (detached)	50	0.45	0.50	0.60	0.70
Multi-Unit (attached)	70	0.60	0.65	0.70	0.80
1/2Acre Lot or Larger		0.30	0.35	0.40	0.60
Apartments	70	0.65	0.70	0.70	0.80
Industrial:					
Light Areas	80	0.71	0.72	0.76	0.82
Heavy Areas	90	0.80	0.80	0.85	0.90
Parks, Cemeteries:	7	0.10	0.10	0.35	0.60
Playgrounds:	13	0.15	0.25	0.35	0.65
Schools:	50	0.45	0.50	0.60	0.70
Railroad Yard Areas:	40	0.40	0.45	0.50	0.60
Undeveloped Areas:					
Historic Flow Analysis		See Lawns			
Greenbelt, Agricultural	2				
Offsite Flow Analysis(when landuse not defined)	45	0.43	0.47	0.55	0.65
Streets:					
Paved	100	0.87	0.88	0.90	0.93
Gravel	13	0.15	0.25	0.35	0.65
Drive and Walks,	96	0.87	0.87	0.88	0.89
Roofs:	90	0.80	0.85	0.90	0.90
Lawns, Sandy Soil:	0	0.00	0.01	0.05	0.20
Lawns, Clayey Soil:	0	0.05	0.10	0.20	0.40

### 3.6 Curve Number infiltration method

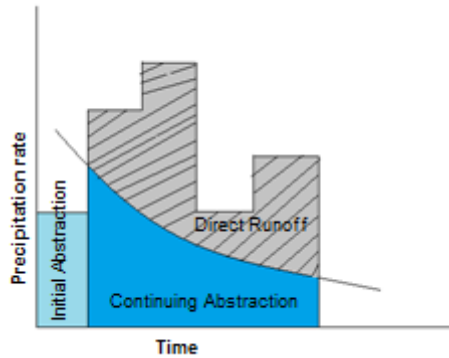
This method obtained from the Natural Resources Conservation Service (NRCS) curve number for rainfall runoff relation simulation. The capacity of total infiltration of a soil found using United States Department of Agriculture (USDA) design curve number table for different land used. There was the major component of SCS-CN method soil curve number and length of time rate rainwater saturated the dry soil. EPA SWMM was also adjusted for monthly basis infiltration rate recovery for the variation of evaporation and groundwater levels factors.

Soil Conservation Service (SCS) method was developed by relationship between four ratios such as actuals and potential quantities which was equal written as

equation (Chow, 1951). There is the initial abstraction, continuing abstraction and direct surface runoff scheme as shown in figure 12.

$$\frac{F_a}{S} = \left( \frac{P_e}{P - I_a} \right) \quad 19$$

$$P = P_e + I_a + F_a \quad 20$$



**Figure 12:** Initial abstraction, continuing abstraction and direct surface scheme.

According to the equation 18 and 19 solved the  $P_e$

$$P_e = \left( \frac{(P - I_a)^2}{(P - I_a + S)} \right) \quad 21$$

This was a basic direct runoff estimation equation by SCS loss method from measured storm. Initial abstraction empirical relation derived from the result of many small catchments experiment.

$$I_a = 0.2S \quad 22$$

Insert the values of  $I_a$  from equation 16 in equation 15

$$P_e = \frac{(P - 0.2S)^2}{P - (0.2S - S)} \quad 23$$

Whereas

$P_e$  = Direct Runoff (mm)

$P$  = Precipitation (mm/day)

$S$  = Potential Maximum Retention (mm)

$I_a$  = Initial Abstraction

$$S = \left( \frac{25400}{CN} - 254 \right) \quad 24$$

$$CN = \left( \frac{25400}{S+254} \right) \quad 25$$

Whereas Curve Number (CN) depend on soil types and land use classification, USDA divided soil into four Hydrological Soil groups A, B, C and D. The characteristics and function of hydrological soil group was explained in chapter two sections 2.13.2. There are many computer model and empirical formula available for calculation Curve Number. Geographic information systems (GIS), hydrological tools are a strong application for hydrological modeling and urban storm water management. Quick Bird and spots-V image Remote sensing technique was collected for land use classification of study area.

The weighted curve number value can be measured of using proposed formula by Halley et al (2000) which is

$$CN_{aw} = \frac{\sum_{k=1}^k (CN_i \times A_i)}{\sum_{k=1}^k A_i} \quad 26$$

This equation indicate parameter  $CN_{aw}$  area weighted curve number of basin,  $CN_i$  defined curve number for each land use class,  $A_i$  area of land use and n represent increment of the land use class.

The evolution surface runoff by Curve Number Infiltration method using SWMM 5.1 is new and based on above described procedure. There were the original curve number uses to predict the rainfall excess from rainfall event due to interception, depression storage and infiltration it was combined loss method that lumps together. But the modified SWMM used account only infiltration losses whereas the rest of other abstraction would be measured separately. The SWMM design curve number model used given below equation relate total event of precipitation (P) mm and total

event of runoff (Q) m<sup>3</sup>/s (Haan et al., 1994; McCuen, 1998; Bedient et al., 2013 & Rossman & Huber, 2016).

$$Q = \frac{P^2}{(P + S_{\max})} \quad 27$$

Where

$S_{\max}$  = Soil's maximum storage moisture storage capacity (mm) and it is also considered amount of water volume difference in a completely saturated soil versus a fully drained soil. But in this content it is considered similar to the maximum moisture deficit parameters which are used in Green-Ampt model. It can be calculate using potential maximum retention equation therefore variations of curve number depend on types of soil and land use class. The values of curve number according soil types and land cover was read Engineering Handbook (NRCS, 2004a).

In the Natural Resources Conservation Services formal method P-I<sub>a</sub> replaced with P because I<sub>a</sub> is an initial abstraction that capturing the rainfall volume by depressing storage filling, initial soil wetting and also vegetation interception. In case SWMM the depression storage parameters ( $d_p$ ) already accounted in sub-catchment section for that I<sub>a</sub> is not considered in equation.

The total amount of infiltration F (mm) assumed from total rainfall that could not produce runoff can be predicted by extending equation 21.

$$F = P - \frac{P^2}{P + S_{\max}} \quad 28$$

For computation rate of infiltration with respect to time interval steps values of precipitation  $P_1$  and infiltration  $F_1$  accumulate at the start of the time step to the time step end respectively.

$$P_2 = P_1 + i\Delta t \quad 29$$

$i$  = increment of rainfall (mm/h)

$\Delta t$  = time step (hour, minute)

$$F_2 = P_2 - \frac{P_2^2}{P_2 + S_e} \quad 30$$

In the above equation  $P_2$  and  $F_2$  represent the accumulative precipitation and infiltration values with respects to time steps start to end. Therefore  $S_e$  is the capacity of moisture storage connected rainfall event start time. The value of  $S_e$  in case of single rainfall event simulation is equal to  $S_{max}$  but it would be lowers in case of depletion moisture storage capacity and due to longer period simulation moisture storage capacity could be recover using given below equation.

The rate of the infiltration (mm/sec) can be estimated as

$$f = \frac{F_2 - F_1}{\Delta t} \quad 31$$

Therefore accumulated value of precipitation updated to ( $P_1 = P_2$ ) and infiltration ( $F_1 = F_2$ ) to design next step but SWMM model limitation it could no allow ponded water infiltration in case no rainfall period with an event and the rate of infiltration assumed remains same for such period.

### 3.6.1 CN method parameters

There are using SWMM model infiltration Curve Number method required to estimates the two parameters for catchment such as:

- I. The Curve Number
- II. The drying Time ( time of fully saturated soil to dry state)

Curve Number calculation technique was explained in detail above section it is used to compute the maximum capacity of soil moisture storage. There is sub-catchment soil drying time  $T_{dry}$  could be related to hydraulic conductivity of a saturated soil  $K_s$  in (mm/h) (Rossman & Huber, 2016) but in SWMM user manuals values of  $K_s$  present in in/h for this study all values converted into metric units. The given equation below is used to estimation of drying time of sub-catchments:

$$T_{dry} = \frac{3.125}{\sqrt{K_s}} \quad 32$$

Whereas the value of hydraulic conductivity of saturated soil is based on soil types.



### 3.7 Drainage capacity measurement & design method

#### 3.7.1 Continuity equation

Continuity equation was used for determination of the capacity of existing drain using equation given below:

$$Q = VA \quad 33$$

Whereas

V = Velocity of flow (m/s)

A = Area of Cross Section (m<sup>2</sup>)

Manning equation was used for estimation of velocity of drain flow.

#### 3.7.2 Manning's equation

The design of storm drainage system and storm sewer system is the basic principles applications of the both hydrological and hydraulics. For estimation of the volume and runoff flow rate from the specific rainfall was used characteristics of the watershed. The design of combine storm water & sewer system Manning equation was used. The most familiar Manning equation which was introduced by Engineer Robert Manning (1889) and it were used in many researches and project would be written as:

$$v = \frac{1.486}{n} R^{\frac{2}{3}} S^{\frac{1}{2}} \quad 34$$

For design of composite drain roughness coefficient was calculated by using following expression:

$$n_w = \frac{P_1 n_1 + P_2 n_2 + \dots + P_m n_m}{P} \quad 35$$

Where:

v = Flow velocity (m/s)

n = Roughness coefficient (dimensionless)

R = Hydraulic Radius (m) which measured by ratio of drains cross section area (m<sup>2</sup>) and perimeter (m)

S = Slope of drains gradient

n<sub>w</sub> = Weighted coefficient of roughness for the drains

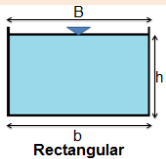
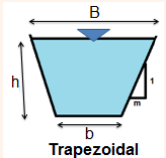
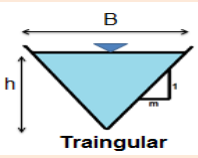
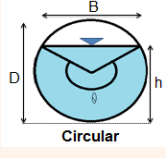
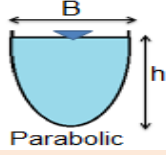
$P_1, P_2, \& P_m$  = Wetted perimeter in meter for each side of roughness

$n_1, n_2, \& n_m$  = Roughness coefficients corresponding to each wetted perimeter

$P$  = the total wetted perimeter, in meter, for the drains.

There are the geometric elements of hydraulic efficient sections without freeboard is summarized in table 5.

**Table 5:** Geometric elements of hydraulic efficient sections without freeboard.

Cross-sections	Area	Wetted Perimeter	Hydraulic Radius	Top width	Hydraulic Depth
	(A)	(P)	( $R_h$ )	(B)	(D)
	( $m^2$ )	(m)	(m)	(m)	(m)
 <p>Rectangular</p>	$bh$	$b + 2h$	$bh/(b + 2h)$	$b$	$h$
 <p>Trapezoidal</p>	$(b + mh)h$	$b + 2h\sqrt{1 + m^2}$	$\frac{(b + mh)h}{b + 2h\sqrt{1 + m^2}}$	$b + 2mh$	$\frac{(b + mh)h}{b + 2mh}$
 <p>Triangular</p>	$mh^2$	$2h\sqrt{1 + m^2}$	$\frac{mh}{2\sqrt{1 + m^2}}$	$2mh$	$\frac{1}{2}h$
 <p>Circular</p>	$\frac{1}{8}(\theta - \sin\theta)D^2$	$\frac{1}{2}\theta D$	$\frac{1}{4}\left[1 - \frac{\sin\theta}{\theta}\right]D$	$\left(\frac{\sin\theta}{2}\right)D$	$\left(\frac{\theta - \sin\theta}{2}\right)\frac{D}{8}$
 <p>Parabolic</p>	$\frac{2}{3}Bh$	$B + \frac{8h^2}{3B}$	$\frac{2B^2h}{3B^2 + 8xh^2}$	$\frac{3}{2}Ah$	$\frac{2}{3}h$

D: Dia meter of the circle

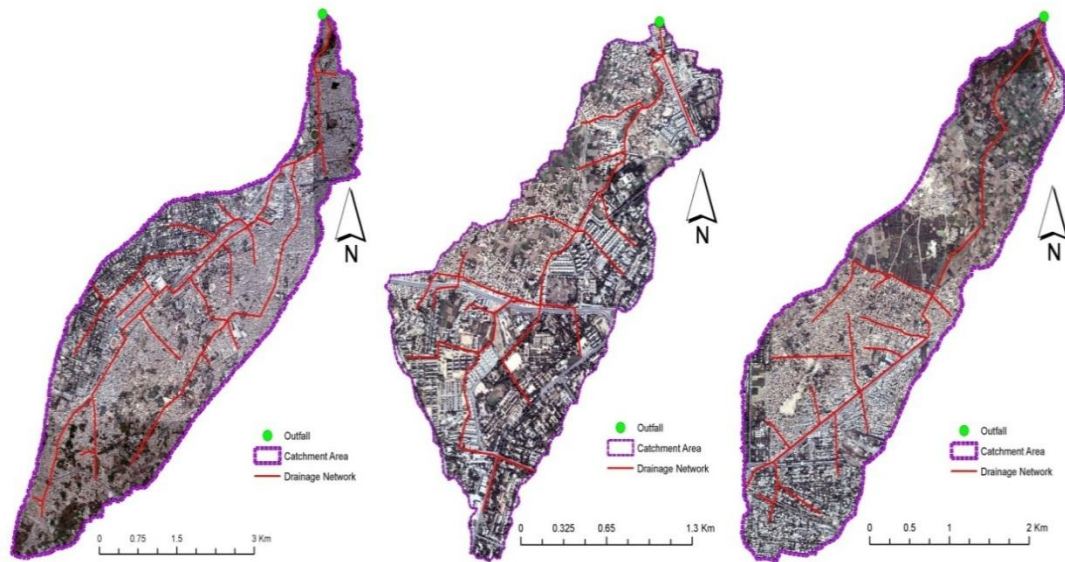
## **4. Chapter Four Results**

### **4.1 Detailed catchments delineation**

The first objective of this study is to improve the data for study area of using GIS and supporting tool for catchment delineation. The adopted surface runoff modeling method is based on catchment geomorphological characteristics. Thus, the calculation of catchment morphological parameters is easier by using watershed delineation techniques.

The 5 meter digital elevation model (DEM) was used for identification of catchment area of the selected drains. The ArcGIS Fill tool was used for filling the sink. The flow direction of every cell was determined by using Flow Direction tool. The flow direction output raster was used as input raster using the Flow Accumulation tool (Esri, 2013) and created flow accumulation raster for sourcing the surface runoff behavior toward outlet point. The catchments highly flow accumulated point was determined by snap pour point tool. Finally the drainage catchments were delineated using Watershed tool. The drainage watershed raster converted were into vector polygon shape file and overlaid stormwater drainage network layout on the Quick Bird image. Detail comparison shows that watershed basin created by DEM had some error.

Finally using the GPS (Global Position System) points that were collected at a 200 meter intervals, street view map, study area settlement layout and Quick Bird image digitized the stormwater drains network. The catchment area boundary which was created from DEM has been corrected using contour shape file and field observation. The delineated catchment area is shows in figure 13.



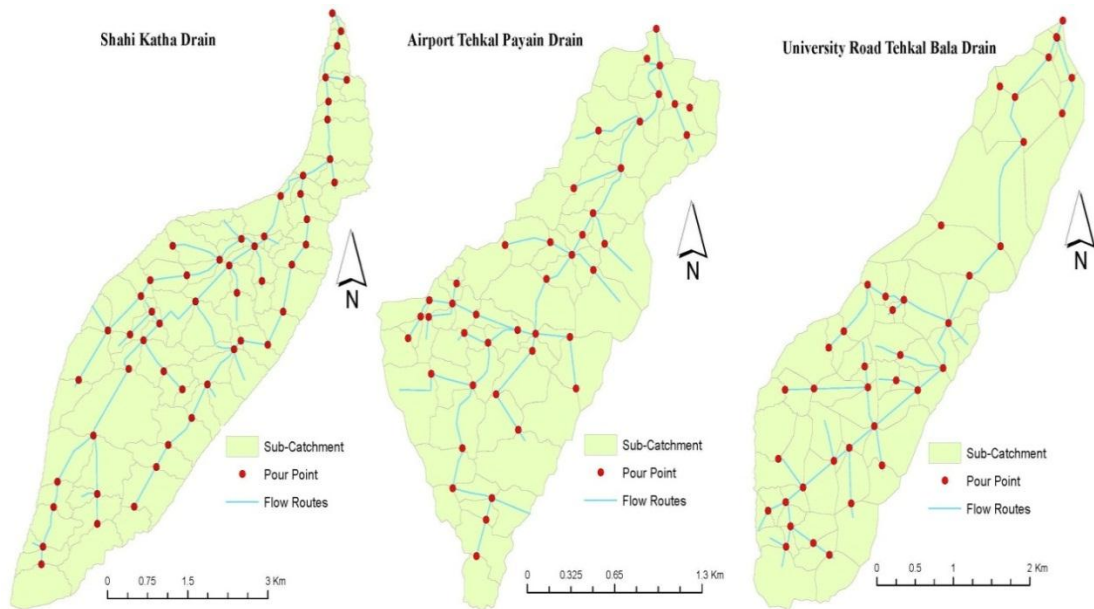
**Figure 13:** Selected drains network and catchments in the study area.

The urban catchment delineation in this study for quality of drainage network data field observation and manually work was considered necessary and error are also corrected. Therefore, the flow direction with in soil may not totally represent flow on the surface. These catchment delineated results are applicable to surface runoff modeling only.

#### 4.2 Catchment subdivision

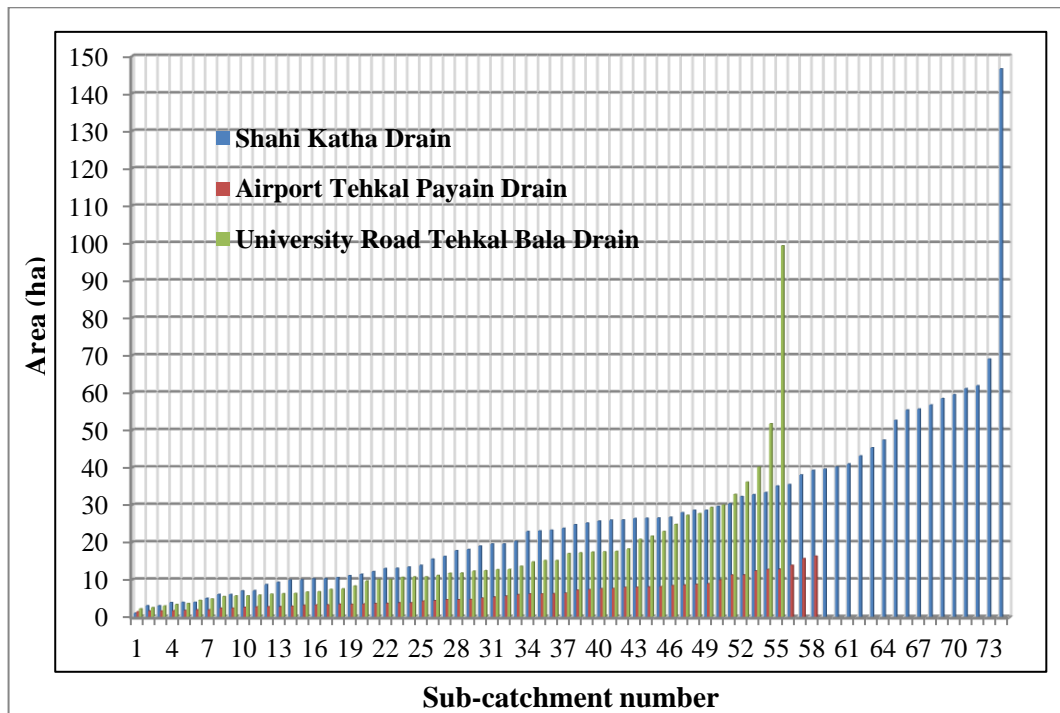
There is much traditional and modern techniques available main catchment classification into sub-catchment for verification or rain water flow behavior toward subject that would be helpful in drain cross-section design. GIS Tools were used to catchment subdivision, in addition to consider the pour points within catchment along the drains. There are two techniques that were considered for adding the pour points such as, *stormwater drains network system layout and drain width*, and GIS spatial analyst tools based on “flow accumulation grid”. For flow accumulation grid, drain polylines were converted into raster using polyline to raster techniques of 5m cell size (Esri, 2013). The drain network polyline had attribute table “drains length” and “Drains width” there is drains length measured with *GIS calculated geometry* and drains width were measured manually during filed investigation in 2014. For the most approximate result of catchments subdivision, drainage catchments raster (created by contours of 5m intervals) and drains network raster was used as an input

raster in GIS “Boolean and” tools (Esri, 2013) and developed a true raster for watershed delineation. Because “Boolean and” tool works on the base of cell integers if the obtained cell values of the both raster is non-zero the results are considered true. Drain catchment was reclassified by keeping view of stream flow routes. Drain network overlaid on flow accumulation raster (Flow aggregated to each cell is a result of flow accumulation raster results which is used to determination aggregated weight of all cells and flow into downslope cell.) and compared. Flow accumulation is considered better method of subdivision of large catchment on the base of pour point. Therefore flow accumulations (FAC) cell value which was not outstripping was adjusting null with the help of GIS Raster Calculator Tools (Esri, 2013). For the vectorization of the stream network, Stream to Feature tools (Esri, 2013) was used and network of stream cell is dissolved into polyline feature. The Pour point location for each sub-catchment which had single or multiple upstream sub-catchment contribution has a question how it locates. The simple technique considered was to add pour point at each location where two or more streams is meeting of sub-catchment area greeter then five (5) ha area. There was the location of the whole drain catchments outlet which was contained by GPS (Global Position System) during field investigation at accurate location (Outlet location of each drain catchment was shown in figure) were merged to the datasets pour point. Therefore Snap Pour point tools (Esri, 2013) was used and snapped the all point again. Finally Watershed tool was used for detailed sub-catchment delineation. The conversion tools (Esri, 2013) were used raster to polygon and calculated the area of each sub-catchment there was some very small Sub-catchments were merged into neighbor sub-catchment after viewing the final delineation results. The delineated sub-catchment and pour points are shown in figure 14.



**Figure 14:** Sub-catchments, flow routes and pour point.

To ensure the sub-catchments delineation sensibility the size distributions of design sub-catchment were plotted. There was few of sub-catchment of size less than 0.2 ha has removed from the plotted data because it was merged into neighbor sub-catchment. The final size distribution of the resulted sub-catchment is shown in figure 15. There was Hydraulic Toolbox design rational equation minimum catchment requirement is 80.9 ha area. Shahi Katha drain and University Road Tehkal Bala drain 1% sub-catchment areas are exceeding as Hydraulic Toolbox rational method has design catchment area limit.



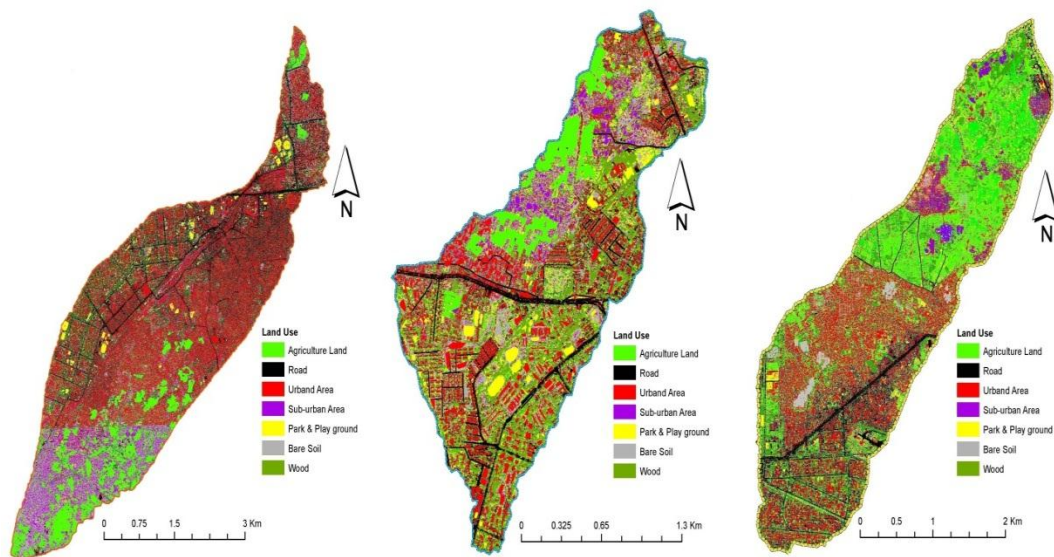
**Figure 15:** Size distribution of the sub-catchment of selected drains.

### 4.3 Land use classification

Surface runoff has direct proportional relationship to land use type, such as high impervious land area generates high quantity of runoff and low impervious land area generates low quantity of runoff. Two methods are selected for rainfall runoff simulation in this study such as Rational Method and NSCS-CN. Two parameters runoff coefficient 'C' and curve number 'CN' used in both methods and varies due to land use types.

The land use classification was performed using Maximum Likelihood Classification tool (Esri, 2013), for calculation of weighted runoff coefficient and weighted curve number. The signature file was created from quick bird image, but the training file of wood land use extracted from world tree map by using Global Mapper blue 16.1.

According to earlier reported literature study 85% or more accuracy land use classification are considered for further calculation, the obtained result of land use classification for each catchment more than 90 to 96% accurate. The land use classification image is shown in figure 16.



**Figure 16:** Land use classification Shahi Katha drain (image on the left), Airport Tehkal Payain drain (image in centre) and University Road Tehkal Bala drain (image one right).

Land use classification raster converted into vector (polygon shape file) and determined the area of each class which is shown into table 6.

**Table 6:** Area of land use

Land Use Type	Shahi Katha drain		Airport Tehkal Payain Drain		University Road Tehkal Bala Drain	
	Area	Area	Area	Area	Area	Area
	(Sq. Km)	(%)	(Sq. Km)	(%)	(Sq. Km)	(%)
Agriculture Land	3.62	17.9	0.42	12	2.49	28.3
Road	2.2	10.9	0.39	11.1	0.69	7.8
Urban Area	7.58	37.4	1.2	34.2	3.11	35.4
Suburban Area	1.9	9.4	0.43	12.3	0.65	7.4
Park & Playground	0.98	4.8	0.33	9.4	0.38	4.3
Bare Soil	2.64	13	0.3	8.5	0.68	7.7
Wood	1.33	6.6	0.44	12.5	0.79	9
<b>SUM</b>	<b>20.25</b>	<b>100</b>	<b>3.51</b>	<b>100</b>	<b>8.79</b>	<b>100</b>

The land use shape file was intersected with sub-catchment shape file to determine the area of land use in each sub-catchment.



#### **4.4 Intensity duration frequency (IDF) curves**

##### **4.4.1 Design rainfall and frequency analysis**

The urban stormwater drainage modeling requires short duration rainfall data. The daily rainfall data was collected from Pakistan Meteorological Department (PMD); Peshawar converted into short duration (1 to 15 hours) using Halcrow formula and India Meteorological Department reduction formula. These selected methods tested on Risalpur and Mardan daily rainfall which was converted into hours and compared with rainfall measured in hours. After detail daily rainfall data analysis IMD reduction formula results funded to be more accurate and that was selected for further data analysis.

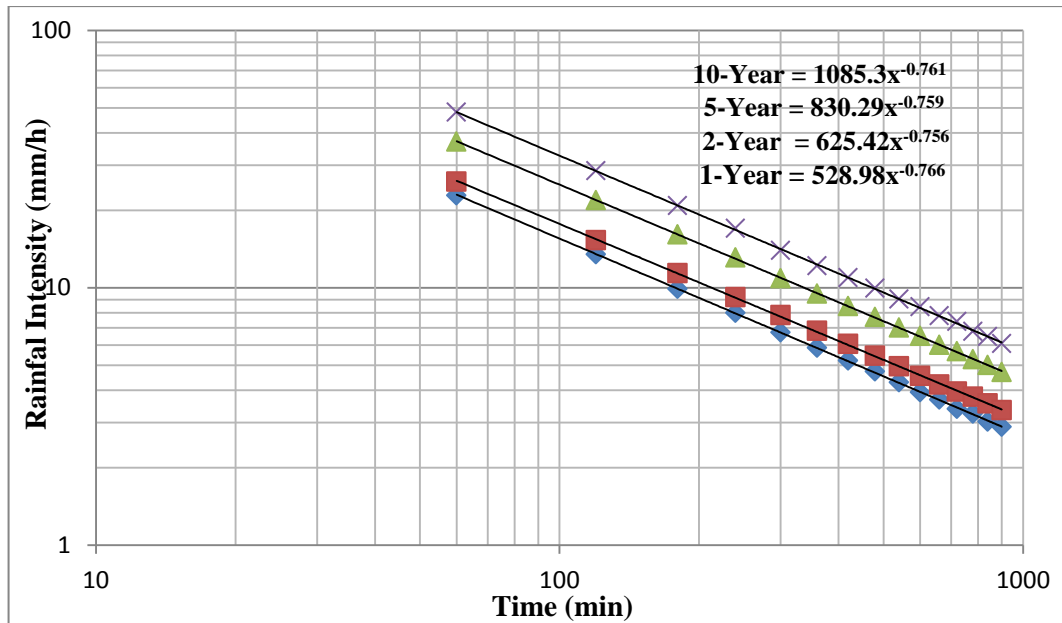
Therefore, daily rainfall analyzed by IMD reduction formula and it was used for determination Bernard and Sherman equation parameters. Extreme Type-I distribution method described in many statistical hydrology books was adopted for rainfall frequency analysis and used calculation of Sherman equation parameters. The design rainfall intensities results for different return period calculated by Extreme Type-I distribution is presented in table 7.

**Table 7:** The design rainfall intensity (mm/hr) for different durations by Extreme Type-I distribution

<b>Durations (hr)</b>	<b>1-Year Frequency</b>	<b>2-Year Frequency</b>	<b>5-Year Frequency</b>	<b>10-Year Frequency</b>
1	22.88	25.89	36.99	48.09
2	13.5	15.31	21.9	28.49
3	9.9	11.4	16.12	20.84
4	8	9.2	13.1	17
5	6.71	7.83	10.9	13.97
6	5.85	6.81	9.5	12.19
7	5.21	6.05	8.5	10.95
8	4.73	5.44	7.7	9.96
9	4.29	4.96	7	9.04
10	3.93	4.55	6.5	8.45
11	3.68	4.21	6	7.79
12	3.39	3.95	5.67	7.39
13	3.24	3.77	5.27	6.77
14	3.02	3.55	5.01	6.47
15	2.88	3.35	4.71	6.07

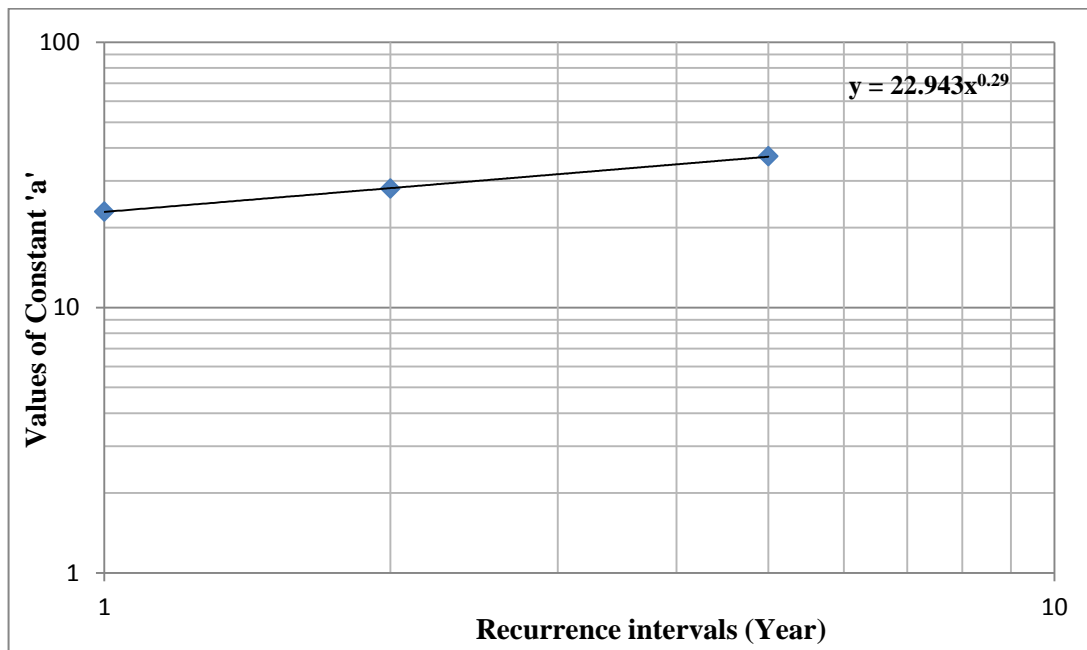
#### 4.4.2 IDF curves derivation

Urban stormwater and drainage design would need smaller time distribution in scale of minutes of rainfall data. These smaller time distribution rainfall patterns are further designed for study area runoff calculation using different empirical method. Sherman Equation consider best for derivation of IDF curves. The basic constant used in Sherman Equation such as ‘a’, ‘d’, ‘b’ and ‘e’ whereas d is duration of rainfall and sometime b also consider duration of rainfall which is described different case study. In case determination of Sherman Equation constant ‘a’ log-log graph is plotted between time and rainfall intensities presented in figure 17, therefore value of graph is taken from table 7.



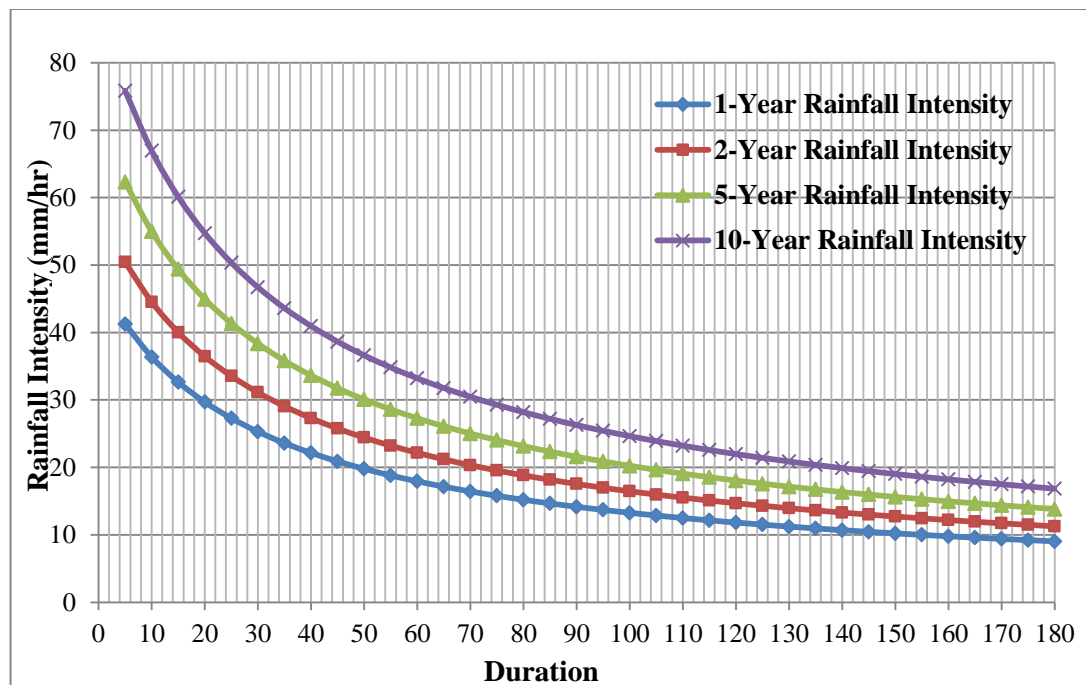
**Figure 17:** Rainfall intensity duration log-log graph.

The values of constant such as  $a = 528.98, 625.42, 830.29, 1085.3$  and  $e = 0.766, 0.756, 0.759, 0.761$  are derived from log-log graph for 1-year, 2-year, 5-year and 10-year recurrence intervals. Therefore, the derivation of constant 'b' values of 'a' is obtained by rainfall intensity and time duration in hours relationship and plotted on log-log graph against recurrence intervals shown in figure 18 below.



**Figure 18:** Log-log graph for determination of Sherman Equation constant 'b'.

The value of constant  $b$  is 22.943 which is derived from relationship between recurrence intervals and constant 'a' in case if value of 'a' obtained by rainfall intensity in mm and time duration in hours than 'e' value would be used 0.29 would probably be it was used in Bernard Equation. Finally using Sherman Equation with calculated constant IDF curves of selected design recurrence interval is generated as in shown figure 19.



**Figure 19:** IDF curves for study area

The design discharge for urban storm drainage construction is based upon duration of storm equal to the selected catchments time of concentration ( $T_c$ ). Time of concentration is the time of water flow from inlet to outlet which is based on land use or drains characteristics and typically is less than one day (24 hours) of stormwater conveyance system components in urban area.

These IDF curves are basically derived for surface runoff calculation using Rational Method and Curve-Number infiltration method of stormwater drainage design. Therefore, the calculation of surface runoff 2-yr and 5-yr rainfall intensity was adopted.

There was the relationship between intensity-duration-frequency (IDF) curves explained in derived equation summarize conditional probability of rainfall or intensities average. The design rainfall intensities average will occur for given

duration especially from graphical representations of IDF curve and probability. Many hydrological design project such as considering urban drainage, bridge sizing, and spillway sizing need IDF curve information to determine the magnitude of design storm of basic required return period. The return period for urban drainage design and control structure for specific water adopted in table 3 are generalized design criteria- return period for water control structures.

#### **4.5 Peak surface runoff assessment Rational Method**

Peak runoff assessment methodology is divided into two parts therefore in first part assessment of peak surface runoff is done by Rational Method. GIS tools was used for the evaluation of various parameters involved in Rational Method such as catchment area (A), runoff coefficient (C), rainfall intensity (I). Therefore according to Hydraulic toolbox model Rational Method is only valid to catchment area 80.9 ha or less, for that main catchment is divided into number of sub-catchment of area less than or equal to 80.9 ha except area of one sub-catchment in Shahi Katha drain and one sub-catchment University Road Tehkal Bala drain exceeding the Rational Method area limitation.

The catchment area of each drain was delineated by keeping view of the contour map of the study area and also from GPS point for particular channels in the settlements and also each drain delineates with the help of GPS point and visible view of QuickBird satellite image using GIS Editor tools polyline shape file. Runoff Coefficient (C) values vary based on proportion of imperviousness of the catchment area. The value of weighted runoff coefficient for rainfall intensity 2-yr and 5-yr return period was calculated land use classification area multiplying values of runoff coefficient with respect to land type which is obtained from many case studies. The values of runoff coefficient for 2-yr and 5-yr return aggregated for different land use obtained from table 4.

Rainfall Intensity of each sub-catchment is depends upon time of concentration. Time of concentration ( $T_c$ ) of each drain is measured by using Kirpich equation because rainfall Intensity (I) is the average rainfall intensity, for a critical period of time (duration of rainfall) equal to the time of concentration,  $T_c$ . The selected stormwater drains catchment in study area have different time of concentration ( $T_c$ ) because for different catchments as Slope (S) and drains length (L) may vary, therefore, rainfall

intensity (I) may vary for each catchment. But its possible value may be read from the IDF curve for the given duration of rainfall ( $T_c$ ). For easy or accuracy of runoff calculations equation of the IDF curve was developed and used for rainfall intensity design of each catchment. The detailed sub-catchment land use area and morphological characteristics used in Rational equation is presented in Appendix-I. The Hydraulic Toolbox 4.2 model was used for peak surface runoff assessment modeling of selected catchment outlets using Rational Method Technique. The calculated surface peak flows of Rational Method are presented in table 8, 9 and 10 respectively.

**Table 8:** Calculated surface peak flow of Shahi Katha drain for 2-yr and 5-yr recurrence intervals.

Sub-Catchment	Area	Weighted Runoff Coefficient		Rainfall Intensity		Q2 = CIA/360	Q5 = CIA/360
		(2-yr Recurrence Intervals)	(5-yr Recurrence Intervals)	(2-yr Recurrence Intervals)	(5-yr Recurrence Intervals)		
#	(A) (ha)	( $C_{w2}$ )	( $C_{w5}$ )	(I) (mm/h)	(I) (mm/h)	( $m^3/s$ )	( $m^3/s$ )
0	55.39	0.32	0.37	13.85	19.59	0.675	1.122
1	23.10	0.32	0.37	22.77	28.76	0.465	0.679
2	7.12	0.32	0.37	38.91	43.51	0.250	0.323
3	39.27	0.38	0.44	9.91	15.13	0.408	0.732
4	35.52	0.33	0.39	12.53	18.13	0.407	0.699
5	12.20	0.32	0.37	16.42	22.34	0.179	0.284
6	24.76	0.37	0.43	18.44	24.44	0.466	0.725
7	59.51	0.42	0.49	6.89	11.42	0.483	0.917
8	61.14	0.42	0.48	9.13	14.20	0.646	1.151
9	61.93	0.31	0.37	12.34	17.92	0.657	1.125
10	40.19	0.43	0.48	23.82	29.79	1.145	1.594
11	146.63	0.49	0.55	9.25	14.34	1.862	3.239
12	30.33	0.57	0.64	5.04	8.97	0.240	0.481
13	58.48	0.57	0.65	8.66	13.63	0.797	1.443
14	56.79	0.42	0.48	9.05	14.10	0.605	1.060
15	26.49	0.47	0.53	9.92	15.14	0.343	0.594
16	9.39	0.52	0.58	20.91	26.93	0.284	0.405
17	25.98	0.42	0.46	13.70	19.43	0.414	0.649
18	26.74	0.51	0.56	8.74	13.73	0.330	0.572
19	40.99	0.53	0.57	10.75	16.10	0.652	1.052
20	18.16	0.58	0.65	11.11	16.52	0.323	0.543
21	19.60	0.50	0.57	12.56	18.17	0.340	0.559

22	11.11	0.48	0.55	20.99	27.01	0.313	0.459
23	9.95	0.54	0.61	7.96	12.76	0.118	0.214
24	10.29	0.54	0.62	16.33	22.25	0.250	0.391
25	3.10	0.44	0.50	28.04	33.78	0.106	0.145
26	43.17	0.55	0.61	5.47	9.56	0.362	0.704
27	4.02	0.54	0.61	30.55	36.10	0.184	0.244
28	19.04	0.50	0.57	25.26	31.16	0.674	0.947
29	29.24	0.47	0.53	11.14	16.56	0.426	0.710
30	33.39	0.54	0.62	9.83	15.04	0.496	0.860
31	11.49	0.55	0.61	10.15	15.41	0.178	0.298
32	47.37	0.54	0.61	14.06	19.82	1.005	1.599
33	39.63	0.55	0.61	11.75	17.26	0.707	1.161
34	5.07	0.51	0.57	44.96	48.65	0.323	0.390
35	28.00	0.53	0.59	10.94	16.33	0.448	0.748
36	32.28	0.55	0.62	17.59	23.57	0.869	1.303
37	32.81	0.54	0.59	14.58	20.38	0.717	1.089
38	52.68	0.56	0.63	14.61	20.41	1.198	1.888
39	13.87	0.47	0.52	26.32	32.17	0.481	0.642
40	20.32	0.53	0.57	14.59	20.40	0.434	0.661
41	10.34	0.52	0.59	9.91	15.12	0.148	0.257
42	10.63	0.52	0.59	13.95	19.70	0.214	0.341
43	35.12	0.56	0.61	18.80	24.81	1.024	1.487
44	6.09	0.51	0.56	37.15	41.99	0.319	0.401
45	6.11	0.50	0.56	57.36	58.74	0.483	0.556
46	26.43	0.56	0.63	22.70	28.70	0.935	1.334
47	23.81	0.53	0.59	26.36	32.21	0.920	1.265
48	17.81	0.48	0.54	56.10	57.73	1.336	1.529
49	4.01	0.49	0.55	30.76	36.29	0.168	0.223
50	3.10	0.52	0.57	40.71	45.06	0.182	0.223
51	45.29	0.57	0.64	16.07	21.98	1.143	1.778
52	25.21	0.52	0.59	24.71	30.64	0.903	1.260
53	13.11	0.50	0.56	31.00	36.51	0.563	0.748
54	10.05	0.54	0.61	10.01	15.24	0.150	0.260
55	25.72	0.55	0.61	30.90	36.42	1.212	1.584
56	23.30	0.56	0.62	24.40	30.35	0.884	1.213
57	16.29	0.50	0.58	12.42	18.01	0.281	0.471
58	69.06	0.52	0.58	9.09	14.16	0.910	1.568
59	26.54	0.53	0.58	22.11	28.12	0.865	1.211
60	13.04	0.51	0.57	13.98	19.73	0.259	0.411
61	13.44	0.50	0.56	20.89	26.92	0.388	0.563
62	7.06	0.51	0.55	13.65	19.38	0.135	0.210
63	19.60	0.44	0.48	16.09	22.00	0.388	0.579
64	8.74	0.42	0.47	27.37	33.16	0.281	0.377
65	3.93	0.41	0.45	31.75	37.19	0.141	0.181

66	1.09	0.37	0.41	15.79	21.68	0.018	0.027
67	55.67	0.31	0.36	13.04	18.70	0.625	1.042
68	26.04	0.30	0.34	19.39	25.41	0.414	0.634
69	38.08	0.53	0.60	15.04	20.88	0.841	1.315
70	22.93	0.54	0.60	11.96	17.49	0.409	0.670
71	15.58	0.53	0.59	8.36	13.27	0.190	0.341
72	29.64	0.54	0.60	16.10	22.01	0.716	1.092
73	28.52	0.55	0.61	12.66	18.27	0.554	0.887
<b>Flow Peak Sum</b>						<b>39.260</b>	<b>60.438</b>

**Table 9:** Calculated surface peak flow of Airport Tehkal Payain drain for 2-yr and 5-yr recurrence intervals.

Sub-Catchment	Area	Weighted Runoff Coefficient		Rainfall Intensity		Q2 = CIA/360	Q5 = CIA/360
		(2-yr Recurrence Intervals)	(5-yr Recurrence Intervals)	(2-yr Recurrence Intervals)	(5-yr Recurrence Intervals)		
#	(A) (ha)	(C <sub>w2</sub> )	(C <sub>w5</sub> )	(I) (mm/hr)	(I) (mm/hr)	(m <sup>3</sup> /s)	(m <sup>3</sup> /s)
0	6.27	0.51	0.62	18.32	30.75	0.163	0.332
1	8.98	0.53	0.64	23.33	39.70	0.306	0.629
2	6.46	0.53	0.64	21.62	37.69	0.205	0.430
3	2.66	0.49	0.59	32.56	49.82	0.117	0.216
4	3.73	0.51	0.62	50.37	67.08	0.267	0.429
5	3.51	0.54	0.65	21.71	37.80	0.115	0.242
6	8.01	0.54	0.66	23.49	39.88	0.283	0.582
7	12.79	0.52	0.63	16.85	31.81	0.312	0.709
8	4.77	0.48	0.58	26.39	43.18	0.168	0.332
9	4.72	0.53	0.64	28.46	45.46	0.198	0.379
10	1.71	0.47	0.57	36.88	54.24	0.082	0.148
11	15.68	0.47	0.56	35.68	53.03	0.724	1.298
12	8.07	0.42	0.54	22.39	38.60	0.213	0.467
13	11.30	0.50	0.60	15.61	30.18	0.244	0.568
14	5.64	0.50	0.61	24.46	41.00	0.192	0.393
15	1.51	0.45	0.54	42.39	59.64	0.080	0.136
16	1.66	0.47	0.55	30.06	47.18	0.065	0.120
17	2.42	0.60	0.71	22.46	38.68	0.090	0.185
18	2.82	0.48	0.59	26.09	42.84	0.099	0.197
19	1.98	0.48	0.58	24.22	40.72	0.064	0.129
20	4.71	0.39	0.47	48.49	65.36	0.245	0.402
21	6.04	0.48	0.59	13.39	27.19	0.108	0.270
22	9.98	0.44	0.53	20.25	36.05	0.244	0.525
23	3.45	0.56	0.67	47.51	64.45	0.256	0.414



24	3.68	0.49	0.59	17.51	32.64	0.088	0.196
25	1.84	0.46	0.55	57.12	73.08	0.134	0.206
26	3.24	0.52	0.62	23.20	39.55	0.109	0.221
27	1.75	0.45	0.54	31.97	49.21	0.070	0.129
28	2.44	0.50	0.60	61.32	76.70	0.208	0.311
29	11.34	0.51	0.63	23.29	39.66	0.378	0.787
30	12.39	0.54	0.66	25.37	42.03	0.476	0.948
31	2.81	0.56	0.67	30.51	47.67	0.132	0.248
32	16.36	0.37	0.44	16.92	31.89	0.281	0.632
33	8.09	0.38	0.46	29.93	47.04	0.258	0.491
34	7.24	0.37	0.44	26.19	42.95	0.194	0.380
35	4.46	0.37	0.44	26.60	43.40	0.123	0.237
36	13.91	0.55	0.66	26.92	43.76	0.571	1.115
37	3.35	0.49	0.58	47.20	64.17	0.215	0.348
38	12.84	0.51	0.61	32.90	50.17	0.601	1.095
39	2.01	0.31	0.36	23.56	39.96	0.041	0.079
40	3.45	0.28	0.33	44.16	61.33	0.120	0.195
41	7.70	0.29	0.34	37.34	54.70	0.232	0.398
42	2.75	0.35	0.39	22.95	39.25	0.060	0.118
43	3.86	0.47	0.57	33.87	51.18	0.170	0.312
44	8.82	0.29	0.33	28.07	45.03	0.197	0.368
45	6.23	0.27	0.32	18.21	33.53	0.085	0.185
46	8.60	0.47	0.57	15.19	29.63	0.170	0.400
47	8.15	0.43	0.50	14.68	28.95	0.144	0.327
48	8.50	0.29	0.33	22.20	38.37	0.151	0.303
49	7.67	0.54	0.65	12.17	25.48	0.140	0.354
50	2.95	0.49	0.58	72.84	86.25	0.290	0.413
51	5.15	0.50	0.60	42.89	60.12	0.307	0.513
52	4.31	0.37	0.44	10.97	23.74	0.048	0.124
53	5.40	0.55	0.66	34.91	52.25	0.290	0.517
54	6.29	0.55	0.65	15.84	30.49	0.151	0.347
55	3.27	0.50	0.60	15.33	29.81	0.069	0.163
56	3.84	0.45	0.54	22.21	38.39	0.106	0.219
57	7.42	0.32	0.37	15.98	30.67	0.106	0.236
<b>Flow Peak Sum</b>						<b>11.556</b>	<b>22.452</b>

**Table 10:** Calculated surface peak flow of University Road Tehkal Bala drain for 2-yr and 5-yr recurrence intervals.

Sub-Catchment	Area	Weighted Runoff Coefficient		Rainfall Intensity		Q2 = CIA/360	Q5 = CIA/360
		(2-yr Recurrence Intervals)	(5-yr Recurrence Intervals)	(2-yr Recurrence Intervals)	(5-yr Recurrence Intervals)		
#	(A) (ha)	(C <sub>w2</sub> )	(C <sub>w5</sub> )	(I) (mm/hr)	(I) (mm/hr)	(m <sup>3</sup> /s)	(m <sup>3</sup> /s)
0	17.43	0.47	0.49	19.91	29.66	0.454	0.711
1	17.21	0.39	0.40	11.32	19.90	0.209	0.377
2	12.47	0.36	0.37	12.07	20.89	0.149	0.265
3	27.27	0.37	0.38	11.05	19.55	0.308	0.563
4	17.52	0.49	0.52	9.87	17.97	0.235	0.457
5	20.86	0.34	0.36	12.82	21.85	0.255	0.450
6	17.65	0.50	0.54	12.35	21.25	0.303	0.562
7	12.32	0.47	0.53	73.36	80.69	1.185	1.451
8	30.05	0.46	0.50	14.84	24.38	0.576	1.019
9	2.59	0.55	0.60	40.20	51.43	0.158	0.223
10	8.34	0.53	0.58	18.73	29.02	0.232	0.387
11	13.65	0.49	0.53	10.27	18.50	0.192	0.372
12	11.82	0.44	0.48	15.78	25.53	0.229	0.399
13	14.77	0.15	0.21	20.91	31.52	0.131	0.274
14	99.33	0.16	0.23	7.03	13.93	0.313	0.888
15	36.16	0.12	0.15	15.46	25.14	0.192	0.377
16	10.78	0.12	0.14	41.24	52.42	0.150	0.221
17	40.16	0.12	0.14	14.05	23.40	0.195	0.378
18	15.17	0.39	0.42	15.74	25.47	0.260	0.451
19	22.94	0.13	0.16	12.97	22.04	0.106	0.220
20	6.78	0.38	0.40	17.95	28.11	0.130	0.214
21	5.75	0.34	0.36	30.44	41.76	0.166	0.242
22	2.25	0.41	0.43	28.27	39.50	0.073	0.107
23	21.69	0.42	0.47	10.62	18.98	0.268	0.537
24	10.07	0.39	0.41	30.12	41.43	0.328	0.473
25	15.18	0.35	0.38	9.42	17.35	0.140	0.277
26	4.92	0.53	0.58	28.74	40.00	0.207	0.318
27	6.84	0.41	0.45	18.48	28.73	0.144	0.248
28	6.20	0.45	0.48	22.59	33.39	0.173	0.273
29	5.93	0.47	0.50	23.83	34.76	0.184	0.289
30	3.40	0.48	0.51	19.27	29.65	0.087	0.142
31	5.51	0.52	0.57	18.91	29.24	0.151	0.255
32	12.73	0.43	0.47	12.56	21.52	0.193	0.355
33	10.83	0.47	0.51	26.82	37.98	0.383	0.582

34	7.45	0.39	0.45	38.62	49.91	0.311	0.464
35	12.83	0.31	0.34	11.71	20.42	0.131	0.247
36	4.53	0.31	0.32	30.44	41.76	0.118	0.168
37	5.71	0.43	0.45	17.80	27.94	0.121	0.200
38	7.59	0.32	0.34	23.82	34.75	0.162	0.249
39	11.19	0.35	0.36	10.55	18.89	0.115	0.214
40	17.04	0.35	0.36	20.52	31.08	0.338	0.531
41	10.67	0.38	0.40	29.65	40.94	0.331	0.482
42	27.73	0.34	0.35	23.03	33.88	0.604	0.918
43	9.70	0.18	0.20	15.95	25.74	0.078	0.137
44	3.69	0.34	0.36	36.16	47.50	0.126	0.173
45	3.05	0.25	0.26	40.21	51.44	0.084	0.115
46	10.10	0.20	0.21	24.14	35.10	0.132	0.204
47	29.37	0.20	0.22	15.40	25.06	0.258	0.445
48	11.76	0.42	0.45	15.45	25.13	0.212	0.369
49	6.28	0.51	0.55	37.48	48.80	0.335	0.471
50	6.39	0.46	0.49	45.83	56.73	0.374	0.497
51	18.23	0.16	0.19	15.77	25.52	0.131	0.241
52	32.83	0.43	0.46	23.12	33.98	0.900	1.416
53	51.72	0.14	0.18	18.13	28.33	0.370	0.737
54	21.00	0.36	0.38	19.23	29.60	0.403	0.659
<b>Flow Peak Sum</b>						<b>14.094</b>	<b>23.293</b>

The computed morphometric parameters and landuse type area with aggregated runoff coefficient of selected drainage sub-catchment are attached in appendix-I.

#### 4.6 Peak runoff simulation using SWMM

The Second method peak surface runoff assessments of selected catchment is using EPA-SWMM, because it was used for simulation of dynamic rainfall-runoff of both single event or long term runoff quantity simulation. The SWMM model is divided into three components for simulation of runoff quantity of selected catchment therefore, first parts is sub-catchment.

##### I. Sub-catchment

The most probably sub-catchment receives rainfall from associated rain gage and generates the surface runoff, which flow drainage system to receiving body. For simulation of surface runoff quantity need to calculate the following basic parameter for sub-catchment.

##### i. Sub-Catchment Width (m)

- ii. Percent Slope
- iii. Percent Impervious
- iv. Overland Roughness
- v. Depression Storage (mm)

#### **4.6.1 Sub-catchment parameterization**

The SWMM model is based on wide range of sub-catchment parameters, some of parameter are easy to calculate using traditional or latest technology (e.g GIS or remote sensing). Thus some of the parameters such as catchment area, conveyance system length, water depth, are easier to obtain with few uncertainties still associated. Some other parameters such as, flow width, mean slope in percent and percent imperviousness of the catchment required complicated processing technique of using GIS tools with input data remote sensing. The parameters and calculation procedure detail is described below.

##### **4.6.1.1 Flow Width**

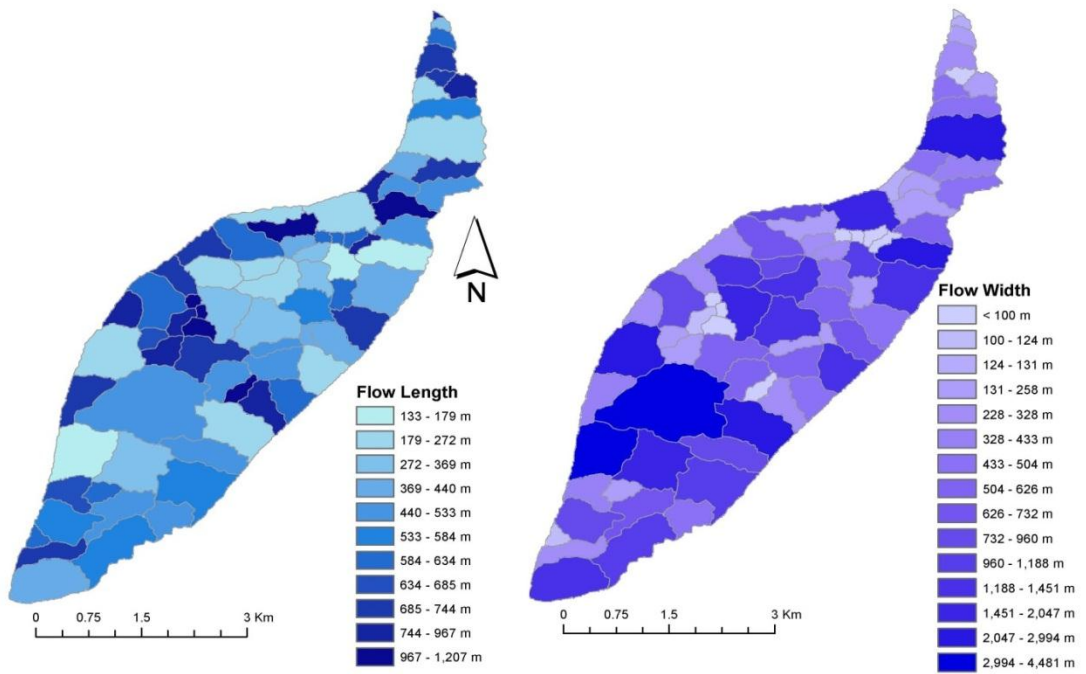
Flow width in SWMM is one of the important required parameters which was the sub-catchment area divided by the longest overland flow path length in the area Saeid Eslamian, (2014). GIS Tools have vital rules of hydrologic parameters calculation peak runoff of selected catchment and which would be used as input data SWMM.

According to flow width definition area (A) and longest overland flow path length also need to calculate by using GIS application. Sub-catchment area was measured after running the watershed tools. For flow length first we need to calculate flow direction cell by cell for running Flow Length Tools. There was the main use of Flow Length tools in generally to estimate the longest flow path length within selected catchment. Flow direction was used as input raster file for flow length of each cell of either longest upstream or downstream flow route. For that purpose calibration was not possible on the base of width which would be estimated by running “Flow length Tools” and “Watershed Tools”.

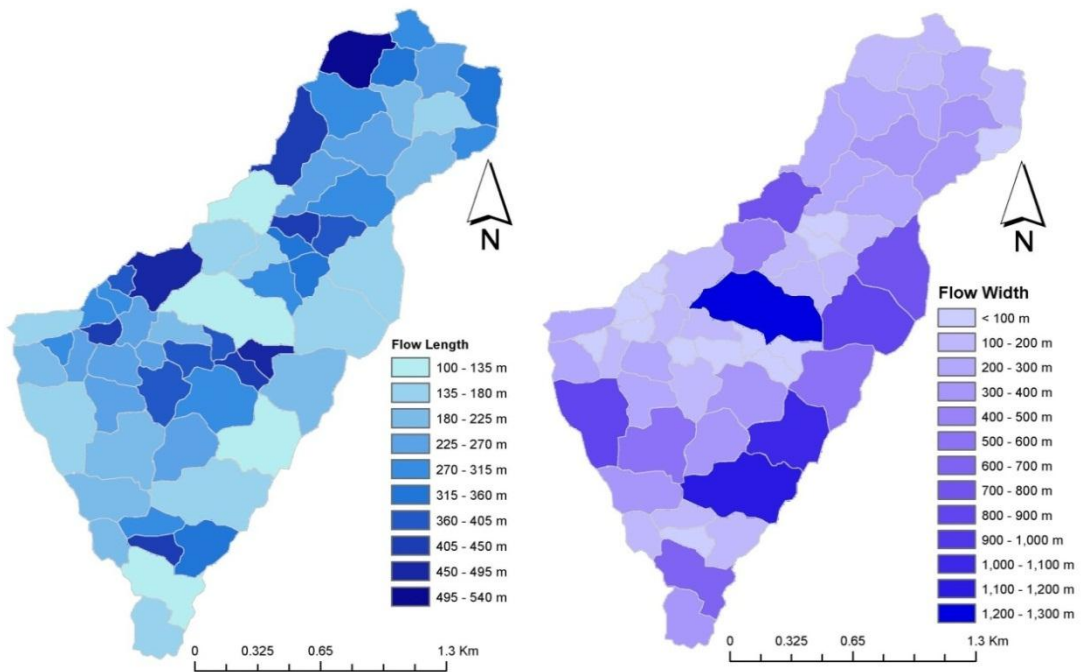
Next steps within sub-catchments source cell of upstream were distinguished by running GIS Flow Length tool with a setting upstream or downstream source cell for drain of each selected catchments. There was the resulting raster cell of upstream or downstream flow length zero which was interpreted as source cells. New Raster was created by setting values using raster calculator under considering these principles “Source cell values was set to the downstream flow length” and “ the rest of the raster cell were set to null’.

The final approach of width calculation sub-catchment resulted flow length summarized of using Zonal Statistics as Table tool (Esri, 2013). The weighted flow length sub-catchment of Shahi Katha drain is appeared 489 m and with ranging of catchment flow length from 133 to 1207 m, weighted flow length sub-catchment Airport Tehkal Payain drain is appeared 498 m and its range from 241 to 1013 m and therefore the weighted flow length of sub-catchment University Road Tehkal Bala drain is 467 and its flow length range varies from 166 to 1247 m. According to the Flow Length tool (Esri, 2013) mostly sub-catchment contained 2% to 40 % area of the neighbor sub-catchment cells area, which is geometrically representing the error for overland flow due to flow direction toward next sub-catchment it was removed by creating the grid cell of sub-catchment using Global Mapper and detailed view cell bay cell flow direction and its contribution of next sub-catchment. Zonal Statistics as table value was exported to excel sheet and reduced the flow length of each individual sub-catchment with correct overland flow length in such sub-catchment.

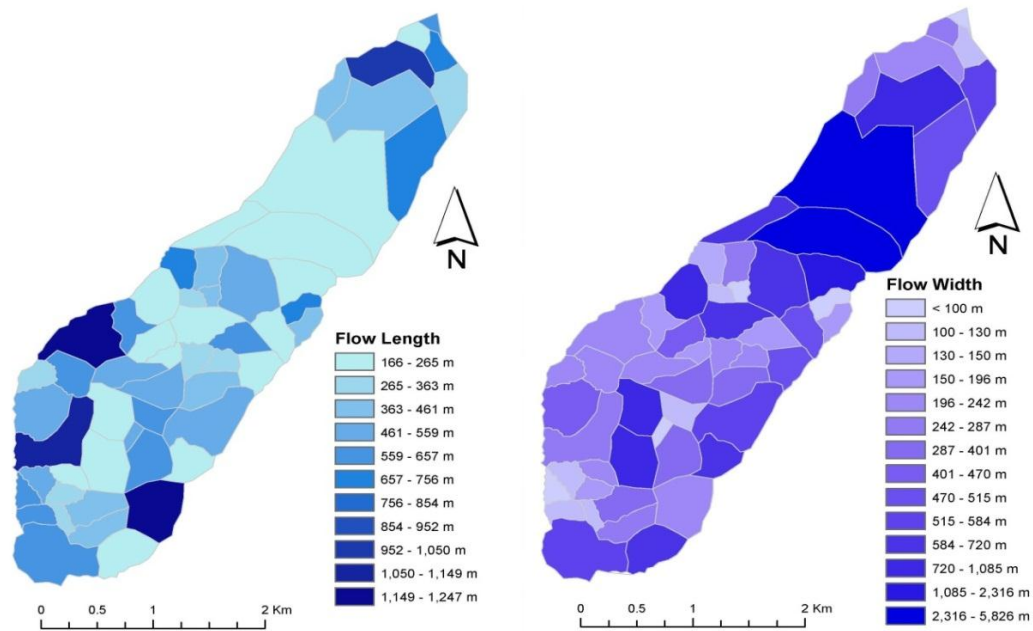
Finally flow width of each sub-catchment is calculated by area of the each sub catchment divided by the flow length of such sub-catchment. There is the final average flow width of selected sub catchment such as 1198 m observed for Shahi Katha drain, 664 m observed for Airport Tehkal Payain drain and 1160 m for University Road Tehkal Bala drain. There is the result of the flow length and flow width is presented in figure 20, 21 and 22.



**Figure 20:** Shahi Katha drains sub-catchment flow length and flow width.



**Figure 21:** Airport Tehkal Payain drains sub-catchment flow length and flow width.



**Figure 22:** University Road Tehkal Bala drain sub-catchment flow length and flow width.

#### 4.6.1.2 Sub-catchment slope

Slope is the second basic parameter which is required as input data in SWMM, but there is the shape of the sub-catchment probably dominated as rectangular planes in the model. The surface runoff according to inclination of sub-catchment plane is flow directly toward the single edges point of the rectangle and the inclination weight tells the actuals slope of the sub-catchment. In fact the slope and shape of the sub-catchment vary with in individual sub-catchment. In this study calculation of slope for all design large heterogeneous sub-catchment is most acquired case. Thus the digital elevation model (DEM) is the most appropriate way to calculate the sub-catchment slope.

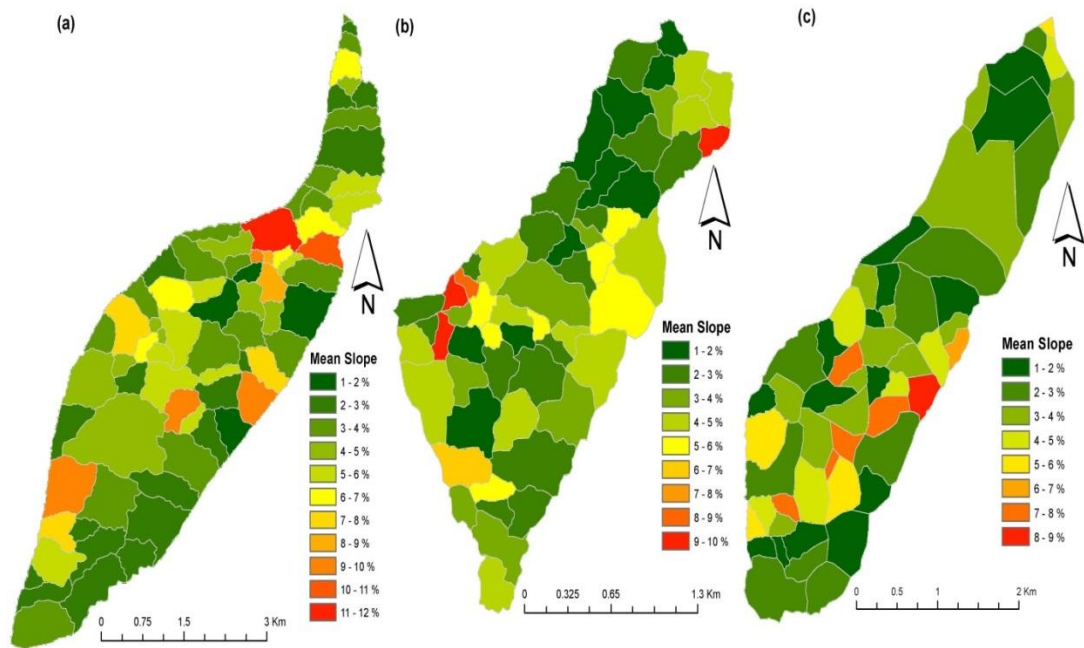
There is the sub-catchment slope should be depended on the paths of flow of selected sub-catchment, and it measured from each cell after running the flow direction cell by cell. There is flow amount form numerous cells which would be transferred from upstream reached only in small quantity toward downstream cells. This is the major reason before sub-catchment flow accumulation; the slope of such catchment should be weighted cell by cell. So that the calculation of slope from original digital elevation model (DEM) is not considered proper input data source of such kind of

modeling because it would give the unrealistic slopes along channel of each cell. For that original DEM was became more perfect source of estimation the slope of such sub-catchment for that GIS Fill tools (Esri, 2013) was run and corrected for DEM resolution error.

The sub-catchment slope raster creation is based on two different GIS methods (tools) according to the first method Slope tool (Esri, 2013) which would be applicable to utilized the neighboring cell elevations and calculate the particular cell slope. In first step this method was applied on main catchment and tried to calculate the each sub-catchment slope after overlying the shape file but it showing the deceptive slope toward the flow direction at acquired point. There is second method that was applied to drop raster obtained by Flow Direction tool (Esri, 2013). But keeping in view slope raster obtained but in second method it was clear that slope value was totally different from expected values. Finally first method was considered for detail slope estimation of each sub-catchment.

The flow patterns are collimating straight line toward pour points from upstream cells because it is basic concept in the SWMM. In fact the flow line always overlying in the raster cell. Though, the mean slope of each sub-catchment had to be averaged as with respect to the each cell flow rate and got the result which is consistent to conceptualization of SWMM. Raster Calculator tool (Esri, 2013) is used to multiplying the slope raster with flow accumulation raster, but before applying this tool for slope parameter only considering over land flow was characterize, such as in flow accumulation raster where flow in stormwater drains happened had been set null. Thus in first stage Zonal Statistical tool (Esri, 2013) was used and calculated the zonal sum of specific sub-catchment from resulted multiplication of slope raster zonal sum and flow accumulation (zonal sum) modified raster. The weighted slopes were obtained for all sub-catchment after dividing zonal sum obtained after multiplication with flow accumulation zonal sum. The final results of slope of selected drains sub-catchment are presented in Figure 23:





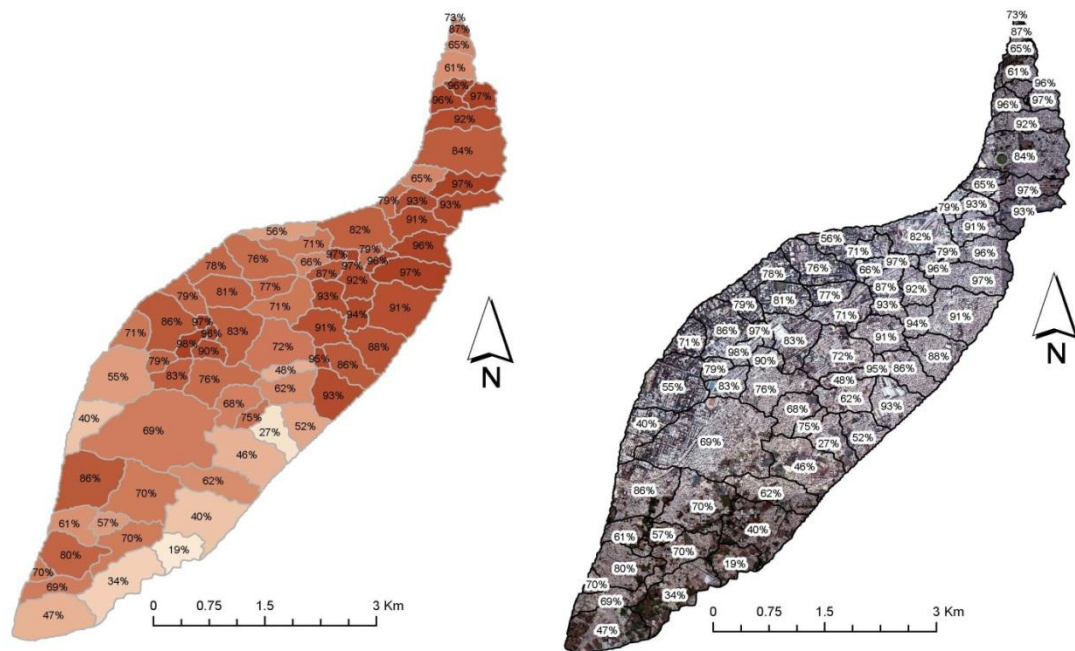
**Figure 23:** Mean hydrologic slope of sub-catchment (a) Shahi Katha drain, (b) Airport Tehkal Payain drain and (c) University Road Tehkal Bala drain.

#### 4.6.1.3 Sub-catchment imperviousness

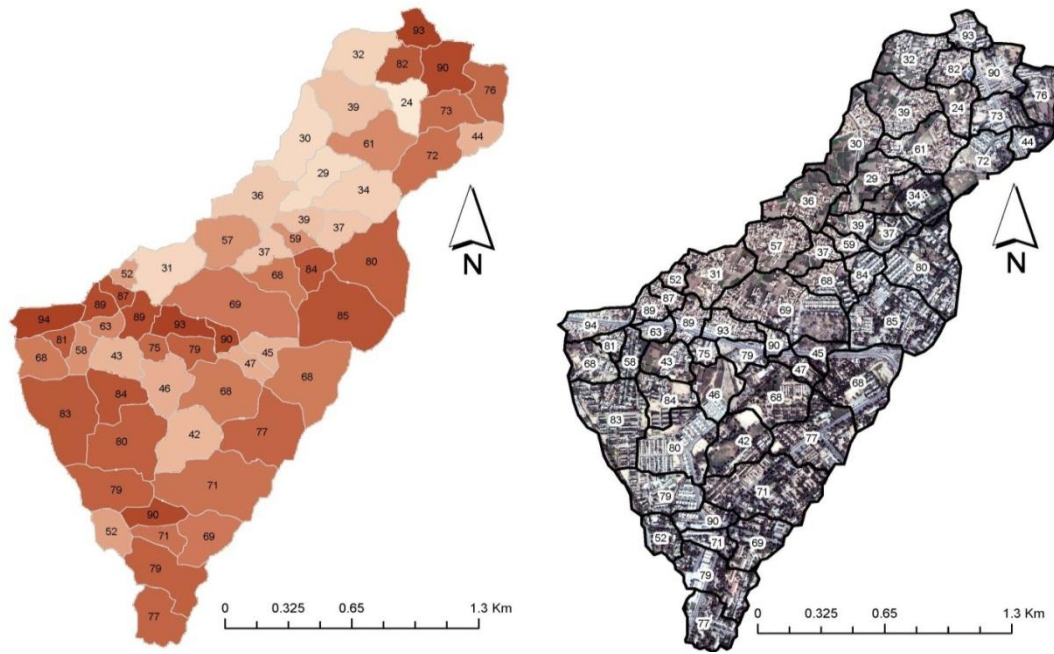
Sub-catchment imperviousness is also one of the most important parameters for SWMM which shows the rate of runoff peak or infiltration rate in the study area. Literature review shows that high impervious areas have low infiltration rates and in inverse they generate high flow peaks. Imperviousness may be used as a calibration parameter in the model. In fact, the mostly surface is not partially impervious because of soil types or materials which were used in the construction of buildings, roads and also some other essential parameters. According to this study, there were no observed flows available for the selected catchment so that a calibration option was not more required. But before running the SWMM flow of each catchment was measured by the Rational Equation which would be helpful for measuring the peak flow at the outfall of the selected drain. The percentage of surface imperviousness is dependant on land use classification data or manually high resolution satellite image processing.

In this study, Quick Bird image was used for the calculation of surface imperviousness of the study area and later it was used for sub-catchment parameterization. Before it was an urban settlement high density imperviousness layer was used for this study it was not considered because of some new construction in the study area. In the first step

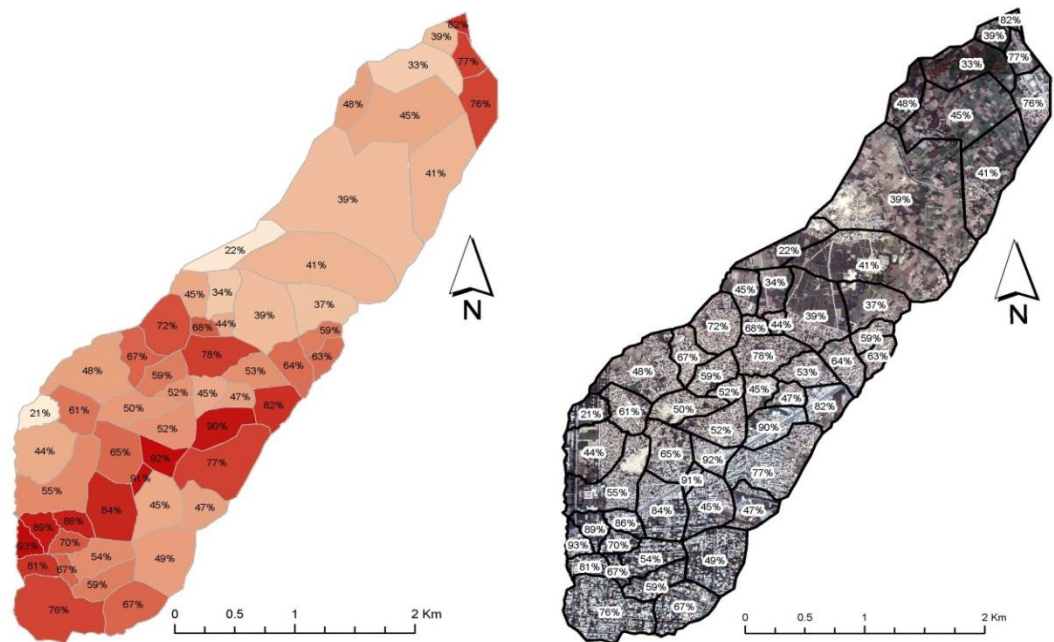
catchment layer of each drain overlies on the urban settlement and intersect area of interest of this study. There is road, streets, water course, non-perennial stream and irrigation canal system presented as polyline created. The aim is extraction of impervious and pervious features in the selected sub-catchment. The polygon of different type of containing building, parking lots (concrete materials), playground, and industrial area which can be assumed impervious and some other major feature and such as road and street also some types of impervious area. However road and streets which was also combined with polygon database and presented as centerline of polyline feature for assumed width. Buffer tools (Esri, 2013) is used for width attributes of the roads and street making buffer zone for all required features. Finally all feature extracted separately by using GIS Analysis tool extension Erase (Esri, 2013). After estimation of area of all feature (building, park, playground, footpath, roads and streets) applied percentage impervious area ratio equation measured the acquired percentage of imperviousness of selected sub-catchment. The imperviousness percentage of selected catchments with comparison land use by using Quick Bird image are shown in figure 24, 25 and 26 respectively.



**Figure 24:** Shahi Katha drain sub-catchment imperviousness values uses in SWMM model.



**Figure 25:** Airport Tehkal Payain drain sub-catchment imperviousness values used in SWMM model.



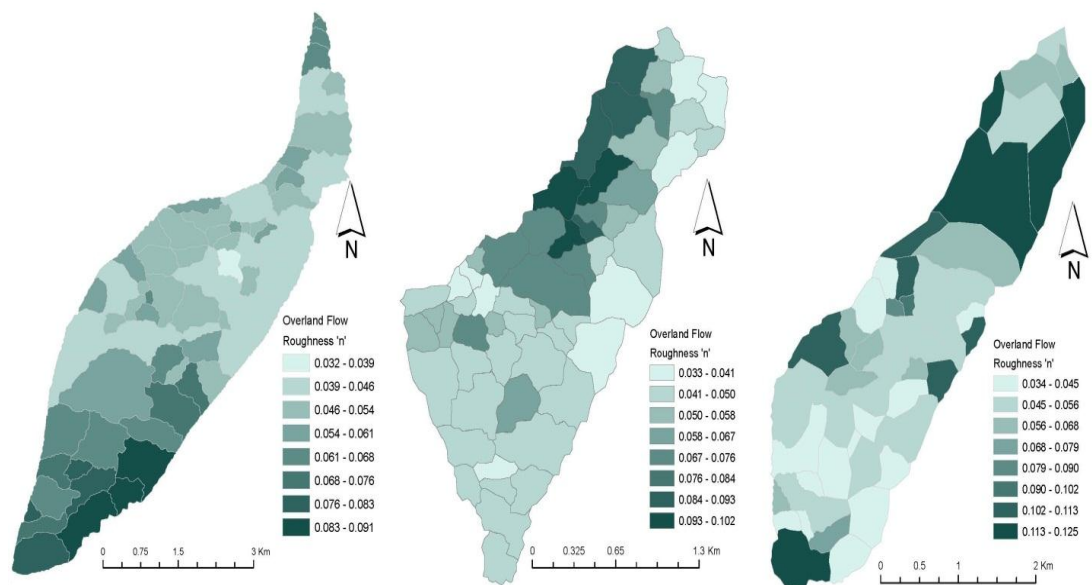
**Figure 26:** University Road Tehkal Bala drain sub-catchment imperviousness values used in SWMM model.

There is the visual comparison of percent imperviousness calculated by topographic data with quick bird satellite image directly showed that value of imperviousness varies with respect land use type. This approach has some gape/limitations because

topographic map could not have vegetation feature but this features obtain from world trees map and overlaid on topographic map calculated the factor of imperviousness for each sub-catchment including vegetation features.

#### 4.6.1.4 Manning’s roughness coefficient for overland flow

Manning’s roughness coefficient for overland flow of selected catchment is calculated using weighted runoff coefficient calculation technique. According to Rossman (2016) for channel flow variability manning’s roughness coefficient ‘n’ values for overland flow are not as well known in considerable characteristics of landscape, modulation between laminar and turbulent flow, critical flow depth, etc. The roughness coefficient values aggregated against land use was taken from table 3.5, Storm water management model reference manual volume I-Hydrology (2016) and attributed in GIS. Finally the weighted roughness coefficient ‘n’ of sub-catchment was calculated by using different ArcGIS attribute. The roughness coefficient ‘n’ values used in SWMM are shows in figure 27.



**Figure 27:** Overland flow roughness Shahi Katha drain (right), Airport Tehkal Payain drain (centre) and University Road Tehkal Bala drain (left).

#### **4.6.1.5 Depression storage**

Depression storage may be used as calibrated parameters in SWMM model; it would be used to determine the rate of interception. It is very sensitive parameter for very small amount of storm. The amount of rainfall water which store in impervious depression storage is depletes by evaporations. There was in pervious study number of easy method explained of calculation depression storage parameters but in this study SWMM user manuals suggested values from literature is used. Depression storage values range 1.3 to 2.5 mm for impervious area. The Denver Urban Drainage and Flood Control District (UDFCD, 2007) used depression storage values for large paved areas 2.5 mm, flat roofs 1.27 mm and for lawn grass and open fields 10.16 mm. On the base of such previous study values of depression storage values sets 1.21mm -1.27 mm for imperviousness fraction sub-catchment and for pervious fraction sub-catchment vales is 5.8 mm - 6.1 mm.

#### **4.6.1.6 Infiltration**

The Curve Number infiltration method in SWMM 5.1 is widely used based on Natural Soil Conservation Services calculation of infiltration rate. Therefore Curve Number infiltration method initially depends on two parameters (i) Curve Number CN and (ii) soil drying time which is directly related saturated hydraulic conductivity  $K_s$ .

These both infiltrations parameters based on soil type. The selected drains catchment overlaid Harmonized World Soil Database map (FAO 1971-1981) and determined the hydrological soil group (A, B, C, and D). Finally using multiple GIS Tool and analyzed land use classification vector data with World soil type and determined the weighted Curve Number and also soil drying time for each catchment is presented in table 11.

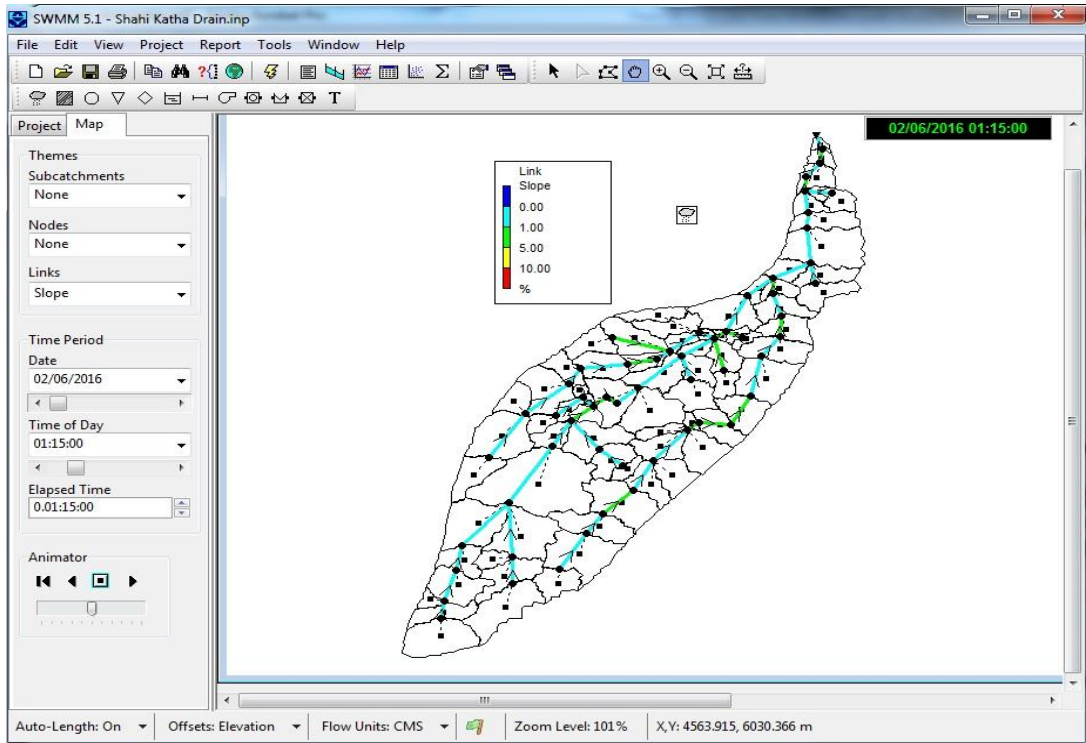
**Table 11:** Calculated, weighted Curve Number and soil drying time.

Drain Name	Weighted Curve Number	Soil Drying Time
	CN <sub>w</sub>	T <sub>dry</sub>
	--	(Day)
Shahi Katha	82	1.74
Airport Tehkal Payain	80	1.55
University Road Tehkal Bala	79	1.44

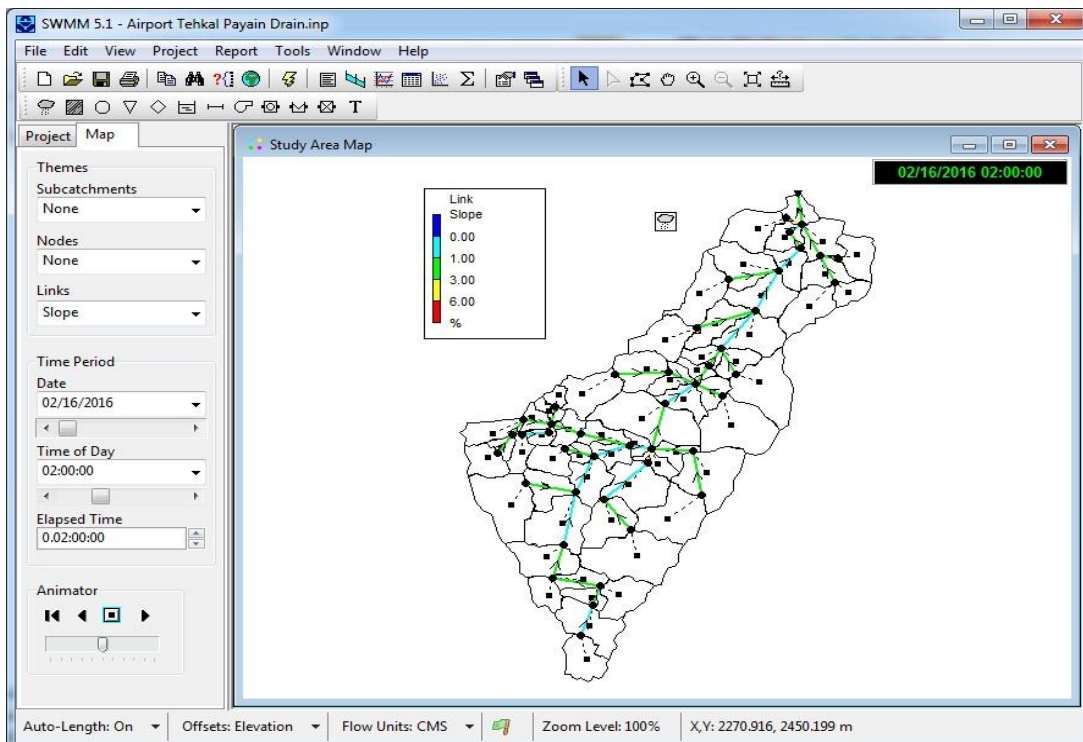
The values of hydraulic conductivity  $K_s$  are essentially approximate equal to Horton parameters minimum infiltration capacity  $f_{\infty}$  (Rossman & Huber, 2016). According to Musgrave (1955) the value of minimum infiltration capacity ranging with respect to hydrological soil group is for soil group A (11.43-7.62 mm/h), B (7.62-3.81 mm/h), C (3.81- 1.27 mm/h) and D (1.27 – 0 mm/h). These values probable depend soil rate of infiltration and used for calculation of soil drying time instead of saturated hydraulic conductivity.

#### 4.6.2 SWMM simulation

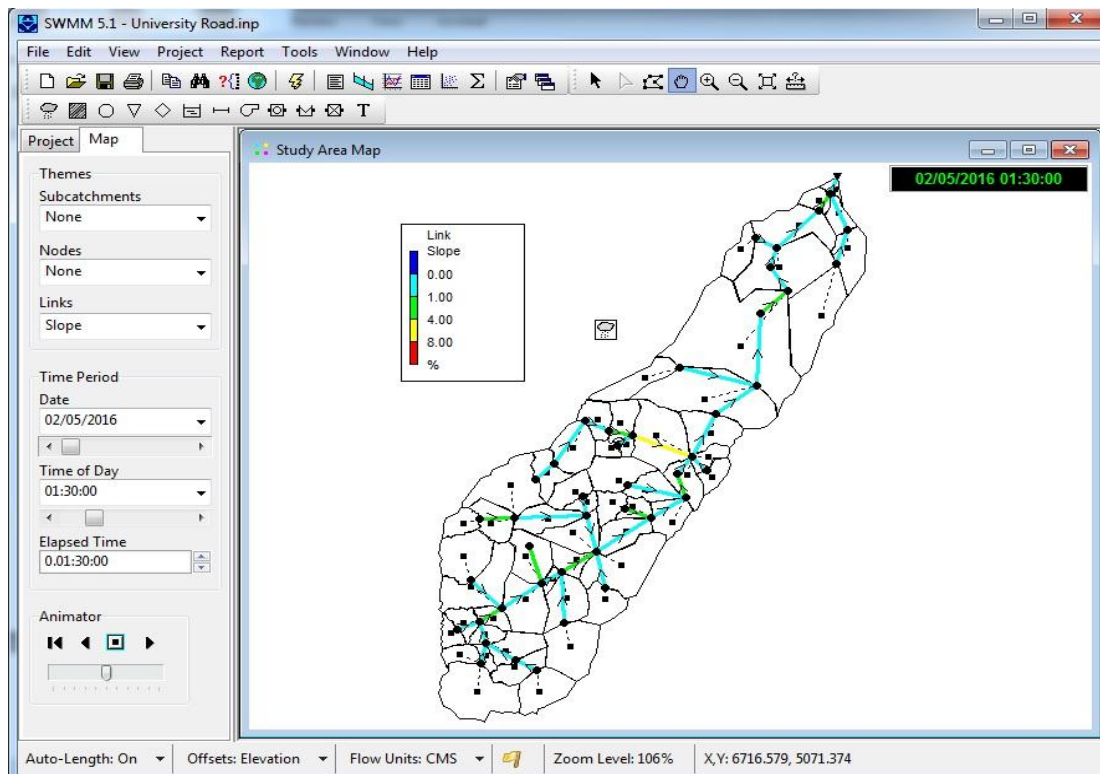
The sub-catchment and stormwater conveyance system was prepared of GIS application used as back-up data set SWMM. There were calculated catchment basic parameters which is input data requirement of model was test and output result analyzed. There is the real model validation that could not be possible in the absence of suitable runoff estimation. For runoff modeling all parameter characteristics which was created from different GIS tools detached in four Esri shape file attributes such as junction, outfall, conduits and sub-catchment and stored in a single map. Thus final map had been uploaded in SWMM and rearranged all input parameter once in the model. The model which is created above described procedure is shown in the figure 28, 29 and 30 respectively.



**Figure 28:** Shahi Katha drain structure of the SWMM model.



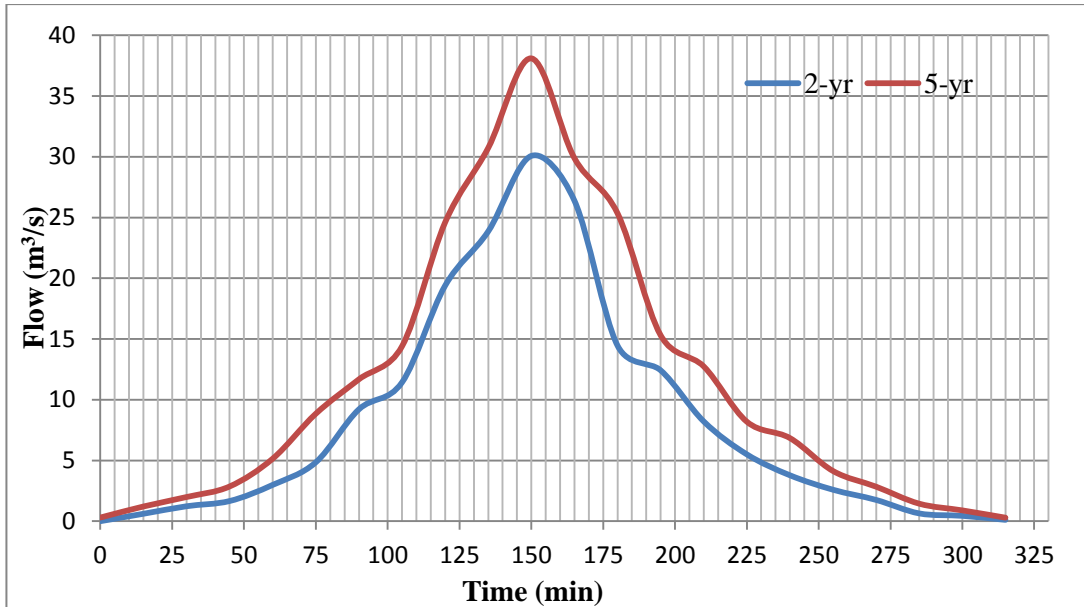
**Figure 29:** Airport Tehkal Payain drain structure of the SWMM model.



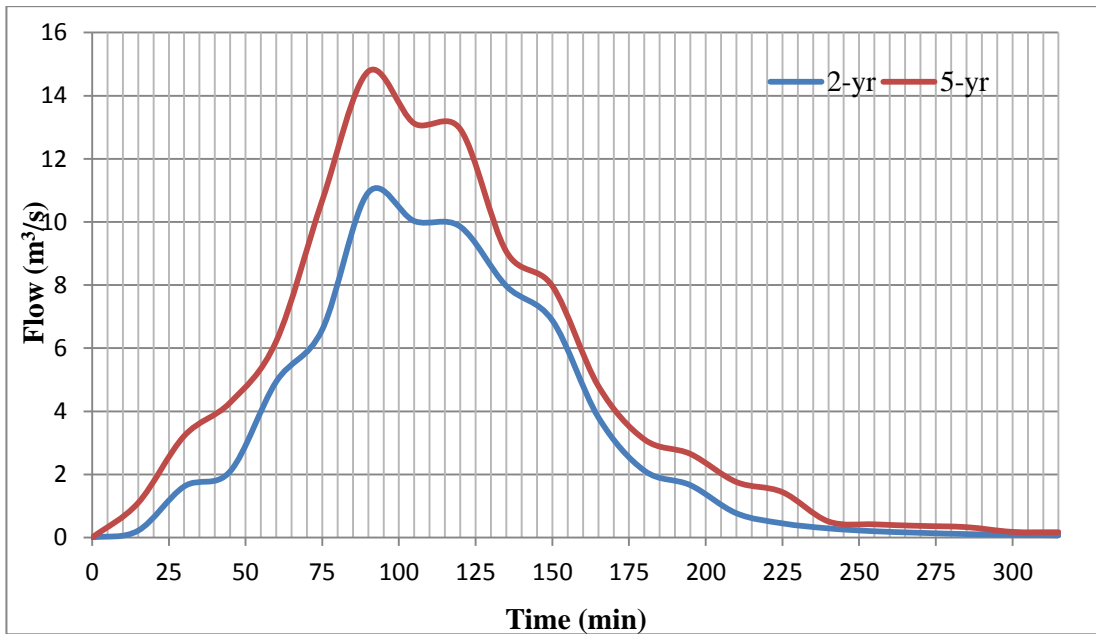
**Figure 30:** University Road Tehkal Bala drain structure of the SWMM model.

The arrow is showing the flow direction in the system and color line dominating the slope of the conduit. For simulation of actual result need to set to time the reporting time was set 15 minutes and hydrologic dry-weather time was set 1 hours and hydraulic routing time step for drain was set 30 s which is according to Rossman (2016) sufficiently short time for dynamic wave routing. Finally model was run on 2-yr and 5-yr return period rainfall distribution which was observed from IDF curve and interpolate as average time of concentration reviewing the each conduit characteristic with respect to its time and slope. The final modeled result was compared with flow calculated by rational method. Therefore, the graphical results obtained by SWMM are shown in figure 31, 32 and 32 respectively.

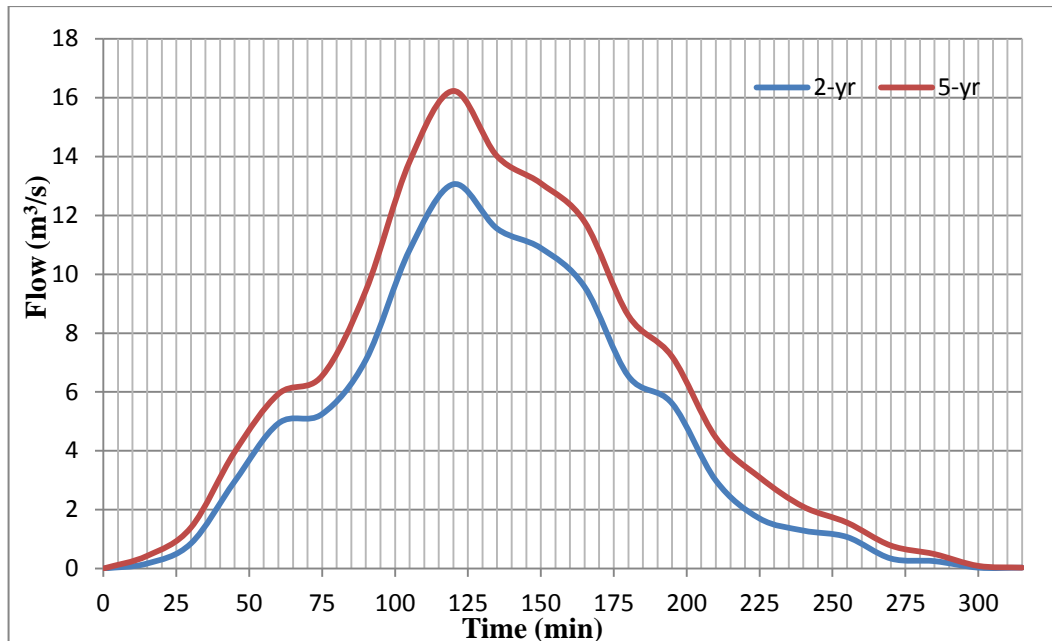




**Figure 31:** Shahi Katha drain surface runoff hydrograph generated by SWMM routing techniques for 2 hour design storm of 2-yr and 5-yr return period.



**Figure 32:** Airport Tehkal Payain drain surface runoff hydrograph generated by SWMM routing techniques for 2 hour design storm of 2-yr and 5-yr return period.



**Figure 33:** University Road Tehkal Bala drain surface runoff hydrograph generated by SWMM routing techniques for 2 hour design storm of 2-yr and 5-yr return period.

There is designed 2 hour storm data 2-yr and 5-yr return period was used in SWMM model of calculation the above surface flow peak for selected catchment. The surface flow peak result higher by calculated Rational Equation method but there is no observed flow available for calibration and validation of obtained results. The model was run of each catchment for both deigned 2 hours storm and it showing continuity error 0.006% to 0.007% which is indicating quality of parameters used in model for runoff results.

#### 4.6.3 Detail summary GIS and surface flow peak simulations

The watershed delineation tools were used for calculation of geomorphological parameters of selected catchments using remote sensing data, GPS point, and topographic maps and the calculation of surface flow peak divided into two parts which are directly and indirectly connected to GIS and remote sensing data. The first part Rational Method using Hydraulic Toolbox 4.2 and second part Curve Number infiltration method using SWMM 5.1 model. There are a few parameters used in both methods are common such as sub-catchment area, land use classification. The detail summary is given in table 12 below.

**Table 12:** Detail summary GIS and surface flow peak simulations

Parameters		Shahi Katha Drain	Airport Tehkal Payain Drain	University Road Tehkal Bala Drain
Area (Km <sup>2</sup> )		20.25	3.51	8.79
Main channel length (m)		11128.12	4195.83	6789.58
Number of sub-catchment		74	59	55
Maximum elevation (m)		377	362	374
Minimum elevation (m)		308	322	317
Catchment relief (m)		69	40	57
Slope (m/m)		0.006201	0.009533	0.008395
Mean runoff coefficient	2-yr	0.48	0.46	0.39
	5-yr	0.54	0.55	0.43
Time of Concentration (minutes)		180	72	110
Rational Method sum of surface peak flow (m <sup>3</sup> /s)	2-yr	39.260	11.556	14.094
	5-yr	60.438	22.452	23.293
Mean flow length (m)		559.496	273.643	460.424
Mean flow width (m)		697.076	292.558	486.543
Mean slope %		4.404	3.894	3.718
Mean surface imperviousness %		76.213	64.655	69.33
Mean manning's roughness for overland flow		0.056	0.055	0.0626
Depression storage (mm)	Impervious sub-catchment	1.21	1.27	1.25
	Pervious sub-catchment	6.1	5.9	5.8
Curve Number		82	80	79
Soil drying time (day)		1.74	1.55	1.44
SWMM surface flow peak (m <sup>3</sup> /s)	2-yr	30.07	10.93	13.06
	5-yr	38.1	14.771	16.23

#### 4.7 Hydraulic flow capacity analysis

Capacity analysis is the final objective of the study in order to ensure that the existing drains have enough capacity of carrying calculated peak runoff and disposed in receiving water bodies. In case if the capacity of drain under peak flow need to design flood protection strategies. Geographically almost all drains flow between high urban areas. Due to condition assessment each drain silted and some of broken. Capacity analysis was performed by continuity equation.

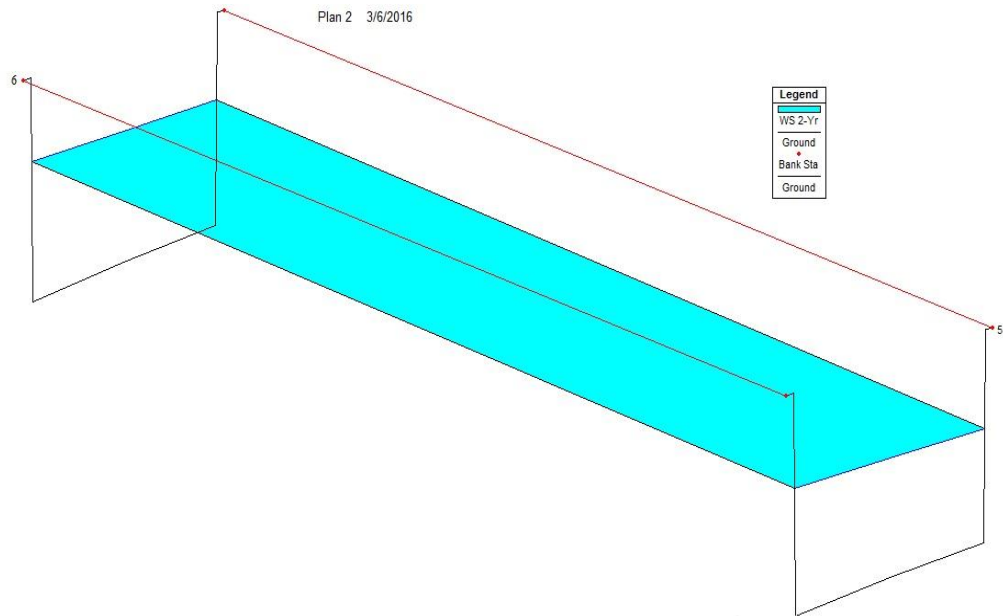
There was the basic parameter of continuity equation such as cross section area of the drain with respect to its longitudinal distance measured by AutoCAD; Velocity (v) was calculated by using Manning equation. The Manning equation parameters such as, hydraulic radius was calculated by cross section area and perimeter (P) ratio,

slope of the surface water was obtain bathymetric survey data of the study are and roughness coefficient (n) considered form literature study. But bathymetric survey of the study area was not fulfilling the requirement. There was the capacity analysis of the selected drain was performed according to the available bathymetric information. The calculated capacity analysis result of the selected drain shows in table 13, 14 and 15.

**Table 13:** Shahi Katha drains calculated flow velocity, hydraulic flow capacity and Surface flow peak results comparisons.

Reach Node to Node		Flow Velocity	Flow Capacity of drain	Peak Discharge (R Method)		Peak Discharge (SWMM)	
From	To	(v)	(q <sub>c</sub> )	(Q <sub>2</sub> )	(Q <sub>5</sub> )	(Q <sub>2</sub> )	(Q <sub>5</sub> )
		(m/Sec)	(m <sup>3</sup> /Sec)	(m <sup>3</sup> /Sec)	(m <sup>3</sup> /Sec)	(m <sup>3</sup> /Sec)	(m <sup>3</sup> /Sec)
2	1	3.58	50.78	39.26	60.44	30.07	38.10
3	2	5.76	63.90	38.00	58.76	29.11	37.66
4	3	3.71	44.43	37.61	58.18	28.21	36.99
5	4	3.11	43.69	36.83	57.00	27.17	35.50
6	5	3.40	71.68	35.96	55.78	26.06	34.06
7	6	2.40	41.36	35.05	54.22	25.17	33.17
8	7	3.03	37.60	32.68	50.95	24.09	31.09
9	8	2.99	33.74	21.75	34.24	21.33	27.16

The flow velocity and hydraulic flow capacity of Shahi Katha drain is calculated for reach length 3516 m from node 9 to node 1 because of short survey data and compared surface flow peak results from node to node measured by R Method and SWMM. The values of manning's roughness varies due to shape and material condition of the drain. The flow capacities of section node 6 to 5 are very high because of bridge and bottle neck is shown in figure 34.



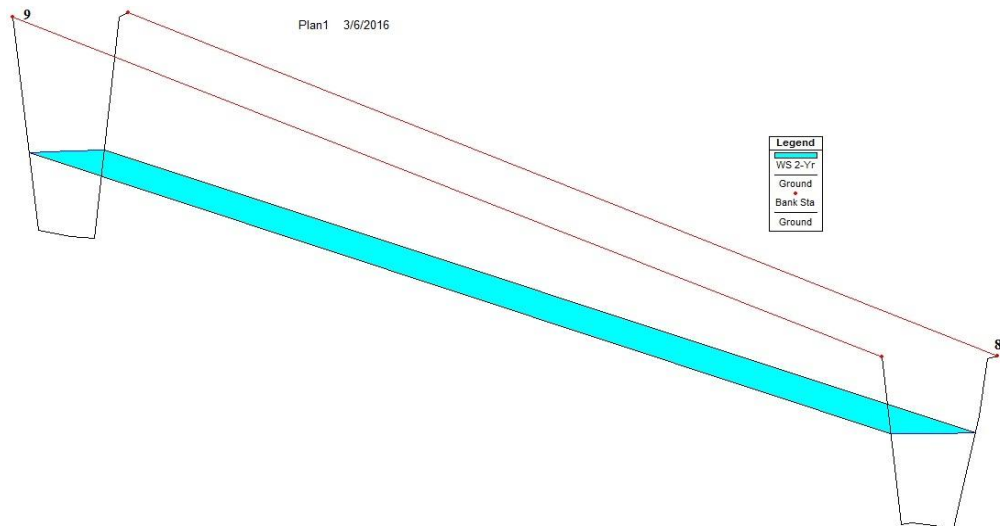
**Figure 34:** Bottle neck cross section for bridge.

There is the flow capacity of section node 3 to 2 due to irregular shape. After viewing above hydraulic and hydrology results it is clear Shahi Katha drain have much higher flow capacity and it play a vital role in of controlling or mitigation urban flood. The most part of drain is choked and silted because of nearest area generated waste. There are parameters detail used in calculation of drain capacity presented in Appendix-I.

**Table 14:** Airport Tehkal Payain drain calculated flow velocity, hydraulic flow capacity and Surface flow peak results comparisons.

Reach Node to Node		Flow Velocity	Capacity of drain	Peak Discharge (R Method)		Peak Discharge (SWMM)	
From	To	(v)	q <sub>c</sub>	(Q <sub>2</sub> )	(Q <sub>5</sub> )	(Q <sub>2</sub> )	(Q <sub>5</sub> )
		(m/Sec)	(m <sup>3</sup> /Sec)	(m <sup>3</sup> /Sec)	(m <sup>3</sup> /Sec)	(m <sup>3</sup> /Sec)	(m <sup>3</sup> /Sec)
2	1	2.44	10.65	11.56	22.45	10.93	14.77
3	2	3.14	11.71	11.08	21.53	10.13	14.02
4	3	3.82	10.15	9.83	19.29	9.23	13.27
5	4	2.38	8.65	9.78	19.16	9.22	12.13
6	5	2.26	8.35	9.29	18.17	9.13	11.43
7	6	1.39	6.06	9.03	17.58	8.65	10.77
8	7	3.05	12.39	8.20	16.06	8.25	10.73
9	8	6.32	27.54	8.16	15.98	7.67	10.62
10	9	2.64	7.67	7.10	14.71	7.60	10.18
11	10	2.39	5.91	6.68	13.21	5.70	9.51
12	11	1.93	5.27	6.40	12.58	5.15	9.46
13	12	2.97	5.78	3.96	7.87	3.38	7.26
14	13	2.85	5.68	2.72	5.54	2.19	4.40
15	14	3.09	5.01	2.23	4.66	1.92	2.80
16	15	3.01	4.82	1.49	2.99	1.35	1.72
17	16	2.99	4.49	1.17	2.28	1.07	1.34
18	17	2.11	0.63	0.79	1.61	0.85	1.02
19	18	1.46	0.44	0.47	0.96	0.55	0.74

The university Road Tehkal Payain drain flow capacity is calculated for reaches length 4196 m from node 19 to node 1. The flow capacity of the drain at each section is less of design flow peak calculated by R Method and SWMM of return period 5-year but there is some section also under capacity design flow peak of 2-yr return period calculated by R Method. Comparatively flow peak values calculated by R Method are much higher than SWMM flow peak values. Mostly cities stormwater drainage system in Pakistan was designed of 2-yr rainfall intensity. The flow carrying capacity of section node 9 to 8 is comparatively very high because bridge and are shown in figure 35. There are parameters details used in calculation of drain capacity presented in appendix-I. The bottle neck cross-section is shown in figure 35.



**Figure 35:** Bottle neck cross section for bridge.

During field investigation and public consultations it was observed that Airport Tehkal Payain drain every year causing high flood in surrounding catchment. The reach sections of length 2280 have irregular shape and the other section is choked and mostly silted by urban solid waste. The flood hazard in such drain might be controlled by cleaning and increasing the size of section using calculated flow peak values. There are parameters detail used in calculation of drain capacity presented in appendix-I.

**Table 15:** University Road Tehkal Bala drains calculated flow velocity, hydraulic flow capacity and Surface flow peak results comparisons.

Reach Node to Node		Flow Velocity	Capacity of drain	Peak Discharge (R Method)		Peak Discharge (SWMM)	
From	To	(v)	q <sub>c</sub>	(Q <sub>2</sub> )	(Q <sub>5</sub> )	(Q <sub>2</sub> )	(Q <sub>5</sub> )
		(m/Sec)	(m <sup>3</sup> /Sec)	(m <sup>3</sup> /Sec)	(m <sup>3</sup> /Sec)	(m <sup>3</sup> /Sec)	(m <sup>3</sup> /Sec)
3	1	3.02	10.22	14.09	23.29	13.06	16.23
4	3	2.31	9.92	13.72	22.09	12.09	15.01
5	4	2.92	9.81	13.37	21.34	11.66	14.21
6	5	2.86	9.68	13.11	20.89	10.78	12.88
7	6	3.58	9.13	12.97	20.49	10.03	11.97
8	7	3.00	8.57	12.78	20.11	8.99	11.12
9	8	3.33	8.16	12.15	19.84	7.90	10.67
10	9	3.00	7.79	11.43	18.29	7.11	9.79
11	10	3.15	7.56	10.53	16.88	6.22	8.90
12	11	3.69	7.53	8.33	13.40	5.96	7.93
12	12	2.88	5.18	7.99	12.93	4.77	7.01
15	14	2.37	3.87	7.64	12.30	4.64	6.23
16	15	1.95	2.31	6.83	11.01	4.18	5.92
17	16	2.89	2.94	6.33	10.15	3.50	4.77
18	17	2.74	2.85	5.11	8.11	2.25	3.71
20	18	1.35	1.46	3.46	5.81	1.87	2.89
21	20	1.61	1.42	2.90	4.80	1.35	1.93
22	21	1.32	1.01	2.18	3.62	0.50	0.75

The University Road Tehkal Bala drain flow capacity is calculated of reach length 6789.6 m from node 22 to 1. The flow carrying capacity of the drain is very low as comparing flow peak values calculated by R Method and SWMM of 2-yr and -5-yr return period rainfall intensity. Therefore reach length 2783 m has irregular shape and silted. The flood hazard might be controlled by increasing the size of cross section and irregular section may be replaced in rectangular shape. There are parameters detail used in calculation of drain capacity presented in appendix-I.



## 5. Chapter Five Discussion

A proper urban watershed delineation using remote sensing and ground observation data linkage with ArcGIS is a best technique especially adding pour point for sub-catchment delineation which was used in this study and obtained more satisfied results. Landuse classification using Maximum Likelihood Classification (MLC) results accuracy depended on training file and satellite image quality. In this study more than 200 reference points was created for each class therefore, reference point for wood in study area cropped from world trees map. Thus the classified land use results fulfill the study requirements.

Short duration rainfall data obtained from daily maximum rainfall by using Indian Meteorological Department (IMD) rainfall reduction formula results are more satisfied because it was adopted for study area after testing on Mardan and Risalpur meteorological station. Gumbel's extreme value type-1 distribution is a best fitting short duration rainfall frequency analysis method for selected catchments. Intensity duration frequency (IDF) curve (figure 19) was developed by Sherman equation which showing computed parameters adopted methodology is suitable especially for homogeneous catchments.

The surface runoff modelling by Rational Method, and infiltration Curve Number method of using SWMM model directly connected landuse characteristics. Thus morphologic, hydrologic and physical parameters were calculated for both methods with GIS and RS techniques founded best phenomenon of evaluations urban hydrology. Parameterization computation proposed methodology for SWMM was constructed for this study almost based on remote sensing data, ground observation and also literature data.

Peshawar city had very old and poor drainage network system for that purpose hydraulic flow carrying capacity of existing drains methodology was developed, weather these drains have enough capacity of carrying computed surface runoff peak which generated in the urban area during heavy rainfall season. The hydraulic parameter evaluations techniques varies on field measure data and computed drains capacity of Airport Tehkal Bala drain and University Road Tehkal Bala drain is very low which need to improve.

## **6. Chapter Six Conclusions**

The delineation of urban watershed are much complicated due its naturally setting and artificial created landscape made a complex hydrologic geometries, but high resolution remote sensing data and GPS point provides the remarkable advantage with integration GIS for urban drainage system delineation and estimation of basic hydrological parameters as various temporal and spatial scales. In this study Digital elevation model (DEM) of resolution 5m, GPS point, Quick Bird image and Topographic maps were used for watershed delineation. The design of storm water network and surface imperviousness against flow direction is also have serious complication. Shahi Katha and University Road Tehkal Bala drain watershed delineation was not easy using Digital elevation model and topographic maps. Several GPS points were taken at various locations spatially drain outfall and starting point. Quick bird image was used as base map and collected GPS point overlaid and delineate the storm water drain. The watershed area of the selected drains was demarcated with help of contour and also GPS point.

The catchment area of all selected drain is greater than limitation of rational method, so GIS spatial analyst tool was used for sub-catchment division with considering the pour point with in catchment. Two different methods are used of adding the pour point one is stormwater drains network system layout and second flow accumulation grid. The storm water drain network system layout vector shape file (polyline) was converted into raster of grid size 5 m. There was both resulted raster is used input raster in “Boolean and tool” developed true raster with the help of non-zero value of both input raster. Finally flow direction and flow accumulation tools were run again and used as input both raster in watershed delineation tool and obtained sub watershed of the drain but few sub-catchment modified keeping view of land use pattern, flow direction with respect of contour and exact outfall point (observed by GPS point).

Daily rainfall data was converted into hours and developed frequency analysis which was performed with the help of statistical probability distribution model SMADA (Storm water Management and Design Aid) of selected homogeneous catchment

using extreme type-1 distribution method. The rainfall intensities in hour's calculated extreme type-1 distribution showing little bit higher intensity which provides more safety factor. For urban storm water modeling rainfall intensity in minute is required, so that Sherman Equation was used for derivation of IDF curves. Therefore Sherman constant is derived from hourly rainfall data of selected recurrence intervals.

To measures runoff coefficient and overland flow manning's roughness coefficient and their impacts on surface runoff land use classification is required. Therefore runoff coefficient and Curve Number values are varies as land use type. For that purpose land use classification of the drain catchment considered necessary tools. Based on high resolution satellite image Maximum Likelihood Classification (MLC) method was used and determined the seven land use type of each catchment. Therefore the training area for signature file was created by using Quick bird image except wood class. Global mapper blue 16.1 was used to extracting the tree data from world tree map. ML classified catchment area Shahi Katha and University Road Tehkal Bala drain into seven classes, with accuracy 93 % and Airport Tehkal Payain drain is approximately 96%.

First approach of peak discharge assessment to design storm water drains Rational Method has been effectively used of the study area. To determination of authentic design discharge peak this method required vast engineering and hydro-meteorology knowledge. For estimation of peak flow from design storm Rational Method is best of basins size less than 80.9 ha. The supposition some basic parameters which is connected with the R Method and met rarely under natural conditions, such as uniform rainfall with respect to time of concentration, runoff coefficient (C) varies due to land change and area of catchment. The Rational Method estimates the flow peak with the same rainfall intensity design return period of combining runoff coefficient(C), average rainfall intensity (i) and drainage area (A). The weighted runoff coefficient was calculated from land use classification and SUDAS table values. Time of concentration was calculated using Kirpich equation. The Rational Method calculated surface peak flow using design rainfall intensity of 2 year and 5 year return periods of Shahi Katha basin, Airport Tehkal Payain basin and University Road Tekal Bala basin is (39.260 m<sup>3</sup>/s, 2-year return period and 60.438 m<sup>3</sup>/s, 5-year

return period), (11.556 m<sup>3</sup>/s 2-year return period and 22.493 m<sup>3</sup>/s 5-year return period) and (14.094 m<sup>3</sup>/s 2-year return period and 23.293 m<sup>3</sup>/s 2-year return period).

There is second method of peak flow is measured by Curve Number infiltration method using SWMM. It was divided into three parts such as heterogeneous sub-catchment parameterization, rainfall, and infiltration method parameters. GIS, remote sensing and ground truth linkage was used for calculation of heterogeneous sub-catchment parameters but manning's roughness and depression storage calculated by combination of literature values and land use type factor. For Curve Number calculation hydrological soil group map is design almost drains catchment varies B, C and D soil groups but University Road Tehkal Bala drain catchment also fall in soil group A. Drying time parameter is calculated by using hydraulic conductivity values from literature.

The selection of certain parameter values is not clear procedure available in literature of simulation surface flow using SWMM approach without calibration. The surface peak flow values was calculated by SWMM using 2 hours rainfall storm of 2-year and 5-year return period for Shahi Katha drain is (30.7 m<sup>3</sup>/s and 38.1 m<sup>3</sup>/s), Airport Tehkal Payain drain (10.93 m<sup>3</sup>/s and 14.771 m<sup>3</sup>/s) and University Road Tehkal Bala drain ( 13.06 m<sup>3</sup>/s and 16.23 m<sup>3</sup>/s).

The calculated flow peak result from both methods comparatively is very different. The Rational Method calculated flow peak values are very high of design rainfall intensity 2-yr and 5-yr return period but SWMM calculated flow peak values is very low. In case design of new stormwater drainage system or modification existing drainage system Rational Method calculated flow peak provided more safety factor.

The hydraulic flow carrying capacity of selected drains was performed by continuity equation. From table 13 values Shahi Katha drains have much hydraulic flow carrying capacity against calculated flow peak values by Rational Method and also SWMM model. There are some bottle necks of Shahi Katha drain because cross section of bridge and irregular shape. Therefore a few existing sections of Airport Tehkal Payain drain are not sufficient to accommodate the calculated runoff. However University Road Tehkal Bala drains existing section also not sufficient to carrying the calculated runoff. The drains silted and blockage due to domestic solid

waste are causing flood hazard in selected drain at various section, so that maintenance of existing drain for controlling or mitigation flood hazard is essential and irregular sections may be modified into proper rectangular sections.

## REFERENCES

- Ahmed, Z., Rao, D., Reddy, K., & Raj, E. (2012). Rainfall Intensity Variation for Observed Data and Derived Data A Case Study of Imphal . *Journal of Engineering and Applied Sciences*, Vol. 7, No. 11, pp1506-1513.
- Ahmad, A., & Quegan, S. (2012). Analysis of Maximum Likelihood Classification on Multispectral Data. *Applied Mathematical Sciences*, Vol. 6 no. 129, 6425 - 6436.
- Akan, A., & Houghtalen, R. (2003). *Urban Hydrology, Hydraulics, and Stormwater Quality*. John Wiley & Sons Inc.
- Akram, F., Golam Rasul, M., Masud Kamal Khan, M., & Imam Ibne Amir, M. (2014). Comparison of Different Hydrograph Routing Techniques in XPSTORM Modelling Software:A Case Study. *International Journal of Environmental, Ecological, Geological and Geophysical Engineering*, Vol:8, No:3, pp 213-223.
- Bedient, P., Huber , W., & Vieux, B. (2013). *Hydrology and Floodplain Analysis*, Prentice-Hall Inc., Upper Saddle River, NJ, Fifth Edition.
- Bernard , J., & Tuttle, R. (1998). Stream Corridor Restoration: Principles, Processes, and Practices. *Engineering Approaches to Ecosystem Restoration*, ASCE, pp. 320-325.
- Bhaskar, J., & Suribabu, C. (2014). Estimation of Surface Run-off for Urban Area Using Integrated Remote Sensing and GIS Approach. *Jordan Journal of Civil Engineering*, Volume 8, No. 1, pp70-80.
- Boonya-aroonnet, S. (2008). Applications of the innovative modelling of urban surface flooding in the UK case studies. *11th International Conference on Urban Drainage, Edinburgh, Scotland, UK.*
- Bryan Ellis, J. (1999). *Impact of Urban Growth on Surface Water and Ground Water Quality* . Wallingford : International Association of Hydrological Sciences, Publication no. 259 .

- Bundschuh , J. (1992). Hydrochemical and hydrogeological studies of groundwater in Peshawar Valley, Pakistan. *Geol. Bull. Univ. Peshawar*, Vol. 25, pp. 23-37.
- Burszta-Adamiak, E., & Mrowiec, M. (2013). Modelling of green roofs' hydrologic performance using EPA's SWMM. *Water Science & Technology*, 68 (1), 36-42.
- Butler , D., & Davies , J. (2011). *Urban Drainage* . London and New York : Spon press .
- Choi, K.-s., & Ball , J. (2002). Parameter estimation for urban runoff modelling. *Urban Water*, 4(1), pp. 31-41.
- Chouli , E., Aftias , E., & Deutsch , J.-C. (2007). Applying storm water management in Greek cities: learning from the European experience. *ScienceDirect*, PP 61-68.
- Chow V. T. . (1951). A general formula for hydrologic frequency analysis. . *Trans. Am Geophys. Union*,, Vol. 32, pp. 231-237.
- Chow, V.T., (1964). *Handbook of applied hydrology a compendium of water-resources technology*. New York: McGraw-Hill.
- Chow, V. T., Maidment D., & Mays L. W. (1988). *Applied Hydrology*. New York: McGraw-Hill.
- Clary J., Urbonas B., Jones J., Strecker E. W., Quigley M., & O'Brien J. (2002). Developing, evaluating and maintaining a standardized stormwater BMP effectiveness database. *Water Science and Technology*, 45(7), 65-73.
- Colorado Department of Transportation. (2004). *Drainage Design Manual Chapter 7, Hydrology*.
- Di Pierro, F., Khu, S., & Savi, D. (2006). From single-objective to multiple-objective multiple-rainfall events automatic calibration of urban storm water runoff models using genetic algorithms. *Water Science and Technology*, 54 (6-7), 57-64.

- Dingman S.L. (1994). *Physical hydrology*. Prentice Hall Upper Saddle River, NJ.
- Dongquan, Z., Jining, C., Haozheng, W., Qingyuan, T., Shangbing, C., & Zheng, S. (2009). GIS-based urban rainfall-runoff modeling using an automatic catchment-discretization approach: a case study in Macau. *Environ Earth Sci*, 59:465–472.
- Durrans, S. (2003). *Stormwater Conveyance Modeling and Design*. Waterbury CT.: Haestad Methods, Inc.
- Engineers and the Water Environment Federation. (1994). *Design and Construction of Urban Stormwater Management Systems*. Alexandria: American Society of Civil Engineers.
- Esri. (2013). The Guide to Geographic Information Systems Maximum Likelihood Classification.
- Fletcher, T., Andrieu, H., & Hamel, P. (2013). Understanding, management and modelling of urban hydrology and its consequences for receiving waters: A state of the art. *Advances in Water Resources*, 51, 261–279.
- Froehlich, D., D.WRE, P., & M.ASCE. (2010). Short-Duration Rainfall Intensity Equations for Urban Drainage Design. *IRRIGATION AND DRAINAGE ENGINEERING*, 519-526.
- Gobel, P., Dierkes, C., & Coldewey, W. (2007). Storm water runoff concentration matrix for urban areas. *Journal of contaminant hydrology*, 91(1–2), pp. 26–42.
- Goonetilleke, A., Thomas, E., Ginn, S., & Gilbert, D. (2005). Understanding the role of land use in urban stormwater quality management. *Journal of Environmental Management*, 74 pp 31–42.
- Goudie A. (1990). The human impact on the natural environment 3rd ed. *The MIT Press, Cambridge, Massachusetts*.
- Haan, C., Barfield, B., & Hayes, J. (1994). Design Hydrology and Sedimentology for Small Catchments. *Academic Press, New York*.



- Haase, D. (2009). Effects of urbanisation on the water balance – A long-term trajectory. *Environmental Impact Assessment Review*, 29(4), pp. 211-219.
- Halley P. E., Mary C., White S. O. , & Watkins E. . (2000). ArcView GIS Extension for Estimating Curve Numbers. *Esri International User Conference*.
- Henonin, J., Russo, B., Roqueta , D., Diezma, R., Sto.Domingo, N., Thomsen , F., et al. (2010). Urban Flood Real-Time Forecasting and Modeling. A State of the Art Review. *Mike by DHI*. Copenhagen: Mike DHI.
- Henri, T. (2013). Hydrological modeling of a large urban catchment using a stormwater management model (SWMM). *Aalto University School of Engineering*.
- Hershfield , D. (1961). Estimating the probable maximum precipitation. *Proceedings American Society of Civil Engineers, Journal Hydraulics Division*, 87(HY5): 99–106.
- Hoffman E.J., Latimer J.S., Mills G.L. , & Quinn J.G. (1982). Petroleum hydrocarbons in urban runoff from a commercial land use area. *Journal Water Pollution Control Federation*, 54, 1517–1525.
- Hutton, C., Kapelan, Z., Vamvakieridou-Lyroudia, L., & Savic, D. (2014). Real-time data assimilation in urban rainfall-runoff models. *Procedia Engineering*, 843 – 852.
- Jacobson, C. (2011). Identification and quantification of the hydrological impacts of imperviousness in urban catchments A review. . *Journal of environmental management*, 92(6), pp. 1438-1448.
- Janet, B., Kenneth, M., & Michael , K. (2008). Automatic Calibration of the U.S. EPA SWMM Model for a Large Urban Catchment. *Journal of Hydraulic Engineering*, Vol.13 No.4, p.466-474.
- Jasiewicz, J., & Metz, M. (2011). A new GRASS GIS toolkit for Hortonian analysis of drainage networks. *Computers & Geosciences*, 37 pp 1162–1173.

- Khan, A., Iqbal, Q., Khan, F., & Ashraf, S. (2013). Impact of Urbanization on Portable Water Quality A Bacteriological Case Study of Bannu City. *Sci.Int.(Lahore)*, 25(4),559-564.
- Konard, C. (2003). Effects of Urban Development on Floods. *U.S. GEOLOGICAL SURVEY*, Fact Sheet 076-03.
- Krebs, G., Kokkonen, T., Valtanen, M., & Koivusalo, H. (2013). A high resolution application of a stormwater management model (SWMM) using genetic parameter optimization. *Urban Water*, Vol.10, No.6, p.394-410.
- Kumar, M., Kumar, R., Singh, P., Singh, M., Yadav, K., & Mittal, H. (2015). Catchment delineation and morphometric analysis using geographical information system. *Water Science and Technology*, 72 (7) 1168-1175.
- Kuusisto, E. (1986). Sadanta. In: S. MUSTONEN, ed, Sovellettu hydrologia. Mänttä. *Vesiyhdistys ry*, pp. 29-47.
- Le, P., Kumar, P., Valocchi, A., & Dang, H.-V. (2015). GPU-based high-performance computing for integrated surface–sub-surface flow modeling. *Environmental Modelling & Software*, Volume 73 Pages 1–13.
- Lee, S.-B., Yoon, C.-G., Jung, K., & Hwang, H. (2010). Comparative evaluation of runoff and water quality using HSPF and SWMM. *Water Science and Technology*, 62 (6), 1401–1409.
- Linsley, R. (1986). Flood estimates: How good are they. *Water Resour. Res.*
- M. Valipour. (2012). Effect of Drainage Parameters Change on Amount of Drain Discharge in Subsurface Drainage Systems. *Journal of Agriculture and Veterinary Science*, Volume 1, Issue 4 PP 10-18.
- Maalel, K., & Huber, W. (1984). SWMM calibration using continuous and multiple event simulation. (pp. p.1564-1577). Gothenburg: Proceedings of 3rd Conference on Urban Storm Drainage.
- Matthew J. Burnsa, Tim D. Fletcher, Christopher J. Walsh, Anthony R. Ladson, & Belinda E. Hatt. (2012). Hydrologic shortcomings of conventional urban

- stormwater management and opportunities for reform. *Landscape and Urban Planning*, 105 pp 230–240.
- McCuen, R. (1998). *Hydrologic Analysis and Design*, Prentice-Hall, Inc., Upper Saddle River, NJ, Second Edition.
- Mitchell, V., Mein, R., & McMahon, T. (2001). Modelling the urban water cycle. *Environmental Modelling & Software*, 16, 615–629.
- Mohan Rao, D., Ahmed, Z., Mohan Reddy, K., & Raj, E. (2013). Selection of Drainage Network Using Raster GIS – A Case Study. *International Journal of Engineering Science Invention*, Volume 2 Issue 8 PP.35-40.
- Mulvaney, T. (1851). On the use of self-registering rain and flood gauges in making observations of the relations of rainfall and flood discharges in a given catchment. *Proceedings of the Institute of Civil Engineers of Ireland*, 4, 18–31.
- Munoz-Carpena R., J.E. Parsons, & W.J. Gilliam. (1999). Modeling hydrology and sediment transport in vegetative filter strips. *J. Hydrol.*, 214(1-4): 111-129.
- Musgrave, G. (1955). How much of the rain enters the soil? In *Water: U.S. Department of Agriculture. Yearbook. Washington, DC.*, pp. 151–159.
- Natural Resource Conservation Service (NRCS). (2009). "Hydrologic Soil Groups", *National Engineering Handbook, Part 630, Chapter 7. U.S. Dept. of Agriculture, Washington, DC.*
- Ning, S., Hall, M., Bongghi, H., & LianJun, Z. (2014). Impact of SWMM catchment discretization: case study in Syracuse, New York. *Journal of Hydrologic Engineering*, 19 (1), 223–234.
- Ouyang, W., Guo, B., Hao, F., Huang, H., Li, J., & Gong, Y. (2012). Modeling urban storm rainfall runoff from diverse underlying surfaces and application for control design in Beijing. *Journal of Environmental Management*, 113, 467e473.

- Park , S., Lee, K., Park, I., & HA, S. (2008). Effect of the aggregation level of surface runoff fields and sewer network for a SWMM simulation. *Desalination*, 226(1–3), pp. 328-337.
- Pei, Y., Zuo, H., Luan, Z., & Gao, S. (2013). Rehabilitation and improvement of Guilin urban water environment: Function-oriented management. *Environmental Sciences*, 25(7), 1477–1482.
- Pilgrim, D. (1986). Bridging the gap between flood research and design practice. *Water Resour. Res.*
- Porse, E. C. (2014). Old Solutions and New Problems: On the Evolution of Urban Water Infrastructure and Environments. *Thesis Doctor of Philosophy University of California.*
- Pourali, S., Arrowsmith , C., Mitchell, D., & Matkan , A. (2014). Modelling An Overland Water Flow Path In An Urban Catchment Using GIS. *Geoinformatica: An International Journal (GIJ)*, Volume (4) : Issue (1).
- Previdi, F., Lovera, M., & Mambretti, S. (1999). Identification of the rainfall-runoff relationship in urban drainage networks. *Control Engineering Practice* 7, volume (7) 1489-1504.
- Qin, H.-p., Li, Z.-x., & Fu. , G. (2013). The effects of low impact development on urban flooding under different rainfall characteristics. *Environmental Management*, 129, 577-585.
- Richards, L. (1931). Capillary conduction of liquids through porous mediums. *Physics*, 1 (5): 318–333.
- Ritzema , H. (2006). *Drainage Priciples and Applications* . Wageningen : ILRI publication 16.
- Robert S. Arthur. (2010). Stormwater Runoff Simulation Using SWMM: Evaluating Stormwater Management on the University of Virginia Grounds. *Thesis Bachelor of Science in Engineering Science University of Virginia.*
- Rossman, L. (2010). Storm Water Management Model User's Manual - Version 5.0. *edn. Cincinnati, OH: U.S. Environmental Protection Agency.*

- Rossmann, L., & Huber, W. (2016). Storm Water Management Model Reference Manual Volume I – Hydrology (Revised). *United States Environmental Protection Agency*.
- Sahely, H., Dudding, S., & Kennedy, C. (2003). Estimating the urban metabolism of Canadian cities: Greater Toronto area case study. *Canadian Journal of Civil Engineering*, 30(2): 468–483.
- Sartor J.D., & Boyd G.B. (1972). Water pollution aspects of street surface contaminants. *US Environmental Protection Agency, Washington, DC*, Report No. EPA-R2-72/081.
- Scalenghe, R., & Marsan, F. (2009). The anthropogenic sealing of soils in urban areas. *Landscape and Urban Planning*, 90(1–2), pp. 1-10.
- Schütze, M., Campisano, A., Colas, H., Vanrolleghe, P., & Schilling, W. (2013). Real-Time Control of Urban Water Systems. *International Conference on Pumps, Electromechanical Devices and Systems Applied to Urban*, Valencia, Spain: PEDS.
- Sheafer J.R. et al. (1982). *Urban storm water management*. New York, Ny: Marcel Dekker .
- Shen, J., & Zhang, Q. (2014). Parameter Estimation Method for SWMM under the Condition of Incomplete Information Based on GIS and RS. *EJGE*, vol. 20 : 6065-6108.
- Shinya M., Tsuchinaga T., Kitano M., Yamada Y., & Ishikawa M. (2000). Characterization of heavy metals and polycyclic aromatic hydrocarbons in urban highway runoff. *Water Science and Technology*, 42, 201–208.
- Stahr, L., Eisenhauer, D., Helmers, M., Dossky, M., & Franti, T. (2004). Green-Ampt Infiltration Parameters in Riparian Buffers. *The Canadian Society for Engineering in Agriculture, Food and Biological Systems*.
- Sun, N., Hong, B., & Hall, M. (2013). Assessment of the SWMM model uncertainties within the generalized likelihood uncertainty estimation

- (GLUE) framework for a high highresolution. *Hydrological Processes*, 28 (6), 3018–3034.
- T. Sjömander Magnusson, & B. van der Merwe. (2005). Context driven policy design in urban water management. A case study of Windhoek, Namibia. *Urban Water Journal*, Vol. 2, Iss. 3.
- Tai Y.L. (1991). Physical and chemical characterization of street dust and dirt from urban areas. *Master of Science Thesis. Department of Civil Engineering, The Graduate School, The Pennsylvania State University.*
- Tammy , E. P., & James, B. C. (2014). Delineating Drainage Network in Urban Area. *ASPRS Annual Conference.*
- Tomlinson A. I. (1980). The frequency of high intensity rainfalls in New-Zealand, part 1. *Water and Soil Technical Publication No. 19*, National Water and Soil Conservation, Wellington, New Zealand, 63p.
- Turazza, D. (1880). *Trattato di idrometria o di idraulica pratica*. Padova, Italy: F. Sacchetto.
- Vallet, B., Muschalla, D., Lessard, P., & Vanrolleghem, P. (2014). A new dynamic water quality model for stormwater basins as a tool for urban runoff management: Concept and validation. *Urban Water Journal*, Vol. 11, No. 3, 211–220.
- Vymazal, J. (2010). Constructed Wetlands for Wastewater Treatment. *Water* , 2(3) 530-549.
- Walsh C. J. , Roy A. H., Feminella J. W., Cottingham P. D., Groffman P. M., & Morgan R. P. (2005). The urban stream syndrome: Current knowledge and the search for a cure. *Journal of the North American Benthological Society*, 24, 706–723.
- Wang, X., Liu, T., & Yang, W. (2012). Development of a robust runoff-prediction model by fusing the Rational Equation and a modified SCS-CN method. *Hydrological Sciences Journal*, 57(6), 1118-1140.

- Weng , Q. (2001). Modeling Urban Growth Effects on Surface Runoff with the Integration of Remote Sensing and GIS. *Environmental Management*, Vol. 28, No. 6, pp. 737–748.
- Woltemade, C. (2010). Impact of Residential Soil Disturbance on Infiltration Rate and Stormwater Runoff. *American Water Resources Association*, Vol. 46, No. 4.
- Wu , F., Zhan, J., & Güneralp, İ. (2015). Present and future of urban water balance in the rapidly urbanizing Heihe River Basin, Northwest China. *Ecological Modelling, Volume* , Volume 318 Pages 254–264.
- Yao, L., Wei, W., & Chen, L. (2016). How does imperviousness impact the urban rainfall-runoff process under various storm cases? *Ecological Indicators*, 60, 893–905.
- Yazdanfar, Z., & Sharma, A. (2015). Urban drainage system planning and design – challenges with climate change and urbanization: a review. *Water Science & Technology*, 165-179.
- Yu, H., Huang , G., & Wu, C. ( 2014). Application of the stormwater management model to a piedmont city: a case study of Jinan City, China. *Water Science & Technology* , pp 858-864.
- Zhifeng Li , Lixin Wu , Wei Zhu , Miaole Hou, Yizhou Yang, & Jianchun Zheng. (2014). A New Method for Urban Storm Flood Inundation Simulation with Fine CD-TIN Surface. *Water* , 6 pp 1151-1171; doi:10.3390/w6051151.
- Zhou, Q. (2014). A Review of Sustainable Urban Drainage Systems Considering the Climate Change and Urbanization Impacts. *Water*, 6, 976-992; doi:10.3390/w6040976.

# Appendix-I

## Shahi Katha drain sub-catchment computed morphometric parameters and landuse type area

Sub-Catchment #	Area (A)	Maximum Elevation (H <sub>max</sub> )	Minimum Elevation (H <sub>min</sub> )	Drain Length (L <sub>D</sub> )	Slope (S)	Time of Concentration (T <sub>C</sub> )	Landuse Type						
							Agriculture Land C2 = 0.2 C5 = 0.25	Road C2 = 0.8 C5 = 0.95	Urban Area C2 = 0.57 C5 = 0.6	Suburban Area C2 = 0.42 C5 = 0.47	Park & Playground C2 = 0.5 C5 = 0.58	Bare Soil C2 = 0.3 C5 = 0.35	Wood C2 = 0.15 C5 = 0.19
							(ha)	(ha)	(ha)	(ha)	(ha)	(ha)	(ha)
0	55.39	375	372	590	0.005085	20	20.33	2.00	0.00	19.20	0.00	12.36	1.50
1	23.10	372	371	260	0.003846	12	6.30	0.00	0.00	10.32	0.00	5.28	1.20
2	7.12	372	370	201	0.009950	7	2.10	0.00	0.00	3.62	0.00	1.10	0.30
3	39.27	370	369	635	0.002362	29	6.20	4.30	0.00	18.39	0.00	7.26	3.12
4	35.52	372	371	448	0.002232	23	14.44	2.77	0.00	12.00	0.00	5.10	1.10
5	12.20	371.5	371	278	0.001799	17	3.60	0.30	0.00	5.30	0.00	2.06	0.94
6	24.76	372	370	397	0.005038	15	7.28	2.39	0.00	12.38	0.00	1.58	1.13
7	59.51	370	368	974	0.002053	42	11.99	6.98	16.53	14.88	0.00	3.93	5.20
8	61.14	371	368	862	0.003480	31	13.11	6.20	13.32	21.20	0.00	4.09	3.22
9	61.93	371	366	777	0.006435	23	29.44	2.48	0.00	23.76	0.00	3.37	2.88
10	40.19	366	362	396	0.010101	11	9.23	1.44	14.65	12.40	1.11	0.40	0.96
11	146.63	366	358	1182	0.006768	31	18.77	19.21	71.77	21.49	3.90	4.92	6.57
12	30.33	362	361	913	0.000767	59	0.00	6.13	18.32	0.00	3.55	0.00	2.33
13	58.48	361	358	905	0.003315	33	0.00	16.91	29.11	0.00	5.67	0.00	6.79
14	56.79	362	361	603	0.001658	32	17.55	4.50	24.37	4.45	0.00	3.53	2.39
15	26.49	357	356.5	440	0.001136	29	6.33	4.22	12.98	0.00	0.00	1.20	1.76
16	9.39	357.5	357	207	0.001932	13	0.00	0.70	5.41	0.00	2.15	0.27	0.86
17	25.98	361	358	589	0.004924	20	7.39	0.33	12.30	0.48	2.41	1.79	1.28
18	26.74	359	358	622	0.001608	33	4.33	2.95	17.58	0.00	0.00	1.25	0.63
19	40.99	356.5	356	409	0.001222	26	3.25	1.99	33.36	0.00	0.00	2.16	0.23
20	18.16	356	354	630	0.003175	26	0.00	3.44	10.07	0.00	4.09	0.22	0.34
21	19.60	362	361	447	0.002237	22	0.00	3.55	9.32	0.00	2.13	0.00	4.60
22	11.11	354	351	385	0.006753	13	0.00	1.93	4.89	0.00	1.38	0.00	2.91
23	9.95	353	353	538	0.000929	36	0.00	2.25	5.93	0.00	0.00	0.00	1.77
24	10.29	354	353	352	0.002841	17	0.00	2.88	5.34	0.00	0.00	0.00	2.07
25	3.10	352.5	351	222	0.004955	10	0.00	0.48	1.44	0.00	0.00	0.00	1.18
26	43.17	358	357	804	0.000746	54	0.00	7.88	29.33	0.00	0.00	1.87	4.09
27	4.02	353	352	192	0.004687	9	0.00	0.72	2.46	0.00	0.30	0.00	0.54
28	19.04	357	355	298	0.006711	11	0.00	3.56	9.13	0.00	2.23	0.00	4.12
29	29.24	355	352	719	0.004172	25	4.44	3.22	14.76	0.00	1.87	2.44	2.51
30	33.39	354	352	704	0.002841	29	0.00	7.71	18.54	0.00	0.00	4.87	2.27
31	11.49	353	352	543	0.001842	28	0.00	1.77	8.05	0.00	0.00	0.89	0.78
32	47.37	345	339	733	0.008186	20	0.00	8.87	26.31	0.00	5.66	1.88	4.65
33	39.63	345	339	863	0.006952	24	0.00	6.88	24.82	0.00	3.30	0.00	4.63
34	5.07	352	348	222	0.018018	6	0.00	0.80	3.20	0.00	0.00	0.00	1.07
35	28.00	348	347	507	0.001972	26	0.00	4.78	17.33	0.00	0.00	2.66	3.23
36	32.28	339	335	522	0.007663	16	0.00	5.98	20.32	0.00	1.22	2.65	2.11
37	32.81	345	342	563	0.005329	19	0.00	2.88	25.99	0.00	0.00	0.99	2.95
38	52.68	340	334	708	0.008475	19	0.00	12.27	32.99	0.00	0.00	2.77	4.65
39	13.87	342	340	287	0.006969	10	0.00	0.77	9.09	0.00	0.00	1.46	2.55
40	20.32	340	336	619	0.006462	19	0.00	1.77	14.93	0.00	0.34	1.30	1.98
41	10.34	337	336	555	0.001802	29	0.00	2.35	5.77	0.00	0.00	0.00	2.22
42	10.63	339	337	512	0.003906	20	0.00	2.11	5.87	0.00	0.54	0.00	2.11
43	35.12	334	332	390	0.005128	15	0.00	5.10	26.12	0.00	0.00	2.02	1.88
44	6.09	336	332	255	0.014118	7	0.00	0.85	3.90	0.00	0.00	0.22	1.12
45	6.11	335	332	154	0.016883	5	0.00	1.02	3.54	0.00	0.00	0.11	1.44
46	26.43	334	331	376	0.007979	12	0.00	6.22	16.22	0.00	0.00	2.12	1.87
47	23.81	339	334	389	0.012853	10	0.00	3.70	12.76	0.00	3.76	0.67	2.92
48	17.81	341	339	144	0.013889	5	0.00	1.67	9.87	0.00	2.06	0.22	3.99
49	4.01	339	336	285	0.010526	9	0.00	0.67	2.12	0.00	0.19	0.00	1.03
50	3.10	336	332	243	0.016461	7	0.00	0.37	2.11	0.00	0.11	0.00	0.51
51	45.29	332	325	683	0.010249	17	0.00	11.30	25.35	0.00	3.76	0.45	4.43
52	25.21	331	327	383	0.010444	11	0.00	4.02	13.44	0.00	3.22	1.22	3.31
53	13.11	325	322	283	0.010601	9	0.00	2.12	6.99	0.00	1.06	0.00	2.94
54	10.05	323	322	550	0.001818	29	0.00	2.23	5.22	0.00	1.01	0.00	1.59
55	25.72	333	323	424	0.023585	9	0.00	4.24	18.16	0.00	0.12	0.32	2.88
56	23.30	323	320	352	0.008523	11	0.00	3.59	17.33	0.00	0.00	0.78	1.60
57	16.29	322	320	569	0.003515	23	0.00	3.11	5.11	0.00	4.66	0.29	3.12
58	69.06	320	319	600	0.001667	32	5.33	7.77	43.63	0.00	5.44	3.34	3.55
59	26.54	319	318	267	0.003745	12	0.00	3.17	17.91	1.02	0.00	2.67	1.77
60	13.04	318	317.3	360	0.001944	20	0.00	2.19	7.38	0.00	0.00	2.03	1.44
61	13.44	319	318.2	261	0.003065	13	1.66	2.12	7.31	0.00	0.00	1.66	0.69
62	7.06	318.2	317.3	400	0.002250	21	0.00	0.50	4.82	0.00	0.00	1.25	0.49
63	19.60	317.3	313	580	0.007414	17	4.51	0.30	11.85	0.00	0.00	2.43	0.51
64	8.74	313	311	277	0.007220	10	2.22	0.34	4.55	0.00	0.00	1.09	0.54
65	3.93	311	310	192	0.005208	8	0.56	0.04	1.95	0.00	0.00	0.89	0.49
66	1.09	310	308.3	433	0.003926	18	0.09	0.00	0.45	0.00	0.00	0.33	0.22
67	55.67	377	373	686	0.005831	22	22.55	0.37	0.00	25.88	0.00	3.76	3.11
68	26.04	373	370	434	0.006912	14	11.22	0.11	0.00	10.34	0.00	2.40	1.97
69	38.08	348	339	789	0.011407	19	0.00	6.99	21.55	0.00	3.11	0.51	5.92
70	22.93	350	348	589	0.003396	24	0.00	3.90	14.15	0.00	1.66	0.11	3.11
71	15.58	345	339	1177	0.005098	34	0.00	3.22	8.95	0.00	0.44	0.08	2.89
72	29.64	349	345	566	0.007067	17	0.00	5.19	19.38	0.00	0.88	0.00	4.19
73	28.52	344	343	444	0.002252	22	0.00	4.92	19.92	0.00	0.00	0.99	2.69



Airport Tehkal Payain drain sub-catchment computed morphometric parameters and landuse type area

Sub-Catchment	Area	Maximum Elevation	Minimum Elevation	Drain Length	Slope	Time of Concentration	Landuse Type						
							Agriculture Land C2 = 0.2 C5 = 0.25	Road C2 = 0.8 C5 = 0.95	Urban Area C2 = 0.57 C5 = 0.6	Suburban Area C2 = 0.42 C5 = 0.47	Park & Playground C2 = 0.5 C5 = 0.58	Bare Soil C2 = 0.3 C5 = 0.35	Wood C2 = 0.15 C5 = 0.19
#	(A)	(H <sub>max</sub> )	(H <sub>min</sub> )	(L <sub>D</sub> )	(S)	(T <sub>C</sub> )	(ha)	(ha)	(ha)	(ha)	(ha)	(ha)	(ha)
0	6.27	362	360	272	0.007353	10	0.00	1.02	4.11	0.00	0.61	0.00	0.53
1	8.98	360	358	224	0.008929	8	0.00	1.79	5.94	0.00	0.52	0.00	0.73
2	6.46	361	357	300	0.013333	8	0.00	1.15	4.79	0.00	0.11	0.00	0.41
3	2.66	358	357	136	0.007353	6	0.00	0.36	1.88	0.00	0.03	0.00	0.39
4	3.73	357	353	152	0.026316	4	0.00	0.67	2.53	0.00	0.12	0.00	0.41
5	3.51	357	353	299	0.013378	8	0.00	0.77	2.34	0.00	0.23	0.00	0.17
6	8.01	353	350	255	0.011765	8	0.00	2.12	4.58	0.00	0.59	0.00	0.79
7	12.79	354	351	333	0.009009	10	0.00	2.33	8.61	0.00	0.66	0.32	0.85
8	4.77	357	356	161	0.006211	7	0.00	0.77	2.89	0.00	0.21	0.09	0.81
9	4.72	354.3	352	200	0.011500	6	0.00	1.34	2.54	0.00	0.10	0.07	0.67
10	1.71	356	354	155	0.012903	5	0.00	0.31	0.88	0.00	0.15	0.01	0.36
11	15.68	356.5	351	223	0.024664	5	0.00	1.76	9.76	0.00	0.82	1.22	2.12
12	8.07	351	348	265	0.011321	8	0.00	0.22	3.81	0.00	2.60	0.56	0.88
13	11.30	350	345	420	0.011905	11	0.00	1.78	7.22	0.00	0.55	0.71	1.04
14	5.64	351	345	311	0.019293	7	0.00	0.87	3.38	0.00	0.77	0.23	0.39
15	1.51	353	352.0	110	0.009091	4	0.31	0.12	1.00	0.00	0.02	0.05	0.01
16	1.66	352	351	140	0.006429	6	0.00	0.15	1.04	0.00	0.00	0.44	0.03
17	2.42	352	351	177	0.005085	8	0.00	0.88	1.44	0.00	0.00	0.05	0.05
18	2.82	354	353	186	0.008065	7	0.13	0.67	1.22	0.00	0.23	0.12	0.45
19	1.98	353.5	351	231	0.010390	7	0.00	0.39	0.97	0.00	0.11	0.22	0.29
20	4.71	350	348	134	0.018657	4	0.99	0.21	2.45	0.00	0.22	0.11	0.73
21	6.04	345	343	350	0.005714	13	0.00	0.66	3.77	0.00	0.89	0.21	0.51
22	9.98	348	342	362	0.016575	9	0.00	0.79	6.78	0.00	0.35	0.13	0.93
23	3.45	351	344	192	0.036458	4	0.00	1.09	1.95	0.00	0.00	0.22	0.19
24	3.68	344	341	323	0.009288	10	0.00	0.67	2.17	0.00	0.10	0.19	0.55
25	1.84	348	343	148	0.033784	3	0.00	0.33	0.98	0.00	0.00	0.09	0.44
26	3.24	343	341	225	0.008889	8	0.00	0.78	1.89	0.00	0.00	0.23	0.34
27	1.75	341	340	138	0.007246	6	0.00	0.19	1.09	0.00	0.00	0.14	0.33
28	2.44	342	340	103	0.019417	3	0.00	0.33	1.78	0.00	0.00	0.11	0.22
29	11.34	352	351	178	0.005618	8	0.00	2.11	6.67	0.00	1.60	0.19	0.77
30	12.39	351	345	302	0.019868	7	0.00	2.88	8.11	0.00	0.56	0.32	0.47
31	2.81	345	340	245	0.020408	6	0.00	0.90	1.59	0.00	0.00	0.00	0.32
32	16.36	340	337	332	0.009036	10	5.11	0.39	6.99	0.88	0.00	2.19	0.80
33	8.09	351	347	231	0.017316	6	2.98	0.09	4.77	0.00	0.00	0.12	0.13
34	7.24	347	338	337	0.026706	7	2.44	0.05	3.11	1.20	0.00	0.11	0.33
35	4.46	337	333	254	0.015748	7	1.16	0.01	1.78	0.93	0.00	0.39	0.19
36	13.91	345	340	271	0.018450	7	0.00	3.91	7.78	0.00	0.67	0.76	0.79
37	3.35	340	333	193	0.036269	4	0.00	0.12	2.77	0.23	0.00	0.17	0.06
38	12.84	342	335	258	0.027132	6	0.00	2.19	8.89	0.00	0.00	0.78	0.98
39	2.01	333	332.5	140	0.003571	8	0.77	0.00	0.00	0.91	0.00	0.23	0.10
40	3.45	338	333	182	0.027473	4	1.79	0.00	0.00	1.22	0.00	0.27	0.17
41	7.70	341	334	233	0.030043	5	3.97	0.00	0.00	3.11	0.00	0.32	0.30
42	2.75	332.5	332	143	0.003497	8	0.59	0.00	0.00	1.76	0.00	0.21	0.19
43	3.86	335	332	190	0.015789	5	0.00	0.56	1.98	0.00	0.44	0.39	0.49
44	8.82	337	334	221	0.013575	7	4.11	0.00	0.00	3.19	0.00	0.88	0.64
45	6.23	334	329	371	0.013477	10	3.89	0.00	0.00	1.88	0.00	0.33	0.13
46	8.60	332	329	362	0.008287	12	1.70	1.71	4.09	0.00	0.31	0.19	0.60
47	8.15	329	327	325	0.006154	12	0.79	0.43	1.90	4.81	0.00	0.12	0.10
48	8.50	334	327	354	0.019774	8	3.28	0.00	0.00	3.79	0.00	0.29	0.79
49	7.67	334	333	300	0.003333	14	0.00	1.89	4.66	0.00	0.55	0.15	0.25
50	2.95	337	333	113	0.035398	3	0.00	0.67	1.39	0.00	0.11	0.29	0.49
51	5.15	333	327	198	0.030303	4	0.00	1.03	3.08	0.00	0.00	0.34	0.70
52	4.31	327	326	326	0.003067	16	0.78	0.00	1.89	0.67	0.00	0.41	0.56
53	5.40	332	330	162	0.012346	5	0.00	1.79	2.80	0.00	0.00	0.22	0.59
54	6.29	327	324	350	0.008571	11	0.00	1.55	4.11	0.00	0.00	0.29	0.34
55	3.27	324	322	314	0.006369	11	0.00	0.59	1.89	0.00	0.27	0.13	0.39
56	3.84	326	324	233	0.008584	8	0.31	0.22	2.46	0.43	0.00	0.09	0.33
57	7.42	326	325	241	0.004149	11	3.09	0.10	0.22	3.55	0.00	0.11	0.35

University Road Tehkal Bala drain sub-catchment computed morphometric parameters and landuse type area

Sub-Catchment	Area	Maximum Elevation	Minimum Elevation	Drain Length	Slope	Time of Concentration	Landuse Type						
							Agriculture Land C2 = 0.2 C5 = 0.25	Road C2 = 0.8 C5 = 0.95	Urban Area C2 = 0.57 C5 = 0.6	Suburban Area C2 = 0.42 C5 = 0.47	Park & Playground C2 = 0.5 C5 = 0.58	Bare Soil C2 = 0.3 C5 = 0.35	Wood C2 = 0.15 C5 = 0.19
#	(A)	(H <sub>max</sub> )	(H <sub>min</sub> )	(L <sub>D</sub> )	(S)	(T <sub>C</sub> )	(ha)	(ha)	(ha)	(ha)	(ha)	(ha)	(ha)
0	17.43	368	366	307	0.006515	11	0.00	3.59	12.22	0.00	0.00	0.33	1.29
1	17.21	359	356	579	0.005181	20	0.55	0.88	13.56	0.00	0.00	1.44	0.78
2	12.47	361	360	352	0.002273	19	0.21	0.22	9.30	0.00	0.00	1.83	0.91
3	27.27	367	366	410	0.002439	20	0.00	0.67	20.77	0.00	0.00	5.21	0.87
4	17.52	364.6	364	382	0.001571	23	0.00	3.87	12.10	0.00	1.22	0.00	0.33
5	20.86	366	364	453	0.004415	17	0.00	0.21	14.67	0.00	0.00	4.29	1.69
6	17.65	362	359	536	0.005597	18	0.00	4.55	11.06	0.00	1.41	0.00	0.63
7	12.32	359	358	77	0.012987	3	0.00	2.91	6.21	0.00	2.21	0.00	0.99
8	30.05	358	356	398	0.005025	15	0.00	5.87	19.30	0.00	2.71	1.11	1.06
9	2.59	364	359	224	0.022321	5	0.00	1.19	0.78	0.00	0.00	0.00	0.62
10	8.34	359	356	371	0.008086	12	0.00	2.98	4.33	0.00	0.00	0.77	0.26
11	13.65	356	353	631	0.004754	22	0.00	4.11	7.11	0.00	0.00	0.66	1.77
12	11.82	353	351	377	0.005305	14	0.00	2.91	5.95	0.00	0.21	0.99	0.76
13	14.77	349	347	294	0.006803	11	10.23	0.00	0.00	2.77	0.00	0.79	0.98
14	99.33	335	329	1111	0.005401	32	68.12	0.24	0.00	23.77	0.00	2.09	5.11
15	36.16	329	324.0	521	0.009597	14	31.95	0.00	0.00	2.11	0.00	0.20	1.90
16	10.78	328	323	219	0.022831	5	8.76	0.00	0.00	0.18	0.00	0.29	1.55
17	40.16	329	324	567	0.008818	16	32.45	0.00	0.00	0.88	0.00	2.94	3.89
18	15.17	324	322	378	0.005291	14	1.88	2.30	7.98	0.00	0.48	1.33	1.19
19	22.94	324	320	565	0.007080	17	17.41	0.00	0.00	1.29	0.00	0.00	4.22
20	6.78	322	318	424	0.009434	12	1.51	0.99	3.76	0.00	0.00	0.22	0.30
21	5.75	320	318	211	0.009479	7	0.79	0.55	2.80	0.00	0.00	0.88	0.73
22	2.25	318	317	166	0.004819	8	0.00	0.28	1.54	0.00	0.00	0.14	0.29
23	21.69	367	366	358	0.001676	21	0.00	3.83	9.99	0.00	3.69	0.46	3.72
24	10.07	360	358	213	0.009390	7	1.22	1.11	6.49	0.00	0.09	0.98	0.18
25	15.18	356.6	356	398	0.001508	24	0.99	1.15	8.40	0.00	0.78	1.42	2.44
26	4.92	372	370	222	0.009009	8	0.00	1.97	1.77	0.00	0.21	0.00	0.97
27	6.84	370	368	328	0.006098	12	0.00	1.33	2.99	0.00	0.57	0.11	1.84
28	6.20	372	371	218	0.004587	10	0.00	1.10	4.05	0.00	0.29	0.00	0.76
29	5.93	368	366	262	0.007634	9	0.00	1.54	3.10	0.00	0.08	0.40	0.81
30	3.40	371	369	316	0.006329	12	0.00	0.81	2.11	0.00	0.09	0.00	0.39
31	5.51	369	368	255	0.003922	12	0.00	1.71	3.09	0.00	0.50	0.00	0.21
32	12.73	369.7	369	325	0.002154	18	0.00	2.29	7.62	0.00	0.62	0.00	2.20
33	10.83	371	369	236	0.008475	8	0.00	2.88	5.91	0.00	0.12	0.00	1.92
34	7.45	363	361	171	0.011696	6	0.87	1.45	2.11	0.00	1.59	0.00	1.43
35	12.83	361	356	666	0.007508	19	0.00	0.68	5.70	0.00	0.00	4.16	2.29
36	4.53	358	356	211	0.009479	7	0.34	0.00	2.90	0.00	0.00	0.11	1.18
37	5.71	354	353	269	0.003717	12	0.22	0.89	3.78	0.00	0.09	0.16	0.57
38	7.59	355	354	208	0.004808	9	1.78	0.50	3.90	0.00	0.00	1.19	0.22
39	11.19	353	351.0	538	0.003717	21	0.44	0.29	7.89	0.00	0.07	1.78	0.72
40	17.04	355	353	299	0.006689	11	0.39	0.19	12.42	0.00	0.22	2.45	1.37
41	10.67	361	359	216	0.009259	7	0.17	0.89	6.79	0.00	0.12	1.78	0.92
42	27.73	363	361	270	0.007407	10	4.94	1.20	18.12	0.00	0.00	2.22	1.25
43	9.70	356.6	356	250	0.002400	14	5.21	0.00	1.89	0.00	0.00	0.80	1.80
44	3.69	357.3	356	157	0.008280	6	0.00	0.00	2.59	0.00	0.11	0.78	0.21
45	3.05	356	354	165	0.012121	5	0.69	0.00	1.23	0.00	0.00	0.34	0.79
46	10.10	356	354	259	0.007722	9	6.12	0.00	2.70	0.00	0.09	0.22	0.97
47	29.37	354	347	585	0.011966	14	19.12	0.88	7.00	0.00	0.00	0.27	2.10
48	11.76	351	347	484	0.008264	14	0.49	2.11	6.42	0.00	0.22	1.40	1.12
49	6.28	350	347	201	0.014925	6	0.00	1.88	3.46	0.00	0.08	0.33	1.01
50	6.39	352	350	147	0.013605	5	0.00	1.34	3.89	0.00	0.51	0.39	0.46
51	18.23	347	342	512	0.009766	14	12.76	0.00	2.30	0.72	0.00	1.76	0.69
52	32.83	374	371	308	0.009740	10	0.00	4.87	21.12	0.00	2.12	0.76	3.96
53	51.72	342	336	481	0.012474	12	39.12	0.32	0.00	5.23	0.00	2.94	4.11
54	21.00	340	336	399	0.010025	12	2.90	1.90	12.10	0.00	0.77	0.44	2.89

C2 = Runoff coefficient for 2-year recurrence intervals

C5 = Runoff coefficient for 5-year recurrence intervals

### Computed hydraulic parameters of Shahi Katha drain

Reach Node to Node		Length	Shape	B.E U/S	B.E D/S	Water surface Slope(From Survey)	1 In:	Manning's Roughness Coefficient	Width	Depth	Area	Perimeter	Hydraulic Radius
From	To	L				S		n	b	d	A	P	R
m	m	m		m	m	m/m			m	m	m <sup>2</sup>	m	m
2	1	250	Irregular	308.18	306.06	0.0085	117.98	0.03	8.1	1.18	14.20	11.29	1.26
3	2	196	Rectangular	310.57	308.18	0.0122	82.28	0.02	7.4	1.5	11.10	10.4	1.07
4	3	450	Rectangular	312.54	310.57	0.0044	227.62	0.02	6.3	1.9	11.97	10.1	1.19
5	4	313	Rectangular	313.39	312.54	0.0027	369.98	0.02	6.1	2.3	14.03	10.7	1.31
6	5	342	Rectangular	314.23	313.38	0.0025	402.35	0.02	7.8	2.7	21.06	13.2	1.60
7	6	797	Rectangular	316.37	315.23	0.0014	697.90	0.02	7.5	2.3	17.25	12.1	1.43
8	7	568	Rectangular	317.98	316.37	0.0028	352.80	0.02	6.2	2	12.40	10.2	1.22
9	8	600	Rectangular	319.75	317.98	0.0029	338.98	0.02	5.93	1.9	11.27	9.73	1.16

### Computed hydraulic parameters of Airport Tehkal Payain drain

Reach Node to Node		Length	Shape	B.E U/S	B.E D/S	Water surface Slope(From Survey)	1 In:	Manning's Roughness Coefficient	Width	Depth	Area	Perimeter	Hydraulic Radius
From	To	L				S		n	b	d	A	P	R
m	m	m		m	m	m/m			m	m	m <sup>2</sup>	m	m
2	1	218	Irregular	319.44	317.89	0.0071	141.14	0.03	3.5	1.27	4.45	6.04	0.74
3	2	125	Irregular	321.08	319.44	0.0131	76.41	0.03	3.1	1.12	3.47	5.34	0.65
4	3	142	Irregular	324.61	321.08	0.0249	40.15	0.03	2.95	0.90	2.66	4.75	0.56
5	4	235	Irregular	326.40	324.61	0.0076	131.58	0.03	3	1.21	3.63	5.42	0.67
6	5	299	Irregular	328.42	326.40	0.0067	148.31	0.03	2.75	1.34	3.69	5.43	0.68
7	6	350	Irregular	329.22	328.42	0.0023	436.41	0.03	3.3	1.32	4.36	5.94	0.73
8	7	150	Irregular	330.95	329.22	0.0115	86.81	0.03	3.1	1.31	4.06	5.72	0.71
9	8	150	Trapezoidal	334.55	330.95	0.0240	41.59	0.028	3.11	1.4	4.35	5.91	0.74
10	9	270	Rectangular	335.5	334.01	0.0055	181.21	0.02	2.2	1.32	2.90	4.84	0.60
11	10	341	Rectangular	337.2	335.5	0.0050	200.59	0.02	2.1	1.18	2.48	4.46	0.56
12	11	136	Irregular	338.021	337.2	0.0060	165.65	0.03	2.1	1.3	2.73	4.7	0.58
13	12	239	Rectangular	340.2	338.021	0.0091	109.68	0.02	1.8	1.08	1.94	3.96	0.49
14	13	256	Rectangular	342.3	340.2	0.0082	121.90	0.02	1.9	1.05	2.00	4	0.50
15	14	360	Rectangular	346.3	342.3	0.0111	90.00	0.02	1.8	0.9	1.62	3.6	0.45
16	15	234	Rectangular	348.8	346.3	0.0107	93.60	0.02	1.6	1	1.60	3.6	0.44
17	16	299	Rectangular	352.12	348.8	0.0111	90.06	0.02	1.5	1	1.50	3.5	0.43
18	17	166	Rectangular	355.1	352.12	0.0180	55.70	0.02	0.5	0.6	0.30	1.7	0.18
19	18	225	Rectangular	357.04	355.1	0.0086	115.98	0.02	0.5	0.6	0.30	1.7	0.18

### Computed hydraulic parameters of University Road Tehkal Bala

Reach Node to Node		Length	Shape	B.E U/S	B.E D/S	Water surface Slope(From Survey)	1 In:	Manning's Roughness Coefficient	Width	Depth	Area	Perimeter	Hydraulic Radius
From	To	L				S		n	b	d	A	P	R
m	m	m		m	m	m/m			m	m	m <sup>2</sup>	m	m
3	1	254	Rectangular	320.20	318.55	0.0065	153.68	0.02	2.4	1.41	3.384	5.22	0.65
4	3	299	Irregular	322.40	320.20	0.0074	135.91	0.03	3.3	1.30	4.29	5.9	0.73
5	4	137	Irregular	324.28	322.4	0.0137	72.87	0.03	2.8	1.20	3.36	5.2	0.65
6	5	188	Irregular	326.76	324.28	0.0132	75.81	0.03	3	1.13	3.39	5.26	0.64
7	6	337	Irregular	330.45	326.76	0.0109	91.33	0.03	2.3	1.11	2.553	4.52	0.56
8	7	650	Irregular	335.11	330.45	0.0072	139.48	0.03	2.2	1.30	2.86	4.8	0.60
9	8	312	Rectangular	338.2	335.11	0.0099	100.97	0.02	1.9	1.29	2.451	4.48	0.55
10	9	600	Rectangular	342.81	338.2	0.0077	130.15	0.02	2	1.30	2.6	4.6	0.57
11	10	360	Rectangular	346.01	342.81	0.0089	112.36	0.02	2	1.20	2.4	4.4	0.55
12	11	300	Rectangular	350.16	346.01	0.0138	72.36	0.02	1.7	1.20	2.04	4.1	0.50
12	12	400	Rectangular	353.88	350.16	0.0093	107.53	0.02	1.5	1.20	1.8	3.9	0.46
15	14	646	Rectangular	357.75	353.88	0.0066	151.29	0.02	1.5	1.09	1.635	3.68	0.44
16	15	799	Rectangular	361.25	357.75	0.0056	177.44	0.02	1.2	0.99	1.188	3.18	0.37
17	16	460	Rectangular	367.42	361.25	0.0134	74.53	0.02	1.2	0.85	1.02	2.9	0.35
18	17	248	Rectangular	370.34	367.42	0.0118	84.84	0.02	1.3	0.80	1.04	2.9	0.36
20	18	300	Rectangular	371.20	370.34	0.0029	348.84	0.02	1.2	0.90	1.08	3	0.36
21	20	260	Rectangular	372.4	371.2	0.0046	216.67	0.02	1.1	0.80	0.88	2.7	0.33
22	21	240	Rectangular	373.20	372.4	0.0033	300.00	0.02	1.1	0.70	0.77	2.5	0.31