

**CZECH UNIVERSITY OF LIFE SCIENCES PRAGUE  
FACULTY OF TROPICAL AGRISCIENCES**

**Department of Sustainable Technologies**



Czech University of Life Sciences Prague  
**Faculty of Tropical  
AgriSciences**

**The effect of using High-Speed Mills on moisture content  
after biomass disintegration**

Dissertation thesis

**Author:** Ing. George Karra'á

**Supervisor:** Assoc. Prof. Vladimír Krepl, CSc.

**Co-Supervisor:** Assoc. Prof. Tatiana Ivanova, Ph.D.

Prague 2019

## **Declaration**

Hereby I declare that I have elaborated the doctoral dissertation thesis independently, only with the help of expert consultations and with the use of credible sources of information which I am stating in the text and then mentioning in the references.

I agree entirely that my Thesis can be saved in the library of the Czech University of Life Sciences Prague and can be available for study purposes.

In Prague 16. 9. 2019

.....

Ing. George Karra'á

## **Acknowledgements**

At this place I would like to thank all people and institutions that have helped me during the research and thesis elaboration and throughout the whole PhD studies.

First, I would like to express my heartfelt appreciation to my supervisor Assoc. Prof. Vladimír Krepl, CSc. who supported me all these years and had a very significant influence on me and on my work. I would like to thank him very much for his time, major help, experienced advice and academic support throughout the research and thesis completing.

I highly appreciate the supervision of Assoc. Prof. Tatiana Ivanova, Ph.D., her help and encouragement.

Special thanks for LAVARIS Ltd., where I was able to use their facilities, equipment's and laboratories to provide all tests of this study.

## Abstract

The need for mechanical disintegration of the biomass is very current topic with regard to the requirements of an agrarian sector. The disadvantages of commonly applied devices are their limited use of moist biomass and high energy consumption for disintegration.

The treatment of materials by means of high-speed grinding allows combining the milling effect (surface refinement) with an increase in the internal energy of the treated substances. There is a direct link between the rotor speed and the output particle size of the milled material. Due to the amount of energy generated during the grinding process and transferred to the processed material, a significant reduction of moisture content of the treated material is achieved.

In collaboration with LAVARIS Ltd., two types of high-speed mills were used. LAV 400/1R with single rotor and single stator and LAV 300/2R, a double rotor H. S. Mill. These mills were predominantly designed for crushing of concrete, rubber and C&D waste. The objective of the new technical solution can be described as assuring, that treatment of materials by means of high-speed grinding allows combining the milling effect (surface refinement) with an increase in the internal energy of the treated substances. Besides that, Due to the amount of energy generated during the grinding process and transferred to the processed material, a significant reduction of moisture content of the treated material is achieved. This confirmed by measuring moisture content reduction in the grinded material as an effect of size reduction process by using high-speed mill, and to evaluate the energy consumption of all the method.

For experimental purposes the following materials were used: apple tree wood, above-ground biomass of Miscanthus (*Miscanthus sinensis*) and pine sawdust (*Pinus L.*). Selected types of used materials are representatives of woody biomass from the fruit tree, herbaceous biomass and typical woody biomass for biofuels that can be found in abundant quantities on agriculture enterprises.



Disintegration of biomass on example materials took place together with testing of real-time drying in order to achieve a desired fraction (particle size) and moisture content of biomass material. Experimental tests on H. S. Mills have shown the following results: for the apple tree wood the output was a significant fraction size reduction, especially for the initial fraction bigger than 1.5 mm from 55% to 15% using LAV 400/1R. In case of *Miscanthus sinensis*, it was a size reduction from 61% to 13%. Also, in the pine wood sawdust the size reduction was obvious, from 49% to 12%. When using LAV 300/2R the size reduction in apple tree wood was to 11%, *Miscanthus sinensis* to 7% and pine wood sawdust was to 27% of the tested samples. Testing on LAV 400/1R on full rotor speed showed a reduction of moisture content in apple tree wood from 21.76% to 12.25%, in *Miscanthus sinensis* from 24.43% to 14.78% and from 37.08% to 23.87% in pine wood sawdust..

Based on the results, it can be concluded that the mechanical disintegration of biomass by high-speed mills has a great potential to become an effective part of raw materials' pre-treatment technology, not only in agriculture, but also in production of different types of biofuels like densified, pyrolysis.

This kind of application for H. S. Mills seems to be promising solution not only for biomass material, but also for other material, where the reduction of moisture content is a major challenge.

**Keywords:** pine sawdust, *Miscanthus sienensis*, apple tree wood, particle size, high-speed mill, sieve analyses, moisture content, solid biofuels, biomass drying, low energy drying.

## Abstrakt

Potřeba mechanického drcení biomasy je velmi aktuálním tématem s ohledem na požadavky agrárního sektoru. Nevýhodou běžně používaných zařízení je jejich omezené použití vlhké biomasy a vysoká spotřeba energie při drcení.

Zpracování materiálů pomocí vysokorychlostního mletí umožňuje kombinovat účinek mletí (zjemnění povrchu) se zvýšením vnitřní energie ošetřovaných látek. Existuje přímá souvislost mezi rychlostí rotoru a výstupní velikostí částic mletého materiálu. Díky množství energie generované během procesu mletí a přenesené do zpracovaného materiálu je dosaženo významného snížení obsahu vlhkosti ošetřeného materiálu.

Ve spolupráci s LAVARIS s.r.o. byly použity dva typy vysokorychlostních mlýnů. LAV 400 / 1R s jedním rotorem a jedním statorem a LAV 300 / 2R, vysokorychlostní mlýn s dvojitým rotorem. Tyto mlýny byly převážně určeny pro drcení betonu, gumy a stavebního odpadu. Cíl nového technického řešení lze označit jako stvrzení, že zpracování materiálů pomocí vysokorychlostního mletí, umožňuje kombinování mlecího efektu (zjemnění povrchu) se zvýšením vnitřní energie zpracovaných látek. Kromě toho se díky množství energie generované během procesu mletí a přenesené do zpracovaného materiálu dosáhne významného snížení obsahu vlhkosti ošetřeného materiálu. To se potvrdilo měřením snížení obsahu vlhkosti v mletém materiálu, jako účinek procesu zmenšení velikosti částic, pomocí vysokorychlostního mlýnu a vyhodnocení energetické spotřeby všech metod.

Pro experimentální účely byly použity následující materiály: dřevo jabloní, nadzemní biomasa *miscanthus* (*Miscanthus sinensis*) a piliny borovice (*Pinus* L.). Vybrané druhy použitých materiálů jsou zástupci dřevní biomasy z ovocného stromu, bylinné biomasy a typické dřevní biomasy pro biopaliva, která se v zemědělských podnicích vyskytují v hojném množství.

Dezintegrace biomasy na testovaných materiálech probíhalo společně s testováním sušení v reálném čase, aby se dosáhlo požadované frakce (velikost částic) a obsahu vlhkosti v biomasovém materiálu. Experimentální testy na V R Mlýnech

ukázaly následující výsledky: pro dřevo jabloní bylo výstupem významné snížení velikosti frakce, zejména pro počáteční frakci větší než 1,5 mm z 55% na 15% při použití LAV 400 / 1R. V případě *Miscanthus sinensis* se jednalo o zmenšení velikosti z 61% na 13%. Také v pilinách z borovicového dřeva bylo zřejmé snížení velikosti z 49% na 12%. Při použití LAV 300/2R bylo snížení velikosti jabloňového dřeva na 11%, *Miscanthus sinensis* na 7% a piliny z borovicového dřeva na 27% testovaných vzorků. Testování na LAV 400 / 1R při plné rychlosti rotoru ukázalo snížení obsahu vlhkosti v jabloňovém dřevu z 21,76% na 12,25%, v *Miscanthus sinensis* z 24,43% na 14,78% a z 37,08% na 23,87% v pilinách z borového dřeva.

Na základě výsledků je možné konstatovat, že mechanické dezintegrace biomasy vysokorychlostními mlýny má velký potenciál, stát se účinnou součástí technologie předúpravy surovin, nejen v zemědělství, ale také ve výrobě různých druhů biopaliv, jako jsou Brikety, pelety a pyrolýza.

Tato aplikace pro V R mlýny se zdá být nadějným řešením, nejen pro biomasu, ale také pro další typy materiálů, kde je snížení vlhkost materiálu hlavní výzvou.

**Klíčová slova:** Piliny, *Miscanthus sinensis*, jabloňové dřevo, velikost částic, vysokorychlostní mlýn, síťová analýza, obsah vlhkosti, pevná biopaliva, sušení biomasy, nízkoenergetické sušení.

# Content

<b>Acknowledgements</b> .....	<b>iii</b>
<b>Abstract</b> .....	<b>iv</b>
<b>Abstrakt</b> .....	<b>vi</b>
<b>List of tables</b> .....	<b>x</b>
<b>List of figures</b> .....	<b>xi</b>
<b>List of abbreviations</b> .....	<b>xiii</b>
<b>List of symbols</b> .....	<b>xiv</b>
<b>1. Introduction</b> .....	<b>1</b>
<b>2. Literature review</b> .....	<b>5</b>
2.1 About biomass .....	5
2.2 Biomass classifications.....	10
2.3 Biomass size reduction .....	11
2.4 Biomass drying.....	16
2.4.1 Passive (open air drying) of biomass.....	19
2.4.2 Active drying of biomass .....	20
2.4.2.1 Rotary dryer method.....	20
2.4.2.2 Fluidized bed dryer method .....	21
2.4.2.3 Pneumatic dryer method .....	21
2.5 High-Speed Milling.....	22
<b>3. Hypotheses and targets of the thesis</b> .....	<b>26</b>
3.1 Hypotheses .....	26
3.2 Main objective .....	26
3.3 Specific objectives.....	27
<b>4. Methodology</b> .....	<b>28</b>
4.1 Materials.....	28
4.1.1 Apple tree wood .....	29
4.1.2 <i>Miscanthus sinensis</i> .....	30
4.1.3 Pine sawdust wood .....	31
4.2 Milling process.....	32
4.2.1 About LAVARIS Ltd. ....	32
4.2.2 Screw conveyor .....	34
4.2.3 High-Speed Mills .....	35
4.2.3.1 Single rotor H. S. Mill.....	35
4.2.3.2 Double rotor H. S. Mill.....	37
4.2.4 Ventilator .....	40
4.2.5 Cyclone.....	41

4.2.6	Vibrating screener.....	41
4.3	Measuring equipment .....	42
4.3.1	Frequency converter .....	42
4.3.2	Ventilator frequency inverter .....	43
4.3.3	Particle size distribution – sieve analysis .....	44
4.3.4	Moisture content .....	46
4.3.5	Temperature measurement.....	46
4.3.6	Power measurement .....	47
4.4	Measurement settings.....	48
4.5	Measurement procedure.....	49
<b>5.</b>	<b>Results.....</b>	<b>51</b>
5.1	High-Speed Mill LAV 400/1R (I).....	51
5.2	High speed mill LAV 300/2R (II) .....	52
5.3	Testing process .....	52
5.3.1	Milling of Apple tree wood on LAV 400/1R (I – A) .....	52
5.3.2	Milling of Apple tree wood on LAV 300/2R (II – A) .....	56
5.3.3	Milling of <i>Miscanthus sinensis</i> on LAV 400/1R (I – M) .....	59
5.3.4	Milling of <i>Miscanthus sinensis</i> on LAV 300/2R (II – M) .....	62
5.3.5	Milling Pine wood sawdust on LAV 400/1R (I – P) .....	65
5.3.6	Milling Pine wood sawdust on LAV 300/2R (II – P) .....	68
<b>6.</b>	<b>Discussion and conclusions .....</b>	<b>71</b>
<b>7.</b>	<b>Recommendations for further research .....</b>	<b>77</b>
<b>8.</b>	<b>References.....</b>	<b>78</b>
<b>9.</b>	<b>List of annexes.....</b>	<b>88</b>
<b>10.</b>	<b>Annexes.....</b>	<b>89</b>

## List of tables

Table 1. Apple tree wood main parameters.....	29
Table 2. <i>Miscanthus sinensis</i> main parameters.....	30
Table 3. Pine sawdust wood main parameters .....	31
Table 4. Label data of the electric motor for LAV 400/1R.....	37
Table 5. Label data of the electric motors of LAV 300/2R.....	39
Table 6. Particle size distribution according to rotor speed for (I – A) .....	53
Table 7. Particle size distribution according to rotor speed for (II – A) .....	56
Table 8. Particle size distribution according to rotor speed for (I – M) .....	59
Table 9. Particle size distribution according to rotor speed for (II – M) .....	62
Table 10. Particle size distribution according to rotor speed for (I – P) .....	65
Table 11. Particle size distribution according to rotor speed for (II – P) .....	68

## List of figures

Figure 1. Biomass traditional sources. Source: Zafar (2019) .....	6
Figure 2. Pellets and briquettes from new sources of biomass. Source: LAVARIS .....	9
Figure 3. Studied materials.....	11
Figure 4. Hammer mill LAV/ HM-350. Source: LAVARIS .....	15
Figure 5. Mixed mode dryer. Source: Prakash et al. (2017) .....	19
Figure 6. High speed counter-direction mill LAV 150/2R .....	22
Figure 7. Pin-type rotor of HSM LAV 650/2R.....	23
Figure 8. Initial particle size distribution for Apple tree wood .....	29
Figure 9. Initial particle size distribution for <i>Miscanthus sinensis</i> .....	30
Figure 10. Initial particle size distribution for Pine sawdust wood.....	31
Figure 11. Scheme of the Line for grinding and drying of Biomass .....	33
Figure 12. Screw conveyer .....	34
Figure 13. High-speed multilevel single rotor mill LAV 400/1R.....	35
Figure 14. Detailed technical drawings of LAV 400/1R.....	36
Figure 15. High-speed multilevel double contra rotor mill LAV 300/2R.....	37
Figure 16. Detailed technical drawings of LAV 300/2R.....	38
Figure 17. CIPRES transport ventilator .....	40
Figure 18. Cyclone with rotary feeder .....	41
Figure 19. Vibrating screener .....	42
Figure 20. Frequency converter Siemens Micromaster 440.....	43
Figure 21. Ventilator frequency inverter .....	44
Figure 22. Laboratory sieve shaker HAVER EML 200.....	45
Figure 23. Laboratory precision balance KERN 572 .....	45
Figure 24. Laboratory dryer HS 62A .....	46
Figure 25. GEWISS temperature measuring device.....	47
Figure 26. Power meter KEW 6305 .....	48
Figure 27. Temperature related to time for (I – A).....	53
Figure 28. Particle size distribution according to rotor speed for (I – A) [mm] .....	54
Figure 29. Moisture content related to rotor speed for (I – A) .....	55
Figure 30. Power related to moisture content (I - A) .....	55
Figure 31. Temperature related to time for (II – A).....	56
Figure 32. Particle size distribution according to rotor speed for (II – A) [mm] .....	57
Figure 33. Moisture content related to rotors speed for (II – A).....	58
Figure 34. Power related to moisture content for (II – A) .....	58
Figure 35. Temperature related to time for (I – M).....	59
Figure 36. Particle size distribution according to rotor speed for (I – M) [mm] .....	60

Figure 37. Moisture content related to Rotor speed for (I – M) .....	61
Figure 38. Power related to moisture content for (I – M) .....	61
Figure 39. Temperature related to time for (II – M) .....	62
Figure 40. Particle size distribution according to rotor speed for (II – M) [mm] .....	63
Figure 41. Moisture content related to Rotor speed for (II – M) .....	64
Figure 42. Power related to moisture content for (II – M) .....	64
Figure 43. Temperature related to time for (I – P) .....	65
Figure 44. Particle size distribution according to rotor speed for (I – P) [mm] .....	66
Figure 45. Moisture content related to rotor speed for (I – P) .....	67
Figure 46. Power related to moisture content for (I – P) .....	67
Figure 47. Temperature related to time for (I – P) .....	68
Figure 48. Particle sizes distribution related to rotor speed for (II – P) [mm] .....	69
Figure 49. Moisture content related to rotor speed for (II – P) .....	70
Figure 50. Power related to moisture content for (II – P) .....	70



## List of abbreviations

(I – A)	testing of Apple tree wood on LAV 400/1R
(I – M)	testing of <i>Miscanthus sinensis</i> on LAV 400/1R
(I – P)	testing of Pine wood sawdust on LAV 400/1R
(I)	High speed mill LAV 400/1R
(II – A)	testing of Apple tree wood on LAV 300/2R
(II – M)	testing of <i>Miscanthus sinensis</i> on LAV 300/2R
(II – P)	testing of Pine wood sawdust on LAV 300/2R
(II)	High speed mill LAV 300/2R
CULS	Czech University of Life Science
EROI (EROEI)	Energy Return on (Energy) Invested
EU	European Union
FTA	Faculty of Tropical AgriSciences
H. S.	High-Speed
H. S. M.	High-Speed Mill
ISO	International Organization for Standardization
M	Moisture
MC	Moisture content
PR	Production rate
RES	Renewable Energy Sources
RIAE	Research Institute of Agricultural Engineering
SA	Sieve analysis
Std	Standard
UP	Unit price

## List of symbols

°C	Degree Celsius
A	Ampere
$\cos \varphi$	Power factor [-]
$d$	Rotor disc diameter
g	Gram (unit of weight)
h	Hour
I	Current, A
kW	Kilowatt
kWh <sup>-1</sup>	Kilowatt per hour
m.s <sup>-1</sup>	Meter per second
md	Dry matter mass of the dried material
MJ	Mega Joule
mm	Millimeter
mm/“g”	Sieve shaker intensity (vibration height in mm or acceleration of the sieve in “g” – acceleration due to gravity 9.81m.s <sup>-2</sup> )
mw	Total mass of wet material
$n$	Revolutions per minute
$P$	Active power kW
rpm	Revolution per minute
t.h <sup>-1</sup>	Ton per hour
$U$	Voltage, V
$v$	<i>Peripheral speed</i>
V	Volt
wt%	Percentage per weight
μm	Micrometer
$\pi$	<i>Mathematical constant approx. equals to 3.1415926</i>

## 1. Introduction

Human society recognizes that technology alone cannot resolve the contradictions of population growth and environmental pollution. There is a big need for interaction of moral, economic and legal constraints and instruments. The growth of human environmental consciousness must play its role.

The proper way to fulfil the theory of sustainable development is by its constantly development and evaluation or control. The original concept has been replaced by a briefer concept of "sustainable development".

The new era of the three great "E" has dominated the present century in the evolution of the human population. Ecology, energy and economics are among the most widely used words in today's technology practice. Pressure from the end consumer then leads to the adoption of number of measures, within the already operated technologies (compliance with the requirements of environmental legislation, integrated prevention) but it also affects the upcoming industrial activities, Uribe-Toril et al. (2019).

The use of voluntary environmental activities at the enterprise level in agrarian sector is therefore of great importance both for the enterprise itself and for society as a whole. Environmental recovery could be a result of using of preventive focus of voluntary instruments and thus contributes significantly to the realization of sustainable production and consumption, resp. sustainable development. At the agrarian farms level, there are other benefits, such as increasing competitiveness, building a better image or saving operating costs.

Size reduction of agricultural products and by-products is a key issue for the further utilization of the materials, Chitoiu et al. (2016) together with a moisture content. Particle size is an important parameter having an impact on the characteristics of loose particulate biomass (e.g. flow ability, compaction, compressibility) as well as mechanical properties of densified biofuels (bulk density, strength, mechanical durability), thus largely affecting their quality and performance

Pietsch (2008); Tumuluru et al. (2011); Guo et al. (2012); Chaloupková et al. (2016); Muntean et al. (2017); Chaloupková et al. (2018).

Mechanical disintegration significantly decreases the size of materials' particles and biomass volume resulting in lower costs of storage, transport and use Guo et al. (2016); Muntean (2017). Grinding, cutting or crushing is carried out by different types of mills, using various energy sources, where the most widely used is a hammer mill, Chitoiu et al. (2016). For the purpose of biomass disintegration for biofuel production, the devices that operate on the principle of shear action (colloid mills, extruders) or shear forces (blade, striking mills) are commonly applied to disintegrated materials with a moisture content over 20 wt%, Kratky & Jirout (2015). However, their disadvantages lie in the limited use of moist biomass and high energy demands, Tumuluru (2018). According to Manlu et al. (2003) besides the grinding degree being a very important indicator, the size reduction has a direct relationship to energy consumption per unit.

"Drying" is the process in which the product is dried until the "safe-moisture" is reached, by removing the water content from the materials. Drying is the utmost commonly used method for the protection of agricultural products or food. Drying of biomass is a crucial operation from technological point of view; thanks to drying the material which would destruct in its natural state very quickly can be stored for a long time, however, drying often involves high energy consumption. That is why, it is essential to find/select an optimal drying equipment. Moreover, the speed of drying is affected by size, shape and type of the used material Ivanova et al. (2012).

The drying methods are variable and can be classified as natural convection, electrical and mechanical methods Veerakumar et al. (2014). The oldest and the simplest method is drying in open atmospheric space, known as Open Yard Sun Drying Method. Sun Tunnel drying or Mixed Mode Dryer, which is a natural convection of solar dryer integrated with a simple biomass burner and bricks for storing heat, Kituu et al. (2010).

Oven drying is a simple electric method, with no need for extra special equipment, but can be used on a small scale, Veerakumar et al. (2014). Spotlight drying method was shown by Manjula et al. (2011) in a laboratory experiment. Mechanical drying methods for agro products, especially biomass, are using several types of dryers. Dryers can be divided into two categories, direct and indirect, depends on whether the heat is in direct contact with the material or using a heat exchange surface, Wade A. Amos (1998).

Tray dryer, Band (belt) dryer, Rotary dryer, Roller Dryers Fluidized Bed Dryer and Spray dryer are methods/technologies of mechanical drying mentioned by Veerakumar et al. (2014). Wade A. Amos (1998) described Rotary Dryer, Flash Dryers, Disc Dryers, Cascade Dryers and Superheated Dryers.

Size reduction has a direct relationship to the energy consumption per unit, and another important indicator is the grinding degree, Manlu et al. (2003). Milling, i.e. size reduction of agricultural products and by-products is a key issue in the process of further use of these materials. Grinding, cutting or crushing is provided by different types of mills, using various energy sources Chitoiu et al. (2016).

Particle size is an important factor having impact on many characteristics of loose particulate biomass (e.g. flow ability, compaction, compressibility) and mechanical properties of densified biofuels (bulk density, strength, mechanical durability), thus largely affecting their quality and performance, Pietsch (2008); Tumuluru et al. (2011); Guo et al. (2012); Muntean et al. (2017); Chaloupková et al. (2016), Chaloupková et al. (2018). Grinding significantly decreases the size of materials' particles and biomass volume resulting in lower costs for storage, transport and utilization Guo et al. (2016); Muntean (2017).

Mechanical pre-treatment is the simplest technique for effectively disrupting the lignocellulose matrix. It improves the biodegradability of the native substrates by breaking large structures into shorter chains, thus making the biodegradable components more accessible to microorganisms, Kratky et al. (2015).

Generally, the importance of developing the sustainable and renewable energy sources, mainly improving the efficiency of such systems for a proper energy saving, is rapidly expanding, Shih et al. (2016). For example, thermo-chemical treatment like combustion or gasification is already a known way of biomass utilization for heat and power generation, Kirsanovs et al. (2014), and since the last years a pyrolysis technology attracts an increasing scientific attention, too. However, the process of pyrolysis is energy-intensive (especially rapid pyrolysis), mainly the pre-treatment of a material before the process like pre-drying of biomass, Rogers & Brammer (2012) as well as size reduction, Choi et al. (2012). Therefore, it is advisable to include disintegration, press or drying unit prior to the pyrolysis reactor, De Jong & Van Ommen (2014). The main purpose of the presented dissertation Thesis is to analyse the possibility of using High-Speed Mills as an alternative solution for combined biomass drying and milling.

## **2. Literature review**

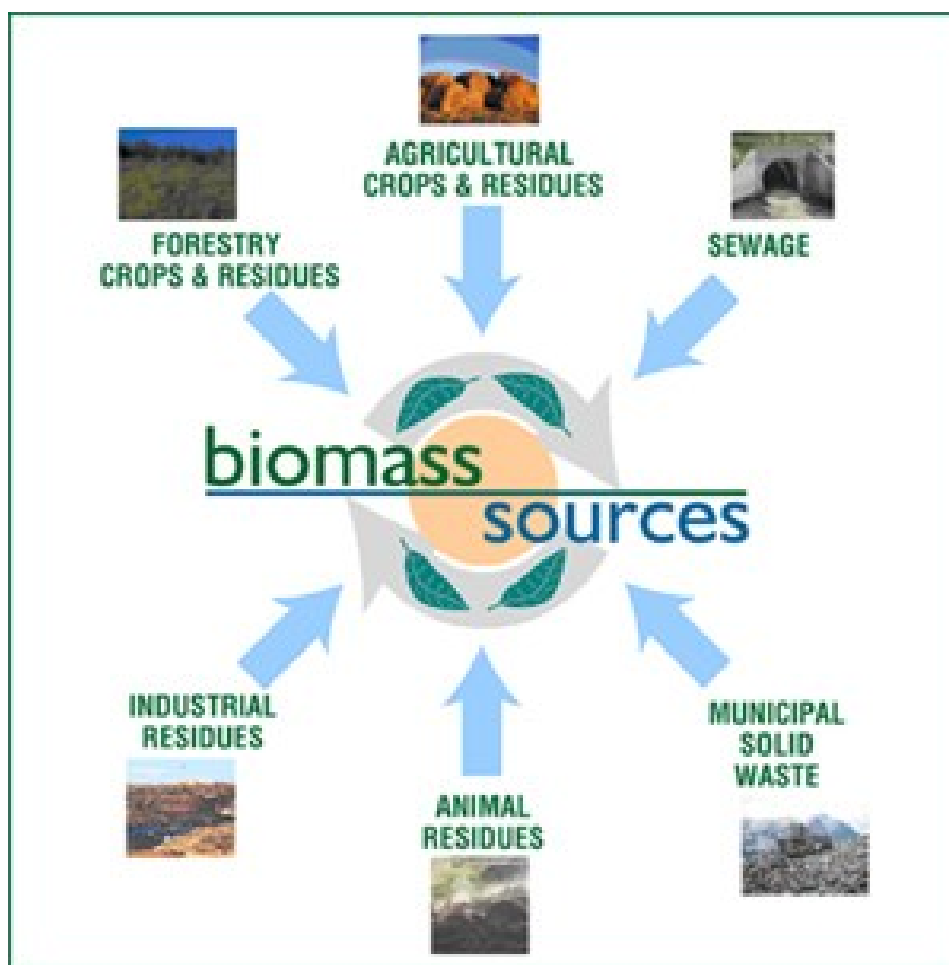
The presented thesis is divided into two fundamental parts, namely theoretical and empirical part. The first, theoretical part of the thesis is based on a literature review of scientific books, published academic articles in impacted journals, and other electronic sources. In the individual chapters, biomass is briefly defined as a central concept of the whole presented text. Special attention is paid to the process and methods of biomass grinding and also to the process and methods of biomass drying. Firstly the process of crushing and drying of biomass is defined, and at the same time, the importance of these processes is pointed out, main attention is paid to the description and analysis of the main methods involved in the processes of drying and crushing of biomass, with focus on the tested method of crushing and drying in one process by using of High-Speed Mills. The aim of the theoretical part is to introduce the issue of drying and crushing of biomass in the context of its global significance.

The second, empirical part of the thesis focuses on the description and analysis of the research itself. This was realized through testing on two types of HSM. With this in mind, the empirical part will firstly focus on the description of techniques, tests, measurements and results on both types of machines individually, and then a comparative evaluation will be carried out in order to formulate recommendations for practice.

### **2.1 About biomass**

First, it is necessary to briefly define the term biomass, which represents the central concept of the whole dissertation thesis. The literature offers many different definitions of biomass. For example Goldemberg (2012) defines biomass as the generic name which is given to material generated by living organisms (wood, charcoal) or organic residues from animals and agriculture, which all these can be used as energy sources. In a similar way, Musil (2009) also states that biomass is a substance of biological origin, where this soil substance is represented, for example, by the cultivation of plants in soil or water, as well as by organic production or, for example, by organic waste. At the same time, this author adds that “biomass is either

deliberately obtained as a result of production activities, or it is the use of garbage from agricultural, food and forestry production, municipal management, landscape maintenance and care". Another source, the U.S. Energy Information Administration on its website mention that biomass can be defined as organic material from plants or animals, which at the same time constitutes a renewable energy source, where biomass can be burned directly, but can also be converted into liquid biofuels, or biogas, which can then be burned as a fuel energy . Within the Czech Republic, biomass is also dealt with in many legislative documents, or in many acts, codes, or decrees. For example, Act No. 165 of 31 January 2012 on promoted energy sources and on amendment to some laws, defines biomass as „a biologically degradable part of products, waste and residues of biological origin from agriculture and forestry and related industries, agricultural produce grown for energy purposes and biologically degradable part of industrial and municipal waste“.



**Figure 1.** Biomass traditional sources. Source: Zafar (2019)



It has been nearly 800,000 years since man discovered fire. Exactly into this era of human development can also date the use of burning wood as an energy source. Until the 18th century, biomass was the most important energy source in the world. Also, some countries (such as Mozambique or Ethiopia) currently cover more than 90% of primary energy consumption by so-called traditional biomass. At the same time, biomass has become almost insignificant until the 20th century in industrialized countries. In Germany, for example, the share of biomass was less than 3% of primary energy consumption in 2000, Quaschnig (2010). In this respect, Smil (2018) adds that *"biomass energy can become an important component of the future energy supply, but only in the case of large-scale and intensive production of selected plant and tree species capable of converting to liquid or gaseous fuels or electricity using modern technologies"*. The same author states that this strategy has three fundamental shortcomings. The first is that photosynthesis works at a very low energy density, and so large-scale biomass fuel production will require vast farmland. The second drawback is the fact that mankind is already taking advantage of a very substantial, nearly 40% share of the net primary biosphere productivity through the harvesting of food and feed crops, logging, but also the deliberate establishment of forest fires. A further burden on massive fuel production would undoubtedly lead to a continuing loss of biodiversity, as well as a deepening degradation of the environment. The last major drawback that cannot be ignored is the high cost of large-scale biomass energy production, Smil (2018). The above-mentioned photosynthesis is the basis of biomass formation, because this biological process of photosynthesis relies to the production of biomass, Staffell et al. (2015). *"The process of photosynthesis in green plants absorbs carbon dioxide from the atmosphere, combines it with water, and uses the energy of sunlight to create carbohydrates and oxygen. These carbohydrates – which include various types of sugar, starches, and fibers – form the building blocks of all biomass material. The efficiency with which plants convert sunlight into biomass varies among species and conditions, with a maximum as high as 6 % and an average closer to 1 %"*, Grinnell (2015). From biomass can be obtained the energy, which is known as biomass energy, Khan (2009).

According to the Act No. 165 of 31 January 2012 on promoted energy sources and on amendment to some laws, biogas can be defined as a gaseous fuel produced from biomass, which is used for generating power, heat, or for bio-methane production, than bio-methane represents adapted biogas, when its quality and purity is comparable with natural gas, and thanks to this bio-methane is regarded as natural gas after it enters the transport or distribution system. At the same time, this document defines bio-liquid as well. Bio-liquid is a liquid fuel produced from biomass, which is used for power and heat generation (Act No. 165 2012). *“Biomass is the only renewable energy that can be converted to liquid fuels or chemical inputs without major technical obstacles”* (Act No. 165 2012), anyway, the use of biomass for energy purposes has a number of limits that make biomass not widely used as one of the renewable energy sources. In terms of limits, Musil (2009) states in particular the following:

- of course, biomass production for energy purposes competes with other uses of biomass, such as for food and feed purposes, the provision of raw materials for industrial purposes, or the non-production function of biomass;
- increasing biomass production, as mentioned above, requires an increase in the production area or an increase in the intensity of biomass production, which implies an increase in the need for investment;
- the extraction of energy from biomass in terms of economic demands and benefits is currently unable to compete with the use of traditional energy sources;
- the maximum use of biomass resources for energy purposes is problematic worldwide, particularly with regard to the deployment of biomass resources and, at the same time, to the location of energy consumers. This deployment of inputs and the use of outputs would cause problems with the accumulation, transport and distribution of the energy obtained;
- the need for large areas for plant cultivation for energy use, depending on the low energy density contained in biomass.

Garcia-Maraver et al. (2015) and Perez-Jimenez (2015) also state that “compared with conventional heating systems, such as oil or gas boilers, biomass technology still entails disadvantages in terms of space, efficiency, particulate emissions and maintenance. In light of the low energy densities yielded, the collection and transportation of biomass can be cost prohibitive. On the other hand, biomass fuels tend to have a high moisture content, which adds weight and increases the cost of transportation. The moisture content also decreases combustion performance. Nevertheless, an intelligent design and sophisticated technology can minimize these disadvantages”.



**Figure 2.** Pellets and briquettes from new sources of biomass. Source: LAVARIS

Of course, attention should not only be given to these shortcomings, but also to the benefits of using biomass for energy purposes. Musil (2009) mentions in particular the following:

- biomass as an energy source has significantly less negative environmental impacts compared to other energy sources;
- biomass is a renewable energy source, as well as a domestic source, which reduces the consumption of imported energy sources;
- biomass resources are locally unlimited;
- the use of biomass as an energy source is an efficient use of combustible, sometimes toxic waste;

- managed biomass production contributes to the creation of the landscape as well as to the management of it.

## 2.2 Biomass classifications

From the point of view of biomass classification, the distribution according to different criteria is used in practice. Biomass resources include natural and derived materials usually classified in view of their origin. These biomass sources could be divided into three principal groups – natural biomass, which is available directly in natural ecosystems, residual biomass, which is coming from the development of different activities, and energy crops, with the sole objective of producing biomass for energy purpose, Garcia-Maraver et al. (2015). Although it would be possible to deal with different divisions of individual authors, it is much more appropriate to use one, in my opinion, structured and detailed division, which lists Risollo-Calle (2012):

- **Natural forests/woodlands** – this group includes all biomass in high standing, closed natural forests and woodlands, when forests can be defined as having a canopy closure of 10–80 %, and so this category can also include forest residues;
- **Forest plantations** – this category includes both commercial and energy plantations, and the total contribution of bioenergy in the future will be strongly linked to the potential of energy forestry and crops plantations, because the potential of residues is more limited;
- **Agro-industrial plantations** – this category includes forest plantations, which are specifically designed to produce agro-industrial raw materials, and wood is collected as a by-product;
- **Trees outside forests and woodlands** – category which consists of trees grown outside forest or woodland, and including bush trees, urban trees, roadside trees, as well as on-farm trees. It is important to mention, that outside trees have a major role as sources of fruits or firewood, but their importance should not be underestimated;

- **Agricultural crops** – this category includes crops grown specifically for food, fodder, fiber or energy production;
- **Crop residues** – within this category are crops and plants residues produced in the field;
- **Processed residues** – category which consists of residues resulting from the agro-industrial conversion or processing of crops, such as sawdust, sawmill off-cuts, bagasse, nutshells or grain husks;
- **Animal wastes** – this category includes waste from both intensive and extensive animal husbandry.

### 2.3 Biomass size reduction

Factors like high volume, low density characteristics of agriculturally produced biomass are a major weakness to using biomass feedstock for many processes, including bioenergy production (ORNL 2003). Transportation costs are higher due to low density and often makes it difficult to feed the material into processing equipment at existing facilities. First step in densification is the size reduction, which reduces the volume of biomass.



**Figure 3.** Studied materials

From left: Apple tree wood, *Miscanthus sinensis* and Pine wood sawdust.

Lack of engineering/ scientific knowledge of biomass fiber grinding delays the use of some feedstocks for biomass use. This unusual with our accepting of grinding brittle-materials that are mathematically described, Austin (1971). Although milling and grinding is one of the oldest methods for processing biomaterials,

we know very little about optimizing the process based on the mechanical properties of the material to be ground. Mohsenin (1986) concluded that almost all of the energy in the grinding process is wasted as heat, and that from 0.06 to 1% of the input energy actually disintegrated the material.

Several ways of obtaining energy from biomass and preparing biomass for energy use can be distinguished as follows Musil (2009):

- thermochemical conversion of biomass or dry processes, which include, for example, combustion, gasification or pyrolysis;
- biochemical conversion of biomass, or wet processes that involve alcohol and methane fermentation;
- physical and chemical conversion of biomass, where mechanical transformations include splitting, crushing, pressing, grinding, or pelleting for example, and chemical transformations include esterification of crude bio-oils;
- recovering waste heat in biomass processing through, for example, composting, aerobic wastewater treatment, or anaerobic fermentation of solid organic waste.

In practice, it can be observed that the process of crushing biomass generally takes place as part of the process of drying biomass. In this respect, many researches have been carried out to see how it affects biomass and its crushing characteristics following the drying process itself. As an example, research conducted by Luo et al. (2014) presented biomass pulverization technology, and they focused on presentation of results of the further detailed studies of this technology. "The effects of feed moisture and crusher operational parameters (rotor speed and blades gap) on product particle size distribution and energy consumption were investigated. The results showed that higher rotor speed and smaller blades gap could improve the hit probability between blades and materials and enhance the impacting and grinding effects to generate finer products, however, resulting in the increase of energy consumption. Under dry conditions finer particles were much more easily achieved, and there was a tendency for the specific energy to increase with increasing feed

moisture. Higher rotor speed generated much finer particles with higher energy consumption. Decreasing blades gap can improve products quality; however, it resulted in the increase of specific energy. The effect became less significant when the blades gap was below 8 mm. higher feed moisture resulted in the decline of products quality and the increase of energy consumption. Therefore, it is necessary for the raw biomass material to be dried before pulverization” Luo et al. (2014).

Biomass crushing, as a process of size reducing, is generally defined as process in which the particle size of a solid is made smaller. Size reduction is usually required before the biomass is used, or before it's stocked. Smaller particles and pieces of biomass without doubt reduce its storage volume, but also insure facilitate handling of the material in the solid state and transport of the material as a slurry or pneumatically, and sometimes it permits ready separation of components such as bark and whitewood, Klass (1998).

As mentioned above, biomass crushing is one of the mechanical processes of biomass processing, preparation and utilization. By means of these mechanical processes, biomass is adjusted to a pre-final or final form. These necessary adjustments facilitate both the transport of biomass and its subsequent use to obtain energy. Mechanical treatments include sawing for processing wood into lumber and fuel, crushing, which serves primarily as a precursor to the production of briquettes and pellets, and also chipping and pressing briquettes or pellets, where these products are subsequently used primarily for heat and electricity production Vobořil (2017). The crushing process uses crushers.

These can be divided into low-speed shredders (which are further subdivided into single and double rollers) and high-speed shredders (which are further subdivided into disc and drum) (City plan 1997). Finally, it may be noted that the crushing of biomass in practice usually results in parts that reach up to 5x5mm in terms of range.

Energy and power requirements in size reduction is a key issue, the cost of power is a major expense in crushing and grinding, so the factors that control this

cost are important. For a proper understanding, we have to take in consideration the following size reduction laws:

1. Rittinger's law;
2. Kick's law;
3. Bond's law.

Rittinger's law: The energy required in crushing is proportional to the new surface created as a result of particle fragmentation.

Kick's law: The Energy is proportional to the size reduction ratio.

Bond's law: The total work input represented by a given weight of crushed product is inversely proportional to the square root of the diameter of the product particles.

The common and mostly extended method and machine used for size reduction is hammer mill. Hammer mills are widely used in food and feed industries due to its advantages of high productivity and flexibility of grinding a large variety of products Chuanzhong et al. (2012).

A scheme of a hammer mill produced by LAVARIS is shown in Figure 4. The importance of this mill is the simplicity and uncomplicated design of the hammers. The construction of the mill allows the use of different types of hammers, which can be changed and selected according the characteristics and structure of milled material.

The importance of such a design, that the hammer mill can process different materials, from minerals, hard biomass, fiber structure biomass, paper, glass and polymers.



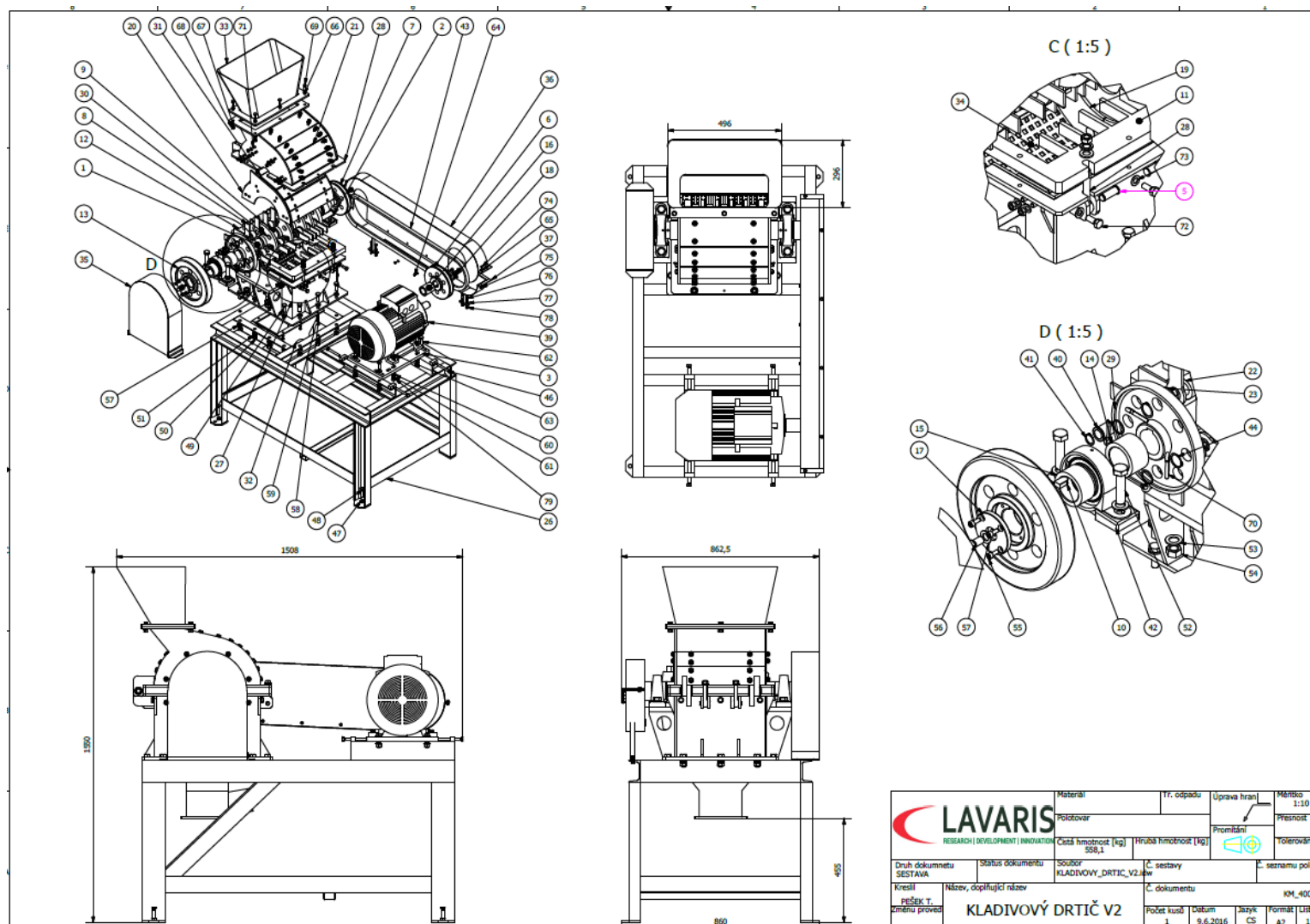


Figure 4. Hammer mill LAV/ HM-350. Source: LAVARIS

## 2.4 Biomass drying

The next chapter deals with the drying of biomass as a process that is essential not only for the processing and use of biomass, but also for the storage itself. The biomass is harvested in the field at higher moisture content, but this results in the biomass being biologically unstable. Drying helps to reduce moisture, which helps biomass to become aerobically more stable and decreases grinding energy in the process, not only stabilizes the biomass for storage *“Furthermore, transport of dried biomass can be more efficient because less water needs to be moved”* Tumuluru (2018). Hromádko (2012) states that drying of biomass represents a very simple process to the removal of excess moisture. Heat is used during the process of drying of biomass, which affects the moisture or water content of the biomass. The following example of beech wood shows how significant the moisture is. Absolutely dry beech wood, or beech wood with 0 % water content, has a calorific value of 5 kWh.kg<sup>-1</sup>. If the wood is dried outdoors in the open air, the water content drops to 12–20 %. In order to achieve this decline, it is necessary for the wood to be split into logs, followed by air drying under a shelter for at least a year (but ideally two years). It should be noted here that the water content of wood which is dried in confined spaces can even be reduced to up to 10%. From the point of view of calorific value, however, it should not be forgotten that even with beech wood with a 15% water content, the calorific value is 4.15 kWh.kg<sup>-1</sup>. For example, for freshly cut wood with a 50% water content, the calorific value drops to 2.16 kWh.kg<sup>-1</sup>, Quaschnig (2010). If the calorific value of absolutely dry beech wood and freshly slaughtered beech wood is compared, it can be seen that the 50% moisture difference causes a decrease in the calorific value to about half. This information only points out why and how the drying process of biomass is essential for the use of biomass, whether from an energy or economic perspective.

Moisture of wood means the proportion of water content in it, and the proportion of other wood components is collectively referred to as "dry matter". In wood, the water content ranges between 65% (raw) and 10–20% (dried), Zárbybnická (2015). *“Because wood is made up of various kinds of cells, water is contained in wood*

cells in two ways: “free” water held in the cell lumen (cavity), and adsorbed or “bound” water attached to the cellulose in the cell wall” Cheng et al. (2017). The water content in biomass of course varies with the type of raw materials, and it is important to mention that even for one tree, the water content is not the same everywhere, which is caused by different growing seasons as well as different parts. In the moment when the water content is below 30 %, wood will tend to dry shrink due to water loss and wet expand due to water absorption. Biomass raw materials can be divided on the basis of water content as following Wang et al. (2016):

- Absolutely dry wood – this wood has after drying a constant weight and no water;
- Green wood – with average water content between 50 and 100 % of absolutely dry weight;
- Moist wood – with commonly water content greater than 100 % after water or wet transport;
- Air-dried wood – by using air drying, when water content is usually between 12–18 %;
- Kiln-dried wood – by using normal artificial drying with water content of 7–15 %.

**Free water** (also called **capillary water**) - it is the water that is in the blood vessels and cell cavities and is the first to evaporate in the drying of wood. This water evaporates on its own or can be removed mechanically from the wood, for example by pressing or centrifuging. At the same time, however, free water is much less important than bound water Zárbynická (2015). In terms of how free water affects the properties of wood, it should be noted that it affects only its weight Cheng et al. (2017). Wang and Luo mention that free water presented not only in biomass cell cavities, but also in intercellular spaces, and this water influences the density, combustion characteristics and permeability of biomass Wang et al. (2016).

**Bound water** (sometimes also called **hygroscopic water**) – it is the water attached to the cellulose in the cell wall, which does affect many properties of wood

Cheng et al. (2017), and it is much more difficult to remove bound water within the drying process. This water is bound by hydrogen bridges to the hydroxyl groups of the amorphous portion of cellulose and hemicelluloses. Bound water cannot be removed from the wood mechanically, but only with the help of heat, and is therefore essentially a conversion of liquid moisture to water vapor. Bound moisture is formed in wood due to binding with substance molecules and is characterized by specific physicochemical properties. In particular, the following should be mentioned Zárbybnická (2015):

- bound water has a specific heat capacity, which is lower than normal and approximately equal to the specific heat of ice;
- bound water freezes at very low temperatures below freezing;
- bound water has a higher density compared to free humidity;
- bound water is non-conductive (essential difference compared to pure water), because it does not contain soluble substances.

**Chemically bound water** – this water in biomass can only be removed by burning (more specifically by thermal drying techniques only Nunes et al. (2017), and therefore chemically bound water occurs even at zero absolute humidity. It is detected in chemical analyses of fuel and its total amount is between 1–2% of dry matter Zárbybnická (2015).

Studničková (2017) said that “drying of biomass is an operation necessary to achieve its long-term shelf life. It must be free of virtually all moisture, whether before storage or before combustion - high humidity reduces overall energy efficiency”. In practice, biomass drying is divided into passive and active drying, depending on whether the biomass drying process is carried out using the dedicated technology. More attention will be paid to passive and active biomass drying in the following sub-chapters.

### 2.4.1 Passive (open air drying) of biomass

Passive drying (also called open air-drying) of biomass has been de facto already described above. Passive drying of biomass is certainly the oldest way of removing moisture, and at the same time it is the basic and natural way in which biomass is dried using free drying in a place where good air circulation is ensured while the material is protected from rain. The final moisture of passive, open air-drying, depends mainly on the size of the material, but as well on characteristics of the material and on its ambient condition. Typical final moisture of this type of drying of biomass is 15–35 %, Tumuluru (2018). At the same time, it should be noted, that open air-drying of biomass is really slow, and, of course, it is impacted by weather conditions Crocker (2010). This slow process of drying can result in the biomass quality loss. The biomass cannot be dry sufficiently, and the material cannot meet the moisture specifications for thermochemical applications such as pyrolysis or gasification, Tumuluru (2018).

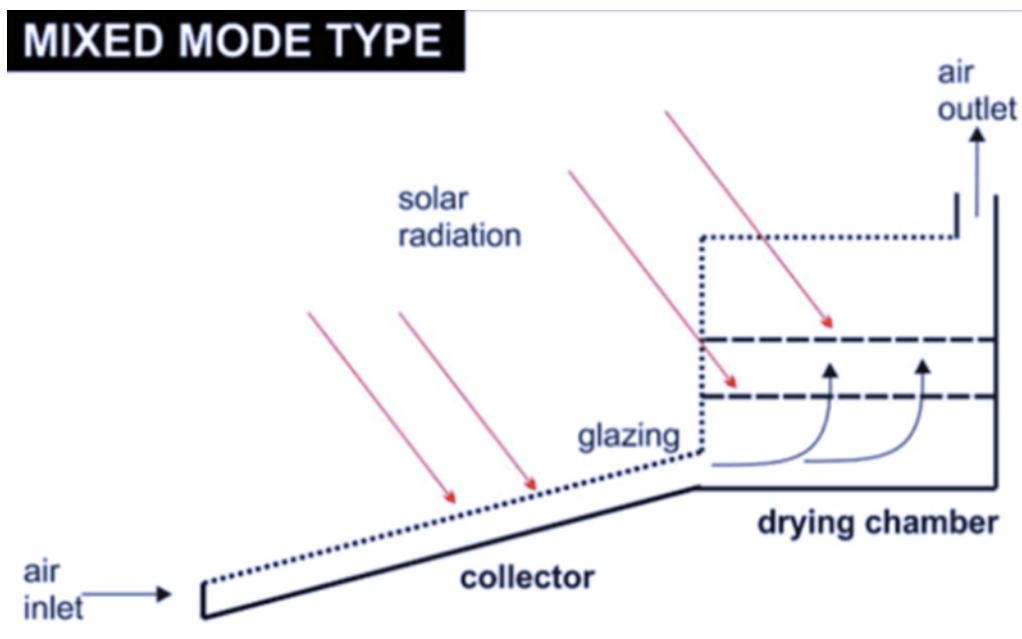


Figure 5. Mixed mode dryer. Source: Prakash et al. (2017)

Open air-drying of biomass “seems to be ideal in terms of cost, but we will find some economic disadvantages in more detail. The main disadvantage of natural drying is the low speed, which results in the need for large storage areas and spaces, which can often be expensive. The demand for energy is almost zero, but the costs

of transport and handling are increasing”, Zárbybnická (2015). Regarding advantages of passive dryers should be mentioned that this method of drying biomass is characterized by low capital and running costs, and it is the simplest method.

At the same time, as disadvantages should be mentioned, that passive drying has low capacity Prakash et al. (2017). Another disadvantage that should be mentioned is mainly the fact that open air-drying of biomass does not meet international standards of quality drying, and of course, there is a disadvantage of air movements, rodents, birds and insects, as well as the risk of unexpected rain Sharma et al. (2015).

### **2.4.2 Active drying of biomass**

In addition to the above-mentioned passive drying methods, active drying systems (also called forced convection systems) are also used in practice, since passive methods may not always achieve the desired drying results. Active drying methods take place in drying ovens, and compared to passive methods, it should be noted that these methods are supplied to the process of drying energy from an external source. *“Active dryers are employed when commercial-scale drying operation must be accomplished within a short duration. They rely on fans or blowers to furnish air draft through the system. Active dryers are becoming increasingly important”*, Prakash et al. (2017). As was the case with passive drying systems, here too, the systems can be divided into direct, indirect and mixed, the principle of these systems remaining the same as described above. In any case, at least some methods of active biomass drying should be briefly mentioned.

#### **2.4.2.1 Rotary dryer method**

This system is based on slow rotation and warm air flow, which ensures efficient drying. *“Rotary drying is one of the many drying methods existing in unit operations of chemical engineering. The drying takes place in rotary dryers, which consist of a cylindrical shell rotated upon bearings and usually slightly inclined to the horizontal. Wet feed is introduced into the upper end of the dryer and the feed progresses through it by virtue of rotation, head effect, and slope of the shell and dried product withdrawn at the lower end”*, Mujumdar (2014). It should be also mentioned

that rotary drying systems (together with fluidized bed drying systems) are the two most common used methods, which have been applied successfully in the industry, Pang (2019), even if, as Joo et al. (2019), rotary drying method is more expensive than simply sun drying method.

#### **2.4.2.2 Fluidized bed dryer method**

Fluidized bed drying is using superheated steam or hot air as the drying and fluidizing medium. *“The sludge granules are intensively mixed in the fluidized bed, and the evaporated water and dust are removing from this bed. The energy required to evaporate the water is supplied by heating pipes located in the fluidized bed”* Hartig (2017). This method is widely applicable in lignite drying for its high drying rate, high processing capacity, but also for its low maintenance cost. Anyway, this method of course finds application also in the process of drying many other products Pang et al. (2019). At the same time, fluidized bed dryer method requires more capital investment.

#### **2.4.2.3 Pneumatic dryer method**

The arrangement but also the principle of drying in this method is similar to that of the aforementioned fluid driers. In pneumatic dryer method *“the dried product is injected into a stream of hot air. The product is immediately dried and then separated from the drying air in a vortex separator. Part of the dry product may be added to the wet feed to optimize the drying process”*, Vich (2017). Humid air is also separated, which helps to make this method highly efficient and thus also popular in practice.

Regarding active drying systems should be mention that the main disadvantage is the fact that these systems are complex, and more expensive than passive dryers. On the other hand, it is not possible to ignore their advantages, such as independency of the ambient climatic conditions, or shorter drying periods in comparison with passive drying systems.

## 2.5 High-Speed Milling

Grinding is commonly known as a procedure of refining grain size and increasing the specific surface area of a material, but also as a process of grain opening. The desired effects are achieved by several basic mechanisms that affect the material being processed. Milling process generally occurs when the energy of the particles to be treated is adequately high to overcome their internal consistency, Mani et al. (2004); Dai et al. (2012); Wang et al. (2018a).

One of the directions that has been developing intensively recently is High-Energy Grinding.

The concept of high-energy and High-Speed Milling is nowhere precisely defined in the literature.

In contrast to conventional grinding with high-energy grinding (and also with High-Speed Milling) there are certain effects (effects) that were not observed with conventional grinding. Effects that a definite amount of energy is converted, which in conventional milling is converted into heat without use.



**Figure 6.** High speed counter-direction mill LAV 150/2R



High-Speed Milling process is continuous, highly efficient and productive. It has a number of advantages over other types of grinding, but also certain limitations in some specific applications.

Example of High-Speed Milling machines are High-Speed Counter-Directional Mills – disintegrators (Figure 6), which are characterized by simple construction, very low weight, high grinding efficiency and mechanical activation of the material to be treated, also the varied range of materials to be treated.

This method of High-Speed Milling is usually referred to in the literature as disintegration.

High-Speed Milling in pin-type disintegrators (Figure 7) take place under the influence of very intense changes in mechanical stress and often with very high frequency. Large force impulse is imparted to the particles of the treated materials, where material structure is not able to compensate for this change. Material particles break down and create further disorders in the newly formed particles.



**Figure 7.** Pin-type rotor of HSM LAV 650/2R

High-Speed Counter-Directional Mills – Disintegrators, have two major advantages. They use a free impact mechanism of the treated material particles on the working bodies or between the grains themselves for grinding. These collisions usually occur at speeds above 100 m.s<sup>-1</sup>. Force impulses act on the particles of the material to be treated, internal structure is not able to fully compensate for changes in the stress fields and break down into smaller elements. Since the friction between the grains and the workpieces is not overcome here, the energy expended is used more efficiently to refine the grain. There is also a mechanical activation of the particles of the material to be treated, and the formation of active surfaces which differ significantly from those produced by other milling mechanisms in geometry and electrical activity.

By Hajratwala (1982) the size reduction and heat amount produced in the High-Speed milling process depend on the mill speed. The peripheral speed ( $v$ ) is the speed that a point in the circumference moves per second and it was calculated for both machines by using the following equation:

$$v = \frac{\pi \times d \times n}{60}, \text{ m.s}^{-1} \quad (\text{Eq. 1})$$

Where:  $\pi$  – 3.1415926;  $d$  – rotor disc diameter, m;  $n$  - revolutions per minute, min<sup>-1</sup>.

High-Speed Milling – mechanical disintegration- is one of the most efficient and promising ways of modifying materials, in which a large amount of energy is mechanically transferred to the mass of the treated material, thereby changing its reactivity and subsequent properties, beside the reduction of material size, Kratky & Jirout (2015). High-Speed Milling allows effective continuous processing of a very wide range of materials. The treatment of materials by means of high-speed grinding allows to combine the milling effect (surface refinement) with a pronounced mechanochemical (mechanical-physical) activation, i.e. an increase in the internal energy of the treated substances. Mechanochemistry refers to reactions, normally of solids induced by mechanical energy, Gomes et al. (2013). Mechanochemical reactions of organic compounds take place at low milling energy, Takacs (2014). In this

study, we tested the moisture content reduction in the material as an effect of reduction size process by using of High-Speed Mill.

The need for mechanical biomass disintegration is a topical issue with regard to the requirements of the agrarian sector. The disadvantages of commonly used devices are their limited use of wet biomass and high energy consumption for decay. In cooperation with the Czech University of Life Sciences, LAVARIS equipment was tested, which was primarily designed for crushing concrete, rubber and construction waste. The aim of the new technical solution was to distribute the biomass together with the simultaneous drying test in order to achieve the desired fraction (particle size) and biomass moisture content.

### **3. Hypotheses and targets of the thesis**

#### **3.1 Hypotheses**

The research of the Thesis and all tests were conducted based on certain hypothetical considerations, built on the long-term knowledge, experience and observations gained through cooperation with LAVARIS team and working as a team leader in the company.

##### **Hypothesis 1**

The treatment of materials by means of High-Speed Milling allows combining the milling effect (surface refinement) with an increase in the internal energy of the treated substances.

##### **Hypothesis 2**

There is a direct link between the rotor speed and the output particle size of the milled material.

##### **Hypothesis 3**

Due to the amount of energy generated during the grinding process and transferred to the processed material, a significant reduction of moisture content of the treated material is achieved.

#### **3.2 Main objective**

The main objective of the present Thesis was to assess the effectiveness/suitability of the High-Speed Milling technology for biomass pre-treatment through an analysis of the moisture content reduction in the milled material as an effect of the size reduction as well as evaluation of the energy consumption throughout the whole process.

### 3.3 Specific objectives

To achieve the above-mentioned goal, the overall objective of the Thesis has been supported and complemented by specific objectives that had been defined as follows:

- To use two different types of High-Speed Mills in our tests, single rotor and double rotor mill;
- To select three types of different biomass materials;
- To determine important input parameters (moisture content and particle size distribution) of selected biomass materials;
- To determine important milling parameters (output air temperature, revolutions and power) of all the milling process;
- To identify the effect of mill speed on the practical size of milled biomass;
- To identify the effect of mill speed/rotor RPM on the amount of released energy/temperature and the biomass moisture content;
- To identify the ratio of the moisture content reduction to energy amount used.

## 4. Methodology

### 4.1 Materials

Selected types of used materials are representatives of typical woody biomass, herbaceous biomass and woody biomass from fruit tree that could be found in abundant quantities on agriculture enterprises.

For experimental purposes the following materials were used: Apple tree wood, untraditional source for biomass in the energy sector, herbaceous biomass of miscanthus (*Miscanthus sinensis*) – a promising perennial energy crop with the high yield and low input requirements Clifton-Brown et al. (2004); Davis et al. (2010) and pine sawdust (*Pinus* L.) – a waste-wood biomass representing traditional feedstock for solid biofuels production, McKendry (2002); Deac et al. (2015); Chaloupková et al. (2018).

All three materials were initially grinded by the hammer mill (model 9FQ-40C, Pest Control Corporation, Vlčnov, Czech Republic) with the screen holes' diameter of 12 mm (i.e. initial fraction was 12 mm).

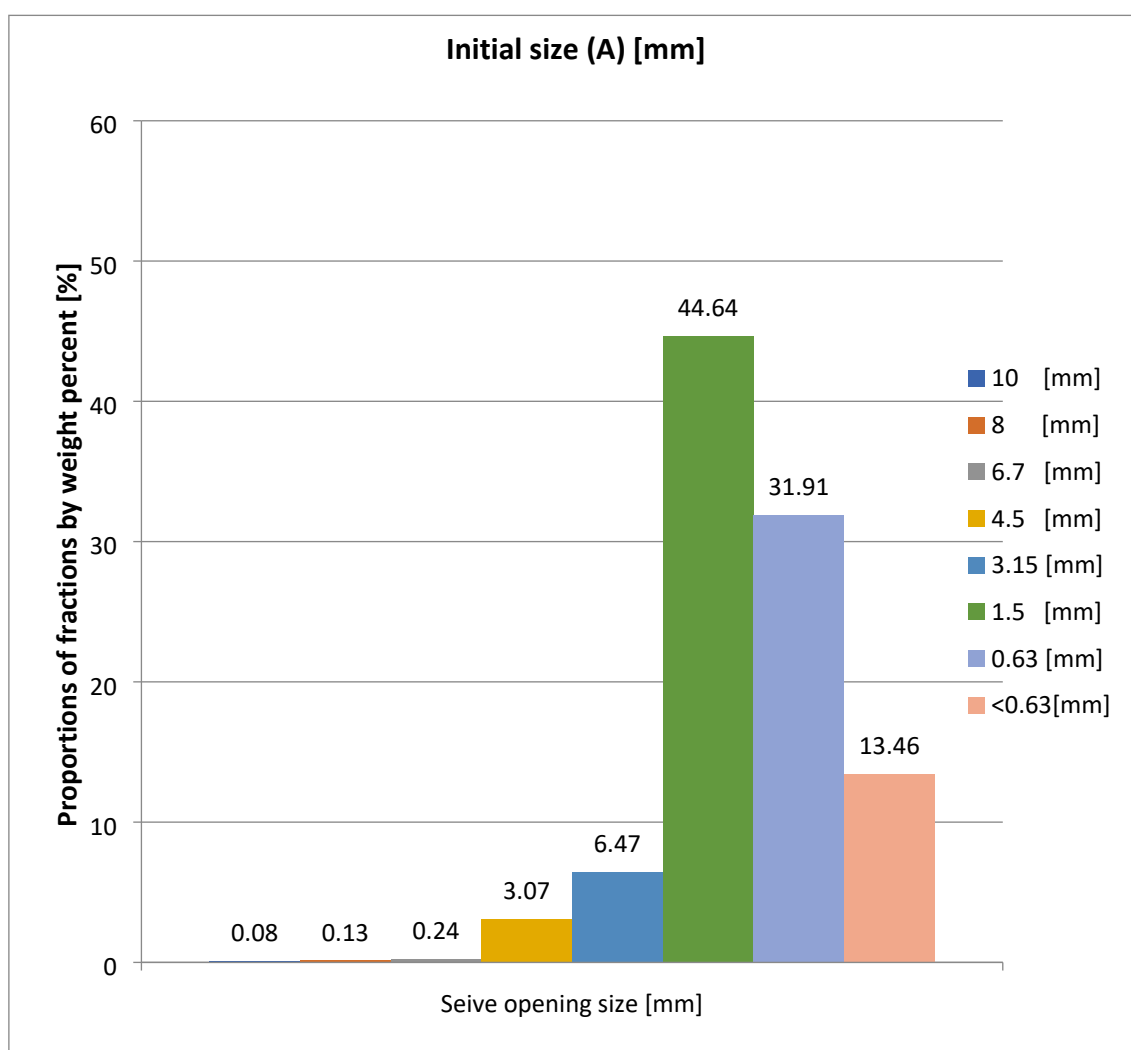
All three materials were supplied by the **Research Institute of Agricultural Engineering, p.r.i. (VÚZT)**. The descriptions of selected materials (detailed analytical characteristics) are included in the annexes (Annex 1 - 3). The most important (fuel) parameters and size distribution of initial materials are shown below (see Table 1 and Figure 8 for apple tree wood, Table 2 and Figure 9 for *Miscanthus sinensis*, Table 3 and Figure 10 for pine sawdust, respectively).

Laboratory analysis were conducted accordance with EN ISO 17225-1 with the following results:

### 4.1.1 Apple tree wood

**Table 1.** Apple tree wood main parameters

Analytical characteristic	Unit	As received	Dry basis
Total water	%	47.58	-
Volatile matter	%	42.02	80.16
Nonvolatile matter	%	9.62	18.35
Ash	%	0.78	1.49
Gross calorific value	MJ.kg <sup>-1</sup>	10.48	20.00
Net calorific value	MJ.kg <sup>-1</sup>	8.63	18.67

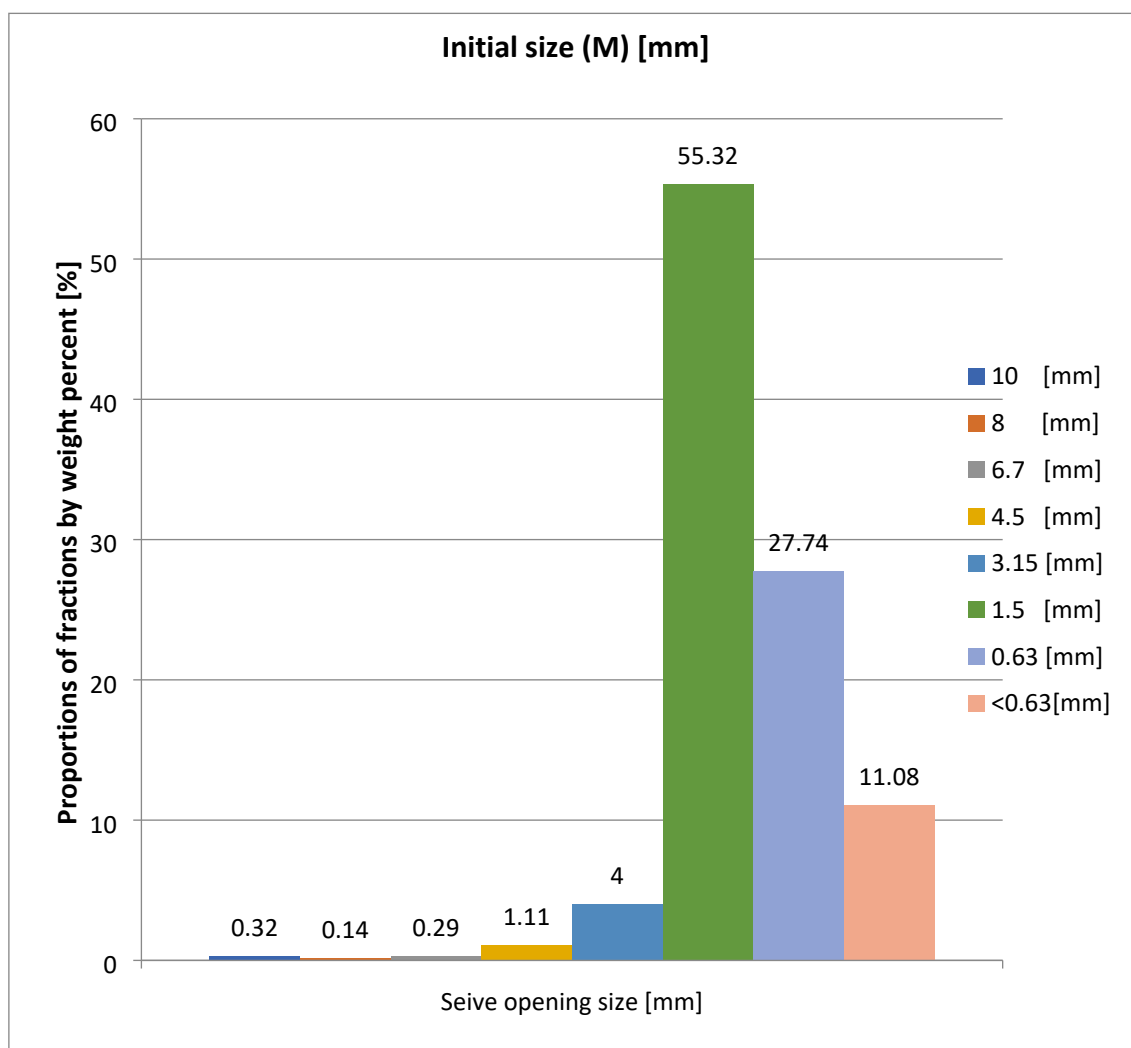


**Figure 8.** Initial particle size distribution for Apple tree wood

#### 4.1.2 *Miscanthus sinensis*

**Table 2.** *Miscanthus sinensis* main parameters

Analytical characteristic	Unit	As received	Dry basis
Total water	%	59.28	-
Volatile matter	%	29.57	72.63
Nonvolatile matter	%	9.13	22.42
Ash	%	2.02	4.95
Gross calorific value	MJ.kg <sup>-1</sup>	7.78	19.11
Net calorific value	MJ.kg <sup>-1</sup>	-	17.80



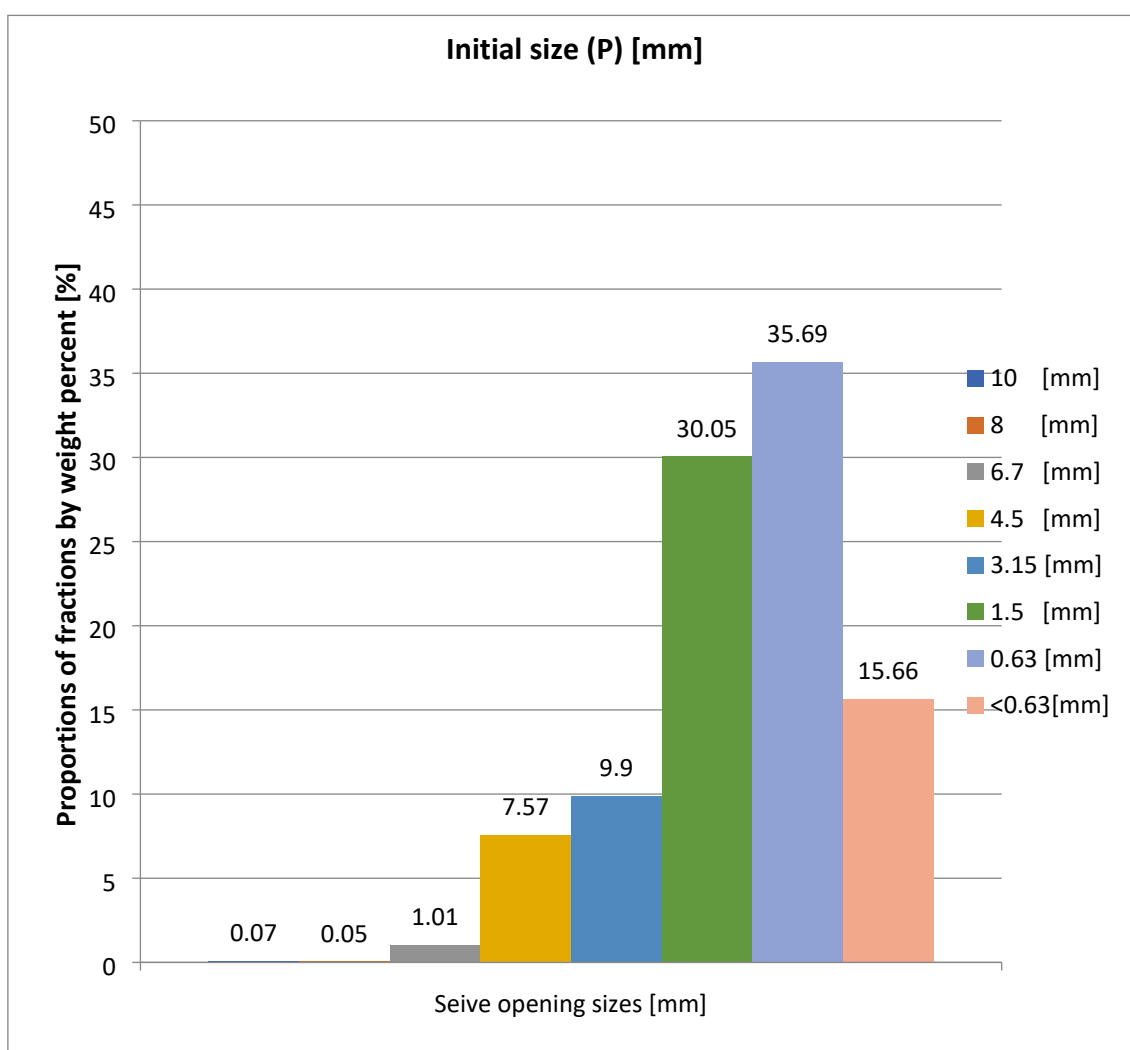
**Figure 9.** Initial particle size distribution for *Miscanthus sinensis*



### 4.1.3 Pine sawdust wood

**Table 3.** Pine sawdust wood main parameters

Analytical characteristic	Unit	As received	Dry basis
Total water	%	43.1	-
Volatile matter	%	46.54	81.80
Nonvolatile matter	%	10.12	17.78
Ash	%	0.24	0.42
Gross calorific value	MJ.kg <sup>-1</sup>	11.47	20.16
Net calorific value	MJ.kg <sup>-1</sup>	9.67	18.83



**Figure 10.** Initial particle size distribution for Pine sawdust wood

## 4.2 Milling process

### 4.2.1 About LAVARIS Ltd.

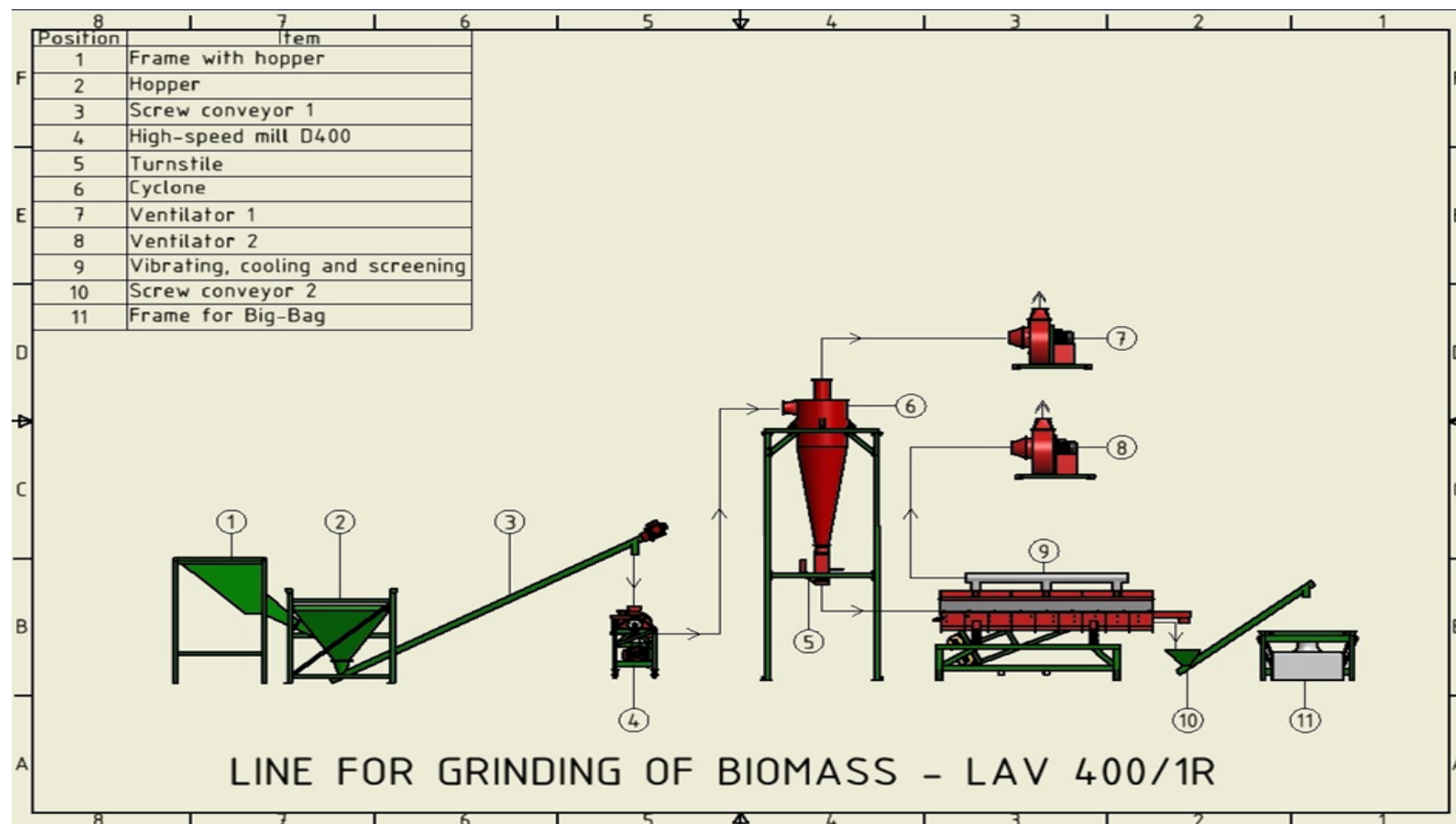
LAVARIS Ltd. is a modern Czech company operating not only in Czech Republic, but also on the worldwide market. The main activity of the company is research and development of new technologies in the field of utilization and processing of secondary raw materials such as rubber, polymers, crushed concrete and construction waste, waste from stone industry and biomass.

Along with the research activities, LAVARIS design novel equipment for processing of the above-mentioned raw materials. These systems process materials that are considered to be waste by others. Standardly untreatable material is transformed into usable secondary raw material and thus protect the environment.

A major part of the company's production is the development of recycling lines for the activation of rubber, stone and concrete dust. Also recycling Gypsum Boards and crushing and drying of biomass. At the heart of each line is a high-speed multilevel mill equipped with patented blades with long life and high hardness. The advantage is the adjustment of the different degree of fineness of grinding. Thanks to the simple but effective design of the line, the operating cost of the line is significantly low, with reasonable energy cost compared to other methods. All equipment's operates under atmospheric pressure and standard operating temperatures.

Recycling lines are available in both stationary and mobile versions. While the stationary line is suitable for indoor and outdoor operations at a fixed workplace, the mobile version of the line allows easy transport over long distances and quick commissioning. Mobile version can be transported in boxes or containers.

A scheme of the production line that was used for the purpose of this thesis is shown in Figure 11. All parts of this line were constructed as universal, to enable the use of these parts in different configurations, according to types of materials tested in the laboratory of LAVARIS. All parts were thoroughly cleaned before our tests, in order to eliminate the contamination of the tested material.



**Figure 11.** Scheme of the Line for grinding and drying of Biomass

Where: 1. Frame with hopper. 2. Hopper for input material. 3. Screw conveyor for input material. 4. High-speed Multilevel Mill LAV 400/1R. 5. Turnstile. 6. Cyclone separator. 7. Ventilator for output material. 8. Ventilator. 9. Vibrating, cooling and screening conveyor. 10. Screw conveyor. 11. Big bag for dried material.

#### 4.2.2 Screw conveyor

The whole process, as mentioned earlier, starts at the screw conveyor (Figure 12). This feeds the feed material into the mill hopper. The screw conveyor is driven by an electric motor from MEZ Náchod. The type of electric motor is 2AP63 – 4s.



**Figure 12.** Screw conveyor

The mass flow through the screw conveyor was measured experimentally. The material was falling to prepared container during five minutes. The empty container weighed 1,450 kg, after 5 minutes its mass increased to 33,195 kg. So, by easy recalculation we can say that the mass flow of input material by screw conveyor was around  $380 \text{ kg}\cdot\text{h}^{-1}$ .

### 4.2.3 High-Speed Mills

Two types of High-Speed Mills, which are an intellectual property of LAVARIS Company, were tested for the biomass disintegration within this study:

#### 4.2.3.1 Single rotor H. S. Mill

High-Speed Multilevel Single Rotor Mill (LAV 400/1R, LAVARIS, Libčice Nad Vltavou, Czech Republic) with the technical specifications: rotor diameter of 400 mm and rotation speed of  $7,800 \text{ min}^{-1}$  (Figure 13 and Figure 14).



**Figure 13.** High-speed multilevel single rotor mill LAV 400/1R

High-Speed Multilevel single Rotor Mill developed and produced by LAVARIS Ltd. is a simple and easy to operate disintegrator, with uncomplicated construction, very low weight, high grinding efficiency and mechanical activation of the material to be treated, also the varied range of materials to be treated by this machine. LAVARIS developed a multilevel grinding element – segments that can be modified for several kinds of materials, according to materials specifications and characteristics taking in consideration the needed properties of grinded output material. One type





by ventilator to a separation cyclone, the material then is falling through turnstile feeder on a vibration conveyor for cooling and sieving, if necessary. The separated air from cyclone is continuing its way through the ventilator away. Another ventilator is extracting air from the space over the vibrating and cooling conveyor. The grinded and the dried material is then packed through a screw conveyor to a big bag.

**Table 4.** Label data of the electric motor for LAV 400/1R

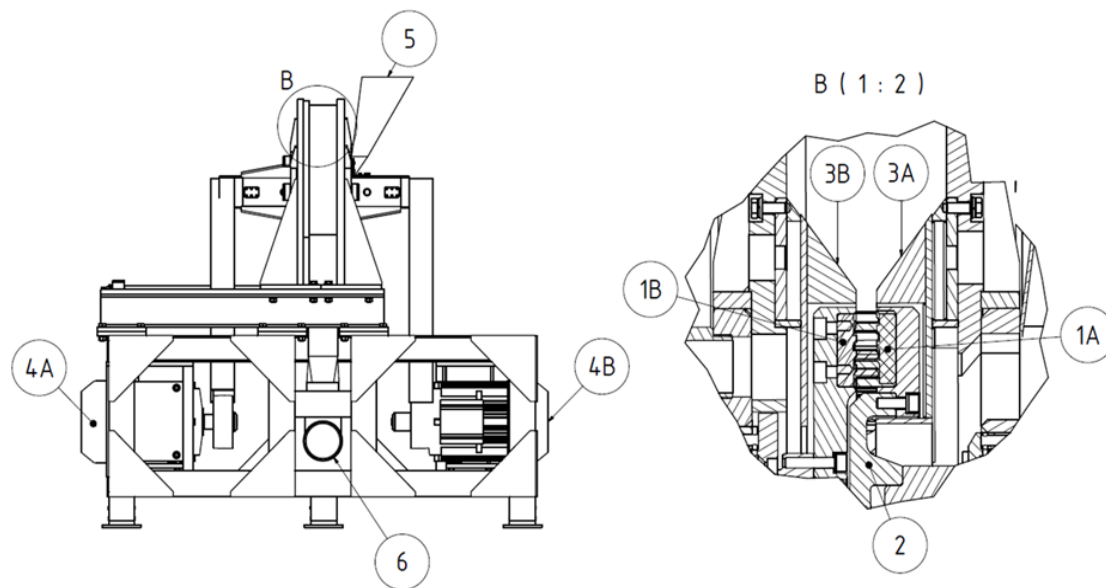
Description	Motor No. 1
Electric motor	Asynchronous Motor
Manufacturer	MEZ Frenštát
Type	F160L02
Voltage (V)	400
Current (A)	35
Frequency (Hz)	50
Power (kW)	18.5
Efficiency (-)	0.85
RPM ( $\text{min}^{-1}$ )	2,905
Weight (kg)	135

#### 4.2.3.2 Double rotor H. S. Mill

High-speed multilevel double rotors mill (LAV 300/2R, LAVARIS, Libčice Nad Vltavou, Czech Republic) with rotor diameter of 300 mm and rotation speed of each rotor of  $6,200 \text{ min}^{-1}$  (Figure 15 and Figure 16).



**Figure 15.** High-speed multilevel double contra rotor mill LAV 300/2R



**Figure 16.** Detailed technical drawings of LAV 300/2R

*1A, 1B – Left & Right rotor with milling elements. 2 – Material splitter. 3A, 3B – Cooling labyrinth. 4A, 4B – electric motors. 5 – Feed hopper. 6 – Output of the milled material.*

High-speed Multilevel double contra rotor mill developed and produced by LAVARIS Ltd. Is a simple and easy to operate disintegrator, with the previous mentioned advantages as uncomplicated construction, very low weight, high grinding efficiency and mechanical activation of the material to be treated, also the varied range of materials to be treated by this machine. The Multilevel grinding elements developed by LAVARIS are used in this machine and can be modified, for several kinds of materials, according to materials specifications and characteristics taking in consideration the needed properties of grinded output material.

The machine has two sides' rotors. The first side rotor is powered by an electric motor with  $15 \text{ kW}\cdot\text{h}^{-1}$ , the other side rotor, where material distributor is a part of the rotor, has an electric motor of  $18 \text{ kW}\cdot\text{h}^{-1}$  power. Both motors rotate with the opposite sense of rotation. Label data of the electric motors are shown in Table 5.

Thanks to this construction, the opposing movement increases the shearing force between the milling elements and improves the grinding process and generate more heat energy. Rotors diameter is 300 mm with maximum rotation speed



of 6,200 min<sup>-1</sup> each were used for milling. Both motors are delta-connected. Specifications of both electric motors and Label data are presented in Table 5.

**Table 5.** Label data of the electric motors of LAV 300/2R

Description	Motor No. 1	Motor No. 2
Electric motor	Asynchronous Motor	Asynchronous Motor
Manufacturer	MEZ Frenštát	ZSE Praha
Type	F160L02	F160M02
Voltage (V)	400	380
Current (A)	35	29.5
Frequency (Hz)	50	50
Power (kW)	18.5	15
Efficiency (-)	0.85	0.8
RPM (min <sup>-1</sup> )	2,905	2,905
Weight (kg)	135	120

From this table (Table 5), we can see that the engine speed is the same, however, the transmitted power varies. Both motors are connected to the same frequency converter Siemens Micromaster 440. It shows the electric current, which is consumed by both mills simultaneously. Each mill will then get out of that sum current draws the appropriate amount needed for operation.

The process is continued by feeding the input material from the inlet hopper to the milling space between stator and rotor, where a special carrier-distributer part is spreading material to sides by centrifugal force. Output material is exhausted by ventilator to a separation cyclone, the material then is falling through turnstile feeder on a vibration conveyor for cooling and sieving, if necessary. The separated air from cyclone is continuing its way through the ventilator away. Another ventilator is extracting air from the space over the vibrating and cooling conveyor. The grinded and the dried material is then packed through a screw conveyor to a big bag.

In addition to all, the special and advanced construction of the tested high-speed mills, invented by the LAVARIS Ltd., allowed to adjust the placements of the milling elements. Due to the flexibility in adjustable gaps between the milling

elements it was possible to regulate a size of the space for the material flow, the intense of friction and the speed of the material's feeding. Thanks to the mentioned advantages, it was feasible to control the final size of output material and a temperature of the milling process.

#### 4.2.4 Ventilator

One of the most important element of the whole process is the Ventilator (Figure 17). Its right adjustment leads to the desired flow of the milled material. The main part of the centrifugal ventilator is impeller, of which they are blades ensuring air intake and its discharge in a direction perpendicular to the direction of rotation. In our particular case it is a radial transport fan type F08T, which is driven by an asynchronous motor of the KEM brand with an output of 7.5 kW.



**Figure 17.** CIPRES transport ventilator

This transport fan has a conveying capacity of  $3,900 \text{ m}^3 \cdot \text{h}^{-1}$ . The stated total pressure, according to the technical sheet supplied by CIPRES, is equal to 4,000 Pa. The weight of this particular fan is 177 kg. However, the fan is stationary, so the motility does not play a big role.

#### 4.2.5 Cyclone

Another device into which the milled material enters is a cyclone – a vortex separator. This is used to separate the air from the ground material due to gravity. The lighter particles contained in the air mixture, together with the air flow, are sucked up in the upper part, while the ground biomass is radially carried down by the conical part due to the greater gravitational force and the shape of the separator. At the end of this conical section is a rotary feeder from CIPRES FILTR BRNO (Figure 18), which releases the ground biomass evenly into the next process.

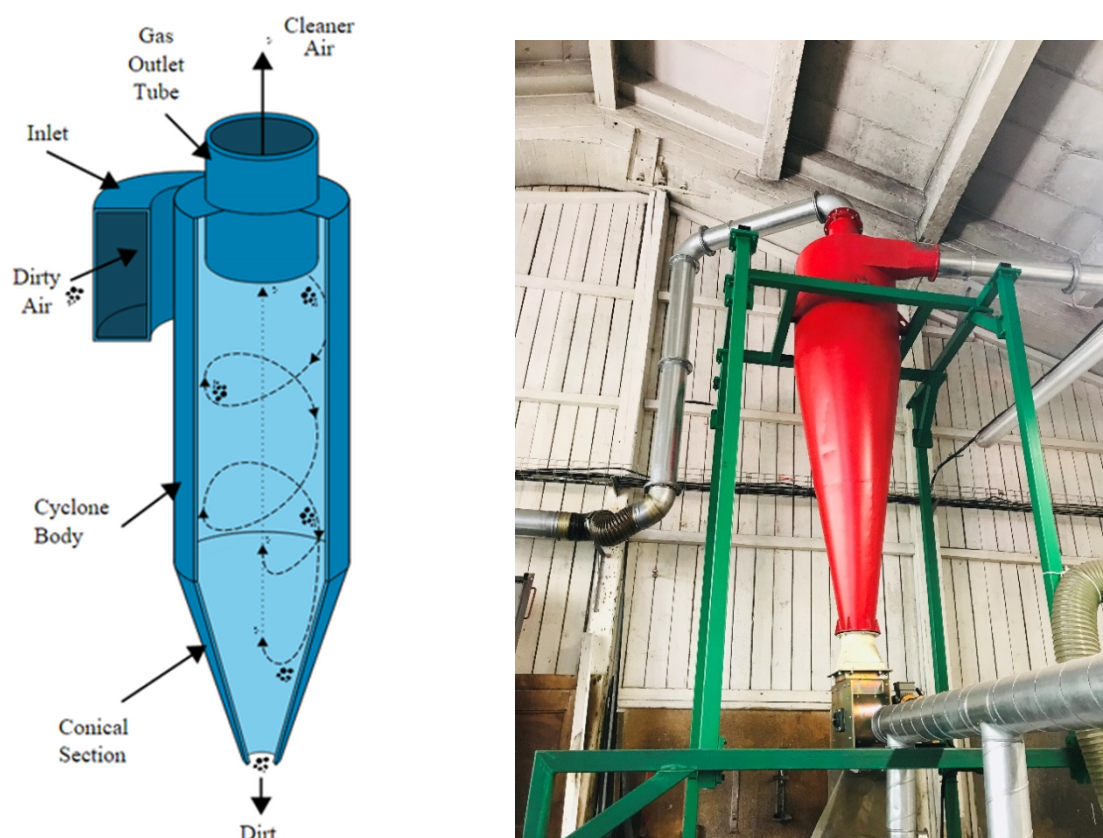


Figure 18. Cyclone with rotary feeder

#### 4.2.6 Vibrating screener

The ground biomass is drained from the cyclone via a rotary feeder to the vibrating screener (Figure 19). Thanks to vibration motor from the Vibros Příbram Ltd. and spring system, the entire screen is vibrated evenly, and the material is sieved through a sieve. However, I did not use the vibrating screen technology to evaluate the

experiments, and I collected the ground material into the containers immediately upon leaving the vortex separator. As a result, the samples contained all fractions of milled biomass.

The vibrating screen also functions as a cooling conveyor. At the end of the sorter a material is stored in bags, in which it is subsequently transported or stored.



Figure 19. Vibrating screener

## 4.3 Measuring equipment

### 4.3.1 Frequency converter

Another advantage in the system is the use of a frequency converter, where we were able, by the frequency adjustment, to change and control number of revolutions per minute and thus the peripheral speed.

Frequency converter Siemens Micromaster 440 (Figure 20) was used for our tests. Through the device display, we were able to measure and record measurement values as speed, rated power, rated voltage and nominal efficiency.



For this measurement, the collected data from used device was sufficient. The drive displays the values with an accuracy of two decimals, but the measurements were usually made only to one decimal place because of frequency fluctuation.



**Figure 20.** Frequency converter Siemens Micromaster 440

#### 4.3.2 Ventilator frequency inverter

Another measuring and regulating device is the device SINUS / IFDEV 400T-11 from Italian company Elettronica Santerno (Figure 21). It is a frequency converter connected to the ventilator. Thanks to the frequency setting we could simply regulate the ventilator output and thus the extraction of material from the mill. For constant conditions during measurement, this drive was always set to 30 Hz.

50 Hz, maximum power and the largest amount of air exhaust, was then used to cool the mill between tests.

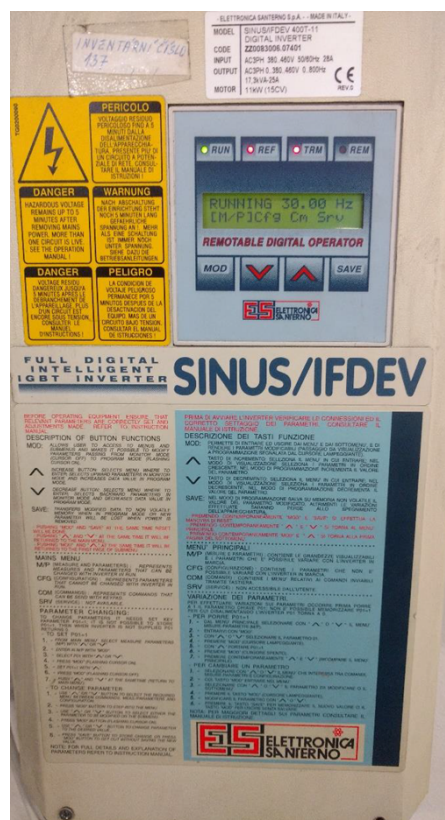


Figure 21. Ventilator frequency inverter

#### 4.3.3 Particle size distribution – sieve analysis

One of the main parameters that characterize an efficient operation of a disintegrator is a particle size distribution (PSD) of the product obtained after the grinding process Tumuluru et al. (2011); Chaloupková et al. (2016). The PSD of the input biomass, and biomass after the milling was determined by the vibrating screen method (EN ISO 17827-2 2016) using a sieve shaker (HAVER EML 200, Haver & Boecker, Germany), Figure 22, with 30-min sieve shaking time for each repeated measurement and amplitude 3.0 mm g<sup>-1</sup>. Therefore, for determination of particle size of the initial materials a set of calibrated sieves with the following mesh sizes was applied: 10.0 mm, 8.0 mm, 6.7 mm, 4.7 mm, 3.15 mm; 1.5 mm; 0.63 mm and the bottom pan. While determining the PSD of the materials obtained by the primary milling the sieves with the mesh sizes of 3.15 mm; 2.5 mm; 1.5 mm; 0.63 mm, including the bottom pan were selected. And, for the materials subjected to the secondary milling the sieves with apertures of 2.5 mm; 1.5 mm; 1 mm; 0.63 mm; 0.50 mm; 0.25 mm and the bottom were used.



#### 4.3.4 Moisture content

Moisture content of the input biomass before milling and output biomass after milling was determined in accordance with EN ISO 18134-3 (2015) by controlled drying of the sample in the laboratory dryer (HS 62 A, Chirana, ČSSR) at 105 °C for several hours until the weight was constant in mass.



**Figure 24.** Laboratory dryer HS 62A

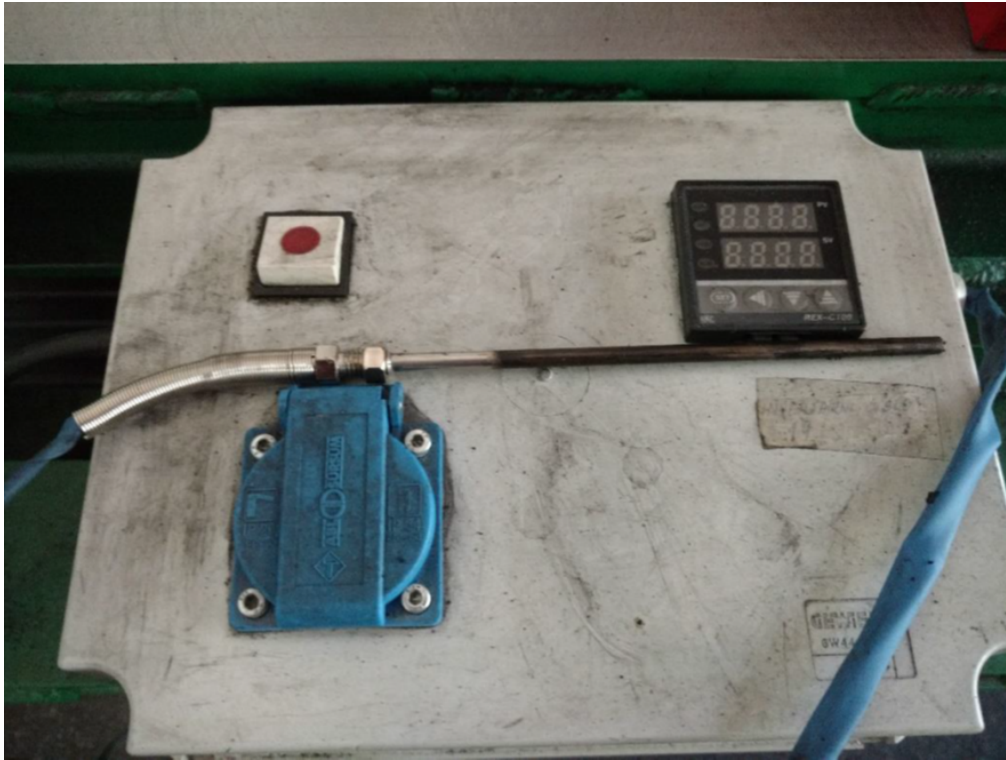
#### 4.3.5 Temperature measurement

As an important guide to determinate the capability of the mills to reduce material moisture content was the temperature of the exhausted mix of air and material at the output side of the mill chamber. The data are in high importance to know more about the process, machines adjustment, rotation speed and input material feeding rate.

Temperature measurement is located just ahead to the mill. A Pt100 resistance thermometer is used for measurement, with Pt indicating platinum, which has ideal temperature measurement properties. The thermal coefficient of electrical resistance for platinum is  $3.92 \times 10^{-3} \text{ K}^{-1}$ . As the temperature rises, the electrical resistance of the



platinum increases. In other words, this principle can convert the resistance to the current temperature value. The number 100 in the resistance thermometer name indicates the sensor resistance at 0 °C. At this temperature, the sensor has a resistance of 100 ohms. The sensitivity of this sensor is  $0.39 \Omega \cdot ^\circ\text{C}^{-1}$ .



**Figure 25.** GEWISS temperature measuring device

The sensor is led into a junction box from GEWISS, type GW 44 218 (Figure 25). Temperature measurement in this case is mainly of an orientation character. A sharp ascent or descent indicates an imminent risk or lack of material at the mill entrance. For a better overview of temperature development, however, the temperature sensor would need to be placed directly in the mill chamber. In fact, the temperature change inside the mill will be reflected in the outlet pipe with a considerable delay, which can have very undesirable consequences.

#### **4.3.6 Power measurement**

The power meter device KEW 6305 produced by Kyoritsu Electrical Instruments Works, Japan (Figure 26) was used to measure a power during each test. The device

was chosen for its simplicity and accurate results, as recommended by the electricians of LAVARIS Company.



**Figure 26.** Power meter KEW 6305

#### 4.4 Measurement settings

There were three important factors to set up before measuring. The first parameter that did not change during all measurements is the ventilator frequency. This was set at 30 Hz, this was the 60% of the motor 2,980 RPM. After measurement, the frequency was always increased up to full speed, 2,980 RPM, on 50 Hz. This increased the flow in the system and the mill and other components cooled more quickly. After returning the temperature close to initial temperature, the ventilator frequency was decreased again to 30 Hz.

The second parameter is the speed of the mill rotors. This value was changed using a potentiometer. The speed was divided into ten points, which were switched by the mentioned potentiometer. Because it is a High-Speed Mill, the speed was usually set to a minimum of 4, which means 40% of the maximum for both high-speed mills.

The last parameter to set up was a continuous, uniform and stable supply of feedstock to the mill hopper.

## 4.5 Measurement procedure

The first necessary step before measurement was to switch on the power supply of individual devices. The ventilator was then switched on to set the desired frequency of 30 Hz, this was the 60% of the motor 2,980 RPM. Then reading the initial value on the temperature meter without rotating the rotors. Then, using the rotary potentiometer, I set the speed to 40%. The mill remained at this value for thirty seconds, after which I read the current value of the electric current and temperature.

Subsequently, I increased the speed to 60% and measured the same way. In this way the measurements continued up to 80% and then to the maximum speed at level 100%. After reading the last values, I switched off the mill. Due to rising temperatures during this measurement, the mill had to be cooled. For this purpose, I increased the Ventilator frequency to the maximum of 50 Hz.

After reaching a temperature close to the initial value, test was started again, this time to 40% of total rotor speed. During five minutes, the mill reached a stabilized temperature. After that, the screw conveyor was turned on, dosing the biomass to the mill. Reading the temperature and the power values was repeated several times. However, except temperature, most values were stabilized almost immediately.

Each test took 30 minutes, at the end of which I collected a sample falling from a rotary feeder under the cyclone into a pre-prepared bowl.

In the same way I performed the test for the potentiometer for 60%, 80% and 100% of total revolutions. For each measurement there was a separate crushed material, from which a sample of 100 g was taken.

The PSD of the input biomass, and biomass after milling was determined by the vibrating screen, as mention before. For the initial materials, applied mesh sizes were: 10.0 mm, 8.0 mm, 6.7 mm, 4.7 mm, 3.15 mm; 1.5 mm; 0.63 mm and the bottom pan. For materials obtained by milling : 3.15 mm; 2.5 mm; 1.5 mm; 0.63 mm, 0.50 mm; 0.25 mm including the bottom pan were selected.

Three tests (repetitions) were performed for each material and measurement; a captured sample weight on each sieve was calculated as a percentage of total weight expressed as arithmetic mean of three repetitions. Laboratory precision balance (KERN 572-35, Kern & Sohn GmbH, Balingen, Germany) with accuracy 0.01 g was used for weighting.

Moisture content of the input biomass, and biomass after milling was determined in accordance with EN ISO 18134-3 (2015) as mention before. The resulting moisture content on wet basis was calculated as the mean of duplicate determinations with respect to repeatability precision (i.e. difference between two individual results of each material sample was not more than 0.2% absolute) and using the following equation:

$$w = \frac{m_2 - m_3}{m_2 - m_1} \times 100, \text{ wt\%} \quad (\text{Eq. 2})$$

Where:  $m_1$  – mass of empty crucible, g;  $m_2$  – mass of crucible with sample before drying, g;  $m_3$  – mass of crucible with sample after drying, g.

Collected raw data from all mentioned methods were organized, cleaned, processed and statistically analyzed using Microsoft Office **Excel** (version 2013, Microsoft, Redmond, WA, USA).

Power, as an important indicator for the milling process efficiency was measured by the power meter device KEW 6305 produced by Kyoritsu Electrical Instruments Works, Japan.

Achieved results were recorded in tables or visualized in graphs and afterward interpreted, evaluated and discussed.

## 5. Results

Tests were planned according to the High-Speed Mill type, each of H. S. Mill test were made separately for the selected three different types of biomass. In addition, five different modes were chosen, in accordance with the value of maximum rotor speed, (0%, 40%, 60%, 80% and 100%) RPM. As a result, we had 30 experimental tests.

The output size of the milled biomass was classified into several grades as mention earlier, the particle size was determined and then shown in tables and figures. It is a key issue however, that the effort of crushing in our case, is obviously to get the lowest values of the output material particle size.

For a better orientation in types of two different mills, we marked them with Roman numerals, High-Speed Multilevel Single Rotor Mill LAV 400/1R was labelled as (I). High-Speed Multilevel Double Rotor Mill LAV 300/2R as (II). For different types of biomass, we used the description (A) – for Apple tree wood, (M) – for *Miscanthus sinensis* and (P) – for Pine sawdust. So, if I describe grinding with single rotor mill, for Apple tree wood we use the designation (I – A).

Test results display the performance values. Power values were measured using the power meter device KEW 6305 produced by Kyoritsu Electrical Instruments Works, Japan.

Results of all tests were further presented. Detailed records of individual tests and measurements are included in **Annexes 4 to Annex 9** at the end of this thesis.

### 5.1 High-Speed Mill LAV 400/1R (I)

As a simpler mill, LAV 400/1R is suitable for a process, where the requirements on output material are not high. Due to the fact, that it has a single rotor and single stator, the maximum peripheral speed is, due to one side rotation is limited but acceptable for several applications. All the three biomass materials were milled using this mill with the results shown afterwards below.

---

## 5.2 High speed mill LAV 300/2R (II)

As a double rotor counter-directional High-Speed Mill, LAV 300/2R has more advantages than single rotor – stator mill. The total speed is a sum of the peripheral speed of both rotors, creating a bigger friction effect that has a significant influence in surface and total breakage of the material and a significant size reduction, releasing at the same time much more energy. Although the rotor diameter is smaller than the previous H. S. Mill, the high peripheral speed substitute the difference and offers a better results.

## 5.3 Testing process

### 5.3.1 Milling of Apple tree wood on LAV 400/1R (I – A)

The initial particle size measurement was the first result on which we built further tests. It is represented in Figure 8 and Annex 1.

Our first step was to know the start point, no-load test was performed, and during which actual temperature and power values were recorded for each speed stage.

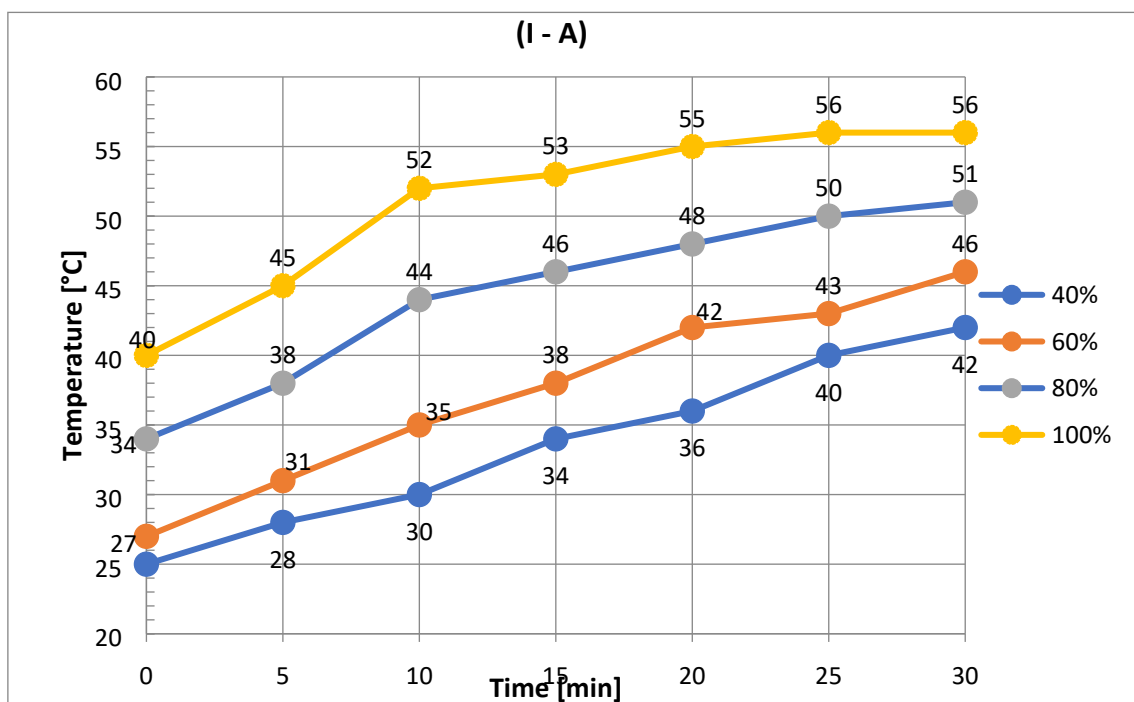
At the start of the screw conveyor, which means the feed to the mill, the actual temperature was recorded for all 4 selected speed stages (40%, 60%, 80% and 100%) RPM. Its development is shown in the Figure 26. From these figures, it's obvious that the temperature incensement was slowly, especially at lower speeds. At stage of 80% RPM and especially at stage of 100% RPM, a more evident development is already significant. The temperature has major effect on the moisture content of the milled material. Samples of the output material were tested, and the particle size data and their distribution are shown in Table 6 and Figure 28.

In comparison with the value of the particle size distribution for initial material before milling, we can notice a significant size reduction. The influence for rotor speed is also clear, although LAV 400/1R is a single rotor mill.

**Table 6.** Particle size distribution according to rotor speed for (I – A)

(I - A) Particle sizes [mm]									
Mesh Sizes [mm]	6.7	5.6	4.5	3.15	2.5	1.5	0.63	<0.63	$\Sigma$
7800 RPM									
0.40	1.27	1.53	2.42	3.87	10.82	36.93	28.11	15.05	100
0.60	1.08	2.02	2.29	2.54	6.2	24.84	31.53	29.5	100
0.80	0.71	0.82	1.24	2.84	4.5	16.87	35.07	37.95	100
1.00	0.14	0.2	0.39	2.95	2.74	8.59	40.36	44.63	100

The temperature has major effect on the moisture content of the milled material the results showing the data of the moisture content in relation to recorded temperature values are clear in next figure. Figure 27 shows, that temperature is increasing rapidly related to rotor speed, reaching the value of 56 °C in full speed of the rotors, which was 7,800 RPM. Taking in consideration that the initial start temperature was 22 °C. All values are recorded in Annex 4.

**Figure 27.** Temperature related to time for (I – A)

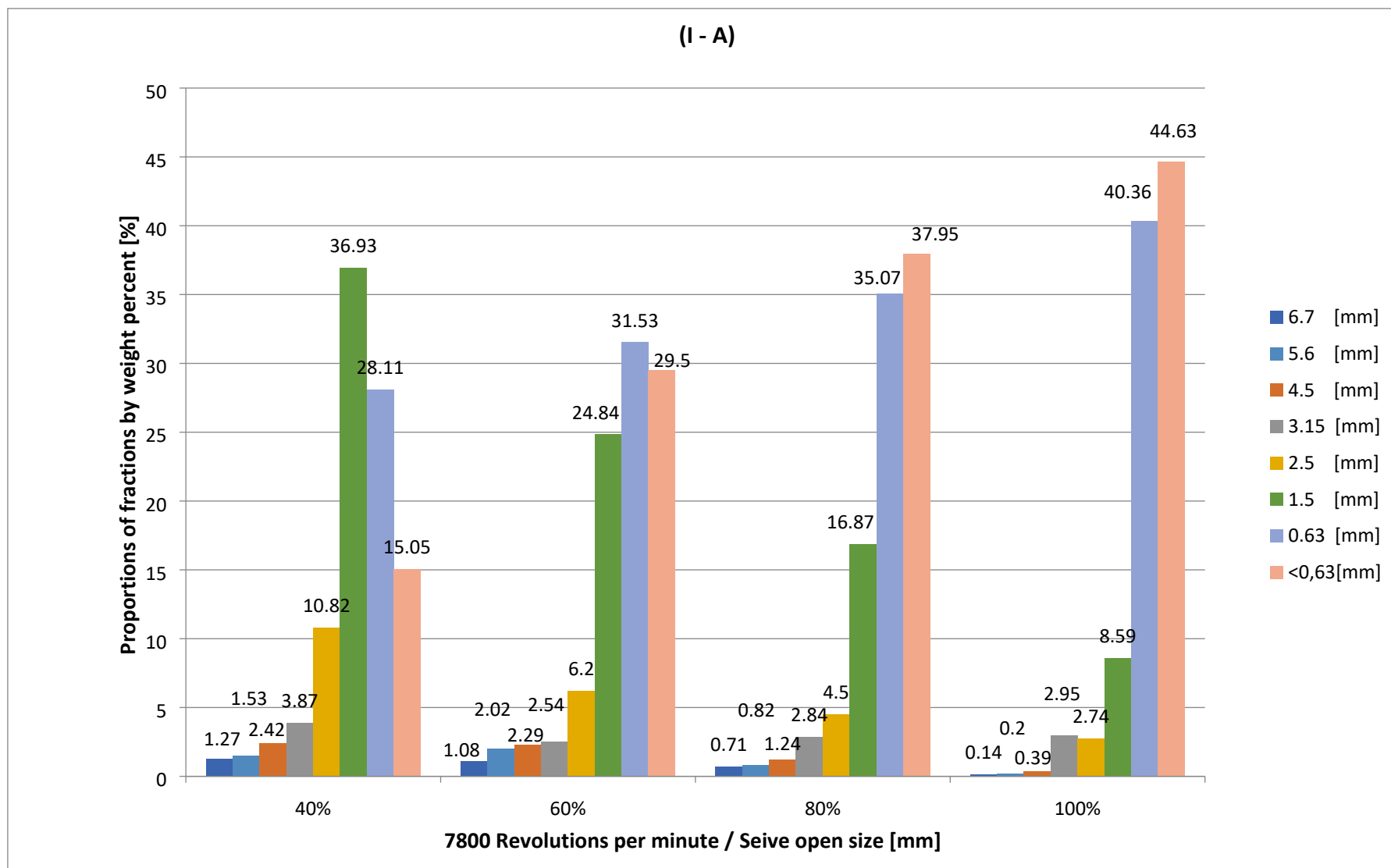


Figure 28. Particle size distribution according to rotor speed for (I – A) [mm]



The fact, that there is a direct reliance between moisture content and rotor speed (revolutions per minute) as it is evident from Figure 29.

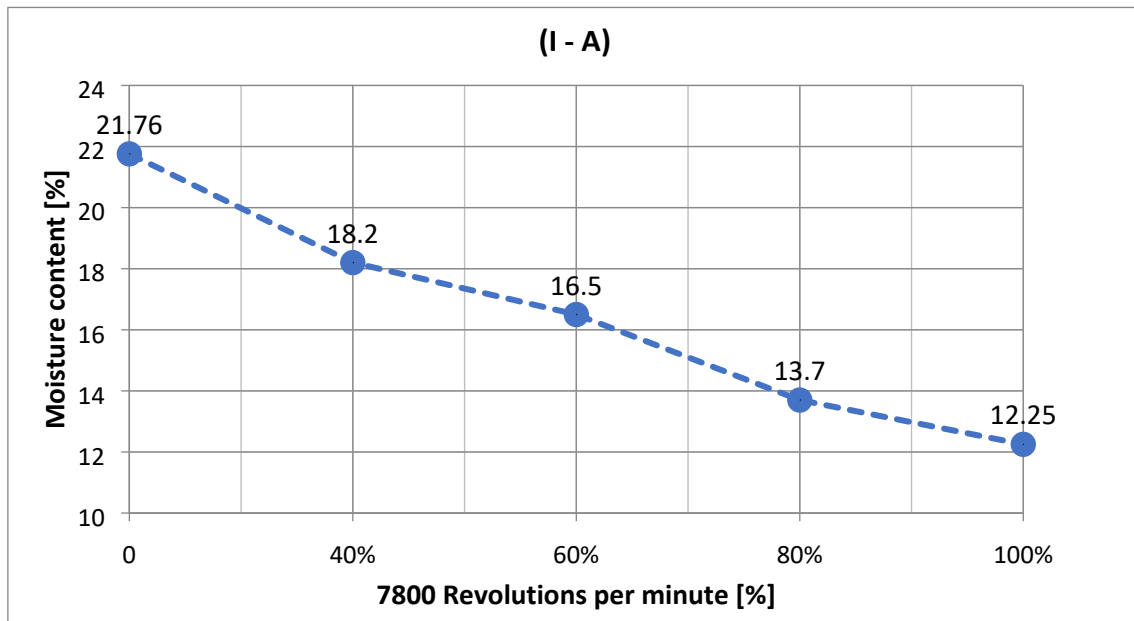


Figure 29. Moisture content related to rotor speed for (I – A)

As conclusion of the tests done for (I – A), Figure 30 shows recorded power values and the moisture content reduction. 7.71 kW was required to reduce the moisture content of apple tree wood from 21.76 % to 12.25 %. The standard material flows of the screw conveyer was 380 kg.h<sup>-1</sup>.

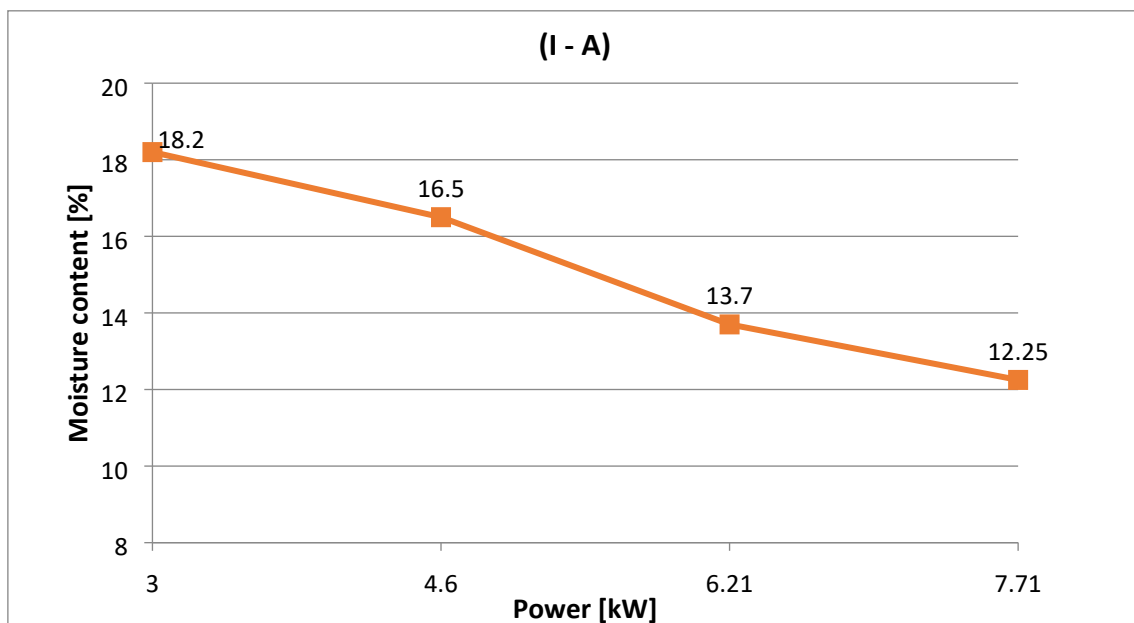


Figure 30. Power related to moisture content (I - A)

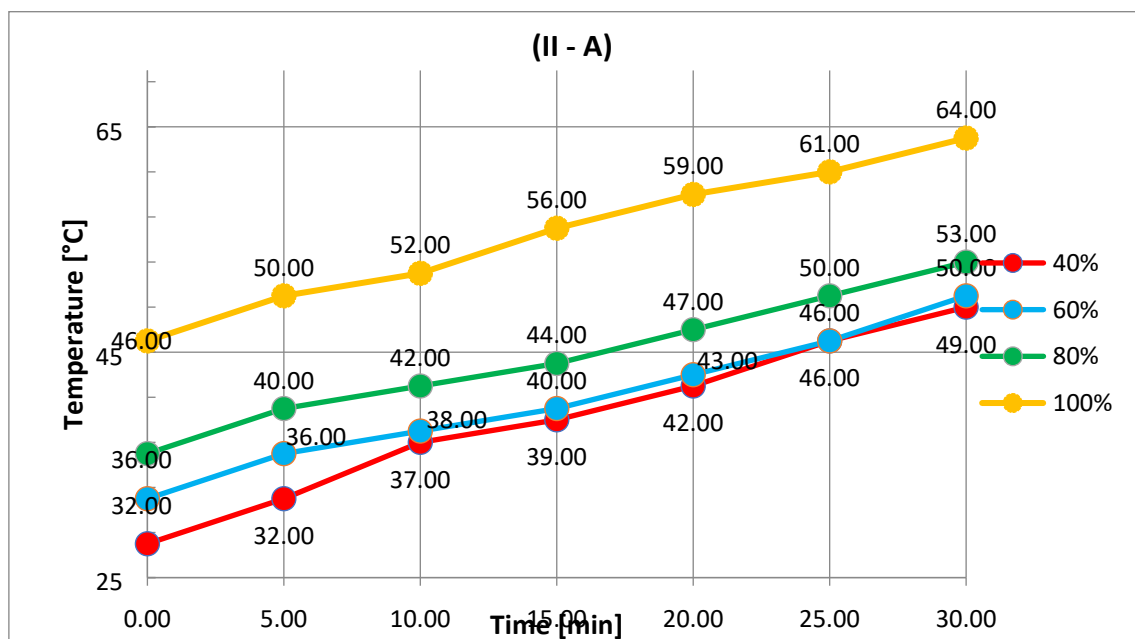
### 5.3.2 Milling of Apple tree wood on LAV 300/2R (II – A)

The initial particle size test and material parameters were the start point for the tests don as (II –A). Table 7 and Figure 32 show the particle size values measured and on sieves after material's milling.

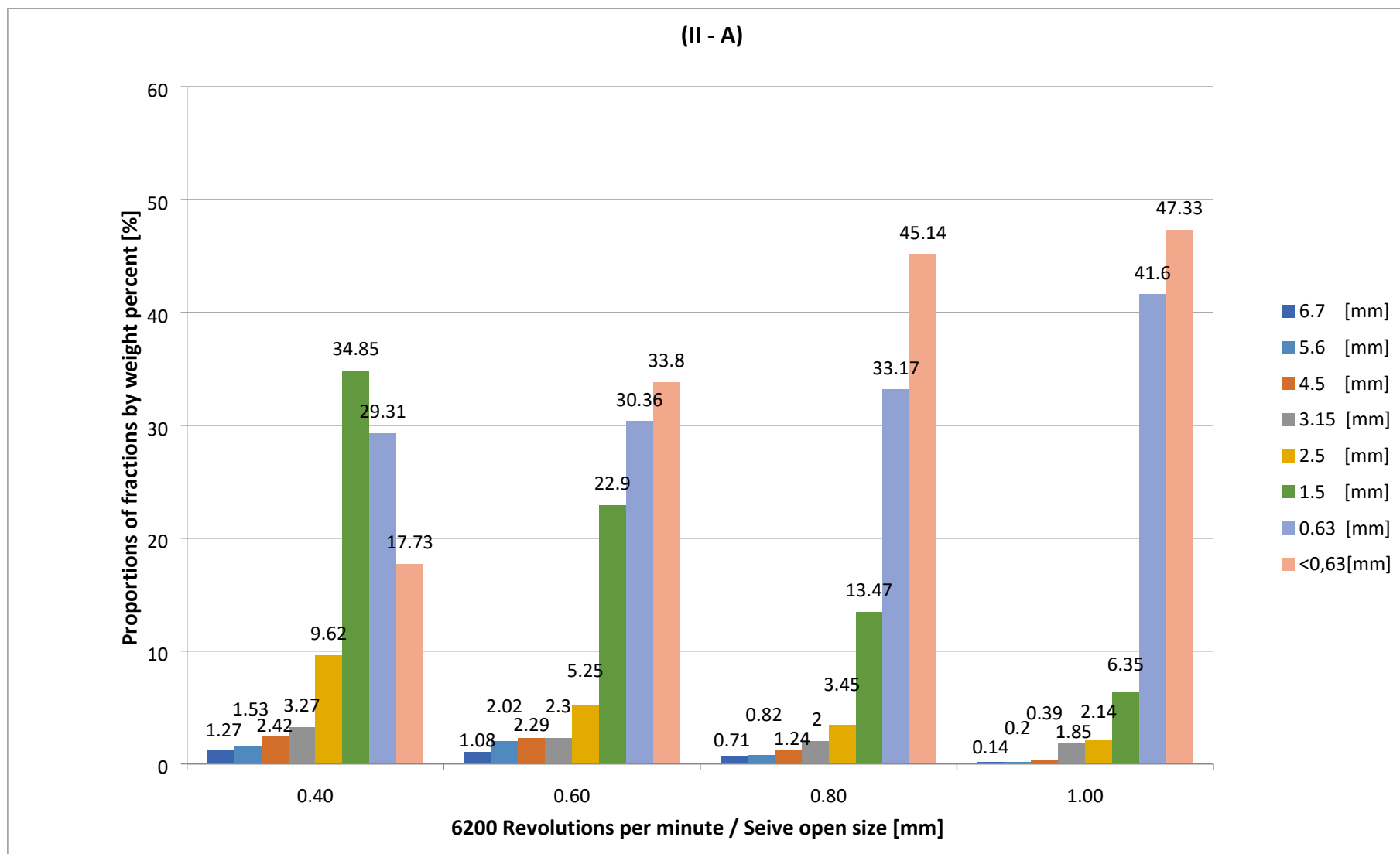
**Table 7.** Particle size distribution according to rotor speed for (II – A)

(II – A) Particle sizes [mm]									
Mesh sizes [mm] 6200 RPM	6.70	5.60	4.50	3.15	2.50	1.50	0.63	<0.63	Σ
0.40	1.27	1.53	2.42	3.27	9.62	34.85	29.31	17.73	100.00
0.60	1.08	2.02	2.29	2.3	5.25	22.9	30.36	33.8	100.00
0.80	0.71	0.82	1.24	2	3.45	13.47	33.17	45.14	100.00
1.00	0.14	0.2	0.39	1.85	2.14	6.35	41.6	47.33	100.00

Double rotor mill LAV 300/2R had even better influence in temperature rise, reaching the value of 64 °C when running the full rotor speed of 6,200 RPM, as shown in Figure 31.



**Figure 31.** Temperature related to time for (II – A)



**Figure 32.** Particle size distribution according to rotor speed for (II – A) [mm]

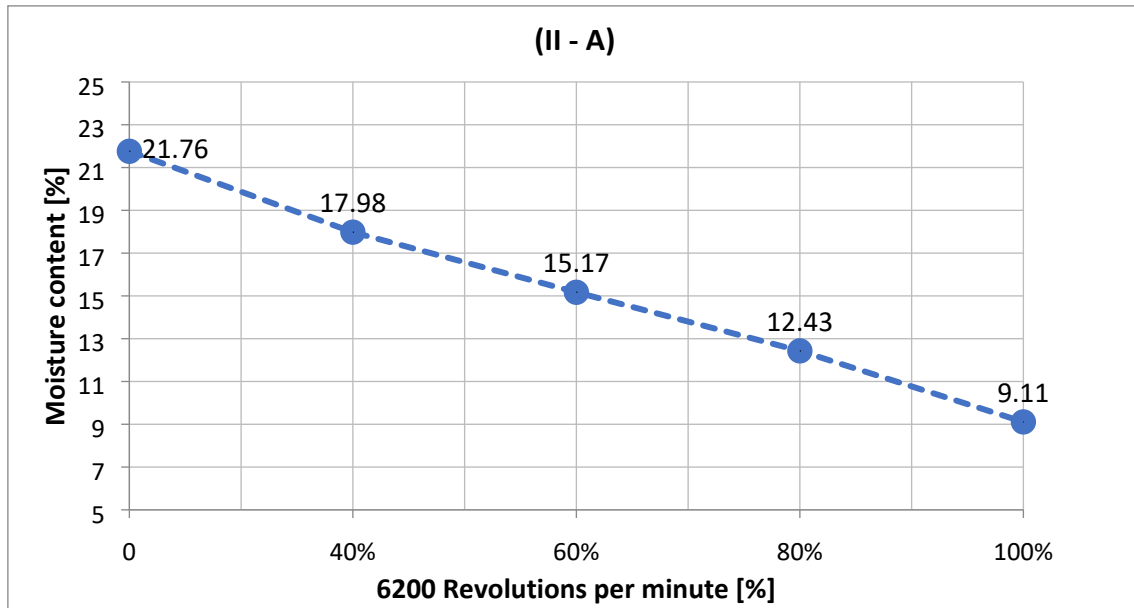


Figure 33. Moisture content related to rotors speed for (II – A)

As it is shown in Figure 31 and Figure 33, the temperature behaviour was similar to (I – A), influenced by time and rotors speed.

The results of the tests and collected data are showing the amount of kW power needed to reduce material moisture content. Both motors consumption was 15.3kW to reduce Apple tree wood moisture from 21.76 % to 9.11 %. Having two counter-direction rotors was helpful (Figure 34). The material flow to the mill was of 380 kg.h<sup>-1</sup>.

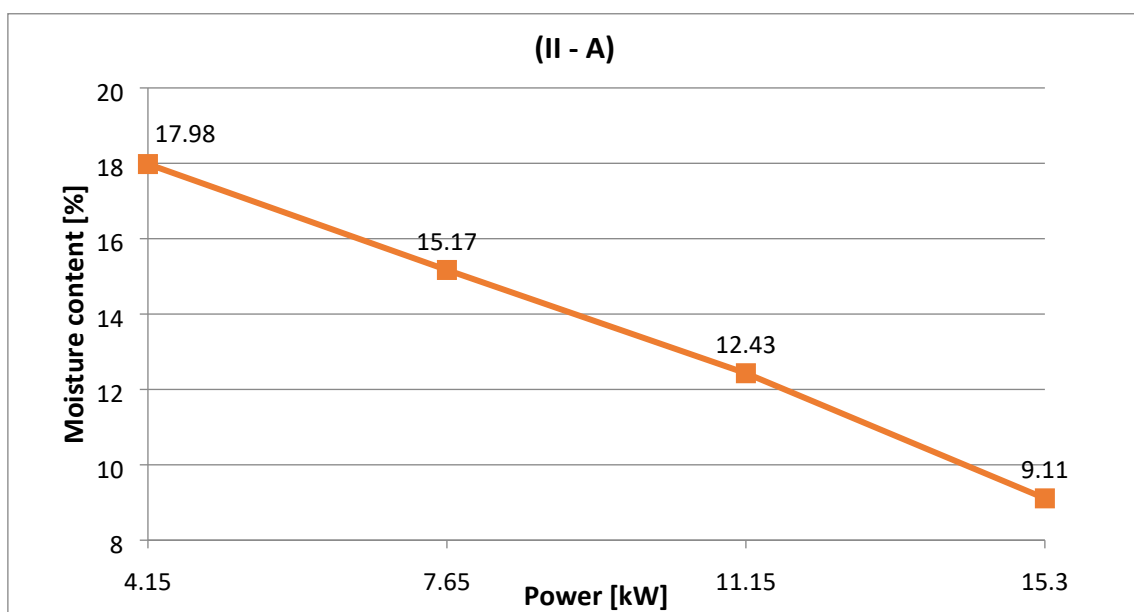


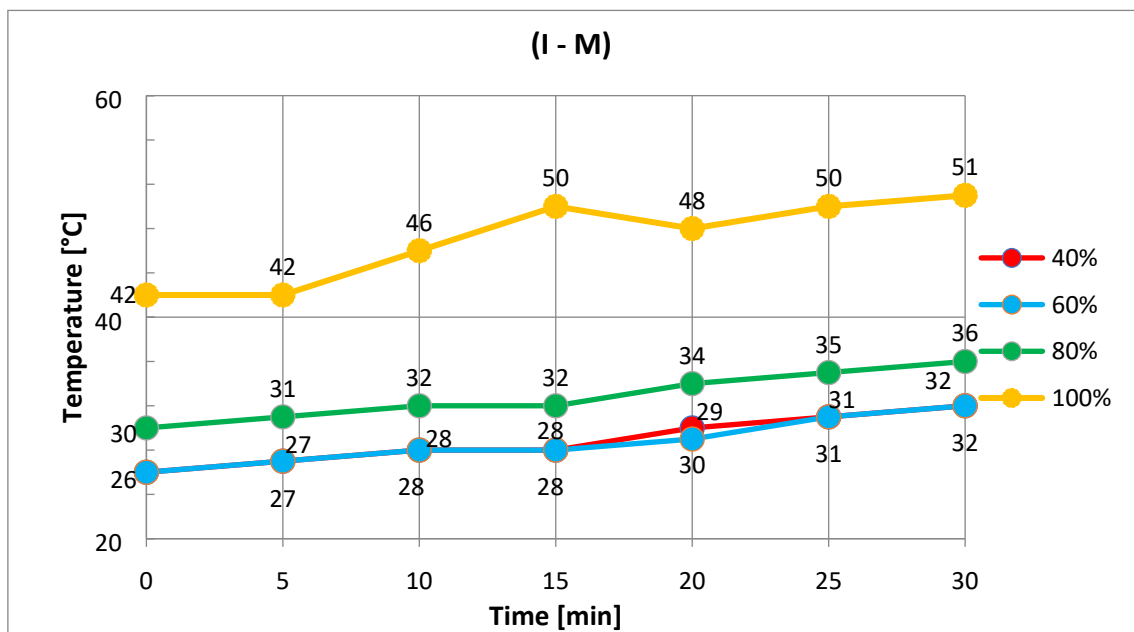
Figure 34. Power related to moisture content for (II – A)

### 5.3.3 Milling of *Miscanthus sinensis* on LAV 400/1R (I – M)

The second biomass material tested in LAV 400/1R was *Miscanthus sinensis*, a sort of perennial herbs belonging to the Poaceae family. Initial material particle size analysis results and material main parameters are represented in Figure 9 and Annex 2. Table 8 and Figure 36 shows the particle size distribution after milling.

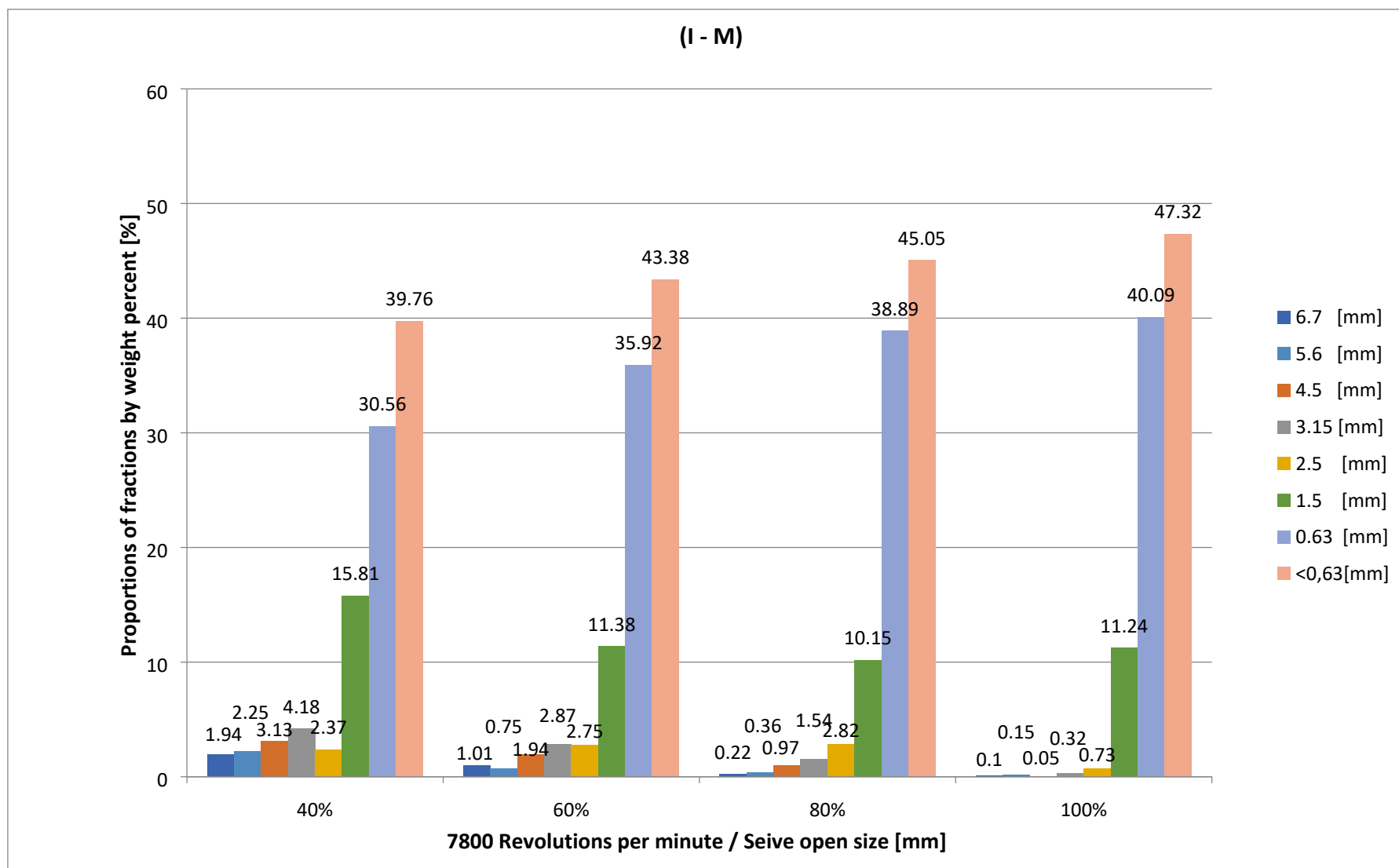
**Table 8.** Particle size distribution according to rotor speed for (I – M)

		(I – M) Particle sizes [mm]								
Mesh Sizes [mm]	7800 RPM	6.70	5.60	4.50	3.15	2.50	1.50	0.63	<0.63	Σ
		0.40	1.94	2.25	3.13	4.18	2.37	15.81	30.56	39.76
0.60	1.01	0.75	1.94	2.87	2.75	11.38	35.92	43.38	100.00	
0.80	0.22	0.36	0.97	1.54	2.82	10.15	38.89	45.05	100.00	
1.00	0.1	0.15	0.05	0.32	0.73	11.24	40.09	47.32	100.00	

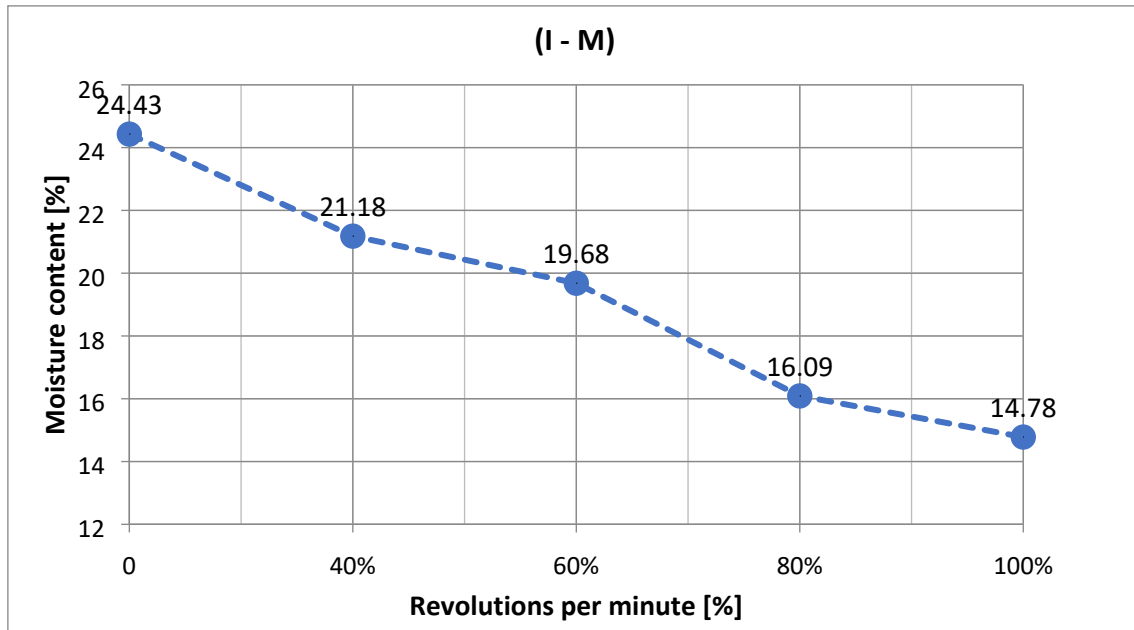


**Figure 35.** Temperature related to time for (I – M)

Temperature versus time had a similar behavior as previous tests with apple tree wood, collected values are illustrated in Figure 35, and where the value reached at 100% of 7,800 RPM after 30 minutes was 51 °C.

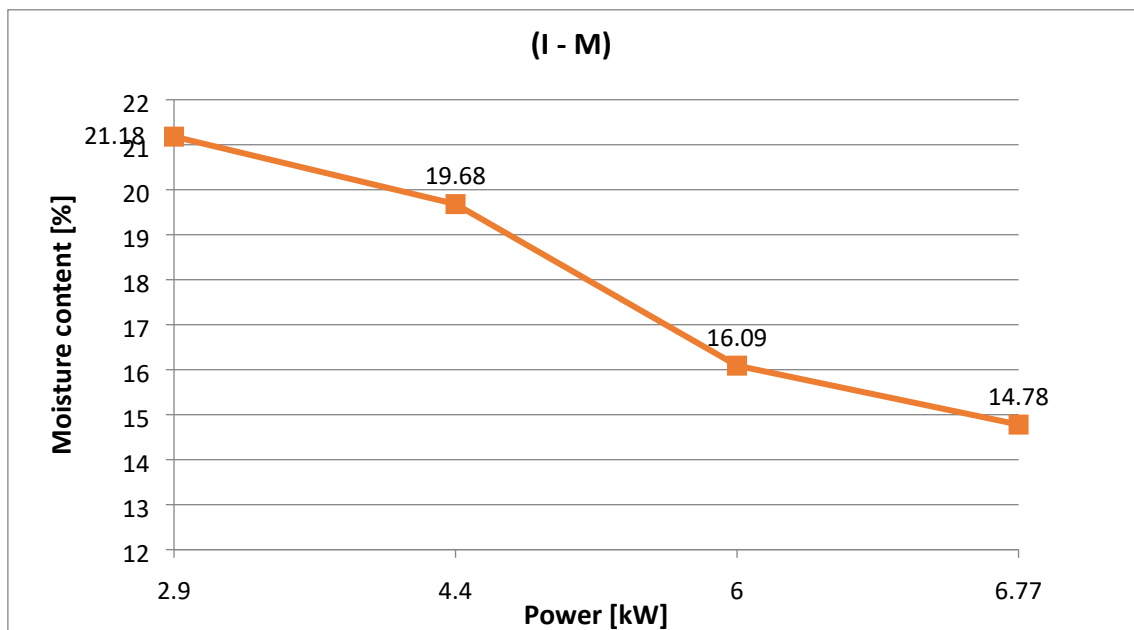


**Figure 36.** Particle size distribution according to rotor speed for (I – M) [mm]



**Figure 37.** Moisture content related to Rotor speed for (I – M)

The moisture content was reduced to 14.78 % when reaching the maximum speed of the rotor, Figure 37. Observing the progress of moisture content reduction, it is useful to notice the comparison between different collected power values for each rotor speed. For comparison, a power value of 6.77 kW for (I – M) as shown in Figure 38 was measured instead of 7.71 kW for (I – A). The standard material flows of the screw conveyor was  $380 \text{ kg}\cdot\text{h}^{-1}$ .



**Figure 38.** Power related to moisture content for (I – M)

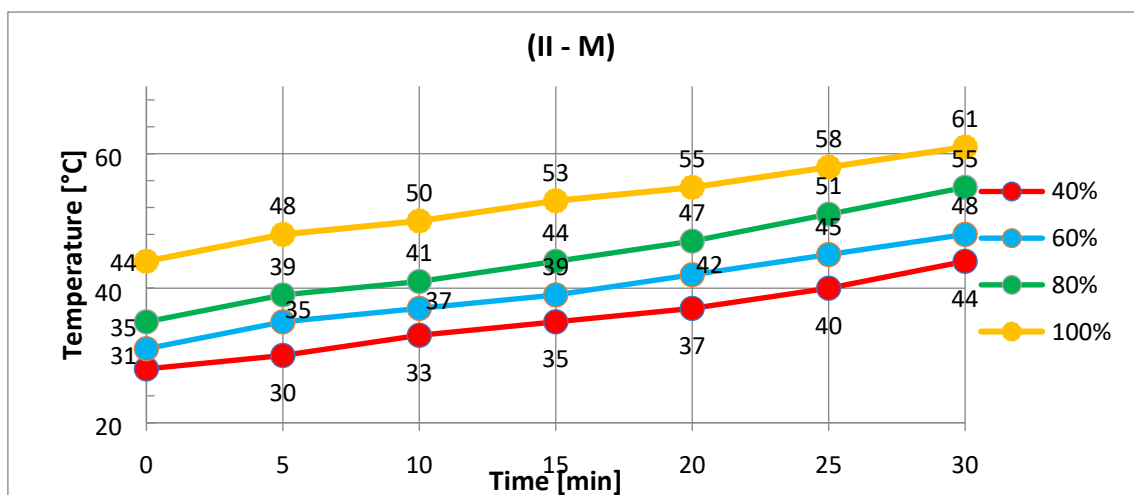
### 5.3.4 Milling of *Miscanthus sinensis* on LAV 300/2R (II – M)

As shown in Figure 9 and Annex 7 for main parameters and initial particle size distribution of this biomass, there was a significant size reduction after testing the material as (II – M). Particle size distribution after milling is shown in Table 9 and Figure 40. Rapid increase of moisture content was monitored in the size smaller than 0.63 mm up to 50.87% of all the milled material. As mention in other parts of this thesis (Methodology), each test was a subject of three times recurrence, for a better assurance.

**Table 9.** Particle size distribution according to rotor speed for (II – M)

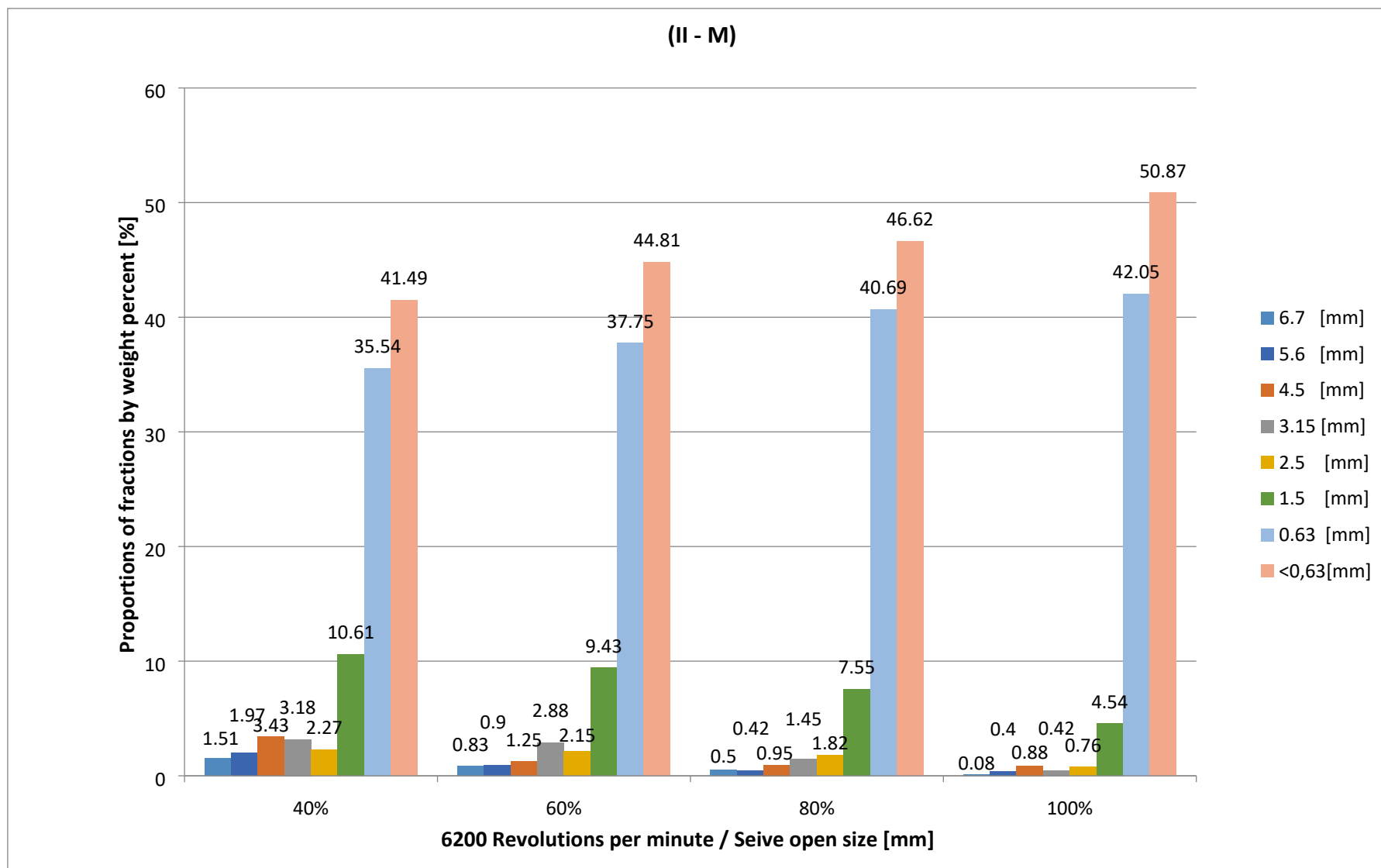
(II – M) Particle sizes [mm]									
Mesh sizes [mm]	6.70	5.60	4.50	3.15	2.50	1.50	0.63	<0.63	Σ
6200 RPM									
0.40	1.51	1.97	3.43	3.18	2.27	10.61	35.54	41.49	100.00
0.60	0.83	0.9	1.25	2.88	2.15	9.43	37.75	44.81	100.00
0.80	0.5	0.42	0.95	1.45	1.82	7.55	40.69	46.62	100.00
1.00	0.08	0.4	0.88	0.42	0.76	4.54	42.05	50.87	100.00

This size reduction was accompanied with temperature increase. Figure 39 shows the recorded data from the several partial tests, where the temperature increases from initially 30°C after first five minutes to 44°C after 30 minutes, when testing in 40% rotors speed.



**Figure 39.** Temperature related to time for (II – M)





**Figure 40.** Particle size distribution according to rotor speed for (II – M) [mm]

Figure 41 shows the moisture content reduction due to different partial tests related to rotors speed during each partial test.

Moisture content related to rotor speed in Figure 41 shows a major decrease in moisture content from initial 24.43% to 13.10% after testing with full 6,200 RPM (100%) rotor speeds.

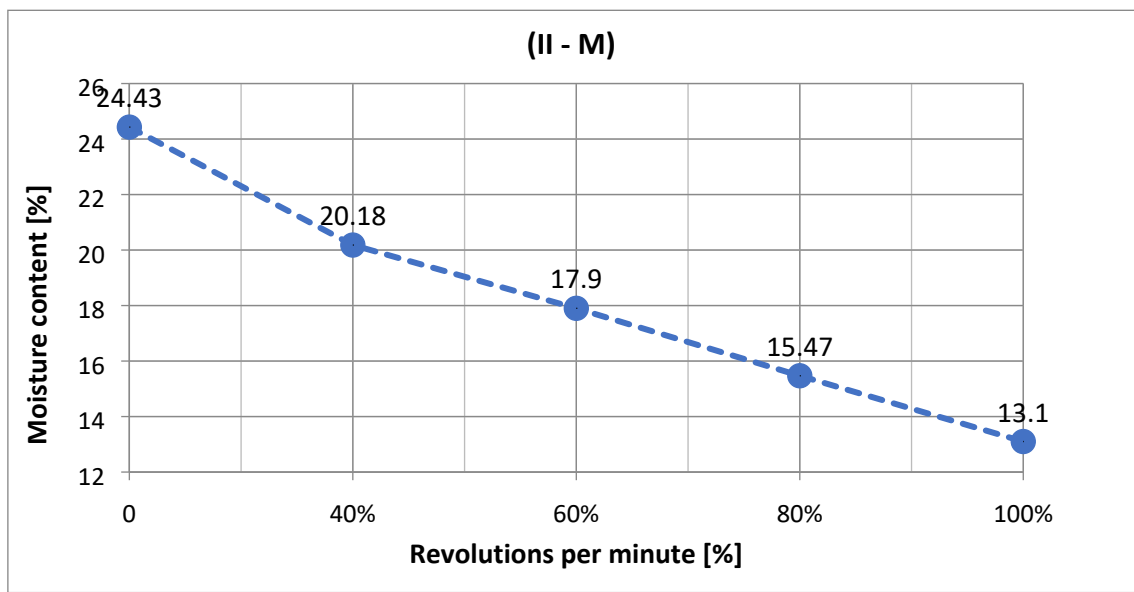


Figure 41. Moisture content related to Rotor speed for (II – M)

A value of 15.9 kW was measured for full speed rotors required (Figure 42) for the reduction of moisture content from 24.43% to 13.10%. The standard material flows was 380 kg.h<sup>-1</sup>.

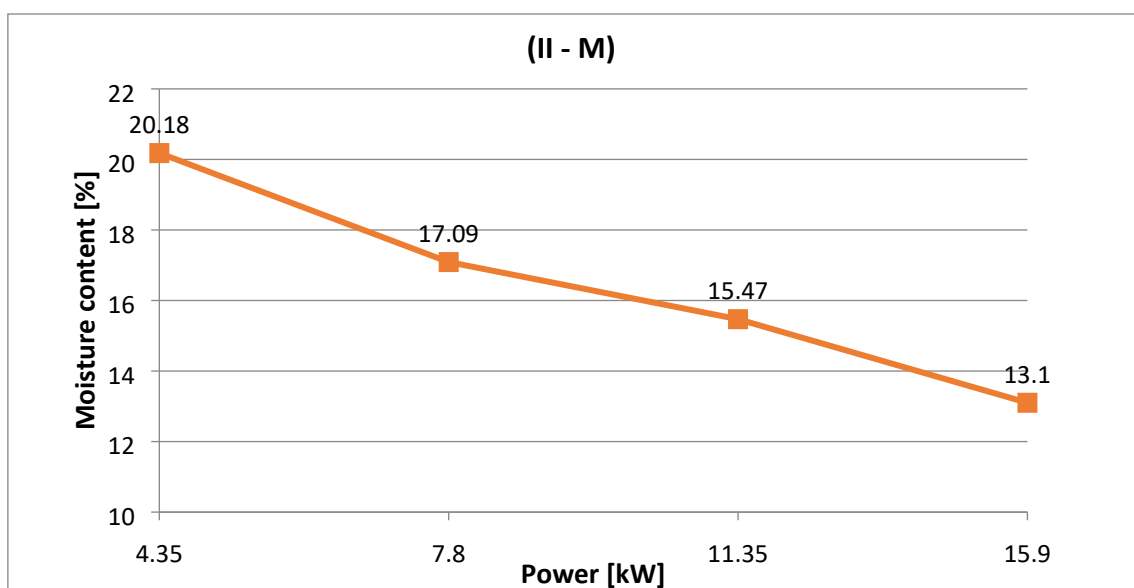


Figure 42. Power related to moisture content for (II – M)

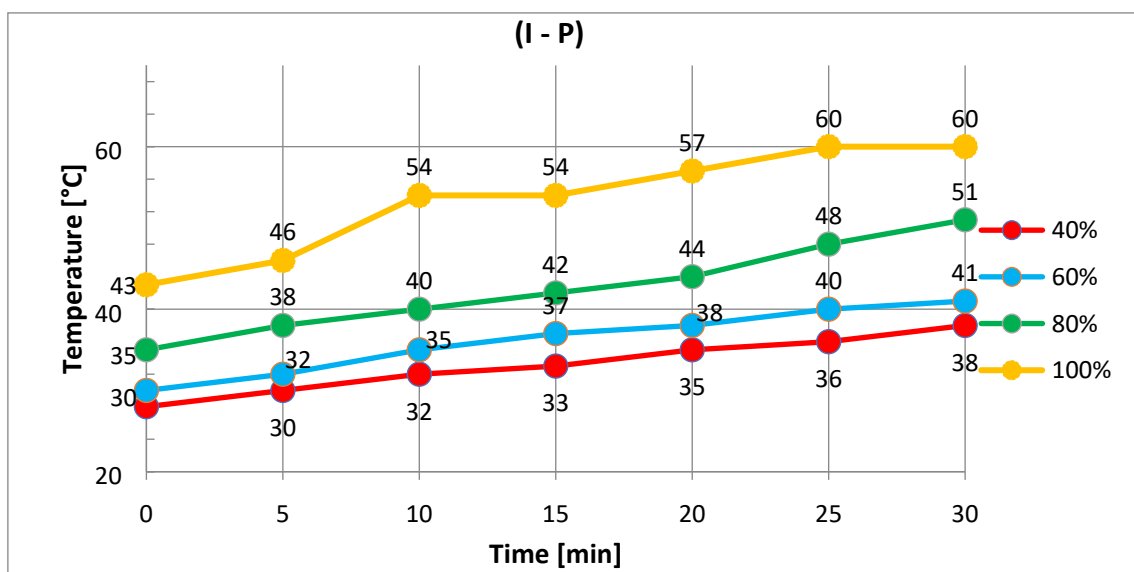
### 5.3.5 Milling Pine wood sawdust on LAV 400/1R (I – P)

The third material tested by LAV 400/1R was pine wood sawdust. Initial particle size distribution and main parameters are represented in Figure 10 and Annex 8. Measured data are recorded and could be seen in Table 10 and Figure 44.

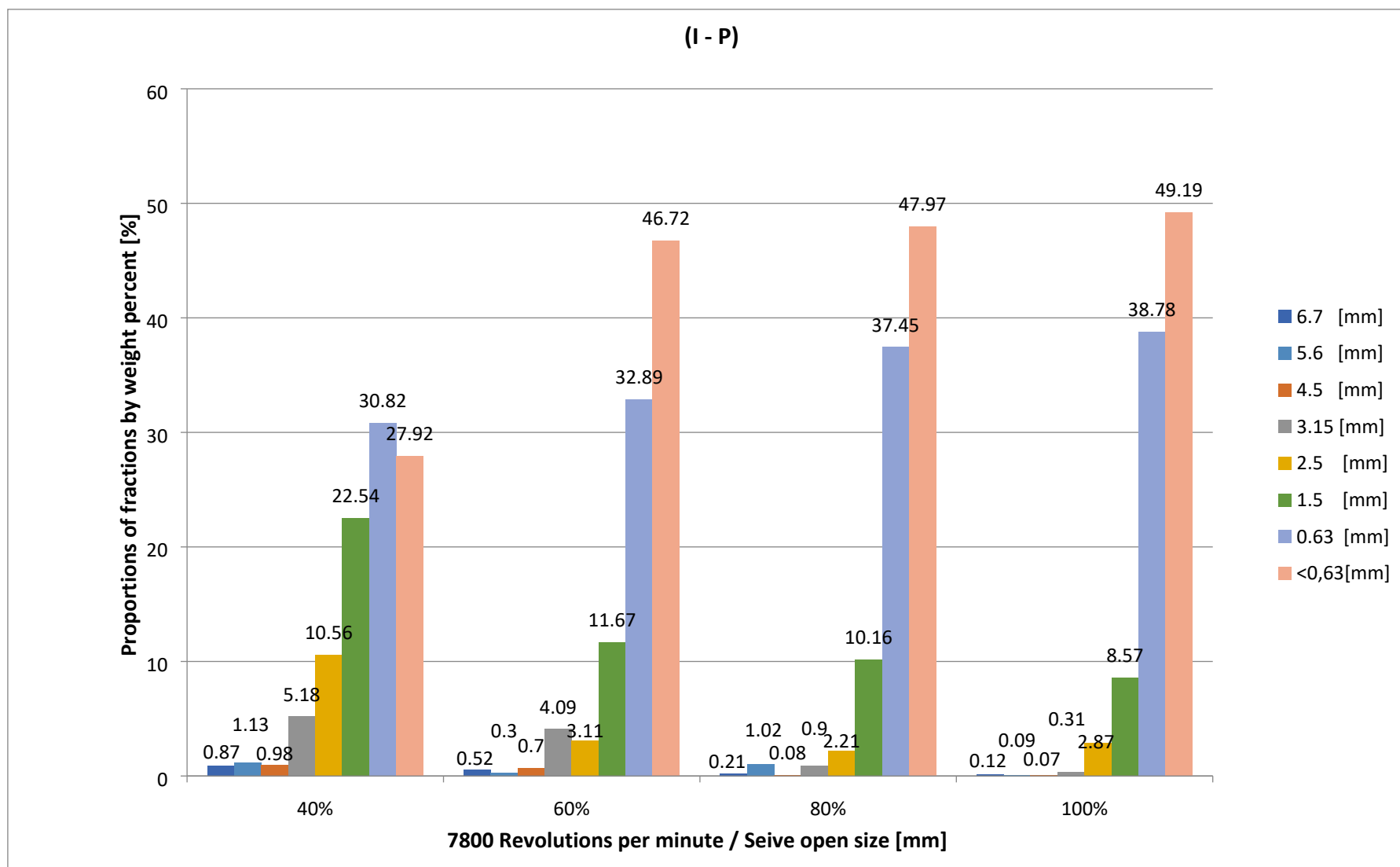
**Table 10.** Particle size distribution according to rotor speed for (I – P)

(I – P) Particle sizes [mm]									
Mesh sizes [mm] 7800 RPM	6.70	5.60	4.50	3.15	2.50	1.50	0.63	<0.63	Σ
0.40	0.87	1.13	0.98	5.18	10.56	22.54	30.82	27.92	100.00
0.60	0.52	0.3	0.7	4.09	3.11	11.67	32.89	46.72	100.00
0.80	0.21	1.02	0.08	0.9	2.21	10.16	37.45	47.97	100.00
1.00	0.12	0.09	0.07	0.31	2.87	8.57	38.78	49.19	100.00

The effect of temperature increase in related with time is clear from Figure 43. It is interesting to watch the style of the diagram of the temperature value after 10th minute, specially with full (100%) 7,800 RPM rotor speed. After 20 minutes the increase of the temperature was almost tiny, so the stabilization of the milling conditions was faster than in other both materials tested before.



**Figure 43.** Temperature related to time for (I – P)



**Figure 44.** Particle size distribution according to rotor speed for (I – P) [mm]

Moisture content related to rotor speed was measured and Figure 45 shows its clear progress. At full (100%) of 7,800 RPM, the moisture content reduction was more than 13.21%.

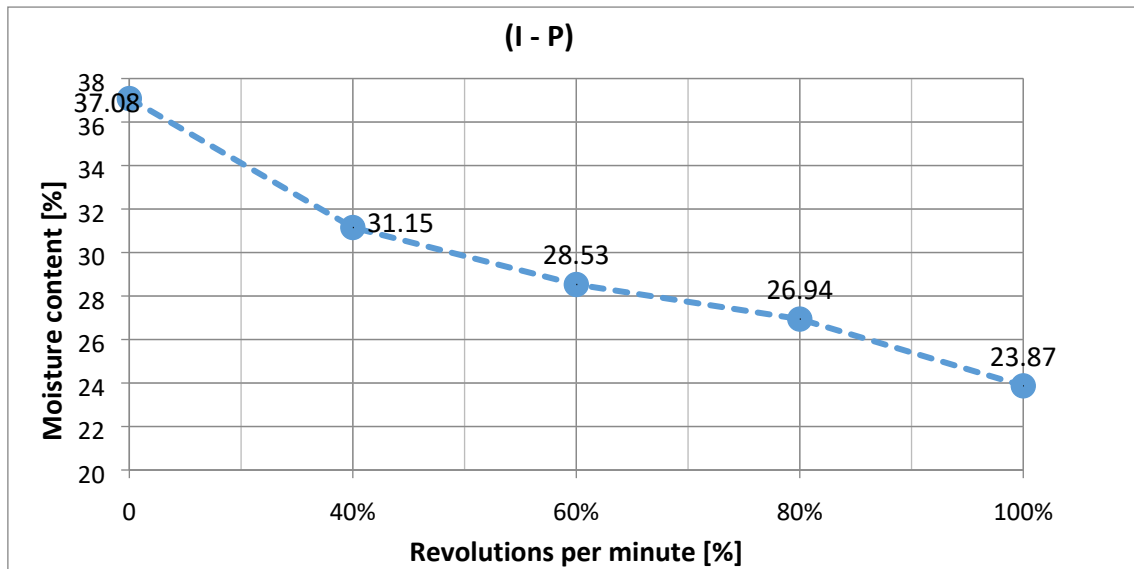


Figure 45. Moisture content related to rotor speed for (I - P)

Moisture content data related to power value were measured, where we can find their expression in Figure 46. Power value amount needed to achieve the goal can be observed well at the same Figure (Figure 46). Still we are in low consumption level as in the previous tests done for both other materials in the same machine. It was 7.71 kW for (I - A), 6.77 kW for (I - M) and 7.1 kW for (I - P), and material flows of 380 kg.h<sup>-1</sup>.

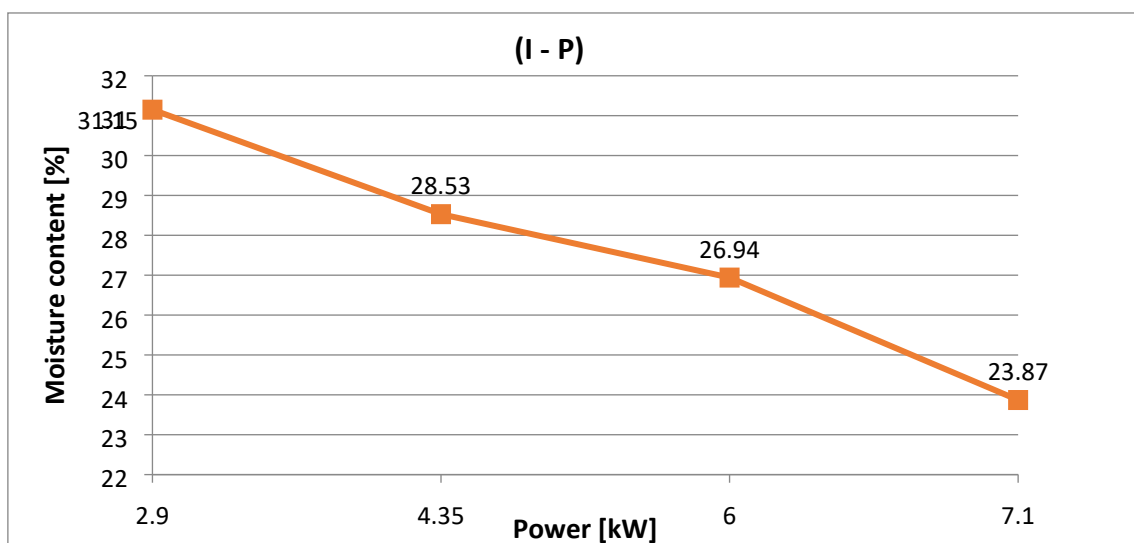


Figure 46. Power related to moisture content for (I - P)

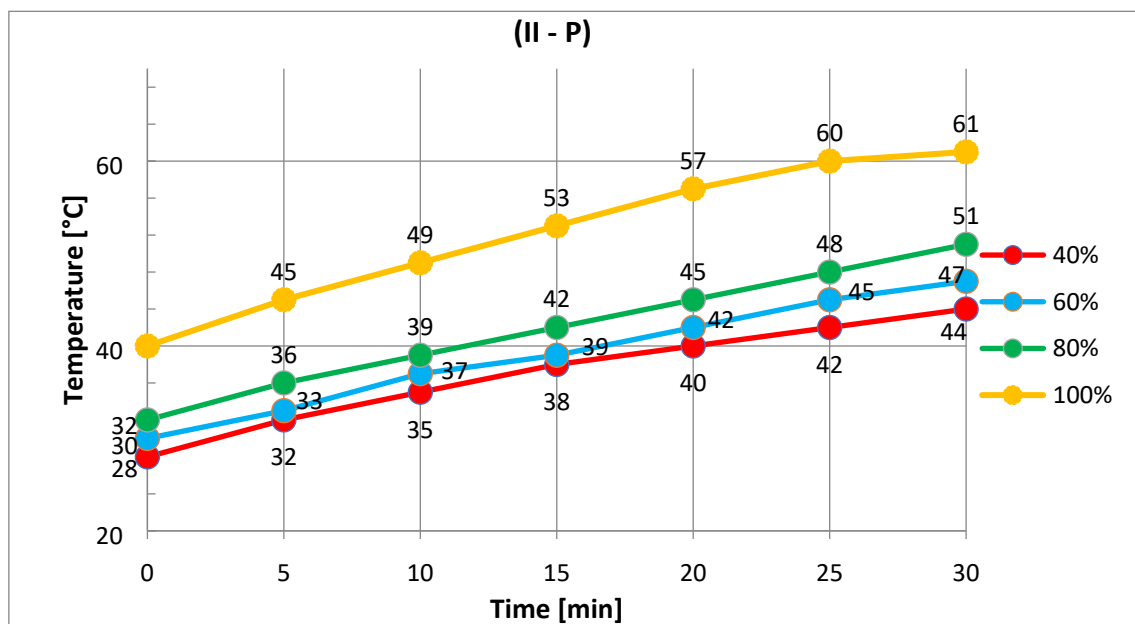
### 5.3.6 Milling Pine wood sawdust on LAV 300/2R (II – P)

In Table 11 we can find the results of the collected data measured and can be compared with the initial data from Annex 9 and Figure 10. Then a clear idea can be made after comparing the mention Figure (Figure 10) with Figure 48 of the milled material.

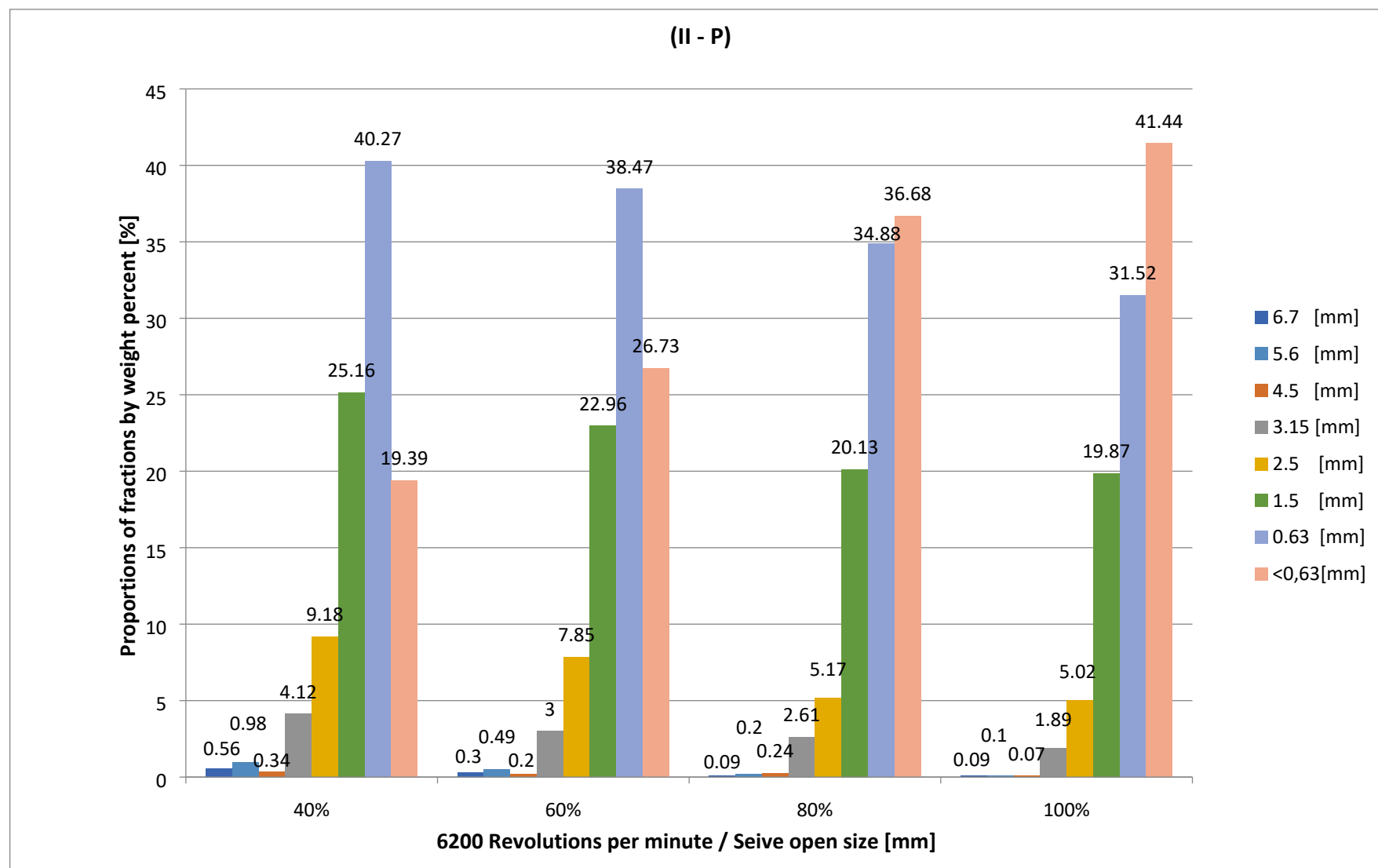
**Table 11.** Particle size distribution according to rotor speed for (II – P)

(II – P) Particle sizes [mm]									
Mesh sizes [mm]	6.70	5.60	4.50	3.15	2.50	1.50	0.63	<0.63	Σ
6200 RPM									
0.40	0.56	0.98	0.34	4.12	9.18	25.16	40.27	19.39	100.00
0.60	0.3	0.49	0.2	3	7.85	22.96	38.47	26.73	100.00
0.80	0.09	0.2	0.24	2.61	5.17	20.13	34.88	36.68	100.00
1.00	0.09	0.1	0.07	1.89	5.02	19.87	31.52	41.44	100.00

In comparison with the previous partial tests on LAV 400/1R, we can notice that after the 20<sup>th</sup> minute, there was a kind of stabilization in temperature increase Figure 47. Only an increase of 4°C in comparison with 17°C during the first 20 minutes, all when testing with maximum rotor speed of 6,200 RPM.



**Figure 47.** Temperature related to time for (I – P)



**Figure 48.** Particle sizes distribution related to rotor speed for (II – P) [mm]

Although the increase in temperature was low during the last 20 minutes, the moisture content reduction gave a good result (Figure 49).

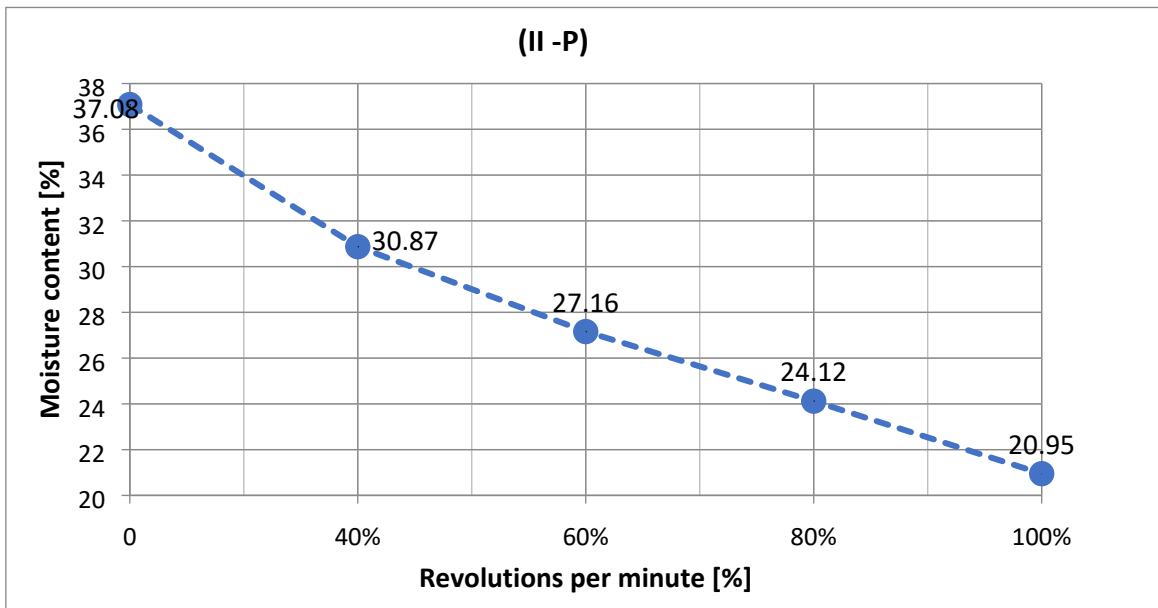


Figure 49. Moisture content related to rotor speed for (II - P)

Also, during this test, still we can notice low power consumption level as in the previous tests done for both other materials using LAV 300/2R, i.e. 15.30 kW for (II - A), 15.90 kW for (II - M) and 15.20 kW for (II - P). Low power consumption was with stable material flow of  $380 \text{ kg}\cdot\text{h}^{-1}$ . We will discuss about the obtained data in the following chapter.

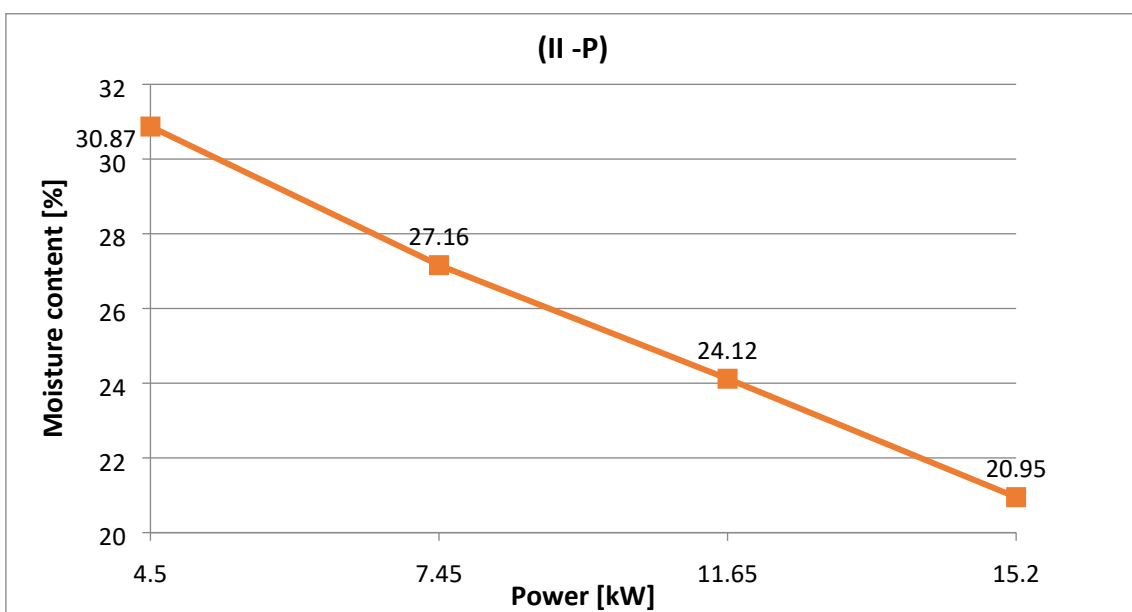


Figure 50. Power related to moisture content for (II - P)



## 6. Discussion and conclusions

The main challenge we are facing during discussion and comparisons with other researches and authors, is the fact that this thesis is dedicated a new and untraditional way of biomass drying by using energy as by-product from the milling process when using High-Speed Mills. Number of authors have committed to the knowledge gained and confirmed from our tests, even when using other devices. The common is that grinding of biomass with higher moisture content is a challenge, which should be solved for an enhanced process of biomass treatment.

We can find several attempts to mention similar subjects by other authors and researchers, such as Kratky & Jirout (2015). Where the use of a disintegrator (H. S. Mill) was for the biomass of high moisture content, without a focus in the moisture content reduction as an aim of the process. In our case, both H.S. Mills fulfilled this assumption and the high energy and heat inside the H.S. Mill during the process helped to circumvent this challenge. This is in line with the statement of Mohsenin (1986), who concluded that almost all of the energy in the grinding process is wasted as heat, and that from 0.06 to 1% of the input energy actually disintegrated the material.

As it was seen during the experiments, there are three factors which affect the treated material. First factor was the gap between milling discs, which has impact on the final size of the output material. Second factor was confirmed by Kratky & Jirout (2015), that milling course temperature as a result of friction forces inside the machine, affects the material moisture. Third factor of high importance is about a rotor speed, where by increasing of rotor speed, the output material size was smaller and the temperature was higher. These factors related to the operating conditions of the high-speed mills were all confirmed by our tests, recorded data from measurements and results.

Kratky & Jirout (2015) mentioned that mechanical disintegration is an effective preliminary step resulting in an increase in biogas yield and in the biodegradability of lignocellulosic biomass. But expressed that grinders and crushers, presently operating at biofuel plants, in an economical and effective manner, do not achieve that

target with various types of biomass, mainly lignocellulosic biomass. I do believe that, depending on the results achieved during tests and measurements, that using of H. S. Mills could be one of the prospective solutions in this direction.

Dey et al. (2013) also wrote about similar result, reached by using an impact hammer mill. The quantum of specific energy expenditure plays an important role in determining the reduction ratio and therefore, has a definite relationship with the latter. Although the author was focusing on size reduction, but it is obvious and confirmed by our results, that the moisture content was surely affected by the mentioned process.

The experimental tests done by researches Voicu et al. (2016) showed that smaller is the particle size, higher is the energy consumption. I can confirm this statement, as the results were obviously in that direction.

Manlu et al. (2003) came to an opinion that the effects of biomass tensile and shear properties, moisture content, and biomass density were noted in size reduction processes. Using hammer mills to reduce particle size through hammer impact and that were classified as straight hammer mill, pre breaker-hammer mill and pre breaker-sieve-hammer mill. Many variables affect hammer mill performance and grinding efficiency. I can only identify with authors statement, as all our tests and results are showing similar conclusion. Mainly shear and friction forces inside the mill had the biggest effect, in combination of high speed, on energy

Heimann (1983) indicted that roller mills were 16% more energy effective than hammer mills in reducing grain to a small particle size (approximately 400 microns). By using of HS Mills, we reached similar or even better results, regarding to the final particle size as an output of the milled material (see Annexes 4 to 9).

Usrey et al. (1992) studied internal shear (tensile test) and shear strengths, and the pressure-density relationships of rice straw during compression. In the process of H. S. Milling, several forces affect the material inside the mill, like crushing, tearing, shearing, breaking, wiping, breaking and peeling, thus it is expected that the milled material will have a better behavior later on during the compression.

Austin (1971) mathematically described grinding processes generally used for homogenous brittle materials. This was used for ball mills, and I couldn't find any mathematical or physical models done for HS Mills, as this type of technology is very recent. Without doubt, this could help us to understand more the process of HS Milling, where knowledge about it is rare. For several years, LAVARIS is cooperating with CTU in Prague in several researches, showing that H. S. Mill could be alternative of ball mills for minerals and hard materials powdering.

Lopo (2002) compared three kinds of equipment (hammer mill, roll mill and vertical hammer mill). All these three mills led to a similar result such as size reduction, but they did not solve a material with higher moisture content, where HS Mills did.

Henkel (2016) published that "Drying" is the process in which the product is dried until the "safe-moisture" is reached, by removing water content from the materials. This was our aim and philosophy, to reach acceptable level of moisture content for further better application of the material. This target was achieved.

According to Guo et al. (2016) drying is the utmost commonly used method for protection of agricultural products or food. Further use of biomass in food or fodder production requires attention in choosing drying temperature, high temperature depredated all nutrients in the material. This is one of the advantages of H. S. Mills, where we are able to adjust the milling temperature by controlling air flow of the ventilator and the gap size between milling elements.

By Papiewski (2018) drying of biomass is a crucial operation from technological point of view; thanks to drying the material which would destruct in its natural state very quickly can be stored for a long time. So, this is another advantage of HS Mill, where the two in one process minimizes the milling and drying costs in shorter operation.

Yorgun (2015) wrote that drying often involves high energy consumption that is why it is essential to find/select an optimal drying equipment. That is why, this is the main motivation of using such technology, to optimize and reduce energy

consumption and thus overall cost. There are many indicators in our results, that such objective could be achieved.

Ivanova et al. (2012) reported that the speed of drying is affected by size, shape and type of the used material. We fully identify with this statement. Each of the three tested materials has different output particle sizes and drying speed. Smaller material has bigger specific surface, which, as I suppose, was effected with an energy released from the milling process.

It can be also mentioned that generally the drying methods are variable and can be classified as natural convention, electrical and mechanical methods (Veerakumar et al. 2014). The oldest and the simplest method is drying in open atmospheric space, known as Open Yard Sun Drying Method. Oven dryer is a simple electric method with no need for extra special equipment, but it can be used only on a small scale (Veerakumar et al. 2014). Spotlight drying method was shown by Manjula et al. (2014) in a laboratory experiment. Mechanical drying methods can be divided into two categories, direct and indirect, depending if the heat is in direct contact with the material or if a heat exchange surface is used (Wade A. Amos 1998).

With respect to all convention methods mentioned by the esteemed authors, I think that H. S. Mills can be suitable alternative to many of these methods. Taking in consideration the simplicity and uncomplicatedness of the process for the operators and the low energy consumption.

As mentioned before, the main motivations for this thesis was to introduce a possible, innovative and eco-friendly way of biomass processing before further operations, not only in the energy sector, but also in other sectors, offering a different and cheaper way, to crush and dry biomass materials, like a source for the production of many further products.

Based on the research results it can be concluded that the disintegration tests done in the framework of this dissertation Thesis – milling of three different biomass material showed that the use of high speed milling had a positive effect on significant of particle size reduction of all materials. Summarizing the main results, in case

of apple tree wood, the output was a size reduction, especially for the initial fraction bigger than 1.5 mm from 55% to 15% using LAV 400/1R. For miscanthus, it was a reduction from 61% to 13% and from 49% to 12% for pine wood sawdust. When using LAV 300/2R the size reduction in apple tree wood was to 11%, for miscanthus to 7% and for pine wood sawdust to 27%.

As a result of the process, size reduction wasn't the only obtained advantage, but also a significant moisture content reduction was achieved which brought the fulfilment of the main objective. Testing on LAV 400/ 1R on full rotor speed shows a reduction of moisture content in apple tree wood from 21.76% to 12.25%. *Miscanthus sinensis* from 24.43% to 14.78% and from 37.08% to 23.87% in pine wood sawdust. For (II – A) it reaches 9.11%, for (II – M) 13.10% and for (II – P) 20.95%.

Energy consumption was part of the main objective of this thesis and also is a very important parameter determining the effectiveness of the milling process, size reduction and moisture content decrease. To sum up, test (I – A) showed that 7.71 kW was needed to reduce the moisture content from 21.76% to 12.25%. (I – M) needed 6.77 kW to reduce the moisture from 24.43% to 14.78%. (I – P) took 7.10 kW to achieve the moisture drop from 37.08 % to 23.87%. For the second mill, (II – A) reached 9.11% from the origin 21.76% by using 15.30 kW, for (II – M) it was needed also about 15.90 kW to obtain 13.10% from 24.43% and almost the same power of 15.20 kW for (II – P) was required to reduce the material's moisture from 37.07% to 20.95%.

All the Hypotheses of the thesis and all the specific objectives were fulfilled. As biomass drying is usually a time consuming process, that's why utilization of High-Speed Mills for coincident biomass drying provides a good solution to the operating time as well, hence the experimental tests showed that application of the manufactured High-Speed Mills with a special construction is a promising technological solution for improved biomass pre-treatment, combining both effects, drying and grinding processes, which are typically very expensive and energy demanding operations, Karra'a et al. (2019).

Finally, it is feasible to do a simple comparison between the tested High-Speed Milling technologies and the conventional systems of milling and drying in relation to the energy consumption. By Deines & Pei (2010), the engine power of commonly applied biomass crushers is about 22 kW and the production output varies, between 400 to 1 000 kg. The engine power of typical drum dryer is 12–14 kW.h<sup>-1</sup> and hot air boiler 300–400 kW.h<sup>-1</sup>, Gigler et al. (2010); Li et al. (2012). So, both systems will need approximately 34–36 kW of electric engine power plus the energy for hot air boiler. Tested high-speed mill LAV 400/1R has maximum electric engine consumption of 7.71 kW.h<sup>-1</sup> for 380 kg, and the second high-speed mill LAV 300/2R has maximum electric consumption of 15.90 kW.h<sup>-1</sup> for 380 kg material. This comparison also shows the advantages of tested systems above the conventional ones. And it confirms, that the use of on rotor mill offers the advantage of lower power consumption for the same material.

Another advantage, which could motivate farmers and agro companies to use this system is its ability to be integrated into already existing and running systems. This is of high importance, since there is no need for extra investment to prepare the system installation. This could be, beside the low running cost, a key issue to make this solution more attractive and encourage investors to decide for it easily.

The system could be integrated to a briquetting or to pelletizing line. The material could be supplied directly from primary shredder to the HS Mill, with no need to pre-dry. It is a significant advantage to use the surplus surface and excess space for storage or operating and logistic purposes, since the installation space for this system does not exceed 50 m<sup>2</sup>.

## 7. Recommendations for further research

For further research we highly recommend to concentrate on the following:

- To study the effect of drying biomass using High-Speed Mills on other biomass materials from developing countries, also ways of proper implementation of such a technology for the target of sustainable development in agrarian and rural sectors;
- To study the mass air flow, controlled by the frequency inverter of the ventilator to optimize moisture reduction as a result of the milling process. The amount of air affects the temperature of all the procedure. This fact was used to cool the mill after each test, to reset the initial temperature as a start point;
- To study in deep, the effect of gap variation, which is possible in all H. S. Mills designed and produced by LAVARIS. The smaller the gap between H. S. Mill rotors, the greater friction is and higher temperature as a result of proper milling and energy release;
- To study the possibility of input material flow regulation by the screw conveyor, to achieve a better control on the stability of temperature level and to increase the safety of the process;
- To study the effect of thermal insulation of the hoses and cyclone, to minimize water condensation in the system, before material separation from the air with a significant percentage of humidity (moisture content);
- To develop an automated controlling system, that will integrate all variables of the line, to improve functionality of key parts of the milling and drying process, taking in consideration safety regulations.

---

## 8. References

- Akhmedov S, Ivanova T, Krepl V, Muntean A. 2017. Research on solid biofuels from cotton waste biomass – alternative for Tajikistan’s energy sector development. *Agronomy Research* **15**:1846–1855.
- Akhtar A, Krepl V, Ivanova T. 2018. Combined overview of combustion, pyrolysis, and gasification of biomass. *Energy and Fuels* **32**:7294–7318.
- Akhtar, J. & Amin, N.S. 2012. A review on operating parameters for optimum liquid oil yield in biomass pyrolysis. *Renewable and Sustainable Energy Reviews* **16**(7):5101–5109.
- Al-Thyabat S, Miles NJ. 2006. An improved estimation of size distribution from particle profile measurements. *Powder Technology* **166**:152–160.
- Austin, L. G. 1971/1972. A Review-Introduction to the Mathematical Description of Grinding as a Rate Process. *Powder Technology* **5**:1–17.
- Bajwa DS, Peterson T, Sharma N, Shojaeiarani J, Bajwa SG. 2018. A review of densified solid biomass for energy production. *Renewable and Sustainable Energy Reviews* **96**:296–305.
- Baranski J, Chuchala, D, Dzurenda, L, Mozinski, T, Orlovski, K. 2013. Determination of moisture content profiles of spruce wood after high temperature process and air drying. *Ann. WULS - SGGW, For. and Wood Technol* **82**.
- Belgiorno, V., De Feo, G., Della Rocca, C. & Napoli, R.M.A. 2003. Energy from gasification of solid wastes. *Waste Management* **23**(1):1–15.
- Bitra VSP, Womac AR, Chevanan N, Miu PI, Igathinathane C, Sokhansanj S, Smith DR. 2009a. Direct mechanical energy measures of hammer mill comminution of switchgrass, wheat straw, and corn stover and analysis of their particle size distributions. *Powder Technology* **193**:32–45.
- Bitra VSP, Womac AR, Yang YT, Igathinathane C, Miu PI, Chevanan N, Sokhansanj S. 2009b. Knife mill operating factors effect on switchgrass particle size distributions. *Bioresource Technology* **100**:5176–5188.
- Bledzki AK, Jaszkiwicz A, Murr M, Sperber VE, LÜTzendgrf R, ReußMann T, Pickering KL. 2008. 4 - Processing techniques for natural- and wood-fibre composites. Pages 163–192. *Properties and Performance of Natural-Fibre Composites*. Woodhead Publishing.
- Brosse N, Dufour A, Meng X, Ragauskas A. 2012. Miscanthus: A fast-growing crop for biofuels and chemicals production. *Biofuels Bioproducts and Biorefining* **6**:580–598.



- Brunerová A, Brožek M, Müller M. 2017a. Utilization of waste biomass from post-harvest lines in the form of briquettes for energy production. *Agronomy Research* **15**: 344–358.
- Černý, D., Malaťák, J. & Bradna, J. Influence of biofuel moisture content on combustion and emission characteristics of stove. *Agronomy Research* **14**(3):725–732.
- Chaloupková, V., Ivanova, T. & Havrland, B. 2016, Sieve analysis of biomass: accurate method for determination of particle size distribution. In: *Engineering for Rural Development*. Jelgava, Latvia, pp. 1012–1017.
- Chaloupková, V., Ivanova, T., Ekrt, O., Kabutey, A. & Herák, D. 2018. Determination of particle size and distribution through image-based macroscopic analysis of structure of biomass briquettes. *Energies* **11**(2):331/1–13.
- Cheng Yi, Wei Fei, Jin Yong. 2017. *Multiphase Reactor Engineering for Clean and Low-Carbon Energy Applications*.
- Chițoiu, M., Voicu, Gh., Paraschiv, G., Moiceanu, G., Vladut, V., Matache, M.G., Marin, E., Bunduchi, G., Danciu, A., Voicea, I. & Gageanu, I. 2016. Energy consumption of a hammer mill when chopping miscanthus stalks. In: 44. Symposium "Actual Tasks on Agricultural Engineering", Opatija, Croatia, pp. 215–223.
- Choi, S.H., Choi, Y.S. & Park, H.C. 2012. Fast pyrolysis characteristics of lignocellulosic biomass with varying reaction conditions. *Renewable Energy* **42**:131–135.
- Chuanzhong X., Liying C., Pei W., Yanhua M., Ding H. 2012. Development on a Hammer Mill with Separate Sieving Device. *TELKOMNIKA Indonesian Journal of Electrical Engineering* **10**(6):1151–1156.
- Clifton-Brown, J.C., Stampfl, P.F. & Jones, M.B. 2004. Miscanthus biomass production for energy in Europe and its potential contribution to decreasing fossil fuel carbon emissions. *Global Change Biology* **10**(2):509–518.
- Crocker M. 2010. *Thermochemical Conversion of Biomass to Liquid Fuels and Chemicals*.
- Dai J, Cui H, Grace JR. 2012. Biomass feeding for thermochemical reactors. *Progress in Energy and Combustion Science* **38**:716–736.
- Davis, S.C., Parton, W.J., Dohleman, F.G., Smith, C.M., Del Grosso, S., Kent, A.D. & Delucia, E.H. 2010. Comparative biogeochemical cycles of bioenergy crops reveal nitrogen-fixation and low greenhouse gas emissions in a Miscanthus × giganteus agroecosystem. *Ecosystems* **13**:144–156.
- De Jong, W. & Van Ommen, J.R. 2014. *Biomass as a sustainable energy source for the future: fundamentals of conversion processes*. John Wiley & Sons, Hoboken, New Jersey, 582 pp.

- 
- Deac, T., Fechete-Tutunaru, L. & Gaspar, F. 2015. Environmental impact of sawdust briquettes use – experimental approach. *Energy Procedia* **85**:178–183.
- Deines, T. Nottingham, D. Pei, Z. J. 2010. Effects of Biomass Type and Sieve Size on Power Consumption in Knife Milling. *Proceedings of the 2010 Industrial Engineering Research Conference*.
- Demirbas A, Demirbas AS, Demirbas AH. 2004. Briquetting Properties of Biomass Waste Materials. *Energy sources* **26**:83–91.
- Demirbas A. 2005. Fuel and combustion properties of bio-wastes. *Energy Sources* **27**:451–462.
- Demirbas, A. 2004. Combustion characteristics of different biomass fuels. *Progress in Energy and Combustion Science* **30**:219–230.
- Dey, A.K., Dey, S., Das, A. 2013. Comminution features in an impact hammer mill, *Powder Technology* **235**:914–920.
- EN ISO 17827-1. 2016. Solid biofuels. Determination of particle size distribution for uncompressed fuels. Oscillating screen method using sieves with apertures of 3,15 mm and above. BSI Standards Publication, 18 pp.
- EN ISO 18134-3. 2015. Solid biofuels – Determination in moisture content – Oven dry method: Part 3: Moisture in general analysis sample. BSI Standards Publication, 14 pp.
- Energetický regulační úřad. Accessible at: [https://www.eru.cz/documents/10540/473304/165\\_2012\\_AJ.pdf/5e2856ee-dbb6-4e0f-891a-ef771f5511cf](https://www.eru.cz/documents/10540/473304/165_2012_AJ.pdf/5e2856ee-dbb6-4e0f-891a-ef771f5511cf)
- Energetický regulační úřad. Accessible at: [https://www.eru.cz/documents/10540/473304/165\\_2012\\_AJ.pdf/5e2856ee-dbb6-4e0f-891a-ef771f5511cf](https://www.eru.cz/documents/10540/473304/165_2012_AJ.pdf/5e2856ee-dbb6-4e0f-891a-ef771f5511cf)
- Fernlund JMR. 1998. The effect of particle form on sieve analysis: a test by image analysis. *Engineering Geology* **50**:111–124.
- Flavel, M.D., and H.W. Rimmer. 1981. Particle Breakage in an impact Crushing Environment. pp.20.
- Freis J. 2008. *Stroje pro zpracování odpadu* [online]. Ostrava: Vysoká škola báňská – Technická univerzita.
- Gad-el-Hak M. 2008. *Large-Scale Disasters: Prediction, Control, and Mitigation*.
- Garcia-Maraver A., Perez-Jimenez J.A. 2015. *Biomass Pelletization: Standards and Production*.
- Garg H.P., Prakash Om. 2000. *Solar Energy: Fundamentals and Applications*.

- Gigler, F., Kanodia, C., Sapra, H., & Venugopalan, R. 2009. Accounting conservatism and the efficiency of debt contracts. *Journal of Accounting Research* **47**:767–797.
- Gil M, Arauzo I. 2014. Hammer mill operating and biomass physical conditions effects on particle size distribution of solid pulverized biofuels. *Fuel Processing Technology* **127**:80–87.
- Gil M, Teruel E, Arauzo I. 2014. Analysis of standard sieving method for milled biomass through image processing. Effects of particle shape and size for poplar and corn stover. *Fuel* **116**:328–340.
- Glé, P., Gourdon, E. & Arnaud, L. 2013. The effect of particle shape and size distribution on the acoustical properties of mixtures of hemp particles. *Acoustical Society America* **134**:4698–4709.
- Goldemberg J. 2012. *What Everyone Needs to Know*.
- Gong C, Huang J, Feng C, Wang G, Tabil L, Wang D. 2016. Effects and mechanism of ball milling on torrefaction of pine sawdust. *Bioresource Technology* **214**:242–247.
- Grinnell S. 2015. *Renewable Energy and Sustainable Design*.
- Grover PD, Mishra SK. 1996. *Biomass briquetting: technology and practise*. FAO, Bangkok.
- Guo, L., Tabil, L., Wang, D. & Wang, G. 2016. Research paper: Influence of moisture content and hammer mill screen size on the physical quality of barley, oat, canola and wheat straw briquettes. *Biomass and Bioenergy* **94**:201–208.
- Guo, Q., Xueli, C. & Haifeng, L. 2012. Experimental research on shape and size distribution of biomass particle. *Fuel* **94**:551–555.
- Hajratwala, B. R. 1982. Particle size reduction by a hammer mill I: Effect of output screen size, feed particle size, and mill speed. *Journal of pharmaceutical sciences*.
- Hartig K. 2017. Sušení Kalů. Accessible at: <http://www.agrocs.cz/get.php?id=408>
- Havrland, B., Pobedinschi, V., Vrancean, V., Pecen, J., Ivanova, T., Muntean, A. & Kandakov, A. 2011. *Biomass processing to biofuel*. PowerPrint, Prague-Chisinau, 86 pp.
- Heimann, M.A. 1983. Energy consumption and machine efficiency in particle reduction: A roller mill and hammermill comparison. In: *First international symposium on particle size reduction in the feed industry*. Kansas State University, Manhattan.
- Henkel, Ch., Muley, P.D., Abdollahi, K.K., Marculescu, C. & Boldor, D. 2016. Pyrolysis of energy cane bagasse and invasive Chinese tallow tree (*Triadica sebifera* L.) biomass in an inductively heated reactor. *Energy Conversion and Management* **109**:175–183.
- Holmgren P, Wagner DR, Strandberg A, Molinder R, Wiinikka H, Umeki K, Broström M. 2017. Size, shape, and density changes of biomass particles during rapid devolatilization. *Fuel* **206**:342–351.

- Hromádko J. 2012. Speciální spalovací motory a alternativní pohony.
- Huhtinen, M. 2005. Wood Biomass as a Fuel. Material for 5EURES Training Sessions. Joensuu, North Karelia University of Applied Sciences, 8 pp.
- Igathinathane C, Womac AR, Sokhansanj S. 2010. Corn stalk orientation effect on mechanical cutting. *Biosystems Engineering* **107**:97–106.
- Igathinathane, C., Melin, S., Sokhansanj, S., Bi, X., Lim, C.J., Pordesimo, L.O. & Columbus, E.P. 2009. Machine vision based particle size and size distribution determination of airborne dust particles of wood and bark pellets. *Powder Technology* **196**(2):202–212.
- Ivanova, T., Havrland, B., Hutla, P. & Muntean A. 2012. Drying of cherry tree chips in the experimental biomass dryer with solar collector. *Research in Agricultural Engineering* **58**(1):16–23.
- Jelínek L., et al. 2010. Ekonomický systém hodnocení výkonnosti zemědělských podniků respektující principy trvalé udržitelnosti hospodaření s přírodními zdroji. Praha: ÚZEI. p. 95.
- Jičínská, K. 2016. Analysis of the pyrolysis process of plant biomass. Bachelor thesis. Czech University of Life Sciences, Prague, 35 pp. (in Czech).
- Joo H., Kumar A. 2019. World biodiesel policies and production. Taylor & Francis group, LLC.
- Joubert, J.E., Carrier, M., Dahmen, N., Stahl, R. & Knoetze, J.H. 2015. Inherent process variations between fast pyrolysis technologies: A case study on Eucalyptus grandis. *Fuel Processing Technology* **131**:389–395.
- Jouiad, M., Al-Nofeli, N., Khalifa, N., Benyettou, F. & Yousef, L.F. 2015. Characteristics of slow pyrolysis biochars produced from rhodes grass and fronds of edible date palm. *Journal of Analytical and Applied Pyrolysis* **111**:183–190.
- Karra'a, G., Ivanova T., Kolarikova, M., Hutla. P., Krepl V. 2019. Using of high-speed mills for biomass disintegration. *Agronomy Research* **17**(1):155–164.
- Khan, B. H. 2009. Non Conventional Energy Resources. pp. 242.
- Kirsanovs, V., Žandeckis, A., Veidenbergs, I., Blumbergs, M., Gedrovičs, M. & Blumberga, D. 2014. Experimental study on optimisation of the burning process in a small scale pellet boiler due to air supply improvement. *Agronomy Research* **12**(2):499–510.
- Kituu, G. Shitanda, D. Kanali, C. L. Mailutha, J.T. Njoroge, C.K. Wainaina, J. K. Silayo V. 2010, Thin layer drying model for simulating the drying of Tilapia fish (*Oreochromis niloticus*) in a solar tunnel dryer. *Journal of Food Engineering* **98**(3):325–331.
- Klass, Donald L. 1998. Biomass for Renewable Energy, Fuels and Chemicals.

- Kratky, L. & Jirout, T. 2015. Mechanical disintegration of wheat straw using a roller-plate grinding system with sharp-edged segments. *Acta Polytechnica* **55** (2):113–122.
- Lela B, Barišić M, Nižetić S. 2016. Cardboard/sawdust briquettes as biomass fuel: Physical–mechanical and thermal characteristics. *Waste Management* **47**:236–245.
- Li M. 2014. Peak Oil, Climate Change, and the Limits to China's Economic Growth.
- Lopo, P. 2002. The right grinding solution for you: roll, horizontal or vertical. *Feed Management* **53**(3):23–26.
- Mani S, Tabil LG, Sokhansanj S. 2004a. Evaluation of compaction equations applied to four biomass species. *Canadian Biosystems Engineering* **46**:55–61.
- Mani, S., L.G. Tabil, and S. Sokhansanj. 2002. Grinding performance and physical properties of selected biomass. Paper No. 026175, ASAE, St. Joseph, MI.
- Manjula, B. Ramachandra, C. T. 2014. Effect of drying methods on physical and chemical characteristics of dried Byadagi chilli. *Journal of Innovative Agriculture* **1**(1):22–30.
- Manlu, Y., Womac, A.R. & Pordesimo, L.O. 2003. Review of biomass size reduction technology, ASAE Annual Meeting. Paper Number: 036077. Available at: <https://elibrary.asabe.org/abstract.asp?aid=15454>
- McKendry, P. 2002. Energy production from biomass (part 1): Overview of biomass. *Bioresource Technology* **83**(1):37–46.
- Mohammed, I.Y., Abakr, Y.A., Kazi, F.K., Yusuf, S., Alshareef, I. & Chin, S.A. 2015. Pyrolysis of Napier Grass in a Fixed Bed Reactor: Effect of Operating Conditions on Product Yields and Characteristics. *BioResources* **10**(4):6457–6478.
- Mohsenin, N. 1986. *Physical Properties of Plant and Animal Materials*. Gordon and Breach Science Publishers, New York.
- Mujumdar A. S. 2014. *Handbook of Industrial Drying*.
- Muntean, A., Ivanova, T., Hutla, P. & Havrand, B. 2017. Influence of raw material properties on the quality of solid biofuel and energy consumption in briquetting process. *Agronomy Research* **15**(4):1708–1715.
- Musil P. 2009. Globální energetický problém a hospodářská politika – se zaměřením na obnovitelné zdroje.
- Nunes L. JR, De Oliveira M, Joao C, Da Silva C, Joano P. 2017. Torrefaction of Biomass for Energy Applications: From Fundamentals to Industrial Scale.

- 
- Pang S, Bhattacharya S, Yan J. 2019. Drying of Biomass, Biosolids, and Coal: For Efficient Energy Supply and environmental Benefits.
- Panoutsou C. 2017. Modeling and Optimizing of Biomass Supply Chains: Top-Down and Bottom-up Assessment for Agricultural Forest and Waste Feedstock.
- Papiewski, J. 2018. What factors influence the rate of a chemical reaction? Sciencing. Available at: <https://sciencing.com/what-factors-influence-the-rate-of-a-chemical-reaction-13710452.html>
- Patel, M., Zhang, X. & Kumar, A. 2016. Techno-economic and life cycle assessment on lignocellulosic biomass thermochemical conversion technologies: A review. *Renewable and Sustainable Energy Reviews* **53**:1486–1499.
- Paulrud S, Mattsson JE, Nilsson C. 2002. Particle and handling characteristics of wood fuel powder: effects of different mills. *Fuel Processing Technology* **76**:23–39.
- Perez-Jimenez, J. A., Biomass Pellet-Fired Boilers. 2015. WIT Transactions on State of the Art in Science and Engineering **85**, WIT Press. ISSN 1755-8336.
- Petříková V. et al. 2006. Energetické plodiny. Praha: Profi Press. p. 127.
- Pietsch, W. 2008. Agglomeration Processes: Phenomena, Technologies, Equipment; John Wiley & Sons: New York, NY, USA, 614 pp.
- Prakash O, Kumar A. 2017. Solar Drying Technology: Concept, Design, Testing, Modeling, Economics, and Environment.
- Probst, K. V., Kingsly Ambrose, R.P., Pinto, R. L., Bali, R., Krishnakumar, P., Ileleji, K. E. 2003. The effect of moisture content on the performance of corn and corncobs bz hammermilling. *American Society of Agricultural and Biological Engineers* ISSN 2151-0032.
- Prokeš, K. 2011. Vacuum pyrolysis and it realization in CR. Biom. Available at <http://biom.cz/cz/odborne-clanky/vakuova-pyrolyza-a-jeji-realizace-v-cr> (in Czech).
- Quaschnig V. 2010. Obnovitelné zdroje.
- Quaschnig, Volker. 2010. Obnovitelné zdroje. Grada, Praha.
- Risollo-Calle F, Woods J. 2012. The Biomass Assessment Hadbook: Bioenergy for a Sustainable Environment..
- Rogers, J.G. & Brammer, J.G. 2012. Estimation of the production cost of fast pyrolysis biooil. *Biomass and Bioenergy* **36**:208–217.
- Rosillo-Call F, Bajay S.V., Rothman H. 2000. Industrial Uses of Biomass Energy: The Example of Brazil.

- Ruud van Ommen, J., Wiebren de Jong . 2014. Biomass as a Sustainable Energy Source for the Future, John Wiley & Sons, Hoboken, New Jersey pp 600.
- Schell, D.J., Hardwood, Ch. 1994. Milling of lignocellulosic biomass. *Applied Biochemistry and Biotechnology* **45–46**(1):159–168. DOI:10.1007/BF02941795
- Šejvl, R. 2013. Energy from wastes II. Available at <http://biom.cz/czp/odborneclanky/energie-z-odpadu-ii> (in Czech).
- Sencan A. 2012. Modeling and Optimization of Renewable Energy Systems.
- Sharma A, Kar S.K. 2015. Energy Sustainability Through Green Energy.
- Shih, Ch.-H., Latham, W. & Sarzynski, A. 2016. A collaborative framework for U.S. state-level energy efficiency and renewable energy governance. *The Electricity Journal* **29**(9):21–26.
- Shukla A, Sharma A. 2016. Energy Security and Sustainability.
- Sladký, V. & Hutla, P. 2000. Increasing calorificity of energetic wooden plants by drying. In: *Technika a technologie pro nepotravinářské využití půdy a její udřování v klidu*. Research Institute of Agricultural Engineering, Prague, pp. 36–48. (in Czech).
- Smil V. 2018. Energie.
- Smil, V. 2018. Energy in World History. Routledge, New York.
- Souza DOC, Menegalli FC. 2011. Image analysis: Statistical study of particle size distribution and shape characterization. *Powder Technology* **214**:57–63.
- Staffell I, Brett D. J.L, Brandon N.P. 2015. Domestic Microgeneration: Renewable and Distributed Energy Technologies, Policies and Economics.
- Studničková R. Sušení biomasy pro energetické účely. Accessible at: <https://biom.cz/cz/odborne-clanky/suseni-biomasy-pro-energeticke-ucely>
- Svihus B, Kløvstad KH, Perez V, Zimonja O, Sahlström S, Schüller RB, Jeksrud WK, Prestløkken E. 2004. Physical and nutritional effects of pelleting of broiler chicken diets made from wheat ground to different coarsenesses by the use of roller mill and hammer mill. *Animal Feed Science and Technology* **117**:281–293.
- Takacs, L. 2014. What Is Unique About Mechanochemical Reactions? *Acta Physica Polonica Series* **126**(4):1040–1043.
- Trávníček, P., Vitázek, I., Vítěz, T., Kotek, L. & Junga, P. 2015. Technology for biomass processing for energy use. Mendel University in Brno, Brno, 210 pp. (in Czech).

- Tripathi, M., Sahu, J.N., Ganesana, P. 2016. Effect of process parameters on production of biochar from biomass waste through pyrolysis: A review. *Renewable and Sustainable Energy Reviews* **55**:467–481.
- Tumuluru Jaya Shankar. 2018. *Biomass Preprocessing and Pretreatments for Production of Biofuels: Mechanical, Chemical and Thermal Methods*.
- Tumuluru J. S., Tabil LG, Song Y, Iroba KL, Meda V. 2014. Grinding energy and physical properties of chopped and hammer-milled barley, wheat, oat, and canola straws. *Biomass and Bioenergy* **60**:58–67.
- Tumuluru J. S. 2018. Effect of Moisture Content and Hammer Mill Screen Size on the Briquetting Characteristics of Woody and Herbaceous Biomass. *Powder and Particle*.
- Tumuluru, J. S. 2018. CRC Press, *Biomass Preprocessing and Pretreatments for Production of Biofuels*, CRC Press.
- Tumuluru, J. S. 2018. *Biomass preprocessing and pretreatments for production of biofuels: mechanical, chemical and thermal methods*. CRC Press, Taylor & Francis Group, 458 pp.
- Tumuluru, J.S., Wright, C.T., Hess, J.R. & Kenney, K.L. 2011. A review of biomass densification systems to develop uniform feedstock commodities for bioenergy application. *Biofuels Bioproducts and Biorefining* **5**(6):683–707.
- U.S. Energy Information Administration. Biomass Explained. Accessible at: [https://www.eia.gov/energyexplained/?page=biomass\\_home](https://www.eia.gov/energyexplained/?page=biomass_home)
- Ulusoy U, Igathinathane C. 2016. Particle size distribution modeling of milled coals by dynamic image analysis and mechanical sieving. *Fuel Processing Technology* **143**:100–109.
- Uribe-Toril, J., Ruiz-Real, J.L., Milán-García, J., Valenciano, J.P. *Energies* 2019, **12**(6), 1120; <https://doi.org/10.3390/en12061120>.
- Usrey, W.M. Muly, E.C. Fitzpatrick D. 1992. Lateral geniculate projections to the superficial layers of visual cortex in the tree shrew. *J Comp Neurol* **319**(1):159–171.
- Veerakumar, K. Marimuthu, G. Kadarkarai, M. 2014. Single-step novel biosynthesis of silver nanoparticles: A potent and eco-friendly mosquitocides. *Journal of Ecobiotechnology* **6**:1–8.
- Vich, M. 2017. Kompaktní a rychlé sušení. Accessible at: <https://www.vekama.cz/compact-and-rapid-drying/>
- Vigneault, C., T. M. Rothwell, and G. Bourgeois. 1992. Hammer mill grinding rate and energy requirements for thin and conventional hammer. *Canadian Agricultural Engineering* **34**(2):203–205.



- Vobořil, David. 2017. Biomasa – využití, zpracování, výhody a nevýhody, energetické využití v ČR. Accessible at: <https://oenergetice.cz/obnovitelne-zdroje/biomasa-vyuziti-zpracovani-vyhody-a-nevyhody/>
- Voicu, G., Paraschiv G., Vladut, V., Moiceanu, G. 2016. Energy consumption of a hammer mill when chopping miscanthus stalks.. Conference: PROCEEDINGS OF THE 44 INTERNATIONAL SYMPOSIUM ON AGRICULTURAL ENGINEERING "Actual Tasks on Agricultural Engineering".
- Wade, A. A. 1998. Report on Biomass Drying Technology. National Renewable Energy Laboratory.
- Wang Shurong, Luo Zhongyang. 2016. Pyrolysis of Biomass.
- Wang Y, Wu K, Sun Y. 2018. Effects of raw material particle size on the briquetting process of rice straw. *Journal of the Energy Institute* **91**:153–162.
- Wannapeera, J. & Worasuwanarak, N. 2015. Examinations of chemical properties and pyrolysis behaviors of torrefied woody biomass prepared at the same torrefaction mass yields. *Journal of Analytical and Applied Pyrolysis* **115**:279–287.
- Williams O, Newbolt G, Eastwick C, Kingman S, Giddings D, Lormor S, Lester E. 2016. Influence of mill type on densified biomass comminution. *Applied Energy* **182**:219–231.
- Womac AR, Yu M, Igathinathane C, Ye P, Hayes D, Narayan S, Sokhansanj S, Wright L. 2005. Shearing characteristics of biomass for size reduction. ASAE Paper No. 056058, St. Joseph, Michigan.
- Yorgun, S. & Yildiz, D. 2015. Slow pyrolysis of paulownia wood: Effects of pyrolysis parameters on product yields and bio-oil characterization. *Journal of Analytical and Applied Pyrolysis* **114**:68–78.
- Zafar S. 2019. Importance of biomass energy. Bioenergy consult.
- Zákony pro lidi. Par. 2 (b), 165/2012. Accessible at: <https://www.zakonyprolidi.cz/cs/2012-165>
- Zárybnická, M. 2015. Biomasa – obnovitelný zdroj energie.

## 9. List of annexes

Annex 1. Apple tree wood .....	89
Annex 2. <i>Miscanthus sinensis</i> .....	90
Annex 3. Pine Wood sawdust.....	91
Annex 4. (I – A) .....	92
Annex 5. (II – A) .....	94
Annex 6. (I – M) .....	96
Annex 7. (II – M) .....	98
Annex 8. (I – P).....	100
Annex 9. (II – P).....	102

## 10. Annexes

### Annex 1. Apple tree wood



Výzkumný ústav zemědělské techniky, v. v. i.  
Drnovská 507, P.O. Box 54, 161 01 Praha 6 -Ruzyně  
zapsaná v rejstříku v.v.i., vedeném u MŠMT, spis.zn. 17 023/2006-34/VÚZT  
IČ: 00027031; DIČ: CZ00027031

### CONFIRMATION

No. 112-2016

For the material: **apple tree wood**

Customer: LAVARIS s.r.o.  
Areál šroubáren 43  
252 66 Liběnice nad Vltavou

Výzkumný ústav zemědělské techniky, v.v.i.  
(Research Institute of Agricultural Engineering, p.r.i.)  
Prague 6 - Ruzyně, Czech Republic

does approve that the sample of concerned product was analyzed  
in accordance with EN ISO 17225-1 with the following results:

Analytical characteristic	Unit	As received	Dry
Total water	%	47,58	-
Volatile matter	%	42,02	80,16
Non volatile matter	%	9,62	18,35
Ash	%	0,78	1,49
Gross calorific value	MJ/kg	10,48	20,00
Net calorific value	MJ/kg	8,63	18,67
Al	mg/kg	350,37	668,39
P	mg/kg	142,28	271,42
V	mg/kg	< DL	< DL
Cr	mg/kg	0,83	1,59
Mn	mg/kg	270,91	516,81
Fe	mg/kg	1132,04	2159,55
Co	mg/kg	0,25	0,47
Ni	mg/kg	0,11	0,21
Cu	mg/kg	3,22	6,14
Zn	mg/kg	15,57	29,70
As	mg/kg	0,04	0,07
Se	mg/kg	0,02	0,04
Cd	mg/kg	0,25	0,47
Hg	mg/kg	0,04	0,07
Pb	mg/kg	0,45	0,86

The sampling was carried out by the customer. The confirmation becomes ineffective if any technical specification is changed.

Prague, July 10, 2016

Responsible worker: Ing. Michel Kolaříková

The test results mentioned above refer to the tested specimen only.

Research Institute of Agriculture Engineering, p.r.i., Drnovská 507, Praha 6 - Ruzyně, 161 01,  
Czech Republic  
Phone: +420 233022238, Fax: +420 233312507, e-mail: petr.hutla@vuzt.cz, www.vuzt.cz

Č.j. VUZT/527/2016

Annex 2. *Miscanthus sinensis*

Výzkumný ústav zemědělské techniky, v. v. i.  
Drnovská 507, P.O. Box 54, 161 01 Praha 6 -Ruzyně  
zapsaná v rejstříku v.v.i., vedeném u MŠMT, spis.zn. 17 023/2006-34/VÚZT  
IČ: 00027031; DIČ: CZ00027031

## CONFIRMATION

No. 111-2016

For the material: **Miscanthus sinensis**

Customer: LAVARIS s.r.o.  
Areál šroubáren 43  
252 66 Libčice nad Vltavou

Výzkumný ústav zemědělské techniky, v.v.i.  
(Research Institute of Agricultural Engineering, p.r.i.)  
Prague 6 - Ruzyně, Czech Republic

does approve that the sample of concerned product was analyzed  
in accordance with EN ISO 17225-1 with the following results:

Analytical characteristic	Unit	As received	Dry
Total water	%	59,28	-
Volatile matter	%	29,57	72,63
Non volatile matter	%	9,13	22,42
Ash	%	2,02	4,95
C	%	20,15	49,49
H	%	2,45	6,02
N	%	1,14	2,81
Gross calorific value	MJ/kg	7,78	19,11
Net calorific value	MJ/kg	-	17,80
Al	mg/kg	675,96	1660,01
P	mg/kg	527,53	1295,50
V	mg/kg	0,09	0,22
Cr	mg/kg	0,32	0,79
Mn	mg/kg	187,61	460,72
Fe	mg/kg	50,26	123,42
Co	mg/kg	0,05	0,12
Ni	mg/kg	0,10	0,24
Cu	mg/kg	3,69	9,07
Zn	mg/kg	4,61	11,31
As	mg/kg	0,01	0,03
Se	mg/kg	0,02	0,06
Cd	mg/kg	0,08	0,19
Hg	mg/kg	0	0,01
Pb	mg/kg	0,11	0,26

The sampling was carried out by the customer. The confirmation becomes ineffective if any technical specification is changed.

Prague, July 10, 2016

Responsible worker: Ing. Michel Kolaříková

The test results mentioned above refer to the tested specimen only.

Research Institute of Agriculture Engineering, p.r.i., Drnovská 507, Praha 6 - Ruzyně, 161 01,  
Czech Republic  
Phone: +420 233022238, Fax: +420 233312507, e-mail: petr.hutla@vuzt.cz, www.vuzt.cz

Č.j. VUZT/526/2016

## Annex 3. Pine Wood sawdust



Výzkumný ústav zemědělské techniky, v. v. i.  
Drnovská 507, P.O. Box 54, 161 01 Praha 6 -Ruzyně  
zapsaná v rejstříku v.v.i., vedeném u MŠMT, spis.zn. 17 023/2006-34/VUZT  
IČ: 00027031; DIČ: CZ00027031

## CONFIRMATION

No. 105-2016

For the material: **woody sawdust**

Customer: LAVARIS s.r.o.  
Areál šroubáren 43  
252 66 Liběnice nad Vltavou

Výzkumný ústav zemědělské techniky, v.v.i.  
(Research Institute of Agricultural Engineering, p.r.i.)  
Prague 6 - Ruzyně, Czech Republic

does approve that the sample of concerned product was analyzed  
in accordance with EN ISO 17225-1 with the following results:

Analytical characteristic	Unit	As received	Dry
Total water	%	43,1	-
Volatile matter	%	46,54	81,80
Non volatile matter	%	10,12	17,78
Ash	%	0,24	0,42
C	%	28,43	49,97
H	%	3,48	6,11
N	%	0,07	0,13
Gross calorific value	MJ/kg	11,47	20,16
Net calorific value	MJ/kg	9,67	18,83
Al	mg/kg	64,14	112,73
P	mg/kg	37,62	66,12
V	mg/kg	0,29	0,51
Cr	mg/kg	0,30	0,52
Mn	mg/kg	40,47	71,12
Fe	mg/kg	39,33	69,12
Co	mg/kg	0,06	0,11
Ni	mg/kg	0,04	0,07
Cu	mg/kg	0,57	1,00
Zn	mg/kg	4,83	8,50
As	mg/kg	0,001	0,002
Se	mg/kg	0,02	0,03
Cd	mg/kg	0,07	0,12
Hg	mg/kg	0,003	0,006
Pb	mg/kg	0,26	0,46

The sampling was carried out by the customer. The confirmation becomes ineffective if any technical specification is changed.

Prague, July 10, 2016

Responsible worker: Ing. Michel Kolaříková

The test results mentioned above refer to the tested specimen only.

Research Institute of Agriculture Engineering, p.r.i., Drnovská 507, Praha 6 - Ruzyně, 161 01,  
Czech Republic  
Phone: +420 233022238, Fax: +420 233312507, e-mail: petr.hutla@vuzt.cz, www.vuzt.cz

Č.j. VUZT/520/2016

**Annex 4. (I – A)**

LAV 400/1R

Datum 09.08.2016

**7800 RPM****40 % revolutions**

no material	initial temperature	22	°C					
	no-load power	2.27	kW					
	temperature rise [°C]	25	°C					
with material	power crushing	3	kW					
	time [min]	0	5	10	15	20	25	30
	temperature rise [°C]	25	28	30	34	36	40	42
	Moisture content at entry (%)	21.76						
	at exit	18.20						

**60 % revolutions**

no material	initial temperature	22	°C					
	no-load power	3.5	kW					
	temperature rise [°C]	27	°C					
with material	power crushing	4.46	kW					
	time [min]	0	5	10	15	20	25	30
	temperature rise [°C]	27	31	35	38	42	43	46
	Moisture content at entry (%)	21.76						
	at exit	16.52						

**80 % revolutions**

no material	initial temperature	22	°C					
	no-load power	4.8	kW					
	temperature rise [°C]	34	°C					
with material	power crushing	6.21	kW					
	time [min]	0	5	10	15	20	25	30
	temperature rise [°C]	34	38	44	46	48	50	51
	Moisture content at entry (%)	21.76						
	at exit	13.70						

**100 % revolutions**

no material	initial temperature	23	°C					
	no-load power	5.25	kW					
	temperature rise [°C]	40	°C					
with material	power crushing	7.71	kW					
	time [min]	0	5	10	15	20	25	30
	temperature rise [°C]	40	45	52	53	55	56	56
	Moisture content at entry (%)	21.76						
	at exit	12.50						

<b>(I - A) Particle sizes [mm]</b>									
<b>Mesh Sizes [mm]</b> <b>7800 RPM</b>	<b>6.7</b>	<b>5.6</b>	<b>4.5</b>	<b>3.15</b>	<b>2.5</b>	<b>1.5</b>	<b>0.63</b>	<b>&lt;0.63</b>	<b>Σ</b>
0.40	1.27	1.53	2.42	3.87	10.82	36.93	28.11	15.05	100
0.60	1.08	2.02	2.29	2.54	6.2	24.84	31.53	29.5	100
0.80	0.71	0.82	1.24	2.84	4.5	16.87	35.07	37.95	100
1.00	0.14	0.2	0.39	2.95	2.74	8.59	40.36	44.63	100

**Annex 5. (II – A)**

LAV 300/2R

Date

16.08.2016

**6200 RPM****40 % revolutions**

Material	Initial temperature	22	°C						
	no-load power	3.98	kW						
	temperature rise [°C]	28	°C						
Material feeding	power crushing	4.35	kW						
	time [min]	0	5	10	15	20	25	30	
	temperature rise [°C]	28	32	37	39	42	46	49	
	Moisture content (%)	input	21.76						
		output	17.98						

**60 % revolutions**

no material	initial temperature	22	°C						
	no-load power	6.1	kW						
	temperature rise [°C]	32	°C						
with material	power crushing	7.8	kW						
	time [min]	0	5	10	15	20	25	30	
	temperature rise [°C]	32	36	38	40	43	46	50	
	Moisture content (%)	Input	21.76						
		output	15.17						

**80 % revolutions**

no material	initial temperature	23	°C						
	no-load power	8.85	kW						
	temperature rise [°C]	36	°C						
with material	power crushing	11.35	kW						
	time [min]	0	5	10	15	20	25	30	
	temperature rise [°C]	36	40	42	44	47	50	53	
	Moisture content (%)	input	21.76						
		output	12.43						

**100 % revolutions**

no material	initial temperature	23	°C						
	no-load power	12.35	kW						
	temperature rise [°C]	46	°C						
with material	power crushing	15.9	kW						
	time [min]	0	5	10	15	20	25	30	
	temperature rise [°C]	46	50	52	56	59	61	64	
	Moisture content (%)	input	21.76						
		output	9.11						



<b>(II – A) Particle sizes [mm]</b>									
<b>Mesh sizes [mm] 6200 RPM</b>	<b>6.70</b>	<b>5.60</b>	<b>4.50</b>	<b>3.15</b>	<b>2.50</b>	<b>1.50</b>	<b>0.63</b>	<b>&lt;0.63</b>	<b>Σ</b>
0.40	1.27	1.53	2.42	3.27	9.62	34.85	29.31	17.73	100.00
0.60	1.08	2.02	2.29	2.3	5.25	22.9	30.36	33.8	100.00
0.80	0.71	0.82	1.24	2	3.45	13.47	33.17	45.14	100.00
1.00	0.14	0.2	0.39	1.85	2.14	6.35	41.6	47.33	100.00

**Annex 6. (I – M)**

LAV 400/1R

Datum 10.08.2016

**7800 RPM****40 % revolutions**

no material	initial temperature	23 °C
	no-load power	2.27 kW
	temperature rise [°C]	26 °C

with material	power crushing	2.9 kW
	time [min]	0 5 10 15 20 25 30
	temperature rise [°C]	26 27 28 28 30 31 32
	Moisture content at entry (%)	24.43
	at exit	21.18

**60 % revolutions**

no material	initial temperature	23 °C
	no-load power	3.5 kW
	temperature rise [°C]	26 °C

with material	power crushing	4.4 kW
	time [min]	0 5 10 15 20 25 30
	temperature rise [°C]	26 27 28 28 29 31 32
	Moisture content at entry (%)	24.43
	at exit	19.68

**80 % revolutions**

no material	initial temperature	23 °C
	no-load power	4.74 kW
	temperature rise [°C]	30 °C

with material	power crushing	6 kW
	time [min]	0 5 10 15 20 25 30
	temperature rise [°C]	30 31 32 32 34 35 36
	Moisture content at entry (%)	24.43
	at exit	16.09

**100 % revolutions**

no material	initial temperature	23 °C
	no-load power	5.3 kW
	temperature rise [°C]	40 °C

with material	power crushing	6.77 kW
	time [min]	0 5 10 15 20 25 30
	temperature rise [°C]	40 42 46 50 48 50 51
	Moisture content at entry (%)	24.43
	at exit	14.78

<b>(I – M) Particle sizes [mm]</b>									
<b>Mesh Sizes [mm] 7800 RPM</b>	<b>6.70</b>	<b>5.60</b>	<b>4.50</b>	<b>3.15</b>	<b>2.50</b>	<b>1.50</b>	<b>0.63</b>	<b>&lt;0.63</b>	<b>Σ</b>
0.40	1.94	2.25	3.13	4.18	2.37	15.81	30.56	39.76	100.00
0.60	1.01	0.75	1.94	2.87	2.75	11.38	35.92	43.38	100.00
0.80	0.22	0.36	0.97	1.54	2.82	10.15	38.89	45.05	100.00
1.00	0.1	0.15	0.05	0.32	0.73	11.24	40.09	47.32	100.00

**Annex 7. (II – M)**

LAV 300/2R

Datum 16.08.2016

**6200 RPM****40 % revolutions**

no material	initial temperature	23	°C					
	no-load power	3.98	kW					
	temperature rise [°C]	26	°C					
with material	power crushing	4.35	kW					
	time [min]	0	5	10	15	20	25	30
	temperature rise [°C]	28	30	33	35	37	40	44
	Moisture content (%) at entry	24.43						
	at exit	20.18						

**60 % revolutions**

no material	initial temperature	23	°C					
	no-load power	6.1	kW					
	temperature rise [°C]	26	°C					
with material	power crushing	7.8	kW					
	time [min]	0	5	10	15	20	25	30
	temperature rise [°C]	31	35	37	39	42	45	48
	Moisture content (%) at entry	24.43						
	at exit	17.09						

**80 % revolutions**

no material	initial temperature	23	°C					
	no-load power	8.85	kW					
	temperature rise [°C]	30	°C					
with material	power crushing	11.35	kW					
	time [min]	0	5	10	15	20	25	30
	temperature rise [°C]	35	39	41	44	47	51	55
	Moisture content (%) at entry	24.43						
	at exit	15.47						

**100 % revolutions**

no material	initial temperature	23	°C					
	no-load power	12.35	kW					
	temperature rise [°C]	40	°C					
with material	power crushing	15.9	kW					
	time [min]	0	5	10	15	20	25	30
	temperature rise [°C]	44	48	50	53	55	58	61
	Moisture content (%) at entry	24.43						
	at exit	13.10						

<b>(II – M) Particle sizes [mm]</b>									
<b>Mesh sizes [mm]</b> <b>6200 RPM</b>	<b>6.70</b>	<b>5.60</b>	<b>4.50</b>	<b>3.15</b>	<b>2.50</b>	<b>1.50</b>	<b>0.63</b>	<b>&lt;0.63</b>	<b>Σ</b>
0.40	1.51	1.97	3.43	3.18	2.27	10.61	35.54	41.49	100.00
0.60	0.83	0.9	1.25	2.88	2.15	9.43	37.75	44.81	100.00
0.80	0.5	0.42	0.95	1.45	1.82	7.55	40.69	46.62	100.00
1.00	0.08	0.4	0.88	0.42	0.76	4.54	42.05	50.87	100.00

**Annex 8. (I – P)**

LAV 400/1R

Datum 10.08.2016

**7800 RPM****40 % revolutions**

no material	initial temperature	23 °C
	no-load power	2.27 kW
	temperature rise [°C]	28 °C

with material	power crushing	2.9 kW
	time [min]	0 5 10 15 20 25 30
	temperature rise [°C]	28 30 32 33 35 36 38
Moisture content (%)	at entry	37.08
	at exit	31.15

**60 % revolutions**

no material	initial temperature	23 °C
	no-load power	3.5 kW
	temperature rise [°C]	30 °C

with material	power crushing	4.35 kW
	time [min]	0 5 10 15 20 25 30
	temperature rise [°C]	30 32 35 37 38 40 41
Moisture content (%)	at entry	37.08
	at exit	28.53

**80 % revolutions**

no material	initial temperature	23 °C
	no-load power	4.8 kW
	temperature rise [°C]	35 °C

with material	power crushing	6 kW
	time [min]	0 5 10 15 20 25 30
	temperature rise [°C]	35 38 40 42 44 48 51
Moisture content (%)	at entry	37.08
	at exit	26.94

**100 % revolutions**

no material	initial temperature	23 °C
	no-load power	5.25 kW
	temperature rise [°C]	43 °C

with material	power crushing	7 kW
	time [min]	0 5 10 15 20 25 30
	temperature rise [°C]	43 46 54 54 57 60 60
Moisture content (%)	at entry	37.08
	at exit	23.87

<b>(I – P) Particle sizes [mm]</b>									
<b>Mesh sizes [mm]</b> <b>7800 RPM</b>	<b>6.70</b>	<b>5.60</b>	<b>4.50</b>	<b>3.15</b>	<b>2.50</b>	<b>1.50</b>	<b>0.63</b>	<b>&lt;0.63</b>	<b>Σ</b>
0.40	0.87	1.13	0.98	5.18	10.56	22.54	30.82	27.92	100.00
0.60	0.52	0.3	0.7	4.09	3.11	11.67	32.89	46.72	100.00
0.80	0.21	1.02	0.08	0.9	2.21	10.16	37.45	47.97	100.00
1.00	0.12	0.09	0.07	0.31	2.87	8.57	38.78	49.19	100.00

**Annex 9. (II – P)**

LAV 300/2R

Datum 17.08.2016

**6200 RPM****40 % revolutions**

no material	initial temperature	25 °C
	no-load power	4 kW
	temperature rise [°C]	28 °C

with material	power crushing	4.35 kW
	time [min]	0 5 10 15 20 25 30
	temperature rise [°C]	28 32 35 38 40 42 44
	Moisture content at entry (%)	37.08
	at exit	30.87

**60 % revolutions**

no material	initial temperature	25 °C
	no-load power	6.1 kW
	temperature rise [°C]	30 °C

with material	power crushing	7.8 kW
	time [min]	0 5 10 15 20 25 30
	temperature rise [°C]	30 33 37 39 42 45 47
	Moisture content at entry (%)	37.08
	at exit	27.16

**80 % revolutions**

no material	initial temperature	25 °C
	no-load power	8.85 kW
	temperature rise [°C]	32 °C

with material	power crushing	11.35 kW
	time [min]	0 5 10 15 20 25 30
	temperature rise [°C]	32 36 39 42 45 48 51
	Moisture content at entry (%)	37.08
	at exit	24.12

**100 % revolutions**

no material	initial temperature	26 °C
	no-load power	12.35 kW
	temperature rise [°C]	40 °C

with material	power crushing	15.9 kW
	time [min]	0 5 10 15 20 25 30
	temperature rise [°C]	40 45 49 53 57 60 62
	Moisture content at entry (%)	37.08
	at exit	20.95



<b>(II – P) Particle sizes [mm]</b>									
<b>Mesh sizes [mm]</b> <b>6200 RPM</b>	<b>6.70</b>	<b>5.60</b>	<b>4.50</b>	<b>3.15</b>	<b>2.50</b>	<b>1.50</b>	<b>0.63</b>	<b>&lt;0.63</b>	<b>Σ</b>
0.40	0.56	0.98	0.34	4.12	9.18	25.16	40.27	19.39	100.00
0.60	0.3	0.49	0.2	3	7.85	22.96	38.47	26.73	100.00
0.80	0.09	0.2	0.24	2.61	5.17	20.13	34.88	36.68	100.00
1.00	0.09	0.1	0.07	1.89	5.02	19.87	31.52	41.44	100.00