

Czech University of Life Sciences Prague

Faculty of Economics and Management

Department of Information Technologies



Diploma Thesis

**Unified Theory of Acceptance and Use of Technology
(UTAUT) LEGO Sets in Education**

Abeer Abusobaih

© 2021 CZU Prague

CZECH UNIVERSITY OF LIFE SCIENCES PRAGUE

Faculty of Economics and Management

DIPLOMA THESIS ASSIGNMENT

Eng. ABEER ABU-Sobaih, BSc

Systems Engineering and Informatics
Informatics

Thesis title

Unified Theory of Acceptance and Use of Technology (UTAUT) LEGO Sets in Education

Objectives of thesis

The main objectives of this study:

- To identify the benefits of including LEGO education sets in the education classes, its influence on the student's acceptance, and understanding.
- To recommend including LEGO education sets as a main class in study plan, according to LEGO sets could be used to explain science, and math concepts, also could teach students about team works, leadership, and collaboration.
- To make students familiar with programming, LEGO has a software part. It could be a good start of programming for primary school students.

Methodology

Using user acceptance testing (UAT) based on unified theory of acceptance and use of technology model (UTAUT), to determine the factors that influence the student's intention to use LEGO sets. Where I will focus on four variables are performance expectancy, effort expectancy, social influence, and enjoyment, with two moderate variables are age and gender.

Where performance expectancy will focus on improvement of using this tool in education, positive impacts on performance, and the useless for the schools.

Effort expectancy will focus on ease of using LEGO sets, and the importance of the use. Social influence focuses on the acceptance of using LEGO sets, and the benefits by using those sets.

The data collection will be from positive research about using LEGO sets in education and the best results will be recommendation.

The proposed extent of the thesis

60-80p.

Keywords

LEGO education, LEGO sets, Robotics education, UTAUT, Education, ICT

Recommended information sources

- Bahjat Altakhayneh. (2020). The Impact of Using the LEGO Education Program on Mathematics Achievement of Different Levels of Elementary Students, *European Journal of Educational Research*, 9 (2) , 603-610.
- David T. Butterworth. Teaching C/C++ programming with Lego Mindstorms. In proceedings of the 3rd International Conference on Robotics in Education. 2012.
- Isabelle M. L. Souza, Wilkerson L. Andrade, L'ivia M. R. Sampaio, Ana Liz Souto O. Araujo. A Systematic Review on the use of LEG Robotics in Education. In proceedings of 2018 IEEE Frontiers in Education Conference (FIE), 3-6 Oct. 2018
- Roslina Ibrahim, Azizah Jaafar. (2011). User Acceptance of Educational Games: A Revised Unified Theory of Acceptance and Use of Technology (UTAUT), *International Journal of Social, Behavioral, Educational, Economic, Business and Industrial Engineering* Vol:5, No:5.
- Venkatesh V, Zhang X (2010) Unified theory of acceptance and use of technology: U.S. vs. China. *Journal of Global Information Technology Management* 13: 5-27.

Expected date of thesis defence

2020/21 SS – FEM

The Diploma Thesis Supervisor

Ing. Martin Havránek, Ph.D.

Supervising department

Department of Information Technologies

Electronic approval: 7. 9. 2020

Ing. Jiří Vaněk, Ph.D.

Head of department

Electronic approval: 19. 10. 2020

Ing. Martin Pelikán, Ph.D.

Dean

Prague on 08. 03. 2021

Declaration

I declare that I have worked on my diploma thesis titled "Unified Theory of Acceptance and Use of Technology (UTAUT) LEGO Sets in Education" by myself and I have used only the sources mentioned at the end of the thesis. As the author of the diploma thesis, I declare that the thesis does not break any copyrights.

In Prague on 17.03.2021

_____ Abeer _____

Acknowledgement

I would like to thank my supervisor Ing. Martin Havranek, Ph.D. for his advice and support during my work on this thesis.

I would like to express my special thanks to my father Khalid Abusobaih who gave me the golden opportunity to complete my study, without your support I would not have reached to where I am today.

Also, I would like to express my thanks to my mother, my sisters, and brothers, for their support, encourage, prayed for my great success. It all turn into easier with their blessings and good wishes for me and my future.

However, my biggest supporter and my number one fan is Mohammad Bakkar, who never gave up on me, encouraged me when I felt low, stayed long nights by my side just to make me feel that I am not alone... I dedicate my success to you today.

Finally, to my friend Dr. Mansoor Abdulhak for being my therapist and my problem solver; you were with me since the first day of my study, thank you for your nonstop support and help, I am so appreciated.

Unified Theory of Acceptance and Use of Technology (UTAUT) LEGO Sets in Education

Abstract

Recently most countries are moving towards using technologies, and digital resources in teaching and learning inside the classrooms. Inserting Lego sets in education have several benefits inside the classroom not only for the teaching of disciplines, but also it develops several skills such as problem solving, teamwork, and creativity. In Jordan, teachers face many struggles in teaching, starting from tradition way in teaching, including decreasing levels of motivation among students, not enough teaching ways of reaching goals in the subjects, and missing problem-solving strategies used by the teachers, and students alike. This diploma thesis aimed at identifying the factors influencing teacher's acceptance of the use of Lego sets in education in light of the unified theory of acceptance and use of technology (UTAUT), to evaluate if there is a relationship between performance expectancy, effort expectancy, social influence, facilitating conditions, and the intention of computer and science school's teachers to use Lego sets in education. Online questionnaire was created based on UTAUT survey instruments to collect data. 116 respondents were participated from computer and science teachers in Jordan. Statistical Package for the Social Sciences (SPSS) used to analyze the data collected. Multiple regression analysis was used to measure the correlations between variables, and the final results. The model was able to predict 60 % of the variation of the intention to use Lego sets in education. The final results found that performance expectancy and effort expectancy were statically significant. Performance expectancy and effort expectancy were the predictors and had the biggest impact. The results can help curriculum decision makers to integrate Lego sets in education. By insert Lego sets in education, students may learn difficult concepts, and make them familiar with programming.

Keywords: Education, Modern teaching, Technology, LEGO, LEGO sets, LEGO education, UTAUT, Jordan, Robotics education.

jednotná teorie přijetí a použití technologie (UTAUT) LEGO zapadá do vzdělávání

Abstrakt

V poslední době většina zemí přechází k používání technologií a digitálních zdrojů při výuce a učení ve třídách. Vkládání stavebnic Lego do výuky má ve třídě několik výhod nejen pro výuku disciplín, ale také rozvíjí několik dovedností, jako je řešení problémů, týmová práce a kreativita. V Jordánsku čelí učitelé při výuce mnohým problémům, počínaje tradičním způsobem výuky, včetně snižování úrovně motivace studentů, nedostatečného počtu způsobů výuky k dosažení cílů v předmětech a chybějících strategií řešení problémů používaných učiteli i studenty. Tato diplomová práce se zaměřila na identifikaci faktorů ovlivňujících přijetí učitele ve využívání Lego sad ve výuce ve světle jednotné teorie přijetí a využití technologie (UTAUT), aby se vyhodnotilo, zda existuje vztah mezi očekáváním výkonu, očekáváním úsilí, sociální vliv, usnadňování podmínek a záměr učitelů počítačových a přírodovědných škol využívat sady Lego ve vzdělávání. Online dotazník byl vytvořen na základě nástrojů průzkumu UTAUT ke shromažďování údajů. 116 respondentů se zúčastnilo učitelů počítačů a přírodních věd v Jordánsku. Statistický balíček pro sociální vědy (SPSS) používaný k analýze shromážděných údajů. K měření korelací mezi proměnnými a konečných výsledků byla použita vícenásobná regresní analýza. Model dokázal předpovědět 60% variace záměru využívat Lego sety ve vzdělávání. Konečné výsledky zjistily, že očekávaný výkon a očekávané úsilí byly staticky významné. Očekávaný výkon a očekávané úsilí byly prediktory a měly největší dopad. Výsledky mohou těm, kdo rozhodují o kurikulu, pomoci integrovat sady Lego do vzdělávání. Vložením sad Lego do výuky se studenti mohou naučit složité koncepty a seznámit je s programováním.

Klíčová slova: Výuka, Moderní výuka, Technologie, LEGO, LEGO soupravy, LEGO vzdělávání, UTAUT, Jordánsko, výuka robotiky.

Table of content

1	Introduction	10
2	Objectives and Methodology	11
2.1	Objectives	11
2.2	Methodology.....	11
3	Theoretical Part	12
3.1	Teaching Concept.....	12
3.1.1	Traditional Concept of Teaching.....	13
3.1.2	Modern Teaching Concept	13
3.2	21 st Century Skills	16
3.3	Gaming in Educantion	17
3.3.1	LEGO	18
3.3.2	LEGO Education History	20
3.3.2.1	LEGO Sets in Education	22
3.4	Author Expeiece	30
4	Practical Part	32
4.1	Problem Statement.....	32
4.2	Purpose Statement	32
4.3	Research Method and Design	33
4.4	Neture of Study.....	33
4.5	Research Question	34
4.6	Hypotheses.....	34
4.7	UTAUT Model	34
4.7.1	Study Model	36
4.8	Participant.....	41
4.9	Data Collection	41
4.9.1	Data Collection Technique	43
4.10	Survey Validity and Reliability	43
4.11	Data Analysis Method	44
5	Results and Discussion	45
5.1	Sample Size	45
5.2	Reliability Analysis	47
5.3	Mulicollinearity	48
5.4	Descriptive Statistics	50
5.5	Regression Analysis	51

6 Conclusion	57
7 References	58
8 Appendix A	63

List of pictures

Figure 1	LEGO Products Timeline	19
Figure 2	LEGO Education History Timeline.	21
Figure 3	Examples of Teaching Mathematics Using LEGO.....	23
Figure 4	More To Math Set.....	25
Figure 5	Sentence “The daddy drives the car“	26
Figure 6	NXT Wheeled Robot	28
Figure 7	Toolchain Developed for Programming EV3 in C Code.....	29
Figure 8	Some of Auther Works	31
Figure 9	Technology Acceptance Model (TAM).....	35
Figure 10	UTAUT Model	37
Figure 11	Percentage of Data Collected.....	45
Figure 12	Percentage of Data Collected According to the Subject Teaching.....	46

List of tables

Table 1	Skills Needed in 21 st Century.....	16
Table 2	Previous Research from the Area of Using Technology in Education	40
Table 3	UTAUT Instrument Used to Collect Data	42
Table 4	Characteristics of the Study Sample	47
Table 5	Reliability Analysis	48
Table 6	Correlation Matrix.....	49
Table 7	Collinearity Statistics	49
Table 8	Descriptive Statistics Analysis.....	50
Table 9	Model Summary.....	51
Table 10	Regression Analysis	52
Table 11	Characteristic of the Sample That Used Other Technologies	55

List of abbreviations

MMk	More To Math Set
UTAUT	The Unified Theory of Acceptance and Use of Technology
PE	Performance Expectancy
EE	Effort Expectancy
SI	Social Influence
FC	Facilitating Cinditions

1 Introduction

Students are the real wealth, and they are the hope for a better future. Caring for and nurture them is a vital matter that is determined by the light of the future milestones. Using games, and technology in education are considered a way to develop education, this includes of preparation of the future human being able to adapt successfully to the successive changes in the knowledge and information revolution and the continuous scientific and technical progresses, and makes him facing the problems of life with ease.

Technologies are very important for teaching, and therefore school institutions should constantly strive to modernize and update their technologies, and train teachers to use that technologies.

Educational games are activities that an individual practices with the aim of achieving a specific educational outcome. The child plays and learns at the same time, and Lego sets are only a type of educational games, and it should be noted that the most of the games that children play may have educational value if it used well.

From the above, it can be concluded how important it is benefit from modern teaching methods, such as educational games like Lego sets, in developing many skills, the most important one are innovative thinking skills.

Inserting Lego sets in education is thing certainly belong to twenty-first century educational skills. Lego sets are one of the most beneficial toys for children and students that help develop their mind regarding creativity, imagination and organization. Lego is useful for revealing certain features of the student's personality, such as patience through trying more than once to reconstruct the robot, as well as the motivation for achievement and knowledge, in addition to being an entertaining game and helps to employ the mental skills of the student, noting that it reveals whether the student has any kind of mental deficiency.

This diploma thesis aimed at identifying the benefits influencing of the use of Lego sets in education. The reason for choosing this topic for me is mainly because I have worked for two years as robotics teacher, and I used Lego set in my teaching. From my experience, I recommend to use Lego sets in education.

2 Objectives and Methodology

2.1 Objectives

The main objective in my thesis is to evaluate if there is a relationship between performance, effort expectancy, social influence, facilitating conditions, and the behavioral intention of computer and science school's teachers in Jordan to use Lego sets in education.

2.2 Methodology

The main goal of this master thesis is to evaluate the factors influences of computer and science school's teachers to use Lego sets in their teaching. Theoretical part was based on professional information sources and literature. It contains the history of teaching, the characteristics of tradition and modern teaching methods, the history of Lego company, the history of Lego education sets, as well as studies of inserting and including of Lego sets in teaching and learning in different fields such as teaching mathematics, computer science, programming, and even for students of disabilities.

Practical part is based on online questionnaire created with 19 questions related to the variables are performance expectancy, effort expectancy, social influence, facilitating conditions, and the behavioral intention to use Lego sets in education. Quantitative correlational method is used to examine the intention of computer and science school's teachers in Jordan to use Lego sets in education.

Based on the synthesis of theoretical knowledge, and the results of the practical part of the work, the conclusions of the master's thesis are formulated.

The conclusion of the work is not only the evaluation of the factors influence the using of Lego sets in education, but also the results can help school curriculum decision makers whether future will include Lego sets in teaching.

3 Theoretical Part

This chapter deals with three sections, the first section deals with both approaches of the teaching, the traditional and modern approach. It also deals with the evaluation of both directions based on positive and negative characteristics. The second section shows the skills needed in the twenty-first century. The third section shows brief history about Lego company, and the positive impact and the influence when using Lego in the education.

3.1 Teaching Concept

Teaching is a process of communication between the teacher and his students, in which he tries to equip them with the required information, skills, and experiences, through teaching methods and teaching aids.

Teaching concepts has many meaning, such as it is a set of activities that a teacher performs in a specific educational situation to help the student reaching specific educational goals, and a purposeful, planned, and organized human activity for the purpose of informing the learner with knowledge and enabling him to discover it (Atyeh, 2008).

Teaching is a planned collaborative process, in which the teacher communicates with his students, and the students with each other, through professional behaviors and skills, using teaching methods and teaching aids to achieve specific educational and educational goals and is subject to a comprehensive and continuous evaluation process.

Teaching methods are the tool by which the action plan is organized in the classroom, through which the content is simplified, the means are determined, the lesson activities are chosen, and the set objectives are achieved. As one of the important elements of the curriculum, it contributes an effective role in the educational development, by taking into account learner's abilities, skills, and preparations, to match the aspiration of those in charge of building the curriculum (Abdaljabar, 2014).

The teaching method is considered one of the priorities that the teacher must know about as the focus of any effective and successful teaching. Different experiences, information and concepts, and good choice of the method leads to positive learning outcomes, and vice versa (Al-Amro, 2004).

3.1.1 Traditional Concept of Teaching

Everyone certainly has an idea of what is meant by “traditional teaching”. We all remember the hours spent at the school’s desk, listening to the teacher’s explanation, and taking notes all the time. Nobody says it is so bad. Listening to the teacher can often be more interesting than any presentation projected on the wall.

The traditional or instructive approach of education is basically teacher-led teaching, which is based on a solid curriculum, where the subject is usually passed on unilaterally to students. Student’s work is independent, students are not subject to discussion, and students are not otherwise active involved in teaching.

This process is focused on working with the textbook text, listening to the teacher’s explanation, and taking notes. This stereotype can lead to children completely losing interest and obliterate the spirit of innovation.

3.1.2 Modern Teaching Concept

The traditional way of teaching has been proven for years, but why not make it a little easier and at the same time make learning fun? A modern approach (so-called constructive, progressive) can help teachers and as well as their students.

This process is focused on working with giving the student the opportunity to think, act and obtain information on his own. Diversification of activities to face individual differences between students during teaching, development of student’s ability to think scientifically and think critically and encourage students to adopt the spirit of teamwork and cooperation.

You can not talk about the effects of technology on humans, but it is always necessary to think about its existence and use in connection with human activity.

Pierre Lévy, a French philosopher, states that “The technique itself is neither good nor bad”, (depending on context, uses and perspectives), nor neutral (because something it conditions or forces something because it opens and elsewhere closes the spectrum of possibilities). According to him it is necessary to understand technology as the products of certain society and culture.

The advantages and disadvantages of modern teaching:

I Advantages

The advantages of integrating technology into teaching obviously include improving the quality of teacher's work. Not only providing preparation for teaching through a variety of programs at creating presentations, graphs, worksheets, interactive learning games or tests, but at the same time, already developed projects are better archived and updated in the case of changes. Data from the teaching process can be processed and subsequently shared via computers with colleagues. So, it is not just about improving, but also about simplifying the work of teachers. Another advantage is easy communication between students and teachers, they can use e-mail, or chat, and so together work on assigned work from home, library, or anywhere. The most important point is certainly to improve learning of students, and their results. The curriculum taught to students using modern technology is more engaging, easier memorable, and in addition, working with technology motivates the students more. Students through technology search for information available on the internet or in databases can solve problems on their own, thus improving students learning independence. Technologies have great potential for effective learning, knowledge dissemination and development of more efficient education services. Technology should be used as a tool to support educational objectives such as cooperation, skills for searching and assessing information, communication and problem solving which those skills are important for the preparation of children for the knowledge society (Drent & Meelissen, 2008). Students can use those skills later in the workplace. Modern technologies support environment by decreasing paper and photocopying costs, promoting concept of "green revolution" according to (Raja & Nagasubramani, 2018).

II Disadvantages

Technology in education may not always be a benefit. Teaching must be conducted by a capable, trained teacher, otherwise modern means could be rather harmful. With poor leadership, students would lose interest in the material being taught (or would not be interested at all) or would not be able to realize the material being studied. For example, a plain text presentation may not always be an appropriate choice. It is important that students do not just

describe the material from the board or other projection screen. It is necessary that students also perceive it and at the same time actively participate in teaching.

In this case, pre-prepared curricula, notes or worksheets that the teacher prepares for the students are suitable. Students only write their own notes in these curricula, so, they have more time to listen to the explanation. It is therefore very important that technology teaching is led by an experienced teacher who can attract students with an interesting program. If this were not the case, the students could easily lose their attention and start looking for their own activity on computers or tablets, which is no longer related to the subject.

Due to excessive usage of online writing such as chatting and shortcuts, the writing skills of new generation students have declined quite tremendously.

According to (Raja & Nagasubramani, 2018), children nowadays are relying more and more on digital communication that makes them without any improving on their writing skills.

In general, the most significant disadvantages of using technology in schools are the rapidly evolving technology that prevents its full use.

Before people learn to work with something new, something new will come again that they do not know much about. In addition, some technologies are very expensive, so not every school can afford to buy it, and therefore must constantly strive to obtain various subsidies.

From psychological point of view, however, the most serious are the social impacts. Technologies such as computers, smartphones, etc. could cause addiction in children, and program broadcast on television can cause aggressive behavior in children. The worst social impact concerns cyberbullying when children are the target of ridicule and swearing through the internet.

Cyberbullying can be understood as deliberate aggressive behavior, which is carried out either by an individual or a group through electronic media towards a person who cannot defend himself against attacks.

It is difficult to control this phenomenon, especially when it is flooded with social networks, where countless “groups” are formed daily, that is why it is important for the teachers to ensure that children need not forget good manners and support each other.

3.2 21st Century Skills

Industrial revolution 4.0 did influence on many fields, including the teaching process in classroom. Implementing technologies as an intra-curricular for schools' students will lead creative learning and skills development. Implementing technologies and robotics provide the basics of engineering, technical skills, and coding. In 21-centurt the learning in the classroom focuses of development of problem-solving, critical thinking, creative, and communication skills (Latip & Hardinata, 2020).

A very important point in the introduction of modern technologies into education already in school is that students are gradually consolidated with the knowledge and skills that a person of the twenty-first century should have.

These skills include in Table 1.

Table 1 Skills Needed in 21st Century

No.	Skill
1	Communication (not only the use of appropriate arguments in the discussion, but also the ability to communicate through digital technologies).
2	Creativity and Innovation (ability to be creative and innovative and to apply these ideas in life).
3	Cooperation (working in teams and through digital networks, flexibility, and the ability to share responsibility).
4	Critical thinking and problem solving (evaluation and use of information to solve problems, analysis of the work of partial parts of the system).
5	Technological competences (information and communication technology literacy-readiness to use useful programs and tools, process information in various formats).

Source: Author

The researcher (Ala-mutka, 2011) divided types of literacy on information and communication technology. Internet literacy, informative literacy, and media literacy, which complement basic literacy (read, write, count).

3.3 Gaming in Education

Children nowadays living in digital environment since their birth, this development create pressure in existing educational systems for finding new ways of the teaching with prevent basic schools subjects on the way with meaningful and related to the future workers who are being educated right now (Leoste & Heidmets, 2019).

The education literature has a definition with many, and varied an implication in the concept of educational games. As Al-Mashqeeh (1992) it is form of an intentional play which in the turn depends on a chance and a skill, and is usually controlled by special rules and laws, and the required a skill level, regulations and rules differ from one game to another.

As (Becker, 2001) defined educational games as competition or a cooperation between more than one a student to determine decisive result according to set of rules that follow grading system indicating the achievement of the goals of the game.

Educational games defined as an individual tactic or method that puts the student in a real dynamic position, dependent on the student's activity and effectiveness. Also, it is an activity or a group of activities that an individual or group of individuals practices achieving certain goals.

Educational games are methods that the teacher can use to achieve educational goals that he seeks, which help to increase student's academic achievement, as well as give a sense of fun and interest together. Educational games are organized activities that attract student's interest and raise student's motivation to think and persevere.

Educational games are among the most important contemporary trends that provide opportunity for students to be positive during the educational process, and to interact with the different situations they face, and their importance is written through what the student gains during the practice of the game.

Many educators emphasized the importance of educational games as they contribute to mental, social, and emotional development, as well as contribute to developing ways for the student to deal with others and urges the student to be positive and contribute to the educational process by analysis, thinking and participating in decision-making while the teacher directs the educational environment.

Educational games work to address many learning difficulties and contribute to treat those difficulties. Developing the student's skills in solving problems and increased motivation towards achievement through the style of the game by continuous evaluation and winning the

game, challenge and defense immediate positivity and reinforcement, games narrowing the gap between the outstanding students, and those who are late in achievement in the same grade.

Electronic educational games contribute to learning, contains simple's games which teach children to read and write numbers and letters, to the most complex games that teach students composition and formation of words and sentences, and dealing with scientific and arithmetic issues. Electronic games are used with teaching public education and information transfer in several fields such as mathematics, science, history, geography, languages, and computer programming languages.

Educational robotics was born during the 1980s when it is possible to place electronics of a smaller computer into mechanized toys (Leoste & Heidmets, 2019).

Robotics is combining different fields of study that in traditional educational systems that usually examine separately: Physics, mathematics, electronic, and computer programming. In Robotics, you can find a practical application for many of the concepts you studied in schools, or even you did not study them.

3.3.1 LEGO

LEGO group is a Danish toy production company based in Billund, was founded in 1932 by Ole Kirk Christiansen. LEGO name comes from Danish words, "leg godt" that mean "play well"¹.

LEGO manufacture starts with wooden toys, then converted to plastic iconic multi-coloured brick, those bricks give the children the creative freedom to create any shape, structure, and vehicles. LEGO products start from wooden duck, then Automatic binding brick, System of play, Technic, Pirates, Island video game, Mindstorms, Star Wars, Bionicle, Mindstorms NXT, and Universe. In 2007, a new line product was created called LEGO architecture to create a world-famous landmark like the Eiffel Tower and the Statue of Liberty in miniature forms. In 2014, it released the LEGO movie.

The LEGO group is the most well-known toy company in the world. In 2015, it was ranked first in Forbes Most Valuable brand list, and this come from its perfect strategies by keep in touch

¹ En.wikipedia.org. 2020. *The Lego Group*. [online] Available at: https://en.wikipedia.org/wiki/The_Lego_Group.

with what parents and children need and wanted to see in markets for this purpose, it established Global Insights division and brought designers from around the world to design toys that truly wanted (Hadjiyski, 2019).

LEGO created and developed a famous system of play. The LEGO system has many benefits it encouraged the whole family to play with LEGO, it is used to encourage children unleash their imaginations in meaningful way, encouraged children to be creative, and its suitable for many age levels.

Why LEGO?

The power of the LEGO system lies in its founding concepts: a reusability. The same bricks could use them today to create an elephant, tomorrow block in an Egyptian pyramid, and the day after race car. Inside one box of Lego an infinite number of possible models you could create with those bricks.

Transforming Lego bricks into a construction system without need glue, a screw, or any special tools to assemble a Lego model. The Lego bricks can easily snap them from each other without any damaging, no matter how much they were assembled.

A modularity it was made Lego easy to use. Not that one bricks connect to another, but they are predefined, and discrete positions. According to their shape you assemble parts following a precise geometric scheme. No need for ruler or any tools to assemble due to something called the precise positioning. Lego is fast, clean, cost-effective, and ecological.

Figure 1 LEGO Products Timeline

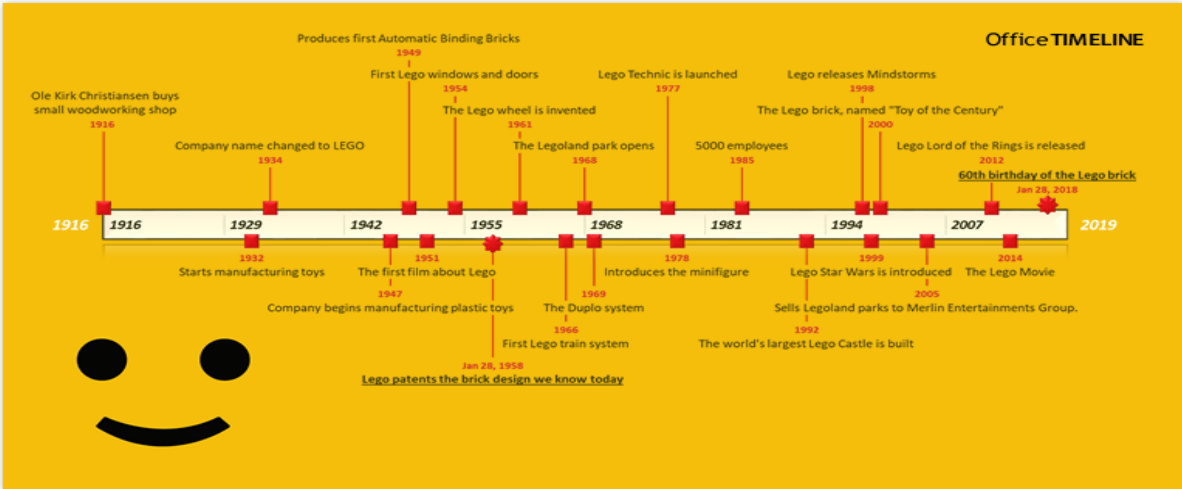

Souce: Beekman, 2017.

3.3.2 LEGO Education History

In the end of 1960s, teachers from America and Europe had begun bringing LEGO products into the classroom, by using activity cards with inelegant ideas for students.

LEGO Company decided to establish a new division called as LEGO education in 1980. This division collaborating with and developing educational tools for teachers around the world, and to ensure that this department would be in touch with education sector, the team recruited a kindergarten as a salesperson.

In the beginning teachers from America and Europe had begun bringing LEGO products into the classroom, by using Duplo sets come with activity cards with inspiring ideas for students, cards with numbers of cards to help students with math, or cards to learn about wildlife, and by encourage learning through role-play, to shop in supermarkets or to build hospital to learn more about health and community helpers' careers.

A professor of mathematics and education at MIT developed a solid and easy to learn programming language is known as Logo. This lead LEGO to collaborate with the professor to develop software to make programmable LEGO models.

In 1992, the first LEGO robotics platforms by released of Technic Computer Control to develop software to make programmable LEGO models. Children were created programmable models, where could control them either manually or automatically via computer.

Children began building LEGO robots, according to catalog with instructions shows how to build and make many ranges of models, including a robotic sorting system, and Dactasaur's model, a dinosaur model used to measure distance and time to determine its average speed using angle and light sensors (Hocker, 2020).

LEGO Mindstorms, the second version of LEGO robotics products. RCX (Robotics Command Explorer) was the first produced brick, after that many of Mindstorms series were produced NXT, and EV3, and to reach younger children, LEGO released a simple coding platform called WeDo in both kits WeDo1.0 and WeDo 2.0. In 2020, LEGO released Spike prime programming kit. LEGO created the timeline with key events in the history of LEGO education showed in Figure 2.

In 1998, the FIRST LEGO League (FLL) was founded by LEGO group, through FLL, children build their own robots to participate in challenges, FLL started from U.S and Denmark, then it has been expended into 98 countries with 320 thousand participants.

3.3.2.1 LEGO Sets in Education

From the setting up the Lego group in 1940, Lego was developed to become an international phenomenon affected in many fields, especially in education field.

The first creation in Lego was in Denmark, and in the beginning, Lego was about of coloured plastic bricks that could assemble and reassemble those bricks in infinite of possibilities. After that Lego became very popular at children form the whole world, and it was necessary to find a relationship between plying and study, and between process and mastery in education, all that reasons had encouraged the Lego group in the end to merge its products with educational curricula that allow teachers using them in classrooms.

LEGO product in the early years was dedicated to construction toys related to the engineering world. The way that how children play with Lego combine between constructions of creativity (innovation) and on the other hand improvisation. Lego considered as a tool to understand of prevalent trends in education policy and practice.

Using Lego in education develops many skills in children and students. Lego provides tools that allow student thinking in a positive way in enjoyable environment. Lego makes students in thinking in very critical way. Because Lego does not have any rules, and that allow the student to create his own rules, this gains the students problem-solving methodology, organization, and planning before the construction. Lego develops the sense of movement in students (Billen et al., 2021). Lego kits used in different ways, and in different disciplines of science, technology, engineering, and mathematics (STEM) (Pirrie, 2017).

I LEGO and Mathematics

Lego's blocks have huge educational value, besides to the creative impacts that Lego provided to children. When children are playing with Lego bricks, and building the first awareness about the vacuum and proportionality.

The ability to form and analyze numbers is the main element in building the awareness of numbers and arithmetic operations in children, and the use of Lego is great way to do so, by using button-like projections on their surface. Students need to count the buttons as pair to make the addition operation easy. Students can add two or more Lego pieces and find the total number

of buttons for them, or they can start with the larger piece and try to cover it with smaller pieces and discover how many pieces are left to cover, as shown in Figure 3.

Lego blocks help children understand the concept of the number multiplication in children, as well as the concepts of the square of numbers, and the properties a reciprocal multiplication. Lego also used to teach fractions, providing students to an experiment with fractions in tangible parts that will make it easier for them to understand fractions, and the concept of different parts and numbers with different denominators. Lego offers many possibilities that could children play and realized the fractions concept. Lego could easily explain the numbers disassembled to prime numbers according to (Zimmerman, 2016).

Figure 3 Examples of Teaching Mathematics Using LEGO

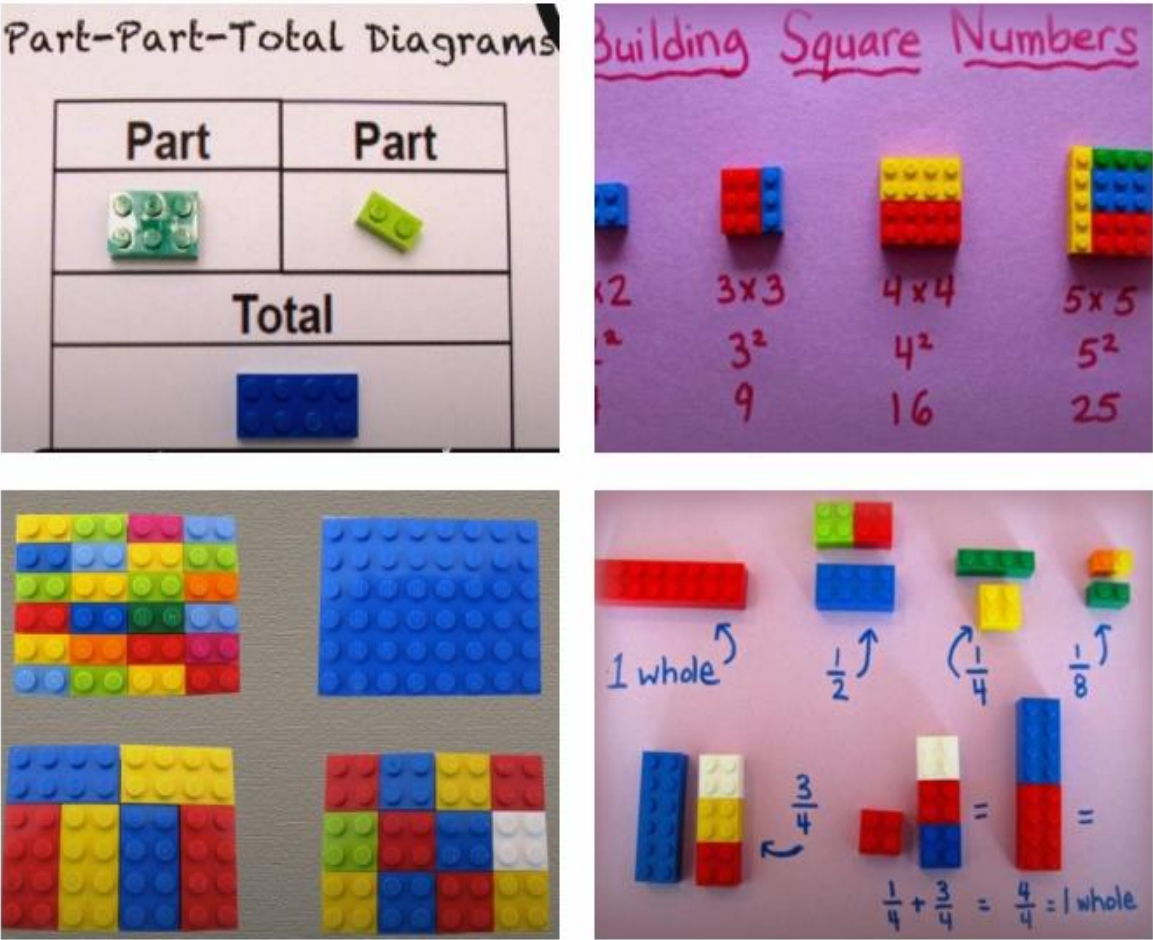

Source: Zimmerman, 2016

“More To Math” kit from Lego is another example of explain math using Lego kits, according to (Altakhayneh, 2020). (MMK) More To Math kit is used to develop the understanding of mathematics concepts and skills.

The participants were 120 students for second grade from school in Jordan. The researcher divided students into two equally groups, the experimental and control groups.

MMK is used in this study to do the arithmetic operations such as addition within single digits (0-9), and double digits (10-99), subtraction, multiplication using both groups and arrays, fractions, and measurement. That is mean covered the basics of mathematics for elementary students.

Students worked in the MMK individually and within groups to ensure skill retention and proficiency; by giving the students exercises related to those operations with teacher’s guiding them how to use Lego pieces in their exercises.

The results from this study were statistically significant for the effectiveness of using More to Math kit on the achievement scores in mathematics. In general, More to Math kit has a significant positive impact when it is used to teach mathematics for elementary students.

More to math kit as shown in Figure 4 designed from Lego education company for first and second grade students to develop and understanding of mathematics concepts in an effective and engaging way. When mathematical problem solving is connected to real-life math becomes relevant for students motivating them to look for make sense of problems.

Mathematical problems can be a difficult concept for young children to grasp where they struggle to make sense of abstract thoughts.

Using More to Math kit in classroom promote a positive attitude towards solving math problems, so students will think right, and speak freely about math.

Lego’s education More to Math kit does not just develop mathematics skills but also develop the critical thinking in students according to the way of learning mathematics concepts and facts.

Lego MM kit allow student to learn math in enjoyable and collaborative environment.

Figure 4 More To Math Set



Source: Lego Education Website, 2021

II LEGO and Disabilities

Duplo sets are developed for the younger preschool children, so the sets typically contain many large size pieces for playing and learning in groups.

According to (Havelka & Částková, 2015), 13 sets from 19 Duplo sets for children from 18 months to 7 years were selected and applicable in educational area and using them indicate possibilities to develop the children's abilities, basic technical thinking, cultivate the communication skills, and task solving.

The methodological Duplo sets of preschools children are used to make children recognize the colour and its hues to build construction model according to the teacher's instruction, to identify which object is belong to the set block and which one does not belong, to recognize block based on the touch, or based on the word command.

Also, Duplo sets used as an application to linguistic scenario by developing a device for an intelligence solution in education for children with dyslexia according to (Lund et al., 2004). Children with dyslexia, suffering in scholastic learning, and they cannot understand the structure of a sentence. Speech therapist tries to use many tools to help children to construct a sentence in the correct way, one of those tools a task with Duplo bricks, those bricks have a different shape:

- For article, small and tall rectangle.
- For noun, rectangle with an icon on.
- For verb, red arrow.
- For preposition, small square.
- For correctness, Sliver brick.

The children must use those bricks to construct a correct sentence as shown in Figure 5, and in case of incorrect sentence the sliver brick produced a sound to alert the children. The sound feedback had encouraged children to reflect on the structure of the sentence in case of error, and children became familiar with bricks and they were able to construct a sentence without icons.

Figure 5 Sentence “The daddy drives the car“

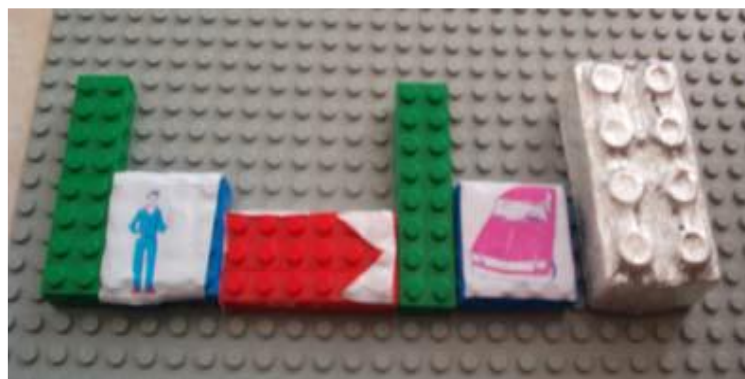

Source: Lund et al., 2004

Another experiment with students who have motor disabilities or complex communication needs (CCN) are struggling in the development of mathematics skills. Lego robots with low-cost could manipulate objects in many mathematics activities especially in early learning. To allow student with complex communication needs to participate in mathematics classes. They have used speech-generating devices (SGDs).

In (Adams & Cook, 2017) study of level 1 mathematics measurement concepts students using robot for practical activities, and speech-generating devices to communicate. The Lego robot controlled by speech-generating devices to compare the length of objects to a pencil referent, ordering the objects to “taller than”, “the same”, and “shorter than” the pencil length. The

understanding in students appear by changing the mathematical objects using the robot or they could talk about the subject using their speech-generating devices (SGDs). Also, could use Lego robot to ask about “how long” instead of “length” and “thing” instead of “unit”.

For this experiment Lego improve that students who have complex communication needs were able to use the robot and objects significantly.

III LEGO and Computer Science

We live today in renewed and changing digital world, as it has become behind all that surrounds us in regardin a business, commerce, a shopping, a science, an invention, health, an aviation, and governments. A software that manages and control it.

Therefore, the need to think deeply about teaching and education students in the computer science, and algorithmic thinking (computational) and the programming in early stages of the education.

Learning how to code with robots is a great way to engage students in the fields of the science, the technology, engineering, arts, and mathematics, using a coding and a programming.

Artistically inclined kids will love putting the robot pieces together, creating a great scope for teamwork, with one designing and the others programming something based on and building on that design.

LEGO Mindstorms Robotics was found of a team effort between the Massachusetts Institute of Technology (MIT) and the LEGO group. Kit consisting of 717 pieces including Lego bricks, motor, gears, and different sensors. The aim is to produce LEGO programming language to command Lego brick robots of their own design connecting to a computer (Beland et al., 2000).

LEGO Mindstorms are recent learning tools that have been used in a course throughout schools Computer Science curriculum (Cliburn, 2006).

Initially the LEGO-supplied programming languages were RCX code (assemble) and ROBOLAB (a graphical language). However, according to the benefits and the enormous popularization of those kits led to creation of new alternatives by the Lego group, mainly as open-source virtual machines, supporting modern programming languages such as C/C++ and Java.

According to (Özüorçun & Bicen, 2017) used Lego robot with engineering students, the students start learning the body of robots, sensor, and their functions, such as how to follow lines with colour sensors, how to expose objects with touch sensors, how to design the robot to be

controlled remotely with an infrared sensor and how to use motors and processors. Students are used one robot and one computer. This experiment used to teach programming algorithm course outline, including programming structure and algorithm instruction, flowchart symbols, conditions (if/ else, nested/if, while repeat, until) and problem solving with decisions (multiple if / then / else).

Brooklyn College developed a system for teaching C/C++ to students entering in an Introductory Course in Programming using a Lego NXT. The programming of the NXT robot has been implemented using a C/C++ cross-compiler, an open-source firmware platform nxtOSEK, is used to generate the code. NxtOSEK is an open-source platform for the Lego Mindstorms NXT, and this allows for using other programming software.

Students create project within Code::Blocks, then select the project type to be a nxtOSEK project. After that students start coding using C++. The use of the NXT robot has an advantage that is utilized more object-oriented constructs, which introduce students to objects and their utility, and learn student a model's communication between computer and external devices as Bluetooth as shown in Figure 6 (Delman et al., 2010).

Figure 6 NXT Wheeled Robot



Source: Delman et al., 2010

In another experiment with engineering students at University of Applied Sciences (Haak et al., 2018) integrated a robot – platform in teaching, and learning of computer science in engineering courses. The problem was that the students could not take the EV3 robot out the laboratory, this study used Ev3 robot to teach students C programming language.

To make this possible, the researchers build a toolchain to make Ev3 programming using C code. The toolchain as shown in Figure 7 consists of plug -in, API, compiler, and uploader, where plug-in used to allow writing a C code that contains the API. The Eclipse plug-in was successfully implemented, including Lego Mindstorms EV3 with application programming interface (API), which include all motors and sensors from EV3 Lego. Uploader is used to download of the files from the host PC to the EV3 via Bluetooth or Wi-Fi.

This plug-in allows the students to build a program using C code and transfer the program onto the robot via USB-interface. EV3 is used to support the learning process, which included conditional statements, loops, pointer, and file management.

Figure 7 Toolchain Developed for Programming EV3 in C Code

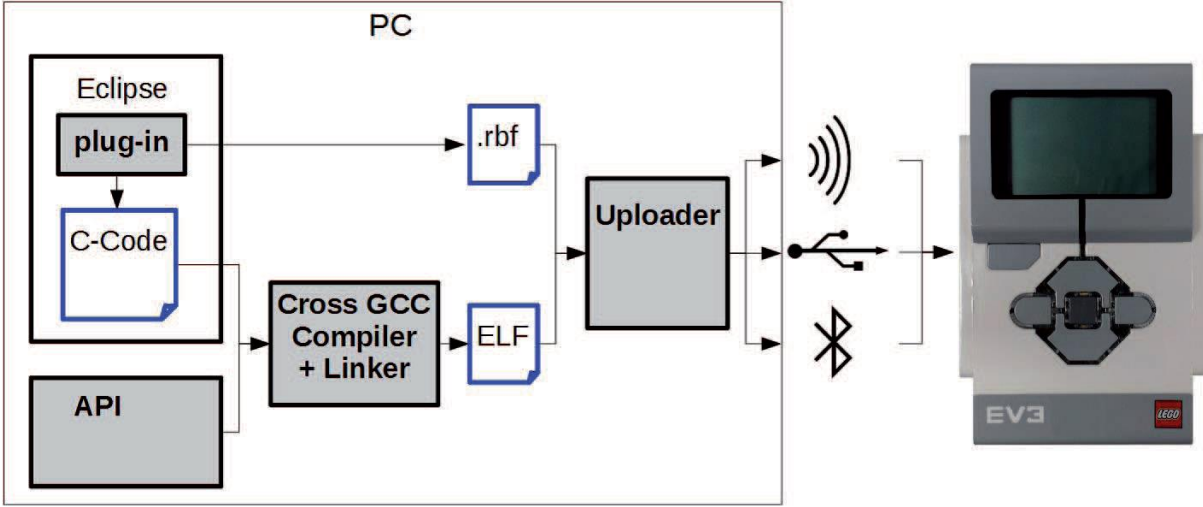

Source: Haak et al., 2018

RWTH Aachen University Department of Electrical Engineering and Information Technology did a practical course to learn the concept comprising mathematical methods, MATLAB programming, and practical engineering, the students to be able to control Lego Mindstorms robots, they have to transferred mathematical basics to algorithms in MATLAB.

A new toolbox called “RWTH-Mindstorms NXT Toolbox” was developed, which enables the robots to be controlled remotely via MATLAB from a host computer (Behrens et al., 2010).

3.4 Author Experience

I have an experience with Lego sets as a robotics teacher at a private school in Jordan. I worked for two years with students from third grade till sixth grade. Furthermore, I used WeDo 2.0 sets in my teaching. WeDo 2.0 sets designed for elementary students to enhance their skills in science, computer, engineering, technology, and coding.

WeDo 2.0 set consists of storage bin with sorting trays, smart hub, motor, motion sensor, tilt sensor, and other building bricks. From the free software has four started projects as introduction and to get more experienced to the hardware, and the software. The purpose of those projects is to give more information about motion sensor, motor, and tilt sensor.

When the student finished the started projects, the software provides eight sciences guided projects. In the beginning of those projects there are an introduction about the topic as video about the benefit or explanation about the science topics. The guided projects where the instruction of them was given from LEGO itself are pulling, speed, robust structures, frog’s metamorphosis, plants, and pollinators, prevent flooding, drop, and rescue, and sort recycle.

WeDo 2.0 software provides instructions to build the robot, when students want to bring their robots to life, they will drag and drop blocks onto the programming canvas. Students create a program string consists of some rules to move the robot. Programming blocks like speed, time, direction, show message, change smart hub colour, and even loop to repeat the programming string many times.

Through the two years, I collaborate with computer and science teachers to combine between the educational subjects and robots. This procedure made student to understand all the science topics more easily and in enjoyment environment. By using Lego sets, I explain some science topics and teach programming concepts at the same time.

In the end of each school’s year, school organized a technology day for robots using Lego sets especially WeDo 2.0 and EV3. Students from third grade to tenth grade is participated in that day with all computer and science teachers. Each group of students explained a specific topic.

Figure 8 Some of Auther Works



Source: Oxford Schools, 2019

From my experience as shown in the Figure 8, students did many models in different environments such as in the sea like the flood gate, constructions like the crane, and the forklift truck, in air as a helicopter used in the rescue, and animals life cycle like the food chain, and the frog life cycle.

I recommended to use Lego sets in the teaching, especially for elementary students. It helps them to improve their skills, learn science topics more easily, and to be familiar with the programming.

4 Practical Part

The following chapter is focused on evaluating the relationship between performance expectancy, effort expectancy, social influence, facilitating conditions, and the intentions of computer and science school's teachers in Jordan to use the Lego sets in their courses. This evaluation could inform computer science curriculum decision makers on what factors could influence computer and science school's teachers to use Lego sets and robots in teaching.

Using the unified theory of acceptance and use of technology (UTAUT), I examined the four independent variables: performance expectancy, effort expectancy, social influence, and facilitating conditions that the model proposes (Venkatesh et al., 2003). The dependent variable was the behavioural intention of computer and science school's teachers to use Lego sets in their teaching methodologies.

4.1 Problem Statement

The general problem is there a lack of practical experience in using technologies, and new modern ways in teaching in schools in Jordan, this leading to weakness in computer science between students, and make student faced a problem to understand science's topics in easy way. The specific problem there is a lack information in school's curriculum decision makers about the relationship between performance expectancy, effort expectancy, social influence, facilitating conditions, and the intentions of computer and science school's teachers in Jordan to use Lego sets in their courses.

4.2 Purpose Statement

The objective of this research study was to evaluate if there was a relationship between the performance expectancy, effort expectancy, social influence, facilitating condition and the intention of computer and science school's teachers to use Lego sets in their teaching. The data collected from computer and science teachers in Jordan and analyzed the data to see whether if the independent variables could influence the school's teachers intention to use Lego sets in teaching inside the classrooms.

The positively results will increase using Lego sets and robots in education and to increase in computer science graduates, and programming.

4.3 Research Method and Design

The study includes designing a questionnaire and distributing it to computer and science school's teachers in Jordan who are used Lego sets or other technologies in their teaching, to find out their opinions and experiences, and to benefit from them in overcoming the study problem. This is done by analyzing the results of these questionnaires, using appropriate statistical methods and by relying on SPSS program.

Correlational quantitative design was used to accomplish this goal. Correlational quantitative is used to find the relationships between variables.

4.4 Nature of Study

A quantitative methodology approach used to evaluate relationship between performance expectancy, effort expectancy, social influence, facilitating conditions, and the intention of computer and science teachers in schools in Jordan to use Lego sets in their teaching.

Quantitative research used to explain or predict the social phenomenon, a human problem or testing a theory consisting of variables, and those phenomena or theories could explain to numerical data which are analyzed by mathematically based methods, especially statistics (Yilmaz, K., 2013). Quantitative research uses formal and structured instruments and begins with a hypothesis or a theory to collect data in numerical indices. Quantitative research also used to discover the relationships between variables.

In this study, I used four independent variables identified in the unified theory of acceptance and use of technology (UTAUT) according to Venkatesh et al. (2003):

- (a) Performance expectancy.
- (b) Effort expectancy.
- (c) Social influence.
- (d) Facilitating conditions.

A correlational quantitative design chose because the purpose of my study is to examine the relationship between the identified independent variables and the behavioural intention to use Lego sets as a specific technology. Correlational design chosen because the main purpose of this study is to examine the relationships between variables in a single group (Keele, 2011).

4.5 Research Question

Do performance expectancy, effort expectancy, social influence, and facilitating conditions significantly predict the intention of computer and science school's teachers in Jordan to use Lego sets in the teaching.

4.6 Hypotheses

According to the purpose of this study is to evaluate the behavioural intention of computer and science school's teachers in Jordan to use Lego sets in their teaching and courses, the hypotheses are:

H0: Performance expectancy, effort expectancy, social influence and facilitating conditions will not significantly predict the intention of computer and science school's teachers to use Lego sets in their courses.

H1: Performance expectancy, effort expectancy, social influence and facilitating conditions will significantly predict the intention of computer and science school's teachers to use Lego sets in their courses.

4.7 UTAUT Model

Whenever a brand-new technology is delivered, there is a problem on whether the intended users will use the technology. To make sure of user acceptance, several theories have come out that try to pick out the key influences on the acceptance of a specific technology (Williams et al., 2015). As a solution to this problem several models were introduced that attempted to identify the factors affecting the end user acceptance of a technology such as the Theory of Reasoned Action (TRA), Technology Acceptance Model (TAM), Motivational Model (MM), Theory of Planned Behaviour (TPB), and many others (Oye et al., 2014).

The primary concept of user acceptance models is that absolutely everyone character of a technology has several reactions toward the technology which influence that person's intention to use it. That intention can be strongly related to the actual use of technology in question. All the models work in predicting the intention to use a technology so that organizations could make better decisions on whether to put into use the technology.

Innovation Diffusion Theory (IDT) has established by Rogers (1995) to explain "The process by which an innovation is communicated through certain channels over time among the members of a social system" (Rogers, 1995).

Fishbein and Ajzen (1975) were developed the Theory of Reasoned Action (TRA). This model is one of the most popular models used. This model used to determine the behavioural intention according to the user's attitude and subjective norms. The definition of subjective norm "The person's perception that most people who are important to him think he should or should not perform the behaviour in question" (Fishbein & Ajzen, 1975).

In (1991), Ajzen developed Theory of Planned Behaviour (TPB). This theory is used the same factors of the Theory of Reasoned Action to determine the intention behaviour (attitude and subjective norms) with another factor called perceived behavioural control (Lai, 2017).

To understand the predictors of human behaviour towards potential acceptance or rejection of technology, the Technology and Acceptance Model (TAM) has developed by Davis and Venkatesh (1996) to address the reasons why individuals and users accept or reject a technology (Marangunić & Granić, 2015).

TAM assumes an indirect role of the influence of the external variables (perceived ease of use and perceived usefulness) and how those variables have a direct influence on behaviour intention as shown in figure 1 below (Abdullah & Ward, 2016). Criticism of this model because discard of social influence and individual characteristics.

Technology of Acceptance (TAM) has been applied in several studies in the field of education, and in many other fields.

As a result of these studies mostly no more than 40% explained of the variance in the dependent variable, leaving room for adding earlier events of acceptance (Legris et al., 2003).

In the end, TAM showed weakness of knowledge and lacked structure (Pynoo et al., 2011), according to this UTAUT was developed.

Figure 9 Technology Acceptance Model (TAM)

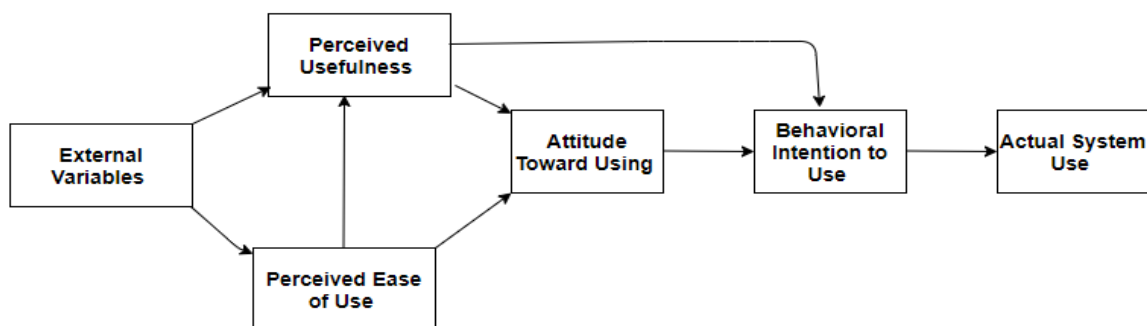

Source: Davis, 1989 & Venkatesh, et al., 2003

As there are numerous models and theories to assess the acceptance of using a new technology and to dispose this confusion, Venkatesh, Morris, Davis and Davis introduced and developed a unified model that brings both alternative perspectives on user and innovation acceptance. (Williams et al., 2015).

The Unified Theory of Acceptance and Use of Technology (UTAUT) is one of the latest technology acceptance models developed from eight various models commonly used to manage and do research on user acceptance of information technology, namely: “The Theory of Reasoned Action (TRA), the Technology Acceptance Model (TAM), the Motivational Model (MM), the Theory of Planned Behaviour (TPB), a combined of the Technology Acceptance Model and the Theory of Planned Behaviour, the Model of PC Utilization, Social Cognitive Theory (SCT), and Innovation Diffusion Theory (IDT)” according to Venkatesh et al. (2003). UTAUT is a research method based on psychology and sociology.

Venkatesh et al. (2003) measured the effects of all independent variables and how those variables predicated behavioural intention. UTAUT in some previous studies models showed that UTAUT has R-squared value of 0.70 and this considered a major improvement over the other models.

The UTAUT theoretical framework identifies four constructs that influence the use behaviour (UB) for a specific system.

The four constructs are performance expectancy (PE), effort expectancy (EE), social influence (SI) and facilitating conditions (FC). There are also four key moderators in the UTAUT model includes gender, age, experience, and voluntariness of use. (Venkatesh et al., 2003).

4.7.1 Study Model

This study using the modified Unified Theory of Acceptance and Use of Technology (UTAUT) method and the independent variables used are performance expectancy, effort expectancy, social influence and facilitating conditions to evaluate the intention of computer and science school’s teachers in Jordan to use Lego sets in their teaching as shown in Figure 10.

Figure 10 UTAUT Model

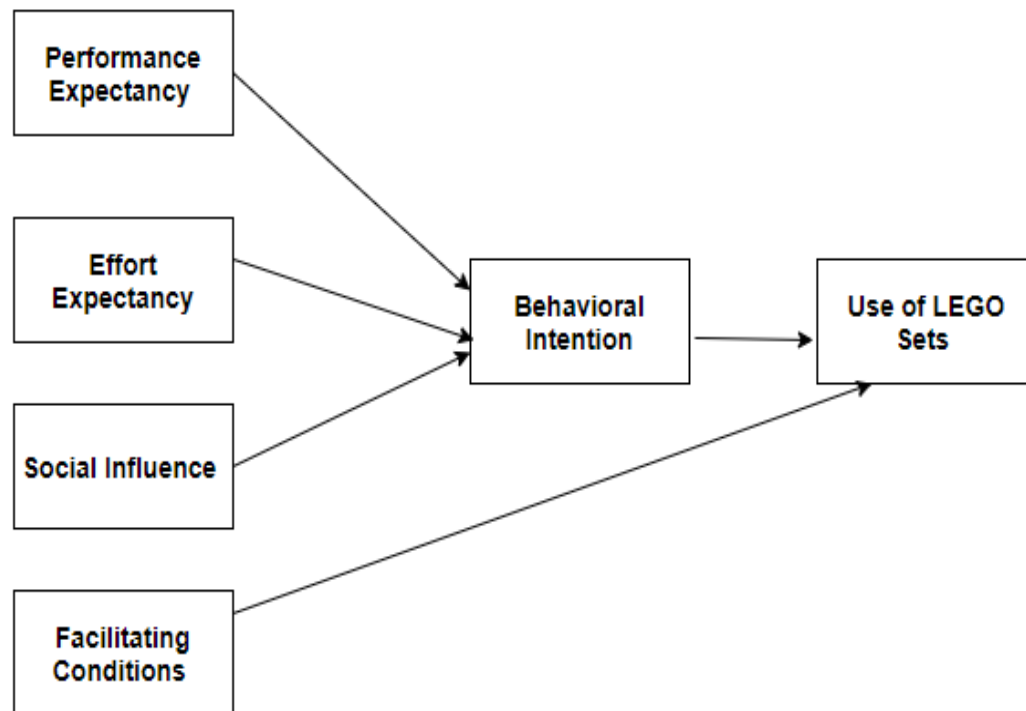

Source: Venkatesh, et al., 2003

The definitions of the terms used throughout this study.

- Behavioural Intention: The measure of intention that allows an understanding and prediction of adoption of a specific behaviour (Venkatesh et al., 2003).
- Performance Expectancy: The belief of an individual of how the use of technology is useful to perform activities (Ain et al., 2015). Performance expectancy considers that the most important construct in UTAUT because it has the highest effect on behavioural intention for predicting using of technology with weight of 0.80.
- Effort Expectancy: The level of an easiness that a person perceives when using the technology (Venkatesh et al., 2003). The effort expectancy is mostly significant at an early stage of using a new technology, and in the study may play a role because using Lego sets in the teaching stills a new experience in Jordan. EE has a significant to predicate behavioural intention with a weight of 0.58.

- Social Influence: This factor defined as a feel of a person how it is important that the others believe he or she should use the technology (Brata & Amalia, 2018). For sure humans are influenced by the opinion of others, so the social influence is important construct of behavioural intention with a weight of 0.75.
- Facilitating Conditions: The believe of a person that his or her organization will support his or her using of the technology (Venkatesh et al., 2003). The importance of this construct is less than performance expectancy and effort expectancy but higher than social influence. The weights of significance were 0.69 and 0.67, respectively.

Supporting Theories:

There are several theories that support the use of UTAUT by using it to predict intention in different environments and showing that framework is applicable to different cultures, genders, and IT competencies according to (Alaiad & Zhou, 2014).

(Boštjan Šumak et al., 2010) They have used UTAUT to develop the measurement to accept and use of Moodle, an open-source Web-based virtual learning environment (VLE). The data collected from 235 undergraduate students from Electrical Engineering and Computer Science Faculty in Maribor, Slovenia. Quantitative research used online questionnaire survey to test the hypotheses.

The results of the study showed that performance expectancy and social influence have a significant direct effect on attitudes toward using Moodle. Effort expectancy did not influence student's attitudes toward using Moodle. The behavioural intention was predicted by social influence while the actual use of Moodle was predicted by the facilitating conditions and behavioural intention.

That is mean that the students do not use e-learning system because it is just easy to use, but also because students find useful for their studies by using e-learning systems.

In (Hsieh & Chiu, 2020) study aimed to find advantages and disadvantages of STEM integration into Robot-Subject Instruction (RSI) through the data from Unified Theory of Acceptance and Use of Technology (UTAUT).

The study contained 12th grade students in a high school in Taiwan. The study found that the students have a positive attitude towards STEM model in robotics activities. Furthermore, students could solve complex problems in international competitions.

According to (AlFarani & Alhijeeli, 2020) their study aimed to identify the factors influencing teacher's acceptance of the use of artificial intelligence in education in the light of UTAUT, where the data collected from 446 school's teacher, all of them employed in ministry of education in Saudi Arabia. Questionnaire was used to collect data and distributed randomly. The results found that there was statistically significant between the sample responses about specify the intention to use artificial intelligence in education attributing to the gender variable, for females. Also found that there was no statistically significant between the sample responses about specify the intention to use artificial intelligence in education due to the variable (age, experience, and the field of educational specialization). Performace expectancy, effort expectancy, social influence, and facilitating conditions were statistically significant of the intention to use artificial intelligence in education.

In the (Durak, 2019) study to identify the factors influencing teacher's acceptance to use social media in education, where the data collected from 274 teachers from public universities in Turkey. Questionnaire was used according to UTAUT instruments. The results found that performance expectancy, effort expectancy, and social influence were statistically significant of the behavioral intention to use social media sites in education, where the social influence was the most impacted.

From the review of the previous studies showed its spending with the current study in its used of the unified theory of acceptance and use of technology (UTAUT), and its theory scale of UTAUT as a study tool. It agreed with the study of (AlFarani & Alhijeeli, 2020) and the study of (Durak, 2019) in the sample, while differed with the study of (B. Šumak et al., 2010) and the study of (Hsieh & Chiu, 2020) in the sample.

In Table 2, presents the previous research that had been done in using Lego sets, and robotics in education and technology acceptance.

The studies presented showing there were researches in both using Lego sets in education, and there are also researches using UTAUT model to predict of using technologies in education field. The current study is unique from all previous studies in that it searches for the factors influencing of school's teachers acceptance of the use of Lego sets in education in light of the unified theory of acceptance and use of technology (UTAUT).

Table 2 Previous Research from the Area of Using Technology in Education

Author/Date	BI	Lego sets	BI to use Lego sets in teaching	Significant Findings
(Latip & Hardinata, 2020)	NO	Yes	NO	Students positively responded to the implementation of NXT robots in teaching.
(Guggemos et al., 2020)	Yes	NO	NO	The study validates the UTAUT model to predict the behavioural intention of using social robots in higher education.
(Kosowska & Kłosowska, 2020)	Yes	No	No	The study showed the effort expectancy, performance expectancy and social influence had directly influence behavioural intention to use Nao humanoid robot in education.
(Kayali & Alaraj, 2020)	Yes	NO	NO	The study showed that the user satisfaction is the most important predictors of behavioural intentions.
(Atmatzidou et al., 2008)	NO	Yes	NO	The study showed the use of Lego robot in education offered creative and efficient method of instruction for the learning of introductory programming knowledge.

Note: BI means behavioral intention.

Source: Author

4.8 Participant

The target sample of my study, the school's teachers in Jordan who taught computer and science subjects, and they used Lego sets or any other technologies in their teaching.

From the Arab Robotics and AI Association (2011)², found out the names of all schools that used Lego sets in their schools, also found out the names of centres that used and trained students for First LEGO league competitions. There were 30 schools and 20 centres that they are used Lego sets.

To ensure that the responses were suitable for the analysis, I sent the survey to all schools and centres that used Lego sets in the teaching. Sending the surveys using my email with explanation about the research and the purpose of the study and provided a link to the survey instruments without any need for the identification and this provides comfortable and privacy for the participant.

4.9 Data Collection

I collected data using an online questionnaire sent to computer and science school's teachers who used Lego sets in their teaching in Jordan. The questions were adopted from the original UTAUT survey instrument as shown in Table 3 (Venkatesh et al., 2003).

The questionnaire consists of three sections. In the first section, introduction about the research and the purpose of the study and how many questions contain, and the background of the respondents such as age, gender, subject that the respondent teach, grade, and an option if the respondent used the Lego sets in education or not.

In second section, respondents do not use Lego sets in education, so I give a brief about Lego sets and its benefits in teaching, and a brief about Sphero a similar technology used in teaching. Also consists of two question to know if the respondents have any interest to use technology in the education. To write what other technologies they are used.

In the third section, the respondent should answer 19 questions related to the variables of the study.

² <http://arabrobotics.org/>

The survey written in English and the survey had an Arabic translation of each question and part to ensure that no one had any problem to understand the questions. The survey with all questions is attached in Appendix A.

Table 3 UTAUT Instrument Used to Collect Data

Construct	Instrument
Performance expectancy	I believe Lego sets are useful in my teaching.
	Using Lego sets will enable me to teach science/programming concepts more quickly.
	Using Lego sets increases my teaching efficiency.
	If I use Lego sets, I will increase my chances of getting an increase.
Effort expectancy	My interaction with Lego sets would be clear, and understandable.
	It is easy for me to become skillful at using Lego sets.
	I find Lego sets easy to use.
	Learning to work with LEGO sets will be easy for me.
Social influence	People who influence my behaviour think that I should use Lego sets in the teaching.
	People who are important to me think that I should use Lego sets in the teaching.
	The senior management of the school will be helpful in the use of Lego sets.
	In general, the organization supports the use Lego sets in the teaching.
Facilitating conditions	I have the necessary resources to use Lego sets.
	I have the knowledge necessary to use Lego sets.
	Lego sets are compatible with other educational tools, I use.
	A specific person (or a group) is available for assistance with Lego sets difficulties.
Behavioural intention	I intend to continue using Lego sets in the future.
	I predict I will use Lego sets in the teaching in the future.
	I plan to learn more about LEGO sets in the future.

Source: Adopted from Venkatesh, et al., 2003

As shown in Table 3 the five constructs used in the survey related to UTAUT, they are performance expectancy, effort expectancy, social influence, facilitating conditions and behavioural intention (Venkatesh et al., 2003).

The 4 independent constructs are measured from four questions related to each construct. Then, the values taken from the four independent variables to evaluate the dependent variable that was behavioural intention.

The survey questions were used a scale measurement with a five-point Likert scale ranging as 1- strongly disagree, 2- disagree, 3- neutral, 4- agree and 5- strongly agree.

The period of the survey lasted for one month to get the maximum possible participation. I sent reminder every week to schools and centres and try to collect more responses.

4.9.1 Data Collection Technique

Online survey using Google form is used to collect data. The reason to choose online survey because it is cheap, flexible, and fast to access to all participant due to increase to use of the Internet technique, and I could reach to all school's teachers in Jordan via email address.

The participant informed via email that the participation was voluntary. No force for the participant to answer all the questions. The participant can end the survey any time by press the exit from the window.

4.10 Survey Validity and Reliability

Correlational quantitative study was used and focused on computer and science school's teachers in Jordan. I sent the survey to all schools that are used Lego sets in education and they registered in Arab Robotics and AI Association website to ensure reliability.

I used validated survey instruments that have been used in previous studies to ensure statistical validity. The survey instruments have been successfully used in previous studies used to the same purpose. The study design can apply the same to evaluate another technology used in education or in other domains.

The questionnaire had 19 questions, where performance expectancy, effort expectancy, social influence, and facilitating conditions had four questions each one of them. Behavioural intention variable had three questions.

4.11 Data Analysis Method

This research study tried to answer one question was there a relationship between performance expectancy, effort expectancy, social influence, facilitating conditions and the behavioural intention of computer and science school's teachers to use Lego sets in their teaching.

There are four independent variables and one dependent variable. The independent variables are performance expectancy, effort expectancy, social influence, and facilitating conditions.

The dependent variable was the behavioural intention of computer and science school's teachers to use Lego sets in education and in their teaching.

Multiple regression analysis was used to determine if the four independent variables had a significant relationship to behavioural intention.

The data gathered were analyzed using SPSS software. Survey questions analyzed as Likert-Type items using modes, medians, and frequencies.

5 Results and Discussion

The following chapter is presented an examination of the factors affecting teacher's acceptance to use Lego sets in education in the light of the unified theory of acceptance and use of technology (UTAUT). This chapter is focused on the final results, and showed the which factors influenced the behavioral intention of computer and science school's teachers in Jordan to use Lego sets in education.

5.1 Sample Size

According to (Green S B, 1991) in the multiple regression study the sample size value should be $N \geq 50 + 8(k)$, where k is the number of independent variables.

In this study there were four independent variables: performance expectancy, effort expectancy, social influence, and facilitating condition, and according to the above equation it will be the minimum size of the study sample is 82.

The total number of collected questionnaires was 116 questionnaires as shown in the Figure 11, and this mean the study covered the required size.

Where 90 responses were used Lego sets in their teaching with 77.8% percentage, and 26 did not use Lego sets in their teaching with 22.2 %, but might be used other type of technologies, or they were interested to use the technology in the teaching.

Figure 11 Percentage of Data Collected

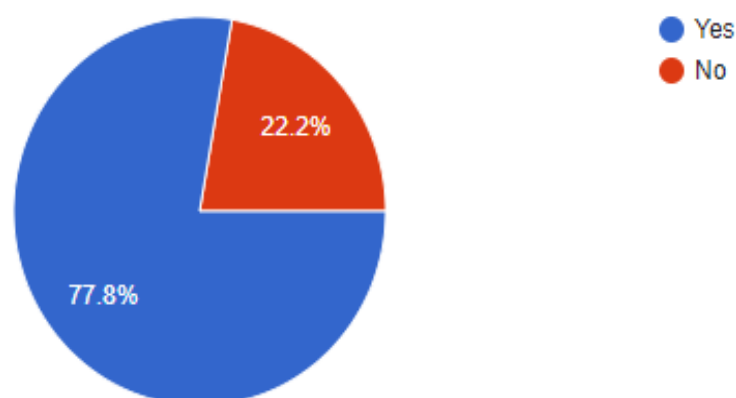

Source: Author

Where the study focused on computer and science school's teachers. From the collected questionnaires, found that most of the respondents were teaching computer science with 65.8 %, then teachers who are teaching science with 13.7 %, and other represented mathematics teachers with 20.5 % as shown in the Figure 12.

Figure 12 Percentage of Data Collected According to the Subject Teaching

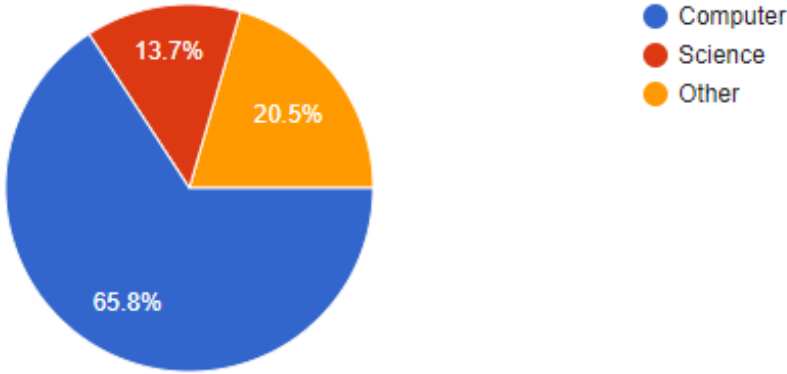

Source: Author

The respondents ages were from 20 to 50. The range of ages was chosen according that in Jordan, the age for retired is 50 for men and 45 for women. Females were 56.9 %, and men were 43.1. The vast majority of teachers who work in the educational sector are women, then it is normal that females had the biggest percentage as shown in the Table 4.

Table 4 Characteristics of the Study Sample

Variable	Frequency	Percentage of the study sample
Age		
20-30	51	44.0
31-40	54	46.6
41-50	11	9.5
Gender		
Female	66	56.9
Male	50	43.1
Total	116	100.0

Source: Author

5.2 Reliability Analysis

The first data analysis was to measure the reliability to ensure that the questions relation to each independent and dependent variable correlated to the specific constructs. The consistency of performance means “ to give the same results approximately If it repeated on the same sample of people, and the same circumstances“ (Abdel-Rahman, 2008). Cronbach’s Alpha coefficient was used to measure the questionnaire’s reliability.

The reliability coefficient was 0.890 for the five variables which was considered good. Table 5 is shown the reliability coefficient of the five variables. The values are from 0.77 and 0.89, and this considered an acceptance measurement of reliability, and the questionnaire was considered reliable.

Table 5 Reliability Analysis

Variable	Cronbach's Alpha	N of items
Performance expectancy	0.834	4
Effort expectancy	0.899	4
Social influence	0.828	4
Facilitating conditions	0.776	4
Behavioural intention	0.873	3

Source: Author

5.3 Multicollinearity

Multicollinearity is a phenomenon in multiple regression model to show in which one predictor variable can be linearly from the other variables with a substantial degree of accuracy.

Multicollinearity is considered an undesirable condition for the explained variables; it forms a kind of repetition of information. Overlapping variables negatively affect each other within the model, which it is necessary to remove some variables from the model.

Since 116 responses were collected, 90 respondents who were used Lego sets in education. The sample size considered small, I had to check for multicollinearity within variables. Correlation matrix in Table 6 shown that all bivariate collineations were less than 0.8, so no multicollinearity exists.

Table 6 Correlation Matrix

	Performance Expectancy	Effort Expectancy	Social Influence	Facilitating Conditions	Behavioral Intention
Performance Expectancy	1	.750	.652	.489	.741
Effort Expectancy	.750	1	.768	.536	.696
Social Influence	.652	.768	1	.657	.540
Facilitating Conditions	.489	.536	.657	1	.414
Behavioral Intention	.741	.696	.540	.414	1

Source: Author

Another way to check for multicollinearity is to find variance inflation factor (VIF). Table 7 shown the values of VIF of all independent variable. The values were performance expectancy 2.380, effort expectancy 3.315, social influence 3.114, and facilitating conditions 1.779, where all values were less than 5. This mean that the variables were more strongly correlated with their indicators than with other variables in the model. Variance inflation factor between 1 and 5 considered as moderately correlated (Dodge, 2008).

Table 7 Collinearity Statistics

Model		Collinearity Statistics	
		Tolerance	VIF
1	Performance Expectancy	.420	2.380
	Effort Expectancy	.302	3.315
	Social Influence	.321	3.114
	Facilitating Conditions	.562	1.779

a. Dependent Variable: Behavioural Intention
Source: Author

5.4 Descriptive Statistics

The total numbers of collected surveys were 116 responses, where there were 90 respondents used Lego sets in their teaching and the rest did not using Lego sets in education. Each survey was fully completed and no missing questions. The descriptive statistics for all the survey questions are shown in Table 8.

Table 8 Descriptive Statistics Analysis

	N	Mean	Std. Deviation
Performance Expectancy	90	4.0722	.65476
Effort Expectancy	90	4.0306	.70594
Social Influence	90	3.8167	.74747
Facilitating Conditions	90	3.5917	.74431
Behavioural Intention	90	4.2689	.59786

Source: Author

It can be seen from Table 8 that performance expectancy had the first rank from the independent variables with mean equal to 4.0722, then in the second rank was effort expectancy with a mean equal to 4.0306, then sequentially social influence with mean equal to 3.8167, and facilitating conditions with mean equal to 3.5917, and this according to the computer and science school's teachers in Jordan point of view.

The behavioral intention had mean equal to 4.2689, and this value emphasized that the sample members had a high acceptance to use Lego sets in education.

This result can be attributed to what studies have stated that the perceived benefit represented in the expected performance expectancy is one of the strong determinants of the behavioral behavior and the actual behavior, which had the greatest impact on determining the intention to use among the sample members.

5.5 Regression Analysis

Multiple linear regression used in this study, $\alpha = 0.05$ two-tailed, to evaluate the relationship and the effectiveness of performance expectancy, effort expectancy, social influence, facilitating conditions in predicting the behavioural intention of computer and science school's teachers in Jordan to use Lego sets in the teaching.

The dependent variable was behavioural intention to use Lego sets in the education, where the independent variables were performance expectancy, effort expectancy, social influence and facilitating conditions.

The study had two hypotheses:

H0: Performance expectancy, effort expectancy, social influence and facilitating conditions will not significantly predict the intention of computer and science school's teachers to use Lego sets in their courses.

H1: Performance expectancy, effort expectancy, social influence and facilitating conditions will significantly predict the intention of computer and science school's teachers to use Lego sets in their courses.

From Table 9 is shown that the value of R^2 was 0.598 and this indicated that the model could explain 59.8 % of the total variability in behavioural intention.

Table 9 Model Summary

Model Summary

Model	R	R Square	Adjusted R Square	Std. Error of the Estimate
1	.773 ^a	.598	.579	.38809

a. Predictors: (Constant), Facilitating Conditions , Performance Expectancy, Social Influence, Effort Expectancy

Source: Author

The final model shown in Table 10 where effort expectancy and performance expectancy were statistically significant with value performance expectancy $t = 4.828$, $p = 0.001$, and value of effort expectancy $t = 2.969$, $p = 0.004$.

Table 10 Regression Analysis

Model	Unstandardized Coefficients		Standardized	t	Sig.	
	B	Std. Error	Beta			
1						
	(Constant)	1.312	.276		4.757	.000
	Performance Expectancy	.468	.097	.513	4.828	.001
	Effort Expectancy	.315	.106	.372	2.969	.004
	Social Influence	-.079	.097	-.099	-.816	.417
	Facilitating Conditions	.023	.074	.029	.317	.752

a. Dependent Variable: Behavioral Intention

Source: Author

The final regression equation was:

$$\text{Behavioural intention} = 1.312 + 0.468 \text{ PE} + 0.315 \text{ EE} - 0.079 \text{ SI} + 0.023 \text{ FC}$$

From the final results, null hypothesis was rejected. This mean Performance expectancy, effort expectancy, social influence and facilitating conditions will significantly predict the intention of computer and science school's teachers to use Lego sets in their courses. In this study performance expectancy, and effort expectancy were statistically significant.

Social influence has a negative slope -0.079 , which means an increase in social influence would predict a decrease in behavioural intention, but it cannot be used to predict behavioural intentions due to fact that p (0.417) was greater than 0.05 and this means that it statistically not significant.

Facilitating conditions has a positive slop 0.023 , and $p = 0.752$ was greater than 0.05 and it statistically not significant, and it cannot be used to predict behavioural intention.

As a summary of this study, to examine the relationship between performance expectancy, effort expectancy, social influence, facilitating conditions, and the behavioural intention of computer and science school's teachers in Jordan to use Lego sets in education.

Multiple linear regression was used. From assumed hypotheses in this study, I rejected null hypothesis and found that performance expectancy, effort expectancy, social influence, and facilitating conditions can predict the behavioural intention of computer and science school's teachers in Jordan to use Lego sets in education.

From four independent variables, performance expectancy and effort expectancy were statistically significant with slopes = 0.468 and 0.315 , which means an increase in performance expectancy and effort expectancy would predict behavioural intention.

In this study, performance expectancy was a statistically significant which means that the computer and science school's teachers know the benefits of using Lego sets in their teaching. This agreed with (AlFarani & Alhijeeli, 2020) which indicated that the performance expectancy had a positive impact on the behavioral intention of teachers to use artificial intelligence in education, (Boštjan Šumak et al., 2010) which indicated that the performance expectancy had a positive impact on the behavioral intention of students to use Moodle in education, (Hsieh & Chiu, 2020) which indicated that the performance expectancy had a positive impact on the behavioral intention of students to integrate STEM in education, and (Durak, 2019) which indicated that the performance expectancy had a positive impact on the behavioral intention of students to use social media in education.

This result can be attributed to the performance expectancy, and the expected benefit of learning gains from using one of the most important factors and pillars that push the teachers to use

technology, and it had a greater impact on the teacher's acceptance and to use Lego sets in education. If the teacher uses the technology, that will improve his teaching performance, it will also improve his students and helps them engage in activities, and it will be more included to adopt the technology.

Effort expectancy was a statistically significant which means that teachers need less effort to use Lego sets in their teaching, and this will be more positive in using Lego sets in teaching.

This agreed with (AlFarani & Alhijeeli, 2020) which indicated that the effort expectancy had a positive impact on the behavioral intention of teachers to use artificial intelligence in education, and (Hsieh & Chiu, 2020) which indicated that the effort expectancy had a positive impact on the behavioral intention of students to integrate STEM in education, and (Durak, 2019) which indicated that the effort expectancy had a positive impact on the behavioral intention of students to use social media in education, and disagreed with (Boštjan Šumak et al., 2010) which indicated that the effort expectancy had not impact on the behavioral intention of students to use Moodle in education.

This result may be attributed to the increase in the teacher's accumulated experience in using technology, which leads to a deeper approach to the difficulties, and challenges that the teacher has and thus is positively reflected on the ease of use.

Social influence was statistically not significant and not predict of behavioural intention. That means teachers are not affected by others to use Lego sets or technology in teaching. This result could change if the managers of private schools or the ministry of education in Jordan encourages teachers to use technologies in education and the benefit of using technology in teaching for both teachers and students.

This agreed with (Durak, 2019) which indicated that the social influence had not impact on the behavioral intention of students to use social media in education, and disagreed with (AlFarani & Alhijeeli, 2020) which indicated that the social influence had a positive impact on the behavioral intention of teachers to use artificial intelligence in education, and (Hsieh & Chiu, 2020) which indicated that the social influence had a positive impact on the behavioral intention of students to integrate STEM in education, and (Boštjan Šumak et al., 2010) which indicated that the social influence had a positive impact on the behavioral intention of students to use Moodle in education.

Facilitating conditions was statistically not significant predictor of behavioural intention to use Lego sets in education. This result agreed with (Durak, 2019) which indicated that the facilitating conditions had not impact on the behavioral intention of students to use social media in education, and (Boštjan Šumak et al., 2010) which indicated that the facilitating conditions had not impact on the behavioral intention of students to use Moodle in education, and disagreed with (AlFarani & Alhijeeli, 2020) which indicated that the facilitating conditions had a positive impact on the behavioral intention of teachers to use artificial intelligence in education, and (Hsieh & Chiu, 2020) which indicated that the facilitating conditions had a positive impact on the behavioral intention of students to integrate STEM in education.

This means that school’s teachers forced a problem to use technology. This result could change if school’s administrators provide all necessary help for teachers to use Lego sets in their teaching.

In the second part of the survey, respondents who were not use Lego sets in their teaching but might be use other technologies like Arduino micro bit, and programming like C++. Table 11 showed the frequencies and the percentage.

Table 11 Characteristic of the Sample That Used Other Technologies

Use other technologies					
		Frequency	Percent	Valid Percent	Cumulative Percent
Valid	Yes	13	11.8	50.0	50.0
	No	13	11.8	50.0	100.0
	Total	26	23.6	100.0	

Source: Author

Where all the respondents were interested to use technology in education. This result will recommend the decision makers of curriculum at the ministry of education or the managers of private schools in Jordan to take a positive action to adopt using Lego sets in computer and science subjects.

Recommendations

In light of the previous results, the following recommendations can be made:

- 1- Expanding the use of Lego sets in education in light of the acceptance of both teachers and students.
- 2- Adopting a Unified Theory of Acceptance and Use of Technology (UTAUT) to make decisions to use technologies in education.
- 3- Developing the infrastructure and providing the necessary resources to employ Lego sets in education.
- 4- Conducting training courses for teachers on the use of Lego sets and software.

6 Conclusion

The final results of this study was showed that performance expectancy and effort expectancy were significantly predict behavioral intention of computer and science school's teachers in Jordan to use Lego sets in education. This means that computer and science school's teachers know the benefits of using Lego sets in teaching, and teachers need less effort to use Lego sets in their teaching.

Technology is an integral part of our lives, so, it is necessary to support including Lego sets in teaching, especially for an early stage of schooling. The implementation of Lego sets in schools depends on how the school's managers can inform students of the benefits of the technology, provide training for teachers to reduce the difficulties to use Lego sets, and support inserting Lego sets by provide all required equipments needed to use Lego sets in education.

By integrating Lego sets in education, students will be familiar with codes and programming methods, and will enhance the problem solving skills, and make them performing better in computer and science courses.

7 References

- Abdaljabar, A. (2014). Classifications of Teaching Methods. *Saudi Academics*.
<https://www.saudiacademics.com/article/education-arts/item/>
- Abdel-Rahman, S. (2008). The Psychological analogy between theory and practice. *Cairo Is the Arab Nile for Publication and Distribution*, 5.
- Abdullah, F., & Ward, R. (2016).). Developing a General Extended Technology Acceptance Model for E-Learning (GETAMEL) by analysing commonly used external factors. *Computers in Human Behavior*, 56, 238–256. <https://doi.org/10.1016/j.chb.2015.11.036>
- Adams, K. D., & Cook, A. M. (2017). Performing mathematics activities with non-standard units of measurement using robots controlled via speech-generating devices: three case studies. *Disability and Rehabilitation: Assistive Technology*, 12(5), 491–503.
<https://doi.org/10.3109/17483107.2016.1151954>
- Ain, N., Kaur, K., & Waheed, M. (2015). The influence of learning value on learning management system use: An extension of UTAUT2. *Information Development*.
<https://doi.org/10.1177/0266666915597546>
- Al-Amro, F. (2004). Methods of teaching social subjects. *Al Motanabi Library*, 2.
- Al-Mashqeeh, M. (1992). Games and Simulation in Education and Training. *Journal of Educational Studies*, 7, 259–277.
- Ala-mutka, K. (2011). Mapping Digital Competence : Author : Kirsti Ala-Mutka. *JRC European Commission, January 2011*, 1–60. <https://doi.org/10.13140/RG.2.2.18046.00322>
- Alaiad, A., & Zhou, L. (2014). The determinants of home healthcare robots adoption: An empirical investigation. *International Journal of Medical Informatics*, 83(11), 825–840.
<https://doi.org/10.1016/j.ijmedinf.2014.07.003>.
- AlFarani, L., & Alhijeeli, S. (2020). The Factors Influencing Teacher’s Acceptance of the Use of Artificial Intelligence in Education in Light of the Unified of Acceptance and Use of Technology (UTAUT). *Arab Journal of Educational and Psychological Sciences*, 4(14).
<https://doi.org/10.33850/jasep.2020.73217>
- Altakhayneh, B. (2020). The impact of using the LEGO education program on mathematics achievement of different levels of elementary students. *European Journal of Educational Research*, 9(2), 603–610. <https://doi.org/10.12973/eu-jer.9.2.603>
- Association, A. R. & A. (2011). *No Title*. <http://arabrobotics.org/Home?lang=en>
- Atmatzidou, S., Markelis, I., & Demetriadis, S. (2008). The use of LEGO Mindstorms in elementary and secondary education : game as a way of triggering learning. *Workshop Proceedings of International Conference on Simulation, Modeling, and Programming for Autonomous Robots (SIMPAN)*, 22–30.

- Atyeh, M. (2008). *Modern Strategies in Effective Education* (1 (ed.)). Safaa House for printing, publishing and distribution.
- Becker, K. (2001). Teaching with games: the Minesweeper and Asteroids experience. *Journal of Computing Sciences in Colleges*, 17(2), 23–33. <https://doi.org/10.11575/PRISM/30356>
- Behrens, A., Atorf, L., Schwann, R., Neumann, B., Schnitzler, R., & Aach, T. (2010). MATLAB meets LEGO Mindstorms – A freshman introduction course into practical engineering. *IEEE Transactions on Education*, 53(2), 306–317.
- Beland, C., Mindell, D., Wesley, C., Clarke, D., & Park, R. (2000). LEGO Mindstorms: The Structure of an Engineering (R)evolution. *Docket 6.399J Structure of Engineering Revolutions*.
- Billen, M. T., Ward, N., DeHart, J., Moran, R., & Yang, S. (2021). StoryVisualizer by LEGO Education: Using Digital Storytelling to Integrate STEM and Literacy. *IGI Global*, 21. <https://doi.org/10.4018/978-1-7998-5770-9.ch008>
- Brata, A. H., & Amalia, F. (2018). Impact Analysis of Social Influence Factor on Using Free Blog as Learning Media for Driving Teaching Motivational Factor. *The 4th International Conference on Frontiers of Educational Technologies*, 29–33. <https://doi.org/10.1145/3233347.3233360>
- Cliburn, D. (2006). . Experiences with the LEGO Mindstorms throughout the Undergraduate Computer Science Curriculum. *Frontiers in Education. 36th Annual Conference*. <https://doi.org/10.1109/fie.2006.322315>
- Delman, A., Ishak, A., Goetz, L., Kunin, M., Langsam, Y., & Raphan, T. (2010). Development of a system for teaching CS1 in C/C++ with Lego NXT robots. Development of a system for teaching CS1 in C/C++ with Lego NXT robots. *Researchgate.Net, February 2015*. <https://www.researchgate.net/publication/220843792>
- Dodge, Y. (2008). *The Concise Encyclopedia of Statistics* (10th ed.). Springer.
- Drent, M., & Meelissen, M. (2008). Which factors obstruct or stimulate teacher educators to use ICT innovatively? *Computers and Education*, 51(1), 187–199. <https://doi.org/10.1016/j.compedu.2007.05.001>
- Durak, H. Y. (2019). Examining the acceptance and use of online social networks by preservice teachers within the context of unified theory of acceptance and use of technology model. *Journal of Computing in Higher Education*, 31, 173–209.
- Fishbein, M., & Ajzen, I. (1975). Beliefs, attitude, intention, and behaviour: An introduction to theory and research. *Reading, MA: Addison-Wesley*.
- Green S B. (1991). How Many Subjects Does It Take To Do A Regression Analysis. *Multivariate Behavioral Research*, 26(3), 499–510. <https://doi.org/10.1207/s15327906mbr2603>

- Guggemos, J., Seufert, S., & Sonderegger, S. (2020). Humanoid robots in higher education: Evaluating the acceptance of Pepper in the context of an academic writing course using the UTAUT. *British Journal of Educational Technology*. <https://doi.org/10.1111/bjet.13006>
- Haak, V., Abke, J., & Borgeest, K. (2018). Conception of a Lego Mindstorms EV3 simulation for teaching C in computer science courses. *IEEE Global Engineering Education Conference, EDUCON, 2018-April*, 478–483. <https://doi.org/10.1109/EDUCON.2018.8363269>
- Hadjiyski, L. (2019). Block by Block: How LEGO came to dominate its market. *Business Today Online Journal*. <https://journal.businesstoday.org/bt-online/2019/block-by-block-how-lego-came-to-dominate-its-market>
- Havelka, M., & Částková, P. (2015). Analysis of Possibilities of Using the Lego Construction Kits in Preschool Education. In: *Quaesti–Virtual Multidisciplinary Conference*.
- Hocker, M. (2020). A History of LEGO Education, Part 2: Path to Mindstorms. *The Brother Brick*. <https://www.brothers-brick.com/2020/01/31/a-history-of-lego-education-part-2-path-to-mindstorms-feature/>
- Hsieh, C., & Chiu, F. (2020). The UTAUT Model Applied to Examine the STEM in Hight School Robot Subject Instruction. *Education and Technology in Sciences*, 1191. https://doi.org/10.1007/978-3-030-45344-2_4
- Kayali, M., & Alaaraj, S. (2020). Adoption of Cloud Based E-learning in Developing Countries : A Combination A of DOI , TAM and UTAUT. *International Journal of Contemporary Management and Information Technology*, 1(1), 1–7.
- Keele, R. (20 C.E.). *Nursing Research and Evidence-Based Practice*. 18(1), 35–52. <https://doi.org/10.1111/j.1552-6909.1989.tb01609.x>.
- Kossewska, J., & Kłosowska, J. (2020). Acceptance of Robot-Mediated Teaching and Therapy for Children With Atypical Development by Polish Professionals. *Journal of Policy and Practice in Intellectual Disabilities*, 17(1), 21–30. <https://doi.org/10.1111/jppi.12296>
- Lai, P. (2017). The Literature Review of Technology Adoption Models and Theories for the Novelty Technology. *Journal of Information Systems and Technology Management*, 14(1), 21–38.
- Latip, A., & Hardinata, A. (2020). Implementation of STEM-Robotics as High School Intra-curricular. *Thabiea : Journal of Natural Science Teaching*, 3(1), 11. <https://doi.org/10.21043/thabiea.v3i1.6770>
- Legris, P., Ingham, J., & Collerette, P. (2003). Why do people use information technology? A critical review of the technology acceptance model. *Information & Management*, 40(3), 191–204. [https://doi.org/10.1016/S0378-7206\(01\)00143-4](https://doi.org/10.1016/S0378-7206(01)00143-4)

- Leoste, J., & Heidmets, M. (2019). The impact of educational robots as learning tools on mathematics learning outcomes in basic education. *Lecture Notes in Educational Technology, January*, 203–217. https://doi.org/10.1007/978-981-13-7361-9_14
- Lund, H. H., Marti, P., & Palma, V. (2004). Educational Robotics : Manipulative Technologies for Cognitive Rehabilitation. *Artificial Life*, 28–30.
- Marangunić, N., & Granić, A. (2015). Technology acceptance model: a literature review from 1986 to 2013. *Universal Access in the Information Society*, 14(1), 81–95. <https://doi.org/10.1007/s10209-014-0348-1>
- Oye, N. D., A., Iahad, N., & Ab.Rahim, N. (2014). The history of UTAUT model and its impact on ICT acceptance and usage by academicians. *Education and Information Technologies*, 19(1), 251–270. <https://doi.org/10.1007/s10639-012-9189-9>
- Özüorçun, N., & Bicen, H. (2017). Does the inclusion of robots affect engineering students' achievement in computer programming courses? ?. *EURASIA Journal of Mathematics Science and Technology Education*, 13(8).
- Pirrie, A. (2017). The Lego story: remolding education policy and practice. *Educational Review*, 69(3), 271–284. <https://doi.org/10.1080/00131911.2016.1207614>
- Pynoo, B., Devolder, P., Tondeur, J., Van Braak, J., Duyck, W., & Duyck, P. (2011). Predicting secondary school teachers' acceptance and use of a digital learning environment: A cross-sectional study. *Computers in Human Behavior*, 27(1), 568–575. <https://doi.org/10.1016/j.chb.2010.10.005>
- Raja, R., & Nagasubramani, P. C. (2018). Impact of modern technology in education. *Journal of Applied and Advanced Research*, 3(S1), 33. <https://doi.org/10.21839/jaar.2018.v3is1.165>
- Šumak, B., Polancic, G., & Hericko, M. (2010). An Empirical Study of Virtual Learning Environment Adoption Using UTAUT. *Second International Conference on Mobile, Hybrid, and On-Line Learning, Saint Maarten*, 17–22. <https://doi.org/10.1109/eLmL.2010.11>
- Šumak, Boštjan, Polančič, G., & Heričko, M. (2010). An empirical study of virtual learning environment adoption using UTAUT. *2nd International Conference on Mobile, Hybrid, and On-Line Learning, EL and ML 2010*, 17–22. <https://doi.org/10.1109/eLmL.2010.11>
- Venkatesh, V., Morris, M., Davis, G., & Davis, F. (2003). User Acceptance of Information Technology: Toward a Unified View. *Management Information Systems Research Center, University of Minnesota Stable*, 27. <http://www.jstor.org/stable/30036540>
- Williams, M. D., Rana, N. P., & Dwivedi, Y. K. (2015). The unified theory of acceptance and use of technology (UTAUT): a literature review. *Enterprise Information Management*, 28(3), 443–488.

Yilmaz, K. (2013). Comparison of quantitative and qualitative research traditions: {Epistemological}, theoretical, and methodological differences. *European Journal of Education*, 48(2), 311–325.

Zimmerman, A. (2016). *Using LEGO to Build Math Concepts*. Scholastic.
<https://www.scholastic.com/teachers/blog-posts/alycia-zimmerman/using-lego-build-math-concepts/>

8 Appendix

A

Survey

The first section.

I'm Abeer a master's degree student at Czech University of Life Science Prague, this survey is for my master thesis analysis "Unified theory of acceptance and use of technology (UTAUT) LEGO sets in education" to evaluate the relationship between performance expectancy, effort expectancy, social influence, facilitating conditions and the intention of computer and science school's teachers in Jordan to use LEGO sets in their courses.

This questionnaire consists of 19 questions, please fill all the question.

* العمر Age

20 -30

31-40

41-50

* Gender الجنس

Male

Female

* الصف Grade

Third Grade - Sixth Grade

Seventh Grade - Tenth Grade

* المادة Subject

Computer

Science

Other

* هل استخدم اللّيجو في التدريس Do you use LEGO sets in teaching

Yes

No

التالي

Second section for teachers who are using Lego sets in their teaching

I would find LEGO sets useful in my teaching
اجد ان الليغو مفيد استخدامه في عملية التدريس *

Strongly disagree

Disagree

Neutral

Agree

Strongly agree

Answer

Using LEGO sets will enable me to teach programming / science concepts more

quickly هل يساعد استخدام الليغو في تعليم مفاهيم العلوم والبرمجة للتعلم بشكل اسرع *

Strongly disagree

Disagree

Neutral

Agree

Strongly agree

Answer

Using LEGO sets increase my teaching efficiency
هل يساعد استعمال ليغو على تحسين اداك *

Strongly disagree

Disagree

Neutral

Agree

Strongly agree

Answer

If I use LEGO sets, I will increase my chances of getting an increase
هل استخدام ليغو

في التدريس يساعد على تحصيلي على زيادة *

Strongly disagree

Disagree

Neutral

Agree

Strongly agree

Answer

هل تفاعلي مع الليغو My interaction with LEGO sets would be clear and understandable
سيكون واضح ومفهوم *

Strongly disagree	Disagree	Neutral	Agree	Strongly agree	
<input type="radio"/>	<input type="radio"/>	<input type="radio"/>	<input type="radio"/>	<input type="radio"/>	Answer

هل سيكون من السهل ان It would be easy for me to become skilful at using LEGO sets
امتلك مهارة استعمال الليغو *

Strongly disagree	Disagree	Neutral	Agree	Strongly agree	
<input type="radio"/>	<input type="radio"/>	<input type="radio"/>	<input type="radio"/>	<input type="radio"/>	Answer

I would find LEGO sets easy to use
اجد ان ليغو سهل الاستعمال *

Strongly disagree	Disagree	Neutral	Agree	Strongly agree	
<input type="radio"/>	<input type="radio"/>	<input type="radio"/>	<input type="radio"/>	<input type="radio"/>	Answer

تعلم كيفية التعامل مع ليغو سيكون سهلا Learning to work with LEGO sets will be easy for me
لي *

Strongly disagree	Disagree	Neutral	Agree	Strongly agree	
<input type="radio"/>	<input type="radio"/>	<input type="radio"/>	<input type="radio"/>	<input type="radio"/>	Answer

People who influence my behaviour think that I should use LEGO sets

المؤثرين والمسؤولين عني يعتقدون انه يجب علي ان استخدم الليغو في الشرح *

Strongly disagree

Disagree

Neutral

Agree

Strongly agree

Answer

People who are important to me think that I should use LEGO sets

للطلاب ان استخدم الليغو في الشرح *

Strongly disagree

Disagree

Neutral

Agree

Strongly agree

Answer

The senior management of the school will be helpful in the use of LEGO sets

المدرسة ستكون متعاونة لاستخدام الليغو *

Strongly disagree

Disagree

Neutral

Agree

Strongly agree

Answer

In general, the organization has supported the use LEGO sets

استخدام الليغو *

Strongly disagree

Disagree

Neutral

Agree

Strongly agree

Answer

I have the resources necessary to use of LEGO sets
الليغو *

Strongly disagree

Disagree

Neutral

Agree

Strongly agree

Answer

I have the knowledge necessary to use of LEGO sets
الليغو *

Strongly disagree

Disagree

Neutral

Agree

Strongly agree

Answer

LEGO sets are not compatible with other educational tools I use
ادوات تعليمية اخرى استخدمها في الشرح *

Strongly disagree

Disagree

Neutral

Agree

Strongly agree

Answer

A specific person (or group) is available for assistance with LEGO sets difficulties
يوجد شخص (او مجموعة) متاحة للمساعدة في اي صعوبة تحصل مع استعمال ليغو *

Strongly disagree

Disagree

Neutral

Agree

Strongly agree

Answer

I intent to use LEGO sets when it will become available

متوفرة *

Strongly
disagree

Disagree

Neutral

Agree

Strongly
agree

Answer

I predict I would use LEGO sets when it becomes available

ان استخدم الليغو في الشرح *

Strongly
disagree

Disagree

Neutral

Agree

Strongly
agree

Answer

I plan to use LEGO sets when it becomes available

متاحة لي *

Strongly
disagree

Disagree

Neutral

Agree

Strongly
agree

Answer

The third part was for teachers who are not use Lego sets in their teaching, but might be use other technologies

? Is LEGO just a game

The use of robots in education is important in all educational stages. Through its design, programming and construction, learners acquire knowledge and skills in the fields of computer engineering, electronic and mechanical engineering

LEGO company plays a great role for entering technology and robot to classrooms by providing many kits like EV3, WeDo 2.0, Motion Essential, and SPIKE to allow elementary and middle-school students in STEM learning and programming languages through build and create robot. LEGO robots a great way to teach children a wide range of skills such as: problem solving, communication skills, and decision making

Sphero an American company also produce robot used in teaching with enjoyable environment such as: +Sphero Mini, BOLT, and SPRK

To know more about these two companies and their products please see the links below

/LEGO --> <https://education.lego.com/en-us>

Sphero --> <https://sphero.com/collections/for-home>

?Do you use any technologies in your teaching process

Yes

No

?If yes, Which technology

إجابتهك _____

? Are you interested to use technology in teaching

Yes

No