

CZECH UNIVERSITY OF LIFE SCIENCES
FACULTY OF ENVIRONMENTAL SCIENCES



DIPLOMA THESIS

*Velipoje Waste Water Treatment Plant Modernization in Perspective
of Albania Transition to EU Standards*

Author of Thesis: B.Sc. Ajla Starja

Thesis Supervisor: Dr. Ing. Miroslav Kravka

PRAGUE 2022



Czech University of Life Sciences

Faculty of Life Sciences

Diploma Thesis Topic

Author of Thesis: Ajla Starja
Thesis Supervisor: Dr. Ing Miroslav Kravka
Study Program: Landscape Engineering
Field Program: Environmental Modelling
Supervisor department: Department of Landscape and Urban Planning
Language of Thesis: English
Thesis Title: **Velipoje Wastewater Treatment Plant Modernization in Perspective of Albania Transition to EU Standards.**

Objective of Thesis The aim of this study work was to make a technically and legally comparison between the Albanian engineering work standard compare to the EU standard by taking into engineering work that is a great example for protection our ecosystem such is the Waste Water Treatment plant, in this case, Velipoja WWT compares to other WWT works of EU countries. This plant has many peculiarities and few shortcomings which will make the overview of the comparison very wide and this comparison would serve for other plants that operate in Albania in order to conform in the future with EU standards.

Methodology The study of this paper concerning on evaluation N and P of treated water discharge through laboratory work, making comparison tables and graphics, schemes and maps.

The proposed extent of thesis: 43 pages

Keyword: Wastewater, MBR, Sewage collection system, Nitrogen and Phosphorus rate discharge

Recommendation information sources:

1. The MBR Book- Principles and Applications of Membranes Bioreactors in Water and Waste Water Treatment Author: Simon Judd, Original Published 27 September 2006, pages
2. Ministry of Public Transport and Telecommunication, General Directory of Waste Supply Treatment and Sewage Report 10
3. LAW No.9115, dated 24.7.2003 For Environmental Waste Water Treatment from Ministry of Tourism and Environmental &The Council Minister Decision Nr. 177, dated 31.3.2005

Expected day to defend: 2022 SS – FES

Consultant: Dr. Ing. Miroslav Kravka

Electronically approved 21/2 /2022

Prof. Ing. Petr Sklenička, CSc /

Head of Department

Electronically approved 22/2 /2022

Prof. RNDr Vladimír Bejček, CSc

DEAN

DECLARATION

I hereby declare that this thesis was carried out independently with the use of the cited literatures and under the supervision and guidance of Dr. Ing. Miroslav Kravka

In Prague, 25.03.2021

Ajla Starja

AKNOWLEDGEMENT

First and foremost I am hugely grateful to my supervisors, Dr. Ing. Miroslav Kravka or the precious advice, continuous support, and patience during my master's degree. His immense knowledge and plentiful experience have encouraged me in all the time of my academic research.

I would like to express my gratitude especially my father which I dedicated this master for the internal force that I got to continue after everything, my loving mom and my adorable brother. Without their tremendous support and encouragement in the past few years, it would be impossible for me to complete my study.

God bless you all,

Ajla Starja

ABSTRACT

Building engineering works for helping nature breathe freely and significantly improve our lives has always been considered a Future Act. One of the biggest works in the favor of the environment is the wastewater treatment plant which must have building standards and functionality in order to guarantee the reason why it was built. Albania, as has earned the green light for paving the way for EU membership negotiations and every engineering work and legal action, must conform to EU standards and norms.

In accordance with this statement, I did a detailed study when I took for a technically and legally comparison an engineering work in Albania the Waste Water Treatment of Velipoje, and two other engineering works in the European Union, the waste Water Treatment of Kaarst NordKannal located in Germany and Waste Water Treatment of Meistratzheim located in France. The methodology of this thesis includes laboratory experimental work, the tables of comparison, schemes, and maps.

This waste water treatment plant has many peculiarities and few shortcomings which will make the overview of the comparison very wide and this comparison would serve for other plants that operate in Albania in order to conform in the future to EU standards.

Table of Contents:

Declaration.....	I
Acknowledgement.....	II
Abstract.....	III
Table of contents.....	IV
List of Figures	V
List of symbols.....	VI
1.1 Introduce	10
1.2 Objective	10
1.3 Literature Review.....	11
1.4 Waste Water Treatment situation in Albania	11
1.5 Emergency Constructions in crisis situation	12
1.6 Principal Issues with Waste Water Treatments plants in Albania.....	12
1.7 Why I Choose Waste Water Treatment of Velipoje.....	13
2 Location	
2.1 Area Location of WWT.....	13
2.2 Terrain and Marine.....	14
3 Hydrography	
3.1 Buna River.....	15
3.2 Water Regime.....	16
3.3 Interconnection between Natural Hydrographic Network and Sewerage.....	16
3.4 Interconnection between Sewage and Groundwater.....	17
4 Economic Role	
4.1 Population Area.....	17
4.2 Population in the Tourism Season.....	18
4.3 Economic Situation.....	18

5 Waste Water Treatment	
5.1 Sewage Collection System	18
5.2 Waste Water Treatment Location.....	21
5.3 Screening (WWT phase 1).....	21
5.4 Grit Removal (WWT phase 1.1).....	22
5.5 Tank Reactor Design (WWT phase 2).....	23
5.6 Aerobic Unit (WWT phase 2.1).....	24
5.7 Dewatering Unit (WWT phase 2.2).....	26
5.8 Centrifugal Unit (WWT phase 2.3).....	26
5.9 Septic tank retrieving station (WWT phase 2.4).....	27
5.10 Densification (WWT phase 2.5).....	28
5.11 Discharge pipe into Buna River (WWT phase 2.6).....	29
5.12 Office and administration building.....	29
6 Modernization of Waste Water Treatment according to EU standards	
6.1 Lack of Phases of Treatments (Laboratory work).....	30
6.2 Lack of Maintenance.....	37
6.3 Lack of Coverage	39
7 Legislation	
7.1 EU Legislation Directives.....	42
7.2 Albanian Frame Laws.....	43
8 Annexes and References	
8.1 References Attached.....	44
8.2 Support Literature.....	46

Pictures References

Photo 1.4. Waste Water Treatment plants locations map (Ministry of Public Transport and Telecommunication, General Directory of Waste Supply Treatment and Sewage Report 11 page

Photo 2.1. Location of Terrain taken by Satellite (Monitoring area station of Velipoje)...13 page

Photo 3.1. Hydrography Map Area (Monitoring area station of Velipoje)..... 15 page

Tab 4.1. Year 2018 December (Instat institutional official report)..... 17 page

Photo 5.1. Sewage Collection System of Velipoje (Ministry of Public Transport and Telecommunication, General Directory of Waste Supply Treatment and Sewage Report)..19 page

Photo 5.1.2. FPS delivering wastewater to WWT(Ministry of Public Transport and Telecommunication, General Directory of Waste Supply Treatment and Sewage Report)..20 page

Photo 5.2. Location and water body is chosen Buna River (Ministry of Public Transport and Telecommunication, General Directory of Waste Supply Treatment and Sewage Report...21 page

Photo 5.3. Screening Equipment Install (Past, Present, and Future Authors: Andreas N. Angelakis & Shane A.Snyder).....22 page

Photo 5.5. Tank Reactor Design (Photo from the site visiting)23 page

Photo 5.5.1. Photo of aerobic mixer device (Practical Wastewater Treatment B.....23 page

Photo 5.6. Illustration Scheme of Aerobic Treatment Unit (Aerobic Processes B).....25 page

Photo 5.8. Centrifugal motor (Ministry of Public Transport and Telecommunication, General Directory of Waste Supply Treatment and Sewage Report)26 page

Photo 5.9 Illustration Scheme after finish the treatment of waste water (Ministry of Public Transport and Telecommunication, General Directory of Waste Supply Treatment and Sewage Report27 page

Photo 5.10. Disinfestation bottles Sodium Hypo (photos from site visiting)28 page

Photo 5.11. Buna River as a body discharge(Ministry of Public Transport and Telecommunication, General Directory of Waste Supply Treatment and Sewage Report) 29 page

Tab 6.1.1 Tab WWT of Kaarst NordKannal discharge rate (European Commission urban waste water, Germany 29)31page

Photo 6.1.2. In Laboratory for experimental work for analyzing N and P with UV method (Photo from Laboratory work)31 page

Photo 6.1.3. Another photo in Laboratory to analyze N and P (Photo from Laboratory).... 32page

Photo 6.1.4. The pipeline estuary (photos from the site vising)32 page

Photos 6.1.5. from the Kaarst NordKanal plant where the bioreactor and MBR are located (The MBR Book- Principles and Applications of Membranes Bioreactors in WWT Author: Simon Judd)..... 35 page

Scheme 6.1.6. shows WWT of Kaarst NordKannal details what is missing (green square) compare to WWT of Velipoje(The MBR Book- in WWT Author: Simon Jud.....35 page

Tab 6.2 Photo of Waste Water Treatment of Meistraizheim (Article WWT of Meis.)...37 page

Tab 6.3.1 Coverage collection network in Germany (European Commission urban waste water, Germany)39 page

Tab 6.3.2 Coverage collection network in Albania (MK Wastewater Report 21).....39 page

Scheme 6.3.3. Sewage collection system (green points are main collectors) of Velipoje WWT (MK Report)..... .41 page

LIST OF SYMBOLS

WWT- Waste Water Treatment

MBR – Membrane Bio Reactor

N- Nitrogen

P –Phosphorus

TN- Total Nitrogen

TP- Total Phosphorus

p.e- Population Equivalent

mg/l –Milligram to liter

WB- World Bank

EC- European Commission

EU- European Union

Introduce

1-Introduce

As a developing country according to the newest report of World Bank 2020, Albanian has earned the green light for paving the way for EU membership negotiations which means every engineering work and legal action, must conform to EU standards and norms. From this point of view, for study comparison which is based on two main tracks *technically* and *legally* detailed.

We took into consideration the Waste Water Treatment plant of Velipoje, a great example because operates till the second phase of treatment of wastewater treatment by showing the *lack of wastewater treatment* in the third stage, we conducted an experimental laboratory work when analyzed the discharge rate of Nitrogen (N) and Phosphorus (P) of Velipoja plant and make technically compare to NoordKannal Waste Waste Treatment located in Germany which operated till the third phases of treatment with that called *MBR technology*.

We noticed also problem, the *lack of maintenance*, and made a comparison which Waste Water Treatment of Meistratzheim located in France, and brought the new annual plan of maintenance.

Another main problem of our study plant was the *lack of coverage*, we compare the collected sewage network in Germany where is 98 % of the territory covered with a public network and 2 % individual system of treatment and Albanian remain only 52 % of coverage, advanced for another fay expansion since the second phase of the project was made and invention that we should make in plant too.

1.2-Objevtive

Problems of pollution of the aquatic ecosystem have increased especially for the developing progressive countries such as Albania, which need to implement advanced technology and should undertake new reforms to conform to the EU standards. Taking the Waste Water Treatment of Velipoje an engineering work whose key purpose is the protection of the aquatic ecosystem, which aim of this study work was to make a technically and legally comparison between the Albanian engineering work standard compare to the EU in order to bring the wide frame and the solutions of lacking problems.

Our point's objectives were:

-Laboratory work to analyze N and P discharge rate to understand operation state if we need another treatment phases in our plant

-Seeking the best technology that would fit with our study plant (MBR technology)

-Looking for an annual form of maintenance in order to have at least a 20% reduced operation cost

-Invention for another expansion in order to increase the coverage- Intervention in Albanian legislation in order to have different norms for treated water from WWT

1.3- Literature Review

This section elaborates some information for MBR technology, waste water treatment plants details information's, why is important the third phase of treatment, maintenance and coverage problems and applications and legislation consider.

1.4 Waste Water Treatment situation in Albania:

Albanian has earned the green light for paving the way for EU membership negotiations by implementing important structural reforms that will support equitable growth, raise productivity and competitiveness in the economy, create more jobs, and improve governance and public service delivery through EUs standard. In the development phase, one main focus is the protection of the environment by perfecting frame law and designing engineering works.

One engineering work that straight supports environmental and marine is the Waste Water Treatment Plant (WWT) which will be the principal of this topic, by considering such an engineering work in Albania, analyzing and comparing design work and frame law with EU standard, and how should improve.

Albania faces today's situation when only 50% of the entire territory of the country is covered by urban wastewater systems, which means that there is a centralized collection and transport of the wastewaters, which are later discharged without any treatment in receiving water environments and only 2 % cover rural zone. There are on total of 14 wastewater treatment plant that operates mostly along the sea-coast which that are Waste Water Treatment plant of Velipoje /of Pogradec/of Durres/of Kavaje/of Vlora/of Orikum /of Lezhe/of Shirok /of Shengjin/of Himare/of Hamallaj/of Tirane/of Korca, see the map below.

Photo 1.4. Waste Water Treatment plants locations map

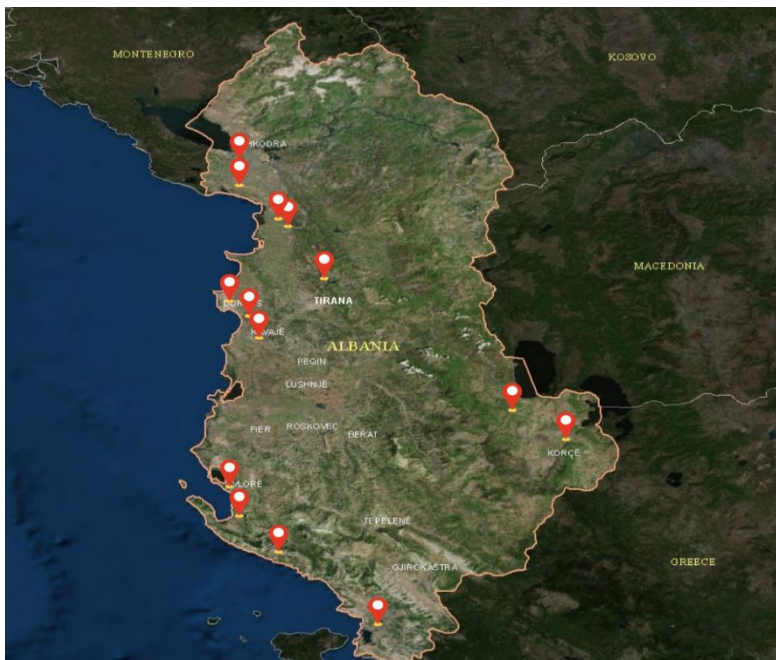

1.5 Emergency Constructions in crisis situation:

In 2013, Albania was in a very delicate situation when all sewage water was discharged on water bodies without any kind of treatment by endangering one of the most important pillars of the economy, tourism, especially sea tourism which is famously known.

Due to this situation, the Albanian government took an emergency decision to provide part of the 0.83 GDP budget between years period 2013-2021 according to WB or by receiving funds to build wastewater treatment plants, but because of the crisis situation and the lack of the funds, they build the partial constructions

1.6 Principal Problems with Waste Water Treatments plants in Albania:

In current situation, Albanian WWT plants faced three main problems:

- *Lack of Phases of Treatments*

In the construction of a WWT plant, the most principal thing is the phases of treatment because they determine the functionality of that construction and quality of treatment water part that will reuse again or it will discharge with a defined standard quality in water bodies (this depends on phases) and also solid sludge part which goes for as fertilizer for farmers. The Waste Water Treatments plants in Albania operates only using the first phase till second phase due: to lack of part of the construction, lack of treatment specific equipment's or maintenance for instance WWT of Vlora operates with only one phase and our example WWT of Velipoje operates until the second phase. To emphasize, according to EU standards Waste Water Treatment plants operate with three-stage or even more like four-stage for special wastewater which comes out from the industrial factories.

- *Lack of Coverage*

Coverage of the territory is only 50 percent and 2 percent only rural areas (mostly tourist villages) who are offered this service and the rest is discharged into water bodies without any treatment. The solution of this issue is to expand the treatment structures and there have also been some extensions have been made in each WWT plant by intervening in treatment structures or at collective sewage system but even with this intervening did not have a major impact to indicate at official total coverage value of the country. According to statistics, it is thought that in 2023 it will decrease to the value of 52 percent of the territory but remains to be seen because there are faced problems with funding.

- *Lack of Maintenance*

Another important issue is the lack of budget to cover ongoing operating costs, lack of annual control plan check and lack of risk prevention capital which are problems in all WWT plants in Albania.

1.7 Why I choose Waste Water Treatment of Velipoje?

This study detailed is dedicated to how Albania should take fair steps towards the European Union where every engineering work must conform to the European standard. In accordance with this approach we took into one engineering work that is of great benefit and protection to our ecosystem such as Waste Water Treatment plant in this case Velipoja to compare it technically and legally with other WWT works of EU countries. This plant has some peculiarities and some shortcomings which will make the overview of the comparison very wide and this comparison would serve for other plants that operate in Albania.

2- Area Location

2.1 Area Location of WWT:

Velipoja area is located in the District of Shkodra, close to the border with Montenegro and has about 8 km of coastline which includes Franc Josef Island that frequently changes shape. The borderline follows the lower Buna River (the only navigable river of Albania), where it flows into the Adriatic Sea near the border with Montenegro. The coastal area of Velipoja oriented West-East, is characterized by a sandy shore and it is supplied by the Buna River which connects Shkodra Lake to the sea that covers about 694 hectares. The area is composed of quaternary sediments with mainly fine sand on the shore; the coast is mainly characterized by alluvium of rivers.

Photo 2.1. Location of Terrain taken by Satellite

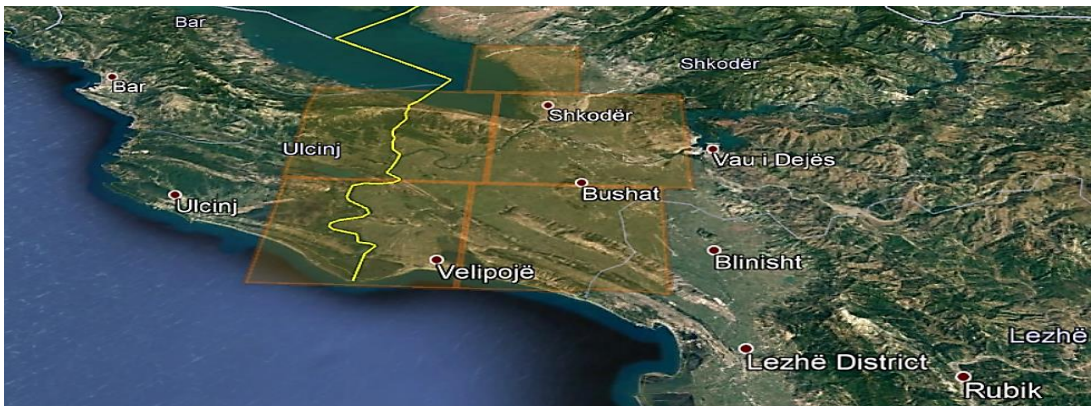

The area is composed of quaternary sediments with mainly fine sand on the shore; the coast is mainly characterized by alluvium of rivers. The Commune (i.e. the administrative unit) of Velipoja has a population of around 10,000, spread over several small settlements, the largest of which is the town of Velipoja itself.

The economy is based on agriculture (arable land and livestock, sheep and cattle), some fishing, and chiefly tourism. The scenery is largely unspoiled: a mixture of sea-coast, river estuary, heathland, thick pine woods, farmland, and high mountains. It has been remarked by visitors that the heathland to the north of Velipoja is very reminiscent of Scottish scenery. A nature reserve lies within the commune. The area is a prime site for bird watching, game shooting, and fishing.

2.2 Terrain and Marine:

The vegetation is mainly composed of sub-Mediterranean xeric broadleaves forest (Orno Ostryetalia). The coast is partly covered by planted pines and elms, and partly by the wetlands. Franc Jozefi island is included in the naturally forested Buna river delta, composed of old riparian marshland and brackish lagoons with several poplar plantations. The island is formed by alluvial sediments covered with coppice forest.

A scientific reserve covers 60 ha, and is a very important nesting site for Ardeidae and Phalacrocoracidae. Coastal dunes between the lagoons and the sea have been planted with pine trees around 20 years ago. Inland, the Kakarriqi plain has been reclaimed from extensive marshlands; presently it is only partially exploited, and most of the abandoned fields are grazed by roaming cattle.

The shoreline position and the underwater dunes can move very quickly during storms or flooding, mostly in spring and autumn. Signs of erosion, created by wave action mostly to the sand dunes, can be seen near the Buna river mouth and on the southern side of Velipoja. Monk seal and dolphins have been observed at the mouth of the river Buna, which is probably a feeding site.

3 Hydrography:

3.1 Buna River:

The area of Velipoje is characterized by several natural channels crossing from north to south and one of them is the Buna River which runs in the last south-west segment of the Albanian – Montenegrin border. This river springs from the Lake of Skadar, quite close to the city of Skadar (Shkoder), between the hill of “Rozafa” Castle and Taraboshi Mountain. Buna is the only emissary of Skadar Lake. First, Buna runs to the south, alongside Taraboshi, further it snakes toward the west, and then it takes again the south direction, up to its mouth in the Adriatic Sea. The Albanian – Montenegrin border traverses the River Buna from village Samish in Albania and Gorica in Montenegro, continuing up to the river mouth. The river has a length of 44 km and flows along with the fields of Bregu I Bunës, including the Field of Anamali on the right side of the river and both Field of Trushi and Field of Velipoja on the left.

The fields of Bregu I Bunës have a field Mediterranean climate, of 1600 – 1800 mm rainfall per year and an average temperature of the air of 16 – 18 °C, with the minimal absolute extreme of 0 °C up to – 4 °C. Buna is the only river with a real natural delta in Albania. In its delta is created Ada Island, which divides the river into two branches flowing to the sea. Ada and the right branch belong to Montenegro. Franz Joseph Island and Unnamed Island, quite close to Ada, belong to Albania.

The water of River Buna in its beginning comes from the Skadar Lake, whose water is mostly provided from Moraça River, running from Montenegro, but with a branch called Cemi River, in Albania.

The National asphalted road divides the area into two parts: the northern one where natural channels run parallel to one another and the southern one, where the channels have an irregular path.

Photo 3.1. Hydrography Map Area

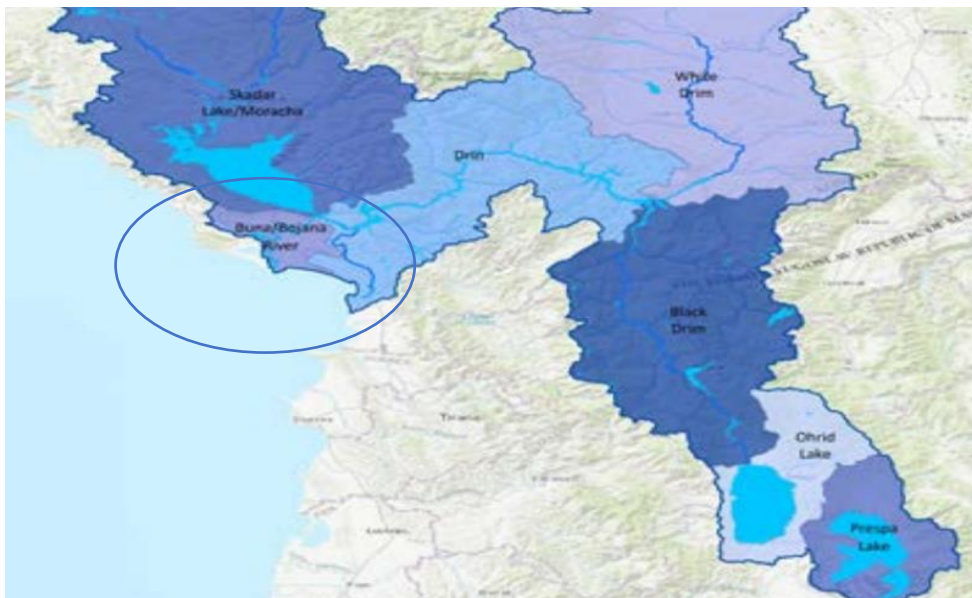

Although Buna is a typical field river, known as a partially navigable river, it gathers waters from a very mountainous territory. The average altitude of this area is 909 m above sea level. A high number of streams run from Annamalai side to Buna, whose longest is the Stream of Milla, at a length of 25 km, and the second is the Stream of Megjureç at a length of 21,6 km. In Buna flows also the water from Lake of Shas in Montenegro, through Vija e Shëngjergji.

3.2 Water Regime:

The water regimen of Buna River is defined from the water regimen of Skadar Lake, River Drin, and Delta of Buna. The average depth of Skadar Lake varies from 4,39 m to 9,40 m and Buna takes water from the lake at an average of 320 m³/sec., but after joining with the Drin the water capacity becomes 680 m³/sec. When the water capacity is high, the water flowing from the lake is blocked.

In such cases, the lake reaches its maximal water capacity, meanwhile, Buna gets out of its bed and floods the fields. This phenomenon was particularly problematic in the past when the maximal water capacity was over 7500 m³/sec.

After the construction of hydroelectric stations on River Drin, the floods are obviously decreased. Thus, River Buna – Skadar Lake – River Drin, form a hydraulic joint very interesting, which defines the water regimen of one of the rivers with the biggest water capacity in the Mediterranean.

The water regimen of the delta is defined from the relation of the water flow of Buna with talasographic parameters. One of these parameters, the waving regimen, is related to the wind. In general, waving influences mostly the winds at speed of 10 – 20 m/sec, which are more frequent and steady Buna is a river with a slow flow, because the inclination of water flow is small and the average inclination is 1,2 m/km and also is a river with a small depth, especially in 12 km of the upstream where are some islands.

3.3 Interconnection between Natural Hydrographic Network and Sewerage

The sewerage system of Velipoje was designed to allow the natural drainage network and groundwater, to emerge from the site and geological survey. For this main reason, it was been carefully analyzed the orographic, hydrographic, and geomorphological aspects of land, in order to identify the natural water collection system. This allowed for designing the sewerage according to natural ground slope and is possible to avoid interconnections with the hydrographic network. In summary, the sewage network is totally independent of the hydrographic network and from the dynamic of groundwater, with particular attention to the discharge points.

3.4 Interconnection between Sewage and Groundwater

The relationship between sewerage and groundwater, with simple words interconnection of groundwater level, could interfere, occasionally or permanently and sewage network. It is important to avoid both groundwater pollution and the collecting of groundwater to the wastewater treatment plant. For this main purpose the design and constructive criteria of sewerage and the choice of materials (pipes and manholes), were directed to guarantee a long life and leak-proof ness so is the use of HDPE pipes and manholes and respective execution of head/head join.

4 Economic Role

4.1 Population Area

Official data taken from the Velipoje Commune provide that the current number of the resident population in the Commune of Velipoje, as by the register of the Registrar's Office, is about 8,700 but because is very touristic are more than 92,000 people visit in an annual period. Actually, the Commune of Velipoje embraces a large area (about 6,400 ha) and the distribution of each zone in the region is shown in the following image

Tab 4.1. Year 2018 December

HAMLET	Inhabitants at beginning of month			Growth						Reduction						Inhabitants at end of month			Number of families at the end of month	Number of Wedding
				Birth		Transfers		Total		Dead		Transfers		Total						
	Total	M	F	M	F	M	F	M	F	M	F	M	F	M	F	Total	M	F		
Pulaj	1268	650	618	1	1	12	9	13	10	1	0	0	0	1	0	1290	662	628	350	
Velipoje	1950	988	962	1	1	1	2	2	3	0	2	0	0	0	2	1953	990	963	482	
Recpulaj	397	197	200	0	0	0	0	0	0	0	1	2	2	2	3	392	195	197	89	
Luant	605	300	305	0	1	0	1	0	2	0	0	0	0	0	0	607	300	307	146	
Grensique e Re	1282	645	637	1	2	0	2	1	4	1	0	0	0	1	0	1286	645	641	316	
Baks Rqjoll	577	291	286	0	0	4	6	4	6	1	0	0	0	1	0	586	294	292	161	
Mali Kolaj	377	199	178	0	0	0	0	0	0	0	0	0	0	0	0	377	199	178	100	
Baks i Ri	572	299	273	0	0	0	0	0	0	0	0	1	0	1	0	571	298	273	147	
Rec i Ri	931	464	467	0	0	0	0	0	0	0	0	4	7	4	7	920	460	460	223	
Cas	738	389	349	1	0	0	0	1	0	0	0	2	1	2	1	736	388	348	171	
Total	8697	4422	4275	4	5	17	20	21	25	3	3	9	10	12	13	8718	4431	4287	2185	

4.2 Population in the Tourism Season

The population in the highest tourist season overpasses ten times the number of residents. The tendency is for this population to concentrate in the beach area, which is inhabited by 92,000 tourists lodging in hotels, bed and breakfast, private houses for rent and touristic structures in general.

In the peak period (July – September) a big figure of tourists (about 81,000) reaches the coastal area during the day in order to have their journal holidays, usually coming from Shkoder and, other surrounding areas. Partial survey and un-official census talk for a number of tourists that is in peak season reaching the number of more than 85,000 holiday-makers. For these people it is possible to foresee a moderate water supply requirement, related mainly to sanitary services and needs.

4.3 Economic Situation

The traditional economy was based on agronomic and animal breeding products, such as silk, cereals, olive oil, wine, honey, beeswax, fish, leather, wool, etc., which have been transported through Buna toward European countries. These areas close to the town of Skadar and Ulcinj, have a civilized and cultured population. These areas own irreplaceable natural values, which are an important factor for sustainable development. Nowadays the economy is still based on agricultural and animal breeding products, whose main products are cereals, potatoes, bean, different vegetables, fruits, milk, eggs, for its own necessities of the population, but also for trade within the country. Fishing is not much developed. Tourism is in its first steps, because of the lack of tradition and infrastructure. Notable importance has the rousing of interest for using the river and its sides for tourism, increasing the elaboration of agricultural and animal breeding products, transport and communication between populations in two sides of Buna, belonging to two countries.

5 Waste Water Treatment

5.1 Sewage Collection System

In one Waste Water Treatment design great importance takes the Sewage Collection System because it clearly shows us the whole coverage and who benefits from this service, and definitely the success of this design work. The sewage collection system is located between Pulaj hamlet central area and Res Pulaj which is currently the most populated area in Velipoja district. The laying of sewage network collectors is realized by observing the necessary distance between the existing facilities.

Photo 5.1. Sewage Collection System of Velipoje



The entire sewerage collection system is composed of the following items, as explained above:

Main force;

Final pumping station;

Main collectors;

Pumping stations;

Secondary sewer,

The sewage collection system scheme is diagonal type: the main collectors lay parallel to coast in the coastal area included between the Viluni lagoon and the Buna River, the secondary sewerage pipelines, instead, lay perpendicular to the main collectors. The coastal area will be served by two main collectors: the main collector number 1 serves the western area of Pulaj, while the main collector n°2 is served the eastern area (the reference point is the Final Pumping Station). The sewage collection system ensures complete waterproofing because the employment of HDPE pipes and ancillaries items and the main collectors were architected according to a scheme so-called "Sawtooth".

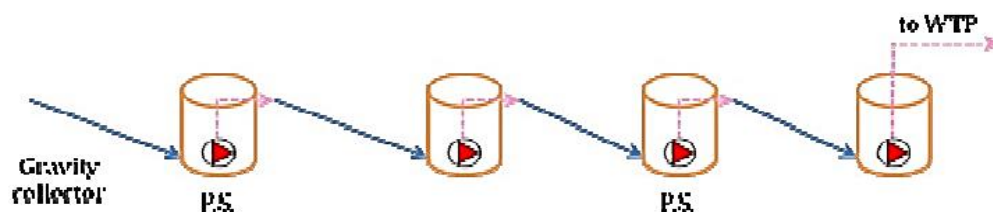
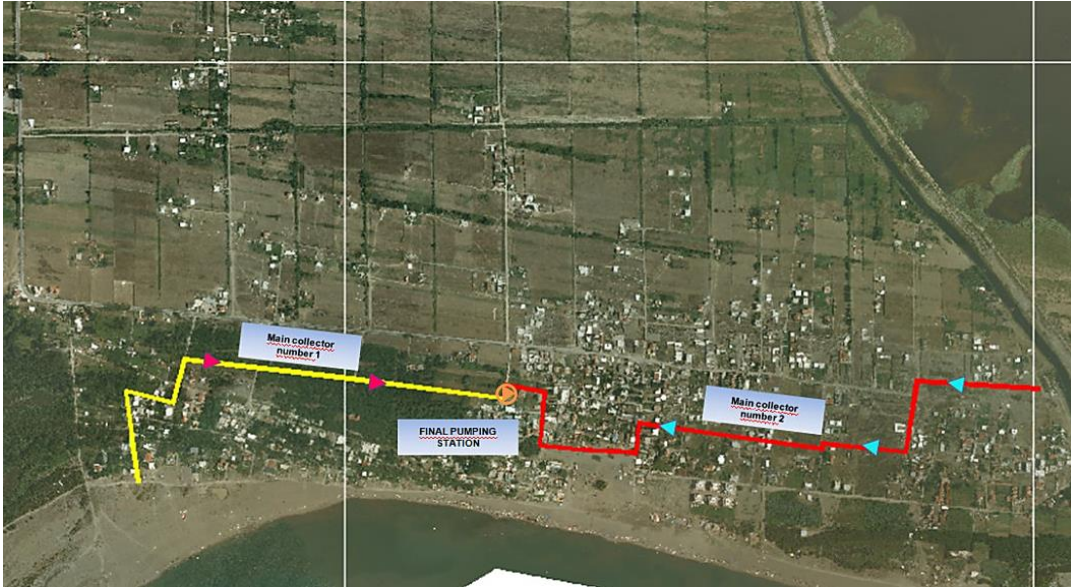
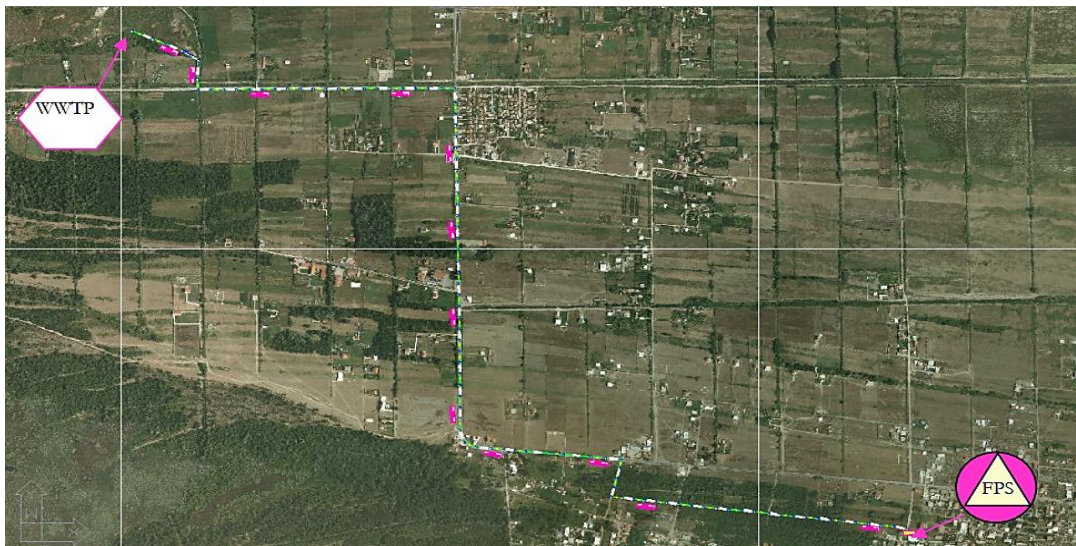

Photo 5.1.1. Sewage Collection System and, two main collector and final pumping



This scheme comes from the orographic conformation of the land, which is on average flat, and foresees the location of some intermediate pumping stations along with the lay-out of the main collector and a Final Pumping Station (FPS) delivering wastewater to WWTP.

Photo 5.1.2. FPS delivering wastewater to WWTP



5.2 Waste Water Treatment Location

The wastewater treatment plant location is located on a little promontory about 12 meters above mean sea level, 3.00 km away from the coastal area and about 1.50 km away from Velipoja hamlet, please find the picture below. Buna River is chosen as the final receiving water body for treated wastewater. Waste Water Treatment of Velipoje as several processing phases.

Photo 5.2. Location and water body is chosen Buna River

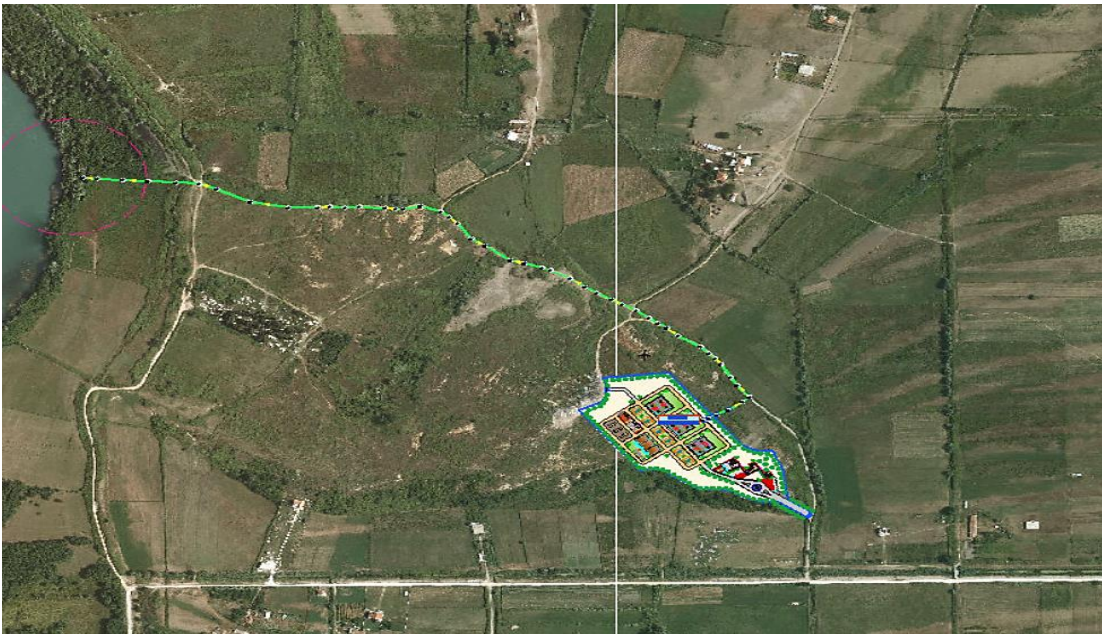

5.3 Screening (*WWT phase 1*)

The first unit operation encountered in WWTP is screening. A screen is a device with openings generally, of uniform size, that is used to retain solids found in the influent wastewater to the treatment plant. The principal role of screening is to remove coarse materials from the flow stream that could damage subsequent process equipment, reduce overall treatment process reliability and effectiveness, or contaminate waterways.

The Screening unit is made up of two screen compactors; with a slim-line combined machine consisting of:

- Screen: a drilled or wedge-wire metal screen section with mesh sizes of 3 mm;
- Conveyor: to elevate the captured solids out of the affluent and de-water by gravity conveying them towards the pressing zone
- Press: de-watering and compressing the screenings to give a volume reduction of up to 40%

Photo 5.3. Screening Equipment Install

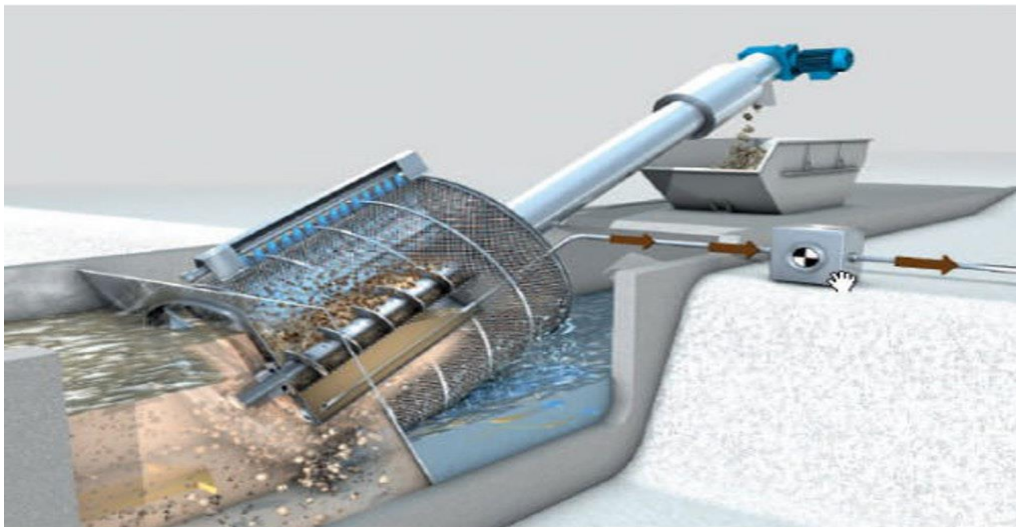

5.4 Grit Removal (WWT phase 1.1)

A grit chamber is designed to remove grit, consisting of sand, gravel, cinders, or heavy solid materials that have subsiding velocities or specific gravities substantially greater than those of the organic putrescible solids in wastewater. The grit chamber is located after the screen and before the equalization tanks. The grit removal is achieved in a vortex-type grit chamber consisting of a truncated conical tank in which the flow enters tangentially creating a vortex flow pattern; centrifugal and gravitational forces cause the grit to separate.

5.5 Tank Reactor Design (WWT phase 2)

Photo 5.5. Tank Reactor Design



Reactors are one of the most important parts, where the wastewater is discharged, and there happen

Physic-chemical processes to eliminate the waste. The tanks have a rectangular shape and a volume of 500 m³ and a height is at least 6 meters. Every tank works with one cycle for 6 hours. The system of reactors works with 2 ventilation (aerobic) methods which are biological and chemical.

Photo 5.5.1. Photo of aerobic mixer device



Tanks actually function with a method called the “*Flow equalization*”.

For short describe flow equalization is a method used to overcome the operational problems caused by flow rate variation, to improve the performance of the downstream process, and to reduce the size and cost of downstream treatment facilities

In fact, the volume of the equalization basin is larger than that theoretically determined to account for the following factors:

- Operation of pumps and equipment is not allow complete drawdown, so it is necessary to provide for died volume;*

- Volume was provided to accommodate the concentrated plant recycle streams that are expected,*

The equalization tank is to the following dimensions:

Width: 11 m;

Length: 16 m;

Water depth: 3 m;

Tank height: 3 m;

5.6 Aerobic Unit (WWT phase 2.1)

The Waste Water of Velipoje uses an Aerobic unit to treat waste-activated sludge that remains in the tank after the densification process. Aerobic digestion is similar to the activated sludge process. As the supply of available substrate is depleted, the microorganisms begin to consume their own protoplasm to obtain energy for cell maintenance reactions. When energy is obtained from cell tissue the microorganism is said to be in the endogenous phase and cell tissue is oxidized aerobically to carbon dioxide, water, and ammonia.

Photo 5.6. Illustration Scheme of Aerobic Treatment Unit

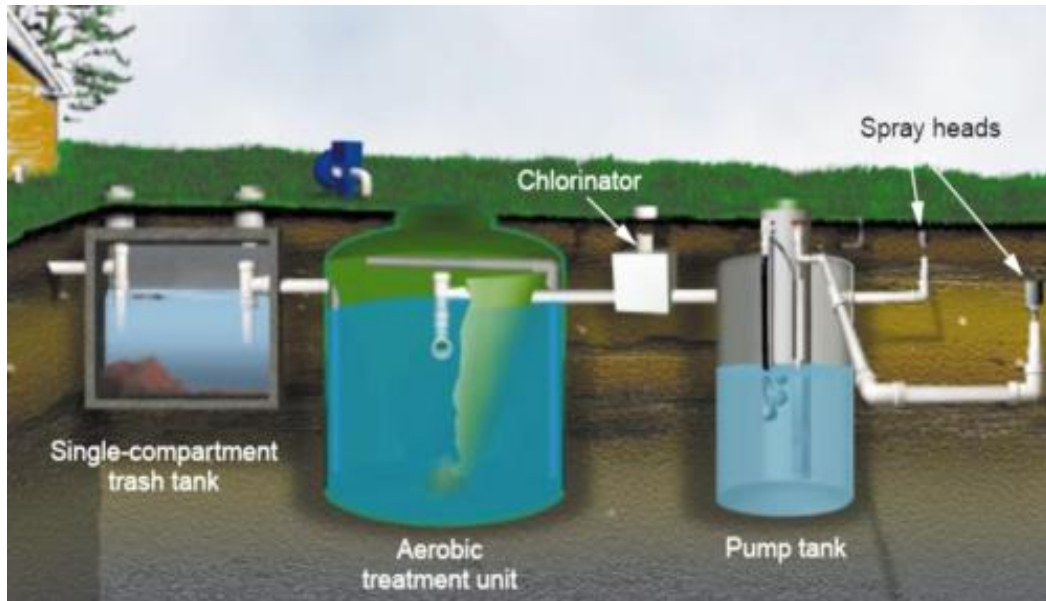

Factors considered in designing conventional aerobic digesters include temperature, solids reduction, tank volume, feed solids concentration, oxygen requirements, energy requirements for mixing, and process operation.

Thickening is a procedure used to increase the solids content of sludge by removing a portion of fraction. In designing thickening facilities, it is important to provide adequate capacity to meet peak demands and prevent septicity, with its attendant odor problems, during the thickening process. Each of these units was designed in order to treat a sludge volume of 300 m³, extracted twice in a month; in order to ensure reliability and operational flexibility, two tanks were provided.

Each tank is able to treat the sludge delivered from one of two SBR tanks. A wise sludge line management entails not overlapping the aeration phase of each tank; in fact, Aerators treatment consumption and it is careful to avoid energy peak demand. For these reasons, while a tank is in the aeration period, the second is in the thickening or spilling phase.

5.7 Dewatering Unit (WWT phase 2.2)

Dewatering is a physical unit operation used to reduce the moisture content of sludge; this is important in order to cut ultimate disposal costs. Indeed, the dewatering sludge is generally easier to handle than the thickened one. Several techniques are used in dewatering devices for removing moisture. Some of these techniques rely on natural evaporation and percolation; in mechanical devices, mechanically assisted physical means are used to dewater the sludge more quickly.

The dewatering processes selected for the designed wastewater treatment plant are both mechanical and natural ones, in order to ensure plant reliability: centrifugal extraction coupled with sludge drying beds in order to face eventual device's out-of-service.

5.8 Centrifugal Unit (WWT phase 2.3)

The centrifugal decanter is used for the separation of two or more phases of different specific gravity, in particular for the clarifying of liquids in which suspended solids are present. The separation of solids and liquids takes place within a cylindrical/conical rotating drum, upon the Velipoje Sewerage Collection System and Waste Water Treatment Plant periphery of which the heavier solid phase collects and is continually removed by the internal conveyor.

A polyelectrolyte, suitably chosen for its type and specific characteristics, may be added to the product being fed to the machine in order to improve the solid-liquid separation. The polyelectrolyte favors the aggregation and thus the easier capture of the solid particles. Centrifugal extractor is designed in order to treat the thickened and digested sludge extracted 4 hours per day and 5 days per month by each tank; sludge flow rate is 3.75 m³/h.

Photo 5.8 Centrifugal motor

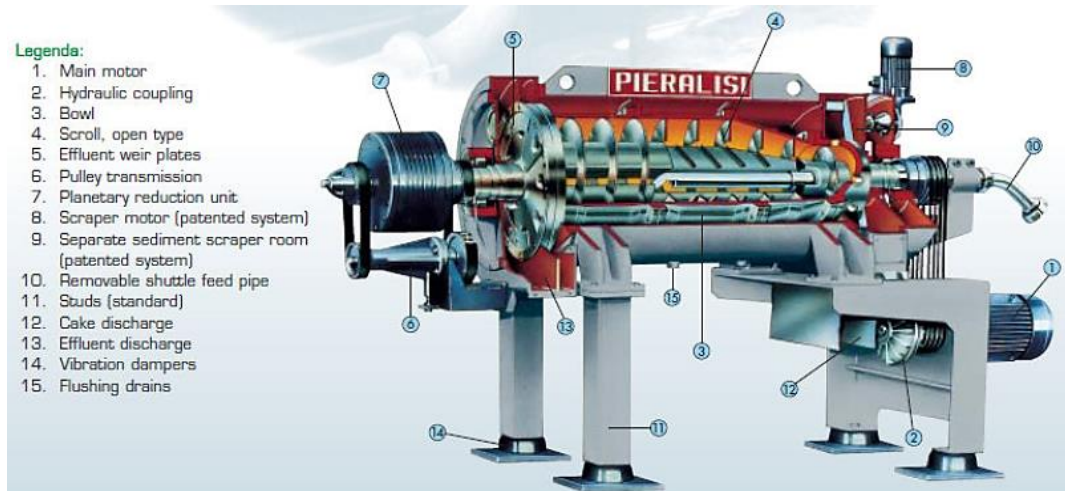

The chosen device is ensured to treat a flow rate of at least 5.5 m³/h, in order to provide for operational flexibility and reliability. The supernatant is returned to the water treatment line by a submersible pump. As already explained, a unique centrifugal extractor is able to treat the sludge produced by each SBR reactor and then digested and thickened in each circular tank. The following diagram reports the scheduled 1-month operation for the centrifugal extractor.

5.9 Septic tank retrieving station (WWT phase 2.4)

A Combined Mechanical Effluent Pretreatment Plant is provided; in fact, the sewage from cesspool tanks/interceptors or industrial plants collected by special tankers, has to be pre-treated before it was introduced into any kind of purification system. The septic tank retrieving station carries out different processes: de-watering and, compaction of screened solid waste, separation of sand and, removal of floating greasy matter. This treatment removes solids, sand and greasy matter that is present in the sewage to avoid overloading of the system.

Photo 5.9 Illustration Scheme after finish the treatment of waste water

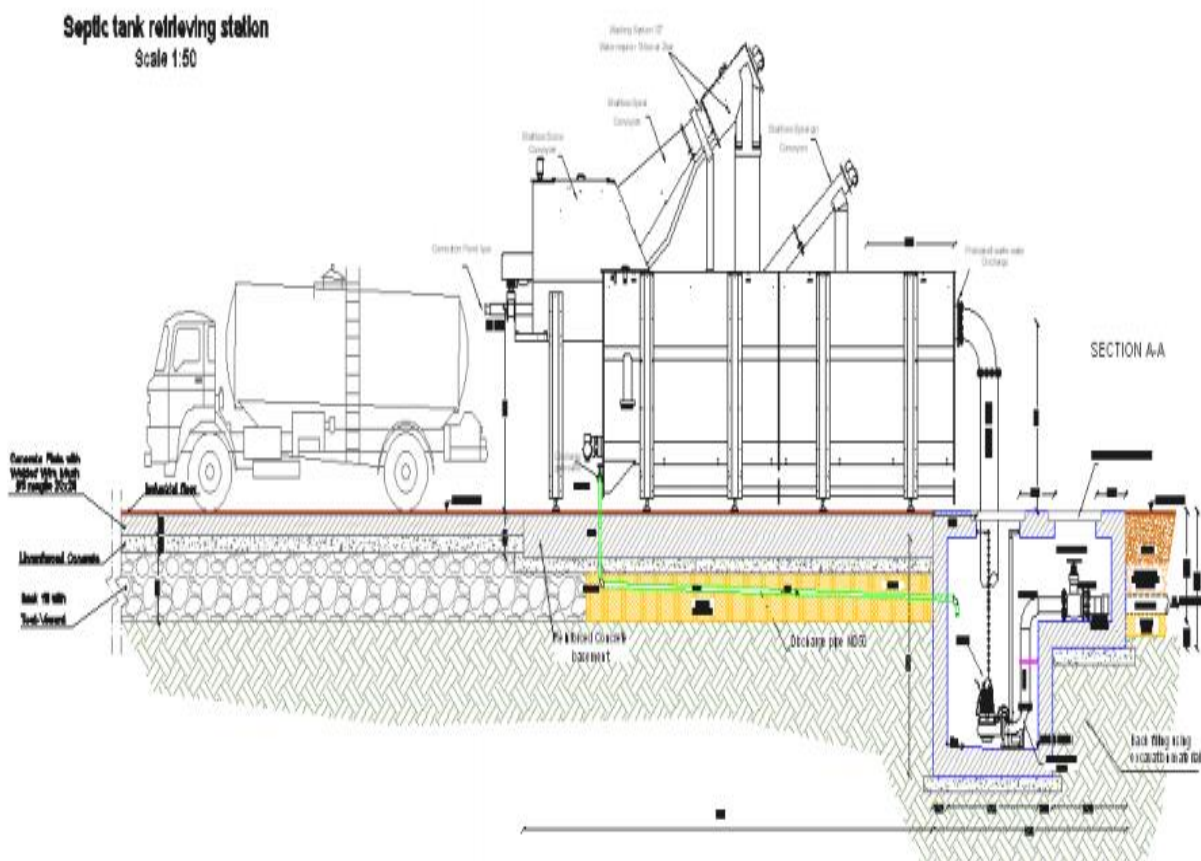

5.10 Disinfection (WWT phase 2.5)

Of all the chemical disinfectants even this implant use chlorine, one used most commonly throughout the world. The reason is that chlorine satisfies most of the characteristics of an ideal disinfectant. Sodium hypochlorite is available as liquid and usually contains 12.5 to 17 % available chlorine at the time it is manufactured. It is stored in a cool location in a corrosion-resistant tank. Actually, disinfection is required when the receiving water body is the sea; while discharging in the river, the most important parameter is BOD concentration rather than a bacterial one.

Photo 5.10 Disinfection bottles Sodium Hypo



Moreover, chlorine presents some disadvantages:

- 1-When chlorine reacts with organic material its concentration is reduced and trihalomethanes (THMs) and disinfection-by-products (DBPs) are formed. These compounds are a concern because they are carcinogenic.
- 2- Chlorine residual, even at low concentrations, is toxic to aquatic life and may require DE chlorination.
- 3-All forms of chlorine are highly corrosive and toxic. Thus, storage, shipping, and handling pose a risk, requiring increased safety regulations.

5.11 Discharge pipe into Buna River (WWT phase 2.6)

The treated wastewater is always discharged into the Buna River. The following image shows the discharge pipe into the Buna River layout:

The discharge pipe has a length equal to 1,035.30 m and it is realized in HDPE. Hydraulic head is equal to 8.20 m, while head losses are equal to 5.83 m. The discharged flow has a velocity equal to 1.84m/sec.

Photo 5.11. Buna River as a body discharge



5.12 Office and administration building

The Office and Administration building has a surface area of 77.35 m²; its flood area is 70.00 m

Rooms of WWT	Flood area m ²
Central Control Room	43000 m ²
Manager Office	18000 m ²
Toilet	500 m ²
Entrance	400 m ²
	Grand Total area = 70000 m ²

6 Modernization of Velipoje Waste Water Treatment plant according EU Standards

6.1 Lack of Phases of Treatment (*Laboratory Work*)

Built-in necessary emergency situation with limited funds where there was no kind of WWT plant in Albania to treat the wastewater and when all sewage discharge into rivers or directly to the sea-coast, like others plants, even the Waste Water Treatment plant of Velipoje faced three main problems: Lack of Phases of Treatments, Lack of Maintenance and, Lack Coverage. So let's jump and to the first issue lack of phases of treatments,

The waste water treatment plant according to EU standards has at least 3 treatment phases:

In primary treatment called Mechanical phases, wastewater or sewage is stored in a basin where solids (sludge) can settle to the bottom and oil and lighter substances can rise to the top. These layers are then removed and then the remaining liquid can be sent to secondary treatment. Sewage sludge is treated in a separate process called sludge digestion.

A secondary treatment called Microbiological stage + Disinfection removes dissolved and suspended biological matter, often using microorganisms in a controlled environment. Most secondary treatment systems use anaerobic or aerobic bacteria same as WWT of Velipoje which consume the organic components of the sewage. Suspended growth systems use "activated" sludge, where decomposing bacteria are mixed directly into the sewage.

Because oxygen is critical to bacterial growth, the wastewater is often mixed with air to facilitate decomposition. In the end for WWT with secondary treatment as the final phase they use disinfection like Sodium hypochlorite before discharge into the body river same as our study of Velipoje WWT.

Technical Comparison

The Kaarst NordKanal Waste Treatment is located in Germany, at Dussedolf city, Schiefbahner area Street. Number 66, a great example which operates till tertiary treatment and use MBR as AdvanceTechnology to treat waste water or sewage when our study WWT of Velipoje operates with two phases of treatment Let's jump to the discharge rate of treatment water of both plants in order to understand the difference and what is lacking. The first table is officially data from discharge treatment water of our example Kaarst NordKanal WWT.

Tab 6.1 Tab WWT of Kaarst NordKannal discharge rate

	Incoming	Discharged	Rate
BOD			
COD			
Nitrogen	42.83 t/year	2.92 t/year	93.2%
	53.54 mg/l	3.65 mg/l	
Phosphorus	9.02 t/year	0.74 t/year	91.8%
	11.28 mg/l	0.93 mg/l	

As you can see the discharge from the table the discharge treatment water has only 3.65 mg/l Nitrogen (N) and 0.93 mg/l Phosphorus (P)

* Concentration calculated using the annual load and the annual volume of wastewater treated.

To obtain accurate and comparative data we have conducted laboratory work where we took 3 samples from different locations from the Buna River which is the selected body of water to discharge. For the experimental part please see the picture below.

Photo 6.1.2. In Laboratory for experimental work for analyzing N and P with UV method



For laboratory experiment we use to measure the Total Nitrogen (TN) and Total Phosphorus (TP) in waste water with that called the UV-visible method. This great method includes two steps: first, the photo-oxidation of nitrogen and phosphorus forms into nitrate and orthophosphate ions, and their quantification by UV-visible spectrophotometry. We use as oxidant the Potassium peroxodisulfate in this experimental.

The developed system consists of on-line association of UV photo-oxidation reactor with UV-visible detector. The conversion yields vary between 80 and 100% for both nitrogen compounds (ammonium, urea, amino acids, and others N-containing compounds), and phosphorus compounds (ADP, ATP, and other P- containing compounds).

The time required for this experimental for the nitrogen and phosphorus forms determination is no longer than 20 minutes. After we performed the result of our data was like below for Nitrogen (N) and Phosphorous (P). The incoming data we took fixed by asking the internal Staff from our site inspection visit that we have in plant.

Photo 6.1.3. Another photo in Laboratory to analyze N and P



Photo 6.1.4. The pipeline estuary



The Result for Sample Nr 1 taken from pipeline estuary

First Sample	Incoming	Discharge (Experimental Result)
Nitrogen (N)	41,67 mg/l	12,85 mg/l
Phosphorius (P)	9,88 m/l	1,63 mg/l

The Second Sample Nr 2 taken from 50 meters away from the shredders and the Result is like below;

Second Sample	Incoming	Discharge (Experimental Result)
Nitrogen (N)	41,67 mg/l	12,66 mg/l
Phosphorius (P)	9,88 m/l	1,529 mg/l

The Third Sample Nr 3 taken from 168 meters away from the shredders and the Result is like below;

Third Sample	Incoming	Discharge (Experimental Result)
Nitrogen (N)	41,67 mg/l	11.42 mg/l
Phosphorius (P)	9,88 m/l	1.43 mg/l

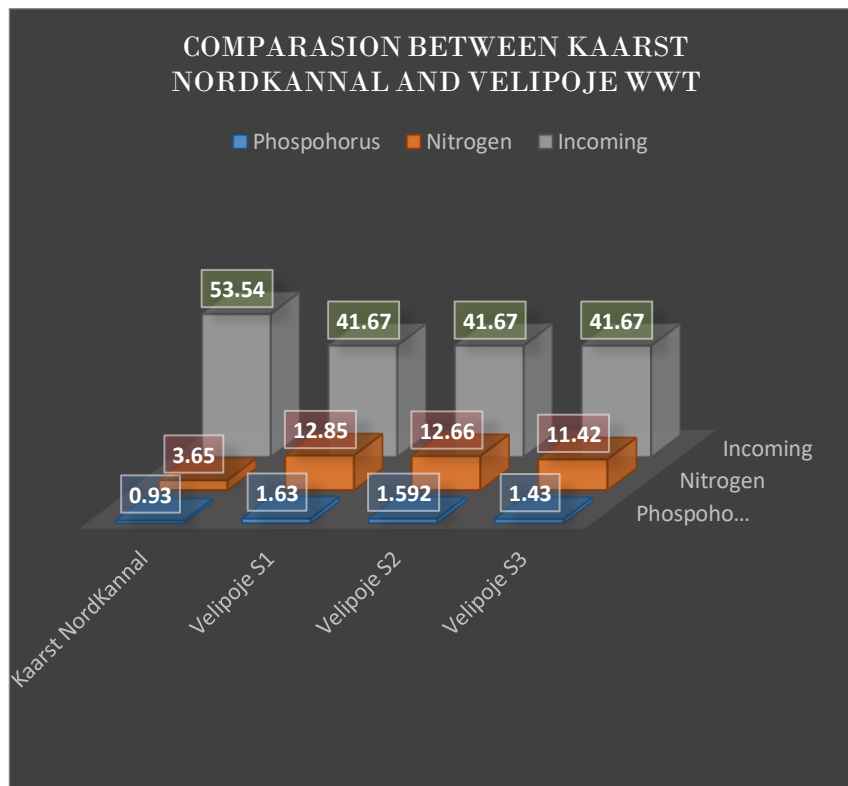

Albeit we can see that the discharge rates of Nitrogen (N) and Phosphorous (P) are considerable in comparison with the Kaarst NordKannal WWT plant whose discharge rates are so low and conform to EU norms. We must know according to the norms that Nitrogen should reach a 2% limit of the discharge where in this experimental work it comes out more than it should. So what is lacking in our study plant?

Let's jump in *Comparison Table*

<i>Velipoje Waste Water Treatment</i>	<i>Kaarst Nordkanal Waste Water Treatment</i>
<i>Albania</i>	<i>Germany</i>
Primary Treatment  Mechanical phase: Screening Equipment Grill Removal Sludge Filtration	Primary Treatment  Mechanical phase: Screening Equipment Grill Removal Sludge Filtration
Secondary Treatment  Microbiological phase : Tank Reactor Disinfection Aerobic Process Dewatering Unit Centrifugal Unit N Removal (half) P Removal (half)	Secondary Treatment  Microbiological phase: Bio Reactor Disinfection Aerobic Process Dewatering Unit Centrifugal Unit N Removal (half) P Removal (half)
Third Treatment  Polishing phase: -	Third Treatment  Polishing phase: MBR (Two Membrane Trains) Back-pulse Tank P Removal (completely) > 90% N Removal (completely) >90 %

The technical comparison is very essential because we can not only understand what phase is lacking which in this case is that called the Polishing phase, but also we can see even the technology that is using in this phase such is the MBR system and Back-pulse reactor tank that may take into consideration in the third phase of treatment.

6.1.5. Photos from the Kaarst NordKanal plant where the bioreactor and MBR are located



Through this scheme, you can show easily what actually is lacking:

Scheme 6.1.6. Kaarst NordKannal details what is missing (green square) compare to WWT of Velipoje

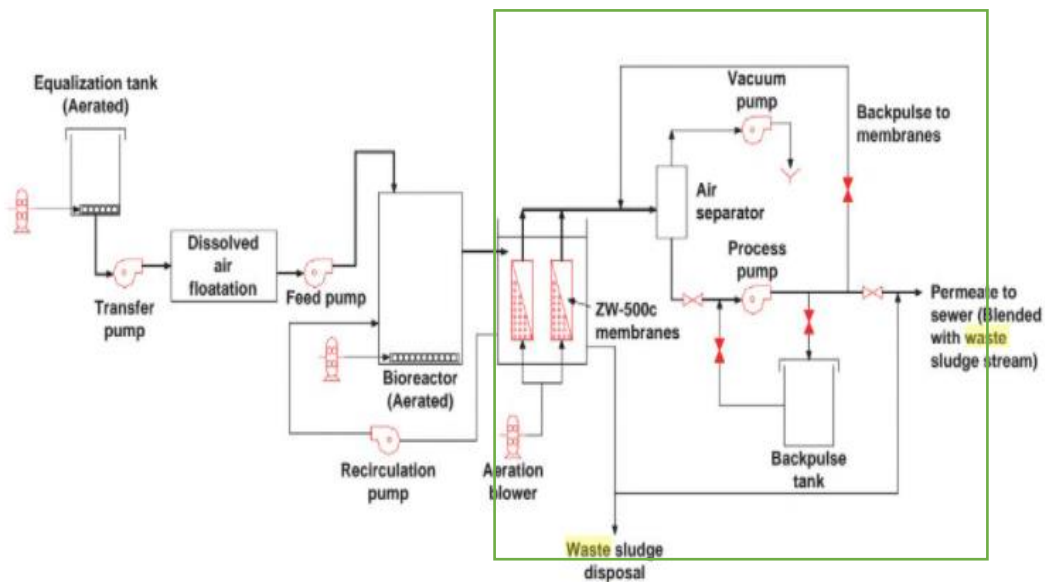

According to the above scheme the orange square shows what is lack in our Waste Water Treatment is of Velipoje and the lack is a tertiary treatment which in his example case is the MBR system. The MBR system is the combination of perm selective membrane filtration process with a suspended growth bioreactor and it is advanced technology and is now widely used for municipal wastewater treatment plant.

The capacity of Kaarst Nodkanal which offered this service is 80.000 inhabits nearest similarity with our study which the second phase after fay of expansion offered the service for 52.000 inhabits and by taking into account the population of one EU country compared to Albania one of the smallest country in Europe.

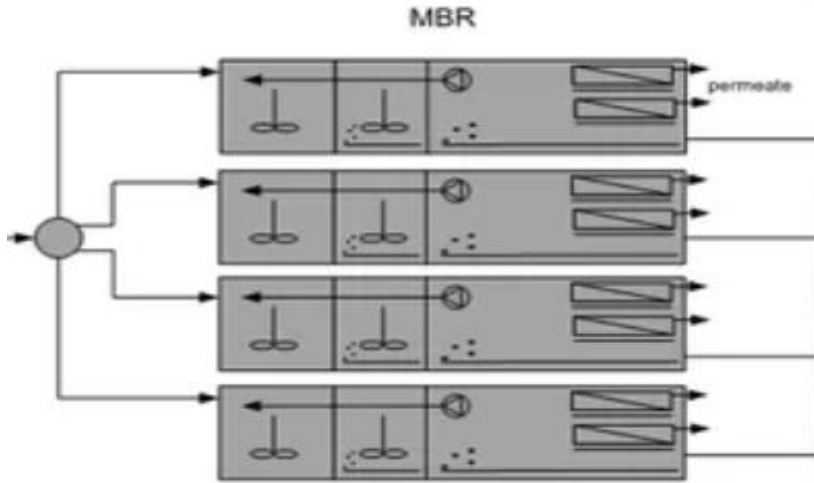

Conclusion

After the experimental laboratory work, we see clearly that adding an advanced phase like the third phase to treat wastewater is necessary to stay within the EU standard and norms of rate discharge. This treatment of wastewater in the tertiary phase gives great results over 90% of mg /l without Nitrogen and Phosphorus which this treatment water quality that discharges into the water body (river or lake) in quite an ecological standard by completely protecting the water ecosystem and for sure even our study WWT of Velipoje plant should treat wastewater same as our example till the third phases in order to fulfill the reason why was built.

Currently, the MBR technology seems to be the only technology capable of addressing the recognized key new challenges in municipal wastewater treatment in a single treatment step, these being micro pollutant and micro plastics removal and the containment of antibiotic-resistant microbes.

6.2 The Lack of Maintenance

Another main issue with Waste Water Implants in Albania include even our study Waste Water Treatment plant of Velipoje is the Lack of maintenance and for comparison, I have chosen an impressive example a Waste Water Treatment of Meistratzheim located in France built by prestigious company Suez, which maintains the plant by performing inspections every 6 months and annual control check forms per year.

Photo 6.2 of Waste Water Treatment of Meistraizheim



Technical Comparison

Following the details, by going to further we are creating a comparison table to make it as clear as possible what is lacking at the Maintenance part.

<i>Waste Water Treatment plant of Velipoje</i>		<i>Waste Water Treatment plant of Meistratzheim</i>	
Annual Control Form Check	✘	Annual Control Form Check	✔
Operation Cost	✔	Operation Cost	✔
Internal Staff	✔	Internal Staff	✔
Risk Prevention Capital	✘	Risk Prevention Capital	✔

By observing this comparison table we focus on two main lacking spots that are Annual Control Plan check and Risk Prevention Capital. Based on our example that we have taken in France, for the second point Risk Prevention Capital is an economical issue that always needed to have a reserve budget that in cases of great risk does not result in fatal failure like closure the activity of the plant, but is the economic issue of total budget we are not going into further detail and for the first point Annual Control Plan the Waste Water Treatment plants operated with this annual control check as example below

Nom du Client :	Numéro de série :	
Adresse :	Type de microstation : Tricel FR ... /	
Contact sur chantier :	Date de la visite : / /	
	Tél. :	

Couvercles, tampons et capots de compresseurs en bon état ?	Oui	Non
Les ventilations sont-elles bien dégagées ?	Oui	Non
Le tampon d'accès est-il verrouillé/sécurisé ?	Oui	Non
La cuve présente-t-elle des défauts ou a-t-elle été endommagée ?	Oui	Non
Le niveau d'eau est-il correct dans chaque compartiment ?	Oui	Non
Les odeurs émanant de la microstation sont-elles normales ?	Oui	Non
Le bassin d'oxygénation semble-t-il fonctionner correctement ?	Oui	Non
Les bulles d'air se dispersent-elles bien dans le bassin d'oxygénation ?	Oui	Non
Le lit bactérien est-il en bon état ?	Oui	Non
La tuyauterie de retour des boues est-elle en bon état ?	Oui	Non
Débit visible dans le té d'inspection quand la recirculation est enclenchée ?	Oui	Non
Le minuteur est-il correctement réglé ?	Oui	Non
L'alarme fonctionne-t-elle correctement ?	Oui	Non
Le disjoncteur fonctionne-t-il correctement ?	Oui	Non
Le compresseur fonctionne-t-il en permanence ?	Oui	Non
Pression du compresseur (100 à 150 mbar) ? mbar	
Les raccords du compresseur sont-ils bien fixés ?	Oui	Non
Le filtre du compresseur a-t-il été remplacé ?	Oui	Non
Niveau de boues en-dessous du niveau maxi ?	Oui	Non
Echéance estimée par extrapolation pour la prochaine vidange ? / /	
<u>Système de pompage (option)</u>		
La pompe fonctionne-t-elle correctement ?	Oui	Non
Le flotteur haut est-il positionné correctement et fonctionne-t-il bien ?	Oui	Non
<u>Inspection finale</u>		
Tous les couvercles et tampons ont-ils été remplacés et sécurisés ?	Oui	Non
Commentaires éventuels :	Nom et signature du technicien	

(English Translate)

The check points have been translated below for your convenience:

Are the compressor covers, buffers and hoods in good condition?
 Are the vents clear?
 Is the access cover locked/secured?
 Are there any defects or damage to the tank?
 Is the water level in each compartment, correct?
 Are the odors from the small wastewater treatment plant normal?
 Does the oxygenation tank appear to be working properly?
 Are air bubbles dispersing well in the oxygenation tank?
 Is the bacterial bed in good condition?
 Is the sludge return piping in good condition?
 Is the flow rate visible in the inspection tee when the recirculation is on?
 Is the timer set correctly?
 Is the alarm working properly?
 Is the circuit breaker working properly?
 Is the compressor running continuously?
 Are the compressor connections fixed?
 Has the compressor filter been replaced?

Conclusion

The maintenance part is a very delicate and important issue that the activity of the plant to continue including the operation cost which is an issue even in some other WWT plants in Albania but not in our study case so except that issue even also the annual forms of maintenance.

According to that a similar form for annual control check like in France can have space and be used even for Waste Water Treatment plants in Albania, which are small engineering works compared to EU countries, and for surely this help to identify the problem directly in annual

monitoring also control performing each 6 six months is the best way to reduce largely operation cost.

6.3 Lack of Coverage

This issue has always been present and for the comparison reason we will get a wide plan between Albania and the German state. Starting from this point of view, in Germany more than 98 percent of the German population is connected to the public sewage system and benefit from this service and 2 % percent have private treatment and collection system and there is no discharge of wastewater without treatment, see the chart below.

Chart 6.3.1 Coverage collection network in Germany

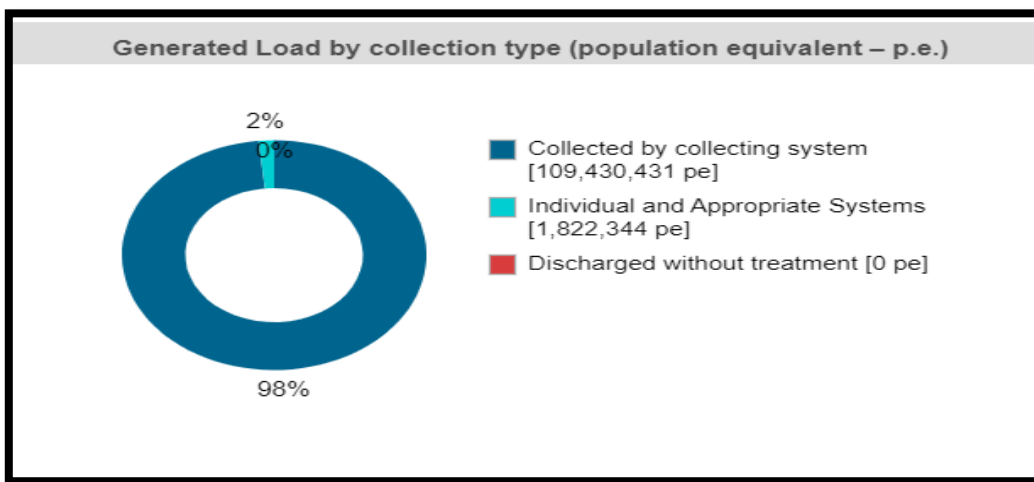

Wastewater from private households is collected in the public sewage system covering 540,723 kilometers of sewers and discharged into just under 10,000 wastewater treatment facilities. The reality in Albania is different when the coverage of the territory is only 50 percent and 2 percent only rural areas (mostly tourist village) who are offered this service and the rest is discharged into water bodies without any treatment, and also there is any individual and appreciate the system

Chart 6.3.2 Coverage collection network in Albania

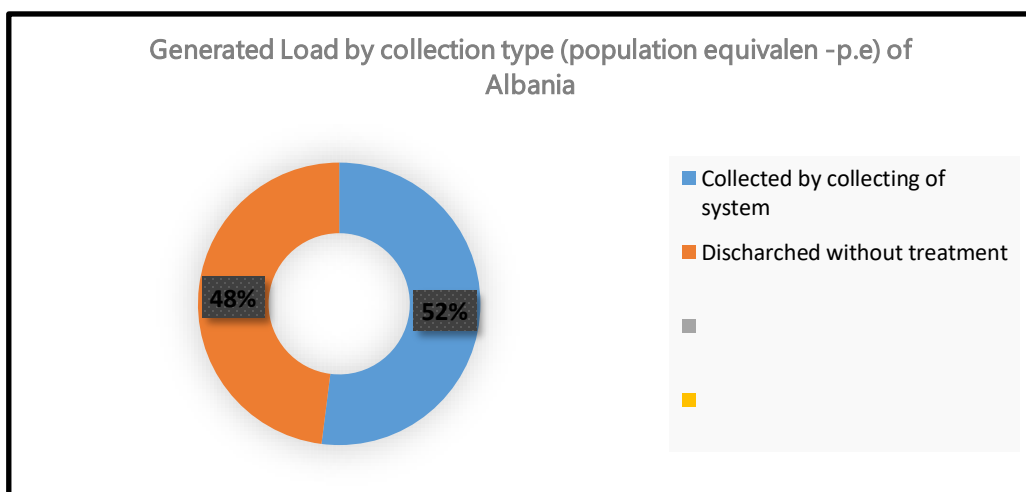

The chart below reveals the countries in the Europe continent that have the best result of coverage all territory with the service of collecting and treating the wastewater (please, in this graphic is not include the private or individual mini collected and treat system) where with the red rectangle is Albania with only 52% and the blue rectangle is Germany with 100% because 2% is individual collected system.

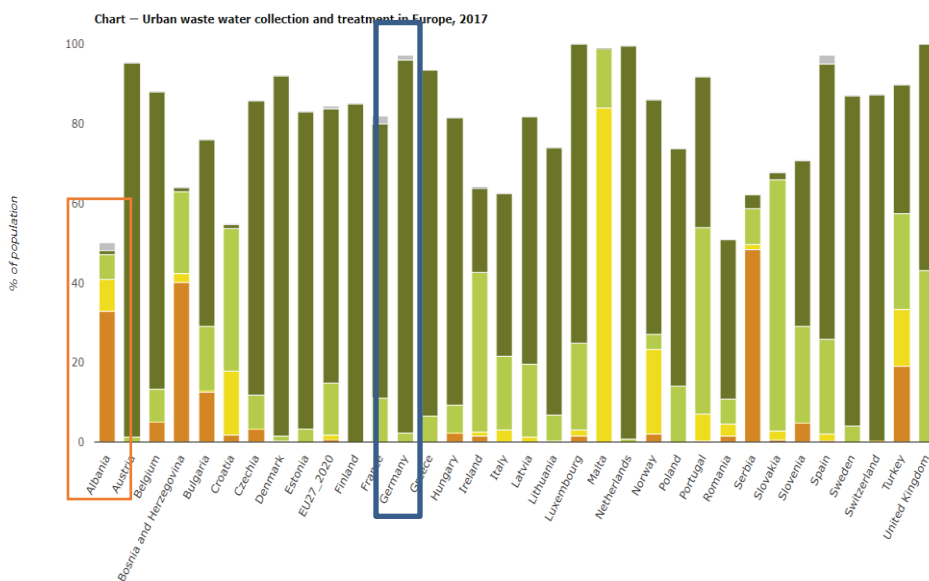

This problem faced even our study Waste Water Treatment plant of Velipoje which had two phases of expansion, when the capacity built for the First Phase of the plant was for 18,000 inhabitants with cost about 3.5 million euros and in phase two of the project in 2016 had an expansion by covering the 55,000 inhabitants.

Technical Comparison

So there are three ways to cover this service:

- Intervention only the sewerage collection system by expanding the sewerage collection system when you have space volume capacity for waste water
- Intervention in the treatment plant + sewerage network add other devices to increase the capacity volume for example add tank reactors etc.

- Build a new implant

The intervention that took place in the Velipoja plant for the expansion and increase of the offered service for 55,000 inhabitants was intervention only. in sewage collection system a scheme below;

Scheme 6.3.3. Sewage collection system (green points are main collectors) of Velipoje WWT



According to this scheme in the first phase of project was lying from starting point Baza till the point 3, and in second phase of the project was expanded from points 4 – 7 by increasing the service when from 18,000 inhabitants now are 55,000 inhabitants that benefit it.

Conclusion

According to our data, the Coverage issue is one of the worst problems for Albanian when only 52 % benefit from this service and the strategy plan and funds need to be as an emergency because the lacking of the coverage indicate in ecosystem but also in tourism which is for Albanian one of economical pillars.

Velipoja is a strategic tourist area so the demand for this service remains high and a study project for another expansion can be develop but in accordance with the second point where expansion project should intervention not only in collection system but even inside the implant e by adding the equipment to create new capacity space.

7 Legislation

7.1 EU Legislation Directives



As a developing country Albania has earned the green light as candidates for join to the European Union, and starting from that the Albanian frame law must be reviewed, erase or adapted in accordance to European Union Directives.

Since the study project was focused on engineering work such as Waste Water Treatment plant then we are bringing the EU directives and laws related to our study.

EU directives:

-Directive 91/271/EEC of Council of 21 May 1991 concerning urban waste water treatment;

In particular, it is important to pay attention to Directive 91/271/EEC of Council of 21 May 1991 concerning urban waste water treatment, in which the quality standards, as well in terms of nutrients, imposed for protected water and terrestrial landscape are reported.

- Directive 2000/60/EC of the European Parliament and of the Council of 23 October 2000 establishing a Frame work for Community action in the field of water policy; On 23 October 2000, the "Directive 2000/60/EC of European Parliament and of the Council established a framework for Community action in the field of “water policy” or, in short, the EU Water Framework Directive (or even shorter the WFD) was finally adopted. The Water Framework Directive establishes a legal framework to protect and restore clean water across Europe and ensure its long-term, sustainable use.

The directive establishes an innovative approach for water management based on river basins, natural geographical and hydrological units and sets specific deadlines for the Member States to protect aquatic ecosystems.

The directive addresses inland surface waters, transitional waters, coastal waters and groundwater. It establishes several innovative principles for water management, including public participation in planning and the integration of economic Approaches, including the recovery of the cost of water services.

-Directive 2003/35/EC of the European Parliament and of the Council of 26 May 2003 providing for public participation in respect of the drawing up of certain plans and programs relating to the environment The amending for the public participation and access to justice Council Directives 85/337/EEC and 96/61/EC - Statement by the Commission

-2003/334/EC Commission Decision of 13 May 2003 on transitional measures under Regulation (EC) n° 1774/2002 of the European Parliament and of the Council as regards the material collected when treating waste water (notified under document number C(2003) 1467);

7.2 Albanian Frame Laws

LAW No.9115, dated 24.7.2003 For Environmental Waste Water Treatment

This law aims to protect the environment and human health from the negative impacts of wastewater, defining National Strategic Water Resources Management and Politics but most important is

Article 29 Technical norms of water discharge into the environment.

The Council of Ministers, on the proposal of the Minister responsible for the environment, approves the technical norms of discharge into the environment for water, hazardous substances, substances and other parameters, in accordance with the requirements of the law on environmental protection, in order to prevent deterioration water quality and environmental protection. According to *The Council Minister Decision Nr. 177, dated 31.3.2005* on permitted rates for liquid discharge and zone criteria of receipting aquatic environments which sufficiently details the discharge rates of the waste water which also applies to treated water which discharge from WWT plant which is not the same.

Conclusion

The Albanian government had legal duty since when it received the candidate status to update the legislation in accordance with EU directives and norms, so for example one of the decisions of the council of ministers Nr 177 that needed to be reconsidered by dividing the discharge rate of waste water vs. discharge rate of treated water. In EUs latest standards the total nitrogen of treated water discharge need to be 2 % of total incoming and phosphorus in treated water are allowed into value 1 mg/l and for the waste water is 5 mg/l.

Something very important is also the coverage of territory that benefit this service which still remain in bad position so need the invention with legal action to indicate and to change the current situation only 52 % far away compare to EU countries 99 or 100%.

8 Annexes and References

8.1 References Attached

Simon Judd, (2006) *The MBR Book- Principles and Applications of Membranes Bioreactors in Water and Waste Water Treatment*, 242- 300 Link

<https://books.google.al/books?id=joSAwT0vUcMC&pg=PA239&lpg=PA239&dq=Kaarst-Nordkanal+waste+water&source=bl&ots=CRWHvGMysx&sig=ACfU3U3D11VwhH-RkcbegutB3wYyTnVtwA&hl=en&sa=X&ved=2ahUKEwiY383Eg8n2AhWOmKQKHRcGAbEQ6AF6BAgtEAM#v=onepage&q=Kaarst-%20Nordkanal%20waste%20water&f=false>

Ministry of Public Transport and Telecommunication (April 2010) *General Directory of Waste Supply Treatment and Sewage Report* 10- 51 Link <https://www.infrastruktura.gov.al/wp-content/uploads/TAV.1.2-ALVE209Rrgn002R2>

Mecaj Stela (2018) *Albanian environmental legislation approach in the framework of the Stabilization and Association Agreement*

Link: <https://cyberleninka.ru/article/n/albanian-environmental-legislation-approach-in-the-framework-of-the-stabilisation-and-association-agreement>

World Bank Albanian Reports 2020 4-8, Link <https://www.worldbank.org/en/country/albania>

European Commission urban waste water official page,

Germany Link: <https://uwwtd.eu/Germany/>

France Link: <https://uwwtd.eu/France/>

Infrastructure Project Facility (2020), *Scientist Technical Assistance 5 Report*, Nr =TA2015030
R0 IPA Link <https://www.infrastruktura.gov.al/wp-content/uploads/2020/07/EN-DRAFT-PESIA-401-874.pdf>

Author David L. Russell (2006) *Practical Wastewater Treatment Book*, Link
<http://www.amac.md/Biblioteca/data/28/14/10/72.2.pdf>

LAW No.9115, dated 24.7.2003 *For Environmental Waste Water Treatment*,
Link https://ikmt.gov.al/index.php?option=com_content&view=article&id=436:ligji-nr-9115-dat%C3%AB-24-07-2003-p%C3%ABr-trajtimin-mjedisor-t%C3%AB-uj%C3%ABrave-t%C3%AB-ndotura-ndryshuar-dhe-aktet-n%C3%ABnligjore-n%C3%AB-zbatim-t%C3%AB-tij&catid=26&Itemid=574

The Council Minister Decision Nr. 177, dated 31.3.2005 Link <https://shukalb.al/wp-content/uploads/2019/07/Vendim-Nr-177-date-31-3-2005.pdf>

Mecaj Stela (2018) Albanian environmental legislation approach in the framework of the Stabilization and Association Agreement

Link: <https://cyberleninka.ru/article/n/albanian-environmental-legislation-approach-in-the-framework-of-the-stabilisation-and-association-agreement>

Euro-LEX Access to European Union Law

Link: <https://eur-lex.europa.eu/legacontent/EN/TXT/?uri=CELEX:31991L0271>

Article Meistratzheim wastewater treatment plant (France) Link
<https://www.suezwaterhandbook.com/case-studies/wastewater-treatment/Meistratzheim-wastewater-treatment-plant-France>

8.2 Support Literature

David F. Tilley (2011) *Aerobic Wastewater Treatment Processes*, Link
https://books.google.al/books/about/Aerobic_Wastewater_Treatment_Processes.html?id=ZRY6rpKFGgC&printsec=frontcover&source=kp_read_button&hl=en&redir_esc=y#v=onepage&q&f=false

Sreedevi Upadhyayula, Amita Chaudhary (2021) *Advanced Materials and Technologies for Wastewater Treatment* Link
https://play.google.com/store/books/details/Advanced_Materials_and_Technologies_for_Wastewater?id=gIo7EAAAQBAJ&hl=en_US&gl=US

Andreas N. Angelakis & Shane A.Snyder Institute of Iraklion, National Foundation for Agricultural Research (N.AG.RE.F.), Iraklion 71307, Greece & Department of Chemical & Environmental Engineering, University of Arizona, 1133 E. James E. Rogers Way, Tucson, AZ 85721-0011, USA(2015) *Wastewater Treatment and Reuse: Past, Present, and Future*, 1-5 Link
<https://www.mdpi.com/2073-4441/7/9/4887>