

VYSOKÉ UČENÍ TECHNICKÉ V BRNĚ
BRNO UNIVERSITY OF TECHNOLOGY

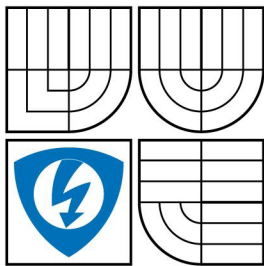

FAKULTA ELEKTROTECHNIKY A KOMUNIKAČNÍCH TECHNOLOGIÍ
ÚSTAV TELEKOMUNIKACÍ

FACULTY OF ELECTRICAL ENGINEERING AND COMMUNICATION
DEPARTMENT OF TELECOMMUNICATIONS

POLICY BASED FLEXIBLE SPECTRUM USAGE FOR NEXT GENERATION MOBILE COMMUNICATION

UŽITÍ PRAVIDEL FLEXIBILNÍHO SPEKTRA PRO MOBILNÍ KOMUNIKAČNÍ SÍŤ NOVÉ
GENERACE

DIPLOMOVÁ PRÁCE

MASTER'S THESIS

AUTOR PRÁCE

AUTHOR

BC. TOMÁŠ MUSIL

VEDOUCÍ PRÁCE

SUPERVISOR

DOC. ING. VLADISLAV ŠKORPIL, CSC.

BRNO 2009

THESIS AWARD

Policies are defined as sets of rules agreed among operators to allow efficient flexible spectrum usage, taking into account their individual traffic and quality of service requirements. This study project also aims at efficient usage, and fair allocation of spectrum among operators based on their individual traffic and quality of service requirements. It provides a mechanism for allowing the coexistence of several operators in a given geographical area with distributed and random network deployment in a local area scenario by minimizing mutual interference and ensuring fair and efficient spectrum allocation. The requirements include understanding the theoretical background of FSU, deployment scenario and policies, developing a suitable algorithm for a fair and efficient spectrum allocation and implementation of the algorithm and performance evaluation. The outcome of the project is expected to be in the form of an algorithm achieving a fair and efficient allocation of the spectrum from a common pool. Since the research area is very new, there is a high possibility of concrete outputs being obtained in terms of publications and inventions.

ANOTACE

Tato diplomová práce se zabývá návrhem algoritmu pro flexibilní sdílení spektra (FSU) založeného na pravidlech dohodnutých mezi operátory. V úvodu jsou uvedeny základní informace o mobilní komunikační síti nové generace ITM – Advanced. Po úvodní části je věnována pozornost technologiím vhodných pro implementaci flexibilního sdílení spektra. Pozornost je také věnována veličinám použitých pro vyhodnocení efektivity algoritmu flexibilního sdílení spektra. Je navrženo několik algoritmu flexibilního sdílení spektra využívajícího hodnot poměru signálu ku interferenci a šumu (SINR). Hodnoty SINR jsou použity pro vypořádání se se vzájemnou interferencí, která je způsobena koexistencí několika operátorů ve stejné zeměpisné oblasti, sdílejících společně frekvenční pásmo. V úvahu jsou také brány u každého operátora individuální potřeby datových přenosů a jejich kvality. Hlavním cílem je maximálně zvýšit datovou propustnost každé buňky, stejně tak i rychlost přenosu dat pro jednotlivé uživatele připojených k domácí základové stanici (HBS).

Pro simulaci navrženého algoritmu je použito rozmístění čtyř domácích základových stanic (HBS) v jednopatrové budově s náhodným počtem uživatelů z daného rozsahu. Každý operátor dělá nezávislá rozhodnutí bez jakékoliv výměny signalizačních dat s ostatními operátory. Jediné možné informace, které může operátor využívat jsou získané snímáním spektra z jeho okolí. K řešení tohoto problému je předpokládáno využití kognitivního rádia (CR).

KLÍČOVÁ SLOVA: IMT-Advanced; flexibilní sdílení spektra; kognitivní rádio;
rozdělení spektra

ABSTRACT

This Master's thesis deals with proposal of Flexible Spectrum Usage (FSU) algorithm based on policy agreed among operators. The introduction presents basic information about properties of next generation mobile communication ITM-Advanced system. After the introductory part the attention is given to the items efficient for FSU implementation as well as parameters used for evaluation of FSU algorithm efficiency. Several variants policy based FSU algorithm utilize value of Signal to Interference plus Noise Ratio (SINR) is designed. The SINR information is used to combat with mutual interference which is caused by coexistence of several operators in the same geographical area sharing over the same spectrum pool. Individual needed as traffic and quality of service requirements of each operator is taken into consideration as well. The main aim is to maximize cell throughput as well as data- rates for each user of HBS.

For simulation of proposal algorithm is considered deployment of four Currently Home Base Stations (HBS) in indoor local area scenerio with random number of users in given range. Each operator makes independent dicsion without signalling exchange among other. The only considered information that HBS can use is gotten by scenning its environment. This problem soliving is considered to use Cognitive Radio (CR)

KEY WORDS: IMT – Advanced, Felxible Spectrum Usage, Cognitive Radio,
Spectrum Allocation

BIBLIOGRAPHICAL CITATIONS OF MY WORK:

MUSIL, T. *Policy-Based Flexible Spectrum Usage for Next-Generation Mobile Communication Networks*. Brno: Vysoké učení technické v Brně, Fakulta elektrotechniky a komunikačních technologií, 2009. 65 s. Vedoucí diplomové práce doc. Ing. Vladislav Škorpil, CSc

DECLARATION

I declare that I elaborated my Master's thesis on the topic "Policy Based Flexible Spectrum Usage for Next Generation Mobile Communication" individually under the leadership of the Head of my thesis and using technical literature and other information sources, which are all quoted in the work and put in the list of literature at the end of work. As the author of this Master's thesis further declare that in connection with the creation of this work, I did not infringe the copyrights of third parties, in particular, I did not encroach on other personal copyright in unauthorized way and I fully aware of the consequences of breach of the provisions § 11 and copyright act number 121/2000 Coll. including possible criminal consequences follow from the provisions § 152 criminal code No 140/1961 Coll.

In Brno.....

.....

(Signature of author)

ACKNOWLEDGEMENT

I would like to express my gratitude to my supervisor Vladislav Škorpil for his guidance to the successful completion of this project.

In Brno.....

.....

(Signature of author)

CONTENT

BIBLIOGRAPHICAL CITATIONS OF MY WORK:	5
DECLARATION	6
ACKNOWLEDGEMENT	7
LIST OF FIGURES	11
LIST OF ABBREVIATIONS	13
LIST OF SYMBOLS	16
1 INTRODUCITON	17
2 INTERNATIONAL MOBILE TELECOMMUNICATION – ADVANCED	19
2.1 TECHNICAL REQUIREMENTS	19
2.2 TECHNICAL REQUIREMENTS	20
2.3 BANDWIDTH AND SPECTRUM REQUIREMENTS	21
3 FLEXIBLE SPECTRUM USAGE	22
3.1 COGNITIVE RADIO	22
3.1.1 INTRODUCTION	22
3.1.2 DEFINITION OF COGNITIVE RADIO.....	24
3.1.3 COGNITIVE RADIO AND BENEFITS	27
3.2 QUALITY OF SERVICE	28
3.2.1 SIGNAL-TO-INTERFERENCE NOISE RATIO (SINR).....	28
3.2.2 THE THROUGHPUT	29
3.2.3 THE THROUGHPUT	30
3.2.4 THE INTERFERENCE	30
3.2.5 THE PATH LOST	31
3.2.6 THE CELL LOAD.....	32
3.3 MULTIPLE ACCESS PRINCIPLE AND DUPLEXING TECHNIQUES	33
3.3.1 OFDM.....	33
3.3.2 DUPLEXING TECHNIQUES: TDD VS FDD.....	34
3.3.3 PHYSICAL RESOURCE BLOCKS	35
3.4 SPECTRUM SHARING	36
3.4.1 PHYSICAL RESOURCE BLOCKS	36
4 ALGORITHM	38
4.1 DESCRIPTION OF ALGORITHMS	38
4.1.1 STRAIGHT AND FULL PRBS ALLOCATION.....	38
4.1.2 INITIALIZATION IMPLEMENTATION	39
4.1.3 THE SINR BASED ALLOCATION – FAST ALGORITHM.....	41
4.1.4 THE SINR BASED ALLOCATION – SLOW ALGORITHM.....	45
5 SIMULATIONS AND RESULTS	47
5.1 SCENARIO	47

5.2 BASIC DESCRIPTION OF THE SIMULATOR	48
5.3 SIMULATIONS RESULTS	50
5.3.1 SBA-F vs. SBA – S ALGORITHM	51
5.3.2 SBA – S, DIFFERENT FSAS AND FSU1 ALGORITHM.....	55
6 CONCLUSIN	61
6.1 CONCLUSION AND POSSIBLE FUTURE IMPROVEMENTS.....	61
REFERENCES	62

LIST OF FIGURES

<i>Figure 1: The interconnection of various network based on IP core network.....</i>	<i>19</i>
<i>Figure 2: Spectrum inefficiency throughout time [8].....</i>	<i>23</i>
<i>Figure 3: Mental process of a cognitive radio based on the cognition cycle form [10]</i>	<i>25</i>
<i>Figure 4: FDM sub-carriers [15]</i>	<i>33</i>
<i>Figure 5: Frequency Domain of OFDM System [15].....</i>	<i>33</i>
<i>Figure 6: OFDM (left) and OFDMA (right)</i>	<i>34</i>
<i>Figure 7: Frequency Division Duplex.....</i>	<i>34</i>
<i>Figure 8: Time Division Duplex.....</i>	<i>35</i>
<i>Figure 9: Generic Sub frame Structure [19]</i>	<i>35</i>
<i>Figure 10: Allocation of resources for operators [22].....</i>	<i>36</i>
<i>Figure 11: Spectrum sharing</i>	<i>37</i>
<i>Figure 12: Straight and full PRBs allocation.....</i>	<i>38</i>
<i>Figure 13: Initialization implementation</i>	<i>41</i>
<i>Figure 14: The SBA-A</i>	<i>44</i>
<i>Figure 15: The SBA-F without loop.....</i>	<i>45</i>
<i>Figure 16: The SBA-S.....</i>	<i>46</i>
<i>Figure 17: Presupposed Indoor Scenerio</i>	<i>48</i>
<i>Figure 18: Flowchart of the Matlab simulation [24].....</i>	<i>49</i>
<i>Figure 19: Fixed and Randomized HeNBs Scenario Topography</i>	<i>50</i>
<i>Figure 20: Average Cell Load of SBA-F and SBA-S with fixed HeNBs</i>	<i>52</i>
<i>Figure 21: Average Cell Load of SBA-F and SBA-S with randomized HeNBs.....</i>	<i>52</i>
<i>Figure 22: Dropped UEs</i>	<i>53</i>
<i>Figure 23: UE 5% throughput & mean cell throughput of SBA-F vs. SBA-S with fixed HeNBs.....</i>	<i>53</i>
<i>Figure 24: UE 5% throughput & mean cell throughput of SBA-F and SBA-S with randomized HeNBs</i>	<i>54</i>
<i>Figure 25: CDF throughput of SBA-F and SBA-S with fixed HeNBs.....</i>	<i>54</i>
<i>Figure 26: CDF throughput of SBA-F and SBA-S with randomized HeNBs</i>	<i>55</i>
<i>Figure 27: Average cell load with fixed HeNBs</i>	<i>56</i>
<i>Figure 28: Average cell load with randomized HeNBs.....</i>	<i>56</i>
<i>Figure 29: UE 5% throughput & mean cell throughput with fixed HeNBs.....</i>	<i>57</i>
<i>Figure 30: UE 5% throughput & mean cell throughput with randomized HeNBs</i>	<i>57</i>

<i>Figure 31: CDF throughput with fixed HeNBs</i>	58
<i>Figure 32: CDF throughput with randomized HeNBs</i>	58
<i>Figure 33: CDF SINR with fixed HeNBs</i>	59
<i>Figure 34: CDF SINR with randomized HeNBs</i>	59

LIST OF ABBREVIATIONS

Abbreviation	Description
3G	Third Generation of Telecommunication Standards
AMC	Adaptive Modulation and Coding
ARQ	Automatic Repeat Request
CCDF	Complementary Cumulative Distribution Function
<i>CDF</i>	Cumulative Distribution Function
CR	Cognitive Radio
DAPSK	Differentially-Encoded Amplitude- and Phase-Shift Keying
DFS	Dynamic Frequency Selection
DL	DownLink
FCC	Federal Communication Commission
FDD	Frequency-Division Duplexing
FDM	Frequency division multiplexing
FSA	Fixed Spectrum Allocation
FSU	Flexible Spectrum Usage
GoS	Grade of Service
HBS	Home Base Station
HeNB	Home enhanced Node B
IMT-A	International Mobile Telecommunications - Advance
IP	Internet Protocol
ITU	International Telecommunications Union
ITU-R	ITU Radiocommunication Sector
LA	Local Area

LAN	Local Area Network
LOS	Line of Sight
LDPC	Low Density Parity Check
MIMO	Multiple-Input and Multiple-Output
MS	Mobile Station
NLOS	Non Line of Sight
OFDM	Orthogonal Frequency - Division Multiplexing
OFDMA	Orthogonal Frequency - Division Multiple Access
PAPR	Peak to Average Power Ratio
PRB	Physical Resource Block
QAM	Quadrature Amplitude Modulation
QoS	Quality of Service
QPSK	Quadrature Phase - Shift Keying
RAN	Radio Access Networks
RAT	Radio Access Technology
SBA-F	SINR Based Allocation – Fast
SBA-S	SINR Based Allocation – Slow
SC-FDMA	Single Carrier - Frequency Division Multiple Access
SINR	Signal to Interference plus Noise Ratio
SLB	Spectrum Load Balancing
TCP/IP	Transmission Control Protocol and the Internet Protocol
TDD	Time-Division Duplex
TPC	Transmit Power Control
TDMA	Time Division Multiple Access
UE	User Equipment

UL	UpLink
VoIP	Voice over Internet Protocol
VPN	Virtual Private Network
WRC	World Radio Conference

LIST OF SYMBOLS

Symbol	Description
σ	Standard deviation of Gaussian stochastic variable
σ^2	Variance of Gaussian stochastic variable
N	Number of cells
K	Number of frequency channels
$SINR_i(k)$	The SINR of channel k and the cell i
B	Bandwith(Hz)
$T_{out,X\%}^i$	The user aoutage throughput for cell i
T_{user}^i	The user throughput
T_{out}	The outage
$ h_{ii}(k) ^2$	Gain for channel k and cell i
$ h_{ij}(k) ^2$	Gain for channel k and the other cells j of the system
$p_i(k)$	Power allocated for channel k and cell i (useful power)
Δf_k	The bandwidth of channel k
Nu_{wall}	Number of walls between the base station and the users
$Loss_{wall}$	The wall penetration loss factor expressed in dB
d	The distance between the user and the base station, expressed in meters
f_c	The carrier frequency of the transmitted signal in Giga Hertz
T_{slot}	Time-slot, expressed in in seconds
n	Time increment
$frame_idx$	Index of the frame
$cell_idx$	Cell index

1 INTRODUCTION

At present, a main part of the spectrum is allocated for licensed operators. The operators have exclusive user rights and nobody can disrupt their privileges. It has been indicated that most of the time many frequency bands remain unused [1]. As user demands for data services and data rates constantly increase, efficient spectrum usage of limited available spectrum is becoming a more discussed issue. Flexible spectrum sharing appears to be a promising approach to solve inefficient spectrum usage problems. Flexible spectrum sharing means that devices are able to use the spectrum in a flexible manner by adapting their operations based on pre-defined policies to the current situation by sensing the environment. In this case, policies are set of rules agreed among the operators to allow fair and efficient flexible spectrum usage, taking into account their individual traffic and quality of service requirements. The essential technology for realizing flexible spectrum sharing is cognitive radio (CR). The CR cycle consists of three fundamental components: sensing, determination and action. Thus, FSU algorithm is a determining part of CR.

At the present time, the ITU Radiocommunication Sector (ITU-R) are working on the standardization of activities for the next generation mobile communication systems called International Mobile Telecommunications-Advanced (IMT-A). Among the key features of IMT-Advanced are enhanced peak data rates to support advanced services and applications and research targets were established as being 100 Mbit/s for high and 1 Gbit/s for low mobility. Commercial deployment of IMT-A is predicted to arise roughly in the 2015 [2]. In order to reach the high data rate and high quality of service for air interface IMT-Advanced in indoor local area scenario it seems to require the employment of Home enhanced Node B (HeNBs). It is considered these HeNBs will be deployed by several operators in a given geographical area without any network planning or any regulation, sharing the common spectrum pool. Therefore, a considerable demand of flexible, efficient and fair spectrum sharing is needed.

The goal of this master's thesis is to develop a suitable algorithm that can be used for fair and efficient spectrum allocation in local area indoor deployment. It is considered several operators to share spectrum pool in the same geographical area. Hence it is obvious that among these operators arise undesirable mutual interference. The mutual interference is greatest problem that has to be considered during designing of the Flexible Spectrum Usage (FSU) algorithm. The deployment is considered decentralized without exchanging any information among HeNBs. However, some essential policies that ensure efficient and fair spectrum sharing are required. The positions of the HeNBs taken into consideration are fixed and randomized and UEs' position in the area is random. The proposed algorithm uses information about mutual interference on the shared spectrum and reflects individual operators' traffic demands.

Due to the FSU algorithm, I am aiming to find the best ratio between operators' quality of service measured with the SINR and a global fairness not to penalise significantly any situation. The ratio is one of the major problems I encounter when I am dealing with Cognitive Radio (CR). Such a system will adapt its behaviors regarding to its surrounding environment which is composed by the operators, interferences and so on. Also, the principal aim of these researches in mobile communications is to improve the data rate between a base station and its belonging users. In a very simple case, it is not so difficult to find some solutions to optimize the data transfer between the infrastructure and a mobile device. However, I have to be carefully about the impact

that this improvement will cause the other users, and especially in a local area indoor deployment. Taking into consideration the fairness and efficiency, then it has to be considered that increasing transmission demands of one operator will imply most of the communication time and make negative impact on the others operators.

2 INTERNATIONAL MOBILE TELECOMMUNICATION – ADVANCED

2.1 Technical requirements

The International Telecommunications Union (ITU) is currently working on the development of recommendations and standardizations for radio interface specification called IMT - Advanced. IMT – Advanced is going to be a successor of IMT 2000. IMT 2000 is a worldwide set of requirements for a family of standards for the 3rd generation of mobile communications (3G). IMT-Advanced was previously known as “*systems beyond IMT-2000*”. The wide deployment of IMT-Advanced systems is supposed to take place around year 2015 in some countries. The system is expected to provide peak data rates of approximately 100 Mbit/s for high mobility such as mobile access and up to approximately 1 Gbit/s for low mobility such as nomadic/local wireless access. IMT-Advanced will enable higher network efficiencies and hence lower prices for the end users. To support this wide variety of services, it may be necessary for IMT-Advanced to have different radio interfaces and frequency bands for mobile access for highly mobile users and for new nomadic/local area wireless access.

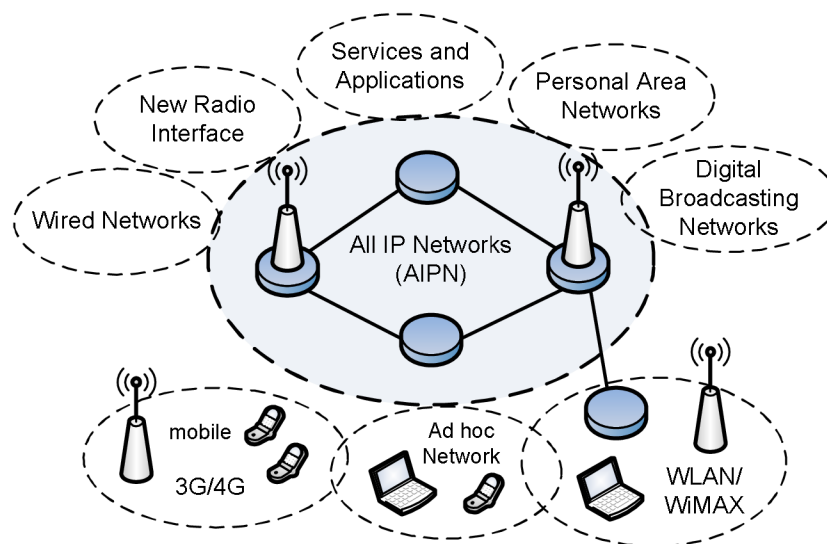

Figure 1: The interconnection of various network based on IP core network

The cardinal part of IMT-Advanced architecture consists in IP based global backbone network based upon core internet protocol TCP/IP. The architecture and concepts have been designed for efficient support of mass-market usage of any IP-based service. The core network will be IP based the IMT-Advanced systems requires support for mobile IP. Various networks (Figure 1.1.) will be connected with this backbone networks. Therefore, all these networks will be able to communicate together via this core network. IMT-Advanced is intended to offer high bit-rate mobile services with targeted bitrates of 100 Mbit/s (wide area, high mobility) and 1 Gbit/s (hot-spot, limited mobility). Seamless application connectivity to cellular networks, hot spots and other IP networks, efficient unicast services, multicast services and support to multiple radio interfaces are the other aspects of this standard. Seamless connectivity between the

terminal and base station will be automatic and transparent to the user as it moves across mobile networks. The IMT Advanced system shall support applications that conform to open standards and protocols. This allows applications including, but not limited to, video, full graphical web browsing, e-mail, file uploading and downloading without size limitations (e.g., FTP), streaming video and streaming audio, IP Multicast, Location based services, VPN connections, VoIP, instant messaging and on-line multiplayer gaming.

2.2 Technical requirements

This section has been written according to the ITU-R Recommendations present in these papers [3], [4].

For air interface IMT-Advanced is considered to use new multiple access technologies which must be backward compatible and able to co-exist with the IMT-2000 systems. According to World Radio Conference (WRC) in 2007 is proposed to utilize 100 MHz bandwidth for next generation IMT-Advanced system. It is inconceivable to allocate such wide bandwidth for several operators in the same geographical area. Hence, a new approach for spectrum sharing among operators is required. Contention based multiple access methods will be inevitable with taking into account flexibility, reuse and efficiency of spectrum usage. Suitable candidates for these multiple access methods are considered Orthogonal Frequency Division Multiple Access (OFDMA), Single Carrier Frequency Division Multiple Access (SC-FDMA) and OFDM-TDMA (Orthogonal Frequency Division Multiplexing - Time Division Multiple Access) because of their capability to support sharing spectrum pool and adequate for broadband transmission and packet switching

Modulation can improved spectrum efficiency, therefore improved modulation techniques are going to be used. Choice depends upon radio environment and spectrum efficiency requirements. Modulations which have lower Peak to Average Power Ratio (PAPR) have higher priority. Accordingly, modulation such as QPSK, 16QAM, 64QAM, DAPSK is proposed. Advanced forward error correction coding scheme such as Turbo and Low Density Parity Check (LDPC) should be considered for reliable communication. In conjunction with modulation scheme, Adaptive Modulation and Coding (AMC) scheme should provide various modulation and coding scheme (MCS) levels. Hybrid Automatic Repeat Request (ARQ) should also be considered for both efficient use of spectrum and link reliability.

IMT-Advanced systems shall support TDD and/or FDD operational modes. The FDD mode shall support both full duplex and half duplex mobile station operation. Specifically, a half-duplex FDD mobile station is defined as a mobile station that is not required to transmit and receive simultaneously. IMT-Advanced systems shall support both unpaired and paired frequency allocations, with fixed duplexing frequency separations when operating in full duplex FDD mode. The choice of the duplexing technology mainly affects the choices of the radio frequency channel bandwidth and the frame length. Duplexing technology may be independent of the access technology since for example either frequency division duplex (FDD), time division duplex (TDD) or half-duplex FDD may be used. It also affects band allocations, sharing studies, and cell size.

Better performance will be achieved by using MIMO technology. MIMO technology has attracted attention in wireless communications, since it offers significant increases in data throughput and link range without additional bandwidth or transmit power. It achieves this by higher spectral efficiency and link reliability. IMT-Advanced systems shall support MIMO and beam-forming including features to support multi-antenna capabilities at both the base station and at the mobile terminal. For the base station, a minimum of two transmit and two receive antennas shall be supported. For the MS, a minimum of one transmit and two received antennas shall be supported.

Both base station and mobile terminal should employ transmit power control mechanisms and exchange control and monitoring information required to achieve optimal performance while keeping the environmental noise floor as low as possible and helping the MS preserve its battery power. The number of transmit Power levels as well as the associated control messaging should be optimized for cost effectiveness and performance. The air interface shall support measurements in the physical layer of both the base station and the mobile terminal. IMT-Advanced systems shall support advanced interference mitigation schemes and enhanced flexible frequency re-use schemes.

IMT-Advanced shall be optimized for low speeds such as mobility classes from stationary to pedestrian and provide high performance for higher mobility classes. The performance shall be degraded gracefully at the highest mobility. In addition, IMT-Advanced shall be able to maintain the connection up to highest supported speed and to support the required spectral efficiency.

Mobility	Performance
Low (0 –15 km/h)	Optimized
High (15– 120 km/h)	Marginal degradation
Highest (120 km/h to 350 km/h)	System should be able to maintain connection

Table 1 IMT-Advanced system mobility support

2.3 Bandwidth and spectrum requirements

During the WRC - 07 of ITU-R which held in Geneva in 2007 ran the discussion about the spectrum allocation for IMT. IMT now include former IMT-2000 and IMT-Advanced. It means bands already identified for IMT-2000 will also be able to be used for IMT. The following frequency ranges were identified for IMT [5]:

1. 3.4–3.6 GHz (200-MHz bandwidth)
2. 2.3–2.4 GHz (100-MHz bandwidth)
3. 698–806 MHz (108-MHz bandwidth)
4. 450–470 MHz (20-MHz bandwidth)

Among these frequency ranges, each administration (in each country) will select suitable ones for the development of IMT.

3 FLEXIBLE SPECTRUM USAGE

Nowadays there are many researches and investigations on the very close topics try to find a new approach to use available spectrum more effectively. There are for example dynamic spectrum management, flexible spectrum management, advanced spectrum management, dynamic spectrum allocation. A crucial component enabling coexistence of several wireless and mobile communication systems and networks over the same bandwidth will be the so called Spectrum Sharing. The Spectrum Sharing could be broadly classified as follows [6].

- *Inter-System Spectrum Sharing*, allowing the coexistence of different Radio Access Technology (RAT).
- *Inter-Network Spectrum Sharing*, allowing the coexistence of different operators/networks,
- *Intra-Network Spectrum Sharing*, allowing the coexistence of different cells owned by the same network, and operating with the same RAT.

Flexible Spectrum Usage is a part of Intra-Network Spectrum Sharing. It mainly means the spectrum is shared between multiple Radio Access Networks (RAN) using the same RAT and providing similar services.

In general, there are two control models for flexible spectrum usage, the centralized control model and the distributed control model [7]. For each of the control scenarios, spectrum sensing is a critical aspect of the control of cognitive radios.

The centralized control model is one in which the management of spectrum opportunities is controlled by a single entity or node which has been referred to as the spectrum broker. The spectrum broker is responsible for deciding which spectrum opportunities can be used and by which radios in the network. A central broker may use sensors from the distributed nodes or may use other means for sensing and spectrum awareness. One application of centralized control is real-time spectrum markets.

The second opportunistic spectrum access or flexible spectrum usage control model is the distributed control model. In this model the interaction is “peer-to-peer”. In other words the cognitive radio or policybased adaptive radio nodes in the network are collectively responsible for identifying and negotiating use of underutilized spectrum. For some scenarios, the distributed control may be between co-operative radio access networks.

3.1 Cognitive Radio

3.1.1 Introduction

A quick observation of the mobile frequency spectrum is showing a highly inefficient occupancy. By inefficient we mean a non-optimized using of the frequencies which can be sometimes almost wasted in terms of performances. Indeed, because of the fixed spectrum access policies which assign statically the frequency bands to the users without any possibilities to modulate or re-assign them, we regrettably notice that

there is a real spectrum scarcity problem. Let me observing the phenomenon in a more visual way:

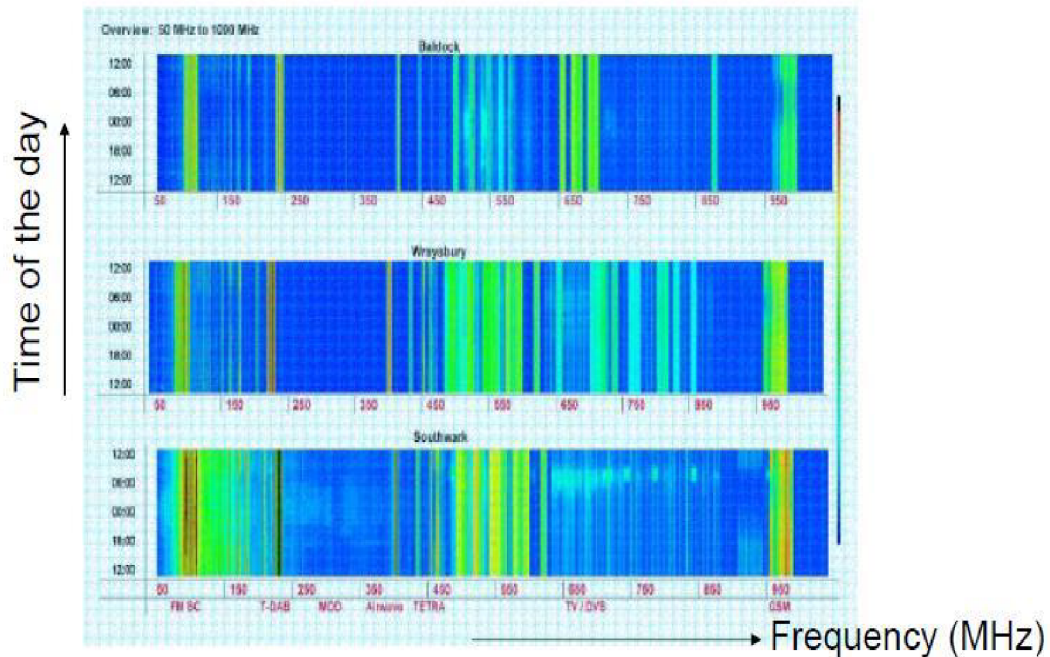

Figure 2: Spectrum inefficiency throughout time [8]

This figure above represents the frequency bands usage all over the day; for the frequency range from 50 MHz to 1 GHz. The colors from blue to red indicate the using intensity of the frequencies' utilization (the bluer, the freer frequencies, the redder, part the busier ones). Two very important things can be noticed:

- There are some frequency bands which are almost unused or barely used all day long like the range 250-300 MHz for example.
- Some other bands are properly utilized during certain periods of the day but at some other moments they could be used for anything else as it remains as a blue state (on the diagram) which means that they are free of use.

Therefore, on the one hand this is quite obvious that we have to find a way to improve the spectrum usage efficiency. However, on the other hand, there have to be a respect for the “environment” not to bring about some messy conditions. Indeed, even though some of these frequencies look free of use, some superior authorities such as emergency, government etc. might need to use them at any moment without waiting any approbation. This is only one special example which is pointed out there but there can be a lot of other situations that would require “a ready to use spectrum” knowing that most of the time it will not be used, or at least, not as efficiently as possible.

Another thing that have to be taken care of is the fairness. If you are an operator who paid for a certain bandwidth, you would probably not appreciate that some other ones would use it without taking care of your needs, or without asking your permission? To simplify this problem, the notion of “*User class*” has been introduced within the cognitive radio. Thanks to it, there is an ability to “transfer” a secondary user to a primary user free spectrum part called in that case “*spectrum hole*”. Typically, these

“spectrum holes” are the deep blue parts of the figure 2. In fact, the users will be called who have paid for a certain bandwidth, and who have to get a minimum quality of service guaranteed the “*Primary Users*” whereas the other ones who will be able to borrow some frequencies from the primary user, but who are not licensed on this bandwidth the “*Secondary Users*”. It is very quickly understandable that there will be some restrictions with respect to the implementation of this kind of policies in the spectrum sharing market. Some few, logical rules can be guessed such as: the *Secondary User* can only use some *Primary User* frequencies’ with the condition that the Interference level between the two systems is under an acceptable level, or even that the primary user is not used to saturate its bandwidth over the range the *Secondary User* wants to use. Another thing that have to be taken in the consideration is not only that the *Secondary User* must not making some troubles to the *Primary User* when both are running together but it also has to avoid Interference to *Primary Users* via sensing and adapting allocation. This last point is more annoying than the first one which can be solved stopping the *Secondary User*’s communications as soon as it provides too many problems to the first ones. Whereas, sensing the spectrum is the most fundamental principle of the cognitive radio concept, thus, there is no way to remove this step.

Here have been described “one view” of the cognitive radio (splitting the frequencies between both licensed users (*Primary Users*) and unlicensed ones (*Secondary Users*)). However, another approach of cognitive radio that seems to be more efficient and usable for this project is to consider that the entire frequency spectrum is like an “unlicensed band”. Therefore, all the users have to deal with each other to get the most efficient configuration for their data transmission. The final argument for the spectrum efficiency improvement is that, industry is expecting so high data rates in the next few years that will widely overload the capabilities by using only the traditional fixed spectrum access. Finding new ways of sharing the telecommunication frequency spectrum in a more efficient and intelligent manner is an issue that has become essential to reach the future hopped goals.

3.1.2 Definition of Cognitive Radio

According to *James Neel* (PhD in Cognitive Radio at Virginia tech), the definition that we could give of the concept of cognitive radio is the following:

“A cognitive radio is a radio whose control processes permit the radio to leverage situational knowledge and intelligent processing to autonomously adapt towards some goal. » [9]

The definition shows that a cognitive radio is a sort of “clever” system which has an ability to sense its environment, and to make some decision in consequence. The cognitive radio is a self-aware communication system that efficiently uses spectrum in an intelligent mode. It autonomously coordinates the usage of spectrum in identifying unused radio spectrum on the basis of observing spectrum usage. Basically, a cognitive radio system can be drawn as the diagram:

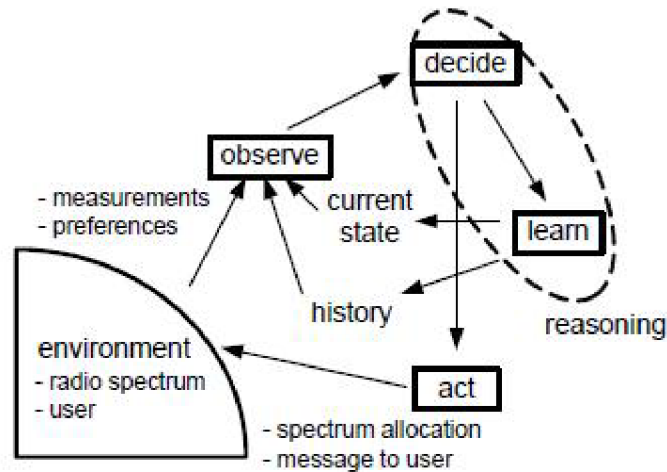

Figure 3: Mental process of a cognitive radio based on the cognition cycle form [10]

Description of the cognition cycle:

- At first, the system observes the environment (whom main parameters are the radio spectrum and the users). By observing, we mean, performing some measurements, and checking the preferences of each operators and users in the system.
- Then, the system has to engage a reasoning step. This is the core of the Cognitive Radio concept. The system has to take its decision, and to “learn” from the results that are obtained consequently.
- In the meantime, the system is doing actions it is supposed to such as allocating the spectrum and managing the users.
- To finish, all the results of this learning process are kept in memory, and this one will be used and improved steps after steps.

Moreover, there are several classes of cognitive radios depending on “how intelligent and autonomous” they are. The problem is that the “Cognitive Radio” principle is not well defined and is quite different depending on the institutions. The table below shows illustrates this “complexity”.

Level	Capability	Comments
0	Pre-programmed	A software radio
1	Goal Driven	Chooses Waveform According to Goal. Requires Environment Awareness.
2	Context Awareness	Knowledge of What the User is Trying to Do
3	Radio Aware	Knowledge of Radio and Network Components, Environment Models
4	Capable of Planning	Analyze Situation (Level 2 and 3) to Determine Goals (QoS, power), Follows Prescribed Plans
5	Conducts Negotiations	Settle on a Plan with Another Radio
6	Learns Environment	Autonomous Determines Structure of Environment
7	Adapts Plans	Generates New Goals
8	Adopts Protocols	Proposes and Negotiates New Protocols

Table 2 Levels of Cognitive Radio Functionality [9]

It is obvious that several levels have been thought about the cognitive radio evolutions, and the higher the level is, the smarter the system will be. Thus, at the lowest level of the cognitive radio, there are some “Pre-programmed” systems which are basically only radio waves. These ones are implemented with software that changes the behavior of the radio under some conditions. On the other side, at the 8th level the system is the most autonomous of this chart, and is even able to “Propose and Negotiate New Protocols”. Indeed, all the collected data about the different base stations in emissions or receptions are analyzed and computed in the aim of optimizing the performance of the global network. The collected data can be the bandwidth necessary to an operator to achieve its communication with its user or even the period during which some bands are used or not and so on.

Below are presented, the features defined by the *Federal communication commission (FCC)* exposed in [11] that the cognitive radio should include to enable more efficient and flexible usage of spectrum:

- **Frequency Agility** – The radio is able to change its operating frequency to optimize its use in adapting to the environment.
- **Dynamic Frequency Selection (DFS)** – The radio senses signals from nearby transmitters to choose an optimal operation environment.
- **Adaptive Modulation** – The transmission characteristics and waveforms can be reconfigured to exploit all opportunities for the usage of spectrum.
- **Transmit Power Control (TPC)** – The transmission power is adapted to full power limits when necessary on the one hand and to lower levels on the other hand to allow greater sharing of spectrum.

- **Location Awareness** – The radio is able to determine its location and the location of other devices operating in the same spectrum to optimize transmission parameters for increasing spectrum re-use.
- **Negotiated Use** – The cognitive radio may have algorithms enabling the sharing of spectrum in terms of prearranged agreements between a licensee and a third party or on an ad-hoc/real-time basis.

These different capabilities give the radio systems new opportunities to increase their performance, raising certain frequency spectrum effectiveness. To put the cognitive radio concept in a nutshell, we can quote the general definition given by Haykin in [12]:

“Cognitive radio is an intelligent wireless communication system that is aware of its surrounding environment (i.e., outside world), and uses the methodology of understanding-by-building to learn from the environment and adapt its internal states to statistical variations in the incoming radio frequency stimuli by making corresponding changes in certain operating parameters (e.g., transmit power; carrier frequency, and modulation strategy) in real-time, with two primary objectives in mind:

- ✓ *Highly reliable communication whenever and wherever needed and*
- ✓ *Efficient utilization of the radio spectrum.”*

With all these elements, it is easily understand pretty that the biggest issue with the cognitive radio is to conceptualize the “intelligent” aspect of the system. Hence, during the development of this project we focused a lot of efforts on the algorithm part and the ways to improve it, as it can be matched to the “brain” of the project’s body.

3.1.3 Cognitive Radio and Benefits

The goal of the research about cognitive radio is mainly to optimize the spectrum frequency with the purpose of being able to transfer more data. In fact, by using more efficiently the frequencies, we are then decreasing the amount of congested or bad channels, which finally means, a better connection for the user.

As was said before, the data rate is expected to be 1 GHz for the Local Area Network (LAN) which is impossible with fixed sharing frequency model. In addition, the cognitive radio will probably open new perspectives that we have not imagined yet. We are actually limited in terms of imagination and implementation by the poor data rate that is being experienced. However, helped by the cognitive radio improvements, researchers and engineers will have some more materials to play with and will not be restricted by data capabilities anymore.

Applications for such an improvement are multiple, however in our case; these developments will concern mainly the communication between mobiles and base stations. There can be wider fields to think about new functions that cognitive radio yields would allow. The videos and data transfer, and in general, entertainments features, require a lot of bandwidth that is already limited. The video call and new high definition voice call also require some improvement at the data rate level. Of course, there are all the new applications that are still in progress (Mobile GPS, social mobile communications and so on) that will need some more capacities to be properly implemented in the future.

Cognitive radio is a very important aspect of our project: Indeed, even though it is still quite new to have the approach of an information system that would have a certain

“intelligence and autonomy” at the same time, it is probably one of the most important field to investigate to improve current telecommunications model. As known, the more resources we have, better final product will be. In conclusion, it can be said that “cognitive radio” is only a tool for the final products, but it is necessary as provider of the whole “raw material” that can be shaped to get the wanted final application.

3.2 Quality of Service

The term “Quality of Service” has to do with giving different priority to different applications, users, or data flows, or to assure a certain level of performance to a data flow. In mobile communication, the ITU standard X.902 defined the quality of service as “A set of quality requirements on the collective behavior of one or more objects”. Many parameters are taken into account to evaluate the Quality of Service such as service time delay, Call Drop rate, signal loss, signal-to-noise ratio, interruptions, frequency response, maximum connection time and many other parameters. It can be also defined the Grade of Service (GoS) as a part of the QoS, but it takes into account different aspects of a connection concerning more the capacity and coverage of a network.

In order to evaluate the algorithm and provide the results of the simulations, it is needful to employ different parameters of QoS:

- The SINR
- The Throughput
- The Outage
- The Interference
- The Path Loss
- The Cell Load

It is important to define all of these terms to clearly understand the graph of the simulation and the overall performance of the algorithm.

3.2.1 Signal-to-Interference Noise Ratio (SINR)

The Signal-to-Interference Noise Ratio (SINR) is an important measure of communication link quality since it takes into account both the Interference and the noise provided by the environment. SINR evaluation is important for wireless data systems where the spectrum is shared amongst users. In our simulation, the SINR is estimated in the following way (for simplicity in equation (2.1) just one user per cell is considered) [13]:

$$SINR_i(k) = \frac{|h_{ii}(k)|^2 p_i(k)}{\sum_{\substack{j=1 \\ j \neq i}}^N |h_{ij}(k)|^2 p_j(k) + \sigma_i^2(k)} \quad (2.1)$$

Where

$|h_{ii}(k)|^2$: Gain for channel k and cell i

$|h_{ij}(k)|^2$: Gain for channel k and the other cells j of the system

$p_i(k)$: Power allocated for channel k and cell i (useful power)

$\sigma_i^2(k)$: Noise at channel k and cell i

The Algorithm is based on the SINR. In fact it can be evaluated the SINR per user and then decide depending on some conditions the way to allocate the spectrum between these different users belonging to the cell i . Furthermore we are aware of the SINR fluctuates according to the environment, the layout, but most of all according to the base stations and the users' position in the cell. The users and the base stations will be randomly placed in the Local Area and so the SINR will be more realistic.

3.2.2 The Throughput

The throughput is certainly the most significant parameter of the QoS and it is used to evaluate the efficiency of the algorithm. In fact, for the algorithm the efficiency of the algorithm is defined as a maximum of spectrum allocated among the operators with the least interference possible in order to achieve a maximum throughput. In communication networks, it is defined as the average rate of successful message delivery over a communication channel. It is a measure of the quantity of users or services that can be simultaneously supported by a limited radio frequency bandwidth in a defined geographic area while maintaining an acceptable quality of service (QoS). For simulations of the algorithm, the throughput is considered equal to the channel capacity and it is measured in Mbit/s. The throughput is generally lower than network access connection speed (the channel capacity). For simulations of the algorithm is going to be assumed throughput equals channel capacity.

DEF: Mean Cell Capacity (Throughput) [13]

$$T_{cell,mean} = \frac{1}{N} \sum_{i=1}^N \left(\sum_{k=1}^K \Delta f_k \log_2(1 + SINR_i(k)) \right) \quad (2.2)$$

N : number of cells (in the simulations we deal with 4 cells, each with one operator)

K : number of frequency channels

Δf_k : The bandwidth of channel k

$SINR_i(k)$: The SINR of channel k and the cell i

This formula of the cell capacity gives the fundamental limit of errorless in Mbit/sec of a channel of bandwidth B (Hz) it is considered for this case that B is equal to 100MHz and the $SINR_i(k)$ is defined as before. The noise is the fundamental (i.e. can't be avoided) limiting factor of capacity. In practice, the mobile channel is restricted by some factors that arise from the multipath propagation, dispersion and interference, especially in the case where multiple-users systems are. Therefore, the estimation of the throughput takes into account both the number of cells and the number of users per cell in order to establish the mean cell capacity of all of the system

3.2.3 The Throughput

Generally, the outage represents the time when the user is out of the service. The statistical approach is required when there are too many paths to determine, which the case in mobile communication is usually. In order to represent the outage of the algorithm efficiently the cumulative distribution function (CDF) is used which describes the probability distribution of the user outage throughput for cell i $T_{out,X\%}^i$.

Let me define a random variable ‘user throughput’ for cell i as T_{user}^i , then the ($X\%$) user outage throughput for cell i $T_{out,X\%}^i$ is defined as the value such that [13] :

$$CDF(T_{out,X\%}^i) = \Pr(T_{user}^i \geq T_{out}^i) = X / 100 \quad (2.3)$$

The 2.3 formula means that the percentage of the user outage throughput represents the probability for the user from the cell _{i} to have a Throughput (T_{user}^i) that is superior to the threshold throughput, defined as the outage throughput T_{out}^i .

The average ($X\%$) user outage throughput is given by [13] :

$$CDF(T_{out,X\%}) = \frac{1}{N} \sum_{i=1}^N CDF(T_{out,X\%}^i) \quad (2.4)$$

Or equivalently
$$CCDF(T_{out,(1-X)\%}) = 1 - \Pr(T_{user}^i \geq T_{out}^i) = \frac{1-X}{100} \quad (2.5)$$

(with
$$CCDF(T_{out,(1-X)\%}) = \frac{1}{N} \sum_{i=1}^N CCDF(T_{out,(1-X)\%}^i) \text{ average }) \quad (2.6)$$

Hence, the User Outage Throughput identifies the 5th percentile of the CDF of user throughput and provides the minimum throughput achieved by the 95% of the users. However, more interesting is the average than the probability of each cell during the simulations: there is not the performance for each individual cell but for the all of our system and this is defined as the summation of the throughput of each cell divided by the number of cells as it is expressed in the formula (2.5) and (2.6).

3.2.4 The Interference

In the field of telephony, the interference is the summation of all phenomena which modify or alter the transmission of a signal between the transmitter and the receiver.

As is known, nowadays the operators do not want to share their spectrum even if they are aware of the improvements achieved by the cognitive radios; their reluctance is mainly due to the inescapable presence of Interference especially in the indoor Local Area (LA) scenario. That means the coverage area is small and the mobility of users is low. It is easily understandable since several operators are working in the same local area and sharing the same spectrum, that the interference is important. In addition, the activation of each Home enhanced Node B (HeNB) (which practically means a Base Station for local area) takes place without collaboration between the different operators. Hence, the operators are free to install their base stations anywhere they want without taking into account the position of the other operators’ base stations. It will be seen later that one experiences the best throughput when each base station is centered in its own cell but, though it is obvious that this situation is not realistic in some situations. A way to deal with the interference has to be found even in the worst case where two base stations are closed to each other. Hence, it is going to be used the spectrum sensing

techniques in order to identify the available spectrum and sharing it without harmful interference with other operators, indeed this is an important requirement of the Cognitive Radio network to sense spectrum holes. The spectrum sensing technique used in the algorithm is the interference based detection. Because this approach it is evident that intelligent radio is useful to analyze the spectrum, to find the free frequencies and then to implement an algorithm, in which the provided interference is maintained under a defined threshold.

3.2.5 The Path Lost

The Path Loss can also be defined as a parameter of the Quality of Service. It represents the attenuation of the signal strength due to the propagation of the electromagnetic wave through the space. Path loss can be separated into several factors as *propagation losses* resulting from a line of sight path through free space with any obstacles nearby; *absorption losses*, occurring when the intensity of the energy beam is reduced as it passes through a specific material; *diffraction losses* which are present when a wave is encountering an obstacle and many other loss depending on the environment where the wave is propagating. The signal in wireless communication system coming from the transmitter reaches the receiver by different paths at the same time. This propagation phenomenon is called multipath. The effects of multipath include both positive and harmful Interference. Obviously these effects have to be taken into consideration in the calculation of the path loss.

The calculation of the path Loss is very hazardous. Many factors as was discussed before have to take into account depending mainly on the environment working with. In an Indoor office scenario, the way to compute the path loss is described in the reference [3] and there is the same formula in the function PL_Calc of the simulator. The simulator considered both a LOS (corridor-to-corridor) and a NLOS (corridor-to-room) case. The LOS case is defined by the formula (2.7) and it is considered when the base station and the user are in the same place as the base station. It means there is any obstacle between the direct paths from the Base station to the user. On the contrary, the NLOS case is considered when the user is not on the Line of Sight (LOS) of the base station. In that case the penetration due to rows of rooms between the base station and the user has to be taking into consideration. However through-wall attenuation multiplied by the number of walls between the base station and the room, where the UE is situated, is applied. The formula (2.8) is used in that case [14]:

$$\text{LOS: } Path\ Loss = 18.7 \log_{10} d + 46,8 + 20 \log_{10} \left(\frac{f_c}{5} \right) \quad (2.7)$$

NLOS with through-wall attenuation:

$$Path\ Loss = 20 \log_{10} d + 46,4 + 20 \log_{10} \left(\frac{f_c}{5} \right) + Nu_wall \times Loss_wall \quad (2.8)$$

Where Nu_wall represents the number of walls between the base station and the user and $Loss_wall$ is the wall penetration loss factor expressed in dB. The distance d between the user and the base station is expressed in meters and the carrier frequency f_c of the transmitted signal in Giga Hertz.

3.2.6 The Cell Load

One cell is defined as the coverage of one operator, meaning the geographical area covered by a certain base station. In our case each cell covers a 100mx25m indoor local Area. The cell load represents the amount of spectrum each operator is using in its coverage area. More precisely we are going to have a look on the percentage of used Physical Resource Blocks (PRBs) over the total number of PRBs. By this way we can evaluate the fairness among the operators and so evaluate our algorithm as we wanted to guarantee both fairness and efficiency

3.3 Multiple Access Principle and Duplexing Techniques

3.3.1 OFDM

Orthogonal Frequency-Division Multiple Access (OFDMA) is an access technique based on Orthogonal Frequency-Division Multiplexing (OFDM). To understand how it works, take a look on how OFDM and FDM work, in order to provide a better explanation. Frequency division multiplexing (FDM) is a technology that transmits signals from multiple transmitters simultaneously over a single transmission path. Each signal has its own sub-carrier, which is modulated separately by a conventional modulation scheme and a guard band is placed between sub-carriers to avoid signal overlap.

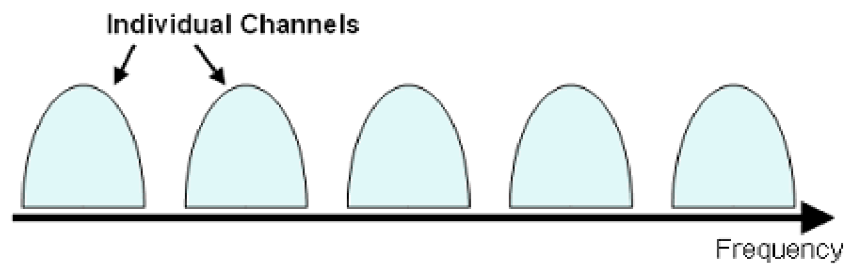

Figure 4: FDM sub-carriers [15]

Orthogonal Frequency-Division Multiplexing (OFDM) is a spread spectrum technique that distributes the data over a large number of evenly spaced sub-carriers. These sub-carriers are spaced apart at precise frequencies to prevent Interference, and the removal of guard bands between adjacent sub-carriers means the sub-carriers are closely spaced to each other. This is possible because the frequencies (sub-carriers) are orthogonal; meaning the peak of one sub-carrier coincides with the null of an adjacent sub-carrier.

Mathematical Description [16]:

$$\int_{-\infty}^{\infty} f_n(t)f_m(t)dt = \begin{cases} 0 & (m \neq n) \\ 1 & (m = n) \end{cases} \quad (1.1)$$

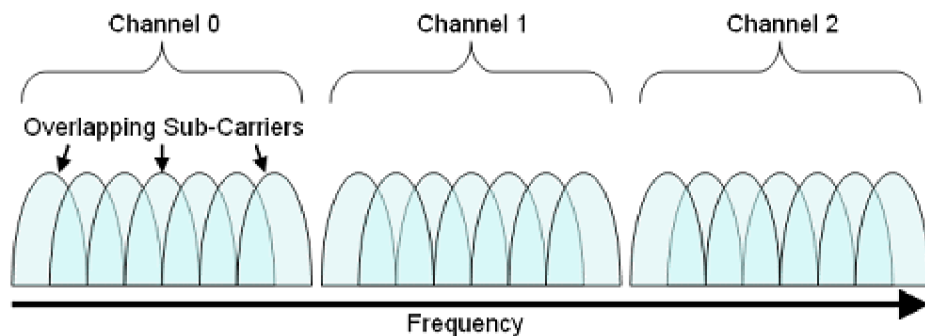

Figure 5: Frequency Domain of OFDM System [15]

Orthogonal Frequency-Division Multiple Access is a multiple access technique that employs multiple spaced sub-carriers like OFDM, but now these sub-carriers are divided into groups of sub-carriers. Each group is called sub-channel and they do not need to be adjacent as shown in Figure 6 [17]. Notice that OFDMA can also be

described as a combination of frequency domain and time domain multiple access as shown in the figure below.

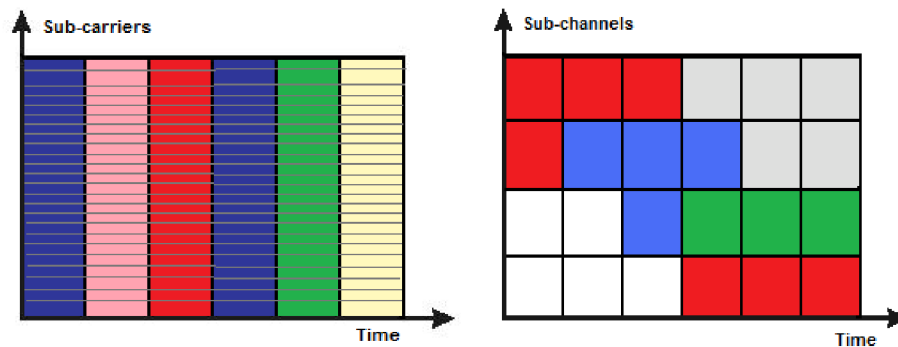

Figure 6: OFDM (left) and OFDMA (right)

Multiple Access is achieved by assigning subsets of sub-carriers to individual users (figure 6), which allows simultaneous low-data-rate transmission from several users.

3.3.2 Duplexing Techniques: TDD vs FDD

In Frequency Division Duplex (FDD) the Downlink (DL) and Uplink (UL) are allocated in two separate frequency bands. The two bands are separated by a guard band which minimizes the interference of the two signals. One of the advantages of FDD systems is that they provide a simultaneous and continuous UL and DL transmission, making them ideal where traffic requirements are symmetrical. Furthermore thanks to the guard band between UL and DL getting immunity to system Interference. On the other hand, the main drawback is that the UL and DL channel allocations are fixed, and as there is needed channel spacing, this results in wasted spectrum. Furthermore FDD requires a transmitter, a receiver and a duplexer that increase the hardware costs [18].

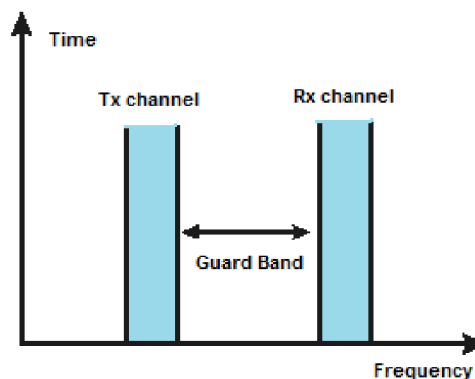

Figure 7: Frequency Division Duplex

In contrast, Time Division Duplex (TDD) uses a single frequency to transmit signals in both DL and UL separating them in the time domain, thus it requires a guard time instead of a guard band. Consequently, TDD systems can flexibly allocate spectrum to UL or DL simply by altering their frame duration. Another advantage is that due to the channel reciprocity, the channel responses are reciprocal, meaning that the station can optimize the transmit parameters used in multiple antenna systems. Oppositely, the most important disadvantages are the interference problems because they use the same frequency and due to the band guards, the efficiency of the system could be reduced [18].

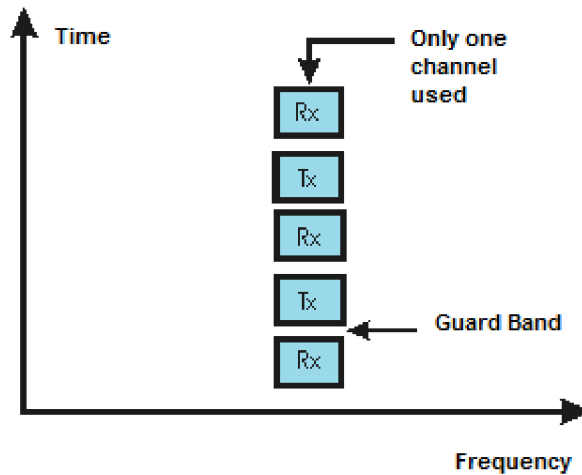

Figure 8: Time Division Duplex

In summary, TDD is a more desirable duplexing technology that allows the UL and DL to share the same spectrum; consequently achieve a more efficient spectrum.

3.3.3 Physical Resource Blocks

In OFDMA, users are allocated a specific number of sub-carriers for a predetermined amount of time. These are referred to as physical resource blocks (PRBs). A PRB is the smallest element of resource allocation assigned by the base station scheduler. Notice that PRBs have both a time and frequency dimension [19].

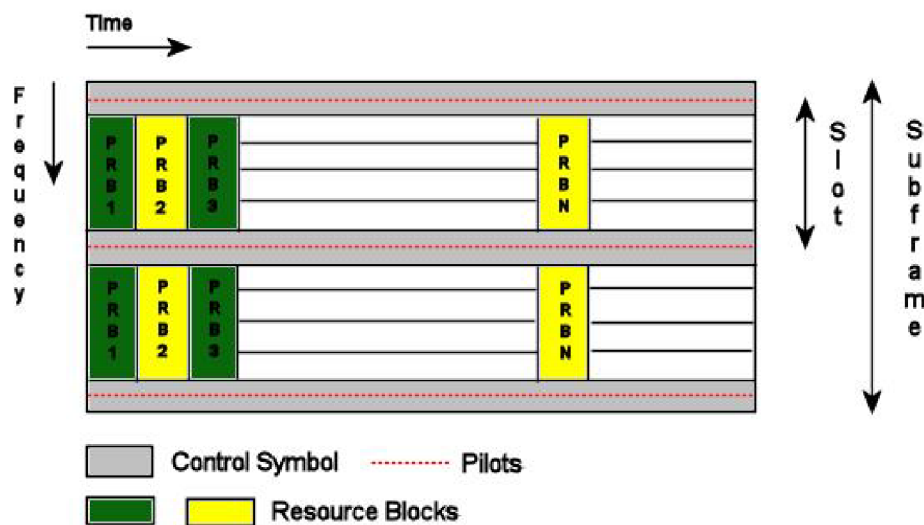

Figure 9: Generic Sub frame Structure [19]

A physical resource block (PRB) is defined as 7 consecutive OFDM symbols in the time domain and 12 consecutive sub-carriers in the frequency domain for one time-slot ($T_{slot} = 0.5$ ms) in duration, as shown in Figure 10. The downlink signal can be represented by a resource grid as depicted in Figure 11. Each box within the grid represents a single sub-carrier for one symbol period and is referred to as a resource element [19]. Assume that the OFDM sub-carrier spacing is $4 * 15$ KHz = 60 KHz and bandwidth of around 90MHz, the number of PRBs is:

$$\frac{90\text{MHz}}{12 \cdot 60\text{kHz}} = 125 \quad (1.10)$$

As a result, the maximum number of PRBs an operator can use is 125. Notice that in the frequency domain, the uplink transmission has the same number of PRBs as the downlink transmission.

3.4 Spectrum Sharing

One of the most important problems nowadays in communications is that much of the priced spectrum is idle at any given instant or location. Regulators grant licenses that offer exclusive access to spectrum. When licensees are not transmitting the spectrum falls into disuse [20]. Furthermore, due to the increase of wireless systems, frequency spectrum is facing with scarcity problem [21].

The problem is that new technology needs more and more spectrum, so there is a necessity of adopting appropriate spectrum policies [20]. The purpose is to achieve an efficient utilization of radio spectrum and manage fulfilling fairness and efficiency. Thus to make possible independent radio systems to use the same spectrum in co-operation is needed. Current systems use what is called Fixed Spectrum Allocation (FSA), where each operator is assigned a fixed dedicated part of the spectrum. In contrast to the actual model, FSU requires that different operators can coexist in the frequency-time domain (Figure 10) [22]. It is called Flexible Spectrum Usage (FSU).

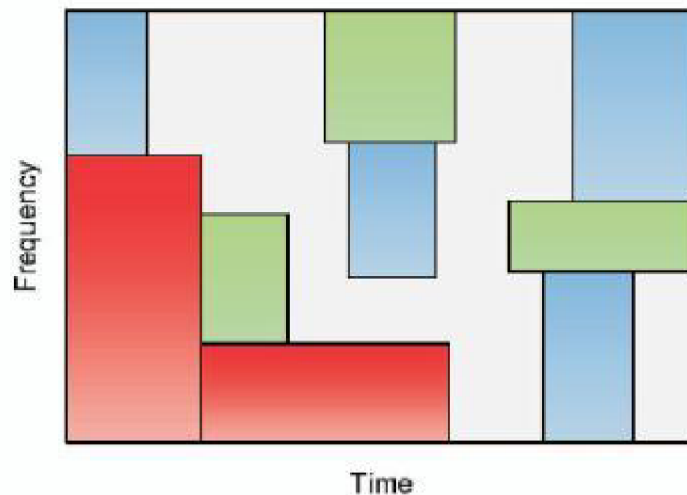

Figure 10: Allocation of resources for operators [22]

3.4.1 Physical Resource Blocks

As a result of Flexible Spectrum Usage, devices are able to use the spectrum in a flexible manner by adapting their operation to the current situation by sensing the environment or based on regulatory policies that can vary based on time, place or events [23]. Consequently, the licensees can lease their spectrum to the other users. Any wireless device can access any band as long as a certain regulation is followed and these devices do not cause unacceptable Interference toward the owner. It is like to make the whole spectrum unlicensed. To handle the peaceful coexistence among operators in several domains: Frequency, Time and Space. The last one is when two antennas are sufficiently far from the each other and the signal is attenuated due to the distance. The

usual control strategy used in FSU is the decentralized approach. In this case the operators can take part in the decisions about the spectrum and they can be either uncoordinated or collaborative. In other words, either they do not exchange information or they collaborate to identify the best way to coexist with each other. Figure 11.

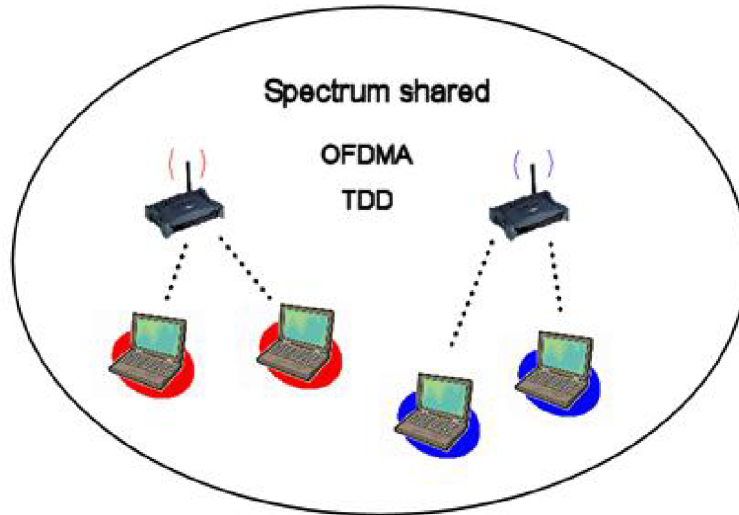

Figure 11: Spectrum sharing

To sum up, Spectrum Sharing and FSU can facilitate the successful implementation of future systems especially for local and personal area wireless systems such as IMT-A systems

4 ALGORITHM

4.1 Description of Algorithms

4.1.1 Straight and full PRBs allocation

In this part, I am going to describe the theoretical aspect of the system in order to implement its “intelligent way of thinking”. This intelligence is actually a set of rules that is changing the system state in function of some parameters such as the SINR, interference, number of operators and users. According to these parameters, can be established a pattern of the surrounding environment and defined a theoretical model, also called the “algorithm”. Therefore, an algorithm has to represent the different cases the system can encounter and the “reactions” it will provoke.

Besides, in this description I will point out the difficulties and the improvements that were performed during the algorithm development to reach the main goals of the project which were an optimized throughput keeping a good fairness. Let me begin with the first algorithm suggestion:

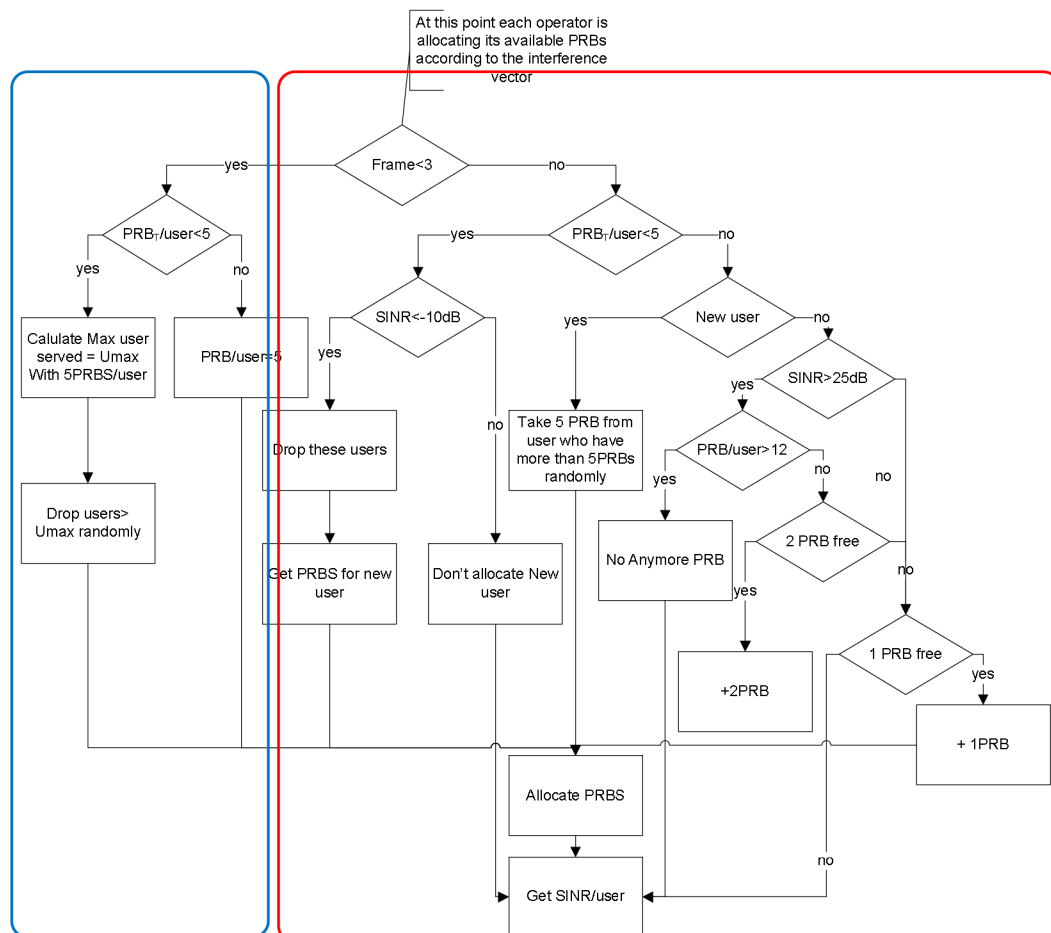

Figure 12: Straight and full PRBs allocation

The initialization phase:

At the beginning I am going to describe the circled blue part. In this first section, there is a limitation of the number of users in the network in order to guarantee some fairness

(in the case of you have too many users) and efficiency (in the case the number of PRBs available to you is too low) among operators. To do so, the interference vector is checked, and the number of available PRBs back is obtained. Then, if the number of PRBs per user is bigger than 5 for your users, there is the next step. Otherwise, you have to choose randomly the users to drop in order to match with the condition. At this point there are:

- All the users at 5 PRBS
- still free PRBs or not anymore
- The SINR of the Users

The PRBs Distribution:

At frame >3 , it is checked if the number of total PRB (used & free) / total users <5 (to check if there is any new user coming in the system);

1. If the this ratio is inferior to 5, it means that new user is coming and have no PRB free for its in that case it is checked if there is some users who are hopeless (= SINR <-10 dB):
 - If yes, is dropped and give the PRBs to the new one.
 - If no, it is not allocated any PRBs.
2. If the ratio > 5 , it means there are some PRBs free either for a new user or to increase the number of PRBs/user.
 - In the case where there is a new user, the number of free PRB is checked:
 - If the number of PRB free > 5 , we allocate 5 PRB for this new user
 - If not, the number of free PRB (1, 2, 3 or 4) is taken and the rest from the user who has more than 5 PRB randomly.
 - In the case where there is no new user, that means the number of PRBs per user can be increased. The SINR of each user is checked :
 - If the SINR > 25 dB & PRB < 12 , 2 PRB are added if it's possible or 1 if it's not. If the user has more than 12 PRB it is not allocated more.
 - If the SINR < 25 dB, just 1 PRB is added.

Limitations and improvements:

I quickly understood that this algorithm was far too complicated. The introduction of new user during the simulation was something which could not be simply implemented in the simulator. In addition, there was not any initialization step in here, which was something that was really wanted to take care about. Besides, it was definitely wanted to keep the SINR as comparison parameter, and the idea of a minimum efficiency per user was maintained, the other important point of this algorithm. Thus, move to look at the next algorithm imagined after these remarks.

4.1.2 Initialization implementation

The main difference compared to the previous one is the introduction of the initialization phase. In fact, to be as realistic as possible this step is really important. We proposed an initialization cell after cell because I was aware of that in a real environment, the operators do not activate their base station on the same time. Hence, I simulated this fact as each operator activates its base station frame after frame. The

condition $cell_idx = frame_idx$ is used to know when it's your turn to activate. As I was working with four operators, which mean four cells, the activation phase takes place in the first four frames. These phases can be schematized in a table:

Frame_idx \ Cell_idx	1	2	3	4
1	- Activation -Blind allocation	- Sense - Allocate / Drop	- Sense - Allocate / Drop	- Sense - Allocate / Drop
2		-Activation -Blind allocation	- Sense - Allocate / Drop	- Sense - Allocate / Drop
3			-Activation -Blind allocation	- Sense - Allocate / Drop
4				-Activation -Blind allocation

Table 3 Initialization phase cycle

The main problem here, is that once the operators are initialized, all of them a trying to use all the PRBs available. For an obvious reason, I can guess this algorithm is then not working properly. Indeed, all the operators are trying to allocate the entire available spectrum, following the interference but all together at the same time! This manner of proceeding implies that operators are acting on the PRBs without any regard to the actions of each other. However, the initialization phase was pretty helpful in collecting the interference, but so unrealistic that was finally decided to change it to a more “real” approach.

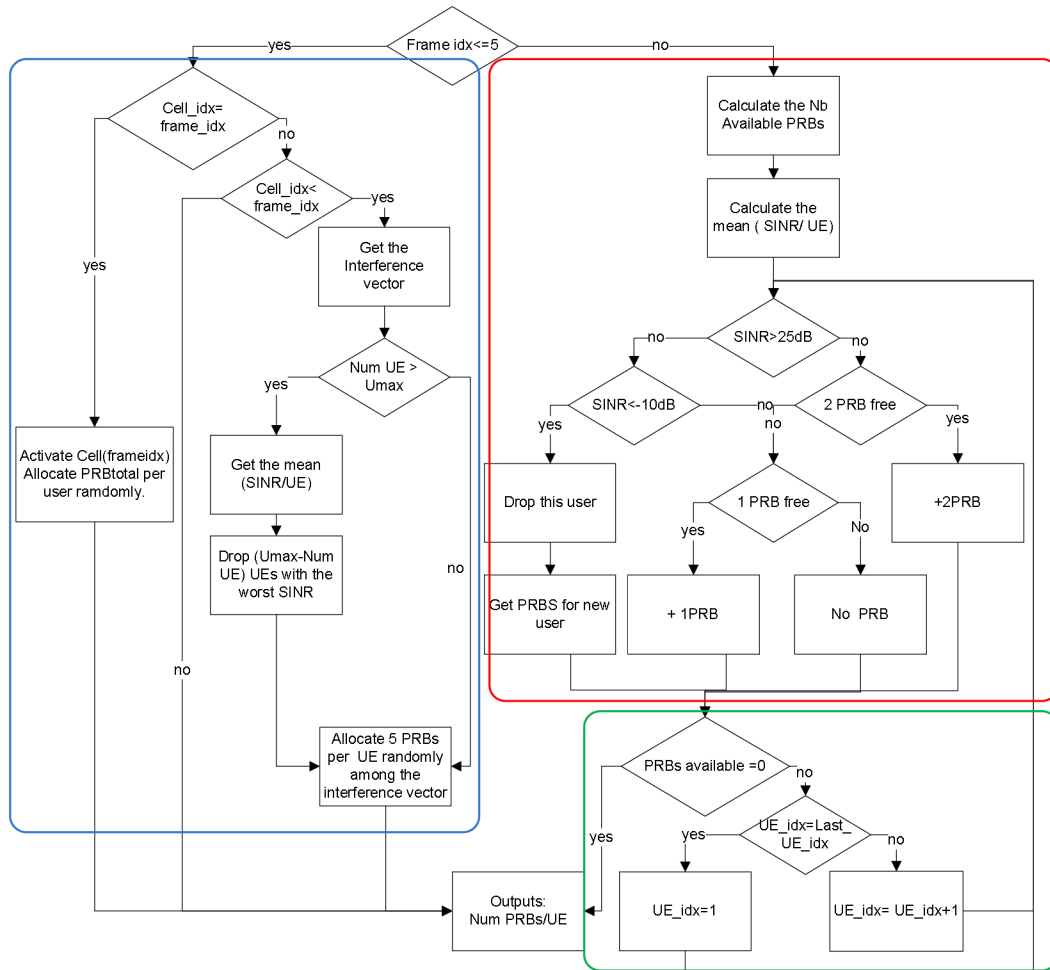

Figure 13: Initialization implementation

In the last part the algorithms which correspond to the final design model will be studied. Two algorithms are going to be compared through simulations and discussed:

- The SINR-Based-Algorithm (SBA) -Fast
- The SINR-Based-Algorithm (SBA)- Slow

4.1.3 The SINR Based Allocation – Fast Algorithm

The way I was thinking about an algorithm is based both on the interference and the SINR. It can be divided it in two parts:

- The initialization which corresponds to the activation of each cell
- The allocation of the spectrum

This algorithm runs with four operators. It deals with spectrum sharing based on the interference detection and tries to be fair with all of the operators. In the simulator, the interferences are measured for all of the PRBS and compared with a threshold in order to define the PRBs as available or not. At least 20% of the total spectrum is free in order to get more for the other operators. Then, once each operator gets a number of PRBs, they are allocated to each user of the cell. This allocation is dependent on the user's SINR, with the restriction of 5 minimum PRBS per user and 12 maximum. With this system it was being tried to maintain a certain quality of service, to improve the cell

throughput and at the same time still have a fairness system. This algorithm works as following:

The initialization:

At the beginning, each cell is activated ones after another, which is more realistic than activating the cell all in the same time since we are in Local Area where one operator can be working alone for a long time. This activation phase is necessary for a first “blind allocation” in the aim of measuring a first interference vector (corresponding to the different level of Interference of each PRB) with a certain notion of fairness, as the process is completely random. This step by step procedure (the blue circled frame on the figure) appears to be closer to the reality and, at the same time to show what is happening when a new operator wants to come in the environment. In this case, there are 4 operators. Once the operator is activated, it allocates the spectrum randomly to its users, under the constraints of 5 PRBs/User. This constraint is used to guarantee some fairness when a new operator is joining the network. Once an operator has finished this step, it means that the initialization have been finished for it. Then, the frame index is increasing (+1 unit) to fulfill the condition “Cell_idx= frame_idx”. Therefore, I am dealing with all the operators one after another as planned in the beginning.

The Allocation of the spectrum:

From this point of the algorithm, let me consider that all the operators are already activated (red circled part of the algorithm). In other words, the answer to the condition “*frame_idx < Nb_Operators*” is equal to “No”. Hence, now have to be considered how to allocate the operators PRBs’ to their users. To proceed to this allocation, must be still kept in mind that a good fairness and a minimum Quality of Service is what is wanted. The first thing here is to give the “right” to allocate the free PRBs to the different operators. To have a system that is pretty realistic system and not too unstable, it was decided to work with only one operator in one frame. One operator is allowed to allocate its PRBs among its user in one frame. The same operator will have to wait for the allocation of the other operators before allocating once again. In the algorithm, the way to check if it is actually the right turn for an operator to allocate is provided by the condition:

$$frame_Idx = cell_idx + n*(nb\ of\ operators)$$

where

$n = [0, 1, \dots, end]$ represents the time increment

$frame_Idx$ = index of the frame we are working on, it is a variable.

$cell_idx$ = variable representing the identity of each operators.

nb of operators = total number of operators working in the system (this number is equal to 4 in our simulation).

If an operator does not have the right to allocate at the n^{th} frame, it will just wait, and running with its previous configuration (initialization configuration, if it has not been in the blue part of the algorithm yet, or previous PRBs allocation if it has already been come in the blue part). On the other hand, if looking at the right operator at the right frame, the first thing will be done is to calculate the number of available PRBs based upon the Interference vector which has a threshold that had been set up. Then the

previous allocation with the new PRBs is being “updated”. In other words, it is changing the PRBs that were being used in the previous allocation by the PRBs which are now available following the new interference vector. Then it is re-distributed the rest of the available PRBs equitably to each user in order to give them the same number of PRBs. Finally, the mean SINR/User is calculated which is the most important parameter to make decisions for our algorithm.

Indeed, there are three different cases:

- User has an SINR $> 25\text{dB}$: This implies that it is a well positioned user, and it should be promoted this one to increase the throughput. To do so, it is allocated to this one, two more PRBs if there are at least two free PRBs. At the same time, this two free PRBs allocation means that there may be some other free PRBs to allocate for this operator but, if not, allocation of at least 1 more PRB to the user is done. If finally there is no longer any free PRB, there will be the variable “PRB_available” equal to 0, which means that it can not be allocated any other PRB for this operator, so to pass to the next one have to be done.
- $10\text{dB} < \text{User SINR} < 25\text{dB}$: In this case, is considered that have to be done the best not to throw the user away, but at the same time, is not wanted to improve its too much either. Indeed, the best compromise is to give its at least one more PRB if there are still any free one(s). If not, once again, the variable “PRB_available” will be equal to 0 which means that will be passed to the next operator.
- User SINR $< -10\text{dB}$: This is the worst situation because this user will cause more negative effects than positive ones. Therefore, the chosen solution in this case is to drop the user and “free” former used PRBs to be use by another user.

Finally, a loop at the end of the algorithm is used (the green circled part) with the goal of allocating all the PRBs available at each frame and spreading all the PRBs to all the users belonging to one operator.

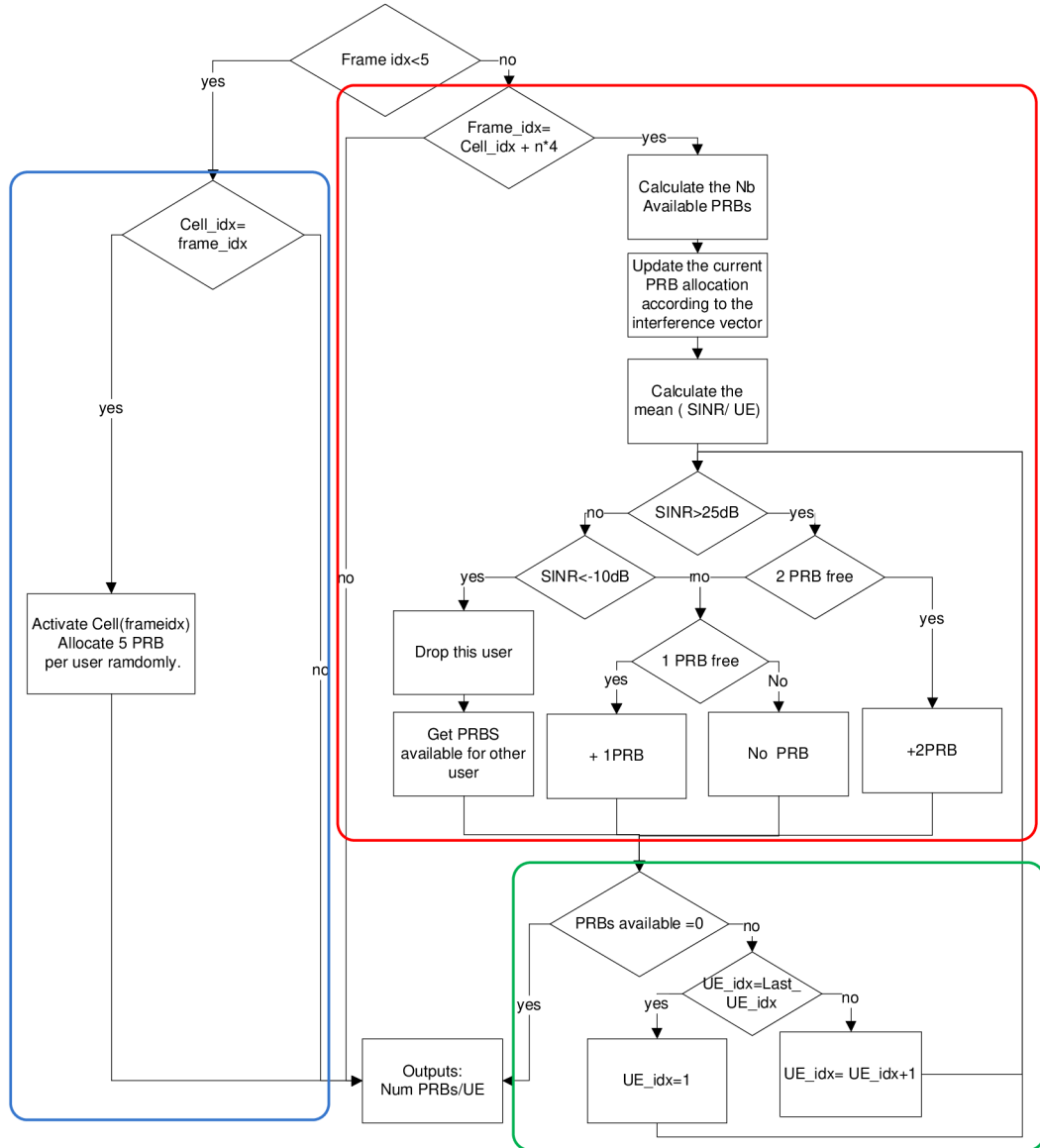

Figure 14: The SBA-A

A way to simplify this algorithm, still based on the same principle (allocating all the PRBs at each frame), but using less resources, is to delete the loop and to proceed to a calculation instead. Indeed, as there are all the elements from the beginning to divide all the available PRBs to the users, an equation that could spread the PRBs/user following our SINR threshold model can be seen on the diagram below. The equation which replaces the loop is defined as following:

$$\text{Weighted PRB Number} = \frac{\text{Number of PRBs Available}}{\text{Number of good UEs} + \left(\frac{\text{Number of average UEs}}{2} \right)} \quad (2.1)$$

The term “Good UES” corresponds to the users of whom the SINR is bigger than 25 dB. “Average UEs” are defined as the user with a SINR range from -10 dB and 25dB. These two kinds of users receive PRBs based on this weighted number. The “good” UEs are allocated with the weighted number of PRBs whereas “average” users get half of this number. By this method all of the PRBs available in one step are allocated based on the same policy as the previous one but there is not the loop anymore.

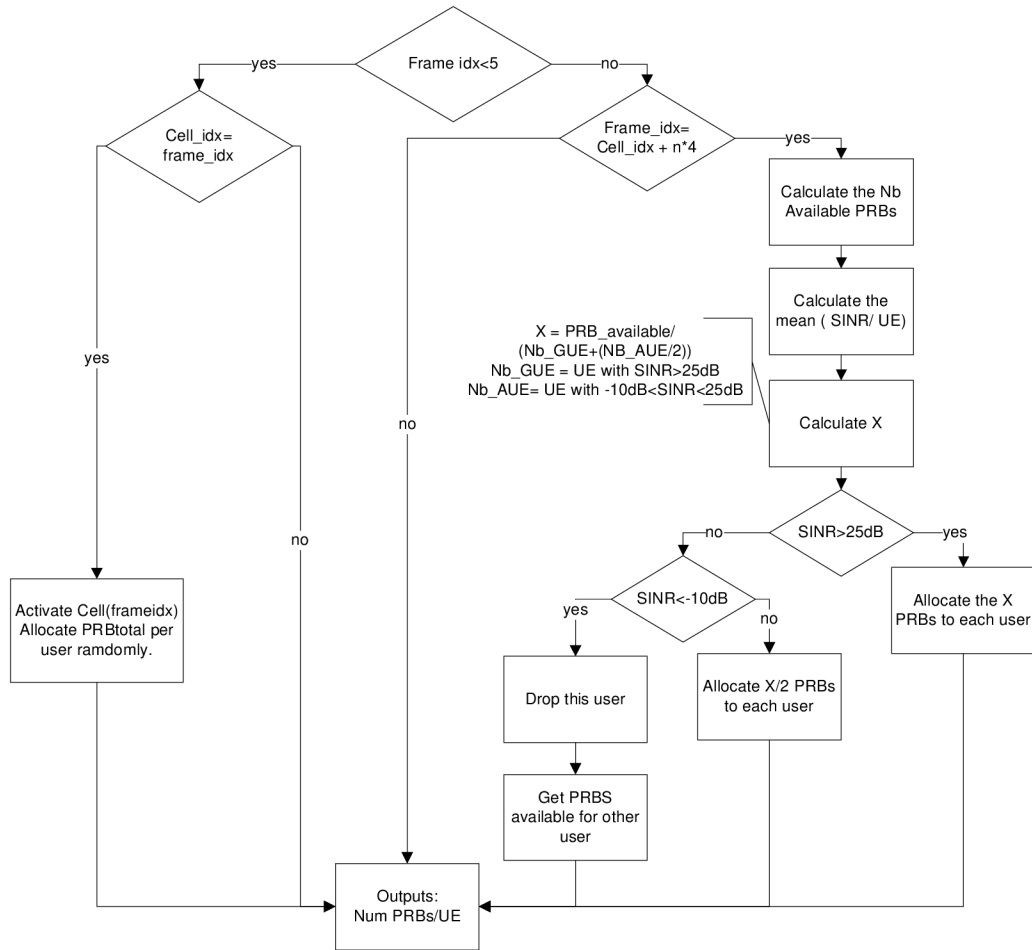

Figure 15: The SBA-F without loop

In conclusion of the algorithm, it presented some good results that will be discussed later but the main argument that arose was the fairness. Obviously the equity between the users belonging to one operator is present, but the fairness between the operators is not. As will be seen next this idea was finally pretty unfair even though it had more rapid efficiency in terms of throughput. This is easily understandable by the fact that here all the PRBs from the first frame are allocated which is not in the allocation part. However, the unfairness comes from the fact that the first operators to allocate will experience minimal Interference and, will have a lot of free PRBs to use in comparison to the last operators which will only sense “the left over” of the other ones. In order to solve this problem, similar algorithm was proposed but instead of allocating all of the PRBs available in one frame, the number of PRBs is increased per user frame after frame. Explanation of the final algorithm follows.

4.1.4 The SINR Based Allocation – Slow Algorithm

As was discussed before, the same principle to activate the cell frame after frame is still used and the allocation of the PRBs based on the user’s SINR too but instead of allocating all of the PRBs available to the users, their PRBs is now increasing by two or by one depending on their SINR. The initialization part, the blue one, is still the same as the previous one. After that, all operators, one after another, allocate their PRBs available to their users, with a maximum of 2 PRBs for each user, when their SINR is greater than 25dB. With this system, the number of PRBs per user increases slowly frame after frame and therefore so does the interference. Contrary to previous versions,

this algorithm is not allocating all the PRBs available in one frame as was realized it was pretty unfair for the last operators. In fact, when you are the first operator to allocate, then, the interference that you experienced with the previous algorithms is minimal since there are not any already allocated PRBs. On the other hand, the interference vector that you would sense being the other operators is then really high as most of the “good PRBs” would have already been allocated by the first operator. Obviously the cell throughput is rising slower than the previous algorithm, but it is fairer and more efficient considering all the operators.

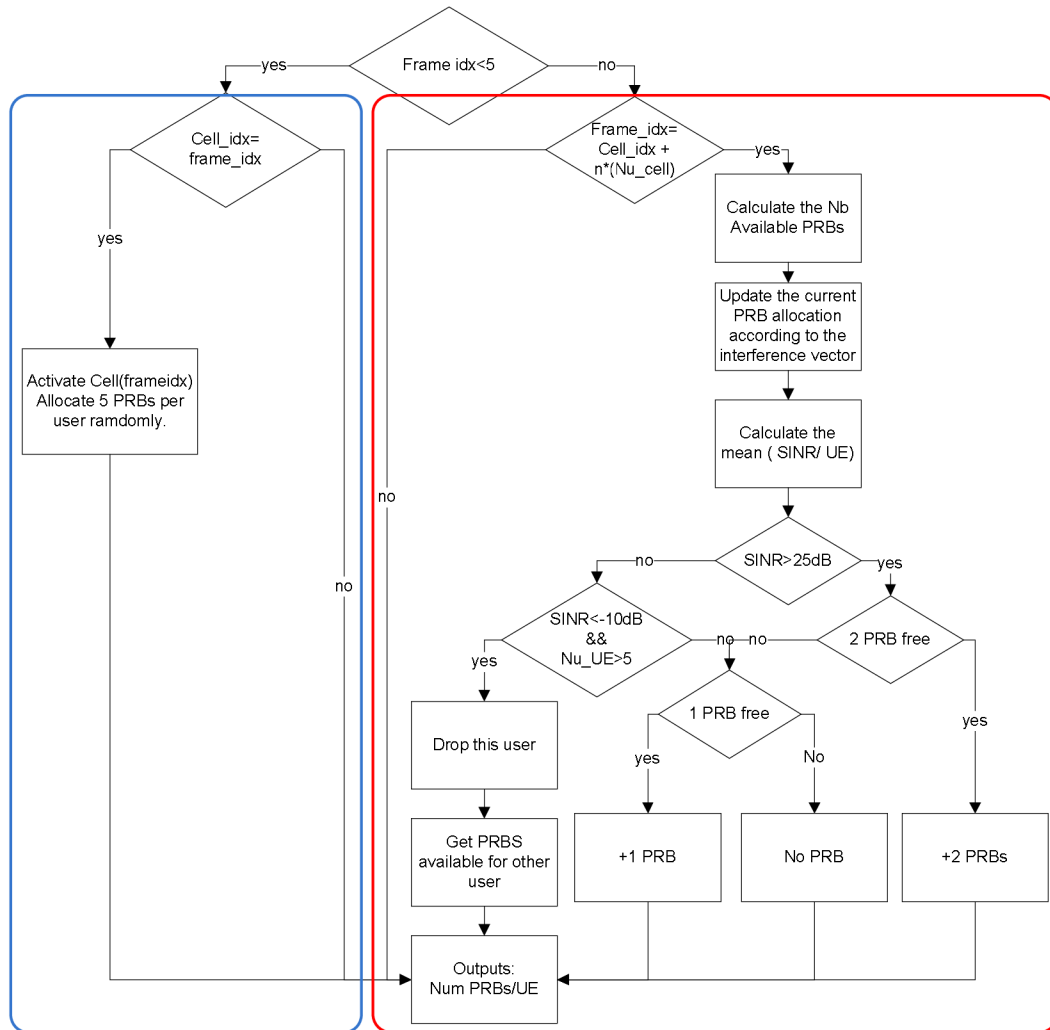

Figure 16: The SBA-S

Describing these algorithms has been given an overview of the project’s evolution. Also, it allowed to analyze theoretically the yields. During this algorithm development, has been also implemented these algorithms in the simulator, and regarding to the simulation results made some modifications and improvements. Now, follow overview of the simulations and the results and comparison between existing algorithms.

5 SIMULATIONS AND RESULTS

In this part, it is going to be shown and discussed the results of the simulations. At the beginning, a particular scenario is specified. It is important to underline that the results can significantly vary depending on the chosen scenario. Some FSU algorithms work better in one specific scenario than other algorithms. On the other hand, with another scenario the result can completely be the opposite. In view of that, it is important to consider the result of the FSU algorithm simulation in conjunction with the scenario.

The algorithms' simulations were implemented using a simulator deployed by Nokia-Siemens. The simulator is useful in knowing how fairly and efficiently the algorithm works. The proposed algorithm is activated by setting FSU-ALGO parameter to 9 for both uplink and downlink. The Interference threshold is set to -80 dB. This value has been chosen during the simulation as the most appropriate one.

5.1 Scenario

Indoor deployment with four operators that operate in different rooms is considered (Figure 17). There are not primary and secondary users. All operators have the same priority, so it means none of them is preferred. For simplification it is assumed that each operator has only one HeNB in the scenario and it has not considered a connection between the HeNB and its operator's network. It has only considered the connection between HeNBs and UEs. The position of HeNBs and UEs in the room is assumed randomly. The number of users is also random. UEs belonging to certain HeNBs can be located only in the same area as HeNBs, so it means UEs of different operators are not active in the same area. Each operator tries to allocate spectrum independently from a common pool and it is assumed that the HeNBs allocate the spectrum simultaneously. It means that the operators cannot change their PRBs allocation at anytime they want but have to keep a defined order. This coordination with other operators is not possible without an implementation of some essential policy.

FSU algorithm utilizes Interference vector information. The vector is obtained periodically by a measurement. The result of FSU algorithm is a spectrum allocation for each user of the HeNB. The outcome of the algorithm is based on Interference vector and SINR information of each user. Certain fairness is guaranteed by allocating maximal number of PRBs for users.



Figure 17: Presupposed Indoor Scenerio

5.2 Basic description of the Simulator

The flowchart for the simulator is shown in Figure 18. The flowchart clearly shows how simulator works. The flowchart is described in detail in the basic simulator manual [24]. The simulator is based on snap-shot that means that the simulation is repeated for defined steps. The duration of a snap-shot is defined by number of frames. The simulator allows a great amount of settings. Such as:

- different scenario (indoor home, indoor office and outdoor Manhattan scenario)
- layout design (number and position of rooms and corridor, number of floors)
- position of HeNBs and UEs (fixed or random in 3D)
- distinguish UL and DL

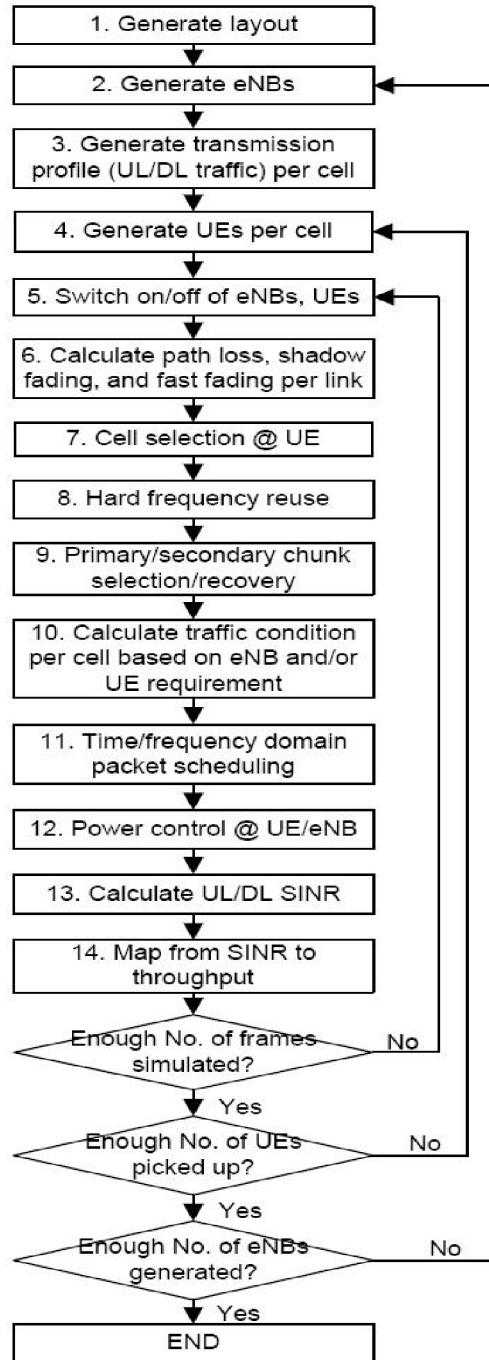

Figure 18: Flowchart of the Matlab simulation [24]

As mentioned before, the simulator allows a great number of parameters settings. For the simulations and proving, the following configuration has been considered. Of course, there are a lot of other parameters that can be changed. If some parameters are not set by the user then the simulator uses default values of parameters.

```

para.nu_layouts = 15; % create the layout 15 times
para.nu_selects = 15; % select UEs 15 times
para.PC_scheme = [0 0]; % no Power Control for DL, no PC for UL
para.synch = 1; % perfect synchronization
para.up_down_ratio = 1; % UL to DL ratio 1:1
para.nu_floors = 1; % single floor scenario
para.frame_scheme = 4; % simplified 2K fft.
para.frequencyreusefactor = [1 1]; % it is not used frequency re-use
  
```

```

para.eNB_pos = [0 0 nan]; % HeNB location
para.nu_rooms_per_cell = [5 2]; % 5 by 2 rooms per cell
para.scenario = 1; % 0: home; 1: office; 2: manhattan
para.min_selected_UEs = 5; % maximum 5 UEs per cell;
para.max_selected_UEs = 10; % maximum 10 UEs per cell;
para.nu_frames = 40; % 40 frames to be simulated for each 'snapshot'
para.room_or_corridor_x = [0 0 0 0 0 0 0 0]; % room or corridor
para.room_or_corridor_y = [0 1 0 0 1 0]; % room or corridor
para.fsu_algo = [9 9]; % SBA Algorithm
para.FSUtargetIntf = [-80 -80]; % Interference threshold

```

This configuration means that there are four operators in room scenario on the same level of a building. Each HeNB operates in 10 rooms with a corridor (Figure 19). The position of the HeNBs is considered in both ways of location in the cell, fixed and randomized. There is a random number of users from 5 to 10 for each operator.

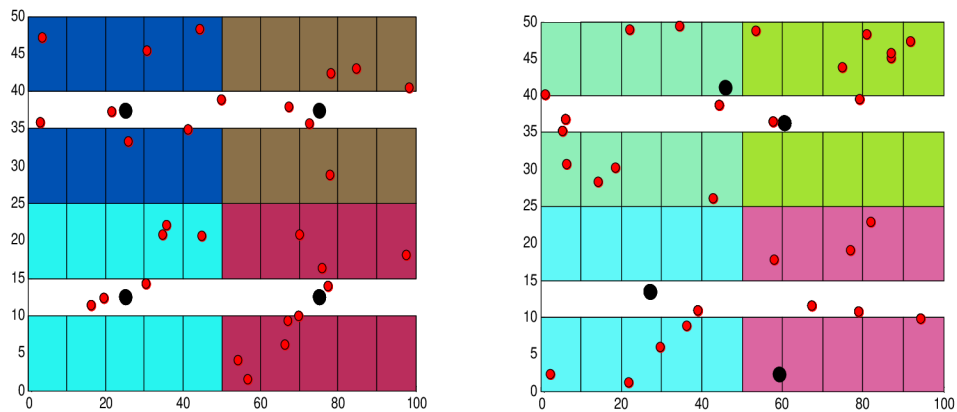

Figure 19: Fixed and Randomized HeNBs Scenario Topography

It was chosen different layouts for the scenario, taking in consideration different positions of the UEs, because the algorithms are based on the SINR of the UEs in downlink. The SINR depends on the interference in the receivers, which in this case are the UEs. As explained before, the interference measurements were used on Uplink and the SINR on Downlink. This is because we cannot measure the SINR on PRBs which are not used yet by the UEs. The interference can be measured for all the PRBs whether they are used or not.

5.3 Simulations Results

In this section, the main concern is to show and compare the fairness of spectrum sharing and the spectrum efficiency of proposed algorithms versus former realized algorithms [25] [26] [27]. FSU algorithm is considered beneficial if improving and maximizing the above mentioned parameters more than fixed usage spectrum approach. More details about the algorithms have been written in chapter 4.

A comparison of the algorithms to other different implemented one. There is a small explanation of each one:

- Fixed Frequency Reused 4 (FSA): Fixed Frequency Allocation is an algorithm in which the total bandwidth is divided equally among the HeNBs, i.e, if we have four operators the frequency reuse would be $\frac{1}{4}$.

- Fixed Frequency Reused 1: The total number of PRBs is used among all operators. If we have 125 PRBs, these same PRBs are used among the four operators we have. The frequency reuse factor is 1.
- Fixed Frequency Reused 2: In this case, the fixed number of PRBS is divided in two. I.e., if we have four operators, two operators use the same 62 PRBS and the other two operators use the rest 63 PRBS. The frequency reuse factor is $\frac{1}{2}$.
- Flexible Spectrum Usage (water-filling): This type of algorithm is Spectrum load balancing (SLB) with water-filling. It divides the PRBs among the cells depending on the SINR. Then it will check the free PRBs left in each cell and it will give them to the cell with less PRBs.

Note: The Graphics are in DOWNLINK. It is clearer to show only the downlink graphics since both uplink and downlink have very analogous results.

5.3.1 SBA-F vs. SBA – S Algorithm

Average cell load

This parameter shows (Figure 20 fixed) how many PRBs are on average used in the cell and it can vary considerably from one operator to another. In the first four frames, SBA-S and SBA-F algorithms have the same cell load because they have exactly the same initialization step. After these four frames, can be seen how the SBA-F algorithm uses more of the spectrum where the number of PRBs per UE begins increasing more quickly than the SBA-S algorithm. The SBA-F algorithm stabilizes its cell load around frame number 15 with around 49% of usage. The SBA-S algorithm increases its cell load smoothly to stabilize in frame number 20 where in the end can be seen how it also reaches the usage of 49%. In the case of random location of HeNBs (Figure 21), there are similar results to the previous case just that in this case it is closer to real situation.

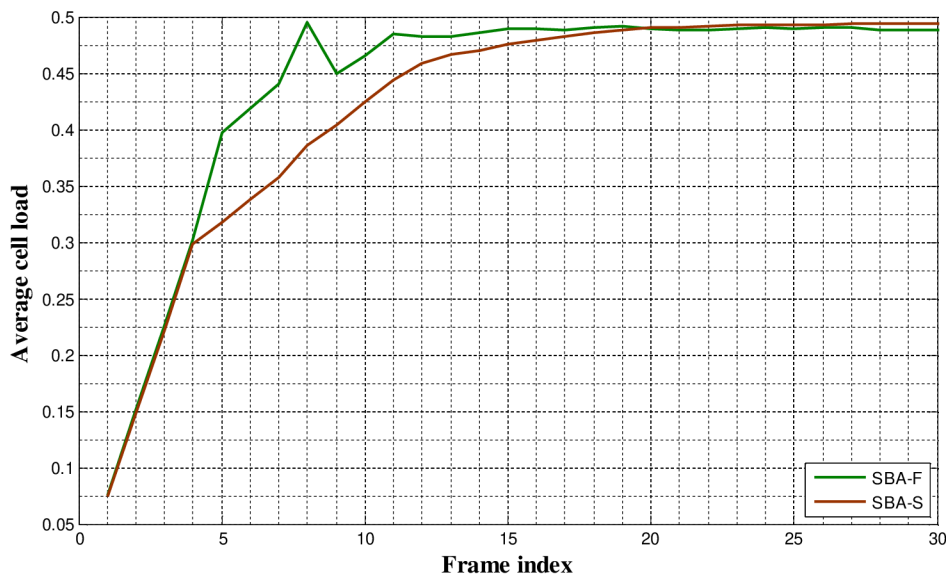
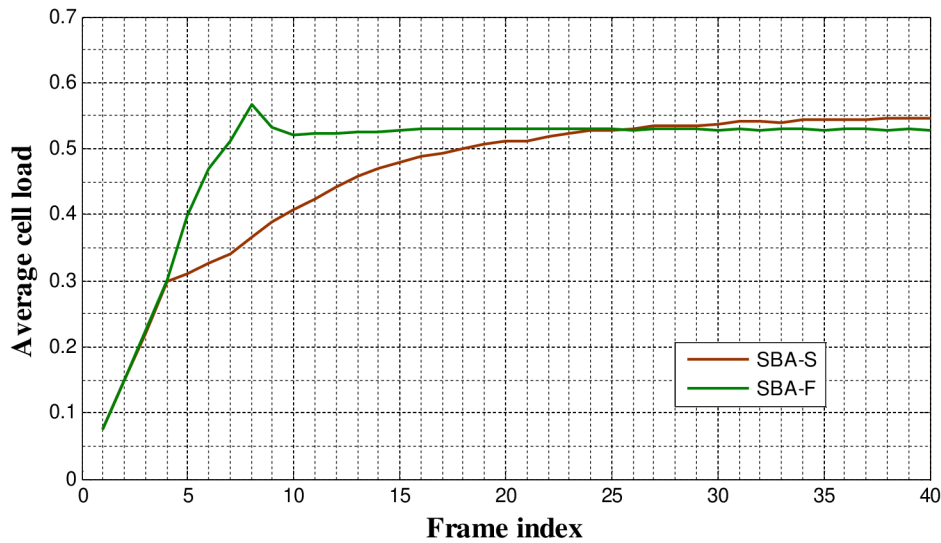

Figure 20: Average Cell Load of SBA-F and SBA-S with fixed HeNBs**Figure 21: Average Cell Load of SBA-F and SBA-S with randomized HeNBs**

In both graphics (Figure 20 and Figure 21) for algorithm SBA-F there is a peak where the slope begins to decrease. This average cell load decreases from frame 8 to 9, which refers to the operator which was initialized in the first frame. This is because this operator has less PRBs in this frame than its previous allocation since as mentioned before the operators allocate simultaneously in different frames. Therefore, that operator has more Interference from the others operators which are using more PRBs than before.

UE 5% outage throughput & mean cell throughput:

Throughput is considered as one of the most important parameters. More information about throughput is written in chapter 2. The graphics (figures 23 and 24) are divided for fixed and random position of HeNBs in the cell. For both types of deployment, is seen that in the first five frames (initialization step), proposed algorithms give to each UE per cell, five PRBs. That is why in both graphics for UE 5% outage and mean cell throughput they are both decreasing. The explanation is because in the beginning when five PRBs are allocated per UE, are allocated randomly without taking in consideration the interference. Therefore, there is more interference in the initialization step, which results in a lower throughput. After the initialization part, the algorithms start improving their condition by allocating more PRBs to the UE with better SINR.

In the random location of HeNBs, both of the algorithms sometimes drop users because they have very bad SINR. As a result, it was taken in consideration in the graphics the dropped UEs because the simulator only uses the active users to make the graphics. With the help of the simulator was obtained the mean of the number of UEs dropped in the scenario (this includes all operators). This result is around 1.3 UEs dropped, which means that it drops between one or two UEs depending on the layout of the scenario. This can be seen in Figure 24.

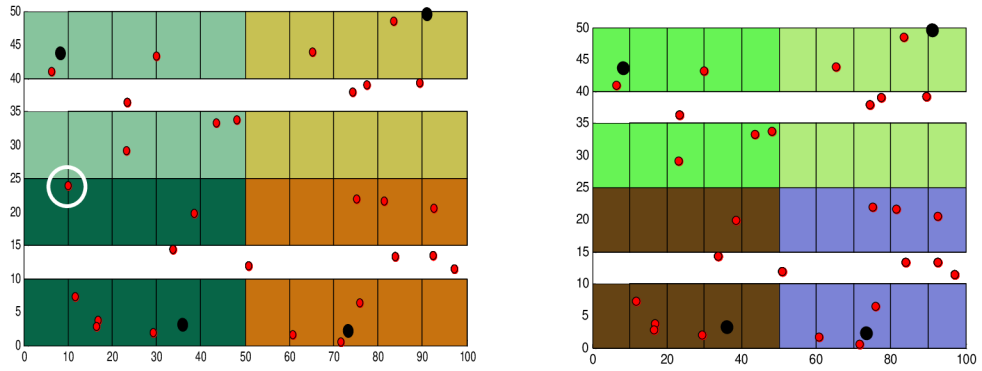

Figure 22: Dropped UEs

There is a difference in the results between fixed and random locations of HeNBs. As the Interference depends on the location of the HeNBs, random location has worst throughput with the Interference being variable and different for each different location. For fixed location the Interference of each base station is known and is similar in each case.

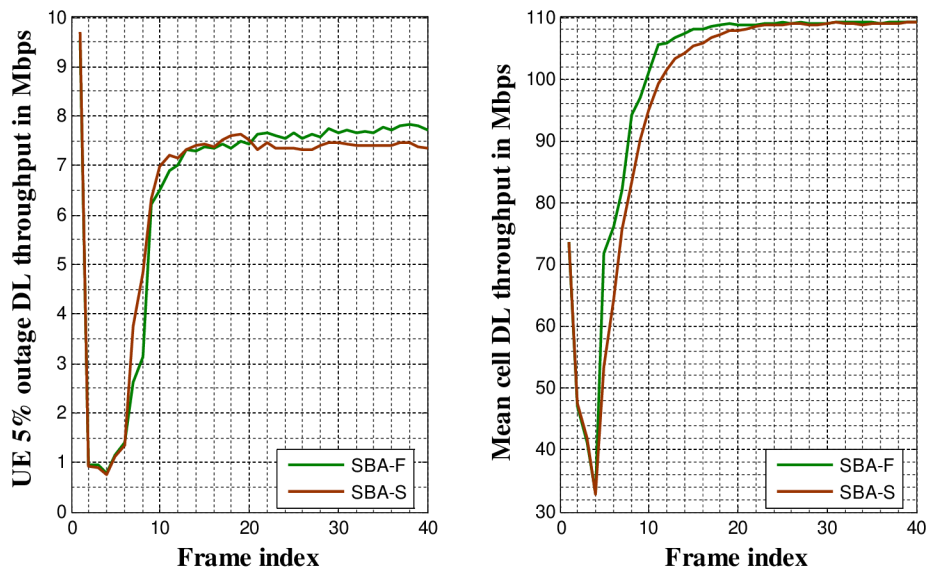

Figure 23: UE 5% throughput & mean cell throughput of SBA-F vs. SBA-S with fixed HeNBs

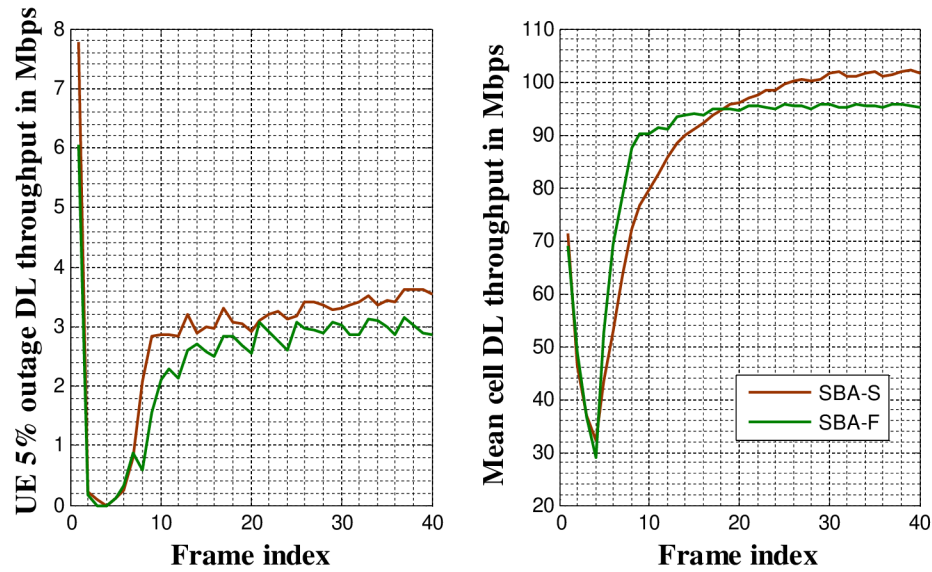

Figure 24: UE 5% throughput & mean cell throughput of SBA-F and SBA-S with randomized HeNBs

CDF throughput:

CDF is explained in section 3.2 and the graphs are similar for both algorithms. The difference between the two different locations of HeNBs is the higher possibility to achieve more throughput in fixed deployment. As a conclusion of these results, the SBA-S is preferred over SBA-F because SBA-S behaves better and achieves higher throughput in random deployment of HeNBs. Therefore, the second step is to compare SBA-S with the other algorithms mentioned in the introduction of this section.

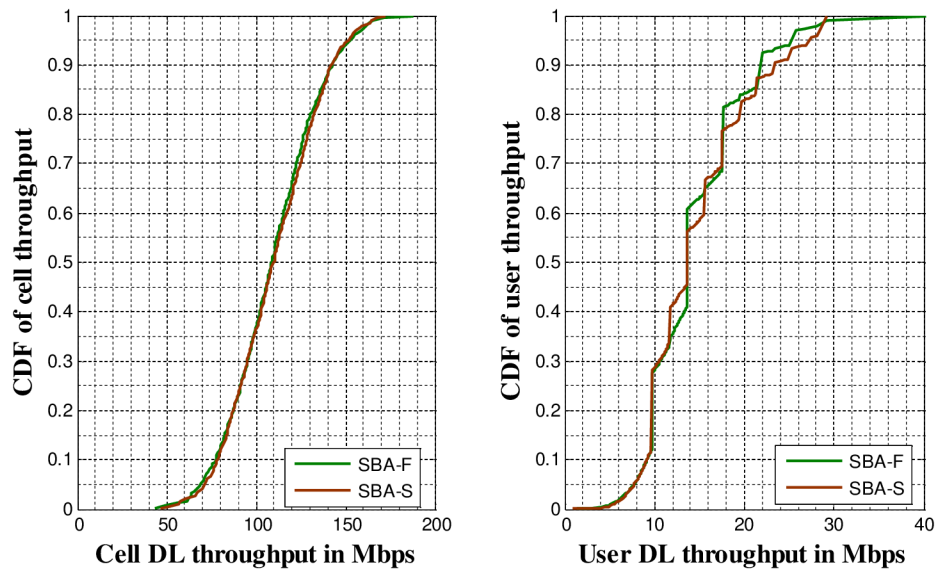

Figure 25: CDF throughput of SBA-F and SBA-S with fixed HeNBs

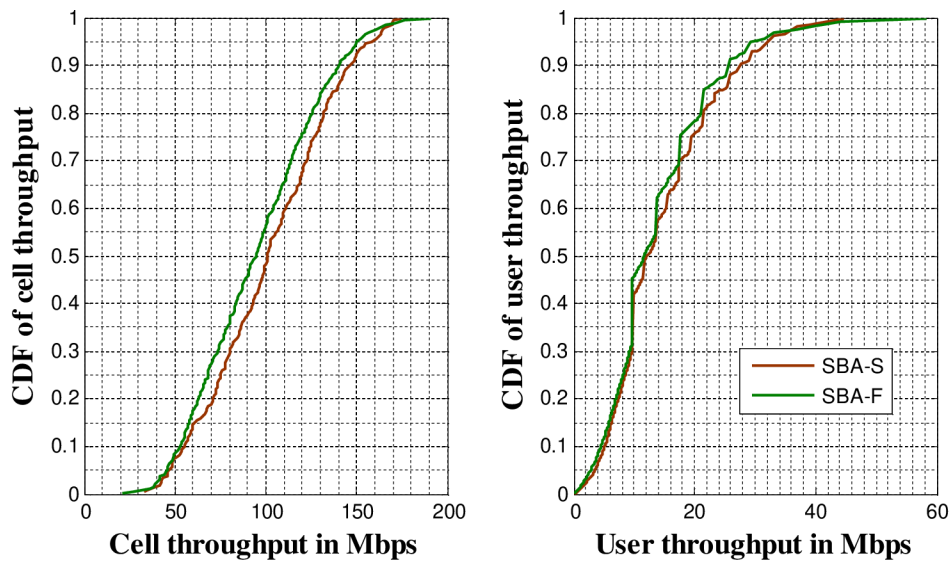

Figure 26: CDF throughput of SBA-F and SBA-S with randomized HeNBs

5.3.2 SBA – S, different FSAs and FSU1 Algorithm

Average cell load:

The graphic 27 shows that FSA 4 uses 25% of the total PRBs. This is due to the number of operators, which are four. In fact, with FSA 4, as the number of PRBs for each operator is fixed and the total amount is divided equally among the operators in this case the total number of PRBs is divided by four. For FSA 1 and FSA 2, they use 100% and 50 % respectively from the total number of PRBs. However, the SBA-S needs more time to stabilize than FSAs algorithms and FSU Water filling. Furthermore, it can be seen in graphic 32 that our SBA-S algorithm has better throughput.

Comparing graphics 27 and 28 for fixed and random location of HeNBs, the FSU uses less PRBs when it is randomly deployed, with 31% of usage in fixed location which decreases to 28% of usage in random location. On the other hand, our algorithm changes its average usage when it is randomly deployed with a usage of around 4% more than compared to the usage of the fixed case.

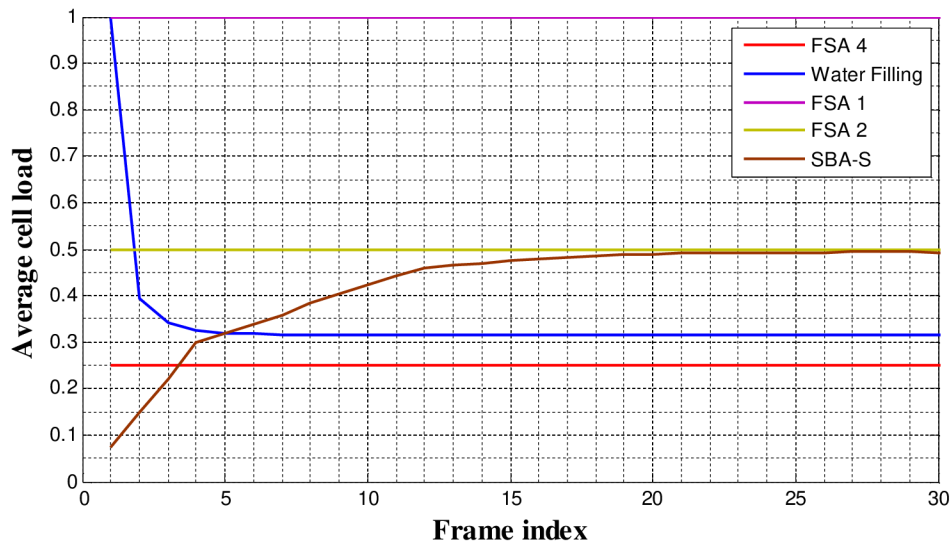

Figure 27: Average cell load with fixed HeNBs

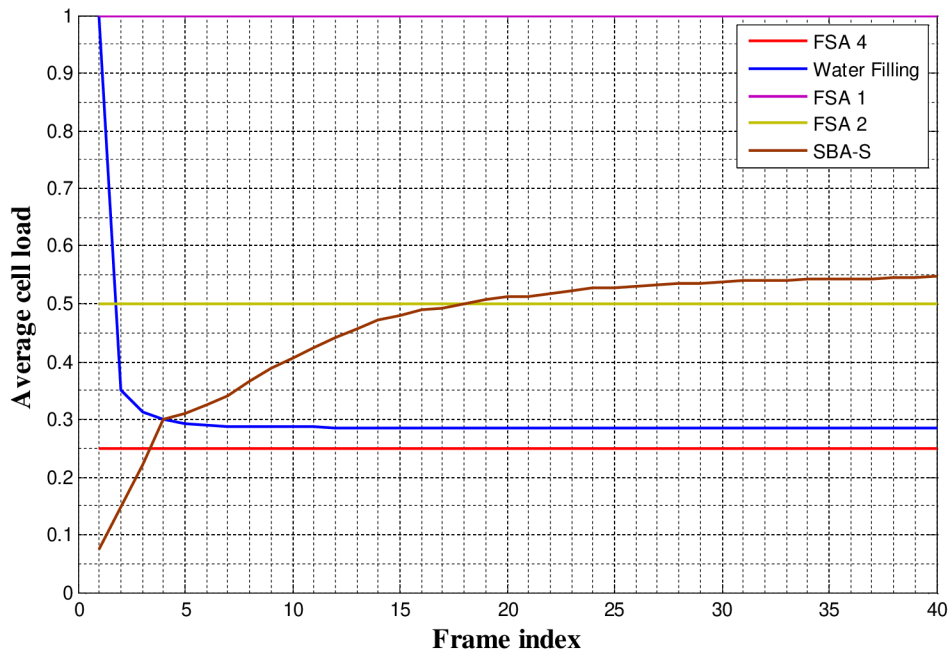

Figure 28: Average cell load with randomized HeNBs

UE 5% throughput & mean cell throughput:

Looking at graphic 29, the results of FSA 2 are somehow better than SBA-S. This is due to that the FSA 2 algorithm depends on the scenario topography and in respect with our scenario, it works better. Our algorithm is designed to be able to adapt to any scenario. Therefore, when there is a random deployment of HeNBs it can be seen that SBA-S achieves better results.

In graphic 30 for random deployment of HeNBs, it is clearly seen that the algorithm has higher throughput than the other one. The FSAs algorithms have a stabilized throughput that does not change in time frames. This solution is referred to the fixed number of

PRBs which does not vary like in the other algorithms. Previously, was mentioned that when there is random deployment of HeNBs, both algorithms sometimes drop users due to their very bad SINR. It is necessary to consider this situation which is not represented in the graphs. It is obvious that SBA-S algorithm shows very good throughput in comparison to others. It is obvious that the users of FSA 4 with 95% of coverage have higher throughput than SBA-S but, on the other hand, the cell throughput is higher in the case of SBA-S.

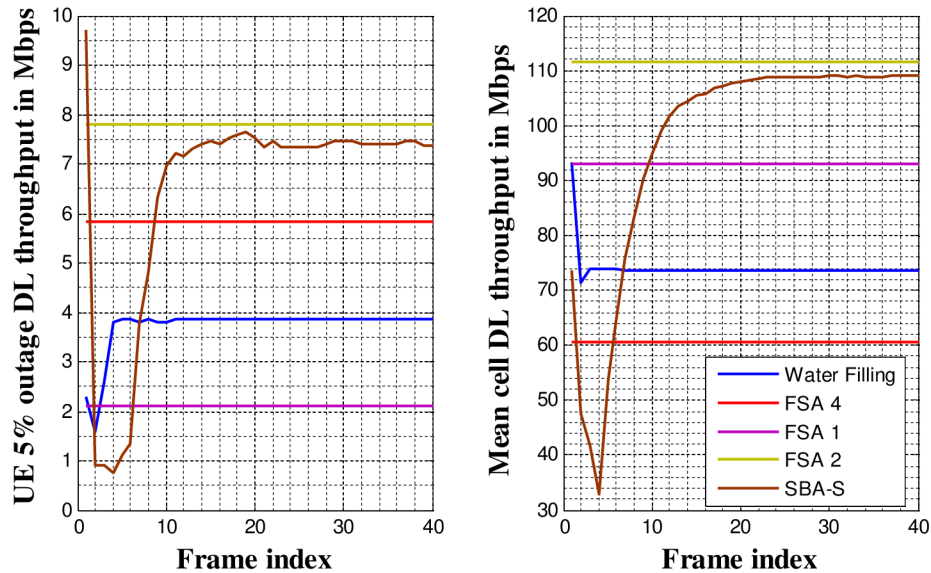

Figure 29: UE 5% throughput & mean cell throughput with fixed HeNBs

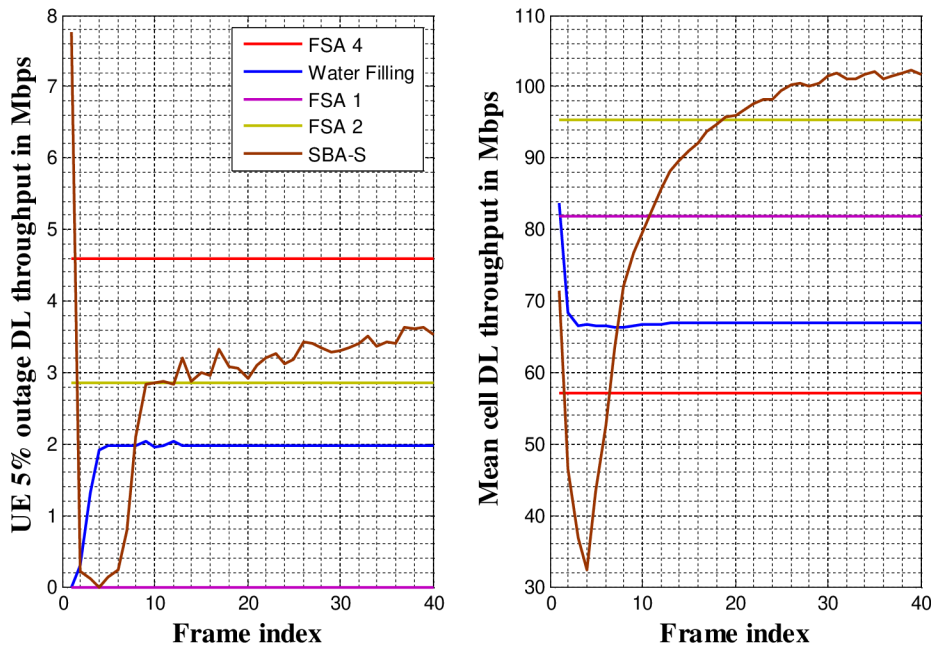

Figure 30: UE 5% throughput & mean cell throughput with randomized HeNBs

CDF Throughput

In graphics 31 and 32, SBA-S algorithm and the FSA 2 have a higher probability of throughput than FSA 1, FSA 4 and FSU 1. For random HeNBs deployment, it is important to see that the FSA 2 has more probability of achieving higher throughput when the percentage of the probability is less than 30% for cell throughput. However, when the probability is higher than the mentioned value, algorithm SBA-S has higher probability in gaining more throughput.

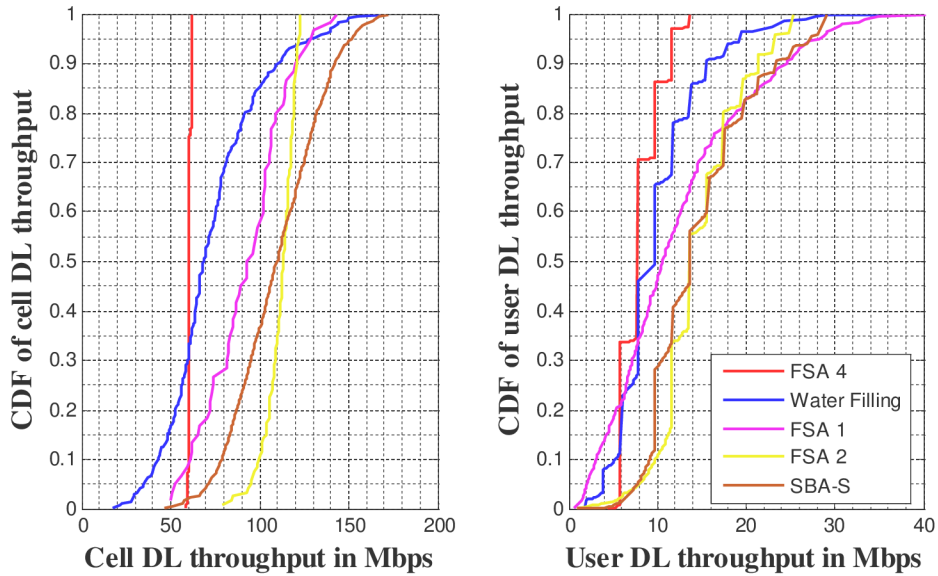

Figure 31: CDF throughput with fixed HeNBs

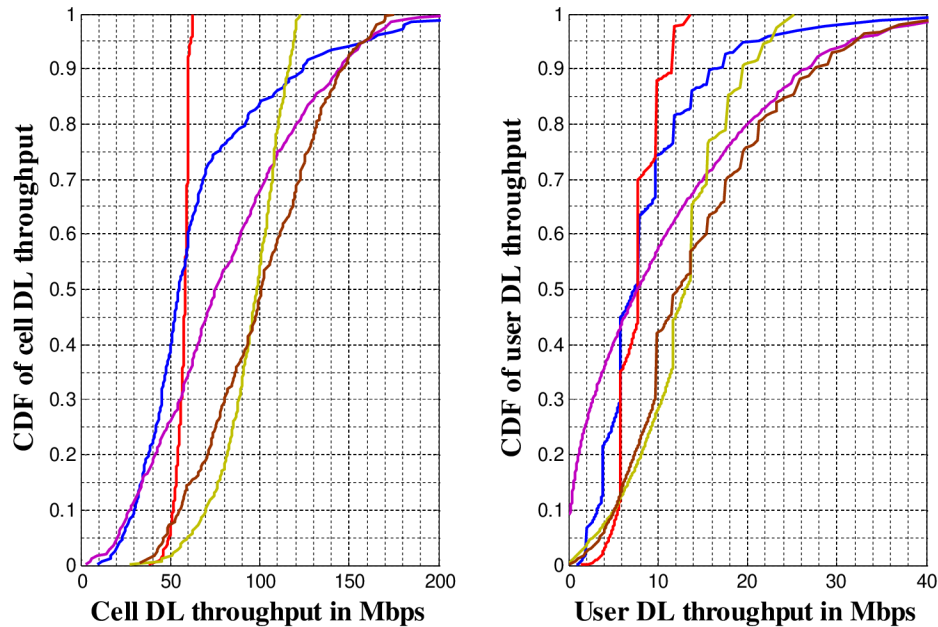

Figure 32: CDF throughput with randomized HeNBs

CDF SINR:

While SINR graphics were considered useless in the comparison between the different types of SBA as they had exactly the same results, they will now be taken into consideration in the following graphics.

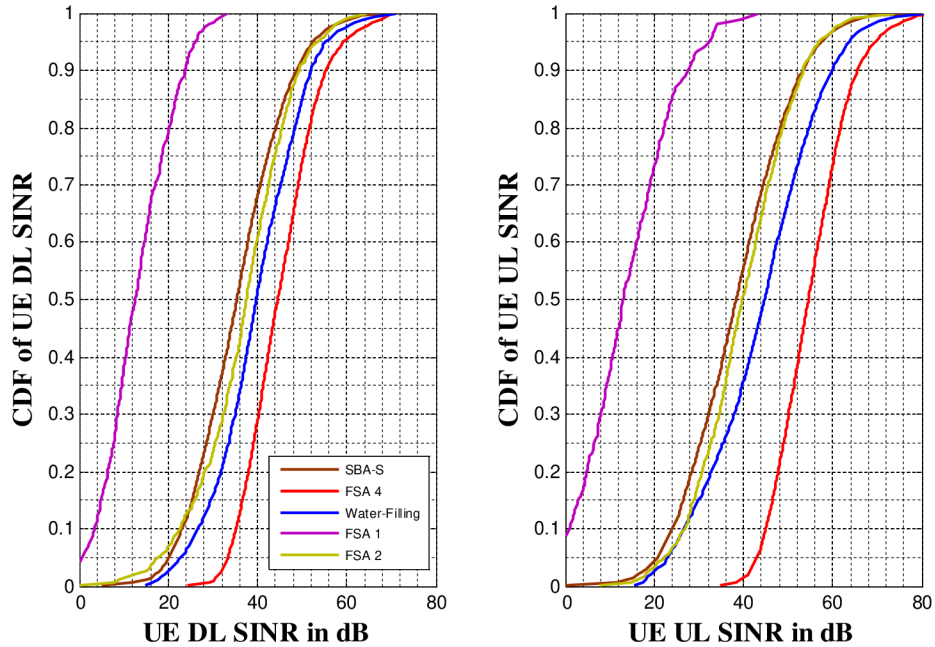

Figure 33: CDF SINR with fixed HeNBs

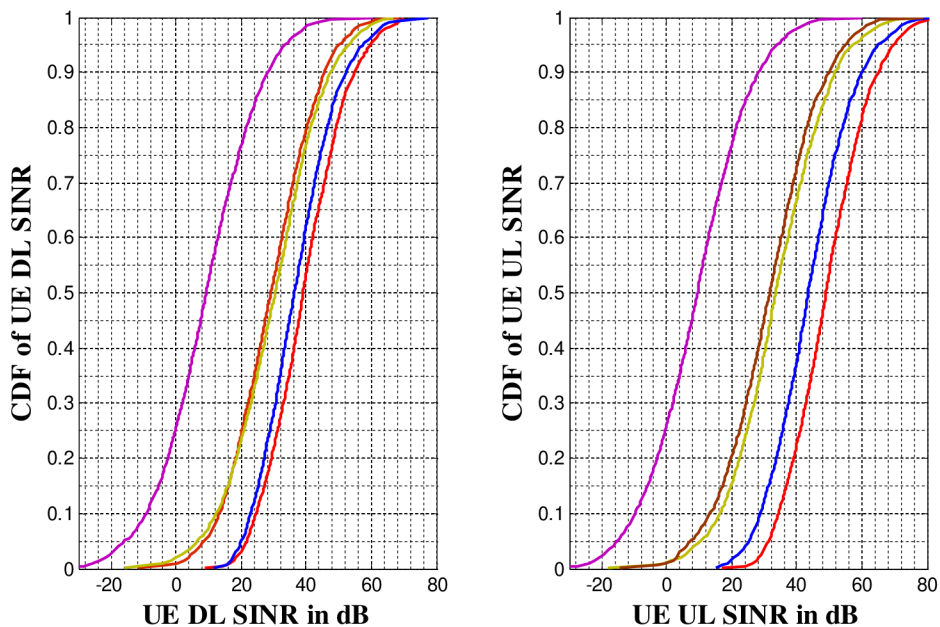

Figure 34: CDF SINR with randomized HeNBs

FSA 1 has the worst SINR because it uses all the spectrum among all its operators therefore it has higher interference than the rest.

Comparing SBA with FSA 4 and FSU 1, it is seen that has worse SINR. SBA-S uses more PRBS, therefore when more PRBs are used, more interference is and depending on the SINR relation mentioned in section 2.3 (S/I), there is an inverse relation i.e., higher Interference will result in lower SINR.

In random deployment of HeNBs, FSA 2 and SBA-S have similar SINR. Having the same SINR, algorithm SBA-S achieves better throughput. In conclusion, SBA is more efficient.

6 CONCLUSIN

6.1 Conclusion and possible future improvements

Flexible spectrum usage is a very powerful tool for solving the problem of efficient spectrum sharing and up until now, research shows that it is going to be one of the component technologies of next generation mobile communication systems.

The project aims to provide a mechanism to allow coexistence of several operators in a given geographical area by minimizing mutual Interference and ensuring fair and efficient spectrum allocation. The simulations were performed for both distributed and random network deployment in a local area. Result of this project should make a valuable contribution towards developing a real suitable algorithm for fair and efficient spectrum allocation.

In comparison with fixed spectrum usage and some FSU algorithms presented in chapter 4, the SBA algorithms show some improvement, especially in cell throughput. It is important to emphasize that care has been taken to improve the cell throughput during the whole time while developing the SBA algorithm. However, in some specific cases, fixed spectrum reuse shows slightly better properties. But these properties are not considered important for the proposed scenario and in addition, it is not too likely that the fixed spectrum is going to be used for the realization of the IMT-A system.

SBA algorithm uncovers a debatable idea of dropping users with very bad quality of connection. It could seem to be an unfair approach, but on the other hand, it is more realistic and gives it some advantage, for instance cell throughput improvement. The essential principle of SBA algorithms is using SINR information for allocation of the most suitable PRBs for given UEs. From simulation results it is confirmed the SINR selection approach provides a viable solution.

For future research there are a lot of questions about practicalities of implementation. Therefore, next step of research of FSU algorithm should be done co-operatively with hardware researchers, to take in the consideration real ability of a cognitive radio while implementing the algorithm. Naturally, the question of the balance between fairness and efficient spectrum usage must be discussed in agreement with the real requirements of wireless service providers.

REFERENCES

- [1] H.W. Lee, "3G LTE & IMT-Advanced Service", February 2006.
- [2] International Telecommunication Union - Radiocommunication Sector , "ITU global standard for international mobile telecommunications IMT-Advanced" Available: <http://www.itu.int/ITU-R/index.asp?category=information&rlink=imt-advanced&lang=en>
- [3] International Telecommunication Union - Radiocommunication Sector , "Contribution to technical requirements for IMT – Advanced systems" Available: http://www.ieee802.org/21/doctree/IMT-Advanced/18-07-00xx-00-0000_IMT_Advanced_d7.doc
- [4] M. Kulkarni, "4G Wireless and International Mobile Telecommunication (IMT) Advanced" Available: <http://www.cs.wustl.edu/~jain/cse574-08/ftp/imta/index.html>
- [5] R. Götz, "IMT in Broadcast Bands - Hot Topic on WRC-07", Winter 2008 Available: http://www.lstelcom.com/e/files/spectrum/spectrum_2008_winter.pdf
- [6] N. Marchetti et al., "Introducing Smartness in Future Wireless Systems Spectrum Utilization: A Cognitive Radio Perspective", *WPMC*, December 2007.
- [7] L. Berlemann, G. Dimitrakopoulos, K. Moessner, J. Hoffmeyer, "Cognitive Radio and Management of Spectrum and Radio Resources in Reconfigurable Networks", 2005.
- [8] A. Shukla, "Cognitive Radio Technology A study for Ofcom – Summary Report", QINETIQ, February 2007. Available: http://www.macltd.com/datafile_downloads/MAC%20Ltd%20-%20Cognitive%20Radio%20-%20Summary.pdf
- [9] J. Neel, "Networking Cognitive Radios", MPRG Symposium Session D-2, June 2007.
- [10] I. F. Akyildiz, S. Mohanty, J. Xie, "A Ubiquitous Communication Architecture for Next-Generation Heterogeneous Wireless Systems", *IEEE Commun. Mag.*, Vol. 43, No. 6, June 2005.
- [11] Federal Communications Commission, "Report and Order (FCC 05-57): Facilitating Opportunities for Flexible, Efficient, and Reliable Spectrum Use Employing Cognitive Radio Technologies," ET Docket No. 03-108, 11 March 2005.
- [12] S. Haykin, "Cognitive Radio: Brain-Empowered Wireless Communications," *IEEE Journal on Selected Areas in Communications*, vol. 23, no. 2, February 2005.
- [13] N. Marchetti, "Definition of Throughput and Outage", October 2008
- [14] P. Kyösti, J. Meinilä, "WINNER II Channel Models", IST-4- 027756 WINNER II, September 2007.
- [15] National Instruments, "OFDM and Multi-Channel Communication Systems", January 2007. Available: <http://zone.ni.com/devzone/cda/tut/p/id/3740>

-
- [16] J. G. Proakis, "Digital Communications", January 2008.
- [17] Z. Ghadialy, "OFDM and OFDMA: The Difference", June 2007. Available: <http://3g4g.blogspot.com/2007/06/ofdm-and-ofdma-difference.html>
- [18] Airspan Networks Inc., "TDD and FDD Wireless Access Systems", White Paper, 2007. Available: http://www.airspan.com/pdfs/whitepaper_AIR0095_WP_2.pdf
- [19] J. Zyren, "Overview of the 3GPP Long Term Evolution Physical Layer", White Paper, 2007.
- [20] J. M. Peha, "Approaches to Spectrum Sharing. Regulatory and Policies Issues", IEEE Communications Magazine, February 2005.
- [21] National Telecommunications and Information Administration, Office of Spectrum Management, "United States Frequency Allocations the Radio Spektrum", October 2003.
Available: http://personalpages.manchester.ac.uk/staff/m.dodge/cybergeography/atlas/us_spectrum_map.pdf
- [22] S. Kumar, G. Costa, S. Kant, F. B. Frederiksen, N. Marchetti, P. Mogensen, "Spectrum Sharing for Next Generation Wireless Communication Networks", Radio Access Technology Section, Aalborg University, Denmark, 2008.
- [23] K. Kalliola, "Spectrum Sharing and Flexible Spectrum Use", Nokia Research Center, August 2004.
- [24] Y. Wang, "A Matlab based system-level simulator for LTE-Advanced TDD systems", October 2008
- [25] G. Costa, S. Kant, F. B. Frederiksen, N. Marchetti, P. Mogensen, "Spectrum Sharing for Next Generation Wireless Communication Networks", 2008.
- [26] S. Kumar, S. Kumar, G. Costa, S. Kant, F. B. Frederiksen, N. Marchetti, P. Mogensen, "Flexible Spectrum Usage in Local Area Deployment Scenario", 2008.
- [27] N. Marchetti, M. I. Rahman, F. B. Frederiksen, "Introducing Smartness in Future Wireless Systems Spectrum Utilization: A Cognitive Radio Perspective", 2008.

LIST OF ANNEXES

CD content

ANNEXES

CD content

CD includes two M files. M-files contain proposed FSU algorithms:

- SINR Based Allocation – Fast (SBA-F)
- SINR Based Allocation – Slow (SBA-S)

To run these M-files properly is inevitable to use a Matlab based system-level simulator for LTE-Advanced TDD systems. This simulator is built based on a light Matlab tool provided by Esa Tiirola (Oulu, Nokia Siemens Networks). The simulator is protected by copyright, hence can not be published on the CD.