



# **BRNO UNIVERSITY OF TECHNOLOGY**

VYSOKÉ UČENÍ TECHNICKÉ V BRNĚ

## **FACULTY OF MECHANICAL ENGINEERING**

FAKULTA STROJNÍHO INŽENÝRSTVÍ

## **INSTITUTE OF AUTOMATION AND COMPUTER SCIENCE**

ÚSTAV AUTOMATIZACE A INFORMATIKY

# **SNAKE-LIKE ROBOT REVIEW AND SIMULATION**

SIMULACE HADOVITÉHO ROBOTA: RESERSE A SIMULACE

## **BACHELOR'S THESIS**

BAKALÁŘSKÁ PRÁCE

### **AUTHOR**

AUTOR PRÁCE

**Anna Stolnikova**

### **SUPERVISOR**

VEDOUČÍ PRÁCE

**doc. Ing. Radomil Matoušek, Ph.D.**

**BRNO 2018**



# Zadání bakalářské práce

Ústav: Ústav automatizace a informatiky  
Studentka: **Anna Stolnikova**  
Studijní program: Strojírenství  
Studijní obor: Aplikovaná informatika a řízení  
Vedoucí práce: **doc. Ing. Radomil Matoušek, Ph.D.**  
Akademický rok: 2017/18

Ředitel ústavu Vám v souladu se zákonem č. 111/1998 o vysokých školách a se Studijním a zkušebním řádem VUT v Brně určuje následující téma bakalářské práce:

## Snake-like Robots Review and Simulation

### Stručná charakteristika problematiky úkolu:

Snake-like robots have been developed with components available online and open-source software to perform search and analyses tasks utilizing the advantages of a slender, legless body paired with rhythmic movements.

This bachelor's thesis aims to demonstrate the performance of the designed motion algorithm by means of computer simulation and common review of snake-like robots.

### Cíle bakalářské práce:

Review of snake-like robot mechanism.

Review of motion control principles (serpenoid, CPG, CGA).

Modeling and Simulation of a Six Link Snake-Like Robot in V-Rep/Gazebo.

Digital presentation of the thesis.

### Seznam doporučené literatury:

HIROSE, Shigeo a Hiroya YAMADA. Snake-like robots [Tutorial]. IEEE Robotics & Automation Magazine [online]. 2009, 16(1), 88-98 [cit. 2018-05-03]. DOI: 10.1109/MRA.2009.932130. ISSN 1070-9932. Dostupné z: <http://ieeexplore.ieee.org/document/4799450/>

Termín odevzdání bakalářské práce je stanoven časovým plánem akademického roku 2017/18.

V Brně, dne 1. 11. 2017

L. S.

---

doc. Ing. Radomil Matoušek, Ph.D.  
ředitel ústavu

---

doc. Ing. Jaroslav Katolický, Ph.D.  
děkan fakulty

## **ABSTRACT**

This project has reviewed the snake locomotion and is to design a simulation of a snake-like robot motion as the real biological snake. One of the targets has been to create a simulation of a 6-chained robot, so the device will move flexible. The construction has multiple joints which enable it to have multiple degrees of freedom, giving it the ability to flex. So, the application is very useful in closed space and environment. Based on reviewed kinematic model of a snake motion, the code has been created to present the motion in simulation environment.

## **KEYWORDS**

Snake-like robot, snake locomotion, simulation, V-REP



## **REFERENCE**

STOLNIKOVA, Anna. *Snake-like Robot Review and Simulation*, Brno, 2018. Bachelor's thesis. Brno University of Technology, Faculty of Mechanical Engineering, Institute of Automation and Computer Science. *Supervisor*: doc. Ing. Radomil Matousek, Ph.D.





## **ACKNOWLEDGEMENT**

I would sincerely like to thank my family for supporting me during Bachelor studies. My appreciation also goes out to my supervisor who led me through process of writing thesis.

## **STATUTORY DECLARATION**

I hereby declare that I am the sole author of this thesis under the supervision of Associate Professor Radomil Matoušek, Ph.D. and that I have not use any sources other than those listed in the bibliography and identified as references. I further declare that I have not submitted this thesis at any other institution in order to obtain a degree.

V Brně dne 2. 6. 2018

.....

Anna Stolnikova

# CONTENT

<b>1</b>	<b>INTRODUCTION .....</b>	<b>3</b>
<b>2</b>	<b>MECHANICAL DESIGN AND BIOLOGICAL INSPIRATION .....</b>	<b>7</b>
<b>3</b>	<b>KINEMATIC MODEL AND BASIC EQUATIONS .....</b>	<b>15</b>
<b>4</b>	<b>SIMULATION EXPERIMENTS.....</b>	<b>21</b>
<b>5</b>	<b>CONCLUSION .....</b>	<b>27</b>
<b>6</b>	<b>REFERENCES.....</b>	<b>29</b>
<b>7</b>	<b>LIST OF FIGURES .....</b>	<b>31</b>



# 1 INTRODUCTION

Robotics is rapidly developing for the past several decades and variety of robots has been created. Many scientists find inspiration in animals and nature, that is why *bionics* has become a trend lately. Bionics uses models of living systems to find new ideas for useful artificial machines and systems. Developing of mobile robots able to work in challenging environment made us take a fresh look at mechanisms.

At some point bionics usually accompanies robots' developers. Many devices, including those used for narrow specialized tasks, have something in common with humans. Besides that human structure cannot always give an optimal solution. Many animals are much better adapted to environment. They can swim, run, jump, fly, crawl. Nowadays, animals and their structure are the field inspiring many robotics engineers.

Principles of organization, functions and characteristics of biological systems are used in order to find original and optimal engineering solutions. With evolution, living organisms, including fauna and flora, has become highly optimized and efficient. The main advantage is taking ready-to-use schemes and ideas from nature.

One of the achievements of bionics is artificial limb or prosthesis which help people harmed in accidents keep self-maintained activity. Many people saw animalistic robots whose movement is designed on same mechanics as motion of dogs and cheetahs. These robots can overcome obstacles, ran at a good speed and jump over barriers. There are robots inspired by fish which can maintain speed of movement and flexibility under water. These robots can be used, for example, for external examinations of ships.

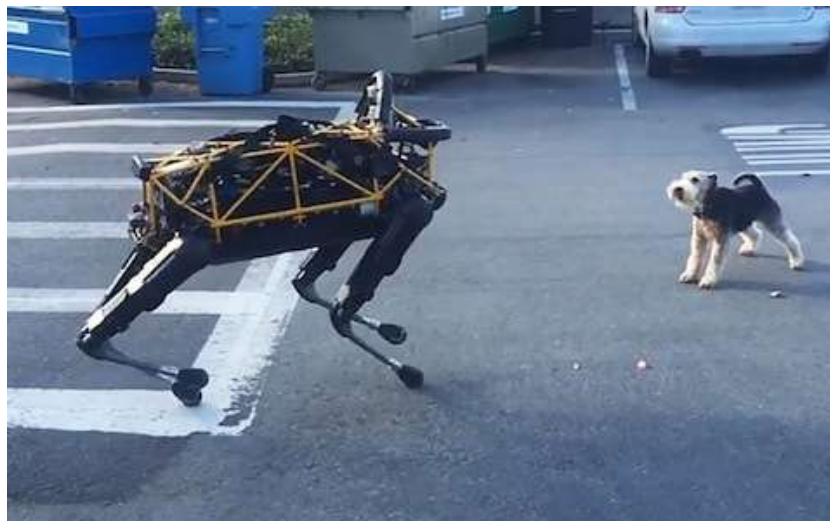

Figure 1 Boston Dynamics robot inspired by dog [Boston Dynamics/Google]

German company Festo has designed remote-piloted robot SmartBird which is copying a flight of seagull. The robot is not just moving wings but bending them at the angle giving it optimal aerodynamic properties as a biological bird. The tail is used to stabilize the device when it is flying or manoeuvring; movement of "head" maintains the right direction. These robots are used to develop *bionic technologies*, helping to create flying robots.



Figure 2 SmartBird by Festo [Festo]

Snakes have been living on the Earth for millions of years now. They have their own way of movements so they can easily overcome the obstacles and move on any surface.

Snake-like robots are fully inspired by biological snake locomotion. The basic structure consists of several body parts connected by joints, so it can easily bend in one or more planes. The difficulty of the structure depends on how many degrees of freedom it has. It makes it harder to control but on the other hand it provides with an opportunity and ability of the robot to work in challenging environment. By that many implementations of this type of robots can be discussed.



Figure 3 The Snake (*Phrynonax poecilonotus*) [Wiki]

Unique characteristics gives snake robots a great advantage over the environment. They can freely move in long and thin pipes or highly cluttered like rubble. That is why the main application nowadays is to assist search and rescue teams. Also their flexibility helps a lot when there is a number of different obstacles to be overcome. They can move on the ground, climb trees, swim in water and perform different types of movements, that is what makes snake robots exceptional.



*Figure 4 An example of 16-joint modular snake robot [01]*

The investigation of snake-like robots has been conducted for several decades. First research and analysis of locomotion was performed by Gray in 1940s. The first snake-like robot was created by Hirose in 1972 [02]. Nowadays, the enormous amount of literature, publications and researches has been proposed covering various approaches to modelling, development and control.





## 2 MECHANICAL DESIGN AND BIOLOGICAL INSPIRATION

As it was already mentioned, the research on snake-like robots is inspired by locomotion of biological snakes. Therefore, biomechanical studies are relevant to investigation on snake-like robots. First analytical studies were performed by Gray [03] who proposed mathematical descriptions of the forces acting on the snake. The main conclusion was that forward motion requires the existence of external forces acting on snake's body. Further investigation on kinematics of snake motion was performed by Hirose who also created first well-known snake-like robot.

By the Hirose-Fukushima Robotics Lab an amphibious snake-like robot called ACM-R5 has been created [04]. Its structure enables it to mimic quite successfully amphibious movement thanks to its joints, which consist of a universal joint and flexible bellow. A universal joint plays the role of bones, and bellow take the role of an integument. This joint structure gives ACM-R5 the ability to form a smooth shape, which is important for effective locomotion.

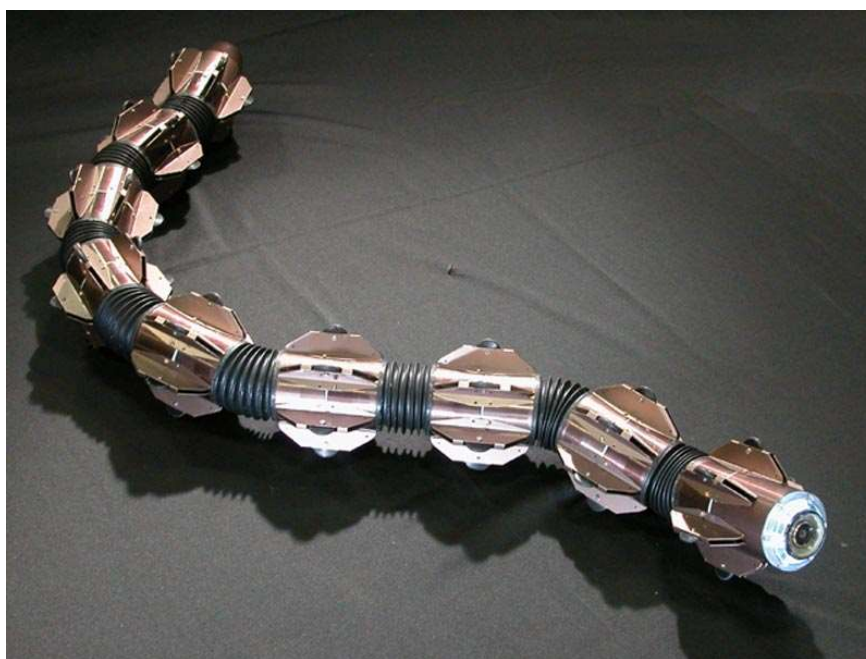

*Figure 5 ACM-R5 by Hirose-Fukushima Robotics Lab*

The robot that has been developed at Pittsburgh-based research centre is designed to move through the surrounding environment by altering the angles of the links that chain together the different segments of its body [05]. This is designed to mirror the way their natural counterparts move through "lateral undulation", the synchronised muscle contractions used by snakes that allow them to appear to be gliding over the ground. This is designed to mirror the way their natural counterparts move through "lateral undulation", the synchronised muscle contractions used by snakes that allow them to appear to be gliding over the ground.

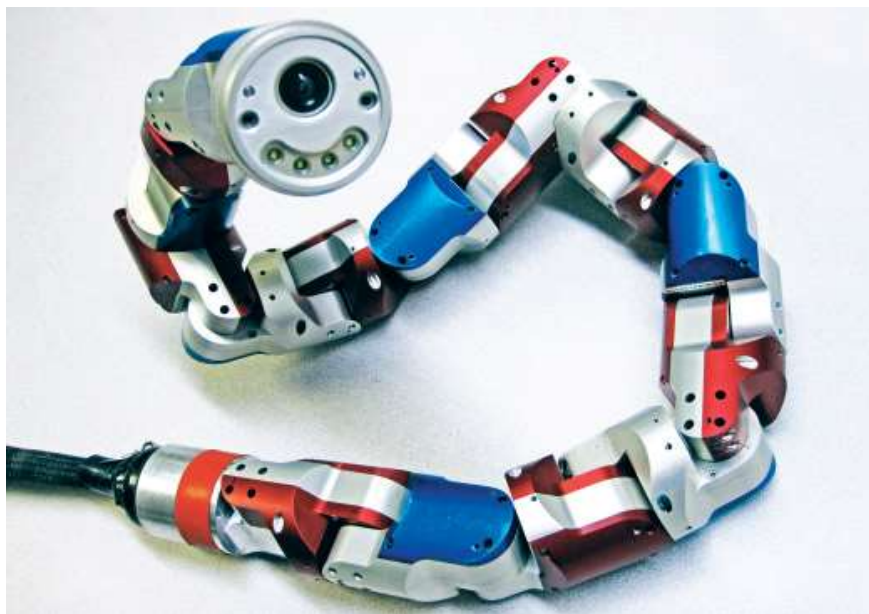

Figure 6 Modular snake robot developed at the Pittsburgh-based research centre

British technology company, OC Robotics, has come up with this snake-like robot, see Fig. 7, that can be used to slither into spaces too dangerous or tight for humans to investigate and explore. This could allow them to have a crucial role in clean up operations, such as the one around Japan's Fukushima Daiichi nuclear power plant.



Figure 7 The snake arm by OC Robotics is being used to explore a vehicle

In a study [06] published in the October 10 issue of the journal *Science*, researchers from the Georgia Institute of Technology, Carnegie Mellon University, Oregon State University and Zoo Atlanta report that sidewinders improve their ability to traverse sandy slopes by simply increasing the amount of their body area in contact with the granular surfaces they're climbing. As part of the study, the principles used by the sidewinders to gracefully climb sand dunes were tested using a modular snake robot developed at Carnegie Mellon. When the robot (Fig. 8) was programmed with the

unique wave motion discovered in the sidewinders, it was able to climb slopes that had previously been unattainable. The research was funded by the National Science Foundation, the Army Research Office and the Army Research Laboratory. The detailed study showed that both horizontal and vertical motion had to be understood and then replicated on the snake-like robot for it to be useful on sloping sand.

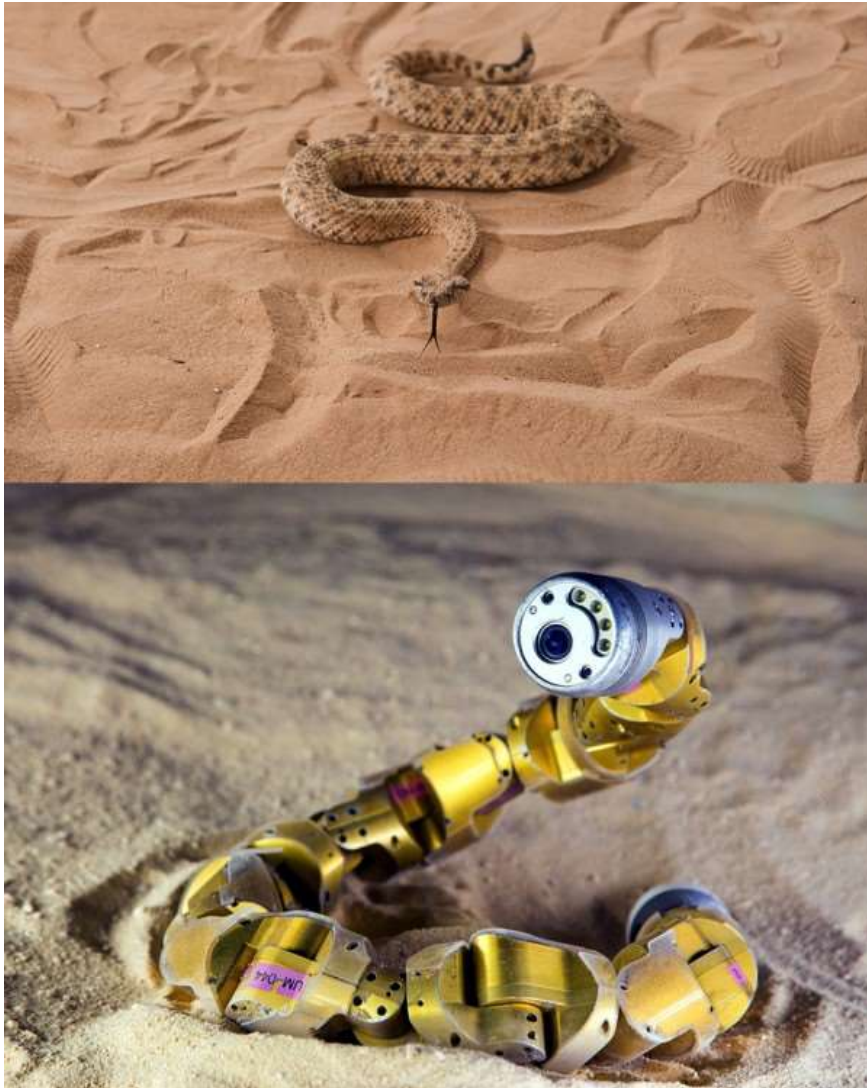

*Figure 8 A sidewinder snake in a sand-filled trackway at Zoo Atlanta (top). Researchers studied the snakes to understand the unique motion they use to climb sandy slopes and apply it to snake-like robots.*

Researches at the SINTEF Research Institute in Norway and at the Norwegian University of Science and Technology are using snakes as an inspiration for a new type of Mars exploration robots [07]. It's because of a snake's ability to get past almost any type of obstacle that makes it useful. The study is more like a written report than it is a series of experiments but these ideas could turn into a prototype very soon.



Figure 9 An imaginary snake robot on Space Station – on the way to inspect anything for the astronaut. Illustration: Shutterstock/SINTEF

Let's take a look at biological snake movements.

It is a known fact that the snake's body is long and soft and consists of 200-400 bones. Based on biological investigations, snakes are moving because of body deformation and typical types of movement:

- a) Concertina motion - the body gets the S-shape, the front part moves forward, the bottom part becomes clenched
- b) Serpentine motion - the snake moves because of friction between the body and the ground. That is the most common type of movement for snake-like robots
- c) Sidewinding motion - starting from the head, parts of the body go up and turn
- d) Rectilinear motion - the snake moves because of friction between the "bottom" and the ground

*Concertina movement* is the movement occurring in snakes and other legless organisms that consists of gripping or anchoring with portions of the body while pulling or pushing other sections in the direction of movement.

Concertina locomotion is used when there is not enough frictional resistance along the locomotor surface for serpentine locomotion. After the body is thrown into a series of tight, sinuous loops, forming a frictional anchor, the head slowly extends forward until the body is nearly straight or begins to slide. The anterior end forms a small series of loops and, with this anchor, pulls the posterior regions forward, after which the sequence of movement is repeated.

This type of movement is often used by snakes to climb through trees or move over smooth surfaces.

*Serpentine motion*, also known as undulatory locomotion (lateral undulation), is used by most snakes on land and in water. Starting at the neck, a snake contracts its muscles, thrusting its body from side to side, creating a series of curves. It gives some advantages in water as this motion easily propels a snake forward because each

contraction pushes against the water. On land, a snake usually finds resistance points in the surface, for example, rocks or dents, and uses its scales to push on the points all at once, thrusting the snake forward.

In serpentine locomotion, when a snake starts to move, the entire body moves, and all parts follow the same path as the head. When the snake stops moving, the entire body stops simultaneously. Propulsion is not by contraction waves undulating the body but by a simultaneous lateral thrust in all segments of the body in contact with solid projections. The muscular thrust against the projection is perpendicular to the axis of the pushing segment.

*Sidewinding motion* is used mostly by snakes that live in areas with loose soil or sand. The snake's head and tail serve as supports. The snake lifts the trunk of its body off the ground and moves it sideways. The snake then moves its head and tail into position with the rest of its body. It then repeats the sequence.

In sidewinding, like serpentine locomotion but unlike concertina locomotion, the entire body of the snake moves forward continuously. Although the body moves through a series of sinuous curves, the track made by the snake is a set of parallel lines that are roughly perpendicular to the axis of movement. This happens because only two parts of the body touch the ground at any instant; the remainder of the body is held off the ground. To begin sidewinding, the snake arches the anterior part of the body forward and forms an elevated loop with only the head and the middle of the body in contact with the ground. Because each part of the body touches the ground only briefly before it begins to arch forward again, the snake seems to roll forward much like a short, coiled spring.

*Rectilinear movement* is also known as creeping. It is mostly used by snakes to climb the trees or move through narrow burrows. The snake contracts certain muscles that pull its belly scales forward. The back edges of the scales catch on bark or rough areas in the soil. The snake then contracts other muscles, which pushes the scales against the bark or rough areas and so moves the body forward.

Unlike the three preceding patterns of movement, in which the body is thrown into a series of curves, in rectilinear locomotion in snakes the body is held relatively straight and glides forward in a manner analogous to the pedal locomotion of snails. The ventral (belly) surface of snakes is covered by scales elongated crosswise that overlap like roof shingles, with the opening of the overlap facing toward the posterior. Each ventral scale is moved by two pairs of muscles, both of which are attached to ribs but not to ribs of the same segment as the scale. One pair of muscles is inclined posterior at an angle (obliquely); the other is inclined anterior at an angle. As contraction waves move rearward from the head simultaneously on both sides, the anterior oblique muscles of a scale contract first and lift the scale upward and forward. When the posterior oblique muscles contract, the scale is pulled rearward, but its edge anchors it, and the body is pulled forward. This sequence is repeated by all segments as the contraction wave passes posteriorly, and, as a series of contraction waves follow one another, the body slowly inches forward. [08]

The simple model of a snake behaviour is described by serpenoid curve which is defined in the next chapter. But it is being restricted to modelling planar locomotion, not the behaviour with out-of-plane motion like sidewinding.

This type of motion uses at least two discrete turning mechanisms in order to change the direction of movement.

Anisotropic friction is one of the main points in studying sidewinding motion as the friction force is in direct ratio with the direction of movement. In many papers it has been proved that because of anisotropic friction the process of movement has a different direction compared to movement by shear load. Due to inhomogeneity of surface materials which were impacted by mechanical processing and wear, the anisotropic friction occurs. Thanks to anisotropic friction forces and scale, snakes contacting with ground surface can perform sidewinding motion. With sliding frontwards friction force is minimal and, on contrary, with backwards sliding it increases significantly. The snake body has many segments, along the whole body there is a wave of contraction coming. Because of a good contact with a surface, the segments of a body move consequently. The movement when segments are moving in a different direction is called sidewinding motion and it means that this motion happens due to a bad contact with a ground surface.

For reducing thermal contact snake lifts the body up and it increases the pressure on the part of the body which is pushing off. This introduces a simulation of a body deformation with a phase of 90 degrees. The length of a snake is equal to a wave length divided by 1.4.

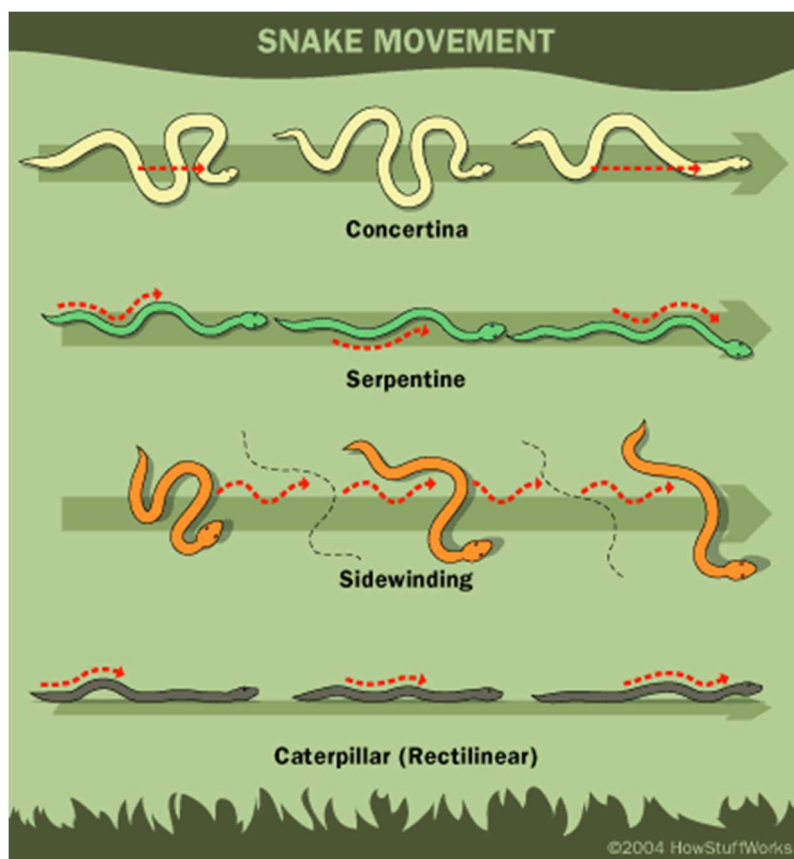

Figure 10 Snake movement [09]

Snake-like robot is a mobile robot with high excessiveness. It can easily move in a close and narrow space. Snake-like robot may have a wide area of use in future as it can be used during post-accident clean-up after earthquakes, in mines' crashes, for investigations on different planets, etc.

As you can see on the Fig. 10, the movement is mostly based on body deformation which is caused by bones' movement. It means we can consider the structure of the robot as the link of serially connected parts.

It is obvious that if we select sphere-like parts, it will be difficult to control the mechanism. While comparing several well-known snake-like robots, they are divided into 2 categories - models with orthogonal axes of rotation and models with cardan axes of rotation.

The most important part is to select the amount of elements. The real snake has almost 200 of them but it is not convenient for a snake-like robot as it is too complicated to control a mechanism like that. Usually the robot consists of 6-20 chains. For our project, we have selected the mechanism with 6 parts and serpentine type of motion.





### 3 KINEMATIC MODEL AND BASIC EQUATIONS

Even though robotics is relatively new area, there have been some investigations and researches on snake-like robots held for the past decades. To have more understanding on construction of mechanical model it is necessary to review various approaches applied to control snake-like robots.

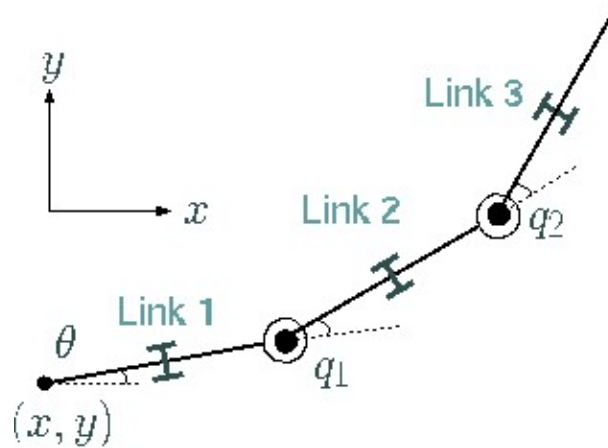

Figure 11 A typical kinematic representation of snake-like robot (example with three chains)

Fig. 11 shows a kinematic behaviour of a simple 3-chained snake-like robot model. It consists of 3 chains linked together by revolute joints. Each body part has a passive wheel on its center, which does not slip nor slide sideways.

One of the most famous works was made by Hirose and Umetami, in the early 1970s, they were the first who explored, designed and developed limbless locomotors.

The pioneer builder of snake robots has studied movements of living snakes, photographed the movement and then implemented that biological inspiration in his robots. He concluded that the serpentine movements followed a curve in which the curvature along the snake's body varied sinusoidally. The waveform that the snake assumes during creeping movement has been called *serpenoid curve* and expressed by following equations:

$$x(s) = sJ_0(\alpha) + \frac{4l}{\pi} \sum_{m=1}^{\infty} \frac{(-1)^{2m}}{2m} J_{2m}(\alpha) \sin\left(m\pi \frac{s}{l}\right); \quad (1)$$

$$y(s) = \frac{4l}{\pi} \sum_{m=1}^{\infty} (-1)^{m-1} \frac{J_{2m-1}(\alpha)}{2m-1} \sin\left(\frac{2m-1}{2} \pi \frac{s}{l}\right); \quad (2)$$

where  $x(s)$ ,  $y(s)$  represent the displacement in the  $x$  and  $y$  directions, respectively, measured along the curved body length  $s$ ;  $l$  is the body length; and  $J(.)$  are Bessel functions.

The action by which one part of the body floats up during advancement, called sinus-lifting, can be also interpreted as an action which concentrates the body weight on the part that can most easily slip. Hirose found that the movement of natural snakes on constant-friction surfaces is very close to the *serpenoid curves* of these equations. He then proposed that a multisegmented vehicle that followed the serpenoid curve could generate

forward movement by applying internal torques to its segments, as a snake might do through muscle contractions.

Hirose has a sustaining interest in limbless locomotion and designed and built several robots over decades. He termed the devices Active Cord Mechanisms or ACM's. Hirose focused on developing robots that could perform lateral undulation and later developed a series of wheeled coupled-mobility devices that followed from this work.

Hirose's development of modeling and control first derived expressions of force and power as functions of distance and torque along the curve described by the snake. The curve was then derived and compared with results from natural snake locomotion. The curve, termed serpenoid, has curvatures that vary sinusoidally along the length of the body axis.

This curve is different from sinusoidal or even clothoid curves. Comparisons with natural snakes across constant friction surfaces showed close agreement between the serpenoid curve and the empirical data.

Hirose then went on to develop models for the distribution of muscular (actuator) forces along the body. This was done for normal and tangential forces as well as power distribution. Again, the developed models closely correlated to muscle exertion data and force measurements from natural snake movements.

Once we consider the biological snake, the snake body's model represents a continuous curve that could not move sideways. For our simulation we will use a formulation of the serpenoid curve by Hirose, which is mathematical description of lateral undulation. That is the most common form of snake locomotion.

The serpenoid curve is defined as:

$$x(s) = \int_0^s \cos(\alpha \cos(b\sigma) + c\sigma) d\sigma ; \quad (3)$$

$$y(s) = \int_0^s \sin(\alpha \cos(b\sigma) + c\sigma) d\sigma, \quad (4)$$

where  $x(s)$  and  $y(s)$  are the coordinates of the point along the curve at arc length  $s$  from the origin, and where  $a, b$ , and  $c$  are positive scalars.

When building a mathematical model of snake-like robot, we used the analogy with manipulator model. Denavit-Hartenberg is a commonly used method for analysing manipulator's kinematics and let us get position parameters and orientation of robot in the process of movement.

On the other hand, snake like robot is functionally a mobile robot. By this way we can get unified matrices of movement for 6-chain flat mechanism from absolute coordinate system to "tail" coordinate system.

While building mathematical model of the mechanism it is necessary to identify main parameters and describe the position and orientation of robot on the surface.

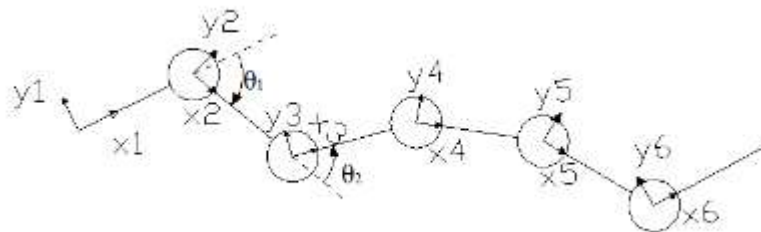

Figure 12 System of relative coordinates of robot

The main difference between a mobile robot and manipulator is that the last one has a fixed support on which we build an absolute coordinate system. Robot, on the other hand, moves on the ground, that's why we cannot build an absolute coordinate system on its "tail". We select a starting point on the ground as the base (start) of non-moving coordinate system and assume an existence of an additional chain between the base and the tail with telescopic and revolute joint.

Let's take a look at movement of "head" from point M to point N with non-changing position of a "tail". We'll use the same method as for manipulator.

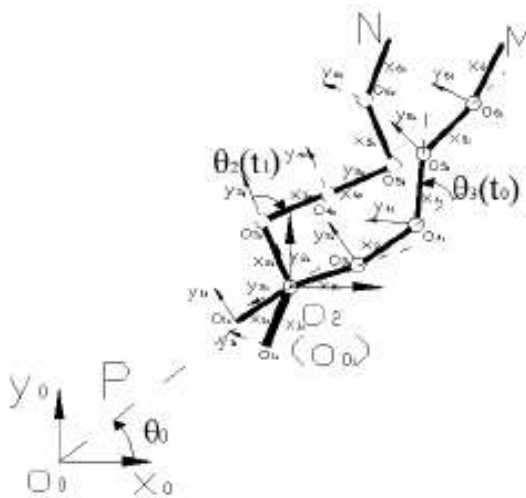

Figure 13 Robot moving from point M to point N [10]

It's important to mention that "tail" is considered as base of "manipulator". So position of the chain itself can change but point O2 stays the same.

If we know coordinates of robot's "head" in absolute coordinate system, then the opposite task can be solved but it can have multiple solutions because of redundancy of robot. There is no common solution or method for this task. To reduce the energy consumption we will need to select a solution based on the principle of minimum angle change. However, this principle works only in theory.

To make the robot able to do different movements, it is necessary for the head to move and it will be a condition for the whole robot to move.

Let's go back to the situation when the model is built analogically with mobile robots which is the aim of our investigation. As we have several chains, for movement these chains have to move in a certain consequence. On the picture you can see fixed position of phase for robot's movement on horizontal surface. It is assumed, that one step is done by period of time  $T$  so every intermediate condition has to be done by  $1/8 T$ .

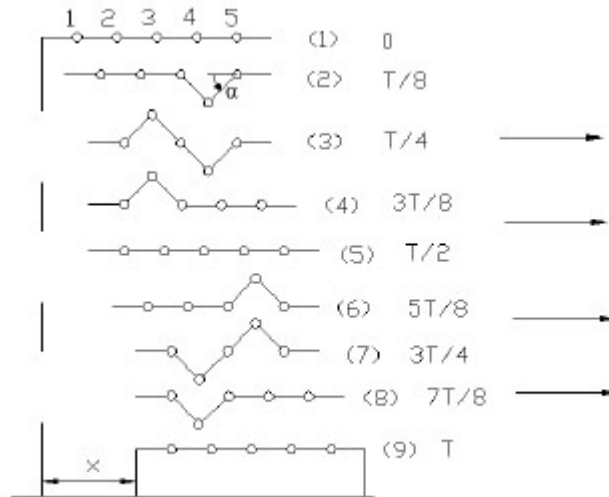

Figure 14 Phase of straight-line movement on horizontal surface

This scheme gives us 2 conclusions:

- snake-like robot is moving by chain's bending; the direction of head and tail stays the same. For different tasks like avoiding obstacles, it is necessary to change the direction of various chains
- when the robot moves straight on the surface, phases have several characteristics. From the scheme it is obvious that in state 1,2,3 and 5,6,7 the position of the head stays the same, in contrast, states 3,4,5 and 7,8,9 show fixed tail position.

Based on that it is not complicated to find the relation between movement of first part and time, or displacement  $F$  and time  $t$ . [10]

$$\begin{cases} F(\alpha, t) = x \cdot n + d_f \\ t = n \cdot T + \tau \end{cases} \quad (5)$$

where  $x$  is a displacement of robot during one cycle,  $x = 8L(1 - \cos\alpha)$ ,  $n$  – number of full cycles,  $d_f$  – displacement of robot inside of one cycle, and  $L$  is length of the robot.

$$d_f = \begin{cases} 2L(1 - \cos(\omega\tau)), 0 \leq \tau \leq \frac{T}{8} \\ 2L(1 - \cos\alpha) + 2L\left(1 - \cos\left(\omega\left(\tau - \frac{T}{8}\right)\right)\right), \frac{T}{8} \leq \tau \leq \frac{T}{4} \\ 4L(1 - \cos\alpha), \frac{T}{4} \leq \tau \leq \frac{T}{2} \\ 4L(1 - \cos\alpha) - 2L\left(1 - \cos\omega\left(\tau - \frac{T}{2}\right)\right), \frac{T}{2} \leq \tau \leq \frac{5T}{8} \\ 6L(1 - \cos\alpha) - 2L\left(1 - \cos\omega\left(\tau - \frac{5T}{8}\right)\right), \frac{5T}{8} \leq \tau \leq \frac{3T}{4} \\ 4L(1 - \cos\alpha), \frac{3T}{4} \leq \tau \leq T, \end{cases} \quad (6)$$

where  $\tau$  – time for displacement  $d_f$ ,  $\sigma$  – angle speed of chain. It makes the robot move only straight which is not enough for a mobile robot.

A possibility to change the direction of movement of snake-like robot gives it a chance to access to any point on horizontal surface.



## 4 SIMULATION EXPERIMENTS

There are many simulation environments have been created. It is defined as a programming environment of a computer that is dedicated to systems simulation and that takes care of a flexible and intelligent interfacing between the user and the system to be experimentally studied. The Visual Simulation Environment provides simulates physical objects and their interactions including collisions, friction and gravity. Many tools are available, such as Gazebo, V-REP, Simulink etc.

To create a simulation for our snake-like robot we have chosen V-REP environment. It is open source and free for academics so it was no problem to install the software. There are also provided sensors and mechanisms. The main advantage is that V-REP is highly customizable. Built-in capabilities are pretty impressive. Default physics engines include Bullet 2.78, Bullet 2.83, ODE, Vortex and Newton.

As for user interace, it included a code and a scene editor, scene objects can be fully interacted with during simulation. The world returns to its initial state when the simulation is reset. Meshes can be manipulated by robots in real time. Outputs include video, custom data plots and text files. It also includes particle systems which is not available in other environments like Gazebo.

When it is coming to programming methods, there are verious ways for implementing functionality, including scripts attached to robots, plug-ins, ROS nodes or separate programs that connect to V-REP via the RemoteAPI. Scripts can be included in robot models and arre often used to describe the models and their capabilities. "CustomUI" API, based on QT, is used to create custom interfaces. Custom UI controllers can be attached to individual robots. For example, it is possible to display a robot's camera output when the robot is clicked on.

While creating a simulation I have not noticed any freezing issues and all functionality is intuitive and follows genetal conventions from similar applications.

It mainly uses Lua programming language but others (e.g. C++) can be imported. Lua is mainly described as a „multi-paradigm“ language as it is providing a small set of general features that can be extended to fit different problem types.

As it was discussed before our snake has 6 chain body connected by revolute joints. Same as Hirose model, each body part has passive wheels. Our snake moves in planar surface replicating a sinusodial pattern (serpenoid curve) and body of a snake is a combination of cuboids which are linked by revolute joints which rotate around the Z axis.

The serpenoid curve can be applied into the snake-like robot by changing the relative angles between body parts using the follow equation, where  $n$  – number of chains.

$$\phi_i = \alpha \sin(\omega t + (i - 1)\beta) + \gamma, (i = 1, \dots, n - 1) \quad (7)$$

where  $\alpha$ ,  $\beta$  and  $\gamma$  are being dependant to the variables a, b and c respectively.

This relationship is shown below:

$$\begin{aligned}\alpha &= a \left| \sin\left(\frac{\beta}{2}\right) \right| \\ \beta &= \frac{b}{n} \\ \gamma &= -\frac{c}{n}\end{aligned}\quad (8)$$

These equations (8) are applied into the programming code, where default values are:  $a = 45$  degree,  $b = 3\pi$ ,  $c = 0$ ,  $n = 6$ .

To represent the angle of each revolute joint, the following programming code has been applied:

```
Ang1=(alpha*sin(t)+gamma+D)
Ang2=(alpha*sin(t+1*beta)+gamma+D)
Ang3=(alpha*sin(t+2*beta)+gamma+D)
```

The value  $D$  represents the value for timer to produce the duty cycle that position the motor to 90 degree. Gamma is used to determine the direction of the snake-like robot. If it is decreasing, then the snake is turning to the left direction.

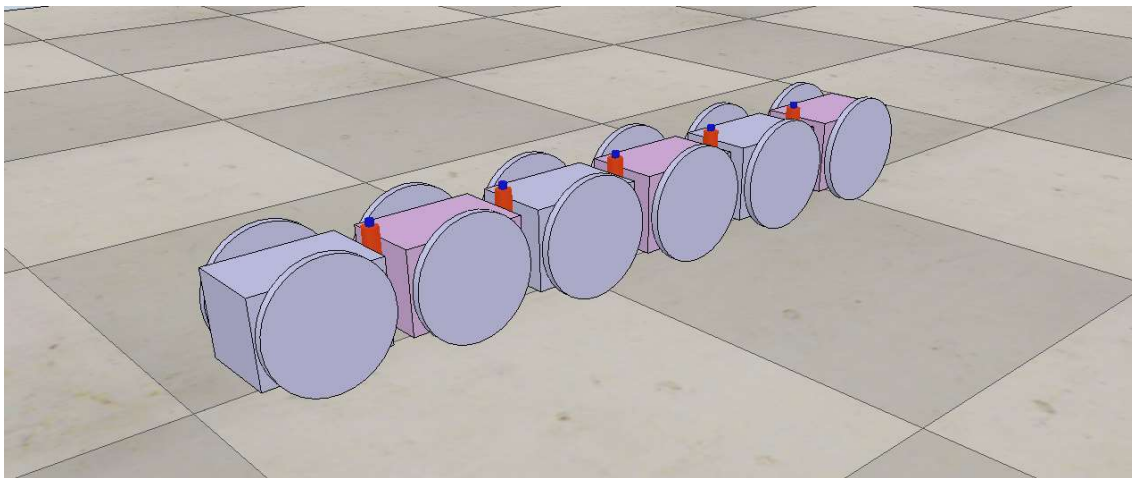

Figure 15 A snake-like robot created in V-REP

As it is seen, there are 6 body parts represented by cuboids, each of them has 2 passive wheels connected to cuboid by a revolute joint. Each body segment is also linked with revolute joint which is programmed with a function of serpenoid curve.



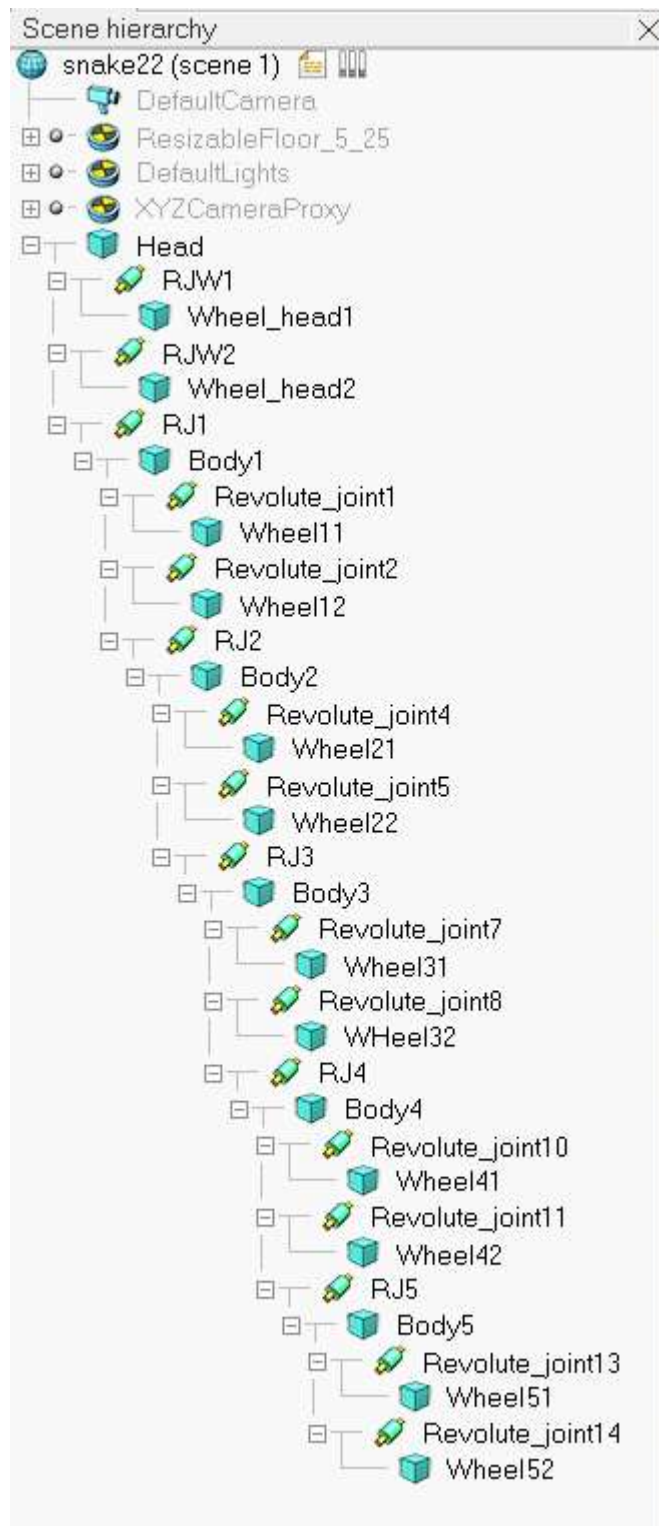

Figure 16 Scene hierarchy for 6-chained snake-like robot

When building a robot, we tried to make it look alike the real robot created at our faculty. The dimensions can be found on the following figure.

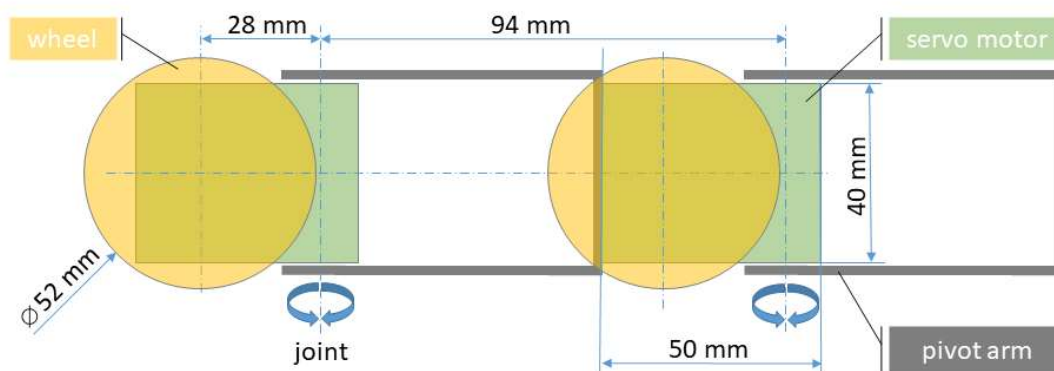

Figure 17 Dimensions for a snake-like robot

These dimensions and structure are based on the real snake-like robot that has been created during the bachelors work at the department.

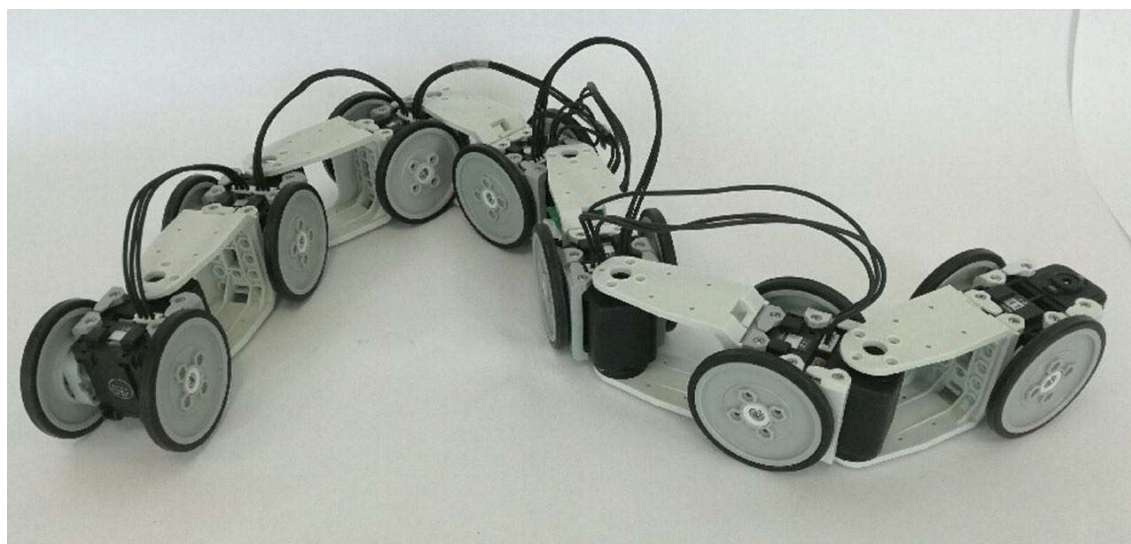

Figure 18 Snake-like robot

There was also a simulation model created based on real robot which contains 6 body parts and 7 wheel pairs.

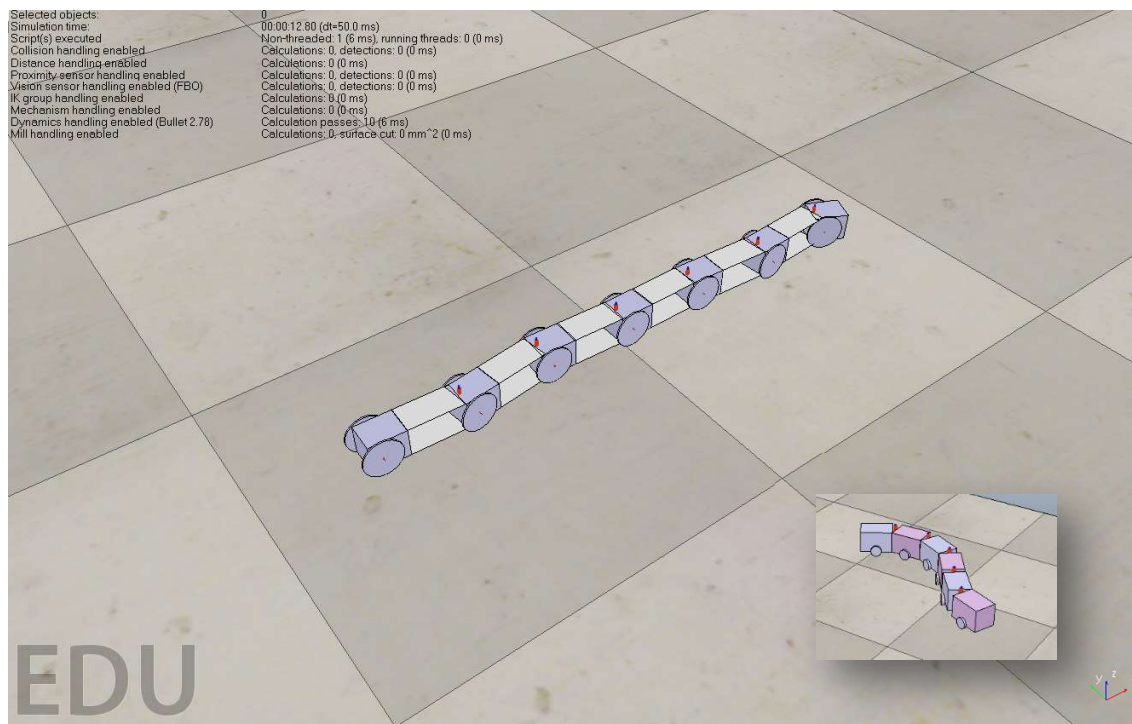

Figure 19 Snake-like robot model in V-REP environment

As it was mentioned before, for V-Rep environment Lua Code is used. Below you can see a part of the code for snake movement.

```

if (sim_call_type==sim.syscb_actuation) then

    local position=sim.getObjectPosition(handle,-1)
    position[1]=position[1]+0.001
    sim.setObjectPosition(handle,-1,position)
        sim.setJointTargetPosition(joints[i],
maxAngle*math.pi/180*(-
math.sin(sim.getSimulationTime()*3+(i-1)*0.7)+0.2))

    if sim.getSimulationTime() > 3.0 and
        sim.getSimulationTime() < 18.0 then
        for i=1,nJoints do
            sim.setJointTargetPosition(joints[i],
maxAngle*math.pi/180*math.sin(sim.getSimulationTime()+i*phase))
        end
    end
end
end

```

During the investigation, several models were designed with different structure and parameters but same principle.



## 5 CONCLUSION

The first part of this paper covers the introduction into the topic and gives an overview of bionics. Second chapter consists of review of snake locomotion, mechanical design of snake movement and biological inspiration found in it. In the third chapter we discuss the kinematic model and mathematical representation of movement; description of serpenoid curve as an implementation of biological lateral undulation. The final chapter is an introduction of snake-like robot which is a virtual implementation of real physical model. Main advantages of simulation are possibility to study the behavior of a system before implementing it on real model; results obtained are highly accurate, compared to analytical model and can help to identify unexpected behavior of the system.

For future investigations, we can consider and review the exact parametrization of simulation by a real model. The calculation of friction on wheel tires, weight calculation and analyzing of dynamic behavior, optimization of movement by parameters need to be performed.

Because of small amount of body parts, the movement is not as smooth as a biological snake in nature. That is why we are planning to use various methods of movement. The practical value of such robot can be increased by adding a camera to improve observation abilities as well as sensors to allow it to know its position and the environment around.



## 6 REFERENCES

- [01] Hamidreza Marvi, Chaohui Gong, Nick Gravish, Henry Astley, Matthew Travers, Ross L. Hatton, Joseph R. Mendelson III, Howie Choset, David L. Hu, and Daniel I. Goldman. *Sidewinding with minimal slip: Snake and robot ascent of sandy slopes*. *Science*, 10 October 2014 DOI: 10.1126/science.1255718
- [02] Hirose, Shigeo. *Snake Inspired Robots*. Japan. Kogyo-chosakai Publishing Co. Ltd. 1987
- [03] Gray J. *The mechanism of locomotion in snakes*. *J Exp Biol*. 1946 Dec; 23(2):101-20.
- [04] H. Yamada, S. Chigisaki, M. Mori, K. Takita, K. Ogami, S. Hirose. *Development of amphibious snake-like robot ACM-R5*. Proc. 36<sup>th</sup> Int. Symp. Robotics, TH3C4, 2005
- [05] Kelion, Leo, 29 April 2013. *Snake robot teams up with search-and-rescue dog in US*. [online]. [Accessed 10 May 2018]. Available from: <http://www.bbc.co.uk/news/technology-22340218>
- [06] Hamidreza Marvi. *Sidewinding with minimal slip: snake and robot ascent of sandy slopes*. *Science*, 2014.
- [07] Dragland, Ase. *Snake robot on Mars?* [online]. Published [16 September, 2013]. [Accessed 12 May 2018] Available from: <https://www.sintef.no/en/latest-news/snake-robot-on-mars/>
- [08] Sampaolo, Marco. 31 August 2017. *Terrestrial locomotion*. [online]. [Accessed 9 April 2018]. Available from: <https://www.britannica.com/topic/locomotion/Saltation>
- [09] Perry, Lacy. 20 April 2004. *How Snakes Work*. [online]. [Accessed 5 March 2018]. Available from: <https://animals.howstuffworks.com/snakes/snake3.htm>
- [10] Zhu Xiao Xiao. *Молодежный научно-технический вестник*. 2011. ISSN 2307-0609





## 7 LIST OF FIGURES

- Figure 1 Boston Dynamics robot inspired by dog [Boston Dynamics/Google]  
Figure 2 SmartBird by Festo [Festo]  
Figure 3 The Snake (Phrynonax poecilonotus) [Wiki]  
Figure 4 An example of 16-joint modular snake robot [01]  
Figure 5 ACM-R5 by Hirose-Fukushima Robotics Lab  
Figure 6 Modular snake robot developed at the Pittsburgh-based research centre  
Figure 7 The snake arm by OC Robotics is being used to explore a vehicle  
Figure 8 A sidewinder snake in a sand-filled trackway at Zoo Atlanta (top).  
Researchers studied the snakes to understand the unique motion they use  
to climb sandy slopes and apply it to snake-like robots.  
Figure 9 An imaginary snake robot on Space Station – on the way to inspect  
anything for the astronaut. Illustration: Shutterstock/SINTEF  
Figure 10 Snake movement [09]  
Figure 11 A typical kinematic representation of snake-like robot (example with three  
chains)  
Figure 12 System of relative coordinates of robot  
Figure 13 Robot moving from point M to point N [10]  
Figure 14 Phase of straight-line movement on horizontal surface  
Figure 15 A snake-like robot created in V-REP  
Figure 16 Scene hierarchy for 6-chained snake-like robot  
Figure 17 Dimensions for a snake-like robot  
Figure 18 Snake-like robot  
Figure 19 Snake-like robot model