

Czech University of Life Sciences Prague

Faculty of Economics and Management

Department of Information Technologies



Diploma Thesis

**Smart agriculture irrigation system powered by solar
energy**

Bc. Saifhasenenkhan Salim Pathan

© 2021 CULS Prague

CZECH UNIVERSITY OF LIFE SCIENCES PRAGUE

Faculty of Economics and Management

DIPLOMA THESIS ASSIGNMENT

Bc. Saifhasenenkhan Salim Pathan

Systems Engineering and Informatics
Informatics

Thesis title

Smart agriculture irrigation system powered by solar energy

Objectives of thesis

The main objective of the thesis is to design a smart agriculture irrigation system powered by solar energy to meet the increasing demand for energy in the field of agriculture using solar energy for farmers.

Partial objectives are:

- to analyze the current approaches in smart agriculture,
- to analyze the possibilities of solar-powered devices in agriculture,
- to analyze the possibilities of sensor equipment for soil analysis,
- to evaluate the proposed solution and to make recommendations.

Methodology

The review of the topic is based on a significant review of scientific and expert literature. The data is collected from various articles, a case study of Solar Powered Irrigation Systems (SPIS) Technology, Economy, Impacts. The qualitative data to be used in the study comprises drip irrigation, solar energy, nutrition balance, sunlight effectiveness, aggregate water supply technique, project realization phases including investment plan, etc. to analyses usage of smart devices to grow crops/animals in weather conditions. Through this, the smart device's performance was analyzed and evaluated so that any conclusions can be reached with recommendations for better implementation, based on current trends. Any problem areas that need to focus on various evaluation measures and the farming sector have been researched so far.

The proposed extent of the thesis

60 – 80 pages

Keywords

KIT – Smart agriculture , Drip water Supply, Ph tester, Crops, animal smart Device, Farming, Sensor, IoT , Solar power, Irrigation, technique, Heating, controlling etc.

Recommended information sources

- AL-ALI, A.r., NABULSI, Ahmad Al, MUKHOPADHYAY, Shayok, AWAL, Mohammad Shihab, FERNANDES, Sheehan and AILABOUNI, Khalil. IoT-solar energy powered smart farm irrigation system. *Journal of Electronic Science and Technology*. 2019. Vol. 17, no. 4p. 100017. DOI 10.1016/j.jnlest.2020.100017.
- A. Syafiq, A. K. Pandey , N. A. Rahim, "Photovoltaic glass cleaning methods – an overview", 4th IET Clean Energy and Technology Conference (CEAT), 2016
- JAN , Sass and ANDREAS, Hahn. *Solar Powered Irrigation Systems (SPIS) Technology, Economy, Impacts* [online]. August 2020. [Accessed 22 November 2020]. Available from: https://energypedia.info/images/7/74/Solar_Powered_Irrigation_Systems_%28SPIS%29_-_Technology%2C_Economy%2C_Impacts.pdf
- M, VIJAYALAKSHMI M., 2019, IoT Based Smart Farming in a Agriculture. *International Journal of Trend in Scientific Research and Development*. 2019. Vol. Volume-3, no. Issue-2, p. 462-466. DOI 10.31142/ijtsrd21362. South Asia Management Association
- PANDYA, ER. A.B., 2019, Solar Powered Irrigation Systems (SPIS). *Irrigation and Drainage*. 2019. Vol. 68, no. 2, p. 379-380. DOI 10.1002/ird.2348. Wiley
- PANIGRAHI, Shreedhar. SMART FARMING: IOT Based Smart Sensor Agriculture Stick For Live Temperature And Humidity Monitoring. *SSRN Electronic Journal*. 2020. DOI 10.2139/ssrn.3651933.
- V R.Balaji, M.Sudha, "Solar Powered Auto Irrigation System", *International Journal of Emerging Technology in Computer Science & Electronics*, Volume 20 ,Issue 2, ISSN: 0976-1353, February 2016.
- V, Viswanatha. Solar powered smart irrigation system. . 2019. DOI 10.31227/osf.io/s5t72.
-

Expected date of thesis defence

2020/21 SS – FEM

The Diploma Thesis Supervisor

Ing. Alexandr Vasilenko, Ph.D.

Supervising department

Department of Information Technologies

Electronic approval: 24. 11. 2020

doc. Ing. Jiří Vaněk, Ph.D.

Head of department

Electronic approval: 25. 11. 2020

Ing. Martin Pelikán, Ph.D.

Dean

Prague on 24. 03. 2021

Declaration

I declare that I have worked on my diploma thesis titled "Smart agriculture irrigation system powered by solar energy" by myself and I have used only the sources mentioned at the end of the thesis. As the author of the diploma thesis, I declare that the thesis does not break any copyrights.

In Prague on 30th November 2021

Pathan Saifhasenenkhan Salim

Acknowledgement

I would like to thank My supervisor Ing. Alexandr Vasilenko and all other persons, & my family for their advice and support during my work on this thesis.

I would like to say a special thank you to My supervisor Ing. Alexandr Vasilenko His encouragement, advice, and general knowledge in this field have made this a motivating experience for me.

I'd also want to express my gratitude to all of the ladies who took part in the study's interviews.

Finally, I'd want to express my gratitude to my family for their continuous encouragement throughout the writing of my research.

Smart agriculture irrigation system powered by solar energy

Abstract

Smart agriculture irrigation system powered by solar energy was set up and tested along with monitoring the data and analysing the various aspects of the system.

The energy needs are increasing with time and the solar power can be one such viable solution to that. Irrigation is one of the chief parts of agriculture and solar powered irrigation systems are a relief for farmers in various ways.

Evolution of the Internet of Things (IoT) has enabled us to fetch information from various devices like sensors, farm, etc. and information can be stored remotely and by means of this, various solar energy resources across different places can be observed as well as operated remotely. In various regions with arid climatic conditions along with shortage of water as well as power, solar energy for the purpose of irrigation serves to be a good alternative. The system consists of various sensors and many different units connected to the solar cell, like the Data Acquisition Unit along with a controller with Wi-Fi connectivity and the controller monitors the moisture along with the humidity in the soil along with reading the water levels. Various design criteria's have been utilised in this system and the various sensors used were successful in serving their purpose. Also, in controlling the system remotely, the mobile application was tested which was utilised to monitor the water flow.

The readings from the prototype system were taken and got the advantages and drawbacks of the systems along with any possible upgrade that could be made in either of the systems to enhance the output. The present crisis in energy for the farmers especially those in remote regions with water and power scarcity and shows how the proposed solution can serve to be a better alternative. By reduction in the utilization of grid power, this system also enables the economic use of electricity as well as helps in the sustainable usage of water resources by minimising the wastage.

Keywords: Smart Irrigation, Internet of Things(IoT), Solar power, Solar pump, Sensors, Automated Irrigation System, Solar pumping system, Water Management, Grid power, Nodemcu ESP8266, Soil Monitoring, Smart water dripping system.

Smart agriculture irrigation system powered by solar energy

Abstrakt

Byl vytvořen a otestován inteligentní zavlažovací systém pro zemědělství poháněný solární energií spolu s monitorováním dat a analýzou různých aspektů systému.

Potřeba energie se časem zvyšuje a solární energie může být jedním z takových životaschopných řešení. Zavlažování je jednou z hlavních částí zemědělství a solární zavlažovací systémy jsou pro zemědělce úlevou různými způsoby.

Vývoj internetu věcí (IoT) nám umožnil získávat informace z různých zařízení, jako jsou senzory, farmy atd., A informace lze ukládat na dálku, a díky tomu lze také pozorovat různé zdroje sluneční energie na různých místech ovládané na dálku. V různých oblastech se suchými klimatickými podmínkami spolu s nedostatkem vody i energie je solární energie pro zavlažování dobrou alternativou. Systém se skládá z různých senzorů a mnoha různých jednotek připojených k solárnímu článku, jako je jednotka pro sběr dat spolu s ovladačem s WiFi připojením a regulátor sleduje vlhkost spolu s vlhkostí v půdě spolu se čtením hladin vody. V tomto systému byla použita různá konstrukční kritéria a různé použité snímače úspěšně sloužily svému účelu. Při dálkovém ovládní systému byla také testována mobilní aplikace, která byla využívána ke sledování toku vody.

Odečty z prototypového systému byly převzaty a získaly výhody a nevýhody systémů spolu s jakýmkoli možným upgradem, který by bylo možné provést v kterémkoli ze systémů pro zvýšení výkonu. Současná energetická krize pro zemědělce, zejména v odlehlých regionech s nedostatkem vody a energie, ukazuje, jak může navrhované řešení sloužit jako lepší alternativa. Snížením využití energie ze sítě tento systém také umožňuje ekonomické využití elektřiny a pomáhá při udržitelném využívání vodních zdrojů minimalizací plýtvání.

Klíčová slova: Inteligentní zavlažování, internet věcí (IoT), solární energie, solární čerpadlo, senzory, automatický zavlažovací systém, solární čerpací systém, vodní hospodářství, síťová energie, Nodemcu ESP8266, monitorování půdy, inteligentní systém kapání vody

Table of content

1	Introduction	Error! Bookmark not defined.
2	Objectives and Methodology	13
2.1	Objectives.....	13
2.2	Methodology	13
3	Literature Review	14
3.1	The proposed Solution	14
3.2	System Description.....	15
3.3	Solar Pumping System.....	16
3.4	Data Acquisition Sensing Unit or DAQ-sen	17
3.5	Components Used.....	18
3.6	Concepts of Solar Powered Irrigation System (SPIS) Plant	18
3.7	Cost Analysis and Limitations	20
3.8	Smart water dripping system.....	27
3.9	Description about the system	20
3.10	Smart Irrigation Systems For Agriculture Using Iot.....	32
3.11	Water Management	27
3.12	Architecture of Smart irrigation system	Error! Bookmark not defined.
3.13	Soil Monitoring.....	33
3.14	Controlling the setup in smart irrigation system.....	35
3.15	Controlling the automatic setup of by thingspeak.....	36
3.16	Benefits of solar powered irrigation.....	39
3.17	Irrigation techniques.....	40
3.18	Challenges in implementation of Smart Irrigation System	41
4	Practical Part	44
4.1	Overview of SPIS in India.....	44
4.2	Experiment	47
4.2.1	Introduction	55
4.2.2	Technology used	55
4.2.3	Overall Assessment	66
5	Results and Discussion	68
6	Conclusion and recommendations	75

6.1 Conclusion.....	75
6.2 Recommendations.....	77
7. References	80
8. Appendix	90

List of pictures

Figure 1 Block Diagram of automated irrigation system.....	15
Figure 2 Effect of varying soil moisture (Source: Al-Ali et al.,2019	17
Figure 3 Solar Drip Irrigation System. (Source: Reddy, 2021)	19
Figure 4 Source: "Soil Moisture Sensor Module", 2021.....	20
Figure 5 Water management (Source: Tarani et al. 2018)	28
Figure 6 Soil monitoring (Source: Baladi and Shah, 2018)	35
Figure 7 solar powered irrigation (Source: Amariei et al.2020)	40
Figure 8 Source owner	36
Figure 9 block diagram of Spis system.....	45
Figure 10 Source owner.....	46
Figure 11 The solar panel, its charge controller and its battery (Source: Bhattacharya et al. 2021)	47
Figure 12 Nodemcu ESP8266 Power of Solar Panel.....	48
Figure 13 : membership diagram of fuzzy logic system.....	49
Figure 14 source owner.....	51
Figure 15: The solar panel, its charge controller and its battery.....	53
Figure 16 Nodemcu ESP8266 Power by Solar Panel Source Owner	54
Figure 17 Relay source owner.....	58
Figure 18 battery charging (source: owner).....	59
Figure 19 Wiring Diagram of Project.	62
Figure 20 blynk source web. system.	64
Figure 21 blynk source web.	66
Figure 22 Flow chart of drip irrigation system reading from blynk	69
Figure 23 Data from thing.speak irrigation system.	71
Figure 24 battery charging estimate system.	73

1 Introduction

Among all the sources of energy that are available in the world, solar energy has been proven to be the most abundant energy source. The concept of solar power generation is not a new one in the world and has developed a lot since its emergence. Based on the views of Sukhatme and Nayak (2017), solar power is the best alternative to traditional energy sources such as coal, petroleum etc, in order to power various processes. But the most important factor is that it is an environmentally friendly energy source that has no harmful impact on the environment as compared to the other non-renewable sources of energy. Various researches have been going on from the last few decades so as to ensure the maximum utilization of this type of energy. The fact that it is a limitless source of energy makes it quite valuable and regarded as an alternative. If used properly its possibilities are endless and can provide significant energy to the modern world.

One of the most effective approaches of the utilization of solar energy is Photovoltaic generation (Sampaio and González, 2017). Solar panels which are basically an array of the photovoltaic cells are being used on a large scale in the modern world. Some of the basic uses of these kinds of solar panels are powering street lights, water heaters and also to meet various domestic uses. Solar panels are gradually acquiring its popularity worldwide and as a result their costing has been descending at a constant pace. This gradual decrease in the costing is encouraging its extensive application in different sectors. One of the most popular applications of this kind of cost efficient and eco friendly technology is in the irrigation systems for commencing farming activities. Irrigation systems that are powered by solar energy could be an appropriate alternative for meeting the global energy crisis that is occurring in the current time (Kabir et al. 2018). The most important reason for the application of this technology is that it offers free energy once after the initial installation procedure. The investment done on the installation is just for once and the benefits can be

consumed for a long period of time. In addition, this kind of technology had zero maintenance costs unless damaged by any external force.

Irrigation especially in the arid geographies are the ones most benefited by this kind of technology. The primary reason for this is that utilization of solar energy represents a virtuous cycle which initiates from the rising of the sun which feeds the irrigation system and at the same time the crops require more water because of the intensity of the sun (Shahsavari and Akbari, 2018). Hence, there is a large availability of energy at the proper time. To be precise, it provides energy when it is needed the most. Hence, modern day agricultural methods emphasize on the utilization of such efficient energy sources, which is not only beneficial to the farmers but also promotes sustainability and causes no possible damages to the environment.

Smart in the new normal as changed to the modern era. Thus, its applications are being implemented in almost all sectors that are known to mankind. According to Liu (2018), smart agricultural systems are not anymore just a concept. With the real time implementations, it has gained immense popularity worldwide. However, there are several researches that are going on at the current time so as to develop these kinds of systems. The advancement of technology in the irrigation system has provided farmers with various benefits. Smart irrigation systems are basically an amalgamation of modern technology of sprinklers which enhances irrigation controllers as well as improves the coverage area. The water conservation system monitors the conditions that are related to the moisturization criteria and by doing so it automatically adjusts the process of watering the crops to the maximum level. Based on the evidence provided by Sushanth and Sujatha (2018), as of the present time there exists two major kinds of smart irrigation technology namely soil moisture based and water based. Both of these types are designed to save water to the maximum possible extent and on the other hand promote energy efficiency.

Smart irrigation technology is the combination of traditional technologies along with IoT or Internet of Things. IoT technology has marked its significance in each and every sector since its arrival and is constantly evolving at a rapid pace. This kind of system is required to be monitored constantly, more specifically in those areas that face a great scarcity of water. Farming operations might also witness various challenges that are associated with the requirement of energy for yielding better quality crops. The aspect of energy efficiency is largely researched from various points of views. The recent technological advancements within the agricultural sector might provide efficient solutions to these kinds of challenges

and could also assist to control the yielding process of any crop in accordance to the fluctuating climatic conditions.

Therefore, it is quite clear that the traditional systems must be replaced by IoT driven agriculture irrigation systems powered by solar energy in order to avoid such problems and also to increase the productivity and profitability by reducing the costs. As stated by Mishra et al. (2019), smart irrigation systems can not only save energy and money but also, they have the ability to inform the users earlier in case of any possible malfunctions. However, the odds of any potential malfunction are astronomical in these kinds of systems due to the fact that they are more task oriented. Understanding the value and potential of new and developed modern agricultural systems is the key to achieve durable success. The fact that modern problems demand modern solutions is inevitable and is also the scenario in the context too (Mekala and Viswanathan, 2017). By following the trend of utilization of technological advancements, in order to enhance the yield and quality of crops, this thesis emphasizes on developing an IoT (Internet of Things) based smart agricultural irrigation system which will be powered by solar energy.

2 Objectives and Methodology

2.1 Objectives

The main objective of the thesis is to design a smart agriculture irrigation system powered by solar energy to meet the increasing demand for energy in the field of agriculture using solar energy for farmers.

Partial objectives are:

- To analyze the current approaches in smart agriculture.
- To analyze the possibilities of solar-powered devices in agriculture.
- To analyze the possibilities of sensor equipment for soil analysis.
- To evaluate the proposed solution and to make recommendations.

2.2 Methodology

The review of the topic is based on a significant review of scientific and expert literature. The data is collected from various articles, a case study of Solar Powered Irrigation Systems (SPIS) Technology, Economy, Impacts. The qualitative data to be used in the study comprises drip irrigation, solar energy, nutrition balance, sunlight effectiveness, aggregate water supply technique, project realization phases including investment plan, etc. to analyses usage of smart devices to grow crops/animals in weather conditions. Through this, the smart device's performance was analysed and evaluated so that any conclusions can be reached with recommendations for better implementation, based on current trends. Any problem areas that need to focus on various evaluation measures and the farming sector have been researched so far.

3 Literature Review

3.1 The proposed Solution

In this study, research identified the energy released from the sun, solar energy to automatically pump water into a grass-root level tank, from the water reservoir or tank by using the solar energy gathered from the solar panels. Unlike the traditional system of pumping out water from the bored well to another well and later pumping it out the field, in this method only one bored well is required, thereby pumping the water into a ground level water reservoir. From this reservoir we supply the water to the fields. This facilitates saving some major amounts of energy and thereby is an efficient use of renewable energy. A valve is used to control and regulate the flow of water onto the fields according to the moisture requirement of the field by using a smart new algorithm (Subramani et al. 2020). By using soil moisture sensors, the detection of the amount of moisture present in the field can be monitored and the adequate requirement of soil moisture could be calculated. Depending upon the requirement of water, the soil can be hydrated, the water flow being regulated wastage of water can be avoided, thus conserving water and not over flooding the crop leading to crop damage.

The proposed solution helps to solve the crisis of energy for the farmers as government by reducing water wastage and prevents scarcity of water supply. The farmers can now not depend on grid power supply for irrigations, also human interference in the irrigation process is minimised by using solar energy which is a renewable source of energy. It is cheap, easily available and eco-friendly. By using smart techniques of solar energy, wastage of water is reduced; no electric grid power supply is required without any attention or rather says without causing any major hurdle, problems. It can be used in any agricultural fields to experimental plants (Maskara et al. 2019). Power achieved from solar energy is enough to run the proposed system to irrigate the land. To overcome the requirement of electric power supply and simplifying the process of irrigation of agricultural fields without erosion of the top soil and over as well under irrigation, it can be of alternate use.

3.2 System Description

Automated Irrigation System:

The system consists mainly of two systems- **automated irrigation system** and **solar pumping system**. In an automated irrigation method, the water releasing valve of the reservoir could be electronically controlled by using a sensor that detects the soil moisture level (Ramachandran et al. 2018). This electronic sensor could be placed anywhere in the agricultural land where the crop is to be cultivated. The electronic sensor captures the data collected by converting soil water into equivalent volts. This electronic moisture sensing circuit receives the data and tells the hydrational level of the field with a reference voltage, the farmers could be easily controlled and adjusts the moisture level according to the crops to be grown. The amount of requirement of water for the soil is proportional to the distinction between the 2 voltages (Susmitha et al. 2017). A signal to control is to be sent to the 12 v DC submersible motor whose angle of rotation is in proportion to the difference in voltage. The stepper motor then controls the flow of water by adjusting its cross-section area of the pipe. Thus, it can be said the water supply amount is proportional to the difference in moisture.

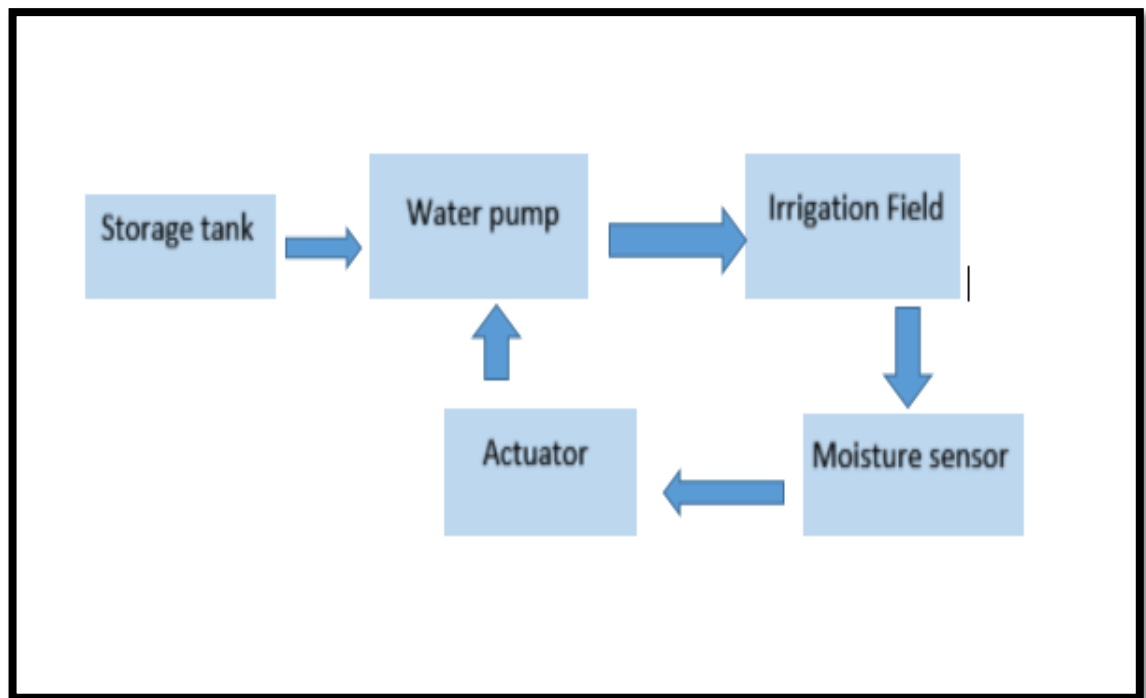

Figure 1: Block Diagram of automated irrigation system

(Source: owner)

3.3 Solar Pumping System work.

During the evening time or during low daylight time, the charge regulator gives capacity to the water system framework from power put away in the battery. In the core of the framework there is a regulator, which comprises of numerous processors, this processor has gained notoriety for its operational speed, and is moderately modest in contrast with any standard miniature handling units, including unwavering quality, long life and simple upkeep. A hand-off board can be utilized to be an interface for the bilge pump and stomach pump, which in turns controls the water system measure. At that point utilizing a control circuit it is utilized to charge a battery.

From the battery utilizing a converter circuit it offers capacity to the water pump which is lowered inside the well. At that point the water is pumped into an overhead tank for putting away water incidentally previously delivering the water into the field. In programmed water system module, the water outlet valve of the tank is electronically constrained by a soil humidity detecting circuit. The sensor is set in the field where the crop is being developed. The sensor changes over the humidity content in the soil into identical voltage. This is given to a detecting circuit which has a reference voltage that can be changed by the rancher for setting distinctive humidity levels for various harvests. The measure of water required for soil is relative to the distinction of these two voltages. A control signal was given to a stepper engine whose rotational point is relative to the distinction in voltage. The stepper engine in turns controls the cross-sectional zone of the valve to be opened controlling progression of water. Hence the measure of water streaming is relative to the humidity distinction

In a solar pumping system, a solar panel of a required specification is needed, which is to be placed near the pumping station of the pump (Biswas et al. 2018). Then by using the control circuit mechanism it is used to charge the battery. This battery is of great value as it stores the solar energy; from this battery power supply is provided to run the water pump.

3.4 Data Acquisition Sensing Unit or DAQ-sen

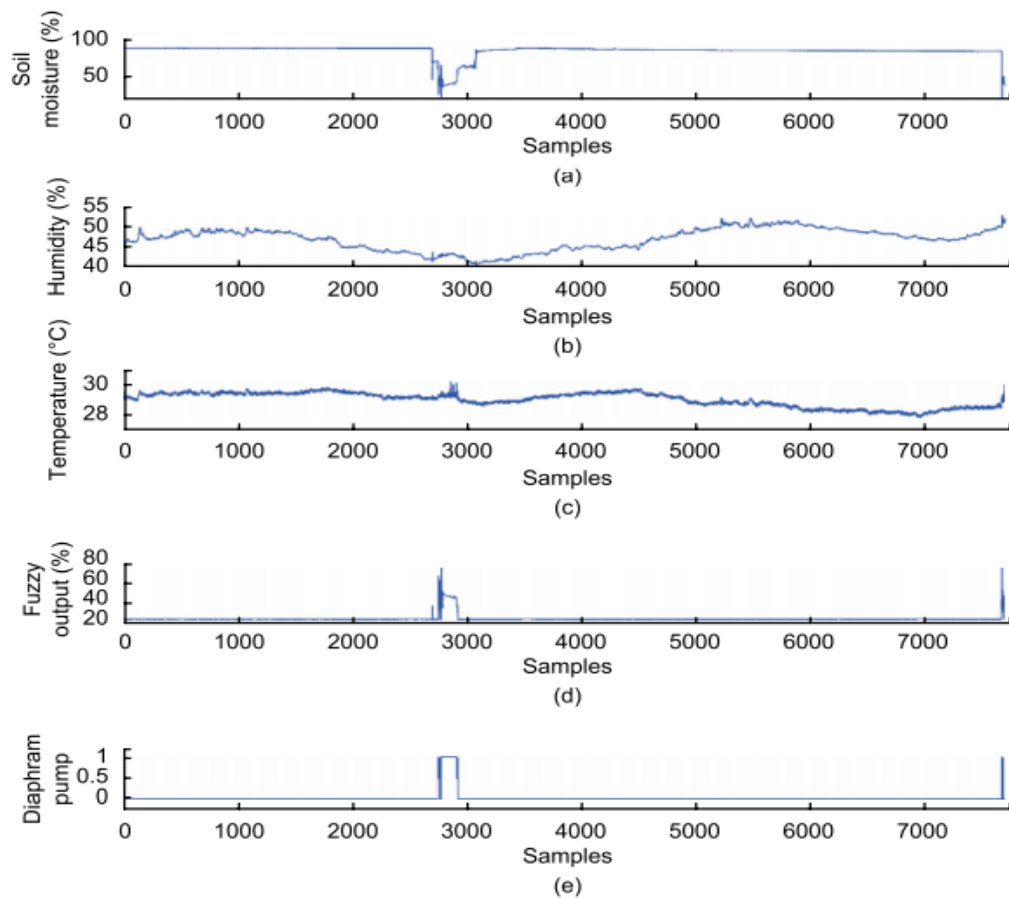

Figure 2: Effect of varying soil moisture: (a) soil moisture, (b) humidity, (c) temperature, (d) fuzzy output, and (e) diaphragm pump
(Source: Al-Ali et al., 2019)

The data acquisition sensing unit or DAQ-Sen is made up of several actuators and sensors, each of them which can be considered to an object and has an access to a unique Internet sub-address that facilitates the farmer to access it through a mobile-app. This is where the IoT concept comes to play. To allow the farmers and other users along with the system to access, read and collect data from the sensor and authorize the actuator, a class containing a set of functions is developed. For example, object, an instance of a class can be used read the environmental variables such as soil moisture, humidity and temperature

Another object (an instance of a class) is responsible for sensor reading. Also, an object (an instance of a class) can be created to control the actuator pump it turns on or off,

according to availability of water in a reservoir or water tank or in the water table. The humidity sensor, flow sensor, temperature sensor, and soil moisture sensor give analog inputs into the controller. The digital inputs such as the high as well as low water level float switches monitor the maximum and minimum water levels in the water reservoir. Likewise, the bottom float switch is an integral part of the system, as it can be used to turn off the diaphragm pump before the storage tank gets completely emptied.

3.5 Concepts of Solar Powered Irrigation System (SPIS) Plant

Variability of Global Solar Radiations: In comparison to the traditional or the conventional energy, the solar energy has various characteristics that are necessary to consider in every solar application. The solar radiations captured by the panels are not constant. As the sun rises in the east and reaches to a maximum height at noon time as well as sets in the west. It takes about 24 hours to reach from noon to noon the next day. The energy that is being carried by the solar rays to the surface over some time is known as the global solar radiations.

Configurations and Operations of SPIS Plant: Depending upon the water resources that are available as well as the site particular situations, the various configurations of the technical SPIS could be possible. The well water tank is the traditional configuration of the SPIS. The solar generator generates electricity for the submersible pump which is being installed in the well which is done via the inverter (Boursianis et al., 2020). The water which has been pumped has been stored in the water tank as well as irrigation has been done by the gravity. The Well Direct irrigation is done by the solar pump which is connected directly to the system of irrigation. So, the flow of the solar water as well as the flow of the irrigation water are similar.

Suitability in the Drip Irrigation: Almost every way of irrigation which includes flood irrigation, sprinkler, open irrigation as well as drip or the trickle irrigations could be utilized in photovoltaic water pumps. The PV generator size has been determined via the pressure as well as via the water requirements of irrigation (Fraga et al., 2020). So, the technologies of the water saving irrigation, works in lower pressure operations have been the preferable option connecting along with the systems of PV pumping. The solar power drip irrigation is the combination between the drip irrigation as well as the solar powered photovoltaic pumps.



Figure 3: Solar Drip Irrigation System.

(Source: Reddy, 2021)

3.6 Components Utilized in spis.

Technical Characteristics and Designs of Solar Powered Irrigation System

Smart irrigation systems using solar power have become a new system in the irrigation system which have aided the farmers worldwide. This smart irrigation system contains the water pumps which are solar powered together with the water flow control which is automatic by utilizing a moisture sensor. This smart irrigation system aids in conserving the electricity by decreasing the use of the grid power as well as aids in conserving the water by decreasing the loss of water. The solar pumps are utilized for transporting the water which are equipped with the solar cells. The solar energy that is absorbed by solar cells is converted into electrical energy by the generator that feeds the electric motor which drives the pump (Mukherjee and Sengupta, 2020). Solar energy is possessed with huge potential for irrigation using solar power as well as could be utilized for pumping the water for the crops and also for the livestock. The technical characteristics as well as the designs of the solar powered irrigation system includes:

The particular components that are used in the solar powered smart irrigation system are listed down below:

- 6V Solar Panel, its Charge Controller and its Battery
- Supply of Power
- Soil Humidity Sensor or DHT11
- Moisture Sensor

- Relay
- Breadboard Kit
- Nodemcu ESP8266
- TP4056 Charging Module with Protection
- Jumpers Wire
- DC Submersible 9V Pump
- CPVC/silicon Pipe of 7mm
- Rain Sensor
- Water level sensor
- Water flow sensor

3.7 Component description

SOIL MOISTURE SENSOR - The soil moisture sensor is used in measuring the volumetric content of water in the soil. As the gravimetric measure of the soil moisture needs removal, drying as well as weighting of the soil, the soil moisture sensor is utilized for measuring volumetric content of water by utilizing the properties of the soil which includes the dielectric constant, electrical resistance, as well as the communication with the neutrons as the proxy for the content of moisture. The relationship between the soil moisture as well as the measured property should be calibrated as well as might vary which depends on the environmental factors which includes type of soil, electric conductivity as well as the temperature of the soil (Velasco, 2020). The reflective microwave rays are being affected by the moisture of the soil as well as is utilized for the remotely sensing in agriculture as well as hydrology.

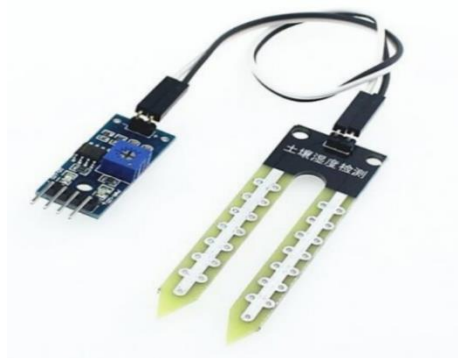

Fig 4: (Source: "Soil Moisture Sensor Module", 2021)

- The soil moisture sensor is utilized in the testing of the soil moisture at the time of shortage of water in the soil. The module output will be of higher level when there is shortage of water, else the module output will be of lower level. By utilising the soil; moisture sensor, the individual could water the crops automatically (Ojo et al., 2020). This technique is also utilized in the various applications of research which includes the agricultural sciences as well as in the horticultural sciences which further includes climate research, irrigation planning.

- **RELAY** - The relay is the switch which is operated by electricity. Various relays utilize the electromagnet for mechanically operating the switch, however the other operating fundamentals have also been utilized which includes the solid-state relays (Samuel et al., 2020). The relays are utilized where it is needed for controlling the circuit by individual lower power signals as well as in the places where various circuits are being controlled by a single signal. Relays are also used for controlling the higher voltage as well as the higher power circuit along with the circuit of lower power.

1-channel 12V relay module, Low level, 250VAC 10A: This is basically a relay module which has the light coupling feature and it also have 12V module standard of safety which controls or measures the load which a particular or acknowledged area have and the groove also have the isolation feature which issues the module based on the coupling which is coupling. It protects a sort of efficient delicate control circuit. There is a vast range of microcontrollers which are ARM, PIC, AVR and many more (Sekkal et al. 2020). Even the Arduino is one of them. The wiring up structure is quite easy and has the terminals of C, NC and NO in the screw's areas are accessible and easy in nature which takes help of the mentioned functionalities. There is no change in the contact position created when there is no supply to the coil. And when lastly the supply is produced or being generated the Normally Closed and Normally Open, open up. And the coil remains unchanged till the energy is being restored and comes to a position or condition where the work can be restarted. Here the level which is high is considered in the usage of the anode voltage at the connection of VCC and it is triggered in the end (Triantafyllou et al. 2019). So, the trigger has a positive voltage even when the relay is in off position. And here the low conduct of voltage refers to the negative voltage at the level of GND connection and in the end when the side of

the trigger has 0V low voltage the voltage can initiate the trigger when the relay is in off position. Here a freewheeling diode is present to protect the microcontroller. The ON and OFF condition can be checked through the help of the LED indicators.

RAIN SENSOR - The rain sensors or the rain switches are the switching devices that are activated by the rainfall. This is utilized in the devices of the conservation of water that are connected to the smart irrigation system which have caused the system to shut during the rainfall.

ULN2003A - ULN2003A refers to the array of the transistor of seven NPN Darlington which is capable of 500mA and with an output of 50 V. The use of the ULN2003A is applied in the driver circuits for the relays.

Solar panel 6V 3W: This particular solar panel has a silver coverage which is considered as waterproof and it is also scratch resistance even with the high UV rays this certain solar panel has the ability to feature its resistance quality and the abilities which can be used in the irrigation purposes and it has also a cell which has the monocrystalline cell operation (Valecce et al. 2019). This small panel of solar issues or provides an output of about 6V at the rate of 180mA via the 3.5mm* 1.1 mm of the direct current jack connector.

The mentioned solar panel comes in an aluminium or the plastic component and it is specifically designed or structured by which it can increase in durability and also maintains its light weight. This solar panel can be kept outside for the usage and it is also suitable for the activities that are held outside. It is efficient up to 19% and it is embedded with the easy screws setting. The particular product weight is up to 67g. It has an output cable which is Red PU coated. It is used for the outside potentiality because of the high capacity and several distinctive specifications and effective and efficient usefulness.

For electrical insulation as well as for structural stabilization, the embedding solar cells are placed in between the glass cover in front and the plastic cover in the rear side (Togneri et al. 2019). Depending upon the necessary electrical output such as the power, current as well as the voltage, various solar panels are linked in series or in parallel format for forming the solar generator. The electrical power of the panel mainly relies on solar irradiance that is being captured by solar panels as well as the temperature of the solar cells

Water Pump (submersible pump): So, this is basically a structure that is in the shape of the pump head which adopts the buckle design but without the utilization of the screw and it can be even removed without the help of buckles and without pressing it. Its feature has the facility of cleaning the product in a very easy way and it is also easy to maintain. It has support of CW and CCW in which the switching supply of the power has negative and the positive pole. The flow of direction can be controlled by the help of the negative and the positive connect. The small structure of the dosing pump has the functionality of the self-priming. Hence this is used in the experimental field and in the other usage objectives as well which are medical and biochemical analysis, in the areas of the pharmaceutical, in fine chemicals, in the technological fields and in the protection of the food, family and the environment (Strobel, 2020).

There is a controller, which consists of many processors, this processor has gained a reputation for its operational speed, and is relatively cheap in comparison to any standard micro processing units, including reliability, long life and easy maintenance. This controller can have many input and output channels with digital input and output lines and WIFI signal receiver The flow rate in the silica gel tube can be measured as 1*3 silica gel tube can initiate the flow of 11ml per minute, 2*4 initiate the flow of 39ml per minute and 3*5 can initiate the flow of 80ml per minute.

IoT ESP8266 Lua Nodemcu V3 WIFI module: This is a source which has an open framework of the prototypes and the development kits are also present in relation to the IoT products and with compact lua script lines. So, the node Mcu is an open IoT platform which includes the functionalities which runs the ESP8266 WIFI module and the certain hardware is based on the module which is named as the ESP-12. The certain term which is Nodemcu which is set as the default refers to the work that takes place into the firmware other than the kits that are based on the development. So, it is based on the Lua scripting language and it is built on board by the usage of USB-TTL converter that is serial type and is dependent on CH340G with the USB socket that is considered to be micro (Froiz-Míguez et al. 2020). The pin headers measures about 2.54mm, 15*2 rows.

The Wi-Fi networking is used as the access point or the certain station or as the host which presents the web server which ensures to connect the internet to fetch or to upload data. Here the ESP8266 uses a vast amount of current or so if a certain

difficulty is being based then it can be considered as the plugging is not on the point so the following cable must be connected to the motherboard USB port or the powered hub of USB. there shouldn't be any other usage of the monitor or the keyboard.

Breadboard: In this kit the parts that resemble the whole kit and those are 830 pin solderless contact field, supply of power module for the beard board and it is 5V, 3.3V power supply it has also the connecting cable for the battery which consists of 9V. So, the most applicable way of connecting the non-soldering voltage field is to plug into the breadboard and utilizing the USB or the adapter for the supply of the power. And the module can connect the power to different two voltage branches. The 3.3V and the 5V can be chosen by the alternation selection of the jumper and the one which is most favourable or preferable (Ramachandran et al. 2018). It is really practical in the usage of the multilevel connections of the voltage and signalling of the LED switch is also being included here. The input voltage or the USB Power supply is up to 6.5-12V direct current. Whereas the output has two independent outputs and that is 3.3V or 5V. It also has the alkaline substitute facility and the property of a 9V battery. There is no shortcut conductivity and the functionalities.

Li-ion cell charger TP4056 with micro-USB protection: In this module it utilizes the TP4056 charge controller and the separate protection of IC and there is also the different sort of modules that uses the TP4056 but these all does not have any sort of protection circuits operate IS which will provide the necessary protection and the lithium-based batteries (Pinzón Trejos et al. 2018). The particular module uses both the TP4056 and the DW01A these follow the specific following function in the practice of the protection. The constant current and the voltage of the current controls the charging of the connection lithium battery. And here the modules will safely and securely charge the battery up to 4.2 V and the overcurrent and the sort of circuit protection is available on the demand of the USB protection. So, the voltage level is pretty connected to the batteries and the module will charge with the 130mA current until the battery is fully charged and reaches to a certain level of the voltage which is 2.9V and again in the meantime the increase of the current will be initiated and the time of the current will increase and will configure out the current that is charged.

The flow of current and the protection from the short circuit will happen which switches the modules off the batteries when the discharge rate is exceeded to 3A and the output is shortened. Though the current and the model reduce the output power and discharge of the battery via the MOSFET diodes.

Here the modules consume very less current when the battery is connected and it is definitely a good idea to keep the battery connected for a long period of time though the charge of the battery is for the period of the 4 months and it being recommended to disconnect the module from the battery.

Samsung ICR18650-22P 2200mAh - 10A: The original Samsung ICR18650-22P is reusable and rechargeable and it has the lithium-ion battery and it consists of the capacity of 2200mAh. Here several months have been spent in the research and in quality assurance of the 18650 batteries with a good performance and the functionalities and the high assurance of the capacity. This is one of the flashlights that has been chosen from the well-known company Samsung which has the largest capacity ever and it can also be handled in the procedure of the discharging which is up to 10A this either have the smaller and the continuous discharge of the particular current or its significant of the cost is more. It comes with the fraction of the capacity when it is compared to the other devices and to the original (Hassan et al. 2020). There are certain particular in this which are there no protective circuit, the nominal capacity is 2200mAh and the charging method is of CC and the CV types, the time charging consumes about three hours and the speed is approx. 2.5 hours, the related voltage is 3.7V. The end of charging includes 65mA

Step-up boost converter with MT3608 micro-USB: It is a continuous and a constant mode of frequency which sets up the model of the converter with MT3608 microUSB which is intended to be small and low applications of the power. The MT3608 optimizes and switches up to the level of 1.2MHz and holds the tiny and small modes of the current which helps in the extension of the battery and the longevity It has an automatic feature of shifting which issues the pulse frequency and the modulation at the field of the light loads (Baviskar et al. 2020). This system or the operation includes the under-voltage lockout, limiting the current flow and the proper thermal flow which protects from the overloading. And this comes in the ultimate cost-efficient price and

its way is more reasonable and it also includes any features and those are it is power MOSFET, has fixed switching frequency which is of 1.2MHz and the input of the voltage is from 2V to 24V. It also includes the adjustable feature of output voltage; an internal compensation is present. And the output voltage is up to 28V.

3.8 Cost Analysis and Limitations

Solar water pumps can play a massive role in the sustainable usage of water in the irrigation process as well as can cut down huge amounts of expenses since a huge amount of tube wells are used for the purpose which cost a lot of money beside the expenses on electricity which makes this a viable option for saving electricity as well. Although the primary expenditure is a bit high but it can be redeemed back in a short span of time assuming the costs of electricity as well as the efficient saving of energy. Meanwhile the excess energy can be provided to grids with little investments which can in return increment the revenue of the farmer. Compared to the normal system of irrigation, the cost of operating the solar panels is comparatively much less since no fuel is required in solar panels unlike pumps which is a major cost cutting factor. Also, the maintenance costs for a solar panel are very low since all it requires is a little cleaning once a week which makes it lower in maintenance over the normal irrigation pumps. Also, it gives a huge output when in times of dry months making it a viable option. And lastly is a small yet a significant advantage about the flexibility of the panels which have a range of 20 meters from the well.

But looking into the limitations we can find quite a few major facts. To begin with, it is not appropriate for places that require high yields so it has to be limited to low yielding places. Also, for its dependence on sunlight, the fickleness of the functioning of the solar panels must be considered before planning to place them. (Closas and Rap, 2017) The solar pumps mostly give their full efficiency during the afternoon while the least is during the early mornings and evenings Also, in case of solar pumps, it's a requirement that the well is to be cleaned properly before the installation of the panels or a good quality of filter should be used since the solar pumps work the most efficiently only if the water is clean and without any sand or soil.

Name of a product	Amount	Price in CZK
1-channel 12V relay module, Low level, 250VAC 10A	1 piece	38
Temperature and humidity sensor DHT11, module	1 piece	54
Battery box 4x18650 wire terminals	1 piece	28
Water pump 12V	1 piece	198
IoT ESP8266 Lua Nodemcu V3 WIFI module	1 piece	148
Breadboard Prototype Kit	1 piece	268
Li-ion cell charger TP4056 with microUSB protection	1 piece	24
Samsung ICR18650-22P 2200mAh - 10A	1 piece	128
Soil moisture sensor	1 piece	38
Solar panel 6V 1W	1 piece	128
Step-up boost converter with MT3608 microUSB	1 piece	18
Battery 24V,100Ah	1 piece	8250
Converter Circuit etc	1 piece	400
Solar Panel (1.4m2)	4 pieces	24000
	Overall Cost	33720 CZK

Cost Table 1. Source: self-developed

And lastly one major problem that solar panels face is the theft problem of the panels and the farmers aren't able to take any such precautions to prevent that. So, the solar panels before installation should be insured properly to minimise the losses of the farmers.

3.9 Water Management

Scarcity of fresh water is a concern for several countries. A connection has been made among the water management and climate policies. By different variables water management can get affected such as demand for water from several sectors. Water management in irrigation systems or agricultural systems is necessary. Water management is an important parameter in countries with scarcity of water. This affects agriculture, as a huge amount of water is preserved for that use. The global warming consequences lead to creating a measurement of water adaptation to ensure the water

availability for food consumption and production. Saving water during the irrigation process has increased from the past few years. Sensors for agricultural purposes are costly which is not possible for smaller farmers to afford this type of system. Almost half of the water in the irrigation system is wasted because of evaporation, wind and runoff.

The reason is that most irrigation systems rely on controllers and simple timers for scheduling (Tripathi et al. 2020). In recent times, several farmers are changing towards the use of solar energy for their needs in irrigation. low-cost sensors are offered by the manufacturer that connects the nodes for implementation of an affordable type of system for agricultural monitoring and irrigation management. Water can be used only when it is required and proper.

IoT helped farmers to control the water supply during the time of irrigation and avoid less wastage of water. As a result, low-cost sensors are offered by the manufacturer that connects the nodes for implementation of an affordable type of system for agricultural monitoring and irrigation management. Due to upgradation of WSN and IoT technology that can be used for the development of these types of systems.

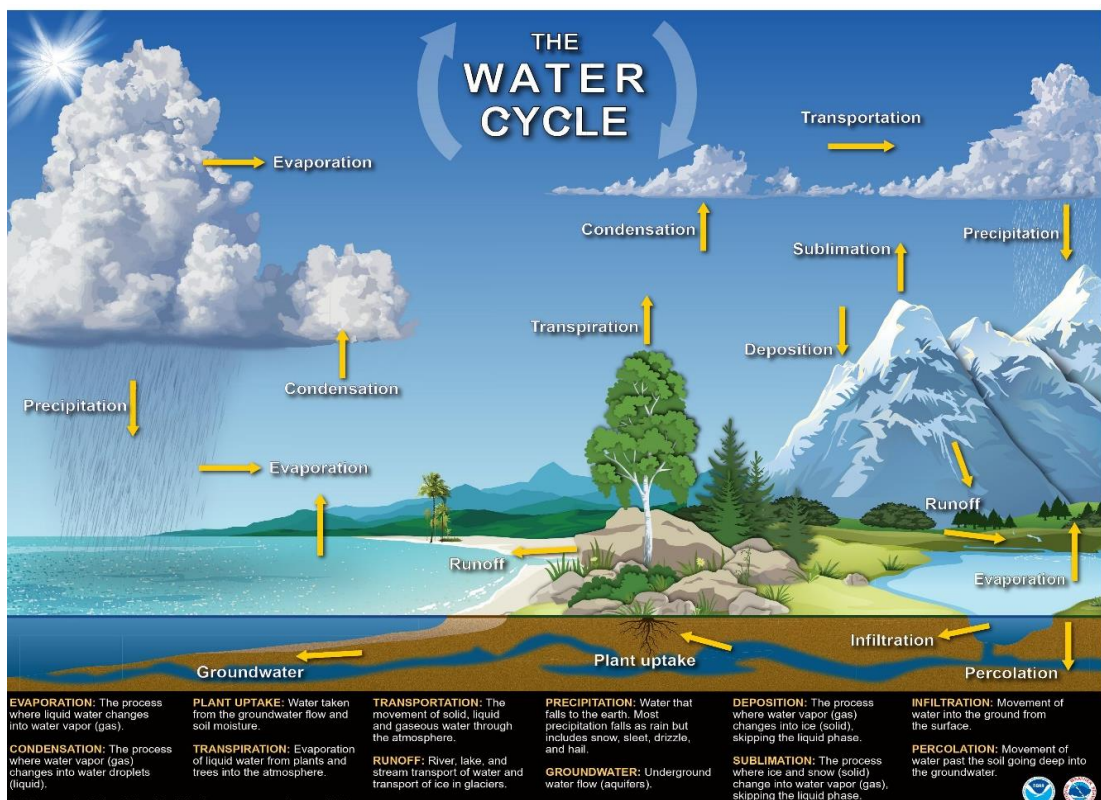

Fig 5: Water management

(Source: NWS Jetstream Max: Water Cycle Poster, 2021)

Water required for agricultural activities there are different techniques by which water can be distributed. A specific procedure is there for every specific crop. It has a great variety which can be categorized as follows: -

- Flood irrigation

- surface water system

Surface water system strategies depend on the rule of moving a water stream over the surface of the land in order to wet it, either totally or somewhat.

- sprinkler water system

It is the application and circulation of water over the field as a shower, or stream, which breaks into drops or drops made by ousting water under tension from a hole or spout.

- subsurface water system

Subsurface water system includes the utilization of water to crops through underground frameworks. In rule, two frameworks can be recognized, a covered stream water system framework and a discard water invasion framework.

- stream / dribble water system drip) (Prinz, 2007)

The guideline of stream water system is to water the plants through low stream pressure pipelines. Water system productivity is high, since misfortunes by vanishing are immaterial and permeation misfortunes are low.

Amount of water is not estimated or calculated in irrigation without any consideration. Schedule irrigation is a type when the supply of water is based on the needs in a period of year. The objective of maintaining water management is to improve sustainability and efficiency. This can be achieved by increasing the water productivity of crops through irrigation. Reduction in loss of water through evaporation of soil that can be used for the growth and development of plants. To increase storage of water in the roots

of plants through to better management of water and soil at farms. Water productivity can be improved by: -

- Water management to reduce loss of water by evaporation
- Using of better varieties of crop
- Use of improved agronomics and cropping systems.
- Low quality water can be used for non-conventional applications (which is not used for human consumption) like forestry.

3.10 Smart water dripping system

Farmers all over the world become resourceful during the time of rainfall. A technology is developed like an irrigation system to get the maximum crop yield and water deficits. Almost half of the water in the irrigation system is wasted because of evaporation, wind and runoff. The reason is that most irrigation systems rely on controllers and simple timers for scheduling. Water can be used only when it is required and proper. IoT helped farmers to control the water supply during the time of irrigation and avoid less wastage of water. It made the farming management smarter by proving the farmers to improve its efficiency by resource consumption. Water scarcity has been a major problem for agriculture (Dutta et al. 2017). Development of a smart water dripping system is useful for the farmers for farm irrigation using an automation system which is automated based on ph, moisture content and temperature of soil. Using a respecting sensor to determine the content of soil water level and based on this microcontroller drives the pump and the servo controller. The database of the irrigation system is updated using a personal computer. This particular technique works by installation of sensors in the field to investigate the type, temperature and moisture of the soil which transfers the data to the microcontroller for determination of quantity of water accurately as per their requirement (Torshizi and Mighani, 2017).

The data which has been collected is updated in a proper interval of time to the server and can be operated by using an android app. Almost half of the water in the irrigation system is wasted because of evaporation, wind and runoff. The reason is that most irrigation systems rely on controllers and simple timers for scheduling. In recent times, several farmers are changing towards the use of solar energy for their needs in irrigation.

low-cost sensors are offered by the manufacturer that connects the nodes for implementation of an affordable type of system for agricultural monitoring and irrigation management (Difallah et al. 2018). Purchasing oil is quite expensive. It gives an impact on the change in climate.

Solar power when used in irrigation systems decreases the dependency on oil. Import of oil is not required for countries which are having solar panels. Solar power has the capability to contribute to renewable energy as well as rural electrification. Energy subsidies can be decreased for fossil fuels. The further watering of plants can be controlled by using the application. Depending on the type of crop and the soil, fertilizer is suggested by application of Naive Bayes algorithm on the database. The required amount of rain is determined by weather forecasting using the crops and web scrapers are watered, that is prediction of heavy rainfall is done then there by reduction of water supply in the crops automatically.

Advantage of using a smart water irrigation system: -

- Cost saving due to reduction in water level.
- Human efforts are minimized
- A combined view of characteristics of soil which includes nutrition and moisture contents.
- Smart notification in case of any abnormalities
- Better landscape health.
- Internet of things system for smart irrigation.

To achieve this benefit, a smart water irrigation system makes use of the Internet of Things sensor. These sensors render real time data and places in the field to a central gateway and then switches to a water pump automatically whenever temperature or moisture values are outside the predetermined ranges. Increase in pressure on the existing water increased the necessity of water management for the sustainability of irrigated agriculture (Hernandez et al. 2019). The aim of smart water dripping is to minimize manual intervention, to make a smart irrigation system, sufficient and autonomous.

3.9 Smart Irrigation Systems for Agriculture Using Iot

Agriculture is the biggest livelihood provider for many countries. Increase in population will lead to increase in production of agriculture. To support more production, the requirement of fresh water quantity is also increased. There is a huge requirement to develop a system which can conserve water by preventing wastage of water without putting any kind of pressure on farmers. Software systems and computers are presently used by farmers to manage their financial data and control their transactions with other parties and also investigate the effectiveness of the crops (Kamienski et al. 2019). Renewable resources, natural gases or diesel are more efficient than solar plants. These moisture content values enable the usage of a system with appropriate quantities of water. IoT is used in irrigation to keep an update about the status of the water sprinklers to the farmer. Information which is obtained from the sensor is updated regularly on a webpage by using GSM-GPRS SIM900A model by which a farmer can monitor where the water sprinkle in on or off at the given time.

Types of internets of things sensor for smart irrigation system:

Soil sensor- it collects related data about volumetric content of water, electrical conductivity, salinity and other parameters. The irrigating time system depends on humidity and temperature reading from the type of crops and sensor and have the ability to irrigate the field automatically when unattended. Information is interchanged between the design system and the far end through SMS on the network of GSM. Interference of the Bluetooth module with the main microcontroller chip rejects the charge of the SMS when there is a limited range of the user to designate the system (Tamburino et al. 2020). About several conditions, the system informs its users about moisture content in the soil, rise in temperature, dry running motors, electricity status and smoke through SMS on Bluetooth or GSM network. The system of IoT SMS alarms is based on SIM900A. The system can collect parameters of the environment such as air humidity and air temperature. Using an automatic microcontroller for irrigation systems where the irrigation system will take only when there will be a huge water requirement that saves a huge amount of water. The change brought by this system of field resource where development of software stack is called, using an android device which consists of operating system, key application and middleware. The tool is provided by the android SDK APIs importance to start developing applications on the

platform of Android using the JAVA programming language. Mobile phones have become an important part of people which are serving several human needs. The farm activities can be automated by transforming agricultural domain from being static and manual to dynamic and intelligent leading to greater production with less supervision of humans. The automation irrigation system which maintains and monitors the desired amount of moisture content through automatic watering.

The system is proposed in a combination of software and hardware combination. The software part consists of a web page designed using PHP and hardware containing embedded systems. Hosting of the webpage is done online and contains a database in which hardware is used for reading from sensors. Soil moisture sensors YL-6p with LM393 comparator modules were put in different types of condition of soil for analysing. The YL-69 sensor is prepared with two electrodes. The moisture content can be determined with it. Current is passed in the electrode from the soil and the soil current resistance determines the moisture content of the soil. If more water is present in the soil, there will be less resistance and more amount of current will pass. Similarly, when there is less moisture content in soil, a high level of resistance in the sensor module. This sensor has both analogue and digital output. The use of digital output is simple but the accuracy is not as analogue output. Sensor's information is transferred to the Arduino board. Microcontroller ATMEGA328P is present in the Arduino board which is responsible for the on and off switch controlling the motor in which sprinkles of the water are attached. The IoT section contains a web page which contains the status of the current water sprinkler in its display that is on and off button. Agriculture is growing very fast in a data intensive industry where farmers are required to evaluate and collect a large amount of data and information from different devices such as farming machineries. The control of water sprinkle can be achieved by setting a threshold value in which the beginning of irrigation can be done. Using an automatic microcontroller for irrigation systems where the irrigation system will take only when there will be a huge water requirement that saves a huge amount of water. When there is less moisture content and when the switch of the sensor is on.

3.10 Soil Monitoring

The particular segment of soil monitoring issues uses IoT technology which empower the persons like farmers and the producers by which the increase of yield can be

generated and it also reduces or minimizes the disease and resources are optimized. The sensors which are related to the IoT can initiate the process of measuring the accuracy and the temperature of the soil with the components that are based on NPK, water content volume., radiation of the photosynthesis, potential of the soil levels and even the level of oxygen that is produced from the soil and its level (Abayomi-Alli et al. 2018). After these processes are being generated the IoT transmitters travel back to the central point or in the cloud for the next and the further analysis and the monitoring of the trends. And the results can be used in the further optimization of the farming operations which will critically analyse the subtle and proper adjustments in regard to the conditions and it will help in the crop development and in the production of the rich quality. The utilization of IoT in the particular field of agriculture is known as Smart agriculture or the process of smart farming. The IoT is the main and important objective or component which helps in the precision of the farming. There are some sensors that are IoT based and are listed and elaborated down below:

- Temperature of the soil is important in the farming process which helps in the conduct of the temperature that occurs belowground. The plan activity includes the respiration, decomposition of the soil and measures the adequate minerals that are present in the soil. And based on these certain factors multiple solutions are being taken and many operational systems are being installed (Karar et al. 2020). The surface layer and its temperature are being audited by the IR technology which is based on the IoT technology.
- Solar based radiations can be measured by the usage of the IoT sensors the radiations that are based on solar energy plays a crucial role in the part of photosynthesis. The light waves can be measured by the following categories and they are solar which radiate the photosynthesis, UV rays and shortwave (Maskara et al. 2019). These radiations can create a real effect on the growth of the plant but the IoT based devices can measure the radiations which helps in the understanding of the correlations and the approaching trends.



Fig 6: Soil monitoring
(Source: Baladi and Shah, 2018)

3.13 Controlling the setup in smart irrigation system

Controlling a smart irrigation system is not at all a difficult task, one just needs the proper knowledge of the functioning of the system. The system itself is a simplified one which makes the user easy to control and access it. A smart irrigation system consists of a well oriented setup that is controlled centrally. This setup has a smart scheduler and a user interface (Munir et al. 2018).

Controlling smart irrigation system using Blynk app: Controlling smart irrigation systems using the Blynk app has been much easier after the introduction of this particular application in the acknowledged field. It was discovered by the person named Pavel Baiborodin so this certain person founded this application and now it has a platform with the collaboration of IOS and the android apps which controls the functionalities of Arduino and the Raspberry Pi which ensures the collectively of the likes through the internet (Assaf and Ishaq, 2020). It is basically a digital platform or the dashboard where all the graphical interfaces are projected for the people's convenience and iot is simple sand solved dragging and dropping of the widgets.

Therefore, Blynk Application is the new and the innovative platform in which it allows the users to build quick interfaces for the controlling and the monitoring purposes of the projects that are related to the hardware from the system of the IOS and devices which are android too. So, after the completion of the download Blynk application a project can be created with the proper arrangements of the particular buttons and the sliders that a dashboard project should consist of, even the graphs are also included with the extra advantage of the widgets that are lying onto the screen. In the blynk app it is assumed that the job can be investigated, altered and incorporated with the coding. It is easy to use in the platforms and devices like MacBook, windows, LINUX and operates and is inbuilt or already installed in the Java platforms that has its own functionalities. And the implementation is done by the various hardware and the program possibilities which helps in the initiation of the specific tasks through the help of the GPIO pins and the already present components of the system.

It helps in the IoT execution through the help and dependence of the prefabricated application or the functions which are intended in the reconciliation. For the establishment or the building of the application the Arduino IDE programming language is being utilized for the better results which can be manipulated in the achievement for an ESP8266 node and the MCU model (Putri et al. 2021). The change brought by this system of field resource where development of software stack is called, using an android device which consists of operating system, key application and middleware.

The tool is provided by the android SDK APIs importance to start developing applications on the platform of Android using the JAVA programming language. Mobile phones have become an important part of people which are serving several human needs. The farm activities can be automated by transforming agricultural domain from being static and manual to dynamic and intelligent leading to greater production with less supervision of humans.

The automation irrigation system which maintains and monitors. In the era of the internet network when information plays an effective role in the lives of people, agriculture is growing very fast in data intensive industry where farmers are required to evaluate and collect a large amount of data and information from different devices such as farming machineries, sensor to increase the efficiency of production and

communication of proper information and the development of the application has helped a lot in the achieving the desired outcome which was not possible only with the physical dependencies. Water can be used only when it is required and proper.

The use of digital output is simple but the accuracy is not as analogue output. Sensor's information is transferred to the Arduino board. Microcontroller Nodemcu ESP8266 is present in the Arduino board which is responsible for the on and off switch controlling the motor in which sprinkles of the water are attached. The IoT section contains a web change which contains the status of the current water sprinkler in its display that is on and off button. agriculture is growing very fast in a data intensive industry where farmers are required to evaluate and collect a large amount of data and information from different devices such as farming machineries. The control of water sprinkle can be achieved by setting a threshold value in which the beginning of irrigation can be done (Pradeep and Balasundaram, 2021).

PIR or the Intruder Detection Network:

Agriculture faces various issues due to lacking in the water resources. Smart Irrigation Systems have aided the farmers worldwide in resolving the difficulties. Various sensors which include DHT11, Soil Moisture as well as PIR or the Intruder detection network have been connected to the input pin of the Arduino microcontroller in these devices. The sensor values are sensed and displayed in the LCD (Penchalaiah et al., 2021). The PIR as well as the ultrasonic sensors are utilized in detecting the movements of wild animals and also sends signals to microcontrollers. This diverts the wild animal as this produces sound as well as signals which are then transmitted to the GSM and alerts the farmers and also the forest department immediately (Sasi, 2021). The human intruder is being detected by utilizing the Passive Infrared Sensor or the PIR. This PIR sensor is being connected to the sensor node of MICAz. This sensor is capable of detecting the intruder, be it human or animals and also gives the information related to the direction from where the movement is coming. The passive infrared sensor or the PIR refers to the electronic sensor that is utilized in measuring the infrared light that radiates from the objects in the farms (Casaccia et al., 2020).

The PIR sensors are being commonly utilized in the applications of automatic lighting. The Passive Infrared Sensors or the PIR are being used for detecting the movement in

general but does not provide any data or what is being moved. (Wu and Wang, 2020). These radiations are not visible in the naked eye by humans as these radiate the infrared wavelengths. The motion detector that is the basis of the PIR is being utilized for sensing the shifting or the movement of the humans as well as the animals and also other things which are also utilized in the burglar alarms by automatically activating the system of lighting (Abildso et al., 2021). Microwave sensors also send the EM radiations to and for in the area and if there is an animal or a human then the radiations are being interrupted and by this the microwave motion sensor rings an alarm. Whereas the Passive Infrared Sensor is used to detect the heat of the object or a person or an animal and by the sensor rings an alarm in this response (Andrews et al., 2020). The PIR motion sensors are not in use when the temperatures are more than 95-degree Fahrenheit. The simple method for defeating them is to turn on more heat in the area or to turn off the air conditioner or can do both. The PIR sensors are smaller as well as cost-effective, have lower power, are rugged as well as have a wider range of lenses which are simple for interfacing and to use (Gu, 2021). They do not wear out and are found in the devices which are known as the Passive Infrared Detectors or the PIDs.

3.13.1 Controls automatic the setup in smart irrigation system by Thingspeaks.

In this project I used to type of web based controlling system one is blynk and other is ThingSpeak is an IoT examination stage administration from MathWorks®, the producers of MATLAB and Simulink. ThingSpeak permits you to total, imagine, and examine live information streams in the cloud. ThingSpeak gives moment perceptions of information posted by your gadgets or hardware. Execute MATLAB code in ThingSpeak, and perform online examination and preparing of the information as it comes in. ThingSpeak speeds up the improvement of confirmation of-idea IoT frameworks, particularly those that require investigation. You can fabricate IoT frameworks without setting up workers or creating web programming. For little to medium-sized IoT frameworks, ThingSpeak gives a facilitated arrangement that can be utilized underway.

ThingSpeak Key Capabilities: ThingSpeak permits you to total, picture and examine live information streams in the cloud. With ThingSpeak, your information is put away in channels. Each channel saves to 8 fields of information. You can make however many channels as you need for your application.

Distantly Visualize Sensor Data in Real-Time: ThingSpeak consequently diagrams the information that you send it, so you can distantly screen your gadgets or hardware from anyplace. View your information from any internet browser or cell phone. Offer read-just perspectives on your information with the customers and partners that you indicate. On the other hand, you can utilize ThingSpeak to deal with your information, and you can construct your own front end for your customers and clients to sign in to. (thingspeak.com: source)

3.14 Benefits of solar powered irrigation

In recent times, several farmers are changing towards the use of solar energy for their needs in irrigation. To support more production, the requirement of fresh water quantity is also increased. There is a huge requirement to develop a system which can conserve water by preventing wastage of water without putting any kind of pressure on farmers. Software systems and computers are presently used by farmers to manage their financial data and control their transactions with other parties and also investigate the effectiveness of the crops. Due to upgradation of WSN and IoT technology that can be used for the development of these types of systems. Farming when done in a large-scale area is quite expensive as a result solar energy incorporation is beneficial there are several benefits of solar powered irrigation.

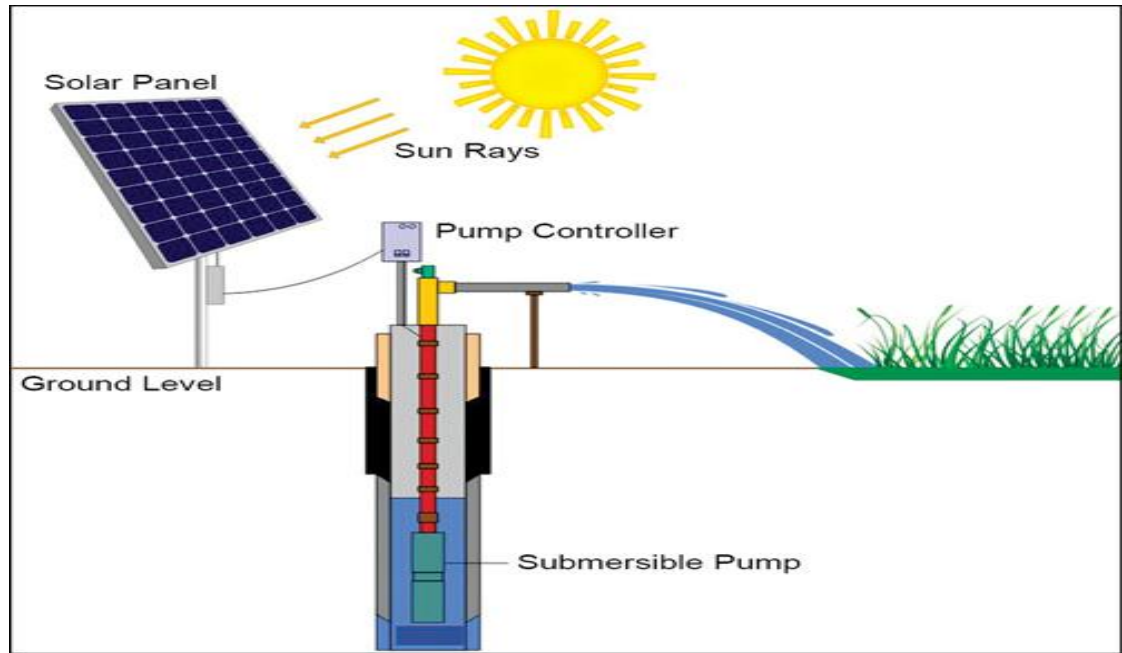

Fig 7: solar powered irrigation

(Source: Amariei et al. 2020)

- Solar based radiations can be measured by the usage of the IoT sensors the radiations that are based on solar energy plays a crucial role in the part of photosynthesis. The light waves can be measured by the following categories and they are solar which radiate the photosynthesis, UV rays and shortwave (Kamienski et al. 2019).
- Solar energy is environmentally friendly- Energy sources such as coals and biogas do not release greenhouse gases. The ideal characteristics of solar irrigation are because it does not have any kind of noise like generators. Water is not required much in solar energy for maintenance purposes. It will save water which can be further used for irrigation purposes.
- Solar energy is free- a monthly payment is required in electricity whereas solar energy is free of cost. Only solar panels are required to be installed in the farm.
- Solar energy can be used in place of electricity- electricity is used by the farmers in irrigation systems. Generators are expensive to run as well as maintenance, solar energy can be used as a most efficient alternative because solar energy depends on sunlight and the system is simple and straightforward (Padalalu et al. 2017).
- Efficiency- solar energy is efficient. Solar panels can be installed in solar irrigation systems, 100% of the energy which is generated can be utilized for

irrigation purposes and also other uses. Renewable resources, natural gases or diesel are more efficient than solar plants. When a pump is used with resources which are non-renewable it shows costly in the process. Quality of the food gets better. Because when renewable resources or diesel is used it makes the environment more polluted. Energy when developed from panels can be used for production purposes (Neupane and Guo, 2019).

3.15 Challenges in implementation of Smart Irrigation System

Lack of Infrastructure

It is matter of fact that if the farmers adopt this kind of technology, there will be no significant advantage to them as per the persisting infrastructure is concerned. This is because of the prevailing poor network connectivity prevailing in maximum geographic areas. Based on the evidence provided by Maddikunta et al. (2021), it is quite clear that agricultural activities are done in remote areas such as villages, country sides etc or in specific allotted places that are physically located at great distances from the general human residences such as cities and towns. The connectivity of the network is quite poor in the remote areas as compared to the towns and cities as a result it will be quite problematic to ensure proper connectivity within the devices that control the smart agriculture systems. The existing infrastructure is thus not sufficient to address this issue and needs to be developed in the near future so as to assist the farmers in undertaking the benefits by the implementation of smart irrigation systems.

Security Issues

When the IoT devices are implanted in the existing irrigation systems there arises some compatibility issues for the specific device while interacting with the existing system. Moreover, there is no guarantee that the existing systems will have the access to inter connection. And it is a matter of fact that without an internet connection the functioning of IoT devices is not possible. As stated by Yang et al. (2020), there is great need for the devices to access different kinds of vital data such as drone mapping data, landscape information, climatic data etc. Without the access of this kind of data the IoT devices cannot function properly. Moreover, the implementation of these kinds of devices will

dispatch huge volumes of data which can be difficult to control and thus will lead to the awakening of different kinds of security issues.

High Cost

The equipment that is required to implement this kind of system is quite costly and moreover the implementation process is much costlier, as far as the present scenario is concerned. However once installed, the maintenance cost is almost negligible given that there is no damage done by external sources, but the primary issue is related to the installation itself. As mentioned by Shilomboleni (2020), the implementation of this kind of system can cost a farmer thousands of dollars. Just the sensors in these devices can cost more than thousand dollars each and the fun fact is that sensors are the least in terms of costing.

Lack of Knowledge

One of the most important issues is the lack of proper knowledge among the farmers about this emerging concept. It is a matter of fact that controlling and understanding an IoT device can be quite complex if proper knowledge is not available to the user. Most the individuals of the farming community are not well educated and are still not compatible with the concept of IoT. However, there are also famers who have proper knowledge of these devices and some are already using this technology. But the fact is that this number is negligible as come to the ones who are not compatible with this concept (Fiehn et al. 2018). Thus, implementation of this kind of technology can be quite difficult without proper knowledge. Also, there is a possibility that without knowing the proper function of the specific features, if the devices are operated then they could produce adverse effects than the desired ones and also can lead to the damage of the entire system.

Complex structure

Developing such a technically advanced device requires complex algorithms and data sets which are quite different to code and manage. Moreover, farming lands are of different geographies, as a result different system will have different kinds of datasets

which can be quite challenging to develop. Implementing them in large scale is rather more complicated due to the different nature of land for instance the fertility of the soil differs from region to region, the climatic conditions also differ in the same (Bu and Wang, 2019). This kind of difference can hold significant challenges in its implementation. Different devices will need different datasets which are very difficult to develop and will also cost more. As a result, there is an utter need to develop such a system which has unified datasets and can perform according to any piece of geography without any possible issues.

4. Practical Part

4.1 Overview of SPIS in India

The current boost in the growth of markets that India & other countries of world is undergoing, appears to have a huge potential in terms of the PV market. A wide range of Solar Powered Irrigation Systems (SPIS) elements have started their production in India. A total of nearabout 12 million grid supplied electric and almost 9 million diesel irrigation pump sets have been operating in the country for the purpose of providing water to almost 39million hectares of land for the purpose of irrigation. To enhance the market of SPIS technology, many international benefactors as well as the Indian government itself are providing allowances along with other kinds of support whichever is important as well as for the demonstration of SPIS technology and thus making an effort in getting a hold at the adoption of SPIS. In that effort, the Ministry of New and Renewable Energy (MNRE) in the early period of the introduction of SPIS also provided various financial aid for financing the amount along with the costs for the solar pumps.

Agrarian fields of farmers are normally might be found miles away from their home. Once in a while, farmers need to make a trip to their horticultural field many occasions in a day to begin and stop water pumps for water system. They can't watch or protect the crops against rainfall or heavy wind time or season. To eliminate these viable hardships, a framework is intended to deal with this multitude of issues consequently. The Smart irrigation system powered by solar energy, system controlling and the end device node, node comprises of Arduino board node MCU esp8266 regulator, Wi-Fi, motor, soil moisture sensor, temperature sensor, rain sensor, water level sensor, and humidity sensor additionally solar panel charger unit to charge the battery to run this framework. The microcontroller device is utilized as the end device just as the coordinator device in the wireless sensor network. It is utilized for information correspondence in the network. Information is constantly gathered from sensors and afterward sent to the coordinator node, which is associated with the thing.speak web server framework likewise by USB sequential transport. The information obtaining is done in the web server for continuous checking of farmland boundaries. From the server, information can be acquired and seen on the Android phone or desktop. Then, at that point, the control signal is consequently shipped off the coordinator node from

the Android application. At whatever point the end Device gets a sign from the coordinator node or node, it acts as per the got signal whether the motor is on or off.

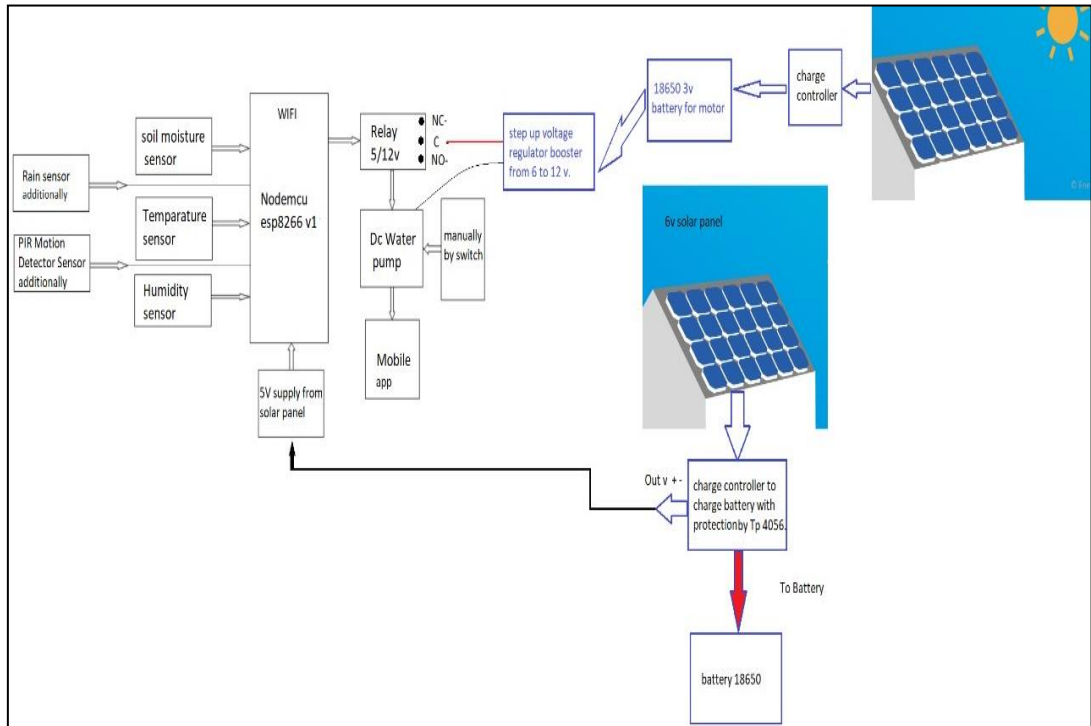

Fig 8. The overall working block diagram is demonstrated in fig.

(Source owner)

The motor on-and-off process for water system is outlined utilizing fuzzy logic. The regulator is customized dependent on fuzzy principles. As needs be, the framework assists farmers with controlling motor and water utilization as indicated by farmland necessities even through remote checking of horticultural fields. Arduino node MCU and its esp8266 inbuilt WIFI get introduced when the power supply is diverted on from the battery associated with the sunlight-based charger to charge it. After the introduction cycle, will likewise developed the framework asks that will request that clients select either the manual mode or the programmed mode yet at the present time this will run naturally definitely have to choose crop or need to enter the humidity or moisture level in soil that is it now framework will run all alone and we will have desired water supply inland. Additionally, when the programmed mode is chosen, the Arduino at first checks the accessibility of sun-oriented energy with the assistance of a Light Dependent Resistor (LDR), which is utilized for detecting the daylight. Here,

the sun powered charger is mounted upon the stepper motor to uncover the sunlight-based charger to the light as indicated by the movement of the sun. When there is no accessibility of sun-oriented energy, the framework runs on battery and for reinforcement, it tends to be powered by off grid main supply.

The water level sensor connected to this framework is utilized to demonstrate the water level in the tank of the agrarian field. Relay is connected to the pump, what starts pumping water to the agrarian field when the soil moisture sensor distinguishes the land is dry. A humidity sensor is utilized to detect the soil humidity of cropland. The temperature sensor identifies the encompassing temperature of the farm field. At the point when it begins rain the pump naturally quits pumping water to the field to save power and updates data to the client utilizing thing.speak web. Later on, I will like additionally to add a full land covering rooftop board to ensure crops which will be consequently cover itself to secure the yield getting impacted by rain, so by this soil disintegration and harm to plants will be saved. Information gathered from sensors are shown utilizing Alpha-Numeric Display on the site of thing.speak, likewise we design it when a manual mode is chosen, insights concerning the rural field are refreshed to the client simply by blynk application and the client needs to wind down on and turn the framework by his end just, so in this both programmed mode automatic mode is standard where there is no human or less association required.

4.1.2 Architecture of Smart irrigation system

In this undertaking, we will utilize the Arduino microcontroller ESP8266 that is considered as the brain of the system to find out with regards to Internet-of-things Smart Agriculture and Automatic Irrigation Systems. Cultivating is fundamental for farming nations' development. Agribusiness troubles have for quite some time been a boundary to the nation's advancement. Subsequently, the main solution for this test is shrewd horticulture, which includes updating present rural cycles. System architecture in the below diagram.

Therefore, the strategy is to utilize robotization and IoT innovation to make horticulture smart. The Internet of Things (IoT) gives an assortment of farming development checking and determination applications, just as independent

water system choice help. To modernize and help crop yield, we introduced an ESP8266 IoT Automatic water system framework.

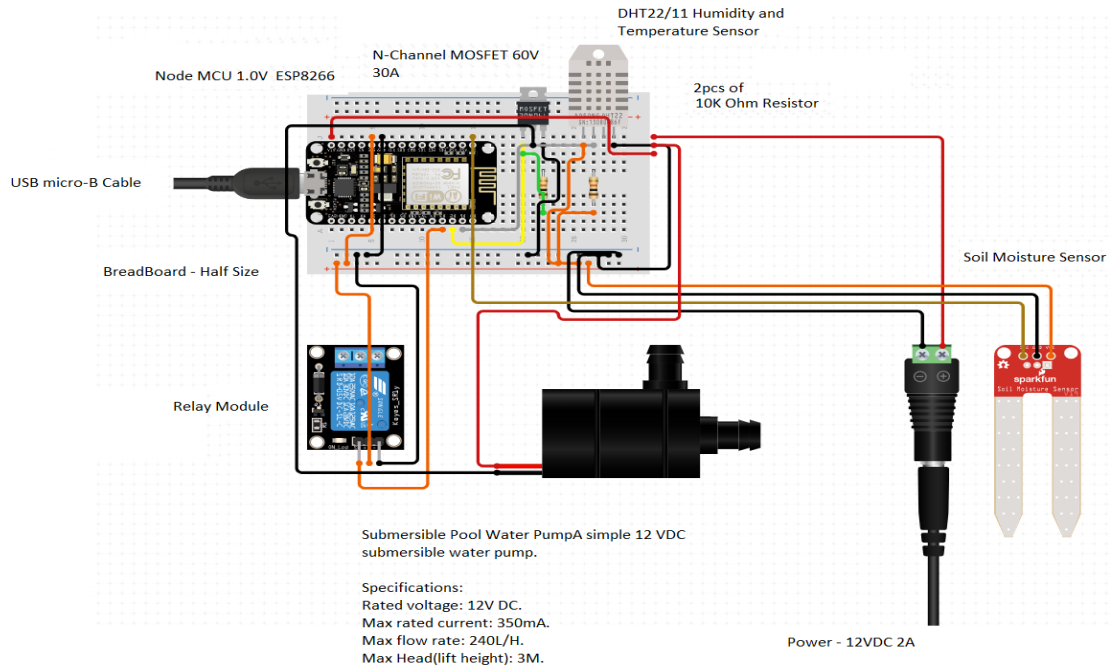

Figure 9: simulation of the circuit diagram (Source self-develop circuito.io)

4.2 Experiment

The aim of this experiment is to effectively deliver the different configurations of technological SPIS may be feasible, based on the accessible water supply and the location unique circumstances. The typical set-up of the SPIS is the well water reservoir.

The solar generator produces power for the pump that is mounted in the inverter power supply. Including this, the SPIS has been developed for the underdeveloped countries, which are dealing with ample number of issues linking with irrigation system just because of the situation like draught and lack of water supply.

The proposed work has been customized programmed utilizing Arduino programming. DHT11 sensor is utilized to gather the data about the humidity (Humidity) and temperature. It is utilized on account of cost viability and quick

reaction while checking the temperature and humidity data information. Correspondingly, the soil moisture sensor is utilized to gather the information with respect to the moistness content of soil in the farm fields field. the general show of the proposed framework. The sunlight powered charger is utilized to create energy.

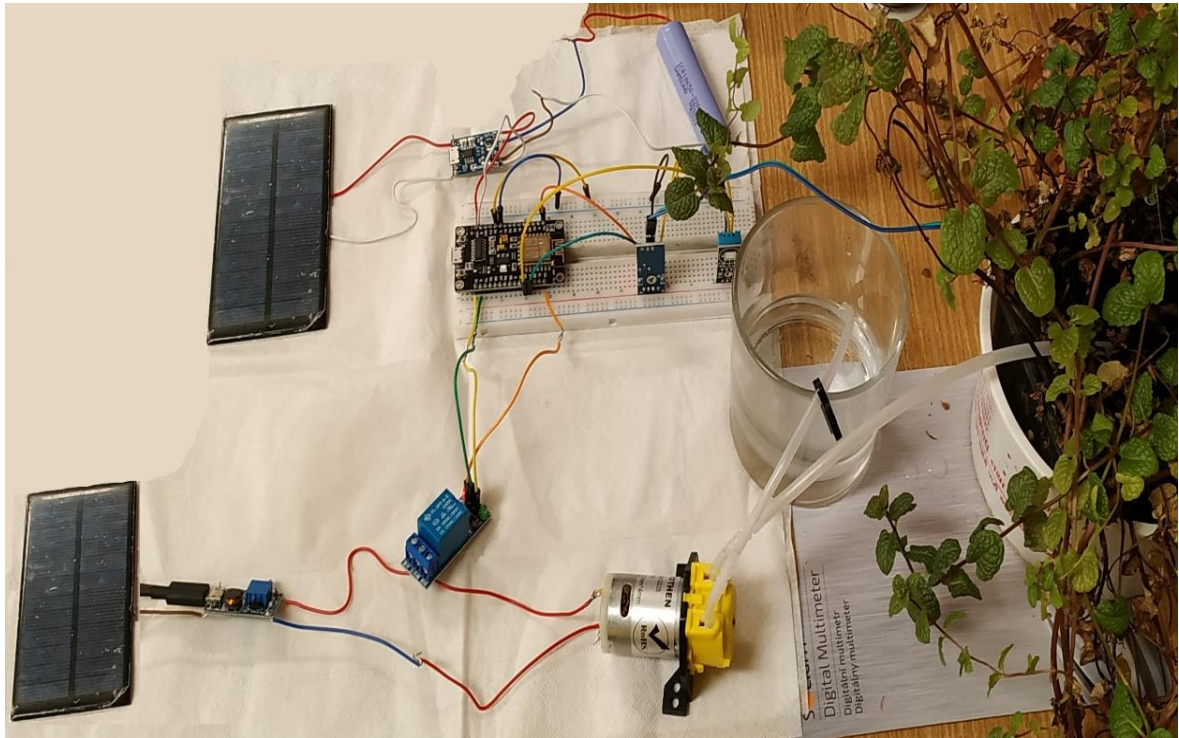

Fig.10: Prototype of Smart agriculture irrigation system
(Source owner)

Sensors are utilized to screen the horticulture field continuously situations. The sensors (for example Rain sensor, Humidity sensor, temperature sensor, soil moisture sensor) are associated with the module. This module is straightforwardly associated with cell phones or desktop through thing.speak web for additional correspondence, exhibits in addition to that a LCD also can be placed to display which shows the farming field monitoring framework. Fig. 11 represents information getting from the sensors.

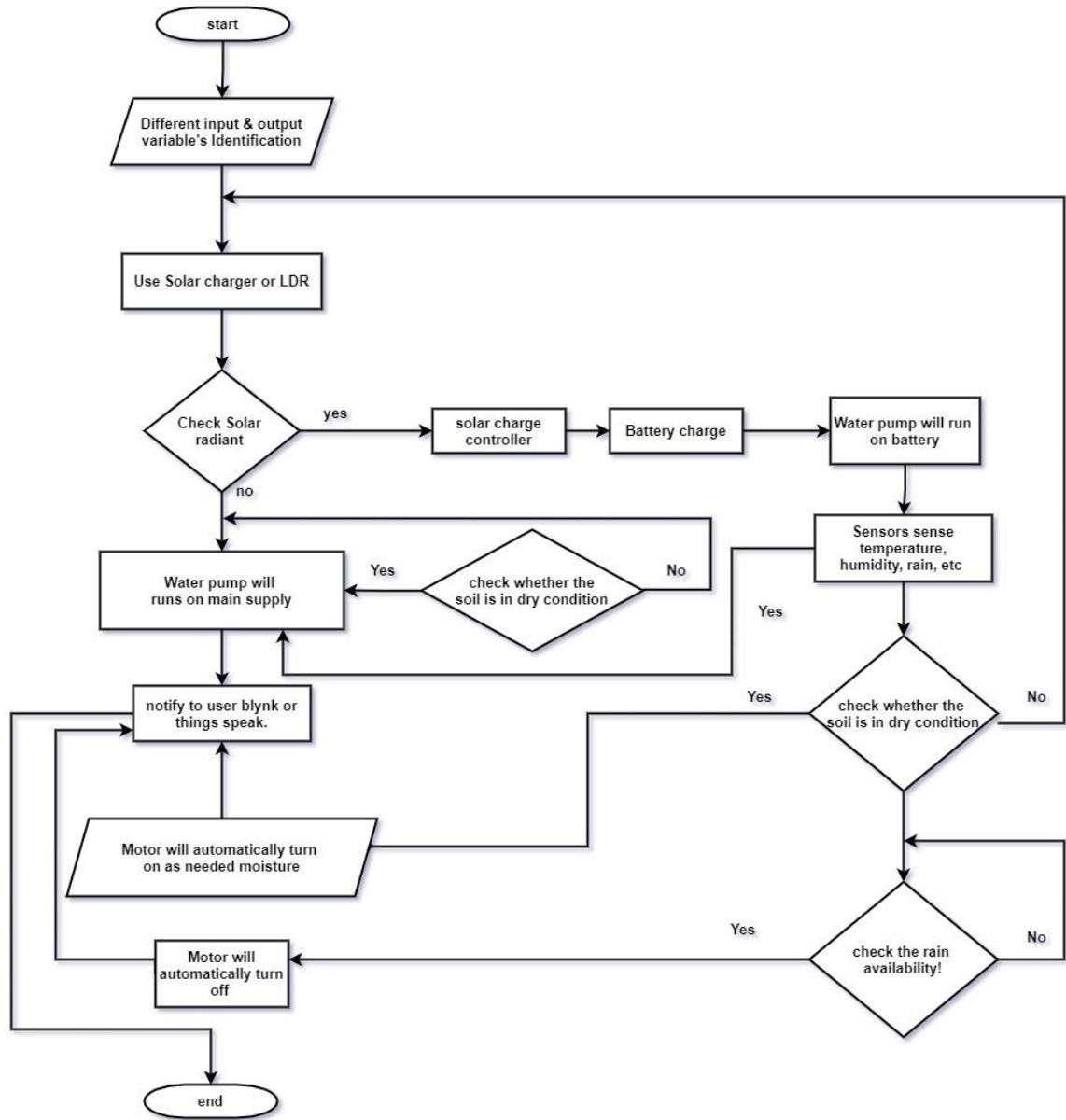

Fig. 11. Fundamental progression of the proposed framework. Source: owner.

Step by step working

- (1) The Nodemcu esp8266 gets initialized when the power supply is turned on.
- (2) Utilizing AT command, Wi-Fi connection communicates with Arduino Nodemcu.
- (3) Thing.speak or an LCD can display is connected to Arduino so information checked by sensors are shown effectively.
- (4) At first, the processor checks accessibility of solar energy with the assistance of Light Dependent Resistor (LDR) for detecting the daylight if not then it will be run on

battery if one had enough power or directly work upon main supply. In this further we can also add Solar tracker to gain maximum energy & it can be attached to the interfaced of stepper motor, which thus is connected with the stepper motor driver.

- (5) The sunlight-based panel turns in both clockwise and counter clockwise and stops where the most extreme sun's power is acquired and stores the energy in battery.
- (6) In the event of accessibility of solar power, water is pumped to horticultural field with the assistance of sun oriented or with the assistance of mains supply single phase or 3 phase if the main supply is AC supply, then we must have to use AC to DC converter known as Rectifier then power can be use in the system.
- (7) The soil moisture sensor checks for the moisture in soil content whose greatest edge is kept at 850 (demonstrating dry) and least of 500. At the point when the soil humidity content is more prominent (more) than 700, type motor will pump water to the agrarian field.
- (8) The temperature sensor measures encompassing temperature of agricultural farm.
- (9) The rain sensor detects rain fall heavily and switches off the motor to save power. As well as water and other resources and protect the crop.
- (10) All the data assembled from sensors will be moved to the client utilizing webserver of thing.speak innovation also monitor it from anywhere.

4.2.1 Fuzzy logic demonstrating

The fuzzy logic is put together system that aims towards what to do at the time of decision-making purpose with respect. It is chiefly used to get fragmented data information to take choice with the ideas called levels of truth and valid or invalid. The fuzzy set completely contains the traditional set of rules which can be made accordingly to requirement.

The membership function property is utilized for executing the fuzziness of components in the set that will have the arrangement dependent on experience despite information.

The weighted normal philosophy is used to execute the participation work with the fuzzy obstruction framework.

The fuzzy standard base framework is utilized to deliver the results as per the given contribution for the framework. In this review, 3 information boundaries are thought of and every boundary comprises of 3 participation works as displayed in the underneath conditions. The quantity of rules is determined dependent on each info

parameter's enrolment work. Thus, every boundary comprises of 3 membership works. The all-out number of rules outlined in (Table 1). The membership function value and the fuzzy standards are outlined by analyst's suspicion dependent on the fuzzy inference idea.

The fuzzy standard table with different classifications of the information and result output in status.

Rules	Soil Moisture conditions	Temperature	Humidity	Motor status
1	Dry	Cold	Low	On
2	Dry	Warm	Low	On
3	Dry	Hot	Low	On
4	Dry	Cold	Medium	On
5	Dry	Warm	Medium	On
6	Dry	Hot	Medium	On
7	Dry	Cold	High	On
8	Dry	Warm	High	On
9	Dry	Hot	High	On
10	Medium	Cold	Low	Off
11	Medium	Warm	Low	Off
12	Medium	Hot	Low	On
13	Medium	Cold	Medium	Off
14	Medium	Warm	Medium	Off
15	Medium	Hot	Medium	Off
16	Medium	Cold	High	Off
17	Medium	Warm	High	Off
18	Medium	Hot	High	Off
19	Wet	Cold	Low	Off
20	Wet	Warm	Low	Off
21	Wet	Hot	Low	Off
22	Wet	Cold	Medium	Off
23	Wet	Warm	Medium	Off
24	Wet	Hot	Medium	Off
25	Wet	Cold	High	Off
26	Wet	Warm	High	Off
27	Wet	Hot	High	Off
	If rain then sensor will sense the water drops and in this any condition above pump will be in off state until unless the little rain.			

Table 2. The fuzzy standard table Source owner)

Demonstrating the Fuzzy interface Framework where the soil moisture, temperature, and stickiness or humidity are the information values. In the wake of finishing Fuzzification, the Defuzzification procedure is utilized for creating the result for producing the situation with the motor. The information participation capacities are figured utilizing the trapezoidal capacity, and the result enrolment work is detailed utilizing the three-sided participation work. the participation work for humidity whose parameters for dissecting humidity moistness are low, medium, and high. shows the participation work for soil humidity whose parameters for examining soil humidity are dry, medium, and wet. the participation work for temperature whose parameters for breaking down temperature are cool, warm, and hot. fuzzy principal settings for the fuzzy rule framework that are the conditions for the participation capacities. The fuzzy standards are outlined dependent on in the event that states of the soil moisture, humidity, and temperature.

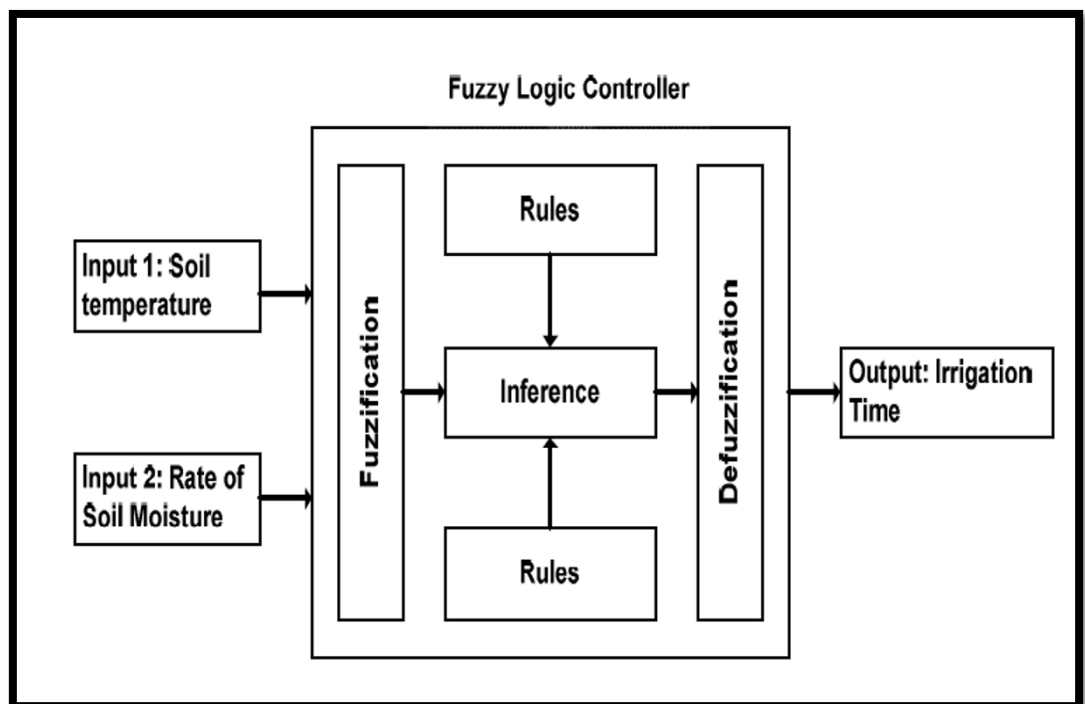

Figure 12: block diagram of fuzzy logic system.

(Source "Artificial Intelligence - Fuzzy Logic Systems", 2021)

Significant Parts of FLC

Followings are the significant parts of the FLC as displayed in the above figure –

- Fuzzifier – The job of a fuzzifier is to change over the fresh information value into fuzzy value. **LP = x is Large positive**
MP = x is Medium positive
S = x is Small
MN = x is Medium positive
LN = x is Large Negative
- Fuzzy knowledge Base – It stores the information pretty much every one of the information output fuzzy connections. It likewise has the participation work which characterizes the info factors to the fuzzy guideline base and the result factors to the plant taken care of.
- Fuzzy Standard Base – It stores the information about the activity of the course of the area.
- Inference Engine – It goes about as a part of any FLC. Fundamentally, it stimulates human choices by performing approximate thinking.
- Defuzzifier – The job of defuzzifier is to change over the fuzzy qualities into crisp value qualities getting from the fuzzy interference engine.

Membership function

The membership function capacities work on fuzzy arrangements of factors. Membership function permit you to evaluate etymological (linguistic) terms and address a fuzzy set graphically. A membership work for a fuzzy set an on the universe of discourse X is characterized as $\mu_A: X \rightarrow [0,1]$.

Here, every component of X is planned to a worth somewhere in the range of 0 and 1. It is called membership worth or level of participation. It measures the level of participation of the component in X to the fuzzy set A.

- the x-axis addresses the universe of discourse.
- the y-axis addresses the levels of membership in the [0, 1] span.

There can be various membership capacities applicable to fuzzify a mathematical value. Basic participation function is utilized as the utilization of perplexing function

doesn't add more accuracy to the result. ("Artificial Intelligence - Fuzzy Logic Systems", 2021)

All membership functions for **LP**, **MP**, **S**, **MN**, and **LN** are shown as below –

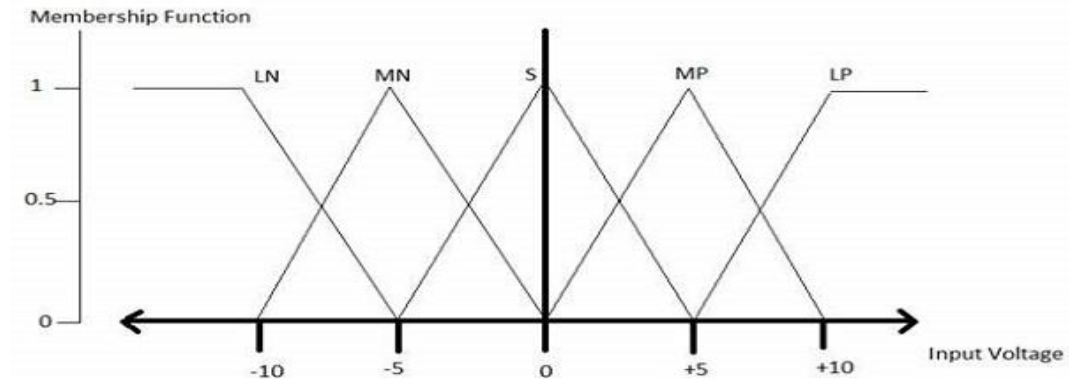

Figure 13: membership diagram of fuzzy logic system.

(Source "Artificial Intelligence - Fuzzy Logic Systems", 2021)

The triangular membership function shapes are generally normal among different other membership function shapes, for example, trapezoidal, singleton, and Gaussian.

Here, the contribution to 5-level fuzzifier changes from - 10 volts to +10 volts. Subsequently the comparing yield likewise changes.

Benefits of Fuzzy Logic Control

Let's examine the upsides of Fuzzy Logic Control.

- Less expensive – Developing a FLC is similarly less expensive than creating model based or other regulator as far as execution.
- Robust – FLCs are more vigorous than PID regulators on account of their ability to cover an enormous scope of working conditions.
- Adjustable – FLCs are adaptable.
- Imitate human logical reasoning – Basically FLC is intended to copy human rational reasoning, the interaction individuals use to gather end from what they know.
- Dependability – FLC is more solid than regular control framework.
- Proficiency – Fuzzy rationale gives more effectiveness when applied in charge framework.

Limitation of Fuzzy Logic Control

- We will currently examine what are the drawbacks of Fuzzy Logic Control.
- Requires lots of information – FLC needs bunches of data information to be applied.
- Helpful if there should arise an occurrence of moderate recorded data – FLC isn't valuable for programs a lot more modest or bigger than historical information.
- Needs high human expertise – This is one disadvantage as the precision of the framework relies upon the information and skill of people.
- Needs normal refreshing of rules – The rules guidelines should be refreshed with time.

4.2.2 Introduction

This experiment is specifically based on smart agriculture irrigation system powered by solar energy and it will be an effective cost-efficient solution for all the electricity needs and for the farmers that are dealing with a number of issues like lack of water and electricity supply. Solar driven smart irrigation systems are the solution to the all the farmers of the world. The machine is a solar-powered water pump and a moisture sensor is used as an automated water flow monitor. It is the alternative suggested for the Indian and other countries farmers to the current energy crisis. Through reducing consumption, this machine conserves electricity.

4.2.3 Technology used

The Solar Panel, its Charge Controller and its Battery: A solar charge controller is essentially a voltage or current controller for charging the battery and preventing overcharging of the electric cells. It is responsible for directing the voltage and current from the solar panels to the electric cell. 12V boards/panels often output 16 to 20V, thus if there is no control, the electric cells will be damaged due to overcharging. Electric storage devices, on average, require 14 to 14.5V to be fully charged.

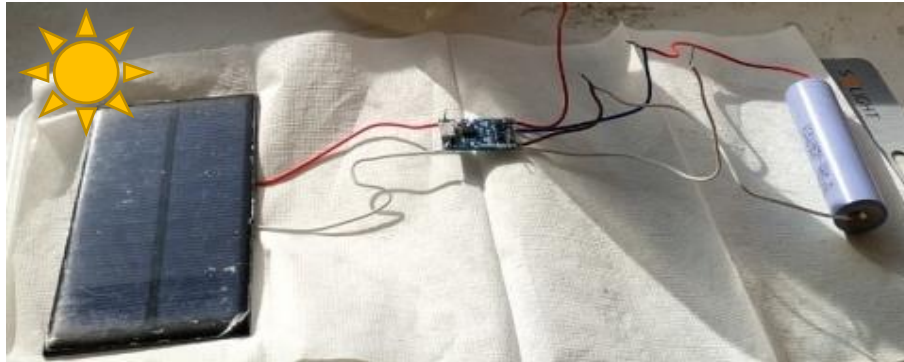

Figure 14: Solar charged battery (Source owner)

Usually there is no responsibility for the alteration within the panels it requires a minimal amount of maintenance. The charge controllers come in all the sizes and the shapes that are required for a particular field area. In a solar charge controller, there are three different types of charge controller and they are: One or two stage controls, the pulse width modulation and the maximum power point tracking which also denote as (MPPT).

The Most extreme PowerPoint of a sunlight-based charger is the voltage at which it can deliver the greatest charging capacity to the batteries. The regulator contrasts the battery voltage and the sun-powered charger and converts the board voltage into the worth which amplifies the current into the battery. MPPT sun-based charge regulators are more costly yet significantly more proficient than the less expensive PWM models. They produce additional power from the sunlight-based chargers in shady climates, for instance, or in the colder time of year season. For bigger frameworks, similar to your off-matrix lodge where proficiency matters. In circumstances where the sunlight-based cluster has a higher voltage than the battery, for example, utilizing your home's sun-powered charger framework to charge a 12V. An MPPT charge regulator will charge this securely.

<u>Solar Panel Charge Time Calculator</u>	
Battery Voltage (V)	= 12
Battery Amp-hours (Ah)	= 10
Battery Type	= Lead acid
Solar Panel Wattage (W)	= 30 approx.
Solar Charge Controller Type	= Mppt
Calculate Estimated charge time: 7.1 hours of direct sunlight	

Supply of Power: A solar panel of 12 Volt is being used in harvesting the energy form the sun to the DC Volt. This DC Volt power is further supplied to the solar charge controller for charging the 12 Volt led bulb which can be considered as an optional supply of power. The Relay would get the signals from the circuit of the Nodemcu in which the humidity as well as the soil sensor. These sensors would provide a signal during the time of having sufficient water in the soil as well as provide feedback to the relay for cutting off the supply of power due to presence of sufficient moisture (Gora and Dulawat, 2017). The pump would supply and would also begin pumping out the water from the soil and uses a 6

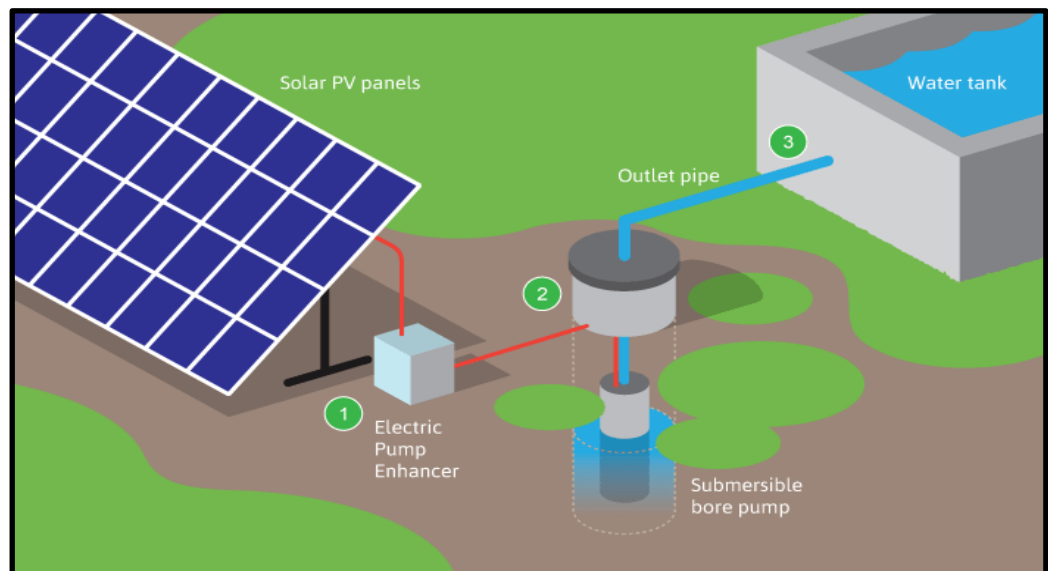

Fig 15: The solar panel, its charge controller and its battery
(Source: Bhattacharya et al. 2021)

to 10 mm of pipe. In the actual farms, the size of the solar panels, the pump, and also the relays are bigger and farmers use cPvc pipes as this has many benefits and also it is water friendly. The farms get sufficient water for their crops by the method of dripping the water in the soil as well as the pipe could also be placed about 6 inches to 10 inches bottom of the ground according to the requirements of the in which the method of drip irrigation will be more effective.

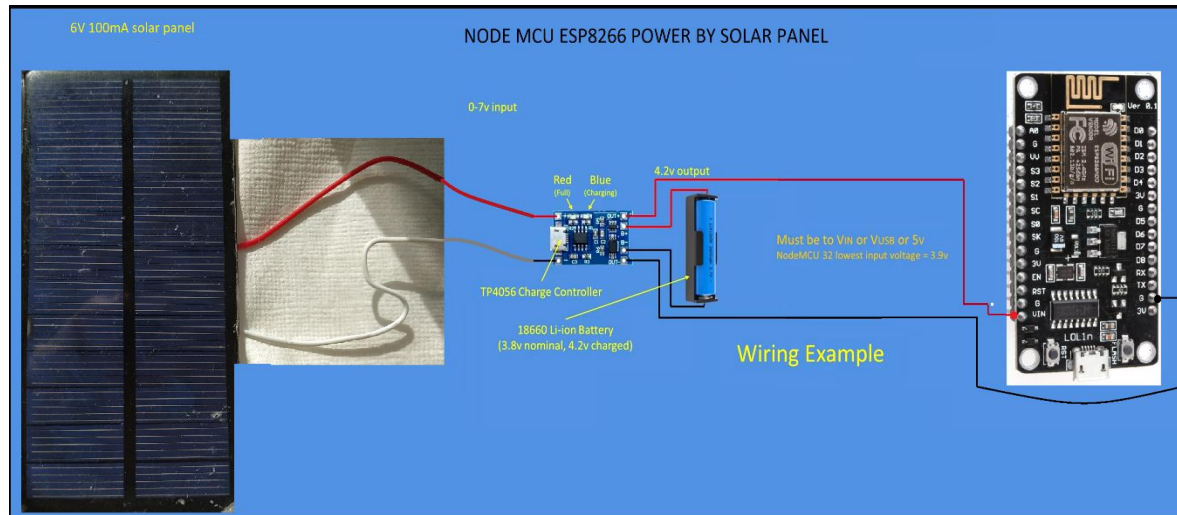

Figure 16: Nodemcu ESP8266 Power by Solar Panel
(Source: Self-Developed)

Soil Humidity Sensor or DHT11: The DHT11 or the soil humidity sensor is the basic as well as ultra-lower humidity and digital temperature sensor. This humidity sensor utilizes a thermostat as well as a capacitive humidity sensor for measuring the air surrounding as well as sputters out on the data pin, the digital signal (Hassan et al. 2020). This is fairly easy for using and needs appropriate timings for grabbing the data. The disadvantages of this soil humidity sensor or the DHT11 is that one could obtain new data every two seconds and when utilizing, the sensors are maximum two seconds old. In the smart irrigation system, the soil humidity sensor is being used for measuring the humidity as well as the air temperature. The size of the DHT11 is compact as well as very cost-effective. The DHT11 or the humidity sensor detects the water vapour which measures the electrical resistance in between the electrodes. The fundamentals of the humidity sensor consist of the component of the humidity sensing, a thermostat or the NTC temperature sensor as well as the IC at the back of this sensor.

Relay: The relay is the switch which is operated by electricity. Various relays utilize the electromagnet for mechanically operating the switch, however the other operating fundamentals have also been utilized which includes the solid-state relays (Samuel et al., 2020). The relays are utilized where it is needed for

controlling the circuit by individual lower power signals as well as in the places where various circuits are being controlled by a single signal. Relays are also used for controlling the higher voltage as well as the higher power circuit along with the circuit of lower power. It is an operating device which depends on the medium of the electricity and this consists of two coils that initiate operation by the help of Normally Closed and Normally Open which are denoted as NC and NO contacts (Velasco, 2020). There is no change in the contact position created when there is no supply to the coil. And when lastly the supply is produced or being generated the Normally Closed and Normally Open, open up. And the coil remains unchanged till the energy is being restored and comes to a position or condition where the work can be restarted.

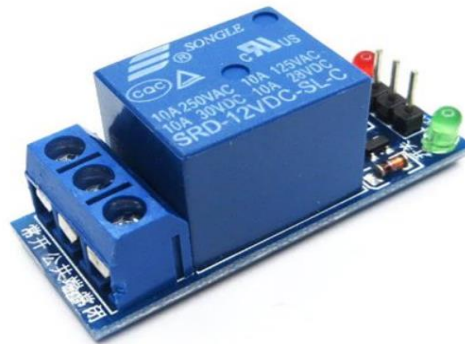

Fig 17: Relay (Source: García et al. 2020)

Breadboard Kit: A mini breadboard is utilized which is being divided into two parts via the ridge for ensuring that there is no cross-connection in between both the halves. Every point of connection in the breadboard is being numbered along with the point sets that are being connected via the strips of metal under the plastics (Mukherjee and Sengupta, 2020). For the connection in series, the jumper cables are being placed in the points which have been in the similar connection line.

Nodemcu ESP8266: The Node mcu is the open-sourced platform of IoT which consists of the firmware that runs on ESP8266 Wi-Fi SoC that is from the Expressive Systems as well as the hardware that is on the basis of the ESP-12 module. The Nodemcu is the firmware which utilizes the Lua Script and the program codes are written by utilizing the Arduino IDE for the ESP8266 for which the installing the ESP8266 library is necessary (Sass and Hahn, 2021).The

Nodemcu ESP8266 is the Wi-Fi microchip of optimum power consumption along with the complete TCP/IP stack with a capability of 32-bit that permits the microcontroller for connecting to the Wi-Fi network as well as making of easy TCP/IP connections that uses the Hayes-style commanding's. This operates on the power of about (+-)3.3 Volt as well as is programmed by utilizing the Lua Script. Along with the acceleration of the rate of chip clock as well as the Analog to Digital Converter (ADC) for improving the sensitivity, the application of the integration with the sensor of the soil humidity is common (Ogidan et al., 2020).

TP4056 Charging Module with Protection Circuit: The TP4056 is a full constant voltage of constant current linear charger for the individual cell of lithium-ion batteries. The SOP package as well as the lower eternal count of

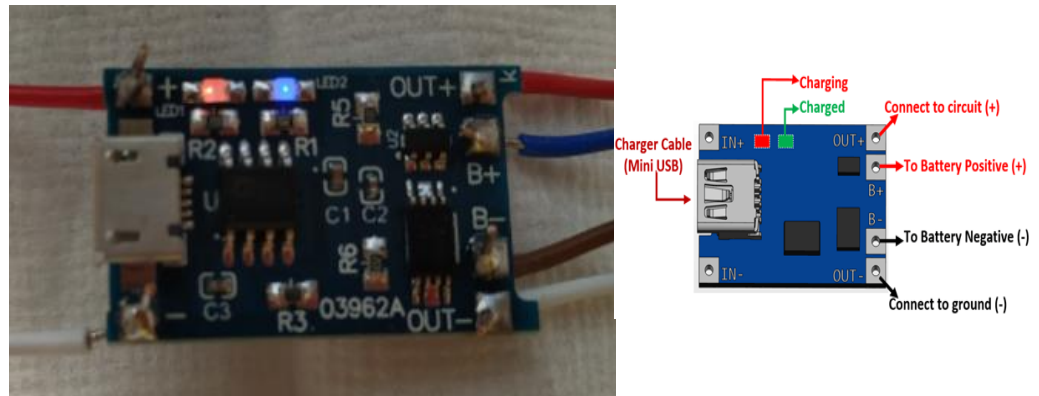

Figure 18: battery charging (source: owner)

components create the TP4056 suited ideally for the applications that are portable. The TP4056 could work inside the USB as well as in the wall adapter (Ssenyimba et al., 2020). The module TP4056 is operated by the supply of the 5 Volt power from the micro-USB or IN+ as well as in the -IN soldering pads. The 1A current is needed for this TP4056 charger for correctly charging the battery that is being

connected to the output terminals. The Ampere meter could be connected only to the 5 Volt

input end of the TP4056. This is much better than 37% of the capacity of the battery of the charging current. The wire that would be connected must not be too thick and the connection point must be safer. If the voltage in the input is higher, such as the 5.2 Volt, the current would be lesser than the estimated which

is about 1000mA which is normal. The protection function facilitates auto-subtraction of the charge current for avoiding the damages by burning of the chip.

Jumpers Wire: The Jumper Wires are the wires which include the connector pins in every end that permits them for utilizing for connecting the two points to one another without the soldering process. The jumper wires are being utilized along with the breadboards as well as the prototyping tools for making it simple for altering the provided circuit as needed. The 5 Volt are being connected from the Nodemcu ESP8266 to the breadboard by utilizing the jumper cables.

Water Pump: The electric motor allows the rotational energy for driving the pump. There are two varied types of pumps that can be found in the recent systems of solar pumping which includes the centrifugal rotor pumps as well as the helical rotor pumps. The centrifugal rotor pumps an increase in the pressure via transferring to a fluid rotating impeller from the mechanical energy of the motor. The fluid always flows from inlet to the centre of the impeller as well as outside along with their blades (Fidelis and Idim, 2020). Whereas the helical rotor pumps are the progressive cavity pumping type that works by rotating the helical motor at the time of sealing against the wall of the helix.

DC Submersible Pump: The energy sources of the DC pumps are from the battery, the motors as well as the solar power for moving the fluid in a number of ways. In this prototype, the power of the direct current which is about 12 Volts are being extracted from the photovoltaic solar panels together with the solar cells that produces the direct current power when it is exposed to the sun. This could be operated from the battery directly and therefore to render more convenient, energy efficient, portable as well as easier for controlling. The direct current of about 9 Volt to 12 Volt mini as well as micro submersible pump of water are of lower expense, smaller in size that could be operated from the power supply of about 2.5 Volt to 6 Volt (Mahmood and Ansari, 2021). This could take a maximum of 120 litres of water per hour with lower consumption of current of about 220mA. The pump should be connected to the outlet of the motor and needs to be submerged in water and to power.

CPVC Pipe: CPVC or the Chlorinated Polyvinyl Chloride is the plastic pressured system of piping which is of higher temperature that is being utilized

in the fire sprinkler extensively in the smart irrigation system for the portable plumbing. 7mm of CPVC pipe is being required for use in the smart irrigation system. These CPVC pipes are safer and are also reliable (Eragamreddy and Sree, 2017). It is corrosion resistant, and provides free from the deposits as well as tuberculation. Black roll pipe or irrigation pipe Dark move pipe is ordinarily utilized for scene water system frameworks in Northern regions and is utilized sometimes in the South. The line comes in 300-foot rolls and is associated with embed fittings and Dark move pipe is to some degree harder to introduce, yet not considerably so.

Dark move pipe is utilized in Northern regions since it will grow a modest quantity, which permits the water in it to be frozen with next to zero harm a significant trademark in the North. In the South we normally won't have pipe freezing issues in the event that we introduce the channelling to the suggested 12-inch profundity. Either dark move channelling or PVC funnelling will function admirably in our environment, yet you may discover the PVC channelling (Author(s) W. Bryan Smith)

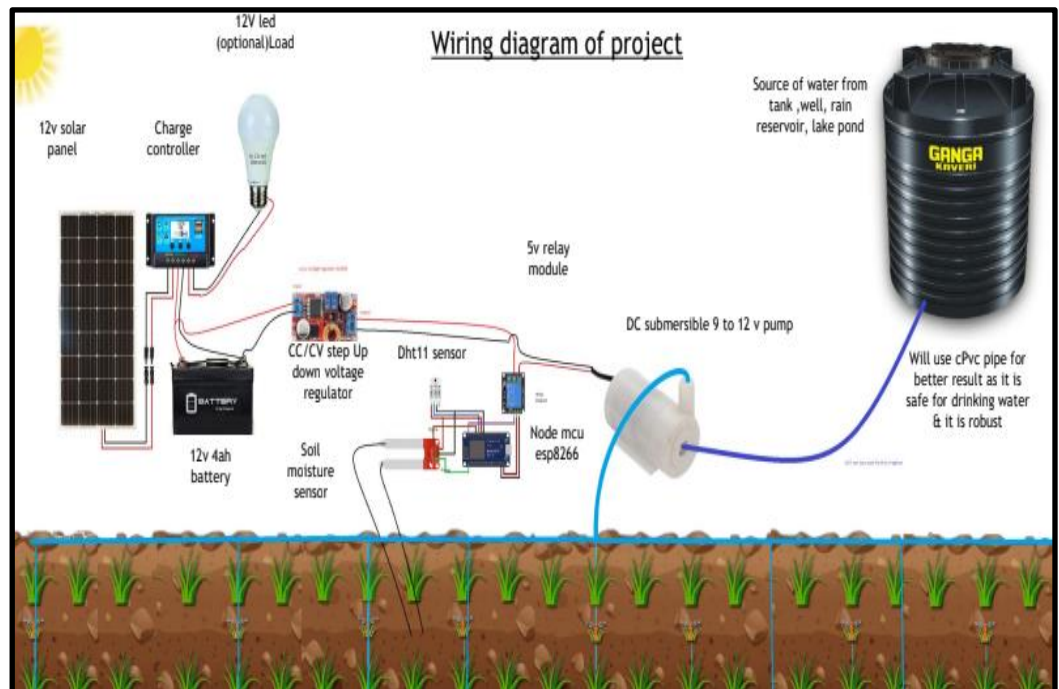

Figure 19: Wiring Diagram of Project

(Source: Self-Developed)

In this above diagram, a 12 Volt solar panel is connected to the solar charger controller which is further connected to the 12 V Led load which is optional as well as connects to the 12 Volt 4ah battery. The battery is further connected to the Constant Current / Constant Voltage step up down voltage regulator as per need of power & which is further connected to the Node mcu ESP8266 and from here the connection goes to the DHT11 sensor or the soil humidity sensor as well as the soil moisture sensor & also other sensor apparently. The Node mcu ESP8266 is connected to the Relay and also to the Dc submersible which is of 9 Volt to 12 Volt. From there the CPVC pipe is connected to the water storage tank for use in the irrigation system further more details are as by checking out the outline circuit we can find out about the functioning model of a solar-powered smart irrigation system. We utilized a 12-v sun powered charger to collect sun-based energy to Dc volt. Will supply that dc power to the sunlight-based charge regulator to charge 12v battery, likewise we can have a dc load supply to drive a 12v drove bulb Which is discretionary. From battery 12V will give to circuit of Constant current/Constant voltage move forward/down voltage controller which will direct a decent voltage and current to drive a Dc submersible pump via relay. The relay will get signal from Nodemcu circuit where soil and humidity sensor will give the sign when it will have sufficient water in the soil, the sensor will give feedback to relay to remove power as the soil had sufficient moisture in it, after that when the moisture in soil get vaporized by the various factor like, air, wind, heat, or crops H₂O daily consumption and our moisture sensor detect difference in moisture value by comparing it with the threshold value and current value of moisture value send feedback to the relay to power dc water pump to supply it will begin pump out the water the wellspring of water as in prototype models will utilize typical 6 to 10mm silicon pipeline yet in a genuine homestead, the size of the water pump and sunlight based charger, the relay will be greater in size, will use cpvc pipe as it had a lot of advantages and its water-friendly. Farm will get sufficient water for the yields through cpvc pipe by trickling H₂O in soil and pipeline can put on top of the ground or 6 to 12 inches in the ground according to needs in which dribble technique is more proficient.

The brain of this circuit is node MCU Esp8266 which control the water to stream or not from the feedback of the soil sensor & also show humidity temperature,

node MCU powered by 3.5 to 5 volts to work and will program it on Arduino ide and will configure to associate it with things speak.com or blynk application for the information and perusing will get from the circuit and can handle it from the web through application or web.

Blynk App Monitoring:

On the Internet, Blynk runs. This ensures a researcher can link to the internet for the hardware researcher pick. Other boards are now internet-enabled such as ESP8266, Raspberri Pi with Wi-Fi dongle, Particle Photon or Spark Fun Blynk Board and some of them need to provide an Ethernet or Wi-Fi Shield to connect to the user. But researcher can attach it via USB to laptop or desktop, if investigator doesn't have a shield. The hardware list with Blynk is enormous and continues to expand. The Internet of Things technology is specifically being utilised planned for Blynk. The hardware can be controlled remotely, sensor data displayed, data stored, viewed and several other interesting stuff can be done.

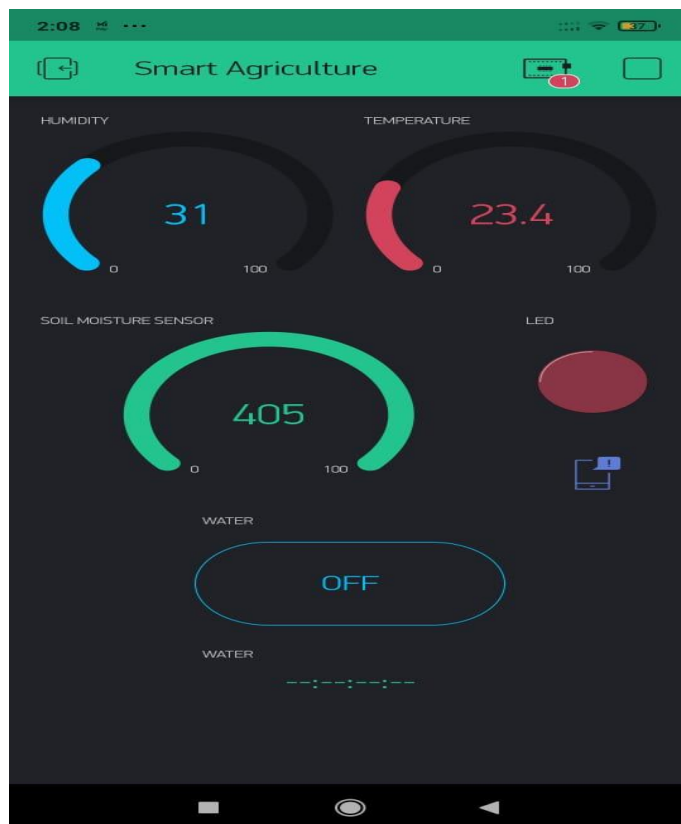

Figure 20: blynk Source Owner

Blynk is another stage that permits you to rapidly fabricate interfaces for controlling and checking your equipment projects from your iOS and Android gadget. Subsequent to downloading the Blynk application, you can make a task dashboard and orchestrate catches, sliders, charts, and different gadgets onto the screen. Utilizing the gadgets, you can turn nails to and off or show information from sensors. there are likely many instructional exercises that make the equipment part lovely simple, yet fabricating the product interface is as yet troublesome.

With Blynk, however, the product side is significantly simpler than the equipment. Blynk is ideal for interfacing with straightforward activities like observing the temperature of your Farm fields or turning motor, lights on and off distantly. Actually, right now, Blynk upholds most Arduino loads up, Raspberry Pi models, the ESP8266, Particle Core, and a modest bunch of other normal microcontrollers and single-load up PCs, and more are being added after some time. Arduino Wi-Fi and Ethernet safeguards are upheld however, you can likewise control gadgets connected to a PC's USB port too.

Why use Blynk application: There are numerous outsider IoT stages however I think Blynk is the awesome it is very easy to understand. Blynk isn't an application that works just with a specific safeguard. All things considered, it's been intended to help the sheets and safeguards you are as of now utilizing. What's more, it chips away at iOS and Android.

How it functions: Blynk works over the Internet. So, the unrivalled necessity is that your equipment can converse with the Internet. Regardless of what sort of association you pick - Ethernet, Wi-Fi or perhaps this new ESP8266 everybody is discussing, Blynk libraries and model portrayals will get you on the web, interface with Blynk Server and pair up with your cell phone.

The design of Blynk framework – Mechatronics: While there are different stages for controlling equipment over the web Particle, ThingSpeak, Temboo), Blynk is quite possibly the easiest to understand I've seen at this point, and it's likewise free and open-source.

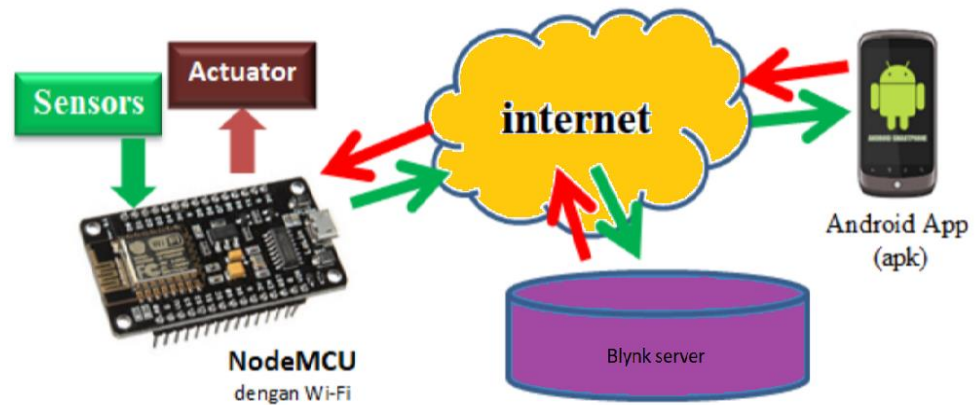

Figure 21: blynk source web

4.2.4 Overall Assessment

Strength

Moisture sensor: The irrigation system has built in moisture sensors that can alert the farmer of low soil moisture level through, allowing the farmer to irrigate as per the requirements of the crops. By monitoring the moisture level, farmer can avoid over-watering the crops. With the use of moisture sensor, farmer can yield various crops which require strict monitoring of the moisture level.

Smart sensor can send alert to mobile: Smart sensor can be used remotely allowing the irrigation to be completed even when the farmer is at another geographical location. The irrigation system can remind the farmer to irrigate crops through mobile apps. The system does not require strict monitoring of various crops as the moisture sensor can monitor that for the farmer.

Low water consumption: The irrigation system can preserve water by only using required amount of water for the crops.

Weaknesses

High price: - The parts required for the radiation system such as solar panels, water pumps, batteries and sensors can be costly. However, as technology progresses various parts will be cheaper effectively reducing the cost of model.

Batteries are not powerful enough: The current technology of batteries and power storage are evolving but are not as efficient. To fulfil the needs of "smart irrigation system" more powerful batteries are required as various large crop fields. Multiple batteries can be used however, the required maintenance would be high.

Opportunities

- Saved water can be utilised: -The irrigation system can help in saving water and the saved water can be utilised for other purposes.
- Useful in low water area: This model can be highly useful in the areas with low water availability and can improve the crop productivity.
- Cost effective:
In long run this system saved water and electricity also reduce Co2 in the atmosphere as well as saves money.

Threats: Internet connectivity: The model requires constant internet connectivity to work efficiently thus making it inefficient in the remote areas where internet connectivity is not stable.

User must have basic knowledge: The user must have basic knowledge of internet and applications and due to the lack of education in underdeveloped countries the model cannot be utilised without training the farmer.

4.2.4 Model working

The model uses solar panels to convert solar energy into DC voltage which is transfer to the circuit board of two different supply one for Nodemcu esp8266 board which consume around 3 to 5 volt and second one is for the supply of dc submersible motor pump to drive as per it need with help of voltage boost regulator and then other process takes place like solar charge controller which monitors the voltage and then recharges the batteries. The batteries are connected to the sensor module monitoring the soil moisture level. The sensor has digital output to the relay which is connected to the pump and provides power supply to the pump allowing the pump to supply water from water reservoir to the crop fields. The model also utilizes a mobile app that monitors the moisture level of the field and can send alerts to the user of low moisture level. The user can then remotely watch the operation from anywhere of the world, can select one method to irrigate farm using automatically or manually on the pump with the help of mobile app and can monitor the current moisture level, air temperature, humidity as well through the app efficiently allowing the user to irrigate the fields remotely.

5. Results and Discussion

An intelligent irrigation system is built which optimises the use of water. This method maintains the durability of irrigation pumps; avoids wastage by recycling water and prioritises water-based pumping in reservoirs as a foundation. This ensures that numerous plants are irrigated for successful growth in connection with their various water needs. It will be useful where water constraints are a threat to irrigation practise. The final readings and discussion have stated that the drip irrigation system which has been installed with the motive of saving the energy and water and extract the best possible outcomes. Drip irrigation is a kind of micro-irrigation device that can conserve water and nutrients by steadily dripping water onto plant roots or over the soil or under the surface (Al-Ali et al., 2019). The aim is to direct water into the root region to mitigate evaporation. Irrigation networks provide water to pipes, tubes, tubes and emitters across the network. The drip irrigation system may be more effective than other irrigation forms such as surface irrigation and sprinkler irrigation, depending on how well built, constructed and managed. The water retaining potential that is often called water conductivity defines the permeability of the soil. High water permeability ensures that the irrigation period is drained out very quickly: It takes about 4-5 days and 2-3 days. However, the permeability of the earth is poor on the other side. The water then becomes stagnant, rotating the root. So, it must be mild and the cultivable crops must be determined. In turn, this specifies the irrigation water demand.

85% of usable freshwater is needed for agriculture and its demand could be increased in the future. A system for effective use of water in agriculture is therefore required. In contrast to conventional approaches, the new drip irrigation technology greatly decreases water consumption. And certain societies need varying quantities of water, e.g., paddy. The paper proposes a drip irrigation automation where the Smartphone initially captures soil images calculates the moisture level and intermediately transmits data to the microcontroller via node mcu esp8266 module. The irrigation is determined by the microcontroller and the field status is sent to the cell phone.

The device has been checked for paddy sector. It is found that, relative to traditional flood and drip irrigation strategies, almost 41.5% and 13% of water saves, from the experimental setup. There are various crops which require large amount of water to harvest like paddy, sugarcane and many others and as per the observation, water is

needed around 20k-40k litres. According to the calculations and readings taken on average 3 days, one acre land requires approximate 20,000 litres which on approximate one day is around 6666.7 litres. It has been analysed that 10 square meter land which is approx. to 0.00247105-acre land needs 16.5 litres of the water every day. Therefore, according to the calculations, this much amount of water is being needed to irrigate the land of 10 square meters within a day. In order to minimise the consumption, project has been developed with drip irrigation system with the motive of consuming less amount of water which will be around 10% to 20% of the total water which is used in flood irrigation to irrigate the land of crops. The model of smart drip irrigation system will allow the water usage of 1.65 to 3.30 litres as compared to the 16-17 litres. Basil plant has been utilised for this project which has the parameter of 3 inches height along with diameter for 4.5 inches which will consume the 70ml of water within 24 hours. Earlier, utilising the old method of flood irrigation with the same kind of size, consumption of the water was around 120 ml within the span of 24 hours. Therefore, by utilising this kind of model, the water saved percentage will be around 40-45%.

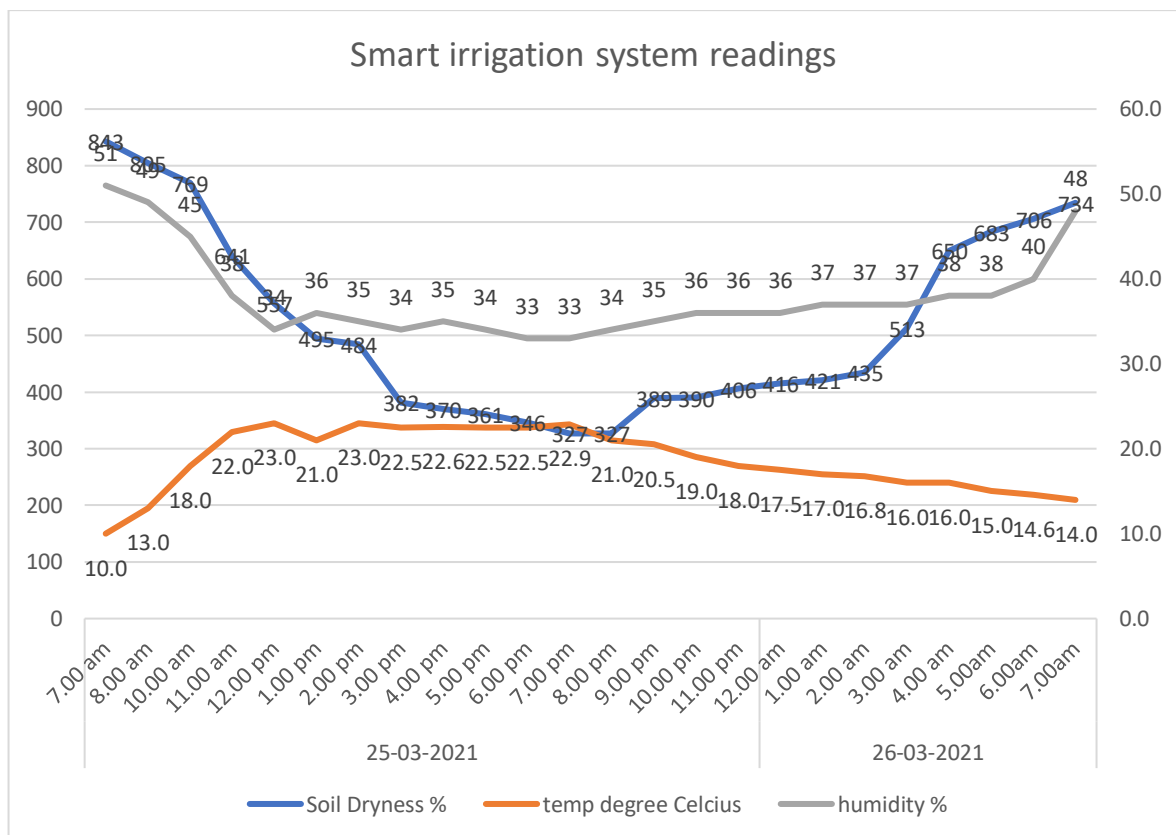

Figure 22: Flow chart of drip irrigation system reading.

(Source: Owner)

According to the chart above, when dryness in soil is up to 800, pump will be start automatically and when it reaches to 500 to 400 it will be turning the motor to stop the flow of water in the field, by blynk app monitoring. Another advantage of this work is the pump used to recycle water back to the water tank. Water from drainage sites which might have been lost during rush harvesting or input into the device obtained by rain water collection or overwater. In environments where water availability is a problem in irrigation, the device built will be useful. There are various readings which has been taken in regular interval of time shows the percentage of soil dryness along with humidity percentage. When the soil dryness percentage goes beyond 800, then the water pump automatically starts with notification and it operates till the dryness percentage lowers down at 400 to 500. These readings have been taken from the 4*3-inch pot of plant where usage of water pump has been shown from the Smartphone application.

Above discussion and results states out that this kind of project can help out in saving up the large consumption of water in the case of flood irrigation to the crops. It is the smart based methodology used through application where the water is used as per the requirements and within limitations as well. As per the total methodology and procedure to utilise the water for the same operations can allow the irrigation to be conducted in helpful way and utilise the saved water for different purposes. Hence, present scenario of saving the water and minimising its consumption can be encouraged through these kinds of smart technology and therefore fulfil the objectives in effective and efficient manner.

In this project we can configure this app into two categories like first with Blynk app in that we can monitor and control but in second configuration I can put the threshold value of moisture that if the value of soil goes down in 50 percent in dry state pump will be automatically start and it will keep turn on until soil moisture increases up to more than 50 percent and below I have put the reading data from things speak of all the sensor and an analogue dial to see he exact percentage in value which can be seen in the below diagram. Also, as soon as you power on the device will start displaying the Soil Humidity, Air Humidity, and also Air Temperature. It shows the real-Time Data. When the soil moisture content is reduced the water pumps turn on and irrigate the field until the required moisture is achieved.

You can monitor the data online from any part of the world using Thingspeak Server. To do that, go to the private view of the Thingspeak server. You can check the soil Moisture, Humidity, and Temperature as well as relay status.

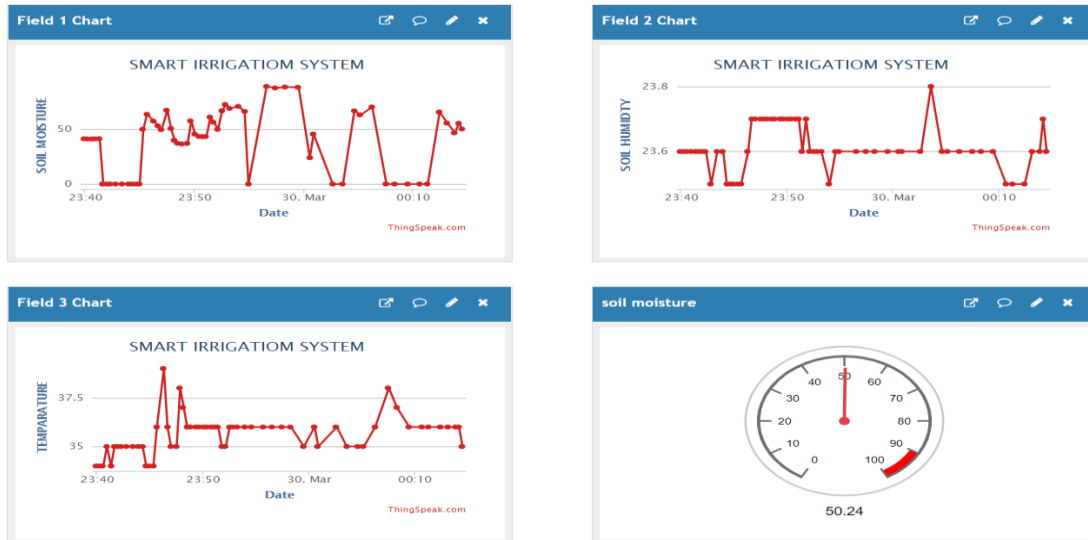

Figure 23: data from ThingSpeak drip irrigation system.

(Source: Owner)

Esp8266 powering from solar panel WIFI On power calculation.

ESP8266	Esp8266 Power Need	mAHr (mile per Hour)	Battery usage per day	Life of battery 18650 2600mAHr
WIFI on continuously	75mA	75mAHr	1800mAHr	1.44 days

Daily solar energy replenishment needed

Assumption: 1	Results: 1
<ol style="list-style-type: none"> Using a 6-volt 1-watt solar panel solar panel is 100% * efficient Five (5) hours of day light. 	<ol style="list-style-type: none"> Solar panel provides $1W \times 5 = 5Watt$ Hours Energy available = $5 \times 0.75 = 4.7Watt$ hour Production in mAHr = $1(watt) / 6 (volts) \times 5(Hours) = 833 mAHr$ $(1/6 \times 5 = 0.833)$ (Amp to milli amp multiply the current by 1000) $0.833 \times 1000 = 833.33$

4. using 2600mAHr battery	4. <u>1 watt panel is too small to support this scenario</u>
---------------------------	--

Assumption: 2	Results: 2
<ol style="list-style-type: none"> 1. Using a 6-volt 3-watt solar panel 2. Solar panel is 100% * efficient 3. Five (5) hours of day light 4. using 2600mAHr battery <p>Assumption 2 will be work better than assumption 1 because it will 800 mAHr in reserve.</p>	<ol style="list-style-type: none"> 1. Solar panel provides $3W \times 5 = 15$-Watt Hours 2. Energy available = $5 \times 0.75 = 11.3$-Watt hour 3. Production in mAHr = $3 \text{ (watt)} / 6 \text{ (volts)} \times 5 \text{ (Hours)} = 2500 \text{ mAHr}$ <p>$(3/6 \times 5 = 2.5 \text{ (Amp to milli amp multiply the current (I) by 1000)} 2.5 \times 1000 = 2500)$</p> <ol style="list-style-type: none"> 4. 3Watt panel to support this scenario with 800 mAHr daily reserve 5. TP4056 will prevent battery overcharging

Computation of charging battery capacity by solar energy step by step.

First green shading cell demonstrated in the chart are to be topped off as per the need or determination of system working.

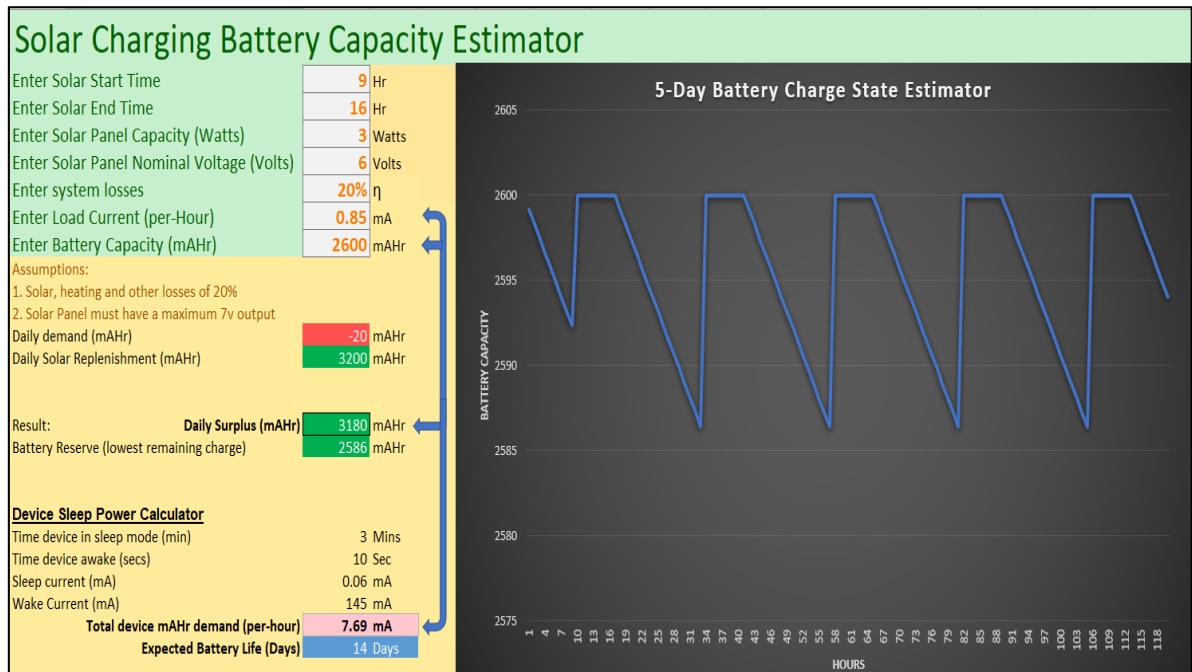

Figure 24: data from ThingSpeak drip irrigation system. (Source: Owner)

- (1) At what time sun beams begin falling let take 9 am in the first part of the day.
- (2) Same what time sun sets 4 pm in early afternoon.
- (3) Enter solar panel capacity one or more attached in series let's take 10 watts.
- (4) Solar panel volts are expressed behind board or on the container, one can check with multimeter turn pot to Dc volt 20 to 200V there we get panel voltage it very well may be shift by the sun development hence we really want a sun-oriented charger to get a steady voltage and consistent current after that put what can be found in meter as 6 volts.
- (5) Every framework has its own losses this framework additionally had its own like as Sun powered, warming and different misfortunes of 20%.
- (6) Now need to enter Load Current (per-Hour) mean Ampere as here I had need for modest quantity of load which is in milli Ampere (mA) it very well may be 0.75 to 100 around.

- (7) Enter Battery Capacity (mAHr) which is found on itself expressed currently in this I had utilized 18650 of 2 to 5A and 2600mAh.
- (8) In these 5 days battery charge estimator we get the outcome as expected form battery life of 10 to 14 days with normal charge of sun and in winter season we can twofold the size of battery and sunlight-based charger to get more run time in no daylight or bad climate.
- (9) In this diagram it tends to be seen Clearly that x axis and y axis where battery limit and hours can be seen of 5 days of 118 hours, in first-hour utilization of battery it runs 6 to 8 hours of operation in that following day 9 am toward the beginning of the day again sun-oriented charger charge the battery for the following hour of activity this is proceed as same to amplify the sudden spike in demand for battery need to introduce multiple times greater solar panel and battery.
- (10) From this graph in upper diagram, it depicts the same set of data in excel table form which had 5 days of data of charging and discharging of battery as here clearly, we can see that hour column 0 to 8 it is charging and after that it charge fully TP4056 will cut off the current for charging to battery is protected by over charging and over current & voltage so our battery is safe and can operate in remote areas is of had made various lines in the diagram.

6. Conclusion and recommendations

6.1 Conclusion

From the above discussions and explanations, it can be concluded that by implementation of this Smart Agricultural Irrigation System powered by Solar Energy, there have been various advantages for the farmers as well as for the governments. As per the calculations done, it has been estimated that agriculture requires 16.5 litres of water approximately of pr flood irrigation for irrigating about 10 square meters of land area in a single day. It is seen that in this research study, a drip irrigation system is being used which uses 10% to 20% of the overall water that is used in flood irrigation and this is approximately 1.65 litres to about 3.30 litres. In this research plan, basil plant is being used which is of 4.5 inches of diameter and 3 inches of height that requires water of approximately 70 ml in the single day. Prior to the flood irrigation, the plant of the similar size consumes water of about 120 ml of water in the whole day. Therefore, by utilizing this model which is being proposed here in this research study saves water about 42% in a single day. By utilizing the automatic system of irrigation, optimizes the water utilization by decreasing the loss of water as well as decreasing the interventions of the human for the farmers. The excessive solar energy that is being produced by the solar panels could also be provided to grids along with the alterations in the circuitry. This would be the revenue source for the farmers which encourages agriculture worldwide as well as provides a better solution for this crisis of energy.

The implementation of this proposed system is easy as well as is an eco-friendly solution for irrigation of the fields. This system that is being proposed in the research study is found to be efficient as well as successful when it is being implemented related to the boreholes as these pumps through the entire day. From this research study, it can also be concluded that there are various issues that are being related to the Smart Irrigation System. These issues include utilization of the battery for storing the charges and due to this there is loss of energy while battery charging forms the panels. This is followed by the discharge of battery due to supplying to the pumps which is also needed to be considered. There are also other issues and disadvantages that include higher expense of setting up the material, long ROI as well as the installation expense is higher. It also requires a large area as the efficiency has not yet reached 100%. Also there exists no solar energy at night so due to this, there requires a bank of larger batteries. There are also disadvantages such as the devices run on direct current power supply which are very

expensive, also the size of the panels depends on the type of the geographical locations, also cloudy days does provide less energy and also the panels have not been produced in large amount because of the lacking in the technology as well as material for cutting the expense for creating it less expensive and affordable.

From the above discussions, it can be analysed that the water necessities depend on the various factors which includes the type of crop that determines the amount of water that will be required. Intense water is needed for the paddy crops which needs about 20,000 litres to about 40,000 litres of water in every three days. Also, the other trees need less amount of water than the paddy crops. In the tropical areas as well as in the subtropical areas, particularly in the arid areas, the interval of irrigation is high which is like every two to three days. In the areas which are slightly moist, the interval of irrigation is like four to five days. Also, there are numerous types of soil which includes clay, loam, sand loam, clay loam, and sandy soil, determines the categories of crops as well as changes the system of irrigation which also determines the requirement of crops. The soil permeability determines the capacity of retention of water that is also known as Conductivity of Water. Higher soil permeability is the process where the water is being drained quickly which reduces the interval of irrigation, which will be from about four to five days and to about two to three days. But also, if the permeability is lower, then the water gets stagnant which rots the roots of the crops. So, the permeability of the soil must be moderate which will be able to determine the crops that need to be cultivated, also which determines the amount of water necessary for irrigation.

From this research study it is also analysed that there are various benefits related to Solar Powered Irrigation which includes that it is free from pollution and does not emit greenhouse gases. There is a reduction in the dependency of fossil fuels as well as foreign oil. The excessive power could also be sold to power companies, it is efficient and could be installed anywhere. The batteries could also be used to store the power which has become excess in the night time. For enhancing the day-to-day tracking arrays of the rates of pumping could be implemented which demonstrates the application in utilizing solar photovoltaic for providing the energy for the requirements of pumping for the sprinkle irrigation. Although there is higher investment of capital, the total benefits are higher as well as are also economical in the longer run.

6.2 Recommendations

After going through the literature mentioned above, it has been observed that sustainability is the need of the hour. Agriculture and farming is one of the most basic systems in any country, however it has been observed that in many countries, there have been major issues in the past centuries as the water table is depleting and the challenge of increased energy demand to supply the water is ever increasing. However, being smart in any system means to be able to provide cost effective solutions as well as must be energy efficient. The non-renewable sources of energy consumption are also ever increasing.

- One of the major challenges related to implementation of solar irrigation is the increased cost of initial installation. The solar panels are costly, also it has been observed that this system's main outcome is to minimise cost for the end user. However, this is not a paradox as farming and agriculture is the backbone of any country. The intervention of the government is necessary in order to mitigate the challenge of high installation cost. The government can take initiative in order to minimize the cost for the end user which is the farmers. Government initiatives may include in providing subsidy in purchasing the products. It has been observed in many cases were providing subsidy (Imjai et al., 2020). The requirement of subsidy is only required in the developing country where the economic condition of the farmers is poor but the country's economic backbone lies on the hand of the agriculture sector. India being the prime example of such an irrigation system where with the help of many government initiatives, the challenge of cost could have been minimised to much greater extent. For government one investment is causing two solutions where the primary solution is that it will help in meeting the nation's green energy target which is to be submitted in global conferences. And secondly which is the most important solution of meeting demands for farmers.

- As technology is ever changing and evolving at a rapid pace, such technology creates major barriers for people who are less knowledgeable and unfamiliar with innovations. It can be seen that in most of the African nations as well as Asian countries like India, South Korea, Bangladesh the lack of technological literacy among the farmers is huge and is a major roadblock in implementing such innovative solutions. The lack of knowledge however can be mitigated with a two-step solution (Biswas and Iqbal, 2018). The first solution relies on government intervention where if any such technology is being used, it is necessary to work with a supervisor from a local level who will

supervise, monitor and operate the devices. Following the adoption, the initiative of teaching and educating the basics of operating the instrument is needed. Such training should be more practical oriented and little theoretical knowledge (Al-Saidi and Lahham, 2019). The government can also open up teaching programs one year after year where the new farmers will be engaged in learning the know-how of such a system in detail for their future implementation.

- Climatic condition heavily influences the system as the climatic condition needs to be sunny. In areas where there are continuous clouds the irrigation system will not work as it is solar operated (ICID, 2019). Also, such kind of irrigation is not possible in the night times when the sun is not available. However, it is recommended to use more solar charged batteries which can provide energy when there is lack of sun in day time and when the weather is mostly cloudy.
- The major challenge is the availability of land in countries where the population density is high also the area for agriculture is significantly on limitations. The installation area for the solar panels is much higher and the area cannot be used for any other irrigation purpose (ICID, 2019). However, this problem has one possible solution that is to keep the solar powered pumps at predefined barren lands where agriculture is not done. Also, the solar panels can be installed on the roadside as it will help in utilising the roadside land as well as minimise the area for required land for installation. Another possible solution is the use of alternate sources of renewable energy such as windmills as it generates more power and can be located at great distance from the main agricultural land. The combined use of windmill and solar panels will also mitigate the problem of required land (Anapalli et al., 2018).
- Lack of an alternate source of water during breakdown of the whole system can lead to great business loss for farmers as there are no substitute means of delivering water. In such cases, an extra storage tank can be used and built at an elevated level from the land (ICID, 2019). Such tanks will provide temporary relief to the farmers as the conventional gravitational pull will deliver the water sources.
- Lack of skilled labour is also another major factor as mentioned above where the skilled labour is required to solve the day-to-day problems related to the system overall. Capacity building is the most crucial stage prior to installing the system as without knowledge, the system is of no practical use. As this technology is gaining popularity as well as the increased installation is now putting the overall cost of installation much

lower than which was a decade ago. Mass implementation however is a question which can be seen with time. It can be said that this solution is not a prototype, however continuous improvement in this system can make the system more refined (Al-Saidi and Lahham, 2019).

- The future scope of this technology is not limited to the use of solar panels however when sustainability comes in question, the multidimensional approach must be considered to meet the challenge of energy demand as most of the solutions have certain restrictions. The combinations of such energy sources will not only provide more feasible solutions but will also increase the independence of the farmers of the nation overall making them more self-reliant than ever (Anapalli et al., 2018).

7 References

- 1) Abayomi-Alli, O., Odusami, M., Ojinnaka, D., Shobayo, O., Misra, S., Damasevicius, R. and Maskoliunas, R., 2018, November. Smart-Solar Irrigation System (SMIS) for Sustainable Agriculture. In *International Conference on Applied Informatics* (pp. 198-212). Springer, Cham.
- 2) Abildso, C.G., Haas, V., Daily, S.M. and Bias, T.K., 2021. Field Test of a Passive Infrared Camera for Measuring Trail-Based Physical Activity. *Frontiers in Public Health*, 9, p.225.
- 3) Al-Ali, A., Al Nabulsi, A., Mukhopadhyay, S., Awal, M., Fernandes, S. and Ailabouni, K., 2019. IoT-solar energy powered smart farm irrigation system. *Journal of Electronic Science and Technology*, 17(4), p.100017.
- 4) Al-Saidi, M. and Lahham, N., 2019. Solar energy farming as a development innovation for vulnerable water basins. *Development in Practice*, 29(5), pp.619-634.
- 5) Amariei, D., Utoiu, C., Ocnean, M., Fazekas, C. and Toth, K., 2020. Adapting smart irrigation systems-sustainable solution for the future. *Agricultural Management/Lucrări Științifice Seria I, Management Agricol*, 22(2).
- 6) Anapalli, S.S., Green, T.R., Reddy, K.N., Gowda, P.H., Sui, R., Fisher, D.K., Moorhead, J.E. and Marek, G.W., 2018. Application of an energy balance method for estimating evapotranspiration in cropping systems. *Agricultural Water Management*, 204, pp.107-117.
- 7) Andrews, J., Kowsika, M., Vakil, A. and Li, J., 2020, April. A motion induced passive infrared (PIR) sensor for stationary human occupancy detection. In *2020 IEEE/ION Position, Location and Navigation Symposium (PLANS)* (pp. 1295-1304).
- 8) Assaf, R. and Ishaq, I., 2020, December. Improving Irrigation by Using a Cloud Based IoT System. In *2020 International Conference on Promising Electronic Technologies (ICPET)* (pp. 28-31). IEEE.
- 9) Baladi, R.A. and Shah, M.A., 2018. Solar Powered Irrigation System for Agriculture based on Moisture Content in the Field and Saving Energy and Water with Optimum Designing. *Asian Journal of Engineering, Sciences & Technology*, 8(1).
- 10) Baviskar, P.V., Chaudhari, N.R. and Koli, N.P., 2020. ADVANCED AUTOMATIC IRRIGATION SYSTEM WITH DAY AND NIGHT SENSING AND AUTO CONTROLLING OF MOTOR.

- 11) Bhattacharya, M., Roy, A. and Pal, J., 2021. Smart Irrigation System Using the Internet of Things. In *Applications of Internet of Things* (pp. 119-129). Springer, Singapore.
- 12) Biswas, S. and Iqbal, M.T., 2018. Dynamic modelling of a solar water pumping system with energy storage. *J. Sol. Energy*, 2018, pp.1-12.
- 13) Biswas, S.B. and Iqbal, M.T., 2018, May. Solar water pumping system control using a low cost ESP32 microcontroller. In *2018 IEEE Canadian conference on electrical & computer engineering (CCECE)* (pp. 1-5). IEEE.
- 14) Boursianis, A.D., Papadopoulou, M.S., Gotsis, A., Wan, S., Sarigiannidis, P., Nikolaidis, S. and Goudos, S.K., 2020. Smart Irrigation System for Precision Agriculture-The AREThOU5A IoT Platform. *IEEE Sensors Journal*.
- 15) Bouzguenda, M., Rajamohamed, S., Shwehdi, M.H. and Aldalbahi, A., 2019. Solar powered smart irrigation system based on low cost wireless network: A senior design project experience. *The International Journal of Electrical Engineering & Education*, p.0020720919860414.
- 16) Bu, F. and Wang, X., 2019. A smart agriculture IoT system based on deep reinforcement learning. *Future Generation Computer Systems*, 99, pp.500-507.
- 17) Casaccia, S., Rosati, R., Scalise, L. and Revel, G.M., 2020, May. Measurement of Activities of Daily Living: a simulation tool for the optimisation of a Passive Infrared sensor network in a Smart Home environment. In *2020 IEEE International Instrumentation and Measurement Technology Conference (I2MTC)* (pp. 1-6). IEEE.
- 18) Closas, A. and Rap, E., 2017. Solar-based groundwater pumping for irrigation: Sustainability, policies, and limitations. *Energy Policy*, 104, pp.33-37.
- 19) Closas, A. and Rap, E., 2017. Solar-based groundwater pumping for irrigation: Sustainability, policies, and limitations. *Energy Policy*, 104, pp.33-37.
- 20) Difallah, W., Benahmed, K., Bounnama, F., Draoui, B. and Saidi, A., 2018. Intelligent Irrigation Management System. *energy*, 9(9).
- 21) Difallah, W.A.F.A., Benahmed, K., Draoui, B.E.L.K.A.C.E.M. and Bounaama, F., 2017. Implementing wireless sensor networks for smart irrigation. *Taiwan water conservancy*, 65(3).
- 22) Dutta, P.K., Mallikarjuna, K. and Satish, A., 2017, September. Sensor based solar tracker system using electronic circuits for moisture detection and auto-irrigation. In

- 2017 *IEEE International Conference on Power, Control, Signals and Instrumentation Engineering (ICPCSI)* (pp. 1475-1478). IEEE.
- 23) Engpaper.com. 2021. IOT Based Crop Protection System. [online] Available at: <<https://www.engpaper.com/ece/iot-based-crop-protection-system.html>> [Accessed 20 March 2021].
- 24) Eragamreddy, G. and Sree, K.R., 2017, August. Solar powered auto watering system for irrigation using embedded controllers. In *2017 International Conference on Energy, Communication, Data Analytics and Soft Computing (ICECDS)* (pp. 2424-2428). IEEE.
- 25) Fidelis, I.S. and Idim, I.A., 2020. Design and Implementation of Solar Powered Automatic Irrigation System. *Am. J. Electric. and Com. Eng*, 4, pp.1-9.
- 26) Fiehn, H.B., Schiebel, L., Avila, A.F., Miller, B. and Mickelson, A., 2018, October. Smart agriculture system based on deep learning. In *Proceedings of the 2nd International Conference on Smart Digital Environment* (pp. 158-165).
- 27) Fraga-Lamas, P., Celaya-Echarri, M., Azpilicueta, L., Lopez-Iturri, P., Falcone, F. and Fernández-Caramés, T.M., 2020. Design and empirical validation of a lorawan IoT smart irrigation system. In *Multidisciplinary Digital Publishing Institute Proceedings* (Vol. 42, No. 1, p. 62).
- 28) Froiz-Míguez, I., Lopez-Iturri, P., Fraga-Lamas, P., Celaya-Echarri, M., Blanco-Novoa, Ó., Azpilicueta, L., Falcone, F. and Fernández-Caramés, T.M., 2020. Design, Implementation, and Empirical Validation of an IoT Smart Irrigation System for Fog Computing Applications Based on LoRa and LoRaWAN Sensor Nodes. *Sensors*, 20(23), p.6865.
- 29) García, L., Parra, L., Jimenez, J.M., Lloret, J. and Lorenz, P., 2020. IoT-based smart irrigation systems: An overview on the recent trends on sensors and IoT systems for irrigation in precision agriculture. *Sensors*, 20(4), p.1042.
- 30) Goap, A., Sharma, D., Shukla, A.K. and Krishna, C.R., 2018. An IoT based smart irrigation management system using Machine learning and open source technologies. *Computers and electronics in agriculture*, 155, pp.41-49.
- 31) Gora, A. and Dulawat, M.S., 2017. Solar powered smart irrigation. *Research Journal of Agriculture and Forest*, 5(6), pp.15-19.
- 32) Gu, Z., 2021. Home smart motion system assisted by multi-sensor. *Microprocessors and Microsystems*, 80, p.103591.

- 33) Harde, M.R. and Choudhari, N.K., 2017. A Review Paper On Wireless Sensor Network And Gprs Module For Automated Irrigation. *International Research Journal of Engineering and Technology (IRJET)*, 4(01).
- 34) Hassan, A., Abdullah, H.M., Farooq, U., Shahzad, A., Asif, R.M., Haider, F. and Rehman, A.U., 2020. A Wirelessly Controlled Robot-based Smart Irrigation System by Exploiting Arduino. *Journal of Robotics and Control (JRC)*, 2(1), pp.29-34.
- 35) Hassan, O.A., Zulkifli, S.A., Norjali, R., Sim, S.Y. and Lam, H.Y., 2020. Iot Based Smart Irrigation Control And Monitoring System. *Advances in Computing and Intelligent System*, 2(2).
- 36) Hernandez, R.R., Armstrong, A., Burney, J., Ryan, G., Moore-O’Leary, K., Diedhiou, I., Grodsky, S.M., Saul-Gershenz, L., Davis, R., Macknick, J. and Mulvaney, D., 2019. Techno–ecological synergies of solar energy for global sustainability. *Nature Sustainability*, 2(7), pp.560-568.
- 37) ICID., 2019. Solar Powered Irrigation Systems in India: Lessons for Africa Through a FAO Study Tour Draft Report (2019). International Commission on Irrigation and Drainage. (ICID). [online] Available at: <<https://www.icid.org/FAO-SPIS-Report.pdf>> Accessed on 31 March 2021.
- 38) Ieee Project Madurai.in. 2021. <<http://www.ieeeprojectmadurai.in/BASE/EMBEDDED%20SYSTEMS/Automated%20Irrigation%20System.pdf>>
- 39) Imjai, T., Thinsurat, K., Ditthakit, P., Wipulanusat, W., Setkit, M. and Garcia, R., 2020. Performance Study of an Integrated Solar Water Supply System for Isolated Agricultural Areas in Thailand: A Case-Study of the Royal Initiative Project. *Water*, 12(9), p.2438.
- 40) Kabir, E., Kumar, P., Kumar, S., Adelodun, A.A. and Kim, K.H., 2018. Solar energy: Potential and future prospects. *Renewable and Sustainable Energy Reviews*, 82, pp.894-900.
- 41) Kamienski, C., Soinenen, J.P., Taumberger, M., Dantas, R., Toscano, A., Salmon Cinotti, T., Filev Maia, R. and Torre Neto, A., 2019. Smart water management platform: Iot-based precision irrigation for agriculture. *Sensors*, 19(2), p.276.
- 42) Karar, M.E., Al-Rasheed, M.F., Al-Rasheed, A.F. and Reyad, O., 2020. IoT and neural network-based water pumping control system for smart irrigation. *arXiv preprint arXiv:2005.04158*.

- 43) Kardile, M.S., Kumar, M.M. and Balaramadu, M.P., 2017. Automated Irrigation System Using a Wireless Sensor Network and GPRS Module. *Asian Journal For Convergence In Technology (AJCT)*, 3.
- 44) Kokkonis, G., Kontogiannis, S. and Tom Tsis, D., 2017. A smart IoT fuzzy irrigation system. *Power (mW)*, 100(63), p.25.
- 45) Krishna, K.L., Silver, O., Malende, W.F. and Anuradha, K., 2017, February. Internet of Things application for implementation of smart agriculture system. In *2017 International Conference on I-SMAC (IoT in Social, Mobile, Analytics and Cloud)(I-SMAC)* (pp. 54-59). IEEE.
- 46) Liu, Z., 2018. What is the future of solar energy? Economic and policy barriers. *Energy Sources, Part B: Economics, Planning, and Policy*, 13(3), pp.169-172.
- 47) Maddikunta, P.K.R., Hakak, S., Alazab, M., Bhattacharya, S., Gadekallu, T.R., Khan, W.Z. and Pham, Q.V., 2021. Unmanned Aerial Vehicles in Smart Agriculture: Applications, Requirements, and Challenges. *IEEE Sensors Journal*.
- 48) Mahmood, F. and Al-Ansari, T.A., 2021. Design and thermodynamic analysis of a solar powered greenhouse for arid climates. *Desalination*, 497, p.114769.
- 49) Maskara, R., Maskara, N. and Bandyopadhyay, S., 2019. Solar system powered IoT solution for smart irrigation. *Asian Journal For Convergence In Technology (AJCT)*.
- 50) Maskara, R., Maskara, N. and Bandyopadhyay, S., 2019. Solar system powered IoT solution for smart irrigation. *Asian Journal For Convergence In Technology (AJCT)*.
- 51) Mekala, M.S. and Viswanathan, P., 2017, August. A Survey: Smart agriculture IoT with cloud computing. In *2017 international conference on microelectronic devices, circuits and systems (ICMDCS)* (pp. 1-7). IEEE.
- 52) Mishra, D., Pande, T., Agrawal, K.K., Abbas, A., Pandey, A.K. and Yadav, R.S., 2019, June. Smart agriculture system using IoT. In *Proceedings of the Third International Conference on Advanced Informatics for Computing Research* (pp. 1-7).
- 53) Mukherjee, P. and Sengupta, T.K., 2020. Design and Fabrication of Solar-Powered Water Pumping Unit for Irrigation System. In *Computational Advancement in Communication Circuits and Systems* (pp. 89-102). Springer, Singapore.
- 54) Munir, M.S., Bajwa, I.S., Naeem, M.A. and Ramzan, B., 2018. Design and implementation of an IoT system for smart energy consumption and smart irrigation in tunnel farming. *Energies*, 11(12), p.3427.

- 55) Muosa, A.H. and Hamed, A.M., 2020, November. Remote Monitoring and Smart Control System for Greenhouse Environmental and Automation Irrigations Based on WSNs and GSM Modules. In *IOP Conference Series: Materials Science and Engineering* (Vol. 928, No. 3, p. 032037). IOP Publishing.
- 56) Nanda, I., Chadalavada, S., Swathi, M. and Khatua, L., 2021, February. Implementation of IIoT based smart crop protection and irrigation system. In *Journal of Physics: Conference Series* (Vol. 1804, No. 1, p. 012206). IOP Publishing.
- 57) Neupane, J. and Guo, W., 2019. Agronomic basis and strategies for precision water management: A review. *Agronomy*, 9(2), p.87.
- 58) Ogidan, O.K., Amusan, A.A. and Nkanga, I.E., 2020. MONITORING OF PHOTOVOLTAIC PANEL IN A SOLAR-POWERED LAB-SCALE SMART IRRIGATION SYSTEM. *LAUTECH Journal of Engineering and Technology*, 14(1), pp.8-20.
- 59) Ojo, M.O., Adami, D. and Giordano, S., 2020, September. Network Performance Evaluation of a LoRa-based IoT System for Crop Protection Against Ungulates. In *2020 IEEE 25th International Workshop on Computer Aided Modeling and Design of Communication Links and Networks (CAMAD)* (pp. 1-6). IEEE.
- 60) Padalalu, P., Mahajan, S., Dabir, K., Mitkar, S. and Javale, D., 2017, April. Smart water dripping system for agriculture/farming. In *2017 2nd international conference for convergence in technology (I2CT)* (pp. 659-662). IEEE.
- 61) Patil, G.L., Gawande, P.S. and Bag, R.V., 2017. Smart agriculture system based on IoT and its social impact. *International Journal of Computer Applications*, 176(1), pp.0975-8887.
- 62) Penchalaiah, N., Pavithra, D., Bhargavi, P., Madhuri, D., Shaik, E. and Md. Sohaib, S., 2021. [online] Jespublication.com. Available at: <<https://jespublication.com/upload/2020-1104126.pdf>> [Accessed 20 March 2021].
- 63) Pinzón Trejos, C., Salazar, R., Rodríguez, A. and Rangel, J.C., 2018. Irrigation system through intelligent agents implemented with arduino technology.
- 64) Pradeep, K.V. and Balasundaram, A., 2021. IoT based Smart Irrigation for Agricultural Fields. *Annals of the Romanian Society for Cell Biology*, pp.2000-2009.
- 65) Prathibha, S.R., Hongal, A. and Jyothi, M.P., 2017, March. IoT based monitoring system in smart agriculture. In *2017 international conference on recent advances in electronics and communication technology (ICRAECT)* (pp. 81-84). IEEE.

- 66) Putri, R.E., Putri, I. and Pilly, M.A., 2021. *Design and Implementation of an IoT System for Smart Irrigation* (No. 5014). EasyChair.
- 67) Ramachandran, V., Ramalakshmi, R. and Srinivasan, S., 2018, November. An automated irrigation system for smart agriculture using the Internet of Things. In *2018 15th International Conference on Control, Automation, Robotics and Vision (ICARCV)* (pp. 210-215). IEEE.
- 68) Ramachandran, V., Ramalakshmi, R. and Srinivasan, S., 2018, November. An automated irrigation system for smart agriculture using the Internet of Things. In *2018 15th International Conference on Control, Automation, Robotics and Vision (ICARCV)* (pp. 210-215). IEEE.
- 69) Raza, A., Khan, M.B., Ali, W., Memon, M.J. and Daudpota, R., 2021. An IoT based Smart Agriculture Monitoring and Control. *International Journal of Electrical Engineering & Emerging Technology*, 4(SI 1), pp.8-14.
- 70) Reddy, J., 2021. Solar Drip Irrigation System Benefits, Model | Agri Farming. [online] Agri Farming. Available at: <<https://www.agrifarming.in/solar-drip-irrigation-system-benefits-model>> [Accessed 20 March 2021].
- 71) Sadowski, S. and Spachos, P., 2018, November. Solar-powered smart agricultural monitoring system using internet of things devices. In *2018 IEEE 9th Annual Information Technology, Electronics and Mobile Communication Conference (IEMCON)* (pp. 18-23). IEEE.
- 72) Sadowski, S. and Spachos, P., 2018, November. Solar-powered smart agricultural monitoring system using internet of things devices. In *2018 IEEE 9th Annual Information Technology, Electronics and Mobile Communication Conference (IEMCON)* (pp. 18-23). IEEE.
- 73) Salman, R.D. and Lam, H.Y., 2020. IoT: Based Solar Powered Water Pump System. *Progress in Engineering Application and Technology*, 1(1), pp.274-283.
- 74) Sampaio, P.G.V. and González, M.O.A., 2017. Photovoltaic solar energy: Conceptual framework. *Renewable and Sustainable Energy Reviews*, 74, pp.590-601.
- 75) Samuel, R., Kumar, G.T., Vignesh, V., Vigneshwaran, V. and Murali, H., (2020). EMPOWERING FARMERS FOR A PROSPEROUS INDIA: IOT ENABLED AUTOMATIC IRRIGATION AND PREVENTION OF ANIMAL INTRUSION FOR BETTER CROP YIELD.

- 76) Sasi, G., 2021, January. Motion detection using Passive Infrared Sensor using IoT. In *Journal of Physics: Conference Series* (Vol. 1717, No. 1, p. 012067). IOP Publishing.
- 77) Sass, J. and Hahn, A., 2021. [online] Energypedia.info. Available at: <https://energypedia.info/images/7/74/Solar_Powered_Irrigation_Systems_%28SPIS%29_-_Technology%2C_Economy%2C_Impacts.pdf> [Accessed 20 March 2021].
- 78) Sekkal, N., Benslimane, S.M., Mrissa, M., Park, C.Y. and Boudaa, B., 2020. Proactive and reactive context reasoning architecture for smart web services. *International Journal of Data Mining, Modelling and Management*, 12(1), pp.1-27.
- 79) Shahsavari, A. and Akbari, M., 2018. Potential of solar energy in developing countries for reducing energy-related emissions. *Renewable and Sustainable Energy Reviews*, 90, pp.275-291.
- 80) Sharma, P., 2021. [online] Ijert.org. Available at: <<https://www.ijert.org/research/smart-irrigation-system-using-iotsis-IJERTV6IS060067.pdf>> [Accessed 20 March 2021].
- 81) Shilomboleni, H., 2020. Political economy challenges for climate smart agriculture in Africa. *Agriculture and Human Values*, 37(4), pp.1195-1206.
- 82) Soil Moisture Sensor Module. (2021). Retrieved 16 November 2021, from <https://components101.com/modules/soil-moisture-sensor-module>
- 83) Srinidhi, J.A., Aasish, A., Kumar, N.K. and Ramakrishnaiah, T., 2021. WSN Smart Irrigation System and Weather Report System. In *IOP Conference Series: Materials Science and Engineering* (Vol. 1042, No. 1, p. 012018). IOP Publishing.
- 84) Srivastava, P., Bajaj, M. and Rana, A.S., 2018, February. Overview of ESP8266 Wi-Fi module based smart irrigation system using IOT. In *2018 Fourth International Conference on Advances in Electrical, Electronics, Information, Communication and Bioinformatics (AEEICB)* (pp. 1-5). IEEE.
- 85) Ssenyimba, S., Kiggundu, N. and Banadda, N., 2020. Designing a solar and wind hybrid system for small-scale irrigation: a case study for Kalangala district in Uganda. *Energy, Sustainability and Society*, 10(1), p.6.
- 86) Strobel, G., 2020. Farming in the Era of Internet of Things: An Information System Architecture for Smart Farming. *Proceedings of the WI2020 Community Tracks*, pp.208-223.

- 87) Subramani, C., Usha, S., Patil, V., Mohanty, D., Gupta, P., Srivastava, A.K. and Dashetwar, Y., 2020. IoT-based smart irrigation system. In *Cognitive Informatics and Soft Computing* (pp. 357-363). Springer, Singapore.
- 88) Subramani, C., Usha, S., Patil, V., Mohanty, D., Gupta, P., Srivastava, A.K. and Dashetwar, Y., 2020. IoT-based smart irrigation system. In *Cognitive Informatics and Soft Computing* (pp. 357-363). Springer, Singapore.
- 89) Sudharshan, N., Karthik, A.K., Kiran, J.S. and Geetha, S., 2019. Renewable Energy Based Smart Irrigation System. *Procedia Computer Science*, 165, pp.615-623.
- 90) Sukhatme, S.P. and Nayak, J.K., 2017. *Solar energy*. McGraw-Hill Education.
- 91) Sushanth, G. and Sujatha, S., 2018, March. IOT based smart agriculture system. In *2018 International Conference on Wireless Communications, Signal Processing and Networking (WiSPNET)* (pp. 1-4). IEEE.
- 92) Susmitha, A., Alakananda, T., Apoorva, M.L. and Ramesh, T.K., 2017, August. Automated Irrigation System using Weather Prediction for Efficient Usage of Water Resources. In *IOP Conference Series: Materials Science and Engineering* (Vol. 225, No. 1, p. 012232). IOP Publishing.
- 93) Tamburino, L., Di Baldassarre, G. and Vico, G., 2020. Water management for irrigation, crop yield and social attitudes: a socio-agricultural agent-based model to explore a collective action problem. *Hydrological Sciences Journal*, 65(11), pp.1815-1829.
- 94) Tararani, G., Shital, G., Sofiya, K., Gouri, P. and Vasekar, S.R., 2018. Smart drip irrigation system using IOT. *International Research Journal of Engineering and Technology (IRJET) Volume*, 5.
- 95) Togneri, R., Kamienski, C., Dantas, R., Prati, R., Toscano, A., Soininen, J.P. and Conic, T.S., 2019. Advancing IoT-based smart irrigation. *IEEE Internet of Things Magazine*, 2(4), pp.20-25.
- 96) Torshizi, M.V. and Mighani, A.H., 2017. The application of solar energy in agricultural systems. *Journal of Renewable Energy and Sustainable Development*, 3(2), pp.234-240.
- 97) Triantafyllou, A., Tsouros, D.C., Sarigiannidis, P. and Bibi, S., 2019, May. An architecture model for smart farming. In *2019 15th International Conference on Distributed Computing in Sensor Systems (DCOSS)* (pp. 385-392). IEEE.

- 98) Tripathi, A., Maurya, A.K., Pal, A. and Gupta, M.A., 2020. Smart Drip Irrigation System using IoT with Artificial Lights.
- 99) Tsirogiannis, I.L., Orsini, F. and Luz, P., 2017. Water management and irrigation systems. In *Rooftop Urban Agriculture* (pp. 129-146). Springer, Cham.
- 100) Valecce, G., Strazzella, S., Radesca, A. and Grieco, L.A., 2019, May. Solar Fertigation: Internet of things architecture for smart agriculture. In *2019 IEEE International Conference on Communications Workshops (ICC Workshops)* (pp. 1-6). IEEE.
- 101) Valipour, M., 2017. Global experience on irrigation management under different scenarios. *Journal of Water and Land Development*, 32(1), pp.95-102.
- 102) Velasco, R.M.A., 2020. Design and Development of a Solar Powered Smart Irrigation System: An Adaptive Process Model.
- 103) Wu, L. and Wang, Y., 2020, September. True Presence Detection via Passive Infrared Sensor Network Using Liquid Crystal Infrared Shutters. In *Smart Materials, Adaptive Structures and Intelligent Systems* (Vol. 84027, p. V001T08A004). American Society of Mechanical Engineers.
- 104) Yang, X., Shu, L., Chen, J., Ferrag, M.A., Wu, J., Nurellari, E. and Huang, K., 2020. A Survey on Smart Agriculture: Development Modes, Technologies, and Security and Privacy Challenges. *IEEE/CAA Journal of Automatica Sinica*, 8(2), pp.273-302.

8 Appendix.

Reading taken in Interval of Every Hours						
Total hours	Date	Time	Soil Dryness %	Temp degree Celsius	Humidity %	Pump
1	25-03-2021	7.00 am	843	10.0	51	1
2		8.00 am	805	13.0	49	1
3		10.00 am	769	18.0	45	1
4		11.00 am	641	22.0	38	1
5		12.00 pm	557	23.0	34	1
6		1.00 pm	495	21.0	36	0
7		2.00 pm	484	23.0	35	0
8		3.00 pm	382	22.5	34	0
9		4.00 pm	370	22.6	35	0
10		5.00 pm	361	22.5	34	0
11		6.00 pm	346	22.5	33	0
12		7.00 pm	327	22.9	33	0
13		8.00 pm	327	21.0	34	0
14		9.00 pm	389	20.5	35	0
15		10.00 pm	390	19.0	36	0
16		11.00 pm	406	18.0	36	0
17	26-03-2021	12.00 am	416	17.5	36	0
18		1.00 am	421	17.0	37	0
19		2.00 am	435	16.8	37	0
20		3.00 am	513	16.0	37	1
21		4.00 am	650	16.0	38	1
22		5.00am	683	15.0	38	1
23		6.00am	706	14.6	40	1
24		7.00am	734	14.0	48	1

Appendix Table: 3 reading taken from prototype.