

**CZECH UNIVERSITY OF LIFE SCIENCES PRAGUE**

**FACULTY OF ECONOMICS AND MANAGEMENT**

**DEPARTMENT OF INFORMATION TECHNOLOGIES**



**DIPLOMA THESIS**

**INFORMATION AND COMMUNICATION PROCESSES IN THE  
MANUFACTURING COMPANY OF EPYLLION GROUP IN  
BANGLADESH**

**S M AKTARUZZAMAN, BBS**

**SUPERVISOR: ING. MILOŠ ULMAN, PH.D.**

**© 2018 CULS Prague**

## DIPLOMA THESIS ASSIGNMENT

Sm Aktaruzzaman, BBS

Informatics

Thesis title

**Information and communication processes in the manufacturing company**

---

### Objectives of thesis

The main objective of the thesis is to analyze current state of information processing and communication in a manufacturing company in Bangladesh.

The partial goals of the thesis are such as:

- To generate a dynamic overview of current state of the art in information processing and enterprise information systems.
- To analyze and select an optimum solution of current state information processing and communication arrangement in the selected manufacturing company.
- To develop a feasibility study and to evaluate the proposed solution.

### Methodology

Methodology of the thesis is based on study and inquiry of academic papers and professional resources of business information processing and communication. The design of information and communication process and implementation will be based on a case study of a selected manufacturing company in Bangladesh. Based on the theoretical findings and outcomes of the practical part of the thesis, the conclusion and recommendations will be framed.

## **The proposed extent of the thesis**

60 – 80 pages

## **Keywords**

Manufacturing companies, Digital information processing and communications, Information and Communication Technologies, Textile Industry.

---

## **Recommended information sources**

Briffaut, J.P., 2015. E-enabled operations management. John Wiley & Sons. ISBN: 9781119145295

EPYLLION GROUP.: a house of Textile, Readymade Garments ... Textile Division

<http://www.epylliongroup.com/backward/pages/textile.php>

Flexible Manufacturing System Shivanand, H.K.; Benal, M.M.; and more New Age International Pvt. Ltd., Publishers 2006 ISBN: 9788122418705, 9788122425598

Information Control Problems in Manufacturing 2006 Dolgui, Alexandre; Morel, Gerard; and more

Elsevier Science 2011 ISBN: 9780080446547, 9780080478487 SERIES: IFAC Proceedings Volumes

The textile and clothing industry of Bangladesh in a changing world economy Sadequul Islam, Centre for Policy Dialogue (Bangladesh) Centre for Policy Dialogue, 2001 ISBN 9840515675, 9789840515677

---

## **Expected date of thesis defence**

2017/18 SS – FEM

## **The Diploma Thesis Supervisor**

Ing. Miloš Ulman, Ph.D.

## **Supervising department**

Department of Information Technologies

Electronic approval: 30. 10. 2017

**Ing. Jiří Vaněk, Ph.D.**

Head of department

Electronic approval: 1. 11. 2017

**Ing. Martin Pelikán, Ph.D.**

Dean

Prague on 12. 02. 2018

## **DECLARATION**

I declare that I have worked on my diploma thesis titled "**INFORMATION AND COMMUNICATION PROCESSES IN THE MANUFACTURING COMPANY**" by myself and I have used only the sources mentioned at the end of the thesis. As the author of the diploma thesis, I declare that the thesis does not break copyrights of any third person.

In Prague on 23<sup>th</sup> November, 2018

---

## **ACKNOWLEDGEMENT**

I would like to Special thanks to Professor Ing. Miloš Ulman, Ph.D. and Md. Mahbubur Rahman (Shohag), MBA - Deputy General Manager (Operation Department) Epyllion Group for their valuable advice, suggestions and emotional support during my work on the thesis. I'm grateful to my parents & family members who always encourage me to do study and to complete my education for a near good future.

### **Abstract:**

The main objective of this thesis is to analyze current state of information system and communication process on the Textile manufacturing sector. An empirical case study of existing system of Epyllion Group (Leading manufacturing industry in Bangladesh) was conducted and a new model was proposed by analyzing current state ICT Infrastructures, considering theoretical part, interview with the Company representative(Corporate IT Manager), documents analysis, research & overviewing the Company data new proposed model was designed. This model include basic functionality and general manufacturing process as well as evaluating usages of ICT communication, analyzing current state ICT Infrastructure, organize it, customized to fit the requirement for new proposed model. The implementation of the new information and communication process Cloud based communication will lead to development and achievements of different business functionalities(ERP, email communication, data security, Software & Applications, documents in cloud, storages etc.) which could not be achieved by the Linear Communication process. The biggest challenge of ICT in the future is security of data, application, software, websites and it could negatively impact the connectivity to public networks and business network where people are involved at every level.

**Keywords:** Manufacturing companies and ICT, impacts of ICT, Current state information and communication process.

1. Introduction .....	12
1.1 Conceptual framework of the thesis: .....	13
2. Objectives and Methodology .....	14
2.1. Objectives of the thesis:.....	14
2.2. Methodology:.....	14
2.3. Overview of the Methodology:.....	14
3. Literature Review .....	15
3.1. Definition of Communication and information: .....	15
3.2. Information systems in manufacturing industry:.....	16
3.3. Types of Communication and Channels:.....	16
3.4. Direction of Communication within Organizations: .....	17
3.5. Communication Tools Used in Modern Day Business: .....	18
HR Communication and Departmental Relation: .....	20
3.6. Concepts of Information Systems: .....	20
3.7. Major Capabilities of Information Systms: .....	21
3.8. Types of Organizational information systems:.....	23
3.9. Nature of Information and Communication technology: .....	23
3.10. Production process and use of information: .....	24
3.11. ERP Systems: .....	25
Enterprise information systems:.....	26
3.12. AUTO CAD in Manufacturing:.....	26
3.13. Fabrics Dyeing Information and communication systems in Manufacturing: .	27
3.14. Information and Communication technology Methods:.....	29
Linear Communication Model: .....	29
3.15. Cloud based Communication Model: .....	31
3.16. Benefits of Cloud Computing:.....	33
3.17. Comparing different Cloud service Providers:.....	34
3.18. Automated vs Manual Information Systems: .....	36
3.19. Business process Management (BPM): .....	38
3.20. Why a Production Process Needs Information Technology:.....	39
3.21. Textile & Garments Industry:.....	40
3.22. Manufacturing industry and impact of ICT:.....	41
3.23. Impact areas of ICT and their relationships: .....	43
3.24. Bangladesh Garment Manufacturers and Exporters Association: .....	44
3.25. ICT in Bangladesh: .....	45
3.26. Digital Culture in Bangladesh: .....	45

4. Practical Part.....	47
4.1. Case Study (Epyllion Group): .....	47
4.2. About Epyllion Group: .....	47
4.3. Corporate Profile: .....	48
4.4. Organizational Structure:.....	50
4.5. Current state Software & Application: .....	52
4.6. Current state information and communication process: .....	52
4.7. Limitations of Linear communication model: .....	55
4.8. Business process and plan: .....	55
4.9. Buying Partners: .....	57
4.10. Brand Analysis: .....	59
4.11. Marketing & Merchandising: .....	59
4.12. Merchandiser: .....	60
4.13. Garments Production Process:.....	61
4.14. SWOT Analysis:.....	65
66	
4.15. Proposed new Design for information and communication process: .....	67
4.16. Proposed software and Application solution: .....	70
4.17. Financial cost and budget analysis: .....	70
4.18. Feasibility study:.....	72
Information and communication process Empirical Findings: .....	72
4.19. Summary:.....	74
5. Discussion & Results:.....	75
5.1 Way to overcome & control Empirical finding: .....	75
5.2 Recommendations: .....	77
5.3 Evaluation of research Approach .....	81
6. Conclusion .....	82
7. Bibliography .....	84



**List of Figures:**

Figure 1-1 Scope of Research (Source: Author) ..... 13

Figure 3-1 Communication process (Source: Author) ..... 15

Figure 3-2 Organizational Communication travels in many different directions [Source: <https://open.lib.umn.edu/organizationalbehavior/chapter/8-4-different-types-of-communication-and-channels/>] ..... 17

Figure 3-3 Impact areas of ICT and their relationships[Source: (RAINER, et al., 2010)] ..... 22

Figure 3-4 Information technology outside organization Source: (Cegielski, 2011)..... 22

Figure 3-5 ERP System for business solution[Source: (By R. Kelly Rainer, 2011)] ..... 25

Figure 3-6 Objectives of ERP (Source: <https://sites.google.com/site/fatoucondebusiness/class-lectures/lecture-1>)..... 26

Figure 3-7 An example of AutoCAD systems[Source: <https://www.topbestalternatives.com/optitex/>]..... 27

Figure 3-8 Dyeing production information & Communication process[Source: Author] ..... 28

Figure 3-9 Liner Communication Model [Source: <https://www.zmescience.com/tech/current-issues-with-cloud-computing/>] ..... 30

Figure 3-10 Cloud Computing [Source: <https://www.zmescience.com/tech/current-issues-with-cloud-computing/>] ..... 32

Figure 3-11 Manual Information System[source: <https://www.micklerandassociates.com/blog/automated-vs-manual-information-systems/>]..... 37

Figure 3-12 Business Process Management[Source: (business-process-management-overview/, July 19th, 2017)..... 38

Figure 3-13 Impact areas of ICT and their relationships[Source: Author] ..... 43

Figure 4-1 Epyllion Textile Division[Source: <http://www.epylliongroup.com/>]..... 47

Figure 4-2 Organizational Structure(Source: <https://www.scribd.com/document/358476409/Organization-Design-and-Development-Epyllion-Group>) ..... 51

Figure 4-3 Current state Network Connectivity Architecture (Source: Author)..... 53

Figure 4-4 Radio Connectivity Epyllion Style Limited (Source: Author) ..... 54

Figure 4-5 Router port Connectivity of Epyllion Style Limited(Source:Author) ..... 54

Figure 4-6 Business Process Plan[Source : Author] ..... 55

Figure 4-7 Business process model (Source: Author)..... 56

Figure 4-8 Respective Brand Buying partners [Source: <http://www.epylliongroup.com/>]..... 58

Figure 4-9 Merchandising Process Flow Chart[Source: <https://www.slideshare.net/AmitDas125/presentation-of-epyllion-group-71008156>]..... 60

Figure 4-10 Merchandiser Communication process flow [Source: Author]..... 61

Figure 4-11 Garments Production process[Source: Author]..... 64

Figure 4-12 SWOT Analysis of Epyllion Group [Source: Author] ..... 66

Figure 4-13 Standard Definition of Cloud base Communication process[Source: <https://www.deltapartnersgroup.com/our-insights/enterprise-cloud-clear-blue-skies-ahead>] ..... 67

Figure 4-14 Cloud Based communication process[Source: Author]..... 69

**List of tables:**

Table 1 Information Channels differ in their richness Source: (Allen & Griffeth, et al., 1997).	16
Table 2 How to use Written & Verbal communication [Source: (Mason Carpenter, October 27, 2015)]	17
Table 3 Types of information systems(Source: G.Cegielski, R. Kelly Rainer Jr. Casey )	23
Table 4 Comprasion of Cloud service providers(Source: <a href="https://aws.amazon.com">https://aws.amazon.com</a> , <a href="https://cloud.google.com/terms/services">https://cloud.google.com/terms/services</a> and <a href="https://azure.microsoft.com/">https://azure.microsoft.com/</a> )	35
Table 5 BGMEA Industry Strengths(Source: <a href="http://www.bgmea.com.bd/home/about/Strengths">http://www.bgmea.com.bd/home/about/Strengths</a> )	44
Table 6 Current State Software & Application[Source: Author]	52
Table 7 Example of Dye and Suitable Fabrics[Source: <a href="https://www.slideshare.net/AmitDas125/presentation-of-epyllion-group-71008156">https://www.slideshare.net/AmitDas125/presentation-of-epyllion-group-71008156</a> ]	65
Table 8 Key Cloud Capability requirement[source: <a href="https://www.deltapartnersgroup.com/our-insights/enterprise-cloud-clear-blue-skies-ahead">https://www.deltapartnersgroup.com/our-insights/enterprise-cloud-clear-blue-skies-ahead</a> ]	68
Table 9 Proposed Software and application for Epyllion business solution[Source: (SSG Implements, SAP for Business Automation, 2016)]	70
Table 10 Financial Cost & Budget Analysis[Source: (SSG Implements, SAP for Business Automation, 2016)	71
Table 11 ERP Comparison between Bangla CAT and Epyllion group) Source: (European Journal of Operational Research, 2003)	80

**List of abbreviations:**

ICT	INFORMATION AND COMMUNICATION TECHNOLOGY
IBM	International Business Machines
AI	Artificial Intelligence
IOT	Internet of things
BGMEA	Bangladesh Garment Manufacturers and Exporters Association
AR	Augmented Reality
VR	Virtual Reality
IS	Information system
ERP	Enterprise Resource Planning
IoE	Internet of Everything
STEM	Science Technology Engineering Mathematics
GPS	Global Positioning System
HR	Human Resources
KPI	Key Performance Indicator
WPC	Worker's Participation Committee
SOP	Standard Operating Procedure
RMG	Readymade Garments
MM	Material Management
CRM	Customer Relationship Management
CAD	Computer Aided Design

## 1. Introduction

Information can be oral or written depending on where we use it, from organizational point of view information could be written, oral, email and text message with authorized signature. On the other hand communication is the key of success of any organization, effective communication can smoothly run organizational daily operations and it might be Department to Department, Manager to Manager, Executive to Executive and Officer to Officer. ICT (Information Communication Technology) plays very effective role in the business organization. It's very important for manufacturing company to communicate each production department through technology to run smooth production and it's also helpful to achieve production target. Manufacturing company usually used oral communication for daily operation as well as important job order, notice, recruitment and others important necessary causes they use official pad with authorized signature.

This research topic has been chosen because of importance and effectiveness of information and communication technology. ICT processes are very useful in real life on manufacturing company as well as previously were working as an **Executive-Internal Audit** under Epyllion Group. Epyllion Group is the largest textile manufacturing Industry in Bangladesh and it has five different manufacturing business units in different locations. In author's role responsible for monitoring and control financial & production audit (related to checked, verify & confirm Bill statement value (\$) of different manufacturing factories as Local LC acceptance) and attended physically inventory with team members to follow up production record keeping & information process and communication in different production department to check their paper's work.

The Author had to check daily accounts operations (Cash and Bank Books and Office and Administrative bills, Yarn dyeing bills, Purchase bills etc.) and was responsible for daily basis audit in two different Manufacturing industries in Gazipur( Epyllion Textile Division and Epyllion Style Ltd). This allowed him to gain and idea about manufacturing industry. Due to fulfilled official requirement the author could visit some of the famous textile manufacturing facilities in Bangladesh such as Anlima Yarn Dyeing Ltd, RC Cola Co- International, Bexmico Textile Mills Ltd, Keya Spinning Mills Limited, Partex Denim Mills Ltd, and The Delta Group of Industries Ltd etc. In that position the author ordered a closing report (after ending all production process) for smoothly maintaining daily order closing operation, it is necessary to communicate with each department to achieve target order closing. During that time it had to be done only in MS Excel for record to reporting so the author realized if modern application software was placed then it would be much easier to collect data and communicate with every production department as well as to do the end of the month reporting. Therefore the topic was chosen for research and analysis to find an optimal solution for a manufacturing company.

## 1.1 Conceptual framework of the thesis:

Thesis issues are:

What is the current state information and communication process in selected manufacturing company?

Why Manufacturing Company need to use ICT?

What is the impact of ICT in Manufacturing Company?

What is the limitations and finding of using Current state communication method?

What is the proposed design or contribution based on current state communication method?

What are the benefits of Case study in organizational point of view?

Why this research is valid and useful for manufacturing company?

What could be the proposed solution based on current ICT infrastructure?

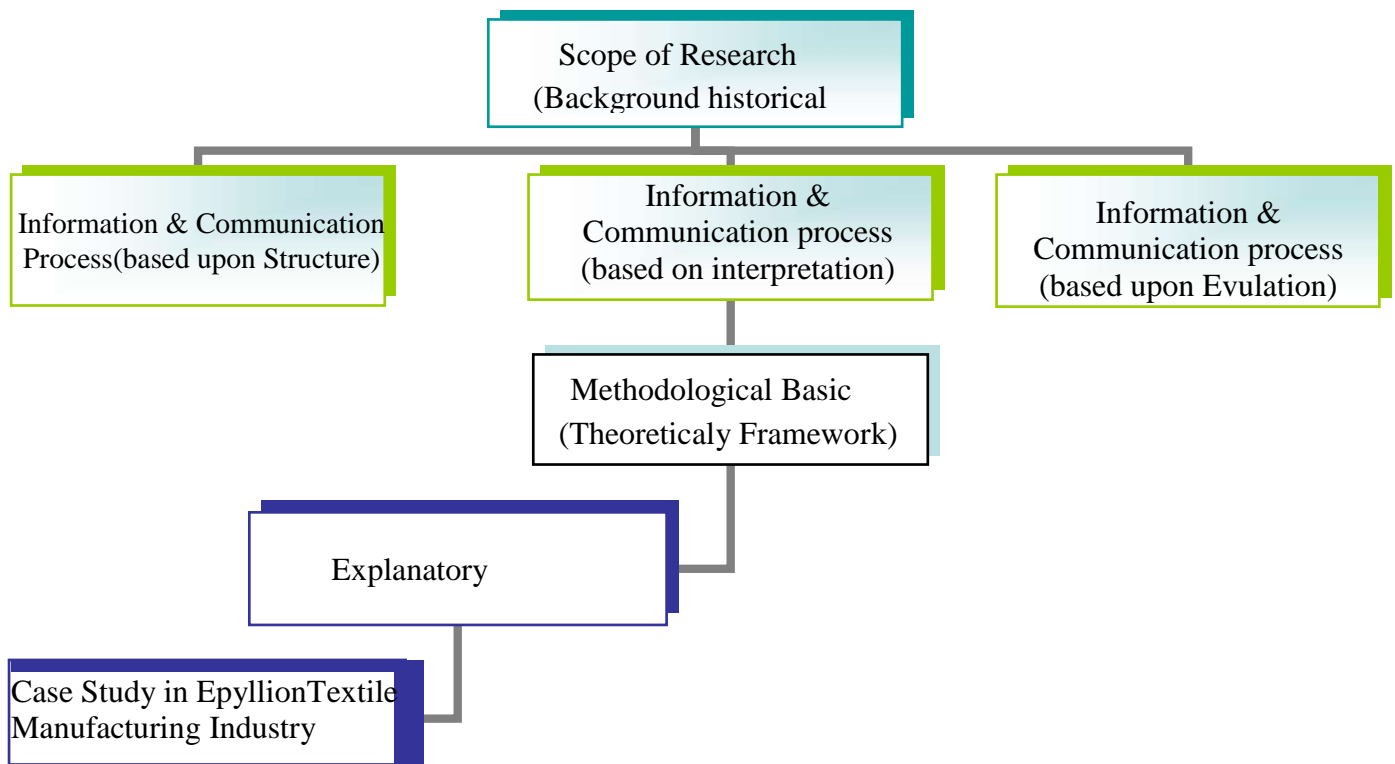

Figure 1-1 Scope of Research (Source: Author)

## **2. Objectives and Methodology**

### **2.1.Objectives of the thesis:**

The main objective of the thesis is to analyze current state of information and communication processes in a manufacturing company in Bangladesh.

The partial goals of this thesis are such as:

To generate a dynamic overview of a current state of the art in information and communication process in manufacturing enterprise information systems. Further a theoretical and practical explanation of current state of ICT (Information and communication technology) in manufacturing environment will be analyzed and address.

To analyze and select an optimum solution of current state information processing and communication arrangement in the selected manufacturing company base on case study.

To develop a feasibility study as well as to evaluate the proposed solution in information and communication process.

### **2.2.Methodology:**

Methodology of the thesis is based on study and inquiry of the academic papers, journal, Books, online search engine and professional resources of business information processing and communication system. The design of information and communication process and implementation will be based on a case study in selected manufacturing company (Epyllion Group) in Bangladesh. Based on the theoretical finding and outcomes of the practical part of thesis, the conclusion and recommendation part will be framed.

### **2.3.Overview of the Methodology:**

The theoretical part will discover the current state information and communications process in manufacturing arena in different point of view and uses of ICT in modern business organization as well as impact of information and communication technology in manufacturing environment and the weaknesses in the current processes of linear communication.

In the theoretical part will also describe current state information and communication technology impact and current usages and future possibilities in BANGLADESHI RMG Sector in the field of manufacturing.

When coming up with the problem solution the strategy methods and technical solutions, prominently the Information and communication Technology (ICT) strategy has been taken into account so the new solution will be in information and communication process in Epyllion Group manufacturing industry is use of ICT and practical implementation of in real business.

In a specific point of view of the methodology and feasibility study the outcome proposed solutions will be proper uses of ICT and it tools and infrastructure, software, application and proposed information & communication methods for future use.

### 3. Literature Review

#### 3.1. Definition of Communication and information:

Information theory, as developed by Claude Shannon in 1948, was about the communication of messages as electronic signals via a transmission channel. Only physical properties of the signal and the channel have been taken into account. While the meaning of the message has been ignore totally. Such an approach to information met very well the requirements of a data communication channel. But recent advances in almost all sciences put an urgent demand for meaningful information inclusion into the body of a communicated message. To meet this demand, I have proposed a new definition of information, In this definition, information is seen as a complex notion composed of two inseparable parts: Physical information and Semantic information. Classical information's such as Shannon, Fisher, Renyi, Kolmogorov's complexity, and Chaitin's algorithmic information- they are all physical information variants. Semantic information is a new concept and it desires to be properly studied, treated, and used.

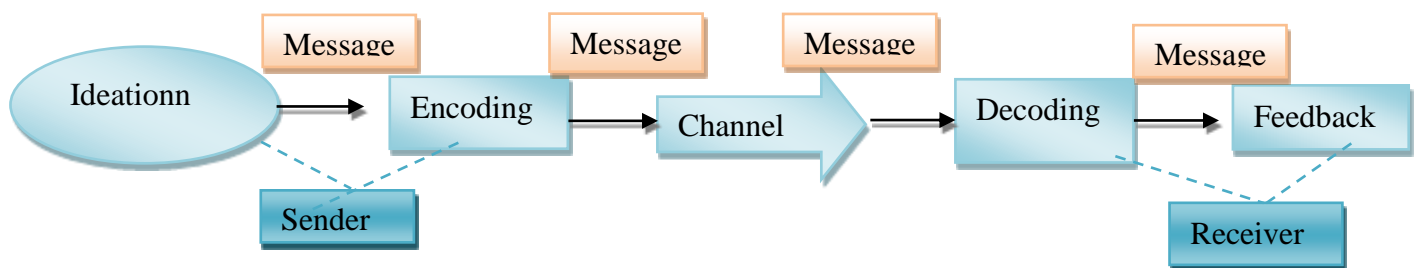

Figure 3-1 Communication process (Source: Author)

Shannon and Weaver broadly defined communication as ‘all of the procedures by which one mind may affect another’. Their communication model consisted of an information source: the source’s message, a transmitter, a signal, and a receiver: the receiver’s message, and a destination. Eventually, the standard communication model featured the source or encoder, who encodes a message by translating an idea into a code in terms of bits. A code is a language or other set of symbols or signs that can be used to transmit a thought through one or more channels to elicit a response in a receiver or decoder. Shannon and Weaver also included the factor noise into the model. Their study conducted by Shannon and Weaver was motivated by the desire to increase the efficiency and accuracy of fidelity of transmission and reception. Efficiency refers to the bits of information per second that can be sent and received. Accuracy is the extent to which signals of information can be understood. In this sense, accuracy refers more to clear reception than to the meaning of message. This engineering model asks quite different questions than do other approaches to human communication research. (Shannon, July, October, 1948.)

### 3.2. Information systems in manufacturing industry:

An information system (IS) is a group of components that interact to produce information. It focuses on the internal rather than the external. Many manufacturing industry basically depend on inform and communication technology (ICT) systems. Industries which engage in producing and processing items using machines, tools and labour's referred as manufacturing industries. The overall procedure of industry can be divided into three phases namely design, procurement and produce.

Information & Communication technology systems play a vital role to coordinate activities within manufacturing industry between manufacturing environment along the production chain and outsides organizations such as financial & manufacturing organizations.

### 3.3. Types of Communication and Channels:

There are three types of communication First one is verbal communication involving listening to a person to understand the meaning of a message or information, Second written communication in which a message is read or readable, and Third nonverbal communication involving observing a person and understanding meaning communication channels is very important for business organization mostly manufacturing industry.

#### Communication Channels:

The channel, or medium, used to communicate a message affects how accurately the message will be received. Channels vary in their "information-richness." Information-rich channels convey more nonverbal information. Research shows that effective managers tend to use more information-rich communication channels than less effective managers (Allen & Griffeth, 1997' Yates & Orlikowski, 1992). The figure below illustrates the information richness of different channels.

Information Channel	Information Richness
Face to Face Conversation	High
Video Conferencing	High
Telephone Conversation	High
E-mails	Medium
Handheld devices	Medium
Face to face conversation	Medium
Video Conferencing	Medium
Formal letters & Memo	Low
Spreadsheet	Low

Table 1 Information Channels differ in their richness Source: (Allen & Griffeth, et al., 1997)



Oral communication, on the other hand, makes more sense when the sender is conveying a sensitive or emotional message, needs feedback immediately, and does not need a permanent record of the conversation. (Mason Carpenter, 2010)

Use Written Communication when	Use Verbal Communication when
Conveying facts	Conveying emotion and feelings
The message needs to become part of a permanent file	The message does not need to be permanent
There is little time urgency	There is time urgency
Do not need immediate feedback	Need immediate feedback
The ideas are complicated	The ideas are simple

Table 2 How to use Written & Verbal communication [Source: (Mason Carpenter, October 27, 2015)]

### 3.4.Direction of Communication within Organizations:

Information can move horizontally, from a sender to a receiver, as we’ve seen. It can also move vertically, down from top management, or up from the front line. Information can also move diagonally between and among levels of an organization, such as a message from a customer service rep to a manager in the manufacturing department or a message from the chief financial officer sent down to all department heads.

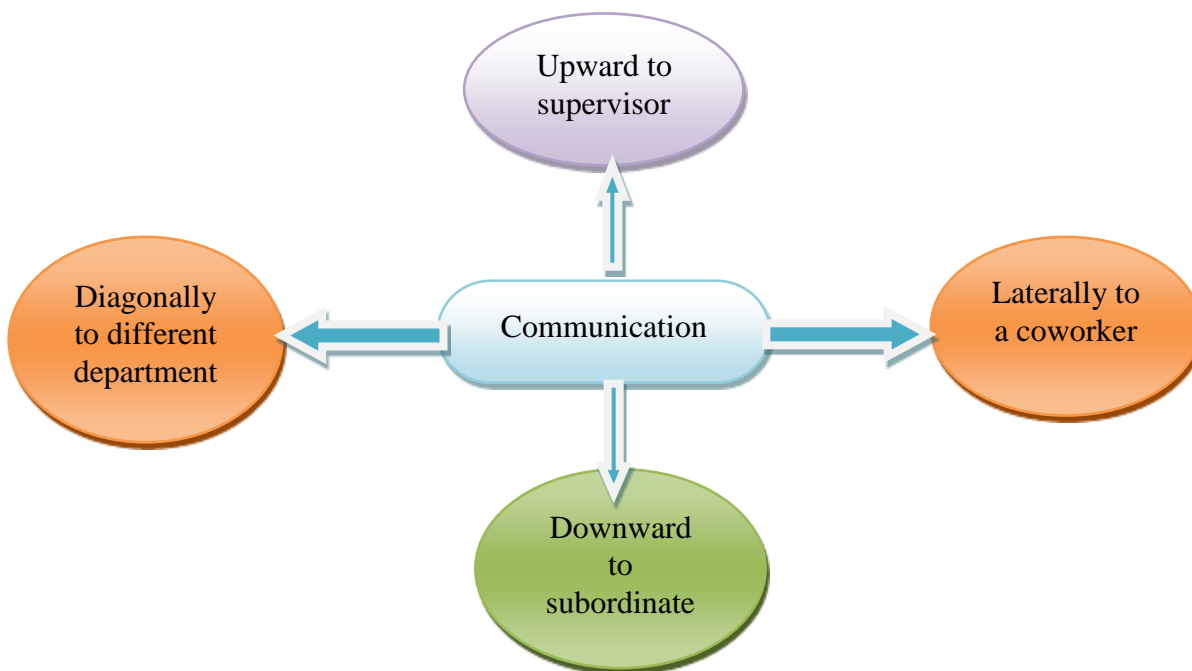

Figure 3-2 Organizational Communication travels in many different directions [Source: <https://open.lib.umn.edu/organizationalbehavior/chapter/8-4-different-types-of-communication-and-channels>]

## **External Communications:**

External communications deliver specific businesses messages to individuals outside an organization. They may announce changes in staff or strategy, earnings, and more. The goal of an external communication is to create a specific message that the receiver will understand and share with (Allen, 1997). It can be HR department interviewer to candidate over skype, email or cell phone.

### **3.5.Communication Tools Used in Modern Day Business:**

To manage these industry changes, many leading organizations in business and government have implemented a digital workplace strategy. By intelligently combining the technologies that many businesses already use, the digital workplace has broken down the communication barriers and is transformation employee experience to one promoting efficiency, growth and innovation. The key to success, however, depends on the implementation of a digital workplace strategy - requiring one that is capable of driving true change within the organization

## **Intranet/Social Intranet:**

An intranet is a private hub that can be accessed by any authorized users within a business organization - it is mainly used for internal communication and collaboration. Modern intranets are often built using content management systems as they are easier for non-technical staff to manage,

In this age of bring-our-own-device (BYOD) and telecommuting, an intranet solution will result in a more flexible workforce and ensure all employees are working towards the same goals.

might be interested in implementing an intranet strategy if:

- We and our human sources find it difficult to stay up to date with any company announcements or news
- If feels like there is a communication breakdown between departments and employees
- Important documents go missing or are buried in thousands of emails
- There is too much paperwork
- There is no clear or standard orientation policy for new employees or interns
- It's difficult to form cross functional teams to resource projects

## **Chat & Private Messaging:**

Collaborative spaces which provide private/group messaging and chatting functions are often viewed as one of the best business communication tools to keep teams working together. It's an effective form of communication for busy employees and managers. Instant messaging makes updates on projects and general team discussion much easier.

This works well when employees or team members are spread across different geographical locations and different time zones. Files can be shared and conversations can be accessed if needed.

Chat rooms and group messaging environments may seem the same, but the interfaces are often very different. For instance, our company might get more out of an instant messaging platform than a chat room if we don't have a lot of team-based projects, and individuals only occasionally need to contact other individuals within the organization.

### **Discussion Forums:**

Although discussion forums may seem like old tech to some, it is still one of the preferred communication business tools used today.

A discussion forum can bring together management and employees and allows for an open discussion on any topic (usually set up and monitored/moderated). It can also help in knowledge dissemination and bring the workforce together. Forums are also effective in archiving organizational knowledge to be used by anyone as a reference. Employee morale can also be boosted by participating in regular discussion forums.

Discussion forums will also facilitate knowledge sharing. No time will be wasted answering the same questions again and again once the company forum has been integrated with enterprise search. This will enable forum information to be discovered by people who need it, when they need it.

### **Tracking & Case Software:**

- An online help desk with a case tracking system enables employees and customers to submit a case or support ticket. This allows it to be assigned to the right employee and have it checked and resolved in time.
- A case tracking system helps centralize customer support queries and keep track of any open issues. Track team productivity, prioritizes the most relevant and important queries and collect valuable customer feedback that can help in improving products, services and customer relationships.
- An issue tracking system is generally used in an organization's customer support call center to create, update and resolve reported customer issues or even issues reported by employees within the company.
- An internal blog is also a good option. This is not something our customers and competitors will be able to access.
- The internal blog is a place where employees can share ideas and experiences fast and in an informal fashion. Internal blog advantages can include:
- Broadcasting and highlighting an employee's knowledge about a certain topic or area of the organization.
- Creating a searchable and permanent archive of KB articles, knowledge and expertise. All the KB articles uploaded and published on an internal blog will stay there unless deleted manually
- It promotes open discussion and collaboration among the workforce. There are instances where some employees will be more likely to speak up in a virtual environment than face-to-face
- It connects employees across departments
- It keeps the staff up-to-date on important information and company updates

So each and every communication tools is useful for modern manufacturing as well as others business for running their smooth operations and achieve business goal and customer satisfaction. Communication tools also useful for personal life for internal and external communication.

### **HR Communication and Departmental Relation:**

It's very important to every organization to touch with Human Resources Department because they can recruit strong manpower in every department even every production unit so that HR communication with other's department is must needed and it's effective. Good HR information and communication process and their practice can solve employee problem and their expectations from company as well as documentations and many more.

An example of HR and Departmental communication: Maria worked in Epic Group as an Executive- planning since 02 years and 10 months now she is waiting for her increment and promotion. If HR department and their policy and related departmental communication are good setup then they will follow her personal file and review his data –joining date, Job Confirmation letter, last increment so that they can take initiative for her increment and promotion after evaluating her job performance. And one more thing Department head need to ask his superior colleague about their confirmation, increment and promotion so that he can take decision about increment. Without good communication & bad HR culture can delay employee exception to company.

### **3.6. Concepts of Information Systems:**

A combination of hardware, software, infrastructures and trained personnel organized to facilitate planning, control, coordination, and decision making in an organization is called information systems.

**Hardware** is a device such as the processor, monitor, keyboard, and printer. Together these devices accept data and information process it and display it.

**Software** is a program or collection of programs that enables the hardware to process data.

**A database** is a collection of related files of tables containing data.

**A network** is a connecting system (wireline or wireless) that permits different computers to share resources.

Procedures are the set of instructions about how to combine the above components in order to process information and generate the desired output.

People are those individuals who use the hardware and software, interface with it, or use its output.

Also information systems usages for these fields for achieving organizational goals:

- Information systems for Marketing
- Information systems for Production/Operations Management
- In-House Logistics and Materials Management
- Inventory Management
- Quality Control
- Planning Production and Operation
- Computer-Integrated Manufacturing

### **3.7.Major Capabilities of Information Systems:**

- Perform high-speed, high-volume numerical computations
- Provide fast, accurate communication and collaboration within and among organizations
- Store huge amounts of information in a small, easy-to access space
- Allow quick and inexpensive access to vast amounts of information worldwide
- Interpret vast amounts of data quickly and efficiently
- Increase the effectiveness and efficiency of people working in groups in one place or in several locations anywhere
- Automate both semiautomatic business processes and manual tasks.

Information systems have become the backbone of most business organizations and personal communications. Manufacturing could not design without Auto CAD, Banks could not process payments, governments could not collect taxes, hospitals could not treat patients, and supermarkets could not stock their shelves without the support of information systems. In almost every sector—education, finance, government, health care, manufacturing, and businesses large and small—information systems play a prominent role in all over the world.

Every day work (personal or official), communication, information gathering, and decision making all rely on information technology (IT). When we visit a travel agency to book a trip, a collection of interconnected information systems is used for checking the availability of flights and hotels and for booking them. When we make an electronic payment, we interact with the bank's information system rather than with personnel of the bank. Modern supermarkets use IT to track the stock based on incoming shipments and the sales that are recorded at cash registers. Most companies and institutions rely heavily on their information systems. Organizations such as banks, online travel agencies, Government foreign office, Hospital, tax authorities, and electronic bookshops can be seen as IT companies given the central role of their information systems.

Organizations offer products to customers to make money. These products can be goods or services. In most organizations, huge volumes of data accumulate: data of products, data of customers, data of employees, data of the delivery of products, and data of other sources. These data therefore play an important role in contemporary organizations and must be stored, managed, and processed, which is where information systems come into play.

An example of concept of ICT:

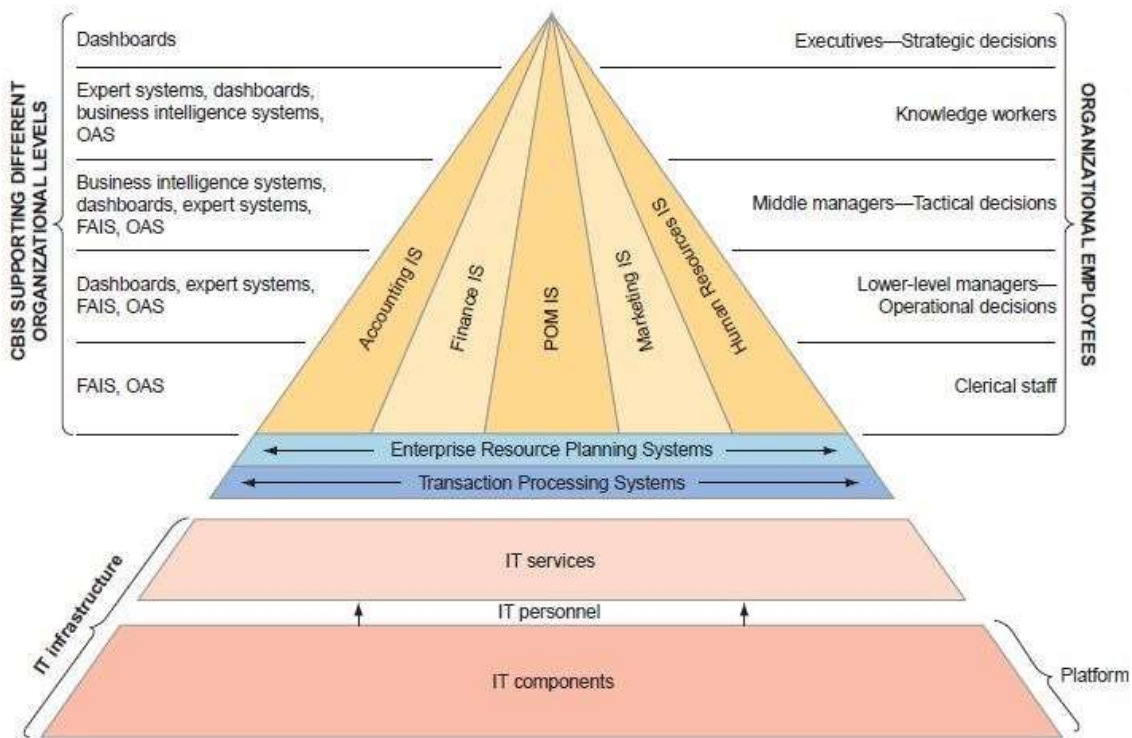

Figure 3-3 Impact areas of ICT and their relationships[Source: (RAINER, et al., 2010)]

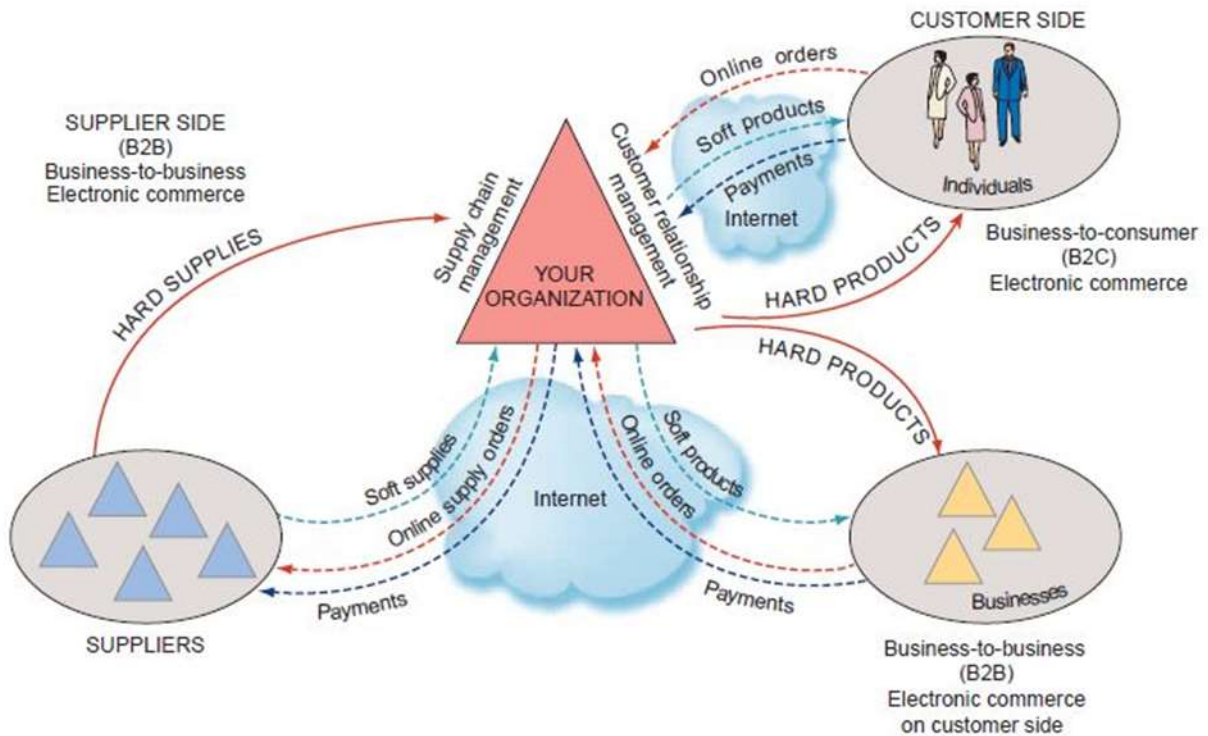

Figure 3-4 Information technology outside organization Source: (Cegielski, 2011)

### 3.8.Types of Organizational information systems:

Type of System	Function	Example
Functional Area IS	Supports the activities within a specific functional area	System for processing payroll
Transaction processing system	Processes transaction data from business events.	Wal-Mart checkout point-of-sale terminal
ERP	Integrates all functional areas of the organization.	Oracle, SAP
Office automation system	Supports daily work activities of individuals and groups.	Microsoft Office
Management information system	Produces reports summarized from transaction data, usually in one functional area	Report on total sales for each customer
Decision support system	Provides access to data and analysis tools	“What-if” analysis of changes in budget
Expert system	Mimics human expertise in a particular area and makes a decision	Credit card approval analysis
Executive dashboard	Presents structured, summarized information about aspects of business important to executives	Status of sales by product
Supply Chain Management	Manages flows of products, services, and information among organizations	Wal-Mart Retail Link system connecting suppliers to Wal-Mart.
Electronic commerce system	Enables transactions among organizations and between organizations and customers	www.dell.com

Table 3 Types of information systems(Source: G.Cegielski, R. Kelly Rainer Jr. Casey )

Information systems are located everywhere in inside organizations, as well as among organizations. Information systems provide different types of support to organizational employees. Information systems can be strategic, meaning that it can provide a competitive advantage if it is used properly. If information systems are fail, often at great cost to the enterprise. Information systems are important to organizations and society as a whole because these systems are so diverse, managing them can be quite difficult without good IT Systems & IT Department. (G.Cegielski, 2011)

### 3.9.Nature of Information and Communication technology:

It has been said the purpose of information systems is to get the right information to the right people at the right time in the right amount and in the right format. Because information systems are intended to supply useful information, we are being by defining information and two closely related terms, data and knowledge.

### **Data, Information, and Knowledge**

One of the Primary goals of information systems is to economically process data into information and knowledge.

Let's take a closer look at these concepts. Data items refer to an elementary description of things, events, activities, and transactions that are recorded, classified, and stored but not organized to convey any specific meaning, Data items can be numbers, letters, figures, sounds or images. Example of data items are a student grade in a class and the number of hours an employee worked in a certain week.

Information refers to data that have been organized so that they have meaning and value to the recipient. For example, a grade point average (GPA) is data, but a student's name coupled with his or her GPA is information. The recipient interprets the meaning and draws conclusions and implications from the information.

Knowledge consists of data and/or information that have been organized and processed to convey understanding, experience, accumulated learning, and expertise as they apply to a current business problem. For example, a company recruiting at a school has found over time that students with grade point averages over 3.0 have had the most success in its management program. Based on its experience, that company may decide to interview only those students with GPAs over 3.0.

Organizational knowledge, which reflects the experience and expertise of many people, has great value to all employees.

Now that we have a better idea of what information is and how it can be organized to convey knowledge, we shift our focus to the ways that organizations organize and use information. To do this we must look closely at an organization's information technology architecture and information technology infrastructure. These concepts underlie all information systems within the organization.

Information Technology Infrastructure an organization's information technology (IT) infrastructure consists of the physical facilities, IT components, IT services, and IT personnel that support the entire organization. Starting from the bottom of Figure, we see that IT components are the computer hardware, software, and communications technologies that provide the foundation for all organization's information systems. As we move up the pyramid, we see that IT personnel use IT components to produce IT services, which include data management, systems development, and security concerns. (G.Cegielski, 2011)

### **3.10. Production process and use of information:**

Now a day Manufacturing Industry is more and more Information technology driven. The below decade has to be the field of Information Technology enabling value creation. Now time for changing from being an internal service provider is one of the major tasks for IT. Information Technologies have been considered as support and data record and reporting and communication



function which is not directly involved in the manufacturing business and value creation process. The success of IT is defined by the success of the Manufacturing business. There is need a change in the approach of implementing and analytical thinking and outcome useful IT solutions based on:

- Speed of new thinking,
- Modernization capability,
- Adaptation of new processes, new functions, new tools,
- The intensity of usage of the software & Applications
- Global activities and competence to run a comprehensive operating model of IT
- professional skills, methods and needed new processes.
- to open an opportunity for programmer's for open a smart information technology (Peniak, 2006)

Therefore an appropriate implementation of information & Communication systems is one of the key factors of business success in manufacturing business arena.

### 3.11. ERP Systems:

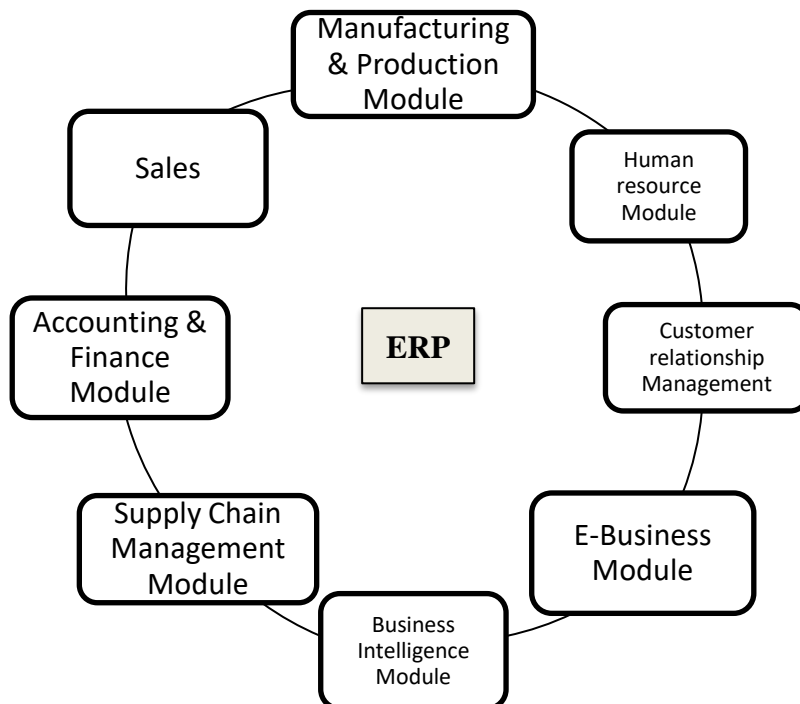

Figure 3-5 ERP System for business solution[Source: (By R. Kelly Rainer, 2011)]

Manufacturing as a part of overall enterprise or local company must be integrated into general business processes that are supported by ERP (Enterprise Resource Planning) Information System. ERP is an industry term for integrated, multi-module application software packages that are designed to provide information system for multiple business functions as order entry, general ledger, purchasing, warehousing, transportation, human resources and manufacturing. With help of ERP companies can standardize business processes and reach easily the best practices.

### Enterprise information systems:

Now a days ERP is most powerful software solutions for any business organizations ERP is a solutions for Sales Management, Inventory and CRM management and Business intelligence, it also handle front office functions such as sales force. On the other hand ERP helps product management and e-commerce also employee knows accurate information that helps to decision making. ERP is lower cost and it develops business process and it reduces business cost.

Enterprise resource planning is an application that helps organization to record keeping to reporting and controlled inventory management and its run business smoothly and it helps supply chain management and customer relationship management.

High growth and mid enterprise now rapidly adopted ERP Systems. Software-as-a- service (SaaS) solutions also referred Cloud Computing. Cloud computing make ERP software more easier implement and affordable.

Financial value is not usually a direct outcome from the implementation of an enterprise information system.

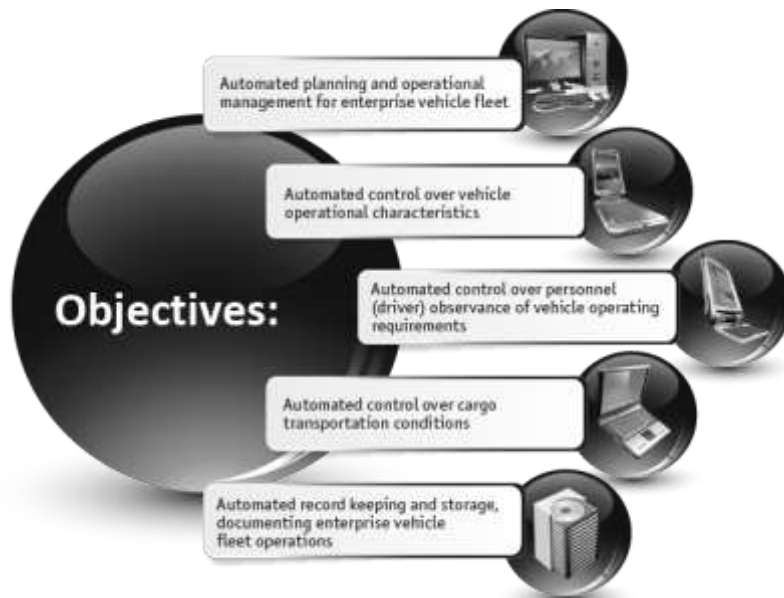

Figure 3-6 Objectives of ERP (Source: <https://sites.google.com/site/fatoucondebusiness/class-lectures/lecture-1>)

### 3.12. AUTO CAD in Manufacturing:

CAD/CAM stands for computer-aided design & computer-aided manufacturing. CAD/CAM software is used to design and manufacture prototypes, finished products, and production runs in garments manufacturing industry. Manufacturers want to achieve faster time to market without hiring large numbers of additional staff. One effective way to increase throughput is via process improvement and workflow optimization. With a team of dedicated mechanical design software

experts, IMAGINiT is uniquely positioned to help manufacturers leverage manufacturing CAD software and services to meet their design. Ref: [ (IMAGINiT TECHNOLOGIES, 2018)]

Advantages of Auto Cad in Textile and Garments industry:

Easy to operate designing system- CAD in any projects or orders.

Flexibility of changes designs many garments parts cutting and less chance to make mistake due to accuracy. So it easily achieves Buyer satisfaction.

The expense and time is reduced in a considerable manner when compared to the laborious manual work of designing. Designing can be done from anywhere as the customers are able to control the process from remote locations as well. The data can be easily stored, transmitted, and transported through computer files. Digital swatches can be saved on floppy disks, zip disks, CD-ROM or hard drive thus saving space. Moreover they can be easily organized for fast and easy retrieval. The designs can be easily customized and personalized as corrections and editing can be done at any time without significant delays or cost increases.

The designers don't need to produce swatches all the time as they can now see how a particular fabric or garment looks in different colors and shapes on computer screen itself.

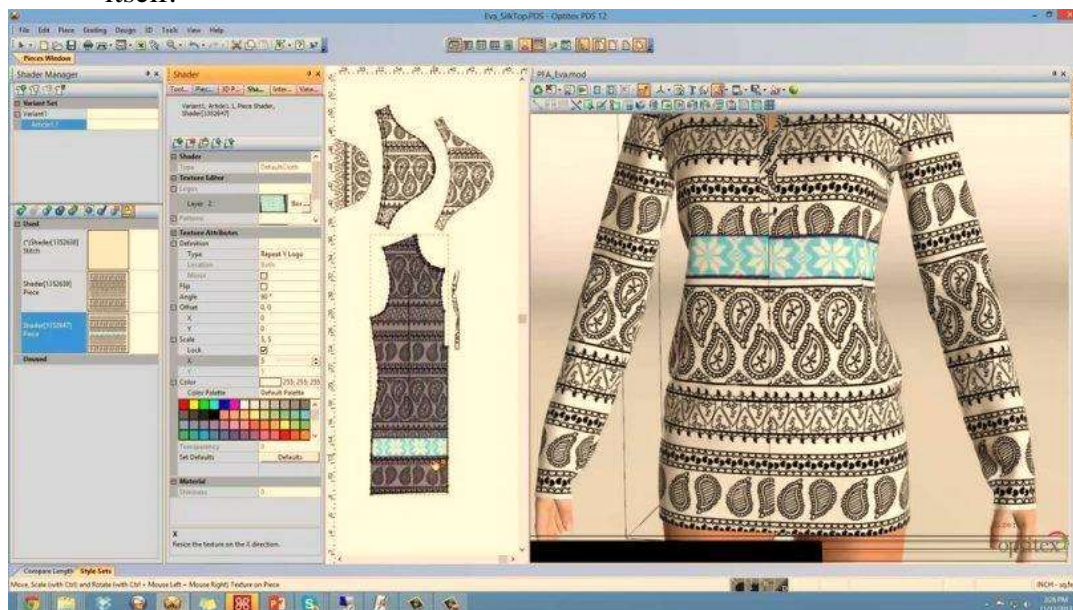

Figure 3-7 An example of AutoCAD systems[Source: <https://www.topbestalternatives.com/optitex/>]

### 3.13. Fabrics Dyeing Information and communication systems in Manufacturing:

Information and communications systems are very important for manufacturing organizations if we look any manufacturing industry and their production information process first they receive information from production department through ERP Application systems or their own develop software systems then they start process for production goods as per related departmental information such as we can see an example of Fabrics dyeing information & Communication production process.

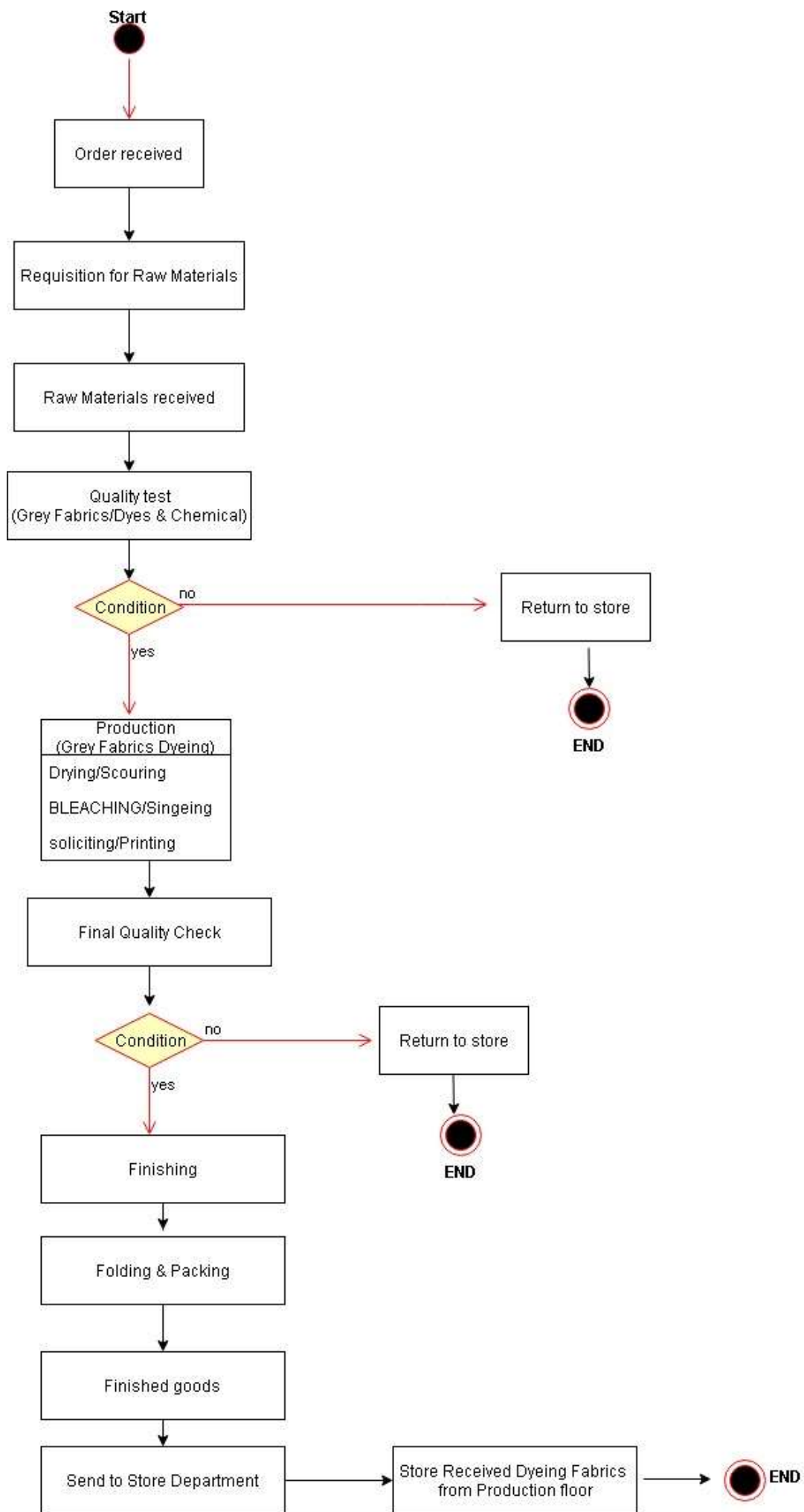

Figure 3-8 Dyeing production information & Communication process[Source: Author]

To fulfilled this production process store Department to Dyeing Department they maintain Software for update order no, order quantity, buyer name, delivery date, goods quantity, fabrics type, identification numbers, bin card and others necessary information by using information and communication systems. Each production floor they have monitoring and working person can look update information about selected order.

The transaction model of communication describes communication as a process in which communicators generate social realities within social, relational, and cultural contexts. This model includes participants who are simultaneously senders and receivers and accounts for how communication constructs our realities, relationships, and communities.

Currently many information and communication systems we use which is Mobile, Wireless network, Satellite communications and network, Cloud computing, Cyber security, big data, Software development, Apps Development, internet, E-commerce, Web development and many more.

### **3.14. Information and Communication technology Methods:**

#### **Linear Communication Model:**

The linear model of communication is an early communication model created by (Shannon, July, October, 1948.) which visualizes the transfer of information as an act being done to the receiver by the sender. Understanding several key terms is important in order to follow the model. The Linear Communication model explains the process of one way communication where a sender transmits a message and receiver absorbs it. According to the model, many things can affect the one-way communication process. For instance, the choice of channel selected may affect the way a receiver interprets a message. Also, a number of disruptions can occur at any point – they're known as 'noise'. It can include 'psychological noise', whereby the psychological state of the receiver will affect the interpretation of the message, including stress, anxiety and anger and so on.

These terms are:

**Sender:** the message creator.

**Encoding:** the process of putting thoughts into messages through the creation of content and symbols.

**Decoding:** the process of interpreting and assigning meaning to a message.

**Message:** the transmitted information.

**Channel:** the medium through which the message passes.

**Receiver:** the target of the sender and collector of the message.

**Noise:** those distractions which interfere with the transmission of the message (/communication-process, 2011)

#### **Advantages of a linear model:**

A linear model of communication envisages a one-way process in which one party is the sender, encoding and transmitting the message, and another party is the recipient, receiving and decoding the information.

Although this model is rather limited and has been superseded by two-way, transactional and mutual models for most purposes, it still has its uses in business.

In marketing, for example, it helps to focus on how an advertising message may be altered and influenced by the encoding process of the business, the effects of the communication channel or medium, noise interference and eventual decoding by the potential customer.

This suits one-way processes such as print and broadcast advertising, where the feedback process is quite separate from the initial communication. (STANFORD, 2016)

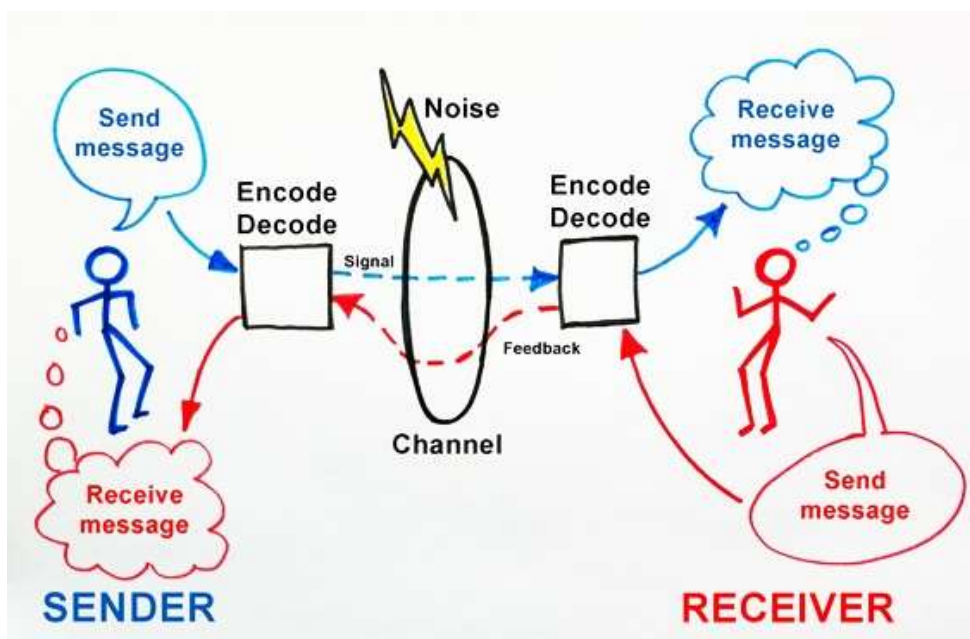

Figure 3-9 Linear Communication Model [Source: <https://www.zmescience.com/tech/current-issues-with-cloud-computing/>]

### Key factors of Linear Communication models:

- One way communication
- Used for mass communication
- Senders send message and receivers only receive message
- No feedback
- Concepts of noise
- Communications is not continuous
- ERP can't share and only corporate admin authorize to do edit, hacker can attack,

### **3.15. Cloud based Communication Model:**

Now a days cloud based communication tools is the best choice for any business organization to smoothly run their operations, and maintaining communication with employee when he work outside of office or abroad. By using cloud based communication it's easy to communicate each other also it helps for decision making. Such as Google Cloud based MS document/MS Excel or email by using those tools official work can easily do in anywhere as per emergency. In our daily personal and business life we easily use it.

#### **Cloud Services:**

Cloud Computing and uses of software, storage or infrastructure that can be accessed by multiple users over the Internet. Cloud Computing is characterised by the following key features:

- Computing resources are accessed as services
- Rapid ability to scale computing resources to match fluctuations in business demand
- Utility-based pricing. Users only pay for computing resources they use.
- Reduced up-front costs
- Access to enterprise strength IT resources (including security infrastructure)
- Business flexibility and agility

#### **Types of Cloud Computing:**

Major corporations including Amazon, Google, IBM, Sun, Cisco, Dell, HP, Intel, Novell, and Oracle have invested in cloud computing and offer individuals and businesses a range of cloud-based solutions.

#### **Social Networking:**

Perhaps the most famous use of cloud computing, which does not strike people as "cloud computing" at first glance is social networking Websites, including Facebook, LinkedIn, Twitter, and many, many others. The main idea of social networking is to find people what we already know or people we would like to know and share our information with them. Of course, when we share the information with these people, we're also sharing it with the people who run the service.

While the primary purpose of social networking previously was connecting people, businesses can use social networking too by creating a Facebook fan page, a business can connect with its customers, and at the same time, those customers will be promoting the business. Also, viral marketing tactics can be used in combination with social networks. There are public relations experts who specialize in social media marketing. So Business organizations can use it to connect with customers.

#### **E-Mail:**

Some of the biggest cloud computing services are Web-based e-mail. As of January 2009, over 500 million people used Microsoft's Web-based e-mail, Hotmail or Windows Live Mail. Using a cloud computing e-mail solution allows the mechanics of hosting an e-mail server and maintaining it to be taken out of the hands. It also means that our e-mail is accessible from anywhere any time and any place.

### Document/Spreadsheet/Other Hosting Services:

As made famous by Google Docs, a number of services like Zoho Office suite on the Internet that allows us to keep and edit our documents in online so the documents will be accessible anywhere, and we can share the documents and collaborate on others. Multiple people can work in the same document simultaneously.

### Backup Services:

Even if we do use services to keep all our documents and photos, chances are will still have data on our personal computer. One of the biggest problems with personal computing has been the tendency to lose that data if our computer is stolen, destroyed, or the storage device damaged. This is where backup comes in. Sometimes, even backing up to media isn't good enough -- we need to store the data off-site for more complete protection. Services like JungleDisk, Carbonite, and Mozy allow to automatically backing up all our data to servers spread around the country or world for a surprisingly low price. Of course, our data is then susceptible to security breaches. Similarly, services like simplicity( Leader in Enterprise File Sync & Sharing) and Dropbox (both offer free versions) make it easy to keep local copies of files on multiple computers synchronized while keeping a copy in the "cloud." Some of these services will even keep previous versions of files or deleted files in case we happen to delete or mess up an important file.

### Banking and Financial Services:

Consumers store personal financial information to cloud computing service providers. In addition, consumers store tax records using free or low cost online backup services.

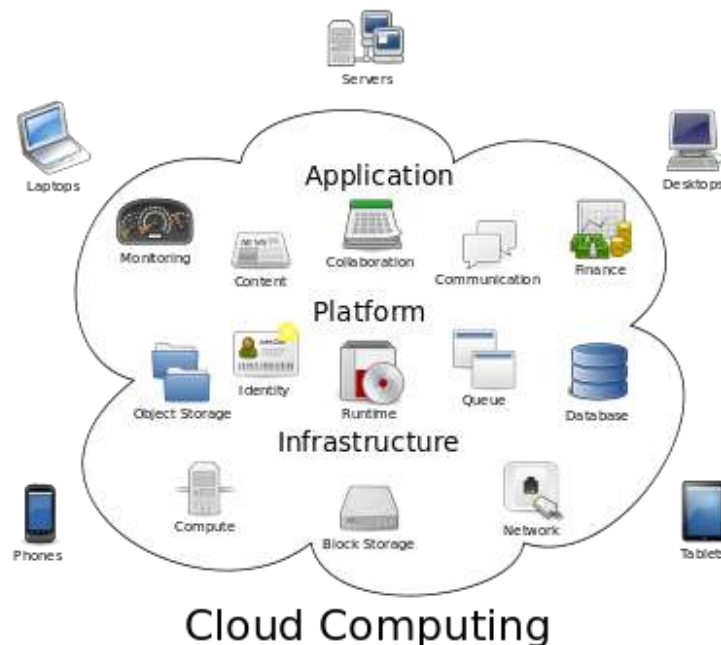

Figure 3-10 Cloud Computing [Source: <https://www.zmescience.com/tech/current-issues-with-cloud-computing/>]



### **3.16. Benefits of Cloud Computing:**

Cloud base computing is a powerful communication system in global and it's every useful and effective for business organizations to communicate each other from long distance by using email, social network, document, spreadsheet and backup services. So that it's very benefited as example while we're in meeting and we need to communicate with our colleagues to edit in spreadsheet that you're not authorized cloud base communication can solve it easily.

#### **New business representations:**

It has become much easier to start business innovation initiatives, often enabled by readily available cloud services. Utilizing or combining these services can result in new and innovative business models, generating new value propositions and resulting in new revenue streams. There are even companies that are building entirely new business models and value propositions solely using cloud services.

#### **Less functioning issues:**

Utilizing standardized services can significantly reduce issues and defects. This increases business continuity and reduce time spent on operational issues, focusing more on the things that matter. Cloud computing allows to deploy the same service or topology of services repetitively, with the same result every time. This allows organizations to predicatively deploy pre-build server images; application services or entire application landscapes defined using design patterns.

#### **Better use of incomes:**

On the other side of the "business agility" model, more efficient projects and less operational issues allow employees to spend their time on other more useful activities that may offer a greater potential value to our business. This benefit is different for every organization and harder to quantify, but people are an organizations biggest asset and this allows to better utilize this asset.

Another take on better resource usage is based on the fact the principle of "economies of scale"; cloud service providers, in general, more efficiently utilize physical resources and reduce energy consumption in contract to a traditional IT approach.

#### **Less capital expense:**

There is some debate about the value of shifting from a capital expense (CapEx) model to an operational expense (Opex) model. Overall sentiment is that, specifically for short and midterm projects, the OpEx model is more attractive because there are no long term financial commitments. In the OpEx model zero upfront investment is required, which allows organizations to start projects faster but also end them without losing any investments in the cloud services.

As we see, there is much more to cloud computing than technology alone. The true power of cloud is what the technology, implementing rapidly deployed services in the cloud, can mean for our business. (Robert Scoble, 2010)

### 3.17. Comparing different Cloud service Providers:

Comparison of AWS and Google Cloud on the basis of

1. Origins
2. Market share and options
3. Pricing
4. Free tiers
5. Configuring instances
6. Other services

Differences	Google	Amazon	Microsoft
Meaning	GCP=Google Cloud Platform	AWS=Amazon web services	Azure=Microsoft Azure
Services	Google is also provide very good cloud computing services	Best cloud computing platform Amazon web services	Microsoft is the Premiere Enterprise technology solution provider.
Instances	Google platform has cheaper instances.	AWS has more than 100 services that span a variety of domains	Azure VMS, Azure App services, Azure SQL, Azure active Dir,
Introduction	Google Cloud platform was launched in 2011 is able to help businesses grow and thrive.	AWS Launched in 2004 that provide business with computer power, database, storage and other functions like migration, networking so on.	October 2008 Azure first Announced at PDC LA.
Service coverages	Services that are intelligent, secure and flexible. At least 60 services and counting and lot more of upcoming..	Year of experience in assisting companies, over \$5.1Billion revenue in the last quarter and their growth is 38%.	Microsoft usages the tools and platforms that millions of developers already relay on.
User Experience	A better UI which improves users experience. A modest however a constantly improving catalog of services and cost saving is fairly more.	At least 100 services available at this moment. They cover 18 geographical regions. 54 availability zone	Virtual Machines, Blob storages, Azure Document DB, Azure Functions, SQL Database, Container services, Cloud services, Azure SQL data Warehouse. They cover 50 geographical regions. 104 availability zone
Contribution	In 2017 Google Cloud contribute 4%	In 2017 AWS contribute 47% market share	In 2017 Microsoft Azure contribute 10%
Revenue	They have revenue 1 billion dollar per quarter and it's growing very fast.	AWS made more than 5 billion in last quarter.	They have 5.3billion revenue in 2018.
Computer	For computer instances 2	For computer instances: 2	Computer instances 50

Instances	CPUs + 8GB RAM by 50USD and for cloud storages 2Cents/GB/Month	CPUs + 8GB RAM by 68USD And for Cloud storages 2.3cents/GB/Month	instances types
Storages	Five s, google map API, Free 5GB cloud storages and a credit of 300USD.	Free 750hours per month AWS Lambda 1 million request per month	
Configuration	Largest instances offers 160CPUs and 3.75TB RAM Pre emptible instances. instances are available at 80% off on demand price.	Configure instances 128CPUs and 4TB RAM for more cost effectiveness to use spot instances.	There are two types of Azure Cloud Services roles. The only difference between the two is how the role is hosted on the VMs:  Web role: Automatically deploys and hosts the app through IIS.  Worker role: Does not use IIS, and runs app standalone.
Opportunities	GCP has superior telemetry tools which helps analyze services and provide more opportunities.	Occupying more than 40% of the market. AWS provide best support for his clients.	Azure Managed Disks encrypt data at rest, by default, using Storage Service Encryption. Control users' level of access to Azure disks with role-based access control (RBAC), and help protect data with point-in-time backup.
Pricing	Price depend on as per services(Compute, Storages, Networking etc.) it can be hourly, monthly etc.	Pricing by hours, Reserved instances.	Pricing by minutes and enterprise agreement
Domain	Domain Telemetry is better. Containers are better.	Domain Telemetry is good Containers are good. Simple storages(S3) Amazon relational database, 6 relational database engines. DynamoBD.CouchDB. MangoDB.	Blob storages, Azure SQL database, Document DB, Table storages

Table 4 Comprasion of Cloud service providers(Source: <https://aws.amazon.com>, <https://cloud.google.com/terms/services> and <https://azure.microsoft.com/>)

Before choosing any services we need to consider their origin and features they provide, their present performance, comparison in terms of Pricing, Market share and option Free tier and Instances configuration.

( Amazon Web Services, 2018) (Google Cloud, 2018) (azure.microsoft.com/).

### **3.18. Automated vs Manual Information Systems:**

Automated manufacturing systems operate in the factory on the physical product. They perform operations such as processing, assembly, inspection, or material handling, in some cases accomplishing more than one of these operations in the same system. Companies undertake projects in manufacturing automation and computer-integrated manufacturing for a variety of good reasons. Some of the reasons used to justify automation are listed below:

#### **To increase labour productivity:**

Automating a manufacturing operation usually increases production rate and labour productivity. This means greater output per hour of labour input.

#### **To reduce labour cost:**

Ever-increasing labour cost has been and continues to be the trend in the world's industrialized societies. Consequently, higher investment in automation has become economically justifiable to replace manual operations.

#### **To mitigate the effects of labour shortages:**

There is a general shortage of labour in some countries, and this has stimulated the development of automated operations as a substitute for labour.

#### **To reduce or eliminate routine manual and clerical tasks:**

An argument can be put forth that there is social value in automating operations that are routine, boring, fatiguing, and possibly irksome. Automating such tasks serves a purpose of improving the general level of working conditions.

#### **To improve worker safety:**

By automating a given operation and transferring the worker from active participation in the process to a supervisory role, the work is made safer. The safety and physical well-being of the worker has become a national objective with the enactment of the Occupational Safety and Health Act (OSHA) in 1970. This has provided an impetus for automation.

#### **To improve product quality:**

Automation not only results in higher production rates than manual operations. It also performs the manufacturing process with greater uniformity and conformity to quality specifications. Reduction of fraction defect rate is one of the chief benefits of automation.

#### **To reduce manufacturing lead time:**

Automation helps to reduce the elapsed time between customer order and product delivery, providing a competitive advantage to the manufacturer for future orders. By reducing manufacturing lead time, the manufacturer also reduces work-in-process inventory.

**To accomplish processes that cannot be done manually:**

Certain operations cannot be accomplished without the aid of a machine. These processes have requirements for precision, miniaturization, or complexity of geometry, which cannot be achieved manually.

**To avoid the high cost of not automating:**

There is a significant competitive advantage gained in automating a manufacturing plant. The advantage cannot easily be demonstrated on a company's project authorization form. (Csanyi, 2016)

True manual assembly systems are typically individual workbenches for each stage in the assembly process. The product gets passed manually from station to station singularly or in batches. However, there are many variations to manual assembly. For example, we could also use a singular assembly line with a manual transfer conveyor. In this case, workers stand at a specific station along the line and manually push the product down the line as its being assembled. This is usually done in lower volumes rather than production runs.

When choosing assemble systems need to do production budget and which type of production and return on investment calculation first to determine to the balance between cost and features for them and their assemble systems. (Manual, Semi-Automated or Automated:, November 20, 2014)

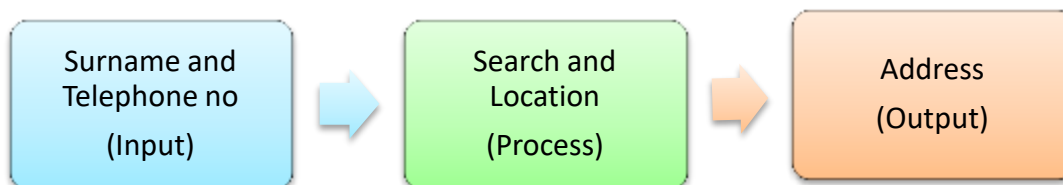

Figure 3-11 Manual Information System[source: <https://www.micklerandassociates.com/blog/automated-vs-manual-information-systems>]

The input data were surname and telephone number; the processing activities were search and locate; and the output was address.

An automated information processing system is a system that uses information technology tools and facilities, such as a computer and a printer, to transform raw data into information. It can be useful for personal and as well as business.

Computerised information systems are much more flexible than manual ones and a lot faster. With a computerised system we could type in a phone number and, if the number was stored in the system, the name and address could be provided immediately.

### Components of automated information processing:

- input (data capture or entry)
- process (for example, analyse, sort, calculate)
- store, retrieve, output (present and disseminate);

The major tasks are the same for both a manual and computerized information system: data entry or capture (input), processing (process), presentation and distribution (output). Information system can be either manual or automated (computerized), or a combination of both.

### 3.19. Business process Management (BPM):

BPM (Business Process Management) is the process of analyzing and improving business processes to create a more efficient and effective organization. Business process management neither task management nor project management (although it can occur within the context of a project). BPM is focused more on repetitive and ongoing processes that follow a predictable pattern. (Business Process Management – Overview, March 31st, 2018)

Business process management (BPM) is often used when:

- Business processes need to be updated frequently (i.e. regulatory compliance changes)
- Certain business processes span across multiple people, regions and business units
- Processes involve the use of different software (i.e. Accounting, CRM, and HR)
- Processes need the capability of being overridden manually from time-to-time
- Some business processes involve exceptions

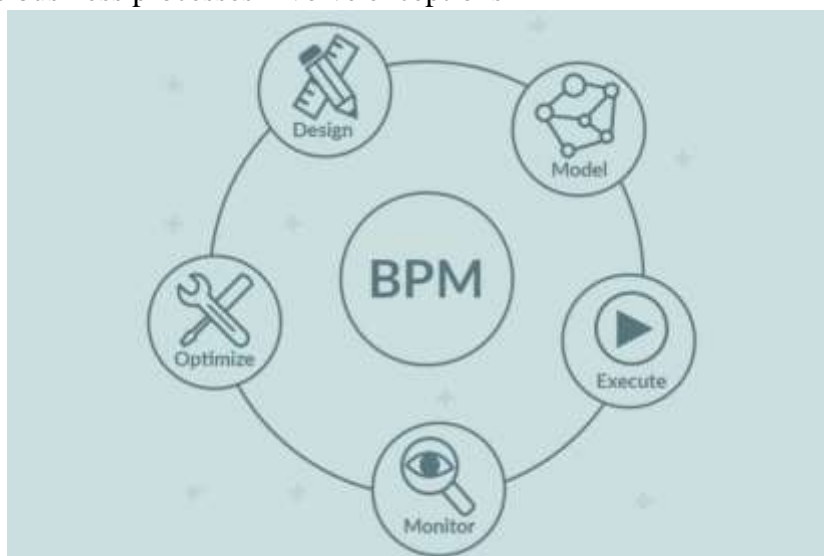

Figure 3-12 Business Process Management[Source: (business-process-management-overview/, July 19th, 2017)

Step 1: Design the process in its ideal state and examine all the conditions that need to be built.

Step 2: Model the process using business process management software.

Step 3: Execute the process, or put a system in place.

Step 4: Monitor the system and gather data about how it is functioning.

Step 5: Business Process Optimize and make changes to the process to improve it.

**There are four critical components of a Business Process Management Suite:**

- Process engine — a robust platform for modeling and executing process-based applications, including business rules
- Business analytics — enable managers to identify business issues, trends, and opportunities with reports and dashboards and react accordingly
- Content management — provides a system for storing and securing electronic documents, images, and other files
- Collaboration tools — remove intra- and interdepartmental communication barriers through discussion forums, dynamic workspaces, and message boards (ISB, 2016)

BPM also addresses many of the critical IT issues underpinning these business drivers, including:

- Managing end-to-end, customer-facing processes
- Consolidating data and increasing visibility into and access to associated data and information
- Increasing the flexibility and functionality of current infrastructure and data
- Integrating with existing systems and leveraging emerging service oriented architecture (SOAs)
- Establishing a common language for business-IT alignment

**3.20. Why a Production Process Needs Information Technology:**

Now days productions are technology oriented due to high reach production target, goods quality and buyer satisfaction. Everywhere is competitions, business risk, government and industrial polices, BGMEA monitoring and evaluation as well regular basic buyer representative Factory visit so that Manufacturing organizations need very strong and effective operational excellency to handle all situations. On the other hand information technology is directly related to production process they provide tools to help business production and achieving business goal such as:

Different shifts from one production to another production

Easy and first implementation of new products and new concepts

Firster production and in time delivery to customers

Reduce production cost and achieve production efficiency

Six sigma, AutoCAD and ERP application is most common example in production process.

For smooth run Manufacturing industry like textile & Garments or spinning Mills it is necessary to use High Voltage Power boiler, ETP, Dyeing Machinery, Printing & Embroidery Machinery, Knitting Machinery, AutoCAD Software and Application, ERP systems, Cutting and Sewing Machines, Internet, Computer, Printer, Scanner Machine and many more tools without using information technology Production process is impossible to run. So now a days Production and technology is related to each other. That's why manufacturing production process need information technology. (Information Technology As A Factor Of Production, 28 Jul 2006)

### **3.21. Textile & Garments Industry:**

Information technology is the capability to electronically input process, store, and output, transmit, and receive data and information. In the year 2016 to current period of time Bangladesh textile & Garments industry has faced many challenges, including worker unrest, gas crisis, political problem, climate change etc. But of course we have many positives Green factories, Cheapest labor, produced quality goods, maintaining international standard, Bangladesh is the second largest clothing exporter in the world. The contribution of this sector accounts for 80% of the country's export earnings. Overall scenario are given below:

#### **Contribution to the GDP:**

According to the IMF, Bangladesh's economy is the second fastest growing major economy of 2016 with 7.11 percent Gross Domestic Product (GDP) growth rate where the growth rate was 6.12 percent in 2015. Contribution of industry to the GDP was 28.1% where RMG sector donate the biggest part.

#### **FDI Trends:**

According to classical and non-classical economic theory, economic growth depends on the supply of capital as well as the supply of labor and technology. Developing countries like Bangladesh face capital shortages that put limit on investment and therefore growth, which can be balanced with an inflow of funds from foreign private or public sector. Foreign Direct Investment (FDI) is very important for economic growth as well as textile industries enhancement. According to the Bangladesh Bank Statistics, in this sector FDI successfully stood up at \$396 million which is 11 percent higher than previous fiscal year when it was \$351.62 million.

#### **Capital Machinery import:**

The country's overall imports grew by 14.75 percent in the first four months of the current FY 2016-17, where 83 percent increase in import of capital machinery and industrial raw materials, according to Bangladesh Bank, Garments Factories, which are obligated to become compliant, are importing most of the capital machinery, in recent times for complying with the requirements of Accord and Alliance.

#### **Work unrest:**

In 2016, the textile industry has observed some incidents where the workers have come down in the streer and making insurgence on their demand and tried to destruct public properties. Operations of 55 factories were stopped for few days. More than 1000 workers have been accused of in instigation, trespassing, vandalism and theft in seven cases started over unrest so far. As a result, companies lost working hours and production targets.



**Compliance:**

Accord and Alliance started inspection to the garment factories after Rana Plaza and Tazreen fashion fire incidents. Accord and Alliance inspection found less 2% factory risky to safety, while global safety risk rate about 4%, according to BGMEA President Siddiqui. Now 150 factories are being prepared as green factories. That will increase confidence of buyers in our clothing industries. (Akter, 2017)

**Export & future:**

Bangladesh garments industry has generated \$28.67bn exports in the calendar year 2016 which is 7.76% higher than the previous calendar year. The export in the last fiscal year 2015-26 was \$ 28.09bn with a 10.21% growth from the fiscal year, according to Export Promotion Bureau data. RMG sector is growing though there is a little bit slow down in last three years but it could be enhanced to take some steps by government and other stake holders. If the country could help bringing more investments to the sector and a strong positive reformation continues the sector would reach its expected growth. More investment behind the human capital of the sector would be key for coming days.

**3.22. Manufacturing industry and impact of ICT:**

Today, technological engagement has become an integral part of garment industry like in any other business. It has changed the industry forever across the world.

In Bangladesh clothing industry, the major impact of technical change is associated with the increasing adaptation of new technologies by the apparel makers to respond to the broader changes in global retailers' strategies.

Apparel makers are increasingly opting for green technology to increase competitiveness in the international market as renowned global brands are preferring establishment of green building with green production to maintain eco-friendly atmosphere in industrialisation.

In the past, the RMG workers used to cut fabric manually, which took a lot of time, but now with the automated systems in place, both time and production cost can be saved, entrepreneurs inform.

The ready-made garment (RMG) industry, which constitutes 80 percent of Bangladesh's exports and is currently worth \$20 billion, is estimated to double in value to roughly \$36 to 42 billion by 2020. (Inside Bangladesh's garment industry, second largest in the world, August 14, 2014)

Today the industry that began with 130 employs over 4 million people—including 3.7 million women—in over 5,000 factories across the country. This exponential growth has been largely driven by Bangladesh's plentiful and low-cost labor supply, and the country is now the second largest ready-made garments (RMG) producer in the world, falling only behind China. (Inside Bangladesh's garment industry, second largest in the world, August 14, 2014)

The target is highly ambitious but not entirely unattainable. Technology along with skilled workforce is required to make the RMG export dream into reality.

Technology allows companies to produce garments more quickly, efficiently and at less cost. It helps generate less waste as RMG is one of those industries in the world that produce most amount wastes.

According to excessive production pushed by strong demands for innovative styles might create a host of problems: increased chemical waste during production, along with thousands of tons of waste from discarded clothes.

Toxic dyes in manufacturing and landfill waste of discarded clothing add to the environmental costs of a garment.

From employee attendance to shipment, dispatching is dependent on information technology.

Such case happened in one of familiar companies. The server collapsed due to a technical glitch.

What next, official work stopped, no output is made resulting in a pile of works.

So, IT is not only important tools but essential for the doing business. Where we need real time data/ information we can't think anything without IT application. Followings are few names of IT tools those are in the garment industry.

Fabric accounts for about 70 per cent of the operational cost of garment manufacturing units, where the average amount of wastages can be generated from 8 per cent to 16 per cent, largely because the length and width of cloth vary across mills, among other factors.

IntelloCut, the software developed by Thread Sol Software, helps garment manufacturers cut down fabric wastage right from the purchase of the fabric to getting the garment ready.

During the process, the material can be saved by up to 10 per cent with a reduction in production time and effort. IntelloCut seamlessly streamlines with the factory processes for minimum fabric wastage and maximum fabric utilization.

"Our solutions represent an incomparable technological leap, providing manufacturers with the much-needed flexibility of automated planning and tracking. The remarkable features of our system can help them trim their efforts to a huge extent, saving them fabric cost," said Anas Shakil, Country Head (BD) at ThreadSol Softwares.

"After implementation of intellocut, we experienced profound improvement in stores and cutting system processes and efficiency," said Ronnie Serasingha, CEO at Aman Graphics.

(THREADSOL'S SOFTWARE EXHIBITS INNOVATION IN DTG-2017, FEB 28,2017)

Various other manufacturing facilities have adopted the technology in Sri Lanka, China, Vietnam, Philippines, Indonesia, and Pakistan.

In Bangladesh, ThreadSol's IntelloCut is used by big names like Epic Group, Pacific Jeans, Beximco, Saitex, Saiham, Dekko and Aman Graphics.

According to Suresh De Silva, GM at Regency, IntelloCut has reduced our effort by effectively handling multiple fabric groups and planning all end pieces which would otherwise be wasted. Indeed a solution worth recommending.

Kalpan, Director at Dekko Group, said, "ThreadSol's overall approach to streamline processes and to generate automated reports on the phone made a difference for us."

Thus, there is no doubt that technology would be the key factor in helping Bangladesh's labor intensive RMG sector increase productivity in days to come.

### 3.23. Impact areas of ICT and their relationships:

The ICT impact and their relationships are shown in the simplified model below: based on reward organizations practices in the field of ICT and organizational behavior & managerial relationship with executives in offices, in call Centre, in school, in university, in manufacturing business, in IT Farm everywhere we seen impact of ICT and their usages so that employment, strongly shows relationship. The model indicates the web of relationships between impact areas and with the broader economy, society and environment. Impacts of ICT arise through ICT supply and ICT demand and, at a country level, are likely to be influenced by the following factors:

- Existing ICT infrastructure, which enables an ICT critical mass that can amplify impacts;
- Country level of education, skills and income;
- Government ICT policy and regulation, and the level of e-government.
- Usages and Impact of ICT in real business world.
- Relations and relative fields of ICT with manager to executive
- Manufacturing business production manager to worker relationships based on daily operation and communication. (Goodman-Deane et, 2016)

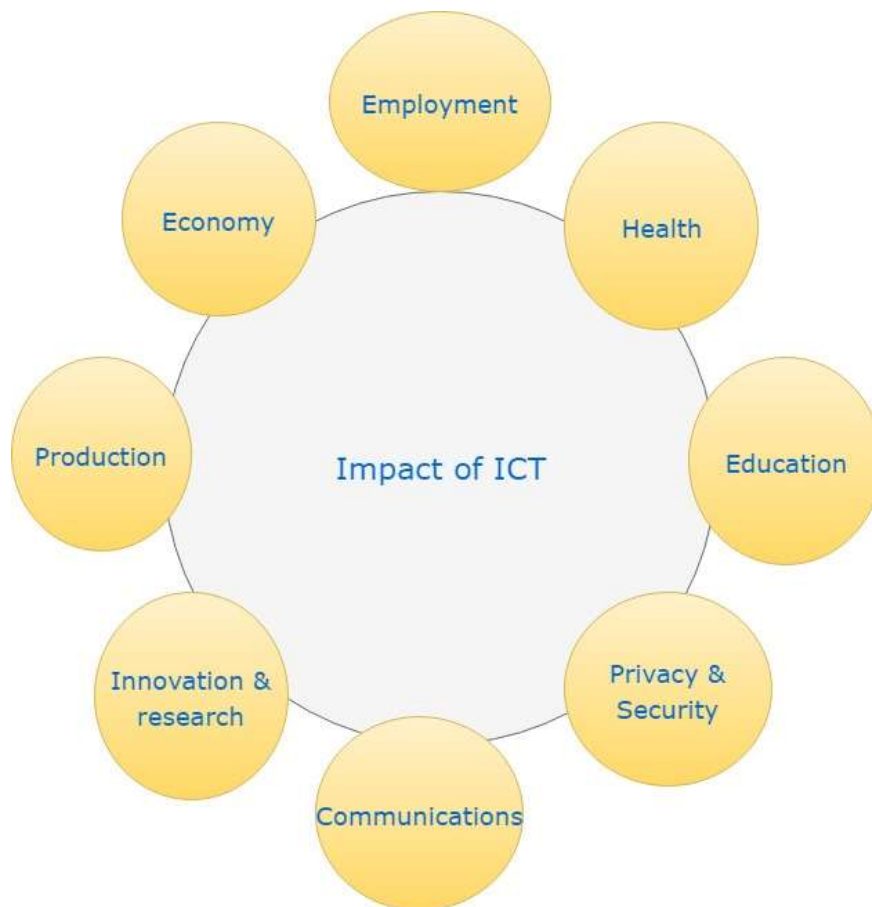

Figure 3-13 Impact areas of ICT and their relationships[Source: Author]

### 3.24. Bangladesh Garment Manufacturers and Exporters Association:

The Bangladesh Garment Manufacturers and Exporters Association (BGMEA) is one of the largest and effective trade associations in the country representing the readymade garment industry, particularly the woven garments, knitwear and sweater sub-sectors with equal importance. It has started its journey in 1983, today BGMEA takes care of a garments industry that is at the backbone of Bangladesh's economy and main human resources. Since the inception, BGMEA is dedicated to promote and facilitate the apparel industry through policy advocacy to the government, services to members, ensuring workers' rights and social compliance at factories. BGMEA has many operations to control to monitoring and to evaluate effective approaches on garments factories and companies.

#### How BGMEA Runs:

BGMEA is being run by a 35-member elected Board of Directors. The Board of Directors is elected for a two-year term. Seven Vice Presidents having important portfolios, along with a secretariat of experienced officials, assists the President in formulating and executing vital policies and programs of the organization. The President is the highest executive authority of the association. The Board of Directors takes assistance from different Standing Committees headed by a Chairman and composed of members having vast experience in the related fields. Strict adherence to democratic norms and code of conduct are being maintained in the BGMEA elections, which has been regarded as a trend setter in trade body elections of Bangladesh for its pre-election projection caucus and election-day discipline. Increasing trend of direct sourcing through local liaison offices at Dhaka (BGMEA, 2018)

#### Industry Strengths:

<b>Industry Strengths</b>	<b>BGMEA</b>
<b>Experience</b>	30 years of experience & reputation in garment manufacturing in country side.
<b>Pricing</b>	Competitive Price and cheap labor to attraction international buyer
<b>Standard</b>	It maintains international standard quality & strong internal compliance.
<b>Weather</b>	Vibrant population, 70% below 40 years age, quick learning & dedicated
<b>Corporate Culture</b>	Irresistible & resilient entrepreneurial spirit and corporate culture
<b>Duty Free</b>	Duty free market access in most of the developed countries & PTA in India, China, Korea, Malaysia
<b>Environment Friendly</b>	Rapid adoption of environment friendly, energy efficient and green factory concepts
<b>Production &amp; Factories</b>	Rapidly developing backward linkage Knitting/Washing/Dying/Finishing/Printing/Embroidery, etc. Versatility of factories to produce different type of products and designs

Table 5 BGMEA Industry Strengths(Source: <http://www.bgmea.com.bd/home/about/Strengths>)

### **3.25. ICT in Bangladesh:**

As a developing nation Bangladesh relies heavily on imported technology, and within the context of education, economy and technology, lags behind other nations. (Academic journals ICT) The sustainable development of Bangladesh will depend upon the employment of science and technology, which will lead to the investment in ICT to promote economic and political sustainability. To date, ICT is entering into Bangladesh but is still in its primary stages of integration and adoption into the existing technology infrastructure, and although ICT could potentially improve the educational systems that already exist in Bangladesh, due to certain barriers Bangladesh is having difficulty reaping the benefits.

According to the Technology Achievement Index (TAI) mandated by the UNDP Human Development Report in 2001, for Bangladesh, "the achievement value for creation of technology and diffusion of recent innovations is negligible in comparison to 72 countries included for TAI computation." The other two dimensions involving diffusion of old innovations and human skills the values are very low as well. (The role of science and technology education) Additionally, an ICT policy has been formulated for Human Resource Development (HRD) stating that Bangladesh must "prepare itself to compete effectively in the global ICT market" (ICT in vocational teaching/learning).

In the last three years Bangladesh has seen tremendous growth in the information and communications technology (ICT) sector. It has a market of 160 million plus people, where consumer spending is around USD 130 billion plus and growing at 6 percent annually. After tele-communications launched 3G services in 2013, internet penetration in Bangladesh grew by 22 percent by the end of 2014. Of the 66.8 million active Internet subscribers (BTRC, 2016), nearly 96 percent are mobile users and 10 million smartphone users. With growing Internet connectivity, availability of cheaper smartphones, and rapid rise in social networking (23 million plus Facebook users), we have seen an increasing emergence of digital savvy consumers. (Taher, February 23, 2017)

### **3.26. Digital Culture in Bangladesh:**

The telecommunication facilities like Radio, Television, Landline telephone, Cell phone and final edition the internet play a significant role in the development of digital culture and thus digitalizing our lives. In our daily life personal perspective people use to with online newspapers, email, social network, cell phones on the other hand Business perspective organization use updated software and application, modern laptops, database storages, network, ERP and many more effective tools. Dr. Jude Genilo( Jude William Genilo, 2013) in their articles "Narratives on Digital Bangladesh: Shared Meanings, Shared Concerns" stated the following definition of digital culture. Bangladesh Computer Council (BCC) Secretary Enamul Kabir, in an interview, specified that in Digital Bangladesh the "citizens would get information through electronic channels. Human interaction would be minimal. Most of the services can be given over electronic channels." In this sense, he merely spoke about the provision of government services.

Former Secretary of the Ministry of Science and ICT Nazmul Huda Khan defined it as applying "the latest advancements in science and technology" in reaching government development targets such as the "amelioration of life and emancipation from causes vexing humanity."

IT Specialist Shahid Uddin Akbar explained it simply as “integrating ICT in social and economic activities.” Bazlur Rahman, CEO of Bangladesh NGOs Network for Radio and Communication (BNNRC) stated that “I see digital Bangladesh in a way which would bring change in life and livelihood of people in rural areas, income would increase, narrows the gap. All the disparities, divide in terms of technology would be reduced. (ICT IN Bangladesh, 2009) Young generations is most effective power for developing ICT in Bangladesh they have quick learning ability which is helpful to personal life as well as business organizations so that near future in Bangladesh will be ICT oriented. (Auwal, 2015)

## 4. Practical Part

### 4.1. Case Study (Epyllion Group):



Figure 4-1 Epyllion Textile Division[Source: <http://www.epylliongroup.com/>]

### 4.2. About Epyllion Group:

Epyllion group is a largest Textile Manufacturing Industry in Bangladesh. Epyllion Group started its journey as a house of Readymade Garments (RMG) engaged in manufacturing and exporting of Knit Apparels since 1994 and has been considered today as one of the biggest conglomerates with substantial establishment of its backward linkage of all kinds of knit garments, textile, wet processing & garments accessories. It has the state of art vertically integrated garments manufacturing facility which ensures one stop service to the buyers. Epyllion Corporate office Located at 227/A Tejgaon-Gulshan Link Road, Postal Code: 1208 Dhaka, Bangladesh and factory offices at different locations. They have 12000 thousands employee in their family. Epyllion Group became the exporter of the year in the same category with annual export turnover less than \$50 million. Recently they published a report on their business capacity growth in 2015-2016 is 3% and 2016-2017 is 5% and Export growth in 2015-2016 is 5% and 201-2017 is 12%. (S.M. Nazmul Ahsan, Manager - HR, Admin & CSR, 2017-2018) They established themselves as an important garments manufacturer for a number of renowned brand apparels of Europe, USA, and Asia & Africa. They have own brand for country side named **Sailor**. [Epyllion spreads wings with Sailor, July 11, 2015]

#### Garments Divisions:

As it stands today, Epyllion Group became the name of lifestyle of its personnel, suppliers & buyers. For the greater commitment & care - Epyllion Group always plays a significant role in its every activity by protecting environment and has earned an iconic image among the green corporate houses. These achievements of ours prevailing due to the personnel of the Epyllion Group are placed at their right positions according to their caliber and inspiration. Garments and textile factories are located in Gazipur, Mirpur, Uttara, Kutubpur and others locations around the country. (Group, Epyllion, 2005)

**Vision:**

Vision is to become a window through which all their interacting parties can see and feel their prospect and dream about their success. Epyllion Group will become a lifestyle towards its employees, suppliers, buyers and above all shall become a role model of a green corporate house which will be regarded as an icon brand in the country.

**Mission:**

Epyllion Group will be known as an entity whose main driven force is its human resources they called human sprits. With such a motivated, high skilled and professional workforce, Epyllion Group has started marching towards its glory of success which is not the profit but to enjoy the joy of life.

**4.3. Corporate Profile:**

A group of experienced senior professionals are running the group. The overall operation is segregated into corporate office and factory office, where the corporate office has eleven departments and the factory office is broadly divided into four business processions. The specific policy & procedure regarding different operational issues and reporting system followed by the management eventually help to ensure proper coordination among decentralized management system. The Group also has separately formed Internal Audit Department to ensure proper implementation of policies & procedures and to keep the irregularities at minimum.

Apart from structured management policy & procedure the IT infrastructure along with easy and quick flow of information assists the management to monitor all its activities effectively and efficiently. The IT department is separated into programming implementation and support service unit. All the associated companies of the Group are facilitated with both procured and in-house developed software for smooth function of business planning & monitoring, finance & accounts, supply chain, inventory management, human resources, administration, CSR along with all manufacturing activities. The Group has installed UK based planning software Fast React, which helps to certain integrated business planning for well-timed production of each step of supply chain without any delay.

The Group also has separately formed Internal Audit Department to ensure proper implementation of policies & procedures and to keep the irregularities at low.



**Corporate Office:**

Group runs business through few separate departments in corporate office which have different role to a common goal.

- HR, Admin & CSR Department
- Business Planning Department
- Marketing & Merchandising Department
- Finance & Accounts Department
- Supply Chain Department
- Garments Operation Department
- Textile Operation Department
- Central Planning Department
- Industrial Engineering Department
- Process Improvement Department
- Commercial Department
- Information Technology Department
- Assurance Department
- Pattern & Sampling Department
- Engineering Department
- Practicing Corporate Culture
- Existence & Practices of Employee Participation Forum / committee

**Management Committee:**

Epyllion Group management committee which is separate from its board of directors. Management committee known as MANCOM which comprises top of the executives of this Group. The major function of this committee is to plan, forecast and execute the business plan of the group.

**Operation Committee:**

Function of Operation Committee is to look over the production process of the group & take initiatives to detect the bottle-neck on the production & undertake its remedy. Unit heads & General Manager, Operations are the key personnel of this Committee.

**Appraisal Committee:**

The major function of this committee is to set objectives for different departments and their Key Performance Indicator (KPI)

**Worker's Participations Committee:**

Worker's Participation Committee (WPC) is an unique team building initiative in the garment industry. This committee helps to achieve objective by creating bridge between the top management & workers. Through this committee, workers and management uphold their mutual interest.

### **Wastage Management Committee:**

Major functions of this committee are –

Adopt, deploy, monitor & review policy & procedure for effective waste management

Review & recommend the appropriate technology for wastage management & environment protection.

### **IT Committee:**

IT committee assesses the need of technological changes & establishes the new ways of IT based office automation.

### **Purchase Committee:**

Major functions of this committee are-

Adopt, deploy, monitor & review policy & procedure for effective sourcing of raw materials & others products

Sourcing quality product to achieve customer satisfaction for establishing good corporate governance through the aforesaid committees, below accustomed manuals is being followed:

Procurement Policy:

- Ethical & Social Compliance Policies
- Operational Procedure for Quality Assurance
- Human Resources Management Manual
- Standard Operating Procedure (SOP) of Sub-contract
- Wastage Management Manual

## **4.4. Organizational Structure:**

Epyllion has strong human spirit in every department from worker level to management level and the manpower is everything for manufacturing Textile, garments and accessories. They have Ethical business practice and protecting environment which is lead the organization. Factory to Corporate office they have good Human resource practice called HR Admin & CSR department mainly this department recruit new employee and maintains employee HR, Admin & Payroll

management system called resources communication (HRMS). They have very good process as confirmation, increment, promotion, festival bonus, Production bonus for employee in each year. Key CSR issues for Epyllion Group is Environmental management, eco efficiency responsible sourcing, labor standard and working conditions, employee and community relations, social equity, gender balance, human rights, good governance. Below shows current organizational structure of Epyllion group -Corporate office.

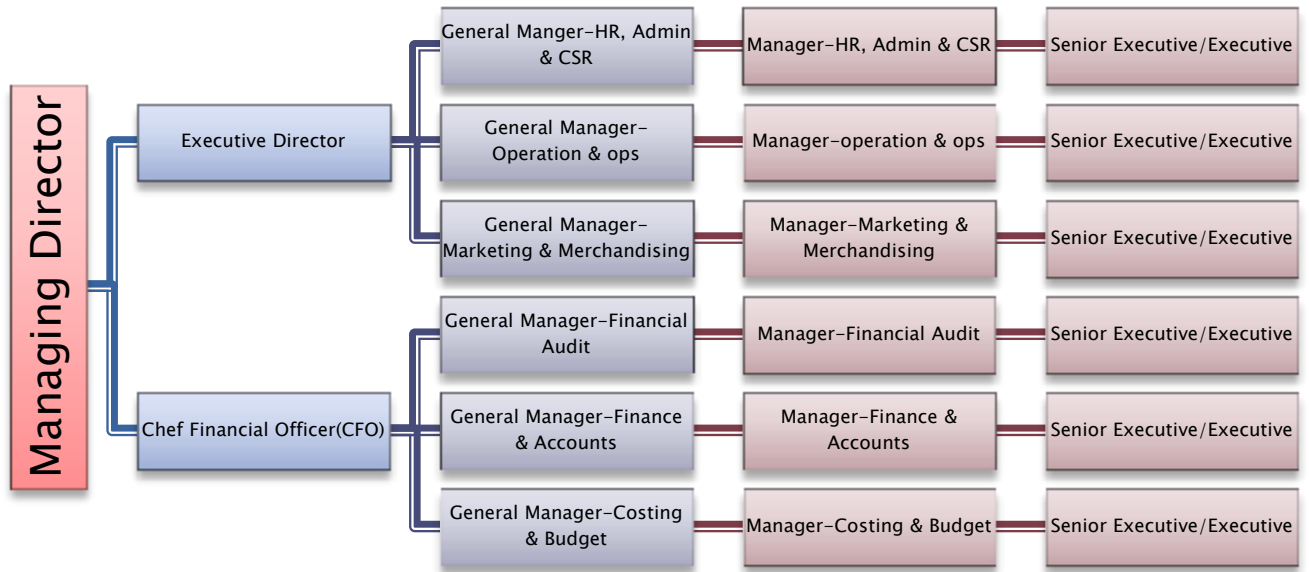

Figure 4-2 Organizational Structure(Source: <https://www.scribd.com/document/358476409/Organization-Design-and-Development-Epyllion-Group>)

#### 4.5. Current state Software & Application:

Epyllion group currently usages below software and applications for maintains their ICT operations:

Name	User	System
Email Communication	Internal Employee-1500clients	Microsoft Exchange email server-Central –Corporate office
Resources Communication(HRMS, ERP-First React )	HRMS-HR Admin & CSR Department-Payroll ERP-Production planning System	M.SQL basis
Network system –AD Service	Internal Employee-900PC, 200Printer, 100 scanner.	Active Directory
GDS(Global distribution system)	Garments base production-real time inventory	Own network system
Dheeraj Accounts Software	Accounts Department	ERP
CC TV	Corporate & Factory offices	NVR

Table 6 Current State Software & Application[Source: Author]

#### 4.6. Current state information and communication process:

##### Linear model of Communication:

Epyllion Group maintains its own IT cycle server to communicate each other in different level of ICT. Maintains form corporate office NINA KABO to factory offices and they use linear communication technology, they use router and ISP –Bandwave setup to add switch to Connect router and firewall device for protect security issue. When they connect Factory to Factory then they use Extra router and VPN connectivity as well as individual router.

Current sate connection represents 200 hundred users they use branch router via Switch to connect its users and two different server panels (HRM Server, ERP Server).

They use server frame switch, wan switch, Internet Gateway, Branch core switch and 10 different user switch, Branch Router and others necessary tools based on Linear Communication technology.

Company internal server manage Payroll management system, ADDC Server, Computer-aided design, ICT and computer-aided manufacture-Processes such as color matching, dye weighing and fabric printing automated. Email resources communication. Procurement and Material control process management and Ethical Business Practice.

Below shown current state linear communication Network Infrastructure of Epyllion Style Ltd:

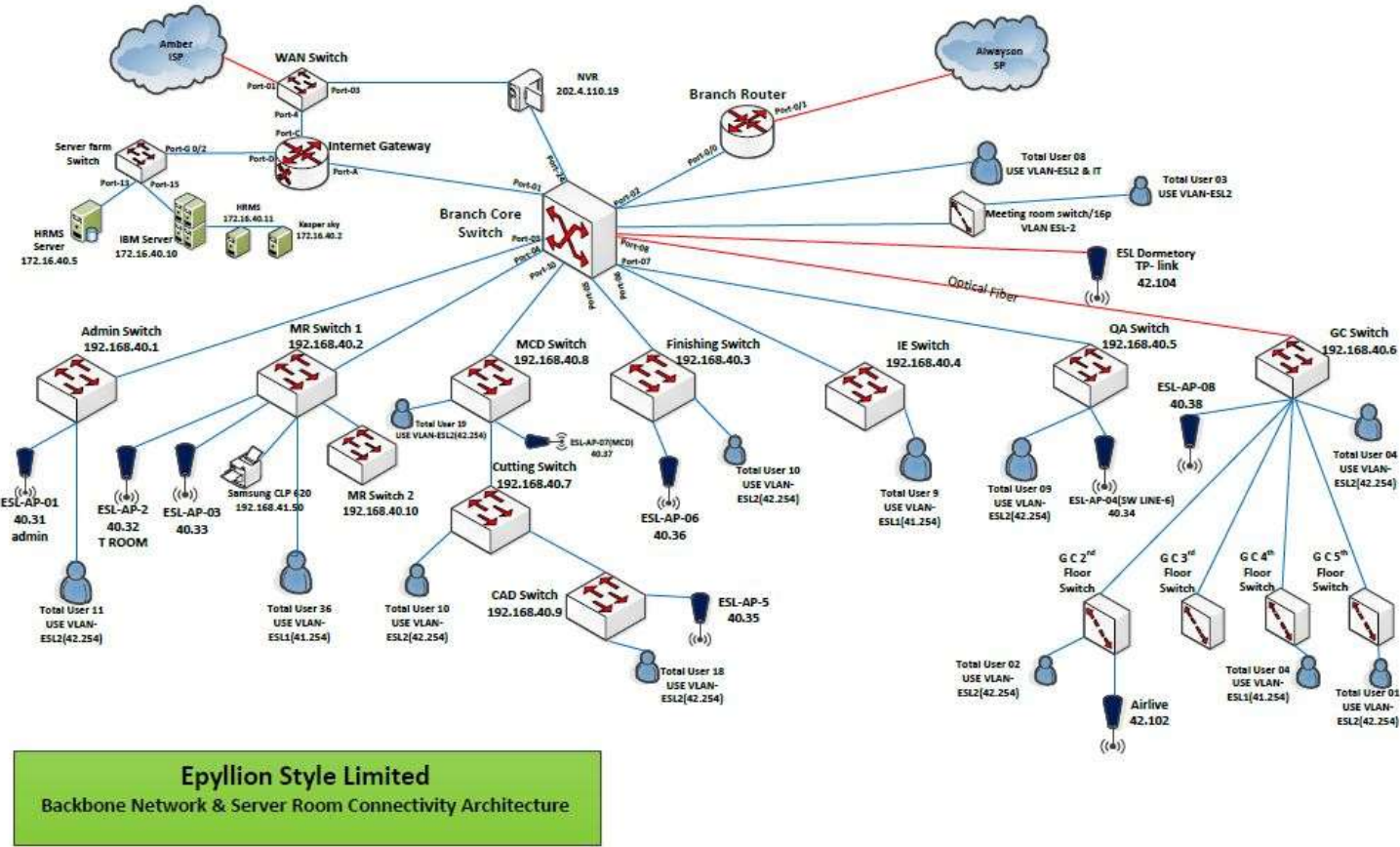

Figure 4-3 Current state Network Connectivity Architecture (Source: Author)

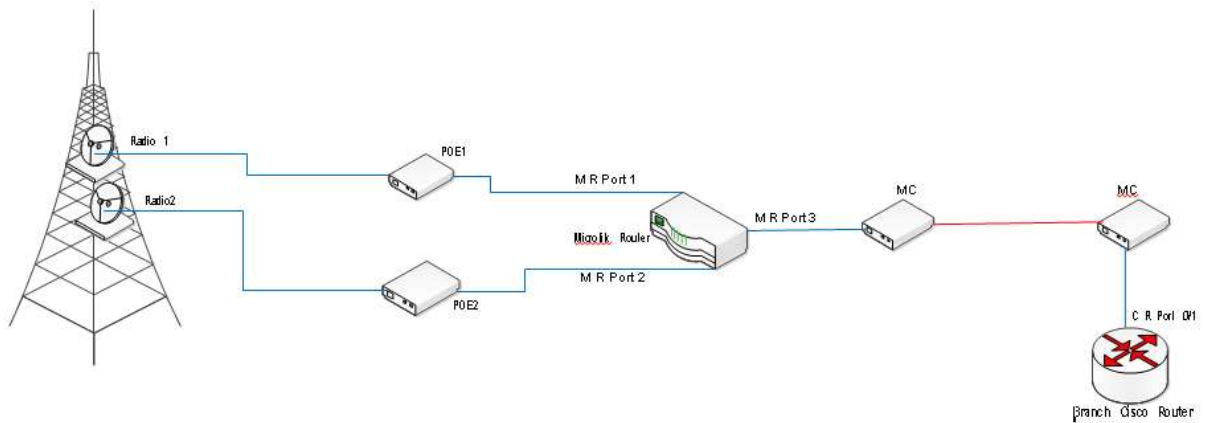
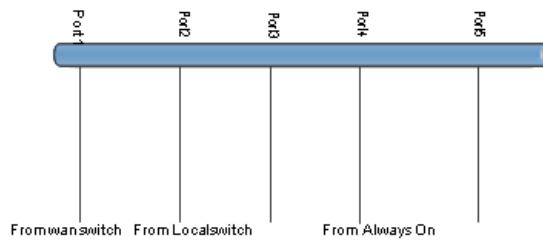

Figure 4-4 Radio Connectivity Epyllion Style Limited (Source: Author)



**Mikrotik Router Port Connection**

Figure 4-5 Router port Connectivity of Epyllion Style Limited (Source: Author)

#### 4.7. Limitations of Linear communication model:

Linear communication model has some Limitations first of all Epyllion ICT server run through corporate authorize admin so if any problem happen they always need to communicate corporate office to solve this issue so it's takes time and its stop smooth operations. On the other hand under this model Software and Applications and data are not secured any one can Cyber Attack or hacked ICT systems and it's a big trouble for company. Linear is a one way communication model so that no room for feedback. Also others important below Limitations occurred:

- Poor broadband & less speed internet
- Expenses are more but services are Limited,
- IT Server has less security as well as switch infrastructure is expensive
- Company important internal data is not secured. Sever has less security.
- Service is slow due to low configuration of PC and Laptops.
- Due to less speed of internet it makes delay for developing software & Applications.
- It covers limited users as well as documents can't be cloud.
- Due to communication gap it may delay for making garments production.

#### 4.8. Business process and plan:

For reaching production target and buyer satisfaction and smooth operation Epyllion



Figure 4-6 Business Process Plan[Source : Author]

Group has Business plan and it has five part first Central plan Second Operational plan and third Machine Plan Fourth Sourcing plan and Fifth Marketing plan and it's every part has different operational activities and goal.

**Business process:**

Epyllion group has very strong business processing steps that can easily reach production target and time frame but sometimes production process also delay due to raw material, lack of production process, follow up Machinery and technical problems, however Epyllion has nice production setup as per different buyers so that they can communicate every production department. Here is an example of how business production process works.

- The Epyllion business process management team covers how to study, identify, change, and monitor business processes to ensure they run smoothly and can be improved over time. Often framed in terms of the daily flow of work – and yes, “workflow” generally does fit under the process improvement umbrella – it is an important piece of the access and use puzzle since no or poor process really degrades their ability to get at and leverage information around outcomes not tasks to ensure the proper focus is maintained;
- Correcting and improving processes before (potentially) automating them;
- Standardizing processes across the enterprise so they can be more readily understood and managed, errors reduced, and risks mitigated;
- Enabling continuous change so the improvements can be extended and propagated over time;
- Improving existing processes, rather than building radically new or “perfect” ones, because that can take so long as to erode or negate any gains achieved.

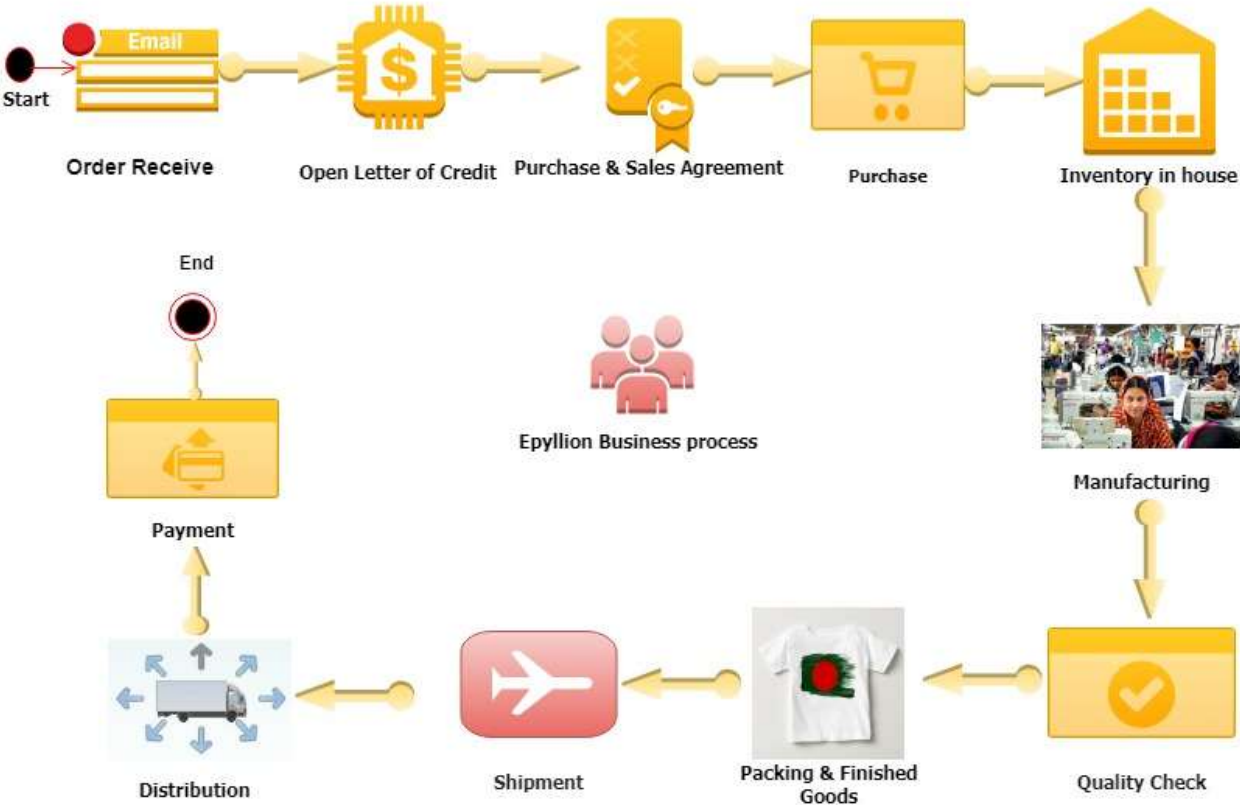

Figure 4-7 Business process model (Source: Author)



#### **4.9. Buying Partners:**

##### **C&A**

One of the biggest fashion retailers in Europe have more than 1,400 stores located in 20 different countries in Europe. They source their goods from around 900 suppliers in 40 countries. Epyllion is one of the biggest suppliers of C&A in Asia and have awarded best supplier's award in 2004.

##### **G-star**

G-Star RAW (commonly called just G-Star) is a Dutch designer clothing company that aims to produce fashionable and high quality urban clothing. It became a very popular clothing brand among students in Europe. G-Star has more than 6000 selling points worldwide, whose flagship stores are located in New York City, San Francisco, Los Angeles, Edinburgh, Australia, Netherlands, Amsterdam and Netherland.

##### **Celio**

Celio is an international men's clothing retailer based in Saint-Ouen, France. They have around 1000 stores in 70 different countries (including 500 in France). Epyllion is a supplier partner of Celio since 1998.

##### **Marks & Spencer**

Marks and Spencer is a British retailer, headquartered in City of Westminster, London. They have around 703 stores in the UK and another 361 stores spread across over 40 different countries.

##### **H&M**

H & M Hennes & Mauritz AB (operating as H&M) is a Swedish multinational retail-clothing company, known for its fast-fashion clothing for men, women, teenagers and children. It has 2,325 stores at end of 2011 and 2,629 stores at end of August 2012. It is ranked the second largest global clothing retailer.

##### **S.Oliver**

S. Oliver currently owns a total of 173 retail stores, as well as running 400 stores in cooperation with partner companies; its products are also sold in 1,991 shops and feature on 2,507 sales floors. Today, s.Oliver is to be found in more than 30 countries, for example in Austria, Switzerland, Belgium, Poland, Bosnia and Herzegovina, Serbia, Croatia, France, Italy, Czech Republic and India. s.Oliver celebrated its 40th company anniversary in 2009.

## Original Marines

Original Marine is an Italy based buyer, founded on 1983. In 2012, Original Marines opens additional 16 stores in Italy with the existing 512 franchise stores and the 65 direct ones.

Buying Partners:



Figure 4-8 Respective Brand Buying partners [Source: <http://www.epylliongroup.com/>]

#### **4.10. Brand Analysis:**

- Varieties of Yarn and fabric types used & Styling
- Different Product ranges & Category & Sizes
- Study consumer culture, behavior & taste
- Study artworks & Production Development process
- Study print & wash and Embroidery types they use frequently
- Price ranges and Costing
- Labels of buyers
- Test Requirements & Quality Parameters
- Compliance and Controlling
- Factories Environment

#### **4.11. Marketing & Merchandising:**

Merchandiser performing for taking orders from different buyers in all over the world, developing sample and bulk Product, monitoring several production departments and live production floors to reach production target and ensure on time shipments. Merchandising team has experience for developing Product Sampling, Communications & Operations with Buying house and real Buyer, Retail Merchandise Planning, Category Management as well as Product Development & Sourcing. They have developed skills sets of being detail oriented, familiar with complete product life cycle and strong negotiations. Currently Epyllion Merchandising Department has 05 Teams these are Merchandising team 1, Merchandising team 2, Merchandising team 3, Merchandising team 4 and Merchandising team 5.

Every different team as different has selected buyer and they work on it order to finished goods.

Merchandising team 1 & Merchandising team 3: for buyer C & A

Merchandising team 2: for buyer M & S, G-STAR, CELIO

Merchandising team 4: for buyer NEXT, MOTHERCARE, H & M

Merchandising team 5: for buyer s.Oliver, Original Marines

In a garments industry merchandiser play a vital role for collecting international buyer and ensure new order to run production and communicating local buying offices for confirming order after confirm order they follow-up production process up to shipment. Merchandising team plans can change any time as per management and business needs.

**Merchandising process Flow chart:** Below shows example of Merchandising process:



Figure 4-9 Merchandising Process Flow Chart[Source: <https://www.slideshare.net/AmitDas125/presentation-of-epyllion-group-71008156>]

#### 4.12. Merchandiser:

As a respective team member of Merchandising team, Merchandiser has to play an important role to achieve sample development to bulk production by communicating with buyer, management to different production departments and Factory to suppliers and sub contact factories. For this communication he/she need to use internal as well as External Communication. So as a merchandiser it is necessary to understand his job responsibilities and organizational behavior. Merchandiser need to know good communication process. Below an example of merchandising communication process:

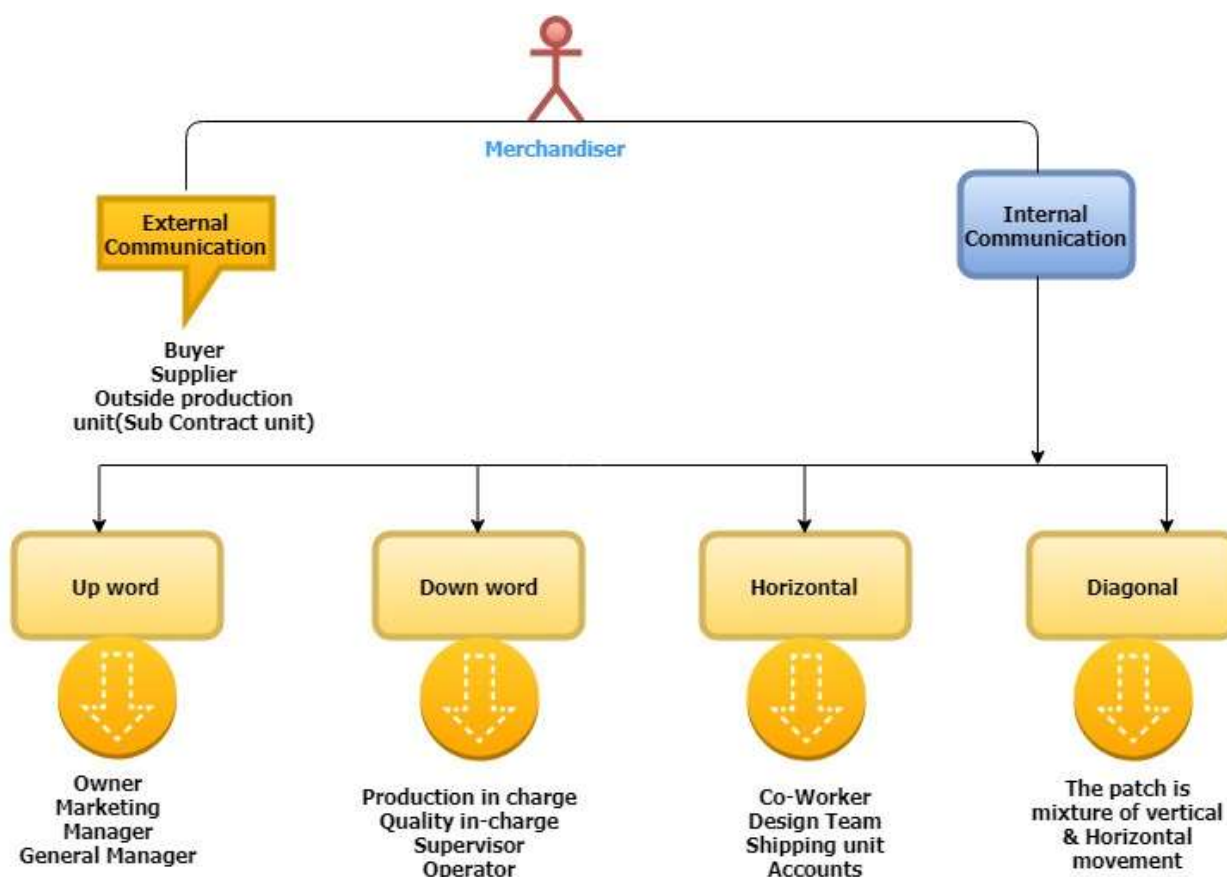

Figure 4-10 Merchandiser Communication process flow [Source: Author]

#### 4.13. Garments Production Process:

For manufacturing Garments they follow the following production process:

##### 1. Design/ Sketch:

For the production of knit garments, or woven garments a sketch of a particular garment including its design features is essential to produce on paper so that after manufacturing of that garment could be verified or checked whether could be done manually or with the help of computer.

##### 2. Pattern Design:

Hard paper copy of each component of the garment of exact dimension of each component is called pattern. The patterns also include seam allowance, trimming allowance, dirt's, and pleats, ease allowance, any special design etc. affairs. Pattern design could also be done manually or with the help of computer.

### **3. Sample Making:**

The patterns are used to cut the fabric. Then the garment components in fabric form are used to sew/assemble the garment. Sample garment manufacturing is to be done by a very efficient and technically sound person.

### **4. Production Pattern:**

The patterns of the approved sample garment are used for making production pattern. During production pattern making, sometimes it may be necessary to modify patterns design if buyer or appropriate authority suggests any minor modification.

### **5. Grading:**

Normally for large scale garments production of any style needs different sizes to produce from a set of particular size of patterns, the patterns of different sizes are produced by using grade rule which is called grading.

### **6. Marker Making:**

All the pattern pieces for all the required sizes are arranged the paper in such a way so that maximum number of garments could be produced with minimum fabric wastage. Markers are made for 6, 12, 18, 24 etc. pieces. Marker is also useful to estimate fabric consumption calculations.

### **7. Spreading:**

It is the process of arranging fabrics on the spreading table as per length and width of the marker in stack form. Normally height of the lay/fabric is limited up to maximum six inches high. But 4 inch to 5 inch height of the lay is safe.

### **8. Fabric Cutting:**

On the fabric lay/spread the marker paper is placed carefully and accurately, and pinned with the fabric to avoid unwanted movement or displacement of the marker paper. Normally straight knife cutting machine is used to cut out the garment component as per exact dimension of each patterns in stack form, care must be taken to avoid cutting defects.

### **9. Sorting/ Bundling:**

After cutting the entire fabric lay, all the garments components in stack form is sorted out as per size and color. To avoid mistake in sorting, it is better to use code number on each pattern.

### **10. Sewing or Assembling:**

It is the most important department/ section of a garment manufacturing industry. Sewing machines of different types are arranged as a vertical line to assemble the garments. Sequence of types of sewing machine arrangement depends on sequence of assembling operations. Number of sewing machine per line varies from 20 nos to 60 nos depending on the style of the garment to be produce. Production per line per hour also varies from 100 to 150 pieces depending on specific circumstances. Number of sewing machine arrangement per line may be up to 60 depending on design and output quantity of garment.

#### **11. Inspection:**

Each and every garment after sewing passes through the inspection table/ point, where the garments are thoroughly and carefully checked to detect/find any defect if present in the garment. The defects may be for example variation of measurement, sewing defect, fabric defects, spots etc. if the defect is possible to overcome, then the garment is sent to the respective person for correction. If the defect is not correctional, then the garment is separated as wastage.

#### **12. Pressing/ Finishing:**

After passing through the inspection table, each garment is normally ironed/ pressed to remove unwanted crease and to improve the smoothness, so that the garments looks nice to the customer. Folding of the garment is also done here for poly packing of the garments as per required dimension.

#### **13. Final Inspection:**

It is the last stage of inspection of the manufactured garments on behalf of the garment manufacturing organization, to detect any defective garments before packing.

#### **14. Packing:**

After final inspection, the garments are poly-packed, dozen-wise, color wise, size ratio wise, bundled and packed in the cartoon. The cartoon is marked with important information in printed form which is seen from outside the cartoon easily.

#### **15. Dispatch:**

The cartoons of the manufactured garments are delivered or placed in the dispatch department or finished product goes down, from where the garments lot is delivered for shipment.

**Garments manufacturing production process UML flow chart is given below:**

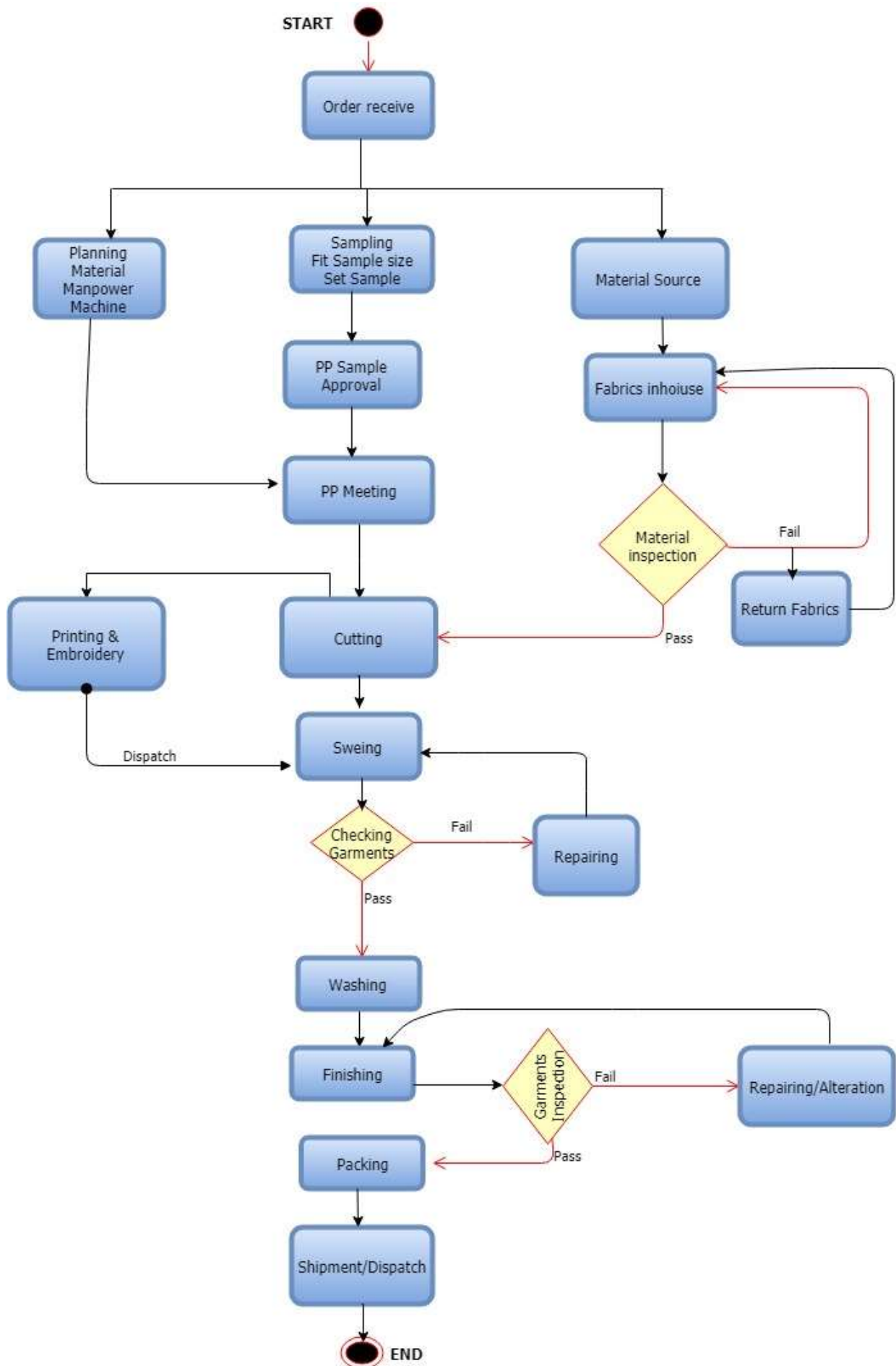

Figure 4-11 Garments Production process [Source: Author]



### Dyes and Fabrics issue:

Example of Different types Dyes & Suitable Fabrics: As per buyer requirement Fabrics need use dyes and chemical for dyeing so that it makes shape and color after that need to Quality test of Dyeing Fabrics Below images an example of this.

<b>CLASS OF DYE</b>	<b>FIBERS WHICH CAN BE DYED</b>
Direct dyes	Man-made & natural cellulosic fibers
Acid dyes	Natural protein fibers, nylon fibers
Basic dyes	Acrylic, modacrylic fibers
Disperse dyes	Polyester, nylon, acrylic, cellulose acetate
Class of dyes	Fibers which can be dyed
Mordant dyes	Wool, silk, nylon & modacrylic
Metal complex dyes	Wool silk (natural protein fibers) & nylon
Reactive dyes	Cellulose & Protein fibers
Sulfur dyes	Natural & man-made cellulosic fibers
Class of dye	Fibers which can be dyed
Vat dyes	Natural and man- made cellulosic fibers

Table 7 Example of Dye and Suitable Fabrics[Source: <https://www.slideshare.net/AmitDas125/presentation-of-epyllion-group-71008156>]

#### 4.14. SWOT Analysis:

SWOT stands for strengths, weaknesses, opportunities, and threats and is a tool for analyzing a business organization and culture. From the early stage it explain about strengths of Epyllion group and secondly its describe weakness then thirdly opportunities and finally it describe threats or Limitations. Organizational strengths and weaknesses are the internal factors. Opportunities and threats deal with factors external to the company--environmental factors. SWOT analysis is done as per theoretical analysis & Case study of this Group as well as interview with Operational head (Factory offcie) Md. Mahbubur Rahman Shohag and Mr. Shamsul karim Rumman- Manager Corporate IT Department as well as considering epyllion group reputation and current situation & business practies. Below figure shows SWOT analysis of Epyllion Group:

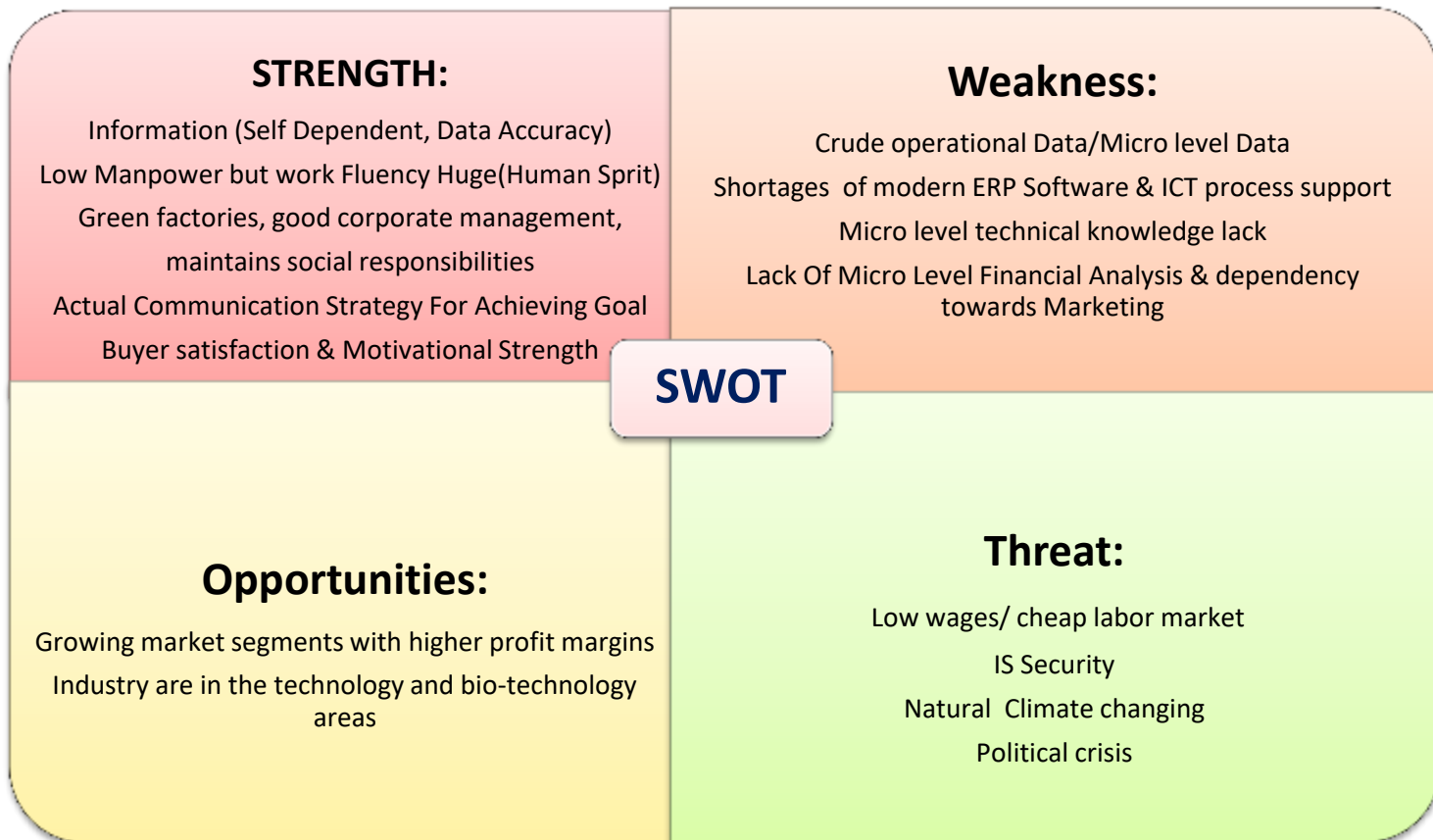

Figure 4-12 SWOT Analysis of Epyllion Group [Source: Author]

**Summary of SWOT Analysis**

SWOT analysis is a vital process where the organizational management team identifies the internal and external factors that will affect the organizations near future performance. Epyllion group has many strength as human spirit, green factories, good corporate management, maintains social responsibilities, buyer satisfaction and they have also some weakness lack of technical knowledge in Micro level, delay for shipment, information & communication process gap, shortages of modern ERP & ICT support etc. On the other hand they have some opportunities like their buyers day by increasing, building new factories to achieve production goals, Achieved recognition from Marks & Spencer and ISO authority for practicing ISO 26000, the international standard of social responsibility. 6th Standard Chartered Financial Express CSR Award in 2016 and 5th HSBC Export Excellence Award in 2014 etc. As well as they have some threats like climate change, international financial Crisis, political Crisis, ICT attack etc.

In this analysis every signal steps is very important for business organization to continue their proper operational functions because after this analysis they can get a strong idea about current organizations scenario so that they need to take necessary steps after finding the problems. So the solution will be implementation of new ICT process, ERP installation etc. Which is described below:

**4.15. Proposed new Design for information and communication process:**

After consideration all the theoretical part and Case Study in this group as well as interview with company representative Mr. Shamsul karim Rumman- Manager Corporate IT Department and Md. Shamim Tonmoy- Former Senior Executive-IT Department and considering company current practices of information and communication process, research, data source and case study analysis after that a new Proposed process designed. The aim of the new model is to implement new information and communication process which is cloud based. Described process contains all necessary steps to improve quality of information and communication flow and develop performance of ERP systems and others applications it also helps data record keeping, inventory management and ICT in the company. The process is in standard form and flow process will be applied according to this process and requirements.

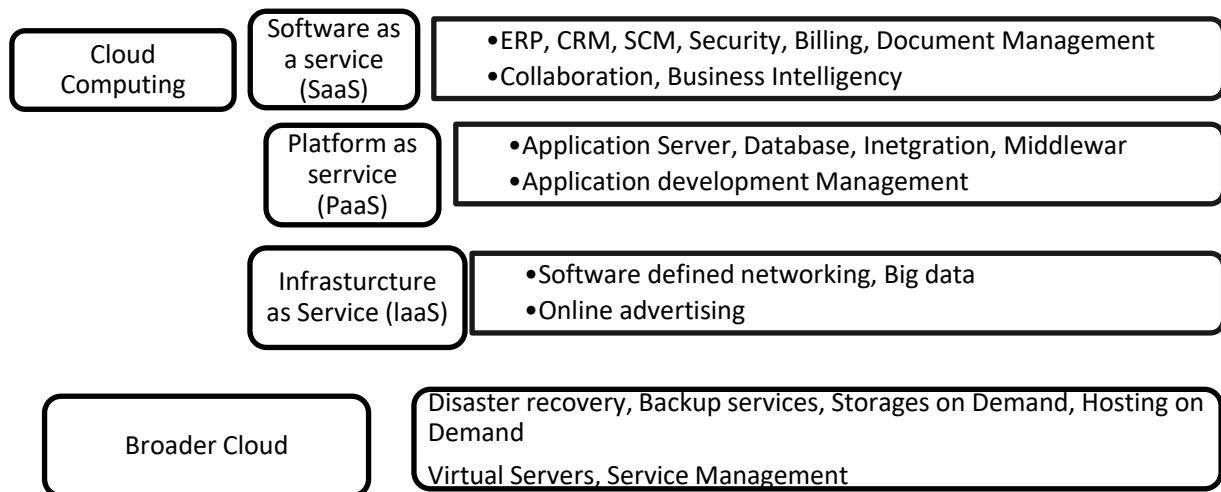

Figure 4-13 Standard Definition of Cloud base Communication process[Source: <https://www.deltapartnersgroup.com/our-insights/enterprise-cloud-clear-blue-skies-ahead>]

**Key requirements:** Basically requirements depended on size of company and their current needs and number of users as well as Current IT infrastructure so considering those and interview with Mr. Shamsul karim Rumman- Manager Corporate IT Department the following requirements is designed. As well as they also need to consideration Dynamic work load and resource management, Reliability, Availability and Security, Integration with data center management tools, Visibility & Reporting, Administrator, Developer and End user.

Name	Description
<b>Infrastructure</b>	Tier 03 to Tier 04 data center Environment, Internet Connectivity.
<b>Platforms</b>	Cloud Product, Provisioning and Management Platform.
<b>People</b>	Cloud Manager and Engineer, Operational specialist and integration consultants.
<b>Process</b>	Process for the Provisioning operations and billing for the new cloud.
<b>Channels</b>	Dedicated corporate channels , Mass Market SME Channels(online-offline).
<b>Heterogeneous systems support</b>	Not only leverage hardware virtualization and software solutions but they also support data center's existing infrastructure.
<b>Service Management</b>	To productize the functionality of cloud compacting it is important that Administrator have a simple tool for defining and metering service offerings.

**Table 8 Key Cloud Capability requirement**[source:<https://www.deltapartnersgroup.com/our-insights/enterprise-cloud-clear-blue-skies-ahead>]

Before one month they need to do pre plan for implementation this project. Cloud based communication now a days very popular technology facility has the potential to streamline business communications, leverage the brand, boost the overall productivity and spark customer engagement. This solution offers a series of features which are simply not available on a traditional phone system. It has become much easier to start business innovation initiatives, often enabled by readily available cloud services. No need indivisible connection as like point to point or Factory to Factory. They can use same email server in place in all over the world from Corporate of office to Factory, Corporate office to outside country. Corporate office is connected with factory offices by Azura cloud communication systems. To run Cloud based communication need to vonnect with Internet. After planning one month if decision is final then need three months for installation and setup after taht need to test it to see how it works if everything is nice then it can get Implementation card. This proposed infrastructure is only for Factory office Epyllion Style Ltd so the same plan they can use for others Factory offices as well as via connect with corporate office which will be effective for whole group.

Epyllion style Ltd Cloud base Solution.

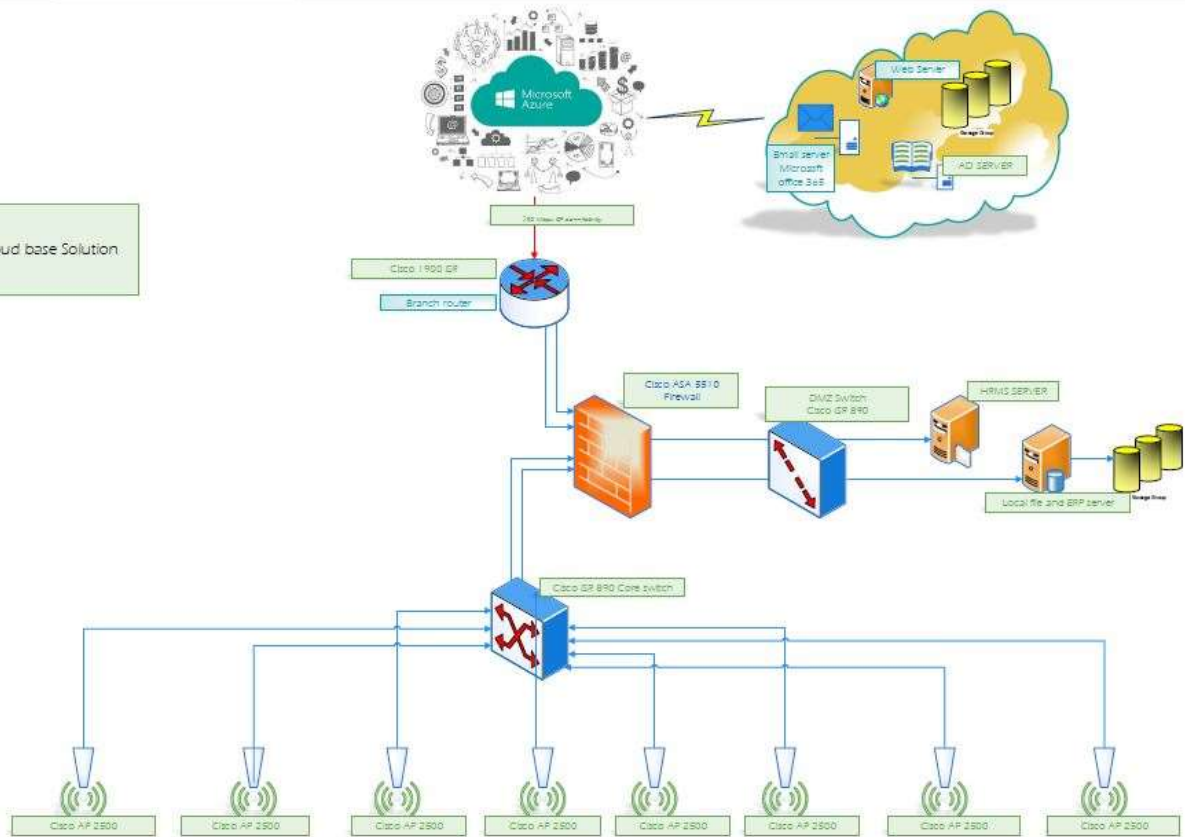

Figure 4-14 Cloud Based communication process[Source: Author]

**Main benefits of Cloud based communication process:**

Based on personal experience with cloud consumers, Epyllion corporate management can easily communicate with factory managers and they can save valuable time and expense. Using Cloud based communication they can communicate worldwide buyers what is necessary for their business.

Partially they will be benefited on below arena:

- Easily communicate from Corporate office to Factory office and abroad
- Reduce time and cost
- Software development & update installation
- ERP usages upgrade
- Better usages resources
- Less operational issues
- Smart use of Bandwidth
- Less complex
- Data security
- Data storages
- Smooth production
- Achieve target production quantity
- Record keeping and Financial reporting
- HRM and better Payroll Management
- Work efficiency and satisfaction

**4.16. Proposed software and Application solution:**

<b>Name</b>	<b>Field of usages</b>	<b>System Brand</b>	<b>Types of cost</b>	<b>Cost(\$)</b>
<b>Material Management (SAP MM)</b>	For Inventory management solutions	SAP	Implementation cost	\$35000
<b>Human Resource Management (SAP HRM)</b>	HRM and Payroll	SAP	License cost	\$10000
<b>Financial Accounting and Controlling (SAP FICO)</b>	Accounting & Reporting	SAP	Hardware & IT Infrastructure, Support cost (Food & Landing)	\$14000
<b>Concur Travel, expenses and invoices</b>	Business Travel & Expense Management	SAP Concur	Core team member, SAP office service & Support cost	\$10000
			<b>Total</b>	<b>\$69000/=</b>

Table 9 Proposed Software and application for Epyllion business solution[Source: (SSG Implements, SAP for Business Automation, 2016)]

Note: The above figure is not exact figure. It is just estimation. Total cost depend on number of users, number of sister concerns for Group of Companies, Implementation partner, and Hardware & IT Infrastructure etc.

**4.17. Financial cost and budget analysis:**

As per theoretical part of methodology and practical part of case study it is important for this organization to make a financial plan for implementation Cloud based communication process and ERP software solution for their business. How much money need for success proposed plan we can't make exact budget but we can figure out expected budget it can be higher it can be lower it's depend on current market prices however below tables shows proposed financial plan and budget:

SL No.	Details of the device	Quantity(pcs/Cores)	Rate(\$)	Total Expense(\$)
1.	WAN Edge at branches: Cisco 1900 ISR	1	\$ 1450	\$1450
2.	HQ Router and HQ Edge: Cisco ISR 890 (24 ports model)	2	\$ 2025	\$4050
3.	Switches (SG 200)	4	\$335	\$1340
4.	Firewall: Cisco ASA 5510	1	\$2599.99	\$2599.99
5.	Microsoft Asure Cloud infrastructure for BD and Web server(Instance D3V2, Cores 4 Ram 14GB, stroages 200GB)	2	\$27985	\$55970
6.	Office 365 E 3 Sloution/ Mail server(Monthly)	200	\$12.47	\$2492
7.	Microsoft AD Cloud Service	As per Premium Features(hourly/Monthly)	\$1000	\$1000
8.	Dell power edge R330 for FTP, Payroll Management	3	\$2396	\$7188
10.	Cables and connectivity devices	n/a	\$500	\$500
11.	PC and laptops(HP,Dell)	200	\$250	\$50000
12.	Server(3 -at head office) 2 one at each regional office.	5	\$1000	\$5000
13.	Software Development Infrastructure & Maintenance	5	\$1200	\$6000
14.	SAP ERP	2	\$100000	\$200000
15.	Service & Maintenance(techancial consultans)	10	\$500	\$5000
Total				<b>\$ 342590.00</b>

**Table 10 Financial Cost & Budget Analysis**[Source: (SSG Implements, SAP for Business Automation, 2016)

(Network Cisco Systems & Juniper)

Note: The above figure is not exact figure. It is just estimation. Total cost depend on number of users, number of sister concerns for Group of Companies, Implementation partner, and Hardware & IT Infrastructure etc. Post Plan 3 month Pre plan 1 month Testing 1 month. Currently top cloud services providers are Amazon.com, Microsoft.com and Google.com so they can choose any services from them as per their requirements.

#### **4.18. Feasibility study:**

Epyllion group is a technology savvy company and has been working with green technology. Epyllion Group looks for sustainable business opportunities while focusing on the triple bottom line of sustainable development. Sustainable businesses have progressive environmental and human rights policies and this is most important for viable industrialization and Globalization. So Epyllion Group is legally and technically feasible as well as economically justifiable for new investment which they can earn back very soon.

#### **Information and communication process Empirical Findings:**

In this thesis current state limitations were identified and time measurements of implementations of new proposed design also given. As a part of Literature review the case study was discussed during the interview with Mr. Shamsul karim Rumman- Manager Corporate IT Department the following conclusions were made:

Empirical finding are:

- lack of reliable infrastructure. Internet speed, bandwidth and electricity
- poor international visibility and lack of brand name as a global offshoring destination
- Inventory Management & data storages as well as for record keeping them use-traditional MS- Excel.
- Communication gap between Gazipur zone Factory to Corporate central IT
- Data record keeping and data Security Issues
- Business travel and expense reporting issues
- Difficulty Training Employees in the field of IT
- Due to production process sometimes delay for as expected production
- Lack of Machinery sometimes needs to take loan different machineries
- Lack of ERP systems for HR payroll, Accounts record keeping and Production
- Linear communication is not continuous as no concept of feedback, no way to know is communication was effective.
- Lack of experience IT skills
- Lack of ICT investment
- Unit labor cost
- Workers Safety problems in working
- Political crisis
- Transportation and communication problem
- Misuses of Raw materials
- Poor internet speed occur problems for Application development
- Factories Computers are very low configured which make delay in work time



## **Technical Feasibility:**

### **Concept:**

Implementation of Cloud based communication model/process.

### **Infrastructure:**

To development new systems they need to change their existing performance infrastructure as per characteristics and functionality.

As per case study and technical resources about this company it is clear that they have skilled manpower in IT Department to develop something new and they are capable to do it because they have manpower in corporate office as well as factory offices so that they can work together to converting ideas, working systems, software & applications development and infrastructure so they are technically feasible.

### **Economic Feasibility:**

Efficient energy usage technology and effective management system lowers the energy consumption and energy cost and is beneficiary for the economy and environment both. For a company whose annual profits are over \$50 million dollars, an investment of approximately \$69000.00 million dollars and \$3,42,590.00 dollars total \$411590.00 is affordable and justifiable, since it will permanently remove the added costs of communication services by third parties while providing better quality of their connectivity. Hence, the return on investment could be expected to as soon as possible maximum 03 years which will be back in different business purposes as like reducing infrastructure cost, Manpower investment, increasing production, increasing ICT and others services, developing software & applications, Increasing sales and international relations.

### **Legal Feasibility:**

Epyllion Group is committed to maintain business practices with being stimulus to the international norms and standards of human rights. They uphold the commitment for their core business but also for suppliers and vendors as well. So they maintain industry, data, zone, social etc. law or acts for properly fulfilled their requirements so that for new model implementations they can do it easily as per their strong economic growth.

### **Operational Feasibility:**

As a Group of Companies Epyllion Group work with international companies, buyers, vendors, suppliers, others manufacturers, different projects so that they need to maintain different accounts, finance, audit, reporting so on so that they can easily figure out, analyze their requirements for fulfilled new upcoming proposed model and they can start developing their systems.

### **ROI Analysis:**

As a financial analysis, ROI is a measure of a company's net income related to its total asset investment. For direct marketers, that "Asset investment" generally is the advertising cost associated with generating the sales that contribute the net income. For Potential solution is calculated as follows :

Estimated Lifetime benefits-Estimated Lifetime costs, or  $ROI = \text{Net present value} / \text{Estimated lifetime costs}$ .

**Net present Value:** After discounting all costs and benefits, subtract sum of the discounted costs from the sum of the discounted benefits to determine the net present value. If it is positive, the investment is good, If negative, the investment is bad, When comparing multiple solutions or projects, the one with the highest positive net present value is the best investment. (Mukund, 2018)

#### **4.19. Summary:**

Summary of expected results by implementing the new proposed design instead of the old broadband network and communication process of the Epyllion Group will not only optimize their business processes and internal communication but also they will reduce the operational expenditures because of the termination of the separate contracts that each of the factories had previously with the internet and mobile service providers. Furthermore, they will have the manageability of the corporate network in their own control. Because of the new IP VPN routing infrastructure, the data traffic within the network will be more equally spread since the factories can easily communicate with each other without the authentication approval from the head quarter. The new network design cloud based communication process will help to run it easier to integration of factory offices and branch offices, just by replicating the current structure of any of the other branches so the implementation of the new information and communication process Cloud based communication will lead to tremendous improvement and achievements of different business functionalities which could not be achieved by the Linear Communication process or system.

## **5. Discussion & Results:**

The incredible brawn and speed of these technologies will give individuals unparalleled control over producing goods and its services. Therefore, communications and information technologies will be especially important for improving the integration of reserve and active components, improving the readiness of reserve components for action, and enhancing the ability of reserve components to carry out future missions.

Innovative uses of cloud based technology-for example, increasing the availability of information workstations and providing training for reserve components in their duty locations or communicating with different international buyers and production department, production need will fulfil new ERP systems as well as inventory management and financial transactions and its data storages and reporting.

So information communication technology(ICT) and its proposed new model, proposed software, hardware and cloud based communication will be most useful tools for manufacturing organization Epyllion Group in Bangladesh.

### **5.1 Way to overcome & control Empirical finding:**

Information communication technologies access to high-speed broadband and cloud based communication provide positively impact in Epyllion operations which ultimately gain profitability of all businesses rather than Linear communication process. They can provide better services and gain well reputation in inside country as well as world-wide by using Cloud based solution. So below shows how the overcome current finding by using of new proposed model:

#### **Internal Advantages are:**

Firstly by using this cloud based communication model communication will be very fast and easier.

It provides high Security for Data and no risk for hacking or Phishing.

ERP systems are more developed and it work fasters as well as centralize any one can make entry or whatever he want can do form anywhere in the world.

Payroll management systems also flexible on the other hand Fast react software, GDS will be centralize Faster and user friendly.

All kind of office packages MS Excel or MS Word will run in cloud based model so anyone can use it updates it in online.

Security systems is very high & protected so that no tension for data or important files.

## **External Advantages are:**

It reduces IT Infrastructure & maintains cost and it consume very low time as well as its user friendly, For email communication or mailing service is very faster and secure no spam will occur.

It also reduce Manpower investment

Data sharing will be user to user, flexible and faster as well as high security. Others important benefits are:

### **□ Reduce costs for businesses through:**

- 'just in time' business operations and production processes
- lower IT infrastructure costs through the use of cloud computing
- reduced travel expenses through tools such as video conferencing, Skype, teleconferencing with remote presentation delivery via the Internet
- paper reduction and related savings
- online training tools

### **□ Increase efficiencies and productivity through:**

- reduced manual processing
- reduced double entry of data and duplication of resource efforts
- automation of processes
- electronic workflow management and scheduling systems
- improved, fast tracked 'go to market' approaches
- ability to undertake real time capacity forecasting
- ability to track and measure the cost of production
- the ability to deal with customers remotely
- the ability to communicate with suppliers and customers online

### **□ Improve business performance through:**

- real time access to information (and business 'dashboards') that enable risks to be identified and managed and the health of a business to be reported dynamically
- The capture and analysis of financial, production, service, customer information to inform rapid decision making
- improved market intelligence relating to competitors, market trends and customer requirements
- access to remote markets

### **□ Improve customer service by:**

- providing services and support to customers in real time
- enabling customer access to services and information from anywhere, at any time
- measuring and guaranteeing service quality
- Improve brand recognition using a range of online and social media tools

- Collaborate more effectively with business partners and internal and external stakeholders
- Access, consolidate, manipulate and retrieve large sets of data
- Increase revenue opportunities through extended market reach, including increased export capability
- Attract investment from anywhere around the world.

## **5.2 Recommendations:**

The research has shown that Currently Epyllion group usages Linear communication models which is provides very slow broadband and poor internet speed as well as less data security and information is also without feedback oriented so for overcome this situations they need to implementation Cloud based Communication model.

Nowadays business are cloud based and internet oriented so that to connect with buyers & customers, suppliers it is necessary to use strong email communication and very good information oriented company Website & YouTube channels etc.

Since many years already past this organization and it has very strong reputation in market so to continue their reputation it is necessary to increase their production & Shipment services by using modern ICT tools.

Epyllion has IT department & they have some applications and it has users who daily usages software like Fast react, CRM, HRMS, Network system-AD services etc. but problem is that those applications are not too modern and fast service provider comparing current market products and their competitor's so strongly recommended that they need to implementations SAP ERP- MM, HRM, FICO etc.

For Development of new marketing techniques use of social media tools to raise brand reputation and it can be monitor customer feedback. Utilization of online and CRM products to customize, personalize and disseminate marketing materials and measure the success of companies.

Implementations of workflow systems that automate process and optimize an end to end business process. Electronic collaboration tools that can be used to speed and develop new ideas, support research.

Epyllion Management they need to communicate global so that it is necessary to improve internet based communication skills – VoIP, Video conferencing, Web conferencing by using new cloud based model.

New cloud based model access to enterprise strength IT resources (including security infrastructure) so it is recommended that to use global cloud community support.

### **Comparison of ERP Implementation:**

Comparison of the ERP is viewed from three different attributes, namely: People, process & organization and technology. Each organization had different experience in ERP implementation process, but in general organization Epyllion group had a better process of ERP implementation than organization Bangla CAT. So that organization Epyllion group could achieve successful implementation of ERP in terms of benefits and performance.

This comparison going on The Bangla Trac Ltd between Epyllion Group Ltd for ERP implementation the selected companies need to research and fix below important things:

Modularity, Strategic aims, top management support, Project Management, Change Management, Education & Training, ERP System selection, Process Preparation, Configuration, Customization, Data Migration, Characteristics of ERP, Selection of ERP, Features of ERP, Advantages, hidden cost etc.

### **Brief History of organization:**

**Epyllion Group** is a largest textile manufacturing industry with more than 10000 employees and 15 factories in the different areas of Bangladesh. They are supplying the knitting, Dyeing, Textile, Garments manufacturing, Spinning, Food & Beverage and Carton etc. The organization has been successfully promoting its trademark in local and international markets since 1990.

**Bangla CAT** is an incorporated as a private limited company under the Companies Act.1994. Bangla Trac Limited(concluding business under the 'Bangla CAT' was appointed the dealership for Caterpillar engines and equipment's in the People's Republic of Bangladesh on the 11<sup>th</sup> of October-2004. ( Bangla Trac Group Brand Management, 2018)

### **Strategic Aims:**

Nowadays business environment rapidly changing to encourage more intimate business to business transactions with key customers, and the old system was not compatible with the new systems that were being installed in the customer base. Future enhancements to the existing systems were not expected, and organization Epyllion and Bangla CAT they need to maintain in- house information systems resources to develop the new capabilities and interfaces that would be required.

### **Top Management Support:**

Bangla CAT realized that top management support is not effective at the stage of the project implementation; also it is not important for ongoing success of the system after the project completed. Project Manager States that the non- supportive behavior of the top management always puts project's unsuccessful.

On the other hand Epyllion Group realized that, the ERP system is highly supported by top management. This reinforcement of top management affected process success positively. Although project team felt this as pressure, the pressure made this project success real. They still believe that top management had given more support to project.

### **Project Management:**

Bangla CAT the execution strategy and implementation plan of the project was not well defined and made clear to all stakeholders. Project did not have clearly established goals to be met in line with the organizational strategic goals. The project manager says that the project scope was

not realistic. The project's milestones were underlined informally, which affects the project success negatively. The project team consists of about five key users which have moderate qualifications to be a part of this kind of project according to project Manager.

Epyllion group the implementation plan of the project and execution strategy was well defined. It was also made clear to all stakeholders. There were clearly established project goals to be accomplished in line with the organizational strategic goals. They used formal plan to define project's milestones and revised it when necessary. Project team was composed of key users from different departments relatively for ERP Module needs. There were many consultants to work with.

### **Change Management:**

Top management was unable to impose to the employee's their vision for change. The process of change was not well managed. In the project, they faced user resistance to the new system especially during redefinition of the business processes and the delegation and reassignment of work between departments. Most of the project team members agree that this change was not managed properly. There might be many reasons for this. There was the limited time and resources mostly allocated to project for more technical and functional issues.

Epyllion Group, the project, they faced high user resistance to new system. They use many methods to cope with this situation. They use different methods to convince people the benefits of the system and make the acceptance of the system guaranteed.

Preparing detailed procedures of new business processes, they tried to not to have any confusion anymore therefore they realized project as not only an information technology project but also as a chance to bring change into their organization to make improvements on business processes.

Others important comparison are shown in a table:

<b>Differences</b>	<b>Bangla CAT</b>	<b>Epyllion Group</b>
Goal & objective	IT aims to facilitate the data consolidation and integration and project was driven from parent company to its sister concern.	Three things is important in the implementation of ERP systems, namely project scope, cost and time.
Implementation team	The implementation team was selected from all functional disciplines. 12 people were selected based on skill.	A cross selection of products, processes, customers and various scenarios were created and tested of project.
Risk Management	ERP implementation project risk described as uncertainty, liability that could cause the project to deviate from established plans.	Good planning & adoption systematic risk management are crucial in project completion on time.
Re-engineering	ERP business process adjusted in order to be aligned with organization's business process therefore they do a lot of changes the standard ERP program.	They done prior to implementation of ERP system, but it were not radical. Organization's business process was adjusted in order to be aligned with ERP's business process.
Communication	They have not established a good communication between consultant team and users. This is because the users do not have a good commitment to this project.	They have established a good communication between consultant team and users and users have agreed commitment to this project.
Education & Training	IT people will be responsible for each module provided the external training for 3 Months but users do not get an adequate training both in terms of quality and needless time allocated.	In Epyllion IT department is responsible for each module, only provide the internal training likewise the users
Technology Attribute	The complexity of the ERP system is not supported by adequate infrastructure, this effect on system performance. The company will make an improvement to its infrastructure.	Epyllion has an adequate infrastructure to support the complexity of ERP system so it can support the system with better performance.
Data Analysis	ERP consultant does not have a good capability in data migration, so a lot of data migration performed by internal IT department, consultant also did not validate the data very well.	The migration performed by consultant with the help of users with a great commitment, so that migration data can be run well.
Planning	Initial planning will be carried out by the Project manager and reviewed by ICE & IFS project Director.	Epyllion has assigned Project Manager and Project Director who is responsible for implementation of ERP project.

Table 11 ERP Comparison between Bangla CAT and Epyllion group) Source: (European Journal of Operational Research, 2003)



ERP's implementation usually implies significant changes to staff work processes and practices in real field. For implement such changes- consulting, customization and support they need to communicate with project manager and for final implementation time depends on business size, number of modules, number of factories, users, customization, process changes etc. Project implementation duration depends on size of Enterprise and process requirements, for medium enterprise 6 to 8 months for large enterprise 12 to 14 months. Small projects can require one or two months, Customization can substantially increase implementation times.

In conclusion Company also needs to consider ERP implementation process, people, place and organization, top management cooperation, team work, consultation, future research etc. In conclusion it can say that Epyllion Group has ability to overcome selected issues and takes new challenges for implementation ERP projects.

### **5.3 Evaluation of research Approach**

Author now turns to the issue of importance and reliability & validity of the research carried out in the basis of dissertation and effects on the research findings and scope as per current frame references and experience in this field. Authors applied current methodology which is applied selected manufacturing organization and proposed future methodology for overcome current state limitations and achieve business goal by using new proposed methodology. As author working experience in selected field case study (Epyllion Group) manufacturing company, the data, figure, content and analysis that all research is effective and mortal and useable so author suggests that the research is valid purely. On the other hand this experience and behavior of the selected participants in EPYLLION GROUP is a true representation of the Bangladeshi current state organisations and their nature, culture and behavior.

The biggest challenge to Information and communication Technology in the future is security of data, application, software, websites and many more. Security could negatively impact connectivity to public networks to business network. If these problems cannot be successfully addressed, I envision a time of closed, Business or private networks and less information sharing. The risks now are so great and getting worse every day that we even see foreign governments toppling superpowers the way Russia toppled the US and put its puppet in charge because of weak controls and poor security. So it's a big issue in our ICT society.

The biggest problem isn't the requirement of ICT, it's the people involved at every level, everywhere, inside and out. The biggest threats are not from the outside - they are insider threats, both innocent and malicious. Even well-meaning people in Government, for example, leave lap tops with classified information on buses by accident. People in the office find security too inconvenient and find ways to get around it. However we have many things to do in this sector we can't amazing what is waiting for us in near future so that we should work on it because of daily need. We can't amazing a single day without our smartphone our MacBook, email and social network every moment we use it fortunately or unfortunately it can be our business need it can be our personal need.

## **6. Conclusion**

The main objective of the thesis was to analyse current state of information and communication process in a manufacturing company in Bangladesh, and partially to generate a dynamic overview of current state of the art in information and communication process in manufacturing process in Bangladesh.

ICT investment for manufacturing business is useful for Communication & manufacturing performance, information and production performance, business development, data storage record keeping and reporting, manufacturing strategy; production process outsourcing will be effective on new system. New information and Communications process will provide substantial increases in bandwidth every year (i.e., vastly increasing the capacity to move large volumes of data quickly). Cloud based communication process are providing dramatic increases in computing power and the capacity for worldwide access to information by users on either secured or unsecured intranets.

The First Partial goal of the thesis was theoretical and practical explanations of current state of ICT (Information and communication technology) analyse and address.

In theoretical and practical part (Case study) already describe current state ICT process and implementation advantages & disadvantage and its details functionality. Which will be very useful information source for Epyllion group as well as others manufacturing companies in Bangladesh.

The second partial goal was to analyse and select an optimum solution of current state information processing and communication arrangement in the selected manufacturing company base on case study.

As per the second goal author analysed current state information communication technology methods of selected company after analysing and interview with company representative new proposed designed is created which is Cloud based communication model that will be the optimum solution for Epyllion group and also others manufacturing company can apply this proposed model.

Nowadays Communications is very fast and easier if we know how to use it so that we need to use Cloud based Information & communication technology for business due to its worldwide business value and strong services, flexibility, users friendly and globally useful.

Based on the feasibility study it can be concluded that, for implementation of the newly proposed model the company needs to make a plan for success of this proposed process and which plan they need to include period of time of this project, financial plan, IT support analysis, current infrastructure analysis, legal supports, manpower analysis etc. need to establish a basic structure flow for connecting all the basic processes starting from entry of the custom order in the system to finalising the customer order and dispatch. This will potentially allow the company to trace the production process and allows for monitoring and emulating process in various production levels checkpoint and it also allows very first ICT services which will be effective for every department. Feasibility study concluded that for a textile manufacturing industry information systems and communication process need to be developed by the organization management. The government at all levels needs to do all things necessary to ensure all textile manufacturing sectors should maintain ICT rules and compliance. The company management needs to enhance national socio-economic development in order to fulfil global standard and appreciation. However the methodological approach & research finding have great potential to explain, analyze & evaluate usages of current ICT model which is the Linear Communication model and solution for future business development will be cloud based communication to increase effective information & communication process in manufacturing industry of Epyllion group in Bangladesh.

## 7. Bibliography

- Amazon Web Services. 2018.** <https://aws.amazon.com>. *amazon.com*. [Online] 2018. <https://aws.amazon.com/what-is-cloud-computing/>.
- Bangla Trac Group Brand Management. 2018.** *about\_us.php*. <http://www.banglacat.com>. [Online] 2018. [http://www.banglacat.com/about\\_us.php](http://www.banglacat.com/about_us.php).
- /communication-process. Kinitex. 2011.** s.l. : <http://www.communicationstudies.com>, 2011. */tanmay-bakshi\_n\_10751360.html*.
- Ivan Mehta, Tech News Editor. 2016/06/30.** s.l. : <https://www.huffingtonpost.in>, 2016/06/30.
- 2011, Chen et al. and Tsai, Lai, and Vasilakos. 2014.** Future Internet of Things: open issues and challenges - ResearchGate. 2014.
- AIMM. 2018.** BUSINESS PROCESS MANAGEMENT. <https://www.aiim.org>. [Online] 2018.
- Akter, Akhi. 2017.** *An overview of Bangladesh RMG 2016*. Dhaka : <https://www.textiletoday.com.bd/overview-bangladesh-rmg-2016/>, 2017.
- Allen & Griffeth, 1997, Fulk & Boyd, 1991 and Yater & Orlikowski, 1992). 1997.** *Communication Channels | Principles of Management*. s.l. : <http://open.lib.umn.edu>, 1997.
- Allen, D. G., & Griffeth, R. W. (1997). 1997.** *Emerging theories of communication in organizations*. 1997. 17, 407–446.
- Ashish Gupta. 2012.** Role of Information Technology in Apparel Industry. *S C R I B D*. [Online] Sep 03, 2012 Sep 03 2012. <https://www.scribd.com/>.
- Auwal, Ahmad Muhammad. 2015.** Completely Erase Traditional Media from the Communication. 2015.
- azure.microsoft.com/. azure.microsoft.com/.** [Online] <https://docs.microsoft.com/en-us/azure/cloud-services/cloud-services-choose-me>.
- BGMEA. 2018.** <http://www.bgmea.com.bd/>. [Online] 2018. <http://www.bgmea.com.bd/home/about>.
- BGMEA. home/about/Strengths. 2018.** s.l. : <http://www.bgmea.com.bd/>, 2018.
- Business Process Management – Overview. Nepal, Manish. March 31st, 2018.** s.l. : <https://kissflow.com/bpm/business-process-management-overview/>, March 31st, 2018.
- business-process-management-overview/. Nepal, Manish. July 19th, 2017.** India : <https://kissflow.com/bpm/>, July 19th, 2017.
- By R. Kelly Rainer, Casey G. Cegielski. 2011.** *Introduction to Information Systems: Enabling and Transforming Business*. s.l. : John Wiley & Sons, Inc., 2011. 978-0470-47352-8.
- Cegielski, R. Kelly Rainer Jr. Casey G. 2011.** *Introduction to Information Systems*. s.l. : John Wiley & Sons, Inc., 2011. ISBN-13 978-0470-47352-8.
- November 2017.** *Communication Tools Used in Modern Day Business*. s.l. : [www.elcomcms.com](http://www.elcomcms.com), November 2017.
- Csanyi, Edvard. 2016.** *Automation Of Manufacturing Processes*. s.l. : <https://electrical-engineering-portal.com>, 2016.
- David L. Olson, Subodh Kesharwani. 2009.** *Enterprise Information Systems: Contemporary Trends and Issues*. s.l. : World Scientific Publishing Company, 2009. 9813107502, 9789813107502.
- 28 February 2018.** *Enterprise\_information\_system*. s.l. : <https://en.wikipedia.org/wiki/>, 28 February 2018.
- Epyllion spreads wings with Sailor. Mirdha, Refayet Ullah. July 11, 2015.** Dhaka : <https://www.thedailystar.net/business/epyllion-spreads-wings-sailor-111295>, July 11, 2015.
- European Journal of Operational Research. Al-Mashari, M., Al-Mudiningh, A. & Zairi, M. 2003.** 2003. 146, 352-364.

*Future trends in Information Technology*. **Sargeant, Przemek**. Tuesday, 06 June 2017. s.l. : <https://www.web-foundry.co.uk/blog/>, Tuesday, 06 June 2017.

**G.Cegielski, R. Kelly Rainer Jr. Casey**. 2011. *Introduction to Information Systems*. River Street, Hoboken, USA : John Wiley & Sons, Inc., 2011. 978-0470-47352-8.

**Goodman-Deane et, al**. 2016. The impact of communication technologies on life and relationship. *Computers in Human Behavior*. 2016.

**Google Cloud**. 2018. <https://cloud.google.com/terms/services>. *cloud.google.com*. [Online] September 18, 2018 2018. <https://cloud.google.com/terms/services>.

**Group, Epyllion**. 2005. Textile Division-Production Unit. <http://www.epylliongroup.com/backward/pages/textile.php>. [Online] 2005.

*ICT IN Bangladesh*. **MAGAZINE, PULSE**. 2009. s.l. : <http://pulsemagazine.stanford.edu/ict-in-bangladesh/>, 2009.

**IMAGINiT TECHNOLOGIES**. 2018. IMAGINiT TECHNOLOGIES. [www.imaginit.com](http://www.imaginit.com). [Online] Multi-industry, 2018. <https://www.imaginit.com/software/autodesk-products/autocad>.

*Information Technology As A Factor Of Production*. **Lorin Hitt, Erik Brynjolfsson**, 28 Jul 2006. Issue 3-4, s.l. : <https://www.tandfonline.com>, 28 Jul 2006, Vols. Volume 3, 1995 - .

*Inside Bangladesh's garment industry, second largest in the world*. **Herman, Chris Reinhardt and Elizabeth D**. August 14, 2014. s.l. : PRI (Public Radio International), August 14, 2014.

— **Herman, Chris Reinhardt and Elizabeth D**. August 14, 2014. August 14, 2014, Vol. PRI(Public Radio International).

**ISB**. 2016. ISB. *Integrated solutions for Business*. [Online] 2016. <http://www.isb-me.com/isb/portal/Solutions/Business-Process-Management.aspx>.

**Jude William Genilo, Phd**. 2013. Attracting and Keeping Bangladeshi Women in the ICT Profession. Third, 2013, Vol. 03, 2307-0099.

*Manual, Semi-Automated or Automated*:. **Invotec**. November 20, 2014. s.l. : Invotec Engineering, November 20, 2014.

**Manufacturing, Committee to Study Information Technology and**. 1995. *Information Technology for Manufacturing*. Washington, D.C. : National Academy Press, 1995. ISBN 978-0-309-05179-8 | DOI 10.17226/4815.

**Mason Carpenter, Talya Bauer, Berrin Erdogan**. October 27, 2015. *Principles of Management* . s.l. : University of Minnesota Libraries Publishing edition, 2015. This edition adapted from a work originally produced in 2010 by a publisher who has requested that it not receive attribution., October 27, 2015. 978-1-946135-18-6.

**Mason Carpenter, Talya Bauer, Berrin Erdogan**. 2010. *Principles of Management - Version 1.1*. New York : Published by Flat World Knowledge, Inc. (2010), 2010. ISBN 10: 1453300902 ISBN 13: 9781453300909.

**Mukund**. 2018. *Why a Feasibility Study is Important in Project Management*. s.l. : [www.simplilearn.com](http://www.simplilearn.com), 2018.

**Network Cisco Systems & Juniper**. <http://itprice.com/cisco-routers-2>. *itprice.com*. [Online] <http://itprice.com/cisco/cisco-1000-series-connected-grid-routers-17795>.

**Online.com, TE**. 2008. *CAD in Textile Industry*. s.l. : TE Online.com, 2008.

**Peniak, P**. 2006. *IMPLEMENTATION OF INFORMATION SYSTEMS IN MANUFACTURING*. s.l. : <https://dspace.vsb.cz/bitstream/handle/10084/.../AEEE-2006-5-3-120-Peniak.pdf?...1>, 2006.

**Plantenberg, Kirstie**. September 22, 2016. *Engineering Graphics Essentials*. Warren, Michigan, United States : [www.SDCpublications.com](http://www.SDCpublications.com), September 22, 2016. ISBN 978-1-63057-052-1.

**RAINER, R. K. and and CEGIELSKI, C. G**. 2010. *Introduction to Information Systems*. 2010. ISBN 9780470473528.

**Robert Scoble. 2010.** University of North Carolina School of Law. *www.unc.edu*. [Online] Mar. 26 March 2010.

<https://www.unc.edu/courses/2010spring/law/357c/001/cloudcomputing/examples.html>.

**21 Jul 2017.** *running-business/it/cloud-computing/benefits*. s.l. : [www.business.qld.gov.au/](http://www.business.qld.gov.au/), 21 Jul 2017.

**S.M. Nazmul Ahsan, Manager - HR, Admin & CSR. 2017-2018.**

<https://www.unglobalcompact.org/participation/report/cop/create-and-submit/active/414341>.

*United Nations Global Compact*. [Online] Epyllion Group, February 2017 – February 2018 2018/02/08, 2017-2018. <https://www.unglobalcompact.org/participation/report/cop/create-and-submit/active/414341>.

**Shannon, C.E., & Weaver, W. (1949). July, October, 1948..** *The mathematical theory of communication*. July, October, 1948. ISBN-13: 978-0252725487.

*SSG Implements, SAP for Business Automation*. **Md. Shafiqul Alam LLB, FCA, FCMA. 2016.** Dhaka : <http://www.icmab.org.bd/>, 2016.

**STANFORD, CARL. 2016.** *What is a Linear Model of Communication*. s.l. :

<https://fleximize.com/articles/000561/a-linear-model-of-communication>, 2016.

**Taher, Mustafizur R Khan and Fayaz. February 23, 2017.** *ICT opens up new prospects for Bangladesh*, *Daily Star, Dhaka*. Dhaka : Daily Star, February 23, 2017.

*THREADSOL'S SOFTWARE EXHIBITS INNOVATION IN DTG-2017*. **correspondent, News hour. FEB 28, 2017.** s.l. : NEWS HOUR, FEB 28, 2017.

