

ŠKODA AUTO VYSOKÁ ŠKOLA o.p.s.

Course: N0413A050001 Business Administration

Field of study/specialisation: Specialization International Supply Chain
Management

Use of Unit Load AGVs for Picking Cart Handling Diploma Thesis

Yuvanesh Kanna Namadevan B.E;

Thesis Supervisor: Prof. Ing. Radim Lenort, Ph.D.



ŠKODA AUTO Vysoká škola

REGISTRATION FOR FINAL THESIS

Candidate: **Yuvanesh kanna Namadevan**
Study programme: Business Administration
Track: International Supply Chain Management

Thesis title: **Use of Unit Load AGVs for Picking Cart Handling**

Aim: The aim of this thesis is to design and evaluate the possibilities of using unit load AGVs for picking carts handling in the assembly hall for the production of passenger cars.

Content areas:

1. Conduct a literature review of the latest knowledge in the field of internal logistics and AGVs.
2. Analyze the parameters of aisles situated in the assembly hall and picking carts used.
3. Identify possible problems associated with using unit load AGVs for picking carts handling.
4. Design and evaluate ways to solve identified problems.
5. Solve the thesis in the assembly hall M1 in ŠKODA AUTO a.s.

Length of thesis: 55 – 65 stran

Recommended literature:

1. JACOBS, F R. – CHASE, R B. *Operations and supply chain management*. McGraw-Hill Education, 2018. 754 p. The McGraw-Hill education series. ISBN 978-1-259-92179-7.
2. GÜNTER, U. – ALBRECHT, T. *Automated Guided Vehicle Systems*. Wiesbaden: Springer, 2022. 300 p.
3. ČECH, M. – LENORT, R. – WICHER, P. – MALČIČ, T. – DAVID, J. – HOLMAN, D. – STAŠ, D. – ZÁRUBA, J. Autonomous Mobile Robot Technology for Supplying Assembly Lines in the Automotive Industry. *Acta logistica*. 2020. v. 7, no. 2, p. 103–109. ISSN 1339-5629. URL: http://www.actalogistica.eu/issues/2020/II_2020_05_Cech_Wicher_Lenort_Malcic_David_Holman_Stas_Zarub

Date of registration: February 2022

Date of submission: January 2023

L. S.

Electronic approval: 3. 5. 2022

Yuvanesh kanna Namadevan
Author of thesis

Electronic approval: 3. 5. 2022

prof. Ing. Radim Lenort, Ph.D.
Thesis supervisor

Electronic approval: 4. 5. 2022

doc. Ing. Jan Fábry, Ph.D.
Study track supervisor

Electronic approval: 5. 5. 2022

doc. Ing. Pavel Mertlík, CSc.
Rector ŠAUni

I declare that I have prepared this thesis on my own and listed all the sources used in the bibliography. I declare that, while preparing the thesis, I followed the internal regulation of ŠKODA AUTO VYSOKÁ ŠKOLA o.p.s. (hereinafter referred to as ŠAVŠ), directive Thesis guidelines.

I am aware that this thesis is covered by Act No. 121/2000 Coll., the Copyright Act, that it is schoolwork within the meaning of Section 60 and that under Section 35 (3) ŠAVŠ is entitled to use my thesis for educational purposes or internal requirements. I agree with my thesis being published in accordance with Section 47b of Act No. 111/1998 Coll., on Higher Education Institutions.

I understand that ŠAVŠ has the right to enter into a licence agreement for this work under standard conditions. If I use this thesis or grant a licence for its use, I agree to inform ŠAVŠ about it. In this case, ŠAVŠ is entitled to demand a contribution to cover the costs incurred in the creation of this work up to their actual amount.

Mladá Boleslav, Date

Signature

I would like to thank Prof. Ing. Radim Lenort, Ph.D. for his professional supervision of my thesis, advice and information. I also want to thank ŠKODA AUTO a.s. and the internal logistics department PF2-I in the M1 assembly hall for the opportunity and the support for this thesis.

Contents

Introduction.....	9
1 Logistics.....	11
1.1 Internal logistics	12
1.2 Material flow	13
2 Industry 4.0	15
2.1 Industry 4.0 and supply chain emergence.....	15
2.2 Industry 4.0 function.....	16
3 Automated Guided Vehicles	18
3.1 History of AGV	18
3.2 Design and methodolgy of AGV	19
3.3 Vehicle	20
3.4 Oriental way	22
3.5 Safety system.....	24
3.6 Application.....	25
4 ŠKODA AUTO a.s.	26
4.1 ŠKODA AUTO internal logistics	27
4.2 M1 assembly hall	27
4.3 Automated guided vehicles	31
4.4 Electric tuggers	33
4.5 Forklifts.....	34
5 Analysis of the current status.....	35
5.1 Problem definition	36
5.2 Analysis of the aisles.....	37
5.3 Analysis of the sequences.....	39
6 Solutions and results.....	43
6.1 Results on the analysis of the sequences	43
6.2 Technical solutions.....	48
6.3 Individual results	56
Conclusion.....	58
Bibliography.....	60

List of figures and tables	63
List of appendices	65

List of abbreviations and symbols

AGV	Automated Guided Vehicle
KLT	Kleinladungsträger
GLT	Grossladungsträger
AKL	Automatic Kleinladungsträger

Introduction

The need for automation in the automotive production industry has increased exponentially in the last decade than ever before. With the introduction of Automated Guided vehicles (AGV) in the production line the workload has greatly reduced and the precision of material delivery on time without accidents has greatly increased. With the AGVs supporting the industry 4.0 the demand for new technologies and new solution in the production line which is currently the most sought out technology in the production, with delivering of the materials to full automation in the production line as the main goal.

Currently, the automotive industry is facing significant challenges, which are increasingly demanding customers, global competition and constantly increasing demand for quality products. One way to deal with the new circumstances, is definitely the automation of logistics processes, and especially in internal logistics. In general, it is important in logistics that everything happens at the right time, in the right place and in the right amount. Thus, this idea can be easily translated into a concrete example timely delivery of the right parts to the right place at the right time, which is its own way the main task of the proper functioning of the material flow in any production operation. However, in such operation, several possibilities arise, how guarantee that all the criteria described above are met. But at this moment it is running out to the basic division, namely into classic manual and relatively new automatic options. It is necessary to understand the importance of the development of new technologies and focus accordingly more on automatic

The diploma thesis is structured into two parts. The first part is dedicated to the theoretical aspect of the thesis explaining the current technology used and the different available technologies available in the current market. The theoretical part explains the working of the AGVs the types of AGVs and the comparison between the different AGVs providing the key differences, the advantages and the disadvantages of the AGVs also about the internal logistics and the role of industry 4.0 in automation.

The second part of the thesis deals with the use of unit load AGVs for picking cart handling in the M1 assembly hall at ŠKODA AUTO a.s. This will be done by considering all the parameters of the plant and the regulations followed. All the AGV

routes and the cart dimensions will be taken into consideration which will be referenced with the width of the streets located in the M1 assembly hall and we will identify which AGV routes doesn't have any problem and pick out the ones which have problems in using the unit load AGV. One of the main problems is changing the orientation of the picking cart in the assembly line according to the requirement by ŠKODA AUTO a.s.,so we need to find technical solutions for the automatic orientation of the picking cart and use multiple criteria evaluation to find out which is the best solution and suggest it. Also, we need to identify all the picking cart and suggest the most feasible and correct solution for the problems faced since some solution may not apply for some picking carts.

1 Logistics

Logistics is described by various definitions. However, it can be said that the logistics deals with the process of planning, organizing and managing material flows as well as storage and provision of services. Part of the logistics are, among other things, communication and information systems that support the path to achieving the main objective of logistics. The aim is to try to coordinate the necessary material by the customer required quality with a specific time and place.

The continuous adjustment and improvement of processes is a key mechanism for the functioning of the company in modern conditions and a significant competitive advantage. Supply chain management practices impact not only overall organizational performance, but also competitive advantage of an organization (Karimi and Rafiee, 2014). The proper supply chain management is a process that reduces costs and increases the competitiveness of the company (Kumar et al., 2006). Hence, the logistics needs to respect the process of planning, implementation and control of the procurement, storage, transport and information and with the sole purpose to improve them. Every company should develop an appropriate mission and vision in order to implement its business logistics. The mission of the business logistics is to ensure availability of the right product in the right quantity, on the right place, at the right time and to the right buyer at the right price. The vision of the business logistics is to ensure sustainable development, or to set logistics activities and operations in order to get the final results with the least possible level of coordination, maximum synergy and lowest costs in accordance with all environmental and consumer laws. Mentzer and Konrad's (1991) definition of logistics effectiveness is the extent to which the logistics function's goals are accomplished. Logistics implicates to the process of planning, implementing, and controlling the efficient, effective flow and storage of goods, services, and related information from point of origin to point of consumption for the purpose of conforming to customer requirements. It comprises the management of raw materials flow to finished goods through an organization. Logistics means planning and organizing activities that ensure that resources are in place so that the process can be effectuated accordingly in efficient and effective manner (Mellat-Parast and Spillan, 2014). The main functions of logistics managers involve organizing and planning of

inventory, purchasing, transportation, warehousing activities. The logistic activities can be divided in two categories (Lambert and Burduroglo, 2000):

- Inbound logistics, that refers to the activities connected with the procurement of material, handling, storage and transportation; and
- Outbound logistics, that refers to the activities connected with the collection, maintenance and distribution or delivery of the product to the final consumer.

Accordingly, logistics is strategically important in many industries as it is central to achieving competitive advantage (Kenyon and Meixell, 2007). However, companies must respond to changing customer needs, and logistics flexibility is an important part of the response (Zhang et al., 2005). Each company must develop or create its own logistical values that will be incorporated into the product, or its value in use. For customers despite the shape of the product, it is important that it will be accessible to them in the required time. There are six reverse logistics capabilities that have impact on companies' performance: logistics information management, close-loop capability, supply chain integration, supply chain coordination, conformity capability, and institutional incentives (Vlachos, 2016). In today's dynamic competitive environment, logistics management strategy plays a significant part in the overall corporate governance, especially in the area of asset management and financial flows of the company. In other words, the use of logistical savings will allow the policy of lower prices, longer payment terms, and higher level of service to customers and therefore, increased operating efficiency (Ristovska et al., 2017). Nowadays, the importance of logistics is growing mainly due to increasing globalization. Companies are under constant competitive pressure and trying to meet needs of customers. Logistics contributes to them by reducing total operating costs, thanks to which companies make higher profits for. That is why a responsible and systemic approach to logistics is particularly important in increasing the efficiency of the overall system.

1.1 Internal logistics

In recent years we do not see internal logistics only as a distribution and transportation logistics, but it also has an important part in companies strategic planning. It is already a crucial part of organisations' success today and for such

success to become a reality, all process must be aligned. It is the area that covers the movement of materials and the support operations that occur within a company. It comprises several processing such as warehousing, stock control, automation and storage systems, material handling, equipment and IT (Burganova et al., 2021). Without the internal logistics there is a problem with internal movement of materials and the goods are not produced on time, where in current world on time delivery is very important to the customers. When there is problem with on time delivery, there is a problem with proper marketing which leads to low profits for the company. This can only be avoided with good flow of materials and good internal logistics management.

Internal logistics play a huge role in the smooth running of the company. However, on a scale it is challenging to maintain a flawless logistic division due to many variables and the requirements to which such a system is subject. Logistics can be seen as a business function responsible for "getting the right goods in the right quantity at the right time in the right place at the right price and in the right condition for the right customer." (Burganova et al., 2021). Figure 1 explains the flow of materials from the supplier to the assembly line.

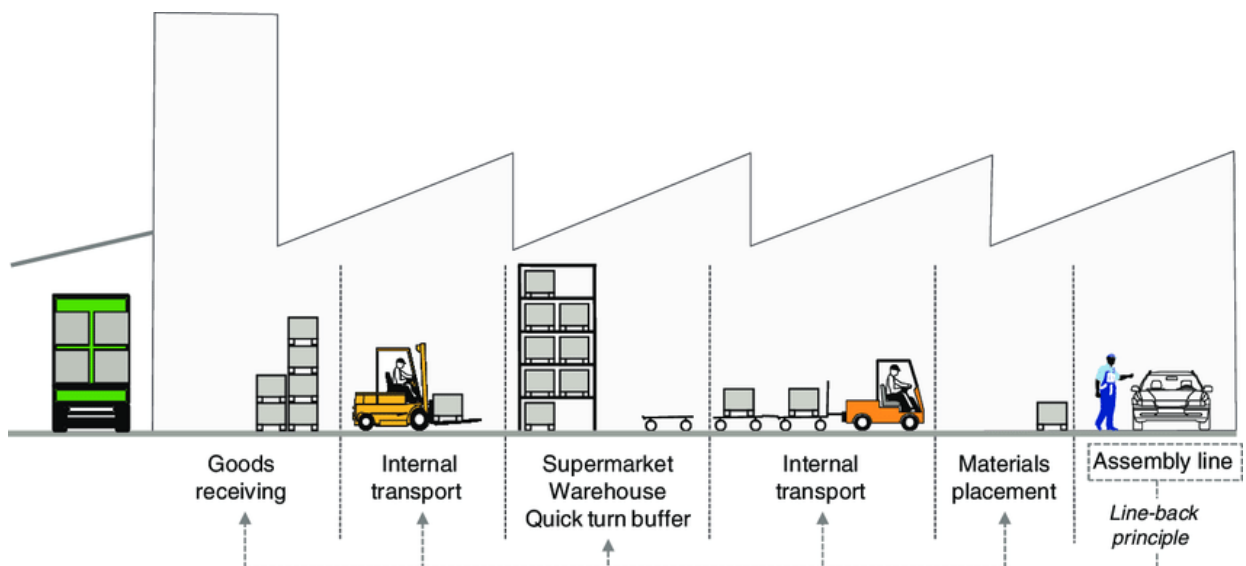

Source: (Klug, 2012)

Figure 1 Internal logistics

1.2 Material flow

Material flow can be understood as the movement of material, information and financial resources. All movement is primarily provided by transport, handling,

warehouse and other technical means. The main task is then such management movement so that any material, information or financial resources are delivered in the right time, in the right quantity, quality and order to the right place.

When planning such a flow, it is necessary that we know in detail all properties of the materials that will be part of the flow. It is necessary to know the features that are characteristic of such material (condition, shape, size, quantity) together. Classification is carried out primarily because in order to classify material having the same or similar characteristics into individual handling groups. Thanks to handling groups, used for the transport of various materials by a similar type of handling resources with the rules and conditions necessary for handling. All these criteria are the main reason for the creation of the material classification.

Among other things, the material flow also works with the company's stocks. Controls and manages routes inventory to the processing site together with the means of handling. Therefore, inventory management in the enterprise is one of the most important activities of the enterprise. Aim material flow control is to ensure movement and all material handling with great emphasis on coordination of movements from a logistical point of view, especially with a view to maximising efficiency combined with minimum operational cost.

It is very important not to forget the fact that all decisions related to managing material flow, they have a direct impact on the level of customer service. This fact implies a direct link to the overall competitiveness of the whole undertaking.

If the business is unable to ensure safe, efficient and effective material management, the manufacturing enterprise will not be able to produce products at the desired price, even when the product is in demand by customers.

2 Industry 4.0

Industry 4.0 symbolizes the fourth industrial revolution, and the goal of Industry 4.0 is to increase the level of automation and data exchange in manufacturing technologies. Industry 4.0 defines a methodology to generate a transformation from machine dominant manufacturing to digital manufacturing. It is a paradigm that includes a new approach to production and changes in traditional, centralized control structures in favor of decentralized structures. Industry 4.0 can be seen as a matter of technology diffusion and adoption and the decentralization of business processes brought about by technological advances. Industry 4.0 refers the fourth industrial revolution initiated by the integration of the Internet of Things (IoT) and the Internet of Services (IoS) in the manufacturing process. Thus Industry 4.0 maximizes the transparency of processes by exploiting the possibilities of digitization and integrates the corporate value chain and the supply chain into a new level of customer value creation. Industry 4.0 allows industrial systems to develop a global cyber-physical network of machines, equipment, sensors and facilities for better data exchange and control. Adopting Industry 4.0 is not just a matter of new technologies and/or tools and/or production methods, but implies changes in all management aspects, and involves all actors of the ecosystem in which a company operates (Yuksel, 2020).

2.1 Industry 4.0 and supply chain emergence

Industry 4.0 is typical for the network environment where the use of extensive communication can support undistorted information exchange among autonomous components, thus bringing self-organization (Oztemel and Gursev, 2020). Generally, the concept of a self-organizing system can be traced to Ashby (1947), who defines it as a system that is able to modify its own structure. More precisely, self-organization is the process that occurs spontaneously, in which the firms organize themselves to produce a new pattern, property or structure without any defined plan (Stacey, 1996; Silva and Guerrini, 2018; Espinosa et al., 2019). Self-organization creates agents as either autonomous or nonautonomous actors of an emerging organizational system (Espejo and Reyes, 2011). Similarly, Goldstein (1994) argues that the collective behavior of self-organized agents characterizes new, unexpected structures, patterns, properties or processes known as

emergence. In other words, the self-organized interactions among agents allow for the spontaneous emergence of an intelligible spatial structure without exterior coordination, where there is no hierarchy of command and control and neither internal nor external agents that monitor the process (Heylighen, 2008). Accordingly, supply chain emergence, characterized by the self-organized actions of its constituents within service triads, leads to new properties from the complex interactions among all actors in the system. Thus, emergence produces characteristics that cannot be found in any of the elements of the system. Supply chain emergence can be, therefore, perceived as the most fundamental component of industry 4.0 (Roblek et al., 2016). The technologies of industry 4.0 can be embedded with capabilities of self-awareness, self-optimization and self-configuration, which then enable decentralization of machine decisions (Santos and Martinho, 2020) and, thus, enhance achieving a self-organizing status of companies in supply chains and transmitting the real-time responses (Qin et al., 2016). Similarly, Mrugalska and Wyrwicka (2017) argue that the industry 4.0 technologies can bring decentralized self-organization and, thus, replace the previous traditional hierarchy. In other words, the industry 4.0 technologies provide decentralization of companies, operation staff and even devices that are able to make their own independent decision rather than depend on the centralized decision-making process (Marques et al., 2017). Although overall control is not advisable, Kamble et al. (2018) highlight that embedded control can enhance the components of the system to make independent decisions and, thus, offer modularity and flexibility of the whole emergent structure (Swierczek, 2022).

2.2 Industry 4.0 function

Based on the prerequisites for the proper functioning of Industry 4.0, manufacturers will have to build more flexible manufacturing facilities that will be able to produce both large and small batches of products configured based on more complex customer requirements. Such batches will have to be produced in a variety of modifications and in a relatively short production and, above all, delivery time.

The industry 4.0 project has 4 main assumptions that serve not only to explain it, but also as points of differentiation from the currently established traditional production:

- Vertical connection of the production system.

- Horizontal integration using global value chain networks.
- Flow production throughout the value chain.
- Significant acceleration with smart technologies.

The main idea of industry 4.0 is the so-called smart process. This is one of the biggest changes compared to the currently established conventional production. The basic part of the concept is the creation of the so-called smart factory that should be able to respond seamlessly to changes in demand, better respond to possible failures, and above all, will be able to produce with maximum operational efficiency. All machines and people will be able not only to fully communicate with each other, but above all they will be able to cooperate with each other. The machinery will be able to report problems and define errors precisely. Products equipped with radio frequency identification are able to control their production flow, have an overview of the specific parts used for production or assembly. The product itself thus becomes a proactive part of the production process (Koredova, 2016).

Nowadays, Industry 4.0 is closely tied to the hyperconnected manufacturing chain concept, involving the horizontal integration of manufacturing processes and industrial operations along the value chain (Hopkins, 2021). The ripple effect of Industry 4.0 reaches beyond the manufacturing industry, as the traces of automation and digitalization is visible across many industrial sectors, given birth to controversial concepts such as Healthcare 4.0 and Construction 4.0 (Ghobakhloo, 2021).

3 Automated Guided Vehicles

Automatic Guided Vehicle (AGVs) are self-propelled trolleys that are fully capable of performing handling operations with material, without human operators. Nowadays, it is one of the most developing branches of internal logistics, both in large manufacturing enterprises as well as in various storage units.

3.1 History of AGV

The history of AGVs began around sixty years ago as production facilities started up again after the second world war and the world economy was booming, self-driven robots were part of the dream that humanity had realized of letting machines do our work for us. The rapid development of sensory and regulatory technology as well as early developments in microelectronics paves the way for AGVs (see Figure 2).

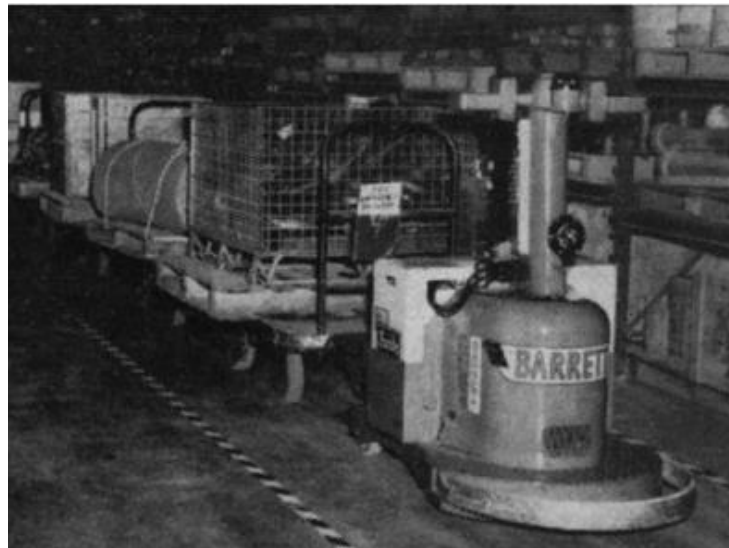

Source: (Ullrich, 2014, p.2)

Figure 2 Barrett AGV

A brief history of AGVs was described by Ulrich (2014):

In Europe, the first representative appeared on the market in 1956 and used as its navigation so-called optical navigation. In this case, the route of the trolley was marked with a color a strip on the floor that was monitored by the trolley using an optical sensor. Since In 1956, Europe took a leading position in the development of AGVs and has maintained this position to this day. Unlike USA and Europe, the first

AGV on the Chinese market was produced only in 1976. Total the design and usability of the AGV is very strongly linked to the development of industrial Technology. The sixty-year history of AGVs can be divided into four eras. These eras can be distinguished by the state of the technology available and emotional attitude towards the systems. They can also be seen as evolutionary stages during which there were only limited technical advancements, but which rather abruptly started into the next era.

The first era of development took place between 1950 and 1970 and took place exclusively on the territory of the United States and Europe. Thanks to the relatively limited quantity Automated technology, the design of the first AGV trucks has evolved quite a bit slowly. The main thing at this time was to come up with a real scenario of using such technology. For this reason, there has been virtually no testing in this era. new technologies in real operation.

The second era took place between 1970 and 1990 and the main topic was computers and support for micro technologies. Thanks to the development of a simple on-board computer and practically daily use of various micro technologies, there has been a boom the development of AGV technology, including practical use in production plants, and especially in the automotive industry. Not long after the beginning of this era, there was also start of development in China.

The third era, which took place between 1990 and 2010, set new production standards, thanks to which began to use a large number of different tracking applications. AGVs have already made full use of electronic navigation together with non-contact sensors. As the main system for controlling and setting up the AGV, it is already a standard computer is used. In the same era, scientific tests are taking place in China the first prototypes deployed in the production environment.

The fourth, and certainly not the last, era is underway, and its beginning occurred in 2010. More and more companies are appearing in the global AGV market, offering what and more independent and, above all, self-sufficient control system. Main the theme of this era of development is undoubtedly the autonomy of guidance (Albrecht, 2022).

3.2 Design and methodolgy of AGV

An automated guided vehicle is a programmable mobile vehicle. The automated guided vehicle is used in industrial application to move material around a

manufacturing facility. The AGV are capable of transportation task fully automated at low expenses. AGV have to make the system automatic by doing the decision on the path selection. This is done through different method frequency selected mode, path selected mode and vision based mode etc. The central processing system of AGV is issue the steering command and speed command. For the pre defined manufacturing environment the map is saved in the AGV memory and control by stationary control unit of warehouse (Vancea and Orha, 2019).

A general AGV system essentially consists of vehicle peripherhal on site component as well as stationary control system. The main components of AGV system are

- Vehicle.
- Guidance Path System.
- Floor Control And Traffic Management System.

The faultless interaction of these components ensuring the efficiency of working plant. AGV will guarantee a safe performance of that care of personal as well as the load and surrounding (Das, Pasan, 2016).

3.3 Vehicle

It is the central element of an AGV as they perform the actual transportation activities. The vehicle is individually designed for its task and the surrounding environment. According to the environment AGV can be divided into 3 categories (Das, Pasan, 2016):

- Driverless train (see Figure 3).
- Pallet truck (see Figure 4).
- Unit load carrier (see Figure 5).



Figure 3 Driverless train



Source: (Vancea and Orha, 2019)

Figure 4 Pallet truck AGV



Source: (TECH design, 2021)

Figure 5 Unit load carrier

3.4 Oriental way

The vehicle guidance system is the method by which AGV are defined and vehicles are controlled to follow the path ways. AGV use the guidance path system chooses a path based on programmed path. It uses the measurement taken from the sensor and compares them to value given to them by programmer. When AGV approaches a decision point if only has to decide whether follow the path. Most commonly used guidance technologies in AGV are (Das, Pasan, 2016):

1. Landmarked based navigation.
2. Behaviors based navigation.
3. Vision based navigation.

3.4.1 Landmark based navigaton

The markup-based navigation technique is based on their identification and subsequent recognition, distinct features of an object in the environment that may be previously known or dynamically extracted. The various technologies used in navigation based on land marking are incorporated into a guided wire and tape type system (line tracking robot). In the wire-guided method, the wires are placed in a small channel inside the workspace floor. AGV senses the low-frequency current in the 1-15 kHz range for guidance vehicle (Das, Pasan, 2016). The guide band or the next AGV line are robots that operate with the vehicle that detects and follows a

predefined line drawn on the work floor. To track the line drawn on the floor, the robot used an array sensor that sends the signal to the robot's control system. According to the input signal, the central system manipulates the robot to remain in operation while constantly correcting the wrong movements of the robot through a feedback mechanism thus forming a simple system of efficient loops (Vancea and Orha, 2019).

Figure 6 is an example how the landmark based navigation system works.

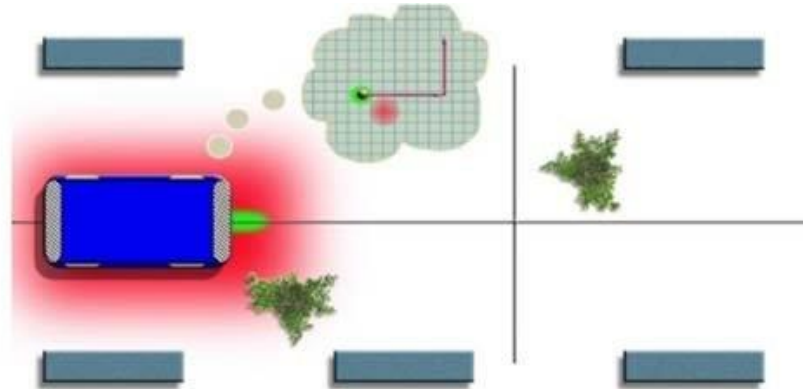

Source: (Vancea and Orha, 2019)

Figure 6 Landmark based navigation

3.4.2 Behaviour based navigation

This type of pattern was credited to be suitable unstructured environment as they can incorporate with large number of sensor. The behaviors of the best navigation technique also require high computational power, neural network, genetic algorithm and several combinations of them. Behavior navigation system uses laser range navigation technology for mobility. Laser range navigation technology is used to determine the vehicle position and navigate the system. Lotter (2018) discusses planner scanning technique to improve precision and accuracy. An important step considering laser navigation is to achieve independence of reflection marker, reduced installation cost which will allow overcoming the limitation of the current triangular system developed more than ten years ago (Das, Pasan, 2016).

3.4.3 Vision based system

The optical navigation system monitors the color strip glued to the floor, reflective coating or reflective layer. The coloured strip shall be clearly recognisable from the surrounding floor. Optical sensor located in the front of the unmanned vehicle, using this navigation, uses special edge detection algorithms, with the help of which calculation of guide signals for the control motor. Thanks to modern technology, the AGV is equipped with this system, capable of tracking even the color strip that appears large signs of damage. Optical navigation is among the cheapest and at the same time the most affordable type of navigation. The guide belts are easily recognizable and can be to cross them without any problems. In the event of a breach of the guide belt, its possible repair and gluing technically and financially undemanding. The same applies to the case of implementation of changes or completely new routes.

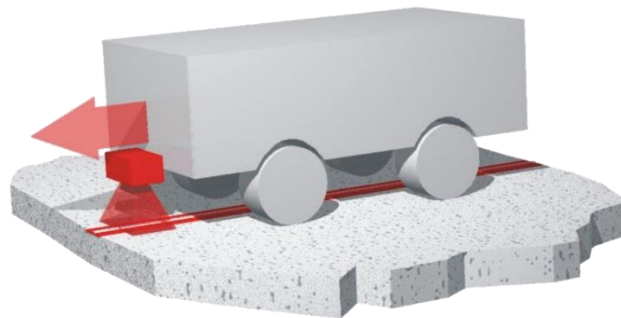

Source: (Vancea and Orha, 2019)

Figure 7 Vision based system

3.5 Safety system

An absolutely indispensable part of every type of AGV must be a safety system. It must be designed in such a way that no endangering or even injuring other employees. Most AGVs are so therefore equipped with a combination of passive bumpers together with active laser device. The laser scanner checks the vehicle circumference throughout operation and detection of any obstacle at a pre-set distance from the AGV first slow down. If the deceleration does not remove the obstacle, the AGV shall interrupt its traffic. Passive bumper made of compressible material, equipped with an integrated the sensor works in much the same way. The only difference is that the device stops at direct contact with the obstacle. Thanks to

the deployment of the AGV, to radically reduce injuries caused by handling equipment. The safety standards of AGVs are regulated by the ANSI standard in the USA B56.5 and Europe EN 1525.



Source: (SICK, 2020)

Figure 8 Safety systems

3.6 Application

Autonomy is the key factor for using AVG in different field. It will achieve high degree of accuracy and precision which will lead to minimize the error of the complete system and improved lead time. Flexibility is the key issue which will help AGV to be popular from other material handling system. The AGV is not only used inside the production house but also increase its premises to other service sectors (Vancea and Orha 2019):

- Material handling.
- Warehouse.
- Commercial.
- Energy and defense.
- Medical service.
- Personal care.

4.1 ŠKODA AUTO internal logistics

The movement of materials inside the assembly hall is monitored and developed by internal logistics department. In the M1 assembly hall the team deals with improving and introducing current and old technologies for the material movement in the assembly hall. They are responsible for the sequences and material distribution in the assembly hall. The department is divided into two parts, one is responsible for internal logistics technologies and the other one is responsible for inventories, material flow etc. See Figure 10 for the detail organization chart of the internal logistics.

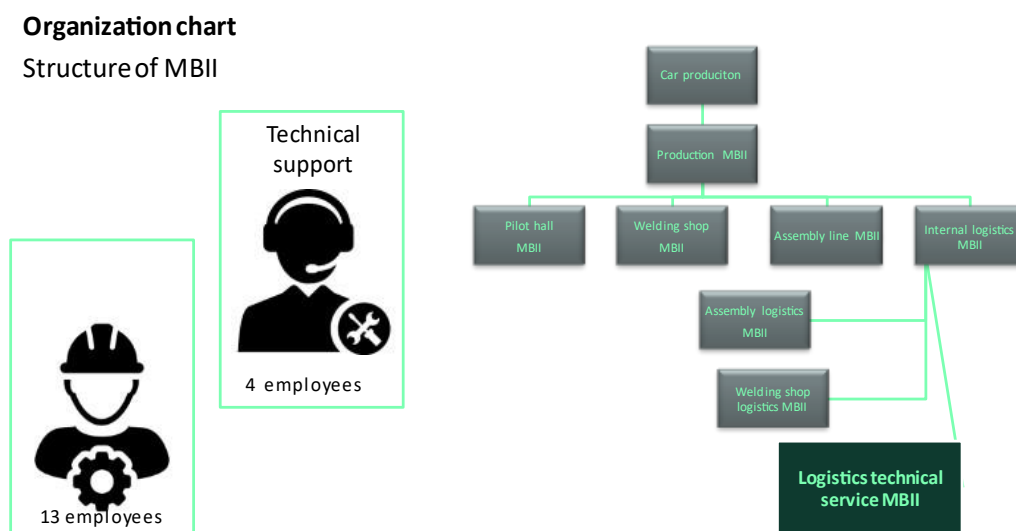

Figure 10 Organization chart of ŠA internal logistics

4.2 M1 assembly hall

ŠA plant in Mlada Boleslav has two assembly halls M1 and M13 to produce its line of cars. M1 hall is the oldest one in ŠA dating back since the beginning of the company. The M1 assembly hall has enough infrastructure to make continuous assembly of cars for the models Fabia, Kamiq and Scala and they make up to 1,300 cars each day. This is only possible with the support of intricate internal logistical operations from delivering materials to the assembly line on time and making sure the assembly line runs without any hitch since stopping the assembly line for even a minute led to one less car produced.

The sequences are handled by a main system which tells the workers when and what part is needed in the assembly line. The system is connected with various

infrastructures like pick by light, pick by point etc. The parts are mainly delivered in KLT, GLT boxes and picking carts. KLT boxes (see Figure 11) mainly consists of small consumable parts and they are delivered from the main warehouse by trolleys to the assembly line according to the needs. GLT boxes (see Figure 12) are delivered by trucks, and they mostly contain big parts needed for the assembly of the cars. Simultaneously the frames of the cars are delivered by specific trolleys specially designed to deliver the certain parts only (see Figure 13). The main parts for example side mirrors, windshield etc, are delivered by sequence trolley (see Figure 14) where the worker picks the part according to the sequence and assemble it.

The M1 assembly hall consist of 9 warehouses and 12 lanes where the material is being stored and delivered to the assembly line. To store and deliver the materials efficiently there are various technologies used which is discussed below.



Figure 11 KLT box



Figure 12 GLT box

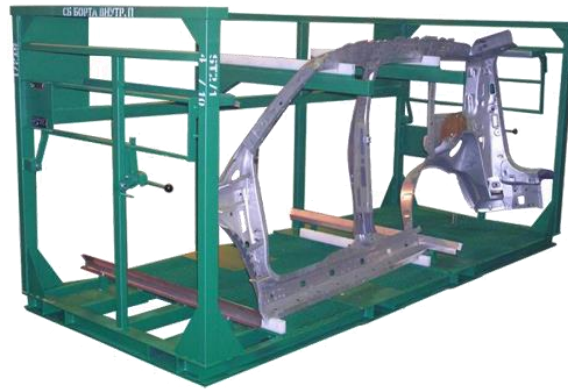

Figure 13 Specific pallet



Figure 14 Sequence trolley

4.2.1 Picking technologies

There are various technology systems used in the assembly hall for the timely delivery of the materials to the assembly line. They are:

- **Pick by light:** Pick by light system is exactly as it sounds, when the worker scans for the part, the place where the part needs to pick up or placed lights up and the worker puts the part in the correct place. This ensures that there is no mistake in placing the parts nor picking them, the worker doesn't need to think or search for the shelf or part which greatly reduces the time and error (see Figure 15).



Figure 15 Pick by light

- **Pick by frame:** Pick by frame is similar to pick by light but it's mainly used for accessories for the cars, the worker picks up the accessories by the sequence indicated by the light on the frame, then the worker bags it and puts it in the sequential trolley where then it's delivered by AGV to the assembly line (see Figure 16).



Figure 16 Pick by frame

- **Pick by point:** Pick by point is where there is a laser pointing at the respective parts according to the sequence in the warehouse and the worker puts it in the sequential trolley which is then delivered by AGV or electric tuggers (see Figure 17).



Figure 17 Pick by point

- **Pick by watch:** In this system the KLT box which needs to be delivered is indicated on the PDA strapped on the workers arm, the worker just goes to the indicated shelf and then place the KLT box at the correct location. This ensures that the box is placed in the correct place and minimizes the error to the very minimum (see Figure 18).



Figure 18 Pick by watch

4.3 Automated guided vehicles

AGVs are a huge part of the internal logistics in ŠA. There are over 104 AGVs in Mlada Boleslav plant and 49 in M1 assembly hall working in the production line to deliver materials on time. The AGVs are programmed to deliver the material on time and has its route and layout designed so that there is minimal error in the working. The AGVs are necessary to reduce human interaction in delivering materials and

eliminating human error in the process. The company which currently operates and produces the AGVs for ŠA is Asseco CEIT, a.s. which is headquartered in Slovakia. There are two types of AGVs used in the M1 assembly hall, the tugger AGV (see Figure 19) and the unit load AGV (see Figure 20). In Figure 21 we can see the AGVs lined up in the AGV terminal located in M1 hall.



Source: (CEIT, 2018)

Figure 19 Tugger AGV



Source: (CEIT, 2020)

Figure 20 Unit load AGV



Figure 21 AGV terminal

4.4 Electric tuggers

Even though there is a huge infrastructure of automated delivery of materials, lot of materials are delivered manually through tuggers (see Figure 22) mainly for the parts which are too heavy or need human intervention in delivering the materials. The major parts which are delivered are through the tuggers are the KLT boxes which contain small parts such as nuts and bolts to assembly line.



Source: (STILL, 2018)

Figure 22 Electric tugger

4.5 Forklifts

Human operated forklifts are essential to deliver the materials delivered by trucks to the warehouse. The materials are usually delivered in the GLT boxes according to the Volkswagen standards and the materials are picked up by the workers and delivered it to the warehouse. These are usually done by electric forklifts (see Figure 23 and Figure 24).



Source: (STILL, 2018)

Figure 23 Heavy electric forklift



Source: (STILL, 2018)

Figure 24 Light electric forklift

5 Analysis of the current status

There are 60 sequences which are delivered to the assembly line in the M1 assembly hall through different methods like manually driven electric tuggers, by hand and AGV's. The main idea is to fully automatize all the sequences which are being delivered in the assembly line and to use the new type of AGV which is the unit load AGV (see Figure 20) instead of the tugger AGV (see Figure 19) which is currently being used to deliver 32 sequences. The problem behind the use of tugger AGV's is the picking cart needs to be loaded and unloaded manually by the worker every time. This results in wastage of time and unnecessary hold up in the aisles where the traffic must wait until the worker is finished with the loading and unloading of the picking cart to the tugger AGV. In case of unit load AGV, the AGV can be completely programmed to deliver the picking cart to the required spot in the assembly line without any human interaction. This also ensures minimal errors, less traffic in the aisle and less wasted time on the handling of the picking cart.

While also using the unit load AGV for the picking cart handling it is necessary to follow certain guidelines in the aisle where the sequence carts are being transported. Since the aisles of the M1 assembly hall (see Figure 25) is not uniform and has bottlenecks and narrow paths it is necessary to map out the width of the aisles and identify the points or the route where there is a problem in the route of the AGV's and to increase passability in the aisles.

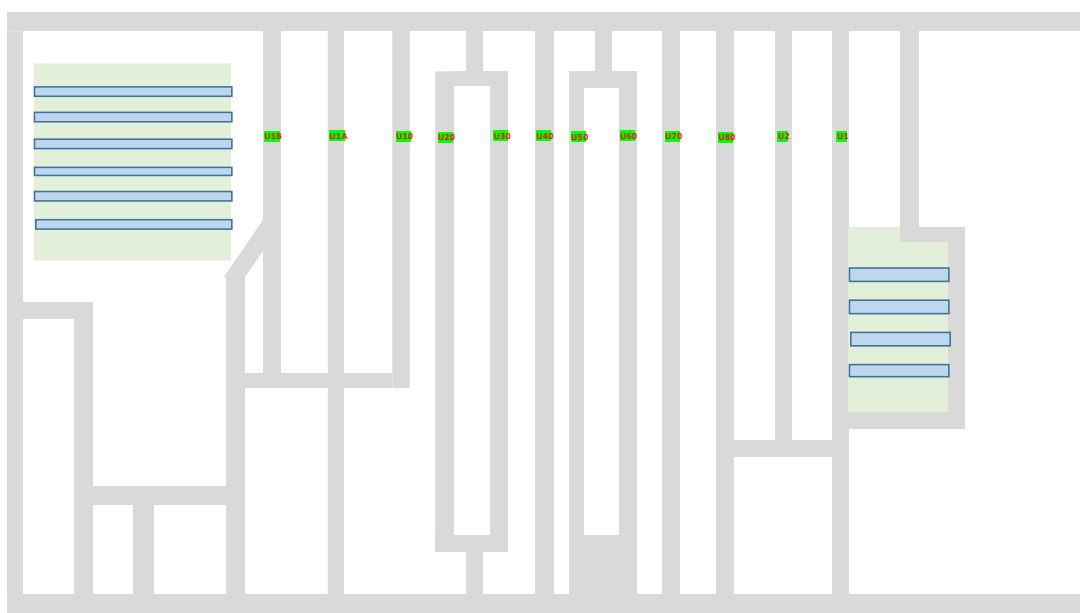

Figure 25 Map of aisles in M1 assembly hall

5.1 Problem definition

Most of the picking carts are rectangular in shape and most of the time the picking cart are loaded in the minimum dimension which is necessary to increase the passability in the aisles. However, a significant percentage of these carts needs to be placed in the lengthwise in the assembly line. This requires change in orientation of the picking carts in the assembly line. In current scenario in the use of tigger AGV the picking carts are turned manually and placed in the assembly line. The orientation is very important in the assembly line since the worker needs to have easy access to the parts since they can't waste time in going around the cart and picking it form the other side. See Figure 26 and Figure 27 for better understanding of the orientation of the picking cart.

Since the main goal is to fully automatize the delivery of the picking carts using the unit load AGV the picking carts need to be placed in the current orientation in the assembly line, so a solution for this issue must be used to avoid this problem.



Figure 26 Picking cart orientation in length wise



Figure 27 Picking cart orientation in width wise

5.2 Analysis of the aisles

The width of the aisle is very important factor in the whole analysis and the usage of unit load AGVs for the picking cart handling. The 60 sequences and the delivery routes were mapped out using the map of the M1 assembly hall. The main aim of this analysis was to increase the passability in the aisles and to avoid the bottlenecks and the narrow routes in the M1 assembly hall for the AGV routes.

The whole M1 assembly hall was mapped out and the width of the aisles were measured out using a measurement device. Figure 28 shows the measurement of the width of the aisles after it was measured.

in some cases the width of the aisle is 5 m where in some cases the width is 2.5 m. The dimensions of the width were measured between two borders of the assembly line or aisles, this includes the walking path in the aisles (see Figure 29).



Figure 29 Representation of the measurement taken

5.3 Analysis of the sequences

There are 60 sequences overall where the materials are being delivered through different means like AGV, tugger and by hand. The picking cart route was mapped out in the layout of the M1 assembly hall from the start to finish according to the delivery route from the warehouse or the loading point to the delivery location in the assembly line. Each of the picking carts were measured for its length and width and tabulated. See Appendix 1 for the table. The table also contains the orientation in which the picking cart needs to be placed in the assembly line. This is very important because the orientation needs to be changed using some solutions since most of the picking carts are transported in the smallest dimension that is the width wise. The routes of the sequences were later applied on the map (see Figure 28) with the dimension of the aisles and the bottlenecks which was later used to determine the narrowest locations the AGV will be travelling.

5.3.1 Analysis by loading concept

The driving concept is how the picking cart will be placed on the unit load AGV. From Appendix 1 we can see that around 75% of the picking cart needs to be transported

in width which in most case the minimum dimension. We need to load the cart in the minimum dimension possible to increase the passability in the streets of the assembly hall. We are using two loading concepts for the picking carts:

- Direct concept.
- Narrow concept.

The direct concept is the natural dimension used to be loaded on to the AGV, it doesn't necessarily mean that it's the widest dimension. The dimension mainly relies on how the AGV is needed to be situated in the assembly line, that is in the lengthwise or the width wise. Applying the direct concept doesn't require any investment but during the analysis we see that it is not necessarily the best way for loading the picking carts since some carts dimension is too big and can completely block the way of the aisle.

The narrow concept is where the picking cart is loaded in the minimum dimension on to the AGV. This concept always uses the minimum dimension and it's the best option since it maximizes the passability of the AGV in the assembly hall. In cases where the placement of the picking cart in the assembly line is different that loading of the carts, we must find solutions for the automatic turning of the picking carts in the assembly line which needs organizational resources to implement and succeed. The analysis was done in two routes, the shortest or natural route for the AGV and the alternate route where we must design an alternative route to avoid the bottlenecks and constricted routes in the assembly line. The width of the narrowest part of the aisle is taken into consideration since it's the most crucial part of the route.

The results of the evaluation were categorized in 3 different results according to the narrowest dimension entered:

- OK – passable.
- Problem – passable without respecting the legal reserves.
- Big problem – physically impassable.

The results are calculated in the following manner:

Reserve width (R) = 800 mm

Width of the driving concept (W)

Width of the narrowest aisle it goes through (n)

The equation if the result should be “OK” is:

$$W \leq \frac{(n-R)}{2} \quad (1)$$

The equation if the result should be “Problem” is:

$$W \leq \frac{n}{2} \quad (2)$$

The equation if the result should be “Big Problem” is:

$$W > \frac{n}{2} \quad (3)$$

We get the results when we satisfy these conditions.

For example, in Gearbox:

$$R = 800 \text{ mm}$$

$$W = 1,220 \text{ mm}$$

$$n = 4,000 \text{ mm}$$

$$(4,000 - 800)/2 = 1,600 \text{ mm}$$

$$1,220 \text{ mm} < 1,600 \text{ mm}$$

So, the result is OK.

When the result is OK for the wide concept and the narrow concept, there is no additional measures to be taken for the picking cart where the position of the assembly line aligns with the loading of the picking cart. If the result shows that there is Problem in the route we need to check if we can load the cart in the narrow concept and use solutions to change the orientation of the cart in the assembly line. When the result shows Big Problem, we need implement solutions such as to change the design of the picking cart or to implement one way traffic in the streets of the assembly line. See Figure 30 for a visual understanding of how the width of the picking cart affects the evaluation.

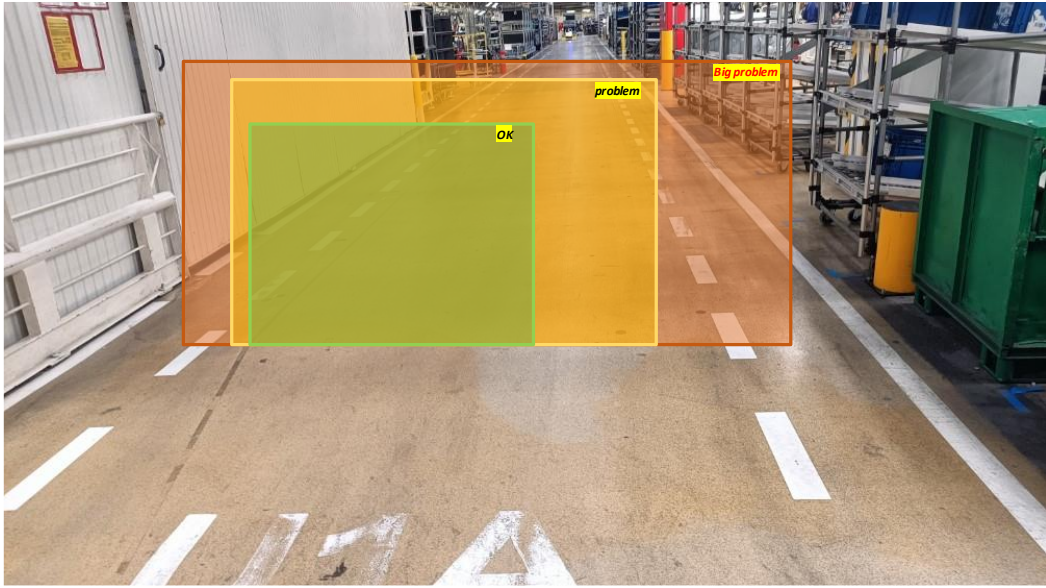

Figure 30 Picking cart size representation

6 Solutions and results

With the analysis of the AGV routes we were able to identify the routes which has problem in the specific routes. The results were identified with three different types of analysis. In the cases where we load the cart using the narrow concept, we need to come up with solutions to change the orientation of the picking cart. The solutions need to be weighted and a best solution needs to be picked out for most of the picking carts. In some cases where the solution cannot be applied, we need to pick out the next best solution for the problem. We will discuss the solutions and the results of the analysis further.

6.1 Results on the analysis of the sequences

The result of the analysis is in the Appendix 2. We used two driving concepts where the cart is loaded in the “direct” concept and the “narrow” concept. The results were categorized in 3 different results where each result and the meaning were already discussed before. The results were observed for the two types of routes the natural or shortest route and the alternative route. In most cases we were not able to use the alternative route as the position of the material in the assembly line made it impossible to bypass the narrowest alley in the assembly line. One such example is shown in Figure 31 in which the joint shaft left is situated in the narrow alley with 3 m as the narrowest part.

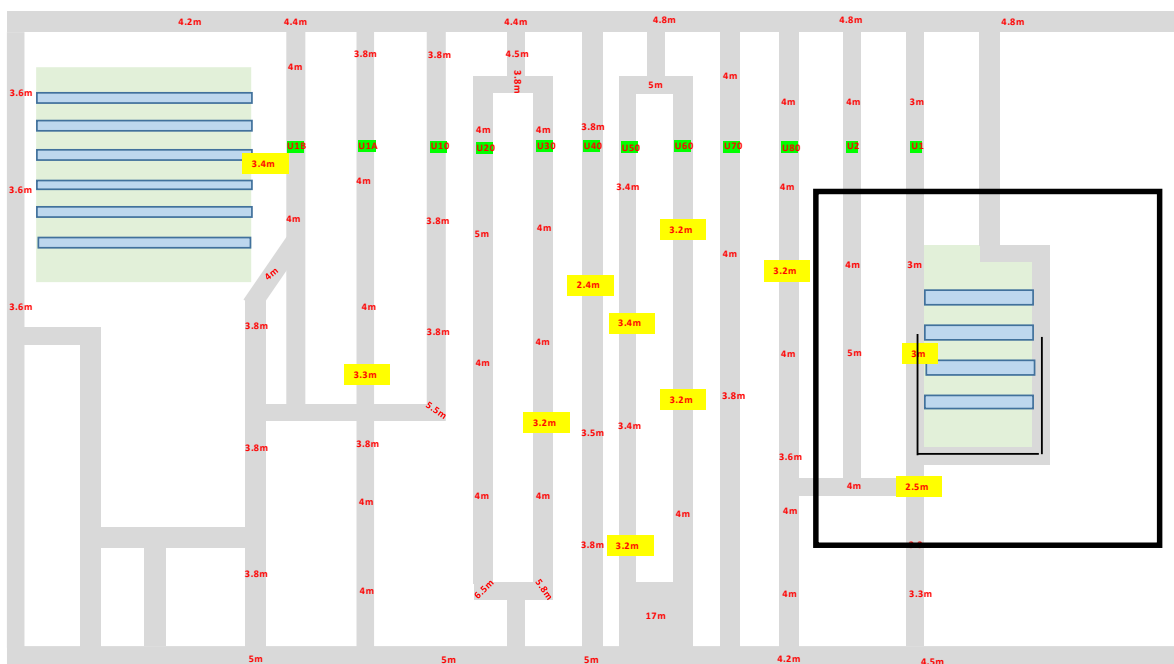

Figure 31 Representation of the route in a narrow aisle

In such cases the alternate route cannot be used and we need to use some solutions to either use the “narrow” loading concept or change the picking cart design. The results of the analysis according to the three different categories is tabulated and the solution is commented (see Table 2) below.

Table 2 Evaluation and suggested solution

The "direct" concept	The "narrow" concept	Solution
38x OK	15x OK width	It does not require, because already currently the front side when loading is the width
	23x OK length	Changing the orientation of the cart during loading
10x Problem	5x OK	<ul style="list-style-type: none"> • Loading using the "narrow" concept and implement one of the technical solutions • Loading using the "direct" concept, but manage the traffic in bottlenecks
	5x Problem	<ul style="list-style-type: none"> • Change the design of the cart • Loading using the "direct" concept, but manage the traffic in bottlenecks • For Spoilers, the solution is an alternative route, in which the problem with traffic does not arise in both concepts
12x Big problem	6x OK	<ul style="list-style-type: none"> • Loading using the "narrow" concept and implement one of the technical solutions • Loading using the "direct" concept, but introduce one-way traffic on entire aisles

	5x Problem	<ul style="list-style-type: none"> • Change the design of the cart • Loading using the "narrow" concept, implement one of the remaining technical solutions and at the same time manage the traffic in bottlenecks • With air conditioning tubes, thanks to an alternative route, it is possible to loading using the "narrow" concept and implement one of the technical solutions • Loading using the "direct" concept, but introduce one-way traffic on entire aisles
	1x Big problem	<ul style="list-style-type: none"> • Change the design of the cart • Loading using the "direct" concept, but introduce one-way traffic on entire aisles

We deduced that in 38 of sequence routes where it is OK to use both the concepts and not have any problems. In 10 sequence routes the “direct” concept cannot be used as it shows Problem but in 5 of those routes, we can use the “narrow” concept and use some technical solution to rotate in the assembly line according to the orientation of the cart needed. In 5 of those routes, we either need change the dimension of the cart as per needed or use the “direct” concept but need to manage the traffic in the aisle. For the spoilers we have created an alternative route where we can completely avoid the bottlenecks and the narrowest aisle. This doesn’t need any extra solutions or managerial costs associated.

In 12 sequence we found Big problem in routes which uses the “direct” concept, in that we found that 6 routes are OK to be loaded in the “narrow” concept and use some solution to turn the cart in the assembly line according to the orientation needed. In 6 of those “narrow” concepts, it results in Problem so we either change the dimension of the picking cart or we implement the “narrow” concept and manage traffic in the alley. For the air conditioning tubes we were able to come up with an alternative route where it is not Problem to use the “narrow” concept and then

implement one of the technical solutions to change the orientation of the cart in the assembly line. In one of the routes, we didn't find an alternative route and all the concept results in Big problem where it is impassable in the aisle we have no choice than to completely re-design the picking cart into an dimension where it is suitable to pass safely.

We consider using the "direct" concept in some cases and redirect or use one way traffic which could be a solution, but it is not recommended since it could increase traffic and delivery time of materials throughout the assembly hall which can impact the production.

6.1.1 Alternative routes

With the analysis we can use alternative routes for some sequences. In case of alternative routes, it is not necessary to have extra solutions where it is OK for both driving concept which is the case in spoilers. If the result is OK only in the narrow driving concept we use the alternative route and some technical solutions for the automatic orientation in the assembly hall. The alternative routes are limited since in most of the cases the delivery location of the parts is located directly in the narrow aisle which makes it impossible to come up with an alternative route. We also note that the alternative route needs to be not overly long which will delay the delivery of materials to the assembly line. We were able to sketch an alternative route for the following routes:

- spoilers,
- air conditioning tubes.

We can see the original route of spoiler in Figure 32.

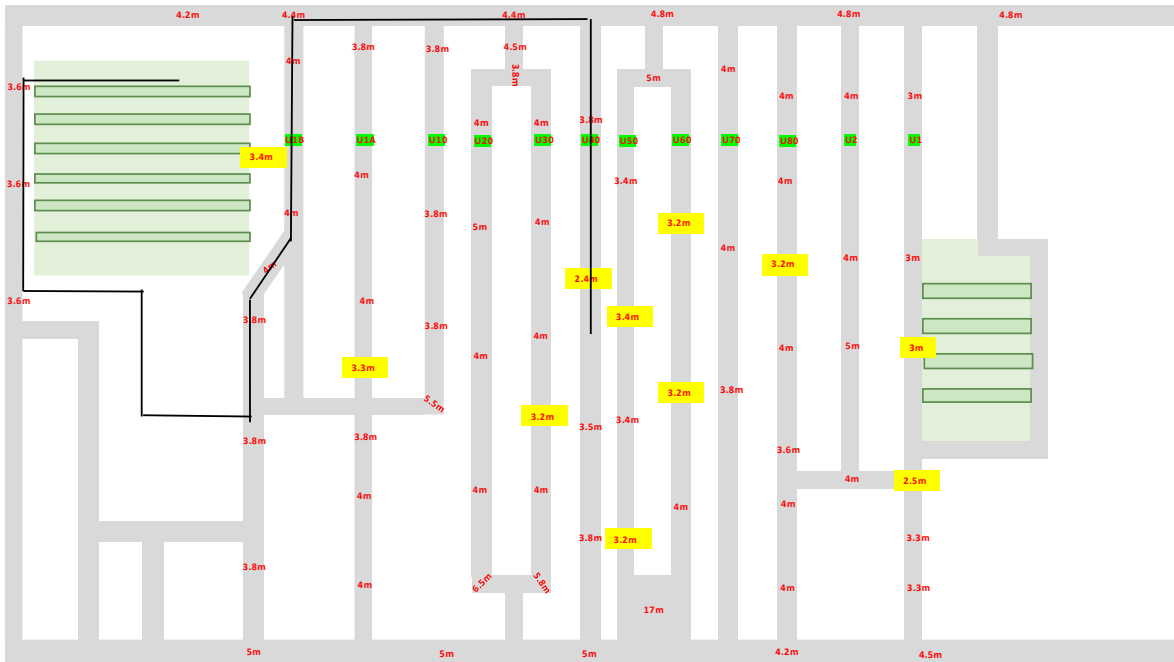

Figure 34 Original route of air conditioning tubes

We can see the alternate route for the air conditioning tube in Figure 35.

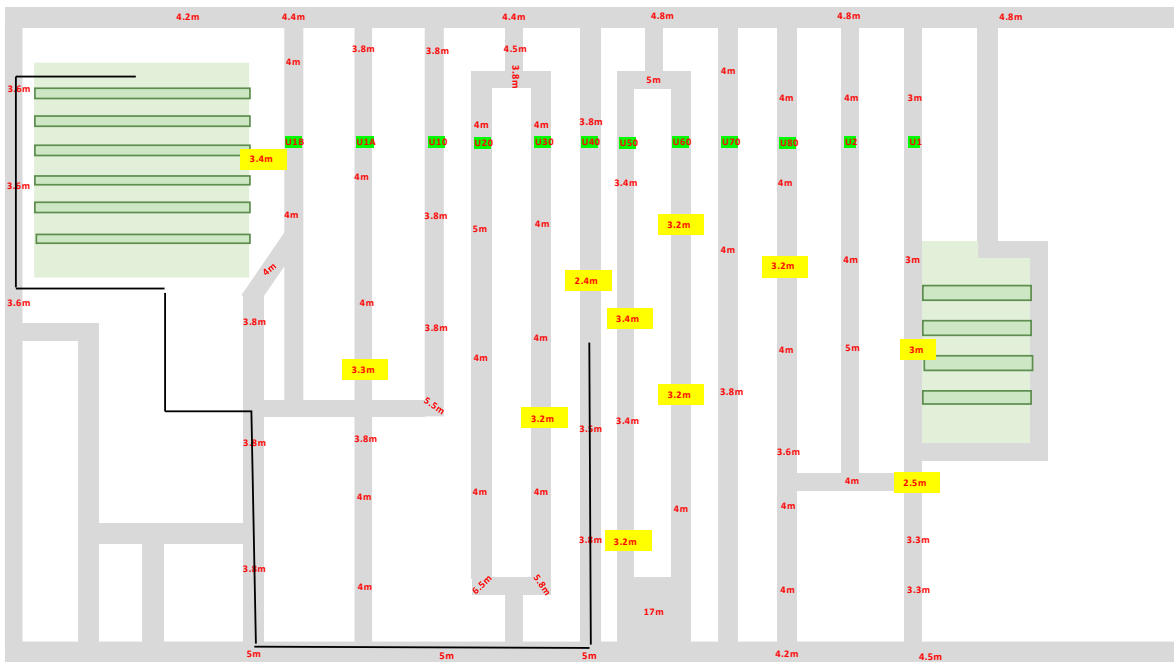

Figure 35 Alternative route of air conditioning tubes

6.2 Technical solutions

As we have already figured out and analyzed the routes for the AGV's we found out that around 21 of the picking carts needs to be placed lengthwise and the orientation needed to be changed which has been mentioned in Table 2. We need to come up

with some technical solutions for automatic changing of the orientation in front of the assembly line. We need to evaluate multiple options since single option cannot be used for all the picking carts since some carts are too big to handle.

6.2.1 Suggested solutions

There are technical solutions as follows:

- **Turning the AGV under the picking cart:** The picking cart is transported in the “narrow” concept, the AGV places the cart in front of the assembly line, rotates 90° under it, it lifts the cart and inserts into the line. This solution requires a change in the safety zone of the AGV and slight increase in the handling operation (see Figure 36).

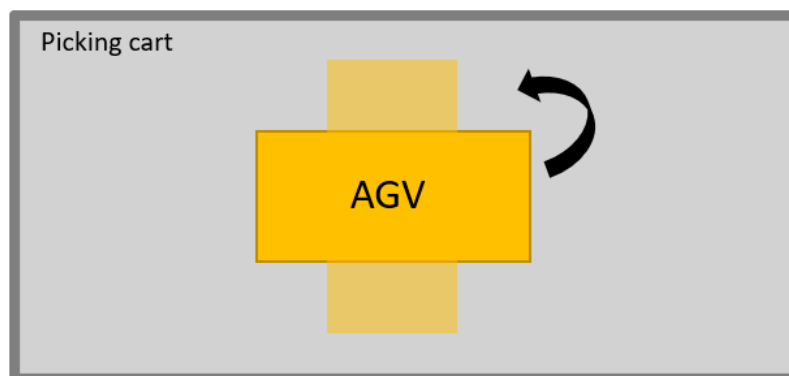

Figure 36 Turning of AGV under the picking cart

- **Changing the picking cart design:** Reducing the width and length of the cart to accommodate the limits in the aisles. This means there is a possibility it will decrease the number of parts delivered in the cart or design in a more efficient way so that all the parts fit in the re-designed cart. In some cases where the cart is too big or in a dimension where it doesn't meet the criteria the only option is to re-design the cart completely to fit in to the standards. As shown in Figures 37 and 38 the cart is modified in its length but increased in height, it's one of an examples on how to deal with certain scenarios. The advantage is we can design in a way it fits the standards and ease of use in

the AGVs, the main disadvantage would be the time and money wasted to design and implement a complete new re-designed cart.

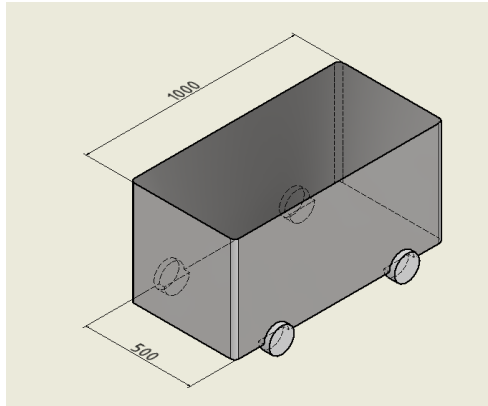

Figure 37 Model of a picking cart

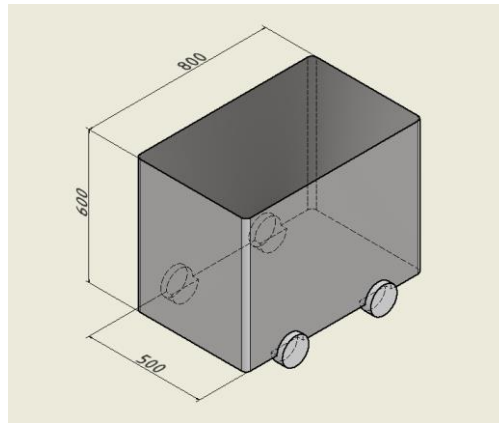

Figure 38 Re-designed picking cart

- **AGV with omni wheels:** This type of AGV is not widely developed yet as the features are still in experimental stage. With multiple manufacturers testing more of this technology its highly likely this technology will be available in the near future. This is highly advantageous since the AGV can move in any direction it wants. This is very helpful to maneuver in tight spots and transport the cart in any position needed (see Figure 39).



Figure 39 AGV with omni wheels

- **AGV with rotating lifting module:** The cart is transported in the “narrow” concept, in front of the line the lifting module rotates the cart to its length and then goes to the line. In this case the aisle permeability will be greatly reduced during the shift in front of the line. The cart can be rotated to the needed dimension and inserted into the assembly line. The disadvantage is the higher purchase price of the AGV in the current market. An example of such AGV is shown in Figure 40.

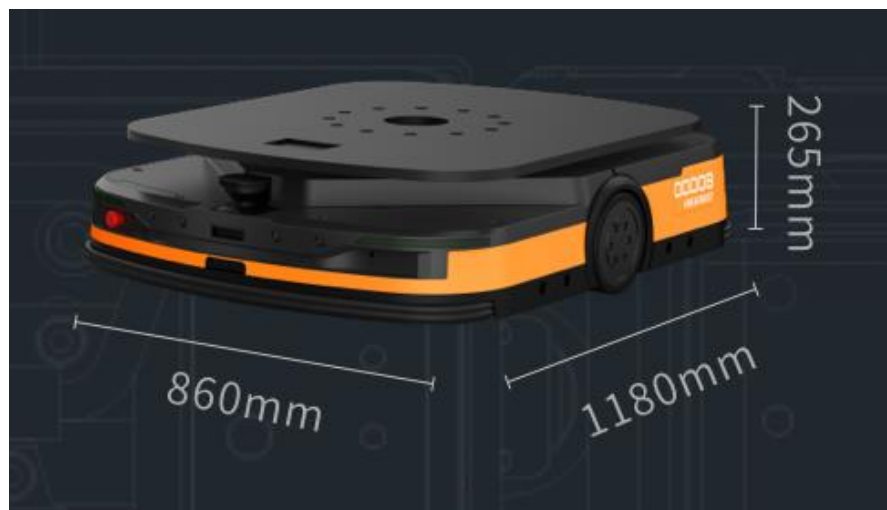

Source: (Hikrobotiks, 2020)

Figure 40 AGV with rotating lifting module

- **Automatic carousel in the assembly line:** The picking cart has an automatic carousel, and it automatically rotates for the required orientation in the assembly line. The disadvantage is the need to develop the carousel (financial and time-consuming) and the occupation of space at the assembly line, at the same time, increased safety risks of the rotating carousel and additional costs for its operation can be assumed.
- **Two-step turn AGV cart handling:** The picking cart is transported in the “narrow” concept, the AGV places the cart in front of the assembly line, the AGV moves in the front turns around and comes to the length side if the cart goes underneath the cart and pushes it to the assembly line. The advantage of this method is the current generation of unit load AGV can be used to do this task, assuming there is enough place in the streets of the assembly line. The disadvantage is the too long time required for handling and the associated temporary occupation of the space in front of the line and blocking of the traffic (see Figure 41).

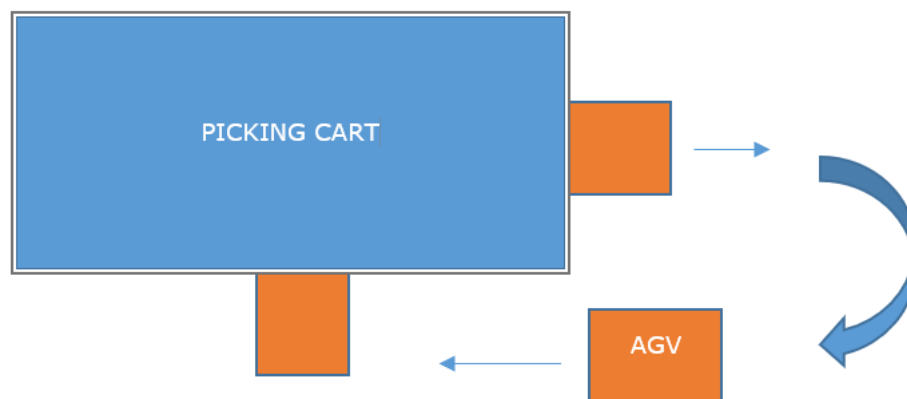

Figure 41 Representation of AGV in two-step turning process

6.2.2 Evaluation of the technical solutions

We need to evaluate the solutions to find out which is the best solution to apply while considering multiple criteria that affects the use of the solutions and the factors which affect the implementation in ŠA assembly hall.

These are the evaluation criteria used to evaluate the solutions:

- Market availability – expresses the necessity of developing the given solution.
- Safety – expresses the level of safety risks associated with the given solution.

- Investment costs – expresses the investment requirement of the given solution.
- Operating costs – expresses the amount of costs associated with operating the given solution.
- Handling time – expresses the time of handling operations for the given solution and thus the degree of effective use of AGV.
- Space requirements – expresses the needs of the given solution on the space at the assembly line (including short-term blocking of the aisle in front of the line).
- Implementation time – expresses the time required for the implementation of the given solution.

We use Saaty’s method for multiple criteria decision making to determine the weight of the criteria. Table 3 shows the weightage calculated using Saaty’s method using Superdecision software (See Appendix 3).

Table 3 Weightage for individual criteria

Criteria	Weight (%)
Market availability	27
Safety	22
Investment costs	17
Operating costs	12
Handling time	9
Space requirements	7
Implementation time	6

Using this method, we have found that market availability is the main criterion we need to evaluate the technical solutions. Since the availability in the market determines how quickly we can implement the solution in the assembly hall.

We use the Likert scale where 1 is the lowest value and 5 being the best value to evaluate the impact on the given technical solution. See the Table 4 below for the scores given in each criterion.

Table 4 Multiple criteria evaluation for the technical solutions

Technical solution	Market availability (27%)	Safety (22%)	Investment costs (17%)	Operating costs (12%)	Handling time (9%)	Space requirements (7%)	Implementation time (6%)
Turning the AGV under the SQ carts	5	2	5	5	4	5	4
Two-stage handling in front of the line	5	3	5	4	2	3	5
Changing the design of the cart	3	5	3	5	5	5	3
FTS rotating lifting module	4	4	3	4	5	4	5
FTS with omni chassis	1	5	1	3	5	5	5
Automatic carousel at the line	3	3	2	3	5	2	2

The evaluation was carried out on the basis of an expert assessment by the authors of the thesis and ŠAVŠ experts. The final score is calculated using the weighted average method (see Table 5).

Table 5 Final score for the technical solutions

Technical solution	Final score
Turning the AGV under the SQ carts	4.19
Two-stage handling in front of the line	4.03
Changing the design of the cart	4
AGV rotating lifting module	3.98

AGV with omni wheels	3
Automatic carousel at the line	2.88

Using the multiple criteria decision making we have concluded that the best technical solution for automatic change in the orientation of the picking carts in the assembly line is **turning the AGV under the picking cart**. The only disadvantage in we need to change the safety area of the AGV, so it doesn't pick up the legs of the cart as an obstacle. In Figure 42 we can see the representation of the safety area of the AGV. It also needs a bit more extra time for the turning and handling of the picking cart.

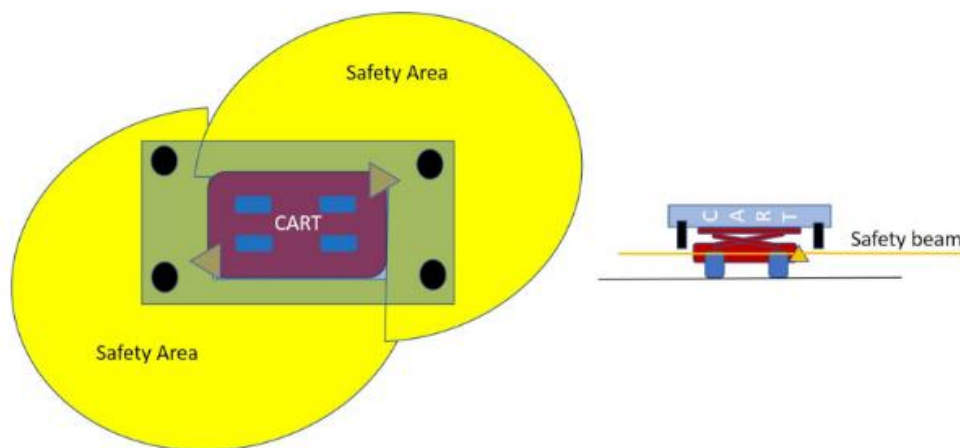

Source: (AGV network, 2019)

Figure 42 Safety area of the AGV

Even though it is the best solution we cannot use the solution for all the problems as we have evaluated in Table 1 there are carts which are too big for the aisles of the assembly hall and the only solution is changing the design of the cart. The disadvantage of changing the cart is takes some time to develop the model and the new design needs to fit the norms of ŠA and the number of parts in the picking cart needs to remain the same.

One additional solution to the carts which has the result Problem is to use the narrower dimension and make the aisle one way and manage the traffic. The disadvantage is that it can cause traffic jams in other aisles because the traffic has

been re-routed. This needs to be sorted out by the management of ŠA and weigh in the pros and cons of either changing the cart design or make one-way traffic in the aisles which has narrow parts.

6.3 Individual results

The picking carts, which can use the “narrow” concept and technical solution **turning the AGV under the picking cart** are:

- joint shaft L,
- alternator,
- airbag + steering wheel,
- B pillar,
- front axle,
- pedals and brake boosters,
- air conditioning tubes (thanks to alternative route),
- AB pillar,
- CD column,
- CW covers,
- window launcher bar,
- top rails.

The picking carts where the solution can be: (1) change the picking cart design or (2) use the “direct” concept, but manage the traffic in bottlenecks, are:

- luggage compartment equipment,
- extra equipment,
- KIT ceiling,
- rear axles.

The picking carts where the solution can be: (1) change the picking cart design or (2) use the “narrow” concept and implement one of the remaining technical solutions and at the same time manage the traffic in bottlenecks or (3) use the “direct” concept, but introduce one-way traffic on entire aisles, are:

- air filter,
- transverse wall damping,
- wheel heads LS/RS.

- Bumpers

The picking cart where the only solution is to change the design of the cart is:

- side lining (Guliver).

Thus, we have identified the best solution for the carts which has problem with the use of unit load AGV and also suggested alternative methods where the solutions cannot be applied.

Conclusion

The purpose of this diploma thesis was to evaluate the possibilities of using the unit load AGV for picking cart handling in the M1 assembly hall in ŠA for the production of passenger cars. The thesis was carried out individually and under the guidance of the internal logistics department in ŠA. The data was provided by the company to evaluate the picking carts and its transition to the unit load AGV.

The first part of the thesis described the theoretical part of the subject that the topic is dealing with. In detail about the supply chain and the role of internal logistics in the supply chain. The history of AGV and the advancement of the technology in the current world where was also investigated the industry 4.0 which is the main force which move the AGV technology faster than ever with the rise in globalization and the increase in supply chain and automation.

The second part consist of information about the company ŠA, ŠA internal logistics and its structure. It also goes into detail about the M1 assembly hall and the various logistics technologies and the internal structure of them. Then next part analyses the current problem where there are 60 sequences currently in the M1 assembly hall where the main goal is to full automatize the delivery of the materials using the unit load AGV. The main problem in transition from the older model of the AGV and to the unit load AGV is due to the fully automatization of the process the carts need to be placed in the assembly hall without any human interaction. Since using the unit load AGV we have encountered another problem where the aisles of the assembly hall are not uniform and some parts of the assembly hall are very narrow, and we have find solution for this problem.

The problem has been defined and the evaluation has been carried out regarding the aisles where the M1 assembly hall was mapped out and all the aisles of the assembly hall was measured, and the narrowest part of the aisles was tabulated. This analysis showed us the how narrow some parts of the assembly line are. The next analysis was the sequences analysis where the route was mapped out and the narrowest part of the route was noted. Different loading concepts were used to determine if the passing of the carts in the aisles were alright or not. The “narrow” concept offers the most passability in the streets, but it needs some technical solution to change the orientation of the carts. Since over 75% of the carts need to

be placed length wise. The results of the evaluation were categorized into three categories according to the narrowest dimension in the aisles. A mathematical model was used to determine where each picking carts belong according to their dimension and the narrowest part of the aisle where the AGV passes through. We had found out that 21 picking carts need to change their orientation in the assembly line. For air conditioning tubes, spoilers, and bumpers an alternative route was mapped out so that there'll be no need to have any unnecessary change in the cart design is needed.

Six technical solution was suggested after careful consideration and its usefulness. The technical solution was evaluated against 7 criteria's which affects the implementation of the solution. Saaty's method was used to find the weightage of each criterion and using the weights the best solution was calculated by multicriteria decision making method. Subsequently, the best solution was the "turning the picking cart under the AGV" where it proved to be the most feasible and every aspect of it provided to be in favourable condition. All the picking carts which has problems in the evaluation was listed out and an appropriate solution was suggested for the problem.

Bibliography

ASHBY, W. R. Principles of the self-organizing dynamic system. *The Journal of General Psychology*. 1947. Vol. 37, no. 2p. 125–128. DOI 10.1080/00221309.1947.9918144.

BURGANOVA, Natalia, GRZNAR, Patrik, GREGOR, Milan and MOZOL, Štefan, 2021, Optimisation of Internal Logistics Transport Time Through Warehouse Management: Case Study. *Transportation Research Procedia*. 2021. Vol. 55, p. 553–560. DOI 10.1016/j.trpro.2021.07.021.

GHOBAKHLOO, Morteza, IRANMANESH, Mohammad, GRYBAUSKAS, Andrius, VILKAS, Mantas and PETRAITĖ, Monika, 2021, Industry 4.0, Innovation, and sustainable development: A systematic review and a roadmap to Sustainable Innovation. *Business Strategy and the Environment*. 2021. Vol. 30, no. 8p. 4237–4257. DOI 10.1002/bse.2867.

HOPKINS, John L., 2021, An investigation into emerging industry 4.0 technologies as drivers of Supply Chain Innovation in Australia. *Computers in Industry*. 2021. Vol. 125, p. 103323. DOI 10.1016/j.compind.2020.103323.

KLUG, Florian, 2013, The internal bullwhip effect in car manufacturing. *International Journal of Production Research*. 2013. Vol. 51, no. 1p. 303–322. DOI 10.1080/00207543.2012.677551.

KUMAR DAS, Suman, 2016, Design and methodology of Automated Guided Vehicle-A Review. *IOSR Journal of Mechanical and Civil Engineering*. 2016. Vol. 03, no. 03p. 29–35. DOI 10.9790/1684-15010030329-35.

LMR, 2020. *Hikrobot* [online],. Available from: <https://www.hikrobotics.com/en/mobilerobot/LMR>

MARQUES, Maria, AGOSTINHO, Carlos, ZACHAREWICZ, Gregory and JARDIM-GONÇALVES, Ricardo, 2017, Decentralized decision support for Intelligent

Manufacturing in industry 4.0. *Journal of Ambient Intelligence and Smart Environments*. 2017. Vol. 9, no. 3p. 299–313. DOI 10.3233/ais-170436.

MRUGALSKA, Beata and WYRWICKA, Magdalena K., 2017, Towards lean production in industry 4.0. *Procedia Engineering*. 2017. Vol. 182, p. 466–473. DOI 10.1016/j.proeng.2017.03.135.

OZTEMEL, Ercan and GURSEV, Samet, 2018, Literature Review of Industry 4.0 and Related Technologies. *Journal of Intelligent Manufacturing*. 2018. Vol. 31, no. 1p. 127–182. DOI 10.1007/s10845-018-1433-8.

QIN, Jian, LIU, Ying and GROSVENOR, Roger, 2016, A categorical framework of manufacturing for Industry 4.0 and Beyond. *Procedia CIRP*. 2016. Vol. 52, p. 173–178. DOI 10.1016/j.procir.2016.08.005.

RISTOVSKA, Natasha, KOZUHAROV, Sasho and PETKOVSKI, Vladimir, 2017, The impact of logistics management practices on Company's performance. *International Journal of Academic Research in Accounting, Finance and Management Sciences*. 2017. Vol. 7, no. 1. DOI 10.6007/ijarafms/v7-i1/2649.

ROBLEK, Vasja, MEŠKO, Maja and KRAPEŽ, Alojz, 2016, A complex view of industry 4.0. *SAGE Open*. 2016. Vol. 6, no. 2p. 215824401665398. DOI 10.1177/2158244016653987.

Safety systems for agvs and amrs safe Agv Easy, 2020. *SICK* [online],. Available from: <https://www.sick.com/fr/en/safety-systems/safety-systems-for-agvs-and-amrs/safe-agv-easy/c/g412755>

SANTOS, Reginaldo Carreiro and MARTINHO, José Luís, 2019, An industry 4.0 maturity model proposal. *Journal of Manufacturing Technology Management*. 2019. Vol. 31, no. 5p. 1023–1043. DOI 10.1108/jmtm-09-2018-0284.

SWIERCZEK, Artur, 2022, The effects of Industry 4.0 Technologies on Relational Performance: The Mediating Role of Supply Chain Emergence in the transitive

logistics service triads. *Supply Chain Management: An International Journal*. 2022. DOI 10.1108/scm-07-2021-0347.

ULLRICH Günter and ALBRECHT, Thomas, 2022, *Automated Guided Vehicle Systems: A Primer - with practical applications - about the technology - for planning*. Wiesbaden : Springer.

Underrun agvs (automated guided vehicles), 2022. *Asseco CEIT* [online], . Available from: <https://www.asseco-ceit.com/en/agv-systems/mouse-agv/>

USER, Super, 2021, AGV and Amr Robot Home. *AGV ROBOT HOME* [online]. 2021. Available from: <https://www.agvnetwork.com/automated-guided-cart-agc>

VANCEA, A. P. and ORHA, I., 2019, A survey in the design and control of Automated Guided Vehicle Systems. *Carpathian Journal of Electronic and Computer Engineering*. 2019. Vol. 12, no. 2p. 41–49. DOI 10.2478/cjece-2019-0016.

YÜKSEL, Hilmi, 2022, Industry 4.0 transformation: Factors affecting adoption and impacts on companies. *International Journal of Industrial Engineering and Operations Management*. 2022. Vol. 4, no. 3p. 63–89. DOI 10.1108/ijjeom-06-2022-0020.

List of figures and tables

List of figures

Figure 1 Internal logistics	13
Figure 2 Barrett AGV	18
Figure 3 Driverless train	21
Figure 4 Pallet truck AGV	21
Figure 5 Unit load carrier	22
Figure 6 Landmark based navigation	23
Figure 8 Safety systems	25
Figure 9 Map of ŠA plant in Mlada Boleslav	26
Figure 10 Organization chart of ŠA internal logistics	27
Figure 11 KLT box	28
Figure 12 GLT box	28
Figure 13 Specific pallet	29
Figure 14 Sequence trolley	29
Figure 15 Pick by light	30
Figure 16 Pick by frame	30
Figure 17 Pick by point	31
Figure 18 Pick by watch	31
Figure 19 Tugger AGV	32
Figure 20 Unit load AGV	32
Figure 21 AGV terminal	33
Figure 22 Electric tugger	33
Figure 23 Heavy electric forklift	34
Figure 24 Light electric forklift	34
Figure 25 Map of aisles in M1 assembly hall	35
Figure 26 Picking cart orientation in length wise	36
Figure 27 Picking cart orientation in width wise	37
Figure 28 Detailed measurement of the width of the aisles in M1 assembly hall ..	38
Figure 29 Representation of the measurement taken	39
Figure 30 Picking cart size representation	42
Figure 31 Representation of the route in a narrow aisle	43

Figure 32 Spoiler original route	47
Figure 33 Alternative route for spoiler	47
Figure 34 Original route of air conditioning tubes	48
Figure 35 Alternative route of air conditioning tubes	48
Figure 36 Turning of AGV under the picking cart	49
Figure 37 Model of a picking cart	50
Figure 38 Re-designed picking cart.....	50
Figure 39 AGV with omni wheels	51
Figure 40 AGV with rotating lifting module	51
Figure 41 Representation of AGV in two-step turning process.....	52
Figure 42 Safety area of the AGV	55

List of tables

Table 1 Narrowest part in each aisle in M1 assembly hall.....	38
Table 2 Evaluation and suggested solution	44
Table 3 Weightage for individual criteria	53
Table 4 Multiple criteria evaluation for the technical solutions.....	54
Table 5 Final score for the technical solutions.....	54

List of appendices

Appendix 1 Data of the picking carts	66
Appendix 2 Evaluation of the picking carts.....	67
Appendix 3 Saaty method evaluation	68

Appendix 1 Data of the picking carts

Name	Length	Width	Height	Position at the assembly line
			without wheels	L-Length
	mm	mm	mm	W-Width
gearbox	1750	1220	900	W
joint shaft L	1500	1000	1170	L
joint shaft R	1500	1000	1170	L
starter	1600	1000	900	L
alternator	1400	1100	1150	L
cables	1550	1080	1800	W
airbag + steering wheel	1600	1020	1630	L
B pillar	1800	1020	1540	L
water canal	1800	1150	1600	W
exterior lights	1300	1000	1570	L
armrest	1500	1100	1600	L
luggage compartment carpet	1500	1250	1160	L
shock absorbers	1300	1020	740	L
front axle	2450	1500	1100	L
flexible damper	1500	950	1400	L
rear glass	2060	1450	1350	W
luggage compartment equipment	1420	1310	1540	L
interior mirror	1920	980	1500	W
rear lights	1460	840	1600	L
air filter	2050	1500	1600	L
transverse wall damping	2425	1520	1663	L
side lining (Guliver)	1950	1970	2235	L
Seat belts	1520	976	1515	W
washer cup	1830	1420	1420	W
CW covers	2027	1130	2124	L
Window launcher bar	2035	1240	1600	L
Pedals and brake boosters	1823	1080	1568	L
electrical installation of doors	1105	905	1440	L
Crankset	1270	1002	1352	L
Engine bed	1205	1008	1210	L
air conditioning tubes	3862	1140	1540	L
front lights	2150	1397	1655	W
front glass	2040	1110	1350	W
AB pillar	1941	1000	1725	L
CL column	1805	1210	1560	L
upper post	1520	1000	1484	L
Side glass	1497	1030	1484	L
exterior mirror LS	1340	1005	1500	L
exterior mirror RS	1340	1005	1500	L
glass management	1300	1162	1385	L
Extra equipment	1540	1240	1860	L
PGL	2170	1450	940	W
spoiler	1500	1254	1600	L
top rails	1962	1085	1368	L
ABS/ESP	1405	950	1012	L
bumpers	2620	1440	1400	L
Batteries and cuffs	1600	1180	790	L
Sill moldings	1940	830	1640	W
Gas springs	1530	900	1830	L
Wheel heads LS/RS	1580	1300	680	L
KIT ceiling	1570	1410	2000	L
Tank cap	1325	700	1550	L
Loor panels 1	1180	1480	2600	L
Loor panels 2	1180	1480	2600	L
Rear axles	2600	1700	820	W
Empty boxes - door line	1400	1000	160/470	W
SEI 5th door	1110	800	1370	W
SEI door SK270	1105	905	1440	L
KIT 1	1980	1210	1970	W
Gearbox bed	1210	1010	1210	W

Appendix 2 Evaluation of the picking carts

Input data							Natural, shortest route			Alternative route		
Name	Length	Width	Height	Position at the assembly line	Width when driving "wide concept"	Width when driving "narrow concept"	The width of the narrowest alley it go through	Results in the "wide concept"	Results in the "narrow concept"	The width of the narrowest alley it go through	Results in the "wide concept"	Results in the "narrow concept"
			without wheels	L-Length				total reserve width	total reserve width		total reserve width	total reserve width
	mm	mm	mm	W-Width	mm	mm	mm	mm	mm	mm	mm	mm
								800	800		800	800
gearbox	1750	1220	900	W	1220	1220	4000	OK	OK	4000	OK	OK
joint shaft L	1500	1000	1170	L	1500	1000	3000	problem	OK	3000	problem	OK
joint shaft R	1500	1000	1170	L	1500	1000	4000	OK	OK	4000	OK	OK
starter	1600	1000	900	L	1600	1000	4000	OK	OK	4000	OK	OK
alternator	1400	1100	1150	L	1400	1100	3000	problem	OK	3000	problem	OK
cables	1550	1080	1800	W	1080	1080	3200	OK	OK	4000	OK	OK
airbag + steering wheel	1600	1020	1630	L	1600	1020	3800	problem	OK	3800	problem	OK
B pillar	1800	1020	1540	L	1800	1020	3800	problem	OK	3800	problem	OK
water canal	1800	1150	1600	W	1150	1150	4000	OK	OK	4000	OK	OK
exterior lights	1300	1000	1570	L	1300	1000	4000	OK	OK	4000	OK	OK
armrest	1500	1100	1600	L	1500	1100	4000	OK	OK	4000	OK	OK
luggage compartment carpet	1500	1250	1160	L	1500	1250	4000	OK	OK	4000	OK	OK
shock absorbers	1300	1020	740	L	1300	1020	3800	OK	OK	3800	OK	OK
front axle	2450	1500	1100	L	2450	1500	4000	big problem	OK	4000	big problem	OK
flexible damper	1500	950	1400	L	1500	950	4000	OK	OK	4000	OK	OK
rear glass	2060	1450	1350	W	1450	1450	3800	OK	OK	3800	OK	OK
luggage compartment equipment	1420	1310	1540	L	1420	1310	3200	problem	problem	3200	problem	problem
interior mirror	1920	980	1500	W	980	980	4000	OK	OK	4000	OK	OK
rear lights	1460	840	1600	L	1460	840	4000	OK	OK	4000	OK	OK
air filter	2050	1500	1600	L	2050	1500	3400	big problem	problem	3400	big problem	problem
transverse wall damping	2425	1520	1663	L	2425	1520	3800	big problem	problem	3800	big problem	problem
side lining (Guliver)	1950	1970	2235	L	1950	1950	3200	big problem	big problem	4000	problem	problem
Seat belts	1520	976	1515	W	976	976	4000	OK	OK	4000	OK	OK
washer cup	1830	1420	1420	W	1420	1420	4000	OK	OK	4000	OK	OK
CW covers	2027	1130	2124	L	2027	1130	4000	big problem	OK	4000	big problem	OK
Window launcher bar	2035	1240	1600	L	2035	1240	3800	big problem	OK	3800	big problem	OK
Pedals and brake boosters	1823	1080	1568	L	1823	1080	3800	problem	OK	3800	problem	OK
electrical installation of doors	1105	905	1440	L	1105	905	4000	OK	OK	4000	OK	OK
Crankset	1270	1002	1352	L	1270	1002	4000	OK	OK	4000	OK	OK
Engine bed	1205	1008	1210	L	1205	1008	3500	OK	OK	3500	OK	OK
air conditioning tubes	3862	1140	1540	L	3862	1140	2400	big problem	problem	3600	big problem	OK
front lights	2150	1397	1655	W	1397	1397	3600	OK	OK	3600	OK	OK
front glass	2040	1110	1350	W	1110	1110	3600	OK	OK	3600	OK	OK
AB pillar	1941	1000	1725	L	1941	1000	3600	big problem	OK	3600	big problem	OK
CL column	1805	1210	1560	L	1805	1210	3600	big problem	OK	4000	problem	OK
upper post	1520	1000	1484	L	1520	1000	4000	OK	OK	4000	OK	OK
Side glass	1497	1030	1484	L	1497	1030	4000	OK	OK	4000	OK	OK
exterior mirror LS	1340	1005	1500	L	1340	1005	4000	OK	OK	4000	OK	OK
exterior mirror RS	1340	1005	1500	L	1340	1005	4000	OK	OK	4000	OK	OK
glass management	1300	1162	1385	L	1300	1162	3800	OK	OK	3800	OK	OK
Extra equipment	1540	1240	1860	L	1540	1240	3200	problem	problem	3200	problem	problem
PGL	2170	1450	940	W	1450	1450	4000	OK	OK	4000	OK	OK
spoiler	1500	1254	1600	L	1500	1254	3200	problem	problem	3800	OK	OK
top rails	1962	1085	1368	L	1962	1085	3800	big problem	OK	3800	big problem	OK
ABS/ESP	1405	950	1012	L	1405	950	4000	OK	OK	4000	OK	OK
bumpers	2620	1440	1400	L	2620	1440	3300	big problem	problem	3300	big problem	problem
Batteries and cuffs	1600	1180	790	L	1600	1180	4000	OK	OK	4000	OK	OK
Sill moldings	1940	830	1640	W	830	830	3600	OK	OK	3600	OK	OK
Gas springs	1530	900	1830	L	1530	900	4000	OK	OK	4000	OK	OK
Wheel heads LS/RS	1580	1300	680	L	1580	1300	3000	big problem	problem	3000	big problem	problem
KIT ceiling	1570	1410	2000	L	1570	1410	3200	problem	problem	3200	problem	problem
Tank cap	1325	700	1550	L	1325	700	3800	OK	OK	3800	OK	OK
Loor panels 1	1180	1480	2600	L	1180	1180	3800	OK	OK	3800	OK	OK
Loor panels 2	1180	1480	2600	L	1180	1180	3300	OK	OK	3300	OK	OK
Rear axles	2600	1700	820	W	1700	1700	4000	problem	problem	4000	problem	problem
Empty boxes - door line	1400	1000	160/470	W	1000	1000	3300	OK	OK	3800	OK	OK
SEI 5th door	1110	800	1370	W	800	800	3300	OK	OK	4000	OK	OK
SEI door SK270	1105	905	1440	L	1105	905	4000	OK	OK	4000	OK	OK
KIT 1	1980	1210	1970	W	1210	1210	4000	OK	OK	4000	OK	OK
Gearbox bed	1210	1010	1210	W	1010	1010	4000	OK	OK	4000	OK	OK

Appendix 3 Saaty method evaluation

safety	>=9.5	9	8	7	6	5	4	3	2	1	2	3	4	5	6	7	8	9	>=9.5	Implementation time
safety	>=9.5	9	8	7	6	5	4	3	2	1	2	3	4	5	6	7	8	9	>=9.5	Market availability
safety	>=9.5	9	8	7	6	5	4	3	2	1	2	3	4	5	6	7	8	9	>=9.5	Investment costs
safety	>=9.5	9	8	7	6	5	4	3	2	1	2	3	4	5	6	7	8	9	>=9.5	space at the production line
safety	>=9.5	9	8	7	6	5	4	3	2	1	2	3	4	5	6	7	8	9	>=9.5	Operational costs
safety	>=9.5	9	8	7	6	5	4	3	2	1	2	3	4	5	6	7	8	9	>=9.5	Operational time requirements
Implementation time	>=9.5	9	8	7	6	5	4	3	2	1	2	3	4	5	6	7	8	9	>=9.5	Market availability
Implementation time	>=9.5	9	8	7	6	5	4	3	2	1	2	3	4	5	6	7	8	9	>=9.5	Investment costs
Implementation time	>=9.5	9	8	7	6	5	4	3	2	1	2	3	4	5	6	7	8	9	>=9.5	space at the production line
Implementation time	>=9.5	9	8	7	6	5	4	3	2	1	2	3	4	5	6	7	8	9	>=9.5	Operational costs
Implementation time	>=9.5	9	8	7	6	5	4	3	2	1	2	3	4	5	6	7	8	9	>=9.5	Operational time requirements
Market availability	>=9.5	9	8	7	6	5	4	3	2	1	2	3	4	5	6	7	8	9	>=9.5	Investment costs
Market availability	>=9.5	9	8	7	6	5	4	3	2	1	2	3	4	5	6	7	8	9	>=9.5	space at the production line
Market availability	>=9.5	9	8	7	6	5	4	3	2	1	2	3	4	5	6	7	8	9	>=9.5	Operational costs
Market availability	>=9.5	9	8	7	6	5	4	3	2	1	2	3	4	5	6	7	8	9	>=9.5	Operational time requirements
Investment costs	>=9.5	9	8	7	6	5	4	3	2	1	2	3	4	5	6	7	8	9	>=9.5	space at the production line
Investment costs	>=9.5	9	8	7	6	5	4	3	2	1	2	3	4	5	6	7	8	9	>=9.5	Operational costs
Investment costs	>=9.5	9	8	7	6	5	4	3	2	1	2	3	4	5	6	7	8	9	>=9.5	Operational time requirements
space at the production line	>=9.5	9	8	7	6	5	4	3	2	1	2	3	4	5	6	7	8	9	>=9.5	Operational costs
space at the production line	>=9.5	9	8	7	6	5	4	3	2	1	2	3	4	5	6	7	8	9	>=9.5	Operational time requirements
space at the production line	>=9.5	9	8	7	6	5	4	3	2	1	2	3	4	5	6	7	8	9	>=9.5	Operational time requirements

ANNOTATION

AUTHOR	YUVANESH KANNA NAMADEVAN		
FIELD	Specialization International Supply Chain Management		
THESIS TITLE	Use of Unit Load AGVs for picking cart handling		
SUPERVISOR	Prof. Ing. Radim Lenort, Ph.D.		
DEPARTMENT	KRVLK - Department of Production, Logistics and Quality Management	YEAR	2023
NUMBER OF PAGES			
	69		
NUMBER OF PICTURES			
	42		
NUMBER OF TABLES			
	5		
NUMBER OF APPENDICES			
	3		
SUMMARY	<p>The main aim is to use the unit load AGV for picking cart handling in the M1 assembly hall in ŠKODA AUTO. We needed to identify the problems in using of unit load AGV. The problems were identified and the solutions were chosen by using multiple criteria decision making process and the best solution was recommended for each sequential trolley.</p>		
KEY WORDS	<p>AGV, ŠKODA AUTO, PICKING CART, MULTI CRITERIA DECISION MAKING</p>		