

# Low-pressure briquetting press construction

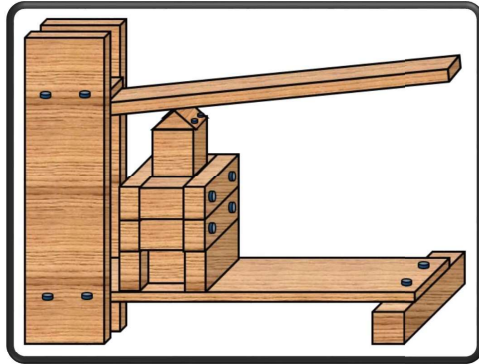

Author: M.Sc. Anna Brunerová  
2017  
brunerova@tf.czu.cz

## 1st step

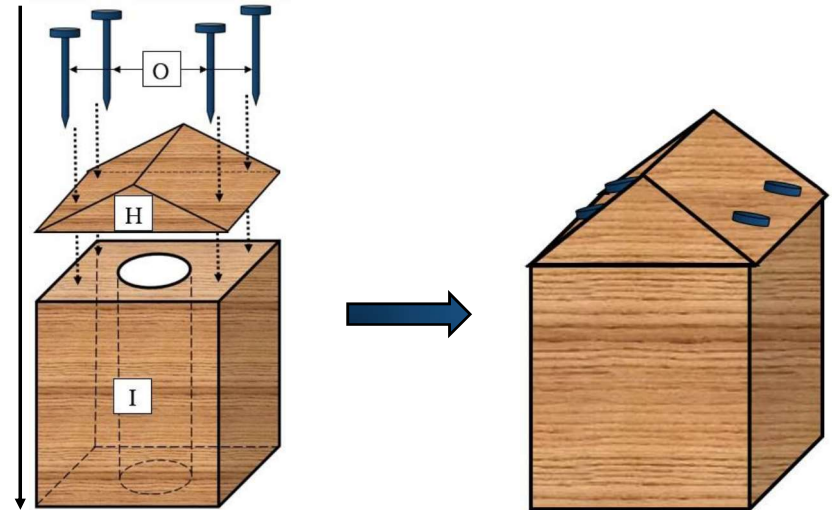

## 2nd step

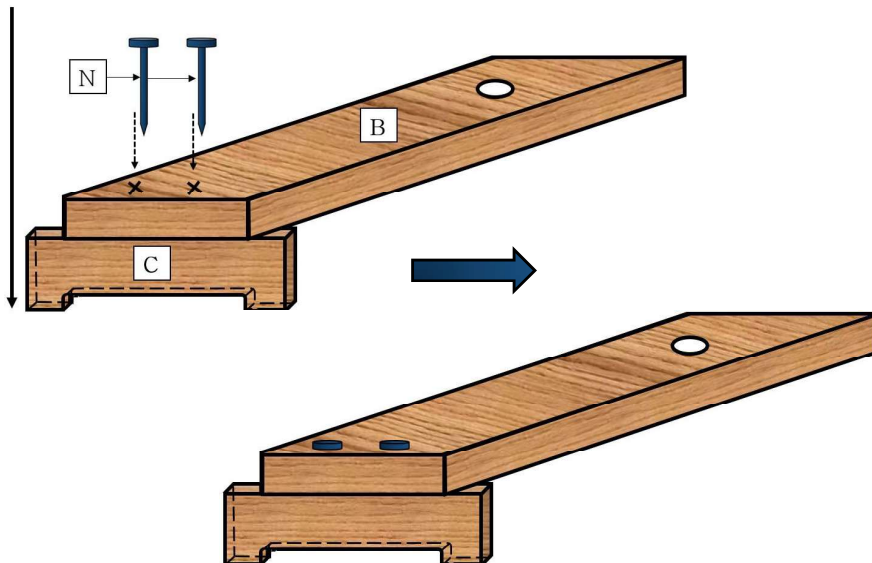

## 3rd step

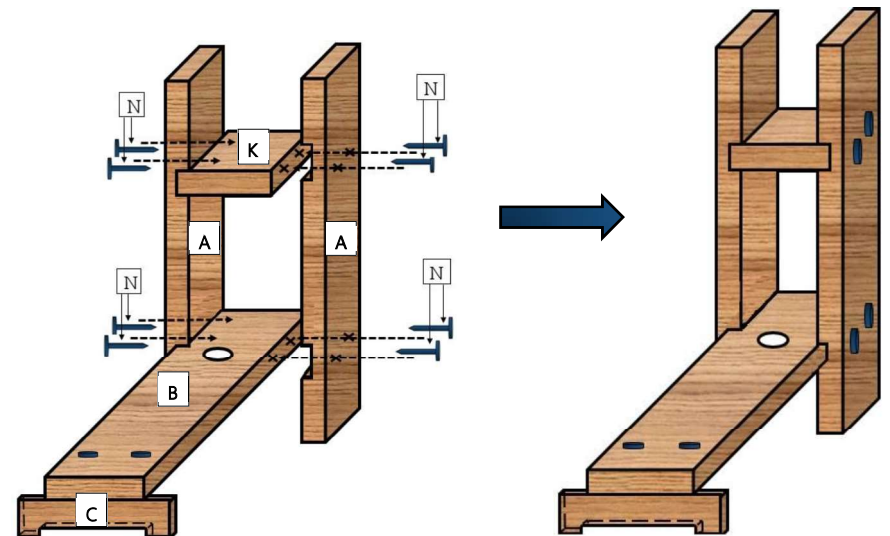

4<sup>th</sup> step

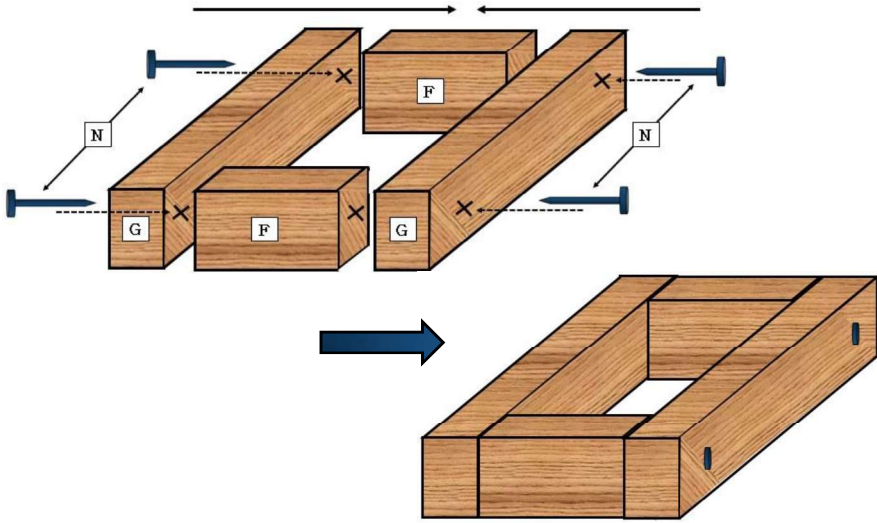

5<sup>th</sup> step

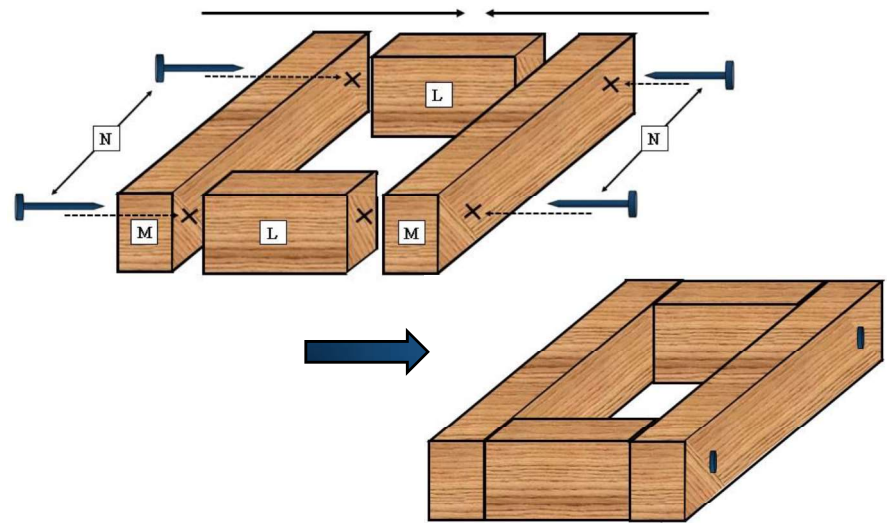

6<sup>th</sup> step

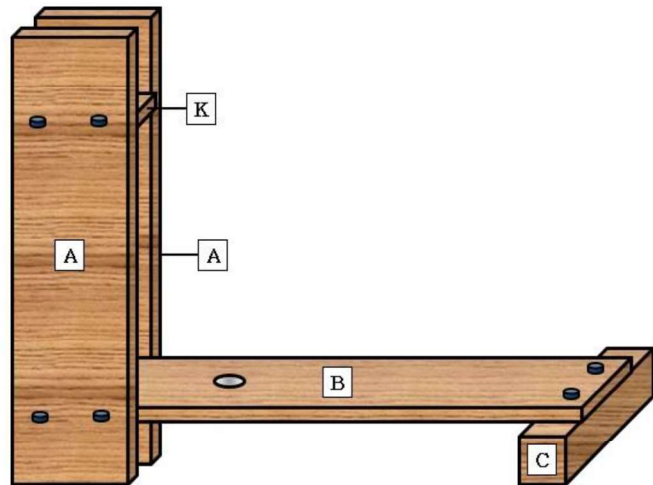

7<sup>th</sup> step

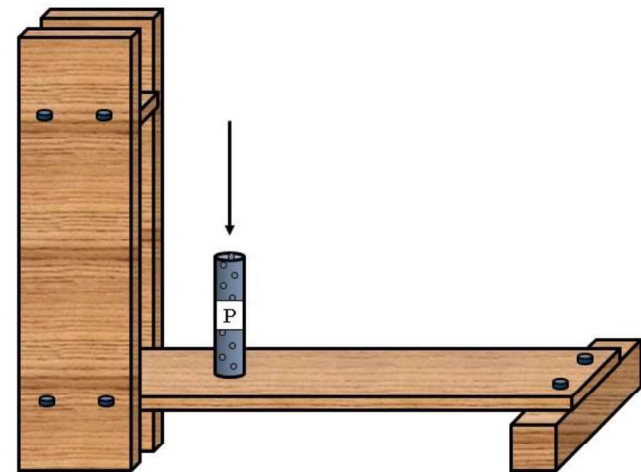

8<sup>th</sup> step

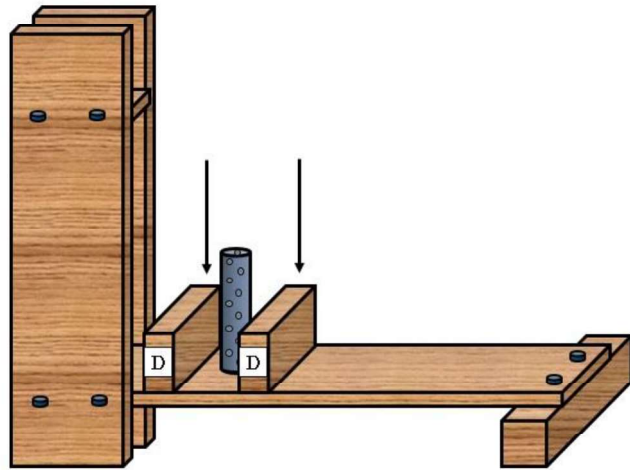

9<sup>th</sup> step

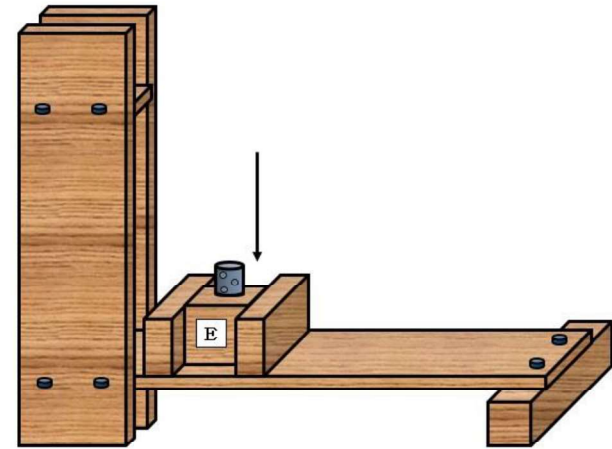

10<sup>th</sup> step

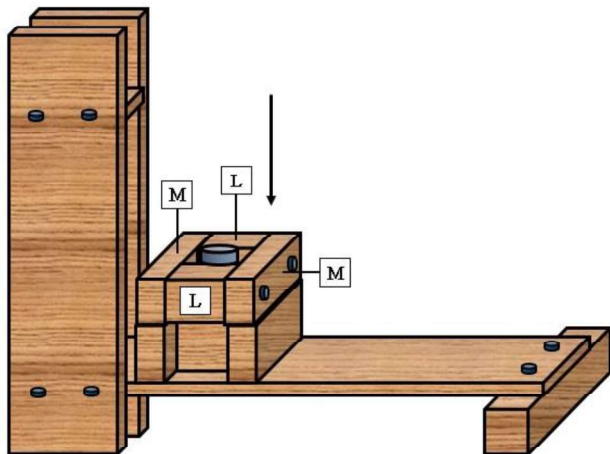

11<sup>th</sup> step

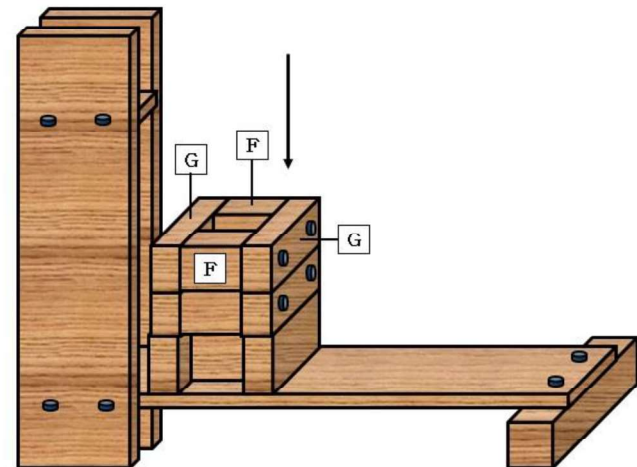

**12<sup>th</sup> step**

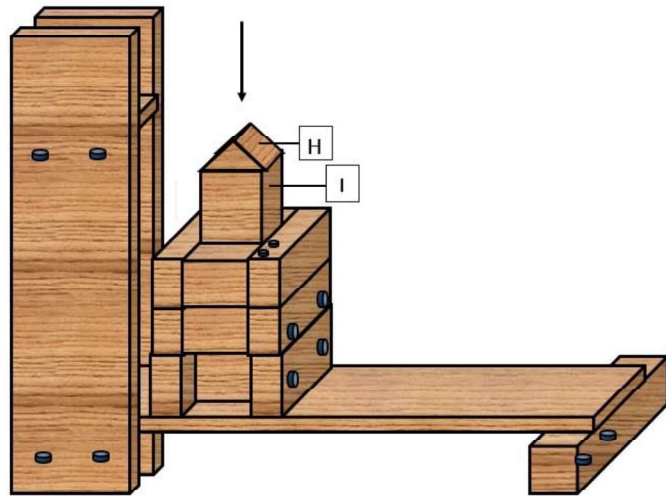

**13<sup>th</sup> step**

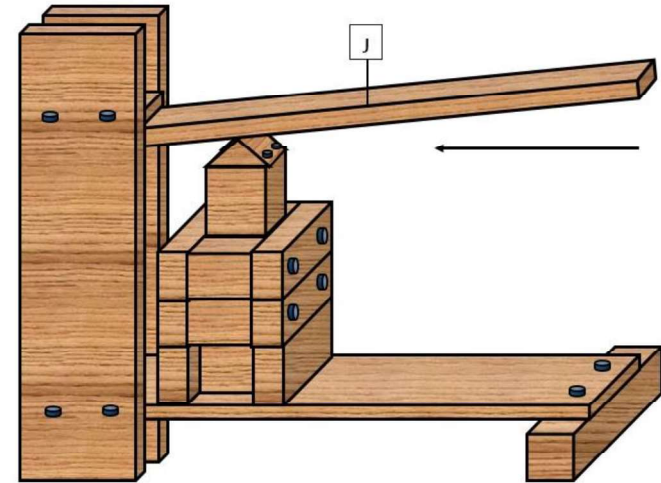

**Ready to use!**

