



**BRNO UNIVERSITY OF TECHNOLOGY**

VYSOKÉ UČENÍ TECHNICKÉ V BRNĚ

**FACULTY OF CIVIL ENGINEERING**

FAKULTA STAVEBNÍ

**INSTITUTE OF BUILDING SERVICES**

ÚSTAV TECHNICKÝCH ZAŘÍZENÍ BUDOV

# HEATING OF AN APARTMENT BUILDING USING RENEWABLE ENERGY SOURCES

**DIPLOMA THESIS**

DIPLOMOVÁ PRÁCE

**AUTHOR**

AUTOR PRÁCE

Bc. Nour Kováčová

**SUPERVISOR**

VEDOUČÍ PRÁCE

doc. Ing. PETR HORÁK, Ph.D.

BRNO 2022



# VYSOKÉ UČENÍ TECHNICKÉ V BRNĚ FAKULTA STAVEBNÍ

<b>Studijní program</b>	NPC-SIS Stavební inženýrství – pozemní stavby
<b>Typ studijního programu</b>	Navazující magisterský studijní program s prezenční formou studia
<b>Specializace</b>	bez specializace
<b>Pracoviště</b>	Ústav technických zařízení budov

## ZADÁNÍ DIPLOMOVÉ PRÁCE

<b>Student</b>	Bc. Nour Kováčová
<b>Název</b>	Heating of an apartment building using renewable energy sources
<b>Vedoucí práce</b>	doc. Ing. Petr Horák, Ph.D.
<b>Datum zadání</b>	31. 3. 2021
<b>Datum odevzdání</b>	14. 1. 2022

V Brně dne 31. 3. 2021

---

prof. Ing. Jiří Hirš, CSc.  
Vedoucí ústavu

---

prof. Ing. Miroslav Bajer, CSc.  
Děkan Fakulty stavební VUT

## MATERIALS AND LITERATURE

Applicable laws, ordinances, regulations and standards related to the solving theme of diploma thesis.

Domestic, European and world literature, proceedings of scientific conferences and professional events in the field of HVAC.

Source on the internet.

Detailed information and further clarification of diploma thesis provides supervisor during consultation.

## PRINCIPLES FOR PREPARATION

The thesis will be processed in accordance with applicable regulations (laws and regulations, standards)

A. Analysis of the theme, objectives, and methods of solution

The analysis of a given topic, normative and legislative requirements

The aim, the chosen methods of solution

Relevant technical solution in practice

Theoretical solutions (using the physical phenomena of processes)

Experimental solutions (description of methods and instrumentation)

B. Application of the topic at the solved building - conceptual design

Design of technical solution in given specialization (including documented calculations) in basic drawings and diagrams, technical report.

Evaluation of the current state of solution, analysis of potential efficiency measures, space requirements, economy of operation, etc.

C. Project - level of the implementation project: floor plans + legend, 1:50, wiring diagram of radiators, 1:50, floor plan of the technical room (1:25, 1:20) and wiring diagram of the heat source, technical report.

## STRUKTURA DIPLOMOVÉ PRÁCE

VŠKP vypracujte a rozčleňte podle dále uvedené struktury:

1. Textová část závěrečné práce zpracovaná podle platné Směrnice VUT "Úprava, odevzdávání a zveřejňování závěrečných prací" a platné Směrnice děkana "Úprava, odevzdávání a zveřejňování závěrečných prací na FAST VUT" (povinná součást závěrečné práce).

2. Přílohy textové části závěrečné práce zpracované podle platné Směrnice VUT "Úprava, odevzdávání, a zveřejňování závěrečných prací" a platné Směrnice děkana "Úprava, odevzdávání a zveřejňování závěrečných prací na FAST VUT" (nepovinná součást závěrečné práce v případě, že přílohy nejsou součástí textové části závěrečné práce, ale textovou část doplňují).

---

doc. Ing. Petr Horák, Ph.D.  
Vedoucí diplomové práce

## ABSTRACT

The diploma thesis is divided into three parts. First part is analysis of the theme, objectives, and methods of solution which contains also theoretical part, second part is application of the topic at the solved building including detailed calculation and design of heating system, hot water preparation, two variants of renewable energy heat sources and their comparison which leads to the selection of the better heat source. Third part is project and it contains technical report of the selected variant and project documentation which includes all necessary drawings.

## ABSTRAKT

Diplomová práce je rozdělena na tři části. První částí je analýza tématu, cílů a způsobů řešení, která obsahuje i teoretickou část. Druhá část je aplikace tématu na řešeném objektu včetně podrobného výpočtu a návrhu otopné soustavy, přípravy teplé vody, dvou variant alternativních zdrojů tepla a jejich porovnání, které vede k výběru lepšího zdroje tepla. Třetí část je projekt a obsahuje technickou zprávu vybrané varianty a projektovou dokumentaci, která obsahuje všechny potřebné výkresy.

## KEY WORDS

Heating, air-to-water heat pump, wood pellet boiler, hot water preparation, radiators, low temperature heating system, dimensioning and hydraulic balancing of the heating system, heat losses, heat transfer coefficient, circulating pump.

## KLÍČOVÁ SLOVA

Vytápění, tepelné čerpadlo vzduch-voda, kotel na pelety, příprava teplé vody, radiátory, nízkoteplotní otopná soustava, dimenzování a hydraulické seřízení otopné soustavy, tepelné ztráty, součinitel prostupu tepla, oběhové čerpadlo.

## BIBLIOGRAPHIC CITATION

Bc. Nour Kováčová *Heating of an apartment building using renewable energy sources*.  
Brno, 2022. 193 pp., 56 pp. of appendices Master's Thesis. Brno University of Technology,  
Faculty of Civil Engineering, Institute of Building Services. Supervisor doc. Ing. Petr Horák,  
Ph.D.

## DECLARATION OF CONFORMITY OF THE PRINTED AND ELECTRONIC FORM OF THE FINAL THESIS

I declare that the electronic form of the submitted master's thesis titled *Heating of an apartment building using renewable energy sources* is identical to the submitted printed form.

Brno, 14. 1. 2022

---

Bc. Nour Kováčová  
author

## DECLARATION OF AUTHORSHIP OF THE FINAL THESIS

I, Bc. Nour Kováčová declare that this master's thesis titled *Heating of an apartment building using renewable energy sources* is my own work and the result of my own original research. I have clearly indicated the presence of quoted or paraphrased material and provided references for all sources.

Brno, 14. 1. 2022

---

Bc. Nour Kováčová  
author

## **THANKS**

I would like to thank my husband and my family for their love and support. I would also like to thank my supervisor, doc. Ing. Petr Horák, Ph.D. , for his professional guidance and advices.

Brno, 14. 1. 2022

Bc. Nour Kováčová  
author

## Table of contents

Introduction .....	11
A. Analysis of the theme, objectives and methods of solution.....	11
A.1. Analysis of the given topic .....	11
A.2. Normative and legislative requirements .....	12
A.3. The aim, and the chosen methods of solution .....	12
A.4. Relevant technical solution in practice (Theoretical part) .....	13
A.4.1. Introduction .....	13
A.4.2. Heat pumps.....	14
A.4.2.1. Principle of heat pumps.....	14
A.4.2.2. Basic components of heat pumps .....	15
A.4.2.3. Refrigerants and their effect on the environment .....	17
A.4.2.4. Types of heat pumps .....	19
A.4.2.5. Modes of operation .....	21
A.4.2.6. Heating factor .....	22
A.4.2.7. Heat pumps regulation .....	23
A.4.3. Biomass boilers .....	25
A.4.3.1. Biomass definition and commercial forms .....	25
A.4.3.2. Ways of biomass usage.....	26
A.4.3.3. Common types of biomass boilers .....	28
B. Application of the topic at the solved building including theoretical solution of used physical equations .....	33
B.1. Calculation of heat output .....	33
B.1.1. Calculation of heat transfer coefficient U of building structures [W/m <sup>2</sup> .K] .....	33
B.1.2. Energy label of the building .....	41
B.1.3. Estimation of heat loss of the building .....	44
B.1.4. Annual energy demand.....	116
B.2. Design of hot water preparation .....	117
B.3. Design of heat sources in two variants.....	120
B.3.1. Variant A – Automatic wood pellet boiler .....	121
B.3.1.a. Wood pellet storage .....	122
B.3.1.b. Annual fuel consumption and fuel storage design – basic determination.....	124
B.3.1.c. Design of storage tank for variant A .....	124
B.3.2. Variant B - Air source heat pump.....	125
B.3.2.a. Annual energy consumption of heat pumps – basic determination .....	127
B.3.1.b. Design of storage tank for variant B .....	128



B.3.3. Heat sources comparison .....	128
B.3.3.a. Economical comparison .....	128
B.3.3.b. Environmental effect comparison .....	130
B.3.3.c. Spatial requirements and user comfort comparison .....	131
B.3.4. Variant selection .....	131
B.4. Design of heating surfaces .....	132
B.4.1. Calculation of temperature drop and mean radiator temperature .....	132
B.4.2. Design of radiators .....	132
B.4.3. Used heating surfaces .....	135
B.5. Dimensioning and hydraulic balancing of heating system .....	139
B.6. Design of Balancing valves .....	156
B.7. Design of Heat meters .....	158
B.8. Design of three-way mixing valves .....	158
B.9. Design of circulating pumps .....	160
B.10. Design of distributor and collector .....	165
B.11. Design of security equipments .....	167
B.11.1. Design of expansion tank .....	167
B.11.2. Design of safety valve .....	171
B.12 Design of filters .....	171
B.13. Design of pipes thermal insulation .....	172
B.14. Design of closing ball valves, drain ball valves, and automatic air release valves .....	174
B.15. Design of heating water replenishment .....	175
B.16. Design of thermometers and manometers .....	175
C. Project .....	176
C.1. Technical report .....	176
C.1.1 Introduction .....	176
C.1.1.1 Starting materials .....	176
C.1.1.2 Used regulations and technical standards .....	176
C.1.2 Basic data .....	177
C.1.2.1 Calculated climatic conditions .....	177
C.1.2.2 Indoor temperatures: .....	177
C.1.3 Thermal technical parameters of structures and heat loss .....	177
C.1.4 Heat and fuel demands .....	178
C.1.5 Heat source .....	178
C.1.6 Expansion tank and safety valve .....	179
C.1.7 Heating system .....	179

C.1.7.1 Description of the heating system .....	179
C.1.7.2 Radiators .....	179
C.1.7.3 Piping .....	180
C.1.7.4 Thermal insulation of pipes .....	180
C.1.7.5 Circulating pumps and three-way mixing valves .....	180
C.1.7.6 Fittings.....	181
C.1.7.7 Accumulation tank .....	181
C.1.7.8 Heat measuring.....	181
C.1.7.9 Hot water preparation .....	181
C.1.7.10 Heating system regulation .....	182
C.1.8 Requirements for other professions.....	182
C.1.8.1 Construction part.....	182
C.1.8.2 Sanitary and water installation .....	183
C.1.8.3 Electrical installation.....	183
C.1.8.4 Ventilation system .....	183
C.1.9 Assembly and commissioning.....	183
C.1.9.1 Heat source .....	183
C.1.9.2 Heating system .....	183
C.1.10 Testing of devices.....	183
C.1.10.1 Flushing of heating system .....	183
C.1.10.2 Leak test.....	184
C.1.10.3 Expansion test.....	184
C.1.10.4 Heating test.....	184
C.1.11 Method of service and control .....	184
C.1.12 Health and environment protection .....	184
C.1.12.1 Environmental protection.....	184
C.1.12.2 Waste management.....	184
C.1.13 Safety during work.....	184
C.2. Drawings .....	185
CONCLUSION.....	186
List of used resources and websites .....	187
List of figures and tables .....	191
List of attachments .....	193

## Introduction

This diploma thesis deals with heating and hot water preparation of a new apartment building that is detached and located in the city of Olomouc in the Czech Republic using renewable energy sources. The apartment building has a basement and 3 above ground floors, which consist in total of 6 apartments. In the basement there are storerooms, technical room, two rooms that serve as private gym for inhabitants and a toilet.

Part A deals with analysis of the topic and theoretical part, in which I talked about heat pumps and biomass boilers.

In part B there are the calculations, which include heat transfer coefficient of each structure, heat losses of the building, preparation of hot water, the design of radiators, and the design of heat sources for the whole building in two variants, one variant is wood pellet boiler, and the other variant is air to water heat pump, which are then compared based on the environmental impact, economical costs, spatial requirements and user comfort, and subsequently one variant is selected. It also includes detailed dimensioning and hydraulic balancing of the heating system and the design of all other necessary safety equipments, devices and fittings.

Part C is the project which includes technical report and drawings.

## A. Analysis of the theme, objectives and methods of solution

### A.1. Analysis of the given topic

The topic of the diploma thesis is the design and elaboration of heating system and hot water preparation using 2 variants of renewable energy sources. Both variants are assessed and compared based on the environmental impact, economical costs, spatial requirements and user comfort, and then the more suitable variant is selected for the project.

The project is designed for an apartment building in the city of Olomouc, it has a basement and 3 above ground floors which consist of 6 apartments. In the basement there are corridors, storerooms, technical room, two rooms that serve as private gym for inhabitants and a toilet.

Entrance door to the apartment building is located on the north side, it leads to entrance vestibule then to the staircase. In each above ground floor, we can find two apartments, eastern and western. Each apartment consists of vestibule, bathroom, toilet, washing machine room, living room combined with kitchen, and two bedrooms. Staircase is of U-shape with half space landing, which serves as entrance vestibule in first floor and as laundry drying room in second and third floor.

The vertical load bearing structure of the apartment building is masonry made of ceramic blocks Porotherm, with thickness of 440 mm for peripheral walls, and 300 mm for internal load bearing walls. Partitions are made of Porotherm as well, thickness 115 mm. The wall between flats is made of two layers of solid concrete blocks with acoustic insulation in between. The horizontal load bearing structure is made of reinforced

concrete slabs thickness 220 mm. The building is constructed on concrete strip foundations and the top of the building is a flat roof that is insulated by mineral wool. The apartment building is insulated using ETICS system of thickness 150 mm.

The outdoor temperature of Olomouc city is - 15°C for the most unfavourable condition.

## **A.2. Normative and legislative requirements**

For elaborating the project the following technical standards, legal regulations were used:

ČSN 73 0540 Thermal protection of buildings

ČSN EN 12 831 Heating systems in buildings - calculation of heat output

ČSN 06 0320 Heating systems in buildings - hot water preparation

ČSN 06 0830 Heating systems in buildings - security equipment

ČSN 06 0310 Central heating - design and installation

ČSN 06 1101 Radiators for central heating

ČSN 01 3452 Technical drawings - Installation - Heating and cooling

ČSN EN 12828 heating systems in buildings – hot water heating systems design

Decree No 193/2007 about the effectiveness of using energy in thermal energy distribution and internal distribution of thermal energy and cold

Decree No . 264/2020 Sb. about energy performance of building.

other related ČSN as amended.

## **A.3. The aim, and the chosen methods of solution**

The aim of this diploma thesis is to design a suitable heating system with hot water preparation using renewable energy sources in two variants for the specified apartment building. One variant is wood pellet boiler, and the other variant is air to water heat pump, which then will be compared and subsequently the more suitable variant will be selected.

In order for the system to be solved and designed, heat transfer coefficient of structures and heat losses with energy label of the object need to be calculated, which then will be followed by the design of heating sources and other heating devices and equipments such as accumulation tanks, radiators, pipes, fittings, safety equipments, circulating pumps, filters etc... , as well as the dimensioning and hydraulic balancing of the whole system.

Both variants will be evaluated in terms of environmental impact, costs, user comfort, and space requirements. For this, annual energy demand and fuel consumption will have to be estimated.

The whole solution will be based on valid technical standards, norms and legal regulations that are used in the Czech Republic, as well as manufacturers' instructions.

It will all be summarized in the technical report, and all necessary drawings for the elaboration and realization of this project will be designed.

I used Excel software for the calculations, and AutoCAD software for drawings, as well as word software for writing and text processing.

#### A.4. Relevant technical solution in practice (Theoretical part)

##### A.4.1. Introduction

In the past several years using of renewable energy sources has been increasing fast as a way to replace using of fossil fuel. This increase is due to the efforts taken for saving the environment from pollution which is causing problems from climate damaging greenhouse gases to health endangering particles. Also, the decline in fossil fuel supply, which is leading to increase in energy prices, has been pushing the globe to find alternative ways for energy generation. And since heating consumption in households is very high and it is the second largest sector of energy consumption after transport [39], it is very important if we could produce the demanded heat for households by using renewable energy sources.

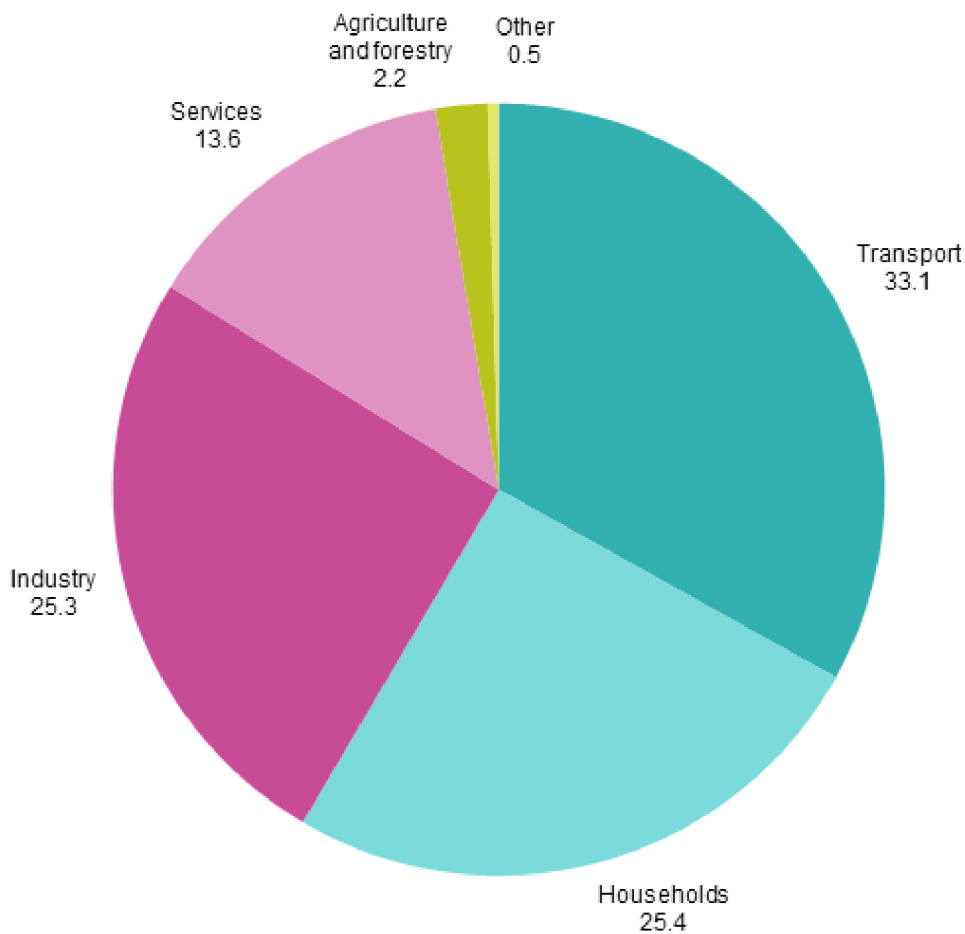

Figure 1-energy consumption according to EU-28 2015[39]

Among the most commonly used renewable energy sources for heating in buildings are boilers that take energy from biomass, which includes wood, pellets, straw or even waste. Other common heat sources include heat pumps that use air energy, ground energy, as well as water energy. In the following chapter I will be talking about heat pumps and biomass boilers.

## A.4.2. Heat pumps

### A.4.2.1. Principle of heat pumps

There is a large amount of low potential energy in the surrounding environment (in air, water and earth), this energy has low temperature that is not suitable for direct use. The principle of heat pump is to transfer the so-called low potential heat into useful heat. Therefore, heat pump is a device that does not produce thermal energy, but only converts it into a usable form.

The working substance is a refrigerant that is constantly circulating in the device and changing its state cyclically. When air or water is brought to the evaporator, the heat is removed from air or water and given to a cooling medium or a refrigerant which evaporates at low temperature and turns into a gaseous state. Then compressor draws in the cooling medium and compresses it. As the pressure increases, temperature also increases, it is thus "pumped" to a higher temperature level. Electrical energy is required for this step. This energy increases the thermal potential of the cooling medium. Then, it gives up its total heat in the condenser to the medium with higher temperature on the other side which is usually heating water or air. This will lead to the condensation of the refrigerant, which is then choked in the expansion valve, so the pressure comes back to its original value and this cycle is continuously repeated. [1]

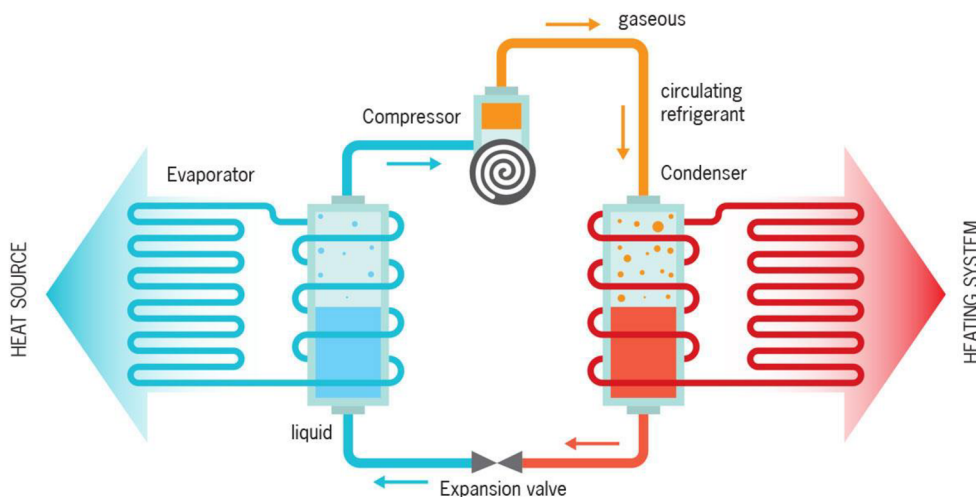

Figure 2-Principle of heat pumps[2]

The whole device of a heat pump for heating purpose can be divided into three main parts:

1. Primary circuit – it's the part that supplies low-potential heat energy from the source to the evaporator.

2. Refrigerant circuit – it is the main part that helps in transferring the energy to a higher temperatures level. Refrigerants are used in this circuit. [1]

3. Secondary circuit - the part that ensures heat distribution for heating purpose which contains usually heating water or air.

#### A.4.2.2. Basic components of heat pumps

##### 1. Compressor:

Compressor is the main working part of the heat pump, that fundamentally affects its efficiency. The compressor increases the pressure of the cooling medium from the pressure corresponding to the evaporating temperature to a value that corresponds to the condensing temperature in the condenser. It is usually powered by electricity, which increases the pressure and subsequently the temperature of the refrigerant. The energy in this way is transferred to a higher thermal level, which then can be used for heating and hot water preparation. Two types of compressors are normally used in heat pumps rotary compressor and scroll compressor. The rotary compressors are usually more stressed, and thus have shorter lifetime than scroll compressor, but they are cheaper that's why they are still commonly used.[7]



Figure 3 - rotary compressor for heat pump[5]

##### 2. Condenser:

This part transfers heat from the cooling medium(refrigerant) to the heating medium of the system by a heat exchanger. The exchanger can be brazed plate or Tubular. During this process heat energy is taken from the refrigerant which causes it to condensate.[7]



Figure 4 - tube heat exchanger[1]



Figure 5 - brazed plate heat exchanger[1]

### 3. Evaporator:

Evaporator is similar to a heat exchanger. On one side the low potential energy source passes, that could be water, or air and on the other side the cooling medium flows. Plate, ribbed and tubular heat exchangers are used for liquid medium, and tubular heat exchangers are used for air.

The heat from the low potential energy source is transferred to the cooling medium, which causes it to gain low temperature and then the cooling medium with low temperature and at low pressure evaporates. The evaporation causes the refrigerant to even gain more heat through the walls of evaporator, but still its temperature is low to be used in heating.[7]

### 4. Expansion valve

It's necessary to maintain the difference between high pressure side and low pressure side of the circuit and that's fulfilled by the using of expansion valve. Expansion valves are thermostatically or electronically controlled. The function of an expansion valve is to regulate cooling medium flow from the condenser to evaporator. It also makes sure that the cooling medium is fully evaporated before it enters to the compressor.[7]





Figure 6-thermostatically controlled expansion valve[1]



Figure 7-electronic expansion valve[6]

#### A.4.2.3. Refrigerants and their effect on the environment

Refrigerants are substances used in refrigeration devices, as well as in heat pumps. Old refrigerants used in the past were harmful to ozone layer and caused a big damage to it, therefore they were prohibited to be used. Due to the fact that refrigerants contribute to global warming, the European union regulates their use. [8]

We have two important indicators for the effect of refrigerants on the environment. First indicator is GWP (global warming potential), that is used to measure the impact of a substance such as a refrigerant on global warming, which means the increase in earth atmosphere temperature due to the heat being bounced back to earth's surface and trapped in the atmosphere. GWP expresses how many times a given gas contributes to the greenhouse more than CO<sub>2</sub> gas. We can define the value of GWP by knowing the lifetime of a gas and its radiation properties.[9]

Second indicator is ODP (ozone depletion indicator) which indicates the potential of a particular refrigerant to deplete the ozone layer, relative to the reference refrigerant, which is R11, and which has ODP = 1. If a refrigerant has ODP value higher than zero, it should be regulated. [8]

Types of refrigerants include:

##### 1. Freon refrigerants

The most famous freon refrigerants include those with the generic designation CFC or HCFC, which were widely used in the second half of the 20th century. Because they contain chlorine and contributes to the global warming by destroying ozone layer, both CFCs and HCFCs are currently banned. Other Examples of these types of refrigerants include R11, R12, R13, R113, R114, R500, R124, R22, R401 and others.[8]

## 2. F-gases

Unlike the previous type of refrigerants, these refrigerants don't contain chlorine and therefore don't endanger ozone layer. However, both freons and F-gases contribute to the global warming [8].

One type of F-gas is the partially fluorinated hydrocarbon HFC, which is a group of substances containing carbon, hydrogen, and fluorine. They are artificial, odourless and colourless. In the following table there are examples of HFC refrigerants with the value of GWP.[8]

Table 1 – Types of HFC refrigerants and their GWP value[8]

Type of refrigerant	ODP	GWP
R-134a	0	1430
R-23	0	14800
R-32	0	675
R404A	0	3922
R407A	0	2107
R407B	0	2804
R407C	0	1774
R410A	0	2088
R417A	0	2346
R422D	0	2729
R427A	0	2138
R437A	0	1805
R507	0	3985
R508A	0	13214
R508B	0	13396

## 3. HFO

Another type of F-gases are HFO or Hydrofluoro-Olefins, which are new refrigerants that are produced on the basis of unsaturated hydrocarbons of alkenes and one double bond

between the carbon atoms in the molecule. Refrigerant R1234yf is one of the most common examples of this group. They are characterized by a very low GWP value and ODP equal to zero.[8]

#### 4. Natural refrigerants

They are created during natural biochemical processes. They are the most environmentally friendly from all previous types because they do not harm ozone layer and do not even contribute to global warming, but only slightly in some cases. Natural refrigerants were used mainly in the 1950s, before other types of refrigerants such as freon refrigerants were created. Nowadays, they are being used again. Among the natural refrigerants we have ammonia, carbon dioxide, propane, isobutane, and ethane. Natural refrigerants other than carbon dioxide have one disadvantage, and that is flammability and toxicity.[8]

##### A.4.2.4. Types of heat pumps

According to the potential source of energy, we divide heat pumps into four types:

1. Air to water heat pump: heat energy is taken from the outside air and subsequently used for heating system and hot water preparation. It is the most common type of heat pumps today, and the most suitable variant for a family house and small apartment buildings, since it doesn't require intensive earthwork. In the lowland areas in the Czech Republic, the average temperature is around 4 ° C in winter which makes it ideal for the usage of air to water heat pump. Air to water heat pumps can overcome periods of lower temperatures either by their specific cooling circuit design or by the use of an additional heat source such as an integrated electric heating element, which is activated in the most unfavourable conditions to help the heat pump cover all required amount of heat.[10],[12]

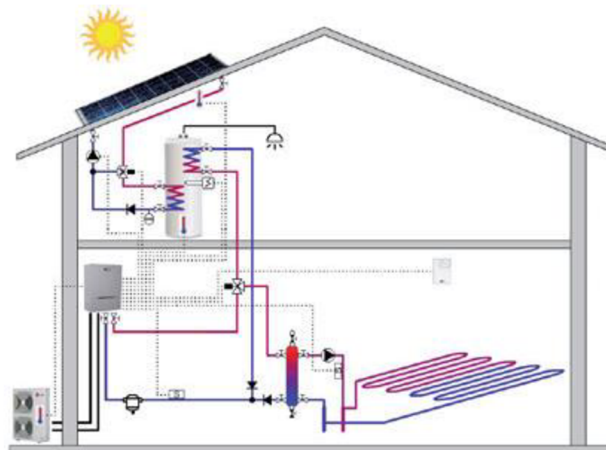

Figure 8-air to water heat pump[15]

2. Ground to water heat pump: this type of heat pumps uses energy from the ground. It has two variants [10],[13]:
  - A. Variant with deep boreholes: In this design, deep drilling of boreholes is performed to a depth of 80 - 200 meters. A plastic tube with flowing medium which has non-freezing properties is installed to the borehole, which transfers

heat from the ground to the evaporator in the heat pump. The number and depth of boreholes depends on the required heat output and the type of soil. The advantage of using boreholes is that it needs less area than the variant with flat earth collector, however intensive earthwork is needed anyway and that makes it more expensive.

- B. Variant with flat earth collector: which lies in a depth of 1-2 meters. Ground collectors use the heat from the ground massif as well as the heat energy from sunlight, so this variant needs a bigger area than the previous variant.

The main advantages of ground to water heat pump are that it has steady performance throughout the year and the heating factor is higher than the one of air to water heat pump. As a result, electricity consumption is lower. The main disadvantages of ground to water heat pump are its higher price due to the earthwork involved and also the need of construction authorization for earthwork.



Figure 9-heat pump ground to water with boreholes[14]



Figure 10-heat pump ground to water with flat earth collector[14]

- 3. Water to water heat pump: Water-to-water heat pumps use groundwater as a low-potential heat source or less commonly streams. This type of heat pumps is also suitable for larger buildings where waste heat from technological processes is generated. Therefore, we do not encounter much of this type in family houses. For using the energy from groundwater, we must have two wells, one which is the source, from which we take groundwater to the evaporator, and other which is seepage well for draining of cooled water. Water quality must be checked if it fulfils specific requirements, and the distance of both wells should be at least 10 m. In this system, we must also ensure the necessary water flow to prevent water from freezing in the evaporator.

The realization of such wells is again expensive, like drilling deep boreholes, and we need construction authorization. This in turn brings us stable performance and a high heating factor.[11]



Figure 11-water to water heat pump[11]

4. Air to air heat pump: this type of heat pumps has the same low-potential heat source as air-to-water heat pump. The difference is in that, it doesn't use water as heat transferring medium, but it transfers heat to the inside air directly which makes its costs lower than previous pumps.

However, the disadvantages of this type of heat pumps are that it can be noisy, we cannot use it for hot water preparation, and it is not suitable for a building with many rooms. Therefore, this type of heat pumps is used as an additional source of heating to other boilers. Also, it involves the construction of air distribution system under ceiling.[16]

#### A.4.2.5. Modes of operation

We can distinguish the following modes of operation of a heat pump [17]:

- 1) Monovalent operation: the only source of heat for heating, and hot water preparation is the heat pump. The heat pump works throughout the heating season, with frequent starts and shutdowns. The acquisition costs of such a heat pump are too high, due to the fact that in monovalent mode the maximum output of the heat pump is designed for the most unfavourable conditions in winter, since the heat pump is the only source of heat used, and it must cover all heat demands even during the coldest days in winter.

- 2) Alternatively bivalent operation: during the most unfavourable conditions (the coldest days in winter) the heat pump shuts down and another heat source such as a boiler is turned on. So, the heat pump in this mode works only during a part of the heating season. Usually, bivalent point for an air to water heat pump lies within temperature range -7 to -10 °C.

- 3) Parallel-bivalent operation - The heat pump works all the time throughout the heating season, and during the lowest temperatures, when heat pump's output is not enough, another heat source such as a boiler or electric heating element is turned on so then both heat sources work simultaneously.

4) Partially parallel-bivalent operation – during heating seasons the heat pump and another heat source such as a boiler are running together, but during the lowest temperatures only the heat pump shuts down and the second heat source keeps working.

5) Monoenergetic operating mode, which means that heat loss of the building and heat output needed for hot water preparation are largely covered by the heat pump, but during the most unfavourable temperatures electric heating is turned on.[40]

It's called monoenergetic because one form of energy, is used to run the main and the additional heat sources, so electricity is used to run the compressor of the heat pump, and also to run any additional electric heating element. So for example, if we used together with the heat pump additional heat source such as a wood gasification boiler, it would no longer be a monoenergetic operation.

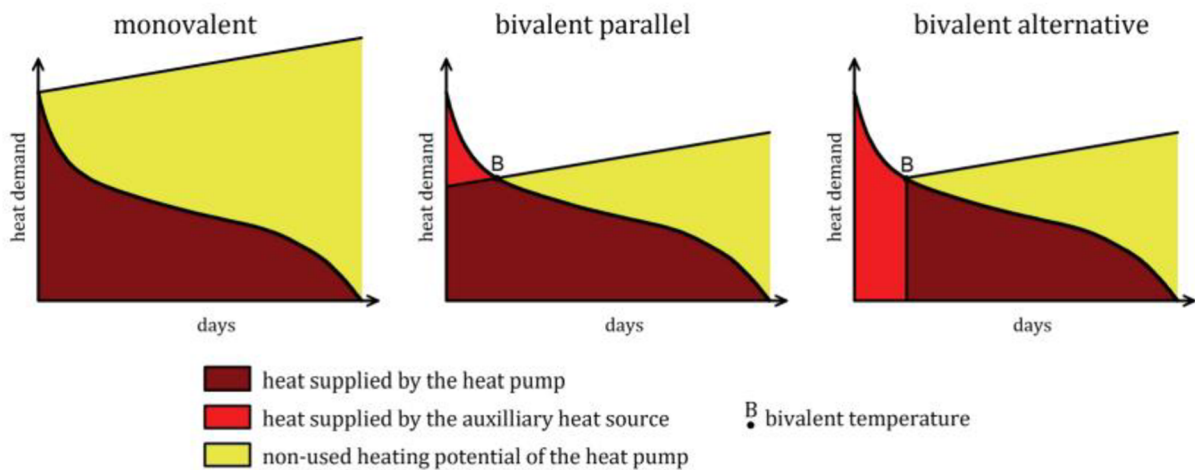

Figure 12-modes of operation of a heat pump[18]

#### A.4.2.6. Heating factor

Heating factor COP or coefficient of performance expresses the efficiency of a heat pump. Which is the ratio between the total energy output and the total electrical energy supplied for running the device. Depending on the type of heat pump, its value is normally within the range from 2,5 to 5. [1]

$$COP = \frac{\Phi}{P_c + P_{aux}} \quad [3]$$

where

$\Phi$  – total heat output of the heat pump [kW]

$P_c$  - compressor electrical input [kW]

$P_{aux}$  - electrical input required for overcoming evaporator and condenser pressure losses, evaporator defrosting, and for heat pump's own regulation [kW]

We can determine heating factor from laboratory measurements under different operating conditions which is done by choosing various evaporator input temperature, and output condenser temperature to cover a sufficient operating range. For air source heat pumps, we test the largest number of points, operating over a wide temperature range at the evaporator input (five values from -15 to +12 °C), while in the case of heat pumps taking heat from water, they are usually tested only for two evaporator input temperatures. (10 °C, 15 °C).[4]

Table 2 - Possible test combinations of evaporator input and condenser output temperatures defined in ČSN EN 14511. [3]

$t_{k2} / t_{v1}$	water-water		ground-water			air-water				
	10 °C	15 °C	-5 °C	0 °C	5 °C	-15 °C	-7 °C	2 °C	7 °C	12 °C
35 °C										
45 °C										
55 °C										
65 °C										

The nominal heating factor COP of a heat pump is always tested under standard conditions that are defined depending on the type of heat pump as follow [4]:

- Air-water A2 / W35 (evaporator input air temperature 2 °C, condenser heating water temperature 35 °C)
- Ground-water B0 / W35 (evaporator input temperature of brine 0 °C, condenser heating water temperature 35 °C)
- Water-water W10 / W35 (evaporator input temperature of water 10 °C, condenser heating water temperature 35 °C)

Table 3 - Minimum heating factors of heat pumps [4]

Heat pump	Standard conditions	Requirement
air-water	A2/W35	$COP > 3.1$
ground-water	B0/W35	$COP > 4.3$
water-water	W10/W35	$COP > 5.1$

#### A.4.2.7. Heat pumps regulation

Equithermal regulation is very important to be used when heating by heat pumps. It increases the efficiency of heat pumps, which in return, reduces heat costs, and protect the environment. The equithermal regulation is built on the relationship between the actual outdoor air temperature, thermal properties of the heating element such as radiator, floor heating system, etc. that transfers heat to the room, the temperature of heating water flowing into this element, the temperature of heating water flowing out of the element and the amount of heating water flowing. As the outdoor temperature decreases, the temperature of the supplied heating water in the given heating system

increases to provide more heat into the rooms, which covers the extra heat loss due to lower outdoor temperatures or greater room heat loss. It's important to realize that this relationship is not direct proportion of straight line.[37]

To calculate the equithermal curve of regulation, it is possible to use online calculation tool on the portal TZB-info.[38]

Equithermal curves describe the interdependence of heating water temperature, room temperature and outdoor temperature. Based on the required room temperature, a certain curve can be selected, and the heating water temperature can be regulated according to the outdoor temperature.

To the specified calculation tool, we have to enter the data about indoor calculation temperature, minimum outdoor calculation temperature, maximum heating water supply temperature, maximum return water temperature, the system temperature exponent, which depends on the type of heating element, the condensing mode temperature and the user outdoor calculation temperature, and we can get equithermal curves such as in the following example – red curve represents the temperature of heating water, dark blue curve represents the temperature of return water, green curve represents the average temperature in heating system, light blue line represents condensation temperature, and brown line represents user's outdoor temperature. [37],[38]

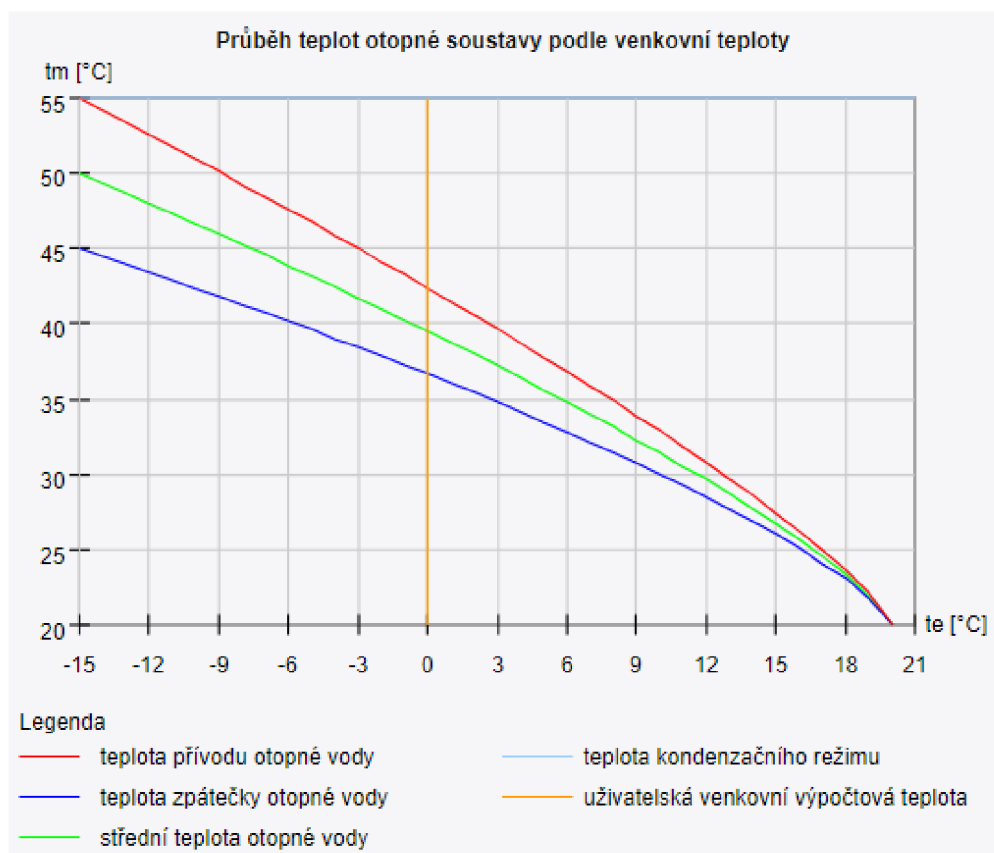



### A.4.3. Biomass boilers

#### A.4.3.1. Biomass definition and commercial forms

Biomass is renewable organic material that comes from plants mainly, and also from animals. These include mainly wood, wood waste and wood products such as briquettes, pellets, which are most often used for heating of family houses, residential and administrative buildings. In industrial and agricultural operations straw and wood chips are widely used. Biomass also include animal excrement.

It's important to understand that Biomass consumption for heating is not emission-free, but it is CO<sub>2</sub> neutral, because during the lifetime of the plant from which the biomass was obtained, it consumes the same amount of CO<sub>2</sub> as it produces during the combustion process. And that makes it a green source of energy that doesn't contribute to the global warming. [19]

Commercial forms of biomass [20]:

They are classified according to their size and way of preparation into:

1. Pellets: with a diameter up to 25 mm. Prepared by mechanical pressing.
2. Briquettes: with a diameter more than 25 mm. Prepared by mechanical pressing.
3. Sawdust: with size 1 to 5 mm. Prepared by sharp cutting.
4. Shavings: with a size of 1 to 30 mm. Prepared by planing the wood with sharp tool.
5. Wood chips: with a size 5 to 100 mm. Prepared by cutting with sharp tools.
6. Firewood: with a size of 100 to 1000 mm. Prepared by cutting with sharp tools.



Figure 13-wood briquettes[22]



Figure 14-wood pellets[21]



Figure 15-sawdust on the left - wood shavings on the right[23]



Figure 16-firewood[24]



Figure 17-wood chips[25]

During the preparation of the project, it is necessary to find out more detailed information about the parameters and properties of the expected biomass used, such as [29]:

- calorific value
- bulk density
- size of pieces
- water content
- ash content
- volatile combustibles content
- chemical composition of combustibles
- chemical composition of ashes
- properties of ashes
- biomass price at the factory (without transport)
- the price of biomass with transport
- real delivery options and prices
- method of storage, capacity of storage and space

#### A.4.3.2. Ways of biomass usage

##### 1. Direct combustion:

it is necessary to bring sufficient amount of oxygen into the combustion process so that all combustible components of fuel especially carbon and hydrogen are burned. The result of burning process is heat generation that can be used for heating and hot water preparation. The advantage of this process is that it is not necessary to do special treatment of biomass and it is possible to use fuel with higher moisture content. It is necessary to pay considerable attention to the optimal conditions during combustion and when cleaning the flue outlets, where it is necessary to control the emission of carbon monoxide and solids, in some cases also the emission of nitrogen oxides and organic substances. Direct combustion devices can range in power from a few kW to tens of MW. This type of combustion is most often used in classic biomass boilers, such as automatic wood pellet boilers, and fireplaces.[27]

##### 2. Pyrolysis

Pyrolysis is thermal decomposition of organic substances that takes place with limited to no supply of oxygen. During pyrolysis, the organic compounds are heated above

the thermal stability limit which results in their decomposition into low molecular weight products and solid residues.

Pyrolysis is divided according to the temperatures, during which the biomass is being burned, into:

1. low temperature (<500 °C),
2. medium temperature (500 - 800 °C),
3. high temperature (> 800 °C).

Rapid pyrolysis is one type of pyrolysis, and it is a very modern and effective technological process, which turns biomass such as wood and waste materials into substances of higher energy levels such as gases, solids, and liquids. Bio-oil is a product of rapid pyrolysis, and it can be used, after further purification and treatment, in industry, or for diesel engines and also it can be used as fuel oil for boilers or as fuel for electricity generation.[27]

### **3. Gasification**

“Gasification is the course of several processes in which hydrocarbons with water vapor are gradually oxidized from the solid fuel and subsequently reduced to flammable gases, distillation products and mineral residue”.[28]

Gasification happens with limited amount of oxygen at temperatures in the range (800 °C to 900 °C) under atmospheric pressure, during which organic compounds are converted into a gas.

Currently, two basic methods are used for biomass gasification, they are gasification in fixed bed generators and gasification in fluid generators. Both methods happen under atmospheric pressure. The calorific value of energy gas produced by biomass gasification ranges from 4 to 6 MJ / m<sup>3</sup>, which can be used directly in combustion processes in classical boiler burners, or after purification, it can be used in the combustion chambers of combustion turbines and combustion engines.[27]

The processes of gasification are divided into the following zones[28]:

fuel drying - fuel heating with water evaporation,  
pyrolysis - thermal decomposition of fuel into gas, condensing vapours, semi-coke, and then further thermal breakdown of vapor into gas and solid carbon,  
oxidation - partial oxidation of flammable gases, and solid carbon,  
reduction - gasification of solid carbon by steam or carbon dioxide.

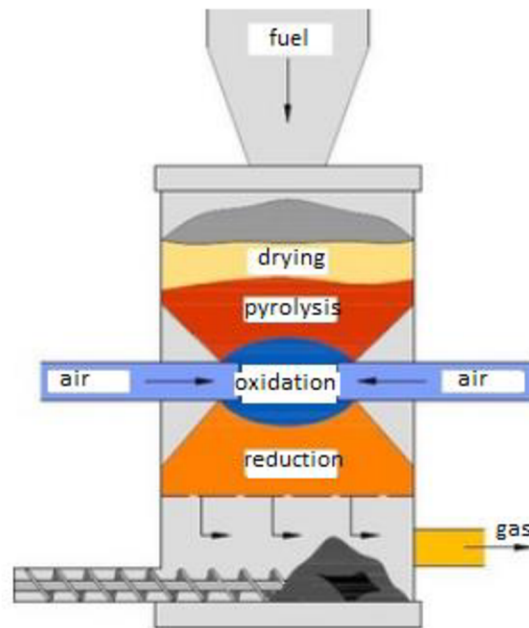

Figure 18-processes of gasification inside of a reactor [28]

One of the most common examples of gasification usage is wood gasification boiler.

#### 4. Carbonization

It is a process of thermal conversion of biomass into charcoal that happens with no air supply. Charcoal is considered a renewable energy source due to the short carbon cycle comparing to fossil fuels. Charcoal contains small percentage of sulphur, it has a specific weight about  $0,2 \text{ kg / m}^3$ , the ignition point is between  $300 - 400 \text{ }^\circ\text{C}$ , and calorific value around  $27 \text{ MJ / kg}$ . [27]

#### A.4.3.3. Common types of biomass boilers

##### a) Automatic wood pellet boilers:

these are widely common boilers in objects such as family houses, offices, apartment buildings, and workshops. They are highly efficient with efficiency around 90% and more. Heat output of a pellet boiler of a family house is usually in the range of 10 to 30 kW and it can be automatically regulated according to the required temperature in the range of 30 to 100%.

Heat from pellets combustion is transferred to the heating medium, which is often water, and then to the heating system and hot water preparation. Boiler output and other burner functions are controlled by an electronic control unit.

Burner operation is fully automatic including automatic ignition and feeding. The pellets are transferred to the boiler automatically by an auger or pneumatic conveyor, which is connected to the pellet storage or container. In figure 21 we can see a simple scheme of the function of an automatic boiler.

##### Pellets storage

Pellets are usually stored inside of the building, in a separate storeroom with sloping floor  $35-40^\circ$  into the collecting gutter, or in a pellet storage container, made of textile, metal or other material. These two options are usually connected to the boiler by a conveyor or a feeder which helps in automatic feeding of pellets to the boiler.

However, sometimes pellets can be stored in bags near the boiler which are then gradually filled into a smaller boiler fuel storage.[30]

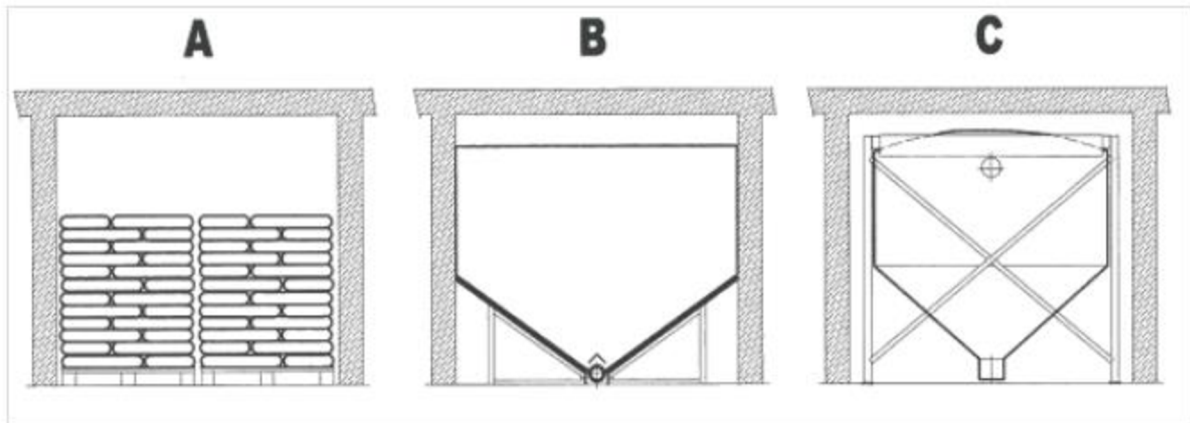

Figure 19- basic ways of pellet storing[36] A. Pellet bags. B. Pellet storeroom. C. Pellet container. Wood pellet boilers should be maintained regularly. Heat exchanger should be cleaned, and ash should be removed regularly from the boiler. Some boilers have a function of automatic ash cleaning.



Figure 20-automatic pellet boiler[30]

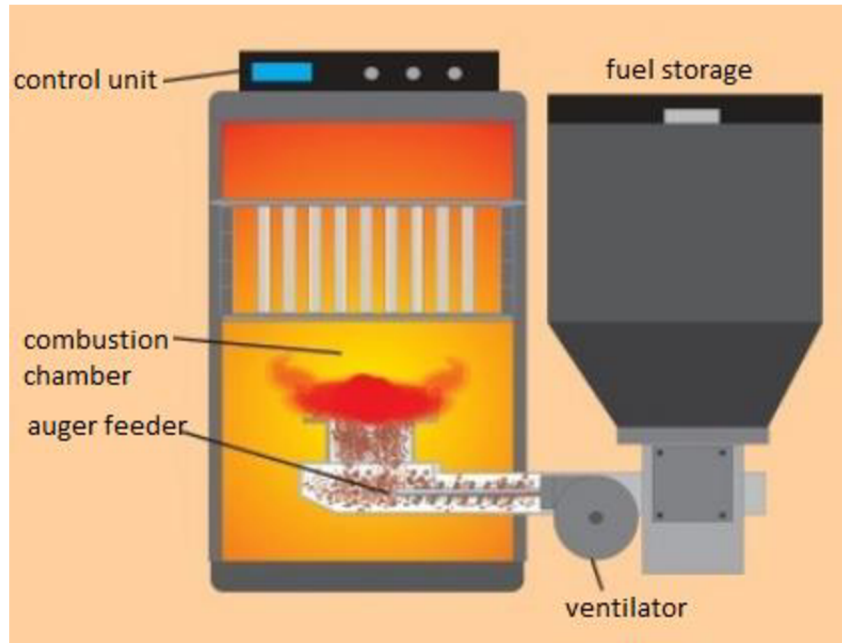

Figure 21-function scheme of automatic boiler[31]

**B) Gasification boilers[31]:**

Gasification boilers use wood mainly as a fuel which passes through gasification process. At first, the wood in boiler's fuel storage tank is dried and volatile combustibles(gases) are released from dry wood. The released volatile combustibles pass through the nozzle into the combustion chamber. Combustion air is usually supplied to the nozzle as well as to the fuel tank by means of a ventilator. The flue gases are discharged through the exchanger into the chimney, see figure 18 and figure 23.

Time interval of fuel storage refilling is determined by the volume of the fuel storage, the degree of its filling and the properties of the fuel such as calorific value, combustion heat, etc...



Figure 22- gasification wood boiler, ATMOS[32]

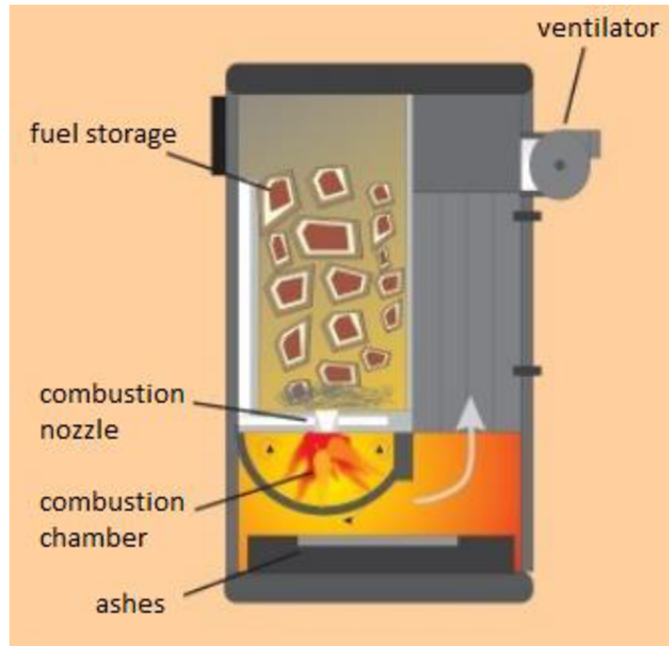

Figure 23-function scheme of gasification boiler[31]

Refilling of fuel storage is usually done manually and regularly which makes it one disadvantage comparing to the automatic pellet boilers with auger or pneumatic conveyer, so they are mainly used in smaller houses.

The wood must be burned as dry as possible, at least with a maximum humidity of up to 15%. Damp wood releases vapor during combustion, which causes condensation, which can be damaging to the boiler.

### C) Stoves and fireplaces

These heat sources are mainly used in households and kitchens as an additional source of heat. They are designed primarily for wood fuel such as wood logs and briquettes.

We also have pellet stoves, which are used for heating individual rooms, smaller apartments and low-energy houses. If the pellet stove is supplemented with a hot water exchanger, it can also be used for heating other rooms or for preparation of hot water.[33]



Figure 24-wood burning fireplace[34]



Figure 25-wood burning stove[35]

### **Conclusion:**

Using renewable energy sources in heating of buildings and hot water preparation is very important way to control global warming and protect the environment. Heat pumps is one great way of how we can extract clean energy from air, water and ground. When choosing water or ground source heat pump, it's very important to remember the earthwork it involves and the need of construction authorization. To design a suitable heat pump for a building, it's important to study and know possible modes of operations, as well as heat output of the heat pump, heat losses of the building, and heat demand for hot water preparation. It's also important to determine heating factor of a heat pump, as it's a great indicator of heat pump's efficiency. When choosing a refrigerant for a heat pump, it is necessary to choose a refrigerant that complies with the current law and regulations of environment protection, and it is important to control GWP and ODP indicators.

Biomass is a clean renewable energy source which is CO<sub>2</sub> neutral. I talked about the common commercial forms of biomass. It's important to know biomass source parameters and properties during the preparation of a project.

Biomass boilers are another way of using renewable energy sources, in addition to heat pumps. Automatic wood pellet boilers are highly efficient and commonly used in houses as well as apartment buildings. It's important to study space possibilities before deciding for a pellet boiler, as storing space of pellets is required. Wood gasification boilers are commonly used in smaller houses and objects. Wood stoves and fireplace are more used as additional energy source in households.



## B. Application of the topic at the solved building including theoretical solution of used physical equations

### B.1. Calculation of heat output

#### B.1.1. Calculation of heat transfer coefficient $U$ of building structures [W/m<sup>2</sup>.K]

Heat transfer coefficient  $U$  expresses the total heat exchange between the rooms that are separated from each other by a structure with a certain thermal resistance.

$$U = \frac{1}{R_T} \quad [\text{W/m}^2.\text{K}]$$

Where  $U$ ... heat transfer coefficient [W/m<sup>2</sup>.K]

$R_T$ ... thermal resistance to heat transfer [m<sup>2</sup>.K / W]

Assessment of the condition

$$U \leq U_{N,20}$$

Where  $U$  ..... heat transfer coefficient of the building structure [W/m<sup>2</sup>.K]

$U_{N,20}$  ..... required value of heat transfer coefficient [m<sup>2</sup>.K / W] given by the standard ČSN 73 0540-2: 2011, thermal protection of buildings.

Thermal resistance of a layer

$$R_j = \frac{d_j}{\lambda_j} \quad [\text{m}^2.\text{K} / \text{W}]$$

Where  $R_j$ ... thermal resistance of  $j$ -th layer [m<sup>2</sup>.K / W]

$d_j$ ... thickness of the  $j$ -th layer of the structure [m]

$\lambda_j$ ... design thermal conductivity coefficient of material [W/ m.K]

Thermal resistance to heat transfer of a structure

$$R_T = R_{si} + R_j + R_{se} \quad [\text{m}^2.\text{K} / \text{W}]$$

Where

$R_T$ ... total thermal resistance to heat transfer of the structure [m<sup>2</sup>.K / W]

$R_{si}$ ... thermal resistance to heat transfer on the internal surface of the structure [m<sup>2</sup>.K / W]. Values are taken from the standards ČSN 73 0540-3.

$R_{se}$ ... thermal resistance to heat transfer on the external surface of the structure [m<sup>2</sup>.K / W]. Values are taken from the standards ČSN 73 0540-3.

$R_j$ ... thermal resistance of  $j$ -th layers [m<sup>2</sup>.K / W]

Calculations of thermal resistance and heat transfer coefficient of all structures of the apartment building:

<b>C1.a - Ceiling separating heated space from unheated part of basement</b>			
Layer	d(m)	$\lambda$ (W/m.K)	R(m <sup>2</sup> .k/W)
Ceramic flooring	0,010	1,010	0,010
Cement adhesive	0,002	-	-
Cement screed cemix 20 MPa coarse	0,040	1,430	0,028
Separation layer of PE foil, lithoplast penefol 500	0,001	-	-
Sound insulation	0,030	0,037	0,811
Reinforced concrete slab	0,220	1,430	0,154
Thermal insulation	0,050	0,042	1,190
Lime plaster	0,010	0,880	0,011
		$\Sigma$	2,204

$$\begin{aligned}
 R_{si} &= 0,170 \text{ m}^2 \cdot \text{k/W} \\
 R_{se} &= 0,040 \text{ m}^2 \cdot \text{k/W} \\
 \Sigma R &= 2,204 \text{ m}^2 \cdot \text{k/W} \\
 R_t = R_{si} + \Sigma R + R_{se} &= 2,414 \text{ m}^2 \cdot \text{k/W} \\
 \mathbf{U_t = 1/R_t} &= \mathbf{0,414 \text{ W/m}^2 \cdot \text{K}} \\
 U_{pas,20} &= 0,300 \text{ W/m}^2 \cdot \text{K} \\
 \mathbf{U_{N,20}} &= \mathbf{0,600 \text{ W/m}^2 \cdot \text{K}} \\
 U_{rec,20} &= 0,400 \text{ W/m}^2 \cdot \text{K} \\
 \mathbf{U_t \leq U_{N,20} \quad \text{it complies}}
 \end{aligned}$$

<b>C1.b - Ceiling separating heated space from heated part of basement</b>			
Layer	d(m)	$\lambda$ (W/m.K)	R(m <sup>2</sup> .k/W)
Ceramic flooring	0,010	1,010	0,010
Cement adhesive	0,002	-	-
Cement screed cemix 20 MPa coarse	0,040	1,430	0,028
Separation layer of PE foil, lithoplast penefol	0,001	-	-
Sound insulation	0,030	0,037	0,811
Reinforced concrete slab	0,220	1,430	0,154
Thermal insulation	0,050	0,042	1,190
Lime plaster	0,010	0,880	0,011
		$\Sigma$	2,204

$$\begin{aligned}
 R_{si} &= 0,170 \text{ m}^2 \cdot \text{k/W} \\
 R_{se} &= 0,040 \text{ m}^2 \cdot \text{k/W} \\
 \Sigma R &= 2,204 \text{ m}^2 \cdot \text{k/W} \\
 R_t = R_{si} + \Sigma R + R_{se} &= 2,414 \text{ m}^2 \cdot \text{k/W} \\
 \mathbf{U_t = 1/R_t} &= \mathbf{0,414 \text{ W/m}^2 \cdot \text{K}} \\
 \\ \\
 \mathbf{U_{N,20}} &= \mathbf{2,200 \text{ W/m}^2 \cdot \text{K}} \\
 U_{rec,20} &= 1,450 \text{ W/m}^2 \cdot \text{K} \\
 \mathbf{U_t \leq U_{N,20} \quad \text{it complies}}
 \end{aligned}$$

<b>C2 - Inset balcony floor above basement</b>			
Layer	d(m)	$\lambda$ (W/m.K)	R(m <sup>2</sup> .k/W)
Ceramic anti-freezing flooring	0,010	1,010	0,010
Cement adhesive	0,002	-	-
Water proofing layer	0,004	-	-
penetration layer	-	-	-
cement screed	0,050	1,430	0,035
Separation layer	-	-	-
Sloping layer of thermal insulation XPS	0,120	0,035	3,429
Reinforced concrete slab	0,220	1,430	0,154
Thermal insulation	0,050	0,042	1,190
Lime plaster	0,010	0,880	0,011
		$\Sigma$	4,829

$$\begin{aligned}
 R_{si} &= 0,170 \text{ m}^2 \cdot \text{k/W} \\
 R_{se} &= 0,040 \text{ m}^2 \cdot \text{k/W} \\
 \Sigma R &= 4,829 \text{ m}^2 \cdot \text{k/W} \\
 R_t = R_{si} + \Sigma R + R_{se} &= 5,039 \text{ m}^2 \cdot \text{k/W} \\
 \mathbf{U_t = 1/R_t} &= \mathbf{0,198 \text{ W/m}^2 \cdot \text{K}} \\
 U_{pas,20} &= 0,150 \text{ W/m}^2 \cdot \text{K} \\
 \mathbf{U_{N,20}} &= \mathbf{0,240 \text{ W/m}^2 \cdot \text{K}} \\
 U_{rec,20} &= 0,160 \text{ W/m}^2 \cdot \text{K}
 \end{aligned}$$

**$U_t \leq U_{N,20}$  it complies**

<b>C3 - internal ceiling separating spaces with temperature difference to 5 °C</b>			
Layer	d(m)	$\lambda$ (W/m.K)	R(m <sup>2</sup> .k/W)
Ceramic flooring	0,010	1,010	0,010
Cement adhesive	0,002	-	-
Cement screed cemix 20 MPa coarse	0,040	1,430	0,028
Separation layer of PE foil, lithoplast penefol 500	0,001	-	-
Sound insulation	0,030	0,037	0,811
Reinforced concrete slab	0,220	1,430	0,154
Lime plaster	0,010	0,880	0,011
		$\Sigma$	1,014

$$\begin{aligned}
 R_{si} &= 0,170 \text{ m}^2 \cdot \text{k/W} \\
 R_{se} &= 0,100 \text{ m}^2 \cdot \text{k/W} \\
 \Sigma R &= 1,014 \text{ m}^2 \cdot \text{k/W} \\
 R_t = R_{si} + \Sigma R + R_{se} &= 1,284 \text{ m}^2 \cdot \text{k/W} \\
 \mathbf{U_t = 1/R_t} &= \mathbf{0,779 \text{ W/m}^2 \cdot \text{K}} \\
 \mathbf{U_{N,20}} &= \mathbf{2,200 \text{ W/m}^2 \cdot \text{K}} \\
 U_{rec,20} &= 1,450 \text{ W/m}^2 \cdot \text{K}
 \end{aligned}$$

**$U_t \leq U_{N,20}$  it complies**

<b>F - Floor on the ground</b>			
Layer	d(m)	$\lambda$ (W/m.K)	R(m <sup>2</sup> .k/W)
PVC flooring	0,003	-	-
Adhesive	0,002	-	-
Cement screed cemix 20 MPa coarse	0,020	1,430	0,014
Seperation layer of PE foil	-	-	-
Thermal insulation EPS grey 100	0,100	0,034	2,933
Water proofing layer	-	-	-
Penetration primer of asphalt emulsion	-	-	-
Oversite concrete	0,140	1,200	0,117
		$\Sigma$	3,063

$$R_{si} = 0,170 \text{ m}^2 \cdot \text{k/W}$$

$$R_{se} = 0,000 \text{ m}^2 \cdot \text{k/W}$$

$$\Sigma R = 3,063 \text{ m}^2 \cdot \text{k/W}$$

$$R_t = R_{si} + \Sigma R + R_{se} = 3,233 \text{ m}^2 \cdot \text{k/W}$$

$$U_t = 1/R_t = 0,309 \text{ W/m}^2 \cdot \text{K}$$

$$U_{pas,20} = 0,220 \text{ W/m}^2 \cdot \text{K}$$

$$U_{N,20} = 0,450 \text{ W/m}^2 \cdot \text{K}$$

$$U_{rec,20} = 0,300 \text{ W/m}^2 \cdot \text{K}$$

**$U_t \leq U_{N,20}$  it complies**

<b>R- Flat roof</b>			
Layer	d(m)	$\lambda$ (W/m.K)	R(m <sup>2</sup> .k/W)
water proofing of pvc-p plastic foil, $\mu=15000$	0,002	-	-
Separation layer of geotextile, polypropylene	0,002	-	-
Thermal insulation of isover mineral wool	0,300	0,043	6,993
Vapour barrier of SBS modified bitumen felt with supporting Al foil and fibreglass	0,050	-	-
Reinforced concrete slab	0,220	1,430	0,154
Lime plaster	0,015	0,880	0,017
		$\Sigma$	7,164

$$R_{si} = 0,170 \text{ m}^2 \cdot \text{k/W}$$

$$R_{se} = 0,040 \text{ m}^2 \cdot \text{k/W}$$

$$\Sigma R = 7,164 \text{ m}^2 \cdot \text{k/W}$$

$$R_t = R_{si} + \Sigma R + R_{se} = 7,374 \text{ m}^2 \cdot \text{k/W}$$

$$U_t = 1/R_t = 0,136 \text{ W/m}^2 \cdot \text{K}$$

$$U_{pas,20} = 0,150 \text{ W/m}^2 \cdot \text{K}$$

$$U_{N,20} = 0,240 \text{ W/m}^2 \cdot \text{K}$$

$$U_{rec,20} = 0,160 \text{ W/m}^2 \cdot \text{K}$$

**$U_t \leq U_{N,20}$  it complies**

<b>S1- Peripheral wall to the exterior</b>			
Layer	d(m)	$\lambda$ (W/m.K)	$R$ (m <sup>2</sup> .k/W)
Lime plaster	0,010	0,880	0,011
Porotherm ceramic blocks	0,440	0,129	3,419
Thermal insulation of EPS Greywall	0,150	0,034	4,412
Lime plaster	0,010	0,880	0,011
		$\Sigma$	7,853

$$R_{si} = 0,130 \text{ m}^2 \cdot \text{k/W}$$

$$R_{se} = 0,040 \text{ m}^2 \cdot \text{k/W}$$

$$\Sigma R = 7,853 \text{ m}^2 \cdot \text{k/W}$$

$$R_t = R_{si} + \Sigma R + R_{se} = 8,023 \text{ m}^2 \cdot \text{k/W}$$

$$U_t = 1/R_t = 0,125 \text{ W/m}^2 \cdot \text{K}$$

$$U_{pas,20} = 0,180 \text{ W/m}^2 \cdot \text{K}$$

$$U_{N,20} = 0,300 \text{ W/m}^2 \cdot \text{K}$$

$$U_{rec,20} = 0,250 \text{ W/m}^2 \cdot \text{K}$$

**$U_t \leq U_{N,20}$  it complies**

<b>S2- Peripheral wall in touch with ground</b>			
Layer	d(m)	$\lambda$ (W/m.K)	$R$ (m <sup>2</sup> .k/W)
Lime plaster	0,010	0,880	0,011
Porotherm ceramic blocks	0,440	0,129	3,419
Waterproofing layer	-	-	-
Thermal insulation of XPS STYRODUR	0,150	0,035	4,286
		$\Sigma$	7,716

$$R_{si} = 0,130 \text{ m}^2 \cdot \text{k/W}$$

$$R_{se} = 0,000 \text{ m}^2 \cdot \text{k/W}$$

$$\Sigma R = 7,716 \text{ m}^2 \cdot \text{k/W}$$

$$R_t = R_{si} + \Sigma R + R_{se} = 7,846 \text{ m}^2 \cdot \text{k/W}$$

$$U_t = 1/R_t = 0,127 \text{ W/m}^2 \cdot \text{K}$$

$$U_{pas,20} = 0,220 \text{ W/m}^2 \cdot \text{K}$$

$$U_{N,20} = 0,450 \text{ W/m}^2 \cdot \text{K}$$

$$U_{rec,20} = 0,300 \text{ W/m}^2 \cdot \text{K}$$

**$U_t \leq U_{N,20}$  it complies**

**S3.a - Internal load bearing wall between rooms with temperature difference to 10 °C**

Layer	d(m)	$\lambda$ (W/m.K)	R(m <sup>2</sup> .k/W)
Lime plaster	0,010	0,880	0,011
Porotherm 30 Profi	0,300	0,175	1,714
Lime plaster	0,010	0,880	0,011
		$\Sigma$	1,737

$$R_{si} = 0,130 \text{ m}^2 \cdot \text{k/W}$$

$$R_{se} = 0,130 \text{ m}^2 \cdot \text{k/W}$$

$$\Sigma R = 1,737 \text{ m}^2 \cdot \text{k/W}$$

$$R_t = R_{si} + \Sigma R + R_{se} = 1,997 \text{ m}^2 \cdot \text{k/W}$$

$$U_t = 1/R_t = \mathbf{0,501 \text{ W/m}^2 \cdot \text{K}}$$

$$U_{N,20} = \mathbf{1,300 \text{ W/m}^2 \cdot \text{K}}$$

$$U_{rec,20} = 0,900 \text{ W/m}^2 \cdot \text{K}$$

**$U_t \leq U_{N,20}$  it complies**

**S3.b - internal load bearing wall separating rooms with temperature difference to 5 °C**

Layer	d(m)	$\lambda$ (W/m.K)	R(m <sup>2</sup> .k/W)
Lime plaster	0,010	0,880	0,011
Porotherm 30 Profi	0,300	0,175	1,714
Lime plaster	0,010	0,880	0,011
		$\Sigma$	1,737

$$R_{si} = 0,130 \text{ m}^2 \cdot \text{k/W}$$

$$R_{se} = 0,130 \text{ m}^2 \cdot \text{k/W}$$

$$\Sigma R = 1,737 \text{ m}^2 \cdot \text{k/W}$$

$$R_t = R_{si} + \Sigma R + R_{se} = 1,997 \text{ m}^2 \cdot \text{k/W}$$

$$U_t = 1/R_t = \mathbf{0,501 \text{ W/m}^2 \cdot \text{K}}$$

$$U_{N,20} = \mathbf{2,700 \text{ W/m}^2 \cdot \text{K}}$$

$$U_{rec,20} = 1,800 \text{ W/m}^2 \cdot \text{K}$$

**$U_t \leq U_{N,20}$  it complies**

**S3.c - Internal load bearing wall separating heated room from unheated room**

Layer	d(m)	$\lambda$ (W/m.K)	R(m <sup>2</sup> .k/W)
Lime plaster	0,010	0,880	0,011
Porotherm 30 Profi	0,300	0,175	1,714
Lime plaster	0,010	0,880	0,011
		$\Sigma$	1,737

$$R_{si} = 0,130 \text{ m}^2 \cdot \text{k/W}$$

$$R_{se} = 0,130 \text{ m}^2 \cdot \text{k/W}$$

$$\Sigma R = 1,737 \text{ m}^2 \cdot \text{k/W}$$

$$R_t = R_{si} + \Sigma R + R_{se} = 1,997 \text{ m}^2 \cdot \text{k/W}$$

$$U_t = 1/R_t = \mathbf{0,501 \text{ W/m}^2 \cdot \text{K}}$$

$$U_{N,20} = \mathbf{0,600 \text{ W/m}^2 \cdot \text{K}}$$

$$U_{rec,20} = 0,400 \text{ W/m}^2 \cdot \text{K}$$

**$U_t \leq U_{N,20}$  it complies**

<b>S4- internal non-load bearing wall between rooms with temperature difference to 5 °C</b>			
Layer	d(m)	$\lambda$ (W/m.K)	R(m <sup>2</sup> .k/W)
Lime plaster	0,010	0,880	0,011
Porotherm 11,5 profi	0,115	0,260	0,442
Lime plaster	0,010	0,880	0,011
		$\Sigma$	0,465

$$\begin{aligned}
 R_{si} &= 0,130 \text{ m}^2 \cdot \text{k/W} \\
 R_{se} &= 0,130 \text{ m}^2 \cdot \text{k/W} \\
 \Sigma R &= 0,465 \text{ m}^2 \cdot \text{k/W} \\
 R_t = R_{si} + \Sigma R + R_{se} &= 0,725 \text{ m}^2 \cdot \text{k/W} \\
 U_t = 1/R_t &= \mathbf{1,379 \text{ W/m}^2 \cdot \text{K}} \\
 U_{N,20} &= \mathbf{2,700 \text{ W/m}^2 \cdot \text{K}} \\
 U_{rec,20} &= 1,800 \text{ W/m}^2 \cdot \text{K}
 \end{aligned}$$

$U_t \leq U_{N,20}$  it complies

<b>S5- Wall between flats</b>			
Layer	d(m)	$\lambda$ (W/m.K)	R(m <sup>2</sup> .k/W)
Lime plaster	0,010	0,880	0,011
Solid concrete blocks	0,080	1,430	0,056
Sound proofing material	0,040	0,039	1,026
Solid concrete blocks	0,080	1,430	0,056
Lime plaster	0,010	0,880	0,011
		$\Sigma$	1,160

$$\begin{aligned}
 R_{si} &= 0,130 \text{ m}^2 \cdot \text{k/W} \\
 R_{se} &= 0,130 \text{ m}^2 \cdot \text{k/W} \\
 \Sigma R &= 1,160 \text{ m}^2 \cdot \text{k/W} \\
 R_t = R_{si} + \Sigma R + R_{se} &= 1,420 \text{ m}^2 \cdot \text{k/W} \\
 U_t = 1/R_t &= \mathbf{0,704 \text{ W/m}^2 \cdot \text{K}} \\
 U_{N,20} &= \mathbf{2,700 \text{ W/m}^2 \cdot \text{K}} \\
 U_{rec,20} &= 1,800 \text{ W/m}^2 \cdot \text{K}
 \end{aligned}$$

$U_t \leq U_{N,20}$  it complies

### Windows and doors:

#### W - triple glazing plastic window and roof hatch

$$U_{n,req} = 1,7 \text{ W/(m}^2 \cdot \text{k)} \geq U_w = 0,7 \text{ W/(m}^2 \cdot \text{k)}$$

$$U_{n,rec} = 1,2 \text{ W/(m}^2 \cdot \text{k)} \geq U_w = 0,7 \text{ W/(m}^2 \cdot \text{k)}$$

#### De1 – plastic entrance door with triple glazing

$$U_{n,req} = 1,7 \text{ W/(m}^2 \cdot \text{k)} \geq U_w = 0,7 \text{ W/(m}^2 \cdot \text{k)}$$

$$U_{n,rec} = 1,2 \text{ W/(m}^2 \cdot \text{k)} \geq U_w = 0,7 \text{ W/(m}^2 \cdot \text{k)}$$

#### De2 – plastic balcony door with triple glazing

$$U_{n,req} = 1,7 \text{ W/(m}^2 \cdot \text{k)} \geq U_w = 0,7 \text{ W/(m}^2 \cdot \text{k)}$$

$$U_{n,rec} = 1,2 \text{ W/(m}^2 \cdot \text{k)} \geq U_w = 0,7 \text{ W/(m}^2 \cdot \text{k)}$$

## Di – interior timber doors

$$U_{n,req} = 3,5 \text{ W}/(\text{m}^2.\text{k}) \geq U_w = 1,8 \text{ W}/(\text{m}^2.\text{k})$$

$$U_{n,rec} = 2,3 \text{ W}/(\text{m}^2.\text{k}) \geq U_w = 1,8 \text{ W}/(\text{m}^2.\text{k})$$

The value of heat transfer coefficient of windows and doors were taken from the catalogue of the manufacturer and compared with standards values.

From previous calculations we can see that all structures of the apartment building meet the requirements of the standards because heat transfer coefficient of each structure is smaller than  $U_{N,20}$  values, which are given by the standard ČSN 73 0540-2: 2011, thermal protection of buildings.

But the building can't be classified as passive building because many structures have  $U$  value bigger than  $U_{pas,20}$ , which are given by the standard ČSN 73 0540-2: 2011, thermal protection of buildings.

Table 4 - summary of all  $U$  values of building structures and their assessment.

Structure	$U_t$ [W/m <sup>2</sup> .K]	$U_{N,20}$ [W/m <sup>2</sup> .k]	$U_t \leq U_{N,20}$
C1.a - Ceiling separating heated space from unheated part of basement	0,414	0,600	it complies
C1.b - Ceiling separating heated space from heated part of basement	0,414	2,200	it complies
C2 - Inset balcony floor above basement	0,198	0,240	it complies
C3 - internal ceiling separating spaces with temperature difference to 5 °C	0,779	2,200	it complies
F - floor on the ground	0,306	0,450	it complies
R- Flat roof	0,136	0,240	it complies
S1- Peripheral wall to the exterior	0,125	0,300	it complies
S2- Peripheral wall in touch with ground	0,127	0,450	it complies
S3.a - Internal load bearing wall between rooms with temperature difference to 10	0,501	1,300	it complies
S3.b - internal load bearing wall separating rooms with temperature difference to 5	0,501	2,700	it complies
S3.c - Internal load bearing wall separating heated room from unheated room	0,501	0,600	it complies
S4- internal non-load bearing wall between rooms with temperature difference to 5	1,379	2,700	it complies
S5- Wall between flats	0,704	2,700	it complies

Structure	$U_t$ [W/m <sup>2</sup> .K]	$U_{pas,20}$ [W/m <sup>2</sup> .K]	$U_t \leq U_{pas,20}$
C1.a - Ceiling separating heated space from unheated part of basement	0,414	0,300	it does not comply
C1.b - Ceiling separating heated space from heated part of basement	0,414		
C2 - Inset balcony floor above basement	0,198	0,150	it does not comply
C3 - internal ceiling separating spaces with temperature difference to 5 °C	0,779		
F - floor on the ground	0,306	0,220	it does not comply
R- Flat roof	0,136	0,150	it complies
S1- Peripheral wall to the exterior	0,125	0,180	it complies
S2- Peripheral wall in touch with ground	0,127	0,220	it complies
S3.a - Internal load bearing wall between rooms with temperature difference to 10	0,501		
S3.b - internal load bearing wall separating rooms with temperature difference to 5	0,501		
S3.c - Internal load bearing wall separating heated room from unheated room	0,501	0,300	it does not comply
S4- internal non-load bearing wall between rooms with temperature difference to 5	1,379		
S5- Wall between flats	0,704		



### B.1.2. Energy label of the building

In order to do energy label of a building, we need to define building envelope, boundary conditions and evaluate average heat transfer coefficient  $U_{em}$  [ $W \cdot m^{-2} \cdot K^{-1}$ ], which is calculated and evaluated according to ČSN 73 0540-2: 2011 and Decree No. 264/2020 Sb.

Calculation: (according to decree No. 264/2020 Sb.)

$$U_{em} = \frac{\sum(U_{N,i} \cdot A_i \cdot b_i)}{\sum A_i} + \Delta U_{em,R} \quad [W \cdot m^{-2} \cdot K^{-1}]$$

$U_{em}$  - average heat transfer coefficient of the assessed building [ $W \cdot m^{-2} \cdot K^{-1}$ ]

$U_{N,i}$  - corresponding value of the heat transfer coefficient of the heat exchanging structure [ $W \cdot m^{-2} \cdot K^{-1}$ ]

$A_i$  - area of the structure determined from external dimensions [ $m^2$ ]

$b_i$  - temperature reduction factor corresponding to the structure [-]

$\Delta U_{em,R}$  - surcharge on the influence of thermal bonds [ $W \cdot m^{-2} \cdot K^{-1}$ ]

$$U_{em,N} = \frac{\sum(U_{N,i} \cdot A_i \cdot b_i)}{\sum A_i} + \Delta U_{em,R} \quad [W \cdot m^{-2} \cdot K^{-1}]$$

$U_{em,N}$  - value of average heat transfer coefficient of reference building [ $W \cdot m^{-2} \cdot K^{-1}$ ]

$U_{N,i}$  - corresponding standard value of the heat transfer coefficient of the heat exchanging structure [ $W \cdot m^{-2} \cdot K^{-1}$ ]

$A_i$  - area of the structure determined from external dimensions [ $m^2$ ]

$b_i$  - temperature reduction factor corresponding to the structure [-]

$\Delta U_{em,R}$  - surcharge on the influence of thermal bonds [ $W \cdot m^{-2} \cdot K^{-1}$ ]

Assessment

$$U_{em} \leq U_{em,N}$$

$U_{em}$  - average heat transfer coefficient of the assessed building [ $W \cdot m^{-2} \cdot K^{-1}$ ]

$U_{em,N}$  - average heat transfer coefficient of reference building [ $W \cdot m^{-2} \cdot K^{-1}$ ]

The assessment is based on the comparison of the ratio of average heat transfer coefficient of the assessed building to the average heat transfer coefficient of the reference building and the classification of this ratio to the classification class according to Annex C of the standard ČSN 73 0540-2: 2011.

Structure	Reference building				Assessed building			
	area	Heat transfer coefficient	Reduction factor	Specific heat transmission loss	area	Heat transfer coefficient	Reduction factor	Specific heat transmission loss
	A [m <sup>2</sup> ]	U [W/m <sup>2</sup> ·K]	b [-]	H <sub>T</sub> [W/K]	A [m <sup>2</sup> ]	U [W/m <sup>2</sup> ·K]	b [-]	H <sub>T</sub> [W/K]
C1.a - Ceiling separating heated space from unheated part of basement	104,6	0,420	0,571	25,109	104,6	0,414	0,571	24,761
R- Flat roof	238,8	0,170	1,000	40,596	238,8	0,136	1,000	32,384
S1- Peripheral wall to the exterior	566,5	0,210	1,000	118,969	566,5	0,125	1,000	70,609
S2- Peripheral wall in touch with ground	26,6	0,320	0,429	3,653	26,6	0,127	0,429	1,455
S3.c - Internal load bearing wall separating heated room from unheated room	49,7	0,420	0,571	11,928	49,7	0,501	0,571	14,221
F - Floor on the ground	118,2	0,320	0,429	16,205	118,2	0,309	0,429	15,662
C5- Inset balcony floor above heated part of basement	6,9	0,170	1,000	1,165	6,9	0,198	1,000	1,359
Façade openings	156,5	1,050	1,000	164,349	156,5	0,700	1,000	109,566
Roof hatch	2,5	1,050	1,000	2,625	2,5	0,700	1,000	1,750
Σ	1270,3			384,598	1270,3			271,769
Thermal bond ΔH <sub>T</sub>		0,020		25,406		0,050		63,516
Total specific heat transmission loss				410,005				335,285
Average heat transfer coefficient		U <sub>em</sub>		required value U <sub>em,N,req</sub>		U <sub>em</sub> = ΣH <sub>T</sub> + ΔH <sub>T</sub> / ΣA		0,264
		U <sub>em,N,req</sub> = Σ (UN <sub>i</sub> · A <sub>i</sub> · b <sub>i</sub> ) / ΣA <sub>j</sub> + 0,02 , max. 0,5		0,323				
		recommended value is 75% from required value		recommended value U <sub>em,N,rec</sub>				
				0,242				
Classification indicator C <sub>f</sub> = U <sub>em</sub> / U <sub>em,N,req</sub>						0,82		
Classification class of building envelope according to ČSN 73 0540-2						C - economical		

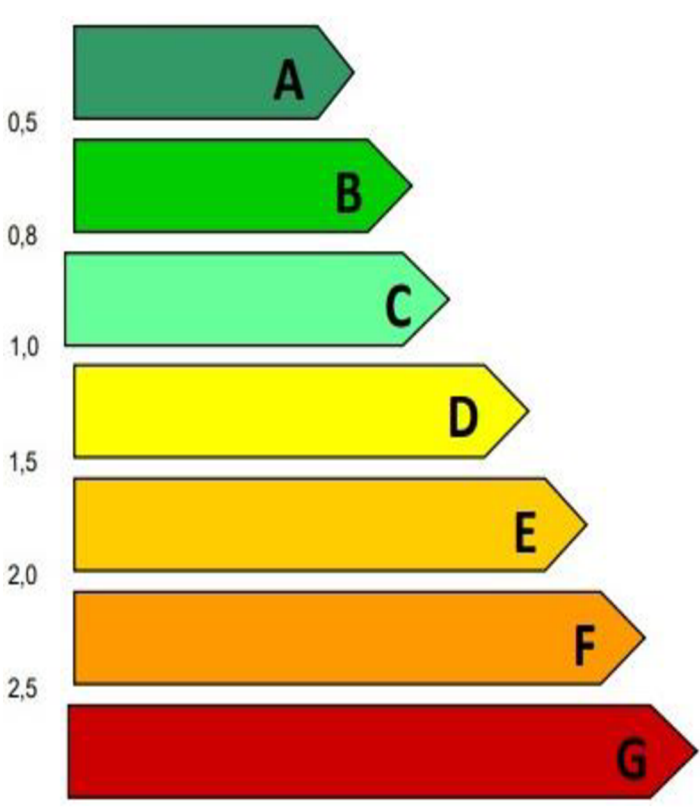
Energy label of the building							
Apartment building Olomouc					Evaluation of building envelope		
Total floor area = 873,03 m <sup>2</sup>					calculated	Recommended	
CI very economical  Extremely uneconomical							
Classification					C		
Average heat transfer coefficient of building envelope $U_{em}$ in [W/m <sup>2</sup> .K]					0,264		
Required value of average heat transfer coefficient of building envelope according to ČSN 730 0540-2 $U_{em,N,req}$ in [W/m <sup>2</sup> .K]					0,323		
Classification coefficient CI and its corresponding value $U_{em}$							
CL	0,5	0,8	1,0	1,00	1,50	2,00	2,50
$U_{em}$	0,161	0,258	0,323	0,323	0,484	0,646	0,807
Validity of energy label until				1.4.2031			

### B.1.3. Estimation of heat loss of the building

Heat losses are calculated according to ČSN EN 12 831-1 Heating systems in buildings – heat output calculation.

#### Total design heat output

Total design heat output is the sum of heat transmission loss and heat loss due to ventilation.

$$\Phi_{HL,i} = \Phi_{T,i} + \Phi_{V,i} \quad [W]$$

$\Phi_{T,i}$  - design heat transmission loss [W]

$\Phi_{V,i}$  - design heat loss due to ventilation [W]

#### Total design heat transmission loss

$$\Phi_{T,i} = ( H_{T,ie} + \underbrace{H_{T,ia} + H_{T,iae} + H_{T,iaBE}}_{H_{T,ia(..)}} + H_{T,ig} ) \cdot (\theta_{int,i} - \theta_e) \quad [W]$$

$H_{T,ia(..)}$

where

$H_{T,ie}$  - specific heat transmission loss directly to exterior [W/k]

$H_{T,ia(..)}$  - specific heat transmission loss from heated space to neighbouring heated space or unheated space or through it [W/k]

$H_{T,ig}$  - specific heat loss to ground [W/k]

$\theta_{int,i}$  – indoor temperature [°C]

$\theta_e$  – outdoor temperature [°C]

#### Specific heat transmission loss directly to exterior

$$H_{T,ie} = \sum ( A_k \cdot (U_k + \Delta U_B) \cdot f_{U,k} \cdot f_{ie,k} ) \quad [W/k]$$

Where:

$A_k$  - structure area [m<sup>2</sup>].

$U_k$  – heat transfer coefficient [W·m<sup>-2</sup>·K<sup>-1</sup>].

$\Delta U_B$  – correction of heat transfer coefficient [W·m<sup>-2</sup>·K<sup>-1</sup>].

$f_{U,k} = 1$  if surface heat transfer resistance was included.

$f_{ie,k}$  - temperature correction factor. It is equal to one if the adjacent space is exterior and the height of the space is not more than 4 m, otherwise it should be calculated as specified in the standards.

#### Specific heat transmission loss from heated space to neighbouring heated space or unheated space or through it

$$H_{T,ia(..)} = \Sigma (A_k \cdot U_k \cdot f_{ix,k}) \text{ [W/k]}$$

Where:

$f_{ix,k}$  – temperature correction factor.  $f_{ix,k} = f_1 + f_2$ .

The temperature correction factor  $f_1$  takes into consideration the difference between the outdoor temperature and the temperature of the neighbouring space or environment.

If there is an outdoor environment next to the structure then it is equal to 1, otherwise it can be determined as follow:

$$F_1 = \frac{\theta_{int,i} - \theta_u}{\theta_{int,i} - \theta_e}$$

$\theta_{int,i}$  – indoor temperature [°C]

$\theta_u$  – temperature of neighbouring heating space [°C]

$\theta_e$  – outdoor temperature [°C]

$f_2$  - correction factor  $f_2$  takes into consideration the difference between the internal temperature and the average surface temperature of the building part k. For spaces up to a height of 4 m  $f_2 = 0$ .

For Olomouc region in the Czech republic and according the standards  $\theta_e = -15^\circ\text{C}$ .

### Specific heat transmission loss to ground $H_{T,ig}$

$$H_{T,ig} = f_{\theta_{ann}} \cdot \Sigma (A_k \cdot U_{equiv,k} \cdot f_{ig,k} \cdot f_{GW,k})$$

Where:  $f_{\theta_{ann}}$  – coefficient that considers the effect of change of outdoor temperature through the year, it is equal to 1,45.

$U_{equiv,k}$  – equivalent heat transfer coefficient of the structural parts in contact with ground.

$A_k$  - structure area [m<sup>2</sup>].

$$B' = A_g / (0,5 \cdot P)$$

$$U_{equiv,k} = \frac{a}{b + (c_1 + B')^{n_1} + (c_2 + z)^{n_2} + (c_3 + U_k + \Delta U_{TB})^{n_3}} + d$$

	$a$	$b$	$c_1$	$c_2$	$c_3$	$n_1$	$n_2$	$n_3$	$d$
Floor	0,967 1	-7,455	10,76	9,773	0,026 5	0,553 2	0,602 7	-0,929 6	-0,020 3
Basement wall	0,933 28	-2,155 2	0 <sup>a</sup>	1,466	0,100 6	0 <sup>a</sup>	0,453 25	-1,006 8	-0,069 2

Where:  $B'$  – geometrical parameter.

$P$  – circumference of the border with outer environment.

$A_g$  – area of the floor in contact with ground.

Note: For rooms without external walls to the exterior, the  $B'$  shall be calculated for the entire heated area of the building.

$U_k$  - heat transfer coefficient of floor structure.

$f_{ig,k}$  – temperature correction coefficient.

$\Delta U_{TB}$  - surcharge on the effect of thermal bonds.

$f_{ig,k}$  – temperature correction factor

$$f_{ig,k} = \frac{\theta_{int,i} - \theta_{e,m}}{\theta_{int,I} - \theta_e}$$

$\theta_{int,i}$  – indoor temperature [°C]  
 $\theta_{e,m}$  – average temperature during heating season [°C].  
 For Olomouc region and according to the standards  $\theta_{e,m} = 3,8^\circ\text{C}$   
 $\theta_e$  – outdoor temperature [°C]

$f_{GW,k}$  – correction coefficient that considers the effect of underground water =1.

**Design heat loss due to ventilation  $\Phi_V, i$  [W]**

The building will be ventilated naturally, only in the bathrooms and toilets will be installed exhaust fans.

**Natural ventilation:**

It depends mainly on the room volume, outdoor and indoor temperature, and air exchange intensity. Also, on the number of unprotected openings, shading factor and the amount of air infiltration. Depending on the type of room, we choose minimal hygienic air exchange intensity  $n_{min}$ .

Type of room	$n_{min}$ [1/h]
residential area	0,5
kitchen and bathroom without window	1,5
office	1
sitting area	2

Table 5 – air exchange intensity[41]

From the volume of the room and the air exchange intensity, we get the minimum hygienic air exchange  $V_{min,i}$ .

$$V_{min,i} = n_{min} \cdot V$$

Where:

$V_{min,i}$  – minimum hygienic air exchange [ $\text{m}^3/\text{h}$ ]

$n_{min}$  - air exchange intensity [1/h]

$V$  - room volume [ $\text{m}^3$ ]

Then we should determine the amount of air infiltrated by building envelope through openings  $V_{inf,i}$

$$V_{inf,i} = 2 \cdot V \cdot n_{50} \cdot e_i \cdot \epsilon_i$$

$V_{inf,i}$  - amount of air infiltrated by building envelope [ $\text{m}^3/\text{h}$ ]

$V$  - room volume [ $\text{m}^3$ ]

$n_{50}$  - value of air exchange intensity at pressure difference 50 Pa [1/h]

in case of natural ventilation  $n_{50} = 4,5$  [1/h]

$e_i$  - shading factor, it depends on the position of the building in the landscape [-]

$\epsilon_i$  - correction factor of height level from terrain [-]

We choose the bigger value of  $V_{\min,i}$  and  $V_{\inf,i}$  and we use it to calculate the total specific heat loss due to ventilation

$$H_{V,i} = 0,34 \cdot V_i \text{ [W} \cdot \text{K}^{-1}\text{]}$$

$H_{V,i}$  - total specific heat loss due to ventilation [W · K<sup>-1</sup>]

$V_i$  - amount of air, the maximum value of  $V_{\min,i}$  and  $V_{\inf,i}$  [m<sup>3</sup>/ h]

Finally, we can estimate design heat loss due to natural ventilation:

$$\Phi_{V,i} = H_{V,i} \cdot (\theta_{\text{int},i} - \theta_e) \text{ [W]}$$

$\Phi_{V,i}$  - design heat loss due to ventilation [W]

$\theta_{\text{int},i}$  - indoor temperature [°C].

$\theta_e$  - outdoor temperature [°C].

$H_{V,i}$  - total specific heat loss due to ventilation [W · K<sup>-1</sup>]

## Heat losses of the basement

Room No.	Name of the room	Indoor temperature $\Theta_{int,j}$ [°C]						
S101	Corridor	15,000 °C						
<b>Calculation of heat transmission loss</b>								
<b>Specific heat transmission loss directly to exterior <math>H_{T,ie}</math></b>								
structures								
No.	Description	$A_k$ [m <sup>2</sup> ]	$U_k$ [W/m <sup>2</sup> .K]	$\Delta U_B$ [W/m <sup>2</sup> .K]	$U_{kc}$ [W/m <sup>2</sup> .K]	$f_{U,k}$ [-]	$f_{ie,k}$ [-]	$A_k \cdot (U_k + \Delta U_B) \cdot f_{U,k} \cdot f_{ie,k}$
								0,000
$H_{T,ie} = \Sigma (A_k \cdot (U_k + \Delta U_B) \cdot f_{U,k} \cdot f_{ie,k})$ (W/k)								0,000

<b>Specific heat transmission loss from heated space to neighbouring heated space or unheated space or through it <math>H_{T,ia(-)}</math></b>								
structures								
No.S.	description	$\theta_u$ [°C]	$A_k$ [m <sup>2</sup> ]	$U_k$ [W/m <sup>2</sup> .K]	$\Delta U$ [W/m <sup>2</sup> .K]	$U_{kc}$ [W/m <sup>2</sup> .K]	$f_{ix,k}$ [-]	$A_k \cdot U_{kc} \cdot f_{ix,k}$
C1.b	ceiling above basement	20,000	3,970	0,414		0,414	-0,167	-0,274
S4	internal non-load bearing wall between rooms	20,000	5,151	1,379		1,379	-0,167	-1,184
Di	interior timber door	10,000	1,890	1,800		1,800	0,167	0,567
S3.b	internal load bearing wall	10,000	4,389	0,501		0,501	0,167	0,366
Di	interior timber door	20,000	1,890	1,800		1,800	-0,167	-0,567
$H_{T,ia(-)} = \Sigma (A_k \cdot U_{kc} \cdot f_{ix,k})$ (W/K)								-1,092
$F_{ix,k} = f_1 = (\theta_{int,i} - \theta_u) / (\theta_{int,i} - \theta_e)$								

<b>Specific heat transmission loss to ground <math>H_{T,ig}</math></b>									
No.S.	description	$A_k$ [m <sup>2</sup> ]	$A_g$ [m <sup>2</sup> ]	P [m]	$U_k$ [W/m <sup>2</sup> .K]	$f_{ig,k}$ [-]	B' [m]	$U_{equiv,k}$ [W/m <sup>2</sup> .K]	$A_k \cdot U_{equiv,k} \cdot f_{ig,k} \cdot f_{GW,k}$
F	Floor on the ground	3,970	118,160	47,400	0,309	0,373	4,986	0,255	0,378
								$\Sigma (A_k \cdot U_{equiv,k} \cdot f_{ig,k} \cdot f_{GW,k})$	0,378
$f_{\theta_{ann}}$ [-]	$H_{T,ig} = f_{\theta_{ann}} \cdot \Sigma (A_k \cdot U_{equiv,k} \cdot f_{ig,k} \cdot f_{GW,k})$ (W/K)				$f_{GW,k}$ [-]	$\theta_{e,m}$ [°C]			
1,450	0,548				1,000	3,800			

<b>Total design heat transmission loss <math>\Phi_{T,i} = (H_{T,ie} + H_{T,ja} + H_{T,iae} + H_{T,jaBE} + H_{T,ig}) \cdot (\theta_{int,i} - \theta_e)</math> [W]</b>				
$\theta_{int,i}$ [°C]	$\theta_e$ [°C]	$\theta_{int,i} - \theta_e$ [°C]	$\Sigma H_{T,i}$ [W·K <sup>-1</sup> ]	Design heat transmission loss $\Phi_{T,i}$ [W]
15,000	-15,000	30,000	-0,544	-16,326

<b>Design heat loss due to ventilation - natural ventilation</b>				
room volume $V_i$ (m <sup>3</sup> )	Outdoor temperature $\theta_e$ [°C]	indoor temperature $\theta_{int,i}$ [°C]	Hygienic requirements	
			$n_{min}$ (h <sup>-1</sup> )	Hygienic air exchange $V_{min,i}$ (m <sup>3</sup> /h)
11,870	-15,000	15,000	0,500	5,935
$n_{50}$ [1/h]	Number of unprotected openings	Shading factor $e_i$	correction factor of height level from terrain $\epsilon_i$	Amount of air infiltrated by building envelope $V_{inf,i}$ (m <sup>3</sup> /h)
4,500	0,000	0,020	1,000	0,000
<b>Heat loss due to natural ventilation</b>				
$\theta_{int,i} - \theta_e$	max. of $V_{min,i}$ , $V_{inf,i}$	$H_t$ [W·K <sup>-1</sup> ]	Design heat loss due to ventilation $\Phi_{v,i}$ (W)	
30,000	5,935	2,018	60,539	

Total design heat transmission loss of the specific room = 44,212 W



Room No.	Name of the room	Indoor temperature $\Theta_{int,i}$ [°C]						
S102	Storeroom	15,000 °C						
<b>Calculation of heat transmission loss</b>								
<b>Specific heat transmission loss directly to exterior <math>H_{T,ie}</math></b>								
structures								
No.	Description	$A_k$ [m <sup>2</sup> ]	$U_k$ [W/m <sup>2</sup> .K]	$\Delta U_B$ [W/m <sup>2</sup> .K]	$U_{kc}$ [W/m <sup>2</sup> .K]	$f_{U,k}$ [-]	$f_{ie,k}$ [-]	$A_k \cdot (U_k + \Delta U_B) \cdot f_{U,k} \cdot f_{ie,k}$
								0,000
$H_{T,ie} = \Sigma (A_k \cdot (U_k + \Delta U_B) \cdot f_{U,k} \cdot f_{ie,k})$ (W/k)								0,000

<b>Specific heat transmission loss from heated space to neighbouring heated space or unheated space or through it <math>H_{T,ia(i)}</math></b>								
structures								
No.S.	description	$\theta_u$ [°C]	$A_k$ [m <sup>2</sup> ]	$U_k$ [W/m <sup>2</sup> .K]	$\Delta U$ [W/m <sup>2</sup> .K]	$U_{kc}$ [W/m <sup>2</sup> .K]	$f_{ix,k}$ [-]	$A_k \cdot U_{kc} \cdot f_{ix,k}$
S4	internal non-load bearing wall	20,000	12,953	1,379		1,379	-0,167	-2,977
C1.b	ceiling above basement	20,000	2,300	0,414		0,414	-0,167	-0,159
$H_{T,ia(i)} = \Sigma (A_k \cdot U_{kc} \cdot f_{ix,k})$ (W/K)								-3,136
$F_{ix,k} = f_1 = (\theta_{int,i} - \theta_u) / (\theta_{int,i} - \theta_e)$								

<b>Specific heat transmission loss to ground <math>H_{T,ig}</math></b>									
No.S.	description	$A_k$ [m <sup>2</sup> ]	$A_g$ [m <sup>2</sup> ]	$P$ [m]	$U_k$ [W/m <sup>2</sup> .K]	$f_{ig,k}$ [-]	$B'$ [m]	$U_{equiv,k}$ [W/m <sup>2</sup> .K]	$A_k \cdot U_{equiv,k} \cdot f_{ig,k} \cdot f_{GW,k}$
F	Floor on the ground	2,300	118,160	47,400	0,309	0,373	4,986	0,255	0,219
$\Sigma (A_k \cdot U_{equiv,k} \cdot f_{ig,k} \cdot f_{GW,k})$									0,219
$f_{\theta ann}$ [-]	$H_{T,ig} = f_{\theta ann} \cdot \Sigma (A_k \cdot U_{equiv,k} \cdot f_{ig,k} \cdot f_{GW,k})$ (W/K)				$f_{GW}$ [-]	$\theta_{e,m}$ [°C]			
1,450	0,317				1,000	3,800			

<b>Total design heat transmission loss <math>\Phi_{T,i} = (H_{T,ie} + H_{T,ia} + H_{T,iae} + H_{T,iaBE} + H_{T,ig}) \cdot (\theta_{int,i} - \theta_e)</math> [W]</b>				
$\Theta_{int,i}$ [°C]	$\Theta_e$ [°C]	$\Theta_{int,i} - \theta_e$ [°C]	$\Sigma H_{T,i}$ [W·K <sup>-1</sup> ]	Design heat transmission loss $\Phi_{T,i}$ [W]
15,000	-15,000	30,000	-2,819	-84,568

<b>Design heat loss due to ventilation - natural ventilation</b>				
room volume $V_i$ (m <sup>3</sup> )	Outdoor temperature $\Theta_e$ [°C]	indoor temperature $\Theta_{int,i}$ [°C]	Hygienic requirements	
6,877	-15,000	15,000	$n_{min}$ (h <sup>-1</sup> )	Hygienic air exchange $V_{min,i}$ (m <sup>3</sup> /h)
			0,500	3,439
$n_{50}$ [1/h]	Number of unprotected openings	Shading factor $e_i$	correction factor of height level from terrain $\epsilon_i$	Amount of air infiltrated by building envelope $V_{inf,i}$ (m <sup>3</sup> /h)
4,500	0,000	0,020	1,000	0,000
<b>Heat loss due to natural ventilation</b>				
$\Theta_{int,i} - \Theta_e$	max. of $V_{min,i}$ , $V_{inf,i}$	$H_t$ [W·K <sup>-1</sup> ]	Design heat loss due to ventilation $\Phi_{v,i}$ (W)	
30,000	3,439	1,169	35,073	

Total design heat transmission loss of the specific room = -49,495 W

Room No.	Name of the room	Indoor temperature $\Theta_{int,j}$ [°C]						
S103	Technical room	20,000 °C						
<b>Calculation of heat transmission loss</b>								
<b>Specific heat transmission loss directly to exterior <math>H_{T,ie}</math></b>								
structures								
No.	Description	$A_k$ [m <sup>2</sup> ]	$U_k$ [W/m <sup>2</sup> .K]	$\Delta U_B$ [W/m <sup>2</sup> .K]	$U_{kc}$ [W/m <sup>2</sup> .K]	$f_{U,k}$ [-]	$f_{ie,k}$ [-]	$A_k \cdot (U_k + \Delta U_B) \cdot f_{U,k} \cdot f_{ie,k}$
De1	plastic entrance door	4,230	0,700		0,700	1,000	1,000	2,961
W	triple glazing plastic window	2,175	0,700		0,700	1,000	1,000	1,523
S1	Peripheral wall to the exterior	26,365	0,125	0,050	0,175	1,000	1,000	4,604
$H_{T,ie} = \Sigma (A_k \cdot (U_k + \Delta U_B) \cdot f_{U,k} \cdot f_{ie,k})$ (W/k)								9,088

<b>Specific heat transmission loss from heated space to neighbouring heated space or unheated space or through it <math>H_{T,ia(..)}</math></b>								
structures								
No.S.	description	$\theta_u$ [°C]	$A_k$ [m <sup>2</sup> ]	$U_k$ [W/m <sup>2</sup> .K]	$\Delta U$ [W/m <sup>2</sup> .K]	$U_{kc}$ [W/m <sup>2</sup> .K]	$f_{ix,k}$ [-]	$A_k \cdot U_{kc} \cdot f_{ix,k}$
S4	internal non-load bearing wall	15,000	7,427	1,379		1,379	0,143	1,463
S3.c	internal load bearing wall	0,000	14,226	0,501	0,050	0,551	0,571	4,477
DI	interior timber door	15,000	1,890	1,800		1,800	0,143	0,486
$H_{T,ia(..)} = \Sigma (A_k \cdot U_{kc} \cdot f_{ix,k})$ (W/K)								6,427
$f_{ix,k} = f_1 = (\theta_{int,i} - \theta_u) / (\theta_{int,i} - \theta_e)$								

<b>Specific heat transmission loss to ground <math>H_{T,jg}</math></b>										
No.S.	description	$A_k$ [m <sup>2</sup> ]	$A_g$ [m <sup>2</sup> ]	$P$ [m]	$U_k$ [W/m <sup>2</sup> .K]	$f_{ig,k}$ [-]	$B'$ [m]	$U_{equiv,k}$ [W/m <sup>2</sup> .K]	$A_k \cdot U_{equiv,k} \cdot f_{ig,k} \cdot f_{GW,k}$	
F	Floor on the ground	29,500	29,500	10,958	0,309	0,463	5,384	0,250	3,413	
								$\Sigma (A_k \cdot U_{equiv,k} \cdot f_{ig,k} \cdot f_{GW,k})$	3,413	
$f_{\theta ann}$ [-]	$H_{T,jg} = f_{\theta ann} \cdot \Sigma (A_k \cdot U_{equiv,k} \cdot f_{ig,k} \cdot f_{GW,k})$ (W/K)					$f_{GW,k}$ [-]	$\theta_{e,m}$ [°C]			
1,450	4,949						1,000	3,800		

<b>Total design heat transmission loss <math>\Phi_{T,i} = (H_{T,ie} + H_{T,ia} + H_{T,iae} + H_{T,iaBE} + H_{T,jg}) \cdot (\theta_{int,i} - \theta_e)</math> [W]</b>				
$\theta_{int,i}$ [°C]	$\theta_e$ [°C]	$\theta_{int,i} - \theta_e$ [°C]	$\Sigma H_{T,i}$ [W·K <sup>-1</sup> ]	Design heat transmission loss $\Phi_{T,i}$ [W]
20,000	-15,000	35,000	20,463	716,206

<b>Design heat loss due to ventilation - natural ventilation</b>				
room volume $V_i$ (m <sup>3</sup> )	Outdoor temperature $\theta_e$ [°C]	indoor temperature $\theta_{int,i}$ [°C]	Hygienic requirements	
88,205	-15,000	20,000	$n_{min}$ (h <sup>-1</sup> )	Hygienic air exchange $V_{min,i}$ (m <sup>3</sup> /h)
				44,103
$n_{50}$ [1/h]	Number of unprotected openings	Shading factor $e_i$	correction factor of height level from terrain $\epsilon_i$	Amount of air infiltrated by building envelope $V_{inf,i}$
4,500	3,000	0,020	1,000	47,631

<b>Heat loss due to natural ventilation</b>			
$\theta_{int,i} - \theta_e$	max. of $V_{min,i}, V_{inf,i}$	$H_t$ [W·K <sup>-1</sup> ]	Design heat loss due to ventilation $\Phi_{v,i}$ (W)
35,000	47,631	16,194	566,805

Total design heat transmission loss of the specific room = 1283,01 W

Room No.	Name of the room	Indoor temperature $\Theta_{int,i}$ [°C]						
S104	Toilet	20,000 °C						
<b>Calculation of heat transmission loss</b>								
<b>Specific heat transmission loss directly to exterior <math>H_{T,ie}</math></b>								
structures								
No.	Description	$A_k$ [m <sup>2</sup> ]	$U_k$ [W/m <sup>2</sup> .K]	$\Delta U_B$ [W/m <sup>2</sup> .K]	$U_{kc}$ [W/m <sup>2</sup> .K]	$f_{U,k}$ [-]	$f_{ie,k}$ [-]	$A_k \cdot (U_k + \Delta U_B) \cdot f_{U,k} \cdot f_{ie,k}$
W	triple glazing plastic window	0,540	0,700		0,700	1,000	1,000	0,378
S1	Peripheral wall to the exterior	5,359	0,125	0,050	0,175	1,000	1,000	0,936
$H_{T,ie} = \Sigma (A_k \cdot (U_k + \Delta U_B) \cdot f_{U,k} \cdot f_{ie,k})$ (W/k)								1,314

<b>Specific heat transmission loss from heated space to neighbouring heated space or unheated space or through it <math>H_{T,ia(.,)}</math></b>								
structures								
No.S.	description	$\theta_u$ [°C]	$A_k$ [m <sup>2</sup> ]	$U_k$ [W/m <sup>2</sup> .K]	$\Delta U$ [W/m <sup>2</sup> .K]	$U_{kc}$ [W/m <sup>2</sup> .K]	$f_{ix,k}$ [-]	$A_k \cdot U_{kc} \cdot f_{ix,k}$
C1.b	Ceiling separating heated space f	24,000	2,600	0,414		0,414	-0,114	-0,123
$H_{T,ia(.,)} = \Sigma (A_k \cdot U_{kc} \cdot f_{ix,k})$ (W/K)								-0,123
$F_{ix,k} = f_{ix} = (\theta_{int,i} - \theta_u) / (\theta_{int,i} - \theta_e)$								

<b>Specific heat transmission loss to ground <math>H_{T,ig}</math></b>										
No.S.	description	$A_k$ [m <sup>2</sup> ]	$A_g$ [m <sup>2</sup> ]	P [m]	$U_k$ [W/m <sup>2</sup> .K]	$f_{ig,k}$ [-]	B' [m]	$U_{equiv,k}$ [W/m <sup>2</sup> .K]	$A_k \cdot U_{equiv,k} \cdot f_{ig,k} \cdot f_{GW,k}$	
S2	eripheral wall in touch with groun	0,380	5,830	2,100	0,127	0,463	5,552	0,186	0,033	
F	Floor on the ground	5,830	5,830	2,100	0,309	0,463	5,552	0,248	0,669	
$\Sigma (A_k \cdot U_{equiv,k} \cdot f_{ig,k} \cdot f_{GW,k})$									0,702	
$f_{\theta ann}$ [-]	$H_{T,ig} = f_{\theta ann} \cdot \Sigma (A_k \cdot U_{equiv,k} \cdot f_{ig,k} \cdot f_{GW,k})$ (W/K)				$f_{GW,k}$ [-]	$\theta_{e,m}$ [°C]				
1,450	1,017					1,000	3,800			

<b>Total design heat transmission loss <math>\Phi_{T,i} = (H_{T,ie} + H_{T,ia} + H_{T,iae} + H_{T,iaBE} + H_{T,ig}) \cdot (\theta_{int,i} - \theta_e)</math> [W]</b>				
$\Theta_{int,i}$ [°C]	$\Theta_e$ [°C]	$\Theta_{int,i} - \theta_e$ [°C]	$\Sigma H_{T,i}$ [W·K <sup>-1</sup> ]	Design heat transmission loss $\Phi_{T,i}$ [W]
20,000	-15,000	35,000	2,208	77,289

<b>Design heat loss due to ventilation - natural ventilation</b>				
room volume $V_i$ (m <sup>3</sup> )	Outdoor temperature $\Theta_e$ [°C]	indoor temperature $\Theta_{int,i}$ [°C]	Hygienic requirements	
17,432	-15,000	20,000	$n_{min}$ (h <sup>-1</sup> )	Hygienic air exchange $V_{min,i}$ (m <sup>3</sup> /h)
			0,500	8,716
$n_{50}$ [1/h]	Number of unprotected openings	Shading factor $e_i$	correction factor of height level from terrain $\epsilon_i$	Amount of air infiltrated by building envelope $V_{inf,i}$
4,500	1,000	0,020	1,000	3,138
<b>Heat loss due to natural ventilation</b>				
$\Theta_{int,i} - \Theta_e$	max. of $V_{min,i}, V_{inf,i}$	$H_i$ [W·K <sup>-1</sup> ]	Design heat loss due to ventilation $\Phi_{v,i}$ (W)	
35,000	8,716	2,963	103,719	

Total design heat transmission loss of the specific room = 181,008 W

Room No.	Name of the room	Indoor temperature $\Theta_{int,j}$ [°C]						
S105	Privat gym for inhabitants	20,000 °C						
<b>Calculation of heat transmission loss</b>								
<b>Specific heat transmission loss directly to exterior <math>H_{T,je}</math></b>								
structures								
No.	Description	$A_k$ [m <sup>2</sup> ]	$U_k$ [W/m <sup>2</sup> .K]	$\Delta U_B$ [W/m <sup>2</sup> .K]	$U_{kc}$ [W/m <sup>2</sup> .K]	$f_{U,k}$ [-]	$f_{ie,k}$ [-]	$A_k \cdot (U_k + \Delta U_B) \cdot f_{U,k} \cdot f_{ie,k}$
W	triple glazing plastic window	2,175	0,700		0,700	1,000	1,000	1,523
S1	Peripheral wall to the exterior	5,778	0,125	0,050	0,175	1,000	1,000	1,009
$H_{T,je} = \Sigma (A_k \cdot (U_k + \Delta U_B) \cdot f_{U,k} \cdot f_{ie,k})$ (W/k)								2,532

<b>Specific heat transmission loss from heated space to neighbouring heated space or unheated space or through it <math>H_{T,ia(,j)}</math></b>								
structures								
No.S.	description	$\theta_u$ [°C]	$A_k$ [m <sup>2</sup> ]	$U_k$ [W/m <sup>2</sup> .K]	$\Delta U$ [W/m <sup>2</sup> .K]	$U_{kc}$ [W/m <sup>2</sup> .K]	$f_{ix,k}$ [-]	$A_k \cdot U_k \cdot f_{ix,k}$
Di	interior timber door	15,000	1,890	1,800		1,800	0,143	0,486
S4	internal non-load bearing wall	15,000	12,408	1,379		1,379	0,143	2,445
C3	Internal ceiling	24,000	1,470	0,414		0,414	-0,114	-0,070
$H_{T,ia(,j)} = \Sigma (A_k \cdot U_k \cdot f_{ix,k})$ (W/K)								2,861
$F_{ix,k} = f_1 = (\theta_{int,i} - \theta_u) / (\theta_{int,i} - \theta_e)$								

<b>Specific heat transmission loss to ground <math>H_{T,ig}</math></b>									
No.S.	description	$A_k$ [m <sup>2</sup> ]	$A_g$ [m <sup>2</sup> ]	P [m]	$U_k$ [W/m <sup>2</sup> .K]	$f_{ig,k}$ [-]	B' [m]	$U_{equiv,k}$ [W/m <sup>2</sup> .K]	$A_k \cdot U_{equiv,k} \cdot f_{ig,k} \cdot f_{GW,k}$
S2	Peripheral wall in touch with gro	1,400	14,830	3,120	0,127	0,463	9,506	0,186	0,120
F	Floor on the ground	14,830	14,830	3,120	0,309	0,463	9,506	0,210	1,440
$\Sigma (A_k \cdot U_{equiv,k} \cdot f_{ig,k} \cdot f_{GW,k})$									1,560
$f_{\theta ann}$ [-]	$H_{T,ig} = f_{\theta ann} \cdot \Sigma (A_k \cdot U_{equiv,k} \cdot f_{ig,k} \cdot f_{GW,k})$ (W/K)				$f_{GW,k}$ [-]	$\theta_{e,m}$ [°C]			
1,450	2,262				1,000	3,800			

<b>Total design heat transmission loss <math>\Phi_{T,i} = (H_{T,je} + H_{T,ia} + H_{T,iae} + H_{T,iaeE} + H_{T,ig}) \cdot (\theta_{int,i} - \theta_e)</math> [W]</b>				
$\theta_{int,i}$ [°C]	$\theta_e$ [°C]	$\theta_{int,i} - \theta_e$ [°C]	$\Sigma H_{T,i}$ [W·K <sup>-1</sup> ]	Design heat transmission loss $\Phi_{T,i}$ [W]
20,000	-15,000	35,000	7,655	267,934

<b>Design heat loss due to ventilation - natural ventilation</b>				
room volume $V_i$ (m <sup>3</sup> )	Outdoor temperature $\theta_e$ [°C]	indoor temperature $\theta_{int,i}$ [°C]	Hygic requirements	
44,342	-15,000	20,000	$n_{min}$ (h <sup>-1</sup> )	Hygienic air exchange $V_{min,i}$ (m <sup>3</sup> /h)
			0,500	22,171
$n_{50}$ [1/h]	Number of unprotected openings	Shading factor $e_i$	correction factor of height level from terrain $\epsilon_i$	Amount of air infiltrated by building envelope $V_{inf,i}$
4,500	1,000	0,020	1,000	7,982
<b>Heat loss due to natural ventilation</b>				
$\theta_{int,i} - \theta_e$	max. of $V_{min,i}$ , $V_{inf,i}$	$H_t$ [W·K <sup>-1</sup> ]	Design heat loss due to ventilation $\Phi_{v,i}$ (W)	
35,000	22,171	7,538	263,833	

Total design heat transmission loss of the specific room = 531,767 W

Room No.	Name of the room	Indoor temperature $\Theta_{int,i}$ [°C]
S106	Privat gym for inhabitants	20,000 °C

**Calculation of heat transmission loss**

**Specific heat transmission loss directly to exterior  $H_{T,ie}$**

structures

No.	Description	$A_k$ [m <sup>2</sup> ]	$U_k$ [W/m <sup>2</sup> .K]	$\Delta U_B$ [W/m <sup>2</sup> .K]	$U_{kc}$ [W/m <sup>2</sup> .K]	$f_{U,k}$ [-]	$f_{ie,k}$ [-]	$A_k \cdot (U_k + \Delta U_B) \cdot f_{U,k} \cdot f_{ie,k}$
W	triple glazing plastic window	2,900	0,700		0,700	1,000	1,000	2,030
C5	inset balcony floor above basem	3,780	0,198		0,198	1,000	1,000	0,750
S1	Peripheral wall to the exterior	16,091	0,125	0,050	0,175	1,000	1,000	2,810
$H_{T,ie} = \Sigma (A_k \cdot (U_k + \Delta U_B) \cdot f_{U,k} \cdot f_{ie,k})$ (W/k)								5,590

**Specific heat transmission loss from heated space to neighbouring heated space or unheated space or through it  $H_{T,ia(i)}$**

structures

No.S.	description	$\theta_u$ [°C]	$A_k$ [m <sup>2</sup> ]	$U_k$ [W/m <sup>2</sup> .K]	$\Delta U$ [W/m <sup>2</sup> .K]	$U_{kc}$ [W/m <sup>2</sup> .K]	$f_{ix,k}$ [-]	$A_k \cdot U_{kc} \cdot f_{ix,k}$
Di	interior timber doors	15,000	1,890	1,800		1,800	0,143	0,486
S4	internal non-load bearing wall	15,000	8,784	1,379		1,379	0,143	1,731
$H_{T,ia(i)} = \Sigma (A_k \cdot U_{kc} \cdot f_{ix,k})$ (W/K)								2,217

$$F_{ix,k} = f_1 = (\theta_{int,i} - \theta_u) / (\theta_{int,i} - \theta_e)$$

**Specific heat transmission loss to ground  $H_{T,ig}$**

No.S.	description	$A_k$ [m <sup>2</sup> ]	$A_g$ [m <sup>2</sup> ]	P [m]	$U_k$ [W/m <sup>2</sup> .K]	$f_{ig,k}$ [-]	B' [m]	$U_{equiv,k}$ [W/m <sup>2</sup> .K]	$A_k \cdot U_{equiv,k} \cdot f_{ig,k} \cdot f_{GW,k}$
S2	Peripheral wall in touch with gro	5,970	17,000	8,348	0,127	0,463	4,073	0,186	0,513
F	Floor on the ground	17,000	17,000	8,348	0,309	0,463	4,073	0,267	2,101
$\Sigma (A_k \cdot U_{equiv,k} \cdot f_{ig,k} \cdot f_{GW,k})$								2,614	

$f_{\theta ann}$ [-]	$H_{T,ig} = f_{\theta ann} \cdot \Sigma (A_k \cdot U_{equiv,k} \cdot f_{ig,k} \cdot f_{GW,k})$ (W/K)	$f_{GW,k}$ [-]	$\theta_{e,m}$ [°C]
1,450	3,791	1,000	3,800

**Total design heat transmission loss  $\Phi_{T,i} = (H_{T,ie} + H_{T,ia} + H_{T,iae} + H_{T,iaBE} + H_{T,ig}) \cdot (\theta_{int,i} - \theta_e)$  [W]**

$\Theta_{int,i}$ [°C]	$\Theta_e$ [°C]	$\Theta_{int,i} - \theta_e$ [°C]	$\Sigma H_{t,i}$ [W·K <sup>-1</sup> ]	Design heat transmission loss $\Phi_{T,i}$ [W]
20,000	-15,000	35,000	11,598	405,929

**Design heat loss due to ventilation - natural ventilation**

room volume $V_i$ (m <sup>3</sup> )	Outdoor temperature $\Theta_e$ [°C]	indoor temperature $\Theta_{int,i}$ [°C]	Hygienic requirements	
			$n_{min}$ (h <sup>-1</sup> )	Hygienic air exchange $V_{min,i}$ (m <sup>3</sup> /h)
50,830	-15,000	20,000	0,500	25,415
$n_{50}$ [1/h]	Number of unprotected openings	Shading factor $e_i$	correction factor of height level from terrain $\epsilon_i$	Amount of air infiltrated by building envelope $V_{inf,i}$ (m <sup>3</sup> /h)
4,500	2,000	0,020	1,000	18,299

**Heat loss due to natural ventilation**

$\Theta_{int,i} - \Theta_e$	max. of $V_{min,i}$ , $V_{inf,i}$	$H_t$ [W·K <sup>-1</sup> ]	Design heat loss due to ventilation $\Phi_{v,i}$ (W)
35,000	25,415	8,641	302,439

Total design heat transmission loss of the specific room = 708,367 W

Room No.	Name of the room	Indoor temperature $\Theta_{int,i}$ [°C]						
S107	Corridor	15,000 °C						
<b>Calculation of heat transmission loss</b>								
<b>Specific heat transmission loss directly to exterior <math>H_{T,ie}</math></b>								
structures								
No.	Description	$A_k$ [m <sup>2</sup> ]	$U_k$ [W/m <sup>2</sup> .K]	$\Delta U_B$ [W/m <sup>2</sup> .K]	$U_{kc}$ [W/m <sup>2</sup> .K]	$f_{U,k}$ [-]	$f_{ie,k}$ [-]	$A_k \cdot (U_k + \Delta U_B) \cdot f_{U,k} \cdot f_{ie,k}$
W	Window	0,400	0,700		0,700	1,000	1,000	0,280
C5	inset balcony floor above basem	0,800	0,198		0,198	1,000	1,000	0,159
s1	Peripheral wall to the exterior	3,487	0,125	0,050	0,175	1,000	1,000	0,609
$H_{T,ie} = \Sigma (A_k \cdot (U_k + \Delta U_B) \cdot f_{U,k} \cdot f_{ie,k})$ (W/k)								1,048

<b>Specific heat transmission loss from heated space to neighbouring heated space or unheated space or structures</b>								
No.S.	description	$\theta_u$ [°C]	$A_k$ [m <sup>2</sup> ]	$U_k$ [W/m <sup>2</sup> .K]	$\Delta U$ [W/m <sup>2</sup> .K]	$U_{kc}$ [W/m <sup>2</sup> .K]	$f_{ix,k}$ [-]	$A_k \cdot U_{kc} \cdot f_{ix,k}$
Di	interior timber doors	20,000	3,780	1,800		1,800	-0,167	-1,134
S3.b	internal load bearing wall	10,000	20,392	0,501		0,501	0,167	1,702
C1.a	Ceiling separating heated space from heated part of basement	20,000	7,050	0,414		0,414	-0,167	-0,487
S4	internal non-load bearing wall	20,000	16,612	1,379		1,379	-0,167	-3,819
$H_{T,ia(..)} = \Sigma (A_k \cdot U_{kc} \cdot f_{ix,k})$ (W/K)								-3,737
$f_{ix,k} = f_1 = (\theta_{int,i} - \theta_u) / (\theta_{int,i} - \theta_e)$								

<b>Specific heat transmission loss to ground <math>H_{T,ig}</math></b>									
No.S.	description	$A_k$ [m <sup>2</sup> ]	$A_g$ [m <sup>2</sup> ]	P [m]	$U_k$ [W/m <sup>2</sup> .K]	$f_{ig,k}$ [-]	B' [m]	$U_{equiv,k}$ [W/m <sup>2</sup> .K]	$A_k \cdot U_{equiv,k} \cdot f_{ig,k} \cdot f_{GW,k}$
F	Floor on the ground	8,860	8,860	1,300	0,136	0,373	13,631	0,127	0,419
								$\Sigma (A_k \cdot U_{equiv,k} \cdot f_{ig,k} \cdot f_{GW,k})$	0,419
$f_{\theta ann}$ [-]	$H_{T,ig} = f_{\theta ann} \cdot \Sigma (A_k \cdot U_{equiv,k} \cdot f_{ig,k} \cdot f_{GW,k})$ (W/K)				$f_{GW,k}$ [-]	$\theta_{e,m}$ [°C]			
1,450	0,608				1,000	3,800			

<b>Total design heat transmission loss <math>\Phi_{T,i} = (H_{T,ie} + H_{T,ia} + H_{T,iae} + H_{T,iaBE} + H_{T,ig}) \cdot (\theta_{int,i} - \theta_e)</math> [W]</b>				
$\Theta_{int,i}$ [°C]	$\Theta_e$ [°C]	$\Theta_{int,i} - \theta_e$ [°C]	$\Sigma H_{T,i}$ [W·K <sup>-1</sup> ]	Design heat transmission loss $\Phi_{T,i}$ [W]
15,000	-15,000	30,000	-2,082	-62,452

<b>Design heat loss due to ventilation - natural ventilation</b>				
room volume $V_i$ (m <sup>3</sup> )	Outdoor temperature $\Theta_e$ [°C]	indoor temperature $\Theta_{int,i}$ [°C]	Hygienic requirements	
			$n_{min}$ (h <sup>-1</sup> )	Hygienic air exchange $V_{min,i}$ (m <sup>3</sup> /h)
26,491	-15,000	15,000	0,500	13,246
$n_{50}$ [1/h]	Number of unprotected openings	Shading factor $e_i$	correction factor of height level from terrain $\epsilon_i$	Amount of air infiltrated by building envelope $V_{inf,i}$
4,500	0,000	0,020	1,000	0,000

<b>Heat loss due to natural ventilation</b>			
$\Theta_{int,i} - \Theta_e$	max. of $V_{min,i}$ , $V_{inf,i}$	$H_t$ [W·K <sup>-1</sup> ]	Design heat loss due to ventilation $\Phi_{v,i}$ (W)
30,000	13,246	4,504	135,106

Total design heat transmission loss of the specific room =	72,654 W
------------------------------------------------------------	----------

Room No.	Name of the room	Indoor temperature $\Theta_{int,i}$ [°C]						
S108	Staircase	10,000 °C						
<b>Calculation of heat transmission loss</b>								
<b>Specific heat transmission loss directly to exterior <math>H_{T,ie}</math></b>								
structures								
No.	Description	$A_k$ [m <sup>2</sup> ]	$U_k$ [W/m <sup>2</sup> .K]	$\Delta U_B$ [W/m <sup>2</sup> .K]	$U_{kc}$ [W/m <sup>2</sup> .K]	$f_{U,k}$ [-]	$f_{ie,k}$ [-]	$A_k \cdot (U_k + \Delta U_B) \cdot f_{U,k} \cdot f_{ie,k}$
$H_{T,ie} = \Sigma (A_k \cdot (U_k + \Delta U_B) \cdot f_{U,k} \cdot f_{ie,k})$ (W/k)								
0,000								

<b>Specific heat transmission loss from heated space to neighbouring heated space or unheated space or structures</b>								
No.S.	description	$\theta_u$ [°C]	$A_k$ [m <sup>2</sup> ]	$U_k$ [W/m <sup>2</sup> .K]	$\Delta U$ [W/m <sup>2</sup> .K]	$U_{kc}$ [W/m <sup>2</sup> .K]	$f_{ix,k}$ [-]	$A_k \cdot U_{kc} \cdot f_{ix,k}$
Di	interior timber doors	0,000	3,780	1,800		1,800	0,400	2,722
Di	interior timber doors	15,000	1,890	1,800		1,800	-0,200	-0,680
S3.c	internal load bearing wall	0,000	32,525	0,501	0,050	0,551	0,400	7,165
S4	internal load bearing wall	15,000	25,146	1,379		1,379	-0,200	-6,936
$H_{T,ia(..)} = \Sigma (A_k \cdot U_{kc} \cdot f_{ix,k})$ (W/K)								2,270
$F_{ix,k} = f_{i1} = (\theta_{int,i} - \theta_u) / (\theta_{int,i} - \theta_e)$								

<b>Specific heat transmission loss to ground <math>H_{T,ig}</math></b>										
No.S.	description	$A_k$ [m <sup>2</sup> ]	$A_g$ [m <sup>2</sup> ]	P [m]	$U_k$ [W/m <sup>2</sup> .K]	$f_{ig,k}$ [-]	B' [m]	$U_{equiv,k}$ [W/m <sup>2</sup> .K]	$A_k \cdot U_{equiv,k} \cdot f_{ig,k} \cdot f_{GW,k}$	
S2	Peripheral wall in touch with ground	6,500	28,000	3,100	0,127	0,248	18,06	0,186	0,299	
F	Floor on the ground	28,000	28,000	3,100	0,136	0,248	18,06	0,115	0,799	
$\Sigma (A_k \cdot U_{equiv,k} \cdot f_{ig,k} \cdot f_{GW,k})$									0,799	
$f_{\theta ann}$ [-]	$H_{T,ig} = f_{\theta ann} \cdot \Sigma (A_k \cdot U_{equiv,k} \cdot f_{ig,k} \cdot f_{GW,k})$ (W/K)					$f_{GW,k}$ [-]	$\theta_{e,m}$ [°C]			
1,450	1,159					1,000	3,800			

<b>Total design heat transmission loss <math>\Phi_{T,i} = (H_{T,ie} + H_{T,ia} + H_{T,iae} + H_{T,iaBE} + H_{T,ig}) \cdot (\theta_{int,i} - \theta_e)</math> [W]</b>				
$\theta_{int,i}$ [°C]	$\theta_e$ [°C]	$\theta_{int,i} - \theta_e$ [°C]	$\Sigma H_{T,i}$ [W.K <sup>-1</sup> ]	Design heat transmission loss $\Phi_{T,i}$ [W]
10,000	-15,000	25,000	3,429	85,721

<b>Design heat loss due to ventilation - natural ventilation</b>				
room volume $V_i$ (m <sup>3</sup> )	Outdoor temperature $\theta_e$ [°C]	indoor temperature $\theta_{int,i}$ [°C]	Hygic requirements	
			$n_{min}$ (h <sup>-1</sup> )	Hygienic air exchange $V_{min,i}$ (m <sup>3</sup> /h)
41,860	-15,000	10,000	0,500	20,930
$n_{50}$ [1/h]	Number of unprotected openings	Shading factor $e_i$	correction factor of height level from terrain $\epsilon_i$	Amount of air infiltrated by building envelope $V_{inf,i}$ (m <sup>3</sup> /h)
4,500	0,000	0,020	1,000	0,000

<b>Heat loss due to natural ventilation</b>			
$\theta_{int,i} - \theta_e$	max. of $V_{min,i}$ , $V_{inf,i}$	$H_t$ [W.K <sup>-1</sup> ]	Design heat loss due to ventilation $\Phi_{v,i}$ (W)
25,000	20,930	7,116	177,905

Total design heat transmission loss of the specific room = 263,626 W

Room No.	Name of the room	Indoor temperature $\theta_{int,i}$ [°C]						
S109	Corridor	0,000 °C						
<b>Calculation of heat transmission loss</b>								
<b>Specific heat transmission loss directly to exterior <math>H_{T,ie}</math></b>								
structures								
No.	Description	$A_k$ [m <sup>2</sup> ]	$U_k$ [W/m <sup>2</sup> .K]	$\Delta U_B$ [W/m <sup>2</sup> .K]	$U_{kc}$ [W/m <sup>2</sup> .K]	$f_{U,k}$ [-]	$f_{ie,k}$ [-]	$A_k \cdot (U_k + \Delta U_B) \cdot f_{U,k} \cdot f_{ie,k}$
De1	plastic entrance door	4,113	0,700		0,700	1,000	1,000	2,879
S1	Peripheral wall	11,525	0,125	0,050	0,175	1,000	1,000	2,013
$H_{T,ie} = \Sigma (A_k \cdot (U_k + \Delta U_B) \cdot f_{U,k} \cdot f_{ie,k})$ (W/K)								4,892

<b>Specific heat transmission loss from heated space to neighbouring heated space or unheated space or through it <math>H_{T,ia(,)}</math></b>								
structures								
No.S.	description	$\theta_u$ [°C]	$A_k$ [m <sup>2</sup> ]	$U_k$ [W/m <sup>2</sup> .K]	$\Delta U$ [W/m <sup>2</sup> .K]	$U_{kc}$ [W/m <sup>2</sup> .K]	$f_{ix,k}$ [-]	$A_k \cdot U_{kc} \cdot f_{ix,k}$
C1.a	basement ceiling	20,000	12,000	0,414		0,414	-1,333	-6,627
Di	interior timber doors	10,000	1,890	1,800		1,800	-0,667	-2,268
S3.c	internal load bearing wall	20,000	14,226	0,501		0,501	-1,333	-9,498
S3.c	internal load bearing wall	10,000	7,379	0,501		0,501	-0,667	-2,463
$H_{T,ia(,)} = \Sigma (A_k \cdot U_{kc} \cdot f_{ix,k})$ (W/K)								-20,857
$F_{ix,k} = f_1 = (\theta_{int,i} - \theta_u) / (\theta_{int,i} - \theta_e)$								

<b>Specific heat transmission loss to ground <math>H_{T,ig}</math></b>										
No.S.	description	$A_k$ [m <sup>2</sup> ]	$A_g$ [m <sup>2</sup> ]	P [m]	$U_k$ [W/m <sup>2</sup> .K]	$f_{ig,k}$ [-]	B' [m]	$U_{equiv,k}$ [W/m <sup>2</sup> .K]	$A_k \cdot U_{equiv,k} \cdot f_{ig,k} \cdot f_{GW,k}$	
F	Floor on the ground	12,000	12,000	2,000	0,309	-0,253	12,00	0,192	-0,584	
$\Sigma (A_k \cdot U_{equiv,k} \cdot f_{ig,k} \cdot f_{GW,k})$									-0,584	
$f_{\theta_{ann}}$ [-]	$H_{T,ig} = f_{\theta_{ann}} \cdot \Sigma (A_k \cdot U_{equiv,k} \cdot f_{ig,k} \cdot f_{GW,k})$ (W/K)					$f_{GW,k}$ [-]	$\theta_{e,m}$ [°C]			
1,450	-0,847					1,000	3,800			

<b>Total design heat transmission loss <math>\Phi_{T,i} = (H_{T,ie} + H_{T,ia} + H_{T,iae} + H_{T,iaBE} + H_{T,ig}) \cdot (\theta_{int,i} - \theta_e)</math> [W]</b>				
$\theta_{int,i}$ [°C]	$\theta_e$ [°C]	$\theta_{int,i} - \theta_e$ [°C]	$\Sigma H_{T,i}$ [W·K <sup>-1</sup> ]	Design heat transmission loss $\Phi_{T,i}$ [W]
0,000	-15,000	15,000	-16,812	-252,177

<b>Design heat loss due to ventilation - natural ventilation</b>				
room volume $V_i$ (m <sup>3</sup> )	Outdoor temperature $\theta_e$ [°C]	indoor temperature $\theta_{int,i}$ [°C]	Hygienic requirements	
			$n_{min}$ (h <sup>-1</sup> )	Hygienic air exchange $V_{min,i}$ (m <sup>3</sup> /h)
35,880	-15,000	0,000	0,500	17,940
$n_{50}$ [1/h]	Number of unprotected openings	Shading factor $e_i$	correction factor of height level from terrain $\epsilon_i$	Amount of air infiltrated by building envelope $V_{inf,i}$ (m <sup>3</sup> /h)
4,500	0,000	0,020	1,000	0,000

<b>Heat loss due to natural ventilation</b>			
$\theta_{int,i} - \theta_e$	max. of $V_{min,i}$ , $V_{inf,i}$	$H_t$ [W·K <sup>-1</sup> ]	Design heat loss due to ventilation $\Phi_{v,i}$ (W)
15,000	17,940	6,100	91,494

Total design heat transmission loss of the specific room = -160,683 W



Room No.	Name of the room	Indoor temperature $\Theta_{int,i}$ [°C]						
S110	Pram room 1	0,000 °C						
<b>Calculation of heat transmission loss</b>								
<b>Specific heat transmission loss directly to exterior <math>H_{T,je}</math></b>								
structures								
No.	Description	$A_k$ [m <sup>2</sup> ]	$U_k$ [W/m <sup>2</sup> .K]	$\Delta U_B$ [W/m <sup>2</sup> .K]	$U_{kc}$ [W/m <sup>2</sup> .K]	$f_{U,k}$ [-]	$f_{ie,k}$ [-]	$A_k \cdot (U_k + \Delta U_B) \cdot f_{U,k} \cdot f_{ie,k}$
W	triple glazing plastic window	0,575	0,700		0,700	1,000	1,000	0,403
S1	Peripheral wall	5,151	0,125	0,050	0,175	1,000	1,000	0,900
$H_{T,je} = \Sigma (A_k \cdot (U_k + \Delta U_B) \cdot f_{U,k} \cdot f_{ie,k})$ (W/k)								1,302

<b>Specific heat transmission loss from heated space to neighbouring heated space or unheated space or</b>								
structures								
No.S.	description	$\theta_u$ [°C]	$A_k$ [m <sup>2</sup> ]	$U_k$ [W/m <sup>2</sup> .K]	$\Delta U$ [W/m <sup>2</sup> .K]	$U_{kc}$ [W/m <sup>2</sup> .K]	$f_{ix,k}$ [-]	$A_k \cdot U_{kc} \cdot f_{ix,k}$
C1.a	basement ceiling	20,000	6,040	0,414		0,414	-1,333	-3,336
$H_{T,ia(..)} = \Sigma (A_k \cdot U_{kc} \cdot f_{ix,k})$ (W/K)								-3,336
$F_{ix,k} = f_1 = (\theta_{int,i} - \theta_u) / (\theta_{int,i} - \theta_e)$								

<b>Specific heat transmission loss to ground <math>H_{T,jg}</math></b>									
No.S.	description	$A_k$ [m <sup>2</sup> ]	$A_g$ [m <sup>2</sup> ]	P [m]	$U_k$ [W/m <sup>2</sup> .K]	$f_{ig,k}$ [-]	B' [m]	$U_{equiv,k}$ [W/m <sup>2</sup> .K]	$A_k \cdot U_{equiv,k} \cdot f_{ig,k} \cdot f_{GW,k}$
F	Floor on the ground	6,040	6,040	1,800	0,309	-0,253	6,711	0,235	-0,360
								$\Sigma (A_k \cdot U_{equiv,k} \cdot f_{ig,k} \cdot f_{GW,k})$	-0,360
$f_{\theta ann}$ [-]	$H_{T,jg} = f_{\theta ann} \cdot \Sigma (A_k \cdot U_{equiv,k} \cdot f_{ig,k} \cdot f_{GW,k})$ (W/K)				$f_{GW,k}$ [-]	$\theta_{e,m}$ [°C]			
1,450	-0,522				1,000	3,800			

<b>Total design heat transmission loss <math>\Phi_{T,i} = (H_{T,je} + H_{T,ja} + H_{T,iae} + H_{T,iae} + H_{T,jg}) \cdot (\theta_{int,i} - \theta_e)</math> [W]</b>				
$\theta_{int,i}$ [°C]	$\theta_e$ [°C]	$\theta_{int,i} - \theta_e$ [°C]	$\Sigma H_{t,i}$ [W·K <sup>-1</sup> ]	Design heat transmission loss $\Phi_{T,i}$ [W]
0,000	-15,000	15,000	-2,555	-38,327

<b>Design heat loss due to ventilation - natural ventilation</b>				
room volume $V_i$ (m <sup>3</sup> )	Outdoor temperature $\theta_e$ [°C]	indoor temperature $\theta_{int,i}$ [°C]	Hygienic requirements	
			$n_{min}$ (h <sup>-1</sup> )	Hygienic air exchange $V_{min,i}$ (m <sup>3</sup> /h)
18,060	-15,000	0,000	0,500	9,030
$n_{50}$ [1/h]	Number of unprotected openings	Shading factor $e_i$	correction factor of height level from terrain $\epsilon_i$	Amount of air infiltrated by building envelope $V_{inf,i}$ (m <sup>3</sup> /h)
4,500	0,000	0,020	1,000	0,000

<b>Heat loss due to natural ventilation</b>			
$\theta_{int,i} - \theta_e$	max. of $V_{min,i}$ , $V_{inf,i}$	$H_t$ [W·K <sup>-1</sup> ]	Design heat loss due to ventilation $\Phi_{v,i}$ (W)
15,000	9,030	3,070	46,052

Total design heat transmission loss of the specific room = 7,725 W

Room No.	Name of the room	Indoor temperature $\Theta_{int,i}$ [°C]						
S111	Bike room 1	0,000 °C						
<b>Calculation of heat transmission loss</b>								
<b>Specific heat transmission loss directly to exterior <math>H_{T,je}</math></b>								
structures								
No.	Description	$A_k$ [m <sup>2</sup> ]	$U_k$ [W/m <sup>2</sup> .K]	$\Delta U_B$ [W/m <sup>2</sup> .K]	$U_{kc}$ [W/m <sup>2</sup> .K]	$f_{U,k}$ [-]	$f_{ie,k}$ [-]	$A_k \cdot (U_k + \Delta U_B) \cdot f_{U,k} \cdot f_{ie,k}$
W	triple glazing plastic window	0,575	0,700		0,700	1,000	1,000	0,403
S1	Peripheral wall	7,947	0,125	0,050	0,175	1,000	1,000	1,388
$H_{T,je} = \Sigma (A_k \cdot (U_k + \Delta U_B) \cdot f_{U,k} \cdot f_{ie,k})$ (W/k)								1,790

<b>Specific heat transmission loss from heated space to neighbouring heated space or unheated space or structures</b>								
No.S.	description	$\theta_u$ [°C]	$A_k$ [m <sup>2</sup> ]	$U_k$ [W/m <sup>2</sup> .K]	$\Delta U$ [W/m <sup>2</sup> .K]	$U_{kc}$ [W/m <sup>2</sup> .K]	$f_{ix,k}$ [-]	$A_k \cdot U_{kc} \cdot f_{ix,k}$
C1.a	basement ceiling	20,000	13,730	0,414		0,414	-1,333	-7,582
$H_{T,ia(..)} = \Sigma (A_k \cdot U_{kc} \cdot f_{ix,k})$ (W/K)								-7,582
$F_{ix,k} = f_1 = (\theta_{int,i} - \theta_u) / (\theta_{int,i} - \theta_e)$								

<b>Specific heat transmission loss to ground <math>H_{T,ig}</math></b>									
No.S.	description	$A_k$ [m <sup>2</sup> ]	$A_g$ [m <sup>2</sup> ]	P [m]	$U_k$ [W/m <sup>2</sup> .K]	$f_{ig,k}$ [-]	B' [m]	$U_{equiv,k}$ [W/m <sup>2</sup> .K]	$A_k \cdot U_{equiv,k} \cdot f_{ig,k} \cdot f_{GW,k}$
F	Floor on the ground	13,730	13,730	2,885	0,309	-0,253	9,518	0,210	-0,729
								$\Sigma (A_k \cdot U_{equiv,k} \cdot f_{ig,k} \cdot f_{GW,k})$	-0,729
$f_{\theta_{ann}}$ [-]	$H_{T,ig} = f_{\theta_{ann}} \cdot \Sigma (A_k \cdot U_{equiv,k} \cdot f_{ig,k} \cdot f_{GW,k})$ (W/K)				$f_{GW,k}$ [-]	$\theta_{e,m}$ [°C]			
1,450	-1,058				1,000	3,800			

<b>Total design heat transmission loss <math>\Phi_{T,i} = (H_{T,je} + H_{T,ia} + H_{T,iae} + H_{T,iaBE} + H_{T,ig}) \cdot (\theta_{int,i} - \theta_e)</math> [W]</b>				
$\theta_{int,i}$ [°C]	$\theta_e$ [°C]	$\theta_{int,i} - \theta_e$ [°C]	$\Sigma H_{T,i}$ [W·K <sup>-1</sup> ]	Design heat transmission loss $\Phi_{T,i}$ [W]
0,000	-15,000	15,000	-6,850	-102,746

<b>Design heat loss due to ventilation - natural ventilation</b>				
room volume $V_i$ (m <sup>3</sup> )	Outdoor temperature $\theta_e$ [°C]	indoor temperature $\theta_{int,i}$ [°C]	Hygienic requirements	
			$n_{min}$ (h <sup>-1</sup> )	Hygienic air exchange $V_{min,i}$ (m <sup>3</sup> /h)
41,053	-15,000	0,000	0,500	20,526
$n_{50}$ [1/h]	Number of unprotected openings	Shading factor $e_i$	correction factor of height level from terrain $\epsilon_i$	Amount of air infiltrated by building envelope $V_{inf,i}$
4,500	1,000	0,020	1,000	7,389
<b>Heat loss due to natural ventilation</b>				
$\theta_{int,i} - \theta_e$	max. of $V_{min,i}, V_{inf,i}$	$H_t$ [W·K <sup>-1</sup> ]	Design heat loss due to ventilation $\Phi_{v,i}$ (W)	
15,000	20,526	6,979	104,684	

Total design heat transmission loss of the specific room = 1,939 W

Room No.	Name of the room	Indoor temperature $\Theta_{int,i}$ [°C]						
S112	Bike room 2	0,000 °C						
<b>Calculation of heat transmission loss</b>								
<b>Specific heat transmission loss directly to exterior <math>H_{T,ie}</math></b>								
structures								
No.	Description	$A_k$ [m <sup>2</sup> ]	$U_k$ [W/m <sup>2</sup> .K]	$\Delta U_B$ [W/m <sup>2</sup> .K]	$U_{kc}$ [W/m <sup>2</sup> .K]	$f_{U,k}$ [-]	$f_{ie,k}$ [-]	$A_k \cdot (U_k + \Delta U_B) \cdot f_{U,k} \cdot f_{ie,k}$
W	triple glazing plastic window	0,600	0,700		0,700	1,000	1,000	0,420
S1	Peripheral wall	21,400	0,125	0,050	0,175	1,000	1,000	3,737
$H_{T,ie} = \Sigma (A_k \cdot (U_k + \Delta U_B) \cdot f_{U,k} \cdot f_{ie,k})$ (W/k)								4,157

<b>Specific heat transmission loss from heated space to neighbouring heated space or unheated space or structures</b>								
No.S.	description	$\theta_u$ [°C]	$A_k$ [m <sup>2</sup> ]	$U_k$ [W/m <sup>2</sup> .K]	$\Delta U$ [W/m <sup>2</sup> .K]	$U_{kc}$ [W/m <sup>2</sup> .K]	$f_{ix,k}$ [-]	$A_k \cdot U_{kc} \cdot f_{ix,k}$
C1.a	basement ceiling	20,000	12,500	0,414		0,414	-1,333	-6,903
$H_{T,ia(i)} = \Sigma (A_k \cdot U_{kc} \cdot f_{ix,k})$ (W/K)								-6,903

<b>Specific heat transmission loss to ground <math>H_{T,ig}</math></b>									
No.S.	description	$A_k$ [m <sup>2</sup> ]	$A_g$ [m <sup>2</sup> ]	P [m]	$U_k$ [W/m <sup>2</sup> .K]	$f_{ig,k}$ [-]	B' [m]	$U_{equiv,k}$ [W/m <sup>2</sup> .K]	$A_k \cdot U_{equiv,k} \cdot f_{ig,k} \cdot f_{GW,k}$
F	Floor on the ground	12,500	12,500	7,358	0,309	-0,253	3,398	0,277	-0,877
								$\Sigma (A_k \cdot U_{equiv,k} \cdot f_{ig,k} \cdot f_{GW,k})$	-0,877
$f_{\theta_{ann}}$ [-]	$H_{T,ig} = f_{\theta_{ann}} \cdot \Sigma (A_k \cdot U_{equiv,k} \cdot f_{ig,k} \cdot f_{GW,k})$ (W/K)				$f_{GW,k}$ [-]	$\theta_{e,m}$ [°C]			
1,450	-1,272				1,000	3,800			

<b>Total design heat transmission loss <math>\Phi_{T,i} = (H_{T,ie} + H_{T,ia} + H_{T,iae} + H_{T,iaBE} + H_{T,ig}) \cdot (\theta_{int,i} - \theta_e)</math> [W]</b>				
$\Theta_{int,i}$ [°C]	$\Theta_e$ [°C]	$\Theta_{int,i} - \theta_e$ [°C]	$\Sigma H_{T,i}$ [W·K <sup>-1</sup> ]	Design heat transmission loss $\Phi_{T,i}$ [W]
0,000	-15,000	15,000	-4,018	-60,270

<b>Design heat loss due to ventilation - natural ventilation</b>				
room volume $V_i$ (m <sup>3</sup> )	Outdoor temperature $\Theta_e$ [°C]	indoor temperature $\Theta_{int,i}$ [°C]	Hygienic requirements	
			$n_{min}$ (h <sup>-1</sup> )	Hygienic air exchange $V_{min,i}$ (m <sup>3</sup> /h)
37,375	-15,000	0,000	0,500	18,688
$n_{50}$ [1/h]	Number of unprotected openings	Shading factor $e_i$	correction factor of height level from terrain $\epsilon_i$	Amount of air infiltrated by building envelope $V_{inf,i}$
4,500	1,000	0,020	1,000	6,728

<b>Heat loss due to natural ventilation</b>			
$\Theta_{int,i} - \Theta_e$	max. of $V_{min,i}$ , $V_{inf,i}$	$H_t$ [W·K <sup>-1</sup> ]	Design heat loss due to ventilation $\Phi_{v,i}$ (W)
15,000	18,688	6,354	95,306

Total design heat transmission loss of the specific room = 35,036 W

Room No.	Name of the room	Indoor temperature $\Theta_{int,i}$ [°C]						
S113	Corridor	0,000 °C						
<b>Calculation of heat transmission loss</b>								
<b>Specific heat transmission loss directly to exterior <math>H_{T,ie}</math></b>								
structures								
No.	Description	$A_k$ [m <sup>2</sup> ]	$U_k$ [W/m <sup>2</sup> .K]	$\Delta U_B$ [W/m <sup>2</sup> .K]	$U_{kc}$ [W/m <sup>2</sup> .K]	$f_{U,k}$ [-]	$f_{ie,k}$ [-]	$A_k \cdot (U_k + \Delta U_B) \cdot f_{U,k} \cdot f_{ie,k}$
W	triple glazing plastic window	0,400	0,700		0,700	1,000	1,000	0,280
S1	Peripheral wall	3,825	0,125	0,050	0,175	1,000	1,000	0,668
$H_{T,ie} = \Sigma (A_k \cdot (U_k + \Delta U_B) \cdot f_{U,k} \cdot f_{ie,k})$ (W/k)								0,948

<b>Specific heat transmission loss from heated space to neighbouring heated space or unheated space or structures</b>								
No.S.	description	$\theta_u$ [°C]	$A_k$ [m <sup>2</sup> ]	$U_k$ [W/m <sup>2</sup> .K]	$\Delta U$ [W/m <sup>2</sup> .K]	$U_{kc}$ [W/m <sup>2</sup> .K]	$f_{ix,k}$ [-]	$A_k \cdot U_{kc} \cdot f_{ix,k}$
S3.c	internal load bearing wall	10,000	25,146	0,501		0,501	-0,667	-8,394
Di	interior timber doors	10,000	1,890	1,800		1,800	0,000	0,000
C1.a	basement ceiling	20,000	15,110	0,414		0,414	-1,333	-8,344
$H_{T,ia(-)} = \Sigma (A_k \cdot U_{kc} \cdot f_{ix,k})$ (W/K)								-16,739
$F_{ix,k} = f_1 = (\theta_{int,i} - \theta_u) / (\theta_{int,i} - \theta_e)$								

<b>Specific heat transmission loss to ground <math>H_{T,ig}</math></b>										
No.S.	description	$A_k$ [m <sup>2</sup> ]	$A_g$ [m <sup>2</sup> ]	P [m]	$U_k$ [W/m <sup>2</sup> .K]	$f_{ig,k}$ [-]	B' [m]	$U_{equiv,k}$ [W/m <sup>2</sup> .K]	$A_k \cdot U_{equiv,k} \cdot f_{ig,k} \cdot f_{GW,k}$	
F	Floor on the ground	15,110	15,110	1,413	0,309	-0,253	21,387	0,148	-0,567	
								$\Sigma (A_k \cdot U_{equiv,k} \cdot f_{ig,k} \cdot f_{GW,k})$	-0,567	
$f_{\theta_{ann}}$ [-]	$H_{T,ig} = f_{\theta_{ann}} \cdot \Sigma (A_k \cdot U_{equiv,k} \cdot f_{ig,k} \cdot f_{GW,k})$ (W/K)					$f_{GW,k}$ [-]	$\theta_{e,m}$ [°C]			
1,450	-0,823					1,000	3,800			

<b>Total design heat transmission loss <math>\Phi_{T,i} = (H_{T,ie} + H_{T,ia} + H_{T,iae} + H_{T,iaBE} + H_{T,ig}) \cdot (\theta_{int,i} - \theta_e)</math> [W]</b>				
$\theta_{int,i}$ [°C]	$\theta_e$ [°C]	$\theta_{int,i} - \theta_e$ [°C]	$\Sigma H_{t,i}$ [W·K <sup>-1</sup> ]	Design heat transmission loss $\Phi_{T,i}$ [W]
0,000	-15,000	15,000	-16,614	-249,203

<b>Design heat loss due to ventilation - natural ventilation</b>				
room volume $V_i$ (m <sup>3</sup> )	Outdoor temperature $\theta_e$ [°C]	indoor temperature $\theta_{int,i}$ [°C]	Hygienic requirements	
			$n_{min}$ (h <sup>-1</sup> )	Hygienic air exchange $V_{min,i}$ (m <sup>3</sup> /h)
45,179	-15,000	0,000	0,500	22,589
$n_{50}$ [1/h]	Number of unprotected openings	Shading factor $e_i$	correction factor of height level from terrain $\epsilon_i$	Amount of air infiltrated by building envelope $V_{inf,i}$ (m <sup>3</sup> /h)
4,500	1,000	0,020	1,000	8,132

<b>Heat loss due to natural ventilation</b>			
$\theta_{int,i} - \theta_e$	max. of $V_{min,i}$ , $V_{inf,i}$	$H_t$ [W·K <sup>-1</sup> ]	Design heat loss due to ventilation $\Phi_{v,i}$ (W)
15,000	22,589	7,680	115,206

Total design heat transmission loss of the specific room = -133,997 W

Room No.	Name of the room	Indoor temperature $\Theta_{int,i}$ [°C]						
S114	Storeroom	0,000 °C						
<b>Calculation of heat transmission loss</b>								
<b>Specific heat transmission loss directly to exterior <math>H_{T,ie}</math></b>								
structures								
No.	Description	$A_k$ [m <sup>2</sup> ]	$U_k$ [W/m <sup>2</sup> .K]	$\Delta U_B$ [W/m <sup>2</sup> .K]	$U_{kc}$ [W/m <sup>2</sup> .K]	$f_{U,k}$ [-]	$f_{ie,k}$ [-]	$A_k \cdot (U_k + \Delta U_B) \cdot f_{U,k} \cdot f_{ie,k}$
W	triple glazing plastic window	0,400	0,700		0,700	1,000	1,000	0,280
S1	Peripheral wall	4,519	0,125	0,050	0,175	1,000	1,000	0,789
$H_{T,ie} = \Sigma (A_k \cdot (U_k + \Delta U_B) \cdot f_{U,k} \cdot f_{ie,k})$ (W/k)								1,069

<b>Specific heat transmission loss from heated space to neighbouring heated space or unheated space or structures</b>								
No.S.	description	$\theta_u$ [°C]	$A_k$ [m <sup>2</sup> ]	$U_k$ [W/m <sup>2</sup> .K]	$\Delta U$ [W/m <sup>2</sup> .K]	$U_{kc}$ [W/m <sup>2</sup> .K]	$f_{ix,k}$ [-]	$A_k \cdot U_{kc} \cdot f_{ix,k}$
C1.a	basement ceiling	24,000	2,210	0,414		0,414	-1,600	-1,465
C1.a	basement ceiling	20,000	4,840	0,414		0,414	-1,333	-2,673
$H_{T,ia(.)} = \Sigma (A_k \cdot U_{kc} \cdot f_{ix,k})$ (W/K)								-2,673

$$F_{ix,k} = f_{i1} = (\theta_{int,i} - \theta_u) / (\theta_{int,i} - \theta_e)$$

<b>Specific heat transmission loss to ground <math>H_{T,ig}</math></b>									
No.S.	description	$A_k$ [m <sup>2</sup> ]	$A_g$ [m <sup>2</sup> ]	P [m]	$U_k$ [W/m <sup>2</sup> .K]	$f_{ig,k}$ [-]	B' [m]	$U_{equiv,k}$ [W/m <sup>2</sup> .K]	$A_k \cdot U_{equiv,k} \cdot f_{ig,k} \cdot f_{GW,k}$
F	Floor on the ground	4,840	4,840	1,645	0,309	-0,253	5,884	0,244	-0,299
$\Sigma (A_k \cdot U_{equiv,k} \cdot f_{ig,k} \cdot f_{GW,k})$									-0,299
$f_{\theta_{ann}}$ [-]	$H_{T,ig} = f_{\theta_{ann}} \cdot \Sigma (A_k \cdot U_{equiv,k} \cdot f_{ig,k} \cdot f_{GW,k})$ (W/K)				$f_{GW,k}$ [-]	$\theta_{e,m}$ [°C]			
1,450	-0,434				1,000	3,800			

<b>Total design heat transmission loss <math>\Phi_{T,i} = (H_{T,ie} + H_{T,ia} + H_{T,iae} + H_{T,iaBE} + H_{T,ig}) \cdot (\theta_{int,i} - \theta_e)</math> [W]</b>				
$\theta_{int,i}$ [°C]	$\theta_e$ [°C]	$\theta_{int,i} - \theta_e$ [°C]	$\Sigma H_{T,i}$ [W.K <sup>-1</sup> ]	Design heat transmission loss $\Phi_{T,i}$ [W]
0,000	-15,000	15,000	-2,038	-30,566

<b>Design heat loss due to ventilation - natural ventilation</b>				
room volume $V_i$ (m <sup>3</sup> )	Outdoor temperature $\theta_e$ [°C]	indoor temperature $\theta_{int,i}$ [°C]	Hygienic requirements	
			$n_{min}$ (h <sup>-1</sup> )	Hygienic air exchange $V_{min,i}$ (m <sup>3</sup> /h)
14,472	-15,000	0,000	0,500	7,236
$n_{50}$ [1/h]	Number of unprotected openings	Shading factor $e_i$	correction factor of height level from terrain $\epsilon_i$	Amount of air infiltrated by building envelope $V_{inf,i}$
4,500	1,000	0,020	1,000	2,605

<b>Heat loss due to natural ventilation</b>			
$\theta_{int,i} - \theta_e$	max. of $V_{min,i}, V_{inf,i}$	$H_t$ [W.K <sup>-1</sup> ]	Design heat loss due to ventilation $\Phi_{v,i}$ (W)
15,000	7,236	2,460	36,903

Total design heat transmission loss of the specific room = 6,337 W

Room No.	Name of the room	Indoor temperature $\Theta_{int,i}$ [°C]						
S115	Storeroom	0,000 °C						
<b>Calculation of heat transmission loss</b>								
<b>Specific heat transmission loss directly to exterior <math>H_{T,ie}</math></b>								
structures								
No.	Description	$A_k$ [m <sup>2</sup> ]	$U_k$ [W/m <sup>2</sup> .K]	$\Delta U_B$ [W/m <sup>2</sup> .K]	$U_{kc}$ [W/m <sup>2</sup> .K]	$f_{U,k}$ [-]	$f_{ie,k}$ [-]	$A_k \cdot (U_k + \Delta U_B) \cdot f_{U,k} \cdot f_{ie,k}$
W	triple glazing plastic window	0,400	0,700	0,000	0,700	1,000	1,000	0,280
S1	Peripheral wall	4,519	0,125	0,050	0,175	1,000	1,000	0,789
$H_{T,ie} = \Sigma (A_k \cdot (U_k + \Delta U_B) \cdot f_{U,k} \cdot f_{ie,k})$ (W/k)								1,069

<b>Specific heat transmission loss from heated space to neighbouring heated space or unheated space or structures</b>								
No.S.	description	$\theta_u$ [°C]	$A_k$ [m <sup>2</sup> ]	$U_k$ [W/m <sup>2</sup> .K]	$\Delta U$ [W/m <sup>2</sup> .K]	$U_{kc}$ [W/m <sup>2</sup> .K]	$f_{ix,k}$ [-]	$A_k \cdot U_{kc} \cdot f_{ix,k}$
C1.a	basement ceiling	20,000	4,840	0,414		0,414	-1,333	-2,673
C1.a	basement ceiling	24,000	2,210	0,414		0,414	-1,600	-1,465
$H_{T,ia(..)} = \Sigma (A_k \cdot U_{kc} \cdot f_{ix,k})$ (W/K)								-1,465
$F_{ix,k} = f_1 = (\theta_{int,i} - \theta_u) / (\theta_{int,i} - \theta_e)$								

<b>Specific heat transmission loss to ground <math>H_{T,ig}</math></b>										
No.S.	description	$A_k$ [m <sup>2</sup> ]	$A_g$ [m <sup>2</sup> ]	P [m]	$U_k$ [W/m <sup>2</sup> .K]	$f_{ig,k}$ [-]	B' [m]	$U_{equiv,k}$ [W/m <sup>2</sup> .K]	$A_k \cdot U_{equiv,k} \cdot f_{ig,k} \cdot f_{GW,k}$	
F	Floor on the ground	7,050	7,050	1,650	0,309	-0,253	8,545	0,218	-0,389	
								$\Sigma (A_k \cdot U_{equiv,k} \cdot f_{ig,k} \cdot f_{GW,k})$	-0,389	
$f_{\theta ann}$ [-]	$H_{T,ig} = f_{\theta ann} \cdot \Sigma (A_k \cdot U_{equiv,k} \cdot f_{ig,k} \cdot f_{GW,k})$ (W/K)					$f_{GW,k}$ [-]	$\theta_{e,m}$ [°C]			
1,450	-0,564					1,000	3,800			

<b>Total design heat transmission loss <math>\Phi_{T,i} = (H_{T,ie} + H_{T,ia} + H_{T,iae} + H_{T,iaBE} + H_{T,ig}) \cdot (\theta_{int,i} - \theta_e)</math> [W]</b>				
$\Theta_{int,i}$ [°C]	$\Theta_e$ [°C]	$\Theta_{int,i} - \theta_e$ [°C]	$\Sigma H_{T,i}$ [W.K <sup>-1</sup> ]	Design heat transmission loss $\Phi_{T,i}$ [W]
0,000	-15,000	15,000	-0,959	-14,389

<b>Design heat loss due to ventilation - natural ventilation</b>				
room volume $V_i$ (m <sup>3</sup> )	Outdoor temperature $\Theta_e$ [°C]	indoor temperature $\Theta_{int,i}$ [°C]	Hygienic requirements	
			$n_{min}$ (h <sup>-1</sup> )	Hygienic air exchange $V_{min,i}$ (m <sup>3</sup> /h)
21,080	-15,000	0,000	0,500	10,540
$n_{50}$ [1/h]	Number of unprotected openings	Shading factor $e_i$	correction factor of height level from terrain $\epsilon_i$	Amount of air infiltrated by building envelope $V_{inf,i}$
4,500	1,000	0,020	1,000	3,794
<b>Heat loss due to natural ventilation</b>				
$\Theta_{int,i} - \Theta_e$	max. of $V_{min,i}$ , $V_{inf,i}$		$H_t$ [W.K <sup>-1</sup> ]	Design heat loss due to ventilation $\Phi_{v,i}$ (W)
15,000	10,540		3,584	53,753

Total design heat transmission loss of the specific room = 39,363 W

Room No.	Name of the room	Indoor temperature $\Theta_{int,i}$ [°C]						
S116	Storeroom	0,000 °C						
<b>Calculation of heat transmission loss</b>								
<b>Specific heat transmission loss directly to exterior <math>H_{T,ie}</math></b>								
structures								
No.	Description	$A_k$ [m <sup>2</sup> ]	$U_k$ [W/m <sup>2</sup> .K]	$\Delta U_B$ [W/m <sup>2</sup> .K]	$U_{kc}$ [W/m <sup>2</sup> .K]	$f_{U,k}$ [-]	$f_{ie,k}$ [-]	$A_k \cdot (U_k + \Delta U_B) \cdot f_{U,k} \cdot f_{ie,k}$
W	triple glazing plastic window	0,800	0,700		0,700	1,000	1,000	0,560
S1	Peripheral wall	13,356	0,125	0,050	0,175	1,000	1,000	2,333
$H_{T,ie} = \Sigma (A_k \cdot (U_k + \Delta U_B) \cdot f_{U,k} \cdot f_{ie,k})$ (W/k)								2,893

<b>Specific heat transmission loss from heated space to neighbouring heated space or unheated space or structures</b>								
No.S.	description	$\theta_u$ [°C]	$A_k$ [m <sup>2</sup> ]	$U_k$ [W/m <sup>2</sup> .K]	$\Delta U$ [W/m <sup>2</sup> .K]	$U_{kc}$ [W/m <sup>2</sup> .K]	$f_{ix,k}$ [-]	$A_k \cdot U_{kc} \cdot f_{ix,k}$
C1.a	basement ceiling	20,000	7,940	0,414		0,414	-1,333	-4,385
$H_{T,ia(..)} = \Sigma (A_k \cdot U_{kc} \cdot f_{ix,k})$ (W/K)								-4,385

$$F_{ix,k} = f_1 = (\theta_{int,i} - \theta_u) / (\theta_{int,i} - \theta_e)$$

<b>Specific heat transmission loss to ground <math>H_{T,ig}</math></b>										
No.S.	description	$A_k$ [m <sup>2</sup> ]	$A_g$ [m <sup>2</sup> ]	P [m]	$U_k$ [W/m <sup>2</sup> .K]	$f_{ig,k}$ [-]	B' [m]	$U_{equiv,k}$ [W/m <sup>2</sup> .K]	$A_k \cdot U_{equiv,k} \cdot f_{ig,k} \cdot f_{GW,k}$	
S2	Peripheral wall in touch with ground	3,700	7,940	5,975	0,127	-0,253	2,66	0,186	-0,174	
F	Floor on the ground	7,940	7,940	5,975	0,309	-0,253	2,658	0,289	0,000	
								$\Sigma (A_k \cdot U_{equiv,k} \cdot f_{ig,k} \cdot f_{GW,k})$	0,000	
$f_{\theta ann}$ [-]	$H_{T,ig} = f_{\theta ann} \cdot \Sigma (A_k \cdot U_{equiv,k} \cdot f_{ig,k} \cdot f_{GW,k})$ (W/K)					$f_{GW,k}$ [-]	$\theta_{e,m}$ [°C]			
1,450	0,000					1,000	3,800			

<b>Total design heat transmission loss <math>\Phi_{T,i} = (H_{T,ie} + H_{T,ia} + H_{T,iae} + H_{T,iaBE} + H_{T,ig}) \cdot (\theta_{int,i} - \theta_e)</math> [W]</b>				
$\Theta_{int,i}$ [°C]	$\Theta_e$ [°C]	$\Theta_{int,i} - \theta_e$ [°C]	$\Sigma H_{t,i}$ [W.K <sup>-1</sup> ]	Design heat transmission loss $\Phi_{T,i}$ [W]
0,000	-15,000	15,000	-1,492	-22,385

<b>Design heat loss due to ventilation - natural ventilation</b>				
room volume $V_i$ (m <sup>3</sup> )	Outdoor temperature $\Theta_e$ [°C]	indoor temperature $\Theta_{int,i}$ [°C]	Hygienic requirements	
			$n_{min}$ (h <sup>-1</sup> )	Hygienic air exchange $V_{min,i}$ (m <sup>3</sup> /h)
23,741	-15,000	0,000	0,500	11,870
$n_{50}$ [1/h]	Number of unprotected openings	Shading factor $e_i$	correction factor of height level from terrain $\epsilon_i$	Amount of air infiltrated by building envelope $V_{inf,i}$ (m <sup>3</sup> /h)
4,500	1,000	0,020	1,000	4,273

<b>Heat loss due to natural ventilation</b>			
$\Theta_{int,i} - \Theta_e$	max. of $V_{min,i}$ , $V_{inf,i}$	$H_t$ [W.K <sup>-1</sup> ]	Design heat loss due to ventilation $\Phi_{v,i}$ (W)
15,000	11,870	4,036	60,539

Total design heat transmission loss of the specific room = 38,153 W

Room No.	Name of the room	Indoor temperature $\Theta_{int,i}$ [°C]						
S117	Storeroom	0,000 °C						
<b>Calculation of heat transmission loss</b>								
<b>Specific heat transmission loss directly to exterior <math>H_{T,je}</math></b>								
structures								
No.	Description	$A_k$ [m <sup>2</sup> ]	$U_k$ [W/m <sup>2</sup> .K]	$\Delta U_B$ [W/m <sup>2</sup> .K]	$U_{kc}$ [W/m <sup>2</sup> .K]	$f_{U,k}$ [-]	$f_{ie,k}$ [-]	$A_k \cdot (U_k + \Delta U_B) \cdot f_{U,k} \cdot f_{ie,k}$
W	triple glazing plastic window	0,400	0,700		0,700	1,000	1,000	0,280
S1	Peripheral wall	5,425	0,125	0,050	0,175	1,000	1,000	0,947
$H_{T,je} = \Sigma (A_k \cdot (U_k + \Delta U_B) \cdot f_{U,k} \cdot f_{ie,k})$ (W/k)								1,227

<b>Specific heat transmission loss from heated space to neighbouring heated space or unheated space or</b>								
structures								
No.S.	description	$\theta_u$ [°C]	$A_k$ [m <sup>2</sup> ]	$U_k$ [W/m <sup>2</sup> .K]	$\Delta U$ [W/m <sup>2</sup> .K]	$U_{kc}$ [W/m <sup>2</sup> .K]	$f_{ix,k}$ [-]	$A_k \cdot U_{kc} \cdot f_{ix,k}$
C1.a	basement ceiling	20,000	7,940	0,414		0,414	-1,333	-4,385
$H_{T,ial(.)} = \Sigma (A_k \cdot U_{kc} \cdot f_{ix,k})$ (W/K)								-4,385
$F_{ix,k} = f_1 = (\theta_{int,i} - \theta_u) / (\theta_{int,i} - \theta_e)$								

<b>Specific heat transmission loss to ground <math>H_{T,ig}</math></b>									
No.S.	description	$A_k$ [m <sup>2</sup> ]	$A_g$ [m <sup>2</sup> ]	P [m]	$U_k$ [W/m <sup>2</sup> .K]	$f_{ig,k}$ [-]	B' [m]	$U_{equiv,k}$ [W/m <sup>2</sup> .K]	$A_k \cdot U_{equiv,k} \cdot f_{ig,k} \cdot f_{GW,k}$
F	Floor on the ground	7,940	7,940	1,948	0,309	-0,253	8,152	0,221	-0,445
								$\Sigma (A_k \cdot U_{equiv,k} \cdot f_{ig,k} \cdot f_{GW,k})$	-0,445
$f_{\theta ann}$ [-]	$H_{T,ig} = f_{\theta ann} \cdot \Sigma (A_k \cdot U_{equiv,k} \cdot f_{ig,k} \cdot f_{GW,k})$ (W/K)				$f_{GW,k}$ [-]	$\theta_{e,m}$ [°C]			
1,450	-0,645				1,000	3,800			

<b>Total design heat transmission loss <math>\Phi_{T,i} = (H_{T,je} + H_{T,ia} + H_{T,iae} + H_{T,iaBE} + H_{T,ig}) \cdot (\theta_{int,i} - \theta_e)</math> [W]</b>				
$\theta_{int,i}$ [°C]	$\theta_e$ [°C]	$\theta_{int,i} - \theta_e$ [°C]	$\Sigma H_{T,i}$ [W.K <sup>-1</sup> ]	Design heat transmission loss $\Phi_{T,i}$ [W]
0,000	-15,000	15,000	-3,803	-57,040

<b>Design heat loss due to ventilation - natural ventilation</b>				
room volume $V_i$ (m <sup>3</sup> )	Outdoor temperature $\theta_e$ [°C]	indoor temperature $\theta_{int,i}$ [°C]	Hygienic requirements	
			$n_{min}$ (h <sup>-1</sup> )	Hygienic air exchange $V_{min,i}$ (m <sup>3</sup> /h)
23,741	-15,000	0,000	0,500	11,870
$n_{50}$ [1/h]	Number of unprotected openings	Shading factor $e_i$	correction factor of height level from terrain $\epsilon_i$	Amount of air infiltrated by building envelope $V_{inf,i}$ (m <sup>3</sup> /h)
4,500	1,000	0,020	1,000	4,273

<b>Heat loss due to natural ventilation</b>			
$\theta_{int,i} - \theta_e$	max. of $V_{min,i}$ , $V_{inf,i}$	$H_t$ [W.K <sup>-1</sup> ]	Design heat loss due to ventilation $\Phi_{v,i}$ (W)
15,000	11,870	4,036	60,539

Total design heat transmission loss of the specific room = 3,499 W



Room No.	Name of the room	Indoor temperature $\Theta_{int,i}$ [°C]						
S118	Storeroom	0,000 °C						
<b>Calculation of heat transmission loss</b>								
<b>Specific heat transmission loss directly to exterior <math>H_{T,ie}</math></b>								
structures								
No.	Description	$A_k$ [m <sup>2</sup> ]	$U_k$ [W/m <sup>2</sup> .K]	$\Delta U_B$ [W/m <sup>2</sup> .K]	$U_{kc}$ [W/m <sup>2</sup> .K]	$f_{U,k}$ [-]	$f_{ie,k}$ [-]	$A_k \cdot (U_k + \Delta U_B) \cdot f_{U,k} \cdot f_{ie,k}$
W	triple glazing plastic window	0,400	0,700		0,700	1,000	1,000	0,280
S1	Peripheral wall	5,425	0,125	0,050	0,175	1,000	1,000	0,947
$H_{T,ie} = \Sigma (A_k \cdot (U_k + \Delta U_B) \cdot f_{U,k} \cdot f_{ie,k})$ (W/K)								1,227

<b>Specific heat transmission loss from heated space to neighbouring heated space or unheated space or</b>								
structures								
No.S.	description	$\theta_u$ [°C]	$A_k$ [m <sup>2</sup> ]	$U_k$ [W/m <sup>2</sup> .K]	$\Delta U$ [W/m <sup>2</sup> .K]	$U_{kc}$ [W/m <sup>2</sup> .K]	$f_{ix,k}$ [-]	$A_k \cdot U_{kc} \cdot f_{ix,k}$
S3.c	Internal load bearing wall	10,000	11,900	0,501		0,501	-0,667	-3,973
C1.a	basement ceiling	20,000	7,940	0,414		0,414	-1,333	-4,385
$H_{T,ia(-)} = \Sigma (A_k \cdot U_{kc} \cdot f_{ix,k})$ (W/K)								-8,358

$$F_{ix,k} = f_{ix} = (\theta_{int,i} - \theta_u) / (\theta_{int,i} - \theta_e)$$

<b>Specific heat transmission loss to ground <math>H_{T,ig}</math></b>									
No.S.	description	$A_k$ [m <sup>2</sup> ]	$A_g$ [m <sup>2</sup> ]	P [m]	$U_k$ [W/m <sup>2</sup> .K]	$f_{ig,k}$ [-]	B' [m]	$U_{equiv,k}$ [W/m <sup>2</sup> .K]	$A_k \cdot U_{equiv,k} \cdot f_{ig,k} \cdot f_{GW,k}$
F	Floor on the ground	7,940	7,940	1,948	0,309	-0,253	8,152	0,221	-0,445
								$\Sigma (A_k \cdot U_{equiv,k} \cdot f_{ig,k} \cdot f_{GW,k})$	-0,445
$f_{\theta ann}$ [-]	$H_{T,ig} = f_{\theta ann} \cdot \Sigma (A_k \cdot U_{equiv,k} \cdot f_{ig,k} \cdot f_{GW,k})$ (W/K)				$f_{GW,k}$ [-]	$\theta_{e,m}$ [°C]			
1,450	-0,645				1,000	3,800			

<b>Total design heat transmission loss <math>\Phi_{T,i} = (H_{T,ie} + H_{T,ia} + H_{T,iae} + H_{T,iaBE} + H_{T,ig}) \cdot (\theta_{int,i} - \theta_e)</math> [W]</b>				
$\theta_{int,i}$ [°C]	$\theta_e$ [°C]	$\theta_{int,i} - \theta_e$ [°C]	$\Sigma H_{T,i}$ [W.K <sup>-1</sup> ]	Design heat transmission loss $\Phi_{T,i}$ [W]
0,000	-15,000	15,000	-7,775	-116,630

<b>Design heat loss due to ventilation - natural ventilation</b>				
room volume $V_i$ (m <sup>3</sup> )	Outdoor temperature $\theta_e$ [°C]	indoor temperature $\theta_{int,i}$ [°C]	Hygienic requirements	
			$n_{min}$ (h <sup>-1</sup> )	Hygienic air exchange $V_{min,i}$ (m <sup>3</sup> /h)
23,741	-15,000	0,000	0,500	11,870
$n_{50}$ [1/h]	Number of unprotected openings	Shading factor $e_i$	correction factor of height level from terrain $\epsilon_i$	Amount of air infiltrated by building envelope $V_{inf,i}$ (m <sup>3</sup> /h)
4,500	1,000	0,020	1,000	4,273

<b>Heat loss due to natural ventilation</b>			
$\theta_{int,i} - \theta_e$	max. of $V_{min,i}$ , $V_{inf,i}$	$H_t$ [W.K <sup>-1</sup> ]	Design heat loss due to ventilation $\Phi_{v,i}$ (W)
15,000	11,870	4,036	60,539

Total design heat transmission loss of the specific room =	-56,091 W
------------------------------------------------------------	-----------

## Heat losses of first floor

<b>Room No.</b>	<b>Name of the room</b>	<b>Indoor temperature <math>\Theta_{int,i}</math> [°C]</b>						
101A	Vestibule	20,000 °C						
<b>Calculation of heat transmission loss</b>								
<b>Specific heat transmission loss directly to exterior <math>H_{T,ie}</math></b>								
structures								
No.	Description	$A_k$ [m <sup>2</sup> ]	$U_k$ [W/m <sup>2</sup> .K]	$\Delta U_B$ [W/m <sup>2</sup> .K]	$U_{kc}$ [W/m <sup>2</sup> .K]	$f_{U,k}$ [-]	$f_{ie,k}$ [-]	$A_k \cdot (U_k + \Delta U_B) \cdot f_{U,k} \cdot f_{ie,k}$
W	Triple glazing plastic window	1,088	0,700		0,700	1,000	1,000	0,762
S1	Peripheral wall	1,857	0,125	0,050	0,175	1,000	1,000	0,324
$H_{T,ie} = \Sigma (A_k \cdot (U_k + \Delta U_B) \cdot f_{U,k} \cdot f_{ie,k})$ (W/k)								1,086

<b>Specific heat transmission loss from heated space to neighbouring heated space or unheated space or through it <math>H_{T,ia(e)}</math></b>								
structures								
No.S.	description	$\Theta_u$ [°C]	$A_k$ [m <sup>2</sup> ]	$U_k$ [W/m <sup>2</sup> .K]	$\Delta U$ [W/m <sup>2</sup> .K]	$U_{kc}$ [W/m <sup>2</sup> .K]	$f_{ix,k}$ [-]	$A_k \cdot U_{kc} \cdot f_{ix,k}$
C1.b	ceiling above basement	15,000	6,700	0,414		0,414	0,143	0,396
S4	internal non-load bearing wall	24,000	6,094	1,379		1,379	-0,114	-0,961
S3.a	internal load bearing wall	10,000	9,771	0,501		0,501	0,286	1,398
Di	interior timber door	10,000	1,890	1,800		1,800	0,286	0,972
Di	interior timber door	24,000	1,680	1,800		1,800	-0,114	-0,346
$H_{T,ia(e)} = \Sigma (A_k \cdot U_{kc} \cdot f_{ix,k})$ (W/K)								1,460
$F_{ix,k} = f_1 = (\Theta_{int,i} - \Theta_u) / (\Theta_{int,i} - \Theta_e)$								

<b>Specific heat transmission loss to ground <math>H_{T,ig}</math></b>										
No.S.	description	$A_k$ [m <sup>2</sup> ]	$A_g$ [m <sup>2</sup> ]	P [m]	$U_k$ [W/m <sup>2</sup> .K]	$f_{ig,k}$ [-]	B' [m]	$U_{equiv,k}$ [W/m <sup>2</sup> .K]	$A_k \cdot U_{equiv,k} \cdot f_{ig,k} \cdot f_{GW,k}$	
									$\Sigma (A_k \cdot U_{equiv,k} \cdot f_{ig,k} \cdot f_{GW,k})$	0,000
$f_{\Theta_{ann}}$ [-]	$H_{T,ig} = f_{\Theta_{ann}} \cdot \Sigma (A_k \cdot U_{equiv,k} \cdot f_{ig,k} \cdot f_{GW,k})$ (W/K)				$f_{GW,k}$ [-]	$\Theta_{e,m}$				
1,450	0,000				1,000	3,900				

<b>Total design heat transmission loss <math>\Phi_{T,i} = (H_{T,ie} + H_{T,ia} + H_{T,iae} + H_{T,iaBE} + H_{T,ig}) \cdot (\Theta_{int,i} - \Theta_e)</math> [W]</b>				
$\Theta_{int,i}$ [°C]	$\Theta_e$ [°C]	$\Theta_{int,i} - \Theta_e$ [°C]	$\Sigma H_{T,i}$ [W·K <sup>-1</sup> ]	Design heat transmission loss $\Phi_{T,i}$ [W]
20,000	-15,000	35,000	2,546	89,114

<b>Design heat loss due to ventilation - natural ventilation</b>				
room volume $V_i$ (m <sup>3</sup> )	Outdoor temperature $\Theta_e$ [°C]	indoor temperature $\Theta_{int,i}$ [°C]	Hygienic requirements	
29,003	-15,000	20,000	$n_{min}$ (h <sup>-1</sup> )	Hygienic air exchange $V_{min,i}$ (m <sup>3</sup> /h)
			0,500	14,502
$n_{50}$ [1/h]	Number of unprotected openings	Shading factor $e_i$	correction factor of height level from terrain $\epsilon_i$	Amount of air infiltrated by building envelope $V_{inf,i}$
4,500	0,000	0,000	1,000	0,000

<b>Heat loss due to natural ventilation</b>			
$\Theta_{int,i} - \Theta_e$	max. of $V_{min,i}$ , $V_{inf,i}$	$H_t$ [W·K <sup>-1</sup> ]	Design heat loss due to ventilation $\Phi_{v,i}$ (W)
35,000	14,502	4,931	172,568

Total design heat transmission loss of the specific room = 261,682 W

Room No.	Name of the room	Indoor temperature $\Theta_{int,i}$ [°C]
102A	Washing machine room	20,000 °C

**Calculation of heat transmission loss**

**Specific heat transmission loss directly to exterior  $H_{T,ie}$**

structures								
No.	Description	$A_k$ [m <sup>2</sup> ]	$U_k$ [W/m <sup>2</sup> .K]	$\Delta U_B$ [W/m <sup>2</sup> .K]	$U_{kc}$ [W/m <sup>2</sup> .K]	$f_{U,k}$ [-]	$f_{ie,k}$ [-]	$A_k \cdot (U_k + \Delta U_B) \cdot f_{U,k} \cdot f_{ie,k}$
								0,000
$H_{T,ie} = \Sigma (A_k \cdot (U_k + \Delta U_B) \cdot f_{U,k} \cdot f_{ie,k})$ (W/k)								0,000

**Specific heat transmission loss from heated space to neighbouring heated space or unheated space or through it  $H_{T,ia(,)}$**

structures								
No.S.	description	$\Theta_u$ [°C]	$A_k$ [m <sup>2</sup> ]	$U_k$ [W/m <sup>2</sup> .K]	$\Delta U$ [W/m <sup>2</sup> .K]	$U_{kc}$ [W/m <sup>2</sup> .K]	$f_{ix,k}$ [-]	$A_k \cdot U_{kc} \cdot f_{ix,k}$
S4	internal non-load bearing wall	24,000	3,190	1,379		1,379	-0,114	-0,503
C1.b	ceiling above basement	15,000	1,980	0,414		0,414	0,143	0,117
$H_{T,ia(,)} = \Sigma (A_k \cdot U_{kc} \cdot f_{ix,k})$ (W/K)								-0,386

$$F_{ix,k} = f_1 = (\Theta_{int,i} - \Theta_u) / (\Theta_{int,i} - \Theta_e)$$

**Specific heat transmission loss to ground  $H_{T,ig}$**

No.S.	description	$A_k$ [m <sup>2</sup> ]	$A_g$ [m <sup>2</sup> ]	P [m]	$U_k$ [W/m <sup>2</sup> .K]	$f_{ig,k}$ [-]	B' [m]	$U_{equiv,k}$ [W/m <sup>2</sup> .K]	$A_k \cdot U_{equiv,k} \cdot f_{ig,k} \cdot f_{GW,k}$
$\Sigma (A_k \cdot U_{equiv,k} \cdot f_{ig,k} \cdot f_{GW,k})$									0,000

$$H_{T,ig} = f_{\theta_{ann}} \cdot \Sigma (A_k \cdot U_{equiv,k} \cdot f_{ig,k} \cdot f_{GW,k})$$
 (W/K)

$f_{\theta_{ann}}$	$f_{GW,k}$	$\Theta_{e,m}$ [°C]
1,450	0,000	1,000 3,900

**Total design heat transmission loss  $\Phi_{T,i} = (H_{T,ie} + H_{T,ia} + H_{T,iae} + H_{T,iaBE} + H_{T,ig}) \cdot (\Theta_{int,i} - \Theta_e)$  [W]**

$\Theta_{int,i}$ [°C]	$\Theta_e$ [°C]	$\Theta_{int,i} - \Theta_e$ [°C]	$\Sigma H_{T,i}$ [W·K <sup>-1</sup> ]	Design heat transmission loss $\Phi_{T,i}$ [W]
20,000	-15,000	35,000	-0,386	-13,501

**Design heat loss due to ventilation - natural ventilation**

room volume $V_i$ (m <sup>3</sup> )	Outdoor temperature $\Theta_e$ [°C]	indoor temperature $\Theta_{int,i}$ [°C]	Hygienic requirements	
			$n_{min}$ (h <sup>-1</sup> )	Hygienic air exchange $V_{min,i}$ (m <sup>3</sup> /h)
5,920	-15,000	20,000	1,500	8,880
$n_{50}$ [1/h]	Number of unprotected openings	Shading factor $e_i$	correction factor of height level from terrain $\epsilon_i$	Amount of air infiltrated by building envelope $V_{inf,i}$
4,500	0,000	0,020	1,000	0,000

**Heat loss due to natural ventilation**

$\Theta_{int,i} - \Theta_e$	max. of $V_{min,i}$ , $V_{inf,i}$	$H_t$ [W·K <sup>-1</sup> ]	Design heat loss due to ventilation $\Phi_{v,i}$ (W)
35,000	8,880	3,019	105,676

Total design heat transmission loss of the specific room = 92,175 W

Room No.	Name of the room	Indoor temperature $\theta_{int,i}$ [°C]
103A	Toilet	20,000 °C

**Calculation of heat transmission loss**

**Specific heat transmission loss directly to exterior  $H_{T,ie}$**

structures								
No.	Description	$A_k$ [m <sup>2</sup> ]	$U_k$ [W/m <sup>2</sup> .K]	$\Delta U_B$ [W/m <sup>2</sup> .K]	$U_{kc}$ [W/m <sup>2</sup> .K]	$f_{U,k}$ [-]	$f_{ie,k}$ [-]	$A_k \cdot (U_k + \Delta U_B) \cdot f_{U,k} \cdot f_{ie,k}$
								0,000
$H_{T,ie} = \Sigma (A_k \cdot (U_k + \Delta U_B) \cdot f_{U,k} \cdot f_{ie,k})$ (W/k)								0,000

**Specific heat transmission loss from heated space to neighbouring heated space or unheated space or through it  $H_{T,ia(i)}$**

structures								
No.S.	description	$\theta_u$ [°C]	$A_k$ [m <sup>2</sup> ]	$U_k$ [W/m <sup>2</sup> .K]	$\Delta U$ [W/m <sup>2</sup> .K]	$U_{kc}$ [W/m <sup>2</sup> .K]	$f_{ix,k}$ [-]	$A_k \cdot U_{kc} \cdot f_{ix,k}$
S4	internal non-load bearing wall	24,000	1,704	1,379		1,379	-0,114	-0,269
$H_{T,ia(i)} = \Sigma (A_k \cdot U_{kc} \cdot f_{ix,k})$ (W/K)								-0,269
$F_{ix,k} = f_{ix} = (\theta_{int,i} - \theta_u) / (\theta_{int,i} - \theta_e)$								

**Specific heat transmission loss to ground  $H_{T,ig}$**

No.S.	description	$A_k$ [m <sup>2</sup> ]	$A_g$ [m <sup>2</sup> ]	P [m]	$U_k$ [W/m <sup>2</sup> .K]	$f_{ig,k}$ [-]	B' [m]	$U_{equiv,k}$ [W/m <sup>2</sup> .K]	$A_k \cdot U_{equiv,k} \cdot f_{ig,k} \cdot f_{GW,k}$
$\Sigma (A_k \cdot U_{equiv,k} \cdot f_{ig,k} \cdot f_{GW,k})$									0,000
$f_{\theta_{ann}}$ [-]	$H_{T,ig} = f_{\theta_{ann}} \cdot \Sigma (A_k \cdot U_{equiv,k} \cdot f_{ig,k} \cdot f_{GW,k})$ (W/K)				$f_{GW,k}$ [-]	$\theta_{e,m}$ [°C]			
1,450	0,000				1,000	3,900			

**Total design heat transmission loss  $\Phi_{T,i} = (H_{T,ie} + H_{T,ia} + H_{T,iae} + H_{T,iaBE} + H_{T,ig}) \cdot (\theta_{int,i} - \theta_e)$  [W]**

$\theta_{int,i}$ [°C]	$\theta_e$ [°C]	$\theta_{int,i} - \theta_e$ [°C]	$\Sigma H_{T,i}$ [W·K <sup>-1</sup> ]	Design heat transmission loss $\Phi_{T,i}$ [W]
20,000	-15,000	35,000	-0,269	-9,403

**Design heat loss due to ventilation - natural ventilation**

room volume $V_i$ (m <sup>3</sup> )	Outdoor temperature $\theta_e$ [°C]	indoor temperature $\theta_{int,i}$ [°C]	Hygienic requirements	
			$n_{min}$ (h <sup>-1</sup> )	Hygienic air exchange $V_{min,i}$ (m <sup>3</sup> /h)
10,405	-15,000	20,000	0,500	5,203
$n_{50}$ [1/h]	Number of unprotected openings	Shading factor $e_i$	correction factor of height level from terrain $\epsilon_i$	Amount of air infiltrated by building envelope $V_{inf,i}$
4,500	0,000	0,020	1,000	0,000

**Heat loss due to natural ventilation**

$\theta_{int,i} - \theta_e$	max. of $V_{min,i}$ , $V_{inf,i}$	$H_i$ [W·K <sup>-1</sup> ]	Design heat loss due to ventilation $\Phi_{v,i}$ (W)
35,000	5,203	1,769	61,911

Total design heat transmission loss of the specific room = 52,508 W

Room No.	Name of the room	Indoor temperature $\theta_{int,i}$ [°C]
104A	Kitchen and living room	20,000 °C

**Calculation of heat transmission loss**

**Specific heat transmission loss directly to exterior  $H_{T,ie}$**

structures								
No.	Description	$A_k$ [m <sup>2</sup> ]	$U_k$ [W/m <sup>2</sup> .K]	$\Delta U_B$ [W/m <sup>2</sup> .K]	$U_{kc}$ [W/m <sup>2</sup> .K]	$f_{U,k}$ [-]	$f_{ie,k}$ [-]	$A_k \cdot (U_k + \Delta U_B) \cdot f_{U,k} \cdot f_{ie,k}$
W+D	Plastic balcony door and windows	9,575	0,700		0,700	1,000	1,000	6,703
S1	peripheral wall	23,166	0,125	0,050	0,175	1,000	1,000	4,046
$H_{T,ie} = \Sigma (A_k \cdot (U_k + \Delta U_B) \cdot f_{U,k} \cdot f_{ie,k})$ (W/k)								10,748

**Specific heat transmission loss from heated space to neighbouring heated space or unheated space or through it  $H_{T,ia(..)}$**

structures								
No.S.	description	$\theta_u$ [°C]	$A_k$ [m <sup>2</sup> ]	$U_k$ [W/m <sup>2</sup> .K]	$\Delta U$ [W/m <sup>2</sup> .K]	$U_{kc}$ [W/m <sup>2</sup> .K]	$f_{ix,k}$ [-]	$A_k \cdot U_{kc} \cdot f_{ix,k}$
S4	internal non-load bearing wall	24,000	7,774	1,379		1,379	-0,114	-1,225
S3.c	internal load bearing wall	0,000	1,286	0,501	0,050	0,551	0,571	0,405
S3.a	internal load bearing wall	10,000	8,282	0,501		0,501	0,286	1,185
C2.b	ceiling above basement	15,000	4,720	0,414		0,414	0,143	0,279
$H_{T,ia(..)} = \Sigma (A_k \cdot U_{kc} \cdot f_{ix,k})$ (W/K)								0,643
$F_{ix,k} = f_{ix} = (\theta_{int,i} - \theta_u) / (\theta_{int,i} - \theta_e)$								

**Specific heat transmission loss to ground  $H_{T,ig}$**

No.S.	description	$A_k$ [m <sup>2</sup> ]	$A_g$ [m <sup>2</sup> ]	$P$ [m]	$U_k$ [W/m <sup>2</sup> .K]	$f_{ig,k}$ [-]	$B'$ [m]	$U_{equiv,k}$ [W/m <sup>2</sup> .K]	$A_k \cdot U_{equiv,k} \cdot f_{ig,k} \cdot f_{GW,k}$
$\Sigma (A_k \cdot U_{equiv,k} \cdot f_{ig,k} \cdot f_{GW,k})$									0,000
$f_{\theta ann}$ [-]	$H_{T,ig} = f_{\theta ann} \cdot \Sigma (A_k \cdot U_{equiv,k} \cdot f_{ig,k} \cdot f_{GW,k})$ (W/K)					$f_{GW,k}$ [-]	$\theta_{e,m}$ [°C]		
1,450	0,000					1,000	3,900		

**Total design heat transmission loss  $\Phi_{T,i} = (H_{T,ie} + H_{T,ia} + H_{T,iae} + H_{T,iaE} + H_{T,ig}) \cdot (\theta_{int,i} - \theta_e)$  [W]**

$\theta_{int,i}$ [°C]	$\theta_e$ [°C]	$\theta_{int,i} - \theta_e$ [°C]	$\Sigma H_{t,i}$ [W.K <sup>-1</sup> ]	Design heat transmission loss $\Phi_{T,i}$ [W]
20,000	-15,000	35,000	11,392	398,703

**Design heat loss due to ventilation - natural ventilation**

room volume $V_i$ (m <sup>3</sup> )	Outdoor temperature $\theta_e$ [°C]	indoor temperature $\theta_{int,i}$ [°C]	Hygienic requirements	
			$n_{min}$ (h <sup>-1</sup> )	Hygienic air exchange $V_{min,i}$ (m <sup>3</sup> /h)
76,036	-15,000	20,000	0,500	38,018
$n_{50}$ [1/h]	Number of unprotected openings	Shading factor $e_i$	correction factor of height level from terrain $\epsilon_i$	Amount of air infiltrated by building envelope $V_{inf,i}$
4,500	1,000	0,020	1,000	13,686

**Heat loss due to natural ventilation**

$\theta_{int,i} - \theta_e$	max. of $V_{min,i}$ , $V_{inf,i}$	$H_t$ [W.K <sup>-1</sup> ]	Design heat loss due to ventilation $\Phi_{v,i}(W)$
35,000	38,018	12,926	452,412

Total design heat transmission loss of the specific room = 851,116 W

Room No.	Name of the room	Indoor temperature $\Theta_{int,i}$ [°C]
105A	Bathroom	24,000 °C

**Calculation of heat transmission loss**

**Specific heat transmission loss directly to exterior  $H_{T,ie}$**

structures								
No.	Description	$A_k$ [m <sup>2</sup> ]	$U_k$ [W/m <sup>2</sup> .K]	$\Delta U_B$ [W/m <sup>2</sup> .K]	$U_{kc}$ [W/m <sup>2</sup> .K]	$f_{U,k}$ [-]	$f_{ie,k}$ [-]	$A_k \cdot (U_k + \Delta U_B) \cdot f_{U,k} \cdot f_{ie,k}$
W	triple glazing plastic window	0,900	0,700		0,700	1,000	1,000	0,630
S1	peripheral wall	4,183	0,125	0,050	0,175	1,000	1,000	0,731
$H_{T,ie} = \Sigma (A_k \cdot (U_k + \Delta U_B) \cdot f_{U,k} \cdot f_{ie,k})$ (W/k)								1,361

**Specific**

structures								
No.S.	description	$\theta_u$ [°C]	$A_k$ [m <sup>2</sup> ]	$U_k$ [W/m <sup>2</sup> .K]	$\Delta U$ [W/m <sup>2</sup> .K]	$U_{kc}$ [W/m <sup>2</sup> .K]	$f_{ix,k}$ [-]	$A_k \cdot U_{kc} \cdot f_{ix,k}$
S4	internal non-load bearing wall	20,000	18,921	1,379		1,379	0,103	2,677
Di	interior timber door	20,000	1,680	1,800		1,800	0,103	0,310
C1.b	ceiling seperating heated space from heated part of basement	20,000	4,400	0,414		0,414	0,103	0,187
$H_{T,ia(.)} = \Sigma (A_k \cdot U_{kc} \cdot f_{ix,k})$ (W/K)								3,174

$$F_{ix,k} = f_1 = (\theta_{int,i} - \theta_u) / (\theta_{int,i} - \theta_e)$$

**Specific heat transmission loss to ground  $H_{T,ig}$**

No.S.	description	$A_k$ [m <sup>2</sup> ]	$A_g$ [m <sup>2</sup> ]	P [m]	$U_k$ [W/m <sup>2</sup> .K]	$f_{ig,k}$ [-]	B' [m]	$U_{equiv,k}$ [W/m <sup>2</sup> .K]	$A_k \cdot U_{equiv,k} \cdot f_{ig,k} \cdot f_{GW,k}$
$\Sigma (A_k \cdot U_{equiv,k} \cdot f_{ig,k} \cdot f_{GW,k})$									0,000
$f_{\theta_{ann}}$ [-]	$H_{T,ig} = f_{\theta_{ann}} \cdot \Sigma (A_k \cdot U_{equiv,k} \cdot f_{ig,k} \cdot f_{GW,k})$ (W/K)				$f_{GW,k}$ [-]	$\theta_{e,m}$ [°C]			
1,450	0,000				1,000	3,900			

**Total design heat transmission loss  $\Phi_{T,i} = (H_{T,ie} + H_{T,ia} + H_{T,iae} + H_{T,iaBE} + H_{T,ig}) \cdot (\theta_{int,i} - \theta_e)$  [W]**

$\theta_{int,i}$ [°C]	$\theta_e$ [°C]	$\theta_{int,i} - \theta_e$ [°C]	$\Sigma H_{t,i}$ [W·K <sup>-1</sup> ]	Design heat
24,000	-15,000	39,000	4,534	176,833

**Design heat loss due to ventilation - natural ventilation**

room volume $V_i$ (m <sup>3</sup> )	Outdoor temperature $\theta_e$ [°C]	indoor temperature $\theta_{int,i}$ [°C]	Hygienic requirements	
			$n_{min}$ (h <sup>-1</sup> )	Hygienic air exchange $V_{min,i}$ (m <sup>3</sup> /h)
13,126	-15,000	24,000	0,500	6,563
$n_{50}$ [1/h]	Number of unprotected openings	Shading factor $e_i$	correction factor of height level from terrain $\epsilon_i$	Amount of air infiltrated by building envelope $V_{inf,i}$ (m <sup>3</sup> /h)
4,500	1,000	0,020	1,000	2,363

**Heat loss due to natural ventilation**

$\theta_{int,i} - \theta_e$	max. of $V_{min,i}$ , $V_{inf,i}$	$H_t$ [W·K <sup>-1</sup> ]	Design heat loss due to ventilation $\Phi_{v,i}$ (W)
39,000	6,563	2,231	87,026

Total design heat transmission loss of the specific room = 236,800 W

Room No.	Name of the room	Indoor temperature $\Theta_{int,i}$ [°C]
106A	Bedroom	20,000 °C

**Calculation of heat transmission loss**

**Specific heat transmission loss directly to exterior  $H_{T,ie}$**

structures								
No.	Description	$A_k$ [m <sup>2</sup> ]	$U_k$ [W/m <sup>2</sup> .K]	$\Delta U_B$ [W/m <sup>2</sup> .K]	$U_{kc}$ [W/m <sup>2</sup> .K]	$f_{U,k}$ [-]	$f_{ie,k}$ [-]	$A_k \cdot (U_k + \Delta U_B) \cdot f_{U,k} \cdot f_{ie,k}$
W+D	triple glazing plastic windows and balcony door	6,652	0,700		0,700	1,000	1,000	4,656
S1	peripheral wall	26,118	0,125	0,050	0,175	1,000	1,000	4,561
$H_{T,ie} = \Sigma (A_k \cdot (U_k + \Delta U_B) \cdot f_{U,k} \cdot f_{ie,k})$ (W/k)								9,218

**Specific heat transmission loss from heated space to neighbouring heated space or unheated space or through it  $H_{T,ia(..)}$**

structures								
No.S.	description	$\theta_u$ [°C]	$A_k$ [m <sup>2</sup> ]	$U_k$ [W/m <sup>2</sup> .K]	$\Delta U$ [W/m <sup>2</sup> .K]	$U_{kc}$ [W/m <sup>2</sup> .K]	$f_{ix,k}$ [-]	$A_k \cdot U_{kc} \cdot f_{ix,k}$
$H_{T,ia(..)} = \Sigma (A_k \cdot U_{kc} \cdot f_{ix,k})$ (W/K)								
$F_{ix,k} = f_1 = (\theta_{int,i} - \theta_u) / (\theta_{int,i} - \theta_e)$								
								0,000

**Specific heat transmission loss to ground  $H_{T,ig}$**

No.S.	description	$A_k$ [m <sup>2</sup> ]	$A_g$ [m <sup>2</sup> ]	$p$ [m]	$U_k$ [W/m <sup>2</sup> .K]	$f_{ig,k}$ [-]	$B'$ [m]	$U_{equiv,k}$ [W/m <sup>2</sup> .K]	$A_k \cdot U_{equiv,k} \cdot f_{ig,k} \cdot f_{GW,k}$
$\Sigma (A_k \cdot U_{equiv,k} \cdot f_{ig,k} \cdot f_{GW,k})$									0,000
$f_{\theta ann}$ [-]	$H_{T,ig} = f_{\theta ann} \cdot \Sigma (A_k \cdot U_{equiv,k} \cdot f_{ig,k} \cdot f_{GW,k})$ (W/K)				$f_{GW,k}$ [-]	$\theta_{e,m}$ [°C]			
1,450	0,000				1,000	3,900			

**Total design heat transmission loss  $\Phi_{T,i} = (H_{T,ie} + H_{T,ia} + H_{T,iae} + H_{T,iae} + H_{T,ig}) \cdot (\theta_{int,i} - \theta_e)$  [W]**

$\Theta_{int,i}$ [°C]	$\Theta_e$ [°C]	$\Theta_{int,i} - \Theta_e$ [°C]	$\Sigma H_{T,i}$ [W.K <sup>-1</sup> ]	Design heat transmission loss $\Phi_{T,i}$ [W]
20,000	-15,000	35,000	9,218	322,617

**Design heat loss due to ventilation - natural ventilation**

room volume $V_i$ (m <sup>3</sup> )	Outdoor temperature $\Theta_e$ [°C]	indoor temperature $\Theta_{int,i}$ [°C]	Hygienic requirements	
			$n_{min}$ (h <sup>-1</sup> )	Hygienic air exchange $V_{min,i}$ (m <sup>3</sup> /h)
58,365	-15,000	20,000	0,500	29,182
$n_{50}$ [1/h]	Number of unprotected openings	Shading factor $e_i$	correction factor of height level from terrain $\epsilon_i$	Amount of air infiltrated by building envelope $V_{inf,i}$
4,500	1,000	0,020	1,000	10,506

**Heat loss due to natural ventilation**

$\Theta_{int,i} - \Theta_e$	max. of $V_{min,i}$ , $V_{inf,i}$	$H_t$ [W.K <sup>-1</sup> ]	Design heat loss due to ventilation $\Phi_{v,i}$ (W)
35,000	29,182	9,922	347,271

Total design heat transmission loss of the specific room = 669,888 W

Room No.	Name of the room	Indoor temperature $\theta_{int,i}$ [°C]
107A	Bedroom	20,000 °C

**Calculation of heat transmission loss**

**Specific heat transmission loss directly to exterior  $H_{T,ie}$**

structures								
No.	Description	$A_k$ [m <sup>2</sup> ]	$U_k$ [W/m <sup>2</sup> .K]	$\Delta U_B$ [W/m <sup>2</sup> .K]	$U_{kc}$ [W/m <sup>2</sup> .K]	$f_{U,k}$ [-]	$f_{ie,k}$ [-]	$A_k \cdot (U_k + \Delta U_B) \cdot f_{U,k} \cdot f_{ie,k}$
W	triple glazing plastic window	2,175	0,700		0,700	1,000	1,000	1,523
S1	peripheral wall	8,978	0,125	0,050	0,175	1,000	1,000	1,568
$H_{T,ie} = \Sigma (A_k \cdot (U_k + \Delta U_B) \cdot f_{U,k} \cdot f_{ie,k})$ (W/k)								3,090

**Specific heat transmission loss from heated space to neighbouring heated space or unheated space or through it  $H_{T,ia(-)}$**

structures								
No.S.	description	$\theta_u$ [°C]	$A_k$ [m <sup>2</sup> ]	$U_k$ [W/m <sup>2</sup> .K]	$\Delta U$ [W/m <sup>2</sup> .K]	$U_{kc}$ [W/m <sup>2</sup> .K]	$f_{ix,k}$ [-]	$A_k \cdot U_{kc} \cdot f_{ix,k}$
S3.a	internal load bearing wall	10,000	4,336	0,501		0,501	0,286	0,620
C1.a	ceiling above basement	0,000	8,875	0,414	0,050	0,464	0,571	2,354
$H_{T,ia(-)} = \Sigma (A_k \cdot U_{kc} \cdot f_{ix,k})$ (W/K)								2,974

$$F_{ix,k} = f_1 = (\theta_{int,i} - \theta_u) / (\theta_{int,i} - \theta_e)$$

**Specific heat transmission loss to ground  $H_{T,ig}$**

No.S.	description	$A_k$ [m <sup>2</sup> ]	$A_g$ [m <sup>2</sup> ]	P [m]	$U_k$ [W/m <sup>2</sup> .K]	$f_{ig,k}$ [-]	B' [m]	$U_{equiv,k}$ [W/m <sup>2</sup> .K]	$A_k \cdot U_{equiv,k} \cdot f_{ig,k} \cdot f_{GW,k}$
$\Sigma (A_k \cdot U_{equiv,k} \cdot f_{ig,k} \cdot f_{GW,k})$									0,000
$f_{\theta_{ann}}$ [-]	$H_{T,ig} = f_{\theta_{ann}} \cdot \Sigma (A_k \cdot U_{equiv,k} \cdot f_{ig,k} \cdot f_{GW,k})$ (W/K)				$f_{GW,k}$ [-]	$\theta_{e,m}$ [°C]			
1,450	0,000				1,000	3,900			

**Total design heat transmission loss  $\Phi_{T,i} = (H_{T,ie} + H_{T,ia} + H_{T,iae} + H_{T,iaBE} + H_{T,ig}) \cdot (\theta_{int,i} - \theta_e)$  [W]**

$\theta_{int,i}$ [°C]	$\theta_e$ [°C]	$\theta_{int,i} - \theta_e$ [°C]	$\Sigma H_{T,i}$ [W.K <sup>-1</sup> ]	Design heat transmission loss $\Phi_{T,i}$ [W]
20,000	-15,000	35,000	6,065	212,265

**Design heat loss due to ventilation - natural ventilation**

room volume $V_i$ (m <sup>3</sup> )	Outdoor temperature $\theta_e$ [°C]	indoor temperature $\theta_{int,i}$ [°C]	Hygienic requirements	
			$n_{min}$ (h <sup>-1</sup> )	Hygienic air exchange $V_{min,i}$ (m <sup>3</sup> /h)
53,073	-15,000	20,000	0,500	26,536
$n_{50}$ [1/h]	Number of unprotected openings	Shading factor $e_i$	correction factor of height level from terrain $\epsilon_i$	Amount of air infiltrated by building envelope $V_{inf,i}$
4,500	1,000	0,020	1,000	9,553

**Heat loss due to natural ventilation**

$\theta_{int,i} - \theta_e$	max. of $V_{min,i}$ , $V_{inf,i}$	$H_i$ [W.K <sup>-1</sup> ]	Design heat loss due to ventilation $\Phi_{v,i}$ (W)
35,000	26,536	9,022	315,781

Total design heat transmission loss of the specific room = 528,046 W



Room No.	Name of the room	Indoor temperature $\Theta_{int,i}$ [°C]
108	Staircase	10,000 °C

**Calculation of heat transmission loss**

**Specific heat transmission loss directly to exterior  $H_{T,ie}$**

structures								
No.	Description	$A_k$ [m <sup>2</sup> ]	$U_k$ [W/m <sup>2</sup> .K]	$\Delta U_B$ [W/m <sup>2</sup> .K]	$U_{kc}$ [W/m <sup>2</sup> .K]	$f_{U,k}$ [-]	$f_{ie,k}$ [-]	$A_k \cdot (U_k + \Delta U_B) \cdot f_{U,k} \cdot f_{ie,k}$
$H_{T,ie} = \Sigma (A_k \cdot (U_k + \Delta U_B) \cdot f_{U,k} \cdot f_{ie,k})$ (W/k)								0,000

**Specific heat transmission loss from heated space to neighbouring heated space or unheated space or through it  $H_{T,ia(.,.)}$**

No.S.	description	$\theta_u$ [°C]	$A_k$ [m <sup>2</sup> ]	$U_k$ [W/m <sup>2</sup> .K]	$\Delta U$ [W/m <sup>2</sup> .K]	$U_{kc}$ [W/m <sup>2</sup> .K]	$f_{ix,k}$ [-]	$A_k \cdot U_{kc} \cdot f_{ix,k}$
S3.a	internal load bearing wall	20,000	44,359	0,501		0,501	-0,400	-8,885
Di	interior timber door	20,000	3,780	1,800		1,800	-0,400	-2,722
S1	Peripheral load bearing wall	0,000	4,420	0,125	0,050	0,175	0,400	0,309
De1	entrance door	0,000	4,700	0,700		0,700	0,400	1,316
$H_{T,ia(.,.)} = \Sigma (A_k \cdot U_{kc} \cdot f_{ix,k})$ (W/K)								-9,982

$$F_{ix,k} = f_{ix} = (\theta_{int,i} - \theta_u) / (\theta_{int,i} - \theta_e)$$

**Specific heat transmission loss to ground  $H_{T,ig}$**

No.S.	description	$A_k$ [m <sup>2</sup> ]	$A_g$ [m <sup>2</sup> ]	P [m]	$U_k$ [W/m <sup>2</sup> .K]	$f_{ig,k}$ [-]	B' [m]	$U_{equiv,k}$ [W/m <sup>2</sup> .K]	$A_k \cdot U_{equiv,k} \cdot f_{ig,k} \cdot f_{GW,k}$
$\Sigma (A_k \cdot U_{equiv,k} \cdot f_{ig,k} \cdot f_{GW,k})$								0,000	

$f_{\theta_{ann}}$ [-]	$H_{T,ig} = f_{\theta_{ann}} \cdot \Sigma (A_k \cdot U_{equiv,k} \cdot f_{ig,k} \cdot f_{GW,k})$ (W/K)	$f_{GW,k}$ [-]	$\theta_{e,m}$ [°C]
1,450	0,000	1,000	3,900

**Total design heat transmission loss  $\Phi_{T,i} = (H_{T,ie} + H_{T,ia} + H_{T,iae} + H_{T,iaE} + H_{T,ig}) \cdot (\theta_{int,i} - \theta_e)$  [W]**

$\theta_{int,i}$ [°C]	$\theta_e$ [°C]	$\theta_{int,i} - \theta_e$ [°C]	$\Sigma H_{T,i}$ [W.K <sup>-1</sup> ]	Design heat transmission loss $\Phi_{T,i}$ [W]
10,000	-15,000	25,000	-9,982	-249,549

**Design heat loss due to ventilation - natural ventilation**

room volume $V_i$ (m <sup>3</sup> )	Outdoor temperature $\Theta_e$ [°C]	indoor temperature $\Theta_{int,i}$ [°C]	Hygienic requirements	
60,129	-15,000	10,000	$n_{min}$ (h <sup>-1</sup> )	Hygienic air exchange $V_{min,i}$ (m <sup>3</sup> /h)
			correction factor of height level from terrain $\epsilon_i$	Amount of air infiltrated by building envelope $V_{inf,i}$
$n_{50}$ [1/h]	Number of unprotected openings	Shading factor $e_i$	1,000	0,000
4,500	0,000	0,000		

**Heat loss due to natural ventilation**

$\theta_{int,i} - \theta_e$	max. of $V_{min,i}$ , $V_{inf,i}$	$H_t$ [W.K <sup>-1</sup> ]	Design heat loss due to ventilation $\Phi_{v,i}$ (W)
25,000	30,064	10,222	255,548

Total design heat transmission loss of the specific room =	5,999 W
------------------------------------------------------------	---------

Room No.	Name of the room	Indoor temperature $\theta_{int,i}$ [°C]
109,000	Entrance vestibule	0,000 °C

**Calculation of heat transmission loss**

**Specific heat transmission loss directly to exterior  $H_{T,ie}$**

structures								
No.	Description	$A_k$ [m <sup>2</sup> ]	$U_k$ [W/m <sup>2</sup> .K]	$\Delta U_B$ [W/m <sup>2</sup> .K]	$U_{kc}$ [W/m <sup>2</sup> .K]	$f_{U,k}$ [-]	$f_{ie,k}$ [-]	$A_k \cdot (U_k + \Delta U_B) \cdot f_{U,k} \cdot f_{ie,k}$
S1	Peripheral load bearing wall	9,302	0,125	0,050	0,175	1,000	1,000	0,022
De1	entrance door	5,600	0,700		0,700	1,000	1,000	0,490
$H_{T,ie} = \Sigma (A_k \cdot (U_k + \Delta U_B) \cdot f_{U,k} \cdot f_{ie,k})$ (W/k)								0,512

**Specific heat transmission loss from heated space to neighbouring heated space or unheated space or through it  $H_{T,ia(-)}$**

structures								
No.S.	description	$\theta_u$ [°C]	$A_k$ [m <sup>2</sup> ]	$U_k$ [W/m <sup>2</sup> .K]	$\Delta U$ [W/m <sup>2</sup> .K]	$U_{kc}$ [W/m <sup>2</sup> .K]	$f_{ix,k}$ [-]	$A_k \cdot U_{kc} \cdot f_{ix,k}$
C1.b	Ceiling above basement	10,000	6,970	0,414		0,414	-0,667	-1,925
S3.c	Peripheral load bearing wall	20,000	5,095	0,501		0,501	-1,333	-3,402
S3.c	Peripheral load bearing wall	10,000	4,569	0,501		0,501	-0,667	-1,525
De	entrance door	10,000	4,700	0,700		0,700	-0,667	-2,193
$H_{T,ia(-)} = \Sigma (A_k \cdot U_{kc} \cdot f_{ix,k})$ (W/K)								-9,045

$$F_{ix,k} = f_1 = (\theta_{int,i} - \theta_u) / (\theta_{int,i} - \theta_e)$$

**Specific heat transmission loss to ground  $H_{T,ig}$**

No.S.	description	$A_k$ [m <sup>2</sup> ]	$A_g$ [m <sup>2</sup> ]	P [m]	$U_k$ [W/m <sup>2</sup> .K]	$f_{ig,k}$ [-]	B' [m]	$U_{equiv,k}$ [W/m <sup>2</sup> .K]	$A_k \cdot U_{equiv,k} \cdot f_{ig,k} \cdot f_{GW,k}$
$\Sigma (A_k \cdot U_{equiv,k} \cdot f_{ig,k} \cdot f_{GW,k})$									0,000
$f_{\theta ann}$ [-]	$H_{T,ig} = f_{\theta ann} \cdot \Sigma (A_k \cdot U_{equiv,k} \cdot f_{ig,k} \cdot f_{GW,k})$ (W/K)					$f_{GW,k}$ [-]	$\theta_{e,m}$ [°C]		
1,450	0,000					1,000	3,900		

**Total design heat transmission loss  $\Phi_{T,j} = (H_{T,ie} + H_{T,ia} + H_{T,iae} + H_{T,iaBE} + H_{T,ig}) \cdot (\theta_{int,i} - \theta_e)$  [W]**

$\theta_{int,i}$ [°C]	$\theta_e$ [°C]	$\theta_{int,i} - \theta_e$ [°C]	$\Sigma H_{T,j}$ [W.K <sup>-1</sup> ]	Design heat transmission loss $\Phi_{T,j}$ [W]
0,000	-15,000	15,000	-8,533	-127,997

**Design heat loss due to ventilation - natural ventilation**

room volume $V_i$ (m <sup>3</sup> )	Outdoor temperature $\theta_e$ [°C]	indoor temperature $\theta_{int,i}$ [°C]	Hygienic requirements	
			$n_{min}$ (h <sup>-1</sup> )	Hygienic air exchange $V_{min,i}$ (m <sup>3</sup> /h)
20,840	-15,000	0,000	0,500	10,420
$n_{50}$ [1/h]	Number of unprotected openings	Shading factor $e_i$	correction factor of height level from terrain $\epsilon_i$	Amount of air infiltrated by building envelope $V_{inf,i}$ (m <sup>3</sup> /h)
4,500	1,000	0,000	1,000	0,000

**Heat loss due to natural ventilation**

$\theta_{int,i} - \theta_e$	max. of $V_{min,i}$ , $V_{inf,i}$	$H_t$ [W.K <sup>-1</sup> ]	Design heat loss due to ventilation $\Phi_{v,i}$ (W)
15,000	10,420	3,543	53,143

Total design heat transmission loss of the specific room = -174,600 W

Room No.	Name of the room	Indoor temperature $\Theta_{int,i}$ [°C]
101B	Vestibule	20,000 °C

**Calculation of heat transmission loss**

**Specific heat transmission loss directly to exterior  $H_{T,ie}$**

structures								
No.	Description	$A_k$ [m <sup>2</sup> ]	$U_k$ [W/m <sup>2</sup> .K]	$\Delta U_B$ [W/m <sup>2</sup> .K]	$U_{kc}$ [W/m <sup>2</sup> .K]	$f_{U,k}$ [-]	$f_{ie,k}$ [-]	$A_k \cdot (U_k + \Delta U_B) \cdot f_{U,k} \cdot f_{ie,k}$
W	Triple glazing plastic window	1,088	0,700		0,700	1,000	1,000	0,762
S1	Peripheral wall	1,857	0,125	0,050	0,175	1,000	1,000	0,324
$H_{T,ie} = \Sigma (A_k \cdot (U_k + \Delta U_B) \cdot f_{U,k} \cdot f_{ie,k})$ (W/k)								1,086

**Specific heat transmission loss from heated space to neighbouring heated space or unheated space or through it  $H_{T,ia(i)}$**

structures								
No.S.	description	$\Theta_u$ [°C]	$A_k$ [m <sup>2</sup> ]	$U_k$ [W/m <sup>2</sup> .K]	$\Delta U$ [W/m <sup>2</sup> .K]	$U_{kc}$ [W/m <sup>2</sup> .K]	$f_{ix,k}$ [-]	$A_k \cdot U_{kc} \cdot f_{ix,k}$
C1.a	ceiling above basement	0,000	9,700	0,414	0,050	0,464	0,571	2,573
S4	internal non-load bearing wall	24,000	6,094	1,379		1,379	-0,114	-0,961
S3.a	internal load bearing wall	10,000	9,771	0,501		0,501	0,286	1,398
Di	interior timber door	10,000	1,890	1,800		1,800	0,286	0,972
Di	interior timber door	24,000	1,680	1,800		1,800	-0,114	-0,346
$H_{T,ia(i)} = \Sigma (A_k \cdot U_{kc} \cdot f_{ix,k})$ (W/K)								3,637
$F_{ix,k} = f_1 = (\Theta_{int,i} - \Theta_u) / (\Theta_{int,i} - \Theta_e)$								

**Specific heat transmission loss to ground  $H_{T,ig}$**

No.S.	description	$A_k$ [m <sup>2</sup> ]	$A_g$ [m <sup>2</sup> ]	P [m]	$U_k$ [W/m <sup>2</sup> .K]	$f_{ig,k}$ [-]	B' [m]	$U_{equiv,k}$ [W/m <sup>2</sup> .K]	$A_k \cdot U_{equiv,k} \cdot f_{ig,k} \cdot f_{GW,k}$
$\Sigma (A_k \cdot U_{equiv,k} \cdot f_{ig,k} \cdot f_{GW,k})$									0,000
$f_{\theta_{ann}}$ [-]	$H_{T,ig} = f_{\theta_{ann}} \cdot \Sigma (A_k \cdot U_{equiv,k} \cdot f_{ig,k} \cdot f_{GW,k})$ (W/K)				$f_{GW,k}$ [-]	$\theta_{e,m}$			
1,450	0,000				1,000	3,900			

**Total design heat transmission loss  $\Phi_{T,i} = (H_{T,ie} + H_{T,ia} + H_{T,iae} + H_{T,iaBE} + H_{T,ig}) \cdot (\Theta_{int,i} - \Theta_e)$  [W]**

$\Theta_{int,i}$ [°C]	$\Theta_e$ [°C]	$\Theta_{int,i} - \Theta_e$ [°C]	$\Sigma H_{T,i}$ [W.K <sup>-1</sup> ]	Design heat transmission loss $\Phi_{T,i}$ [W]
20,000	-15,000	35,000	4,723	165,291

**Design heat loss due to ventilation - natural ventilation**

room volume $V_i$ (m <sup>3</sup> )	Outdoor temperature $\Theta_e$ [°C]	indoor temperature $\Theta_{int,i}$ [°C]	Hygienic requirements	
			$n_{min}$ (h <sup>-1</sup> )	Hygienic air exchange $V_{min,i}$ (m <sup>3</sup> /h)
29,003	-15,000	20,000	0,500	14,502
$n_{50}$ [1/h]	Number of unprotected openings	Shading factor $e_i$	correction factor of height level from terrain $\epsilon_i$	Amount of air infiltrated by building envelope $V_{inf,i}$
4,500	0,000	0,000	1,000	0,000

**Heat loss due to natural ventilation**

$\Theta_{int,i} - \Theta_e$	max. of $V_{min,i}$ , $V_{inf,i}$	$H_t$ [W.K <sup>-1</sup> ]	Design heat loss due to ventilation $\Phi_{v,i}$ (W)
35,000	14,502	4,931	172,568

Total design heat transmission loss of the specific room = 337,859 W

Room No.	Name of the room	Indoor temperature $\Theta_{int,i}$ [°C]
102B	Washing machine room	20,000 °C

**Calculation of heat transmission loss**

**Specific heat transmission loss directly to exterior  $H_{T,ie}$**

structures								
No.	Description	$A_k$ [m <sup>2</sup> ]	$U_k$ [W/m <sup>2</sup> .K]	$\Delta U_B$ [W/m <sup>2</sup> .K]	$U_{kc}$ [W/m <sup>2</sup> .K]	$f_{U,k}$ [-]	$f_{ie,k}$ [-]	$A_k \cdot (U_k + \Delta U_B) \cdot f_{U,k} \cdot f_{ie,k}$
								0,000
$H_{T,ie} = \Sigma (A_k \cdot (U_k + \Delta U_B) \cdot f_{U,k} \cdot f_{ie,k})$ (W/K)								0,000

**Specific heat transmission loss from heated space to neighbouring heated space or unheated space or through it  $H_{T,ia(,)}$**

structures								
No.S.	description	$\theta_u$ [°C]	$A_k$ [m <sup>2</sup> ]	$U_k$ [W/m <sup>2</sup> .K]	$\Delta U$ [W/m <sup>2</sup> .K]	$U_{kc}$ [W/m <sup>2</sup> .K]	$f_{ix,k}$ [-]	$A_k \cdot U_{kc} \cdot f_{ix,k}$
S4	internal non-load bearing wall	24,000	3,187	1,379		1,379	-0,114	-0,502
C1.a	ceiling above basement	0,000	1,980	0,414	0,050	0,464	0,571	0,525
$H_{T,ia(,)} = \Sigma (A_k \cdot U_{kc} \cdot f_{ix,k})$ (W/K)								0,023
$F_{ix,k} = f_1 = (\theta_{int,i} - \theta_u) / (\theta_{int,i} - \theta_e)$								

**Specific heat transmission loss to ground  $H_{T,ig}$**

No.S.	description	$A_k$ [m <sup>2</sup> ]	$A_g$ [m <sup>2</sup> ]	p [m]	$U_k$ [W/m <sup>2</sup> .K]	$f_{ig,k}$ [-]	B' [m]	$U_{equiv,k}$ [W/m <sup>2</sup> .K]	$A_k \cdot U_{equiv,k} \cdot f_{ig,k} \cdot f_{GW,k}$
$\Sigma (A_k \cdot U_{equiv,k} \cdot f_{ig,k} \cdot f_{GW,k})$									0,000
$f_{\theta_{ann}}$ [-]	$H_{T,ig} = f_{\theta_{ann}} \cdot \Sigma (A_k \cdot U_{equiv,k} \cdot f_{ig,k} \cdot f_{GW,k})$ (W/K)				$f_{GW,k}$ [-]	$\theta_{e,m}$ [°C]			
1,450	0,000				1,000	3,900			

**Total design heat transmission loss  $\Phi_{T,i} = (H_{T,ie} + H_{T,ia} + H_{T,iae} + H_{T,iaBE} + H_{T,ig}) \cdot (\theta_{int,i} - \theta_e)$  [W]**

$\theta_{int,i}$ [°C]	$\theta_e$ [°C]	$\theta_{int,i} - \theta_e$ [°C]	$\Sigma H_{T,i}$ [W·K <sup>-1</sup> ]	Design heat transmission loss $\Phi_{T,i}$ [W]
20,000	-15,000	35,000	0,023	0,797

**Design heat loss due to ventilation - natural ventilation**

room volume $V_i$ (m <sup>3</sup> )	Outdoor temperature $\theta_e$ [°C]	indoor temperature $\theta_{int,i}$ [°C]	Hygienic requirements	
			$n_{min}$ (h <sup>-1</sup> )	Hygienic air exchange $V_{min,i}$ (m <sup>3</sup> /h)
5,920	-15,000	20,000	1,500	8,880
$n_{50}$ [1/h]	Number of unprotected openings	Shading factor $e_i$	correction factor of height level from terrain $\epsilon_i$	Amount of air infiltrated by building envelope $V_{inf,i}$
4,500	0,000	0,020	1,000	0,000

**Heat loss due to natural ventilation**

$\theta_{int,i} - \theta_e$	max. of $V_{min,i}$ , $V_{inf,i}$	$H_t$ [W·K <sup>-1</sup> ]	Design heat loss due to ventilation $\Phi_{v,i}$ (W)
35,000	8,880	3,019	105,676

Total design heat transmission loss of the specific room = 106,473 W

Room No.	Name of the room	Indoor temperature $\Theta_{int,i}$ [°C]						
103B	Toilet	20,000 °C						
<b>Calculation of heat transmission loss</b>								
<b>Specific heat transmission loss directly to exterior <math>H_{T,ie}</math></b>								
structures								
No.	Description	$A_k$ [m <sup>2</sup> ]	$U_k$ [W/m <sup>2</sup> .K]	$\Delta U_B$ [W/m <sup>2</sup> .K]	$U_{kc}$ [W/m <sup>2</sup> .K]	$f_{U,k}$ [-]	$f_{ie,k}$ [-]	$A_k \cdot (U_k + \Delta U_B) \cdot f_{U,k} \cdot f_{ie,k}$
								0,000
$H_{T,ie} = \Sigma (A_k \cdot (U_k + \Delta U_B) \cdot f_{U,k} \cdot f_{ie,k})$ (W/k)								0,000

<b>Specific heat transmission loss from heated space to neighbouring heated space or unheated space or through it <math>H_{T,ia(-)}</math></b>								
structures								
No.S.	description	$\Theta_u$ [°C]	$A_k$ [m <sup>2</sup> ]	$U_k$ [W/m <sup>2</sup> .K]	$\Delta U$ [W/m <sup>2</sup> .K]	$U_{kc}$ [W/m <sup>2</sup> .K]	$f_{ix,k}$ [-]	$A_k \cdot U_{kc} \cdot f_{ix,k}$
S4	internal non-load bearing wall	24,000	1,704	1,379		1,379	-0,114	-0,269
C1.a	ceiling above basement	0,000	3,480	0,414	0,050	0,464	0,571	0,923
$H_{T,ia(-)} = \Sigma (A_k \cdot U_{kc} \cdot f_{ix,k})$ (W/K)								0,654
$F_{ix,k} = f_1 = (\Theta_{int,i} - \Theta_u) / (\Theta_{int,i} - \Theta_e)$								

<b>Specific heat transmission loss to ground <math>H_{T,ig}</math></b>									
No.S.	description	$A_k$ [m <sup>2</sup> ]	$A_g$ [m <sup>2</sup> ]	P [m]	$U_k$ [W/m <sup>2</sup> .K]	$f_{ig,k}$ [-]	B' [m]	$U_{equiv,k}$ [W/m <sup>2</sup> .K]	$A_k \cdot U_{equiv,k} \cdot f_{ig,k} \cdot f_{GW,k}$
$\Sigma (A_k \cdot U_{equiv,k} \cdot f_{ig,k} \cdot f_{GW,k})$									0,000
$f_{\theta_{ann}}$ [-]	$H_{T,ig} = f_{\theta_{ann}} \cdot \Sigma (A_k \cdot U_{equiv,k} \cdot f_{ig,k} \cdot f_{GW,k})$ (W/K)				$f_{GW,k}$ [-]	$\theta_{e,m}$ [°C]			
1,450	0,000				1,000	3,900			

<b>Total design heat transmission loss <math>\Phi_{T,i} = (H_{T,ie} + H_{T,ja} + H_{T,iae} + H_{T,iabE} + H_{T,ig}) \cdot (\Theta_{int,i} - \Theta_e)</math> [W]</b>				
$\Theta_{int,i}$ [°C]	$\Theta_e$ [°C]	$\Theta_{int,i} - \Theta_e$ [°C]	$\Sigma H_{T,i}$ [W·K <sup>-1</sup> ]	Design heat transmission loss $\Phi_{T,i}$ [W]
20,000	-15,000	35,000	0,654	22,905

<b>Design heat loss due to ventilation - natural ventilation</b>				
room volume $V_i$ (m <sup>3</sup> )	Outdoor temperature $\Theta_e$ [°C]	indoor temperature $\Theta_{int,i}$ [°C]	Hygienic requirements	
10,405	-15,000	20,000	$n_{min}$ (h <sup>-1</sup> )	Hygienic air exchange $V_{min,i}$ (m <sup>3</sup> /h)
			0,500	5,203
$n_{50}$ [1/h]	Number of unprotected openings	Shading factor $e_i$	correction factor of height level from terrain $\epsilon_i$	Amount of air infiltrated by building envelope $V_{inf,i}$
4,500	0,000	0,020	1,000	0,000
<b>Heat loss due to natural ventilation</b>				
$\Theta_{int,i} - \Theta_e$	max. of $V_{min,i}$ , $V_{inf,i}$	$H_t$ [W·K <sup>-1</sup> ]	Design heat loss due to ventilation $\Phi_{v,i}$ (W)	
35,000	5,203	1,769	61,911	

Total design heat transmission loss of the specific room =	84,816 W
------------------------------------------------------------	----------

Room No.	Name of the room	Indoor temperature $\Theta_{int,i}$ [°C]
104B	Kitchen and living room	20,000 °C

**Calculation of heat transmission loss**

**Specific heat transmission loss directly to exterior  $H_{T,ie}$**

structures								
No.	Description	$A_k$ [m <sup>2</sup> ]	$U_k$ [W/m <sup>2</sup> .K]	$\Delta U_B$ [W/m <sup>2</sup> .K]	$U_{kc}$ [W/m <sup>2</sup> .K]	$f_{U,k}$ [-]	$f_{ie,k}$ [-]	$A_k \cdot (U_k + \Delta U_B) \cdot f_{U,k} \cdot f_{ie,k}$
W+D	Plastic balcony door and windows	9,575	0,700		0,700	1,000	1,000	6,703
S1	peripheral wall	23,166	0,125	0,050	0,175	1,000	1,000	4,046
$H_{T,ie} = \Sigma (A_k \cdot (U_k + \Delta U_B) \cdot f_{U,k} \cdot f_{ie,k})$ (W/k)								10,748

**Specific heat transmission loss from heated space to neighbouring heated space or unheated space or through it  $H_{T,ia(i)}$**

structures								
No.S.	description	$\theta_u$ [°C]	$A_k$ [m <sup>2</sup> ]	$U_k$ [W/m <sup>2</sup> .K]	$\Delta U$ [W/m <sup>2</sup> .K]	$U_{kc}$ [W/m <sup>2</sup> .K]	$f_{ix,k}$ [-]	$A_k \cdot U_{kc} \cdot f_{ix,k}$
S4	internal non-load bearing wall	24,000	7,774	1,379		1,379	-0,114	-1,225
S3.c	internal load bearing wall	0,000	1,286	0,501	0,050	0,551	0,571	0,405
S3.a	internal load bearing wall	10,000	8,282	0,501		0,501	0,286	1,185
C2.b	ceiling above basement	0,000	25,430	0,414		0,414	0,571	6,019
$H_{T,ia(i)} = \Sigma (A_k \cdot U_{kc} \cdot f_{ix,k})$ (W/K)								6,383

$$F_{ix,k} = f_1 = (\theta_{int,i} - \theta_u) / (\theta_{int,i} - \theta_e)$$

**Specific heat transmission loss to ground  $H_{T,ig}$**

No.S.	description	$A_k$ [m <sup>2</sup> ]	$A_g$ [m <sup>2</sup> ]	P [m]	$U_k$ [W/m <sup>2</sup> .K]	$f_{ig,k}$ [-]	B' [m]	$U_{equiv,k}$ [W/m <sup>2</sup> .K]	$A_k \cdot U_{equiv,k} \cdot f_{ig,k} \cdot f_{GW,k}$
$\Sigma (A_k \cdot U_{equiv,k} \cdot f_{ig,k} \cdot f_{GW,k})$									0,000

$f_{\theta_{ann}}$ [-]	$H_{T,ig} = f_{\theta_{ann}} \cdot \Sigma (A_k \cdot U_{equiv,k} \cdot f_{ig,k} \cdot f_{GW,k})$ (W/K)	$f_{GW,k}$ [-]	$\theta_{e,m}$ [°C]
1,450	0,000	1,000	3,900

**Total design heat transmission loss  $\Phi_{T,i} = (H_{T,ie} + H_{T,ia} + H_{T,iae} + H_{T,iaBE} + H_{T,ig}) \cdot (\theta_{int,i} - \theta_e)$  [W]**

$\theta_{int,i}$ [°C]	$\theta_e$ [°C]	$\theta_{int,i} - \theta_e$ [°C]	$\Sigma H_{T,i}$ [W.K <sup>-1</sup> ]	Design heat transmission loss $\Phi_{T,i}$ [W]
20,000	-15,000	35,000	17,131	599,584

**Design heat loss due to ventilation - natural ventilation**

Room volume $V_{room}$ [m <sup>3</sup> ]	Outdoor temperature $\theta_e$ [°C]	indoor temperature $\theta_{int,i}$	Hygienic requirements	
			$n_{min}$ (h <sup>-1</sup> )	Hygienic air exchange $V_{min,i}$ (m <sup>3</sup> /h)
76,036	-15,000	20,000	0,500	38,018
$n_{50}$ [1/h]	Number of unprotected openings	Shading factor $e_i$	correction factor of height level from terrain $\epsilon_i$	Amount of air infiltrated by building envelope $V_{inf,i}$
4,500	1,000	0,020	1,000	13,686

**Heat loss due to natural ventilation**

$\theta_{int,i} - \theta_e$	max. of $V_{min,i}$ , $V_{inf,i}$	$H_t$ [W.K <sup>-1</sup> ]	Design heat loss due to ventilation $\Phi_{v,i}$ (W)
35,000	38,018	12,926	452,412

Total design heat transmission loss of the specific room =	1051,996 W
------------------------------------------------------------	------------

Room No.	Name of the room	Indoor temperature $\Theta_{int,i}$ [°C]						
105B	Bathroom	24,000 °C						
<b>Calculation of heat transmission loss</b>								
<b>Specific heat transmission loss directly to exterior <math>H_{T,ie}</math></b>								
structures								
No.	Description	$A_k$ [m <sup>2</sup> ]	$U_k$ [W/m <sup>2</sup> .K]	$\Delta U_B$ [W/m <sup>2</sup> .K]	$U_{kc}$ [W/m <sup>2</sup> .K]	$f_{U,k}$ [-]	$f_{ie,k}$ [-]	$A_k \cdot (U_k + \Delta U_B) \cdot f_{U,k} \cdot f_{ie,k}$
W	triple glazing plastic window	0,900	0,700		0,700	1,000	1,000	0,630
S1	peripheral wall	4,183	0,125	0,050	0,175	1,000	1,000	0,731
$H_{T,ie} = \Sigma (A_k \cdot (U_k + \Delta U_B) \cdot f_{U,k} \cdot f_{ie,k})$ (W/k)								1,361

<b>Specific heat transmission loss from heated space to neighbouring heated space or unheated space or through it <math>H_{T,ia(i)}</math></b>								
structures								
No.S.	description	$\theta_u$ [°C]	$A_k$ [m <sup>2</sup> ]	$U_k$ [W/m <sup>2</sup> .K]	$\Delta U$ [W/m <sup>2</sup> .K]	$U_{kc}$ [W/m <sup>2</sup> .K]	$f_{ix,k}$ [-]	$A_k \cdot U_{kc} \cdot f_{ix,k}$
C1.a	ceiling above basement	0,000	4,400	0,414		0,414	0,615	1,121
S4	internal non-load bearing wall	20,000	18,921	1,379		1,379	0,103	2,677
Di	interior timber door	20,000	1,680	1,800		1,800	0,103	0,310
$H_{T,ia(i)} = \Sigma (A_k \cdot U_{kc} \cdot f_{ix,k})$ (W/K)								4,108

$$F_{ix,k} = f_1 = (\theta_{int,i} - \theta_u) / (\theta_{int,i} - \theta_e)$$

<b>Specific heat transmission loss to ground <math>H_{T,ig}</math></b>										
No.S.	description	$A_k$ [m <sup>2</sup> ]	$A_g$ [m <sup>2</sup> ]	P [m]	$U_k$ [W/m <sup>2</sup> .K]	$f_{ig,k}$ [-]	B' [m]	$U_{equiv,k}$ [W/m <sup>2</sup> .K]	$A_k \cdot U_{equiv,k} \cdot f_{ig,k} \cdot f_{GW,k}$	
$\Sigma (A_k \cdot U_{equiv,k} \cdot f_{ig,k} \cdot f_{GW,k})$									0,000	
$f_{\theta_{ann}}$ [-]	$H_{T,ig} = f_{\theta_{ann}} \cdot \Sigma (A_k \cdot U_{equiv,k} \cdot f_{ig,k} \cdot f_{GW,k})$ (W/K)					$f_{GW,k}$ [-]	$\theta_{e,m}$ [°C]			
1,450	0,000					1,000	3,900			

<b>Total design heat transmission loss <math>\Phi_{T,i} = (H_{T,ie} + H_{T,ia} + H_{T,iae} + H_{T,iaBE} + H_{T,ig}) \cdot (\theta_{int,i} - \theta_e)</math> [W]</b>				
$\theta_{int,i}$ [°C]	$\theta_e$ [°C]	$\theta_{int,i} - \theta_e$ [°C]	$\Sigma H_{t,i}$ [W·K <sup>-1</sup> ]	Design heat transmission loss $\Phi_{T,i}$ [W]
24,000	-15,000	39,000	5,469	213,281

<b>Design heat loss due to ventilation - natural ventilation</b>				
room volume $V_i$ (m <sup>3</sup> )	Outdoor temperature $\theta_e$ [°C]	indoor temperature $\theta_{int,i}$ [°C]	Hygienic requirements	
			$n_{min}$ (h <sup>-1</sup> )	Hygienic air exchange $V_{min,i}$ (m <sup>3</sup> /h)
13,156	-15,000	24,000	0,500	6,578
$n_{50}$ [1/h]	Number of unprotected openings	Shading factor $e_i$	correction factor of height level from terrain $\epsilon_i$	Amount of air infiltrated by building envelope $V_{inf,i}$ (m <sup>3</sup> /h)
4,500	1,000	0,020	1,000	2,368

<b>Heat loss due to natural ventilation</b>			
$\theta_{int,i} - \theta_e$	max. of $V_{min,i}$ , $V_{inf,i}$	$H_t$ [W·K <sup>-1</sup> ]	Design heat loss due to ventilation $\Phi_{v,i}$ (W)
39,000	6,578	2,237	87,224

Total design heat transmission loss of the specific room = 436,900 W

Room No.	Name of the room	Indoor temperature $\Theta_{int,i}$ [°C]
106B	Bedroom	20,000 °C

**Calculation of heat transmission loss**

**Specific heat transmission loss directly to exterior  $H_{T,ie}$**

structures								
No.	Description	$A_k$ [m <sup>2</sup> ]	$U_k$ [W/m <sup>2</sup> .K]	$\Delta U_B$ [W/m <sup>2</sup> .K]	$U_{kc}$ [W/m <sup>2</sup> .K]	$f_{U,k}$ [-]	$f_{ie,k}$ [-]	$A_k \cdot (U_k + \Delta U_B) \cdot f_{U,k} \cdot f_{ie,k}$
W+D	triple glazing plastic windows and balcony door	6,652	0,700		0,700	1,000	1,000	4,656
S1	peripheral wall	26,118	0,125	0,050	0,175	1,000	1,000	4,561
$H_{T,ie} = \Sigma (A_k \cdot (U_k + \Delta U_B) \cdot f_{U,k} \cdot f_{ie,k})$ (W/K)								9,218

**Specific heat transmission loss from heated space to neighbouring heated space or unheated space or through it  $H_{T,ia(,)}$**

structures								
No.S.	description	$\theta_u$ [°C]	$A_k$ [m <sup>2</sup> ]	$U_k$ [W/m <sup>2</sup> .K]	$\Delta U$ [W/m <sup>2</sup> .K]	$U_{kc}$ [W/m <sup>2</sup> .K]	$f_{ix,k}$ [-]	$A_k \cdot U_{kc} \cdot f_{ix,k}$
C1.a	Ceiling above basement	0,000	19,520	0,414	0,050	0,464	0,571	5,178
$H_{T,ia(,)} = \Sigma (A_k \cdot U_{kc} \cdot f_{ix,k})$ (W/K)								5,178

$$F_{ix,k} = f_1 = (\theta_{int,i} - \theta_u) / (\theta_{int,i} - \theta_e)$$

**Specific heat transmission loss to ground  $H_{T,ig}$**

No.S.	description	$A_k$ [m <sup>2</sup> ]	$A_g$ [m <sup>2</sup> ]	P [m]	$U_k$ [W/m <sup>2</sup> .K]	$f_{ig,k}$ [-]	B' [m]	$U_{equiv,k}$ [W/m <sup>2</sup> .K]	$A_k \cdot U_{equiv,k} \cdot f_{ig,k} \cdot f_{GW,k}$
$\Sigma (A_k \cdot U_{equiv,k} \cdot f_{ig,k} \cdot f_{GW,k})$									0,000
$f_{\theta ann}$ [-]	$H_{T,ig} = f_{\theta ann} \cdot \Sigma (A_k \cdot U_{equiv,k} \cdot f_{ig,k} \cdot f_{GW,k})$ (W/K)					$f_{GW,k}$ [-]	$\theta_{e,m}$ [°C]		
1,450	0,000					1,000	3,900		

**Total design heat transmission loss  $\Phi_{T,i} = (H_{T,ie} + H_{T,ia} + H_{T,iae} + H_{T,iaBE} + H_{T,ig}) \cdot (\theta_{int,i} - \theta_e)$  [W]**

$\theta_{int,i}$ [°C]	$\theta_e$ [°C]	$\theta_{int,i} - \theta_e$ [°C]	$\Sigma H_{T,i}$ [W.K <sup>-1</sup> ]	Design heat transmission loss $\Phi_{T,i}$ [W]
20,000	-15,000	35,000	14,395	503,836

**Design heat loss due to ventilation - natural ventilation**

room volume $V_i$ (m <sup>3</sup> )	Outdoor temperature $\theta_e$ [°C]	indoor temperature $\theta_{int,i}$ [°C]	Hygienic requirements	
			$n_{min}$ (h <sup>-1</sup> )	Hygienic air exchange $V_{min,i}$ (m <sup>3</sup> /h)
58,365	-15,000	20,000	0,500	29,182
$n_{50}$ [1/h]	Number of unprotected openings	Shading factor $e_i$	correction factor of height level from terrain $\epsilon_i$	Amount of air infiltrated by building envelope $V_{inf,i}$
4,500	1,000	0,020	1,000	10,506

**Heat loss due to natural ventilation**

$\theta_{int,i} - \theta_e$	max. of $V_{min,i}$ , $V_{inf,i}$	$H_t$ [W.K <sup>-1</sup> ]	Design heat loss due to ventilation $\Phi_{v,i}$ (W)
35,000	29,182	9,922	347,271

Total design heat transmission loss of the specific room = 851,106 W



Room No.	Name of the room	Indoor temperature $\Theta_{int,i}$ [°C]
107B	Bedroom	20,000 °C

**Calculation of heat transmission loss**

**Specific heat transmission loss directly to exterior  $H_{T,ie}$**

structures								
No.	Description	$A_k$ [m <sup>2</sup> ]	$U_k$ [W/m <sup>2</sup> .K]	$\Delta U_B$ [W/m <sup>2</sup> .K]	$U_{kc}$ [W/m <sup>2</sup> .K]	$f_{U,k}$ [-]	$f_{ie,k}$ [-]	$A_k \cdot (U_k + \Delta U_B) \cdot f_{U,k} \cdot f_{ie,k}$
W	triple glazing plastic window	2,175	0,700		0,700	1,000	1,000	1,523
S1	peripheral wall	8,978	0,125	0,050	0,175	1,000	1,000	1,568
$H_{T,ie} = \Sigma (A_k \cdot (U_k + \Delta U_B) \cdot f_{U,k} \cdot f_{ie,k})$ (W/k)								3,090

**Specific heat transmission loss from heated space to neighbouring heated space or unheated space or through it  $H_{T,ia(i)}$**

structures								
No.S.	description	$\Theta_u$ [°C]	$A_k$ [m <sup>2</sup> ]	$U_k$ [W/m <sup>2</sup> .K]	$\Delta U$ [W/m <sup>2</sup> .K]	$U_{kc}$ [W/m <sup>2</sup> .K]	$f_{ix,k}$ [-]	$A_k \cdot U_{kc} \cdot f_{ix,k}$
S3.a	internal load bearing wall	10,000	4,336	0,501		0,501	0,286	0,620
C1.a	ceiling above basement	0,000	17,750	0,414	0,050	0,464	0,571	4,708
$H_{T,ia(i)} = \Sigma (A_k \cdot U_{kc} \cdot f_{ix,k})$ (W/K)								5,328

$$F_{ix,k} = f_1 = (\Theta_{int,i} - \Theta_u) / (\Theta_{int,i} - \Theta_e)$$

**Specific heat transmission loss to ground  $H_{T,ig}$**

No.S.	description	$A_k$ [m <sup>2</sup> ]	$A_g$ [m <sup>2</sup> ]	P [m]	$U_k$ [W/m <sup>2</sup> .K]	$f_{ig,k}$ [-]	B' [m]	$U_{equiv,k}$ [W/m <sup>2</sup> .K]	$A_k \cdot U_{equiv,k} \cdot f_{ig,k} \cdot f_{GW,k}$
								$\Sigma (A_k \cdot U_{equiv,k} \cdot f_{ig,k} \cdot f_{GW,k})$	0,000
$f_{\theta ann}$ [-]	$H_{T,ig} = f_{\theta ann} \cdot \Sigma (A_k \cdot U_{equiv,k} \cdot f_{ig,k} \cdot f_{GW,k})$ (W/K)				$f_{GW,k}$ [-]	$\Theta_{e,m}$ [°C]			
1,450	0,000				1,000	3,900			

**Total design heat transmission loss  $\Phi_{T,i} = (H_{T,ie} + H_{T,ia} + H_{T,iae} + H_{T,iae} + H_{T,ig}) \cdot (\Theta_{int,i} - \Theta_e)$  [W]**

$\Theta_{int,i}$ [°C]	$\Theta_e$ [°C]	$\Theta_{int,i} - \Theta_e$ [°C]	$\Sigma H_{T,i}$ [W·K <sup>-1</sup> ]	Design heat transmission loss $\Phi_{T,i}$ [W]
20,000	-15,000	35,000	8,419	294,658

**Design heat loss due to ventilation - natural ventilation**

room volume $V_i$ (m <sup>3</sup> )	Outdoor temperature $\Theta_e$ [°C]	indoor temperature $\Theta_{int,i}$ [°C]	Hygienic requirements	
			$n_{min}$ (h <sup>-1</sup> )	Hygienic air exchange $V_{min,i}$ (m <sup>3</sup> /h)
53,073	-15,000	20,000	0,500	26,536
$n_{50}$ [1/h]	Number of unprotected openings	Shading factor $e_i$	correction factor of height level from terrain $\epsilon_i$	Amount of air infiltrated by building envelope $V_{inf,i}$
4,500	1,000	0,020	1,000	9,553

**Heat loss due to natural ventilation**

$\Theta_{int,i} - \Theta_e$	max. of $V_{min,i}$ , $V_{inf,i}$	$H_t$ [W·K <sup>-1</sup> ]	Design heat loss due to ventilation $\Phi_{v,i}$ (W)
35,000	26,536	9,022	315,781

Total design heat transmission loss of the specific room = 610,439 W

### Heat losses of second floor

Room No.	Name of the room	Indoor temperature $\Theta_{int,i}$ [°C]						
201A	Vestibule	20,000 °C						
<b>Calculation of heat transmission loss</b>								
<b>Specific heat transmission loss directly to exterior <math>H_{T,ie}</math></b>								
structures								
No.	Description	$A_k$ [m <sup>2</sup> ]	$U_k$ [W/m <sup>2</sup> .K]	$\Delta U_B$ [W/m <sup>2</sup> .K]	$U_{kc}$ [W/m <sup>2</sup> .K]	$f_{U,k}$ [-]	$f_{ie,k}$ [-]	$A_k \cdot (U_k + \Delta U_B) \cdot f_{U,k} \cdot f_{ie,k}$
W	Triple glazing plastic window	1,088	0,700		0,700	1,000	1,000	0,762
S1	Peripheral wall	1,857	0,125	0,050	0,175	1,000	1,000	0,324
$H_{T,ie} = \Sigma (A_k \cdot (U_k + \Delta U_B) \cdot f_{U,k} \cdot f_{ie,k})$ (W/K)								1,086

<b>Specific heat transmission loss from heated space to neighbouring heated space or unheated space or through it</b>								
structures								
No.S.	description	$\theta_u$ [°C]	$A_k$ [m <sup>2</sup> ]	$U_k$ [W/m <sup>2</sup> .K]	$\Delta U$ [W/m <sup>2</sup> .K]	$U_{kc}$ [W/m <sup>2</sup> .K]	$f_{ix,k}$ [-]	$A_k \cdot U_{kc} \cdot f_{ix,k}$
S4	internal non-load bearing wall	24,000	6,094	1,379		1,379	-0,114	-0,961
S3.a	internal load bearing wall	10,000	9,771	0,501		0,501	0,286	1,398
Di	interior timber door	10,000	1,890	1,800		1,800	0,286	0,972
Di	interior timber door	24,000	1,680	1,800		1,800	-0,114	-0,346
$H_{T,ia(i)} = \Sigma (A_k \cdot U_{kc} \cdot f_{ix,k})$ (W/K)								1,064
$F_{ix,k} = f_1 = (\theta_{int,i} - \theta_u) / (\theta_{int,i} - \theta_e)$								

<b>Specific heat transmission loss to ground <math>H_{T,ig}</math></b>										
No.S.	description	$A_k$ [m <sup>2</sup> ]	$A_g$ [m <sup>2</sup> ]	P [m]	$U_k$ [W/m <sup>2</sup> .K]	$f_{ig,k}$ [-]	B' [m]	$U_{equiv,k}$ [W/m <sup>2</sup> .K]	$A_k \cdot U_{equiv,k} \cdot f_{ig,k} \cdot f_{GW,k}$	
$\Sigma (A_k \cdot U_{equiv,k} \cdot f_{ig,k} \cdot f_{GW,k})$									0,000	
$f_{\theta_{ann}}$ [-]	$H_{T,ig} = f_{\theta_{ann}} \cdot \Sigma (A_k \cdot U_{equiv,k} \cdot f_{ig,k} \cdot f_{GW,k})$ (W/K)					$f_{GW,k}$ [-]	$\theta_{e,m}$			
1,450	0,000					1,000	3,900			

<b>Total design heat transmission loss <math>\Phi_{T,i} = (H_{T,ie} + H_{T,ia} + H_{T,iae} + H_{T,iaBE} + H_{T,ig}) \cdot (\theta_{int,i} - \theta_e)</math> [W]</b>				
$\Theta_{int,i}$ [°C]	$\Theta_e$ [°C]	$\Theta_{int,i} - \theta_e$ [°C]	$\Sigma H_{T,i}$ [W·K <sup>-1</sup> ]	Design heat transmission loss $\Phi_{T,i}$ [W]
20,000	-15,000	35,000	2,150	75,239

<b>Design heat loss due to ventilation - natural ventilation</b>				
room volume $V_i$ (m <sup>3</sup> )	Outdoor temperature $\Theta_e$ [°C]	indoor temperature $\Theta_{int,i}$ [°C]	Hygienic requirements	
			$n_{min}$ (h <sup>-1</sup> )	Hygienic air exchange $V_{min,i}$ (m <sup>3</sup> /h)
29,003	-15,000	20,000	0,500	14,502
$n_{50}$ [1/h]	Number of unprotected openings	Shading factor $e_i$	correction factor of height level from terrain $\epsilon_i$	Amount of air infiltrated by building envelope $V_{inf,i}$ (m <sup>3</sup> /h)
4,500	0,000	0,000	1,000	0,000

<b>Heat loss due to natural ventilation</b>			
$\Theta_{int,i} - \Theta_e$	max. of $V_{min,i}, V_{inf,i}$	$H_t$ [W·K <sup>-1</sup> ]	Design heat loss due to ventilation $\Phi_{v,i}$ (W)
35,000	14,502	4,931	172,568

Total design heat transmission loss of the specific room = 247,807 W

Room No.	Name of the room	Indoor temperature $\Theta_{int,i}$ [°C]
202A	Washing machine room	20,000 °C

**Calculation of heat transmission loss**

**Specific heat transmission loss directly to exterior  $H_{T,ie}$**

structures								
No.	Description	$A_k$ [m <sup>2</sup> ]	$U_k$ [W/m <sup>2</sup> .K]	$\Delta U_B$ [W/m <sup>2</sup> .K]	$U_{kc}$ [W/m <sup>2</sup> .K]	$f_{U,k}$ [-]	$f_{ie,k}$ [-]	$A_k \cdot (U_k + \Delta U_B) \cdot f_{U,k} \cdot f_{ie,k}$
								0,000
$H_{T,ie} = \Sigma (A_k \cdot (U_k + \Delta U_B) \cdot f_{U,k} \cdot f_{ie,k})$ (W/k)								0,000

**Specific heat transmission loss from heated space to neighbouring heated space or unheated space or through it**

structures								
No.S.	description	$\theta_u$ [°C]	$A_k$ [m <sup>2</sup> ]	$U_k$ [W/m <sup>2</sup> .K]	$\Delta U$ [W/m <sup>2</sup> .K]	$U_{kc}$ [W/m <sup>2</sup> .K]	$f_{ix,k}$ [-]	$A_k \cdot U_{kc} \cdot f_{ix,k}$
S4	internal non-load bearing wall	24,000	3,190	1,379		1,379	-0,114	-0,503
$H_{T,ia(-)} = \Sigma (A_k \cdot U_{kc} \cdot f_{ix,k})$ (W/K)								-0,503

$$F_{ix,k} = f_1 = (\theta_{int,i} - \theta_u) / (\theta_{int,i} - \theta_e)$$

**Specific heat transmission loss to ground  $H_{T,ig}$**

No.S.	description	$A_k$ [m <sup>2</sup> ]	$A_g$ [m <sup>2</sup> ]	P [m]	$U_k$ [W/m <sup>2</sup> .K]	$f_{ig,k}$ [-]	B' [m]	$U_{equiv,k}$ [W/m <sup>2</sup> .K]	$A_k \cdot U_{equiv,k} \cdot f_{ig,k} \cdot f_{GW,k}$
$\Sigma (A_k \cdot U_{equiv,k} \cdot f_{ig,k} \cdot f_{GW,k})$									0,000
$f_{\theta ann}$ [-]	$H_{T,ig} = f_{\theta ann} \cdot \Sigma (A_k \cdot U_{equiv,k} \cdot f_{ig,k} \cdot f_{GW,k})$ (W/K)				$f_{GW,k}$ [-]	$\theta_{e,m}$ [°C]			
1,450	0,000				1,000	3,900			

**Total design heat transmission loss  $\Phi_{T,i} = (H_{T,ie} + H_{T,ia} + H_{T,iae} + H_{T,iaBE} + H_{T,ig}) \cdot (\theta_{int,i} - \theta_e)$  [W]**

$\theta_{int,i}$ [°C]	$\theta_e$ [°C]	$\theta_{int,i} - \theta_e$ [°C]	$\Sigma H_{T,i}$ [W·K <sup>-1</sup> ]	Design heat transmission loss $\Phi_{T,i}$ [W]
20,000	-15,000	35,000	-0,503	-17,601

**Design heat loss due to ventilation - natural ventilation**

room volume $V_i$ (m <sup>3</sup> )	Outdoor temperature $\theta_e$ [°C]	indoor temperature $\theta_{int,i}$ [°C]	Hygienic requirements	
			$n_{min}$ (h <sup>-1</sup> )	Hygienic air exchange $V_{min,i}$ (m <sup>3</sup> /h)
5,920	-15,000	20,000	1,500	8,880
$n_{50}$ [1/h]	Number of unprotected openings	Shading factor $e_i$	correction factor of height level from terrain $\epsilon_i$	Amount of air infiltrated by building envelope $V_{inf,i}$
4,500	0,000	0,020	1,000	0,000

**Heat loss due to natural ventilation**

$\theta_{int,i} - \theta_e$	max. of $V_{min,i}$ , $V_{inf,i}$	$H_t$ [W·K <sup>-1</sup> ]	Design heat loss due to ventilation $\Phi_{v,i}$ (W)
35,000	8,880	3,019	105,676

Total design heat transmission loss of the specific room = 88,075 W

Room No.	Name of the room	Indoor temperature $\Theta_{int,i}$ [°C]
203A	Toilet	20,000 °C

**Calculation of heat transmission loss**

**Specific heat transmission loss directly to exterior  $H_{T,ie}$**

structures

No.	Description	$A_k$ [m <sup>2</sup> ]	$U_k$ [W/m <sup>2</sup> .K ]	$\Delta U_B$ [W/m <sup>2</sup> .K ]	$U_{kc}$ [W/m <sup>2</sup> .K ]	$f_{U,k}$ [-]	$f_{ie,k}$ [-]	$A_k \cdot (U_k + \Delta U_B) \cdot f_{U,k} \cdot f_{ie,k}$
								0,000

$H_{T,ie} = \Sigma (A_k \cdot (U_k + \Delta U_B) \cdot f_{U,k} \cdot f_{ie,k})$  (W/k) 0,000

**Specific heat transmission loss from heated space to neighbouring heated space or unheated space or through it  $H_{T,ia(-)}$**

structures

No.S.	description	$\Theta_u$ [°C]	$A_k$ [m <sup>2</sup> ]	$U_k$ [W/m <sup>2</sup> .K ]	$\Delta U$ [W/m <sup>2</sup> .K ]	$U_{kc}$ [W/m <sup>2</sup> .K ]	$f_{ix,k}$ [-]	$A_k \cdot U_{kc} \cdot f_{ix,k}$
S4	internal non-load bearing wall	24,000	1,704	1,379		1,379	-0,114	-0,269

$H_{T,ia(-)} = \Sigma (A_k \cdot U_{kc} \cdot f_{ix,k})$  (W/K) -0,269

$F_{ix,k} = f_i = (\Theta_{int,i} - \Theta_u) / (\Theta_{int,i} - \Theta_e)$

**Specific heat transmission loss to ground  $H_{T,ig}$**

No.S.	description	$A_k$ [m <sup>2</sup> ]	$A_g$ [m <sup>2</sup> ]	P [m]	$U_k$ [W/m <sup>2</sup> .K ]	$f_{ig,k}$ [-]	B' [m]	$U_{equiv,k}$ [W/m <sup>2</sup> .K]	$A_k \cdot U_{equiv,k} \cdot f_{ig,k} \cdot f_{GW,k}$
									$\Sigma (A_k \cdot U_{equiv,k} \cdot f_{ig,k} \cdot f_{GW,k})$ <span style="float: right;">0,000</span>

$H_{T,ig} = f_{\theta ann} \cdot \Sigma (A_k \cdot U_{equiv,k} \cdot f_{ig,k} \cdot f_{GW,k})$  (W/K)

$f_{\theta ann}$ [-]	1,450	0,000	$f_{GW,k}$ [-]	1,000	$\Theta_{e,m}$ [°C]	3,900
-------------------------	-------	-------	-------------------	-------	------------------------	-------

**Total design heat transmission loss  $\Phi_{T,i} = (H_{T,ie} + H_{T,ia} + H_{T,iae} + H_{T,iaBE} + H_{T,ig}) \cdot (\Theta_{int,i} - \Theta_e)$  [W]**

$\Theta_{int,i}$ [°C]	$\Theta_e$ [°C]	$\Theta_{int,i} - \Theta_e$ [°C]	$\Sigma H_{t,i}$ [W.K <sup>-1</sup> ]	Design heat transmission loss $\Phi_{T,i}$ [W]
20,000	-15,000	35,000	-0,269	-9,403

**Design heat loss due to ventilation - natural ventilation**

room volume $V_i$ (m <sup>3</sup> )	Outdoor temperature $\Theta_e$ [°C]	indoor temperature $\Theta_{int,i}$ [°C]	Hygienic requirements	
10,405	-15,000	20,000	$n_{min}$ (h <sup>-1</sup> )	Hygienic air exchange $V_{min,i}$ (m <sup>3</sup> /h)
			0,500	5,203
$n_{50}$ [1/h]	Number of unprotected openings	Shading factor $e_i$	correction factor of height level from terrain $\epsilon_i$	Amount of air infiltrated by building envelope $V_{inf,i}$ (m <sup>3</sup> /h)
4,500	0,000	0,020	1,000	0,000

**Heat loss due to natural ventilation**

$\Theta_{int,i} - \Theta_e$	max. of $V_{min,i}$ , $V_{inf,i}$	$H_t$ [W.K <sup>-1</sup> ]	Design heat loss due to ventilation $\Phi_{v,i}$ (W)
35,000	5,203	1,769	61,911

Total design heat transmission loss of the specific room = 52,508 W

Room No.	Name of the room	Indoor temperature $\Theta_{int,i}$ [°C]
204A	Kitchen and living room	20,000 °C

**Calculation of heat transmission loss**

**Specific heat transmission loss directly to exterior  $H_{T,ie}$**

structures								
No.	Description	$A_k$ [m <sup>2</sup> ]	$U_k$ [W/m <sup>2</sup> .K]	$\Delta U_B$ [W/m <sup>2</sup> .K]	$U_{kc}$ [W/m <sup>2</sup> .K]	$f_{U,k}$ [-]	$f_{ie,k}$ [-]	$A_k \cdot (U_k + \Delta U_B) \cdot f_{U,k} \cdot f_{ie,k}$
W+D	Plastic balcony door and windows	9,575	0,700		0,700	1,000	1,000	6,703
S1	peripheral wall	23,166	0,125	0,050	0,175	1,000	1,000	4,046
$H_{T,ie} = \Sigma (A_k \cdot (U_k + \Delta U_B) \cdot f_{U,k} \cdot f_{ie,k})$ (W/k)								10,748

**Specific heat transmission loss from heated space to neighbouring heated space or unheated space or through it  $H_{T,ia(i)}$**

structures								
No.S.	description	$\theta_u$ [°C]	$A_k$ [m <sup>2</sup> ]	$U_k$ [W/m <sup>2</sup> .K]	$\Delta U$ [W/m <sup>2</sup> .K]	$U_{kc}$ [W/m <sup>2</sup> .K]	$f_{ix,k}$ [-]	$A_k \cdot U_{kc} \cdot f_{ix,k}$
S4	internal non-load bearing wall	24,000	7,774	1,379		1,379	-0,114	-1,225
S3.c	internal load bearing wall	15,000	5,980	0,501		0,501	0,143	0,428
S3.a	internal load bearing wall	10,000	4,336	0,501		0,501	0,286	0,620
$H_{T,ia(i)} = \Sigma (A_k \cdot U_{kc} \cdot f_{ix,k})$ (W/K)								-0,177

$$F_{ix,k} = f_{i1} = (\theta_{int,i} - \theta_u) / (\theta_{int,i} - \theta_e)$$

**Specific heat transmission loss to ground  $H_{T,ig}$**

No.S.	description	$A_k$ [m <sup>2</sup> ]	$A_g$ [m <sup>2</sup> ]	P [m]	$U_k$ [W/m <sup>2</sup> .K]	$f_{ig,k}$ [-]	B' [m]	$U_{equiv,k}$ [W/m <sup>2</sup> .K]	$A_k \cdot U_{equiv,k} \cdot f_{ig,k} \cdot f_{GW,k}$
$\Sigma (A_k \cdot U_{equiv,k} \cdot f_{ig,k} \cdot f_{GW,k})$									0,000
$f_{\theta ann}$ [-]	$H_{T,ig} = f_{\theta ann} \cdot \Sigma (A_k \cdot U_{equiv,k} \cdot f_{ig,k} \cdot f_{GW,k})$ (W/K)					$f_{GW,k}$ [-]	$\theta_{e,m}$ [°C]		
1,450	0,000					1,000	3,900		

**Total design heat transmission loss  $\Phi_{T,i} = (H_{T,ie} + H_{T,ia} + H_{T,iae} + H_{T,iaBE} + H_{T,ig}) \cdot (\theta_{int,i} - \theta_e)$  [W]**

$\theta_{int,i}$ [°C]	$\theta_e$ [°C]	$\theta_{int,i} - \theta_e$ [°C]	$\Sigma H_{t,i}$ [W·K <sup>-1</sup> ]	Design heat transmission loss $\Phi_{T,i}$ [W]
20,000	-15,000	35,000	10,571	369,975

**Design heat loss due to ventilation - natural ventilation**

room volume $V_i$ (m <sup>3</sup> )	Outdoor temperature $\theta_e$ [°C]	indoor temperature $\theta_{int,i}$ [°C]	Hygienic requirements	
			$n_{min}$ (h <sup>-1</sup> )	Hygienic air exchange $V_{min,i}$ (m <sup>3</sup> /h)
76,036	-15,000	20,000	0,500	38,018
$n_{50}$ [1/h]	Number of unprotected openings	Shading factor $e_i$	correction factor of height level from terrain $\epsilon_i$	Amount of air infiltrated by building envelope $V_{inf,i}$ (m <sup>3</sup> /h)
4,500	1,000	0,020	1,000	13,686

**Heat loss due to natural ventilation**

$\theta_{int,i} - \theta_e$	max. of $V_{min,i}$ , $V_{inf,i}$	$H_t$ [W·K <sup>-1</sup> ]	Design heat loss due to ventilation $\Phi_{v,i}$ (W)
35,000	38,018	12,926	452,412

Total design heat transmission loss of the specific room = 822,388 W

Room No.	Name of the room	Indoor temperature $\Theta_{int,i}$ [°C]						
205A	Bathroom	24,000 °C						
<b>Calculation of heat transmission loss</b>								
<b>Specific heat transmission loss directly to exterior <math>H_{T,ie}</math></b>								
structures								
No.	Description	$A_k$ [m <sup>2</sup> ]	$U_k$ [W/m <sup>2</sup> .K]	$\Delta U_B$ [W/m <sup>2</sup> .K]	$U_{kc}$ [W/m <sup>2</sup> .K]	$f_{U,k}$ [-]	$f_{ie,k}$ [-]	$A_k \cdot (U_k + \Delta U_B) \cdot f_{U,k} \cdot f_{ie,k}$
W	triple glazing plastic window	0,900	0,700		0,700	1,000	1,000	0,630
S1	peripheral wall	4,183	0,125	0,050	0,175	1,000	1,000	0,731
$H_{T,ie} = \Sigma (A_k \cdot (U_k + \Delta U_B) \cdot f_{U,k} \cdot f_{ie,k})$ (W/k)								1,361

<b>Specific heat transmission loss from heated space to neighbouring heated space or unheated space or through it <math>H_{T,ia(i)}</math></b>								
structures								
No.S.	description	$\theta_u$ [°C]	$A_k$ [m <sup>2</sup> ]	$U_k$ [W/m <sup>2</sup> .K]	$\Delta U$ [W/m <sup>2</sup> .K]	$U_{kc}$ [W/m <sup>2</sup> .K]	$f_{ix,k}$ [-]	$A_k \cdot U_{kc} \cdot f_{ix,k}$
S4	internal non-load bearing wall	20,000	18,921	1,379		1,379	0,103	2,677
Di	interior timber door	20,000	1,680	1,800		1,800	0,103	0,310
$H_{T,ia(i)} = \Sigma (A_k \cdot U_{kc} \cdot f_{ix,k})$ (W/K)								2,987
$F_{ix,k} = f_1 = (\theta_{int,i} - \theta_u) / (\theta_{int,i} - \theta_e)$								

<b>Specific heat transmission loss to ground <math>H_{T,ig}</math></b>										
No.S.	description	$A_k$ [m <sup>2</sup> ]	$A_g$ [m <sup>2</sup> ]	P [m]	$U_k$ [W/m <sup>2</sup> .K]	$f_{ig,k}$ [-]	B' [m]	$U_{equiv,k}$ [W/m <sup>2</sup> .K]	$A_k \cdot U_{equiv,k} \cdot f_{ig,k} \cdot f_{GW,k}$	
$\Sigma (A_k \cdot U_{equiv,k} \cdot f_{ig,k} \cdot f_{GW,k})$									0,000	
$f_{\theta_{ann}}$ [-]	$H_{T,ig} = f_{\theta_{ann}} \cdot \Sigma (A_k \cdot U_{equiv,k} \cdot f_{ig,k} \cdot f_{GW,k})$ (W/K)					$f_{GW,k}$ [-]	$\theta_{e,m}$ [°C]			
1,450	0,000					1,000	3,900			

<b>Total design heat transmission loss <math>\Phi_{T,i} = (H_{T,ie} + H_{T,ia} + H_{T,iae} + H_{T,iae} + H_{T,ig}) \cdot (\theta_{int,i} - \theta_e)</math> [W]</b>				
$\theta_{int,i}$ [°C]	$\theta_e$ [°C]	$\theta_{int,i} - \theta_e$ [°C]	$\Sigma H_{T,i}$ [W.K <sup>-1</sup> ]	Design heat transmission loss $\Phi_{T,i}$ [W]
24,000	-15,000	39,000	4,347	169,543

<b>Design heat loss due to ventilation - natural ventilation</b>				
room volume $V_i$ (m <sup>3</sup> )	Outdoor temperature $\theta_e$ [°C]	indoor temperature $\theta_{int,i}$ [°C]	Hygienic requirements	
			$n_{min}$ (h <sup>-1</sup> )	Hygienic air exchange $V_{min,i}$ (m <sup>3</sup> /h)
13,126	-15,000	24,000	0,500	6,563
$n_{50}$ [1/h]	Number of unprotected openings	Shading factor $e_i$	correction factor of height level from terrain $\epsilon_i$	Amount of air infiltrated by building envelope $V_{inf,i}$ (m <sup>3</sup> /h)
4,500	1,000	0,020	1,000	2,363
<b>Heat loss due to natural ventilation</b>				
$\theta_{int,i} - \theta_e$	max. of $V_{min,i}$ , $V_{inf,i}$	$H_t$ [W.K <sup>-1</sup> ]	Design heat loss due to ventilation $\Phi_{v,i}$ (W)	
39,000	6,563	2,231	87,026	

Total design heat transmission loss of the specific room =	240,900 W
------------------------------------------------------------	-----------

Room No.	Name of the room	Indoor temperature $\Theta_{int,i}$ [°C]
206A	Bedroom	20,000 °C

**Calculation of heat transmission loss**

**Specific heat transmission loss directly to exterior  $H_{T,ie}$**

structures

No.	Description	$A_k$ [m <sup>2</sup> ]	$U_k$ [W/m <sup>2</sup> .K]	$\Delta U_B$ [W/m <sup>2</sup> .K]	$U_{kc}$ [W/m <sup>2</sup> .K]	$f_{U,k}$ [-]	$f_{ie,k}$ [-]	$A_k \cdot (U_k + \Delta U_B) \cdot f_{U,k} \cdot f_{ie,k}$
W+D	triple glazing plastic windows and balcony door	6,652	0,700		0,700	1,000	1,000	4,656
S1	peripheral wall	26,118	0,125	0,050	0,175	1,000	1,000	4,561
$H_{T,ie} = \Sigma (A_k \cdot (U_k + \Delta U_B) \cdot f_{U,k} \cdot f_{ie,k})$ (W/k)								9,218

**Specific heat transmission loss from heated space to neighbouring heated space or unheated space or through it  $H_{T,ia(-)}$**

structures

No.S.	description	$\theta_u$ [°C]	$A_k$ [m <sup>2</sup> ]	$U_k$ [W/m <sup>2</sup> .K]	$\Delta U$ [W/m <sup>2</sup> .K]	$U_{kc}$ [W/m <sup>2</sup> .K]	$f_{ix,k}$ [-]	$A_k \cdot U_{kc} \cdot f_{ix,k}$
$H_{T,ia(-)} = \Sigma (A_k \cdot U_{kc} \cdot f_{ix,k})$ (W/K)								0,000

$$f_{ix,k} = f_1 = (\theta_{int,i} - \theta_u) / (\theta_{int,i} - \theta_e)$$

**Specific heat transmission loss to ground  $H_{T,ig}$**

No.S.	description	$A_k$ [m <sup>2</sup> ]	$A_g$ [m <sup>2</sup> ]	$p$ [m]	$U_k$ [W/m <sup>2</sup> .K]	$f_{ig,k}$ [-]	$B'$ [m]	$U_{equiv,k}$ [W/m <sup>2</sup> .K]	$A_k \cdot U_{equiv,k} \cdot f_{ig,k} \cdot f_{GW,k}$
$\Sigma (A_k \cdot U_{equiv,k} \cdot f_{ig,k} \cdot f_{GW,k})$									0,000
$f_{\theta ann}$ [-]	$H_{T,ig} = f_{\theta ann} \cdot \Sigma (A_k \cdot U_{equiv,k} \cdot f_{ig,k} \cdot f_{GW,k})$ (W/K)					$f_{GW,k}$ [-]	$\theta_{e,m}$ [°C]		
1,450	0,000					1,000	3,900		

**Total design heat transmission loss  $\Phi_{T,i} = (H_{T,ie} + H_{T,ia} + H_{T,iae} + H_{T,iae} + H_{T,ig}) \cdot (\theta_{int,i} - \theta_e)$  [W]**

$\Theta_{int,i}$ [°C]	$\Theta_e$ [°C]	$\Theta_{int,i} - \Theta_e$ [°C]	$\Sigma H_{t,i}$ [W·K <sup>-1</sup> ]	Design heat transmission loss $\Phi_{T,i}$ [W]
20,000	-15,000	35,000	9,218	322,617

**Design heat loss due to ventilation - natural ventilation**

room volume $V_i$ (m <sup>3</sup> )	Outdoor temperature $\Theta_e$ [°C]	indoor temperature $\Theta_{int,i}$ [°C]	Hygienic requirements	
			$n_{min}$ (h <sup>-1</sup> )	Hygienic air exchange $V_{min,i}$ (m <sup>3</sup> /h)
58,365	-15,000	20,000	0,500	29,182
$n_{50}$	Number of unprotected	Shading	correction factor of height level	Amount of air infiltrated by
4,500	1,000	0,020	1,000	10,506

**Heat loss due to natural ventilation**

$\Theta_{int,i} - \Theta_e$	max. of $V_{min,i}, V_{inf,i}$	$H_t$ [W·K <sup>-1</sup> ]	Design heat loss due to ventilation $\Phi_{v,i}$ (W)
35,000	29,182	9,922	347,271

Total design heat transmission loss of the specific room = 669,888 W

Room No.	Name of the room	Indoor temperature $\Theta_{int,i}$ [°C]
207A	Bedroom	20,000 °C

**Calculation of heat transmission loss**

**Specific heat transmission loss directly to exterior  $H_{T,ie}$**

structures

No.	Description	$A_k$ [m <sup>2</sup> ]	$U_k$ [W/m <sup>2</sup> .K]	$\Delta U_B$ [W/m <sup>2</sup> .K]	$U_{kc}$ [W/m <sup>2</sup> .K]	$f_{U,k}$ [-]	$f_{ie,k}$ [-]	$A_k \cdot (U_k + \Delta U_B) \cdot f_{U,k} \cdot f_{ie,k}$
W	triple glazing plastic window	2,175	0,700		0,700	1,000	1,000	1,523
S1	peripheral wall	8,978	0,125	0,050	0,175	1,000	1,000	1,568
$H_{T,ie} = \Sigma (A_k \cdot (U_k + \Delta U_B) \cdot f_{U,k} \cdot f_{ie,k})$ (W/K)								3,090

**Specific heat transmission loss from heated space to neighbouring heated space or unheated space or through it  $H_{T,ia(i)}$**

structures

No.S.	description	$\Theta_u$ [°C]	$A_k$ [m <sup>2</sup> ]	$U_k$ [W/m <sup>2</sup> .K]	$\Delta U$ [W/m <sup>2</sup> .K]	$U_{kc}$ [W/m <sup>2</sup> .K]	$f_{ix,k}$ [-]	$A_k \cdot U_{kc} \cdot f_{ix,k}$
S3.a	internal load bearing wall	10,000	4,336	0,501		0,501	0,286	0,620
$H_{T,ia(i)} = \Sigma (A_k \cdot U_{kc} \cdot f_{ix,k})$ (W/K)								0,620

$$F_{ix,k} = f_1 = (\Theta_{int,i} - \Theta_u) / (\Theta_{int,i} - \Theta_e)$$

**Specific heat transmission loss to ground  $H_{T,ig}$**

No.S.	description	$A_k$ [m <sup>2</sup> ]	$A_g$ [m <sup>2</sup> ]	P [m]	$U_k$ [W/m <sup>2</sup> .K]	$f_{ig,k}$ [-]	B' [m]	$U_{equiv,k}$ [W/m <sup>2</sup> .K]	$A_k \cdot U_{equiv,k} \cdot f_{ig,k} \cdot f_{GW,k}$
$\Sigma (A_k \cdot U_{equiv,k} \cdot f_{ig,k} \cdot f_{GW,k})$									0,000
$f_{\theta ann}$ [-]	$H_{T,ig} = f_{\theta ann} \cdot \Sigma (A_k \cdot U_{equiv,k} \cdot f_{ig,k} \cdot f_{GW,k})$ (W/K)					$f_{GW,k}$ [-]	$\theta_{e,m}$ [°C]		
1,450	0,000					1,000	3,900		

**Total design heat transmission loss  $\Phi_{T,i} = (H_{T,ie} + H_{T,ia} + H_{T,iae} + H_{T,iaBE} + H_{T,ig}) \cdot (\Theta_{int,i} - \Theta_e)$  [W]**

$\Theta_{int,i}$ [°C]	$\Theta_e$ [°C]	$\Theta_{int,i} - \Theta_e$ [°C]	$\Sigma H_{T,i}$ [W·K <sup>-1</sup> ]	Design heat transmission loss $\Phi_{T,i}$ [W]
20,000	-15,000	35,000	3,711	129,872

**Design heat loss due to ventilation - natural ventilation**

room volume $V_i$ (m <sup>3</sup> )	Outdoor temperature $\Theta_e$ [°C]	indoor temperature $\Theta_{int,i}$ [°C]	Hygienic requirements	
			$n_{min}$ (h <sup>-1</sup> )	Hygienic air exchange $V_{min,i}$ (m <sup>3</sup> /h)
53,073	-15,000	20,000	0,500	26,536
$n_{50}$ [1/h]	Number of unprotected openings	Shading factor $e_i$	correction factor of height level from terrain $\epsilon_i$	Amount of air infiltrated by building envelope $V_{inf,i}$ (m <sup>3</sup> /h)
4,500	1,000	0,020	1,000	9,553

**Heat loss due to natural ventilation**

$\Theta_{int,i} - \Theta_e$	max. of $V_{min,i}$ , $V_{inf,i}$	$H_t$ [W·K <sup>-1</sup> ]	Design heat loss due to ventilation $\Phi_{v,i}$ (W)
35,000	26,536	9,022	315,781

Total design heat transmission loss of the specific room = 445,653 W



Room No.	Name of the room	Indoor temperature $\Theta_{int,i}$ [°C]
208	Staircase	10,000 °C

**Calculation of heat transmission loss**

**Specific heat transmission loss directly to exterior  $H_{T,je}$**

structures								
No.	Description	$A_k$ [m <sup>2</sup> ]	$U_k$ [W/m <sup>2</sup> .K]	$\Delta U_B$ [W/m <sup>2</sup> .K]	$U_{kc}$ [W/m <sup>2</sup> .K]	$f_{U,k}$ [-]	$f_{ie,k}$ [-]	$A_k \cdot (U_k + \Delta U_B) \cdot f_{U,k} \cdot f_{ie,k}$
$H_{T,je} = \Sigma (A_k \cdot (U_k + \Delta U_B) \cdot f_{U,k} \cdot f_{ie,k})$ (W/K)								0,000

**Specific heat transmission loss from heated space to neighbouring heated space or unheated space or through it  $H_{T,ia(i)}$**

structures								
No.S.	description	$\theta_u$ [°C]	$A_k$ [m <sup>2</sup> ]	$U_k$ [W/m <sup>2</sup> .K]	$\Delta U$ [W/m <sup>2</sup> .K]	$U_{kc}$ [W/m <sup>2</sup> .K]	$f_{ix,k}$ [-]	$A_k \cdot U_{kc} \cdot f_{ix,k}$
S3.a	internal load bearing wall	20,000	44,359	0,501		0,501	-0,400	-8,885
Di	interior timber door	20,000	3,780	1,800		1,800	-0,400	-2,722
Di	interior timber door	15,000	1,890	1,800		1,800	-0,200	-0,680
S4	internal non-load bearing wall	15,000	7,379	1,379		1,379	-0,200	-2,035
$H_{T,ia(i)} = \Sigma (A_k \cdot U_{kc} \cdot f_{ix,k})$ (W/K)								-14,323

$$F_{ix,k} = f_{i1} = (\theta_{int,i} - \theta_u) / (\theta_{int,i} - \theta_e)$$

**Specific heat transmission loss to ground  $H_{T,ig}$**

No.S.	description	$A_k$ [m <sup>2</sup> ]	$A_g$ [m <sup>2</sup> ]	P [m]	$U_k$ [W/m <sup>2</sup> .K]	$f_{ig,k}$ [-]	B' [m]	$U_{equiv,k}$ [W/m <sup>2</sup> .K]	$A_k \cdot U_{equiv,k} \cdot f_{ig,k} \cdot f_{GW,k}$
$\Sigma (A_k \cdot U_{equiv,k} \cdot f_{ig,k} \cdot f_{GW,k})$									0,000
$f_{\theta ann}$ [-]	$H_{T,ig} = f_{\theta ann} \cdot \Sigma (A_k \cdot U_{equiv,k} \cdot f_{ig,k} \cdot f_{GW,k})$ (W/K)					$f_{GW,k}$ [-]	$\theta_{e,m}$ [°C]		
1,450	0,000					1,000	3,900		

**Total design heat transmission loss  $\Phi_{T,i} = (H_{T,je} + H_{T,ia} + H_{T,iae} + H_{T,iaBE} + H_{T,ig}) \cdot (\theta_{int,i} - \theta_e)$  [W]**

$\theta_{int,i}$ [°C]	$\theta_e$ [°C]	$\theta_{int,i} - \theta_e$ [°C]	$\Sigma H_{T,i}$ [W·K <sup>-1</sup> ]	Design heat transmission loss $\Phi_{T,i}$ [W]
10,000	-15,000	25,000	-14,323	-358,064

**Design heat loss due to ventilation - natural ventilation**

room volume $V_i$ (m <sup>3</sup> )	Outdoor temperature $\theta_e$ [°C]	indoor temperature $\theta_{int,i}$ [°C]	Hygienic requirements	
			$n_{min}$ (h <sup>-1</sup> )	Hygienic air exchange $V_{min,i}$ (m <sup>3</sup> /h)
52,654	-15,000	10,000	0,500	26,327
$n_{50}$ [1/h]	Number of unprotected openings	Shading factor $e_i$	correction factor of height level from terrain $\epsilon_i$	Amount of air infiltrated by building envelope $V_{inf,i}$ (m <sup>3</sup> /h)
4,500	0,000	0,000	1,000	0,000

**Heat loss due to natural ventilation**

$\theta_{int,i} - \theta_e$	max. of $V_{min,i}$ , $V_{inf,i}$	$H_t$ [W·K <sup>-1</sup> ]	Design heat loss due to ventilation $\Phi_{v,i}$ (W)
25,000	26,327	8,951	223,779

Total design heat transmission loss of the specific room = -134,285 W

Room No.	Name of the room	Indoor temperature $\Theta_{int,i}$ [°C]						
201B	Vestibule	20,000 °C						
<b>Calculation of heat transmission loss</b>								
<b>Specific heat transmission loss directly to exterior <math>H_{T,ie}</math></b>								
structures								
No.	Description	$A_k$ [m <sup>2</sup> ]	$U_k$ [W/m <sup>2</sup> .K]	$\Delta U_B$ [W/m <sup>2</sup> .K]	$U_{kc}$ [W/m <sup>2</sup> .K]	$f_{U,k}$ [-]	$f_{ie,k}$ [-]	$A_k \cdot (U_k + \Delta U_B) \cdot f_{U,k} \cdot f_{ie,k}$
W	Triple glazing plastic window	1,088	0,700		0,700	1,000	1,000	0,762
S1	Peripheral wall	1,857	0,125	0,050	0,175	1,000	1,000	0,324
$H_{T,ie} = \Sigma (A_k \cdot (U_k + \Delta U_B) \cdot f_{U,k} \cdot f_{ie,k})$ (W/k)								1,086

<b>Specific heat transmission loss from heated space to neighbouring heated space or unheated space or through it <math>H_{T,ia(.,)}</math></b>								
structures								
No.S.	description	$\theta_u$ [°C]	$A_k$ [m <sup>2</sup> ]	$U_k$ [W/m <sup>2</sup> .K]	$\Delta U$ [W/m <sup>2</sup> .K]	$U_{kc}$ [W/m <sup>2</sup> .K]	$f_{ix,k}$ [-]	$A_k \cdot U_{kc} \cdot f_{ix,k}$
S4	internal non-load bearing wall	24,000	6,094	1,379		1,379	-0,114	-0,961
S3.a	internal load bearing wall	10,000	9,771	0,501		0,501	0,286	1,398
Di	interior timber door	10,000	1,890	1,800		1,800	0,286	0,972
Di	interior timber door	24,000	1,680	1,800		1,800	-0,114	-0,346
$H_{T,ia(.,)} = \Sigma (A_k \cdot U_{kc} \cdot f_{ix,k})$ (W/K)								1,064
$F_{ix,k} = f_1 = (\theta_{int,i} - \theta_u) / (\theta_{int,i} - \theta_e)$								

<b>Specific heat transmission loss to ground <math>H_{T,ig}</math></b>									
No.S.	description	$A_k$ [m <sup>2</sup> ]	$A_g$ [m <sup>2</sup> ]	p [m]	$U_k$ [W/m <sup>2</sup> .K]	$f_{ig,k}$ [-]	B' [m]	$U_{equiv,k}$ [W/m <sup>2</sup> .K]	$A_k \cdot U_{equiv,k} \cdot f_{ig,k} \cdot f_{GW,k}$
$\Sigma (A_k \cdot U_{equiv,k} \cdot f_{ig,k} \cdot f_{GW,k})$									0,000
$f_{\theta_{ann}}$ [-]	$H_{T,ig} = f_{\theta_{ann}} \cdot \Sigma (A_k \cdot U_{equiv,k} \cdot f_{ig,k} \cdot f_{GW,k})$ (W/K)				$f_{GW,k}$ [-]	$\theta_{e,m}$ [°C]			
1,450	0,000				1,000	3,900			

<b>Total design heat transmission loss <math>\Phi_{T,i} = (H_{T,ie} + H_{T,ia} + H_{T,iae} + H_{T,iaBE} + H_{T,ig}) \cdot (\theta_{int,i} - \theta_e)</math> [W]</b>				
$\theta_{int,i}$ [°C]	$\theta_e$ [°C]	$\theta_{int,i} - \theta_e$ [°C]	$\Sigma H_{T,i}$ [W·K <sup>-1</sup> ]	Design heat transmission loss $\Phi_{T,i}$ [W]
20,000	-15,000	35,000	2,150	75,239

<b>Design heat loss due to ventilation - natural ventilation</b>					
room volume $V_i$ (m <sup>3</sup> )	Outdoor temperature $\theta_e$ [°C]	indoor temperature $\theta_{int,i}$ [°C]	Hygienic requirements		
29,003	-15,000	20,000	$n_{min}$ (h <sup>-1</sup> )	Hygienic air exchange $V_{min,i}$ (m <sup>3</sup> /h)	
			0,500	14,502	
$n_{50}$ [1/h]	Number of unprotected openings	Shading factor $e_i$	correction factor of height level from terrain $\epsilon_i$	Amount of air infiltrated by building envelope $V_{inf,i}$ (m <sup>3</sup> /h)	
4,500	0,000	0,000	1,000	0,000	
<b>Heat loss due to natural ventilation</b>					
$\theta_{int,i} - \theta_e$	max. of $V_{min,i}$ , $V_{inf,i}$	$H_t$ [W·K <sup>-1</sup> ]	Design heat loss due to ventilation $\Phi_{v,i}$ (W)		
35,000	14,502	4,931	172,568		

Total design heat transmission loss of the specific room = 247,807 W

Room No.	Name of the room	Indoor temperature $\Theta_{int,i}$ [°C]						
202B	Washing machine room	20,000 °C						
<b>Calculation of heat transmission loss</b>								
<b>Specific heat transmission loss directly to exterior <math>H_{T,ie}</math></b>								
structures								
No.	Description	$A_k$ [m <sup>2</sup> ]	$U_k$ [W/m <sup>2</sup> .K]	$\Delta U_B$ [W/m <sup>2</sup> .K]	$U_{kc}$ [W/m <sup>2</sup> .K]	$f_{U,k}$ [-]	$f_{ie,k}$ [-]	$A_k \cdot (U_k + \Delta U_B) \cdot f_{U,k} \cdot f_{ie,k}$
								0,000
$H_{T,ie} = \Sigma (A_k \cdot (U_k + \Delta U_B) \cdot f_{U,k} \cdot f_{ie,k})$ (W/k)								0,000

<b>Specific heat transmission loss from heated space to neighbouring heated space or unheated space or through it <math>H_{T,ia(-)}</math></b>								
structures								
No.S.	description	$\Theta_u$ [°C]	$A_k$ [m <sup>2</sup> ]	$U_k$ [W/m <sup>2</sup> .K]	$\Delta U$ [W/m <sup>2</sup> .K]	$U_{kc}$ [W/m <sup>2</sup> .K]	$f_{ix,k}$ [-]	$A_k \cdot U_{kc} \cdot f_{ix,k}$
S4	internal non-load bearing wall	24,000	3,187	1,379		1,379	-0,114	-0,502
$H_{T,ia(-)} = \Sigma (A_k \cdot U_{kc} \cdot f_{ix,k})$ (W/K)								-0,502
$F_{ix,k} = f_1 = (\Theta_{int,i} - \Theta_u) / (\Theta_{int,i} - \Theta_e)$								

<b>Specific heat transmission loss to ground <math>H_{T,ig}</math></b>									
No.S.	description	$A_k$ [m <sup>2</sup> ]	$A_g$ [m <sup>2</sup> ]	P [m]	$U_k$ [W/m <sup>2</sup> .K]	$f_{ig,k}$ [-]	B' [m]	$U_{equiv,k}$ [W/m <sup>2</sup> .K]	$A_k \cdot U_{equiv,k} \cdot f_{ig,k} \cdot f_{GW,k}$
									0,000
$\Sigma (A_k \cdot U_{equiv,k} \cdot f_{ig,k} \cdot f_{GW,k})$								0,000	
$f_{\theta ann}$ [-]	$H_{T,ig} = f_{\theta ann} \cdot \Sigma (A_k \cdot U_{equiv,k} \cdot f_{ig,k} \cdot f_{GW,k})$ (W/K)				$f_{GW,k}$ [-]	$\Theta_{e,m}$ [°C]			
1,450	0,000				1,000	3,900			

<b>Total design heat transmission loss <math>\Phi_{T,i} = (H_{T,ie} + H_{T,ia} + H_{T,iae} + H_{T,iaBE} + H_{T,ig}) \cdot (\Theta_{int,i} - \Theta_e)</math> [W]</b>				
$\Theta_{int,i}$ [°C]	$\Theta_e$ [°C]	$\Theta_{int,i} - \Theta_e$ [°C]	$\Sigma H_{t,i}$ [W·K <sup>-1</sup> ]	Design heat transmission loss $\Phi_{T,i}$ [W]
20,000	-15,000	35,000	-0,502	-17,584

<b>Design heat loss due to ventilation - natural ventilation</b>				
room volume $V_i$ (m <sup>3</sup> )	Outdoor temperature $\Theta_e$ [°C]	indoor temperature $\Theta_{int,i}$ [°C]	Hygienic requirements	
5,920	-15,000	20,000	$n_{min}$ (h <sup>-1</sup> )	Hygienic air exchange $V_{min,i}$ (m <sup>3</sup> /h)
			1,500	8,880
$n_{50}$ [1/h]	Number of unprotected openings	Shading factor $e_i$	correction factor of height level from terrain $\epsilon_i$	Amount of air infiltrated by building envelope $V_{inf,i}$ (m <sup>3</sup> /h)
4,500	0,000	0,020	1,000	0,000
<b>Heat loss due to natural ventilation</b>				
$\Theta_{int,i} - \Theta_e$	max. of $V_{min,i}$ , $V_{inf,i}$	$H_t$ [W·K <sup>-1</sup> ]	Design heat loss due to ventilation $\Phi_{v,i}$ (W)	
35,000	8,880	3,019	105,676	

Total design heat transmission loss of the specific room = 88,091 W

Room No.	Name of the room	Indoor temperature $\Theta_{int,i}$ [°C]
203B	Toilet	20,000 °C

**Calculation of heat transmission loss**

**Specific heat transmission loss directly to exterior  $H_{T,ie}$**

structures

No.	Description	$A_k$ [m <sup>2</sup> ]	$U_k$ [W/m <sup>2</sup> .K]	$\Delta U_B$ [W/m <sup>2</sup> .K]	$U_{kc}$ [W/m <sup>2</sup> .K]	$f_{U,k}$ [-]	$f_{ie,k}$ [-]	$A_k \cdot (U_k + \Delta U_B) \cdot f_{U,k} \cdot f_{ie,k}$
								0,000
$H_{T,ie} = \Sigma (A_k \cdot (U_k + \Delta U_B) \cdot f_{U,k} \cdot f_{ie,k})$ (W/k)								0,000

**Specific heat transmission loss from heated space to neighbouring heated space or unheated space or through it  $H_{T,ia(..)}$**

structures

No.S.	description	$\theta_u$ [°C]	$A_k$ [m <sup>2</sup> ]	$U_k$ [W/m <sup>2</sup> .K]	$\Delta U$ [W/m <sup>2</sup> .K]	$U_{kc}$ [W/m <sup>2</sup> .K]	$f_{ix,k}$ [-]	$A_k \cdot U_{kc} \cdot f_{ix,k}$
S4	internal non-load bearing wall	24,000	1,704	1,379		1,379	-0,114	-0,269
$H_{T,ia(..)} = \Sigma (A_k \cdot U_{kc} \cdot f_{ix,k})$ (W/K)								-0,269
$F_{ix,k} = f_1 = (\theta_{int,i} - \theta_u) / (\theta_{int,i} - \theta_e)$								

**Specific heat transmission loss to ground  $H_{T,ig}$**

No.S.	description	$A_k$ [m <sup>2</sup> ]	$A_g$ [m <sup>2</sup> ]	P [m]	$U_k$ [W/m <sup>2</sup> .K]	$f_{ig,k}$ [-]	B' [m]	$U_{equiv,k}$ [W/m <sup>2</sup> .K]	$A_k \cdot U_{equiv,k} \cdot f_{ig,k} \cdot f_{GW,k}$
$\Sigma (A_k \cdot U_{equiv,k} \cdot f_{ig,k} \cdot f_{GW,k})$								0,000	
$f_{\theta_{ann}}$ [-]	$H_{T,ig} = f_{\theta_{ann}} \cdot \Sigma (A_k \cdot U_{equiv,k} \cdot f_{ig,k} \cdot f_{GW,k})$ (W/K)				$f_{GW,k}$ [-]	$\theta_{e,m}$ [°C]			
1,450	0,000				1,000	3,900			

**Total design heat transmission loss  $\Phi_{T,i} = (H_{T,ie} + H_{T,ia} + H_{T,iae} + H_{T,iaBE} + H_{T,ig}) \cdot (\theta_{int,i} - \theta_e)$  [W]**

$\theta_{int,i}$ [°C]	$\theta_e$ [°C]	$\theta_{int,i} - \theta_e$ [°C]	$\Sigma H_{T,i}$ [W.K <sup>-1</sup> ]	Design heat transmission loss $\Phi_{T,i}$ [W]
20,000	-15,000	35,000	-0,269	-9,403

**Design heat loss due to ventilation - natural ventilation**

room volume $V_i$ (m <sup>3</sup> )	Outdoor temperature $\theta_e$ [°C]	indoor temperature $\theta_{int,i}$ [°C]	Hygienic requirements	
			$n_{min}$ (h <sup>-1</sup> )	Hygienic air exchange $V_{min,i}$ (m <sup>3</sup> /h)
10,405	-15,000	20,000	0,500	5,203
$n_{50}$ [1/h]	Number of unprotected openings	Shading factor $e_i$	correction factor of height level from terrain $\epsilon_i$	Amount of air infiltrated by building envelope $V_{inf,i}$ (m <sup>3</sup> /h)
4,500	0,000	0,020	1,000	0,000

**Heat loss due to natural ventilation**

$\theta_{int,i} - \theta_e$	max. of $V_{min,i}$ , $V_{inf,i}$	$H_t$ [W.K <sup>-1</sup> ]	Design heat loss due to ventilation $\Phi_{v,i}$ (W)
35,000	5,203	1,769	61,911

Total design heat transmission loss of the specific room = 52,508 W

Room No.	Name of the room	Indoor temperature $\Theta_{int,i}$ [°C]						
204B	Kitchen and living room	20,000 °C						
<b>Calculation of heat transmission loss</b>								
<b>Specific heat transmission loss directly to exterior <math>H_{T,ie}</math></b>								
structures								
No.	Description	$A_k$ [m <sup>2</sup> ]	$U_k$ [W/m <sup>2</sup> .K]	$\Delta U_B$ [W/m <sup>2</sup> .K]	$U_{kc}$ [W/m <sup>2</sup> .K]	$f_{U,k}$ [-]	$f_{ie,k}$ [-]	$A_k \cdot (U_k + \Delta U_B) \cdot f_{U,k} \cdot f_{ie,k}$
W+D	Plastic balcony door and windows	9,575	0,700		0,700	1,000	1,000	6,703
S1	peripheral wall	23,166	0,125	0,050	0,175	1,000	1,000	4,046
$H_{T,ie} = \Sigma (A_k \cdot (U_k + \Delta U_B) \cdot f_{U,k} \cdot f_{ie,k})$ (W/K)								10,748

<b>Specific heat transmission loss from heated space to neighbouring heated space or unheated space or through it <math>H_{T,ia(i)}</math></b>								
structures								
No.S.	description	$\theta_u$ [°C]	$A_k$ [m <sup>2</sup> ]	$U_k$ [W/m <sup>2</sup> .K]	$\Delta U$ [W/m <sup>2</sup> .K]	$U_{kc}$ [W/m <sup>2</sup> .K]	$f_{ix,k}$ [-]	$A_k \cdot U_{kc} \cdot f_{ix,k}$
S4	internal non-load bearing wall	24,000	7,774	1,379		1,379	-0,114	-1,225
S3.c	internal load bearing wall	15,000	5,980	0,501		0,501	0,143	0,428
S3.a	internal load bearing wall	10,000	4,336	0,501		0,501	0,286	0,620
$H_{T,ia(i)} = \Sigma (A_k \cdot U_{kc} \cdot f_{ix,k})$ (W/K)								-0,177
$F_{ix,k} = f_1 = (\theta_{int,i} - \theta_u) / (\theta_{int,i} - \theta_e)$								

<b>Specific heat transmission loss to ground <math>H_{T,ig}</math></b>									
No.S.	description	$A_k$ [m <sup>2</sup> ]	$A_g$ [m <sup>2</sup> ]	P [m]	$U_k$ [W/m <sup>2</sup> .K]	$f_{ig,k}$ [-]	B' [m]	$U_{equiv,k}$ [W/m <sup>2</sup> .K]	$A_k \cdot U_{equiv,k} \cdot f_{ig,k} \cdot f_{GW,k}$
								$\Sigma (A_k \cdot U_{equiv,k} \cdot f_{ig,k} \cdot f_{GW,k})$	0,000
$f_{\theta ann}$ [-]	$H_{T,ig} = f_{\theta ann} \cdot \Sigma (A_k \cdot U_{equiv,k} \cdot f_{ig,k} \cdot f_{GW,k})$ (W/K)				$f_{GW,k}$ [-]	$\theta_{e,m}$ [°C]			
1,450	0,000				1,000	3,900			

<b>Total design heat transmission loss <math>\Phi_{T,i} = (H_{T,ie} + H_{T,ia} + H_{T,iae} + H_{T,iaBE} + H_{T,ig}) \cdot (\theta_{int,i} - \theta_e)</math> [W]</b>				
$\theta_{int,i}$ [°C]	$\theta_e$ [°C]	$\theta_{int,i} - \theta_e$ [°C]	$\Sigma H_{T,i}$ [W·K <sup>-1</sup> ]	Design heat transmission loss $\Phi_{T,i}$ [W]
20,000	-15,000	35,000	10,571	369,975

<b>Design heat loss due to ventilation - natural ventilation</b>				
room volume $V_i$ (m <sup>3</sup> )	Outdoor temperature $\theta_e$ [°C]	indoor temperature $\theta_{int,i}$ [°C]	Hygienic requirements	
			$n_{min}$ (h <sup>-1</sup> )	Hygienic air exchange $V_{min,i}$ (m <sup>3</sup> /h)
76,036	-15,000	20,000	0,500	38,018
$n_{50}$ [1/h]	Number of unprotected openings	Shading factor $e_i$	correction factor of height level from terrain $\epsilon_i$	Amount of air infiltrated by building envelope $V_{inf,i}$ (m <sup>3</sup> /h)
4,500	1,000	0,020	1,000	13,686

<b>Heat loss due to natural ventilation</b>			
$\theta_{int,i} - \theta_e$	max. of $V_{min,i}$ , $V_{inf,i}$	$H_t$ [W·K <sup>-1</sup> ]	Design heat loss due to ventilation $\Phi_{v,i}$ (W)
35,000	38,018	12,926	452,412

Total design heat transmission loss of the specific room = 822,388 W

Room No.	Name of the room	Indoor temperature $\Theta_{int,j}$ [°C]
205B	Bathroom	24,000 °C

**Calculation of heat transmission loss**

**Specific heat transmission loss directly to exterior  $H_{T,ie}$**

structures								
No.	Description	$A_k$ [m <sup>2</sup> ]	$U_k$ [W/m <sup>2</sup> .K]	$\Delta U_B$ [W/m <sup>2</sup> .K]	$U_{kc}$ [W/m <sup>2</sup> .K]	$f_{U,k}$ [-]	$f_{ie,k}$ [-]	$A_k \cdot (U_k + \Delta U_B) \cdot f_{U,k} \cdot f_{ie,k}$
W	triple glazing plastic window	0,900	0,700		0,700	1,000	1,000	0,630
S1	peripheral wall	4,183	0,125	0,050	0,175	1,000	1,000	0,731
$H_{T,ie} = \Sigma (A_k \cdot (U_k + \Delta U_B) \cdot f_{U,k} \cdot f_{ie,k})$ (W/K)								1,361

**Specific heat transmission loss from heated space to neighbouring heated space or unheated space or through it  $H_{T,ia(i)}$**

structures								
No.S.	description	$\theta_u$ [°C]	$A_k$ [m <sup>2</sup> ]	$U_k$ [W/m <sup>2</sup> .K]	$\Delta U$ [W/m <sup>2</sup> .K]	$U_{kc}$ [W/m <sup>2</sup> .K]	$f_{ix,k}$ [-]	$A_k \cdot U_{kc} \cdot f_{ix,k}$
S4	internal non-load bearing wall	20,000	18,921	1,379		1,379	0,103	2,677
Di	interior timber door	20,000	1,680	1,800		1,800	0,103	0,310
$H_{T,ia(i)} = \Sigma (A_k \cdot U_{kc} \cdot f_{ix,k})$ (W/K)								2,987

$f_{ix,k} = f_1 = (\theta_{int,i} - \theta_u) / (\theta_{int,i} - \theta_e)$

**Specific heat transmission loss to ground  $H_{T,ig}$**

No.S.	description	$A_k$ [m <sup>2</sup> ]	$A_g$ [m <sup>2</sup> ]	P [m]	$U_k$ [W/m <sup>2</sup> .K]	$f_{ig,k}$ [-]	B' [m]	$U_{equiv,k}$ [W/m <sup>2</sup> .K]	$A_k \cdot U_{equiv,k} \cdot f_{ig,k} \cdot f_{GW,k}$
								$\Sigma (A_k \cdot U_{equiv,k} \cdot f_{ig,k} \cdot f_{GW,k})$	0,000
$f_{\theta ann}$ [-]	$H_{T,ig} = f_{\theta ann} \cdot \Sigma (A_k \cdot U_{equiv,k} \cdot f_{ig,k} \cdot f_{GW,k})$ (W/K)					$f_{GW,k}$ [-]	$\theta_{e,m}$ [°C]		
1,450	0,000					1,000	3,900		

**Total design heat transmission loss  $\Phi_{T,i} = (H_{T,ie} + H_{T,ia} + H_{T,iae} + H_{T,iae} + H_{T,ig}) \cdot (\theta_{int,i} - \theta_e)$  [W]**

$\theta_{int,i}$ [°C]	$\theta_e$ [°C]	$\theta_{int,i} - \theta_e$ [°C]	$\Sigma H_{T,i}$ [W·K <sup>-1</sup> ]	Design heat transmission loss $\Phi_{T,i}$ [W]
24,000	-15,000	39,000	4,347	169,543

**Design heat loss due to ventilation - natural ventilation**

room volume $V_i$ (m <sup>3</sup> )	Outdoor temperature $\theta_e$ [°C]	indoor temperature $\theta_{int,i}$ [°C]	Hygienic requirements	
			$n_{min}$ (h <sup>-1</sup> )	Hygienic air exchange $V_{min,i}$ (m <sup>3</sup> /h)
13,156	-15,000	24,000	0,500	6,578
$n_{50}$ [1/h]	Number of unprotected openings	Shading factor $e_i$	correction factor of height level from terrain $\epsilon_i$	Amount of air infiltrated by building envelope $V_{inf,i}$ (m <sup>3</sup> /h)
4,500	1,000	0,020	1,000	2,368

**Heat loss due to natural ventilation**

$\theta_{int,i} - \theta_e$	max. of $V_{min,i}$ , $V_{inf,i}$	$H_t$ [W·K <sup>-1</sup> ]	Design heat loss due to ventilation $\Phi_{v,i}$ (W)
39,000	6,578	2,237	87,224

Total design heat transmission loss of the specific room = 230,400 W

Room No.	Name of the room	Indoor temperature $\Theta_{int,i}$ [°C]
206B	Bedroom	20,000 °C

**Calculation of heat transmission loss**

**Specific heat transmission loss directly to exterior  $H_{T,ie}$**

structures								
No.	Description	$A_k$ [m <sup>2</sup> ]	$U_k$ [W/m <sup>2</sup> .K]	$\Delta U_B$ [W/m <sup>2</sup> .K]	$U_{kc}$ [W/m <sup>2</sup> .K]	$f_{U,k}$ [-]	$f_{ie,k}$ [-]	$A_k \cdot (U_k + \Delta U_B) \cdot f_{U,k} \cdot f_{ie,k}$
W+D	triple glazing plastic windows and balcony door	6,652	0,700		0,700	1,000	1,000	4,656
S1	peripheral wall	26,118	0,125	0,050	0,175	1,000	1,000	4,561
$H_{T,ie} = \Sigma (A_k \cdot (U_k + \Delta U_B) \cdot f_{U,k} \cdot f_{ie,k})$ (W/k)								9,218

**Specific heat transmission loss from heated space to neighbouring heated space or unheated space or through it  $H_{T,ia(-)}$**

structures								
No.S.	description	$\theta_u$ [°C]	$A_k$ [m <sup>2</sup> ]	$U_k$ [W/m <sup>2</sup> .K]	$\Delta U$ [W/m <sup>2</sup> .K]	$U_{kc}$ [W/m <sup>2</sup> .K]	$f_{ix,k}$ [-]	$A_k \cdot U_{kc} \cdot f_{ix,k}$
$H_{T,ia(-)} = \Sigma (A_k \cdot U_{kc} \cdot f_{ix,k})$ (W/K)								0,000

$$F_{ix,k} = f_1 = (\theta_{int,i} - \theta_u) / (\theta_{int,i} - \theta_e)$$

**Specific heat transmission loss to ground  $H_{T,ig}$**

No.S.	description	$A_k$ [m <sup>2</sup> ]	$A_g$ [m <sup>2</sup> ]	P [m]	$U_k$ [W/m <sup>2</sup> .K]	$f_{ig,k}$ [-]	B' [m]	$U_{equiv,k}$ [W/m <sup>2</sup> .K]	$A_k \cdot U_{equiv,k} \cdot f_{ig,k} \cdot f_{GW,k}$
$\Sigma (A_k \cdot U_{equiv,k} \cdot f_{ig,k} \cdot f_{GW,k})$								0,000	
$f_{\theta ann}$ [-]	$H_{T,ig} = f_{\theta ann} \cdot \Sigma (A_k \cdot U_{equiv,k} \cdot f_{ig,k} \cdot f_{GW,k})$ (W/K)				$f_{GW,k}$ [-]	$\theta_{e,m}$ [°C]			
1,450	0,000				1,000	3,900			

**Total design heat transmission loss  $\Phi_{T,i} = (H_{T,ie} + H_{T,ia} + H_{T,iae} + H_{T,iaBE} + H_{T,ig}) \cdot (\theta_{int,i} - \theta_e)$  [W]**

$\theta_{int,i}$ [°C]	$\theta_e$ [°C]	$\theta_{int,i} - \theta_e$ [°C]	$\Sigma H_{T,i}$ [W·K <sup>-1</sup> ]	Design heat transmission loss $\Phi_{T,i}$ [W]
20,000	-15,000	35,000	9,218	322,617

**Design heat loss due to ventilation - natural ventilation**

room volume $V_i$ (m <sup>3</sup> )	Outdoor temperature $\theta_e$ [°C]	indoor temperature $\theta_{int,i}$ [°C]	Hygienic requirements	
			$n_{min}$ (h <sup>-1</sup> )	Hygienic air exchange $V_{min,i}$ (m <sup>3</sup> /h)
58,365	-15,000	20,000	0,500	29,182
$n_{50}$ [1/h]	Number of unprotected openings	Shading factor $e_i$	correction factor of height level from terrain $\epsilon_i$	Amount of air infiltrated by building envelope $V_{inf,i}$ (m <sup>3</sup> /h)
4,500	1,000	0,020	1,000	10,506

**Heat loss due to natural ventilation**

$\theta_{int,i} - \theta_e$	max. of $V_{min,i}$ , $V_{inf,i}$	$H_t$ [W·K <sup>-1</sup> ]	Design heat loss due to ventilation $\Phi_{v,i}$ (W)
35,000	29,182	9,922	347,271

Total design heat transmission loss of the specific room = 669,888 W

Room No.	Name of the room	Indoor temperature $\Theta_{int,i}$ [°C]
207B	Bedroom	20,000 °C

**Calculation of heat transmission loss**

**Specific heat transmission loss directly to exterior  $H_{T,ie}$**

structures

No.	Description	$A_k$ [m <sup>2</sup> ]	$U_k$ [W/m <sup>2</sup> .K]	$\Delta U_B$ [W/m <sup>2</sup> .K]	$U_{kc}$ [W/m <sup>2</sup> .K]	$f_{U,k}$ [-]	$f_{ie,k}$ [-]	$A_k \cdot (U_k + \Delta U_B) \cdot f_{U,k} \cdot f_{ie,k}$
W	triple glazing plastic window	2,175	0,700		0,700	1,000	1,000	1,523
S1	peripheral wall	8,978	0,125	0,050	0,175	1,000	1,000	1,568
$H_{T,ie} = \Sigma (A_k \cdot (U_k + \Delta U_B) \cdot f_{U,k} \cdot f_{ie,k})$ (W/k)								3,090

**Specific heat transmission loss from heated space to neighbouring heated space or unheated space or through it  $H_{T,ia(..)}$**

structures

No.S.	description	$\theta_u$ [°C]	$A_k$ [m <sup>2</sup> ]	$U_k$ [W/m <sup>2</sup> .K]	$\Delta U$ [W/m <sup>2</sup> .K]	$U_{kc}$ [W/m <sup>2</sup> .K]	$f_{ix,k}$ [-]	$A_k \cdot U_{kc} \cdot f_{ix,k}$
S3.a	internal load bearing wall	10,000	4,336	0,501		0,501	0,286	0,620
$H_{T,ia(..)} = \Sigma (A_k \cdot U_{kc} \cdot f_{ix,k})$ (W/K)								0,620

$$f_{ix,k} = f_1 = (\theta_{int,i} - \theta_u) / (\theta_{int,i} - \theta_e)$$

**Specific heat transmission loss to ground  $H_{T,ig}$**

No.S.	description	$A_k$ [m <sup>2</sup> ]	$A_g$ [m <sup>2</sup> ]	P [m]	$U_k$ [W/m <sup>2</sup> .K]	$f_{ig,k}$ [-]	B' [m]	$U_{equiv,k}$ [W/m <sup>2</sup> .K]	$A_k \cdot U_{equiv,k} \cdot f_{ig,k} \cdot f_{GW,k}$
								$\Sigma (A_k \cdot U_{equiv,k} \cdot f_{ig,k} \cdot f_{GW,k})$	0,000
$f_{\theta_{ann}}$ [-]	$H_{T,ig} = f_{\theta_{ann}} \cdot \Sigma (A_k \cdot U_{equiv,k} \cdot f_{ig,k} \cdot f_{GW,k})$ (W/K)					$f_{GW,k}$ [-]	$\theta_{e,m}$ [°C]		
1,450	0,000					1,000	3,900		

**Total design heat transmission loss  $\Phi_{T,i} = (H_{T,ie} + H_{T,ia} + H_{T,iae} + H_{T,iaBE} + H_{T,ig}) \cdot (\theta_{int,i} - \theta_e)$  [W]**

$\Theta_{int,i}$ [°C]	$\Theta_e$ [°C]	$\Theta_{int,i} - \Theta_e$ [°C]	$\Sigma H_{T,i}$ [W.K <sup>-1</sup> ]	Design heat transmission loss $\Phi_{T,i}$ [W]
20,000	-15,000	35,000	3,711	129,872

**Design heat loss due to ventilation - natural ventilation**

room volume $V_i$ (m <sup>3</sup> )	Outdoor temperature $\Theta_e$ [°C]	indoor temperature $\Theta_{int,i}$ [°C]	Hygienic requirements	
			$n_{min}$ (h <sup>-1</sup> )	Hygienic air exchange $V_{min,i}$ (m <sup>3</sup> /h)
53,073	-15,000	20,000	0,500	26,536
$n_{50}$ [1/h]	Number of unprotected openings	Shading factor $e_i$	correction factor of height level from terrain $\epsilon_i$	Amount of air infiltrated by building envelope $V_{inf,i}$ (m <sup>3</sup> /h)
4,500	1,000	0,020	1,000	9,553

**Heat loss due to natural ventilation**

$\Theta_{int,i} - \Theta_e$	max. of $V_{min,i}$ , $V_{inf,i}$	$H_t$ [W.K <sup>-1</sup> ]	Design heat loss due to ventilation $\Phi_{v,i}$ (W)
35,000	26,536	9,022	315,781

Total design heat transmission loss of the specific room = 445,653 W



Room No.	Name of the room	Indoor temperature $\Theta_{int,i}$ [°C]
211	Laundry drying room	15,000 °C

**Calculation of heat transmission loss**

**Specific heat transmission loss directly to exterior  $H_{T,ie}$**

structures								
No.	Description	$A_k$ [m <sup>2</sup> ]	$U_k$ [W/m <sup>2</sup> .K]	$\Delta U_B$ [W/m <sup>2</sup> .K]	$U_{kc}$ [W/m <sup>2</sup> .K]	$f_{U,k}$ [-]	$f_{ie,k}$ [-]	$A_k \cdot (U_k + \Delta U_B) \cdot f_{U,k} \cdot f_{ie,k}$
S1	Peripheral wall	5,519	0,125	0,050	0,175	1,000	1,000	0,964
W	triple glazing plastic window	3,750	0,700		0,700	1,000	1,000	2,625
$H_{T,ie} = \Sigma (A_k \cdot (U_k + \Delta U_B) \cdot f_{U,k} \cdot f_{ie,k})$ (W/k)								3,589

**Specific heat transmission loss from heated space to neighbouring heated space or unheated space or through it  $H_{T,ia(..)}$**

structures								
No.S.	description	$\theta_u$ [°C]	$A_k$ [m <sup>2</sup> ]	$U_k$ [W/m <sup>2</sup> .K]	$\Delta U$ [W/m <sup>2</sup> .K]	$U_{kc}$ [W/m <sup>2</sup> .K]	$f_{ix,k}$ [-]	$A_k \cdot U_{kc} \cdot f_{ix,k}$
S3.b	internal load bearing wall	20,000	12,379	0,501		0,501	-0,167	-1,033
S4	internal non-load bearing wall	10,000	7,379	1,379		1,379	0,167	1,696
C3	internal ceiling	0,000	6,970	0,779		0,779	0,500	2,714
C3	internal ceiling	10,000	3,760	0,779		0,779	0,167	0,488
Di	interior timber door	10,000	1,890	1,800		1,800	0,167	0,567
$H_{T,ia(..)} = \Sigma (A_k \cdot U_{kc} \cdot f_{ix,k})$ (W/K)								4,433

$$F_{ix,k} = f_1 = (\theta_{int,i} - \theta_u) / (\theta_{int,i} - \theta_e)$$

**Specific heat transmission loss to ground  $H_{T,ig}$**

No.S.	description	$A_k$ [m <sup>2</sup> ]	$A_g$ [m <sup>2</sup> ]	p [m]	$U_k$ [W/m <sup>2</sup> .K]	$f_{ig,k}$ [-]	B' [m]	$U_{equiv,k}$ [W/m <sup>2</sup> .K]	$A_k \cdot U_{equiv,k} \cdot f_{ig,k} \cdot f_{GW,k}$
$\Sigma (A_k \cdot U_{equiv,k} \cdot f_{ig,k} \cdot f_{GW,k})$									0,000
$f_{\theta ann}$ [-]	$H_{T,ig} = f_{\theta ann} \cdot \Sigma (A_k \cdot U_{equiv,k} \cdot f_{ig,k} \cdot f_{GW,k})$ (W/K)				$f_{GW,k}$ [-]	$\theta_{e,m}$ [°C]			
1,450	0,000				1,000	3,900			

**Total design heat transmission loss  $\Phi_{T,i} = (H_{T,ie} + H_{T,ia} + H_{T,iae} + H_{T,iaBE} + H_{T,ig}) \cdot (\theta_{int,i} - \theta_e)$  [W]**

$\Theta_{int,i}$ [°C]	$\Theta_e$ [°C]	$\Theta_{int,i} - \theta_e$ [°C]	$\Sigma H_{T,i}$ [W.K <sup>-1</sup> ]	Design heat transmission loss $\Phi_{T,i}$ [W]
15,000	-15,000	30,000	8,021	240,644

**Design heat loss due to ventilation - natural ventilation**

room volume $V_i$ (m <sup>3</sup> )	Outdoor temperature $\Theta_e$ [°C]	indoor temperature $\Theta_{int,i}$ [°C]	Hygienic requirements	
			$n_{min}$ (h <sup>-1</sup> )	Hygienic air exchange $V_{min,i}$ (m <sup>3</sup> /h)
32,083	-15,000	15,000	0,500	16,041
$n_{s0}$ [1/h]	Number of unprotected openings	Shading factor $e_i$	correction factor of height level from terrain $\epsilon_i$	Amount of air infiltrated by building envelope $V_{inf,i}$ (m <sup>3</sup> /h)
4,500	0,000	0,000	1,000	0,000

**Heat loss due to natural ventilation**

$\Theta_{int,i} - \Theta_e$	max. of $V_{min,i}$ , $V_{inf,i}$	$H_v$ [W.K <sup>-1</sup> ]	Design heat loss due to ventilation $\Phi_{v,i}$ (W)
30,000	16,041	5,454	163,622

Total design heat transmission loss of the specific room = 404,266 W

### Heat losses of third floor

Room No.	Name of the room	Indoor temperature $\Theta_{int,i}$ [°C]
301A	Vestibule	20,000 °C

**Calculation of heat transmission loss**

**Specific heat transmission loss directly to exterior  $H_{T,ie}$**

structures								
No.	Description	$A_k$	$U_k$	$\Delta U_B$	$U_{kc}$	$f_{U,k}$	$f_{ie,k}$	$A_k \cdot (U_k + \Delta U_B) \cdot f_{U,k} \cdot f_{ie,k}$
W	Triple glazing plastic window	1,088	0,700		0,700	1,000	1,000	0,762
S1	Peripheral wall	1,857	0,125	0,050	0,175	1,000	1,000	0,324
R	Roof	9,700	0,136		0,136	1,000	1,000	1,315
$H_{T,ie} = \Sigma (A_k \cdot (U_k + \Delta U_B) \cdot f_{U,k} \cdot f_{ie,k})$ (W/K)								2,401

**Specific heat transmission loss from heated space to neighbouring heated space or unheated space or through it  $H_{T,ia(i)}$**

structures								
No.S.	description	$\theta_u$	$A_k$	$U_k$	$\Delta U$	$U_{kc}$	$f_{ix,k}$	$A_k \cdot U_{kc} \cdot f_{ix,k}$
S4	internal non-load bearing wall	24,000	6,094	1,379		1,379	-0,114	-0,961
S3.a	internal load bearing wall	10,000	9,771	0,501		0,501	0,286	1,398
Di	interior timber door	10,000	1,890	1,800		1,800	0,286	0,972
Di	interior timber door	24,000	1,680	1,800		1,800	-0,114	-0,346
$H_{T,ia(i)} = \Sigma (A_k \cdot U_{kc} \cdot f_{ix,k})$ (W/K)								1,064
$F_{ix,k} = f_{i1} = (\theta_{int,i} - \theta_u) / (\theta_{int,i} - \theta_e)$								

**Specific heat transmission loss to ground  $H_{T,ig}$**

No.S.	description	$A_k$ [m <sup>2</sup> ]	$A_g$ [m <sup>2</sup> ]	P [m]	$U_k$ [W/m <sup>2</sup> .K]	$f_{ig,k}$ [-]	B' [m]	$U_{equiv,k}$ [W/m <sup>2</sup> .K]	$A_k \cdot U_{equiv,k} \cdot f_{ig,k} \cdot f_{GW,k}$
$\Sigma (A_k \cdot U_{equiv,k} \cdot f_{ig,k} \cdot f_{GW,k})$									0,000
$f_{\theta ann}$ [-]	$H_{T,ig} = f_{\theta ann} \cdot \Sigma (A_k \cdot U_{equiv,k} \cdot f_{ig,k} \cdot f_{GW,k})$ (W/K)				$f_{GW,k}$ [-]	$\theta_{e,m}$ [°C]			
1,450	0,000				1,000	3,900			

**Total design heat transmission loss  $\Phi_{T,i} = (H_{T,ie} + H_{T,ia} + H_{T,iae} + H_{T,iaBE} + H_{T,ig}) \cdot (\theta_{int,i} - \theta_e)$  [W]**

$\Theta_{int,i}$ [°C]	$\Theta_e$ [°C]	$\Theta_{int,i} - \theta_e$ [°C]	$\Sigma H_{t,i}$ [W·K <sup>-1</sup> ]	Design heat transmission loss $\Phi_{T,i}$ [W]
20,000	-15,000	35,000	3,465	121,280

**Design heat loss due to ventilation - natural ventilation**

room volume $V_i$ (m <sup>3</sup> )	Outdoor temperature $\Theta_e$ [°C]	indoor temperature $\Theta_{int,i}$ [°C]	Hygienic requirements	
			$n_{min}$ (h <sup>-1</sup> )	Hygienic air exchange $V_{min,i}$ (m <sup>3</sup> /h)
29,003	-15,000	20,000	0,500	14,502
$n_{50}$ [1/h]	Number of unprotected openings	Shading factor $e_i$	correction factor of height level from terrain $\epsilon_i$	Amount of air infiltrated by building envelope $V_{inf,i}$ (m <sup>3</sup> /h)
4,500	0,000	0,000	1,000	0,000

**Heat loss due to natural ventilation**

$\Theta_{int,i} - \Theta_e$	max. of $V_{min,i}$ , $V_{inf,i}$	$H_t$ [W·K <sup>-1</sup> ]	Design heat loss due to ventilation $\Phi_{v,i}$ (W)
35,000	14,502	4,931	172,568

Total design heat transmission loss of the specific room = 293,848 W

Room No.	Name of the room	Indoor temperature $\Theta_{int,i}$ [°C]
302A	Washing machine room	20,000 °C

**Calculation of heat transmission loss**

**Specific heat transmission loss directly to exterior  $H_{T,ie}$**

structures								
No.	Description	$A_k$ [m <sup>2</sup> ]	$U_k$ [W/m <sup>2</sup> .K]	$\Delta U_B$ [W/m <sup>2</sup> .K]	$U_{kc}$ [W/m <sup>2</sup> .K]	$f_{U,k}$ [-]	$f_{ie,k}$ [-]	$A_k \cdot (U_k + \Delta U_B) \cdot f_{U,k} \cdot f_{ie,k}$
R	Roof	1,980	0,136		0,136	1,000	1,000	0,269
$H_{T,ie} = \Sigma (A_k \cdot (U_k + \Delta U_B) \cdot f_{U,k} \cdot f_{ie,k})$ (W/k)								0,269

**Specific heat transmission loss from heated space to neighbouring heated space or unheated space or through it  $H_{T,ia(.,.)}$**

structures								
No.S.	description	$\theta_u$ [°C]	$A_k$ [m <sup>2</sup> ]	$U_k$ [W/m <sup>2</sup> .K]	$\Delta U$ [W/m <sup>2</sup> .K]	$U_{kc}$ [W/m <sup>2</sup> .K]	$f_{ix,k}$ [-]	$A_k \cdot U_{kc} \cdot f_{ix,k}$
S4	internal non-load bearing wall	24,000	3,190	1,379		1,379	-0,114	-0,503
$H_{T,ia(.,.)} = \Sigma (A_k \cdot U_{kc} \cdot f_{ix,k})$ (W/K)								-0,503

$$f_{ix,k} = f_1 = (\theta_{int,i} - \theta_u) / (\theta_{int,i} - \theta_e)$$

**Specific heat transmission loss to ground  $H_{T,ig}$**

No.S.	description	$A_k$ [m <sup>2</sup> ]	$A_g$ [m <sup>2</sup> ]	P [m]	$U_k$ [W/m <sup>2</sup> .K]	$f_{ig,k}$ [-]	B' [m]	$U_{equiv,k}$ [W/m <sup>2</sup> .K]	$A_k \cdot U_{equiv,k} \cdot f_{ig,k} \cdot f_{GW,k}$
$\Sigma (A_k \cdot U_{equiv,k} \cdot f_{ig,k} \cdot f_{GW,k})$									0,000
$f_{\theta ann}$	$H_{T,ig} = f_{\theta ann} \cdot \Sigma (A_k \cdot U_{equiv,k} \cdot f_{ig,k} \cdot f_{GW,k})$ (W/K)				$f_{GW,k}$ [-]	$\theta_{e,m}$ [°C]			
1,450	0,000				1,000	3,900			

**Total design heat transmission loss  $\Phi_{T,i} = (H_{T,ie} + H_{T,ia} + H_{T,iae} + H_{T,iaBE} + H_{T,ig}) \cdot (\theta_{int,i} - \theta_e)$  [W]**

$\Theta_{int,i}$ [°C]	$\Theta_e$ [°C]	$\Theta_{int,i} - \theta_e$ [°C]	$\Sigma H_{t,i}$ [W·K <sup>-1</sup> ]	Design heat transmission loss $\Phi_{T,i}$ [W]
20,000	-15,000	35,000	-0,234	-8,203

**Design heat loss due to ventilation - natural ventilation**

room volume $V_i$ (m <sup>3</sup> )	Outdoor temperature $\Theta_e$ [°C]	indoor temperature $\Theta_{int,i}$ [°C]	Hygienic requirements	
			$n_{min}$ (h <sup>-1</sup> )	Hygienic air exchange $V_{min,i}$ (m <sup>3</sup> /h)
5,920	-15,000	20,000	1,500	8,880
$n_{50}$ [1/h]	Number of unprotected openings	Shading factor $e_i$	correction factor of height level from terrain $\epsilon_i$	Amount of air infiltrated by building envelope $V_{inf,i}$ (m <sup>3</sup> /h)
4,500	0,000	0,000	1,000	0,000

**Heat loss due to natural ventilation**

$\Theta_{int,i} - \Theta_e$	max. of $V_{min,i}$ , $V_{inf,i}$	$H_t$ [W·K <sup>-1</sup> ]	Design heat loss due to ventilation $\Phi_{v,i}$ (W)
35,000	8,880	3,019	105,676

Total design heat transmission loss of the specific room = 97,473 W

Room No.	Name of the room	Indoor temperature $\Theta_{int,i}$ [°C]						
303A	Toilet	20,000 °C						
<b>Calculation of heat transmission loss</b>								
<b>Specific heat transmission loss directly to exterior <math>H_{T,ie}</math></b>								
structures								
No.	Description	$A_k$ [m <sup>2</sup> ]	$U_k$ [W/m <sup>2</sup> .K]	$\Delta U_B$ [W/m <sup>2</sup> .K]	$U_{kc}$ [W/m <sup>2</sup> .K]	$f_{U,k}$ [-]	$f_{ie,k}$ [-]	$A_k \cdot (U_k + \Delta U_B) \cdot f_{U,k} \cdot f_{ie,k}$
R	Roof	3,480	0,136		0,136	1,000	1,000	0,472
$H_{T,ie} = \Sigma (A_k \cdot (U_k + \Delta U_B) \cdot f_{U,k} \cdot f_{ie,k})$ (W/k)								0,472

<b>Specific heat transmission loss from heated space to neighbouring heated space or unheated space or through it <math>H_{T,ia(.,)}</math></b>								
structures								
No.S.	description	$\theta_u$ [°C]	$A_k$ [m <sup>2</sup> ]	$U_k$ [W/m <sup>2</sup> .K]	$\Delta U$ [W/m <sup>2</sup> .K]	$U_{kc}$ [W/m <sup>2</sup> .K]	$f_{ix,k}$ [-]	$A_k \cdot U_{kc} \cdot f_{ix,k}$
S4	internal non-load bearing wall	24,000	1,704	1,379		1,379	-0,114	-0,269
$H_{T,ia(.,)} = \Sigma (A_k \cdot U_{kc} \cdot f_{ix,k})$ (W/K)								-0,269
$F_{ix,k} = f_1 = (\theta_{int,i} - \theta_u) / (\theta_{int,i} - \theta_e)$								

<b>Specific heat transmission loss to ground <math>H_{T,ig}</math></b>									
No.S.	description	$A_k$ [m <sup>2</sup> ]	$A_g$ [m <sup>2</sup> ]	P [m]	$U_k$ [W/m <sup>2</sup> .K]	$f_{ig,k}$ [-]	B' [m]	$U_{equiv,k}$ [W/m <sup>2</sup> .K]	$A_k \cdot U_{equiv,k} \cdot f_{ig,k} \cdot f_{GW,k}$
$\Sigma (A_k \cdot U_{equiv,k} \cdot f_{ig,k} \cdot f_{GW,k})$									0,000
$f_{\theta ann}$ [-]	$H_{T,ig} = f_{\theta ann} \cdot \Sigma (A_k \cdot U_{equiv,k} \cdot f_{ig,k} \cdot f_{GW,k})$ (W/K)				$f_{GW,k}$ [-]	$\theta_{e,m}$ [°C]			
1,450	0,000				1,000	3,900			

<b>Total design heat transmission loss <math>\Phi_{T,i} = (H_{T,ie} + H_{T,ia} + H_{T,iae} + H_{T,iaBE} + H_{T,ig}) \cdot (\theta_{int,i} - \theta_e)</math> [W]</b>				
$\Theta_{int,i}$ [°C]	$\Theta_e$ [°C]	$\Theta_{int,i} - \theta_e$ [°C]	$\Sigma H_{T,i}$ [W·K <sup>-1</sup> ]	Design heat transmission loss $\Phi_{T,i}$ [W]
20,000	-15,000	35,000	0,203	7,115

<b>Design heat loss due to ventilation - natural ventilation</b>				
room volume $V_i$ (m <sup>3</sup> )	Outdoor temperature $\Theta_e$ [°C]	indoor temperature $\Theta_{int,i}$ [°C]	Hygienic requirements	
10,405	-15,000	20,000	$n_{min}$ (h <sup>-1</sup> )	Hygienic air exchange $V_{min,i}$ (m <sup>3</sup> /h)
			0,500	5,203
$n_{50}$ [1/h]	Number of unprotected openings	Shading factor $e_i$	correction factor of height level from terrain $\epsilon_i$	Amount of air infiltrated by building envelope $V_{inf,i}$ (m <sup>3</sup> /h)
4,500	0,000	0,020	1,000	0,000

<b>Heat loss due to natural ventilation</b>			
$\Theta_{int,i} - \Theta_e$	max. of $V_{min,i}$ , $V_{inf,i}$	$H_t$ [W·K <sup>-1</sup> ]	Design heat loss due to ventilation $\Phi_{v,i}$ (W)
35,000	5,203	1,769	61,911

Total design heat transmission loss of the specific room = 69,026 W

Room No.	Name of the room	Indoor temperature $\Theta_{int,i}$ [°C]
304A	Kitchen and living room	20,000 °C

**Calculation of heat transmission loss**

**Specific heat transmission loss directly to exterior  $H_{T,ie}$**

structures								
No.	Description	$A_k$ [m <sup>2</sup> ]	$U_k$ [W/m <sup>2</sup> .K]	$\Delta U_B$ [W/m <sup>2</sup> .K]	$U_{kc}$ [W/m <sup>2</sup> .K]	$f_{U,k}$ [-]	$f_{ie,k}$ [-]	$A_k \cdot (U_k + \Delta U_B) \cdot f_{U,k} \cdot f_{ie,k}$
W+D	Plastic balcony door and windows	9,575	0,700		0,700	1,000	1,000	6,703
S1	peripheral wall	23,166	0,125	0,050	0,175	1,000	1,000	4,046
R	flat roof	25,430	0,700		0,700	1,000	1,000	17,801
$H_{T,ie} = \Sigma (A_k \cdot (U_k + \Delta U_B) \cdot f_{U,k} \cdot f_{ie,k})$ (W/k)								28,549

**Specific heat transmission loss from heated space to neighbouring heated space or unheated space or through it  $H_{T,ia(i)}$**

structures								
No.S.	description	$\theta_u$ [°C]	$A_k$ [m <sup>2</sup> ]	$U_k$ [W/m <sup>2</sup> .K]	$\Delta U$ [W/m <sup>2</sup> .K]	$U_{kc}$ [W/m <sup>2</sup> .K]	$f_{ix,k}$ [-]	$A_k \cdot U_{kc} \cdot f_{ix,k}$
S4	internal non-load bearing wall	24,000	7,774	1,379		1,379	-0,114	-1,225
S3.c	internal load bearing wall	15,000	5,980	0,501		0,501	0,143	0,428
S3.a	internal load bearing wall	10,000	4,336	0,501		0,501	0,286	0,620
$H_{T,ia(i)} = \Sigma (A_k \cdot U_{kc} \cdot f_{ix,k})$ (W/K)								-0,177

$$f_{ix,k} = f_1 = (\theta_{int,i} - \theta_u) / (\theta_{int,i} - \theta_e)$$

**Specific heat transmission loss to ground  $H_{T,ig}$**

No.S.	description	$A_k$ [m <sup>2</sup> ]	$A_g$ [m <sup>2</sup> ]	P [m]	$U_k$ [W/m <sup>2</sup> .K]	$f_{ig,k}$ [-]	B' [m]	$U_{equiv,k}$ [W/m <sup>2</sup> .K]	$A_k \cdot U_{equiv,k} \cdot f_{ig,k} \cdot f_{GW,k}$
$\Sigma (A_k \cdot U_{equiv,k} \cdot f_{ig,k} \cdot f_{GW,k})$									0,000
$f_{\theta_{ann}}$ [-]	$H_{T,ig} = f_{\theta_{ann}} \cdot \Sigma (A_k \cdot U_{equiv,k} \cdot f_{ig,k} \cdot f_{GW,k})$ (W/K)					$f_{GW,k}$ [-]	$\theta_{e,m}$ [°C]		
1,450	0,000					1,000	3,900		

**Total design heat transmission loss  $\Phi_{T,i} = (H_{T,ie} + H_{T,ia} + H_{T,iae} + H_{T,iaBE} + H_{T,ig}) \cdot (\theta_{int,i} - \theta_e)$  [W]**

$\theta_{int,i}$ [°C]	$\theta_e$ [°C]	$\theta_{int,i} - \theta_e$ [°C]	$\Sigma H_{T,i}$ [W.K <sup>-1</sup> ]	Design heat transmission loss $\Phi_{T,i}$ [W]
20,000	-15,000	35,000	28,372	993,010

**Design heat loss due to ventilation - natural ventilation**

room volume $V_i$ (m <sup>3</sup> )	Outdoor temperature $\theta_e$ [°C]	indoor temperature $\theta_{int,i}$ [°C]	Hygienic requirements	
			$n_{min}$ (h <sup>-1</sup> )	Hygienic air exchange $V_{min,i}$ (m <sup>3</sup> /h)
76,036	-15,000	20,000	0,500	38,018
$n_{50}$ [1/h]	Number of unprotected openings	Shading factor $e_i$	correction factor of height level from terrain $\epsilon_i$	Amount of air infiltrated by building envelope $V_{inf,i}$ (m <sup>3</sup> /h)
4,500	1,000	0,020	1,000	13,686

**Heat loss due to natural ventilation**

$\theta_{int,i} - \theta_e$	max. of $V_{min,i}$ , $V_{inf,i}$	$H_t$ [W.K <sup>-1</sup> ]	Design heat loss due to ventilation $\Phi_{v,i}$ (W)
35,000	38,018	12,926	452,412

Total design heat transmission loss of the specific room = 1445,423 W

Room No.	Name of the room	Indoor temperature $\Theta_{int,i}$ [°C]
305A	Bathroom	24,000 °C

**Calculation of heat transmission loss**

**Specific heat transmission loss directly to exterior  $H_{T,ie}$**

structures

No.	Description	$A_k$ [m <sup>2</sup> ]	$U_k$ [W/m <sup>2</sup> .K]	$\Delta U_B$ [W/m <sup>2</sup> .K]	$U_{kc}$ [W/m <sup>2</sup> .K]	$f_{U,k}$ [-]	$f_{ie,k}$ [-]	$A_k \cdot (U_k + \Delta U_B) \cdot f_{U,k} \cdot f_{ie,k}$
R	Flat roof	4,390	0,136		0,136	1,000	1,000	0,595
W	triple glazing plastic window	0,900	0,700		0,700	1,000	1,000	0,630
S1	peripheral wall	4,183	0,125	0,050	0,175	1,000	1,000	0,731

$H_{T,ie} = \Sigma (A_k \cdot (U_k + \Delta U_B) \cdot f_{U,k} \cdot f_{ie,k})$  (W/k) 1,956

**Specific heat transmission loss from heated space to neighbouring heated space or unheated space or through it  $H_{T,ia(,)}$**

structures

No.S.	description	$\theta_u$ [°C]	$A_k$ [m <sup>2</sup> ]	$U_k$ [W/m <sup>2</sup> .K]	$\Delta U$ [W/m <sup>2</sup> .K]	$U_{kc}$ [W/m <sup>2</sup> .K]	$f_{ix,k}$ [-]	$A_k \cdot U_{kc} \cdot f_{ix,k}$
S4	internal non-load bearing wall	20,000	18,921	1,379		1,379	0,103	2,677
Di	interior timber door	20,000	1,680	1,800		1,800	0,103	0,310

$H_{T,ia(,)} = \Sigma (A_k \cdot U_{kc} \cdot f_{ix,k})$  (W/K) 2,987

$F_{ix,k} = f_{i1} = (\theta_{int,i} - \theta_u) / (\theta_{int,i} - \theta_e)$

**Specific heat transmission loss to ground  $H_{T,ig}$**

No.S.	description	$A_k$ [m <sup>2</sup> ]	$A_g$ [m <sup>2</sup> ]	P [m]	$U_k$ [W/m <sup>2</sup> .K]	$f_{ig,k}$ [-]	B' [m]	$U_{equiv,k}$ [W/m <sup>2</sup> .K]	$A_k \cdot U_{equiv,k} \cdot f_{ig,k} \cdot f_{GW,k}$
$\Sigma (A_k \cdot U_{equiv,k} \cdot f_{ig,k} \cdot f_{GW,k})$									0,000

$f_{\theta_{ann}}$ [-]	$H_{T,ig} = f_{\theta_{ann}} \cdot \Sigma (A_k \cdot U_{equiv,k} \cdot f_{ig,k} \cdot f_{GW,k})$ (W/K)	$f_{GW,k}$ [-]	$\theta_{e,m}$ [°C]
1,450	0,000	1,000	3,900

**Total design heat transmission loss  $\Phi_{T,i} = (H_{T,ie} + H_{T,ia} + H_{T,iae} + H_{T,iae} + H_{T,ig}) \cdot (\theta_{int,i} - \theta_e)$  [W]**

$\theta_{int,i}$ [°C]	$\theta_e$ [°C]	$\theta_{int,i} - \theta_e$ [°C]	$\Sigma H_{T,i}$ [W·K <sup>-1</sup> ]	Design heat transmission loss $\Phi_{T,i}$ [W]
24,000	-15,000	39,000	4,943	192,761

**Design heat loss due to ventilation - natural ventilation**

room volume $V_i$ (m <sup>3</sup> )	Outdoor temperature $\theta_e$ [°C]	indoor temperature $\theta_{int,i}$ [°C]	Hygienic requirements	
			$n_{min}$ (h <sup>-1</sup> )	Hygienic air exchange $V_{min,i}$ (m <sup>3</sup> /h)
13,126	-15,000	24,000	0,500	6,563
$n_{50}$	Number of unprotected	Shading factor	correction factor of height	Amount of air infiltrated by
4,500	1,000	0,020	1,000	2,363

**Heat loss due to natural ventilation**

$\theta_{int,i} - \theta_e$	max. of $V_{min,i}$ , $V_{inf,i}$	$H_t$ [W·K <sup>-1</sup> ]	Design heat loss due to ventilation $\Phi_{v,i}$ (W)
39,000	6,563	2,231	87,026

Total design heat transmission loss of the specific room = 279,000 W

Room No.	Name of the room	Indoor temperature $\Theta_{int,i}$ [°C]
306A	Bedroom	20,000 °C

**Calculation of heat transmission loss**

**Specific heat transmission loss directly to exterior  $H_{T,ie}$**

structures

No.	Description	$A_k$ [m <sup>2</sup> ]	$U_k$ [W/m <sup>2</sup> .K]	$\Delta U_B$ [W/m <sup>2</sup> .K]	$U_{kc}$ [W/m <sup>2</sup> .K]	$f_{U,k}$ [-]	$f_{ie,k}$ [-]	$A_k \cdot (U_k + \Delta U_B) \cdot f_{U,k} \cdot f_{ie,k}$
R	flat roof	19,520	0,136		0,136	1,000	1,000	2,647
W+D	triple glazing plastic windows and balcony door	6,652	0,700		0,700	1,000	1,000	4,656
S1	peripheral wall	26,118	0,125	0,050	0,175	1,000	1,000	4,561
$H_{T,ie} = \Sigma (A_k \cdot (U_k + \Delta U_B) \cdot f_{U,k} \cdot f_{ie,k})$ (W/k)								11,865

**Specific heat transmission loss from heated space to neighbouring heated space or unheated space or through it  $H_{T,ia(,)}$**

structures

No.S.	description	$\theta_u$ [°C]	$A_k$ [m <sup>2</sup> ]	$U_k$ [W/m <sup>2</sup> .K]	$\Delta U$ [W/m <sup>2</sup> .K]	$U_{kc}$ [W/m <sup>2</sup> .K]	$f_{ix,k}$ [-]	$A_k \cdot U_{kc} \cdot f_{ix,k}$
$H_{T,ia(,)} = \Sigma (A_k \cdot U_{kc} \cdot f_{ix,k})$ (W/K)								0,000

$$f_{ix,k} = f_1 = (\theta_{int,i} - \theta_u) / (\theta_{int,i} - \theta_e)$$

**Specific heat transmission loss to ground  $H_{T,ig}$**

No.S.	description	$A_k$ [m <sup>2</sup> ]	$A_g$ [m <sup>2</sup> ]	P [m]	$U_k$ [W/m <sup>2</sup> .K]	$f_{ig,k}$ [-]	B' [m]	$U_{equiv,k}$ [W/m <sup>2</sup> .K]	$A_k \cdot U_{equiv,k} \cdot f_{ig,k} \cdot f_{GW,k}$
								$\Sigma (A_k \cdot U_{equiv,k} \cdot f_{ig,k} \cdot f_{GW,k})$	0,000
$f_{\theta ann}$ [-]	$H_{T,ig} = f_{\theta ann} \cdot \Sigma (A_k \cdot U_{equiv,k} \cdot f_{ig,k} \cdot f_{GW,k})$ (W/K)				$f_{GW,k}$ [-]	$\theta_{e,m}$ [°C]			
1,450	0,000				1,000	3,900			

**Total design heat transmission loss  $\Phi_{T,i} = (H_{T,ie} + H_{T,ia} + H_{T,iae} + H_{T,iaBE} + H_{T,ig}) \cdot (\theta_{int,i} - \theta_e)$  [W]**

$\theta_{int,i}$ [°C]	$\theta_e$ [°C]	$\theta_{int,i} - \theta_e$ [°C]	$\Sigma H_{t,i}$ [W·K <sup>-1</sup> ]	Design heat transmission loss $\Phi_{T,i}$ [W]
20,000	-15,000	35,000	11,865	415,269

**Design heat loss due to ventilation - natural ventilation**

room volume $V_i$ (m <sup>3</sup> )	Outdoor temperature $\Theta_e$ [°C]	indoor temperature $\Theta_{int,i}$ [°C]	Hygienic requirements	
			$n_{min}$ (h <sup>-1</sup> )	Hygienic air exchange $V_{min,i}$ (m <sup>3</sup> /h)
58,365	-15,000	20,000	0,500	29,182
$n_{50}$ [1/h]	Number of unprotected openings	Shading factor $e_i$	correction factor of height level from terrain $\epsilon_i$	Amount of air infiltrated by building envelope $V_{inf,i}$ (m <sup>3</sup> /h)
4,500	1,000	0,020	1,000	10,506

**Heat loss due to natural ventilation**

$\theta_{int,i} - \theta_e$	max. of $V_{min,i}$ , $V_{inf,i}$	$H_t$ [W·K <sup>-1</sup> ]	Design heat loss due to ventilation $\Phi_{v,i}$ (W)
35,000	29,182	9,922	347,271

Total design heat transmission loss of the specific room = 762,539 W

Room No.	Name of the room	Indoor temperature $\Theta_{int,i}$ [°C]						
307A	Bedroom	20,000 °C						
<b>Calculation of heat transmission loss</b>								
<b>Specific heat transmission loss directly to exterior <math>H_{T,ie}</math></b>								
structures								
No.	Description	$A_k$ [m <sup>2</sup> ]	$U_k$ [W/m <sup>2</sup> .K]	$\Delta U_B$ [W/m <sup>2</sup> .K]	$U_{kc}$ [W/m <sup>2</sup> .K]	$f_{U,k}$ [-]	$f_{ie,k}$ [-]	$A_k \cdot (U_k + \Delta U_B) \cdot f_{U,k} \cdot f_{ie,k}$
R	flat roof	17,750	0,136		0,136	1,000	1,000	2,407
W	triple glazing plastic window	2,175	0,700		0,700	1,000	1,000	1,523
S1	peripheral wall	8,978	0,125	0,050	0,175	1,000	1,000	1,568
$H_{T,ie} = \Sigma (A_k \cdot (U_k + \Delta U_B) \cdot f_{U,k} \cdot f_{ie,k})$ (W/k)								5,497

<b>Specific heat transmission loss from heated space to neighbouring heated space or unheated space or through it <math>H_{T,ia(i)}</math></b>								
structures								
No.S.	description	$\theta_u$ [°C]	$A_x$ [m <sup>2</sup> ]	$U_k$ [W/m <sup>2</sup> .K]	$\Delta U$ [W/m <sup>2</sup> .K]	$U_{kc}$ [W/m <sup>2</sup> .K]	$f_{ix,k}$ [-]	$A_k \cdot U_{kc} \cdot f_{ix,k}$
S3.a	internal load bearing wall	10,000	4,336	0,501		0,501	0,286	0,620
$H_{T,ia(i)} = \Sigma (A_k \cdot U_{kc} \cdot f_{ix,k})$ (W/K)								0,620
$F_{ix,k} = f_1 = (\theta_{int,i} - \theta_u) / (\theta_{int,i} - \theta_e)$								

<b>Specific heat transmission loss to ground <math>H_{T,ig}</math></b>									
No.S.	description	$A_k$ [m <sup>2</sup> ]	$A_g$ [m <sup>2</sup> ]	P [m]	$U_k$ [W/m <sup>2</sup> .K]	$f_{ig,k}$ [-]	B' [m]	$U_{equiv,k}$ [W/m <sup>2</sup> .K]	$A_k \cdot U_{equiv,k} \cdot f_{ig,k} \cdot f_{GW,k}$
$\Sigma (A_k \cdot U_{equiv,k} \cdot f_{ig,k} \cdot f_{GW,k})$									0,000
$f_{\theta_{ann}}$ [-]	$H_{T,ig} = f_{\theta_{ann}} \cdot \Sigma (A_k \cdot U_{equiv,k} \cdot f_{ig,k} \cdot f_{GW,k})$ (W/K)				$f_{GW,k}$ [-]	$\theta_{e,m}$ [°C]			
1,450	0,000				1,000	3,900			

<b>Total design heat transmission loss <math>\Phi_{T,i} = (H_{T,ie} + H_{T,ia} + H_{T,iae} + H_{T,iaBE} + H_{T,ig}) \cdot (\theta_{int,i} - \theta_e)</math> [W]</b>				
$\theta_{int,i}$ [°C]	$\theta_e$ [°C]	$\theta_{int,i} - \theta_e$ [°C]	$\Sigma H_{T,i}$ [W·K <sup>-1</sup> ]	Design heat transmission loss $\Phi_{T,i}$ [W]
20,000	-15,000	35,000	6,118	214,122

<b>Design heat loss due to ventilation - natural ventilation</b>				
room volume $V_i$ (m <sup>3</sup> )	Outdoor temperature $\theta_e$ [°C]	indoor temperature $\theta_{int,i}$ [°C]	Hygienic requirements	
			$n_{min}$ (h <sup>-1</sup> )	Hygienic air exchange $V_{min,i}$ (m <sup>3</sup> /h)
53,073	-15,000	20,000	0,500	26,536
$n_{50}$ [1/h]	Number of unprotected openings	Shading factor $e_i$	correction factor of height level from terrain $\epsilon_i$	Amount of air infiltrated by building envelope $V_{inf,i}$ (m <sup>3</sup> /h)
4,500	1,000	0,020	1,000	9,553
<b>Heat loss due to natural ventilation</b>				
$\theta_{int,i} - \theta_e$	max. of $V_{min,i}$ , $V_{inf,i}$	$H_t$ [W·K <sup>-1</sup> ]	Design heat loss due to ventilation $\Phi_{v,i}$ (W)	
35,000	26,536	9,022	315,781	

Total design heat transmission loss of the specific room = 529,903 W



Room No.	Name of the room	Indoor temperature $\Theta_{int,i}$ [°C]
308	Staircase	10,000 °C

**Calculation of heat transmission loss**

**Specific heat transmission loss directly to exterior  $H_{T,ie}$**

structures								
No.	Description	$A_k$ [m <sup>2</sup> ]	$U_k$ [W/m <sup>2</sup> .K]	$\Delta U_B$ [W/m <sup>2</sup> .K]	$U_{kc}$ [W/m <sup>2</sup> .K]	$f_{U,k}$ [-]	$f_{ie,k}$ [-]	$A_k \cdot (U_k + \Delta U_B) \cdot f_{U,k} \cdot f_{ie,k}$
$W_R$	Roof hatch	2,500	0,700		0,700	1,000	1,000	1,750
R	flat roof	17,610	0,136	0,050	0,186	1,000	1,000	3,269
$H_{T,ie} = \Sigma (A_k \cdot (U_k + \Delta U_B) \cdot f_{U,k} \cdot f_{ie,k})$ (W/K)								5,019

**Specific heat transmission loss from heated space to neighbouring heated space or unheated space or through it  $H_{T,ia(..)}$**

structures								
No.S.	description	$\theta_u$ [°C]	$A_k$ [m <sup>2</sup> ]	$U_k$ [W/m <sup>2</sup> .K]	$\Delta U$ [W/m <sup>2</sup> .K]	$U_{kc}$ [W/m <sup>2</sup> .K]	$f_{ix,k}$ [-]	$A_k \cdot U_{kc} \cdot f_{ix,k}$
S3.a	internal load bearing wall	20,000	44,359	0,501		0,501	-0,400	-8,885
Di	interior timber door	20,000	3,780	1,800		1,800	-0,400	-2,722
Di	interior timber door	15,000	1,890	1,800		1,800	-0,200	-0,680
S4	internal non-load bearing wall	15,000	7,379	1,379		1,379	-0,200	-2,035
$H_{T,ia(..)} = \Sigma (A_k \cdot U_{kc} \cdot f_{ix,k})$ (W/K)								-14,323

$$F_{ix,k} = f_1 = (\theta_{int,i} - \theta_u) / (\theta_{int,i} - \theta_e)$$

**Specific heat transmission loss to ground  $H_{T,ig}$**

No.S.	description	$A_k$ [m <sup>2</sup> ]	$A_g$ [m <sup>2</sup> ]	P [m]	$U_k$ [W/m <sup>2</sup> .K]	$f_{ig,k}$ [-]	B' [m]	$U_{equiv,k}$ [W/m <sup>2</sup> .K]	$A_k \cdot U_{equiv,k} \cdot f_{ig,k} \cdot f_{GW,k}$
$\Sigma (A_k \cdot U_{equiv,k} \cdot f_{ig,k} \cdot f_{GW,k})$									0,000
$f_{\theta ann}$ [-]	$H_{T,ig} = f_{\theta ann} \cdot \Sigma (A_k \cdot U_{equiv,k} \cdot f_{ig,k} \cdot f_{GW,k})$ (W/K)				$f_{GW,k}$ [-]	$\theta_{e,m}$ [°C]			
1,450	0,000				1,000	3,900			

**Total design heat transmission loss  $\Phi_{T,i} = (H_{T,ie} + H_{T,ia} + H_{T,iae} + H_{T,iaBE} + H_{T,ig}) \cdot (\theta_{int,i} - \theta_e)$  [W]**

$\theta_{int,i}$ [°C]	$\theta_e$ [°C]	$\theta_{int,i} - \theta_e$ [°C]	$\Sigma H_{T,i}$ [W·K <sup>-1</sup> ]	Design heat transmission loss $\Phi_{T,i}$ [W]
10,000	-15,000	25,000	-9,304	-232,598

**Design heat loss due to ventilation - natural ventilation**

room volume $V_i$ (m <sup>3</sup> )	Outdoor temperature $\theta_e$ [°C]	indoor temperature $\theta_{int,i}$ [°C]	Hygienic requirements	
			$n_{min}$ (h <sup>-1</sup> )	Hygienic air exchange $V_{min,i}$ (m <sup>3</sup> /h)
52,654	-15,000	10,000	0,500	26,327
$n_{50}$ [1/h]	Number of unprotected openings	Shading factor $e_i$	correction factor of height level from terrain $\epsilon_i$	Amount of air infiltrated by building envelope $V_{inf,i}$ (m <sup>3</sup> /h)
4,500	0,000	0,000	1,000	0,000

**Heat loss due to natural ventilation**

$\theta_{int,i} - \theta_e$	max. of $V_{min,i}$ , $V_{inf,i}$	$H_t$ [W·K <sup>-1</sup> ]	Design heat loss due to ventilation $\Phi_{v,i}$ (W)
25,000	26,327	8,951	223,779

Total design heat transmission loss of the specific room = -8,819 W

Room No.	Name of the room	Indoor temperature $\Theta_{int,i}$ [°C]
301B	Vestibule	20,000 °C

**Calculation of heat transmission loss**

**Specific heat transmission loss directly to exterior  $H_{T,ie}$**

structures

No.	Description	$A_k$ [m <sup>2</sup> ]	$U_k$ [W/m <sup>2</sup> .K]	$\Delta U_B$ [W/m <sup>2</sup> .K]	$U_{kc}$ [W/m <sup>2</sup> .K]	$f_{U,k}$ [-]	$f_{ie,k}$ [-]	$A_k \cdot (U_k + \Delta U_B) \cdot f_{U,k} \cdot f_{ie,k}$
W	Triple glazing plastic window	1,088	0,700		0,700	1,000	1,000	0,762
S1	Peripheral wall	1,857	0,125	0,050	0,175	1,000	1,000	0,324
R	Flat roof	9,700	0,136		0,136	1,000	1,000	1,315

$H_{T,ie} = \Sigma (A_k \cdot (U_k + \Delta U_B) \cdot f_{U,k} \cdot f_{ie,k})$  (W/K) 2,401

**Specific heat transmission loss from heated space to neighbouring heated space or unheated space or through it  $H_{T,ia(.,)}$**

structures

No.S.	description	$\Theta_u$ [°C]	$A_k$ [m <sup>2</sup> ]	$U_k$ [W/m <sup>2</sup> .K]	$\Delta U$ [W/m <sup>2</sup> .K]	$U_{kc}$ [W/m <sup>2</sup> .K]	$f_{ix,k}$ [-]	$A_k \cdot U_{kc} \cdot f_{ix,k}$
S4	internal non-load bearing wall	24,000	6,094	1,379		1,379	-0,114	-0,961
S3.a	internal load bearing wall	10,000	9,771	0,501		0,501	0,286	1,398
Di	interior timber door	10,000	1,890	1,800		1,800	0,286	0,972
Di	interior timber door	24,000	1,680	1,800		1,800	-0,114	-0,346

$H_{T,ia(.,)} = \Sigma (A_k \cdot U_{kc} \cdot f_{ix,k})$  (W/K) 1,064

$f_{ix,k} = f_1 = (\Theta_{int,i} - \Theta_u) / (\Theta_{int,i} - \Theta_e)$

**Specific heat transmission loss to ground  $H_{T,ig}$**

No.S.	description	$A_k$ [m <sup>2</sup> ]	$A_g$ [m <sup>2</sup> ]	p [m]	$U_k$ [W/m <sup>2</sup> .K]	$f_{ig,k}$ [-]	B' [m]	$U_{equiv,k}$ [W/m <sup>2</sup> .K]	$A_k \cdot U_{equiv,k} \cdot f_{ig,k} \cdot f_{GW,k}$
									$\Sigma (A_k \cdot U_{equiv,k} \cdot f_{ig,k} \cdot f_{GW,k})$ <span style="float:right">0,000</span>

$f_{\theta ann}$ [-]	$H_{T,ig} = f_{\theta ann} \cdot \Sigma (A_k \cdot U_{equiv,k} \cdot f_{ig,k} \cdot f_{GW,k})$ (W/K)	$f_{GW,k}$ [-]	$\Theta_{e,m}$ [°C]
1,450	0,000	1,000	3,900

**Total design heat transmission loss  $\Phi_{T,i} = (H_{T,ie} + H_{T,ia} + H_{T,iae} + H_{T,iaBE} + H_{T,ig}) \cdot (\Theta_{int,i} - \Theta_e)$  [W]**

$\Theta_{int,i}$ [°C]	$\Theta_e$ [°C]	$\Theta_{int,i} - \Theta_e$ [°C]	$\Sigma H_{t,i}$ [W.K <sup>-1</sup> ]	Design heat transmission loss $\Phi_{T,i}$ [W]
20,000	-15,000	35,000	3,465	121,280

**Design heat loss due to ventilation - natural ventilation**

room volume $V_i$ (m <sup>3</sup> )	Outdoor temperature $\Theta_e$ [°C]	indoor temperature $\Theta_{int,i}$ [°C]	Hygienic requirements	
29,003	-15,000	20,000	$n_{min}$ (h <sup>-1</sup> )	Hygienic air exchange $V_{min,i}$ (m <sup>3</sup> /h)
			0,500	14,502
$n_{50}$ [1/h]	Number of unprotected openings	Shading factor $e_i$	correction factor of height level from terrain $\epsilon_i$	Amount of air infiltrated by building envelope $V_{inf,i}$ (m <sup>3</sup> /h)
4,500	0,000	0,000	1,000	0,000

**Heat loss due to natural ventilation**

$\Theta_{int,i} - \Theta_e$	max. of $V_{min,i}$ , $V_{inf,i}$	$H_t$ [W.K <sup>-1</sup> ]	Design heat loss due to ventilation $\Phi_{v,i}$ (W)
35,000	14,502	4,931	172,568

Total design heat transmission loss of the specific room = 293,848 W

Room No.	Name of the room	Indoor temperature $\Theta_{int,i}$ [°C]						
302B	Washing machine room	20,000 °C						
<b>Calculation of heat transmission loss</b>								
<b>Specific heat transmission loss directly to exterior <math>H_{T,ie}</math></b>								
structures								
No.	Description	$A_k$ [m <sup>2</sup> ]	$U_k$ [W/m <sup>2</sup> .K]	$\Delta U_B$ [W/m <sup>2</sup> .K]	$U_{kc}$ [W/m <sup>2</sup> .K]	$f_{U,k}$ [-]	$f_{ie,k}$ [-]	$A_k \cdot (U_k + \Delta U_B) \cdot f_{U,k} \cdot f_{ie,k}$
R	Flat roof	1,980	0,136		0,136	1,000	1,000	0,269
$H_{T,ie} = \Sigma (A_k \cdot (U_k + \Delta U_B) \cdot f_{U,k} \cdot f_{ie,k})$ (W/k)								0,269

<b>Specific heat transmission loss from heated space to neighbouring heated space or unheated space or through it <math>H_{T,ia(..)}</math></b>								
structures								
No.S.	description	$\Theta_u$ [°C]	$A_k$ [m <sup>2</sup> ]	$U_k$ [W/m <sup>2</sup> .K]	$\Delta U$ [W/m <sup>2</sup> .K]	$U_{kc}$ [W/m <sup>2</sup> .K]	$f_{ix,k}$ [-]	$A_k \cdot U_{kc} \cdot f_{ix,k}$
S4	internal non-load bearing wall	24,000	3,187	1,379		1,379	-0,114	-0,502
$H_{T,ia(..)} = \Sigma (A_k \cdot U_{kc} \cdot f_{ix,k})$ (W/K)								-0,502
$F_{ix,k} = f_1 = (\Theta_{int,i} - \Theta_u) / (\Theta_{int,i} - \Theta_e)$								

<b>Specific heat transmission loss to ground <math>H_{T,ig}</math></b>									
No.S.	description	$A_k$ [m <sup>2</sup> ]	$A_g$ [m <sup>2</sup> ]	P [m]	$U_k$ [W/m <sup>2</sup> .K]	$f_{ig,k}$ [-]	B' [m]	$U_{equiv,k}$ [W/m <sup>2</sup> .K]	$A_k \cdot U_{equiv,k} \cdot f_{ig,k} \cdot f_{GW,k}$
$\Sigma (A_k \cdot U_{equiv,k} \cdot f_{ig,k} \cdot f_{GW,k})$									0,000

$f_{\theta_{ann}}$ [-]	$H_{T,ig} = f_{\theta_{ann}} \cdot \Sigma (A_k \cdot U_{equiv,k} \cdot f_{ig,k} \cdot f_{GW,k})$ (W/K)	$f_{GW,k}$ [-]	$\Theta_{e,m}$ [°C]
1,450	0,000	1,000	3,900

<b>Total design heat transmission loss <math>\Phi_{T,i} = (H_{T,ie} + H_{T,ia} + H_{T,iae} + H_{T,iaBE} + H_{T,ig}) \cdot (\Theta_{int,i} - \Theta_e)</math> [W]</b>				
$\Theta_{int,i}$ [°C]	$\Theta_e$ [°C]	$\Theta_{int,i} - \Theta_e$ [°C]	$\Sigma H_{T,i}$ [W·K <sup>-1</sup> ]	Design heat transmission loss $\Phi_{T,i}$ [W]
20,000	-15,000	35,000	-0,234	-8,186

<b>Design heat loss due to ventilation - natural ventilation</b>				
room volume $V_i$ (m <sup>3</sup> )	Outdoor temperature $\Theta_e$ [°C]	indoor temperature $\Theta_{int,i}$ [°C]	Hygic requirements	
5,920	-15,000	20,000	$n_{min}$ (h <sup>-1</sup> )	Hygienic air exchange $V_{min,i}$ (m <sup>3</sup> /h)
			1,500	8,880
$n_{50}$ [1/h]	Number of unprotected openings	Shading factor $e_i$	correction factor of height level from terrain $\epsilon_i$	Amount of air infiltrated by building envelope $V_{inf,i}$ (m <sup>3</sup> /h)
4,500	0,000	0,020	1,000	0,000
<b>Heat loss due to natural ventilation</b>				
$\Theta_{int,i} - \Theta_e$	max. of $V_{min,i}$ , $V_{inf,i}$	$H_t$ [W·K <sup>-1</sup> ]	Design heat loss due to ventilation $\Phi_{v,i}$ (W)	
35,000	8,880	3,019	105,676	

Total design heat transmission loss of the specific room = 97,489 W

Room No.	Name of the room	Indoor temperature $\Theta_{int,i}$ [°C]						
303B	Toilet	20,000 °C						
<b>Calculation of heat transmission loss</b>								
<b>Specific heat transmission loss directly to exterior <math>H_{T,ie}</math></b>								
structures								
No.	Description	$A_k$ [m <sup>2</sup> ]	$U_k$ [W/m <sup>2</sup> .K]	$\Delta U_B$ [W/m <sup>2</sup> .K]	$U_{kc}$ [W/m <sup>2</sup> .K]	$f_{U,k}$ [-]	$f_{ie,k}$ [-]	$A_k \cdot (U_k + \Delta U_B) \cdot f_{U,k} \cdot f_{ie,k}$
R	Flat roof	3,480	0,136		0,136	1,000	1,000	0,472
$H_{T,ie} = \Sigma (A_k \cdot (U_k + \Delta U_B) \cdot f_{U,k} \cdot f_{ie,k})$ (W/k)								0,472

<b>Specific heat transmission loss from heated space to neighbouring heated space or unheated space or through it <math>H_{T,ia(i)}</math></b>									
structures									
No.S.	description	$\theta_u$ [°C]	$A_k$ [m <sup>2</sup> ]	$U_k$ [W/m <sup>2</sup> .K]	$\Delta U$ [W/m <sup>2</sup> .K]	$U_{kc}$ [W/m <sup>2</sup> .K]	$f_{ix,k}$ [-]	$A_k \cdot U_{kc} \cdot f_{ix,k}$	
S4	internal non-load bearing wall	24,000	1,704	1,379		1,379	-0,114	-0,269	
$H_{T,ia(i)} = \Sigma (A_k \cdot U_{kc} \cdot f_{ix,k})$ (W/K)									-0,269
$F_{ix,k} = f_1 = (\theta_{int,i} - \theta_u) / (\theta_{int,i} - \theta_e)$									

<b>Specific heat transmission loss to ground <math>H_{T,ig}</math></b>									
No.S.	description	$A_k$ [m <sup>2</sup> ]	$A_g$ [m <sup>2</sup> ]	P [m]	$U_k$ [W/m <sup>2</sup> .K]	$f_{ig,k}$ [-]	B' [m]	$U_{equiv,k}$ [W/m <sup>2</sup> .K]	$A_k \cdot U_{equiv,k} \cdot f_{ig,k} \cdot f_{GW,k}$
$\Sigma (A_k \cdot U_{equiv,k} \cdot f_{ig,k} \cdot f_{GW,k})$									0,000
$f_{\theta ann}$ [-]	$H_{T,ig} = f_{\theta ann} \cdot \Sigma (A_k \cdot U_{equiv,k} \cdot f_{ig,k} \cdot f_{GW,k})$ (W/K)				$f_{GW,k}$ [-]	$\theta_{e,m}$ [°C]			
1,450	0,000				1,000	3,900			

<b>Total design heat transmission loss <math>\Phi_{T,i} = (H_{T,ie} + H_{T,ia} + H_{T,iae} + H_{T,iaBE} + H_{T,ig}) \cdot (\theta_{int,i} - \theta_e)</math> [W]</b>				
$\Theta_{int,i}$ [°C]	$\Theta_e$ [°C]	$\Theta_{int,i} - \theta_e$ [°C]	$\Sigma H_{t,i}$ [W·K <sup>-1</sup> ]	Design heat transmission loss $\Phi_{T,i}$ [W]
20,000	-15,000	35,000	0,203	7,115

<b>Design heat loss due to ventilation - natural ventilation</b>				
room volume $V_i$ (m <sup>3</sup> )	Outdoor temperature $\Theta_e$ [°C]	indoor temperature $\Theta_{int,i}$ [°C]	Hygienic requirements	
			$n_{min}$ (h <sup>-1</sup> )	Hygienic air exchange $V_{min,i}$ (m <sup>3</sup> /h)
10,405	-15,000	20,000	0,500	5,203
$n_{50}$ [1/h]	Number of unprotected openings	Shading factor $e_i$	correction factor of height level from terrain $\epsilon_i$	Amount of air infiltrated by building envelope $V_{inf,i}$ (m <sup>3</sup> /h)
4,500	0,000	0,020	1,000	0,000

<b>Heat loss due to natural ventilation</b>			
$\Theta_{int,i} - \Theta_e$	max. of $V_{min,i}$ , $V_{inf,i}$	$H_t$ [W·K <sup>-1</sup> ]	Design heat loss due to ventilation $\Phi_{v,i}$ (W)
35,000	5,203	1,769	61,911

Total design heat transmission loss of the specific room = 69,026 W

Room No.	Name of the room	Indoor temperature $\Theta_{int,i}$ [°C]
304B	Kitchen and living room	20,000 °C

**Calculation of heat transmission loss**

**Specific heat transmission loss directly to exterior  $H_{T,ie}$**

structures

No.	Description	$A_k$ [m <sup>2</sup> ]	$U_k$ [W/m <sup>2</sup> .K]	$\Delta U_B$ [W/m <sup>2</sup> .K]	$U_{kc}$ [W/m <sup>2</sup> .K]	$f_{U,k}$ [-]	$f_{ie,k}$ [-]	$A_k \cdot (U_k + \Delta U_B) \cdot f_{U,k} \cdot f_{ie,k}$
W+D	Plastic balcony door and windows	9,575	0,700		0,700	1,000	1,000	6,703
S1	peripheral wall	23,166	0,125	0,050	0,175	1,000	1,000	4,046
R	flat roof	25,430	0,700		0,700	1,000	1,000	17,801
$H_{T,ie} = \Sigma (A_k \cdot (U_k + \Delta U_B) \cdot f_{U,k} \cdot f_{ie,k})$ (W/K)								28,549

**Specific heat transmission loss from heated space to neighbouring heated space or unheated space or through it  $H_{T,ia(i)}$**

structures

No.S.	description	$\theta_u$ [°C]	$A_k$ [m <sup>2</sup> ]	$U_k$ [W/m <sup>2</sup> .K]	$\Delta U$ [W/m <sup>2</sup> .K]	$U_{kc}$ [W/m <sup>2</sup> .K]	$f_{ix,k}$ [-]	$A_k \cdot U_{kc} \cdot f_{ix,k}$
S4	internal non-load bearing wall	24,000	7,774	1,379		1,379	-0,114	-1,225
S3.c	internal load bearing wall	15,000	5,980	0,501		0,501	0,143	0,428
S3.a	internal load bearing wall	10,000	4,336	0,501		0,501	0,286	0,620
$H_{T,ia(i)} = \Sigma (A_k \cdot U_{kc} \cdot f_{ix,k})$ (W/K)								-0,177

$F_{ix,k} = f_{i1} = (\theta_{int,i} - \theta_u) / (\theta_{int,i} - \theta_e)$

**Specific heat transmission loss to ground  $H_{T,ig}$**

No.S.	description	$A_k$ [m <sup>2</sup> ]	$A_g$ [m <sup>2</sup> ]	P [m]	$U_k$ [W/m <sup>2</sup> .K]	$f_{ig,k}$ [-]	B' [m]	$U_{equiv,k}$ [W/m <sup>2</sup> .K]	$A_k \cdot U_{equiv,k} \cdot f_{ig,k} \cdot f_{GW,k}$
$\Sigma (A_k \cdot U_{equiv,k} \cdot f_{ig,k} \cdot f_{GW,k})$									0,000
$f_{\theta_{ann}}$ [-]	$H_{T,ig} = f_{\theta_{ann}} \cdot \Sigma (A_k \cdot U_{equiv,k} \cdot f_{ig,k} \cdot f_{GW,k})$ (W/K)					$f_{GW,k}$ [-]	$\theta_{e,m}$ [°C]		
1,450	0,000					1,000	3,900		

**Total design heat transmission loss  $\Phi_{T,i} = (H_{T,ie} + H_{T,ia} + H_{T,iae} + H_{T,iabE} + H_{T,ig}) \cdot (\theta_{int,i} - \theta_e)$  [W]**

$\Theta_{int,i}$ [°C]	$\Theta_e$ [°C]	$\Theta_{int,i} - \theta_e$ [°C]	$\Sigma H_{t,i}$ [W.K <sup>-1</sup> ]	Design heat transmission loss $\Phi_{T,i}$ [W]
20,000	-15,000	35,000	28,372	993,010

**Design heat loss due to ventilation - natural ventilation**

room volume $V_i$ (m <sup>3</sup> )	Outdoor temperature $\Theta_e$ [°C]	indoor temperature $\Theta_{int,i}$ [°C]	Hygienic requirements	
			$n_{min}$ (h <sup>-1</sup> )	Hygienic air exchange $V_{min,i}$ (m <sup>3</sup> /h)
76,036	-15,000	20,000	0,500	38,018
$n_{50}$ [1/h]	Number of unprotected openings	Shading factor $e_i$	correction factor of height level from terrain $\epsilon_i$	Amount of air infiltrated by building envelope $V_{inf,i}$ (m <sup>3</sup> /h)
4,500	1,000	0,020	1,000	13,686

**Heat loss due to natural ventilation**

$\Theta_{int,i} - \Theta_e$	max. of $V_{min,i}$ , $V_{inf,i}$	$H_t$ [W.K <sup>-1</sup> ]	Design heat loss due to ventilation $\Phi_{v,i}$ (W)
35,000	38,018	12,926	452,412

Total design heat transmission loss of the specific room = 1445,423 W

Room No.	Name of the room	Indoor temperature $\Theta_{int,i}$ [°C]
305B	Bathroom	24,000 °C

**Calculation of heat transmission loss**

**Specific heat transmission loss directly to exterior  $H_{T,ie}$**

structures								
No.	Description	$A_k$ [m <sup>2</sup> ]	$U_k$ [W/m <sup>2</sup> .K]	$\Delta U_B$ [W/m <sup>2</sup> .K]	$U_{kc}$ [W/m <sup>2</sup> .K]	$f_{U,k}$ [-]	$f_{ie,k}$ [-]	$A_k \cdot (U_k + \Delta U_B) \cdot f_{U,k} \cdot f_{ie,k}$
R	Flat roof	4,390	0,136	0,050	0,186	1,000	1,000	0,815
W	triple glazing plastic window	0,900	0,700		0,700	1,000	1,000	0,630
S1	peripheral wall	4,183	0,125	0,050	0,175	1,000	1,000	0,731
$H_{T,ie} = \Sigma (A_k \cdot (U_k + \Delta U_B) \cdot f_{U,k} \cdot f_{ie,k})$ (W/K)								2,175

**Specific heat transmission loss from heated space to neighbouring heated space or unheated space or through it  $H_{T,ia(.,)}$**

structures								
No.S.	description	$\theta_u$ [°C]	$A_k$ [m <sup>2</sup> ]	$U_k$ [W/m <sup>2</sup> .K]	$\Delta U$ [W/m <sup>2</sup> .K]	$U_{kc}$ [W/m <sup>2</sup> .K]	$f_{ix,k}$ [-]	$A_k \cdot U_{kc} \cdot f_{ix,k}$
S4	internal non-load bearing wall	20,000	18,921	1,379		1,379	0,103	2,677
Di	interior timber door	20,000	1,680	1,800		1,800	0,103	0,310
$H_{T,ia(.,)} = \Sigma (A_k \cdot U_{kc} \cdot f_{ix,k})$ (W/K)								2,987

$$F_{ix,k} = f_1 = (\theta_{int,i} - \theta_u) / (\theta_{int,i} - \theta_e)$$

**Specific heat transmission loss to ground  $H_{T,ig}$**

No.S.	description	$A_k$ [m <sup>2</sup> ]	$A_g$ [m <sup>2</sup> ]	P [m]	$U_k$ [W/m <sup>2</sup> .K]	$f_{ig,k}$ [-]	B' [m]	$U_{equiv,k}$ [W/m <sup>2</sup> .K]	$A_k \cdot U_{equiv,k} \cdot f_{ig,k} \cdot f_{GW,k}$
$\Sigma (A_k \cdot U_{equiv,k} \cdot f_{ig,k} \cdot f_{GW,k})$									0,000
$f_{\theta ann}$ [-]	$H_{T,ig} = f_{\theta ann} \cdot \Sigma (A_k \cdot U_{equiv,k} \cdot f_{ig,k} \cdot f_{GW,k})$ (W/K)					$f_{GW,k}$ [-]	$\theta_{e,m}$ [°C]		
1,450	0,000					1,000	3,900		

**Total design heat transmission loss  $\Phi_{T,i} = (H_{T,ie} + H_{T,ia} + H_{T,iae} + H_{T,iaBE} + H_{T,ig}) \cdot (\theta_{int,i} - \theta_e)$  [W]**

$\theta_{int,i}$ [°C]	$\theta_e$ [°C]	$\theta_{int,i} - \theta_e$ [°C]	$\Sigma H_{t,i}$ [W·K <sup>-1</sup> ]	Design heat transmission loss $\Phi_{T,i}$ [W]
24,000	-15,000	39,000	5,162	201,322

**Design heat loss due to ventilation - natural ventilation**

room volume $V_i$ (m <sup>3</sup> )	Outdoor temperature $\theta_e$ [°C]	indoor temperature $\theta_{int,i}$ [°C]	Hygienic requirements	
			$n_{min}$ (h <sup>-1</sup> )	Hygienic air exchange $V_{min,i}$ (m <sup>3</sup> /h)
13,126	-15,000	24,000	0,500	6,563
$n_{50}$ [1/h]	Number of unprotected openings	Shading factor $e_i$	correction factor of height level from terrain $\epsilon_i$	Amount of air infiltrated by building envelope $V_{inf,i}$ (m <sup>3</sup> /h)
4,500	1,000	0,020	1,000	2,363

**Heat loss due to natural ventilation**

$\theta_{int,i} - \theta_e$	max. of $V_{min,i}$ , $V_{inf,i}$	$H_t$ [W·K <sup>-1</sup> ]	Design heat loss due to ventilation $\Phi_{v,i}$ (W)
39,000	6,563	2,231	87,026

Total design heat transmission loss of the specific room = 279,000 W

Room No.	Name of the room	Indoor temperature $\Theta_{int,i}$ [°C]
306B	Bedroom	20,000 °C

**Calculation of heat transmission loss**

**Specific heat transmission loss directly to exterior  $H_{T,ie}$**

structures								
No.	Description	$A_k$ [m <sup>2</sup> ]	$U_k$ [W/m <sup>2</sup> .K]	$\Delta U_B$ [W/m <sup>2</sup> .K]	$U_{kc}$ [W/m <sup>2</sup> .K]	$f_{U,k}$ [-]	$f_{ie,k}$ [-]	$A_k \cdot (U_k + \Delta U_B) \cdot f_{U,k} \cdot f_{ie,k}$
R	flat roof	19,520	0,136		0,136	1,000	1,000	2,647
W+D	triple glazing plastic windows and balcony door	6,652	0,700		0,700	1,000	1,000	4,656
S1	peripheral wall	26,118	0,125	0,050	0,175	1,000	1,000	4,561
$H_{T,ie} = \Sigma (A_k \cdot (U_k + \Delta U_B) \cdot f_{U,k} \cdot f_{ie,k})$ (W/k)								11,865

**Specific heat transmission loss from heated space to neighbouring heated space or unheated space or through it  $H_{T,ia(i)}$**

structures								
No.S.	description	$\Theta_u$ [°C]	$A_k$ [m <sup>2</sup> ]	$U_k$ [W/m <sup>2</sup> .K]	$\Delta U$ [W/m <sup>2</sup> .K]	$U_{kc}$ [W/m <sup>2</sup> .K]	$f_{ix,k}$ [-]	$A_k \cdot U_{kc} \cdot f_{ix,k}$
$H_{T,ia(i)} = \Sigma (A_k \cdot U_{kc} \cdot f_{ix,k})$ (W/K)								0,000

$$f_{ix,k} = f_1 = (\Theta_{int,i} - \Theta_u) / (\Theta_{int,i} - \Theta_e)$$

**Specific heat transmission loss to ground  $H_{T,ig}$**

No.S.	description	$A_k$ [m <sup>2</sup> ]	$A_g$ [m <sup>2</sup> ]	P [m]	$U_k$ [W/m <sup>2</sup> .K]	$f_{ig,k}$ [-]	B' [m]	$U_{equiv,k}$ [W/m <sup>2</sup> .K]	$A_k \cdot U_{equiv,k} \cdot f_{ig,k} \cdot f_{GW,k}$
$\Sigma (A_k \cdot U_{equiv,k} \cdot f_{ig,k} \cdot f_{GW,k})$								0,000	
$f_{\theta ann}$ [-]	$H_{T,ig} = f_{\theta ann} \cdot \Sigma (A_k \cdot U_{equiv,k} \cdot f_{ig,k} \cdot f_{GW,k})$ (W/K)				$f_{GW,k}$ [-]	$\Theta_{e,m}$ [°C]			
1,450	0,000				1,000	3,900			

**Total design heat transmission loss  $\Phi_{T,i} = (H_{T,ie} + H_{T,ia} + H_{T,iae} + H_{T,iae} + H_{T,ig}) \cdot (\Theta_{int,i} - \Theta_e)$  [W]**

$\Theta_{int,i}$ [°C]	$\Theta_e$ [°C]	$\Theta_{int,i} - \Theta_e$ [°C]	$\Sigma H_{T,i}$ [W.K <sup>-1</sup> ]	Design heat transmission loss $\Phi_{T,i}$ [W]
20,000	-15,000	35,000	11,865	415,269

**Design heat loss due to ventilation - natural ventilation**

room volume $V_i$ (m <sup>3</sup> )	Outdoor temperature $\Theta_e$ [°C]	indoor temperature $\Theta_{int,i}$ [°C]	Hygienic requirements	
			$n_{min}$ (h <sup>-1</sup> )	Hygienic air exchange $V_{min,i}$ (m <sup>3</sup> /h)
58,365	-15,000	20,000	0,500	29,182
$n_{50}$ [1/h]	Number of unprotected openings	Shading factor $e_i$	correction factor of height level from terrain $\epsilon_i$	Amount of air infiltrated by building envelope $V_{inf,i}$ (m <sup>3</sup> /h)
4,500	1,000	0,020	1,000	10,506
Heat loss due to natural ventilation				
$\Theta_{int,i} - \Theta_e$	max. of $V_{min,i}$ , $V_{inf,i}$	$H_t$ [W.K <sup>-1</sup> ]	Design heat loss due to ventilation $\Phi_{v,i}$ (W)	
35,000	29,182	9,922	347,271	

Total design heat transmission loss of the specific room = 762,539 W

Room No.	Name of the room	Indoor temperature $\Theta_{int,i}$ [°C]
307B	Bedroom	20,000 °C

**Calculation of heat transmission loss**

**Specific heat transmission loss directly to exterior  $H_{T,ie}$**

structures								
No.	Description	$A_k$ [m <sup>2</sup> ]	$U_k$ [W/m <sup>2</sup> .K]	$\Delta U_B$ [W/m <sup>2</sup> .K]	$U_{kc}$ [W/m <sup>2</sup> .K]	$f_{U,k}$ [-]	$f_{ie,k}$ [-]	$A_k \cdot (U_k + \Delta U_B) \cdot f_{U,k} \cdot f_{ie,k}$
R	Flat roof	17,750	0,136		0,136	1,000	1,000	2,407
W	triple glazing plastic window	2,175	0,700		0,700	1,000	1,000	1,523
S1	peripheral wall	8,978	0,125	0,050	0,175	1,000	1,000	1,568
$H_{T,ie} = \Sigma (A_k \cdot (U_k + \Delta U_B) \cdot f_{U,k} \cdot f_{ie,k})$ (W/k)								5,497

**Specific heat transmission loss from heated space to neighbouring heated space or unheated space or through it  $H_{T,ia(-)}$**

structures								
No.S.	description	$\theta_u$ [°C]	$A_k$ [m <sup>2</sup> ]	$U_k$ [W/m <sup>2</sup> .K]	$\Delta U$ [W/m <sup>2</sup> .K]	$U_{kc}$ [W/m <sup>2</sup> .K]	$f_{ix,k}$ [-]	$A_k \cdot U_{kc} \cdot f_{ix,k}$
S3.a	internal load bearing wall	10,000	4,336	0,501		0,501	0,286	0,620
$H_{T,ia(-)} = \Sigma (A_k \cdot U_{kc} \cdot f_{ix,k})$ (W/K)								0,620

$$F_{ix,k} = f_1 = (\theta_{int,i} - \theta_u) / (\theta_{int,i} - \theta_e)$$

**Specific heat transmission loss to ground  $H_{T,ig}$**

No.S.	description	$A_k$ [m <sup>2</sup> ]	$A_g$ [m <sup>2</sup> ]	P [m]	$U_k$ [W/m <sup>2</sup> .K]	$f_{ig,k}$ [-]	B' [m]	$U_{equiv,k}$ [W/m <sup>2</sup> .K]	$A_k \cdot U_{equiv,k} \cdot f_{ig,k} \cdot f_{GW,k}$
								$\Sigma (A_k \cdot U_{equiv,k} \cdot f_{ig,k} \cdot f_{GW,k})$	0,000
$f_{\theta_{ann}}$ [-]	$H_{T,ig} = f_{\theta_{ann}} \cdot \Sigma (A_k \cdot U_{equiv,k} \cdot f_{ig,k} \cdot f_{GW,k})$ (W/K)				$f_{GW,k}$ [-]	$\theta_{e,m}$ [°C]			
1,450	0,000				1,000	3,900			

**Total design heat transmission loss  $\Phi_{T,i} = (H_{T,ie} + H_{T,ia} + H_{T,iae} + H_{T,iae} + H_{T,ig}) \cdot (\theta_{int,i} - \theta_e)$  [W]**

$\Theta_{int,i}$ [°C]	$\Theta_e$ [°C]	$\Theta_{int,i} - \theta_e$ [°C]	$\Sigma H_{t,i}$ [W·K <sup>-1</sup> ]	Design heat transmission loss $\Phi_{T,i}$ [W]
20,000	-15,000	35,000	6,118	214,122

**Design heat loss due to ventilation - natural ventilation**

room volume $V_i$ (m <sup>3</sup> )	Outdoor temperature $\Theta_e$ [°C]	indoor temperature $\Theta_{int,i}$ [°C]	Hygienic requirements	
			$n_{min}$ (h <sup>-1</sup> )	Hygienic air exchange $V_{min,i}$ (m <sup>3</sup> /h)
53,073	-15,000	20,000	0,500	26,536
$n_{50}$ [1/h]	Number of unprotected openings	Shading factor $e_i$	correction factor of height level from terrain $\epsilon_i$	Amount of air infiltrated by building envelope $V_{inf,i}$ (m <sup>3</sup> /h)
4,500	1,000	0,020	1,000	9,553

**Heat loss due to natural ventilation**

$\Theta_{int,i} - \Theta_e$	max. of $V_{min,i}$ , $V_{inf,i}$	$H_t$ [W·K <sup>-1</sup> ]	Design heat loss due to ventilation $\Phi_{v,i}$ (W)
35,000	26,536	9,022	315,781

Total design heat transmission loss of the specific room = 529,903 W



Room No.	Name of the room	Indoor temperature $\Theta_{int,i}$ [°C]						
311	Laundry drying room	15,000 °C						
<b>Calculation of heat transmission loss</b>								
<b>Specific heat transmission loss directly to exterior <math>H_{T,ie}</math></b>								
structures								
No.	Description	$A_k$ [m <sup>2</sup> ]	$U_k$ [W/m <sup>2</sup> .K]	$\Delta U_B$ [W/m <sup>2</sup> .K]	$U_{kc}$ [W/m <sup>2</sup> .K]	$f_{U,k}$ [-]	$f_{ie,k}$ [-]	$A_k \cdot (U_k + \Delta U_B) \cdot f_{U,k} \cdot f_{ie,k}$
S1	Peripheral wall	5,519	0,125	0,050	0,175	1,000	1,000	0,964
W	triple glazing plastic window	3,750	0,700		0,700	1,000	1,000	2,625
R	flat roof	10,730	0,136		0,136	1,000	1,000	1,455
$H_{T,ie} = \Sigma (A_k \cdot (U_k + \Delta U_B) \cdot f_{U,k} \cdot f_{ie,k})$ (W/k)								5,044

<b>Specific heat transmission loss from heated space to neighbouring heated space or unheated space or through it <math>H_{T,ia(.,)}</math></b>								
structures								
No.S.	description	$\theta_u$ [°C]	$A_k$ [m <sup>2</sup> ]	$U_k$ [W/m <sup>2</sup> .K]	$\Delta U$ [W/m <sup>2</sup> .K]	$U_{kc}$ [W/m <sup>2</sup> .K]	$f_{ix,k}$ [-]	$A_k \cdot U_{kc} \cdot f_{ix,k}$
S3.b	internal load bearing wall	20,000	12,379	0,501		0,501	-0,167	-1,033
S4	internal non-load bearing wall	10,000	7,379	1,379		1,379	0,167	1,696
C3	internal ceiling	10,000	10,730	0,779		0,779	0,167	1,393
Di	interior timber door	10,000	1,890	1,800		1,800	0,167	0,567
$H_{T,ia(.,)} = \Sigma (A_k \cdot U_{kc} \cdot f_{ix,k})$ (W/K)								2,623
$F_{ix,k} = f_{ix} = (\theta_{int,i} - \theta_u) / (\theta_{int,i} - \theta_e)$								

<b>Specific heat transmission loss to ground <math>H_{T,ig}</math></b>										
No.S.	description	$A_k$ [m <sup>2</sup> ]	$A_g$ [m <sup>2</sup> ]	P [m]	$U_k$ [W/m <sup>2</sup> .K]	$f_{ig,k}$ [-]	B' [m]	$U_{equiv,k}$ [W/m <sup>2</sup> .K]	$A_k \cdot U_{equiv,k} \cdot f_{ig,k} \cdot f_{GW,k}$	
									$\Sigma (A_k \cdot U_{equiv,k} \cdot f_{ig,k} \cdot f_{GW,k})$	
									0,000	
$f_{\theta_{ann}}$ [-]	$H_{T,ig} = f_{\theta_{ann}} \cdot \Sigma (A_k \cdot U_{equiv,k} \cdot f_{ig,k} \cdot f_{GW,k})$ (W/K)					$f_{GW,k}$ [-]	$\theta_{e,m}$ [°C]			
1,450	0,000					1,000	3,900			

<b>Total design heat transmission loss <math>\Phi_{T,i} = (H_{T,ie} + H_{T,ia} + H_{T,iae} + H_{T,iaE} + H_{T,ig}) \cdot (\theta_{int,i} - \theta_e)</math> [W]</b>				
$\theta_{int,i}$ [°C]	$\theta_e$ [°C]	$\theta_{int,i} - \theta_e$ [°C]	$\Sigma H_{t,i}$ [W·K <sup>-1</sup> ]	Design heat transmission loss $\Phi_{T,i}$ [W]
15,000	-15,000	30,000	7,667	230,010

<b>Design heat loss due to ventilation - natural ventilation</b>				
room volume $V_i$ (m <sup>3</sup> )	Outdoor temperature $\theta_e$ [°C]	indoor temperature $\theta_{int,i}$ [°C]	Hygienic requirements	
32,083	-15,000	15,000	$n_{min}$ (h <sup>-1</sup> )	Hygienic air exchange $V_{min,i}$ (m <sup>3</sup> /h)
			0,500	16,041
$n_{50}$	Number of unprotected	Shading factor	correction factor of height	Amount of air infiltrated by
4,500	0,000	0,000	1,000	0,000
<b>Heat loss due to natural ventilation</b>				
$\theta_{int,i} - \theta_e$	max. of $V_{min,i}$ , $V_{inf,i}$	$H_t$ [W·K <sup>-1</sup> ]	Design heat loss due to ventilation $\Phi_{v,i}$ (W)	
30,000	16,041	5,454	163,622	

Total design heat transmission loss of the specific room = 478,000 W

### Summary of heat losses from each floor

<b>Heat loss from the basement</b>			
Room No.	Heat transmission loss $\Phi_{T,i}$ [W]	Heat loss due to ventilation $\Phi_{V,i}$ [W]	Total heat loss [W]
S101	-16,33	60,54	44,21
S102	-84,57	35,07	-49,50
S103	716,21	566,81	1283,01
S104	77,29	103,72	181,01
S105	267,93	263,83	531,77
S106	405,93	302,44	708,37
S107	-62,45	135,11	72,65
S108	85,72	177,91	263,63
S109	-252,18	91,49	-160,68
S110	-38,33	46,05	7,72
S111	-102,75	104,68	1,94
S112	-60,27	95,31	35,04
S113	-249,20	115,21	-134,00
S114	-30,57	36,90	6,34
S115	-14,39	53,75	39,36
S116	-22,39	60,54	38,15
S117	-57,04	60,54	3,50
S118	-116,63	60,54	-56,09
$\Sigma$			2816

<b>Heat loss from the first floor</b>			
Room No.	Heat transmission loss $\Phi_{T,i}$ [W]	Heat loss due to ventilation $\Phi_{V,i}$ [W]	Total heat loss [W]
101A	89,11	172,57	261,68
102A	-13,50	105,68	92,18
103A	-9,40	61,91	52,51
104A	398,70	452,41	851,12
105A	176,83	87,03	236,80
106A	322,62	347,27	669,89
107A	212,26	315,78	528,05
108	-249,55	255,55	6,00
101B	165,29	172,57	337,86
102B	0,80	105,68	106,47
103B	22,90	61,91	84,82
104B	599,58	452,41	1052,00
105A	213,28	87,22	436,90
106B	503,84	347,27	851,11
107B	294,66	315,78	610,44
109	-128,00	53,14	-174,60
$\Sigma$			6003

<b>Heat loss from the second floor</b>			
Room No.	Heat transmission loss $\Phi_{T,i}$ [W]	Heat loss due to ventilation $\Phi_{V,i}$ [W]	Total heat loss [W]
201A	75,24	172,57	247,81
202A	-17,60	105,68	88,07
203A	-9,40	61,91	52,51
204A	369,98	452,41	822,39
205A	169,54	87,03	240,90
206A	322,62	347,27	669,89
207A	129,87	315,78	445,65
211	240,64	163,62	404,27
208	-358,06	223,78	-134,28
201B	75,24	172,57	247,81
202B	-17,58	105,68	88,09
203B	-9,40	61,91	52,51
204B	369,98	452,41	822,39
205B	169,54	87,22	240,90
206B	322,62	347,27	669,89
207B	129,87	315,78	445,65
$\Sigma$			5404

<b>Heat loss from the third floor</b>			
Room No.	Heat transmission loss $\Phi_{T,i}$ [W]	Heat loss due to ventilation $\Phi_{V,i}$ [W]	Total heat loss [W]
301A	121,28	172,57	293,85
302A	-8,20	105,68	97,47
303A	7,12	61,91	69,03
304A	993,01	452,41	1445,42
305A	192,76	87,03	279,00
306A	415,27	347,27	762,54
307A	214,12	315,78	529,90
308	-232,60	223,78	-8,82
301B	121,28	172,57	293,85
302B	-8,19	105,68	97,49
303B	7,12	61,91	69,03
304B	993,01	452,41	1445,42
305B	201,32	87,03	279,00
306B	415,27	347,27	762,54
307B	214,12	315,78	529,90
311	230,01	163,62	478,00
$\Sigma$			7424

**Total heat loss of the whole building = 21,70 kW**

#### B.1.4. Annual energy demand

I used online calculator from tzb-info website [42] for the estimation of total annual energy demand for heating and hot water preparation which calculates according to location, outdoor calculation temperature, length of heating period and other boundary conditions.

It uses the following equation to calculate annual heat demand:

$$Q_{H,a} = \frac{24 \cdot \Phi_{HL} \cdot \varepsilon \cdot D}{\theta_{is} - \theta_e} \quad [\text{kWh/year}]$$

Where:

$Q_{H,a}$  ... annual heat demand [kWh/year]

$\Phi_{HL}$  ... heat loss of the object [kW]

$\varepsilon$  ... correction factor for temperature reduction, shortening of heating time, non-simultaneous heat loss of ventilation and transmission [-]

$D$  ... number of day degrees [K.day]

$\theta_{is}$  ... average calculation indoor temperature [°C]

$\theta_e$  ... outdoor calculation temperature [°C]

Lokalita (Tabulka)   $t_{em} = 12\text{ }^{\circ}\text{C}$    $t_{em} = 13\text{ }^{\circ}\text{C}$    $t_{em} = 15\text{ }^{\circ}\text{C}$  ???

Město  Délka topného období  $d =$   [dny]

Venkovní výpočtová teplota  $t_e =$    $^{\circ}\text{C}$  Prům. teplota během otopného období  $t_{es} =$    $^{\circ}\text{C}$

---

**Vytápění**

Teplotná ztráta objektu  $Q_C =$   kW

Průměrná vnitřní výpočtová teplota  $t_{is} =$    $^{\circ}\text{C}$  ???

Vytápěcí denostupně  
 $D = d \cdot (t_{is} - t_{es}) = 3511$  K.dny

Opravné součinitele a účinnosti systému

$e_j =$   ???  $\eta_o =$   ???

$e_t =$   ???  $\eta_r =$   ???

$e_d =$   ???

Opravný součinitel  $\varepsilon$  ???

$\varepsilon = e_j \cdot e_t \cdot e_d = 0.785$

$\varepsilon =$

$$Q_{VYT,r} = \frac{\varepsilon}{\eta_o \cdot \eta_r} \cdot \frac{24 \cdot Q_C \cdot D}{(t_{is} - t_e)} \cdot 3,6 \cdot 10^{-3}$$

$Q_{VYT,r} =$  (  MWh/rok )

**Ohřev teplé vody**

$t_1 =$    $^{\circ}\text{C}$  ???  $\rho =$    $\text{kg/m}^3$  ???

$t_2 =$    $^{\circ}\text{C}$  ???  $c =$    $\text{J/kgK}$  ???

$V_{2p} =$    $\text{m}^3/\text{den}$  ???

Koeficient energetických ztrát systému  $z =$   ???

Denní potřeba tepla pro ohřev teplé vody

$$Q_{TUV,d} = (1 + z) \cdot \frac{\rho \cdot c \cdot V_{2p} \cdot (t_2 - t_1)}{3600} = 154.5$$
 kWh

Teplota studené vody v létě  $t_{svl} =$    $^{\circ}\text{C}$

Teplota studené vody v zimě  $t_{svz} =$    $^{\circ}\text{C}$

Počet pracovních dní soustavy v roce  $N =$   [dny]

$$Q_{TUV,r} = Q_{TUV,d} \cdot d + 0,8 \cdot Q_{TUV,d} \cdot \frac{t_2 - t_{svl}}{t_2 - t_{svz}} \cdot (N - d)$$

$Q_{TUV,r} =$  (  GJ/rok /  MWh/rok )

---

Celková roční potřeba energie na vytápění a ohřev teplé vody

$Q_r = Q_{VYT,r} + Q_{TUV,r} =$  (  GJ/rok /  MWh/rok )

Total annual energy demand for heating and hot water preparation

$$E_{\text{heat,T}} = 96,6 \text{ MWh/year} = 347,8 \text{ GJ/year.}$$

## B.2. Design of hot water preparation

Hot water will be prepared by indirect storage heating. Connection of water storage heater will be accomplished by separate branches from the collector and distributor.

The most important parameters of a storage heater are its volume, output and heat exchanging surface. First, the daily hot water demand must be determined and based on it, the amount of heat needed to heat this amount of water, including system losses, will be calculated.

Then we divide hot water consumption based on its consumption during separate periods of the day to be able to draw the so-called consumption diagram, from which we can determine the size of the tank, its capacity and the required heat exchanging surface.

Calculations:

a) Theoretical heat taken from the heater during one period which is one day in case of apartment building :

$$Q_{2t} = n \cdot Q_{2P} \quad \text{kWh}$$

Where

$Q_{2P}$  ...is the heat consumed from the heater during one period per unit of measurement.

$Q_{2P} = 4,3$  kWh/person.

$n$ ... number of units of measurement which is in our case the number of inhabitants.

The apartment building is designed for 24 inhabitants so  $n = 24$  persons.

$$Q_{2t} = 24 \cdot 4,3 = 103,2 \text{ kWh}$$

b) Heat lost during heating and distribution of hot water  $Q_{2z}$  (kWh) according to the relation:

$$Q_{2z} = Q_{2t} \cdot z$$

Where  $z$  is a coefficient expressing the estimation of heat losses during heating and distribution of hot water (with good insulation of heaters and pipes  $z = 0,5$  to  $0,8$ )

$$Q_{2z} = 103,2 \cdot 0,5 = 51,6 \text{ kWh}$$

c) Total consumed and lost heat:  $Q_{2p} = Q_{2t} + Q_{2z} = 154,8$  kWh

It is possible to consider the so-called time analysis of hot water consumption. For apartment buildings, the standard ČSN 06 0320 states the following time distribution:

- from 5 to 17 hour = 35% of the total amount of hot water.
- from 17 to 20 hour = 50% of the total amount of hot water.
- from 20 to 24 hour = 15% of the total amount of hot water.

So for our building:

From 5 to 17, the consumption =  $103,2 \cdot 35/100 = 36,12$  kWh

From 17 to 20, the consumption =  $103,2 \cdot 50/100 = 51,6$  kWh

From 20 to 24, the consumption =  $103,2 \cdot 15/100 = 15,48$  kWh

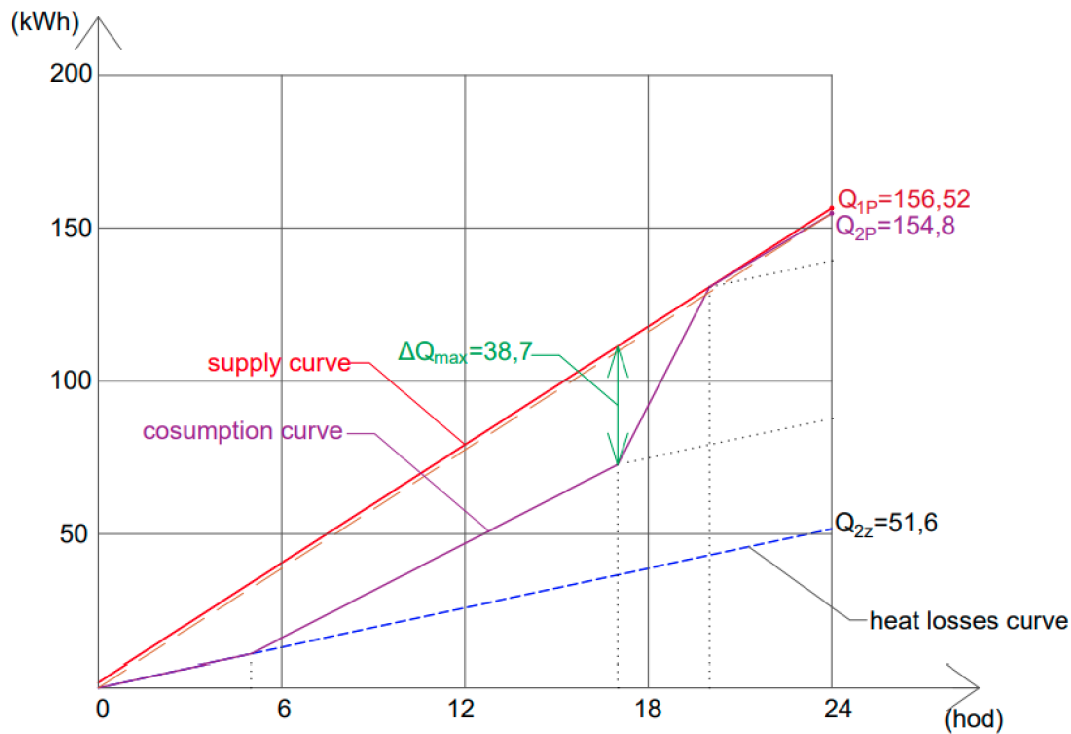

Figure 26- hot water supply, consumption, and losses curves

d) From the previous graph I got  $Q_{1p}$ , which is heat provided by the heater to heat the water during one period.  $Q_{1p} = 156,52$  kWh. And the largest possible difference between the supply curve and the consumption curve  $\Delta Q_{\max} = 38,7$  kWh.

e) The volume of storage heater  $V_z$  ( $m^3$ ), according to ČSN 06 0320:

$$V_z = \Delta Q_{\max} / (c_w \cdot \Delta t)$$

Where

$\Delta Q_{\max}$  ... the largest possible difference between the supply curve and the heat consumption curve (kWh)

$c_w$  - specific heat capacity of water ( $kWh / m^3 \cdot K$ ),  $c_w = 1,163$   $kWh/m^3 \cdot K$

$\Delta t$  - difference between hot and cold water temperature (K),  $\Delta t = 55 - 10 = 45$  K.

$$V_z = 38,7 / (1,163 \cdot 45) = \mathbf{0,7395 \text{ m}^3 = 739,5 \text{ l}}$$

f) Nominal heat output for water heating  $Q_z$  (kW) is determined according to the relation:

$$Q_z = (\Delta Q_1 / t_p)$$

Where

$\Delta Q_1$  ... amount of heat supplied by the heater to heat the water during a period  $t_p$ , in which heat supply curve has the greatest slope (kWh)

$t_p$  ... time period (h), in which heat supply curve has the greatest slope

$$Q_z = 156,52 / 24 = \mathbf{6,522 \text{ kW}}$$

I chose indirect storage heater ENBRA NOR 750 with volume 744 l



Figure 27-section of storage heater ENBRA NOR 750[43]

Typ	Obj. kód	Objem l	Ø D <sub>0</sub> mm	Výška H	Překlápěcí rozměr a mm	Hmotnost j kg	Plocha výměníku m <sup>2</sup>	Tloušťka izolace mm	Trvalý výkon kW	Trvalý výkon l/h	Pohotovostní ztráta W	Energ. třída
NOR 100	NOR100	99	512	849	960	50	0,61	50	19	480	50	C
NOR 160	NOR160	157	540	1222	1290	67	0,75	50	25	615	56	B
NOR 200	NOR200	196	540	1473	1530	79	0,95	50	31	760	68	C
NOR 300	NOR300	304	700	1834	1472	117	1,45	50	48	1170	69	B
NOR 400	NOR400	385	700	1631	1472	137	1,8	50	57	1395	84	C
NOR 500	NOR500	473	700	1961	1738	189	1,9	50	65	1590	99	C
NOR 750	NOR750	744	950	2023	1990	259	3,7	100	99	2440	123	C
NOR 1000	NOR1000	970	1050	2050	2025	322	4,5	100	110	2715	142	C

Figure 28-Parameters of storage heater ENBRA NOR 750[43]

### B.3. Design of heat sources in two variants

Total heat loss of the whole building = 21,7 kW.

Heat output needed for hot water preparation = 6,522 kW.

Heat output of the heat source is designed according to ČSN EN 12828. The so-called connection value of heat output is estimated, this is the higher of the two connection values. For the first value, we calculate only 70% of heat output needed for heating and air conditioning, meanwhile we count with the entire output needed for hot water preparation. In the second value we calculate the full output needed for heating and air conditioning, but we do not count the output for hot water preparation at all.  $Q_{PRIP} = \max.( Q_{PRIP1}, Q_{PRIP2} )$

$$Q_{PRIP1} = 0,7Q_{VYT} + 0,7Q_{VZT} + Q_{TV}$$

$$Q_{PRIP1} = 0,7 \cdot 21,7 + 0,7 \cdot 0 + 6,522 = 21,712 \text{ kW}$$

$$Q_{PRIP2} = Q_{VYT} + Q_{VZT} = 21,7 + 0 = 21,7 \text{ kW}$$

$$Q_{PRIP} = \max.( Q_{PRIP1}, Q_{PRIP2} ) = 21,712 \text{ kW}$$



Where

$Q_{PRIP}$  - connection value [kW]

$Q_{PRIP1}$  - connection value for heating with intermittent ventilation and preparation of hot water [kW]

$Q_{PRIP2}$  - connection value for heating with permanent ventilation [kW]

$Q_{VYT}$  - required output for heating [kW]

$Q_{VZT}$  - required output for air conditioning [kW]

$Q_{TV}$  - required output for hot water preparation [kW]

In this diploma thesis I will be comparing two variants of energy sources.

### B.3.1. Variant A – Automatic wood pellet boiler

Total needed heat output is equal to **21,7 kW**.

I suggest the following source of energy: automatic wood pellet boiler KP 21 from company Ponast. The boiler is equipped with automatic ignition and semi-automatic cleaning of exchangers, it is designed for installation from family houses to residential, and industrial buildings. Semi-automatic operation is ensured by automatic dosing of fuel and combustion air, manual operation is only cleaning the exchanger and ash removal. This boiler can be equipped with equithermal regulation, GSM system for remote monitoring and control and a module for connection to the Internet.

This boiler has possible operation of continuous output from 8,6 kW to 29 kW with recommended temperature of heating water 55-80 °C. The boiler output can be controlled in the range of 30 - 100% of the nominal output.

It consists of a boiler body - a steel weldment with a wall thickness of 3 – 6,3 mm, a linear burner made of heat-resistant stainless steel, ceramic parts, a thermally insulated boiler casing, an electronic control unit and fuel feeders. The boiler is designed for burning wood pellets with a diameter of 6 to 8 mm.

Exhaust fume expelling and combustion air supply will be performed separately. The flue opens into the chimney Schiedel UNI ADVANCED with a diameter of 180 mm and the combustion air supply is provided by an opening in the façade, that is equipped with a grid. The boiler takes combustion air from the space.

According to the manufacturer, the opening must be near the floor with an area of 10 cm<sup>2</sup>/1 kW of boiler output and it should be at least 20 cm<sup>2</sup>.

So, I suggest opening with an area of 220 cm<sup>2</sup> and diameter of about 170 mm.



Figure 29-Automatic boiler for wood KP 21 [44]

Parametr	Hodnota
Jmenovitý výkon	29 kW
Výkonový rozsah	8,6 - 29 kW
Spotřeba paliva	1,9 - 6,6 x hod -1
Účinnost	90,9 %
Teplota spalin	101 - 141 °C
Minimální provozní tah komína	8 Pa
Doporučená teplota topné vody	55 - 80 °C
Hmotnost	335 kg
Rozměry	693 x 1100 x 1440 mm
El. příkon (2 motory, ventilátor)	193 W
Připojovací napětí	230 V AC ± 10%, 50Hz ± 2Hz

Figure 30-Parameters of automatic boiler KP 21[44]

### Boiler maintenance

It is an automatic boiler with space sensors, permanent maintenance is not necessary, occasional maintenance consists of checking the amount of fuel in the storage and checking the amount of ash in the ashtray. At approximately a monthly interval, the heat exchanger is cleaned by a simple movement of the lever located on the outer casing of the boiler and ash is removed.

#### B.3.1.a. Wood pellet storage

A fixed silo with sloping floor 45° made of osb boards, with metal supporting structure will be installed in room number S103 B which will be added as well in the technical room using masonry partition walls. This fixed silo will serve as wood pellet storage. More details are provided in the drawing of floor plan of technical room-variant 1.

The fixed silo has an area of 6,1 m<sup>2</sup>, and is filled with pellets provided by tank truck which fills pellets in the silo through two PVC filling pipes with diameters of 120 mm three times per year. The pellets are automatically collected by the auger feeder and driven into the boiler.

the walls of the silo must be designed in such a way, to avoid contamination of the fuel. The silo must be equipped with an inspection opening (located under the ceiling, with a size 80 x 80 cm) it must have dustproof window to prevent dust from escaping into the surrounding area. No switches, sockets, or lamps may be installed inside the silo.

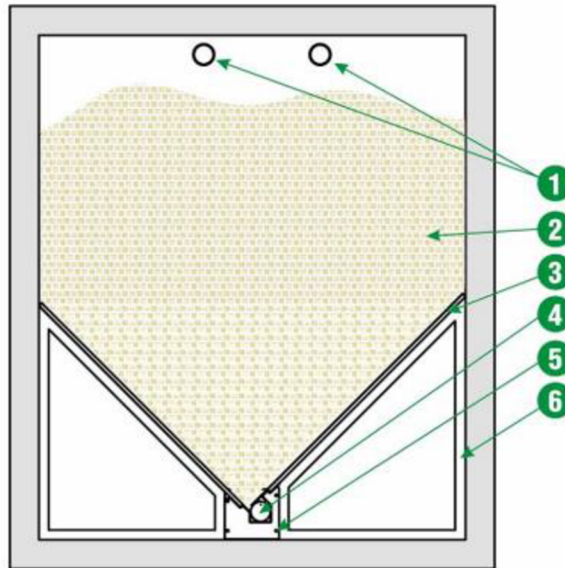

Figure 31- cross section of the fixed silo for wood pellet storage[45]  
 1: filling openings. 2: fuel-pellets. 3: sloping floor 45 °, made of OSB boards. 4: auger feeder gutter. 5: delivering channel. 6: metal supporting structure

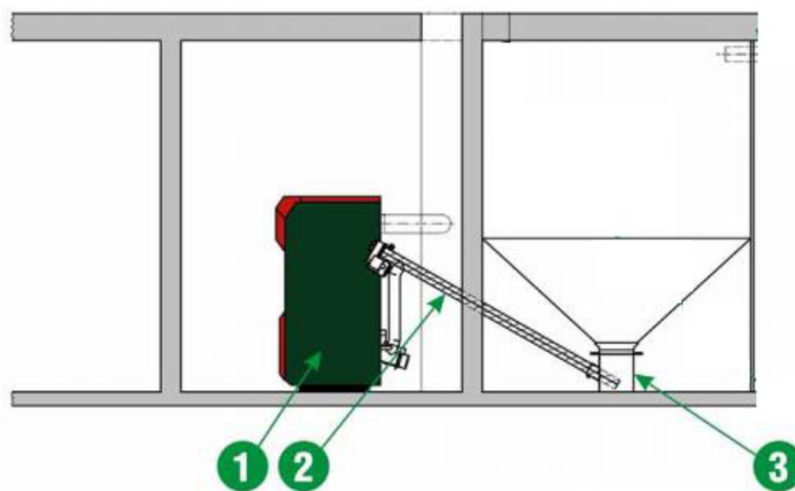

Figure 32- fixed silo for wood pellet storage [45]  
 1: automatic pellet boiler. 2 : pellet auger feeder. 3: pellet collector.

It is necessary to build a sloping floor at an angle of 45 ° made of OSB boards, to achieve complete emptying of pellet storage. Due to the sloping floor and the unusable space under the ceiling, we can count for storage only 2/3 of its total volume. Pellet storage also will be provided with a damping curtain 1400x1400 mm, to dampen the impact of the pellets hitting silo wall (to prevent crushing of the pellets and plaster).

All structural elements of the silo must withstand the static requirements of the wood pellet load (bulk weight = 650 kg /m<sup>3</sup>) and dynamic load caused by pneumatic filling from the tank.

The fixed silo has an area of 6,1 m<sup>2</sup> from which I calculated the possible **used volume for pellet in the fixed silo**.

$$V = 6,1 * 2,840 * (2/3) = 11,55 \text{ m}^3$$

### B.3.1.b. Annual fuel consumption and fuel storage design – basic determination

#### Annual pellets consumption and storage volume calculations

Annual energy demand for heating and hot water preparation =	347 800 MJ (see B.1.4. Annual energy demand)
Calorific value of wood pellets =	18 MJ/kg
Efficiency of wood pellet boiler =	90 %
Fuel consumption per year =	22 083 kg/year = 22,08 ton
Density of wood pellets =	0,62 kg/dm <sup>3</sup>
Volume needed for storage of wood pellets =	35 617 dm <sup>3</sup> /year
Volume needed for storage of wood pellets =	35,6 m <sup>3</sup> /year

#### Checking of fixed silo volume

Volume used for pellets in fixed silo =	11,55 m <sup>3</sup>
Number of refilling of the pellet warehouse in the fixed silo =	3 times/year
Pellets weight per one refilling =	7,36 ton/refilling

### B.3.1.c. Design of storage tank for variant A

When designing the storage tank, I considered a value of 50 liters per 1 kW of heat output according to the manufacturer[46].

The total volume of the tank is therefore 22 kW x 50 l = 1100 l.

I chose storage tank LMG 1200 0V, that will be insulated using PU foam.

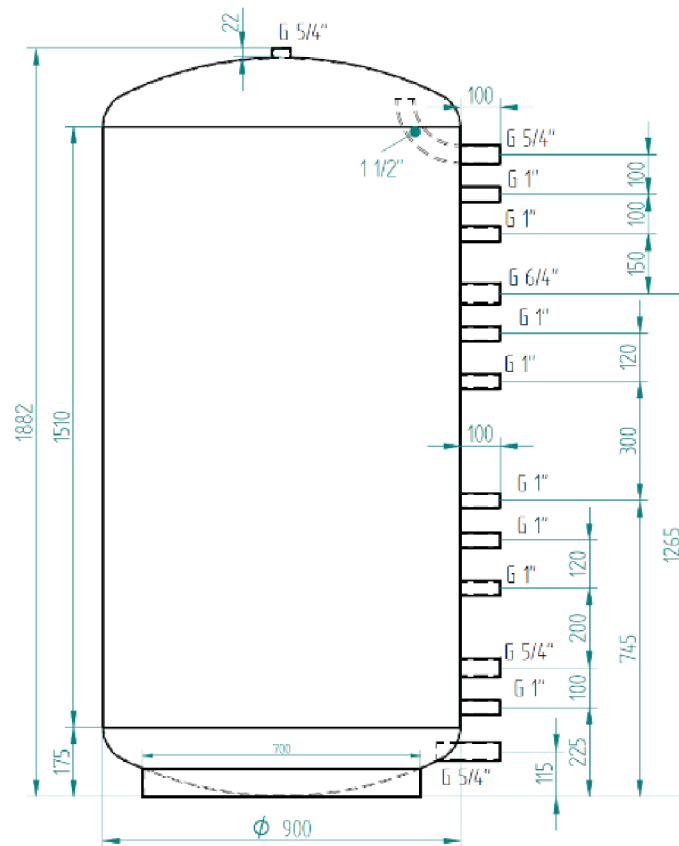

Figure 33-storage tank LMG 1200 0V [47]

LMG 1200 0V without coil		
Volume	Total Height	Diameter
1200 litres	1882 mm	900 mm
Coils	-	

Figure 34-parameters of storage tank LMG 1200 0V[47]

### B.3.2. Variant B - Air source heat pump

In my design I've chosen mono-energy operation mode of the heat pump, which means that Heat loss of the building and heat output needed for hot water preparation are largely covered by the heat pump, but during the most unfavourable temperatures electric heating is turned on.[40]

I chose two heat pumps **Logatherm WPL 14 AR Comfort**. Each one has output of 14 kW and is supplied by electrical heat insert which has maximal output of 9 kW.

Total required heat output of our apartment building(-15° C) is equal to 21,7 kW. Required heat output of one heat pump is equal to 10,86 kW. When choosing a heat pump it is very important to specify the bivalent point, which is outdoor temperature under which electric heating(or a secondary heat source) is turned on. It should lie within the range -7 to -10° C [48]. Both heat pumps will be running during winter for heating and

hot water preparation, and during summer only one heat pump will be running for hot water preparation.

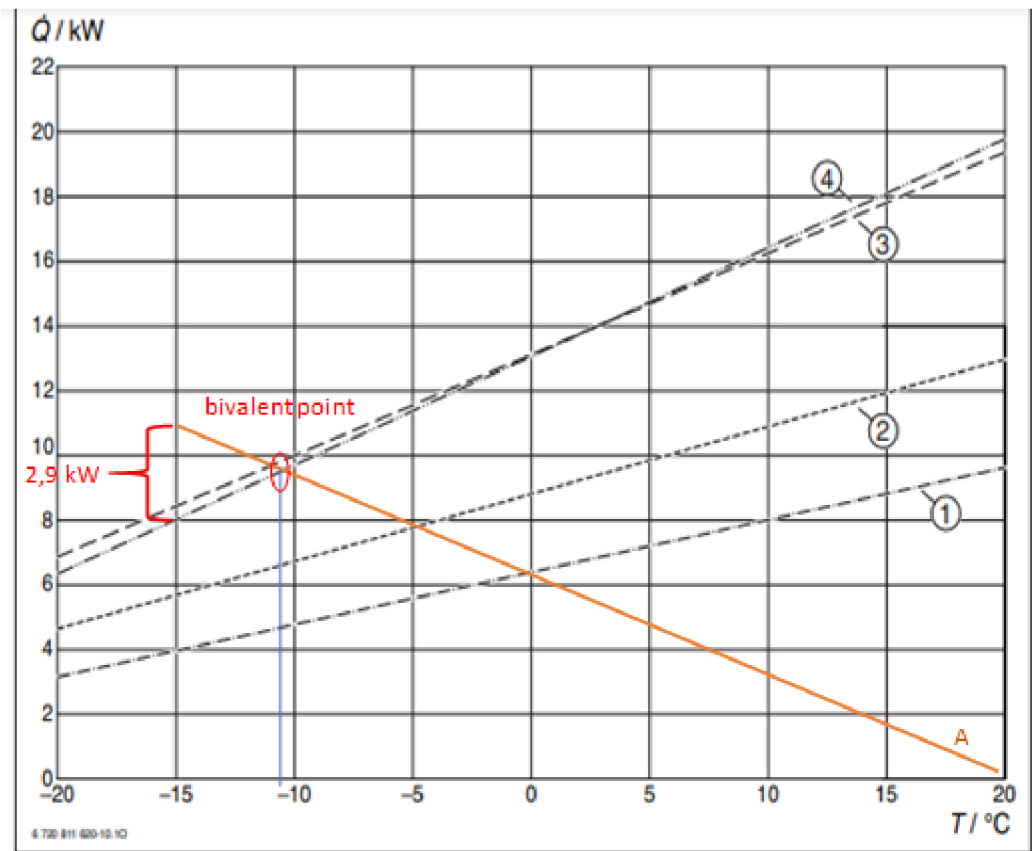

Obr. 5 Bivalentní bod, výkonové křivky tepelných čerpadel WPL ... AR při výstupní teplotě 55 °C a modulaci 100 %

- Q Potřeba tepelného výkonu
- T Venkovní teplota
- 1 Křivky tepelného výkonu WPL 6 AR
- 2 Křivky tepelného výkonu WPL 8 AR
- 3 Křivky tepelného výkonu WPL 11 AR
- 4 Křivky tepelného výkonu WPL 14 AR

A : characteristic of the apartment building which represents half of the heat loss (as two heat pumps will be used)

Figure 35-specifying bivalent point for Logatherm WPL AR heat pump and the apartment building

From previous graph we can see that bivalent point lies at  $-10,7^{\circ}\text{C}$ . Until this temperature two heat pumps cover all required heat output. At lower temperature than  $-10,7^{\circ}\text{C}$  the electrical inserts are switched on and they supply the extra heat output needed which is 2,9 kW for each heat pump at the most unfavourable temperature which is  $-15^{\circ}\text{C}$  in Olomouc city.

This heat pump consists of two units that are connected to each other:

1. Inner unit that is mounted on the wall, the wall must be load bearing.

2. Outdoor unit, which must be accessible from all sides. Details about its position are provided in the drawing of the technical room. It must be placed on a stable base, made of precast concrete strips.

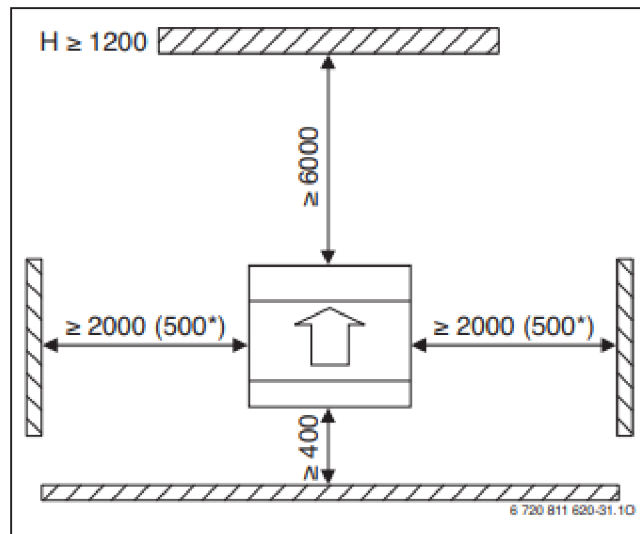

Figure 36- minimal distance around heat pump[40]

Heat pump parameters:

Bivalence point:  $-10,7^{\circ}\text{C}$

Total required heat output( $-15^{\circ}\text{C}$ ) is equal to 21,7 kW.

Required heat output of one heat pump ( $-15^{\circ}\text{C}$ ): 10,86 kW

Output of one heat pump at the bivalence point: 9,5 kW

Output of one heat pump at temperature ( $-15^{\circ}\text{C}$ ): 8 kW

Required output of electrical inserts at temperature ( $-15^{\circ}\text{C}$ ): 2,9 kW

**The output of both heat pumps at  $-15^{\circ}\text{C}$  is  $2 \times 8 \text{ kW} = 16 \text{ kW}$ .**

Each heat pump also contains an **electric heating insert** with an output up to 9 kW but only 2,9 kW is required, so in total **5,8 kW will be required from both electric heating inserts** of the two heat pumps during the most unfavourable conditions( $-15^{\circ}\text{C}$ ).

### B.3.2.a. Annual energy consumption of heat pumps – basic determination

I used online calculator from TZB-info website to calculate annual energy consumption of heat pumps air/water. [49]

This calculator helps in comparing the costs for heating, hot water and electricity. It calculates according to location, outdoor calculation temperature, length of heating period, total heat loss, number of inhabitants, amount of hot water needed per one person per day and other details about energy source which is in our case heat pump air/water in addition to other boundary conditions. After entering all necessary information about the object, I got the value of **19 436 kWh/year**.

### B.3.1.b. Design of storage tank for variant B

The storage tank is designed to optimize the operation of heat pumps, and to store enough amount of heating water for longer period of time, to reduce the frequency of compressor start-up and thus prolongs its life.

The design of storage tank is done according to manufacturer's recommendation:

Volume of storage tank:  $V_{\min} = 15 \times 21,7 = 325,68 \text{ l}$ .

$$V_{\max} = 20 \times 21,7 = 440 \text{ l}.$$

I chose storage tank PS 400 K+ of volume 403 l, from company Regulus.

Technické údaje	
Celkový objem nádrži	403 l
Max. teplota v nádrži	95 °C
Max. tlak v nádrži	4 bar
Materiály	
Nádrž	S235JR
Izolace pláště nádrže	flís
Vnější povrch izolace pláště	koženka
Izolace dna a vrchní části nádrže	flís
Rozměry, klopná výška a hmotnost	
Průměr nádrže	600 mm
Průměr nádrže s izolací	800 mm
Celková výška nádrže	1665 mm
Klopná výška bez izolace	1700 mm
Tloušťka izolace pláště nádrže	100 mm
Tloušťka izolace dna nádrže	50 mm
Tloušťka izolace vrchní části nádrže	120 mm
Hmotnost nádrže bez izolace	65 kg

Figure 37-parameters of storage tank PS 400 K+

### B.3.3. Heat sources comparison

#### B.3.3.a. Economical comparison

##### 1) Automatic wood pellet boiler economical evaluation:

##### Calculation of costs of wood pellet automatic boiler KP 21 and its installation

Cost of wood pellet automatic boiler KP 21 =	94 380 Kč
Other costs:	
pellet feeder(of length 1,8m)=	10 000 Kč
Damping curtain =	1 653 Kč
Connecting pipe in the filling openings =	2 676 Kč
Installation =	30 000 Kč
OSB boards, supporting angles =	20 000 Kč

**Total costs (of pellet boiler and its installation) 158 709 Kč**



### Annual price of pellets and its delivery

I chose company biomac for ordering pellets(WOOD PELLETS STANDARD - TANK)

Price of pellets per 1 ton =	5 890 Kč/ton
Fee for delivery of pellets by a tank truck =	free
Pellets weight per one refilling =	7,36 ton/refilling
Number of refilling per year =	3 times/year
Cost of pellets per one refilling =	43 355 Kč/refilling
Total cost of pellets including delivery per year =	130 066 Kč/year

### 2) Heat pumps economical evaluation:

#### Calculation of costs of heat pumps Logatherm WPL 14 AR Comfort and their installation

Cost of one heat pump Logatherm WPL 14 AR Comfort =	240 000 Kč
Cost of two heat pumps Logatherm WPL 14 AR Comfort =	480 000 Kč
Installation and earthwork =	15 000 Kč
Concrete base and gravel =	3000 Kč
<b>Total costs(of heat pumps and their installation) =</b>	<b>498 000 Kč</b>

#### Annual consumption price calculation

Annual energy consumption of two pumps =	19436 kWh/year
Price of electricity per kWh =	2,95 Kč/kWh
<b>Annual cost of electricity =</b>	<b>57336 Kč</b>

### 3) Summary of costs:

	Wood pellet boiler	Air source heat pump
<b>Annual fuel consumption</b>	22,08 ton/year	19,4 kWh/year
<b>Annual fuel consumption price</b>	130 051 Kč	57 336 Kč
<b>Cost of boiler/pumps</b>	94 380 Kč	480 000 Kč
<b>Other costs including installation</b>	64 329 Kč	18 000 Kč
<b>Total annual cost in first year</b>	<b>288 760 Kč</b>	<b>555 336 Kč</b>

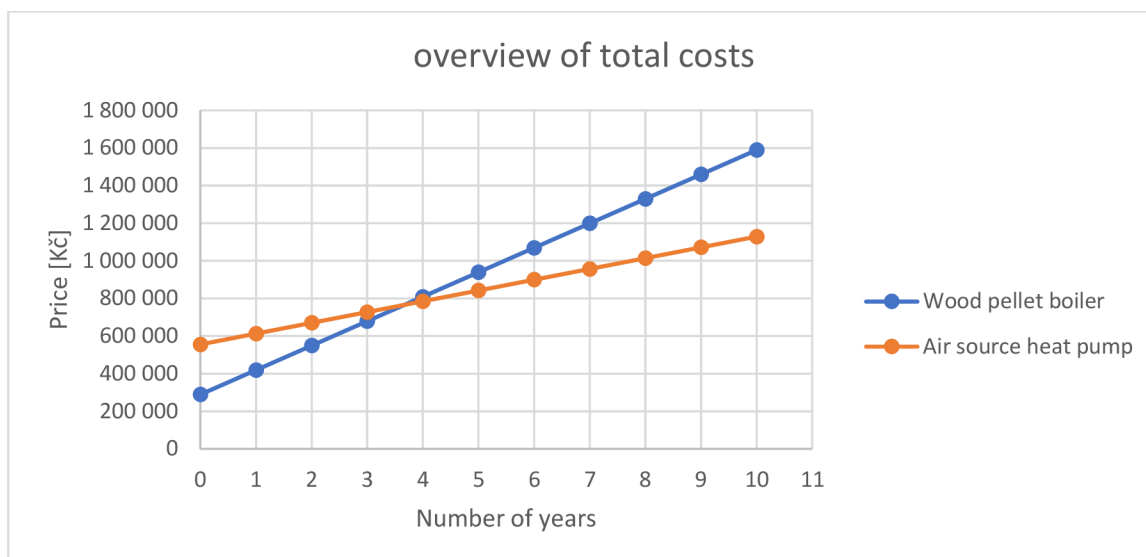

Figure 38- overview of total costs of both variants of heat source

	Wood pellet	Air source heat pump
<b>Annual operating costs</b>	130 051 Kč	57 336 Kč
<b>Acquisition costs</b>	158 709 Kč	498 000 Kč

**Payback = investment cost/ difference of annual costs = 7 years**

**Conclusion:** since payback period is 7 years and life span of heat pumps and wood pellet boilers according to ČSN EN 15459-1 is 15-20 years, we can conclude that in long terms the air source heat pump is more economical than wood pellet boiler for our apartment building.

### B.3.3.b. Environmental effect comparison

The environmental effect of both sources is carried out based on the amount of CO<sub>2</sub> emission of both energy sources.

**Variant-A(Wood pellet boiler):** Wood is a renewable energy source, that during its lifetime it binds just as much CO<sub>2</sub> as it produces when it is burnt, resulting in zero CO<sub>2</sub> balance. Biomass wood pellets are therefore a CO<sub>2</sub>-neutral fuel. Utilization of biomass boilers such as wood pellet boiler may have great impact on the reduction of greenhouse effect.[19]

#### **Variant-B(Air source heat pump):**

The heat pump runs on electricity and takes most of the heat from the environment which is air in our case and according to the manufacturer heat pump Logatherm WPL 14 AR, has high heating factor COP of 4,2 (thus an efficiency of 420%).

Electricity production results in CO<sub>2</sub> emission with a value of 0,86 ton per 1 MWh of electricity according to decree No. 140/2021 Coll(Energy Audit Decree). And we know that annual energy consumption of both heat pumps is 19,44 MWh/year.

Therefore the annual amount of CO<sub>2</sub> emitted for electricity generation, which is required to run both air source heat pumps is :

$$\frac{19,44 \text{ MWh/year}}{420\%} \times 0,86 \text{ t CO}_2/\text{MWh} = 3,98 \text{ t CO}_2 / \text{year}$$

**Conclusion:**

Both heat sources are highly eco-friendly and has zero to minimum impact on the environment. Wood pellets are CO<sub>2</sub>-neutral fuel, meanwhile electricity that is needed to run both air source heat pumps produces 3,98 t of CO<sub>2</sub>/year, which has minimal impact on the environment. So we can conclude that a wood pellet boiler makes a better choice from the environmental aspect comparing to air source heat pump.

**B.3.3.c. Spatial requirements and user comfort comparison**

**Variant-A(Wood pellet boiler):** it's important to consider the spatial requirements of a wood pellet boiler. In our design, we've seen that a wood pellet storage of fixed silo of an area of 6,1 m<sup>2</sup> is necessary to have.

Occasional maintenance of wood pellet boiler is required, it consists of checking the amount of fuel in the storage and checking the amount of ash in the ashtray. At approximately a monthly interval, the heat exchanger should be cleaned by a simple movement of the lever located on the outer casing of the boiler and ash should be removed.

**Variant-B(Air source heat pump):** in the case of an air source heat pump, smaller indoor space is required for the inner unit and an outdoor space is required for the outdoor unit.

Air source heat pump requires relatively little maintenance. In winter, it is necessary to control the outflow of water during defrosting. If ice accumulates somewhere, the ice should be removed. However, Buderus heat pumps are equipped with controlled automatic defrosting, which removes any ice from the evaporator.

At the beginning of heating season, evaporator slats should be cleaned. Because after time of standing or using they may become clogged with dirt, so special brushes are used to clean the slats.

**B.3.4. Variant selection**

Both variants are highly energy-efficient. Wood pellet boiler has zero impact on the environment since it's Co<sub>2</sub> neutral and air to water heat pump has minimal impact on the environment, however it is more economical on the long term than a wood pellet boiler. On the other hand, wood pellet boiler requires more space and more maintenance during heating season than air source heat pump.

I select air source heat pump because it makes a better economical solution on the long term than wood pellet boiler, and it requires less maintenance and less space.

## B.4. Design of heating surfaces

### B.4.1. Calculation of temperature drop and mean radiator temperature

To determine temperature drop between heating water and return water in the heating circuits, I used the calculation of the mean radiator temperature and surface temperature of the window, from which I subsequently determined temperature drop.

The largest window in the apartment building with the following parameters was selected for the calculation.

$$\alpha_{i,w} = 8 \text{ W/m}^2\text{K}$$

$$U_w = 0,7 \text{ W/m}^2\text{K}$$

$$t_i = 20 \text{ }^\circ\text{C}$$

$$t_e = -15 \text{ }^\circ\text{C}$$

$$H_w = 1,45\text{m} \quad L_w = 2,3 \text{ m (of window)}$$

$$H_{OT} = 0,9 \text{ m} \quad L_{OT} = 2,2 \text{ m (of radiator)}$$

Calculation of surface temperature of window  $t_w$

$$U_w \cdot (t_i - t_e) = \alpha_{i,w} \cdot (t_i - t_w)$$

$$0,7 \cdot (20+15) = 8 \cdot (20-t_w) \implies t_w = 16,94 \text{ }^\circ\text{C}$$

Calculation of mean radiator temperature  $t_{ot,m}$

$$L_{ot} \cdot H_{ot} \cdot (t_{ot,m} - t_i) \geq L_w \cdot H_w \cdot (t_i - t_w)$$

$$2,2 \cdot 0,9 \cdot (t_m - 20) \geq 2,3 \cdot 1,45 \cdot (20 - 16,94) \implies t_{ot,m} \geq 25,15 \text{ }^\circ\text{C}$$

So average heat temperature in the heating system should be more than 25,15 and since air to water heat pumps work in low temperature heating systems, I choose temperature drop of **55/45 with  $t_{ot,m} = 50 \text{ }^\circ\text{C}$** .

where  $t_{w1} = 55 \text{ }^\circ\text{C}$ , it is the temperature of heating water.

and  $t_{w2} = 45 \text{ }^\circ\text{C}$ , it is the temperature of return water.

### B.4.2. Design of radiators

For the design, I chose radiators from the company Korado. Radiator type RADIK VK will be designed in all rooms of the apartment building except the bathrooms. Radik VK radiator is a steel panel radiator which allows right or left bottom connection with forced circulating system. Panel radiators are usually designed in residential units and in communal areas.

The bathroom of each apartment will have a towel rail radiator KORALUX LINEAR CLASSIC-M, which is made of closed steel profiles with a "D" - shaped cross-section and straight profiles with a circular cross-section.

### Real radiator output $Q_{real}$

$$Q_{real} = Q_T \cdot \varphi \cdot z_1 \cdot z_2 \cdot z_3 \text{ [W]}$$

Where:

$Q_T$  ..... heat output of radiator in design conditions

$\varphi$  ..... coefficient considering the way of connection of the radiator

$z_1$  ..... coefficient for the adjustment of the surroundings (cover, placement under the window sill, etc.)

$z_2$  ..... coefficient per number of elements

$z_3$  ..... coefficient for the location of the radiator in the room

The following must be fulfilled :  $\Sigma Q_{real} \geq Q_T$

When choosing the radiators, I used online software from KORADO company for the conversion of radiator output for a specific temperature drop.

Branches B1, B2, and B3 on collector and distributor will supply heating water to all radiators.

#### Basment

Branch	Room No.	Description of the room	ti (°C)	Heat losses of the room $Q_{HL,i}$ (W)	Type of radiator	No. Of pieces	Radiator output 55/45 (W)	z1	z2	z3	$\Phi$	Real radiator output $Q_{real}$ (W)
B3	S101	Corridor	15	44,21	not needed	-	-	-	-	-	-	-
B3	S102	Storeroom	15	-49,50	not needed	-	-	-	-	-	-	-
B3	S103	Technical room	20	1283,01	Radik 22 VKL - 600/1500	1	1358	1	1	1	1	1358
B3	S104	Toilet	20	181,01	Radik 10 VK - 600/700	1	218	1	1	1	1	218
B3	S105	Privat gym for inhabitants	20	531,77	Radik 11 VKL - 600/1200	1	615	1	1	1	1	615
B3	S106	Privat gym for inhabitants	20	708,37	Radik 11 VKL - 700/2000	1	715	1	1	1	1	715
B3	S107	Corridor	15	72,65	not needed	-	-	-	-	-	-	-
B3	S108	staircase	10	263,63	Radik 10 VKL - 700/1100	1	393	1	1	1	1	393
											$\Sigma$	3299

**First floor**

Branch	Room No.	Description of the room	ti (°C)	Heat losses of the room $Q_{HL,i}$ (W)	Type of radiator	No. Of pieces	Radiator output 55/45 (W)	z1	z2	z3	Φ	Real radiator output $Q_{real}$ (W)
B2	101A	Vestibule	20	261,68	Radik 10 VK - 600/700	1	359	1	1	1	1	359
B2	102A	Washing machine room	20	92,18	not needed	-	-	-	-	-	-	-
B2	103A	Toilet	20	52,51	not needed	-	-	-	-	-	-	-
B2	104A	Kitchen and living room	20	851,12	Radik 10 VKL - 600/1600 Radik 10 VKL - 600/1400	1	499 437	1	1	1	1	936
B2	105A	Bathroom	24	236,80	Koralux linear classic M - 1220/450	1	243	1	1	1	1	243
B2	106A	Bedroom	20	669,89	Radik 10 VK - 600/1200 Radik 10 VK - 600/1200	1	374 374	1	1	1	1	748
B2	107A	Bedroom	20	528,05	Radik 10 VKL - 700/1600	1	572	1	1	1	1	572
B3	108	Staircase	10	6,00	not needed	-	-	-	-	-	-	-
B1	101B	Vestibule	20	337,86	Radik 10 VKL - 600/700	1	359	1	1	1	1	359
B1	102B	Washing machine room	20	106,47	not needed	-	-	-	-	-	-	-
B1	103B	Toilet	20	84,82	not needed	-	-	-	-	-	-	-
B1	104B	Kitchen and living room	20	1052,00	Radik 10 VK - 600/1600 Radik 11 Vk - 600/1000	1	499 513	1	1	1	1	1012
B1	105B	Bathroom	24	436,90	Koralux linear classic M - 1500/750	1	487	1	1	1	1	487
B1	106B	Bedroom	20	851,11	Radik 10 VKL - 600/1600 Radik 10 VKL - 600/1200	1	499 374	1	1	1	1	873
B1	107B	Bedroom	20	610,44	Radik 11 VK - 600/1200	1	615	1	1	1	1	615
B1	109	Entrance vestibule	0	-174,60	not needed	-	-	-	-	-	-	-
Σ												6204

**Second floor**

Branch	Room No.	Description of the room	ti (°C)	Heat losses of the room $Q_{HL,i}$ (W)	Type of radiator	No. Of pieces	Radiator output 55/45 (W)	z1	z2	z3	Φ	Real radiator output $Q_{real}$ (W)
B2	201A	Vestibule	20	247,81	Radik 10 VK - 700/700	1	250	1	1	1	1	250
B2	202A	Washing machine room	20	88,07	not needed	-	-	-	-	-	-	-
B2	203A	Toilet	20	52,51	not needed	-	-	-	-	-	-	-
B2	204A	Kitchen and living room	20	822,39	Radik 10 VKL - 600/1600 Radik 10 VKL - 600/1100	1	499 343	1	1	1	1	842
B2	205A	Bathroom	24	240,90	Koralux linear classic M - 1220/450	1	243	1	1	1	1	243
B2	206A	Bedroom	20	669,89	Radik 10 VK - 600/1200 Radik 10 VK - 600/1200	1	374 374	1	1	1	1	748
B2	207A	Bedroom	20	445,65	Radik 10 VKL - 600/1600	1	499	1	1	1	1	499
B3	208	Staircase	10	-134,28	not needed	-	-	-	-	-	-	-
B1	201B	Vestibule	20	247,81	Radik 10 VKL - 700/700	1	250	1	1	1	1	250
B1	202B	Washing machine room	20	88,09	not needed	-	-	-	-	-	-	-
B1	203B	Toilet	20	52,51	not needed	-	-	-	-	-	-	-
B1	204B	Kitchen and living room	20	822,39	Radik 10 VK - 600/1600 Radik 10 Vk - 600/1100	1	499 343	1	1	1	1	842
B1	205B	Bathroom	24	240,90	Koralux linear classic M - 1220/450	1	243	1	1	1	1	243
B1	206B	Bedroom	20	669,89	Radik 10 VKL - 600/1200 Radik 10 VKL - 600/1200	1	374 374	1	1	1	1	748
B1	207B	Bedroom	20	445,65	Radik 10 VK - 600/1600	1	499	1	1	1	1	499
B3	211	Laundry room	15	404,27	Radik 10 VK - 600/1600	1	499	1	1	1	1	499
Σ												5663

Third floor

Branch	Room No.	Description of the room	ti (°C)	Heat losses of the room $Q_{HL,i}$ (W)	Type of radiator	No. Of pieces	Radiator output 55/45 (W)	z1	z2	z3	$\Phi$	Real radiator output $Q_{real}$ (W)
B2	301A	Vestibule	20	293,85	Radik 10 VK - 600/700	1	359	1	1	1	1	359
B2	302A	Washing machine room	20	97,47	not needed	-	-	-	-	-	-	-
B2	303A	Toilet	20	69,03	not needed	-	-	-	-	-	-	-
B2	304A	Kitchen and living room	20	1445,42	Radik 10 VKL - 700/1800 Radik 11 VKL - 700/1400	1	643 815	1	1	1	1	1458
B2	305A	Bathroom	24	279,00	Koralux linear classic M - 900/750	1	279	1	1	1	1	279
B2	306A	Bedroom	20	762,54	Radik 10 VK - 600/1400 Radik 10 VK - 600/1200	1	437 374	1	1	1	1	811
B2	307A	Bedroom	20	529,90	Radik 10 VKL - 700/1600	1	572	1	1	1	1	572
B3	308	Staircase	10	-8,82	not needed	-	-	-	-	-	-	-
B1	301B	Vestibule	20	293,85	Radik 10 VK - 600/700	1	359	1	1	1	1	359
B1	302B	Washing machine room	20	97,49	not needed	-	-	-	-	-	-	-
B1	303B	Toilet	20	69,03	not needed	-	-	-	-	-	-	-
B1	304B	Kitchen and living room	20	1445,42	Radik 10 VK - 700/1800 Radik 11 Vk - 700/1400	1	643 815	1	1	1	1	1458
B1	305B	Bathroom	24	279,00	Koralux linear classic M - 900/750	1	279	1	1	1	1	279
B1	306B	Bedroom	20	762,54	Radik 10 VKL - 600/1400 Radik 10 VKL - 600/1200	1	437 374	1	1	1	1	811
B1	307B	Bedroom	20	529,90	Radik 10 VK - 700/1600	1	572	1	1	1	1	572
B3	311	Laundry room	15	478,00	Radik 10 VK - 600/1600	1	499	1	1	1	1	499
											$\Sigma$	7457

Branches	Description	Total output [kW]
B1	Eastern flats	9,407
B2	Western flats	8,919
B3	Comunal areas	4,297
<b>Total</b>		<b>22,623</b>

B.4.3. Used heating surfaces

- Steel panel radiator KORADO RADIK VK

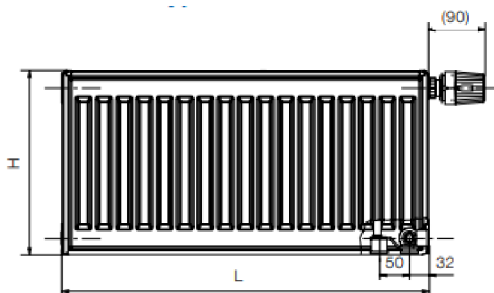
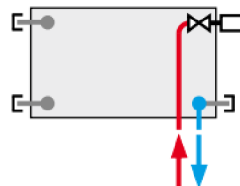

Figure 39- Steel panel radiator Korado Radik VK[50]



right bottom  
 $\phi = 1$

Figure 40- connection of radiator Radik VK to the heating system[50]

Overview of types

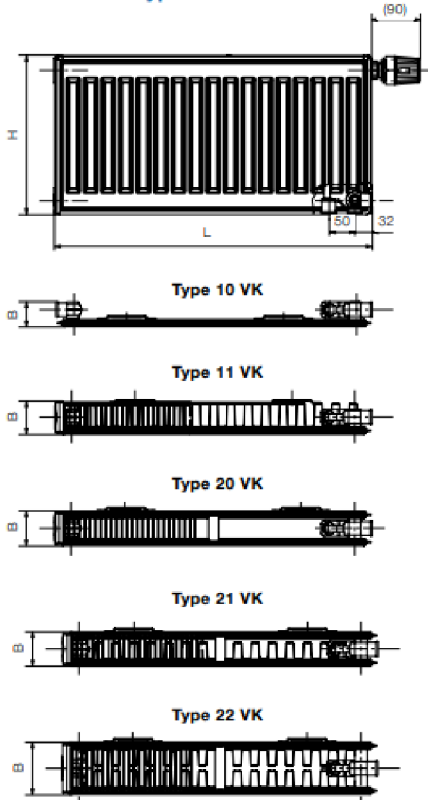

Technical data

Height H	300, 400, 500, 600, 700, 900 mm
Length L	400, 500, 600, 700, 800, 900, 1000, 1100, 1200, 1400, 1600, 1800, 2000, 2300, 2600, 3000 mm
Depth B	
Type 10 VK	47 mm
Type 11 VK	63 mm
Type 20 VK	66 mm
Type 21 VK	66 mm
Type 22 VK	100 mm
Type 33 VK	155 mm
Connecting pitch	50 mm
Connecting thread	6 × G1/2" inside
Highest allowed working pressure	10 bar
Highest allowed working temperature	110 °C
Radiator connection	right bottom

Figure 41-technical data of Korado Radik VK radiator[50]

• Steel panel radiator RADIK VKL

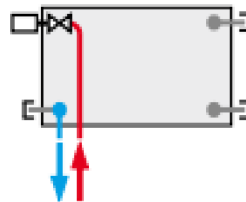
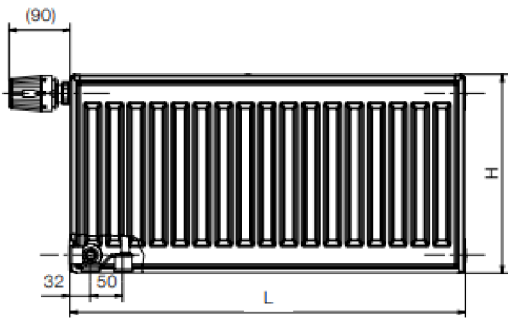

left bottom  
 $\varphi = 1$

Figure 42-Steel panel radiator Radik VKL[50]

Figure 43-Radiator Radik VKL connection to the heating system[50]



### Overview of types

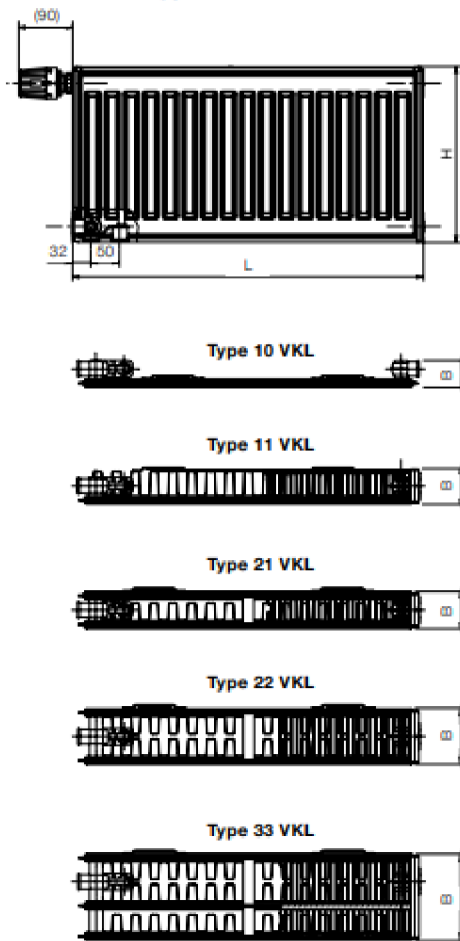

### Technical data

Height H	300, 400, 500, 600, 700, 900 mm
Length L	400, 500, 600, 700, 800, 900, 1000, 1100, 1200, 1400, 1600, 1800, 2000, 2300, 2600, 3000 mm
Depth B	Type 10 VKL: 47 mm Type 11 VKL: 63 mm Type 21 VKL: 66 mm Type 22 VKL: 100 mm Type 33 VKL: 155 mm
Connecting pitch	50 mm
Connecting thread	6 × G1/2" inside
Highest allowed working pressure	10 bar
Highest allowed working temperature	110 °C
Radiator connection	left bottom

Figure 44-technical data of Korado Radik VKL radiator[50]



Figure 45- thermostatic head Heimeier - Type DX[50]

- Towel rail radiator KORALUX LINEAR CLASSIC - M

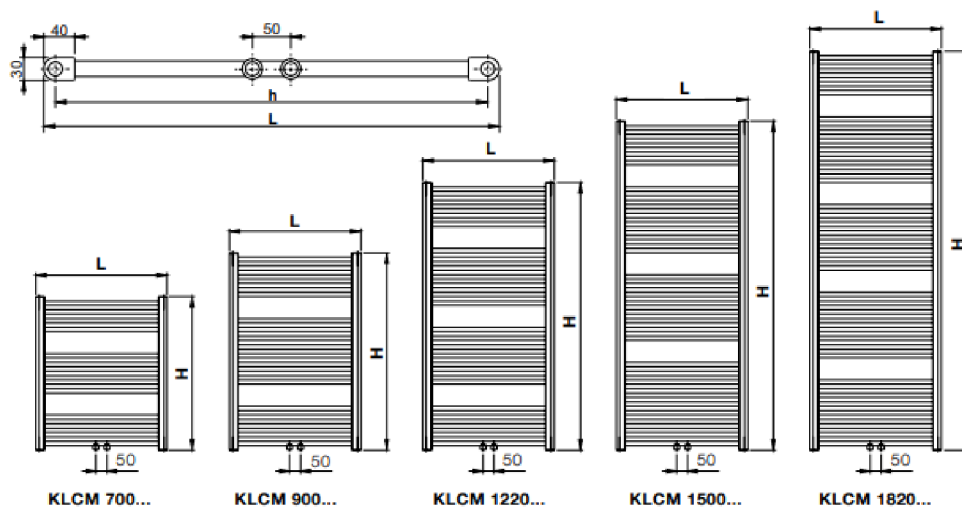
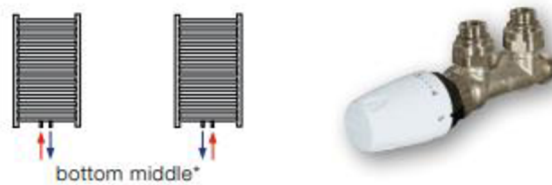

Figure 46-Radiator Koralex linear classic – M[51]

### Type of Connection KORALUX LINEAR CLASSIC - M



\*For radiators with the bottom middle connection you can use the integrated connection fittings HM delivered together with a thermostatic head (see page 39).

Figure 47- connection of radiator Koralex Linear classic – M[51]

### Technical Data

Height H	700, 900, 1220, 1500, 1820 mm
Length L	450, 500, 600, 750 mm
Depth B	30 mm
Connecting pitch (KLC)	$h = L - 30$ mm
Connecting pitch (KLCM)	50 mm
Connecting thread (KLC)	4 x G 1/2 inside
Connecting thread (KLCM)	6 x G 1/2 inside
Highest allowed working pressure	10 bar
Test pressure	13 bar
Maximum water temperature	110 °C
Flow coefficient (KLC)	$A_T = 2,1 \times 10^{-4} \text{ m}^2$
Flow coefficient (KLCM)	$A_T = 7,1 \times 10^{-5} \text{ m}^2$
Coefficient of resistance (KLC)	$\xi_T = 1,8$
Coefficient of resistance (KLCM)	$\xi_T = 16,0$

Figure 48-technical data of radiator Koralex linear classic-M[51]

## B.5. Dimensioning and hydraulic balancing of heating system

Heating system is designed as a two-pipe, low temperature heating system. The apartment building is divided into two parts of apartments; east and west; and a part with communal areas. Each part has its own branch from the distributor and collector in the basement, and then own rising pipe leading from the basement up to the last floor.

On each floor and before the entrance to each apartment, there will be a niche in the masonry wall, in which will be measuring unit for each apartment. A measuring unit consists of a heat meter Sharky 774, DN 20, installed on the heating water pipe, which is connected with a temperature measuring ball valve on the return pipes. Closing ball valves are installed before and after the heat meter, as well as on the return pipe. Also, a filter before the heat meter is necessary to have to protect the device from getting clogged.

Total disposition pressure loss to the furthest radiator must be equal to total disposition pressure loss to any other radiator, in order for the water to flow to all radiators, so hydraulic balancing is required.

The whole heating system is balanced by the presetting of thermostatic valves TRV of panel radiators Radik VK and Radik VKL, and also the presetting of HM fittings of Koralux linear classic-M towel rail radiator.

The most distant and at the same time the most powerful radiator in each apartment is selected and from there each section is dimensioned. Section means the part where the mass flow is the same. The design is done according to economic (optimal) speeds. Speeds in the connecting pipes should be in the range 0,15 - 0,6 m/s and for main horizontal distribution pipes the speed should be in the range 0,6 - 1,0 m/s . Specific pressure loss should be in the range 60 - 100 Pa/m for connecting pipes and 110 - 200 Pa/m for main distribution pipes. According to these principles, we can choose nominal pipe diameter DN, and calculate specific pressure loss R [Pa /m] and flow speed w [m/s]. [41]

The following values should be determined:

### Determination of mass flow

$$M = (Q \cdot 3600) / (c \cdot \Delta t) \quad [\text{kg/h}]$$

Where Q ..... heat output[W]

c.....specific thermal capacity of water[J/kg.K]

$\Delta t$ .....temperature difference[K]

### Determination of Disposition pressure

Disposition pressure consists of the sum of friction pressure loss, local resistance pressure loss in the pipelines and pressure loss due to presetting of valves. It is necessary to

overcome these pressure losses by using a pump, in order for the heating water to flow in pipes.

#### Friction pressure loss

$$\Delta P_{\lambda} = \lambda \cdot \frac{l}{d} \cdot \frac{w^2}{2} \cdot \rho = R \cdot l$$

Where  $\Delta p_{\lambda}$  ... friction pressure losses [Pa]

R ... specific pressure loss [Pa/m]

L ... section length [m]

$\lambda$  ... coefficient of friction depending on the type of flow and roughness of the material [-]

d ... internal pipe profile [mm]

w ... water velocity in the pipe [m/s]

$\rho$  ... water density [kg /m<sup>3</sup>]

To calculate the pressure loss due to friction, I used online software on TZB - info website.

Pressure loss was calculated for average temperature 50°. [52]

#### Local resistance pressure loss

$$Z = \Delta p_{\xi} = \sum \xi \cdot \frac{w^2}{2} \cdot \rho$$

Where Z,  $\Delta p_{\xi}$  ... pressure loss by local resistances [Pa]

$\xi$  ... local resistance factor [-]

w ... water velocity in the pipe [m /s]

$\rho$  ... water density [kg /m<sup>3</sup>]

#### Presetting of valves

The system must be hydraulically balanced. Panel radiators are provided with thermostatic valve (TRV). The towel rail radiators are provided with HM fitting.

We determine the correct presetting of TRV valves and HM fitting according to the required pressure loss and mass flow by using diagrams that are provided by the manufacturer.

## Two-pipe heating system

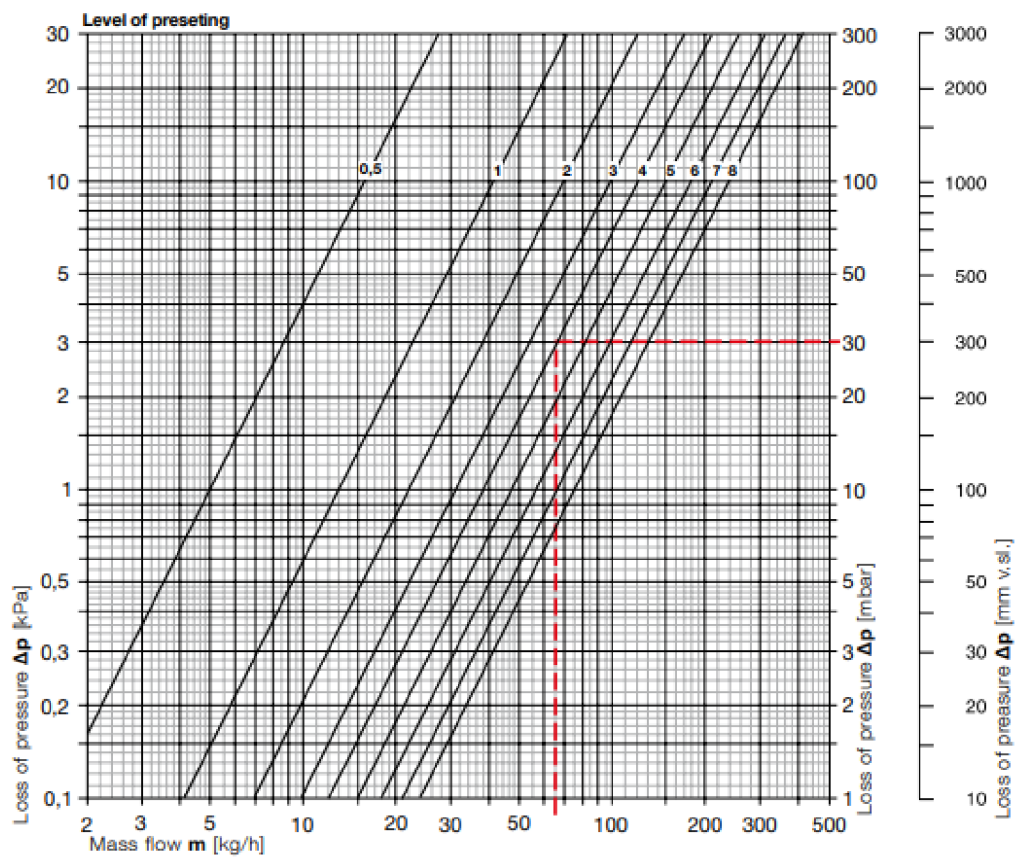

Figure 45-Graph for determining the presetting of thermostatic valve (TRV) for RADIK VK and VKL radiators[50]

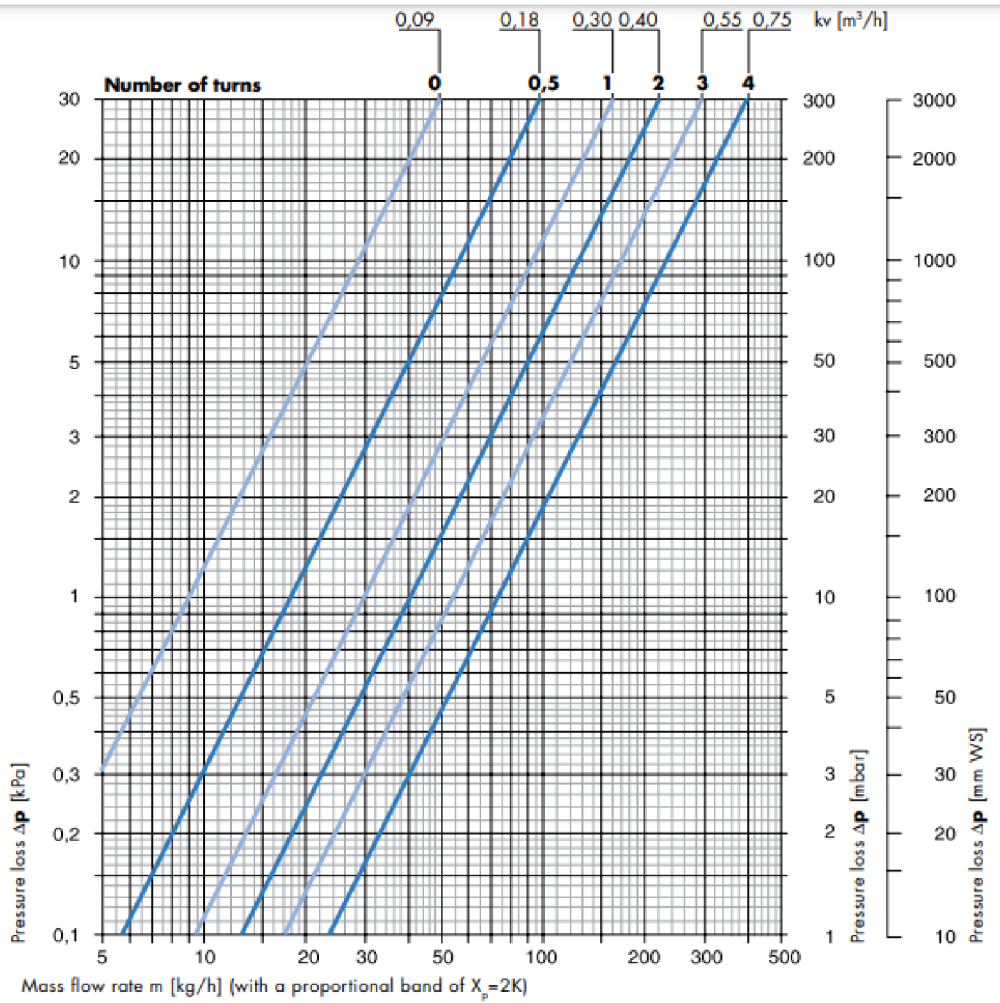

Figure 46 - diagram for presetting of HM fitting[51]



Figure 47- thermostatic valve of RADIK VK and VKL radiators[50]

## Calculations of dimensioning and hydraulic balancing of the whole heating system

### THIRD FLOOR

Temperature difference 10K (55/45)

**Dimensioning of basic longest circuit to radiator 11 - VKL 700/1400 in room 304 A (to apartment 5) including rising pipe S1**

Sec. No.	l (m)	Q (W)	M (kg/h)	DN (D x t)	R (Pa/m)	w (m/s)	R*I (Pa)	ξ (-)	Z (Pa)	Valve setting	TRV/HM	Δp <sub>RV</sub> (Pa)	R*I+Z + Δp <sub>RV</sub> (Pa)	Δp <sub>DIS</sub> (Pa)	
1	7,94	643	55,378	12x1	76,3	0,20	605,82	22,49	449,80	TRV(8)		550	1605,62	1605,62	
2	17,4	1458	125,569	15x1	102	0,27	1774,8	4,69	170,95				1945,75	3551,37	
3	13,89	3479	299,627	22x1	58,6	0,27	813,95	16,09	586,48			2000	3400,43	6951,81	
Heat meter Sharky 774(DN 20)												Δp <sub>RV</sub> =	2000	Pa	
4	6,42	6061	522	28x1,5	53,2	0,3	341,54	0,9	40,50				382,04	7333,85	
5	29,7	8919	<b>768,14</b>	28x1,5	105	0,44	3118,5	25,4	2458,72			7430	13007,22	20341,07	
Balancing valve(DN=25)												Δp <sub>RV</sub> =	2500	Pa	
Filter(DN25)												Δp <sub>RV</sub> =	4930	Pa	<b>20341,07</b>
Three way valve(DN20)												Δp <sub>RV</sub> =	9441	Pa	<b>29781,78</b>

Local resistance ξ (-)

1	radiator	connection valvex2	elbow x 8	connection	division	enlargement	narrowing	KK	Σ
	3	8	10,4	0,6	0,3	0,15	0,04		22,49
2			elbow x 2	connection	division	enlargement	narrowing		Σ
			2,6	0,6	1,3	0,15	0,04		4,69
3			elbow x 10	connection	division	enlargement	narrowing	KKx4	Σ
			13	0,6	0,3	0,15	0,04	2	16,09
4			connection	division					Σ
			0,6	0,3					0,90
5	VKx4	ZKx1	elbow x 12	collector and distributor entrance		collector and distributor exit		KKx4	Σ
	2	4,3	15,6	1		0,5		2	25,40

**Dimensioning of section to radiator 10-VKL 700/1800 in room 304 A**

Sec. No.	l (m)	Q (W)	M (kg/h)	DN (D x t)	R (Pa/m)	w (m/s)	R*I (Pa)	ξ (-)	Z (Pa)	Valve setting	TRV/HM	Δp <sub>RV</sub> (Pa)	R*I+Z + Δp <sub>RV</sub> (Pa)	Δp <sub>DIS</sub> (Pa)
6	1,8	815	70,1914	15x1	32,1	0,15	57,78	18,29	205,76	TRV(7)			263,54	263,54
Design of presetting of valve of radiator														
1605,62 - 263,54 = 1342,08 Pa Presetting according to diagram (7)														

Local resistance ξ (-)

6	radiator	connection valvex2	elbow x 4	connection	division	enlargement	narrowing	KK	Σ
	3	8	5,2	0,6	1,3	0,15	0,04		18,29

**Dimensioning of circuit to radiator 10 - VK 600/1400 in room 306 A**

Sec. No.	l (m)	Q (W)	M (kg/h)	DN (D x t)	R (Pa/m)	w (m/s)	R*I (Pa)	ξ (-)	Z (Pa)	Valve setting	TRV/HM	Δp <sub>RV</sub> (Pa)	R*I+Z + Δp <sub>RV</sub> (Pa)	Δp <sub>DIS</sub> (Pa)
7	5,13	437	37,6364	10x1	92,3	0,21	473,13	22,49	495,90	TRV(4)			969,03	969,03
8	6,2	811	69,8469	12x1	125	0,25	775	1,09	34,06				809,06	1778,10
9	5,96	1383,85	119,183	15x1	89	0,25	530,44	3,69	115,31				645,75	2423,85
10	1,55	1955,85	168,446	18x1	63,4	0,24	98,27	1,09	31,39				129,66	2553,51
Design of presetting of valve of radiator														
3551,37 - 2553,51 = 997,86 Pa Presetting according to diagram (4)														

Local resistance ξ (-)

7	radiator	connection valvex2	elbow x 8	connection	division	enlargement	narrowing	KK	Σ
	3	8	10,4	0,6	0,3	0,15	0,04		22,49
8			connection	division	enlargement	narrowing			Σ
			0,6	0,3	0,15	0,04			1,09
9			elbow x 2	connection	division	enlargement	narrowing		Σ
			2,6	0,6	0,3	0,15	0,04		3,69
10			connection	division	enlargement	narrowing			Σ
			0,6	0,3	0,15	0,04			1,09

**Dimensioning of section to radiator 10-VK 600/1200 in room 306 A**

Sec. No.	l (m)	Q (W)	M (kg/h)	DN (D x t)	R (Pa/m)	w (m/s)	R*I (Pa)	ξ (-)	Z (Pa)	Valve setting	TRV/HM	Δp <sub>RV</sub> (Pa)	R*I+Z + Δp <sub>RV</sub> (Pa)	Δp <sub>DIS</sub> (Pa)
11	5,156	374	32,2105	10x1	60,2	0,18	310,39	18,29	296,30	TRV(3)			606,69	606,69
Design of presetting of valve of radiator														
		1966,90	-	606,69	=	1360,21 Pa	Presetting according to diagram (3)							

**Local resistance ξ (-)**

11	radiator	connection valvex2	elbow x 4	connection	division	enlargement	narrowing	KK	Σ
	3	8	5,2	0,6	1,3	0,15	0,04		18,29

**Dimensioning of section to radiator KLC-M 900/750 in room 305A**

Sec. No.	l (m)	Q (W)	M (kg/h)	DN (D x t)	R (Pa/m)	w (m/s)	R*I (Pa)	ξ (-)	Z (Pa)	Valve setting	TRV/HM	Δp <sub>RV</sub> (Pa)	R*I+Z + Δp <sub>RV</sub> (Pa)	Δp <sub>DIS</sub> (Pa)
12	7,1	279	24,0287	10x1	35,5	0,13	252,05	25,59	216,24		HM(0,5)		468,29	468,29
13	1,4	638	54,9474	12x1	76,3	0,20	106,82	2,09	41,80				148,62	616,91
Design of presetting of valve of radiator														
		2775,96	-	616,91	=	2159,05 Pa	Presetting according to diagram (0,5)							

**Local resistance ξ (-)**

12	radiator	connection valvex2	elbow x 10	connection	division	enlargement	narrowing	KK	Σ
	2,5	8	13	0,6	1,3	0,15	0,04		25,59
13	radiator	connection valvex2	elbow x 10	connection	division	enlargement	narrowing	KK	Σ
				0,6	1,3	0,15	0,04		2,09

**Dimensioning of section to radiator 10-VK 600/700 in room 301A**

Sec. No.	l (m)	Q (W)	M (kg/h)	DN (D x t)	R (Pa/m)	w (m/s)	R*I (Pa)	ξ (-)	Z (Pa)	Valve setting	TRV/HM	Δp <sub>RV</sub> (Pa)	R*I+Z + Δp <sub>RV</sub> (Pa)	Δp <sub>DIS</sub> (Pa)
14	3,55	359	30,9187	10x1	51,4	0,17	182,47	17,29	249,84	TRV(2)			432,31	432,31
Design of presetting of valve of radiator														
		2627,34	-	432,31	=	2195,03 Pa	Presetting according to diagram (2)							

**Local resistance ξ (-)**

14	radiator	connection valvex2	elbow x 4	connection	division	enlargement	narrowing	KK	Σ
	3	8	5,2	0,6	0,3	0,15	0,04		17,29

**Dimensioning of section to radiator 10-VKL 700/1600 in room 307A**

Sec. No.	l (m)	Q (W)	M (kg/h)	DN (D x t)	R (Pa/m)	w (m/s)	R*I (Pa)	ξ (-)	Z (Pa)	Valve setting	TRV/HM	Δp <sub>RV</sub> (Pa)	R*I+Z + Δp <sub>RV</sub> (Pa)	Δp <sub>DIS</sub> (Pa)
15	12,8	572	49,2632	12x1	56,9	0,18	728,32	23,49	380,54	TRV(3)			1108,86	1108,86
Design of presetting of valve of radiator														
		3421,71	-	1108,86	=	2312,85 Pa	Presetting according to diagram (3)							

**Local resistance ξ (-)**

15	radiator	connection valvex2	elbow x 8	connection	division	enlargement	narrowing	KK	Σ
	3	8	10,4	0,6	1,3	0,15	0,04		23,49



### Third floor(continuation)

Temperature difference 10K (55/45)

#### Dimensioning of basic longest circuit to radiator 11 -VK 700/1400 in room 304 B(aptartment 6)including rising pipe S2

Sec. No.	l (m)	Q (W)	M (kg/h)	DN (D x t)	R (Pa/m)	w (m/s)	R*I (Pa)	ξ (-)	Z (Pa)	Valve setting	TRV/HM	Δp <sub>RV</sub> (Pa)	R*I+Z + Δp <sub>RV</sub> (Pa)	Δp <sub>DIS</sub> (Pa)	
1	7,94	643	55,378	12x1	76,3	0,20	605,82	22,49	449,80	TRV(8)		550	1605,62	1605,62	
2	17,4	1458	125,569	15x1	102	0,27	1774,8	4,69	170,95				1945,75	3551,37	
3	13,89	3479	299,627	22x1	58,6	0,27	813,95	16,09	586,48			2000	3400,43	6951,81	
Heat meter Sharky 774(DN 20)												Δp <sub>RV</sub> =	2000	Pa	
4	6,42	6061	522	28x1,5	53,2	0,3	341,54	0,9	40,50				382,04	7333,85	
5	29,7	9407	<b>810,17</b>	28x1,5	105	0,44	3118,5	26,4	2555,52			4820	10494,02	17827,87	
Balancing valve(DN=25)												Δp <sub>RV</sub> =	2900	Pa	
Filter(DN25)												Δp <sub>RV</sub> =	1920	Pa	<b>17827,87</b>
Three way valve(DN20)												Δp <sub>RV</sub> =	4102	Pa	<b>21930,24</b>

#### Local resistance ξ (-)

1	radiator	connection valvex2	elbow x 8	connection	division	enlargement	narrowing	KK	Σ
	3	8	10,4	0,6	0,3	0,15	0,04		22,49
2			elbow x 2	connection	division	enlargement	narrowing		Σ
			2,6	0,6	1,3	0,15	0,04		4,69
3			elbow x 10	connection	division	enlargement	narrowing	KKx4	Σ
			13	0,6	0,3	0,15	0,04	2	16,09
4				connection	division				Σ
				0,6	0,3				0,90
5	VKx4	ZKx1	elbow x 12	collector and distributor entrance		collector and distributor exit		KKx6	Σ
	2	4,3	15,6	1		0,5		3	26,40

#### Dimensioning of section to radiator 10-VK 700/1800 in room 304 B

Sec. No.	l (m)	Q (W)	M (kg/h)	DN (D x t)	R (Pa/m)	w (m/s)	R*I (Pa)	ξ (-)	Z (Pa)	Valve setting	TRV/HRŠ	Δp <sub>RV</sub> (Pa)	R*I+Z + Δp <sub>RV</sub> (Pa)	Δp <sub>DIS</sub> (Pa)
6	1,8	815	70,1914	15x1	32,1	0,15	57,78	18,29	205,76	TRV(7)			263,54	263,54
Design of presetting of valve of radiator														
1605,62 - 263,54 = 1342,08 Pa Presetting according to diagram (7)														

#### Local resistance ξ (-)

6	radiator	connection valvex2	elbow x 4	connection	division	enlargement	narrowing	KK	Σ
	3	8	5,2	0,6	1,3	0,15	0,04		18,29

#### Dimensioning of circuit to radiator 10 -VKL 600/1400 in room 306 B

Sec. No.	l (m)	Q (W)	M (kg/h)	DN (D x t)	R (Pa/m)	w (m/s)	R*I (Pa)	ξ (-)	Z (Pa)	Valve setting	TRV/HM	Δp <sub>RV</sub> (Pa)	R*I+Z + Δp <sub>RV</sub> (Pa)	Δp <sub>DIS</sub> (Pa)
7	5,13	437	37,6364	10x1	92,3	0,21	473,13	22,49	495,90	TRV(4)			969,03	969,03
8	6,2	811	69,8469	12x1	125	0,25	775	1,09	34,06				809,06	1778,10
9	5,96	1383,85	119,183	15x1	89	0,25	530,44	3,69	115,31				645,75	2423,85
10	1,55	1955,85	168,446	18x1	63,4	0,24	98,27	1,09	31,39				129,66	2553,51
Design of presetting of valve of radiator														
3551,37 - 2553,51 = 997,86 Pa Presetting according to diagram (4)														

#### Local resistance ξ (-)

7	radiator	connection valvex2	elbow x 8	connection	division	enlargement	narrowing	KK	Σ
	3	8	10,4	0,6	0,3	0,15	0,04		22,49
8				connection	division	enlargement	narrowing		Σ
				0,6	0,3	0,15	0,04		1,09
9			elbow x 2	connection	division	enlargement	narrowing		Σ
			2,6	0,6	0,3	0,15	0,04		3,69
10				connection	division	enlargement	narrowing		Σ
				0,6	0,3	0,15	0,04		1,09

**Dimensioning of section to radiator 10-VKL 600/1200 in room 306 B**

Sec. No.	l (m)	Q (W)	M (kg/h)	DN (D x t)	R (Pa/m)	w (m/s)	R*I (Pa)	ξ (-)	Z (Pa)	Valve setting TRV/HM	Δp <sub>RV</sub> (Pa)	R*I+Z + Δp <sub>RV</sub> (Pa)	Δp <sub>DIS</sub> (Pa)
11	5,156	374	32,2105	10x1	60,2	0,18	310,39	18,29	296,30	TRV(3)		606,69	606,69
Design of presetting of valve of radiator													
1966,90 - 606,69 = 1360,21 Pa Presetting according to diagram (3)													

**Local resistance ξ (-)**

11	radiator	connection valvex2	elbow x 4	connection	division	enlargement	narrowing	KK	Σ
	3	8	5,2	0,6	1,3	0,15	0,04		18,29

**Dimensioning of section to radiator KLC-M 900/750 in room 305B**

Sec. No.	l (m)	Q (W)	M (kg/h)	DN (D x t)	R (Pa/m)	w (m/s)	R*I (Pa)	ξ (-)	Z (Pa)	Valve setting TRV/HM	Δp <sub>RV</sub> (Pa)	R*I+Z + Δp <sub>RV</sub> (Pa)	Δp <sub>DIS</sub> (Pa)
12	7,1	279	24,0287	10x1	35,5	0,13	252,05	25,59	216,24	HM(0,5)		468,29	468,29
13	1,4	638	54,9474	12x1	76,3	0,20	106,82	2,09	41,80			148,62	616,91
Design of presetting of valve of radiator													
2775,96 - 616,91 = 2159,05 Pa Presetting according to diagram (0,5)													

**Local resistance ξ (-)**

12	radiator	connection valvex2	elbow x 10	connection	division	enlargement	narrowing	KK	Σ
	2,5	8	13	0,6	1,3	0,15	0,04		25,59
13	radiator	connection valvex2	elbow x 4	connection	division	enlargement	narrowing	KK	Σ
				0,6	1,3	0,15	0,04		2,09

**Dimensioning of section to radiator 10-VKL 600/700 in room 301B**

Sec. No.	l (m)	Q (W)	M (kg/h)	DN (D x t)	R (Pa/m)	w (m/s)	R*I (Pa)	ξ (-)	Z (Pa)	Valve setting TRV/HM	Δp <sub>RV</sub> (Pa)	R*I+Z + Δp <sub>RV</sub> (Pa)	Δp <sub>DIS</sub> (Pa)
14	3,55	359	30,9187	10x1	51,4	0,17	182,47	17,29	249,84	TRV(2)		432,31	432,31
Design of presetting of valve of radiator													
2627,34 - 432,31 = 2195,03 Pa Presetting according to diagram (2)													

**Local resistance ξ (-)**

14	radiator	connection valvex2	elbow x 4	connection	division	enlargement	narrowing	KK	Σ
	3	8	5,2	0,6	0,3	0,15	0,04		17,29

**Dimensioning of section to radiator 10-VK 700/1600 in room 307B**

Sec. No.	l (m)	Q (W)	M (kg/h)	DN (D x t)	R (Pa/m)	w (m/s)	R*I (Pa)	ξ (-)	Z (Pa)	Valve setting TRV/HM	Δp <sub>RV</sub> (Pa)	R*I+Z + Δp <sub>RV</sub> (Pa)	Δp <sub>DIS</sub> (Pa)
15	12,8	572	49,2632	12x1	56,9	0,18	728,32	23,49	380,54	TRV(3)		1108,86	1108,86
Design of presetting of valve of radiator													
3421,71 - 1108,86 = 2312,85 Pa Presetting according to diagram (3)													

**Local resistance ξ (-)**

15	radiator	connection valvex2	elbow x 8	connection	division	enlargement	narrowing	KK	Σ
	3	8	10,4	0,6	1,3	0,15	0,04		23,49

**SECOND FLOOR**

Temperature difference 10K (55/45)

**Dimensioning of basic circuit to radiator 10 -VKL 600/1100 in room 204 A (apartment 3)**

Sec. No.	l (m)	Q (W)	M (kg/h)	DN (D x t)	R (Pa/m)	w (m/s)	R*I (Pa)	ξ (-)	Z (Pa)	Valve setting TRV/HM	Heat meter Sharky 774 (DN20)(Pa)	Δp <sub>RV</sub> (Pa)	R*I+Z + Δp <sub>RV</sub> (Pa)	Δp <sub>DIS</sub> (Pa)
1	8,224	343	29,5407	10x1	51,4	0,17	422,71	22,49	324,98	TRV(3)			747,69	747,69
2	17,4	842	72,5167	12x1	134	0,26	2331,6	4,69	158,52				2490,12	3237,82
3	7,5	2582	222,373	18x1	99,6	0,31	747	14,49	696,24		1200		2643,24	5881,06
6951,81 - 5881,06 = 1070,75 Pa Setting according to diagram from the catalogue TRV(3)														

**Local resistance ξ (-)**

1	radiator	connection valvex2	elbow x 8	connection	division	enlargement	narrowing	KK	Σ
	3	8	10,4	0,6	0,3	0,15	0,04		22,49
2	radiator	connection valvex2	elbow x 2	connection	division	enlargement	narrowing	KK	Σ
			2,6	0,6	1,3	0,15	0,04		4,69
3	radiator	connection valvex2	elbow x 8	connection	division	enlargement	narrowing	KKx4	Σ
			10,4	0,6	1,3	0,15	0,04	2	14,49

**Dimensioning of section to radiator 10-VKL 600/1600 in room 204 A**

Sec. No.	l (m)	Q (W)	M (kg/h)	DN (D x t)	R (Pa/m)	w (m/s)	R*I (Pa)	ξ (-)	Z (Pa)	Valve setting	TRV/HRŠ	Δp <sub>RV</sub> (Pa)	R*I+Z + Δp <sub>RV</sub> (Pa)	Δp <sub>DIS</sub> (Pa)
4	1,8	499	42,9761	12x1	34,4	0,15	61,92	18,29	205,76	TRV(4)			267,68	267,68

Design of presetting of valve of radiator

1818,44 - 267,68 = 1550,76 Pa      Presetting according to diagram (4)

**Local resistance ξ (-)**

4	radiator	connection valvex2	elbow x 4	connection	division	enlargement	narrowing	KK	Σ
	3	8	5,2	0,6	1,3	0,15	0,04		18,29

**Dimensioning of circuit to radiator 10 -VK 600/1200 in room 206 A**

Sec. No.	l (m)	Q (W)	M (kg/h)	DN (D x t)	R (Pa/m)	w (m/s)	R*I (Pa)	ξ (-)	Z (Pa)	Valve setting	TRV/HM	Δp <sub>RV</sub> (Pa)	R*I+Z + Δp <sub>RV</sub> (Pa)	Δp <sub>DIS</sub> (Pa)
5	5,314	374	32,2105	10x1	60,2	0,18	319,9	22,49	364,34	TRV(2)			684,24	684,24
6	6,2	748	64,4211	12x1	108	0,23	669,6	1,09	28,83				698,43	1382,67
7	5,962	1241,00	106,88	15x1	77	0,23	459,07	3,69	97,60				556,67	1939,35
8	1,552	1740,00	149,856	18x1	50,2	0,21	77,91	1,09	24,03				101,94	2041,29

Design of presetting of valve of radiator

4308,56 - 2041,29 = 2267,27 Pa      Presetting according to diagram (2)

**Local resistance ξ (-)**

5	radiator	connection valvex2	elbow x 8	connection	division	enlargement	narrowing	KK	Σ
	3	8	10,4	0,6	0,3	0,15	0,04		22,49
6				connection	division	enlargement	narrowing		Σ
				0,6	0,3	0,15	0,04		1,09
7			elbow x 2	connection	division	enlargement	narrowing		Σ
			2,6	0,6	0,3	0,15	0,04		3,69
8				connection	division	enlargement	narrowing		Σ
				0,6	0,3	0,15	0,04		1,09

**Dimensioning of section to radiator 10-VK 600/1200 in room 206 A**

Sec. No.	l (m)	Q (W)	M (kg/h)	DN (D x t)	R (Pa/m)	w (m/s)	R*I (Pa)	ξ (-)	Z (Pa)	Valve setting	TRV/HM	Δp <sub>RV</sub> (Pa)	R*I+Z + Δp <sub>RV</sub> (Pa)	Δp <sub>DIS</sub> (Pa)
9	5,156	374	32,2105	10x1	60,2	0,18	310,39	18,29	296,30	TRV(2)			606,69	606,69

Design of presetting of valve of radiator

2951,51 - 606,69 = 2344,82 Pa      Presetting according to diagram (2)

**Local resistance ξ (-)**

9	radiator	connection valvex2	elbow x 4	connection	division	enlargement	narrowing	KK	Σ
	3	8	5,2	0,6	1,3	0,15	0,04		18,29

**Dimensioning of sections to radiator KLC-M 1220/450 in room 205A**

Sec. No.	l (m)	Q (W)	M (kg/h)	DN (D x t)	R (Pa/m)	w (m/s)	R*I (Pa)	ξ (-)	Z (Pa)	Valve setting	TRV/HM	Δp <sub>RV</sub> (Pa)	R*I+Z + Δp <sub>RV</sub> (Pa)	Δp <sub>DIS</sub> (Pa)
10	7,1	243	20,9282	10x1	32,8	0,12	232,88	25,59	184,25		HM(0,5)		417,13	417,13
11	1,4	493	42,4593	10x1	134	0,24	187,6	2,09	60,19				247,79	664,92

Design of presetting of valve of radiator

3649,94 - 664,92 = 2985,02 Pa      Presetting according to diagram (0,5)

**Local resistance ξ (-)**

10	radiator	connection valvex2	elbow x 10	connection	division	enlargement	narrowing	KK	Σ
	2,5	8	13	0,6	1,3	0,15	0,04		25,59
11				connection	division	enlargement	narrowing		Σ
				0,6	1,3	0,15	0,04		2,09

**Dimensioning of section to radiator 10-VK 700/700 in room 201A**

Sec. No.	l (m)	Q (W)	M (kg/h)	DN (D x t)	R (Pa/m)	w (m/s)	R*I (Pa)	ξ (-)	Z (Pa)	Valve setting TRV/HM	Δp <sub>RV</sub> (Pa)	R*I+Z + Δp <sub>RV</sub> (Pa)	Δp <sub>DIS</sub> (Pa)
12	3,55	250	21,5311	10x1	32,8	0,12	116,44	17,29	124,49	TRV(1)		240,93	240,93
Design of presetting of valve of radiator													
		3402,15	-	240,93	=	3161,22 Pa		Presetting according to diagram (1)					

**Local resistance ξ (-)**

12	radiator	connection valvex2	elbow x 4	connection	division	enlargement	narrowing	KK	Σ
	3	8	5,2	0,6	0,3	0,15	0,04		17,29

**Dimensioning of section to radiator 10-VKL 600/1600 in room 207A**

Sec. No.	l (m)	Q (W)	M (kg/h)	DN (D x t)	R (Pa/m)	w (m/s)	R*I (Pa)	ξ (-)	Z (Pa)	Valve setting TRV/HM	Δp <sub>RV</sub> (Pa)	R*I+Z + Δp <sub>RV</sub> (Pa)	Δp <sub>DIS</sub> (Pa)
13	12,8	499	42,9761	12x1	34,4	0,15	440,32	23,49	264,26	TRV(2)		704,58	704,58
Design of presetting of valve of radiator													
		4206,62	-	704,58	=	3502,04 Pa		Presetting according to diagram (2)					

**Local resistance ξ (-)**

13	radiator	connection valvex2	elbow x 8	connection	division	enlargement	narrowing	KK	Σ
	3	8	10,4	0,6	1,3	0,15	0,04		23,49

**Second floor (continuation)**

Temperature difference 10K (55/45)

**Dimensioning of basic circuit to radiator 10 -VK 600/1100 in room 204 B(aptartment 4)**

Sec. No.	l (m)	Q (W)	M (kg/h)	DN (D x t)	R (Pa/m)	w (m/s)	R*I (Pa)	ξ (-)	Z (Pa)	Valve setting TRV/HM	Heat meter Sharky 774 (DN20)(Pa)	Δp <sub>RV</sub> (Pa)	R*I+Z + Δp <sub>RV</sub> (Pa)	Δp <sub>DIS</sub> (Pa)
1	8,224	343	29,5407	10x1	51,4	0,17	422,71	22,49	324,98	TRV(3)			747,69	747,69
2	17,4	842	72,5167	12x1	134	0,26	2331,6	4,69	158,52				2490,12	3237,82
3	7,5	2582	222,373	18x1	99,6	0,31	747	14,49	696,24		1200		2643,24	5881,06
		6951,81	-	5881,06	=	1070,75 Pa		Setting according to diagram from the catalogue TRV(3)						

**Local resistance ξ (-)**

1	radiator	connection valvex2	elbow x 8	connection	division	enlargement	narrowing	KK	Σ
	3	8	10,4	0,6	0,3	0,15	0,04		22,49
2			elbow x 2	connection	division	enlargement	narrowing		Σ
			2,6	0,6	1,3	0,15	0,04		4,69
3			elbow x 8	connection	division	enlargement	narrowing	KKx4	Σ
			10,4	0,6	1,3	0,15	0,04	2	14,49

**Dimensioning of section to radiator 10-VK 600/1600 in room 204 B**

Sec. No.	l (m)	Q (W)	M (kg/h)	DN (D x t)	R (Pa/m)	w (m/s)	R*I (Pa)	ξ (-)	Z (Pa)	Valve setting TRV/HRŠ	Δp <sub>RV</sub> (Pa)	R*I+Z + Δp <sub>RV</sub> (Pa)	Δp <sub>DIS</sub> (Pa)
4	1,8	499	42,9761	12x1	34,4	0,15	61,92	18,29	205,76	TRV(4)		267,68	267,68
Design of presetting of valve of radiator													
		1818,44	-	267,68	=	1550,76 Pa		Presetting according to diagram (4)					

**Local resistance ξ (-)**

4	radiator	connection valvex2	elbow x 4	connection	division	enlargement	narrowing	KK	Σ
	3	8	5,2	0,6	1,3	0,15	0,04		18,29

**Dimensioning of circuit to radiator 10-VKL 600/1200 in room 206 B**

Sec. No.	l (m)	Q (W)	M (kg/h)	DN (D x t)	R (Pa/m)	w (m/s)	R*I (Pa)	ξ (-)	Z (Pa)	Valve setting	TRV/HM	Δp <sub>RV</sub> (Pa)	R*I+Z + Δp <sub>RV</sub> (Pa)	Δp <sub>DIS</sub> (Pa)
5	5,314	374	32,2105	10x1	60,2	0,18	319,9	22,49	364,34	TRV(2)			684,24	684,24
6	6,2	748	64,4211	12x1	108	0,23	669,6	1,09	28,83				698,43	1382,67
7	5,962	1241,00	106,88	15x1	77	0,23	459,07	3,69	97,60				556,67	1939,35
8	1,552	1740,00	149,856	18x1	50,2	0,21	77,91	1,09	24,03				101,94	2041,29

Design of presetting of valve of radiator

4308,56 - 2041,29 = 2267,27 Pa Presetting according to diagram (2)

**Local resistance ξ (-)**

Sec. No.	radiator	connection valvex2	elbow x	connection	division	enlargement	narrowing	KK	Σ
5			8						
	3	8	10,4	0,6	0,3	0,15	0,04		22,49
6									
				0,6	0,3	0,15	0,04		1,09
7			2						
			2,6	0,6	0,3	0,15	0,04		3,69
8									
				0,6	0,3	0,15	0,04		1,09

**Dimensioning of section to radiator 10-VKL 600/1200 in room 206 B**

Sec. No.	l (m)	Q (W)	M (kg/h)	DN (D x t)	R (Pa/m)	w (m/s)	R*I (Pa)	ξ (-)	Z (Pa)	Valve setting	TRV/HM	Δp <sub>RV</sub> (Pa)	R*I+Z + Δp <sub>RV</sub> (Pa)	Δp <sub>DIS</sub> (Pa)
9	5,156	374	32,2105	10x1	60,2	0,18	310,39	18,29	296,30	TRV(2)			606,69	606,69

Design of presetting of valve of radiator

2951,51 - 606,69 = 2344,82 Pa Presetting according to diagram (2)

**Local resistance ξ (-)**

Sec. No.	radiator	connection valvex2	elbow x	connection	division	enlargement	narrowing	KK	Σ
9			4						
	3	8	5,2	0,6	1,3	0,15	0,04		18,29

**Dimensioning of sections to radiator KLC-M 1220/450 in room 205B**

Sec. No.	l (m)	Q (W)	M (kg/h)	DN (D x t)	R (Pa/m)	w (m/s)	R*I (Pa)	ξ (-)	Z (Pa)	Valve setting	TRV/HM	Δp <sub>RV</sub> (Pa)	R*I+Z + Δp <sub>RV</sub> (Pa)	Δp <sub>DIS</sub> (Pa)
10	7,1	243	20,9282	10x1	32,8	0,12	232,88	25,59	184,25		HM(0,5)		417,13	417,13
11	1,4	493	42,4593	10x1	134	0,24	187,6	2,09	60,19				247,79	664,92

Design of presetting of valve of radiator

3649,94 - 664,92 = 2985,02 Pa Presetting according to diagram (0,5)

**Local resistance ξ (-)**

Sec. No.	radiator	connection valvex2	elbow x	connection	division	enlargement	narrowing	KK	Σ
10			10						
	2,5	8	13	0,6	1,3	0,15	0,04		25,59
11									
				0,6	1,3	0,15	0,04		2,09

**Dimensioning of section to radiator 10-VKL 700/700 in room 201B**

Sec. No.	l (m)	Q (W)	M (kg/h)	DN (D x t)	R (Pa/m)	w (m/s)	R*I (Pa)	ξ (-)	Z (Pa)	Valve setting	TRV/HM	Δp <sub>RV</sub> (Pa)	R*I+Z + Δp <sub>RV</sub> (Pa)	Δp <sub>DIS</sub> (Pa)
12	3,55	250	21,5311	10x1	32,8	0,12	116,44	17,29	124,49	TRV(1)			240,93	240,93

Design of presetting of valve of radiator

3402,15 - 240,93 = 3161,22 Pa Presetting according to diagram (1)

**Local resistance ξ (-)**

Sec. No.	radiator	connection valvex2	elbow x	connection	division	enlargement	narrowing	KK	Σ
12			4						
	3	8	5,2	0,6	0,3	0,15	0,04		17,29

**Dimensioning of section to radiator 10-VK 600/1600 in room 207B**

Sec. No.	l (m)	Q (W)	M (kg/h)	DN (D x t)	R (Pa/m)	w (m/s)	R*I (Pa)	ξ (-)	Z (Pa)	Valve setting TRV/HM	Δp <sub>RV</sub> (Pa)	R*I+Z + Δp <sub>RV</sub> (Pa)	Δp <sub>DIS</sub> (Pa)
13	12,8	499	42,9761	12x1	34,4	0,15	440,32	23,49	264,26	TRV(2)		704,58	704,58

Design of presetting of valve of radiator

$$4206,62 - 704,58 = 3502,04 \text{ Pa} \quad \text{Presetting according to diagram (2)}$$

**Local resistance ξ (-)**

13	radiator	connection valvex2	elbow x 8	connection	division	enlargement	narrowing	KK	Σ
	3	8	10,4	0,6	1,3	0,15	0,04		23,49

**FIRST FLOOR**

Temperature difference 10K (55/45)

**Dimensioning of basic circuit to radiator 10 -VKL 600/1400 in room 104 A (apartment 1)**

Sec. No.	l (m)	Q (W)	M (kg/h)	DN (D x t)	R (Pa/m)	w (m/s)	R*I (Pa)	ξ (-)	Z (Pa)	Valve setting TRV/HM	Heat meter Sharky 774 (DN20)(Pa)	Δp <sub>RV</sub> (Pa)	R*I+Z + Δp <sub>RV</sub> (Pa)	Δp <sub>DIS</sub> (Pa)
1	7,942	437	37,6364	12x1	23,3	0,13	185,05	22,49	190,04	TRV(2)			375,09	375,09
2	17,4	936	80,6124	15x1	45,5	0,17	791,7	4,69	67,77				859,47	1234,56
3	7,5	2858	246,144	18x1	117	0,34	877,5	14,49	837,52		1500		3215,02	4449,58

Design of presetting of radiator valve

$$7333,85 - 4449,58 = 2884,27 \text{ Pa} \quad \text{Presetting according to diagram (2)}$$

**Local resistance ξ (-)**

1	radiator	connection valvex2	elbow x 8	connection	division	enlargement	narrowing	KK	Σ
	3	8	10,4	0,6	0,3	0,15	0,04		22,49
2			elbow x 2	connection	division	enlargement	narrowing		Σ
			2,6	0,6	1,3	0,15	0,04		4,69
3			elbow x 8	connection	division	enlargement	narrowing	KKx4	Σ
			10,4	0,6	1,3	0,15	0,04	2	14,49

**Dimensioning of section to radiator 10-VKL 600/1600 in room 104 A**

Sec. No.	l (m)	Q (W)	M (kg/h)	DN (D x t)	R (Pa/m)	w (m/s)	R*I (Pa)	ξ (-)	Z (Pa)	Valve setting TRV/HRŠ	Δp <sub>RV</sub> (Pa)	R*I+Z + Δp <sub>RV</sub> (Pa)	Δp <sub>DIS</sub> (Pa)
4	1,8	499	42,9761	12x1	34,4	0,15	61,92	18,29	205,76	TRV(3)		267,68	267,68

Design of presetting of valve of radiator

$$3259,36 - 267,68 = 2991,68 \text{ Pa} \quad \text{Presetting according to diagram (3)}$$

**Local resistance ξ (-)**

4	radiator	connection valvex2	elbow x 4	connection	division	enlargement	narrowing	KK	Σ
	3	8	5,2	0,6	1,3	0,15	0,04		18,29

**Dimensioning of circuit to radiator 10 -VK 600/1200 in room 106 A**

Sec. No.	l (m)	Q (W)	M (kg/h)	DN (D x t)	R (Pa/m)	w (m/s)	R*I (Pa)	ξ (-)	Z (Pa)	Valve setting TRV/HM	Δp <sub>RV</sub> (Pa)	R*I+Z + Δp <sub>RV</sub> (Pa)	Δp <sub>DIS</sub> (Pa)
5	5,314	374	32,2105	10x1	60,2	0,18	319,9	22,49	364,34	TRV(3)		684,24	684,24
6	6,2	748	64,4211	12x1	108	0,23	669,6	1,09	28,83			698,43	1382,67
7	5,962	1350,00	116,268	15x1	89,1	0,25	531,21	3,69	115,31			646,53	2029,20
8	1,552	1922,00	165,531	15x1	161	0,35	249,87	1,09	66,76			316,63	2345,83

Design of presetting of valve of radiator

$$4118,83 - 2345,83 = 1773,00 \text{ Pa} \quad \text{Presetting according to diagram (3)}$$

**Local resistance ξ (-)**

5	radiator	connection valvex2	elbow x 8	connection	division	enlargement	narrowing	KK	Σ
	3	8	10,4	0,6	0,3	0,15	0,04		22,49
6				connection	division	enlargement	narrowing		Σ
				0,6	0,3	0,15	0,04		1,09
7			elbow x 2	connection	division	enlargement	narrowing		Σ
			2,6	0,6	0,3	0,15	0,04		3,69
8				connection	division	enlargement	narrowing		Σ
				0,6	0,3	0,15	0,04		1,09

**Dimensioning of section to radiator 10-VK 600/1200 in room 106 A**

Sec. No.	l (m)	Q (W)	M (kg/h)	DN (D x t)	R (Pa/m)	w (m/s)	R*I (Pa)	ξ (-)	Z (Pa)	Valve setting	TRV/HM	Δp <sub>RV</sub> (Pa)	R*I+Z + Δp <sub>RV</sub> (Pa)	Δp <sub>DIS</sub> (Pa)
9	5,156	374	32,2105	10x1	60,2	0,18	310,39	18,29	296,30	TRV(2)			606,69	606,69

Design of presetting of valve of radiator

$$2457,24 - 606,69 = 1850,55 \text{ Pa} \quad \text{Presetting according to diagram (2)}$$

**Local resistance ξ (-)**

9	radiator	connection valvex2	elbow x 4	connection	division	enlargement	narrowing	KK	Σ
	3	8	5,2	0,6	1,3	0,15	0,04		18,29

**Dimensioning of sections to radiator KLC-M 1220/450 in room 105A**

Sec. No.	l (m)	Q (W)	M (kg/h)	DN (D x t)	R (Pa/m)	w (m/s)	R*I (Pa)	ξ (-)	Z (Pa)	Valve setting	TRV/HM	Δp <sub>RV</sub> (Pa)	R*I+Z + Δp <sub>RV</sub> (Pa)	Δp <sub>DIS</sub> (Pa)
10	7,1	243	20,9282	10x1	32,8	0,12	232,88	25,59	184,25		HM(0,5)		417,13	417,13
11	1,4	602	51,8469	12x1	66,1	0,19	92,54	2,09	37,72				130,26	562,58

Design of presetting of valve of radiator

$$3155,67 - 562,58 = 2593,09 \text{ Pa} \quad \text{Presetting according to diagram (0,5)}$$

**Local resistance ξ (-)**

10	radiator	connection valvex2	elbow x 10	connection	division	enlargement	narrowing	KK	Σ
	2,5	8	13	0,6	1,3	0,15	0,04		25,59
11	radiator	connection valvex2	elbow x 4	connection	division	enlargement	narrowing	KK	Σ
				0,6	1,3	0,15	0,04		2,09

**Dimensioning of section to radiator 10-VK 600/700 in room 101A**

Sec. No.	l (m)	Q (W)	M (kg/h)	DN (D x t)	R (Pa/m)	w (m/s)	R*I (Pa)	ξ (-)	Z (Pa)	Valve setting	TRV/HM	Δp <sub>RV</sub> (Pa)	R*I+Z + Δp <sub>RV</sub> (Pa)	Δp <sub>DIS</sub> (Pa)
12	3,55	359	30,9187	10x1	51,4	0,17	182,47	17,29	249,84	TRV(2)			432,31	432,31

Design of presetting of valve of radiator

$$3010,22 - 432,31 = 2577,91 \text{ Pa} \quad \text{Presetting according to diagram (2)}$$

**Local resistance ξ (-)**

12	radiator	connection valvex2	elbow x 4	connection	division	enlargement	narrowing	KK	Σ
	3	8	5,2	0,6	0,3	0,15	0,04		17,29

**Dimensioning of section to radiator 10-VKL 700/1600 in room 107A**

Sec. No.	l (m)	Q (W)	M (kg/h)	DN (D x t)	R (Pa/m)	w (m/s)	R*I (Pa)	ξ (-)	Z (Pa)	Valve setting	TRV/HM	Δp <sub>RV</sub> (Pa)	R*I+Z + Δp <sub>RV</sub> (Pa)	Δp <sub>DIS</sub> (Pa)
13	12,8	572	49,2632	12x1	56,9	0,18	728,32	23,49	380,54	TRV(3)			1108,86	1108,86

Design of presetting of valve of radiator

$$3802,19 - 1108,86 = 2693,34 \text{ Pa} \quad \text{Presetting according to diagram (3)}$$

**Local resistance ξ (-)**

13	radiator	connection valvex2	elbow x 8	connection	division	enlargement	narrowing	KK	Σ
	3	8	10,4	0,6	1,3	0,15	0,04		23,49

Temperature difference 10K (55/45)

Dimensioning of basic circuit to radiator 11 -VK 600/1000 in room 104 B (apartment 2)

Sec. No.	l (m)	Q (W)	M (kg/h)	DN (D x t)	R (Pa/m)	w (m/s)	R*I (Pa)	ξ (-)	Z (Pa)	Valve setting TRV/HM	Heat meter Sharky 774 (DN20)(Pa)	Δp <sub>RV</sub> (Pa)	R*I+Z + Δp <sub>RV</sub> (Pa)	Δp <sub>DIS</sub> (Pa)
1	8	513	44,1818	12x1	41,1	0,16	328,8	22,49	287,87	TRV(4)			616,67	616,67
2	17,4	1012	87,1579	15x1	50,2	0,18	873,48	4,69	75,98				949,46	1566,13
3	7,5	3346	288,172	18x1	157	0,40	1177,5	14,49	1159,20		1800		4136,70	5702,83

Design of presetting of radiator valve

7333,85 - 5702,83 = 1631,02 Pa Presetting according to diagram (4)

Local resistance ξ (-)

1	radiator	connection valvex2	elbow x 8	connection	division	enlargement	narrowing	KK	Σ
	3	8	10,4	0,6	0,3	0,15	0,04		22,49
2			elbow x 2	connection	division	enlargement	narrowing		Σ
			2,6	0,6	1,3	0,15	0,04		4,69
3			elbow x 8	connection	division	enlargement	narrowing	KKx4	Σ
			10,4	0,6	1,3	0,15	0,04	2	14,49

Dimensioning of section to radiator 10-VK 600/1600 in room 104 B

Sec. No.	l (m)	Q (W)	M (kg/h)	DN (D x t)	R (Pa/m)	w (m/s)	R*I (Pa)	ξ (-)	Z (Pa)	Valve setting TRV/HRŠ	Δp <sub>RV</sub> (Pa)	R*I+Z + Δp <sub>RV</sub> (Pa)	Δp <sub>DIS</sub> (Pa)
4	1,8	499	42,9761	12x1	34,4	0,15	61,92	18,29	205,76	TRV(3)		267,68	267,68

Design of presetting of valve of radiator

2247,69 - 267,68 = 1980,01 Pa Presetting according to diagram (3)

Local resistance ξ (-)

4	radiator	connection	elbow x 4	connection	division	enlargement	narrowing	KK	Σ
	3	8	5,2	0,6	1,3	0,15	0,04		18,29

Dimensioning of circuit to radiator 10 -VKL 600/1200 in room 106 B

Sec. No.	l (m)	Q (W)	M (kg/h)	DN (D x t)	R (Pa/m)	w (m/s)	R*I (Pa)	ξ (-)	Z (Pa)	Valve setting TRV/HM	Δp <sub>RV</sub>	R*I+Z + Δp <sub>RV</sub>	Δp <sub>DIS</sub>
5	4,8	374	32,2105	10x1	60,2	0,18	288,96	17,29	280,10	TRV(3)		569,06	569,06
6	6,2	873	75,1866	12x1	143	0,27	886,6	1,09	39,73			926,33	1495,39
7	5,962	1719,00	148,048	18x1	50,2	0,21	299,29	3,5	77,18			376,47	1871,86
8	1,552	2334,00	201,014	18x1	83,2	0,28	129,13	1,09	42,73			171,85	2043,71

Design of presetting of valve of radiator

3197,15 - 2043,71 = 1153,44 Pa Presetting according to diagram (3)

Local resistance ξ (-)

5	radiator	connection valvex2	elbow x 4	connection	division	enlargement	narrowing	KK	Σ
	3	8	5,2	0,6	0,3	0,15	0,04		17,29
6				connection	division	enlargement	narrowing		Σ
				0,6	0,3	0,15	0,04		1,09
7			elbow x 2	connection	division	enlargement	narrowing		Σ
			2,6	0,6	0,3				3,50
8				connection	division	enlargement	narrowing		Σ
				0,6	0,3	0,15	0,04		1,09

Dimensioning of section to radiator 10-VKL 600/1600 in room 106 B

Sec. No.	l (m)	Q (W)	M (kg/h)	DN (D x t)	R (Pa/m)	w (m/s)	R*I (Pa)	ξ (-)	Z (Pa)	Valve setting TRV/HM	Δp <sub>RV</sub> (Pa)	R*I+Z + Δp <sub>RV</sub> (Pa)	Δp <sub>DIS</sub> (Pa)
9	5,156	499	42,9761	12x1	34,4	0,15	177,37	18,29	205,76	TRV(5)		383,13	383,13

Design of presetting of valve of radiator

1722,50 - 383,13 = 1339,37 Pa Presetting according to diagram (5)

Local resistance ξ (-)

9	radiator	connection valvex2	elbow x 4	connection	division	enlargement	narrowing	KK	Σ
	3	8	5,2	0,6	1,3	0,15	0,04		18,29



**Dimensioning of sections to radiator KLC-M 1500/750 in room 105B**

Sec. No.	l (m)	Q (W)	M (kg/h)	DN (D x t)	R (Pa/m)	w (m/s)	R*I (Pa)	ξ (-)	Z (Pa)	Valve setting	TRV/HM	Δp <sub>RV</sub> (Pa)	R*I+Z + Δp <sub>RV</sub> (Pa)	Δp <sub>DIS</sub> (Pa)
10	7,1	487	41,9426	12x1	34,4	0,15	244,24	25,59	287,89		HM(1)		532,13	532,13
11	1,4	846	72,8612	15x1	32,1	0,15	44,94	2,09	23,51				68,45	500,76
Design of presetting of valve of radiator														
2648,83 - 500,76 = 2148,07 Pa Presetting according to diagram (1)														

**Local resistance ξ (-)**

Sec. No.	radiator	connection valvex2	elbow x	connection	division	enlargement	narrowing	KK	Σ
10	2,5	8	13	0,6	1,3	0,15	0,04		25,59
11				0,6	1,3	0,15	0,04		2,09

**Dimensioning of section to radiator 10-VKL 600/700 in room 101B**

Sec. No.	l (m)	Q (W)	M (kg/h)	DN (D x t)	R (Pa/m)	w (m/s)	R*I (Pa)	ξ (-)	Z (Pa)	Valve setting	TRV/HM	Δp <sub>RV</sub> (Pa)	R*I+Z + Δp <sub>RV</sub> (Pa)	Δp <sub>DIS</sub> (Pa)
12	3,55	359	30,9187	10x1	51,4	0,17	182,47	17,29	249,84	TRV(2)			432,31	432,31
Design of presetting of valve of radiator														
2680,19 - 432,31 = 2247,88 Pa Presetting according to diagram (2)														

**Local resistance ξ (-)**

Sec. No.	radiator	connection valvex2	elbow x	connection	division	enlargement	narrowing	KK	Σ
12	3	8	5,2	0,6	0,3	0,15	0,04		17,29

**Dimensioning of section to radiator 11-VK 600/1200 in room 107B**

Sec. No.	l (m)	Q (W)	M (kg/h)	DN (D x t)	R (Pa/m)	w (m/s)	R*I (Pa)	ξ (-)	Z (Pa)	Valve setting	TRV/HM	Δp <sub>RV</sub> (Pa)	R*I+Z + Δp <sub>RV</sub> (Pa)	Δp <sub>DIS</sub> (Pa)
13	12,8	615	52,9665	12x1	66,1	0,19	846,08	23,49	423,99	TRV(5)			1270,07	1270,07
Design of presetting of valve of radiator														
3025,30 - 1270,07 = 1755,22 Pa Presetting according to diagram (5)														

**Local resistance ξ (-)**

Sec. No.	radiator	connection valvex2	elbow x	connection	division	enlargement	narrowing	KK	Σ
13	3	8	10,4	0,6	1,3	0,15	0,04		23,49

## Dimensioning of communal rooms

### Riser S3

Dimensioning of riser S3 until radiator 10-VK 600/1600 room 311

Temperature difference 10K(55/45)

Sec. No.	l (m)	Q (W)	M (kg/h)	DN (D x t)	R (Pa/m)	w (m/s)	R*I (Pa)	ξ (-)	Z (Pa)	Filter (Pa)	Heat meter (Pa)	Δp <sub>RV</sub> (Pa)	R*I+Z + Δp <sub>RV</sub> (Pa)	Δp <sub>Dis</sub> (Pa)
1	15,568	499	42,9761	10x1	134	0,24	2086,1	16,99	489,31			320	2895,42	2895,42
2	3,564	998	85,9522	15x1	50,2	0,18	178,91	4,5	72,90				251,81	3147,24
3	1,98	1391	119,799	15x1	89,1	0,25	176,42	1,39	43,44				219,86	3367,09
4	1,45	2106	181,378	18x1	68,1	0,25	98,745	1,2	37,50				136,25	3503,34
5	19,83	2721	234,344	18x1	111	0,33	2201,1	1,2	65,34				2266,47	5769,81
6	4,636	2939	253,12	18x1	123	0,35	570,23	1,2	73,50				643,73	6413,54
7	7,8	4297	370,077	22x1	83,7	0,33	652,86	11,4	620,73	1140	3000		5413,59	11827,13

Valve setting of radiator 10 - VK 600/1600 in room 311 : TRV (8)

Heat meter Sharky 774(DN 20) ΔpRV = 3000 Pa

Filter(DN20) ΔpRV = 1140 Pa

Balancing valve(DN20) ΔpRV = 6000 Pa

Three way valve(DN20) ΔpRV = 2,2 Pa

6000		17827,13
2200		20027,13

Local resistance ξ (-)

1			elbow x 12	connection	division	enlargement	narrowing		Σ
			15,6	0,9	0,3	0,15	0,04		16,99
2				connection	division				Σ
				3	1,5				4,50
3				connection	division	enlargement	narrowing		Σ
				0,9	0,3	0,15	0,04		1,39
4				connection	division				Σ
				0,9	0,3				1,20
5				connection	division				Σ
				0,9	0,3				1,20
6				connection	division				Σ
				0,9	0,3				1,20
7	VKx2	ZKx1	elbow x 2	collector and distributor entrance		collector and distributor exit		KKx4	Σ
	1	4,3	2,6	1		0,5		2	11,40

Dimensioning of section to radiator 10-VK 600/1600 in room 211

Sec. No.	l (m)	Q (W)	M (kg/h)	DN (D x t)	R (Pa/m)	w (m/s)	R*I (Pa)	ξ (-)	Z (Pa)	Valve setting TRV/HM	Δp <sub>RV</sub> (Pa)	R*I+Z + Δp <sub>RV</sub> (Pa)	Δp <sub>Dis</sub> (Pa)
8	8,64	499	42,9761	10x1	134	0,24	1157,8	14,39	414,43	TRV(4)		1572,19	1572,19

Design of presetting of valve of radiator

2895,42 - 1572,19 = 1323,23 Pa Presetting according to diagram (4)

Local resistance ξ (-)

8			elbow x 10	connection	division	enlargement	narrowing		Σ
			13	0,9	0,3	0,15	0,04		14,39

Dimensioning of section to radiator 10-VKL 700/1100 in room 108

Sec. No.	l (m)	Q (W)	M (kg/h)	DN (D x t)	R (Pa/m)	w (m/s)	R*I (Pa)	ξ (-)	Z (Pa)	Valve setting TRV/HM	Δp <sub>RV</sub> (Pa)	R*I+Z + Δp <sub>RV</sub> (Pa)	Δp <sub>Dis</sub> (Pa)
9	4	393	33,8469	10x1	67	0,19	268	9,19	165,88	TRV(2)		433,88	433,88

Design of presetting of valve of radiator

3147,24 - 433,88 = 2713,36 Pa Presetting according to diagram (2)

Local resistance ξ (-)

9			elbow x 6	connection	division	enlargement	narrowing		Σ
			7,8	0,9	0,3	0,15	0,04		9,19

Dimensioning of section to radiator 11-VKL 700/2000 in room S106

Sec. No.	l (m)	Q (W)	M (kg/h)	DN (D x t)	R (Pa/m)	w (m/s)	R*I (Pa)	ξ (-)	Z (Pa)	Valve setting TRV/HM	Δp <sub>RV</sub> (Pa)	R*I+Z + Δp <sub>RV</sub> (Pa)	Δp <sub>Dis</sub> (Pa)
10	18,334	715	61,5789	12x1	99,7	0,22	1827,9	11,79	285,32	TRV(6)		2113,22	2113,22

Design of presetting of valve of radiator

3367,09 - 2113,22 = 1253,87 Pa Presetting according to diagram (6)

Local resistance ξ (-)

10			elbow x 8	connection	division	enlargement	narrowing		Σ
			10,4	0,9	0,3	0,15	0,04		11,79

**Dimensioning of section to radiator 11-VKL 600/1200 in room S105**

Sec. No.	l (m)	Q (W)	M (kg/h)	DN (D x t)	R (Pa/m)	w (m/s)	R*I (Pa)	ξ (-)	Z (Pa)	Valve setting	TRV/HM	Δp <sub>RV</sub> (Pa)	R*I+Z + Δp <sub>RV</sub> (Pa)	Δp <sub>DIS</sub> (Pa)
11	17,7	615	52,9665	12x1	66,1	0,19	1170	9,19	165,88	TRV(4)			1335,85	1335,85

Design of presetting of valve of radiator

3503,34	-	1335,85	=	2167,49 Pa	Presetting according to diagram (4)
---------	---	---------	---	------------	-------------------------------------

Local resistance ξ (-)

11	elbow x 6	connection	division	enlargement	narrowing	Σ
	7,8	0,9	0,3	0,15	0,04	9,19

**Dimensioning of section to radiator 10-VK 600/700 in room S104**

Sec. No.	l (m)	Q (W)	M (kg/h)	DN (D x t)	R (Pa/m)	w (m/s)	R*I (Pa)	ξ (-)	Z (Pa)	Valve setting	TRV/HM	Δp <sub>RV</sub> (Pa)	R*I+Z + Δp <sub>RV</sub> (Pa)	Δp <sub>DIS</sub> (Pa)
12	11,164	218	18,7751	10x1	30	0,11	334,92	9,19	55,60	TRV(1)			390,52	390,52

Design of presetting of valve of radiator

5769,81	-	390,52	=	5379,29 Pa	Presetting according to diagram (1)
---------	---	--------	---	------------	-------------------------------------

Local resistance ξ (-)

12	elbow x 6	connection	division	enlargement	narrowing	Σ
	7,8	0,9	0,3	0,15	0,04	9,19

**Dimensioning of section to radiator 22-VKL 600/1500 in room S103A**

Sec. No.	l (m)	Q (W)	M (kg/h)	DN (D x t)	R (Pa/m)	w (m/s)	R*I (Pa)	ξ (-)	Z (Pa)	Valve setting	TRV/HM	Δp <sub>RV</sub> (Pa)	R*I+Z + Δp <sub>RV</sub> (Pa)	Δp <sub>DIS</sub> (Pa)
13	8,7	1358	116,957	15x1	89,1	0,25	775,17	9,19	287,19	TRV(6)			1062,36	1062,36

Design of presetting of valve of radiator

6413,54	-	1062,36	=	5351,18 Pa	Presetting according to diagram (6)
---------	---	---------	---	------------	-------------------------------------

Local resistance ξ (-)

13	elbow x 6	connection	division	enlargement	narrowing	Σ
	7,8	0,9	0,3	0,15	0,04	9,19

**Dimensioning of hot water preparation circuit**

Temperature difference 10K (55/45)

Sec. No.	l (m)	Q (W)	M (kg/h)	DN (D x t)	R (Pa/m)	w (m/s)	R*I (Pa)	ξ (-)	Z (Pa)	Filter (Pa)	Storage heater (Pa)	Δp <sub>RV</sub> (Pa)	R*I+Z + Δp <sub>RV</sub> (Pa)	Δp <sub>DIS</sub> (Pa)
1	8,8	6522	561,703	22x1	176	0,5	1548,8	18,1	2262,50	2620	350		6781,30	6781,30

Balancing valve (DN20) Δp<sub>RV</sub> = 10500 Pa

												10500		17281,30
--	--	--	--	--	--	--	--	--	--	--	--	-------	--	----------

Local resistance ξ (-)

1	elbow x 6	Entrance to storage heater	Exit of storage heater	Entrance to distributor and collector	Exit of distributor and collector	KK x 6	ZK	Σ
	7,8	1	0,5	1	0,5	3	4,3	18,10

**Dimensioning of the circuit between storage tank and collector and distributor**

Temperature difference 10K (55/45)

Sec. No.	l (m)	Q (W)	M (kg/h)	DN (D x t)	R (Pa/m)	w (m/s)	R*I (Pa)	ξ (-)	Z (Pa)				R*I+Z + Δp <sub>RV</sub> (Pa)	Δp <sub>DIS</sub> (Pa)
1	13,5	22000	1894,74	35x1,5	161	0,66	2173,5	11,8	2570,04				4743,54	4743,54

Local resistance ξ (-)

1	elbow x 6	Entrance to accumulation tank	Exit of accumulation tank	Exit of distributor and collector	Entrance to distributor and collector	KKx2	Σ
	7,8	1	0,5	0,5	1	1	11,80

**Dimensioning of the circuit between each internal unit of heat pump and storage tank**

Temperature difference 10K (55/45)

Sec. No.	l (m)	Q (W)	M (kg/h)	DN (D x t)	R (Pa/m)	w (m/s)	R*I (Pa)	ξ (-)	Z (Pa)	Filter (Pa)			R*I+Z + Δp <sub>RV</sub> (Pa)	Δp <sub>DIS</sub> (Pa)
1	17,5	10850	934,45	28x1,5	153	0,54	2677,5	17	2478,60	2560			7716,10	7716,10

Local resistance ξ (-)

1	elbow x 10	Entrance to accumulation tank	Exit of accumulation tank			KK x 5	Σ
	13	1	0,5			2,5	17,00

## Dimensioning of the circuit between each internal unit and external unit of heat pump

Temperature difference 10K (55/45)

Sec. No.	l (m)	Q (W)	M (kg/h)	DN (D x t)	R (Pa/m)	w (m/s)	R*I (Pa)	$\xi$ (-)	Z (Pa)	$\Delta p_{RV}$ (Pa)			$R^*l+Z+\Delta p_{RV}$ (Pa)	$\Delta p_{DIS}$ (Pa)
1	3,9	10850	934,45	28x1,5	153	0,54	596,7	13	1895,40	22900			25392,10	33108,20

### B.6. Design of Balancing valves

A balancing valve is designed for each of the main branches B1, B2 and B3 on the distributor and collector.

The purpose of these valves at branches B1, B2, and B3(heating circuits) is only measuring of the flow of heating water and for possible adjustment of the heating system.

Also, a balancing valve is designed for the branch of hot water preparation circuit on the distributor and collector. The purpose of it is measuring of the flow of heating water and raising the pressure loss value because on this branch we have small pressure loss.

**Branch B1:** Mass flow:  $M = 768,14 \text{ kg / h}$

**Balancing valve D 9505 from company hydronix, DN25, Presetting level: 2,5 Kv=4,8.**

$$\Delta P = 2,5 \text{ kPa}$$

**Branch B2:** Mass flow:  $M = 810,17 \text{ kg / h}$

**Balancing valve D 9505 from company hydronix, DN25, Presetting level: 2,5. Kv=4,8.**

$$\Delta P = 2,9 \text{ kPa}$$

**Branch B3:** Mass flow:  $M = 370,077 \text{ kg / h}$

**Balancing valve D 9505 from company hydronix, DN20, Presetting level: 2,5. Kv=1,5.**

$$\Delta P = 6 \text{ kPa}$$

**Hot water preparation branch:** Mass flow:  $M = 561,7 \text{ kg / h}$

**Balancing valve D 9505 from company hydronix, DN20, Presetting level: 2,5. Kv=1,5.**

$$\Delta P = 10,5 \text{ kPa}$$

Pressure losses were taken from the graphs, which are provided by the manufacturer.

DN 25

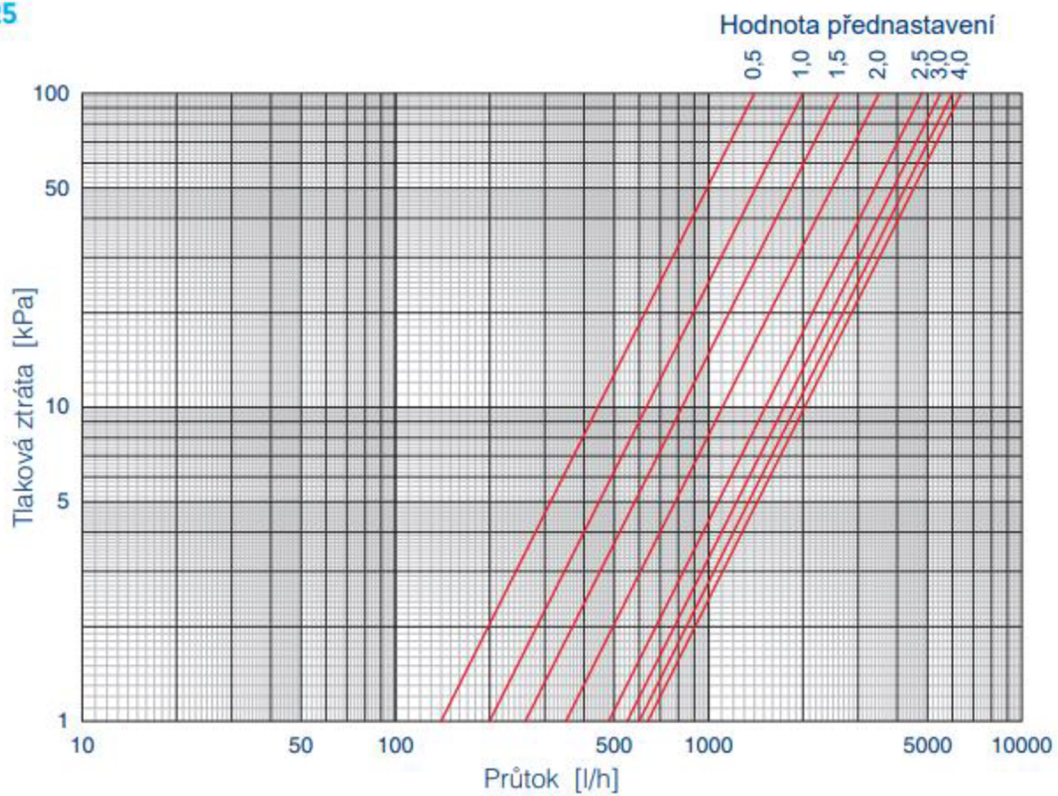

Figure 48-Presetting graph of balancing valve Hydronix D 9505[53]

DN 20

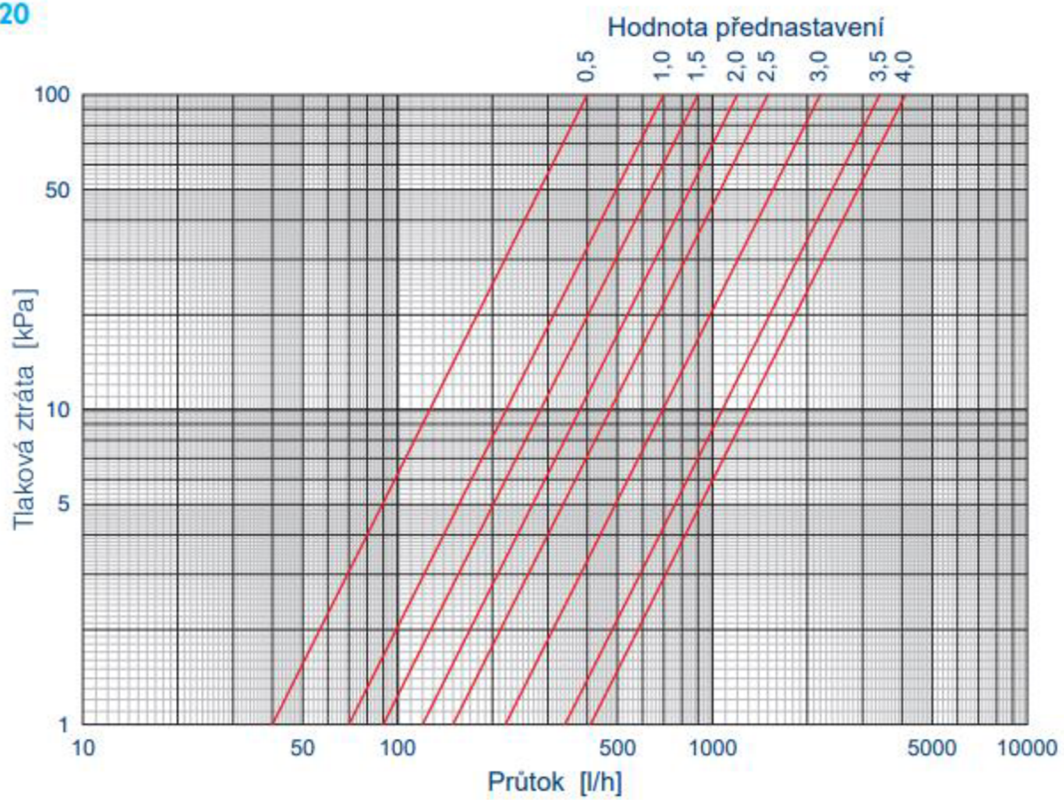

Figure 49-Presetting graph of balancing valve Hydronix D 9505[53]

### B.7. Design of Heat meters

Heat meters in the niches before each apartment will be used to measure the amount of heat taken from each individual apartment. Also, one heat meter will be positioned on branch B3 in the technical room for measuring the amount of heat used for communal areas.

I chose heat meters type SHARKY 775 DN20 . Heat meters will be placed on heating water pipe and will be connected with a temperature measuring ball valve on the return pipes.

Pressure losses were taken from the following graph, which is provided by the manufacturer.

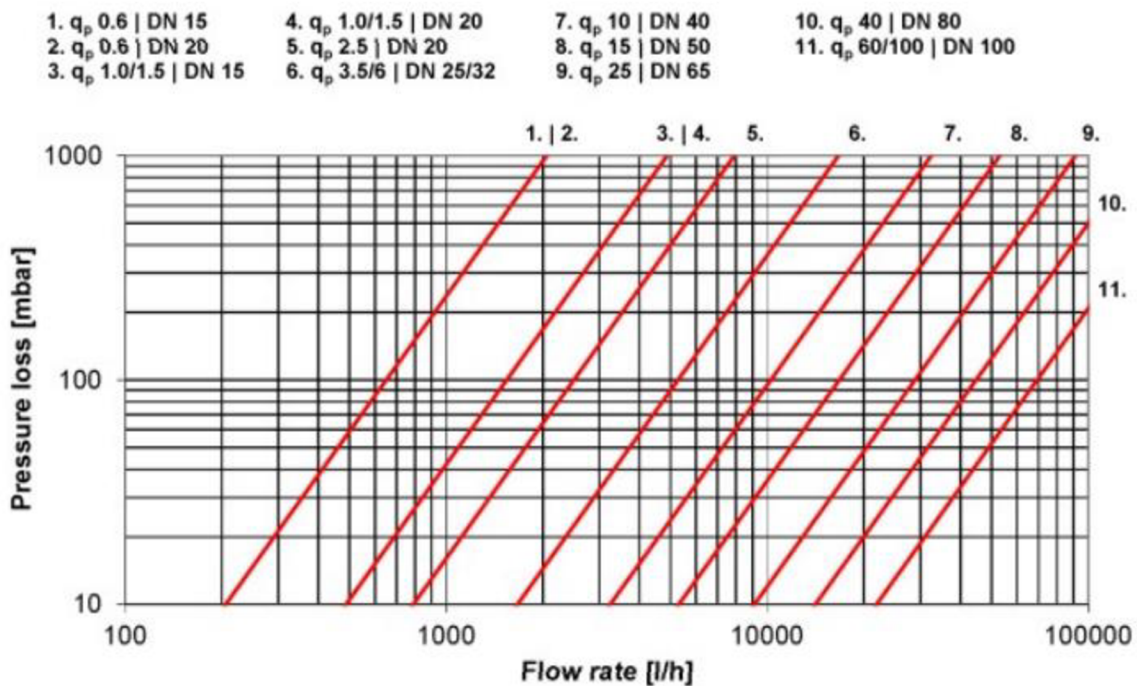

Figure 50- pressure loss graph of heat meter sharky 775 [54]

### B.8. Design of three-way mixing valves

The required pressure loss of the valve is recommended by the manufacturer and is 50% of ΔP<sub>d</sub>is to ensure sufficient authority. ΔP<sub>d</sub>is is the total circuit pressure loss including balancing pressure loss. I used online calculator at tzb-info.cz to estimate Kv value.[55]

This calculator uses the following equations :

Flow factor:

$$k_v = \frac{10 * \tilde{V}}{\sqrt{\Delta p_{[kPa]}}} \quad [m^3/h]$$

Water density:

$$\rho = 1000 - (t - 4) * [0,097 + 0,0036 * (t - 4)] [kg/m^3]$$

Volume flow:

$$\tilde{V} = \frac{\dot{m}}{\rho} [m^3/h]$$

**Branch B1:**

Total circuit pressure loss:  $\Delta P_{dis} = 20,34$  kPa

Mass flow:  $M = 768,14$  kg / h

Required valve pressure loss:  $\Delta p_v = 0,5 \cdot 20,34 = 10,17$  kPa

Volume flow =  $0,778$  m<sup>3</sup>/h

Flow factor  $K_v = 2,44$  m<sup>3</sup>/h

I suggest three way valve ESBE VRG 131 :  **$K_v = 2,5$  m<sup>3</sup>/h, DN20**, with servo drive ARA600.

Real pressure loss,  $\Delta P_{rv} = \left(\frac{M}{K_v} \cdot 0,01\right)^2 = 9,44$  Kpa

**Branch B2:**

Total circuit pressure loss:  $\Delta P_{dis} = 17,83$  kPa

Mass flow:  $M = 810,17$  kg / h

Required valve pressure loss:  $\Delta p_v = 0,5 \cdot 17,83 = 8,913$  kPa

Volume flow =  $0,82$  m<sup>3</sup>/h

Flow factor  $K_v = 2,75$  m<sup>3</sup>/h

I suggest three way valve ESBE VRG 131 :  **$K_v = 4$  m<sup>3</sup>/h, DN20**, with servo drive ARA600.

Real pressure loss,  $\Delta P_{rv} = \left(\frac{M}{K_v} \cdot 0,01\right)^2 = 4,1$  Kpa

**Branch B3:**

Total circuit pressure loss:  $\Delta P_{dis} = 17,83$  kPa

Mass flow:  $M = 370,08$  kg / h

Required valve pressure loss:  $\Delta p_v = 0,5 \cdot 17,83 = 8,913$  kPa

Volume flow =  $0,375$  m<sup>3</sup>/h

Flow factor  $K_v = 1,256$  m<sup>3</sup>/h

I suggest three way valve ESBE VRG 131 :  **$K_v = 2,5$  m<sup>3</sup>/h, DN20**, with servo drive ARA600.

Real pressure loss,  $\Delta P_{rv} = \left(\frac{M}{K_v} \cdot 0,01\right)^2 = 2,2$  Kpa

OTOČNÉ SMĚŠOVACÍ VENTILY

## SMĚŠOVACÍ VENTILY ŘADA VRG130

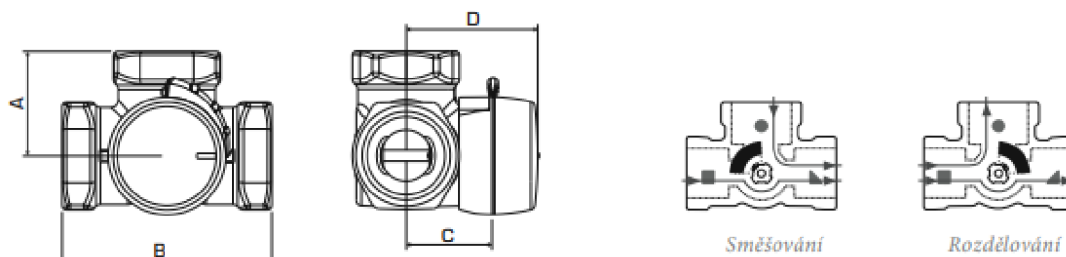

Zploštělý konec hřídele srdce ventilu, stejně jako ukazatel knoflíku indikuje otevřenou pozici

### OTOČNÉ SMĚŠOVACÍ VENTILY ŘADY VRG131, VNITŘNÍ ZÁVIT

Obj. č.	Označení	DN	Kvs *	Připojení	A	B	C	D	Hmot. [kg]	Nahrazuje	Pozn.
1160 01 00	VRG131	15	0.4	Rp 1/2"	36	72	32	50	0.40	–	
1160 02 00	VRG131	15	0.63	Rp 1/2"	36	72	32	50	0.40	3 MG 15-0.6	
1160 03 00	VRG131	15	1	Rp 1/2"	36	72	32	50	0.40	3 MG 15-1.0	
1160 04 00	VRG131	15	1.63	Rp 1/2"	36	72	32	50	0.40	3 MG 15-1.6	
1160 05 00	VRG131	15	2.5	Rp 1/2"	36	72	32	50	0.40	3 MG 15-2.5	
1160 06 00	VRG131	15	4	Rp 1/2"	36	72	32	50	0.40	–	
1160 07 00	VRG131	20	2.5	Rp 3/4"	36	72	32	50	0.43	–	
1160 08 00	VRG131	20	4	Rp 3/4"	36	72	32	50	0.43	3 MG 20-4	
1160 09 00	VRG131	20	6.3	Rp 3/4"	36	72	32	50	0.43	3 MG 20-6.3	
1160 10 00	VRG131	25	6.3	Rp 1"	41	82	34	52	0.70	3 MG 25-8	
1160 11 00	VRG131	25	10	Rp 1"	41	82	34	52	0.70	3 MG 25-12	
1160 12 00	VRG131	32	16	Rp 1 1/4"	47	94	37	55	0.95	3 MG 32-18	
1160 13 00	VRG131	40	25	Rp 1 1/2"	58	116	44	62	1.75	3 G 40-28	
1160 14 00	VRG131	50	40	Rp 2"	62	125	44	62	2.05	3 G 50-44	

Figure 51- Technical data sheet of the three-way mixing valve ESBE VRG131[56]

### B.9. Design of circulating pumps

The basic parameters for the design of a circulating pump are volume flow, and pressure loss of the whole circuit. Circulating pumps are characterized by a curve that indicates the dependence between volume flow and pressure of the circulating pump.

The pump is designed for calculation operating point so that it operates in the range of maximal Efficiency.

**Branch B1:** Mass flow = 768,14 kg/h = 0,768 m<sup>3</sup>/h

Heating circuit pressure loss = 29,78 kPa

I suggest circulating pump Grundfos ALPHA A2 25-50 130



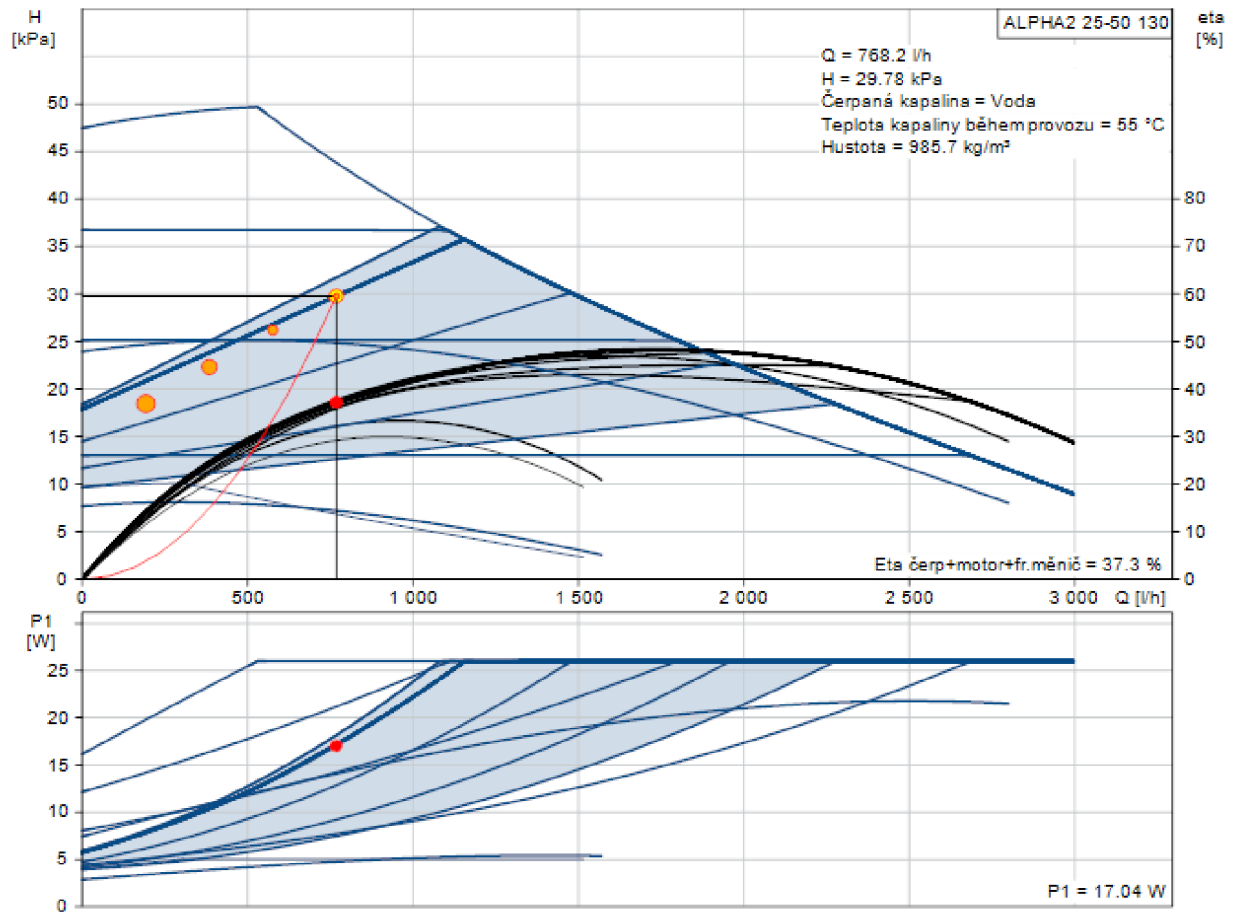

Figure 52-circulating pump Grundfos ALPHA A2 25-50 130 [57]

**Branch B2:** Mass flow =  $810,17 \text{ kg/h}$

Heating circuit pressure loss =  $21,93 \text{ kPa}$

I suggest circulating pump Grundfos ALPHA A2 25-40 130

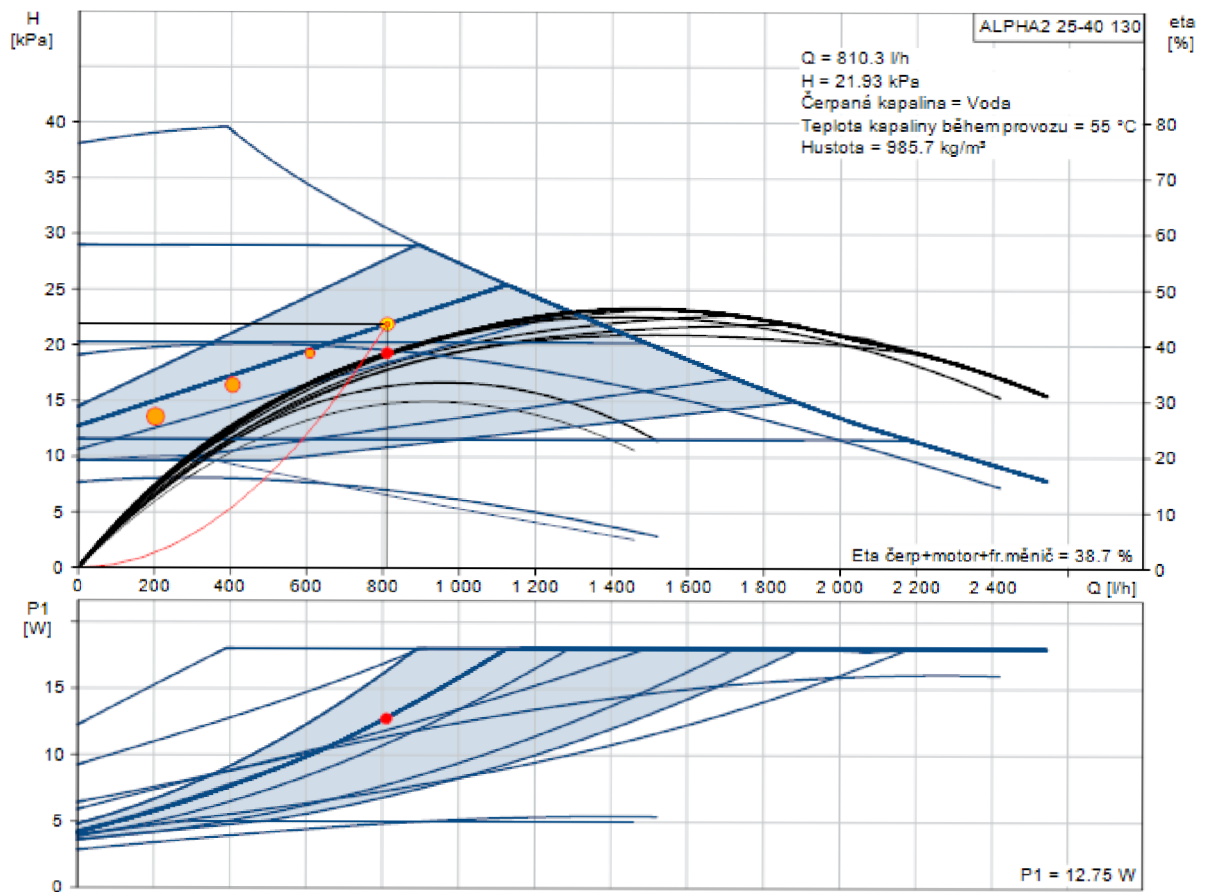

Figure 53-circulating pump Grundfos ALPHA A2 25-40 130[57]

**Branch B3:** Mass flow =  $370,1 \text{ kg/h}$

Heating circuit pressure loss =  $20,03 \text{ kPa}$

I suggest circulating pump Grundfos ALPHA A2 25-40 130

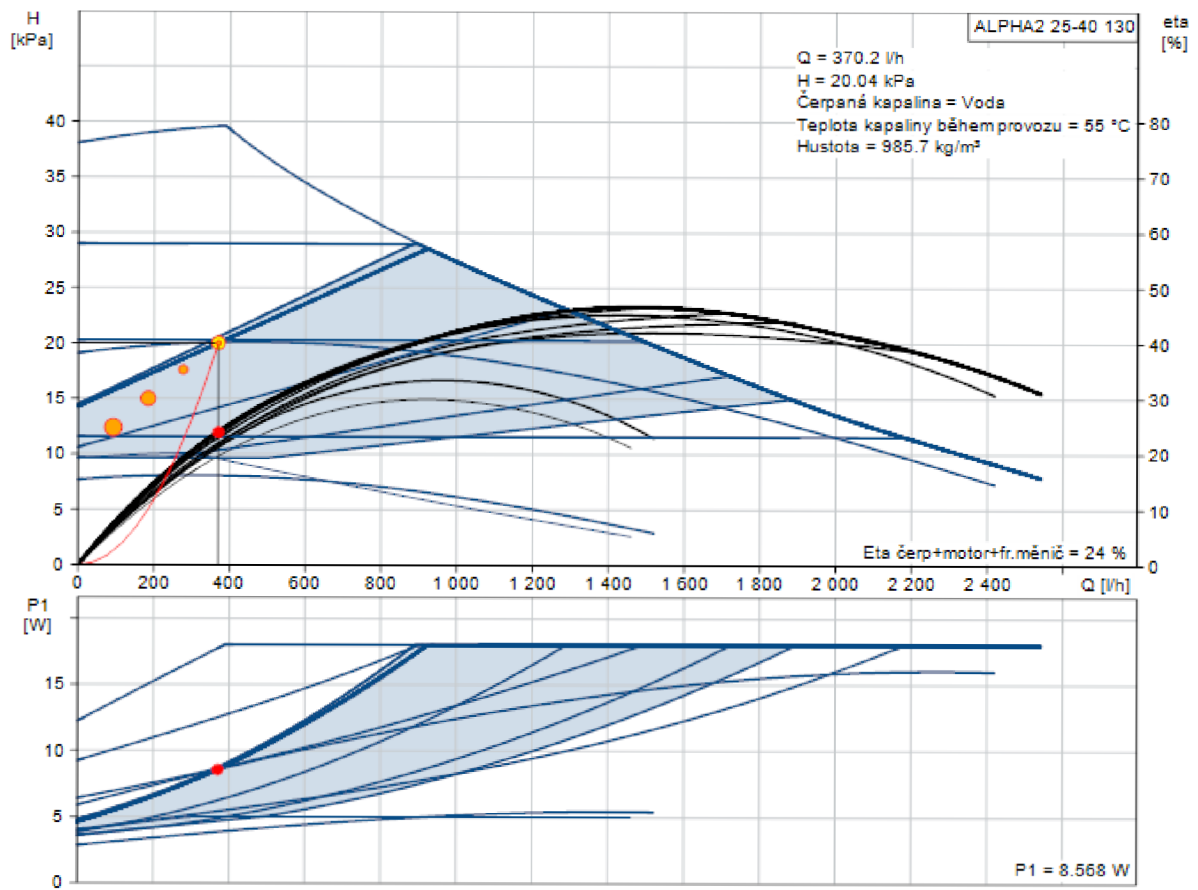

Figure 54-circulating pump Grundfos ALPHA A2 25-40 130[57]

**Branch of hot water preparation circuit:**

Mass flow = 561,7 kg/h

Heating circuit pressure loss = 17,28 kPa

I suggest circulating pump ALPHA A2 25-40 130

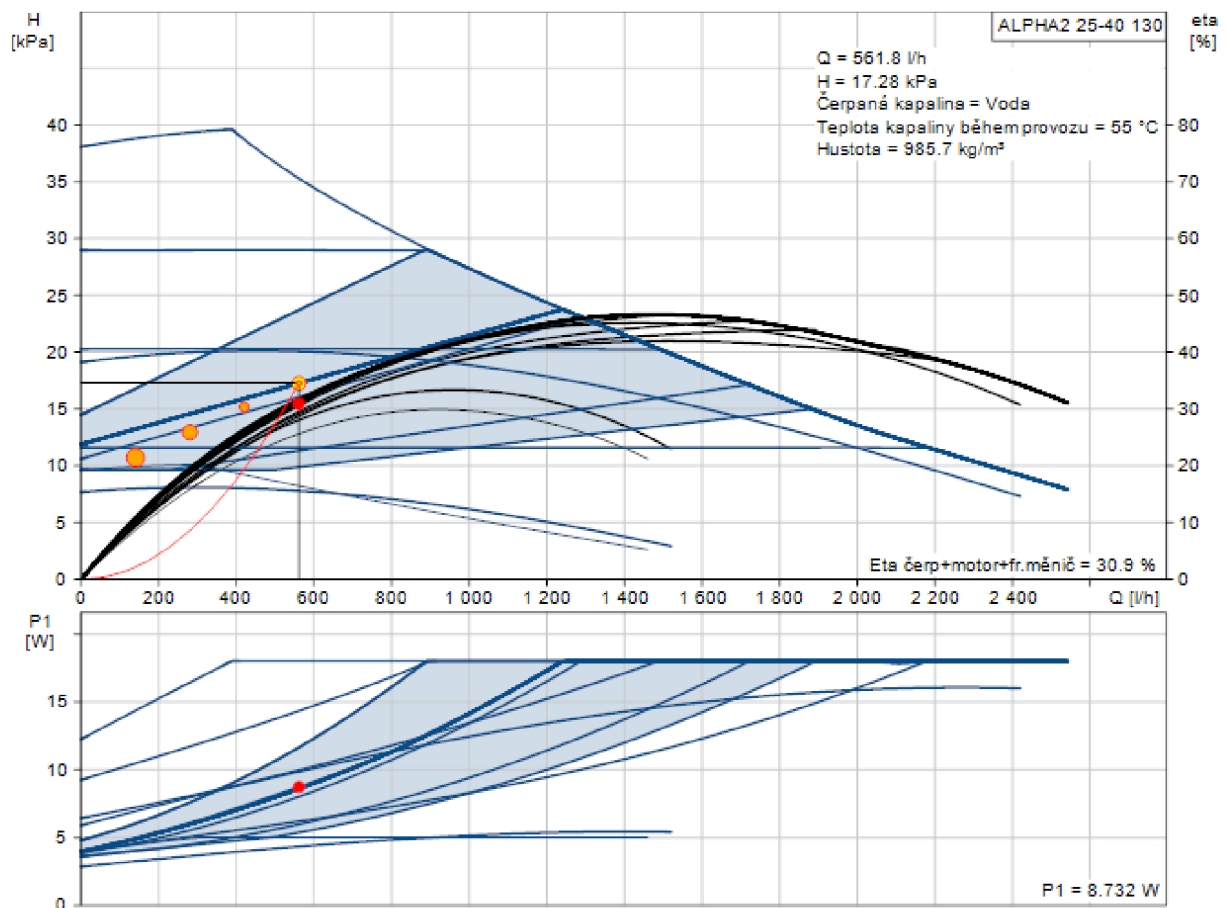

Figure 55-circulating pump Grundfos ALPHA A2 25-40 130[57]



Figure 56-Grundfos ALPHA2 circulation pump with thermal insulation[57]

**Circulating pump in the internal unit of each heat pump:**

Mass flow = 934,5 kg/h

Pressure loss = 33,11 kPa

Each internal unit of each heat pump is provided with a circulating pump Grundfos UPM GEO 25-85 PWM by the manufacturer, which are controlled by electric change of turns. In the following graph I assessed the sufficiency of the circulating pump, and made sure that it is sufficient.

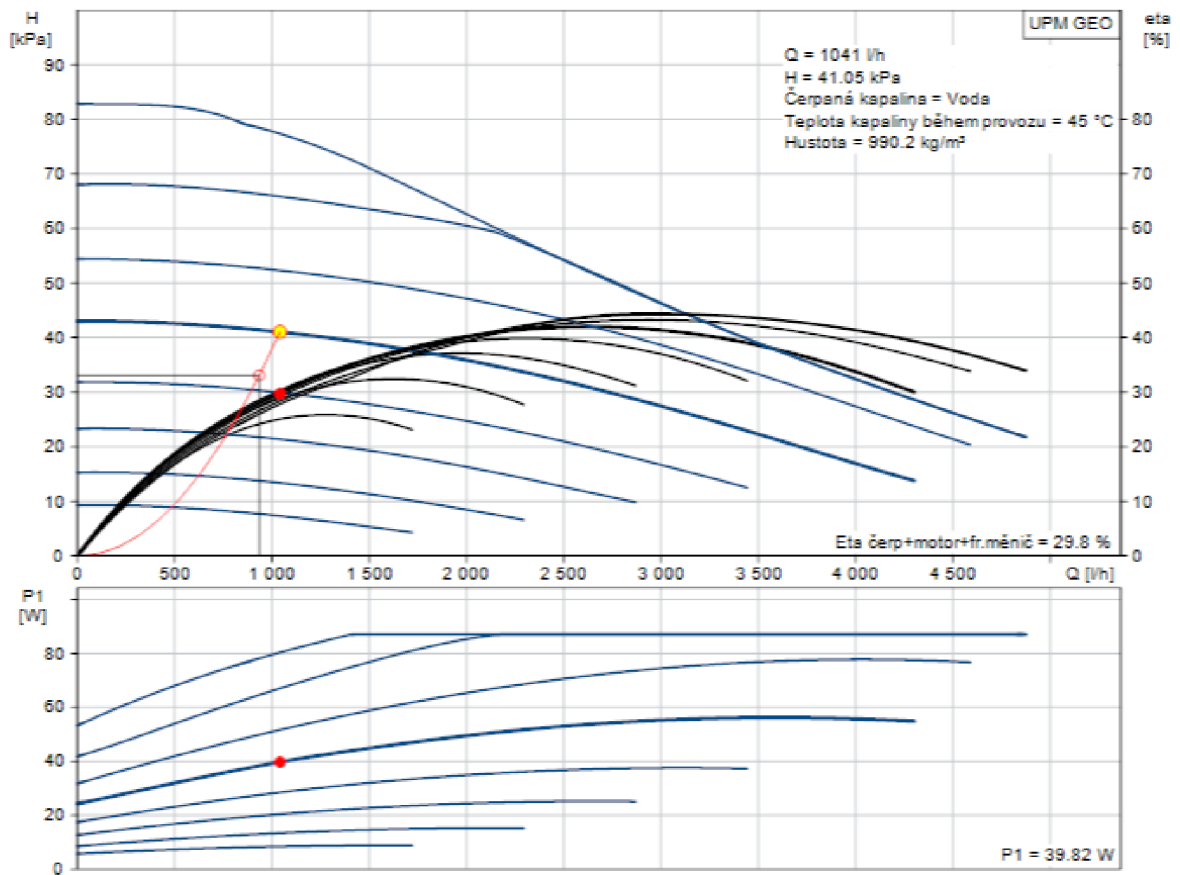

Figure 57-UPM GEO 25-85 circulating pump curve with marked working point[57]

### B.10. Design of distributor and collector

As a part of the design of the technical room, I am designing a combined distributor and collector, from company ETL. I used the ETL online software for the design.[58]

Input data of distributor and collector design - Volume flow:

Branch B1/S1 768,14 kg/h

Branch B2/S2 810,17 kg/h

Branch B3/S3 370,077 kg/h

Heating of hot water 561,70 kg/h

**Total volume flow = 2510 kg/h = 2,51 m<sup>3</sup> /h**

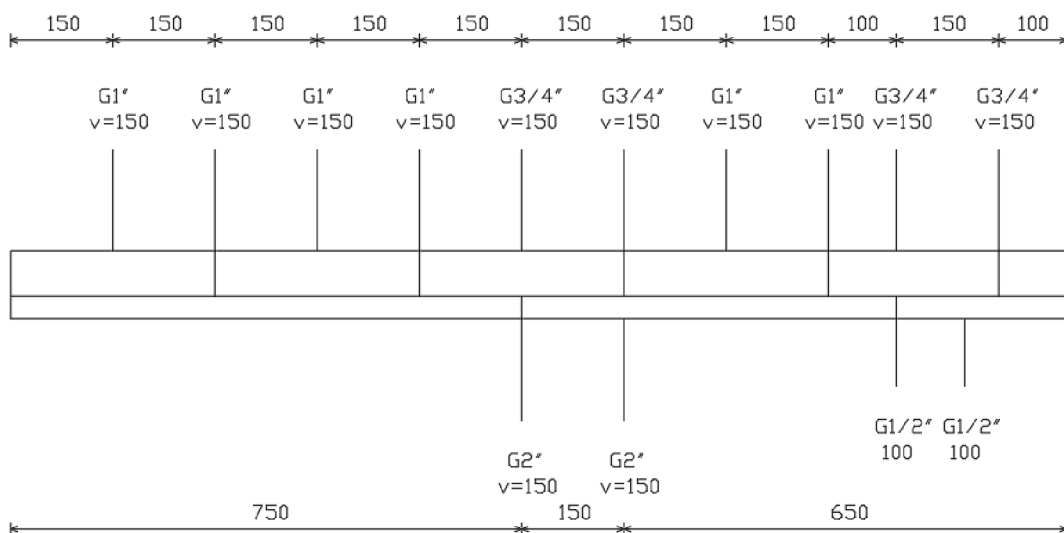

Figure 58-distributor and collector design

Distributor and collector type	RS KOMBI with insulation, MODULE 100, PN 6, $T_{\max}=105^{\circ}\text{C}$ , $l=1550\text{mm}$ , $M = 32,9 \text{ kg}$
Type and number of stands	KFS 65-200/400, $m=2,00\text{kg} - 2x$
Thermal isolation	PUR 100, $m=0,20\text{kg}$
Designer	Nour Kováčová
Module size	100
Nominal pressure PN	6 Bar
Maximal operating temperature	$105^{\circ}\text{C}$
Length	1550 mm
Weight	32,9 kg

TABULKA UVÁDÍ POUZE ORIENTAČNÍ VÝKONOVÉ PARAMETRY! VŽDY ZÁLEŽÍ NA ROZMÍSTĚNÍ HRDEL!								
<b>Q<sub>max</sub> = [m<sup>3</sup>/hod]</b>	6	10	15	23	42	65	95	130
<b>do výkonu [kW] při Δt=20</b>	120	250	350	550	1000	1500	2100	3000
<b>MODUL</b>	80	100	120	150	200	250	300	350
<b>Průtok, průřez komor S<sub>p</sub>, (m<sup>2</sup>)</b>	0,0019	0,0028	0,0040	0,0070	0,0114	0,0176	0,0271	0,0380
<b>Max. délka (m)</b>	1,5	2,0	3,0					

Těla všech RS KOMBI standardně PN 0,6 MPa, teplota 110 °C

Figure 59-parameters of distributor and collector ETL[59]

The designed combined collector and distributor ETL module 100 has a maximal flow of  $Q_{\max} = 10 \text{ m}^3/\text{h}$  and contains in total 5 paired branches: 3 heating branches, one branch for hot water preparation and one backup branch. It is fixed on two stands and provided by draining pipes.

The connection of collector and distributor is selected approximately in the middle of the product.

## B.11. Design of security equipments

### B.11.1. Design of expansion tank

The expansion tank allows changes in the volume of water in the system due to the thermal volume changes, and it prevents unwanted pressure increase and unnecessary heating water losses. The calculation is made according to ČSN 06 0830.

#### Water volume in pipes $V_p$ :

DN	Water volume in 1m of pipe(l/m)	length of pipes(m)	total water volume(l)
12x1	0,079	222,0	17,43
10x1	0,050	172,2	8,66
15x2	0,133	120,2	15,95
18x2	0,201	69,6	14,00
22x1	0,314	44,4	13,94
28x1,5	0,491	89,7	44,05
35x1,5	0,804	13,5	10,86
		<b>Σ</b>	<b>124,18</b>

### Water volume in radiators V<sub>R</sub>:

Room No.	Type of radiator	Water volume in radiator(l/m)	Water volume in radiator(l)
S103	Radik 22 VKL - 600/1500	5,8	8,70
S104	Radik 10 VK - 600/700	3,1	2,17
S105	Radik 11 VKL - 600/1200	3,1	3,72
S106	Radik 11 VKL - 700/2000	3,5	7,00
S108	Radik 10 VKL - 700/1100	3,1	3,41
101A	Radik 10 VK - 600/700	3,1	2,17
104A	Radik 10 VKL - 600/1600 Radik 10 VKL - 600/1400	3,1	9,30
105A	Koralux linear classic M - 1220/450		4,50
106A	Radik 10 VK - 600/1200 Radik 10 VK - 600/1200	3,1	7,44
107A	Radik 10 VKL - 700/1600	3,5	5,60
101B	Radik 10 VKL - 600/700	3,1	2,17
104B	Radik 10 VK - 600/1600 Radik 11 Vk - 600/1000	3,1	8,06
105A	Koralux linear classic M - 1500/750		8,00
106B	Radik 10 VKL - 600/1600 Radik 10 VKL - 600/1200	3,1	8,68
107B	Radik 11 VK - 600/1200	3,1	3,72
201A	Radik 10 VK - 700/700	3,5	2,45
204A	Radik 10 VKL - 600/1600 Radik 10 VKL - 600/1100	3,1	8,37
205A	Koralux linear classic M - 1220/450		4,50
206A	Radik 10 VK - 600/1200 Radik 10 VK - 600/1200	3,1	6,82
207A	Radik 10 VKL - 600/1600	3,1	4,96
201B	Radik 10 VKL - 700/700	3,5	2,45
204B	Radik 10 VK - 600/1600 Radik 10 Vk - 600/1100	3,1	8,37
205B	Koralux linear classic M - 1220/450		4,50
206B	Radik 10 VKL - 600/1200 Radik 10 VKL - 600/1200	3,1	7,44
207B	Radik 10 VK - 600/1600	3,1	4,96
211	Radik 10 VK - 600/1600	3,1	4,96
301A	Radik 10 VK - 600/700	3,1	2,17
304A	Radik 10 VKL - 700/1800 Radik 11 VKL - 700/1400	3,5	11,20
305A	Koralux linear classic M - 900/750		4,70
306A	Radik 10 VK - 600/1400 Radik 10 VK - 600/1200	3,1	8,06
307A	Radik 10 VKL - 700/1600	3,5	5,60
301B	Radik 10 VKL - 600/700	3,1	2,17
304B	Radik 10 VK - 700/1800 Radik 11 Vk - 700/1400	3,5	11,20
305A	Koralux linear classic M - 900/750		4,70
306B	Radik 10 VKL - 600/1400 Radik 10 VKL - 600/1200	3,1	8,06
307B	Radik 10 VK - 700/1600	3,5	5,60
311	Radik 10 VK - 600/1600	3,1	4,96
		<b>Σ</b>	<b>212,84</b>



**Water volume in other devices  $V_D$  :**

Water volume in other devices (l)	
Heat pumps	8
Accumulation tank	403
Distributor and collector	20
$\Sigma$	<b>431,00</b>

**Total water volume in the system  $V_T$ :**

$$V_T = V_P + V_R + V_D = 768 \text{ l} = 0,768 \text{ m}^3$$

**Expansion volume**

$$V_e = 1,3 \cdot V_o \cdot n = 1,3 \cdot 0,768 \cdot 0,01475 = 0,01473 \text{ m}^3$$

The coefficient of thermal expansion  $n$  is determined according to the temperature of heating water which is heated from  $10^\circ \text{C}$  to the maximal required temperature in the system which is  $55^\circ \text{C}$ .

$$\Delta t_m = t_{\max} - 10 = 55 - 10 = 45^\circ \text{C}$$

table 6 - coefficient of thermal expansion [60]

$\Delta t_m$	40	60	70	80	90
$n$	0,012	0,023	0,0295	0,035	0,044

**Lowest permissible operating overpressure**

$$p_{d,dov} > 1,1 \cdot h \cdot \rho \cdot g \cdot 10^{-3}$$

$$p_{d,dov} > 1,1 \cdot 10,83 \cdot 1000 \cdot 9,81 \cdot 10^{-3} = 116,87$$

I suggest expansion tank with lowest operating overpressure of  $P_d = 150 \text{ kPa}$

Where...  $p_{d,dov}$  lowest permissible operating overpressure [kPa]

$h$  height of the water column between the neutral point and the highest point of the heating system [m]

**Highest permissible operating overpressure**

$$p_{h,dov} < p_k - (h_{MR} \cdot \rho \cdot g \cdot 10^{-3})$$

$$p_{h,dov} < 300 - ((-0,6) \cdot 1000 \cdot 9,81 \cdot 10^{-3}) = 305,89 \text{ kPa}$$

I suggest expansion tank with highest operating overpressure of  $P_h = 250 \text{ kPa}$

where ...  $p_{h,dov}$  highest permissible system overpressure [kPa]

$h_{MR}$  altitude distance of the device with the smallest  $p_k$  from the manometric planes, (+) upwards, (-) downwards [m]. The manometric plane is 1,5 m from the

floor, and the device with the smallest  $p_k$  is the heat pump WPL 14AR comfort from company Buderus, which has a design overpressure of 300 kPa.

$p_k$  minimum of design overpressures of all system devices [kPa]

### Preliminary expansion tank volume with a membrane

$$V_{ep} = V_e \cdot (p_h + 100) / (p_h - p_d) = 0,01473 \cdot (250 + 100) / (250 - 150) = 0,052 \text{ m}^3 = 52 \text{ l}$$

The internal unit of both heat pumps contains expansion tank that is provided by the manufacturer. Each expansion tank has a volume of 10 l, which is not enough for the whole heating system.

**So I suggest a membrane expansion tank Reflex NG 35/6 , with a volume of 35 l.**

### Diameter of expansion pipes

$d_p = 10 + 0,6 \cdot Q^{0,5} = 10 + 0,6 \cdot 21,7^{0,5} = 12,8 \text{ mm}$  .... I suggest pipes made of copper with diameter of 15x1 mm

Where... Q pumps output [kW]

$d_p$  inner diameter of pipe [mm]

## Technická data Reflex

### Reflex NG, N

- pro uzavřené soustavy topení a chlazení
- závitové připojení
- od 35 litrů stojaté provedení
- membrána podle DIN EN 13831
- přípustná teplota 70 °C
- koncentrace glykolu max 30 %
- schválení podle směrnice pro tlaková zařízení 97/23/EG

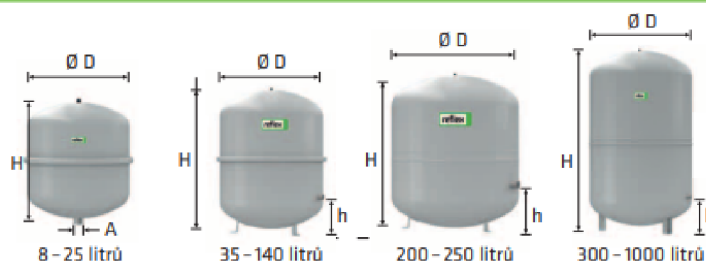

6 bar	Typ *	Obj. číslo		Počet na paletě	Hmotnost (kg)	Ø D (mm)	H (mm)	h (mm)	A	Přetlak plynu (bar)
	6 bar/120 °C	šedá	bílá							
	NG 8/6	8230100	7230107	96	1,6	206	285	-	R ¾	1,5
	NG 12/6	8240100	7240107	72	2,4	280	275	-	R ¾	1,5
	NG 18/6	8250100	7250107	56	3,4	280	345	-	R ¾	1,5
	NG 25/6	8260100	7260107	42	4,2	280	465	-	R ¾	1,5
	NG 35/6	8270100	7270107	24	4,8	354	460	130	R ¾	1,5
	NG 50/6	8001011	7001100	24	5,7	409	493	175	R ¾	1,5
	NG 80/6	8001211	7001300	12	8,7	480	565	175	R 1	1,5
	NG 100/6	8001411	7001500	10	11,4	480	670	175	R 1	1,5
	NG 140/6	8001611	7001700	6	13,1	480	912	175	R 1	1,5
6 bar	N 200/6	8213300	-	4	22,0	634	758	205	R 1	1,5
	N 250/6	8214300	-	4	24,7	634	888	205	R 1	1,5
	N 300/6	8215300	-	-	27,0	634	1092	235	R 1	1,5
	N 400/6	8218000	-	-	47,0	740	1102	245	R 1	1,5
	N 500/6	8218300	-	-	52,0	740	1321	245	R 1	1,5
	N 600/6	8218400	-	-	66,0	740	1531	245	R 1	1,5
	N 800/6	8218500	-	-	96,0	740	1996	245	R 1	1,5
	N 1000/6	8218600	-	-	118,0	740	2406	245	R 1	1,5

↑  $V_n$  jmenovitý objem v litrech / tlak

\* pro soustavy s maximální teplotou výstupní větve 120 °C

Figure 60-technical data of expansion tank Reflex NG [61]

### B.11.2. Design of safety valve

Safety valves of 1" with an opening overpressure of 300 kPa are a part of each internal unit of each heat pump. The sufficiency of the dimensions of the safety valve were checked using the available online program at tzb info. The safety valves comply.

### B.12 Design of filters

The filter is used to catch dirt and tiny particles in the heating system and thus to protect the circulating pumps from damage. Filters from Giacomini type R74B are designed. Filter dimensions are chosen according to pipe dimensions. I chose flow coefficient Kv according to manufacturer's catalogue then I calculated Individual pressure loss using online calculator on webpage of TZB-info [55].



VERZE B

Figure 61-Giacomini filter R74B [62]

Kódy	Kv	Max. průtok [m <sup>3</sup> /h]
VERZE B		
R74AY103	3,5	0,83
R74AY104	5,9	1,5
R74AY105	10,0	2,3
R74AY106	18,2	3,8
R74AY107	20,9	5,9
R74AY108	32,0	9,2

Figure 62-Filter Giacomini R74B with information about flow coefficient Kv and maximal flow[62]  
Detailed calculations of filters design in the technical room:

Position	Pipe DN (D x t)	Filter DN	M (Kg/h)	M (m <sup>3</sup> /h)	filter Kv	max.flow of filter (m <sup>3</sup> /h)	Filter code	Pressure loss(Pa)
<b>B1</b>	28x1,5	25	768,14	0,768	3,5	0,83	R74AY103	4930
<b>B2</b>	28x1,5	25	810,17	0,81	5,9	1,5	R74AY104	1920
<b>B3</b>	22x1	20	370,08	0,37	3,5	0,83	R74AY103	1140
<b>Hot water circuit</b>	22x1	20	561,70	0,562	3,5	0,83	R74AY103	2620
<b>Boiler circuit</b>	28x1,5	25	934,45	0,934	5,9	1,5	R74AY105	2560

### B.13. Design of pipes thermal insulation

The thermal insulation is designed using online calculator at tzb-info website [63].

Thickness of thermal insulation is designed so that the heat transfer coefficient of insulated pipe complies with Decree No. 193/2007.

For the pipes that are led in the floor, insulation MIRELON (PRO) is used, which is reduced to half the thickness, because the insulation is already provided by the insulation layer in the floor. For the pipes that are led along the wall, in wall grooves and under ceiling, insulation ROCKWOOL PIPO ALS is used.

Decree No 193/2007 defines the so-called "determining heat transfer coefficients". The calculated heat transfer coefficient must be smaller or equal to the determining heat transfer coefficient.

Calculated heat transfer coefficient of insulated pipe:

$$U_o = \frac{\pi}{\frac{1}{\alpha_i \cdot (d - 2 \cdot s_t)} + \frac{1}{2 \cdot \lambda_t} \cdot \ln \frac{d}{d - 2 \cdot s_t} + \frac{1}{2 \cdot \lambda_{iz}} \cdot \ln \frac{D}{d} + \frac{1}{\alpha_e \cdot D}} \quad [\text{W/mK}]$$

Where ...  $\lambda_t$  coefficient of thermal conductivity of pipe material [W/m·K]

- d pipe outer diameter [mm]
- $s_t$  pipe wall thickness [mm]
- $\lambda_{iz}$  coefficient of thermal conductivity of insulation material [W/m·K]
- D pipe diameter with insulation thickness [mm]
- $s_{iz}$  insulation thickness [mm]
- $\alpha_e$  heat transfer coefficient between the pipe surface and the surrounding [W/m·K]

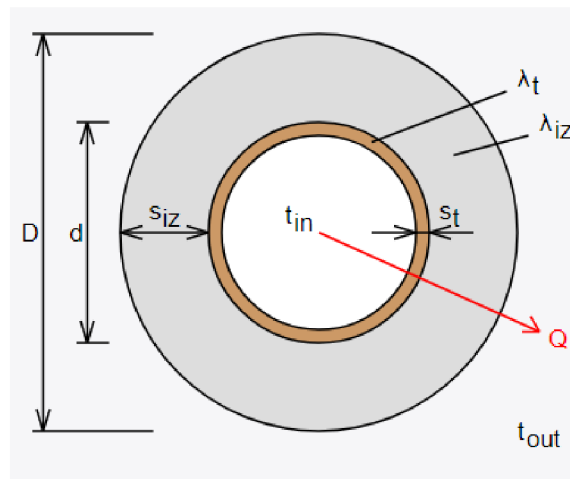

Figure 63-Cross section of a copper pipe with thermal insulation [63]

Table 7 - Design of thermal insulation of indoor pipes

Pipe dimensions	Type of insulation	Insulation thickness d(mm)	Calculated heat transfer coefficient $U_o$ (W/m <sup>2</sup> .K)	Determining heat transfer coefficient $U_o$ (W/m <sup>2</sup> .K)	Assessment
<b>Copper pipes in floor with possibility of thickness reduction of thermal insulation to half</b>					
10x1	MIRELON (PRO)	6	0,230	0,3	It complies
12x1	MIRELON (PRO)	6	0,258	0,3	It complies
15x1	MIRELON (PRO)	9	0,258	0,3	It complies
18x1	MIRELON (PRO)	9	0,29	0,3	It complies
22x1	MIRELON (PRO)	9	0,333	0,36	It complies
<b>Copper pipes along the wall, in wall grooves, under ceiling, and in measuring niches</b>					
10x1	ROCKWOOL PIPO ALS	25	0,121	0,15	It complies
12x1	ROCKWOOL PIPO ALS	25	0,132	0,15	It complies
15x1	ROCKWOOL PIPO ALS	25	0,147	0,15	It complies
18x1	ROCKWOOL PIPO ALS	30	0,149	0,15	It complies
22x1	ROCKWOOL PIPO ALS	30	0,165	0,18	It complies
28x1,5	ROCKWOOL PIPO ALS	40	0,164	0,18	It complies
35x1,5	ROCKWOOL PIPO ALS	50	0,165	0,18	It complies

For the pipes outside the building which connect external unit with internal unit of heat pump I chose insulation of mineral wool, ROCKWOOL PIPO ALS, which will be protected from outer environment by galvanized sheet metal duct.

Table 8 - Design of thermal insulation of outdoor pipes

Pipe dimensions	Type of insulation	Insulation thickness d(mm)	Calculated heat transfer coefficient $U_o$ ( $W/m^2.K$ )	Determining heat transfer coefficient $U_o$ ( $W/m^2.K$ )	Assessment
<b>Copper pipes outside the building</b>					
28x1,5	ROCKWOOL PIPO ALS + galvanized sheet metal duct	40	0,159	0,18	It complies

### B.14. Design of closing ball valves, drain ball valves, and automatic air release valves

The ball valve is used to close the flow in the heating system. Drain ball valve serves for draining of heating water of the heating system. I chose Giacomini ball valves R250D and Giacomini R608D drain ball valves. Dimensions of ball valves were chosen according to dimension of pipes, and dimensions of discharge ball valves is DN15.

The automatic air release valve ensures that there is no air in the heating system, which would have a negative effect on the functionality of the heating system. I chose automatic air release valves Giacomini type R88.

> **R250D**



Figure 64-Ball valve Giacomini R250D

> **R608D**



Figure 65-Drain ball valve Giacomini R608D



Figure 66- air release valve Giacomini R88

### B.15. Design of heating water replenishment

A refilling device is necessary to refill the heating system with water when pressure drops. This device records and automatically refills the required amount of heating water. I chose a refilling device type NK300TCA with a separation pipe, from company Aquaproduct.[64]



Figure 67-refilling device NK300TCA-Aquaproduct[64]

### B.16. Design of thermometers and manometers

Thermometers and manometers are used during the operation of the heating system to monitor the current state of the heating system and with their help it is possible to detect problems in the heating system like for example insufficient temperature of heating water, problems with circulating pumps, clogged filter, and others. I chose thermometer Giacomini type R540I and manometer Giacomini type R225I.

## **C. Project**

### **C.1. Technical report**

#### **C.1.1 Introduction**

The project solves the design of heating system and hot water preparation in a new apartment building, that is detached and located in Olomouc city using renewable energy sources. The apartment building has a basement and 3 above ground floors, which consist of 6 apartments. In the basement there are storerooms, technical room, two rooms that serve as private gym for inhabitants, and a toilet.

The vertical load bearing structure of the apartment building is masonry made of ceramic blocks Porotherm. The horizontal load bearing structure is made of reinforced concrete slabs. The building is constructed on concrete strip foundations and the top of the building is a flat roof that is insulated by mineral wool. Staircase is of U- shape with half space landing that serves as entrance vestibule in first floor and as laundry drying room in second and third floor. The apartment building is insulated using ETICS system.

After designing and comparing two variants of heat sources, one variant was selected to be used for further design of heating system and hot water preparation, and this variant is air source heat pump.

##### **C.1.1.1 Starting materials**

Construction drawings were used as a starting point for project processing.

##### **C.1.1.2 Used regulations and technical standards**

ČSN 73 0540 Thermal protection of buildings

ČSN EN 12 831 Heating systems in buildings - calculation of heat output

ČSN 06 0320 Heating systems in buildings - hot water preparation

ČSN 06 0830 Heating systems in buildings - security equipment

ČSN 06 0310 Central heating - design and installation

ČSN 06 1101 Radiators for central heating

ČSN 01 3452 Technical drawings - Installation - Heating and cooling

ČSN EN 12828 heating systems in buildings – hot water heating systems design

Decree No 193/2007 about the effectiveness of using energy in thermal energy distribution and internal distribution of thermal energy and cold

Decree No.264/2020 Sb. about energy performance of building.

other related ČSN as amended.



## C.1.2 Basic data

### C.1.2.1 Calculated climatic conditions

Location:	Olomouc
Altitude:	219 m above sea level
Calculated outdoor temperature:	-15 ° C
Number of days in the heating season:	231 days
Average temperature in heating season:	3,8 ° C

### C.1.2.2 Indoor temperatures:

Technical room 20 °C

Storerooms in basement 0 °C

Private gym 20 °C

Toilet and washing machine room 20 °C

Living room, Bedroom, apartment vestibule 20 °C

Bathroom 24 °C

Staircase 10 °C

Entrance vestibule in first floor 0 °C

Drying laundry room 15°C

Corridor in basement near the gym 15°C

## C.1.3 Thermal technical parameters of structures and heat loss

All structures comply with the required values that are specified in the norms.

Table 9- Overview of thermal technical parameters

Structure	$U_t$ [W/m <sup>2</sup> .K]	$U_{N,20}$ [W/m <sup>2</sup> .k]	$U_t \leq U_{N,20}$
C1.a - Ceiling separating heated space from unheated part of basement	0,414	0,600	it complies
C1.b - Ceiling separating heated space from heated part of basement	0,414	2,200	it complies
C2 - Inset balcony floor above basement	0,198	0,240	it complies
C3 - Internal ceiling separating spaces with temperature difference to 5 °C	0,779	2,200	it complies
F - Floor on the ground	0,309	0,450	it complies
R- Flat roof	0,136	0,240	it complies
S1- Peripheral wall to the exterior	0,125	0,300	it complies
S2- Peripheral wall in touch with ground	0,127	0,450	it complies
S3.a - Internal load bearing wall between rooms with temperature difference to 10 °C	0,501	1,300	it complies
S3.b - Internal load bearing wall separating rooms with temperature difference to 5 °C	0,501	2,700	it complies
S3.c - Internal load bearing wall separating heated room from unheated room	0,501	0,600	it complies
S4- Internal non-load bearing wall between rooms with temperature difference to 5 °C	1,379	2,700	it complies
S5- Wall between flats	0,704	2,700	it complies

Heat losses are calculated according to ČSN EN 12 831-1 Heating systems in buildings – heat output calculation.

Total energy output of the apartment building is equal to 21,7 kW. This number represents the total sum of heat transmission loss and heat loss due to ventilation.

Energy label of the building was done, and it shows C classification.

#### C.1.4 Heat and fuel demands

Heat demands:

For heating	21,7 kW
For hot water preparation	6,522 kW
Total heat demand:	21,712
Annual heat demand for heating	46,2 MWh/year (166,4 GJ/year)
Annual heat demand for hot water preparation	50,4 MWh/year (181,4 GJ/year)
Total annual energy demand	96,6 MWh/year (347,8 GJ/year)
Annual electricity demand for heat pumps	19 436 kWh/year

#### C.1.5 Heat source

Two air/water heat pumps Logatherm WPL 14 AR Comfort from company Buderus are used. Each one has output of 14 kW and is supplied by an electrical heat insert which has maximal output of 9 kW. Both heat pumps will be running during heating season in winter for heating system and hot water preparation system. However, in summer only one heat pump will be running for hot water preparation system.

The two heat pumps function with mono-energy operation. Bivalent point lies at  $-10,7^{\circ}\text{C}$ . At this temperature both heat pumps cover all needed heat output. At lower temperature than  $-10,7^{\circ}\text{C}$  the electrical inserts are switched on and they supply the extra heat output needed.

Each heat pump consists of two units that are connected to each other:

1. Inner unit that is mounted on the loadbearing wall in the technical room.
2. Outdoor unit that is accessible from all sides. Details about its positions are provided in the drawing of the technical room. It must be placed on a stable base, made of precast concrete strips with gravel bedding underneath. Earthwork must be done to make gravel bedding under concrete base

Each outer unit is connected to its inner unit by pipes and connecting cables that pass through an opening in the wall in a protecting tube with insulation. The copper pipes outside the building are insulated by mineral wool and placed in galvanized sheet metal duct together with other connecting cables.

The condensate must be drained through a suitable non-freezing waste pipe which is led 1 m under ground level. Electrical heating cable is installed around condensate pipe to prevent freezing. This heating cable will be turned on only when outdoor temperature drops below freezing point, and it will keep heating 30 minutes after the end of its defrosting operation.

Internal units of heat pumps are connected to storage tank in the technical room by copper pipes.

Refilling of heating water will be solved with the help of automatic refilling equipment NK300TCA, which will refill the system when the pressure drops below the minimum value. The manufacturer of heat pumps states that, if water hardness  $<16,8$  ° dH, then no further treatment of water is necessary and since the water in Olomouc city has hardness of  $14,14$  ° dH [65], then no further water treatment is necessary.

### **C.1.6 Expansion tank and safety valve**

Each heat pump contains expansion tank in the internal unit, together they will provide a volume of 20 l and that is not enough for the whole heating system, therefore another expansion membrane tank is designed Reflex NG 35/6 (volume 35 l).

Safety valve, with an opening overpressure of 300 kPa, is a part of each heat pump internal unit.

### **C.1.7 Heating system**

#### **C.1.7.1 Description of the heating system**

The heating system is designed to be hot water, closed, two-pipe system, with forced water circulation. It is a low temperature heating system with temperature drop of  $55/45$  °C.

Collector and distributor are combined and of type ETL module 100. They are insulated by PUR of 100 mm thickness, and have 3 branches for heating system, one branch for hot water preparation and one backup branch.

Branch B1 provides heating for the eastern apartments. Branch B2 provides heating for the western apartment. Branch B3 provides heating for communal areas. A three-way mixing valve will be installed on each of these three heating branches to provide quality regulation of heating water.

The branch for hot water preparation is connected to indirect storage heater ENBRA NOR 750.

#### **C.1.7.2 Radiators**

Steel panel radiators KORADO RADIK VK and VKL are designed for the apartment building with a lower right connection and with a lower left connection. For bathrooms towel rail radiators KORALUX LINEAR CLASSIC-M are designed with lower middle connection. All radiators are from Korado company.

### C.1.7.3 Piping

Pipes distribution system is designed to be closed, two-pipe, made of copper. Distribution pipes in the apartments are led in the thermal insulation of the floor, and in grooves in masonry wall. In the basement, distribution pipes are led under ceiling, along the wall, and above the floor.

Rising pipes S1,S2, and S3 are led vertically alongside the wall.

### C.1.7.4 Thermal insulation of pipes

MIRELON (PRO) insulation from polyethylene foam is used for the pipes led in floor insulation, which is reduced to half the thickness, sine the insulation is already provided in the floor. ROCKWOOL PIPO ALS insulation from mineral wool is used for pipes that are led along the wall, in wall grooves, under ceiling and in measuring niches.

Copper pipes outside the apartment building that connect heat pump internal unit with outer unit are insulated by mineral wool, ROCKWOOL PIPO ALS, and are protected by a galvanized sheet metal duct.

Table 7 - Design of thermal insulation of indoor pipes

Pipe dimensions	Type of insulation	Insulation thickness d(mm)	Calculated heat transfer coefficient $U_o$ (W/m <sup>2</sup> .K)	Determining heat transfer coefficient $U_o$ (W/m <sup>2</sup> .K)	Assessment
<b>Copper pipes in floor with possibility of thickness reduction of thermal insulation to half</b>					
10x1	MIRELON (PRO)	6	0,230	0,3	It complies
12x1	MIRELON (PRO)	6	0,258	0,3	It complies
15x1	MIRELON (PRO)	9	0,258	0,3	It complies
18x1	MIRELON (PRO)	9	0,29	0,3	It complies
22x1	MIRELON (PRO)	9	0,333	0,36	It complies
<b>Copper pipes along the wall, in wall grooves, under ceiling, and in measuring niches</b>					
10x1	ROCKWOOL PIPO ALS	25	0,121	0,15	It complies
12x1	ROCKWOOL PIPO ALS	25	0,132	0,15	It complies
15x1	ROCKWOOL PIPO ALS	25	0,147	0,15	It complies
18x1	ROCKWOOL PIPO ALS	30	0,149	0,15	It complies
22x1	ROCKWOOL PIPO ALS	30	0,165	0,18	It complies
28x1,5	ROCKWOOL PIPO ALS	40	0,164	0,18	It complies
35x1,5	ROCKWOOL PIPO ALS	50	0,165	0,18	It complies

Table 8 - Design of thermal insulation of outdoor pipes

Pipe dimensions	Type of insulation	Insulation thickness d(mm)	Calculated heat transfer coefficient $U_o$ (W/m <sup>2</sup> .K)	Determining heat transfer coefficient $U_o$ (W/m <sup>2</sup> .K)	Assessment
<b>Copper pipes outside the building</b>					
28x1,5	ROCKWOOL PIPO ALS + galvanized sheet metal duct	40	0,159	0,18	It complies

### C.1.7.5 Circulating pumps and three-way mixing valves

The heating system is designed with forced water circulation so a circulating pump will be installed on each one of the branches B1, B2, B3 and hot water preparation branch. Heat pumps are from company GRUNDFOS, and they are of types ALPHA2 25-50 130 for

branch B1, ALPHA2 25-40 130 for branches B2 and B3. For hot water preparation branch it is of type ALPHA A2 25-40 130.

Internal unit of heat pump is provided with circulating pump GRUNDFOS UPM GEO 25-85 PWM.

For the regulation of temperature of heating circuits, branches B1, B2, and B3 will be provided with three-way mixing valves type ESBE VRG 131, DN20, with servo drive ARA600.

#### **C.1.7.6 Fittings**

The heating system is provided with closing ball valves, filters, return valves, and three way mixing valves. Pipes are further provided with air valves, drain valves and measuring fittings.

Towel rail radiators KORALUX LINEAR CLASSIC-M are provided with HM fitting with integrated valve, which connects the radiator and allows the presetting of flow and closing of radiator. VK Radiators are provided with integrated thermostatic valve TRV for presetting of flow, and they are also provided with H-type angle connection fitting which connects the radiator and enable closing it. All radiators will have thermostatic head and air valve.

Air releasing valve will be installed at the highest points of each riser and ball valve with drain will be installed at the lowest point.

The fittings in the technical room will be installed according to the scheme drawing of the technical room. In each niche before each apartment there will be closing ball valves before and after heat meter, filter before heat meter, individual heat meter on the supply pipe which will be connected with a temperature measuring ball valve on the return pipes and a closing ball valve on return pipe. More details about positioning, diameters, and types are provided in the drawings.

#### **C.1.7.7 Accumulation tank**

Storage tank PS 400 K+ of volume 403 l is designed to reduce the number of compressor start-ups, and to ensure sufficient supply of the required amount of water in the heating and hot water preparation by storing heating water.

#### **C.1.7.8 Heat measuring**

The amount of heat taken will be measured in individual apartments using heat meters in each niche before each apartment and one additional heat meter will be installed on the branch B3 for measuring the heat used for communal areas. Heat meters will be of the type ENBRA SHARKY 775.

#### **C.1.7.9 Hot water preparation**

Hot water preparation will be ensured by using indirect storage heater ENBRA NOR 750 with volume of 750 l volume. The heater contains also hot water, cold water and circulating water outlets. The storage heater is insulated with 50 mm of polyurethane

foam insulation and is equipped with a heat sink sensor for sensing the temperature of hot water.

#### **C.1.7.10 Heating system regulation**

Heating system regulation and measuring system will ensure the automatic operation of the entire heating system.

Heating water temperature will be controlled depending on outdoor temperature. The unit HMC300 which is a part of the internal unit of each heat pump will regulate heat pump operation, circulating pumps, and three-way mixing valves by equithermal regulation.

Regulation involves:

- Regulation of both air source heat pumps output according to the maximum required heating water temperature and switching of the electric inserts when outdoor temperature drops under 10,7 °C.
- Regulation of heating water temperatures after mixing points at each heating branch of distributor and collector, according to the equithermal curves, which depends on outdoor temperature. Controlling of the operation of circulating pumps and three-way mixing valves.
- Regulation of hot water indirect storage heater, according to the required hot water temperature (if hot water temperature drops below 45 ° C, the circulating pump switches on)
- Monitoring of operating conditions, and technical room emergency security

Signalling, sensing:

- fault states signalling
- minimum and maximum pressure in the system
- maximum temperature in the radiator system
- maximum temperature in the hot water system
- maximum temperature in the technical room
- power supply outage

#### **C.1.8 Requirements for other professions**

##### **C.1.8.1 Construction part**

For pipes installation there should be securing and sealing of penetrations through building structures according to the requirements.

For installing the outer unit of each heat pump earth work is required. Gravel bedding will be applied to depth 1300, and on the top two concrete strip bases will be used under the outer unit, each has a length of 700 mm, width of 200 mm, placed with a distance of 680

mm (more details are provided in the connection scheme of the technical room). Condensation non-freezing pipes will be led from the outer unit of heat pump down through gravel layer to non-freezing level. These condensation pipes will also be provided with electrical heating cable. Anchoring of the outer unit will be done according to manufacturer's documents. All penetrations through the structures will be covered with insulation.

#### **C.1.8.2 Sanitary and water installation**

It is necessary to ensure the supply of cold water for the replenishment device of heating system. To the hot water storage heater tank, it is necessary to connect cold drinking water, hot water and circulating water. In the technical room there will be floor inlet. Condensation non-freezing pipes will be led from the outer unit of heat pump down through gravel layer to non-freezing level. These condensation pipes will also be provided with electrical heating cable.

#### **C.1.8.3 Electrical installation**

Outer unit of heat pump must be connected by cables to electrical outlet of electrical current 400/230 V AC. Internal unit must be as well connected to electrical current of 400 V AC.

#### **C.1.8.4 Ventilation system**

The building will be ventilated naturally, only in the bathrooms and toilets will be installed exhaust fans.

### **C.1.9 Assembly and commissioning**

#### **C.1.9.1 Heat source**

The installation and launching of heat source must be carried out by a suitably qualified person holding a certificate or qualification of competency. Prior to launching, the electrical installation must be inspected. Further information about installation and launching are provided in the manufacturer's documentation.

#### **C.1.9.2 Heating system**

Installation and launching of heating system must be performed by a person with a training certificate. Before launching all valves must be set to values according to the project.

#### **C.1.10 Testing of devices**

##### **C.1.10.1 Flushing of heating system**

The heating system must be flushed before starting. Setting of fittings and valves on branches, risers and fittings on radiators are recommended to be set to minimum hydraulic resistance during flushing. Flushing is performed during 24-hour operation of the circulating pump. Cleaning and rinsing are parts of the installation and there should be done a record about its implementation.

#### **C.1.10.2 Leak test**

Leak tests are performed before the grooves are filled up, canals are covered, and before coatings and insulation. Heating system is tested with water to the maximum permissible overpressure specified in the project for that part of the installation. The system is filled with water and properly vented and the entire system including all connections, radiators, fittings, etc. are inspected, taking into account that they must not show visible leaks. The system will remain filled for at least 6 hours, after which a new inspection is carried out. The test result is considered successful, if no leaks occur during this inspection or if there is no noticeable drop in the level in the expansion tank.

#### **C.1.10.3 Expansion test**

The expansion test is performed before the grooves are filled up, canals are covered, and before coatings and insulation. In this test, the heating water is heated to the highest working temperature, and then allowed to cool down until it reaches the surrounding temperature, and it is repeated once more. If a leakage is found after a detailed inspection, another test is required to be repeated after repairs.

#### **C.1.10.4 Heating test**

This Heating test lasts 24 hours and is carried out in presence of representatives of the investor, user, supplier, and designer. Then the results of the heating test are evaluated and recorded in the report. Heating test is considered successful, if the output of the radiators ensures calculation indoor temperature for each room and if the heating system is adjusted according to the project documentation.

#### **C.1.11 Method of service and control**

Heating system and its devices should be occasionally checked by one person. This person should be acquainted with the safety and operating conditions of the devices and should have documents with the instructions from the manufacturers of the devices.

#### **C.1.12 Health and environment protection**

##### **C.1.12.1 Environmental protection**

The proposed heating system will not have environmental impact and it meets all requirements in accordance with Decree No. 193/2007 Coll., and 194/2007 Coll.

##### **C.1.12.2 Waste management**

Waste generated during construction will be disposed in accordance with Act No. 541/2020 Coll. Act one waste.

#### **C.1.13 Safety during work**

Implementation of the heating system must comply with:

- Government Regulation 591/2006 Coll. on minimum requirements of security and health protection during work on construction sites
- Government Regulation 362/2005 Coll. on specified health and safety requirements for



work in workplaces with a risk of falling from a height or to depth.

- Act 309/2006 Coll. Act on Ensuring Additional Conditions of Safety and Health protection at Work.

## **C.2. Drawings**

The following drawings are parts of the attachment:

D.1.BASEMENT FLOOR PLAN	Scale: 1:50
D.2.FIRST FLOOR PLAN	Scale: 1:50
D.3.SECOND FLOOR PLAN	Scale: 1:50
D.4.THIRD FLOOR PLAN	Scale: 1:50
D.5.RADIATORS CONNECTION SCHEME	Scale: 1:50
D.6.CONNECTION SCHEME OF TECHNICAL ROOM-VARIANT 1	Scale: 1:25
D.7.CONNECTION SCHEME OF TECHNICAL ROOM-VARIANT 2	Scale: 1:25
D.8.FLOOR PLAN OF TECHNICAL ROOM-VARIANT 1	Scale: 1:25
D.9.FLOOR PLAN OF TECHNICAL ROOM-VARIANT 2	Scale: 1:25

## CONCLUSION

The aim of this diploma thesis is to design suitable heating system and hot water preparation system in a new apartment building in Olomouc city. The thermal technical properties of the structures are satisfactory and heat transfer coefficient values comply with the required norm values. Heat loss of the whole apartment building is estimated to be 21,7 kW and energy label indicates the building to be in category C-economical. Two variants of heat sources were designed and compared based on the environmental impact, economical costs, spatial requirements, and user comfort and subsequently one variant was selected for further design of the heating system.

Theoretical part focused on heat pumps and biomass boilers as renewable energy sources.

In the calculation part, all necessary calculations for the correct design and operation of the heating system were carried out. It contains the calculation of heat losses, radiators design, heat source design, pipes design, its dimensioning and hydraulic balancing, hot water preparation design, circulating pumps design, security equipments design and the design of other equipments, devices, and fittings necessary for the proper functioning of the heating system.

In the project part, the project documentation is processed for the realization of project. It contains a technical report, floor plans of individual floors, radiators connection scheme, scheme of connection of technical room in two variants, floor plan of the technical room in two variants.

## List of used resources and websites

- [1] DŘÍMAL, Petr. Tepelná čerpadla, geotermální energie [online]. Střední průmyslová škola elektrotechnická a informačních technologií Brno, ©2016. ISBN 978-80-88058-05-2. Available from: <https://publi.cz/books/93/Impresum.html>
- [2] Herz, heat pumps [online]. Available from : <https://www.herz-energie.at/en/products/heat-pumps/>
- [3] ČSN EN 14511 – Klimatizátory vzduchu, jednotky pro chlazení kapalin a tepelná čerpadla s elektricky poháněnými kompresory pro ohřívání a chlazení prostoru, soubor norem pro zkoušení tepelných čerpadel, ÚNMZ 2014.
- [4] MATUŠKA, Tomáš. Parametry pro hodnocení efektivity tepelných čerpadel: COP a SCOP. [online] at: TZB-info . Buštěhrad: Topinfo, 2015. Available from: <https://vytapani.tzb-info.cz/tepelna-cerpadla/13196-parametry-pro-hodnoceni-efektivita-tepelnych-cerpadel-cop-a-scop>
- [5] R290 9000btu ac rotary hermetic compressor for heat pump,[online]. Available from: <https://www.coowor.com/shop/product-detail/20200411095456LWCA.htm>
- [6] E6v electronic expansion valve,[online]. Available from: [https://www.carel.com/electronic-expansion-valve/-/journal\\_content/56\\_INSTANCE\\_i4q5KIMLlnKK/10191/95217](https://www.carel.com/electronic-expansion-valve/-/journal_content/56_INSTANCE_i4q5KIMLlnKK/10191/95217)
- [7] TZB-info/Vytápění/Tepelná čerpadla[online]. Available from: <https://vytapani.tzb-info.cz/tepelna-cerpadla>
- [8] Straka, Tomáš.Hodboď, Josef. Tepelná čerpadla a kontroly těsnosti od 1. ledna 2017 [online]. 22.11.2016 . Available from : <https://vytapani.tzb-info.cz/14986-tepelna-cerpadla-a-kontroly-tesnosti-od-1-ledna-2017>
- [9] Sedlář, Jan. Chladiva. úvod, definice, historie - Refrigerants - introduction, definition, history [online]. V Praze Univerzitní centrum energeticky efektivních budov, 28.12.2015. Available from : <https://vetrani.tzb-info.cz/klimatizace-a-chlazení/13626-chladiva-uvod-definice-historie>
- [10] VIESSMANN, spol. s r.o., Tepelná čerpadla, druhy, výhody, úspory[online], 17.12.2019, available from : <https://vytapani.tzb-info.cz/tepelna-cerpadla/20011-tepelna-cerpadla-druhy-vyhody-uspory>
- [11] Tepelná čerpadla voda – voda : vytápíme studenou vodou,[online]. Available from: <https://www.topeni-topenari.eu/topeni/topidla-alternativni/tepelna-cerpadla/voda-voda/>
- [12] Tepelná čerpadla, rozdělení TČ [online]. Available from: <https://vytapani.tzb-info.cz/tepelna-cerpadla>
- [13] Tepelná čerpadla země-voda : úsporné vytápění energií Země,[online]. Available from: <https://www.topeni-topenari.eu/topeni/topidla-alternativni/tepelna-cerpadla/zeme-voda/>
- [14] Typy tepelných čerpadel,[online]. Available from: <https://www.cerpadla-ivt.cz/cz/typy-tepelnych-cerpadel>
- [15] Tepelná čerpadla vzduch – voda,[online]. Available from: <https://www.topeni-topenari.eu/topeni/topidla-alternativni/tepelna-cerpadla/vzduch-voda/>

- [16] Tepelná čerpadla vzduch – vzduch,[online]. Available from: <https://www.topeni-topenari.eu/topeni/topidla-alternativni/tepelna-cerpadla/vzduch-vzduch/>
- [17] Jelínek Vladimír, Linhartová Vladimíra . Využívání a provozování tepelných čerpadel v nízkoenergetických domech, 10.1.2015[online]. Available from: <https://vytapani.tzb-info.cz/tepelna-cerpadla/12211-vyuzivani-a-provozovani-tepelných-cerpadel-v-nízkoenergetických-domech>
- [18] Buday,Tomas. Reduction of environmental impacts of heat pump usage with special regard on systems with borehole heat exchangers.University of Debrecen, Department of Mineralogy and Geology, 22 December 2014[online].Available from: [https://www.researchgate.net/publication/283849752\\_Reduction\\_of\\_environmental\\_impacts\\_of\\_heat\\_pump\\_usage\\_with\\_special\\_regard\\_on\\_systems\\_with\\_borehole\\_heat\\_exchangers](https://www.researchgate.net/publication/283849752_Reduction_of_environmental_impacts_of_heat_pump_usage_with_special_regard_on_systems_with_borehole_heat_exchangers)
- [19] Biomasa,TZB-info [online]. Available from: <https://oze.tzb-info.cz/biomasa>
- [20] Lyčka, Zdeněk. Co je dřevní biomasa, 7.11.2011 [online]. Available from: <https://oze.tzb-info.cz/biomasa/8011-co-je-drevni-biomasa>
- [21] Pelety [online]. Available from : <https://ceska-peleta.cz/palivo/pelety/>
- [22] DŘEVĚNÉ BRIKETY NESTRO[online]. Available from <https://www.kohutovypaliva.cz/brikety/drevene-brikety-nestro/>
- [23] by David Dominguez-Santos, Daniel Mora-Melia, Gonzalo Pincheira-Orellana, Pablo Ballesteros-Pérez, Cesar Retamal-Bravo. Mechanical Properties and Seismic Performance of Wood-Concrete Composite Blocks for Building Construction, 8 May 2019[online].Available from: <https://www.mdpi.com/1996-1944/12/9/1500/htm>
- [24] PALIVOVÉ DŘEVO MLADÁ BOLESLAV – STŘEDOČESKÝ KRAJ[online]. Available from : <https://www.fowood-drevo.cz/palivove-drevo-mlada-boleslav-stredocesky-kraj/>
- [25] Buková štěpka PROFI 15 kg zrnitost 2/16 – hrubá[online].Available from : <https://www.kamnkrby.cz/bukova-stepka-profi-15-kg-zrnitost-2-16-hruba>
- [26] Ochodek Tadeáš, Koloničný Jan, Branc Michal, technologie pro přípravu a energetické využití biomasy, Ostrava 2007, ISBN 978-80-248-1426-1,[online]. Available from : <http://www.biomasa-info.cz/cs/doc/tech.pdf>
- [27] Jaroslav Jakubes, Helena Bellingová, Michal Šváb. MODERNÍ VYUŽITÍ BIOMASY TECHNOLOGICKÉ A LOGISTICKÉ MOŽNOSTI. Česká energetická agentura v roce 2006 [online]. Available from: <https://www.mpo-efekt.cz/dokument/02.pdf>
- [28] Peer Václav, Friedel Pavel, VŠB – TU Ostrava, Výzkumné energetické centrum, 25.1.2016 [online]. Available from: <https://vytapani.tzb-info.cz/vytapime-pevnymi-palivy/13729-zplynovani-principy-a-reaktory>
- [29] Energie z biomasy [online]. Available from : <http://www.spvez.cz/pages/OZE/biomasa.htm>
- [30] Vladimír Stupavský, Kotel na pelety - peletový kotel pro ústřední vytápění [online]. Available from : <https://biom.cz/cz/odborne-clanky/kotel-na-pelety-peletovy-kotel-pro-ustredni-vytapani>
- [31] Jiří Ryšavý, Jiří Horák, František Hopan, Kamil Krpec, Kubesa, Jiří Kremer, Komfort kotlů na tuhá/pevná paliva – část I., VŠB-TU Ostrava, Výzkumné energetické centrum, 26.3.2018 [online].

Available from: <https://vytapani.tzb-info.cz/vytapime-pevnymi-palivy/17137-komfort-kotlu-na-tuha-pevna-paliva-cast-i>

[32] <https://www.atmos.eu/zplynovaci-kotle-na-drevo/>

[33] Vytápění peletami [online]. Available from : <https://oze.tzb-info.cz/vytapani-peletami>

[34] <https://www.archiexpo.com/prod/panadero/product-136095-2016779.html>

[35] <https://www.woodcookstoves.ca/regina-wood-cook-stove.html>

[36] Lyčka Zdeněk, Kotelny s kotli na dřevo a pelety, 6.10.2008 [online]. Available from : <https://vytapani.tzb-info.cz/vytapime-pevnymi-palivy/5117-kotelny-s-kotli-na-drevo-a-pelety>

[37] Hodboď Josef, Výpočet a graf ekvitermní křivky, 8.3.2017[online]. Available from: <https://vytapani.tzb-info.cz/mereni-a-regulace/15462-vypocet-a-graf-ekvitermni-krivky>

[38] Výpočet a graf ekvitermní křivky,[online]. Available from : <https://vytapani.tzb-info.cz/tabulky-a-vypocty/50-vypocet-a-graf-ekvitermni-krivky>

[39] Final energy consumption, EU-28, 2015 [online]. Available from [https://ec.europa.eu/eurostat/statistics-explained/index.php?title=Archive:Consumption\\_of\\_energy#Consumption](https://ec.europa.eu/eurostat/statistics-explained/index.php?title=Archive:Consumption_of_energy#Consumption)

[40] Buderus, Projekční podklady Tepelná čerpadla vzduch/voda Vydání 2015/04 Logatherm WPL ... AR, Vydání 2015/04 [online] available from: [https://www.buderus.com/cz/media/country\\_pool/fuer\\_partner/planunsdokumente/heat\\_pumps/pp\\_logatherm\\_wpl-ar\\_cz\\_cz\\_cz.pdf](https://www.buderus.com/cz/media/country_pool/fuer_partner/planunsdokumente/heat_pumps/pp_logatherm_wpl-ar_cz_cz_cz.pdf)

[41] Počinková Marcela. VUT FAST TZB II Vytapeni [online]. Brno: Fakulta stavební, 2020. Available from: <https://www.fce.vutbr.cz/TZB/pocinkova.m/vytapani.htm>

[42] Výpočet potřeby tepla pro vytápění, větrání a přípravu teplé vody [online]. Available from : <https://vytapani.tzb-info.cz/tabulky-a-vypocty/47-vypocet-potreby-tepla-pro-vytapani-vetrani-a-pripravu-teple-vody>

[43] Nepřímohřevný zásobník ENBRA NOR 750 [online]. Available from: <https://www.enbra.cz/nepriamoohrevny-zasobnik-enbra-nor-750>

[44] Automatický kotel na pelety KP 21, company Ponast[online]. Available from : <http://www.ponast.cz/produkt/kotle-na-peletky-KP-line-1/automaticky-kotel-na-pelety-kp-21/katalog-c-HKYI2101>

[45] Ponast automatické kotle na pelety, informační a plánovací návod 04/2014 [online]. Available from : [http://www.ponast.cz/userfiles/file/ke-stazeni/man\\_projcz\\_14\\_04\\_14.pdf](http://www.ponast.cz/userfiles/file/ke-stazeni/man_projcz_14_04_14.pdf)

[46] Často kladené dotazy. Akumulační-nádrž.cz [online]. Available from: <https://akumulacni-nadrz.cz/faq.php>

[47] LMG accumulator tanks[online]. Available from: <https://accumulator-tank.co.uk/lmg-accumulator-tank.php>

[48] Honzík, Jiří. Dimenzování tepelného čerpadla vzduch-voda, bivalentní/záložní zdroj. 3.11.2011 [online]. Available from: <https://vytapani.tzb-info.cz/tepelna-cerpadla/7995-dimenzovani-tepelneho-cerpadla-vzduch-voda-bivalentni-zalozni-zdroj>

- [49] Porovnání nákladů na vytápění, teplou vodu a elektrickou energii - TZB-info[online]. Available from : <https://vytapani.tzb-info.cz/tabulky-a-vypocty/138-porovnani-nakladu-na-vytapani-teplou-vodu-a-elektrickou-energii-tzb-info>
- [50] Radik-steel panel radiators, 06/2019, Korado[online], available from: [https://www.korado.com/downloads.html?pci\[\]=3&dti\[\]=5001](https://www.korado.com/downloads.html?pci[]=3&dti[]=5001)
- [51] Koralux-towel rail radiators, 06/2019, Korado[online], available from: [https://www.korado.com/downloads.html?pci\[\]=3&dti\[\]=5001](https://www.korado.com/downloads.html?pci[]=3&dti[]=5001)
- [52] Výpočet tlakové ztráty třením v potrubí, tzb-info [online]. Available from : <https://vytapani.tzb-info.cz/tabulky-a-vypocty/87-vypocet-tlakove-ztraty-trenim-v-potrubi>
- [53] Ruční vyvažovací ventil D 9505, vyvažovací ventily D 9505, 1.2021,Hydronix[online]. Available from : <https://www.hydronix.cz/rucni-vy vazovaci-ventil-d-9505/>
- [54] Sharky 775 Heat Meter, technical catalogue 07.07.2018 [online]. Available from: [https://www.dmsltd.com/p\\_195\\_sharky-775-heat-meter](https://www.dmsltd.com/p_195_sharky-775-heat-meter)
- [55] Výpočet průtokového součinitele kv a graf tlakových ztrát, tzb-info[online]. Available from: <https://vytapani.tzb-info.cz/tabulky-a-vypocty/48-vypocet-prutokoveho-soucinitele-kv-a-graf-tlakovych-ztrat>
- [56] Trojcestný směšovací ventil ESBE VRG 131 20-4,[online]. Available from: <https://www.bola.cz/trojcestny-smesovaci-ventil-esbe-vrg-131-20-4>
- [57]Grundfos [online].Available from: <https://product-selection.grundfos.com/cz>
- [58] ETL[online].Available from : <http://designer.etl.cz/Special-pages/Sign-in?returnurl=%2f>
- [59] PRODUKTOVÝ KATALOG,2020[online]. Available from: <https://www.etl.cz/katalog-vyrodku>
- [60] Vysoké učení technické v Brně: Vytápění [online]. [cit. 2020-03-07]. Available from: [https://www.fce.vutbr.cz/TZB/pocinkova.m/vytapani\\_soubory/BT01\\_C10.pdf](https://www.fce.vutbr.cz/TZB/pocinkova.m/vytapani_soubory/BT01_C10.pdf)
- [61] Membránové expanzní nádoby, Reflex[online]. Available from: <https://www.reflexcz.cz/cz/expanzni-nadoby-reflex-ng-a-n>
- [62] R74A Mosazný Y-filtr s vnitřními závitými a nerezovým sítkem, katalogový list [online]. Available from: <https://www.giacomini.cz/katalog/r74a>
- [63] Výpočet tepelné ztráty potrubí s izolací [online]. Available from: <https://vytapani.tzb-info.cz/tabulky-a-vypocty/44-vypocet-tepelne-ztraty-potrubi-s-izolaci>
- [64] NK300T - automatické doplňovací zařízení[online]. Available from: <https://katalog.aquaproduct.cz/?id=automaticke-doplnovaci-zarizeni-nk300t>
- [65] MORAVSKÁ VODÁRENSKÁ [online]. Available from: <https://www.smv.cz/vse-o-vode/pitna-voda/kvalita-pv/>

# List of figures and tables

## List of used figures

Figure 1-energy consumption according to EU-28 2015[39] .....	13
Figure 2-Principle of heat pumps[2] .....	14
Figure 3 - rotary compressor for heat pump[5] .....	15
Figure 4 - tube heat exchanger[1].....	16
Figure 5 - brazed plate heat exchanger[1] .....	16
Figure 6-thermostatically controlled expansion valve[1] .....	17
Figure 7-electronic expansion valve[6] .....	17
Figure 8-air to water heat pump[15] .....	19
Figure 9-heat pump ground to water with boreholes[14]      Figure 10-heat pump ground to water with flat earth collector[14] .....	20
Figure 11-water to water heat pump[11] .....	21
Figure 12-modes of operation of a heat pump[18] .....	22
Figure 13-wood briquettes[22] .....	25
Figure 14-wood pellets[21].....	25
Figure 15-sawdust on the left - wood shavings on the right[23].....	25
Figure 16-firewood[24] .....	26
Figure 17-wood chips[25] .....	26
Figure 18-processes of gasification inside of a reactor [28] .....	28
Figure 19- basic ways of pellet storing[36] A. Pellet bags. B. Pellet storeroom. C. Pellet container..	29
Figure 20-automatic pellet boiler[30] .....	29
Figure 21-function scheme of automatic boiler[31] .....	30
Figure 22- gasification wood boiler, ATMOS[32] .....	30
Figure 23-function scheme of gasification boiler[31] .....	31
Figure 24-wood burning fireplace[34]                      Figure 25-wood burning stove[35] .....	32
Figure 26- hot water supply, consumption, and losses curves .....	119
Figure 27-section of storage heater ENBRA NOR 750[43] .....	120
Figure 28-Parameters of storage heater ENBRA NOR 750[43] .....	120
Figure 29-Automatic boiler for wood KP 21 [44] .....	122
Figure 30-Parameters of automatic boiler KP 21[44] .....	122
Figure 31- cross section of the fixed silo for wood pellet storage[45] .....	123
Figure 32- fixed silo for wood pellet storage [45].....	123
Figure 33-storage tank LMG 1200 0V [47] .....	125
Figure 34-parameters of storage tank LMG 1200 0V[47] .....	125
Figure 35-specifying bivalent point for Logatherm WPL AR heat pump and the apartment building .....	126
Figure 36- minimal distance around heat pump[40] .....	127
Figure 37-parameters of storage tank PS 400 K+ .....	128
Figure 38- overview of total costs of both variants of heat source .....	130
Figure 39- Steel panel radiator Korado Radik VK[50]              Figure 40- connection of radiator Radik VK to the.....	135
Figure 41-technical data of Korado Radik VK radiator[50] .....	136
Figure 42-Steel panel radiator Radik VKL[50] .....	136
Figure 43-Radiator Radik VLK connection to the heating system[50] .....	136
Figure 44-technical data of Korado Radik VKL radiator[50].....	137

Figure 45-Graph for determining the presetting of thermostatic valve(TRV) for RADIK VK and VKL radiators[50] .....	141
Figure 46 - diagram for presetting of HM fitting[51] .....	142
Figure 47- thermostatic valve of RADIK VK and VKL radiators[50] .....	142
Figure 48-Presetting graph of balancing valve Hydronix D 9505[53] .....	157
Figure 49-Presetting graph of balancing valve Hydronix D 9505[53] .....	157
Figure 50- pressure loss graph of heat meter sharky 775 [54] .....	158
Figure 51- Technical data sheet of the three-way mixing valve ESBE VRG131[56] .....	160
Figure 52-circulating pump Grundfos ALPHA A2 25-50 130 [57].....	161
Figure 53-circulating pump Grundfos ALPHA A2 25-40 130[57] .....	162
Figure 54-circulating pump Grundfos ALPHA A2 25-40 130[57] .....	163
Figure 55-circulating pump Grundfos ALPHA A2 25-40 130[57] .....	164
Figure 56-Grundfos ALPHA2 circulation pump with thermal insulation[57] .....	164
Figure 57-UPM GEO 25-85 circulating pump curve with marked working point[57].....	165
Figure 58-distributor and collector design.....	166
Figure 59-parameters of distributor and collector ETL[59] .....	166
Figure 60-technical data of expansion tank Reflex NG [61].....	171
Figure 61-Giacomini filter R74B [62].....	171
Figure 62-Filter Giacomini R74B with information about flow coefficient Kv and maximal flow[62] .....	172
Figure 63-Cross section of a copper pipe with thermal insulation [63].....	173
Figure 64-Ball valve Giacomini R250D .....	174
Figure 65-Drain ball valve Giacomini R608D.....	174
Figure 66- air release valve Giacomini R88 .....	175
Figure 67-refilling device NK300TCA-Aquaproduct[64].....	175

### List of used tables

Table 1 – Types of HFC refrigerants and their GWP value[8]

Table 2 - Possible test combinations of evaporator input and condenser output temperatures defined in ČSN EN 14511. [3]

Table 3 - Minimum heating factors of heat pumps [4]

Table 4 - summary of all U values of building structures and their assessment.

Table 5 – air exchange intensity[41]

table 6 - coefficient of thermal expansion [60]

Table 7 - Design of thermal insulation of indoor pipes

Table 8 - Design of thermal insulation of outdoor pipes

Table 9- Overview of thermal technical parameters



## List of attachments

### Drawings:

D.1.BASEMENT FLOOR PLAN	Scale: 1:50
D.2.FIRST FLOOR PLAN	Scale: 1:50
D.3.SECOND FLOOR PLAN	Scale: 1:50
D.4.THIRD FLOOR PLAN	Scale: 1:50
D.5.RADIATORS CONNECTION SCHEME	Scale: 1:50
D.6.CONNECTION SCHEME OF TECHNICAL ROOM-VARIANT 1	Scale: 1:25
D.7.CONNECTION SCHEME OF TECHNICAL ROOM-VARIANT 2	Scale: 1:25
D.8.FLOOR PLAN OF TECHNICAL ROOM-VARIANT 1	Scale: 1:25
D.9.FLOOR PLAN OF TECHNICAL ROOM-VARIANT 2	Scale: 1:25