



Synthesis of robust PID controller for non-stationary object

Diploma thesis

Study program: N2612 Electrical Engineering and Informatics

Specialization: Mechatronics

Author: **B. Sc. Nikita Zemtsov**

Supervisor: doc. Ing. Osvald Modrlák, CSc.

Consultant: prof. Dr. Galina A. Frantsuzova



DIPLOMA THESIS ASSIGNMENT

(PROJECT, ART WORK, ART PERFORMANCE)

First name and surname: **Nikita Zemtsov, B.Sc.**
Study program: **N2612 Electrical Engineering and Informatics**
Identification number: **M13000297**
Specialization: **Mechatronics**
Topic name: **Synthesis of robust PID controller for non-stationary object**
Assigning department: **Institute of Mechatronics and Computer Engineering**

R u l e s f o r e l a b o r a t i o n :

1. A comparative analysis of methods for calculating the parameters of PID controller.
2. Studying the known methods of robust control.
3. Development of a technique for designing of robust PID controller based on the localization method.
4. Describe structure of once -through boiler, familiarize yourself with the complex model of the once - through boiler in Matlab/Simulink.
5. Application of the PID controller in a robust control system for once - through boiler.
6. Documentation and description of the created control system.



Scope of graphic works: **In respect to the documentation needs**
Scope of work report
(scope of dissertation): **c. 40–50 pages**
Form of dissertation elaboration: **printed/electronical**
Language of dissertation elaboration: **English**
List of specialized literature:

- [1] Dorf Richard C., Bishop Robert H. Modern Control Systems. Prentice Hall, Upper Saddle River, NJ, 11th edition, 2008, 1034 s. (or in Russian: Moscow: Laboratory of Basic Knowledge, 2002, 832 s.).
- [2] Aström Karl J., Murray Richard M. Feedback Systems: An Introduction for Scientists and Engineers, URL:
http://www.cds.caltech.edu/~murray/amwiki/index.php/Main_Page
- [3] Franklin G. F., Powell J. D., Emami-Naeini A. Feedback Control of Dynamic Systems. Prentice Hall, Upper Saddle River, NJ, 5th edition, 2005.
- [4] PID control on practical examples. URL:
<http://pidcontrollers.narod.ru/pidregulator/chapter3page18.html>
- [5] Encyclopedia of Automated process control systems, URL:
<http://www.bookasutp.ru>
- [6] Vostrikov A. S., Frantsuzova G.A. The theory of automatic control. Moscow, Higher School, 2006, 365 s.

Tutor for dissertation: **doc. Ing. Osvald Modrlák, CSc.**
Institute of Mechatronics and Computer Engineering
Dissertation Counsellor: **prof. Dr. Galina A. Frantsuzova**
Novosibirsk State Technical University, Russia
Date of dissertation assignment: **29 November 2013**
Date of dissertation submission: **16 May 2014**

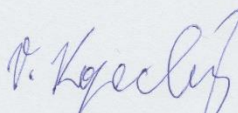
prof. Ing. Václav Kopecký, CSc.
Dean

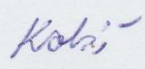

doc. Ing. Milan Kolář, CSc.
Department Manager

Liberec, dated: 29 November 2013

Declaration

I hereby certify that I have been informed the Act 121/2000, the Copyright Act of the Czech Republic, namely § 60 - Schoolwork, applies to my master thesis in full scope.

I acknowledge that the Technical University of Liberec (TUL) does not infringe my copyrights by using my master thesis for TUL's internal purposes.

I am aware of my obligation to inform TUL on having used or licensed to use my master thesis; in such a case, TUL may require compensation of costs spent on creating the work at up to their actual amount.

I have written my master thesis myself using literature listed therein and consulting it with my thesis supervisor and my tutor.

Concurrently I confirm that the printed version of my master thesis is coincident with an electronic version, inserted into the IS STAG.

Date:

Signature:

Abstract

The diploma work is aimed at designing of robust PID-controller method and applying it to once-through boiler model. The method is based on the localization method.

One of the goal is to develop an algorithm of typical controller calculation. The obtained controller should provide the robust properties: control of non-stationary and non-linear plant. Application of the method to non-stationary and to non-linear model of once-through boiler was done. The controller fulfills appropriate requirements: quality of transient process, disturbance reaction and shape of manipulated variable.

The work contains chapter with modelling results, which illustrate the properties of the developed method. The simulations were made by using the “MatLab Simulink”. The simulation models and appropriate scripts are attached to the CD.

Keywords:

Robust control, robustness, localization method, PID-controller, PIDD-controller typical controller, simulation, differentiating filter, derivatives calculation.

CONTENT

INTRODUCTION	8
1. METHODS OF TYPICAL AND ROBUST CONTROLLERS CALCULATION ..9	
1.1. The meaning of typical controllers	9
1.2. PIDD-controller as a modification of PID-controller	10
1.3. The root locus method	11
1.4. PID-controller by the Ziegler–Nichols method	12
1.5. PID-controller by the Chien-Hrones-Reswick method.....	13
1.6. The technical optimum method	14
1.7. Analysis of the considered calculation methods	15
1.8. Calculation of robust controllers.....	15
1.8.1. Modeling of uncertainty	16
1.8.2. Calculation of robust controller by using H_2 and H_∞ norms.....	18
2. CALCULATION OF PID-CONTROLLER PARAMETERS BASED ON THE LOCALIZATION METHOD	21
2.1. The linear interpretation of the localization method.....	21
2.2. The application of the localization method for PID-controller.....	23
2.3. Application of the localization method for PIDD-controller.....	25
3. ANALYSIS OF THE CONSIDERED METHODS	27
3.1. Description of control object	27
3.2. Identification of the control object.....	28
3.3. Synthesis of PID-controller based on the localization method.....	29
3.4. The synthesis of PID-controller based on the root locus method	32
3.5. Synthesis of robust controller	35
3.6. Analysis of the considered methods	37
4. DESCRIPTION OF THE ONCE-THROUGH BOILER MODEL.....	39
4.1. Appointment of the once-through boiler	39
4.2. Temperature control of steam in the superheater.....	40
4.3. Simplified mathematical model of the superheater	41
4.4. Features of the once-through boiler as a control object.....	44
4.5. Requirements of the control system.....	45

5.	SYNTESIS OF THE ONCE-THROUGH BOILER CONTROL SYSTEM.....	46
5.1.	Stabilizing of the inner circle.....	46
5.2.	Calculation of PID-controller parameters based on the localization method	46
5.3.	Application of the PID-controller based on the localization method	47
5.3.1.	Constant power level, the step response	47
5.3.2.	Constant power level, the disturbance reaction	49
5.3.3.	Changing power level, step response	50
5.4.	Calculation of PIDD-controller parameters based on the localization method ...	51
5.5.	Application of the PIDD-controller based on the localization method.....	52
5.5.1.	Constant power level, the step response	52
5.5.2.	Constant power level, the disturbance reaction	53
5.5.3.	Changing power level, step response	55
5.6.	Calculation of PID-controller parameters based on the root locus method.....	55
5.7.	Application of the PIDD-controller based on the root locus method	57
5.7.1.	Constant power level, the step response	57
5.7.2.	Constant power level, the disturbance reaction	58
5.7.3.	Changing power level, step response	60
5.8.	Calculation of robust controller	60
5.9.	Application of the robust-controller to the system	62
5.9.1.	Constant power level, the step response	62
5.9.2.	Constant power level, the disturbance reaction	64
5.9.3.	Changing power level, step response	65
5.10.	Analysis of the obtained control systems.....	66
5.11.	Application of the PID-controller to the great system	67
5.11.1.	Constant power level, the step response	67
5.11.2.	Constant power level, the disturbance reaction	69
5.11.3.	Changing power level, step response	70
	CONCLUSION.....	72
	REFERENCE	73
	ATTACHMENT.....	75

INTRODUCTION

Environmental protection in production is promoted globally. The role of environmental protection is increasing in the production of electricity and energy in general. To avoid unnecessary damage to the environment during the production of electricity in thermal power plants is one of the important requirements to achieve maximum process efficiency of electricity production. With the current trend in using of electric energy from renewable sources is a big emphasis taken on adapting the output of thermal power plants according to the energy balance of the electrification of the network. This changes the classical requirement on management of thermal power plants that was the control at nominal power fundamentally. It is desired to assure quality control at all power levels. The process of electricity production is highly non-linear. However, this means that it is not possible to implement the classical linear controllers.

The problem of PowerStation control can be solved by using sophisticated algorithms, such as algorithm "Model predictive control MPI" or algorithms "Robust or fuzzy control". Because of the plant is a non-linear system, it is possible to implement non-linear algorithms such as "Non-linear predictive control" or others. The classical control methods are simpler, but it is impossible to solve fully the described problem. For non-linear and non-stationary objects, it is possible to use the strategy of the localization method. There is an idea to implement this method to classical PID-controller, because from one hand this type of controller is enough simple, but from another hand, is very popular in technical field and can solve wide range of the control tasks. The results based on this strategy are the new calculation method of PID-controller with special structures of control system. My diploma thesis deals with analyzing and design this algorithm and comparison with the classical tuning methods of PID-controller. This analyzing was worked out on the institute of Mechatronics and Computer Engineering that is solving the project "Predictive control system for improved stability and increasing the efficiency of power units" led under the Technology Agency of the Czech Republic ALFA program - 2nd call, number of project TA02020109.

First chapter is an overview about the known methods of PID-controller calculation and the robust control. Then results of these methods will be compared with results of new method.

Second chapter is an introduction into the localization method and description of the PID-controller calculation algorithm, based on this method.

Third chapter is a comparative analysis of all considered methods by applying it to a simple control system.

Fourth chapter is a description of the once-through boiler model. This plant describes the problem of PowerStation control. The model is non-linear and non-stationary.

Fifth chapter contains the results of applying all considered method to once-through boiler model and a comparative analysis of appropriate control systems.

1. METHODS OF TYPICAL AND ROBUST CONTROLLERS CALCULATION

Nowadays there is a great number of different methods of typical or PID-controllers calculation. These methods are based on different meaning of the control theory and usually they are able to solve only part of control tasks. The important point is that the solutions obtained by using different methods can provide different results, which are not the optimal ones. Summing it up, researching of the regular method of PID-controller calculation is still particularly topical issue.

The important point in this work is the calculation of robust controller for non-stationary object. There are many different descriptions what is the robust control. The common idea from all of these meanings is that, robust controller should allow keeping the desired quality of transient processes when plant parameters can change. Non-stationary control object contains uncertainty that means object parameters are able to change in depending on external factors [7].

The current chapter contains an introduction in to the basics of typical controller and the robust control and a short review of known synthesis methods.

1.1. The meaning of typical controllers

Proportional-Integral-Derivative (PID) controller or typical controller is a device, which provides a control variable in feedback control system. The well-known structure of PID-controller is shown in figure 1.1.

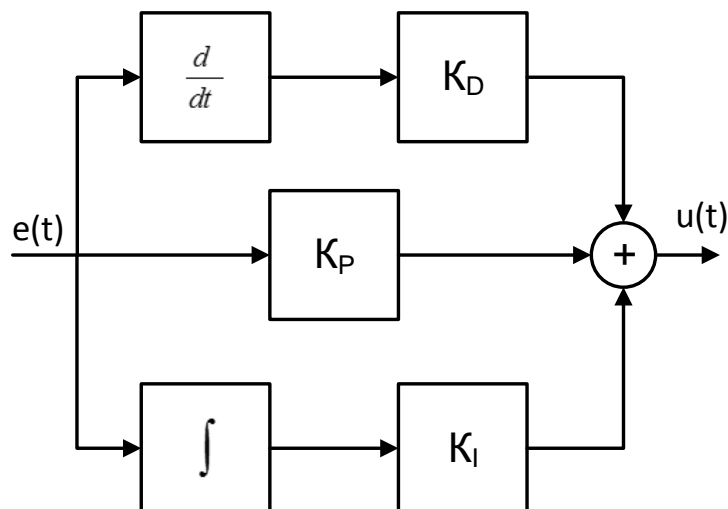

Figure 1.1: Structure of PID-controller

, where $e(t)$ – the control error;

$u(t)$ – the manipulated variable;

K_P, K_I and K_D – the coefficients of corresponding channel;

\int – the integrator;

$\frac{d}{dt}$ – the differentiator.

The control variable provided by PID-controller is a sum of three channel (proportional, international, derivative). The appropriate transfer function has the following form:

$$R_{PID}(s) = K_P + \frac{K_I}{s} + K_D s. \quad (1.1)$$

It is impossible to realize the controller in form (1.1) because of the ideal differentiator realization. That is why the aperiodic element with relatively small time-constant is added in to the derivative channel in real control system. The transfer function of real PID-controller has the following form:

$$R_{PID}(s) = K_P + \frac{K_I}{s} + K_D \frac{s}{Ts + 1}, \quad (1.2)$$

where T is a relatively small time-constant.

It is possible to consider the addition aperiodic element from derivative channel, as a filter, which allows separating useful signal and noise with high frequency by changing of the small time-constant.

There are several different modifications of the typical controller. It is possible to obtain its by zeroing the appropriate coefficient.

- P-controller ($K_D = 0, K_I = 0$);
- I-controller ($K_P = 0, K_D = 0$);
- PI-controller ($K_D = 0$);
- PD-controller ($K_I = 0$).

1.2. PIDD-controller as a modification of PID-controller

There is also more sophisticated modification of PID-controller, which allows expanding of existing PID-controller limit [10]. The main difference between these two controllers is existence of an extra derivative channel. This channel provides possibility to use the second order of derivative for manipulated variable calculation. The structure of PIDD-controller is shown in figure 1.2.

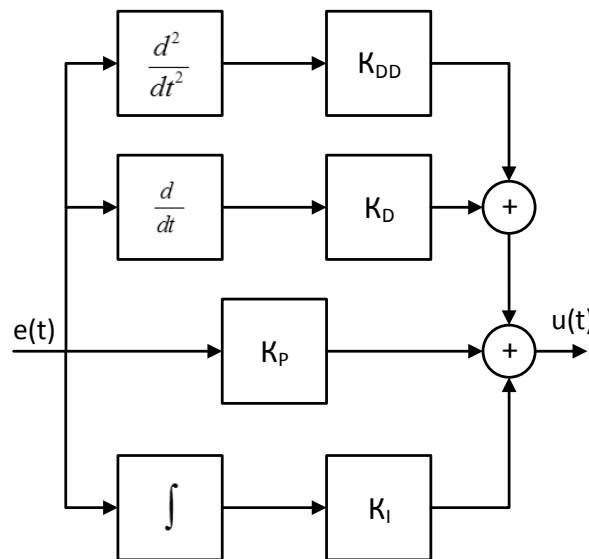

Figure 1.2: Structure of PIDD-controller

The ideal transfer function of PID-controller is the following:

$$R_{PID}(s) = K_P + \frac{K_I}{s} + K_D s + K_{DD} s^2. \quad (1.3)$$

In case of real PID-controller, it is necessary to add aperiodic elements to the derivative channel and to “double-derivative” channel first and second order correspondingly. Consequently, transfer function (1.3) becomes the next transfer function:

$$R_{PID}(s) = K_P + \frac{K_I}{s} + K_D \frac{s}{T_S + 1} + K_{DD} \frac{s^2}{T^2 s^2 + 2T_S + 1}. \quad (1.4)$$

The time constants of the filter in the derivative channel and in the “double-derivative” channel were chosen equal for simplification of work with such controller type. It is important to note that in general situation they can be different.

1.3. The root locus method

The main idea of the root locus method is a using of controller zeroes $\{n_{ri}\}$ to compensate unacceptable poles of object $\{p_{oi}\}$ and setting desired dynamic quality by selection of controller poles $\{n_{ri}\}$ [3, p. 558].

It is common knowledge that the transfer function of any linear objects contains the appropriate numerator and denominator:

$$G(s) = \frac{B(s)}{A(s)} = \frac{b_m s^m + b_{m-1} s^{m-1} + \dots + b_1 s + b_0}{a_n s^n + a_{n-1} s^{n-1} + \dots + a_1 s + a_0} \quad (1.5)$$

It is possible to obtain the set of poles p_{oi} , $i = \overline{1..n}$ and the set of zeroes n_{oi} , ($i = \overline{1..m}$) by zeroing the denominator and the numerator respectively. Then transfer function (1.5) takes the form:

$$G(s) = \frac{B(s)}{A(s)} = \frac{K_0 (s - n_{o1})(s - n_{o2}) \dots (s - n_{om})}{(s - p_{o1})(s - p_{o2}) \dots (s - p_{on})}$$

PID-controller and standard modifications of them contains five set of poles and zeroes which are represented in table 1.1.

Table 1.1

Number of zeroes \ Number of poles	0	1	2
0	P-controller K_P	PD-controller $K_P + K_D s$	-
1	I-controller $\frac{K_I}{s}$	PI-controller $K_P + \frac{K_I}{s}$	PID-controller $K_P + \frac{K_I}{s} + K_D s$

The following algorithm shows recommendation how to use available resource of PID-controller (two zeroes and one poles):

1. Analysis of object spectrum; defining of object zeroes and poles.
2. Inclusion of integral channel in to PID-controller structure, if an object is not astatic, to provide the zero steady-state error.
3. Compensation of right (unstable) poles of object by appropriate controller zeroes.
4. Compensation of left (stable) poles of object, which have high oscillation level or low margin of stability, by appropriate controller zeroes.

It is easy to see from table 1.1, that the resource of PID-controller is limited by two zeroes and one zero-pole generated by the integrator. Therefore, the possibilities of the typical controller are limited by compensating of two undesired object poles and by increasing astatic level in one. That is why the PID-controller can fully provide all required system performance only for second order control object.

1.4. PID-controller by the Ziegler–Nichols method

The Ziegler-Nichols method is one of the most popular empirical tuning method of PID-controller. The method is based on the research of **J. G. Ziegler** and **N. B. Nichols**, which derived “optimal” relations between parameters of typical controllers [4].

The following algorithm describe the logicality of parameters calculation by the Ziegler–Nichols method [5].

1. Definition of the parameters L (delay) and a , by using step response of control object, as it is shown in figure 1.3.

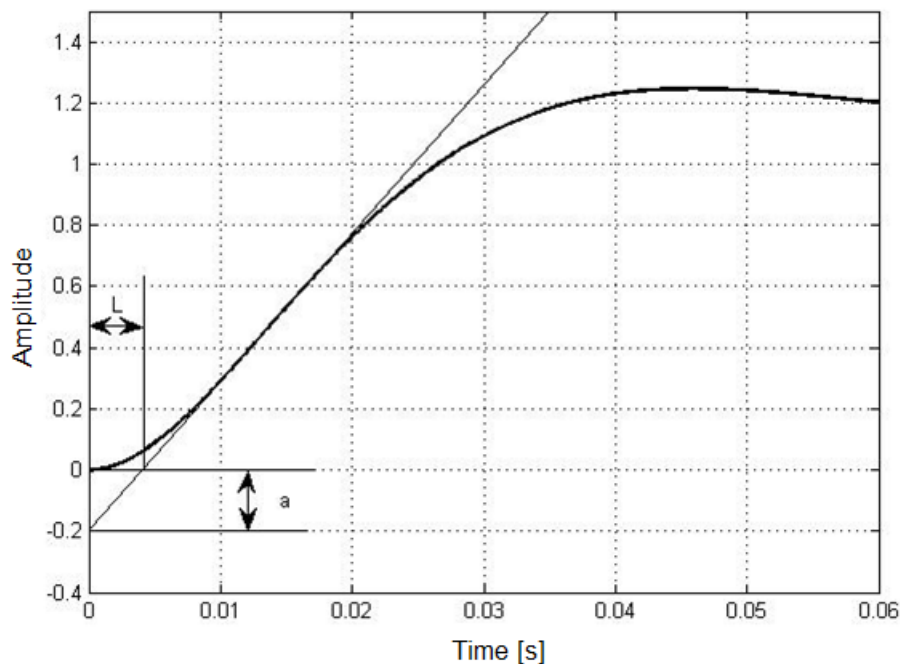

Figure 1.3: Definition of L and a

2. Calculation of PID-controller parameters by using table 1.2.

Table 1.2

	Coefficient of proportional channel, K_P	Time constant of integral channel, T_I ($K_I = \frac{1}{T_I}$)	Time constant of differentiating channel, T_D ($K_D = T_D$)
P-controller	$\frac{1}{a}$	-	-
PI-controller	$\frac{0,9}{a}$	$\frac{3L}{K}$	-
PID-controller	$\frac{1,2}{a}$	$\frac{0,9L}{K}$	$\frac{0,5L}{K}$

1.5. PID-controller by the Chien-Hrones-Reswick method

The Chien-Hrones-Reswick method is another popular empirical method. The main advantage is that the method provides respectively fast dynamic quality for slow control object.

The Chien-Hrones-Reswick method is acceptable for at least second order control object [4].

The following algorithm describe the logic of parameters calculation by the current methods.

1. Definition of the object gain K_0 , delay time T_u and time of leveling T_g , by using step response of control object, as it is shown in figure 1.4.

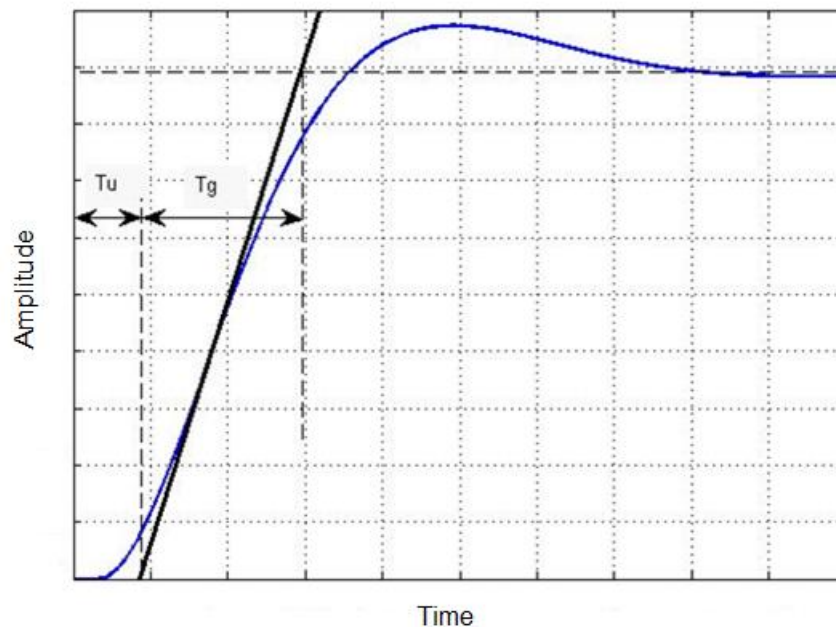

Figure 1.4: Definition of the parameters T_u and T_g

The gain can be obtain by the following equation (in steady state):

$$K_0 = \frac{y}{u}$$

where, y – the output of object; u – the input of object.

2. Calculation of PID-controller parameters by using table 1.3;

Table 1.3

	Coefficient of proportional channel, K_P	Time constant of integral channel, T_I ($K_I = \frac{1}{T_I}$)	Time constant of differentiating channel, T_D ($K_D = T_D$)
P-controller	$3,3K_0 \cdot \frac{T_n}{T_g}$	-	-
PI-controller	$3,86K_0 \cdot \frac{T_n}{T_g}$	$1,2T_g$	-
PID-controller	$1,66K_0 \cdot \frac{T_n}{T_g}$	T_g	$0,5T_n$

1.6. The technical optimum method

The main idea of the technical optimum is close to the root locus method: compensation of object poles by controller zeroes. Calculations of the proportional channel gain are based on empirical researches. Choosing of controller structure and calculation of controller parameters are shown in table 1.4. [8].

Table 1.4

Controller \ Object	I-controller $\frac{1}{T_0 p}$ $K_I = \frac{1}{T_0}$	PI-controller $\frac{T_{R1} p + 1}{T_0 p}$ $K_P = \frac{T_{R1}}{T_0}$ $K_I = \frac{1}{T_0}$	PID-controller $\frac{(T_{R1} p + 1)(T_{R2} p + 1)}{T_0 p}$ $K_P = \frac{T_{R1} + T_{R2}}{T_0}$ $K_I = \frac{1}{T_0} K_D = \frac{T_{R1} T_{R2}}{T_0}$
$\frac{K}{(T_1 p + 1)}$	$T_0 = 2KT_1$ $t_{s.t.} \approx 5T_1$	-	-
$\frac{K}{(T_1 p + 1)(T_\Sigma p + 1)}$	$T_0 = 2KT_1$ $t_{s.t.} \approx 5T_1$	$T_0 = 2KT_\Sigma$ $T_{R1} = T_1$ $t_{s.t.} \approx 5T_\Sigma$	-
$\frac{K}{(T_1 p + 1)(T_2 p + 1)(T_\Sigma p + 1)}$	$T_0 = 2K(T_1 + T_2)$ $t_{s.t.} \approx 5(T_1 + T_2)$	$T_0 = \frac{2KT_1 T_2 (T_1 + T_2)}{T_1^2 + T_1 T_2 + T_2^2}$ $T_{R1} = \frac{(T_1^2 + T_2^2)(T_1 + T_2)}{T_1^2 + T_1 T_2 + T_2^2}$	$T_0 = 2KT_\Sigma$ $T_{R1} = T_1, T_{R2} = T_2$ $t_{s.t.} \approx 5T_\Sigma$

- $t_{s.t.}$ – approximate setting time of transient process;
- T_Σ – “ parasitic ” time constant, which contain all respectively small time constant of control object.

1.7. Analysis of the considered calculation methods

As it is written before, no one of the considered methods is a regular. These methods use different meaning about synthesis of PID-controller and provides acceptable result only for some part of control object types.

The empirical method of Ziegler–Nichols and the method of Chien-Hrones-Reswick do not involve any requirements to control system. It is said that these methods provide the optimal result, but it is impossible to consider this result like the best one.

The technical optimum is based on the similar idea as the root locus method. That is why this method provide acceptable result only for part of tasks. From another point of view, this method is empirical as the method of Ziegler–Nichols and the method of Chien-Hrones-Reswick. Hence, it is difficult to implement the desired requirements of system by using these methods.

The disadvantages of root locus method in direct form is dependence of controller parameters and object parameter. The general idea of method is compensation of plant poles by controller zeroes, it is easy to make mathematically in model, but it is difficult to implement in real system, because all real object is non-stationary. The comparative analysis made before [14] shows, that this method provide quite acceptable result with relatively easy and fast process of controller parameters calculation. That is a reason why this method is popular and often used in practice. In situation, when it is necessary to work with non-stationary control object and to avoid uncertainty, there is a recommendation to place controller zeroes not directly into the plant poles. It is better to place zeroes in to some vicinity of the plant poles, then the reaction of system will be the same as changing of object poles.

1.8. Calculation of robust controllers

That is well known fact that the dynamics of any real system can be changed by many external factors, as:

- disturbance;
- measurement noise of output system parameter;
- non-linearity;
- dependence of object parameters from parameters of technological process;
- changes of object parameters by the time.

All of these factors are an uncertainty of control object and describe the task of the robust control. From another point of view, an uncertainty is discrepancy between mathematical model of object and real control object.

The structure of system with uncertainty is shown in figure 1.5.

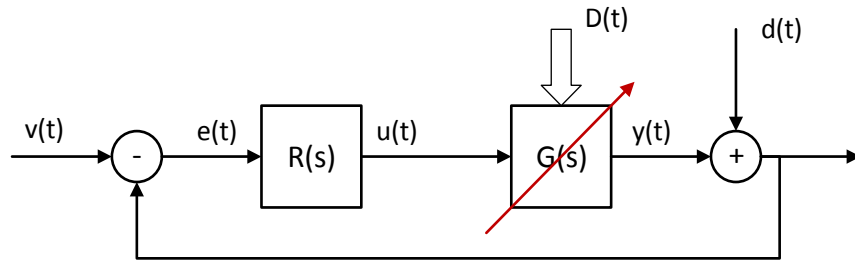

Figure 1.5: Structure of system with uncertainty
, where $v(t)$ – the input;
 $R(s)$ – the robust controller;
 $G(s)$ – the control object with uncertainty;
 $D(t)$ – the disturbance on object;
 $d(t)$ – the disturbance on output of system.

The main task of the robust control is desired quality providing of transient process in the system with uncertainty [7]. Robust controller is a controller with constant structure and constant parameters, which is able to solve this task.

1.8.1. Modeling of uncertainty

In general case of working with non-stationary object, it is possible to consider the control object as a set of transfer functions with different parameters, which represent current uncertainty. Then one of this transfer function is chosen as a nominal transfer function. The following scheme can be used for modeling such control object with uncertainty [15]:

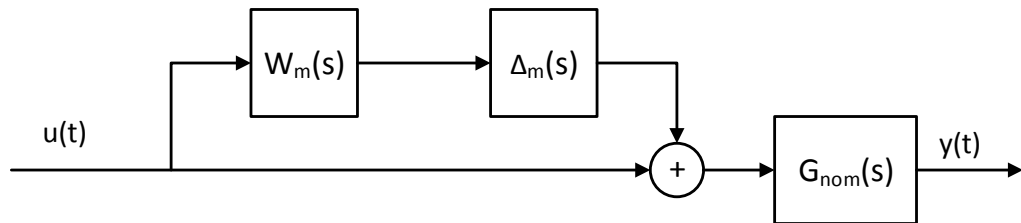

Figure 1.6: Control object with uncertainty
, where $G_{nom}(s)$ – the nominal transfer function;
 $W_m(s)$ – the filter contained information about uncertainty;
 $\Delta_m(s)$ – the block represented disturbance in object.

Obviously, that such approach of uncertainty modeling provide only approximate result, because $\Delta_m(s)$ is undefined. There is only known that the following stability condition is fulfilled:

$$\max_{\omega} |\Delta_m(i\omega)| \leq 1 \quad (1.6)$$

The figure 2.1 shows that transfer function of object with uncertainty has the following form:

$$G(s) = G_{nom}(s) + G_{nom}(s)W_m(s)\Delta_m(s) \quad (1.7)$$

The following inequality were obtained by using inequality (1.6) and transfer function (1.7):

$$|G(j\omega)| \leq |G_{nom}(j\omega)| + |G_{nom}(j\omega)| \cdot |W_m(j\omega)|$$

The control object is represented by the set of transfer function $G_k(s)$ ($k = 1..n$), then it is possible to calculate appropriate filter $W_m(s)$ for every transfer function by using equation (1.8).

$$|W_k(j\omega)| = \frac{|G_k(j\omega)|}{|G_{nom}(j\omega)|} - 1 \quad (1.8)$$

It is known that an absolute value of $W_m(i\omega)$ depends on frequency ω , that is why the filter which represent the maximum possible changing of object parameters is:

$$|W_m(j\omega)| = \max_{\omega} |W_k(j\omega)|$$

Usually this filter has the following form:

$$W_m(s) = \frac{s}{M + \omega_b} \cdot \frac{1}{s + A\omega_b}, \quad (1.9)$$

where M defines the filter gain in high frequency region;

A defines filter the gain in low frequency region;

ω_b is a frequency appropriate to the zero gain of filter.

It is easy to find the filter parameters M , A and ω_b by empirical way in the bode plot. The example of $W_m(s)$ finding is shown in figure 1.7. Red line corresponds to $W_m(s)$ filter, blue lines corresponds to the set of $W_k(s)$ filters [15].

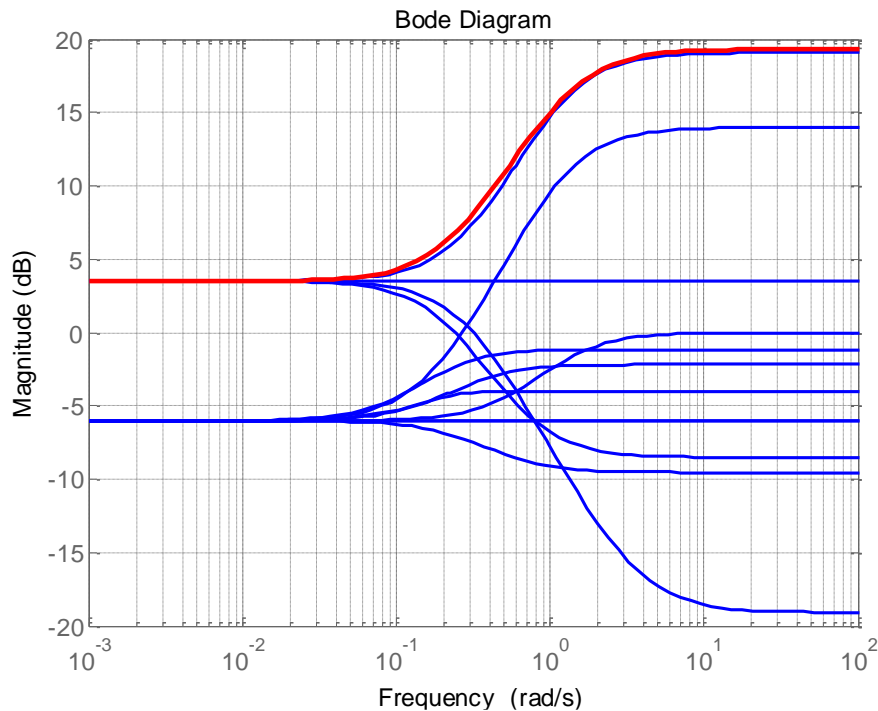

Figure 1.7: Example of $W_m(s)$ finding

Figure 1.7 shows that the following requirement is fulfilled:

$$|W_m(j\omega)| \leq \max_k |W_k(j\omega)|.$$

1.8.2. Calculation of robust controller by using H_2 and H_∞ norms

The most popular methods of robust controller calculation are methods which use H_2 and H_∞ norms. The main idea is to synthesize optimal controller by using the appropriate norms. These methods allow taking into consideration the existing uncertainty of control object as one of the optimization criterion.

It is possible to define a standard H_2 norm in the Hilbert space [15, p. 16]:

$$\|G\|_2 = \sqrt{\frac{1}{2\pi} \int_{-\infty}^{+\infty} |G(-j\omega) \cdot G(j\omega)| d\omega} = \lim_{t \rightarrow \infty} \sqrt{\int_{-\infty}^{+\infty} g^2(t) dt}, \quad (1.10)$$

where $g(t)$ is a weight factor.

Obviously that the norm H_2 is always finite, if $G(\infty) = 0$, what corresponds to stable and physically realizable system. It is easier to use square of norm, then the equation (1.10) takes the following form:

$$\|G\|_2^2 = \frac{1}{2\pi} \int_{-\infty}^{+\infty} |G(-j\omega) \cdot G(j\omega)| d\omega = \lim_{t \rightarrow \infty} \int_{-\infty}^{+\infty} g^2(t) dt.$$

The H_∞ norm has a sense of maximum system gain in power [17]. In case of multi-input-multi-output system, this norm is equal to singular numbers of transfer function (1.11); in case of single-input-single-output, this norm is equal to a maximum value (1.12).

$$\|G\|_\infty = \sup_{\omega} \bar{\sigma}[G(j\omega)]. \quad (1.11)$$

$$\|G\|_\infty = \max_{\omega} |G(j\omega)|. \quad (1.12)$$

In practice, the suboptimal controller is usually used, which is based on a meaning of the H_∞ norm. Such controller provides possibility to take into account the following requirements:

1. requirements of manipulated variable (z_1);
2. requirements of transient process quality (z_2);
3. uncertainty (z_3).

The scheme from figure 1.8 shows how to obtain these criteria of optimization ($z_1 - z_3$).

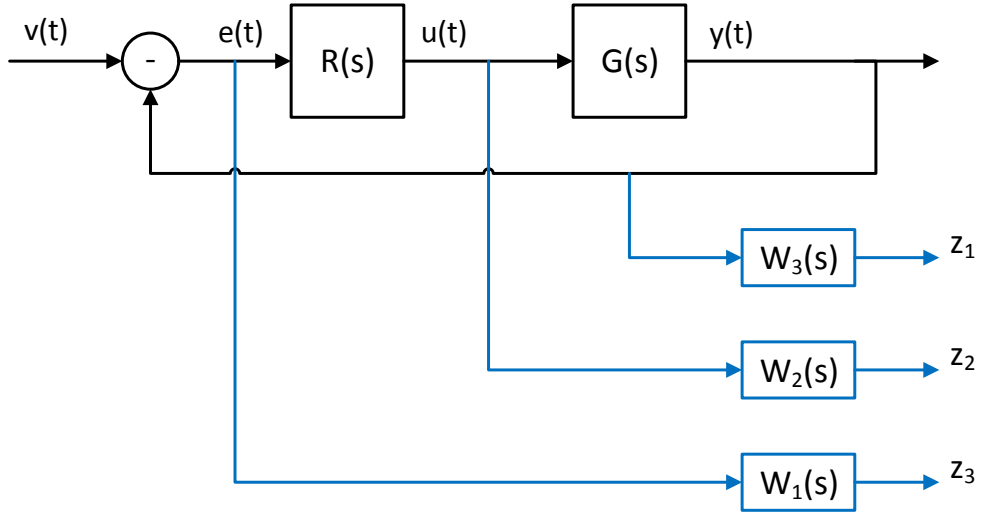

Figure 1.8: Formation of the optimization criteria
, where $W_{1-2}(s)$ – the filters which define the desired quality of appropriate criterion;
 $W_3(s)$ – the filter which defines uncertainty.

The norm for suboptimal controller is calculated in the following form:

$$\max_{\omega} \left| \sqrt{|z_1| + |z_2| + |z_3|} \right|.$$

These calculations are based on meaning of the H_{∞} norm.

It is convenient to use the “Robust Control” from MatLab for calculation such type of controllers. This toolbox contains the special function called **mixsyn**, which allows easy calculation of robust controller.

The function has the following syntax:

$$[K, CL, GAM] = \text{mixsyn}(G, W1, W2, W3),$$

where: K – the transfer function of obtained controller; CL – the transfer function of closed-loop system; GAM – the parameter of optimization; G – the nominal function of control object.

Filter W_1 specifies the desired quality of control error in system that means this filter defines the quality of transient process. Filter W_1 is the transfer function of n-th order with the following structure:

$$W_1(s) = \frac{\left(\frac{s}{M^{1/n}} + \omega_b \right)^n}{(p + A^{1/n} \omega_b)^n}.$$

Usually it is enough to use first order filter, then the transfer function takes the following form:

$$W_1(s) = \frac{\frac{s}{M} + \omega_b}{s + A\omega_b}. \quad (1.13)$$

The parameters of filter $W_1(s)$ can be obtained by empirical way. It is possible to take into account the requirements for desired quality of transient process. The parameter A defines the gain in low frequency region (steady state), it is necessary to choose this coefficient enough small to provide the desired steady-state error.

The filter $W_2(s)$ allows providing the manipulated variable in the desired range, it is necessary because all real objects has control limit. This filter is a gain, which can be founded by empirical way too.

The presented procedure of robust controller calculation lets to solve the control task with non-stationary object. However, the result of the method is a controller with free structure; usually there is a controller of high order (3-th and more), this fact complicates the technical application and excludes the possibility of this controller realization by using typical controller.

2. CALCULATION OF PID-CONTROLLER PARAMETERS BASED ON THE LOCALIZATION METHOD

The effective method of controller synthesis for non-linear and non-stationary objects is the localization method. The method of localization was invented in the Novosibirsk State Technical University 30 years ago. The main idea of this method is using a derivative vector of output parameter for manipulated variable calculation [2]. The highest derivative implicitly contains full information about object state at current time. This fact allows using the method of localization as a base for calculation of robust PID-controller.

2.1. The linear interpretation of the localization method

The practical realization of the localization method implies necessity of derivatives calculation. The special device named differentiating filter is used to provide these calculations. The structure of linear interpretation of the localization method corresponding to second-order linear non-stationary object is shown in figure 2.1.

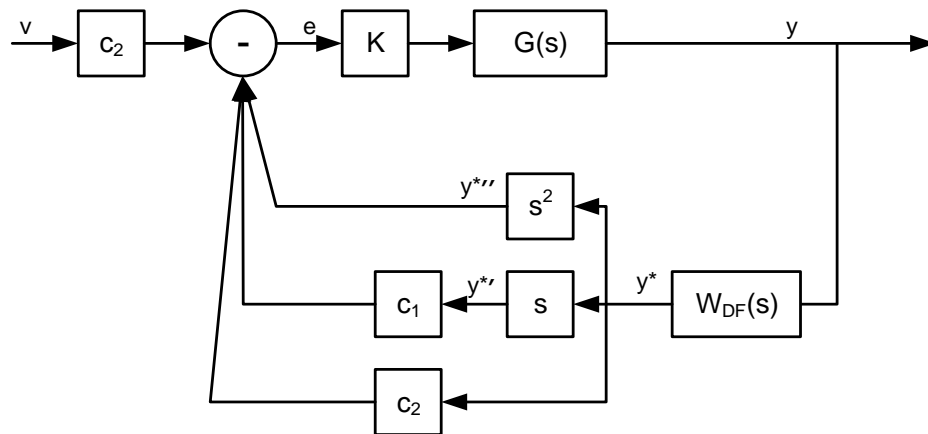

Figure 2.1: Linear interpretation of the localization method,

where:

- v – the input variable;
- $G(s)$ – the transfer function of control object;
- $W_{DF}(s)$ – the transfer function of differentiating filter;
- c_1, c_2 – the parameters corresponding to desired dynamic quality of transient process;
- K – the controller gain.

The desired dynamic quality of system is determined by the following transfer function:

$$W_D(s) = \frac{c_2}{s^2 + c_1s + c_2}. \quad (2.1)$$

The order of the differentiating filter corresponds to the order of control object. In this case, the first and the second derivatives are used to generate manipulated variable, because the control object is a second order object. Therefore the differentiating filter should also be at least second order.

$$W_{DF}(s) = \frac{1}{\tau^2 s^2 + 2\tau s + 1}, \quad (2.2)$$

where τ is a small time constant, which allows to separate useful signal with low frequency and noise with relatively high frequency.

Then, the transfer function of the feedback has the following view:

$$W_{FB}(s) = \frac{s^2 + c_1 s + c_2}{\tau^2 s^2 + 2\tau s + 1}. \quad (2.3)$$

It is possible to transform the structure from figure 2.1 in to the following structure by using transfer function (2.3):

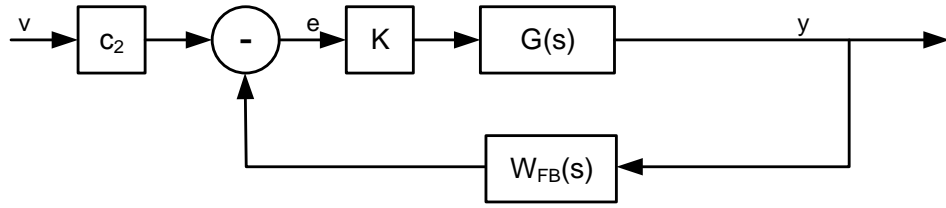

Figure 2.2: Transformed structure

The closed-loop transfer function was used for analysis of the obtained system:

$$W_{CL}(s) = \frac{KG(s)c_2}{1 + KG(s)W_{FB}(s)}. \quad (2.4)$$

It is possible to get the following transfer function by substitution of equation (2.3) into equation (2.4):

$$W_{CL}(s) = \frac{KG(s)c_2(\tau^2 s^2 + 2\tau s + 1)}{(\tau^2 s^2 + 2\tau s + 1) + KG(s)(s^2 + c_1 s + c_2)}.$$

The parameter τ is enough small, therefore it is possible to reckon $\tau = 0$, then:

$$W_{CL}(s) = \frac{KG(s)c_2}{1 + KG(s)(s^2 + c_1 s + c_2)}. \quad (2.5)$$

Transfer function (2.5) takes form (2.6) if $K \rightarrow \infty$.

$$\lim_{K \rightarrow \infty} W_{CL}(s) = \frac{c_2}{s^2 + c_1 s + c_2}. \quad (2.6)$$

Limit (2.6) shows, that in the ideal case we can obtain the desired dynamic quality of transient process (2.1).

The main advantages of the localization method is no strict dependency between parameters of control object and parameters of the obtained controller. That confirms possibility to use this method for synthesis of robust controllers for non-stationary objects.

2.2. The application of the localization method for PID-controller

The scheme presented in figure 2.2 can be transformed it to the following scheme by using the general conversion.

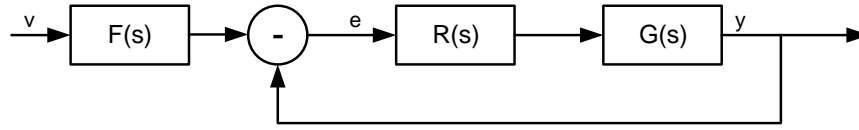

Figure 2.3: Transformed scheme,

where: $F(s)$ – the transfer function of pre-filter; $R(s)$ – the transfer function of controller corresponding to the localization method.

The transfer function of the pre-filter has the corresponding form:

$$F(s) = \frac{c_2(\tau^2 s^2 + 2\tau s + 1)}{s^2 + c_1 s + c_2}.$$

The parameter τ is enough small, therefore $\tau = 0$, then:

$$F(s) = \frac{c_2}{s^2 + c_1 s + c_2}. \quad (2.7)$$

The transfer function of controller has the following view:

$$R(s) = \frac{K(s^2 + c_1 s + c_2)}{\tau^2 s^2 + 2\tau s + 1}. \quad (2.8)$$

The structure of system shown in figure 3.3 describes the classical control task. The pre-filter allows improving the quality of transient process [6].

Transfer function of PID-controller (1.2) can be transformed it to the following form:

$$R_{PID}(s) = \frac{(K_D + TK_P)s^2 + (K_P + TK_I)s + K_I}{s(Ts + 1)}. \quad (2.9)$$

That is easy to find, that transfer function of PID-controller (2.9) and the final transfer function of controller corresponding to the localization method have consimilar structure. The distinction is in the denominator of transfer function, which represent the differentiating filter. The main point that the orders of these denominators are equal. That is why PID-controller also provides possibility to make calculate of the second derivative.

The following relations between parameters of PID-controller and parameters of controller corresponding to the localization method were obtained by comparison of the numerators of transfer function (2.8) and transfer function (2.9).

$$\begin{cases} K = K_D + TK_P, \\ c_1 = \frac{K_P + TK_I}{K_D + TK_P}, \\ c_2 = \frac{K_I}{K_D + TK_P}. \end{cases} \quad (2.10)$$

The structure of system takes the final form:

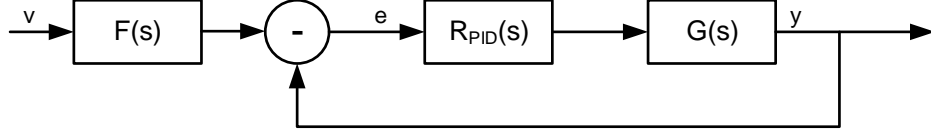

Figure 2.4: Structure with PID-controller

It is possible to get the transfer function for closed-loop system with PID-controller (figure 2.4) with using relations (2.10)

$$W_{CL}(s) = \frac{KG(s)c_2(Ts^2 + s)}{(Ts^2 + s) + KG(s)(s^2 + c_1s + c_2)}. \quad (2.11)$$

Transfer function (2.11) takes the following form if $K \rightarrow \infty$.

$$\lim_{K \rightarrow \infty} W_{CL}(s) = \frac{c_2}{s^2 + c_1s + c_2}. \quad (2.12)$$

Expression (2.12) shows that the system with PID-controller has the same properties as the system with controller corresponding to the localization method.

Therefore, it is possible to define the following algorithm of PID-controller parameters calculation based on the localization method:

1. Formation of the desired transfer function:

$$W_D(s) = \frac{c_2}{s^2 + c_1s + c_2}.$$

Recommendation is to form the desired transfer function in simpler form:

$$W_D(s) = \frac{c}{s^2 + 2cs + c^2}. \quad (2.13)$$

The desired transfer function (2.13) provides a damping factor is equal one, which corresponds to zero overshoot and the lowest setting time. In that case, the parameter c is determined by the desired setting time of transient process.

2. Choosing of the small time constant T of the differentiating filter. This parameter should be at least ten times smaller than the smallest time constant of the desired transfer function.

3. Choosing of the controller gain K determines the accuracy of method considering the limitation of manipulated variable.
4. Calculations of the PID-controller parameters by using the following relations:

$$\begin{aligned}K_P &= Kc_1 - TKc_2, \\K_I &= Kc_2, \\K_D &= K - TK_P.\end{aligned}$$

5. Addition of the pre-filter in form (2.7) or (2.13).

2.3. Application of the localization method for PID-controller

As it is written in subchapter 1.3, the resource of PID-controller is limited and sometimes PID-controller is not able to provide the desired quality of transient process in system with 3-th and more order of control object. In such case, it is possible to use PID-controller, the resource of such controllers is wider. The structure scheme of control system with 3-th order control object is corresponding to scheme presented in figure 2.3. The desired pre-filter and controller transfer functions are one order higher and have the following forms:

$$W_D(s) = \frac{c_3}{s^3 + c_1s^2 + c_2s + c_3}, \quad (2.14)$$

$$F(s) = \frac{c_3}{s^3 + c_1s^2 + c_2s + c_3},$$

$$R(s) = \frac{K(s^3 + c_1s^2 + c_2s + c_3)}{\tau^3s^3 + 3\tau^2s^2 + 3\tau s + 1}. \quad (2.15)$$

Obviously, that this system should have the same quality as the system founded in subchapter 2.1. The transfer function of closed-loop system is equal to expression (2.14), when $K \rightarrow \infty$.

The transfer function of PID-controller (1.4) can be transformed in to the following form:

$$R_{PID}(s) = \frac{(K_P T^2 + K_D T + K_{DD})s^3 + (K_I T^2 + 2K_P T + K_D)s^2 + (2K_I T + K_P)s + K_I}{T^2 s^3 + 2T s^2 + s}. \quad (2.16)$$

It is possible to find the relations between parameters of controller corresponding to the localization method (2.15) and the parameters of PID-controller (2.16) by using the same meaning as in case of PID-controller.

$$\begin{cases} K = K_P T^2 + K_D T + K_{DD}, \\ c_1 = \frac{K_I T^2 + 2K_P T + K_D}{K_P T^2 + K_D T + K_{DD}}, \\ c_2 = \frac{2K_I T + K_P}{K_P T^2 + K_D T + K_{DD}}, \\ c_3 = \frac{K_I}{K_P T^2 + K_D T + K_{DD}}, \end{cases} \quad (2.17)$$

The algorithm of PIDD-controller parameters calculation based on the localization method has the following view:

1. Formation of the desired transfer function:

$$W_D(s) = \frac{c_3}{s^3 + c_1s^2 + c_2s + c_3},$$

Recommendation is to form the desired transfer function in simpler form:

$$W_D(s) = \frac{27c^3}{s^3 + 9cs^2 + 27c^2s + 27c^3}. \quad (2.18)$$

This form of the desired transfer function was obtained by using the Naslin method [8]. Transfer function (2.18) provides zero overshoot and the lowest setting time. In that case, the parameter c is determined by the desired setting time of transient process.

2. Choosing of the small time constant T of the differentiating filter. This parameter should be at least ten times smaller than the smallest time constant of the desired transfer function.
3. Choosing of the controller gain K determines the accuracy of method considering the limitation of manipulated variable.
4. Calculations of the PID-controller parameters by using the following relations:

$$K_P = Kc_2 - 2KTc_2,$$

$$K_I = Kc_3,$$

$$K_D = 3Kc_3T^2 - 2Kc_2T + Kc_1,$$

$$K_{DD} = Kc_2T^2 - Kc_3T^3 + Kc_1T + K.$$

5. Addition of the pre-filter in form (2.14) or (2.18).

3. ANALYSIS OF THE CONSIDERED METHODS

3.1. Description of control object

The control object contains two direct current (DC) motors clutched by an elastic shaft. The functional scheme of the process is shown in figure 3.1 [18].

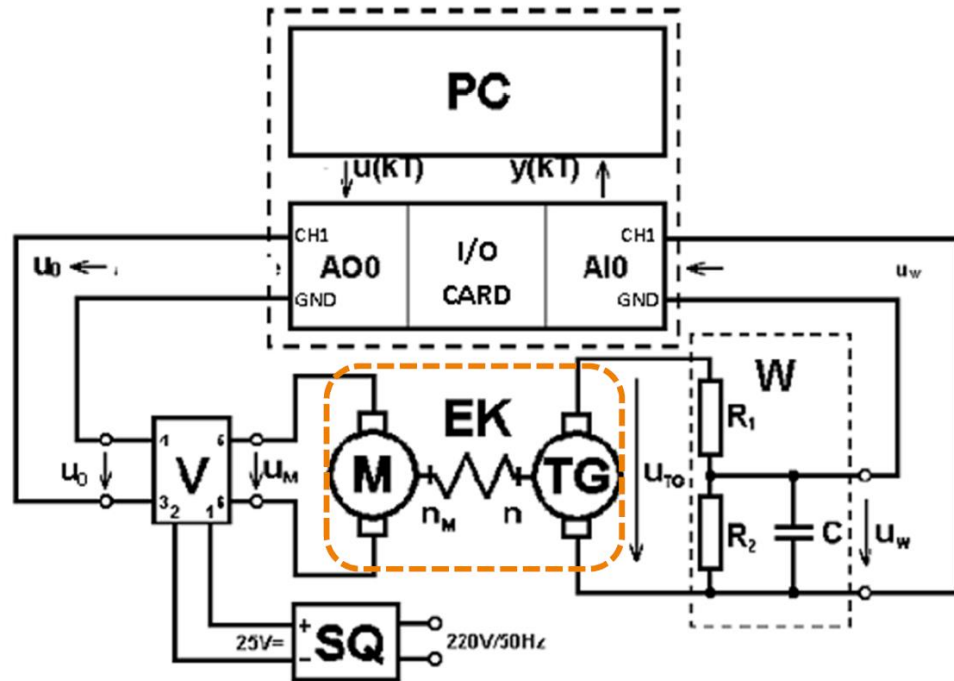

Figure 3.1: Functional scheme of the process and the connection with the PC

The motor M works in motion mode that sets in motion the DC motor TG, which works in generator mode and represents the tachogenerator. The input sequence $u(kT)$ is provided by the Personal Computer (PC) through the special scheme *Advantech PCI-1711*. The output sequence is measured by the same scheme and goes to the PC. In general case this system is a discrete, but it is possible to consider it as a continuous system, when sampling time is enough small.

The special driver allows controlling this scheme by using the MatLab Simulink. The appropriate model, which provides possibility to obtain a transient processes, is shown in figure 3.2.

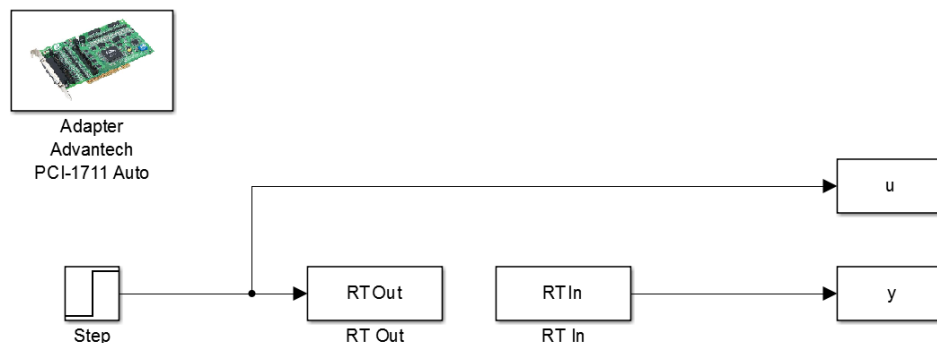

Figure 3.2: Example of model in the MatLab Simulink

The block “RT Out” is an output of the scheme *PCI-171* that also is an input of whole system. The limit of input voltage is 0–10V. The block “RT In” is an input of the scheme *PCI-171* that also is an output of whole system. The limit of output voltage also is 0–10V.

The step response of the system without controller is shown in figure 3.3.

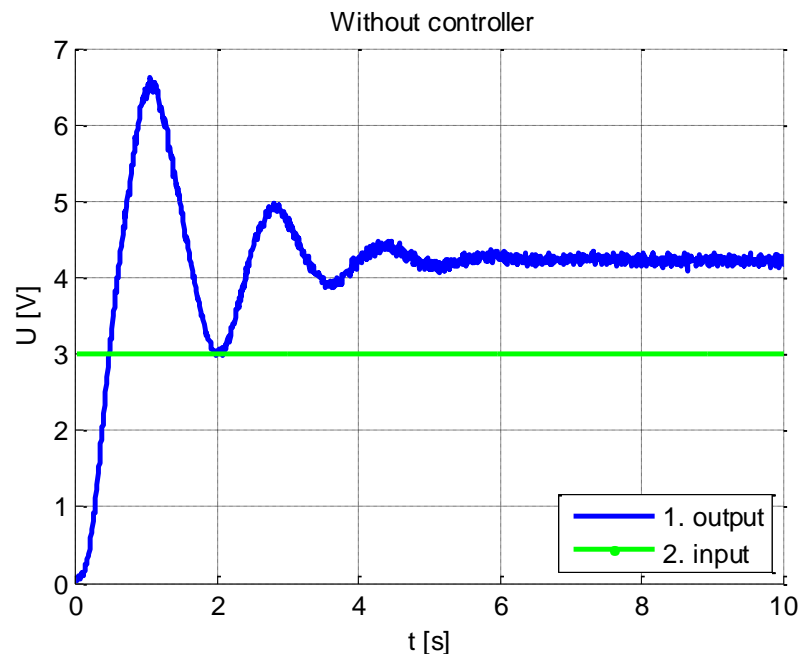

Figure 3.3: Step response of the system without controller

3.2. Identification of the control object

It is well known that a DC motor can be considered as the second order linear object. The electromechanical time constant of these DC motors is enough smaller than the mechanical time constant, therefore it is possible to reckon that the DC motor is a first order object. Then the system is a system of third order.

- two DC motors give a second order;
- the elastic shaft adds one order.

Program (A.1.) was used to obtain the transfer function of the control object. The input data for this program is an array of input and output sequence and the order of the system. The identification process is based on the selection of parameters, which provides the smallest difference (the integral of error between the real process and the founded process). The result of identification is presented in figure 3.4. The appropriate transfer function is:

$$G(s) = \frac{1,415}{0,006466s^3 + 0,09387s^2 + 0,1956s + 1} \quad (3.1)$$

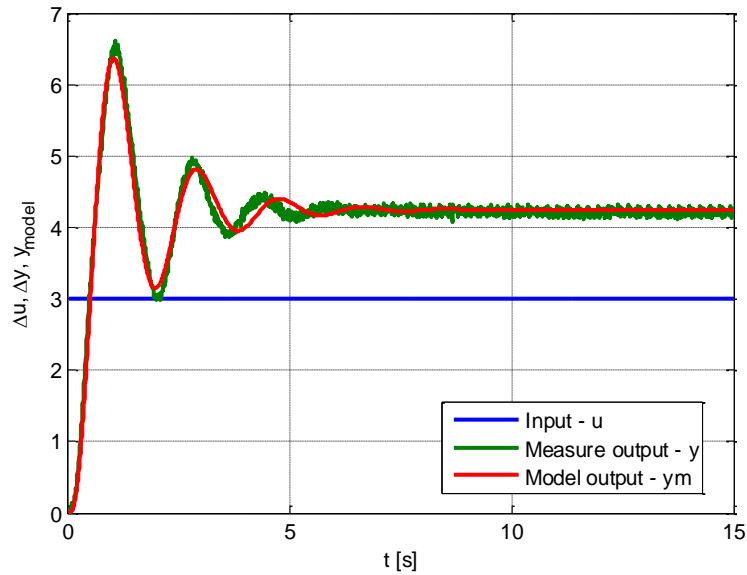

Figure 3.4: Result of identification

3.3. Synthesis of PID-controller based on the localization method

The resource of PID-controller is limited by controlling of a second order object. In case of third order and more, it is necessary to impose the restrictions to keep system stability. Then the task of controller synthesis reduces to finding of the parameters K and c as tradeoff between stability and operation speed of system.

The following model was developed for the synthesis of PID-controller and operability tests.

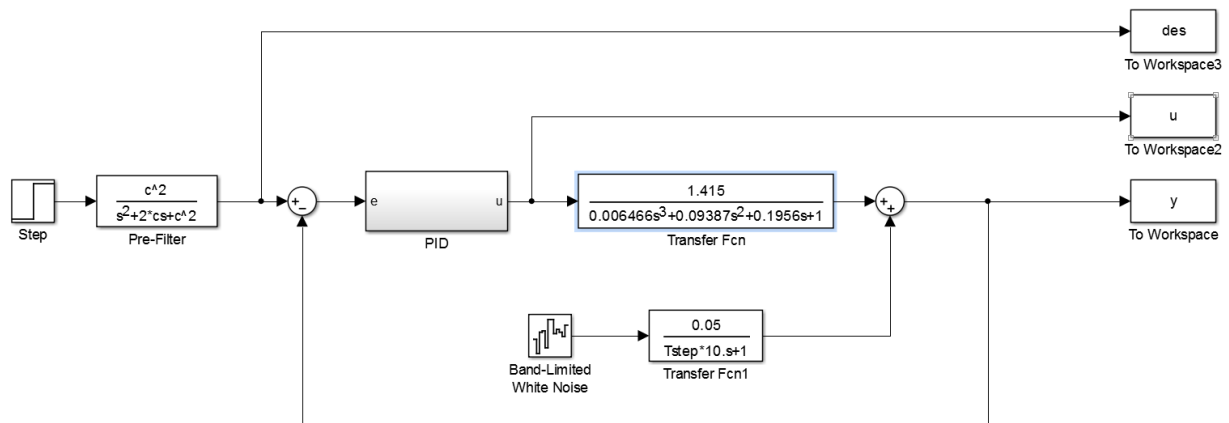

Figure 3.5: Model of system

The noise added to output of model provides the processes, which is close to real. The appropriate transfer function allow changing of amplitude and frequency.

The parameters K and c were chosen such that the transient processes are stable and have the least setting time. The pre-filter has the following form:

$$F(s) = \frac{c^2}{s^2 + 2cs + c^2} \quad (3.2)$$

The parameters of founded PID-controller are shown in table 3.1.

Table 3.1

c	K	T	K_P	K_I	K_D
3	0,1	0,6	0,06	0,9	0,064

The founded value of parameter T provides low enough influence of the noise.
 The modelling results of the system with PID-controller are shown in figure 3.6.

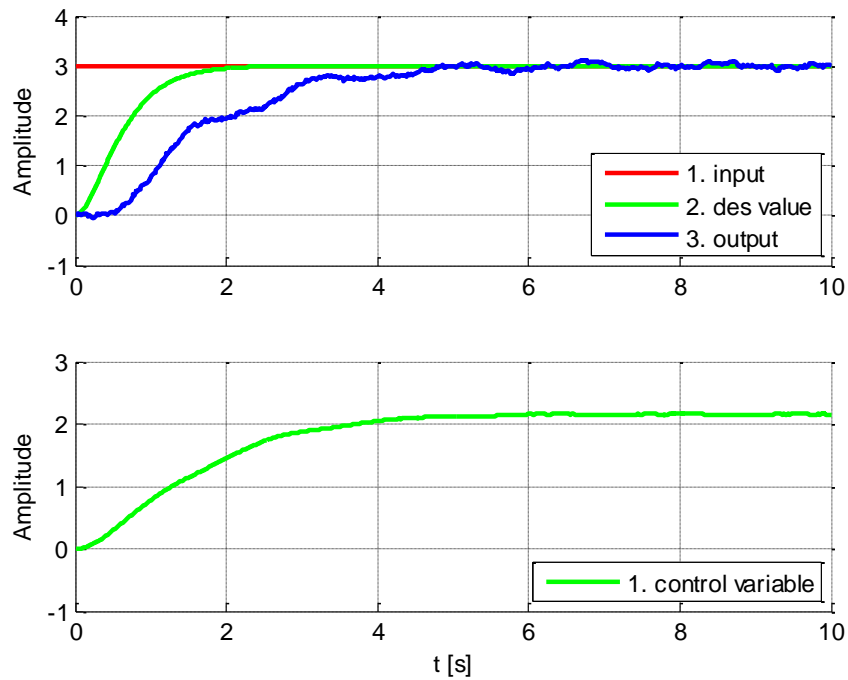

Figure 3.6: Modelling results

The following scheme was developed to check operability of the founded controller in the real system.

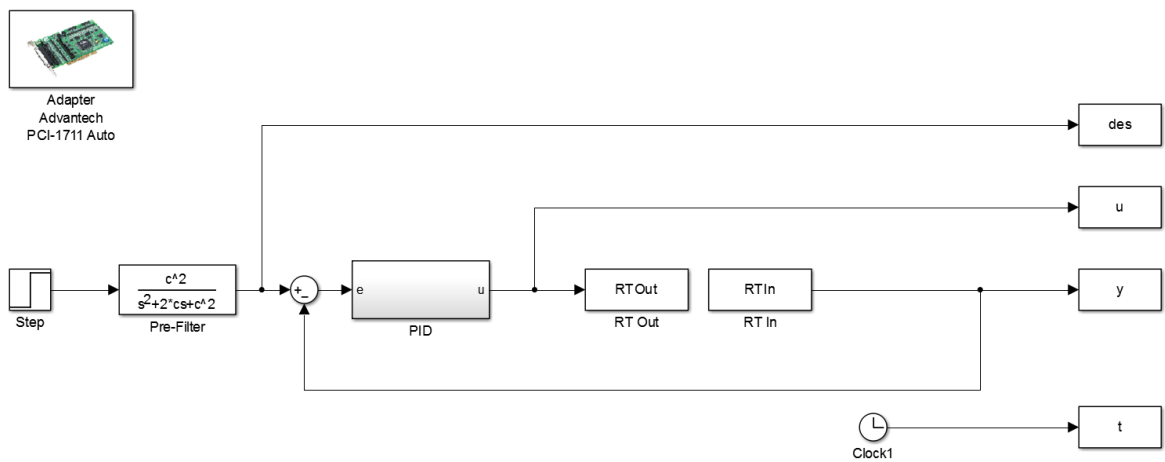

Figure 3.7: Scheme with PID-controller

The obtained results are shown in figure 3.8.

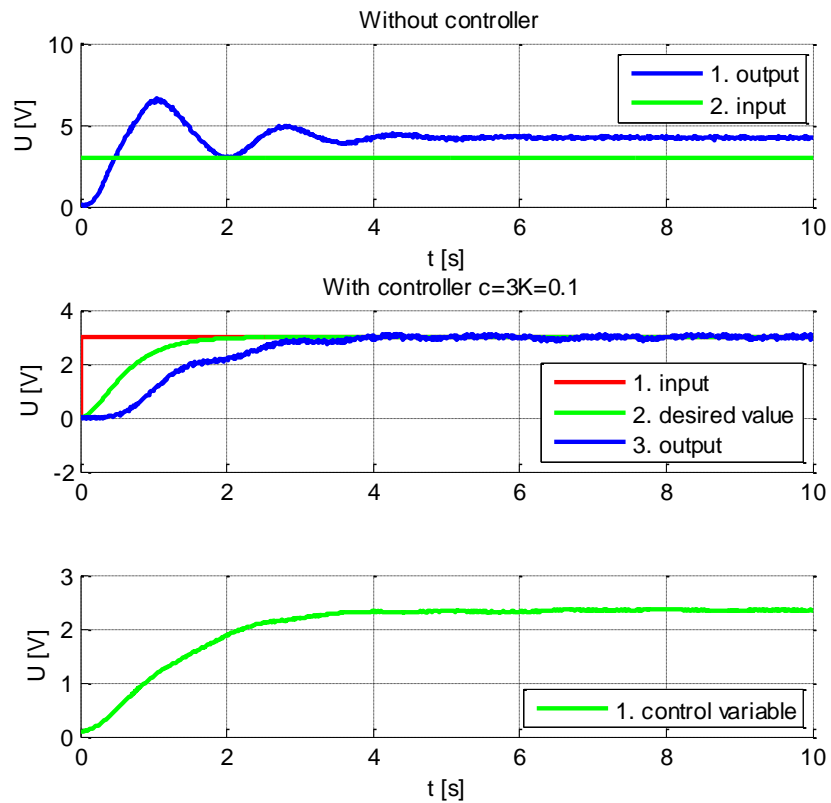

Figure 3.8: Transient processes in system with PID-controller

The transient processes in system with obtained PID-controller have no overshoot and the setting time is two second less.

The results of disturbance reaction are shown in figure 3.9.

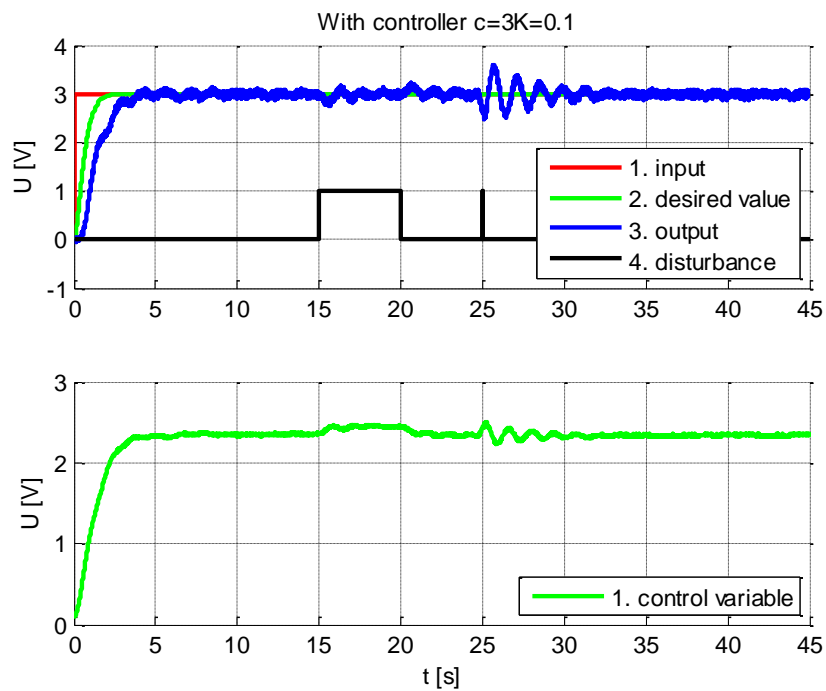

Figure 3.9: Results of disturbance reaction

The black line from figure 3.9 qualitatively shows the disturbance (1 – disturbance is acting; 0 – disturbance is not acting). There is two possible type of disturbance:

- The disturbance on input of system (the first “step”);
- The disturbance on output of system (the “impulse”).

Figure 3.9 shows that the obtained controller is able to handle both type of disturbance. However, the handling quality of the output disturbance has oscillatory nature; the reason is that such type of disturbance goes directly to the controller.

3.4. The synthesis of PID-controller based on the root locus method

The resource of PID-controller is limited. It has two zeroes and one zero pole. Hence, the task of PID-controller synthesis based on the root locus method reduces to finding two zeroes and the gain of controller.

The MatLab contains “the SISO Design Tool”. This toolbox helps to find controller with free structure by using meaning of the root locus method.

The root locus of system with PID-controller is shown in figure 3.10.

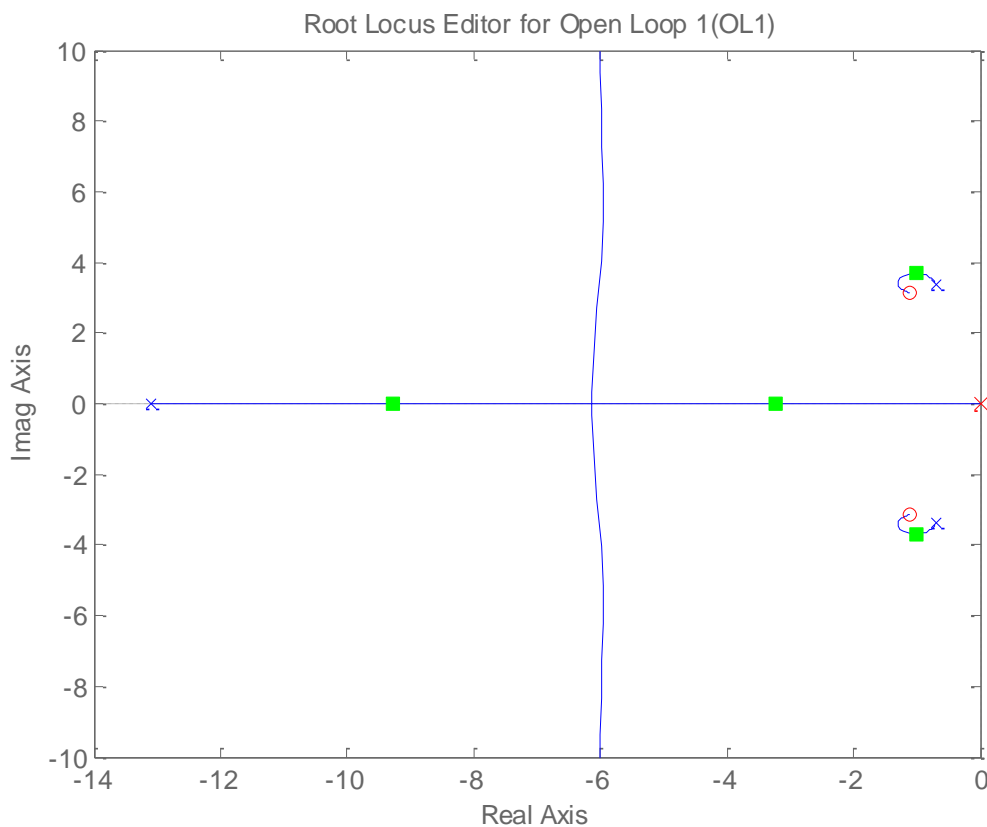

Figure 3.10: Root locus of the system

, where the blue markers “x” – the poles of control object;

the red markers “o” – the zeroes of controller;

the red marker “x” – the zero poles of controller;

the green square markers – the roots of closed loop;

the blue lines – the trajectory of system root shifting when the gain of controller is changing.

Figure 3.10 shows that the control object has three poles, two of these poles are complex conjugate with small stability margin that is why the transient process in the system without controller has oscillatory nature (figure 3.3). Hence, it is necessary to compensate these poles of control object by the controller zeroes. The meaning of the root locus method implies placing of the controller zeroes directly in to the poles of control object. However, there is a recommendation to parry the identification error and the changing of the object parameters it is necessary to place zeroes in some location of these poles.

The founded controller has the following form (3.3); the appropriate root locus is shown in figure 3.10.

$$R(s) = \frac{2 \cdot (0,09s^2 + 0,2s + 1)}{s} \quad (3.3)$$

The technical realization of transfer function (3.3) is the PID-controller with the parameters, which are presented in the table 3.2.

Table 3.2

T	K_P	K_I	K_D
0,01	0,38	2	0,1762

The modelling results of the system with PID-controller (scheme 3.5) are shown in figure 3.11.

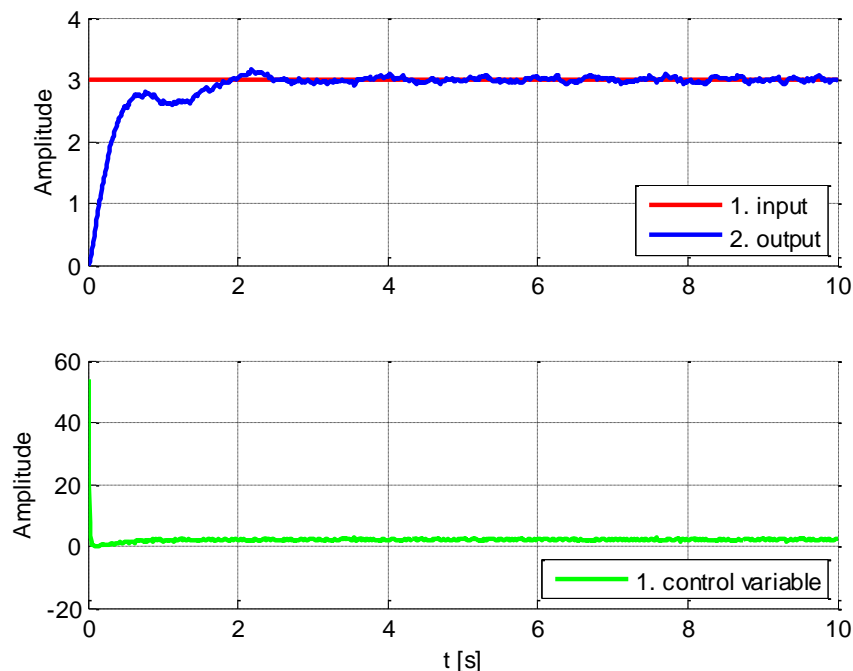

Figure 3.11: Modelling results

The root locus method provides fast obtaining of the controller parameters. Figure 3.11 shows that this result is acceptable. The disadvantage of this method is the saltation in the beginning of manipulated variable.

The results of the obtained controller application in real system are presented in figure 3.12.

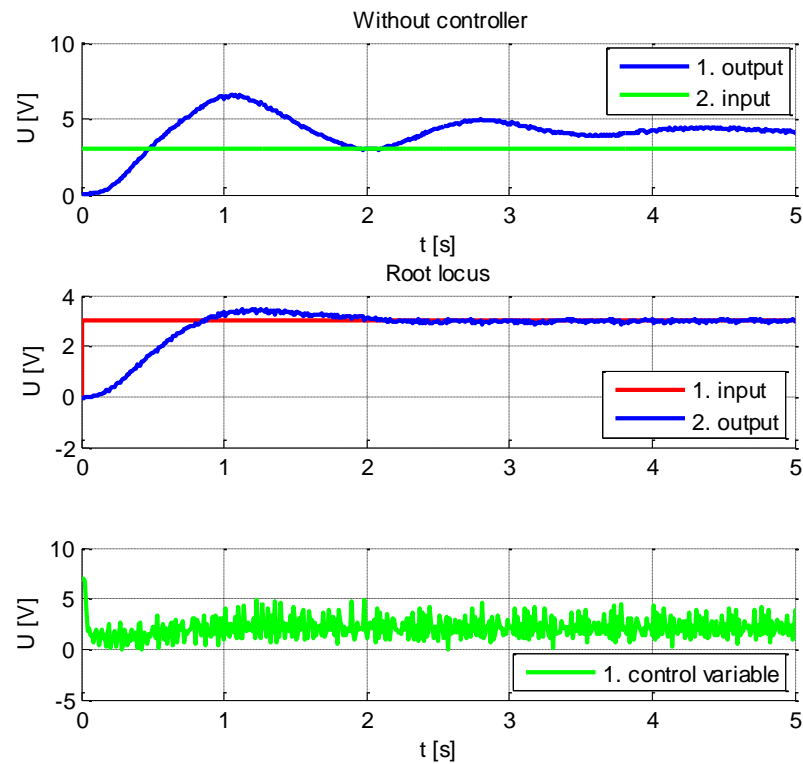

Figure 3.12: Transient processes in the system with PID-controller

The setting time is less in comparison with PID-controller based on the localization method. However, the system with the founded PID-controller has overshoot. The manipulated variable has oscillatory nature, but that is acceptable in such type of system.

The results with disturbance reaction are shown in figure 3.13.

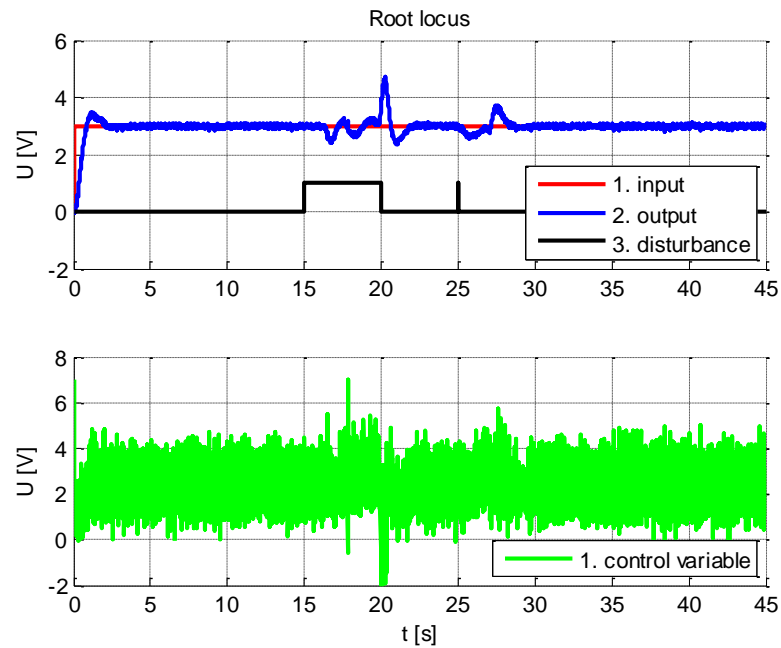

Figure 3.13: Results with disturbance

Figure 3.13 shows that obtained controller also is able to deal with both type of disturbance. Nevertheless, the manipulated variable has unacceptable shape.

3.5. Synthesis of robust controller

The following code was developed for the synthesis of robust controller based on the H_∞ norm.

Code 3.1.

```
s = tf('s');
G = 1.415/(0.006466*s^3+0.09387*s^2+0.1956*s+1);

M=10^(20/20);A=10^(-100/20);Omegb=10;
W1=(1/M*s+Omegb)/(s+A*Omegb)
W2=[2]; W3=[];

[K,CL,GAM]=mixsyn(G,W1,W2,W3);
R=tf(K)
```

Where: G – the transfer function of control object; $W1$, $W2$, $W3$ – the filters describing the desired quality of transient process and uncertainty; A , M , $Omegb$ – the parameters of filter $W1$; R – the transfer function of the robust controller.

The parameters of the filters were obtained by empirical way, such that the system has acceptable quality of transient process. The filter $W3$ is empty because there is no information about uncertainty. The result of robust controller synthesis is the following transfer function:

$$R(s) = \frac{3086s^3 + 44810s^2 + 93370s + 477300}{p^4 + 1873s^3 + 36180s^2 + 203900s + 20,39} \quad (3.4)$$

The modelling results of the system with the robust controller are shown in figure 3.14.

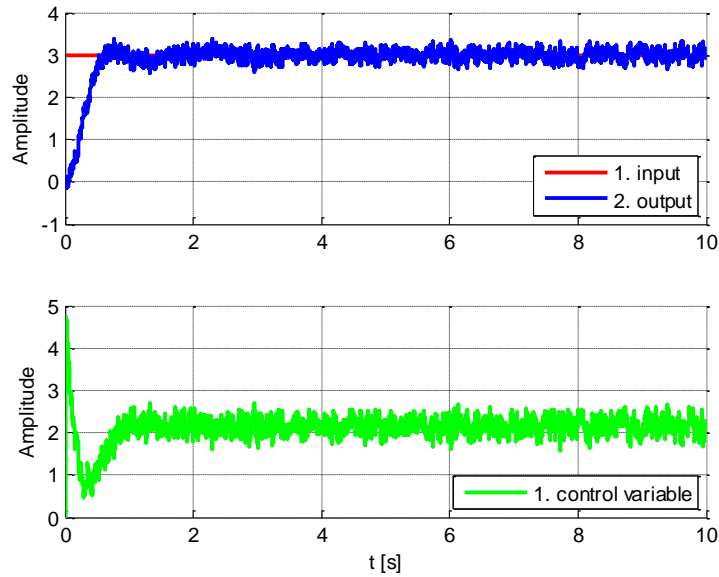

Figure 3.14: Modelling results

The system with obtained controller has good dynamic quality, but the system is sensitive to noise. The result of application of the robust controller to the real system is presented in figure 3.15.

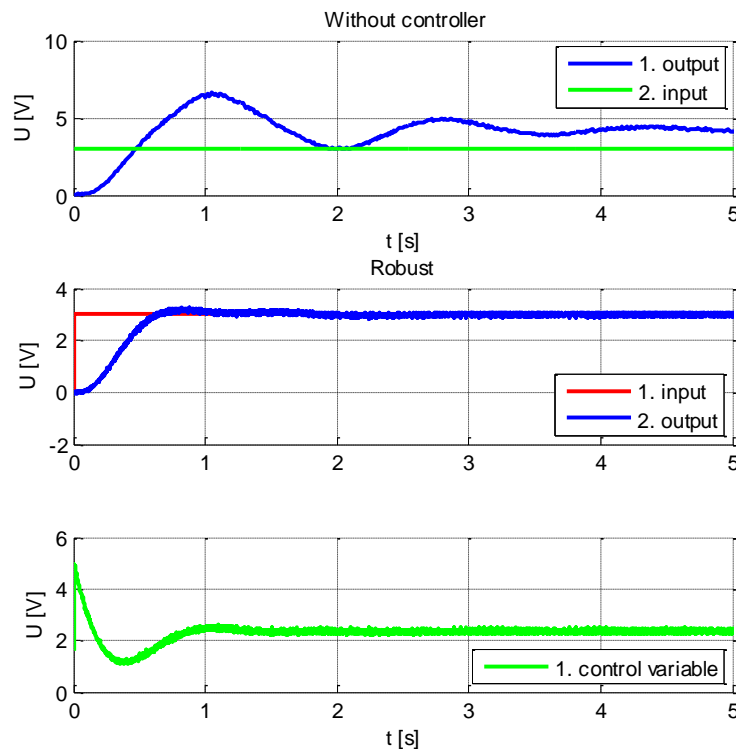

Figure 3.15: Transient processes in the system with the robust controller

Figure 3.15 shows that the transient processes in the system with the robust controller have the best quality in comparison with the previous systems.

The results with disturbance reaction are shown in figure 3.16.

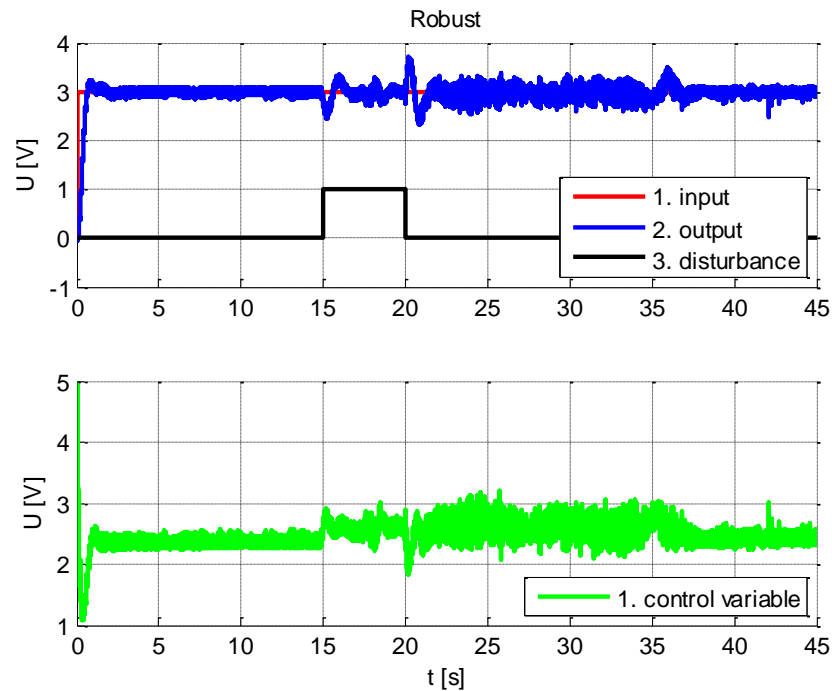

Figure 3.16: Results of disturbance reaction

The system with the robust controller can parry disturbance with the same quality as system with the PID-controller based on the root locus method. The manipulated variable has more acceptable shape, however the presence of the disturbance can lead to loosing of steady state.

3.6. Analysis of the considered methods

The comparative analysis is presented in figure 3.17, the appropriate parameters of transient processes are shown in table 3.3. For qualitative parameters, the following marks were used: “good”, “normal” and “bad”.

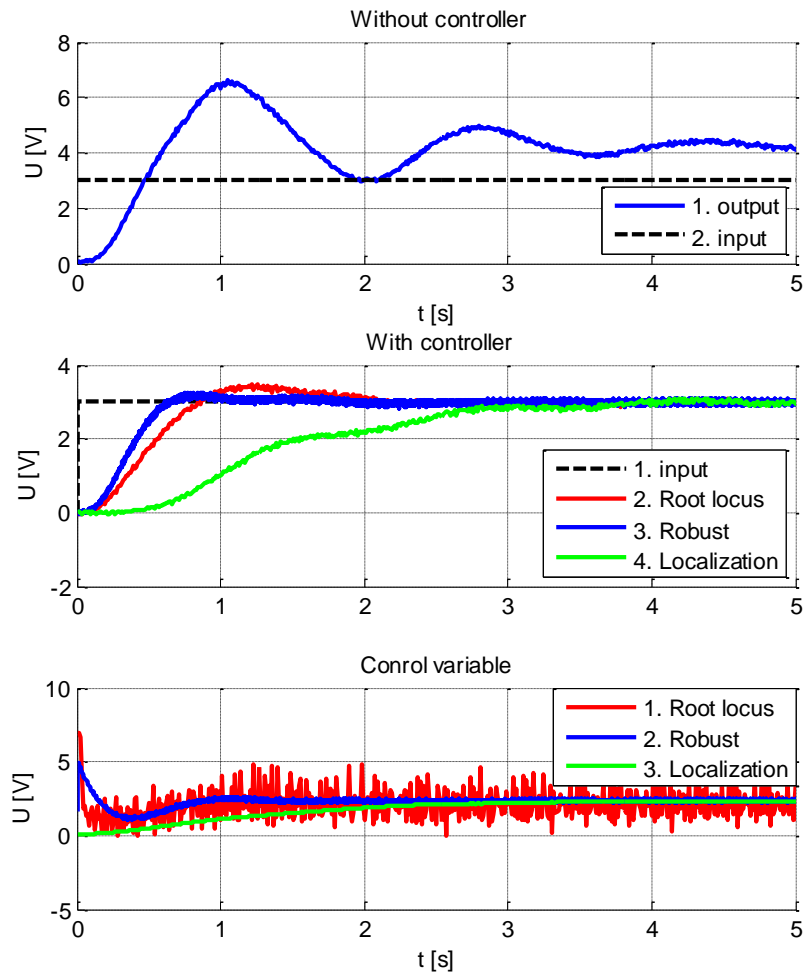

Figure 3.17: Comparison of the results

Table 3.3

	PID-controller (localization method)	PID-controller (root locus method)	Robust controller
Setting time	2,8 s	2,1 s	1 s
Overshoot	0%	13%	5%
Disturbance reaction	normal	good	bad
Shape of manipulated variable	good	bad	normal

The control task was to improve the quality of transient process: to reduce the setting time; to reduce oscillation nature; to eliminate overshoot. All obtained controllers provide an acceptable result with different quality. The system with controller based on the localization method satisfies to all of these requirements but it has the biggest setting time.

4. DESCRIPTION OF THE ONCE-THROUGH BOILER MODEL

The vivid example of a non-stationary control object is a one-through boiler. These boilers are widely used in the heat power engineering for producing of high-pressure superheated steam. Such steam drives a turbine, which drives a generator to provide electrical energy.

The parameters of the once-through boiler are changed during technological process. In addition, such type of system has serious disturbance requirements. These factors determine the complex control task.

4.1. Appointment of the once-through boiler

The simplified functional scheme of once-through boiler is presented in figure 4.1 [11, 12]. The scheme shows how the once-through boiler works from the temperature control point of view. The feature of the once-through boiler is that water goes through evaporating tubes, turning into steam, only once.

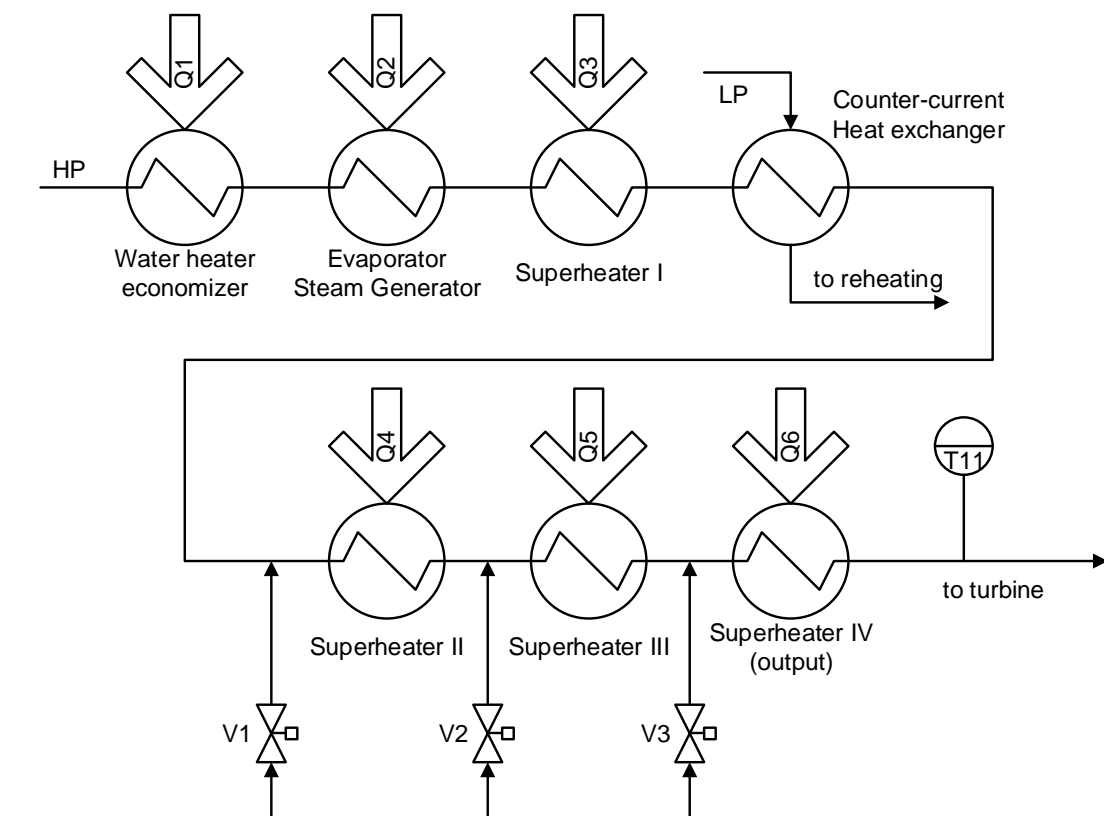

Figure 4.1: Simplified functional scheme of the one-through boiler

The once-through boiler, considered in this work, has seven heaters in series.

The first is called “Water heater economizer”. The special pumps supply the feedwater (200°C) to this heater. Then the water is heated to the desired temperature and goes to the “Evaporator Steam Generator”, where it turns into steam.

Once-through boiler is open-loop system; however, the whole system is closed-loop respectively of steam. The “Counter-current heat exchanger” provides possibility to use the low-pressure steam after turbine to increase efficiency [13].

The obtained steam goes through four “Superheaters” (Superheater I – Superheater IV), where it reaches the desired temperature. Then it is goes to the turbine.

The technological process is relatively complicated and non-linear, it contains many parameters, which depend on the current level of power (Q) and on the steam quality. The possible power level can be changed in rage 50%-100% that corresponds to 125-250 MW.

The main task in this work is to control of steam temperature. The most important target is to control of output steam temperature in “Superheater IV”, which drives the turbine.

The once-through boiler provides possibility to control three last “Superheater” by decreasing of input steam temperature. It is possible thanks to appropriate valve (V1 – V3). The cooling water is supplied through these valves.

Nowadays the control of temperature in this system is based on the meaning of the cascade control. The adaptive PI-controllers are used to solve this task. The parameters of these controllers are not constant; they depend on the current power level and are based on years of empirical experience. This solution was applied in real system and provides only part of requirements.

The task of the robust control is the synthesis of controller with constant structure and constant parameters, which are able to provide all desired requirements.

4.2. Temperature control of steam in the superheater

As it is written before, the technological process suggests the control of three last superheaters. These superheaters have the identical structure and the same parameters.

The structure scheme of the cascade control is presented in figure 4.2.

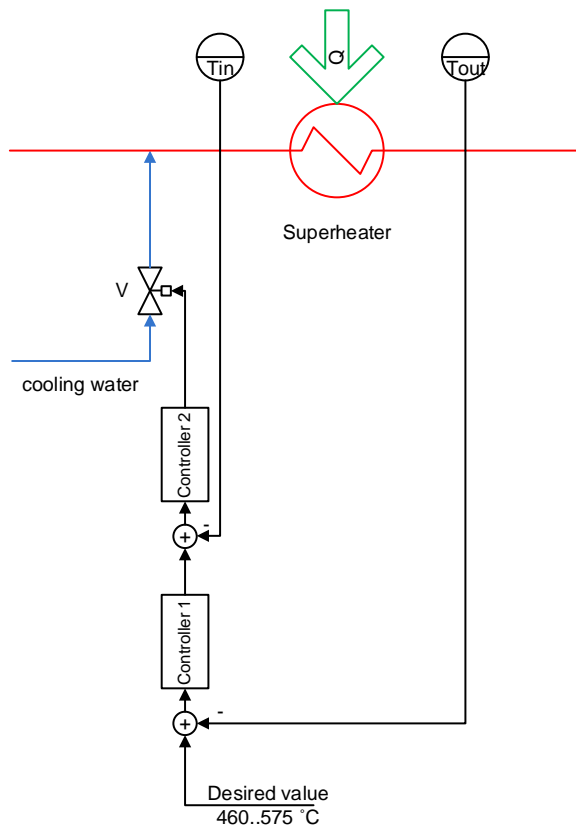

Figure 4.2: Structure scheme of the cascade control

The red line represents the heated steam. The blue line represents the cooling water, which allows controlling the temperature of input steam by the valve V. The green arrow shows dependence of the superheater parameters from the current power level. The temperature sensors (T_{in} , T_{out}) provide possibility to organize the cascade control. The inner circle controls the input steam temperature. The outer circle controls the output steam temperature.

4.3. Simplified mathematical model of the superheater

The superheater in general is multiple-input-multiple-output, non-linear and non-stationary system. However, in case of temperature control task it is possible to describe this system as single-input-single-output system with a set of transfer function. The parameters of these transfer functions depend on the power level.

There are three main parameters, which describe the station of the one-trough boiler:

- Position of valve (value is provided by controller);
- Temperature of input steam (value is measured by the appropriate sensor);
- Temperature of output steam (value is measured by the appropriate sensor).

The interrelation between these parameters determines the mathematical model of the system. Transfer function 4.1 determines relation between the valve position and the changing of input steam temperature.

$$G_1(s) = \frac{K_{T_{in}}}{(T_{T_{in1}}s + 1)(T_{T_{in2}}s + 1)(T_{T_{in3}}p + 1)} \quad (4.1)$$

Opening of valve corresponds to decreasing of the steam temperature; hence, the gain of transfer function (4.1) is under zero. The interrelation between parameter of the transfer function and the power level is presented in table 4.1.

Table 4.1

Power level (Q)	G_1			
	$K_{T_{in}}$	$T_{T_{in1}}$	$T_{T_{in2}}$	$T_{T_{in3}}$
0%-50%	-118,74	1,69	1,82	3,8
50%-70%	-73,6931	1,69	1,82	3,8
70%-90%	-48,9919	1,69	1,82	3,8
90%-100%	-40,6271	1,69	1,82	3,8

The time constants are independent from the power level, because these time constants are determined by dynamics of the valve. However, the power level influences on the gain of the transfer function, because the increasing of power level brings increasing of mass flux. Therefore, the efficiency of steam cooling is decreased. The important note is that the initial position of the valve is shifted when the power level is changing. This non-linearity is presented in table 4.2.

Table 4.2

Power level (Q)	0-50%	50%-60%	60%-70%	70%-80%	80%-90%	90%-100%
V0	0,5952%	5,849%	9,66%	11,79%	11,09%	7,32%

Transfer function 4.2 determines the relation between the input steam temperature and the output steam temperature.

$$G_2(s) = \frac{K_{T_{out}}}{(T_{T_{out}}s + 1)^n} \quad (4.2)$$

The interrelation between parameters of transfer function (4.2) and the power level is presented in table 4.3.

Table 4.3

Power level (Q)	G_2		
	$K_{T_{out}}$	$T_{T_{out}}$	n
0%-50%	1,0675	43	4
50%-70%	1,1313	39	3
70%-90%	1,1723	28	3
90%-100%	1,1948	25	3

Table 5.3 shows that increasing of the power level corresponds to increasing of heating speed and heating efficiency. The power level 0%-50% provides increasing of the system order by one. This power level is the worst situation for the controlling of the system.

The following model is based on the information described before.

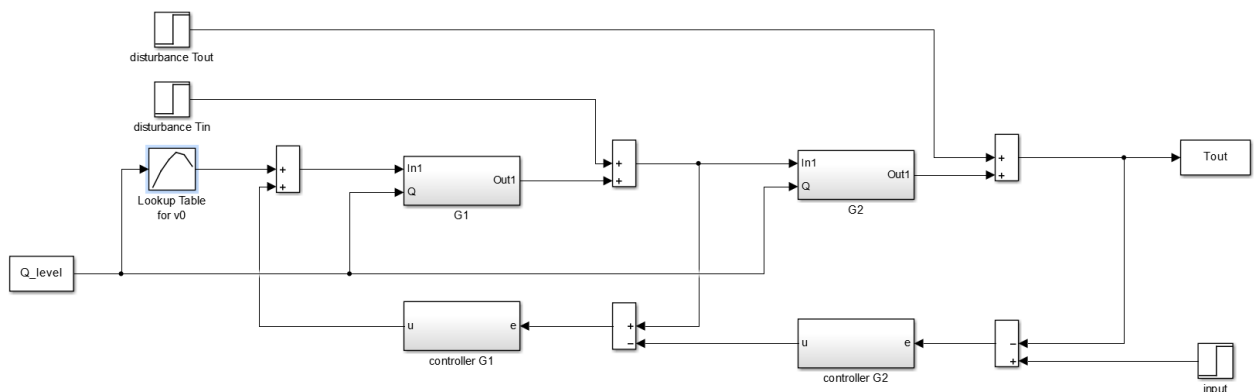

Figure 4.3: Model of the once-through boiler

The input signal is the desired temperature. Output signal is a current output temperature of the steam.

The technological process suggests possibility of the following disturbance type:

- Disturbance on the input temperature (disturbance Tin);

- Disturbance on the output temperature (disturbance T_{out}).

The dynamics changing of system parameters were realized by the special block called “Lookup Table”. The example of valve position changing respectively to the power level is presented in figure 4.4.

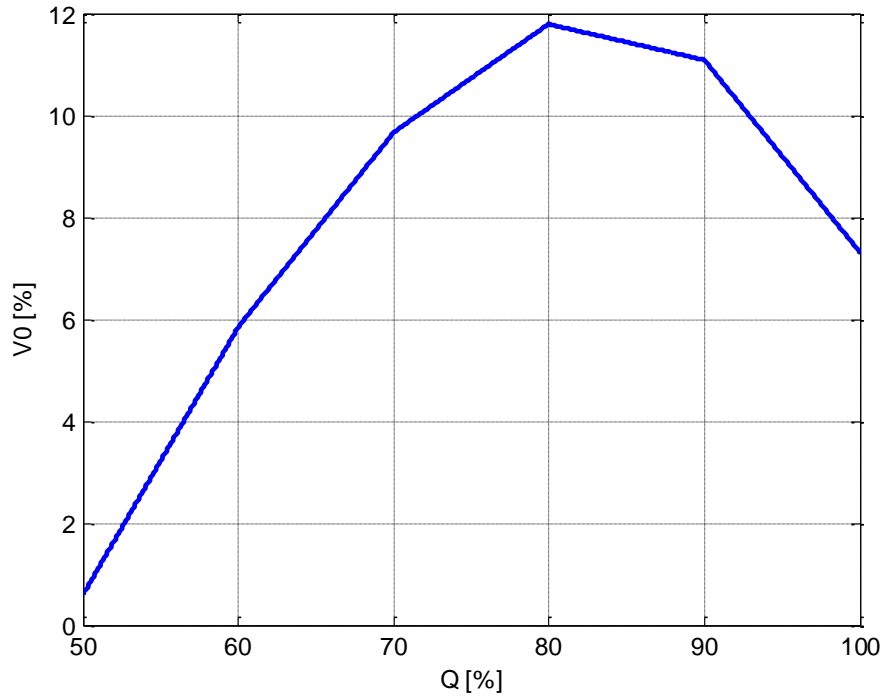

Figure 4.4: Example of the valve position changing

It is impossible to change parameters of transfer function during modelling by using the standard “Transfer Fcn” block. That is why the transfer functions $G1$ and $G2$ are realized by the following way: these transfer functions are represented as set of the first order elements in series. The example of the transfer function $G2$ realization is shown in figure 4.5. The appropriate “Lookup Table” blocks contain information about the changing of parameters.

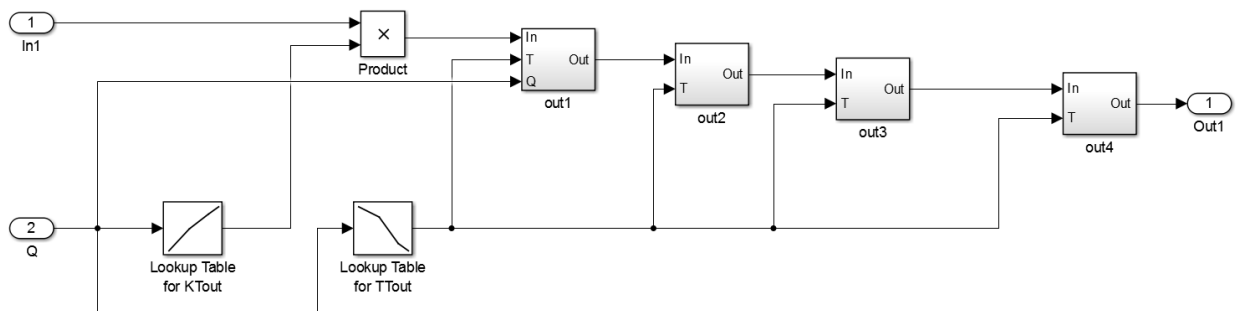

Figure 4.5: Example of the transfer function $G2$ realization

The realization of the first order element is presented in figure 4.6.

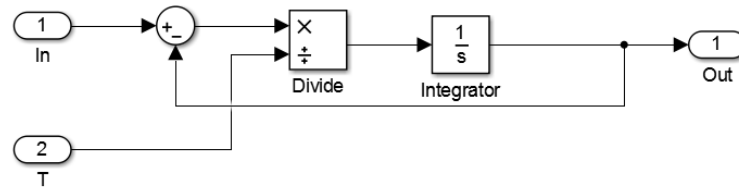

Figure 4.6: Realization of first order elements (out2 – out4)

It is also necessary to change the order of transfer function G2. It was realized by the following way:

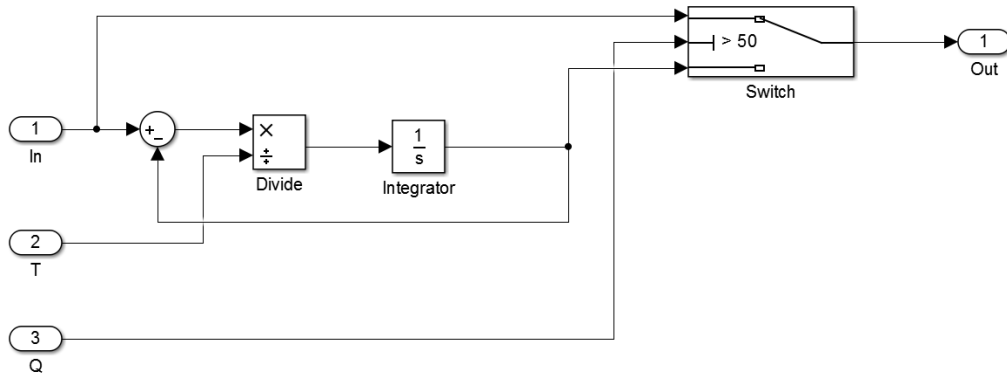

Figure 4.7: Realization of first order element (out1)

4.4. Features of the once-through boiler as a control object

Obviously, the obtained once-through boiler model is non-linear and non-stationary. There are few main points should be taken into account:

- Changing of the object parameters respectively to the power level;
- Changing of the object order respectively to the power level;
- The limit of the manipulated variable;
- The disturbances belong to the input and to the output of the object.

The changing of the parameters and the changing of the order make it is impossible to use the known methods of PID-controller calculation in direct form. Therefore, the method of localization is useful in this situation, because this method does not directly use the object parameters.

It is very important to keep the manipulated variable in range between zero (0%) and one (100%) that is corresponds to close and open state of the valve respectively. The only one possible impact to the system is to cool down the steam. In case, when the steam temperature is too low it is necessary to close the valve and to wait while the steam is heating.

The quality of disturbance reaction is one of the important requirements, because the main task of the once-through boiler is to keep the desired temperature. The most difficult is to parry the output disturbance; this type of disturbance goes directly to the controller.

All these features of the superheater describe the complex and sophisticated control task. However, it is possible to consider this system as linear, if the power level is constant. The worst case is when the power level is equal 50%. This state corresponds to the highest order and the largest time constant of the control object. Hence, it is better to use this state of the control object for controller synthesis.

4.5. Requirements of the control system

Nowadays control system of the once-through boiler is applied to the real factory. As it is written before, this control system was obtain by empirical way. Obviously, this control system could not be optimal. In addition, the actual control system has variable structure and the controllers parameters are changed respectively to the current power level. The main goal is to develop the robust control system, which is able to provide the following requirements:

- Constant structure and constant parameters of the controller;
- Setting time of step response should correspond to technological process;
- Parry of the power level changing;
- Disturbance reaction should correspond to the technological process;
- Manipulated variable should be in rage between zero (0%) and one (100%);
- Manipulated variable should not contain high-frequency oscillations.

There are the following working modes, which can proof if all requirements are fulfilled:

- The power level is constant, step response;
- The power level is constant, disturbance reaction;
- The power level is changing (linear), step response.

5. SYNTHESIS OF THE ONCE-THROUGH BOILER CONTROL SYSTEM

The model of the once-through boiler contains two control circles. The dynamics of these circles is different; the time constants of the inner loop are ten times smaller than the time constants of outer circle. Thus, it is possible to synthesize appropriate controllers separately.

5.1. Stabilizing of the inner circle

The previous research of the system shows that to stabilize the inner circle it is expedient to use usual P-controller [19]. Figure 5.1 shows the transient processes with different value of the proportional coefficient.

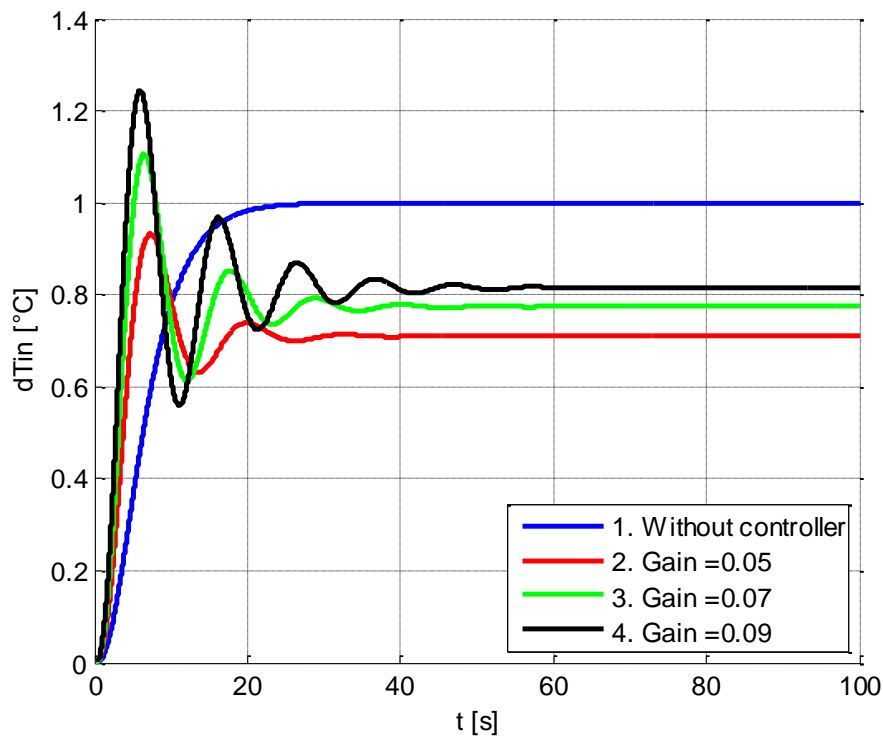

Figure 5.1: Stabilizing of the inner circle

The optimal value of the coefficient is 0.07. This coefficient provides acceptable dynamic quality; the steady state error will be compensated by the controller of the outer circle.

5.2. Calculation of PID-controller parameters based on the localization method

The calculation was made by the algorithm presented in subchapter 2.2. The model presented in figure 4.3 was used to check the result. The parameters of the control object corresponded to the power level is equal 50%.

The parameters c and K were chosen as tradeoff between stability and setting time. The obtained parameters are presented in table 5.1.

Table 5.1

c	K	T	K_P	K_I	K_D
0,017	35	20	0,9877	0,0101	0,0656

Figure 5.2 shows the modelling result with the obtained controller.

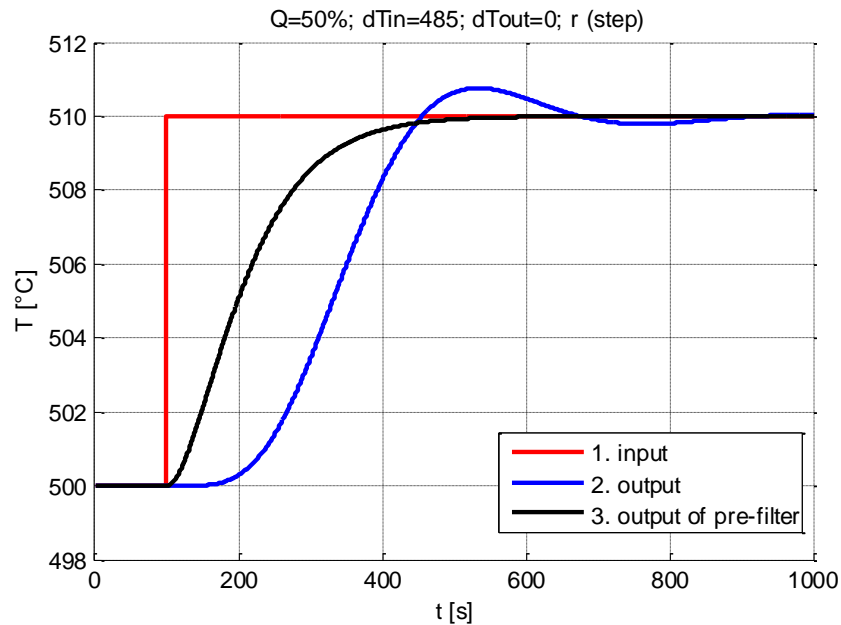

Figure 5.2: Modelling result

The result has the acceptable quality of the transient process. The try of the setting time reduction provides the increasing of overshoot. The modelling has non-zero initial state to make results closer to the real processes.

5.3. Application of the PID-controller based on the localization method

The controller was tested in the modes described in subchapter 4.5. The following transient processes were considered:

- Output steam temperature;
- Pre-filter output;
- Control error;
- Disturbance (output and position of valve);
- Manipulated variable.

5.3.1. Constant power level, the step response

This mode corresponds to the changing of output steam temperature in the same region. The appropriate results are shown in figures 5.3 – 5.6.

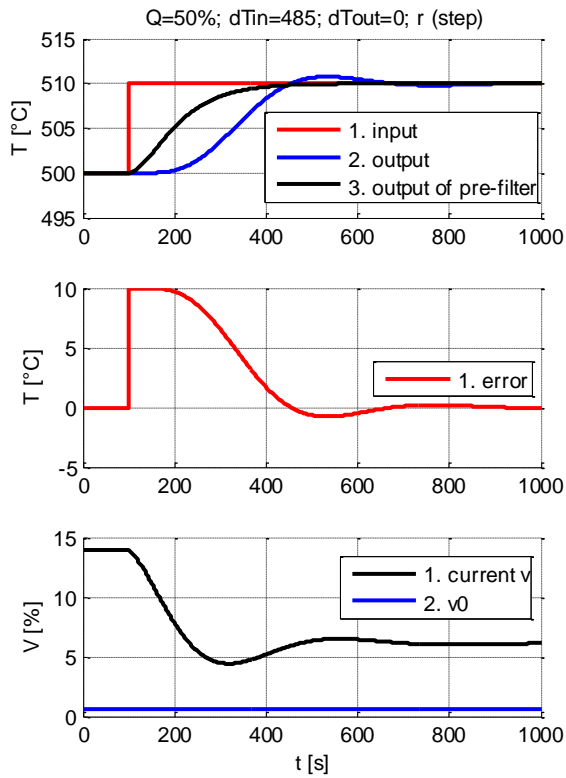

Figure 5.3: Modelling result (the power level is equal 50%)

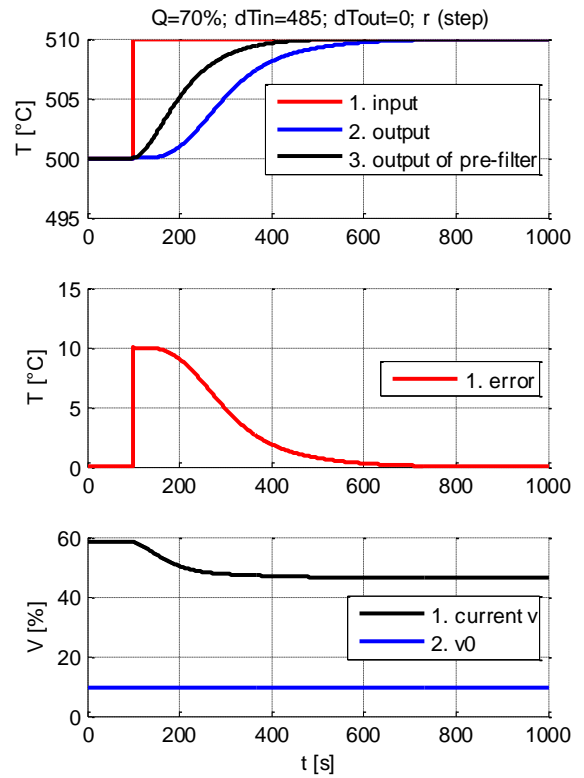

Figure 5.4: Modelling result (the power level is equal 70%)

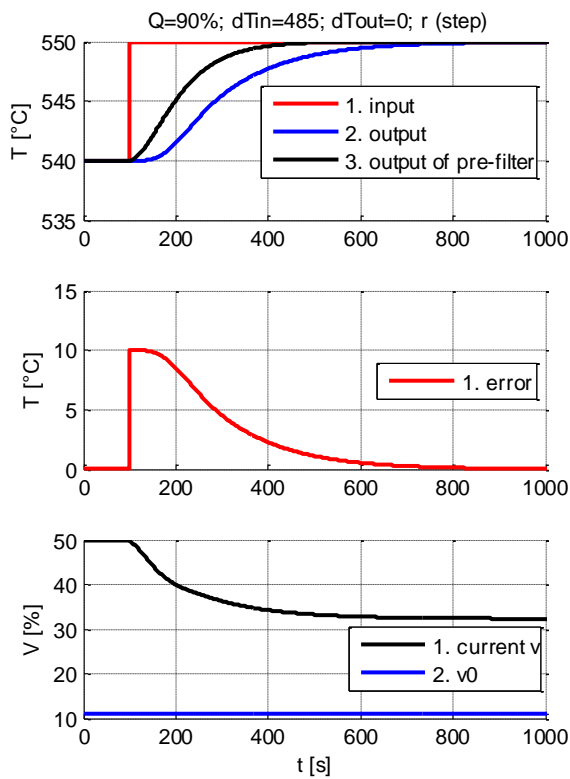

Figure 5.5: Modelling result (the power level is equal 90%)

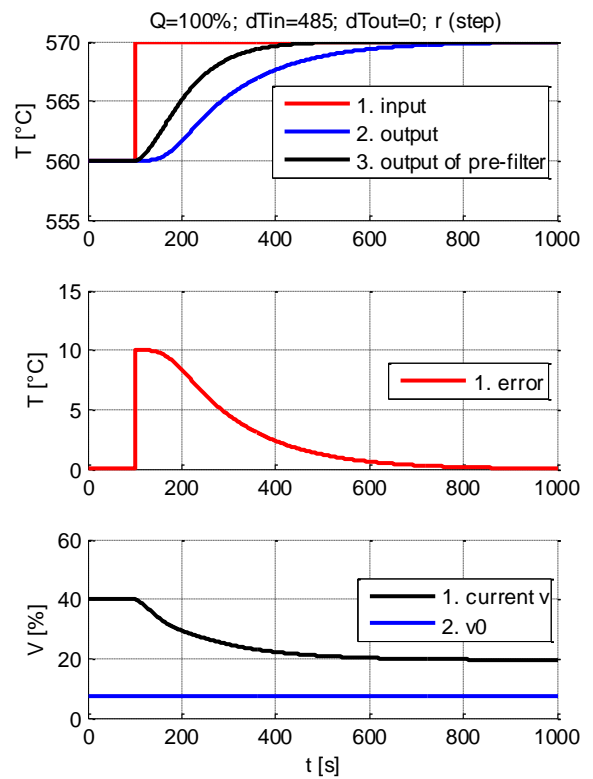

Figure 5.6: Modelling result (the power level is equal 100%)

The results presented in figures 5.3 – 5.6 have acceptable quality with different values of the system parameters. The important advantage is the shape of the manipulated variable, it has no oscillation nature and it lays in the desired range.

5.3.2. Constant power level, the disturbance reaction

Quality of disturbance reaction is the most important property of the controller. The main control task is to keep the desired value of the steam temperature during the technological process.

The disturbance is generated as a ramp with saturation. The obtained modelling results are presented in figures 5.7 – 5.10.

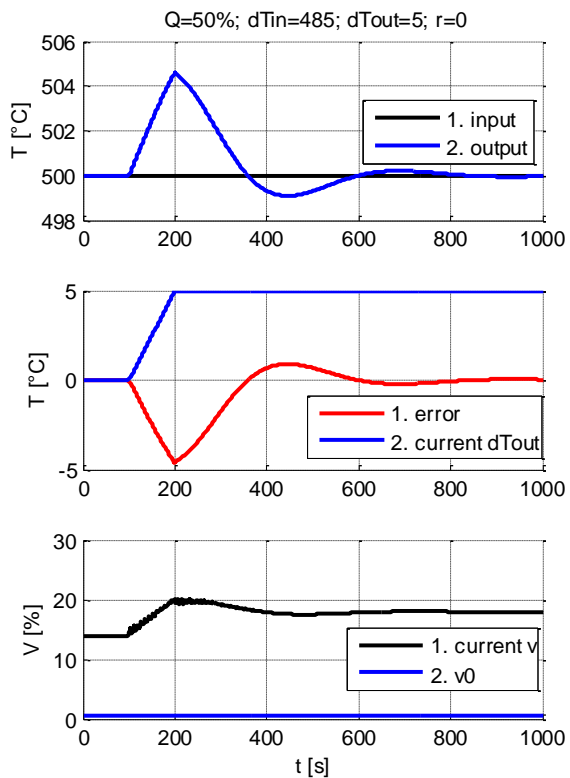

Figure 5.7: Modelling result (the power level is equal 50%)

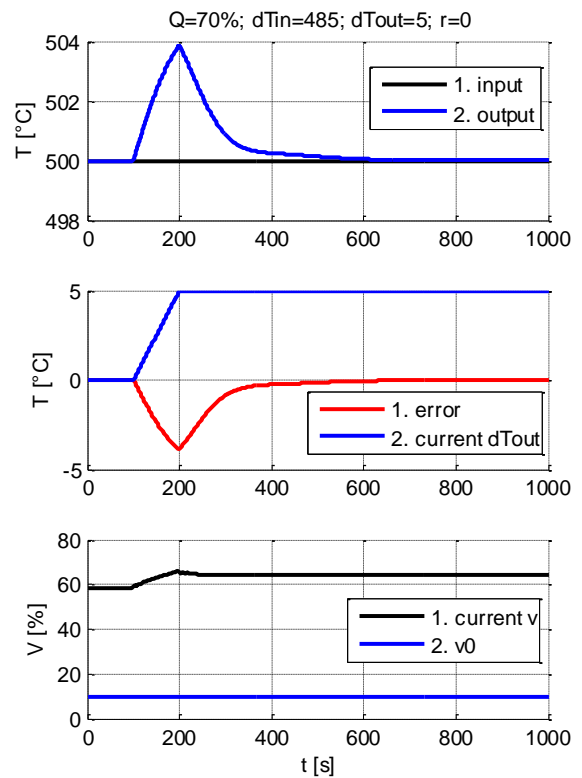

Figure 5.8: Modelling result (the power level is equal 70%)

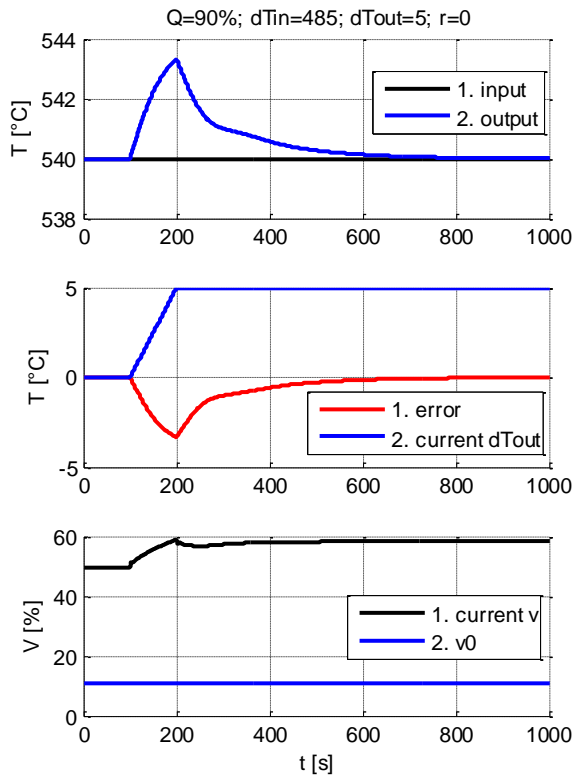

Figure 5.9: Modelling result (the power level is equal 90%)

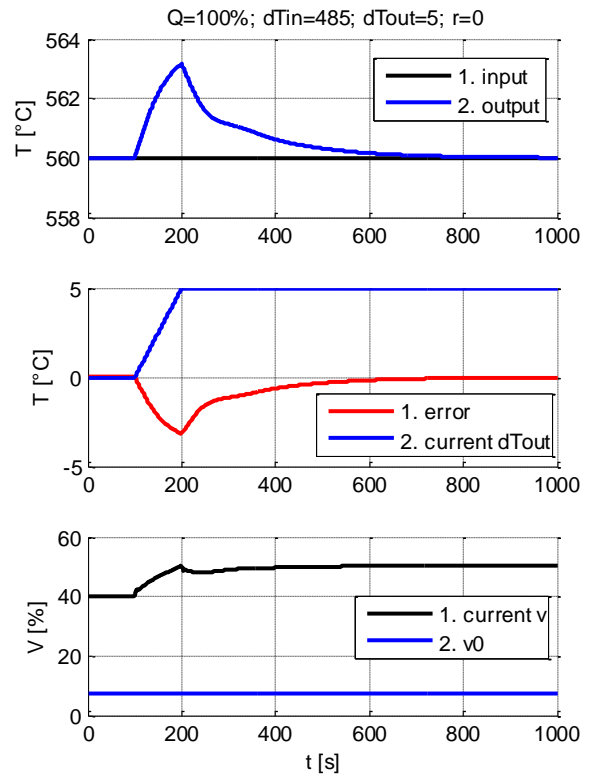

Figure 5.10: Modelling result (the power level is equal 100%)

The obtained controller provides acceptable disturbance reaction. All requirements are fulfilled.

5.3.3. Changing power level, step response

This mode is also important from technological point of view. The available power levels correspond to the different ranges of the output temperatures, because the power level influences on the control object gain (table 4.1). Therefore, it is necessary to change the desired value when the power level is greater than 70%.

The power level changing is generated as a ramp with saturation between 50% and 100%. The result is shown in figure 5.11.

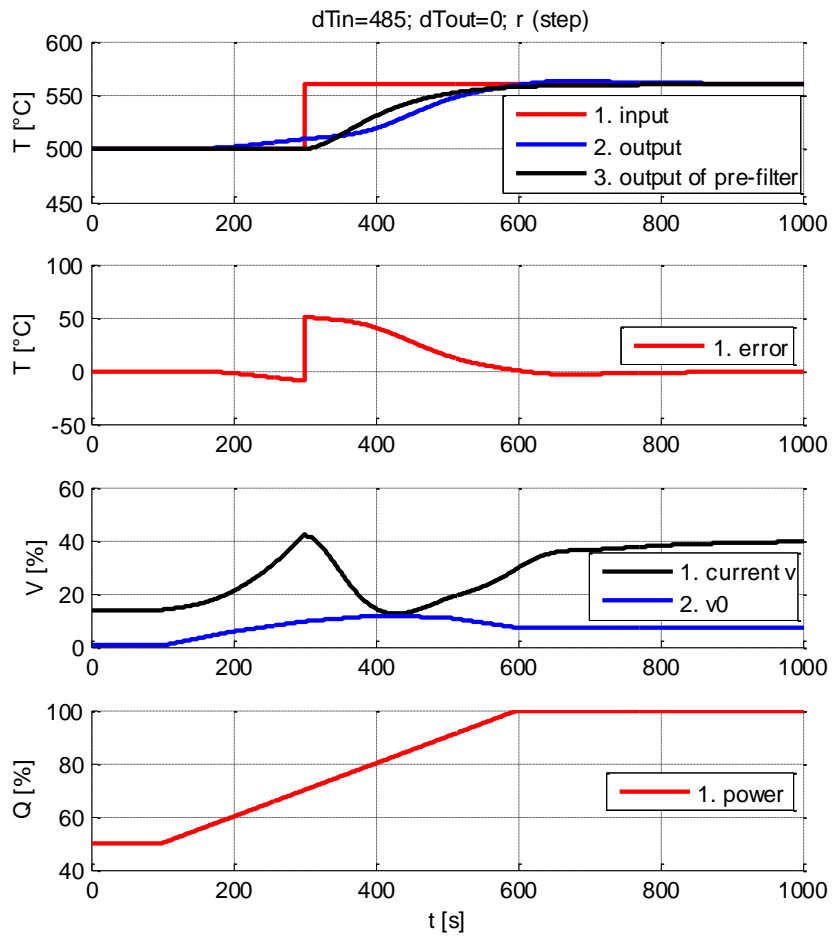

Figure 5.11: Modelling result

The obtained controller provides good performance for this mode. All requirements are fulfilled.

5.4. Calculation of PIDD-controller parameters based on the localization method

The resource of PID-controller is limited. Using of PIDD-controller provides possibility to improve quality of the system processes: to decrease overshoot, to decrease setting time. The calculation was made by using the algorithm presented in subchapter 2.3.

The obtained controller has transfer function (1.4) and the pre-filter in form 2.18. The parameters of the obtained PIDD-controller are presented in table 5.2.

Table 5.2

c	K	T	K_p	K_I	K_D	K_{DD}
0,008	$6 \cdot 10^5$	1	8,2944	0,0674	334,5633	$4,5352 \cdot 10^3$

The result of the PIDD-controller application is presented in figure 5.12.

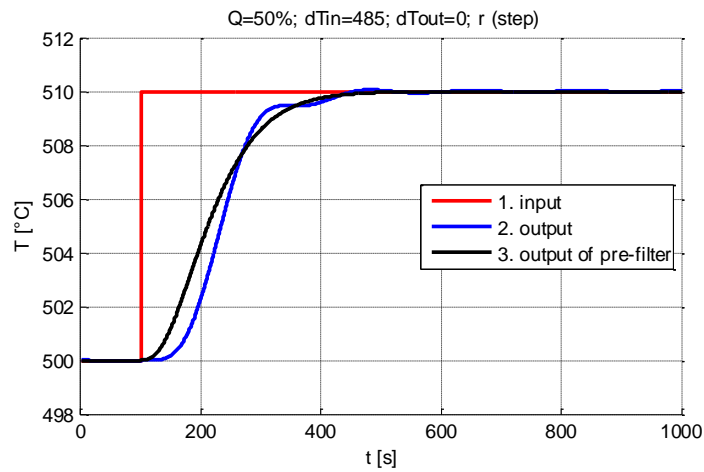

Figure 5.12: Modelling result

The results with the PIDD-controller are better: there is no overshoot and the setting time is two times smaller. However, the great coefficients of derivatives channel (table 5.2) could provide oscillation nature in the manipulated variable.

5.5. Application of the PIDD-controller based on the localization method

The checking of the results with PIDD-controller was made by the same way as with the PID-controller.

5.5.1. Constant power level, the step response

The modelling results are shown in figures 5.13 – 5.16.

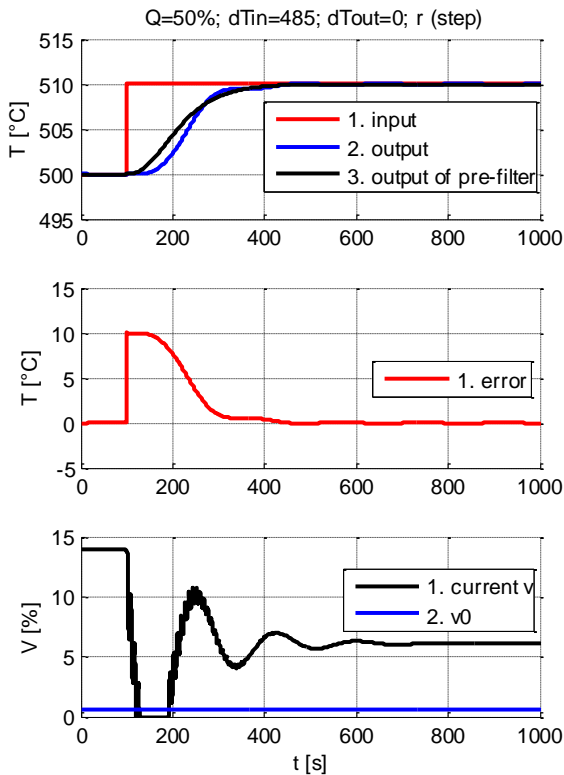

Figure 5.13: Modelling result (the power level is equal 50%)

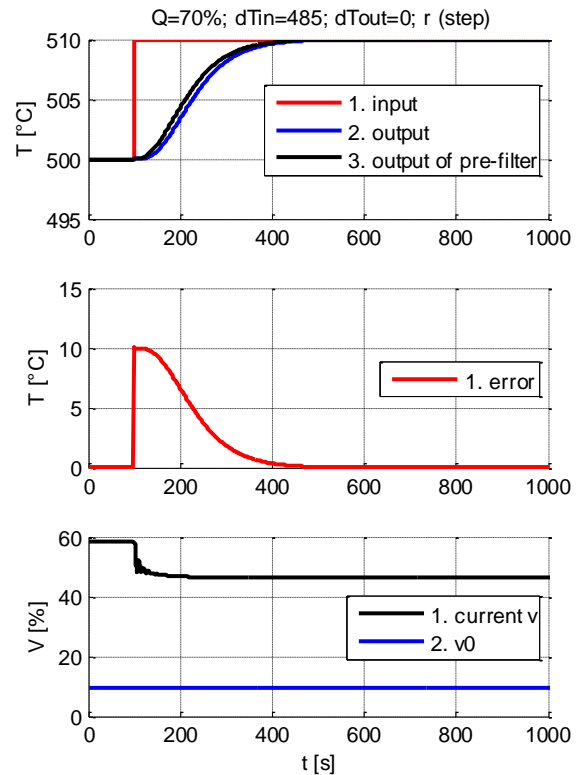

Figure 5.14: Modelling result (the power level is equal 70%)

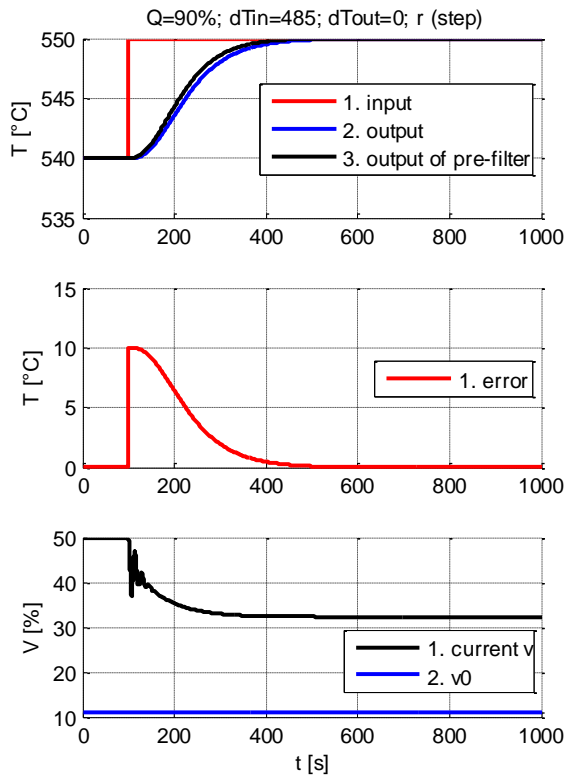

Figure 5.15: Modelling result (the power level is equal 90%)

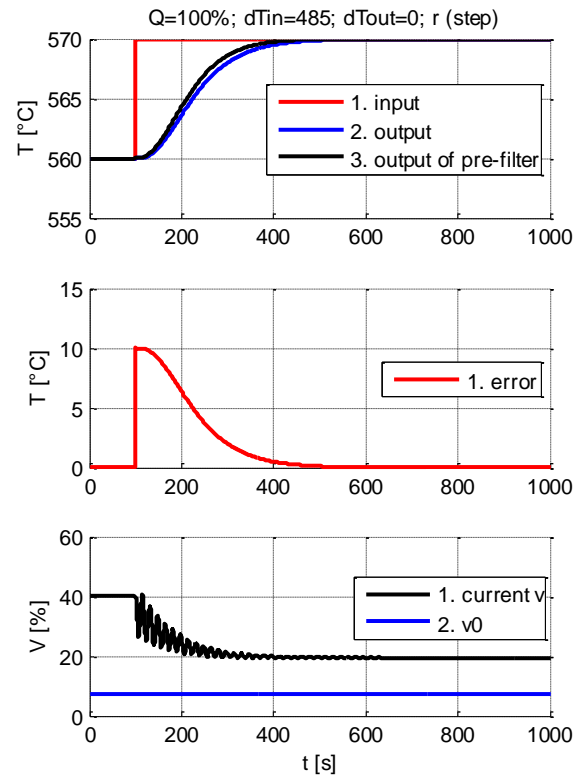

Figure 5.16: Modelling result (the power level is equal 100%)

The PID-controller provides the same behavior for all available power levels. However, the shape of the manipulated variable has oscillation nature that is unacceptable for the system, because the valve is a mechanical device.

5.5.2. Constant power level, the disturbance reaction

The modelling results are shown in figures 5.17 – 5.20.

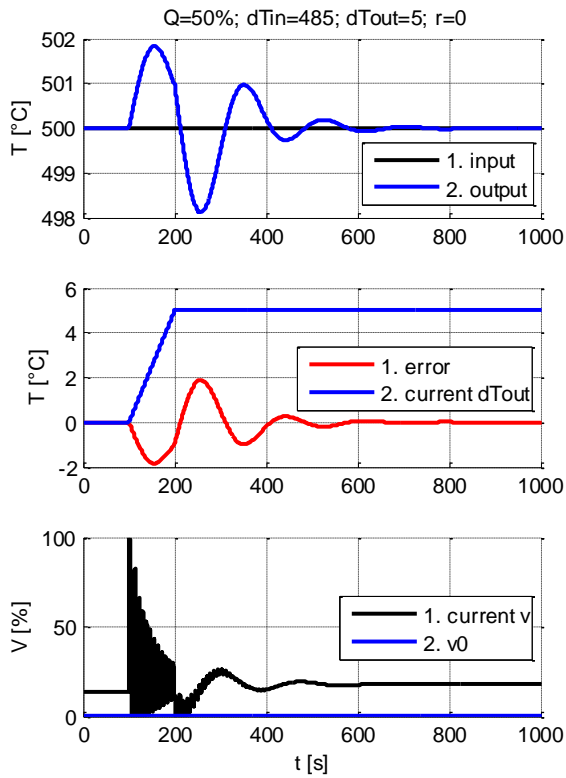

Figure 5.17: Modelling result (the power level is equal 50%)

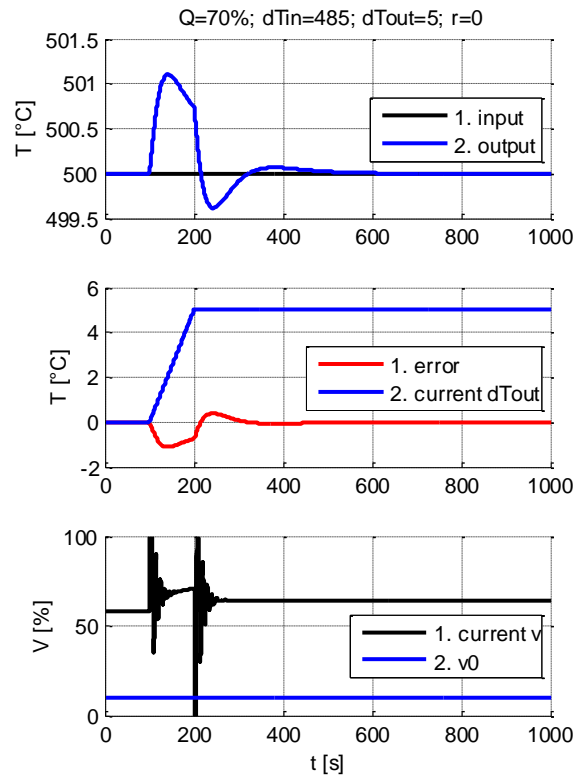

Figure 5.18: Modelling result (the power level is equal 70%)

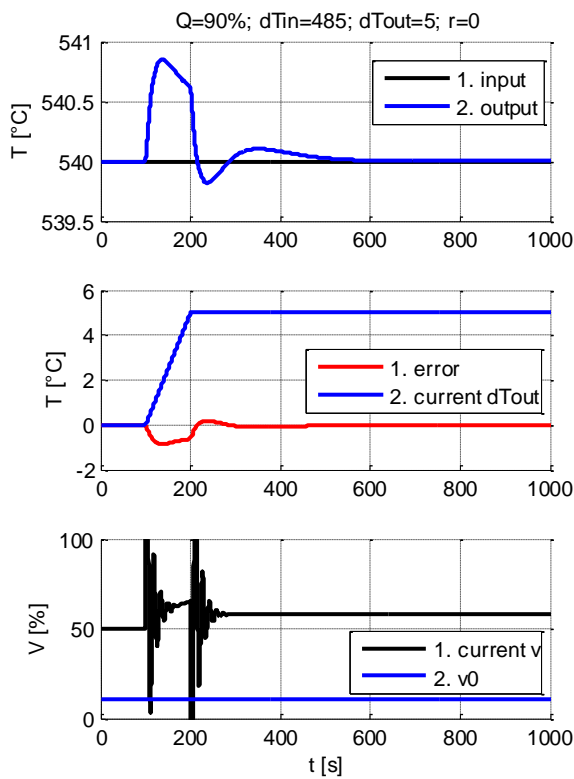

Figure 5.19: Modelling result (the power level is equal 90%)

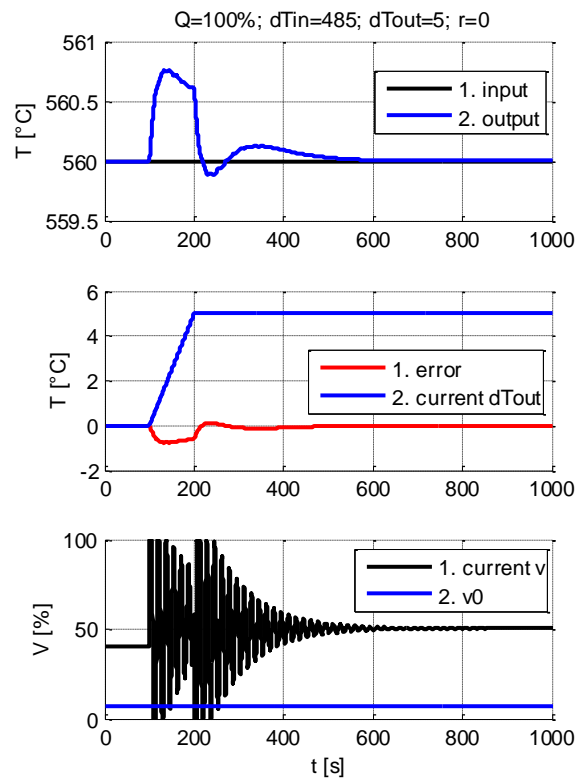

Figure 5.20: Modelling result (the power level is equal 100%)

Quality of the disturbance reaction is significantly better, but the manipulated variable has unacceptable shape. It was necessary to include the saturation to keep the manipulated variable in the required range.

5.5.3. Changing power level, step response

The modelling results are shown in figure 5.21.

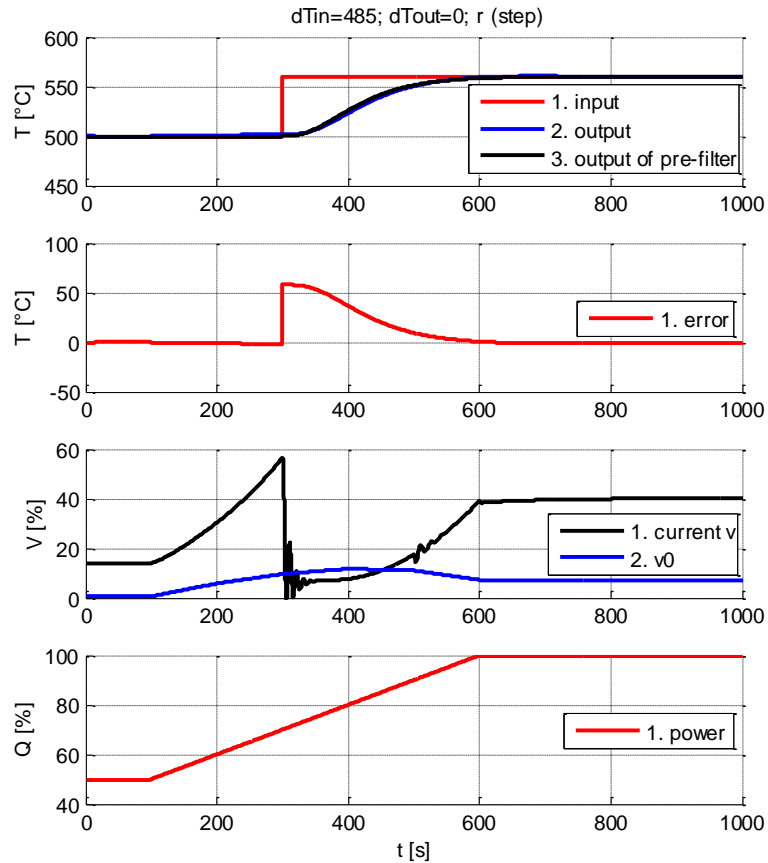

Figure 5.21: The modelling result

The PIDD-controller also provides better result than the PID-controller in this mode. Unlike the previous tests, all requirements are fulfilled. The oscillation nature of the manipulated variable is enough smaller than in case of the disturbance reaction.

5.6. Calculation of PID-controller parameters based on the root locus method

“The SISO Design Tool” was used for the calculation of the PID-controller based on the root locus method. The algorithm is the same as in subchapter 3.4. The parameters corresponding to the power level is equal 50% was used for the calculations. The root locus of the closed-loop system is presented in figure 5.22.

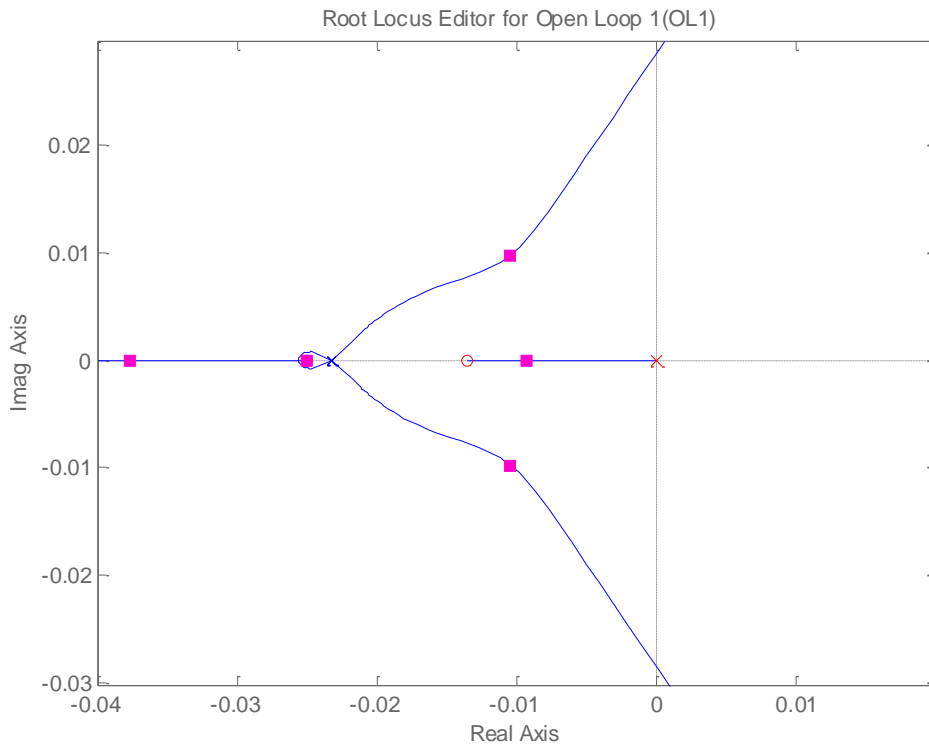

Figure 5.22: Root locus of the system

The obtained PID-controller has only real zeroes, because the control object has only real poles. The criterion of choosing the controller parameters was the providing of the fastest dynamics. Transfer function of the controller has the following form:

$$R(s) = \frac{0,0058 \cdot (1 + 74s)(1 + 40s)}{s} \quad (5.1)$$

The technical realization of transfer function (5.1) is the PID-controller with the parameters presented in table 5.3.

Table 5.3

T	K_P	K_I	K_D
0,1	0,661	0.0058	17,1

Figure 5.23 shows the modelling result with the obtained controller.

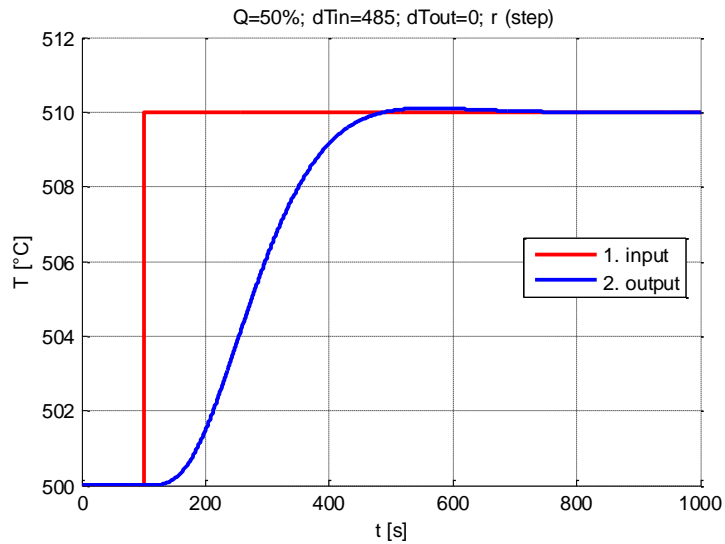

Figure 5.23: Modelling results

The results with PID-controller based on the root locus method is better than the results with PID-controller based on the localization method (figure 5.2): there is no overshoot and the setting time is smaller.

5.7. Application of the PID-controller based on the root locus method

5.7.1. Constant power level, the step response

The modelling results are shown in figures 5.24 – 5.27.

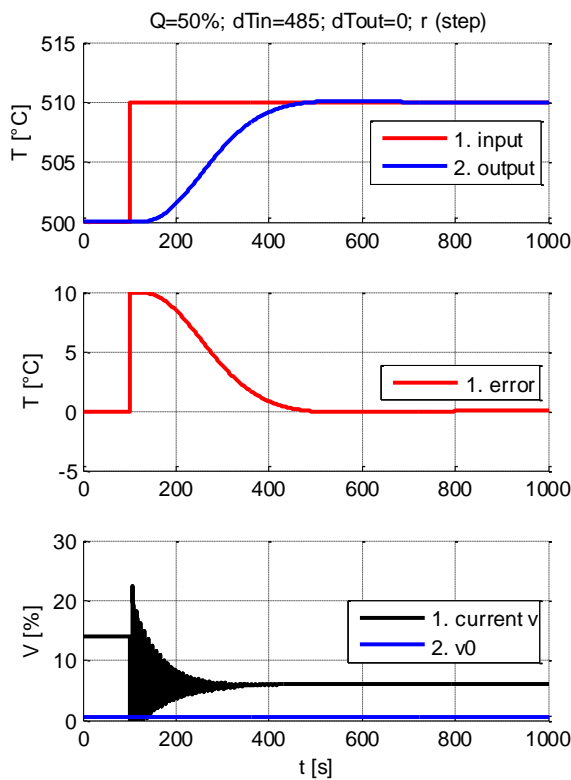

Figure 5.24: Modelling result (the power level is equal 50%)

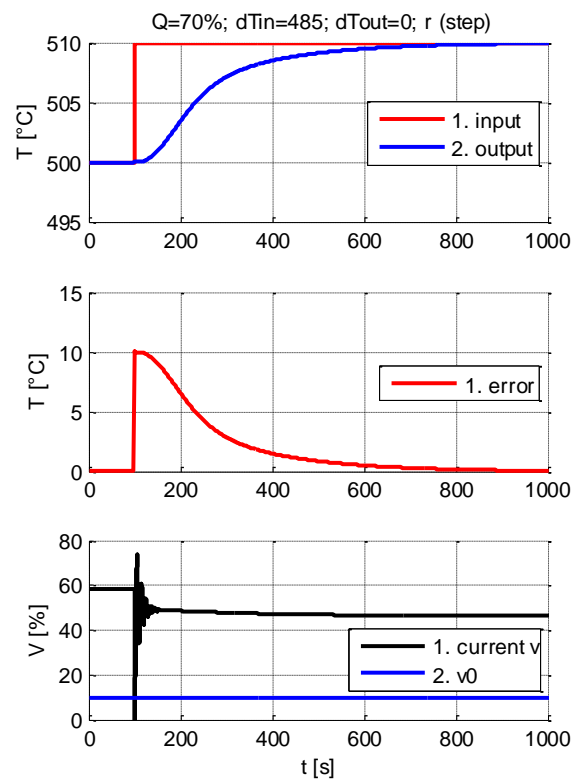

Figure 5.25: Modelling result (the power level is equal 70%)

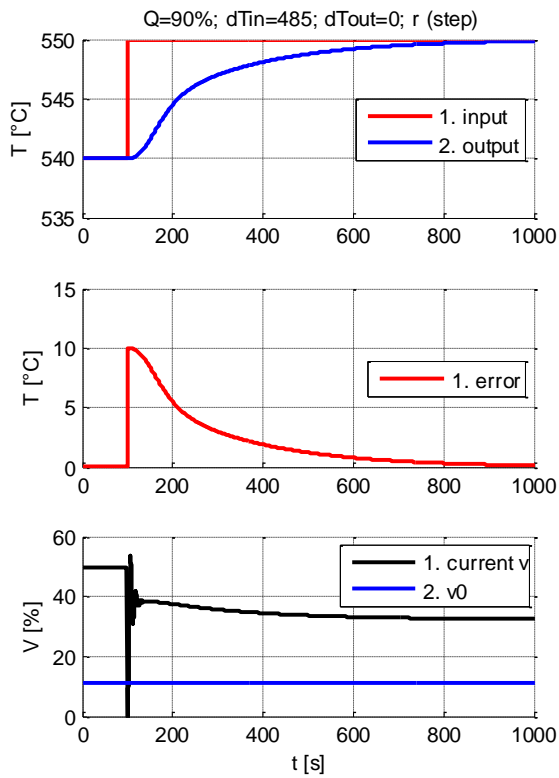

Figure 5.26: Modelling result (the power level is equal 90%)

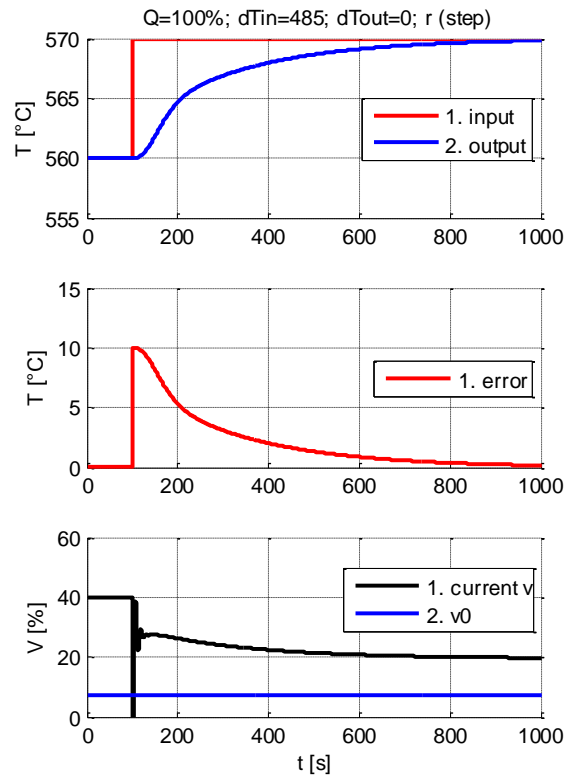

Figure 5.27: Modelling result (the power level is equal 100%)

The results show that the PID-controller based on the root locus method can parry the changing of parameters. However, the manipulated variable has oscillation nature.

5.7.2. Constant power level, the disturbance reaction

The modelling results are shown in figures 5.28 – 5.31.

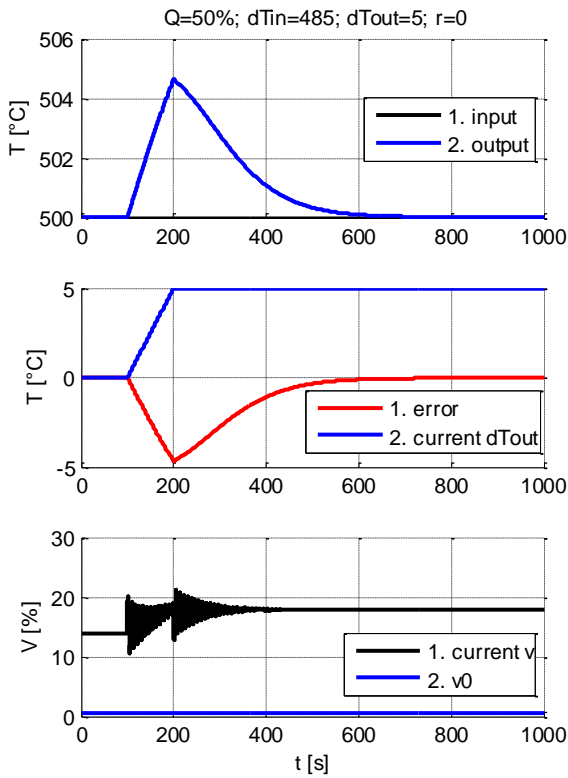

Figure 5.28: Modelling result (the power level is equal 50%)

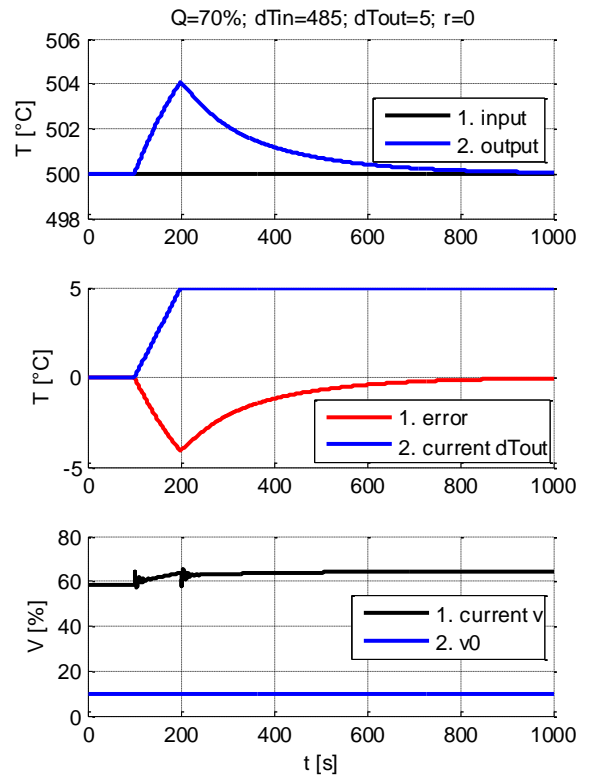

Figure 5.29: Modelling result (the power level is equal 70%)

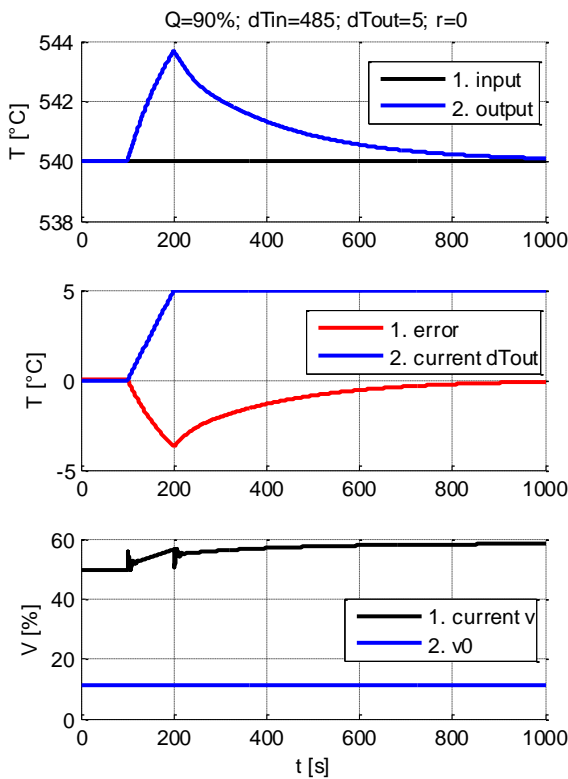

Figure 5.30: Modelling result (the power level is equal 90%)

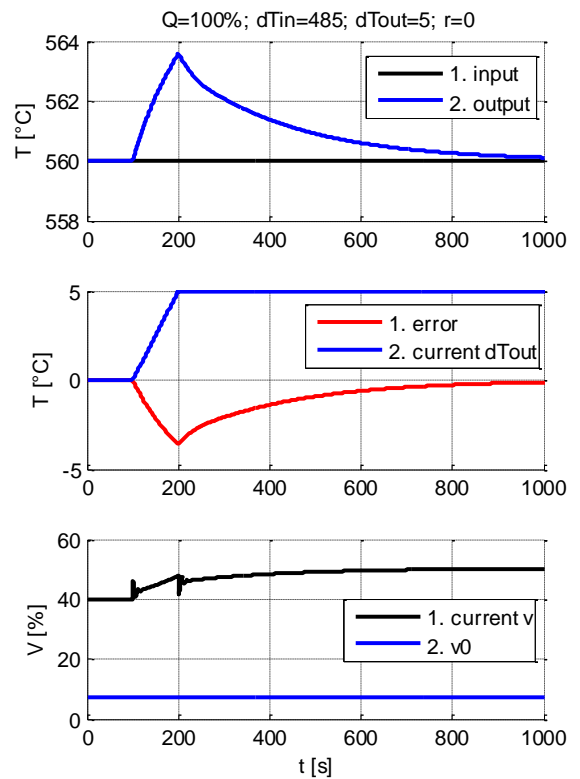

Figure 5.31: Modelling result (the power level is equal 100%)

The disturbance reaction is slower than in the system with the PID-controller based on the localization method (subchapter 5.3.2). In figure (5.28) the manipulated variable has unacceptable oscillation nature.

5.7.3. Changing power level, step response

The modelling results are shown in figure 5.21.

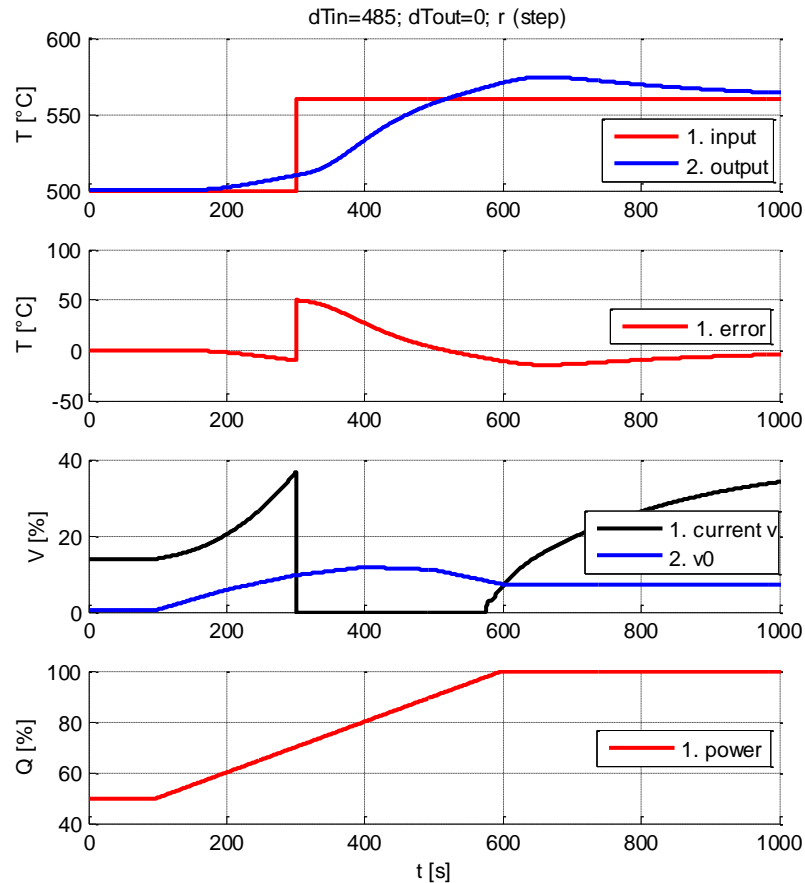

Figure 5.32: Modelling result

Quality of the transient process is worse than in case of PID-controller and PIDD-controller based on the localization method.

5.8. Calculation of robust controller

The synthesis of the robust controller uses information about uncertainty. The filter $W_3(s)$ defines this information. The algorithm of the filter calculation is described in subchapter 2.1. The parameters corresponding to the power level is equal 50% are a nominal parameters. The special filters were calculated by equation (1.8). The result of the filter choosing is presented in figure 5.33.

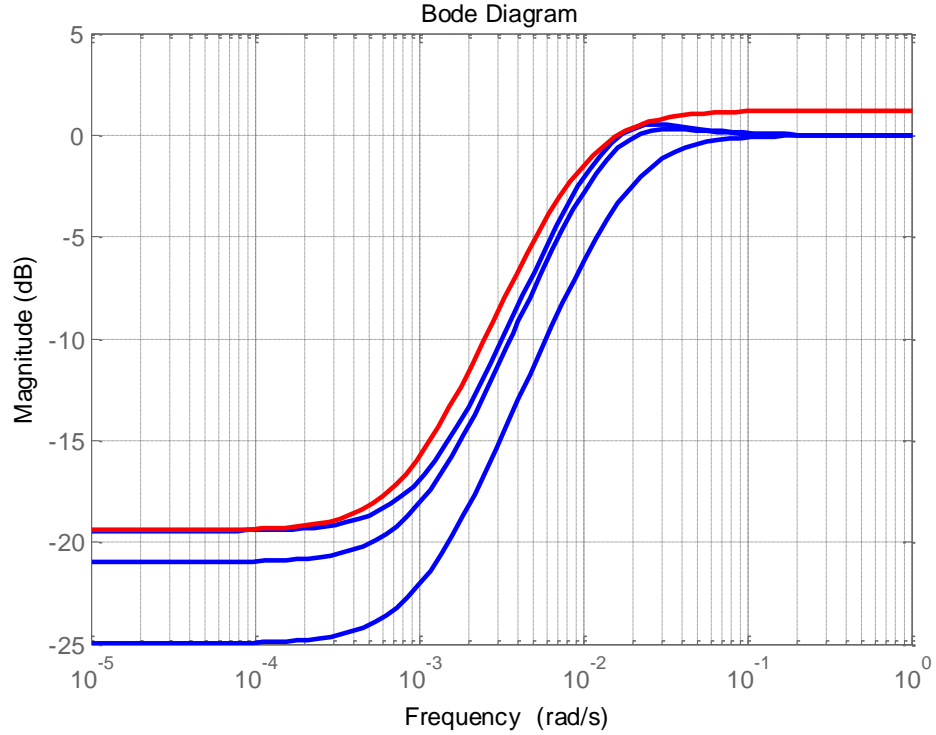

Figure 5.33: Result of the filter $W_3(s)$ choosing, where:
red line represents the filter;
blue lines correspond to the special filters.

The appropriate filter transfer function has the following form:

$$W_3(s) = \frac{s + 0,000871}{0,871s + 0,008128}$$

The parameters of the filters $W_1(s)$ and $W_2(s)$ were chosen by empirical way as tradeoff between stability and dynamics of the system.

$$W_1(s) = \frac{0,1s + +0,1}{s + 10^{-6}}$$

$$W_2(s) = 10$$

The founded controller has the following form:

$$R(s) = \frac{19,91s^5 + 2,038s^4 + 0,08188s^3 + 0,001604s^2 + 1,517 \cdot 10^{-5}s + 5,434 \cdot 10^{-8}}{s^6 + 12,41s^5 + 1,329s^4 + 0,05729s^3 + 0,001249s^2 + 7,658 \cdot 10^{-6}s + 7,657 \cdot 10^{-12}} \quad (5.2)$$

Figure 5.34 shows the modelling result with the obtained controller.

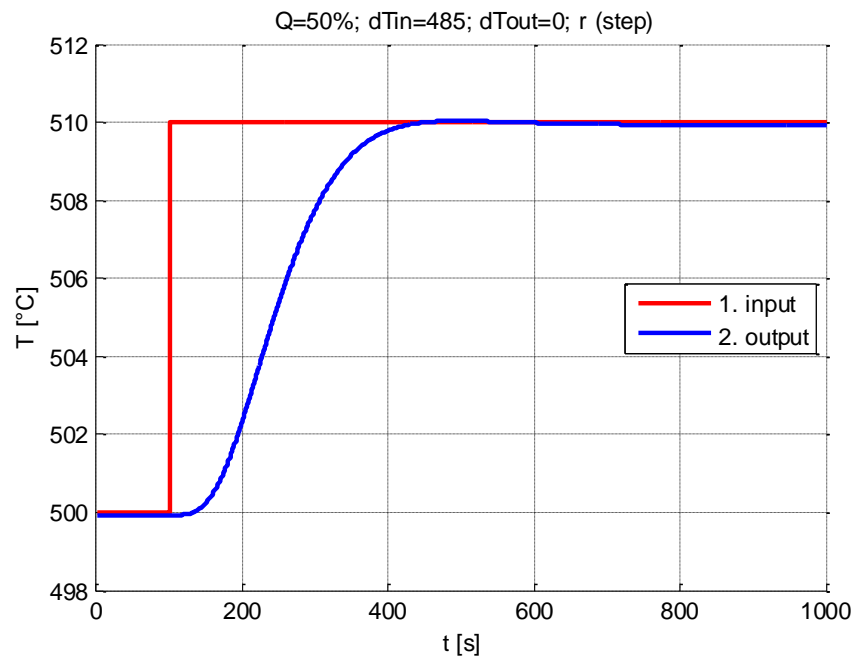

Figure 5.34: Modelling result

The robust controller provides the fastest transient process and zero-overshoot. The reason is that the resource of the robust controller is much larger than the resources of PID-controller or PIDD-controller.

5.9. Application of the robust-controller to the system

5.9.1. Constant power level, the step response

The modelling results are shown in figures 5.35 – 5.38.

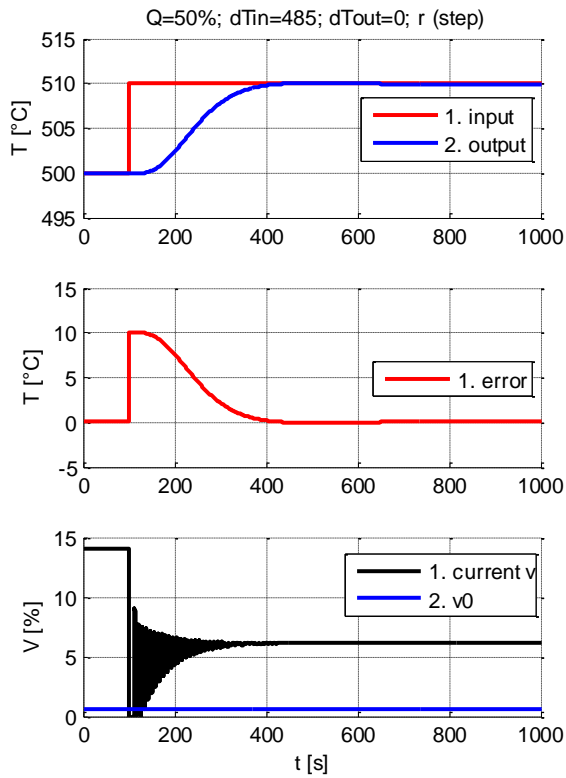

Figure 5.35: Modelling result (the power level is equal 50%)

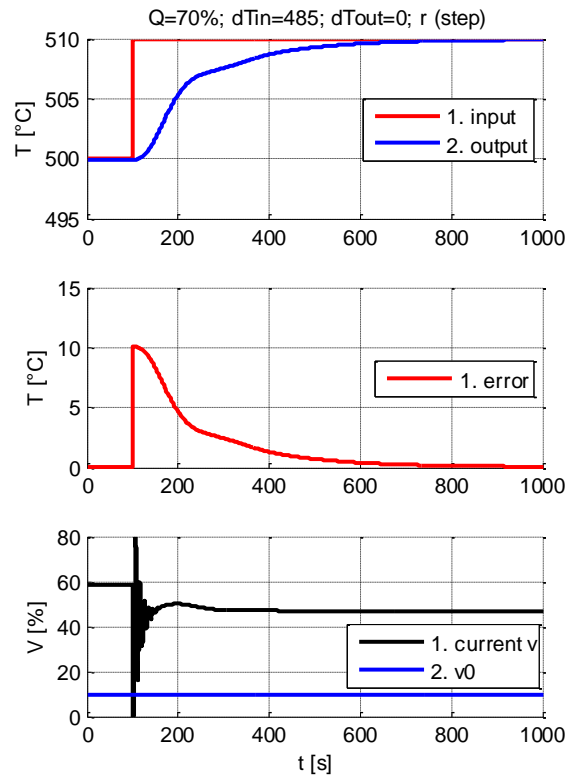

Figure 5.36: Modelling result (the power level is equal 70%)

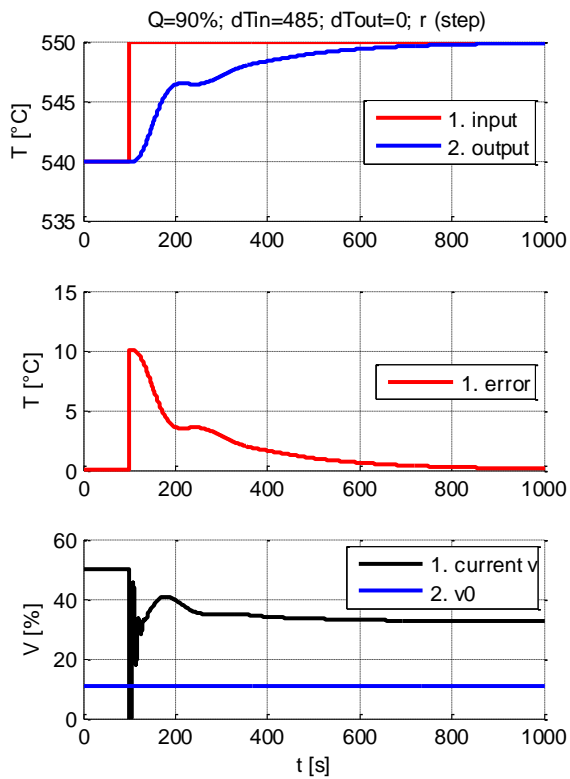

Figure 5.37: Modelling result (the power level is equal 90%)

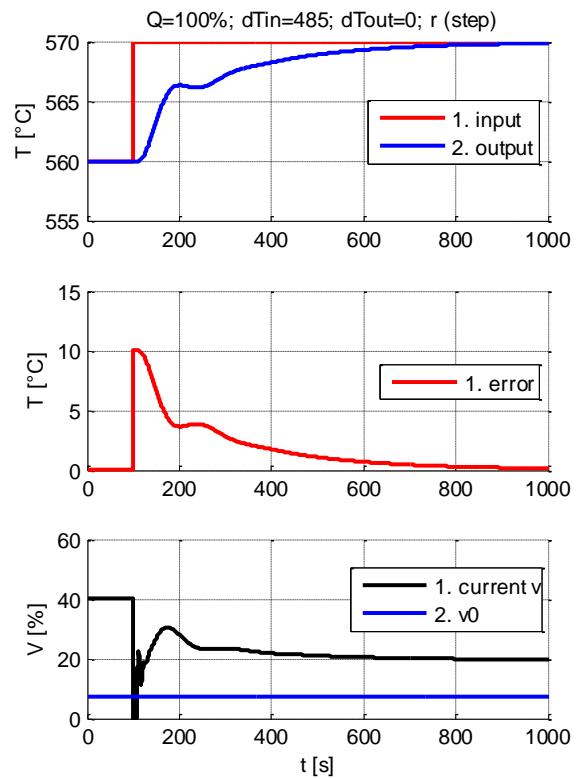

Figure 5.38: Modelling result (the power level is equal 100%)

The robust controller provides acceptable quality of the transient processes in whole range of the system parameters. The settling time is approximately the same as in the system with the PID-controller based on the localization method (subchapter 5.3.1). The manipulated variable has unacceptable shape.

5.9.2. Constant power level, the disturbance reaction

The modelling results are shown in figures 5.39 – 5.42.

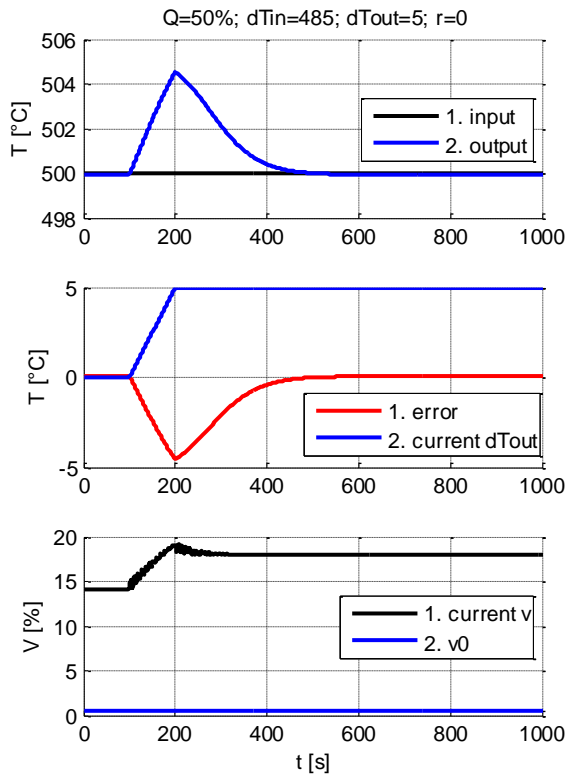

Figure 5.39: Modelling result (the power level is equal 50%)

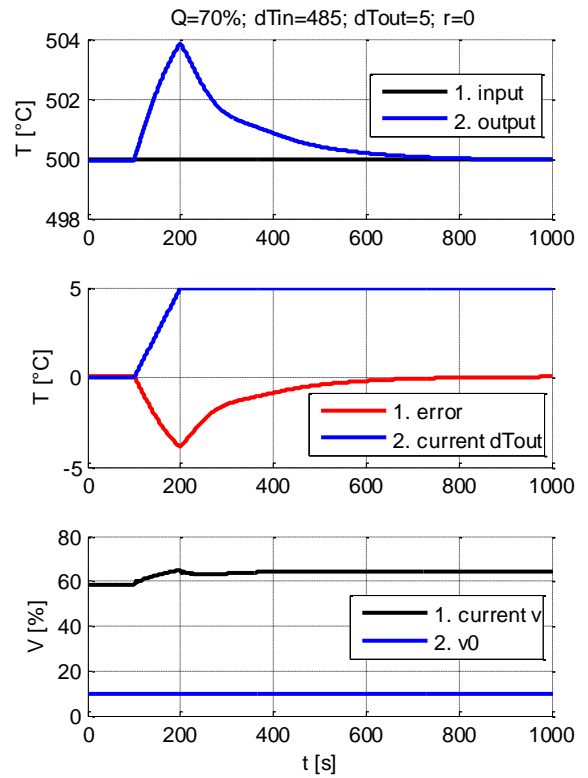

Figure 5.40: Modelling result (the power level is equal 70%)

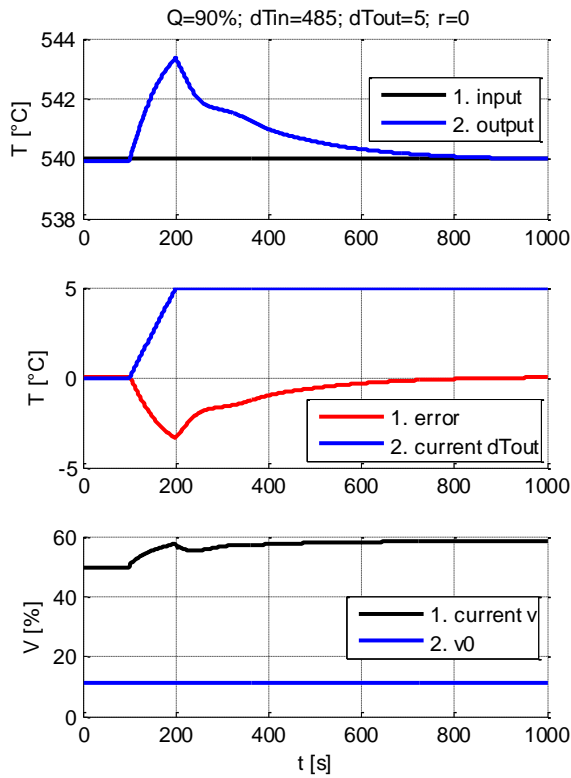

Figure 5.41: Modelling result (the power level is equal 90%)

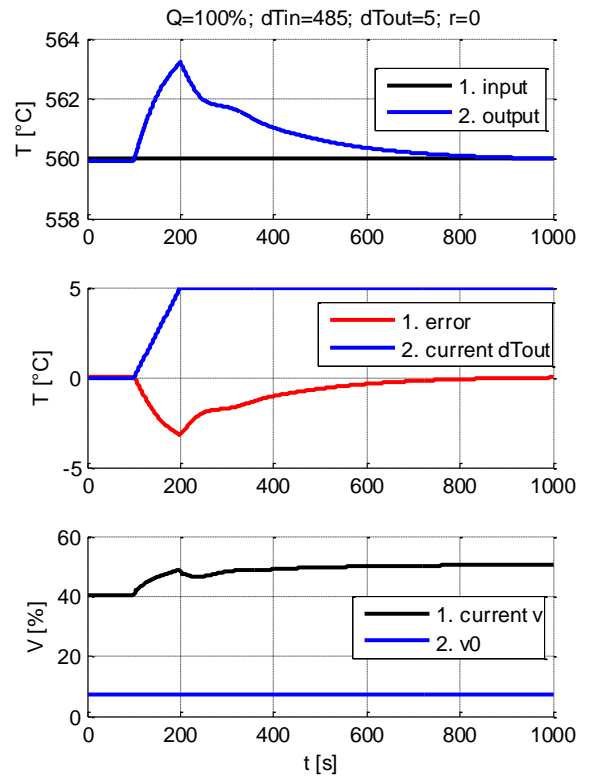

Figure 5.42: Modelling result (the power level is equal 100%)

The disturbance reaction is slower than in system with PID-controller based on the localization method. The manipulated variable has acceptable shape.

5.9.3. Changing power level, step response

The modelling results are shown in figure 5.43.

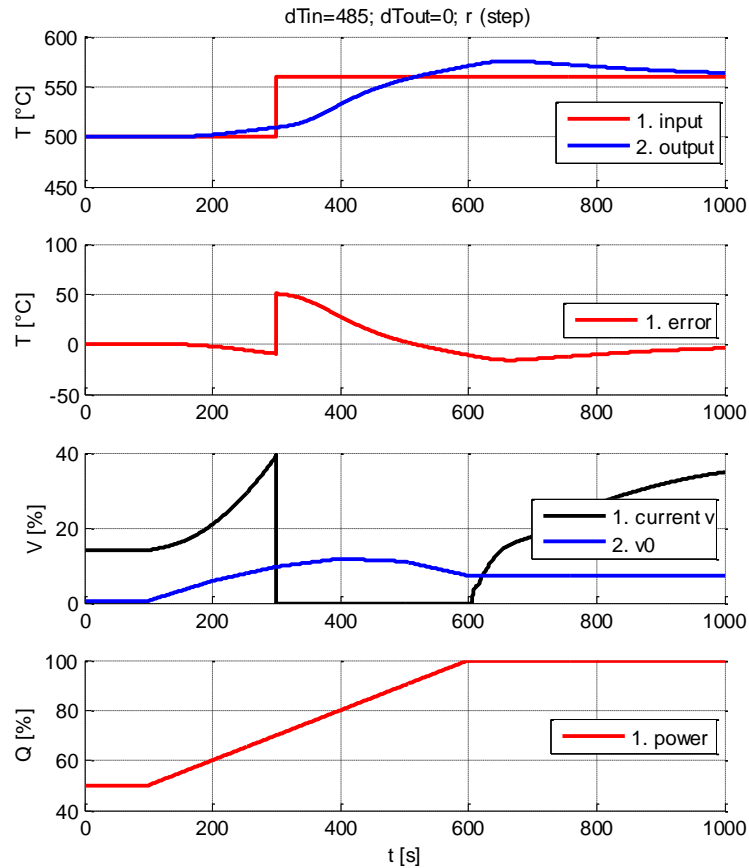

Figure 5.43: Modelling result

Quality of the transient process is worse than in case of the PID-controller and PIDD-controller based on the localization method.

5.10. Analysis of the obtained control systems

The comparative analysis is presented in table 5.4. For qualitative parameters, the following marks were used: “good”, “normal” and “bad”.

Table 5.4

	PID-controller (localization method)	PIDD-controller (localization method)	PID-controller (root locus method)	Robust controller
Setting time (50%)	700 s	400 s	500 s	400 s
Setting time (70%)	700 s	450 s	700 s	700 s
Setting time (90%)	800 s	450 s	800 s	700 s
Setting time (100%)	800 s	450 s	800 s	800 s
Disturbance reaction	normal	good	normal	normal
Shape of manipulated variable	good	bad	bad	bad
Performance with changing power level	good	good	bad	bad

The system with the PIDD-controller provides the best quality of transient processes (the least setting time and zero-overshoot). However, the system has the unacceptable shape of manipulated variable.

The system with the PID-controller based on the localization method is the only system, which fulfilled all requirements and provides the acceptable result for the all tests.

The system with the PID-controller based on the root locus method and the system with the robust controller also have the acceptable result, but the manipulated variable has oscillation nature.

The PID-controller based on the localization method was chosen to test on the great non-linear model, which was developed in the Technical University of Liberec [19, 20]. This controller was chosen because it is the only controller, which fulfills all requirements.

5.11. Application of the PID-controller to the great system

This model is closer to the real system than the linear model. The obtained controller from subchapter 5.2 was used without any changing.

Figure 5.23 shows the modelling result with the PID-controller.

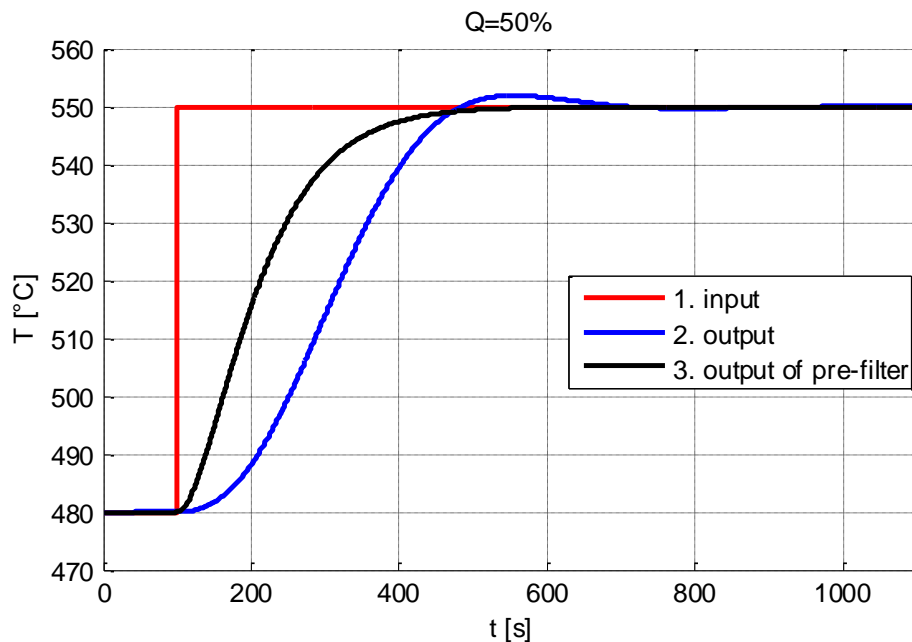

Figure 5.44: Modelling result

5.11.1. Constant power level, the step response

The modelling results are shown in figures 5.35 – 5.38.

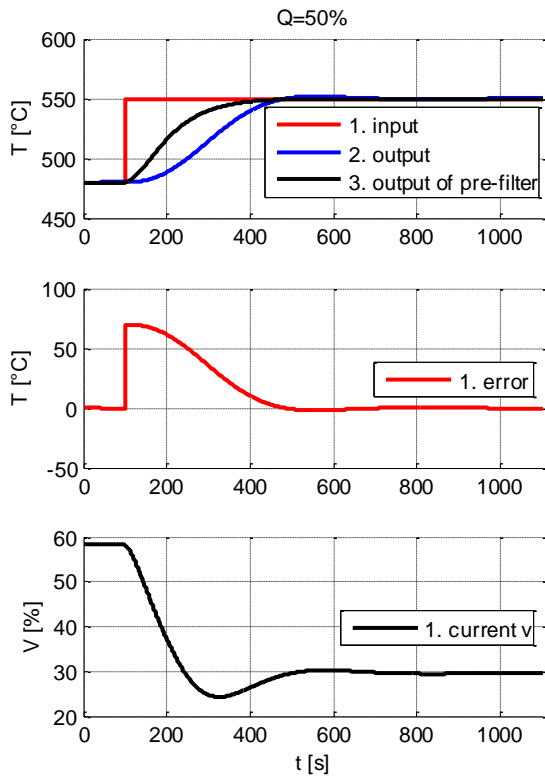

Figure 5.45: Modelling result (the power level is equal 50%)

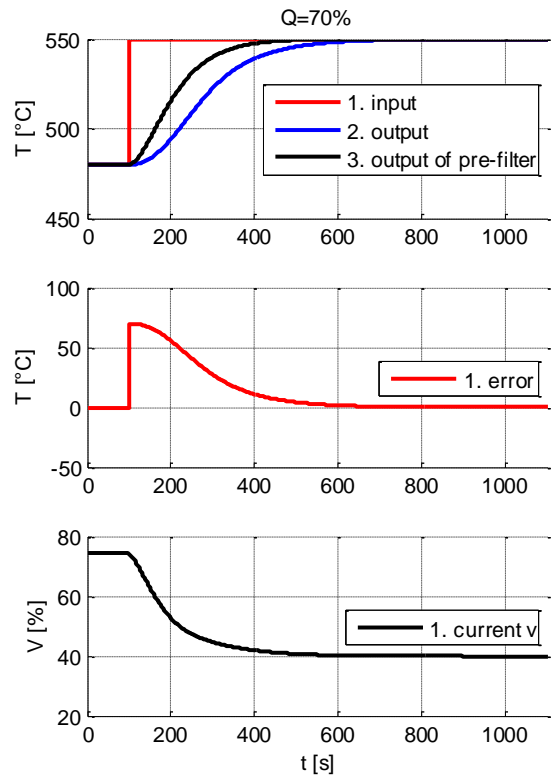

Figure 5.46: Modelling result (the power level is equal 70%)

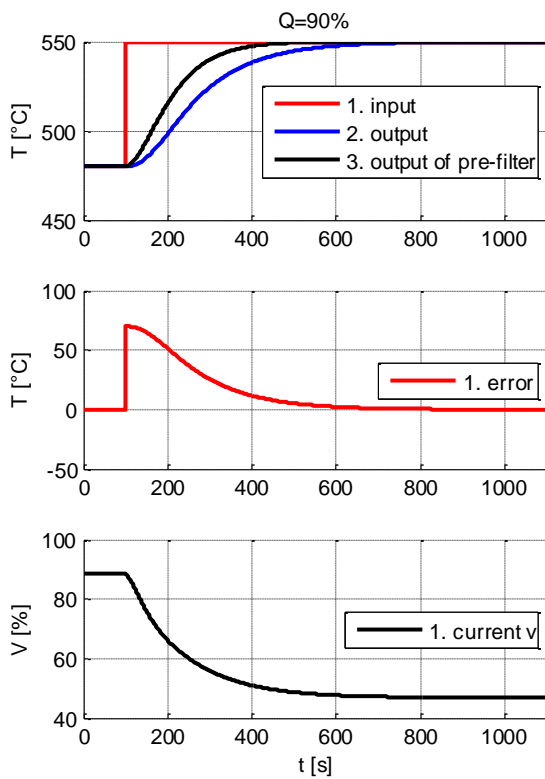

Figure 5.47: Modelling result (the power level is equal 90%)

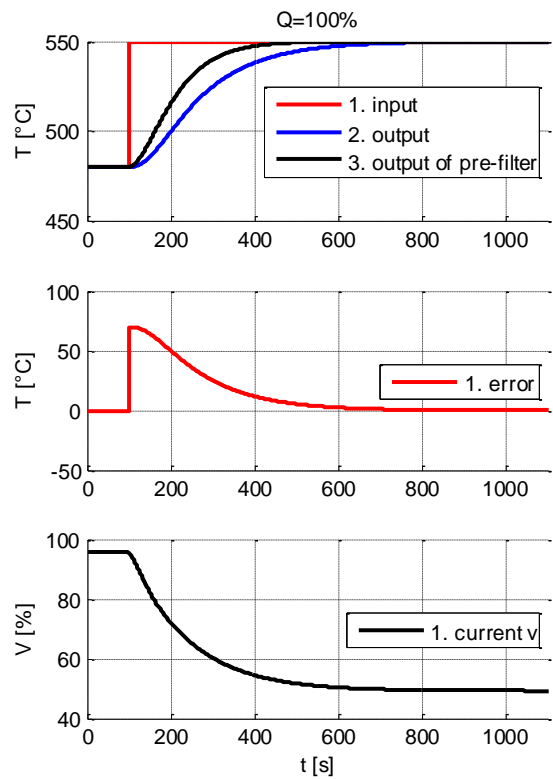

Figure 5.48: Modelling result (the power level is equal 100%)

The obtained results are similar to the results from subchapter 5.3.1. The setting time is smaller; the overshoot is equal zero.

5.11.2. Constant power level, the disturbance reaction

The modelling results are shown in figures 5.49 – 5.52.

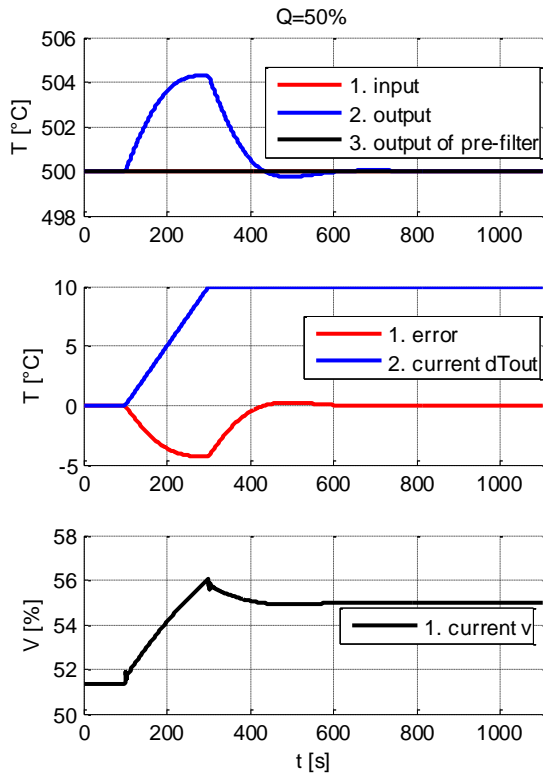

Figure 5.49: Modelling result (the power level is equal 50%)

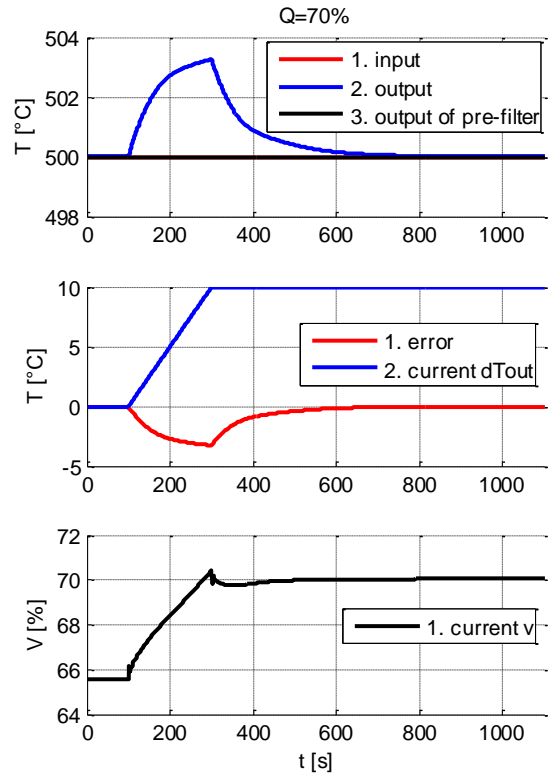

Figure 5.50: Modelling result (the power level is equal 70%)

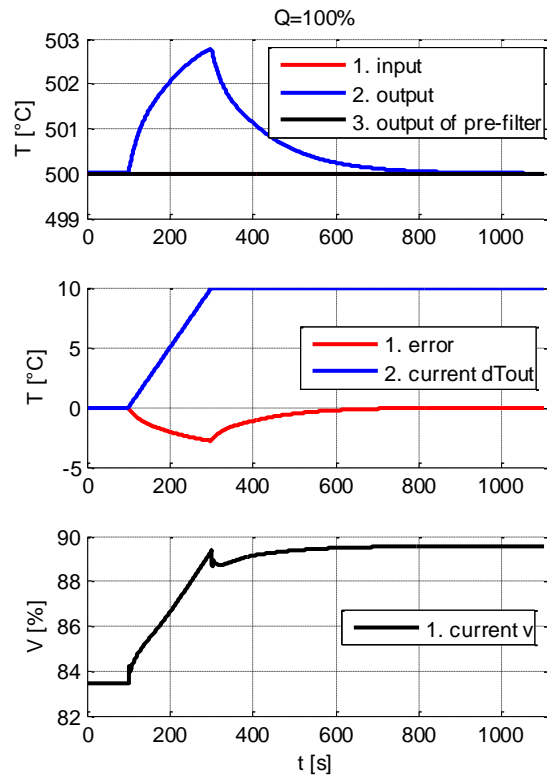
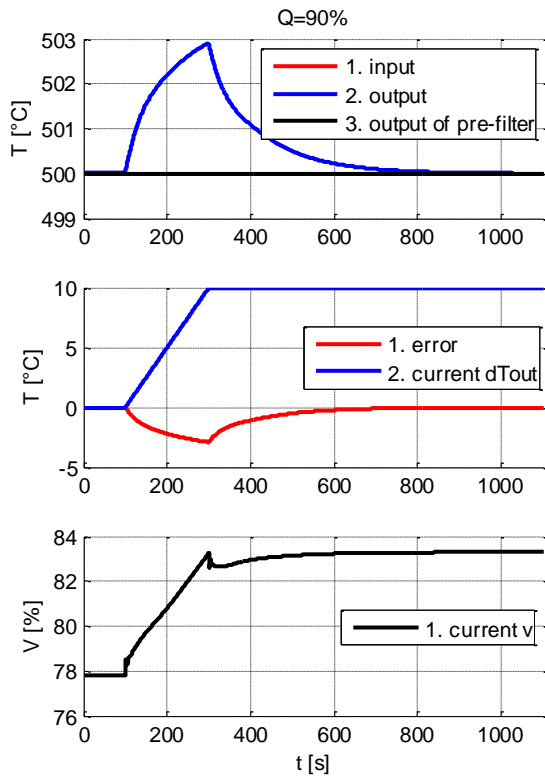

Figure 5.51: Modelling result (the power level is equal 90%)

Figure 5.52: Modelling result (the power level is equal 100%)

The obtained results are similar to the results from subchapter 5.3.2. The time of disturbance reaction is smaller.

5.11.3. Changing power level, step response

The modelling results are shown in figure 5.53.

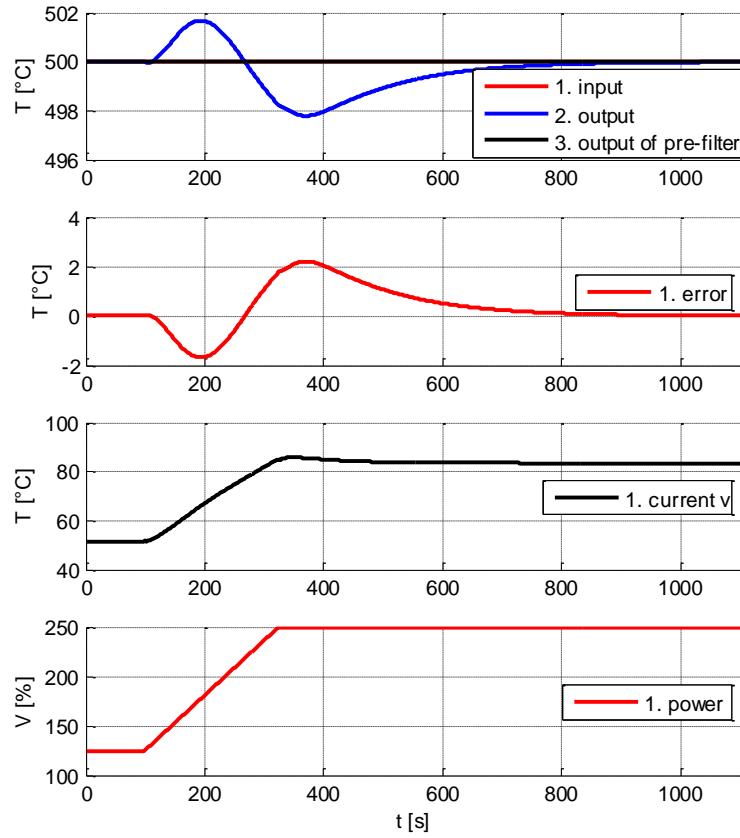

Figure 5.53: Modelling result

The PID-controller is able to keep the output steam temperature in the desired level with changing power level. All results show that the PID-controller based on the localization method solves the given task; all requirements are fulfilled.

CONCLUSION

The following contributions were done during the work:

1. The method of PID-controller calculation, based on the localization method, was developed. This method provides possibility to control system with non-linear and non-stationary plant.
2. This obtained method was implemented to assigned problems, which include Real Rotation speed control with an elastic clutch and temperature control of a non-linear PowerStation.
3. The robust control method and the root locus method were also implemented in the same systems for comparison with developed method.
4. The results were obtained by making experiments in laboratory on the real control process and the numerical simulation with linear and non-linear model of the once-through boiler.

Evaluation of achieved results is based on numerical experiments and measurements in the laboratory. The achieved results can be summarized as follows:

1. The results of the PIDD-controller, based on the localization method, show that this method enables to design and parameterize a PIDD-controller. The measurement and simulation show that there is a good quality of the transient processes and performance with different power level. However, the shape of manipulated variable makes it to be impossible to implement this controller to the real system.
2. The results of PID-controller, based on the localization method, enable to design and parameterize a PID-controller. The system with such controller works slower, but it fulfills the requirements of the control system.
3. The results obtained by using other considered methods (the Root locus method, the robust control method) show that these methods can solve only some part of the task.
4. The obtained algorithm of PID-controller calculation is respectively simple and independent from type of control object. I suppose, it can be used as for control of simple linear plant as for control of great non-linear plant. Of course there must be fulfilled a number of restriction and limitation given by the controlled plant. It is a classical trial error method.
5. In addition, the method was tested in the real system of speed control and on the great non-linear model of the once-through boiler. These results show that method can be implement in practice.

REFERENCE

- [1] PID-controller [online], 2014 [01.03.14] <http://ru.wikipedia.org/wiki/ПИД-регулятор>
- [2] Vostrikov A.S., Frantsuzova G.A. Theory of automatic control. Novosibirsk: NSTU, 2003.
- [3] Nikulin E.F. Basics of automatic control theory. Frequency methods of analysis and synthesis systems. Manual for high schools. Saint Petersburg: BHV - Petersburg, 2004.
- [4] PID-controller on practical examples [online], 2013 [10.12.13] <http://pidcontrollers.narod.ru/>
- [5] Encyclopedia of APCS [online], 2014 [01.03.14] <http://www.bookasutp.ru/>
- [6] Dorf Richard C., Bishop Robert H. Modern control system. Prentice Hall, Upper Saddle River, NJ, 11th edition, 2008, 1034p. (or in Russian: Moscow: Laboratory of Basic Knowledge, 2002, 832p.).
- [7] Robust control [online], 2014 [02.03.14] http://ru.wikipedia.org/wiki/Робастное_управление
- [8] Prof. Proske. Automatic Control Theory. Course of lectures. Zittau: Hochschule Zittau/Görlitz, 2013. 290p.
- [9] Boiler [online], 2014 [21.03.14] http://ru.wikipedia.org/wiki/Паровой_котел
- [10] Vostrikov A.S. The problem of controller synthesis for automatic system: state prospects. AUTOMETRIYA, 2010 T.46, №2
- [11] T. Nahlovsky, O. Modrlak, "The Fuzzy Approach to the Temperature Control of Superheated Steam" System Theory, Control and Computing (ICSTCC), 2013 17th International Conference
- [12] Opalka, J.; Nahlovsky, T., "Continuously switched linearized models of the nonlinear once-through boiler model," Process Control (PC), 2013 International Conference on , vol., no., pp.263,267, 18-21 June 2013 doi: 10.1109/PC.2013.6581420
- [13] Steam turbine [online], 2014 [28.03.14] http://ru.wikipedia.org/wiki/Паровая_турбина
- [14] Zemtsov N.S. Analysis of typical controller parameters calculations for linear system Novosibirsk: NSTU, 2012, 52p.
- [15] Prof. Modrlák, Ing. Hubka. ROBUST AND FUZZY CONTROL. Course of lectures. Liberec: TECHNICKÁ UNIVERZITA V LIBERCI, 2014. 216p.
- [16] Hilbert Space [online], 2014 [02.04.14] http://ru.wikipedia.org/wiki/Гильбертово_пространство
- [17] H-infinity methods in control theory [online], 2014 [02.04.14] [http://ru.wikipedia.org/wiki/H∞-синтез_\(теория_управления\)](http://ru.wikipedia.org/wiki/H∞-синтез_(теория_управления))
- [18] L. Hubka, P. Školník, S. Gärtner. Rotation Speed Control with Flexible Binding. Liberec, 2013.
- [19] Hubka, L.; Modrlak, O., "The practical possibilities of steam temperature dynamic models application," Carpathian Control Conference (ICCC), 2012 13th International , vol., no., pp.237,242, 28-31 May 2012 doi: 10.1109/CarpathianCC.2012.6228646

- [20] Hubka, L: Temperature dynamics of heat exchangers in boiler, "Eurosime 2010 -7th EUROSIM Congress on Modelling and Simulation" Praha. CTU, 2010. ISBN 978-80-01-04589-3

ATTACHMENT

A.1. Identification program

identific.m:

```
clear all; clc; close all;

load('PID_mestdesyu without controller_1.mat');

for i=1:1:1500
    t(i)=mes(1501+i,1)-15;
    u(i)= 3;
    y(i)=mes(1501+i,3) - 3;
end
t = t'; u = u'; y = y';
figure;
plot(t, u, t, y, 'LineWidth',2);
title(strcat('Input Data To Identification, Step #',num2str(i)));
grid on; xlabel('Time [s]'); ylabel('\Deltau, \Deltay [1]');
legend('Input \Deltau', 'Output \Deltay', 0);
%% initial guess and structure definition
T=[1 2 1];
K=1.3;
%% run the parameters estimation process
F=idKTi_func(t,u,y,K,T)
```

idKTi_func.m:

```
function G=idKTi_func(tx,ux,yx,Kx,Tx)
global t u y lB

t=tx; u=ux; y=yx;

T=Tx; K=Kx;
% x - vector of parameters to optimize
x=[K T];
lB=length(K);

%% optimization via 'fminsearch'
OPTIONS=optimset('LargeScale','off','MaxIter',500,'Display','off','TolFun',1e-9);
figure;
x = fminsearch('critIdKTi',x,OPTIONS);
close;

%% postprocessing
% reconstruction of the A, B polynomials from x vector
K=x(1:lB); A=[x(lB+1:end) 1];

% system transfer function definition
G=tf(K,A);

%% plot results
[yi,ti]=lsim(G,u,t);
figure;
plot(t,u,t,y,'LineWidth',2);hold on;plot(t,yi,'r','LineWidth',2);hold off;
grid on; xlabel('t [s]'); ylabel('\Deltau, \Deltay, y_{model}');
string_TF=evalc('G');
title(strcat('Model and measure, T=[',num2str(T),'],'',10,' Model TF:',
string_TF));
legend('Input - u','Measure output - y','Model output - ym',0);
```

critIdKTi.m:

```
%% criterium function for N different time constant transfer function
structure
function f=critIdKTi(x)
global t u y lB

%% reading of 'x' vector
K=x(1:lB); A=[x(lB+1:end) 1];

sys=tf(K,A);
[yi,ti]=lsim(sys,u,t);
f_sum=sum((yi-y).*(yi-y));
plot(t,y,t,yi,'LineWidth',2);grid on;
title(strcat('Criterion = ',num2str(f_sum)));
pause(0.01)
%% criterium calculation (LQ)
f=f_sum;
```

