

**Czech University of Life Sciences Prague**

**Faculty of Economics and Management**

**System Engineering and Informatics**



**Master's Thesis**

**Design of a smart baby cradle prototype: A case of the traditional Uzbek Beshik  
cradle**

**TOKHIRJON SIROJIDDINOV**

**© 2023 CZU Prague**

# **DIPLOMA THESIS ASSIGNMENT**

Bc. Tokhirjon Sirojiddinov, BSc

Systems Engineering and Informatics  
Informatics

Thesis title

**Design of a smart baby cradle prototype: A case of the traditional Uzbek Beshik cradle**

---

## **Objectives of thesis**

The main goal of this master's thesis is to propose and design smart features for the traditional baby cradle called Beshik made in Uzbekistan.

Partial Objectives:

- Review the current state of the art of using IoT and sensors in modern baby cradles.
- Analyze the requirements of parents from the modern baby cradles and identify new functions.
- Design and build a new system prototype using IoT and sensors.
- Evaluate the solutions and make recommendations.

## **Methodology**

The methodology of the diploma thesis is based on the study and analysis of scientific and technical papers related to the topic. The practical part is dedicated to the requirements analysis of the users, identification of new functions of the smart Beshik cradle, design of the new system, and implementation of the prototype. The evaluation of the prototype will be done with a group of target users.



## The proposed extent of the thesis

80

## Keywords

IoT, Cradle, Beshik, Smart Cradle, Automation, Baby

---

## Recommended information sources

- HUSSAIN, Tanveer, et al. Intelligent baby behavior monitoring using embedded vision in IoT for smart healthcare centers. *Journal of Artificial Intelligence and Systems*, 2019, 1.1: 110-124.
- JABBAR, Waheb A., et al. IoT-BBMS: Internet of Things-based baby monitoring system for smart cradle. *IEEE Access*, 2019, 7: 93791-93805.
- JOSHI, Madhuri P.; MEHETRE, Deepak C. IoT based smart cradle system with an Android app for baby monitoring. In: *2017 International Conference on Computing, Communication, Control and Automation (ICCUBEA)*. IEEE, 2017. p. 1-4.
- SAUDE, Natasha; VARDHINI, PA Harsha. IoT based Smart Baby Cradle System using Raspberry Pi B+. In: *2020 International Conference on Smart Innovations in Design, Environment, Management, Planning and Computing (ICSIDEMPC)*. IEEE, 2020. p. 273-278.
- TRIPATHY, Shuvendra Kumar; BISWAL, Pradyut Kumar. IoT-Based Baby Swing Monitoring, Alerting and Security System. In: *Advances in Intelligent Computing and Communication*. Springer, Singapore, 2020. p. 360-365.
- 

## Expected date of thesis defence

2022/23 SS – FEM

## The Diploma Thesis Supervisor

Ing. Miloš Ulman, Ph.D.

## Supervising department

Department of Information Technologies

Electronic approval: 14. 7. 2022

**doc. Ing. Jiří Vaněk, Ph.D.**

Head of department

Electronic approval: 28. 11. 2022

**doc. Ing. Tomáš Šubrt, Ph.D.**

Dean

Prague on 19. 12. 2023

## Declaration

I declare that I have worked on my master's thesis titled "**Design of a smart baby cradle prototype: A case of the traditional Uzbek Beshik cradle**" by myself and I have used only the sources mentioned at the end of the thesis. As the author of the master's thesis, I declare that the thesis does not break any copyrights.

In Prague on 19.12.2023

---

## **Acknowledgement**

Firstly, I would like to thank and acknowledge my thesis supervisor Ing. Milos Ulman, Ph.D. for his valuable contribution, guidance, suggestions and friendly co-operation during my thesis completion. As well, I would like to thank my teachers, who have taught and guided me in ensuring I had the best practices and theories. Thank you Mr. Ján Hučko, Mr. Martin Kozak and others I cannot mention now to save time. Lastly, I would like to extend my gratefulness and appreciation to my family, friends and others that have contributed to my development for their financial, moral and general support in bringing me thus far in my life. I feel blessed to have this group of people around me.

# **Design of a smart baby cradle prototype: A case of the traditional Uzbek Beshik cradle**

## **Abstract**

### **Summary**

This research aims to develop a smart Uzbek Beshik, an electronic cradle that enhances the safety and comfort of infants. The project seeks to incorporate modern technology into the traditional Uzbek Beshik to create an innovative solution for child-rearing practices. The study will focus on the software aspect of the system, including a mobile application for controlling and monitoring the Beshik. The application will have a user-friendly interface for parents to conveniently monitor their child's safety and comfort.

The methodology of the research will involve a combination of literature review, interviews with parents, and the development of a 3D model and mobile application. The literature review will provide an understanding of the history and cultural significance of the traditional Uzbek Beshik and the current state of technology in child-rearing. Interviews with parents will be conducted to gather insights into their needs and expectations and inform the design of the 3D model and mobile application. The 3D model and mobile application will be tested and refined based on feedback from parents and experts in child-rearing.

The outcome of this research will contribute to the advancement of technology in child-rearing and support the development of innovative solutions for the care of infants. The results will be useful for parents, manufacturers of child-care products, and researchers in the field. Additionally, the research will provide a foundation for future research in the area of smart Beshik. The prototype will be evaluated based on functionality, usability, and user satisfaction, providing valuable feedback for any necessary changes and improvements to the final product.

The primary objective of this research is to provide a convenient and safe solution for parents using the traditional Uzbek Beshik. The incorporation of modern technology will

not only enhance the safety and comfort of infants but also gather insight into the needs and expectations of parents. The research will provide a foundation for future advancements in the field of smart Beshik and support the development of innovative solutions for child-rearing practices.

Keywords: Smart Cradle, Swing Bed, Automation, Upgradation, Beshik, Design, Baby, Technologies, Uzbekistan, Sensors, IoT

## Table of content

|       |   |    |
|-------|---|----|
| 1.    | Introduction .....  | 8  |
| 2.    | Objectives and Methodology .....                                      | 9  |
| 2.1   | Objectives .....  | 9  |
| 2.2   | Methodology .....   | 10 |
| 3.    | Literature Review .....   | 11 |
| 3.1   | Overview of traditional Uzbek Beshik .....                            | 11 |
| 3.1.1 | History and origin .....  | 13 |
| 3.2   | Smart devices for infants .....                                       | 15 |
| 3.2.1 | Advantages and limitations of current smart devices for infants.....  | 16 |
| 3.3   | Current mobile application development .....                          | 17 |
| 3.3.1 | Overview of mobile application development .....                      | 17 |
| 3.3.2 | Key components of mobile application for the smart baby cradle.....   | 18 |
| 3.3.3 | User interface design and prototyping .....                           | 19 |
| 3.4   | Integration of electronic components .....                            | 20 |
| 3.4.1 | Overview of electronic components .....                               | 20 |
| 3.4.2 | Types of electronic components used in smart devices for infants..... | 20 |
| 3.4.3 | Interfacing the components with a mobile application .....            | 23 |
| 3.5   | Previous studies and research on smart Uzbek Beshik .....             | 24 |
|       | Overview of previous studies and research .....                       | 24 |
| 3.5.1 | Implications for the current study .....                              | 27 |
| 3.6   | Summary of main findings.....   | 27 |
| 4.    | Practical Part.....   | 27 |
| 4.1   | Research questions .....  | 28 |
| 4.2   | User requirements analysis for the baby cradle .....                  | 28 |
| 4.3   | Analysis of functions of the smart cradle.....                        | 30 |
| 4.4   | Design and Development of 3D Model .....                              | 31 |
| 4.4.1 | Overview of the design process .....                                  | 31 |
| 4.4.2 | 3D modeling software and tools used.....                              | 32 |
| 4.4.3 | Slight modifications to the design .....                              | 32 |
| 4.5   | Integration of Electronic Components .....                            | 33 |
| 4.5.1 | Overview of the integration process.....                              | 33 |
| 4.5.2 | Software and tools used .....   | 37 |
| 4.5.3 | Connection of electronic components to the mobile application.....    | 38 |
| 4.5.4 | Mobile application .....  | 40 |
| 4.5.5 | Overview of the user interface design process .....                   | 44 |
| 4.5.6 | Software and tools used .....   | 45 |
| 4.5.7 | Iterations and modifications to the user interface.....               | 45 |
| 4.6   | Testing and Evaluation .....  | 46 |
| 4.6.1 | Overview of the testing process .....                                 | 46 |
| 4.6.2 | Testing criteria and methods .....                                    | 46 |
| 4.6.3 | Evaluation of the smart Uzbek Beshik .....                            | 47 |

|  |    |
|--|----|
| 5. Results and Analyses .....                          | 48 |
| 6. 3D Model of the Smart Uzbek Beshik .....            | 49 |
| 6.1 Overview of the 3D model.....                      | 49 |
| 6.2 Comparison with traditional Uzbek Beshik .....     | 52 |
| 6.3 Analysis of the design features.....               | 52 |
| 7. Mobile Application .....                            | 53 |
| 7.1 Overview of the mobile application .....           | 53 |
| 7.1.1 Analysis of the user interface.....              | 53 |
| 7.2 User Testing and Evaluation .....                  | 55 |
| 7.2.1 Overview of the user testing .....               | 55 |
| 7.2.2 Results of the user testing .....                | 55 |
| 7.2.3 Analysis of the evaluation results.....          | 55 |
| 8. Implications and recommendations of the study ..... | 56 |
| 9. Some of the limitations during the research .....   | 56 |
| 10. Conclusion.....                                    | 57 |
| 11. References .....                                   | 57 |
| 12. List of pictures.....                              | 60 |

## 1. Introduction

The unique characteristic of Uzbeks is that they value family as sacred and associate family with the new-born. To be more exact, having children is the main goal of the union. Additionally, it's unusual to live a single life. Like other Central Asian nations, the Uzbek people are passionate about having children. However, there are additional reasons for wanting to have more children in a family, such as the use of children as labour in agricultural production, a deep religious belief in Islam, and the social role of women as housewives who raise the children. It's important to note that while families with many children were valued, those with few children were ignored, and those without any children were given frigid treatment. (*Ansiklopedisi, 2012 - 2023*)

Beshik is important to Uzbek culture's traditions of baby care. According to studies, it was the primary method of baby care up to the 1970s and 1980s. Beshik has a long history and was widely used not just in Central Asia but also in Afghanistan, Iran, Iraq, Kashgar, Mongolia, and the Persian Gulf. R.S.Gershenovich, a historian who researched the customs of the inhabitants of Central Asia towards caring newborns, supports the theory that beshik was practiced among Tajiks prior to the arrival of nomadic Uzbek tribes in the eleventh century. Facts from *Devoni Lugotit Turk*, written by Makhmud Koshgariy in the eleventh century, further support the old history of a beshik. The narrative of the book is about Sumak and Beshik

According to Abu Ali ibn Sino, "To temper the baby's body, two things are necessary: first, oscillatory movements, and second, the mother's Alla." The beshik was built of fruit tree wood and is made up of items like wooden cradle pieces called "sumak", clay pots called "tuvak", and blankets, quilts, and "yopqich"-covers. The basic blanket covers the bottom of the beshik, which is stuffed with hay made of oats or wheat and is known as "qovus." The cradle is covered in two layers of cotton blankets. In the summertime, the blankets are made of cotton fabric, and in the wintertime, the blankets are made of velvet fabric. Old Uzbek women believe that if you carry your baby constantly, it will make him irritable. So, at that time, it was forbidden to carry your baby for long periods of time in your arms.

Most Uzbek families use beshik to care for their babies, but the time it is used and the length of time it is put into the beshik are shorter these days. According to ethno sociological information, 80.5% of respondents tie their children into beshik. But most of



them, 60.7%, use it for a month, 10.5% for 5-6 months. Therefore, there is no case where mothers tie their children in beshik as in the 60-80s of last century. The reason for this is that 1st young mothers have more free time to take care of their children these days because, nowadays, the mother who works can have maternity leave for 3 years. 2nd reason is that there is a wider use of nappies which has decreased the demand for beshik. (*Mashrabjonovna, 2019*)

## **2. Objectives and Methodology**

### **2.1 Objectives**

The main goals of this master's thesis is to propose and design smart features for the traditional Uzbek baby cradle, called Beshik.

Partial Objectives:

- Review the current state of the art of using IoT and sensors in modern baby cradles.
- Analyze the requirements of parents from the modern baby cradles and identify new functions.
- Design and build a new system prototype using IoT and sensors.
- Evaluate the solutions and make recommendations.

The research attempts to provide a novel approach to child raising by fusing contemporary technologies with the traditional Uzbek Beshik. The software component of the system, which includes a mobile application for operating the Beshik and keeping tabs on the child's behavior, will be the subject of the research. Parents will have an easy way to keep track on their child's safety and comfort thanks to the application's user-friendly layout.

This study aims to improve infant comfort and safety while also learning more about the wants and needs of parents who use Beshik. . This will be accomplished by speaking with parents in interviews to learn about their daily struggles and the qualities they would like to see in a modernized Beshik. The 3D model and mobile application that best serves the needs of parents and their newborns will be designed using the information gleaned from these interviews.

Additionally, this research will promote the creation of ground-breaking baby care strategies and enhance technological development in the area of child rearing. The findings of this study will be helpful to parents, companies who make child care items, and specialists in the field. The results of this study will serve as a starting point for further investigation on smart Beshik.

## **2.2 Methodology**

The methodology of the diploma thesis is based on the study and analysis of scientific and technical papers related to the topic. The practical part is dedicated to the requirements analysis of the users, identification of new functions of the smart Beshik cradle, design of the new system, and implementation of the prototype. The evaluation of the prototype will be done with a group of target users and healthcare professionals, followed by a marketing study of the smart Beshik cradle in Uzbekistan.

A combination of literature analysis, parent interviews, the creation of a 3D model and a mobile application will make up the technique for this study. A comprehension of the tradition of the Uzbek Beshik's history and cultural significance, as well as the status of technology in the field of child-rearing, will be provided by the literature review. Interviews with parents who own a Beshik will be done in order to gain insight into the requirements and expectations of parents. The questions will center on their daily struggles, the features they want to see in a modernized Beshik, and the features they want to see in the mobile application. The 3D model and mobile application will be designed using the information gained from these interviews.

The smartphone application will be created using an appropriate programming language, while the 3D model of the Beshik will be created using computer-aided design (CAD) software. The interview-identified features and functions will be included in the mobile application, which will also have a user-friendly interface. Based on input from parents and professionals in the field of child raising, the 3D model and mobile application will be put to the test and improved.

Based on its usability, functionality, and user satisfaction, the smart Uzbek Beshik prototype will be assessed. Any necessary alterations and enhancements to the final

product will be informed by the evaluation's insightful input. As a result of this study, best practices for the creation and usage of smart Beshik will be developed, which will be helpful for current and future studies in the area.

### 3. Literature Review

#### 3.1 Overview of traditional Uzbek Beshik

The Uzbek Beshik is a traditional cradle used in Uzbekistan for rocking infants to sleep. The cradle has been an integral part of Uzbek culture for generations and holds great cultural significance for Uzbek families. The use of the Beshik dates back several centuries, with evidence of its use being found in the artwork and writings of the time . The design and construction of the Beshik was a skill passed down from generation to generation and was considered a highly valued craft in Uzbekistan

The Beshik was traditionally made from wood and was decorated with intricate designs and patterns, which were meant to symbolize the wealth and status of the family. The decoration of the Beshik was also meant to bring good luck to the child and to ward off evil spirits. It was believed that a well-made Beshik would bring happiness and prosperity to the child and the family (*Ulko, 2017*)



Figure 1 – (*Sputnik, 2023*)

In addition to being used as a sleeping place for infants, the Beshik was also a portable bed that could be easily carried and used when the family travelled. The design of the Beshik allowed parents to keep a close watch on their children, even when they were sleeping, and it also provided a sense of security for both the child and the parents.

*(Ansiklopedisi, 2012 - 2023)*

3D view of Tradational Uzbek Beshik, with and without fabric.



*Figure 2 – Author made*

In recent years, there has been a renewed interest in traditional Uzbek crafts, including the Beshik, and there have been efforts to preserve and promote the use of the Beshik as part of Uzbek cultural heritage. This has led to an increase in the number of people who are interested in learning the skill of making Beshik and a renewed appreciation for the cultural significance of the Beshik in Uzbek society.

Incorporating modern technology into the traditional Beshik will help to enhance its practicality and safety, making it a more convenient option for families in today's society. The aim of this research is to develop a smart Uzbek Beshik that will bring together the traditional design and cultural significance with modern technology to create an innovative solution for child-rearing practices.

Through conducting interviews with parents who own a Beshik, the research will gather information on the challenges faced with the traditional Beshik and what features they would like to see in a modernized version. This information will be used to guide the design and development of the smart Uzbek Beshik, ensuring that it meets the needs and expectations of families.

By preserving the cultural significance of the traditional Uzbek Beshik while incorporating modern technology, the aim is to create a product that not only serves a practical purpose but also holds cultural and emotional value for families. The smart Uzbek Beshik is an innovative solution that will bring together the best of both worlds, making it a product that not only enhances the safety and comfort of infants but also preserves a piece of Uzbek cultural heritage for future generations. (Ulko, 2017)

### **3.1.1 History and origin**

Beshik has been widely used among Uzbek, Tajik, Turkmen, Karakalpak, Kyrgyz and other eastern peoples since ancient times. It is mentioned in ancient sources, "Devonu Lugotit Turk" (11th century). (Encyclopedia, 2000 - 2005)

#### **Beshik - the history of the cradle of nomads**



*Figure 3 - (Sputnik, 2023)*

Historically, the Uzbeks were a nomadic people who lived in yurts, or portable tents made of felt. The beshik was an essential part of their mobile lifestyle as it provided a safe and comfortable place for babies to sleep and rest while their parents were on the move.

## Culture



Figure 4 – (Sputnik, 2023)

The beshik is typically made of wood and is designed with a curved base that allows it to rock back and forth. It is often decorated with intricate carvings and patterns, reflecting the artistic traditions of Uzbekistan.

The Beshik represents the continuity of life and is often passed down from generation to generation. The mother's care and love are believed to be transferred to the Beshik, which in turn comforts and protects the newborn. In addition to its functional role, the Beshik is also an important cultural artifact and is often used in traditional ceremonies and celebrations. (*Encyclopedia, 2000 - 2005*)

### 3D view of the traditional, historical Beshik

A 3D view of the traditional, historical Beshik offers a unique opportunity to explore the intricate design details and craftsmanship of this important cultural artifact.

The 3D model can capture the nuances of the Beshik's woven fabric and woodwork, providing an accurate representation of the cradle's historical and cultural significance. (Sputnik, 2023)



Figure 5 - (Sputnik, 2023)

### 3.2 Smart devices for infants

The development of novel tools intended to enhance the safety, health, and wellbeing of infants has recently been made possible by the emergence of smart technology. These technologically advanced gadgets allow parents to monitor and take care of their baby's needs from a distance. They frequently operate via mobile apps and are fitted with a variety of sensors and technology. These gadgets, which range from intelligent baby monitors to pacifiers and even diapers, are made to make parenting simpler while also bringing peace of mind and better understanding of a kid's development. Let's examine some of the different smart baby products that are now on the market in this aspect.

- Smart baby monitors: These devices use cameras and sensors to monitor a baby's movements, sound, and sleep patterns, and can send alerts to parents' smartphones.
- Smart pacifiers: These pacifiers come equipped with sensors that can monitor a baby's temperature, heart rate, and other vital signs, and can send alerts to parents' smartphones.
- Smart thermometers: These thermometers can take a baby's temperature quickly and accurately, and can store data to track temperature trends over time.
- Smart baby bottles: These bottles can measure the amount of milk a baby consumes and provide feedback to parents via a mobile app.

- Smart diapers: These diapers have sensors that can detect when a baby has urinated or defecated, and can send alerts to parents' smartphones.
  - Smart sleep aids: These devices use white noise, gentle vibrations, and other soothing sounds to help babies fall asleep and stay asleep, and can be controlled via a mobile app.
  - Smart toys: These toys are designed to stimulate a baby's development and can be controlled via a mobile app, providing interactive play experiences.
- (Lele, 2022)

### **3.2.1 Advantages and limitations of current smart devices for infants**

#### **Pros**

- Improved safety: Parents can monitor their baby's vital signs, sleep patterns, and movements with the use of smart newborn devices, which can send warnings if something changes. If a baby is in trouble, this may help parents act quickly.
- Convenience: By remotely monitoring and managing the devices with mobile apps, parents can save time and effort.
- Better insights: Infant smart devices can track data and offer insights into a baby's growth, empowering parents to choose the best care for their child. Smart devices can give parents peace of mind by reassuring them that their child is secure and healthy, which will lessen their stress and worry.

#### **Limitations**

- False alerts: Smart devices can emit false alarms, causing parents unneeded stress and concern.
- Overreliance: Parents who rely too heavily on smart devices for their infants may become complacent and neglect their child's requirements.
- Cost: Infant smart gadgets can be pricey, making them unaffordable for some families.



- Smart gadgets have the potential to capture personal information, which raises questions about security and privacy.

### **3.3 Current mobile application development**

#### **3.3.1 Overview of mobile application development**

For baby cradles, mobile app development entails developing software programs that work with smartphones, tablets, and other portable electronics. These apps are made to work with smart baby cradles and allow parents and other caregivers access to real-time data about the baby's surroundings and health as well as remote control and setting adjustment capabilities.

The criteria and features of the mobile app are often defined first, such as the capability to track the infant's activity and sleep patterns, regulate the temperature of the cradle, turn on calming sounds or lights, and receive alerts for any odd events or emergencies.

As the criteria are set, the user interface and user experience (UI/UX) of the app are designed, making sure it is logical, simple to use, and visually appealing. Wireframes, mockups, and prototypes must be made in order to test the app's appearance and functioning. (*Scott, 2004*)

The development team can start coding and creating the app after the design phase using programming languages like Java, Swift, or Kotlin. Via communication protocols like MQTT or HTTP, the app must be integrated with the microcontrollers, actuators, and sensors of the smart baby cradle.

The development team can start coding and creating the app after the design phase using programming languages like Java, Swift, or Kotlin. Via communication protocols like MQTT or HTTP, the app must be integrated with the microcontrollers, actuators, and sensors of the smart baby cradle. (*Hillar, MQTT Essentials - A Lightweight IoT Protocol, 2017*)

### 3.3.2 Key components of mobile application for the smart baby cradle

While creating a mobile app for a baby cradle, there are some crucial elements to keep in mind. These elements consist of:

- **Monitoring and tracking:** Using the mobile application, parents should be able to keep an eye on and track their infant's sleeping habits, including the quantity and quality of their baby's naps as well as any disturbances or changes to their regular schedule.
- **Alerts and notifications:** When a baby wakes up, needs to be fed or changed, or if there are any problems or worries, the application should send parents alerts and notifications.
- **Customization and personalization:** The program should enable parents to adjust the settings to their liking and their child's need, such as establishing particular sleep schedules or calming noises.
- **Security:** The application should be made with safety and security in mind, including features like data encryption and password protection to safeguard private data.
- **Integration with other devices:** To offer a thorough and seamless user experience, the application should be able to integrate with other devices, such as baby monitors.
- **User-friendly interface:** The application should have an intuitive user interface that is simple to use and navigate, with instructions that are clear and succinct.
- **With features that offer alerts and notifications, customization possibilities, and seamless interaction with other devices, a mobile application for a baby cradle should be created to assist parents in monitoring and caring for their baby's sleep. The program should have a user-friendly interface that is simple to use and navigate, as well as be created with safety and security in mind. (Jagannath Singh , Debasish Das , Lov Kumar , Aneesh Krishna, 2023)**

### **3.3.3 User interface design and prototyping**

The process of creating the visual organization and user interface of digital products, such as websites, mobile apps, and software programs, is known as user interface design (UI design). The objective of UI design is to produce an intuitive and user-friendly interface that aids users in efficiently and successfully achieving their objectives. (*Treu, 2012*)

To test and assess a product's functionality, usability, and design, a preliminary version of the product or interface is created through the prototyping process. Because it enables problem-solving prior to the creation of the final product, prototyping is an essential step in the design process.

Prototyping is the process of developing mockups, wireframes, or interactive prototypes that represent the final product's functionality and user experience. These prototypes can be used to test and improve the design, get input from key players, and make sure the finished product will work for the target audience.

For UI design and prototyping, there are various tools available, from basic drawing tools to more complex software tools that enable designers to make interactive prototypes with realistic animations and user interactions. Tools like Sketch, Figma, Adobe XD, InVision, and Axure are some of the well-liked ones for UI design and prototyping.

Overall, UI design and prototyping are crucial steps in the creation of digital products because they guarantee its usability, functionality, and aesthetic appeal. (*Scott, 2004*)

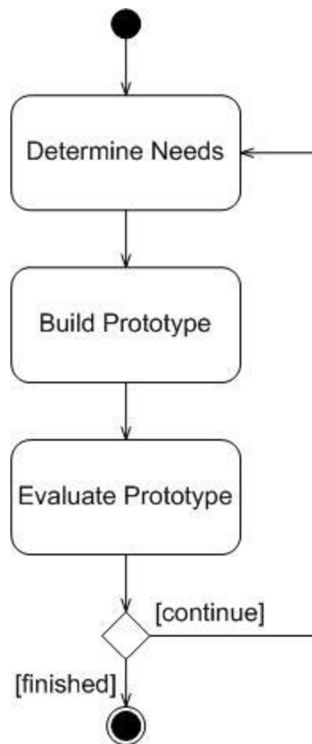

*(Scott, 2004)*

### **3.4 Integration of electronic components**

#### **3.4.1 Overview of electronic components**

Electronic components are integral parts of smart devices, including smart baby devices such as smart baby cradles. These components play a crucial role in ensuring the safety and comfort of the baby while providing essential information to caregivers. In this section, author will discuss the types of electronic components commonly used in smart baby cradles, their specific functions, and their integration into the device.

#### **3.4.2 Types of electronic components used in smart devices for infants**

- **Sensors:** Sensors are electronic components that detect physical inputs such as temperature, pressure, and motion. In smart baby cradles, sensors are used to monitor the baby's environment and state, providing real-time information to caregivers. Here are some examples of how different types of sensors are used in smart baby cradles.

- Temperature sensors: These sensors measure the temperature of the baby and the surrounding environment. They can alert caregivers if the temperature is too high or too low, and they can activate a heating or cooling system to maintain a comfortable temperature. For example, the 4moms mamaRoo sleep bassinet uses temperature sensors to monitor the baby's temperature and adjust the thermostat accordingly.
- Motion sensors: These sensors detect the baby's movements, allowing caregivers to monitor the baby's activity level and sleep patterns. They can also alert caregivers if the baby is in an unusual or dangerous position. For example, the SNOO smart bassinet uses motion sensors to detect the baby's movements and activate a gentle rocking motion to soothe the baby. *(Megha Dangi, Shraddha Sarna, Vinod Kumar Ahuja, 2020)*
- Pressure sensors: These sensors detect the weight of the baby and can alert caregivers if the baby has left the cradle or if the weight distribution is uneven. For example, the Nanit Plus smart baby monitor uses pressure sensors to detect the weight of the baby and provide real-time information to caregivers. *(Fraden, 2015)*
- Microcontrollers: Microcontrollers are electronic components that process data from the sensors and perform logical operations. They act as the "brain" of the smart baby cradle, ensuring that the device operates smoothly and efficiently.
- Data processing: Data processing in a smart baby cradle involves collecting data from sensors embedded in the cradle and processing that data to derive insights that can be used to improve infant safety, comfort, and health. *(N. Saude and P. A. H. Vardhini, 2020)*
- Actuators: Actuators are devices that are designed to convert electrical energy into mechanical energy in order to produce a physical movement or force. In the context of a baby cradle, actuators are commonly used to provide gentle rocking or vibration motion to soothe the baby.

- **Audio systems:** Audio systems can be a useful addition to a baby cradle as they can help soothe the baby and promote better sleep. There are various types of audio systems that can be incorporated into a baby cradle, including built-in speakers, Bluetooth-enabled speakers, and white noise machines.
- **Built-in speakers** can be integrated into the cradle itself, allowing the baby to hear calming lullabies or other soothing sounds without the need for an external device. Bluetooth-enabled speakers can be paired with a mobile device or other audio source, allowing parents to play customized music or sounds for their baby..
- **Lights:** LED lights in a baby cradle can serve multiple purposes. They can be used to create a soothing ambiance that helps calm the baby and facilitate sleep. Additionally, they can be used as a safety feature to help parents see their baby during nighttime feedings or check-ins without disturbing the baby's sleep. (Asif Sabanovic, Kouhei Ohnishi, 2011)
- **LED lights** are a good choice for baby cradles because they are energy-efficient and generate less heat compared to traditional incandescent lights. This means that they are safe to use near the baby, and they are less likely to cause overheating or discomfort.
- **Wireless connectivity modules:** Wireless connectivity modules are electronic components that allow devices to communicate wirelessly with other devices or the internet. In smart baby cradles, wireless connectivity modules are used to enable remote monitoring and control, provide access to additional features, and integrate with other smart home devices.
- **Remote monitoring and control:** With wireless connectivity, caregivers can monitor the baby's sleep and activity from a remote location using a smartphone app or other device. For example, the Nanit Plus smart baby monitor uses a Wi-Fi connection to allow caregivers to view live video of the baby and receive real-time notifications of the baby's activity.
- **Access to additional features:** Wireless connectivity also allows smart baby cradles to access additional features and services, such as personalized sleep coaching or

music playlists. For example, the SNOO smart bassinet connects to the Happiest Baby app, which provides customized sleep coaching and tracks the baby's sleep patterns over time. (*Dunton, 2006*)

### **3.4.3 Interfacing the components with a mobile application**

Integrating the components of a smart baby cradle with a mobile application is a crucial aspect of creating a seamless and user-friendly experience for caregivers. By integrating the smart baby cradle with a mobile app, caregivers can easily monitor their baby's activity and receive real-time updates on their smartphone.

The mobile application acts as a remote control for the smart baby cradle, allowing caregivers to adjust settings and monitor the baby's activity from their phone. Here are some examples of how mobile applications can be integrated with smart baby cradles:

Remote monitoring: Caregivers can use the mobile application to monitor the baby's activity and sleep patterns in real-time. They can receive alerts if the baby is restless or if the temperature is too high or too low. For example, the Nanit Plus smart baby monitor allows caregivers to access live video feeds and receive notifications on their mobile device. To begin with, the smart baby cradle must be designed with the capability to connect to the internet and send data to the cloud. This is usually achieved by including a Wi-Fi module in the device, which allows it to connect to a wireless network and communicate with other devices on that network. Once the smart baby cradle is connected to the internet, it can begin sending data to the cloud, where it can be processed and stored. This data can include information about the baby's sleep patterns, activity level, temperature, and more. To integrate the smart baby cradle with a mobile application, the mobile application must be designed to communicate with the cloud service that is processing and storing the data from the smart baby cradle. This is typically achieved by using an application programming interface (API), which allows the mobile application to send requests to the cloud service and receive data in response. (*Daniel Bryant , Matthew Auburn, 2022*).

The mobile application must also be designed with a user interface that allows caregivers to view and interact with the data from the smart baby cradle. This can include displaying real-time information about the baby's state, providing alerts and notifications

based on the data from the smart baby cradle, and allowing caregivers to adjust the settings of the smart baby cradle. To ensure that the data transmitted between the smart baby cradle, the cloud service, and the mobile application is secure, encryption and authentication protocols are typically used. This helps to protect the privacy and security of the data, ensuring that only authorized users can access it. In terms of technology, there are several platforms and tools that can be used to integrate smart baby cradles with mobile applications. Some popular options include Amazon Web Services (AWS), Google Cloud Platform (GCP), and Microsoft Azure, which provide cloud services and APIs for IoT devices. Additionally, mobile application development platforms such as Xamarin and React Native can be used to build mobile applications that can communicate with IoT devices through APIs. (*Mangla, 2021*)

### **3.5 Previous studies and research on smart Uzbek Beshik**

#### **Overview of previous studies and research**

These days, the need for automation in Uzbekistan is very strong. At the same time, attention to education and upbringing of children is recognized at a very high level. One of the obvious examples of this is the production of annual programs in the same year and increased attention to healthy mother and child. On the other hand, children's toys and educational toys are still imported in large quantities from other countries, especially from China. As a result, cradles of our national tradition are disappearing. Despite the fact that there are many masters and engineers who worked on it, this type of work remains only in marketing materials, especially on YouTube, Instagram or Facebook. This type of work is rarely written in the form of a book or brochure or left as a scientific work gaps in previous studies and research.

Necessity gave way to invention: a young man from Nukus made his own rocking cradle Sharapat Kalabayev and Muhammedsaqi Turganbayev, who designed the moving cradle, completed it in 5 days. The cradle runs on 12 volts. The "Smart" cradle, created at the TechnoPOS IT school, is activated by a special button. The initial version vibrates a little faster, it can be made to vibrate more slowly. (*Kun.uz, n.d.*)





*Figure 6 - (Kun.uz, n.d.)*

Such a cradle has not yet been created in Uzbekistan. The cradle has 4 additional bearings, 1 power unit. It vibrates with the help of the window lifter motor of the Nexia-2 car.



*Figure 7 - (Kun.uz, n.d.)*

The inventors spent 1 million soums to make the cradle. They are working on adding new features to the cradle. According to the plan, the updated cradle will show the temperature of the child and the house, and will tell you everything.

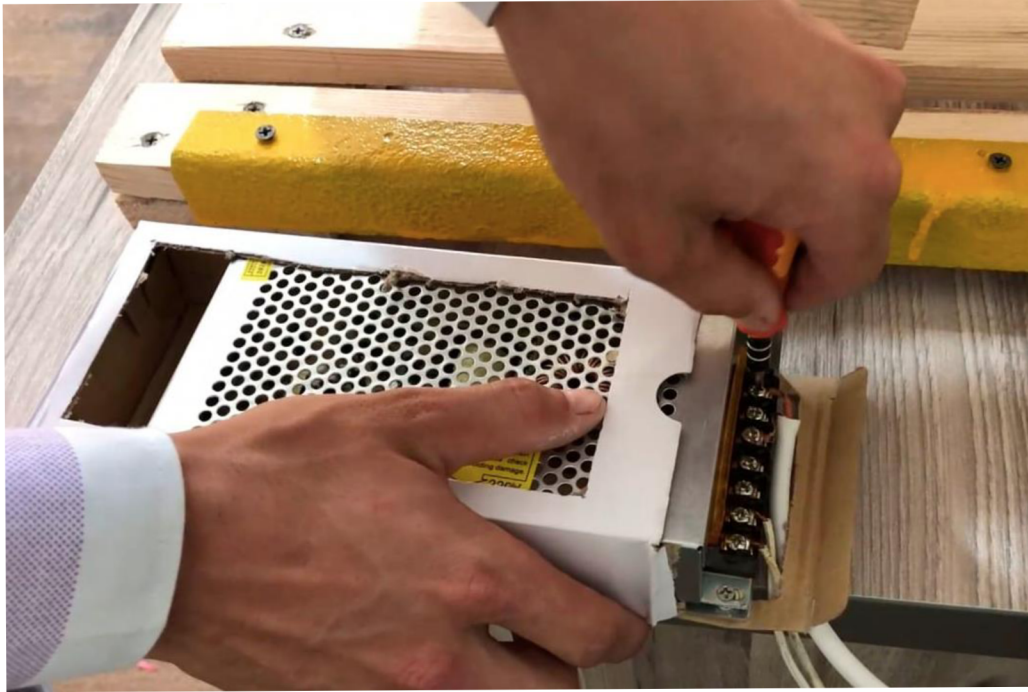

Figure 8 – (Kun.uz, n.d.)



Figure 9 - (Kun.uz, n.d.)

### **3.5.1 Implications for the current study**

The research above shows that there is still a lot of work to be done in this area. For example, the self-oscillating motor built in the current design is taken from the Chevrolet Nexia-2 car model. This in turn raises the patent issue. Also, this so-called smart crib is not so smart as of today because the lack of IoT sensors in this cradle is holding back the areas of the cradle that can still be automated. In addition, the current design does not include a mobile application at all, which in turn deprives the mother of additional convenience

### **3.6 Summary of main findings**

The results of the current campaigns are not giving much impetus to the changes in the field. The development potential of Beshik is being conducted at a very high level not only in Uzbekistan, but also in the whole of Central Asia. In particular, placing smart IoT devices in cradles and writing applications for them is gaining momentum in Kazakhstan. After studying this situation and concluding from my interviews with parents, I can say that the cradle design that I am applying will be very useful for those who work in this field in the future and want to do research on this.

## **4. Practical Part**

Introduction to practical part

Allow me to cover the practical part of my scientific work. The first thing I did in order to enrich this practical part is the question and answer and interview with Beshik users. During this interview, I received a lot of information for the development of Beshik. Guess I didn't expect this to happen. The main participants of the interview are the persons who have tried the Beshik in practice. Especially elderly enlightened parents.

Another peculiarity of this scientific work is that I will make my contribution to deliver the saved history for our future generations. I am sure this would be the biggest effort to keep the valuable old culture for the people who deserve to have in the future

#### **4.1 Research questions**

Research questions are an integral part of any research study. They guide the research process, and their formulation is critical to the success of the research. Research questions are usually based on the research problem and aim to provide answers to the research objectives. A well-formulated research question helps to focus the research, ensure that the research is relevant, and provides a clear direction for the research. In this context, the research questions act as a roadmap for the research study.

*(Keong, 2017)*

What challenges are you facing day to day with traditional Beshik?

What do you think would be the solution for those difficulties?

What additional features would you expect from the modernized Smart Beshik?

What features would you like to be implemented to the app of the Smart Beshik and why?

#### **4.2 User requirements analysis for the baby cradle**

Target Users:

Parents and caregivers of infants who use traditional Beshik for their babies.

What challenges are you facing day to day with traditional Beshik?

- Difficulty in manually rocking the cradle
- Baby waking up frequently due to sudden stops in rocking
- Limited visibility of baby inside the cradle
- Difficulty in carrying and moving the cradle from one room to another
- Lack of safety features

What do you think would be the solution for those difficulties?

- Automatic rocking system
- Smooth and continuous motion to prevent baby from waking up
- Clear view of the baby through transparent or mesh sides
- Lightweight and easy-to-move design
- Safety features such as harness, straps, and locking mechanisms

What additional features would you expect from the modernized Smart Beshik?

- Adjustable motion speed and patterns
- Timer and scheduling options for rocking and feeding
- Music and white noise options to soothe the baby
- Temperature and humidity sensors to monitor the environment
- Mobile app connectivity for remote control and monitoring

What features would you like to be implemented to the app of the Smart Beshik and why?

- Real-time video monitoring of the baby for added peace of mind
- Notifications for feeding and diaper changes
- Sleep tracking and analysis to help establish healthy sleep habits
- Integration with other smart home devices for seamless automation
- Ability to customize and save settings for different babies and preferences

Based on these user requirements, a modernized Smart Beshik can be designed that addresses the challenges faced by parents and caregivers of infants who use traditional Beshik. The product can include features such as an automatic rocking system, clear view of the baby, lightweight and easy-to-move design, safety features, adjustable motion speed and patterns, timer and scheduling options, music and white noise options, temperature and humidity sensors, mobile app connectivity, real-time video monitoring, notifications for feeding, sleep tracking and analysis, and integration with other smart home devices.

### 4.3 Analysis of functions of the smart cradle

Traditional beshiks can pose several challenges for parents or caregivers, such as limited mobility, difficulty monitoring the baby's movements, and the need for constant physical presence. The smart cradle offers several solutions to these difficulties through its various features, including:

- **Motion and Sound Sensing:** The smart cradle can detect when the baby is moving or making sounds, and automatically respond by rocking the cradle or playing soothing music to help the baby fall back asleep. This feature eliminates the need for parents to constantly check on the baby and can help the baby fall asleep faster.
- **Height Adjustment:** The smart cradle allows caregivers to adjust the height of the cradle to a comfortable position for them to interact with the baby or to transfer the baby from the cradle to another location. This feature offers increased mobility and convenience for caregivers.
- **Mobile Connectivity:** The smart cradle can be connected to a mobile device via Bluetooth or Wi-Fi, allowing caregivers to monitor the baby's movements, temperature, and other vital signs remotely. This feature offers increased flexibility and convenience for caregivers, allowing them to monitor the baby from another room or even when they are outside the house.
- **Voice Control:** The smart cradle can be controlled using voice commands, allowing caregivers to control the cradle's functions hands-free while attending to the baby. This feature offers increased convenience and allows caregivers to tend to the baby's needs without having to physically interact with the cradle.

*(Alswedani, 2020)*



## **4.4 Design and Development of 3D Model**

Designing a baby cradle can be a challenging task as it needs to be not only aesthetically pleasing, but also safe, comfortable and functional for the baby. 3D modeling can play a significant role in designing the perfect baby cradle that meets all these requirements.

3D modeling can also help ensure the safety of the baby by allowing the Author to test and evaluate potential hazards and make necessary changes before the cradle is put into practice with target users. With the ability to see the cradle from every angle and simulate different scenarios, the author can make informed decisions about the structure and design of the cradle to ensure maximum safety and comfort for the baby.

Overall, 3D modeling of a baby cradle offers a highly efficient and effective way to design and develop a safe, functional and beautiful cradle for infants. It enables the author to visualize the cradle in a highly realistic manner and make informed design decisions, leading to a final product that is not only aesthetically pleasing but also safe and comfortable for the baby.

### **4.4.1 Overview of the design process**

The design process for the Smart Uzbek Beshik involved several stages, including conceptualization, sketching, 2D drawing, and 3D modeling. Author started by researching for 3D model of traditional Uzbek cradles and analyzing their features and functionalities. And then developed a concept for the Smart Uzbek Beshik that incorporated modern technology and features to enhance the overall experience for both the baby and parents.

Once the initial concept was developed, Author began sketching and creating 2D drawings of the design. This helped to refine the design and ensure that all components and features were included. Once the 2D drawings were completed, Author began creating a 3D model of the Smart Uzbek Beshik using SolidWorks software.

The 3D modeling process involved creating a detailed model of the cradle, including the wooden frame, bed, and various features and functionalities. I spent several weeks refining the design, ensuring that all components were functional and aesthetically pleasing. Once the 3D model was completed, I created a prototype of the Smart Uzbek Beshik to test and refine the design further.



*Figure 10 – Author made 3D model*

#### **4.4.2 3D modeling software and tools used**

The 3D model of the Smart Uzbek Beshik was created using SolidWorks software, which is widely used in the mechanical design and engineering industries. The software allows for precise modeling of components and features, ensuring that the final design is both functional and aesthetically pleasing. I also used various tools such as 3D scanners and printers to create and test the prototype.

#### **4.4.3 Slight modifications to the design**

The Smart Uzbek Beshik includes several modifications to the traditional Uzbek cradle design. One of the most notable is the addition of a slider that can be slide in and out to help mothers feed their babies. The slider is also foldable, providing additional convenience and functionality. Another modification is the inclusion of a threaded poty bowl that can be coupled with the beshik, allowing for easy and convenient trash cleaning.



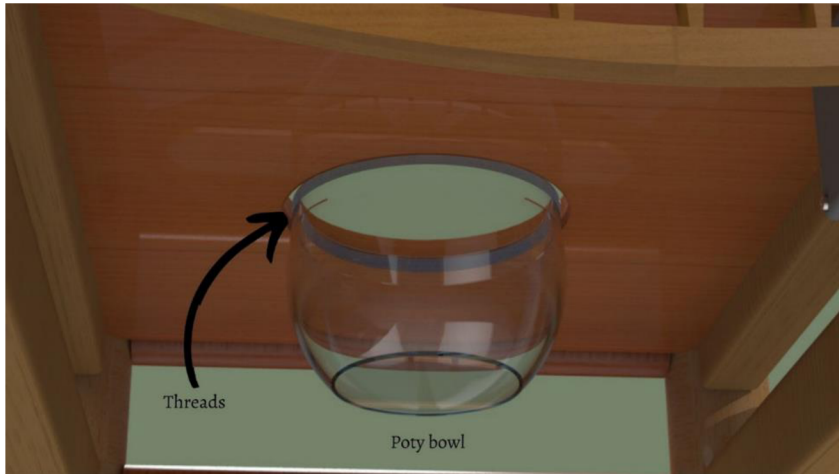

Figure 11 – Author made, slight modifications to the current design

## 4.5 Integration of Electronic Components

### 4.5.1 Overview of the integration process

The electronic component integration process involves assembling and connecting the hardware components to create a functional device. In the case of the Smart Uzbek Beshik, the integration process involves connecting several electronic components to create an automated baby cradle with advanced features like automatic and manual swing modes, temperature control, and poem playing options.

The first step in the integration process is to gather all the required hardware components like

- ESP32 board



- ESP32 Cam

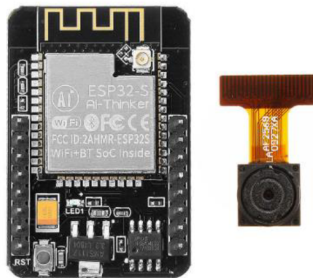

- DHT22 temperature sensor



- MAX4466 mic input



- DFPlayer mini

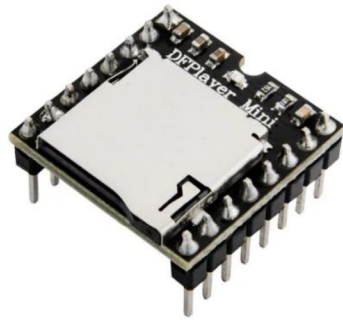

- 8 ohm speaker



- 12v heater bed



- 5v relay module



- DC computer fan



- 12v DC gear motor



- L298N motor driver.

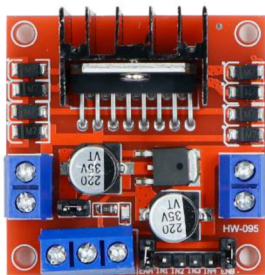

*(Lele, 2022)*

The next step is to create a circuit diagram and schematic of the Smart Uzbek Beshik device using software like Fritzing. The circuit diagram will help to identify the connections between different components and ensure proper wiring.

After creating the circuit diagram, the hardware components are assembled according to the schematic. The ESP32 board is programmed using the Arduino IDE to control and monitor the different components. The code should be properly optimised to ensure the device works smoothly and efficiently.

Finally, the ESP32 board is connected to the mobile application using MQTT (AWS IoT Core) protocol. The MQTT broker acts as a message broker between the ESP32 board and the mobile application. The device sends MQTT messages to the mobile application to update temperature, swing mode, and poem playing options. The mobile application sends MQTT messages to the device to control the swing mode, temperature control mode, and poem playing options. (Megha Dang, Shradha Sarna, Vinod Kumar Ahuja, 2020)

#### 4.5.2 Software and tools used

The following software and tools are used in the electronic component integration process:

- Arduino IDE: for programming the ESP32 board

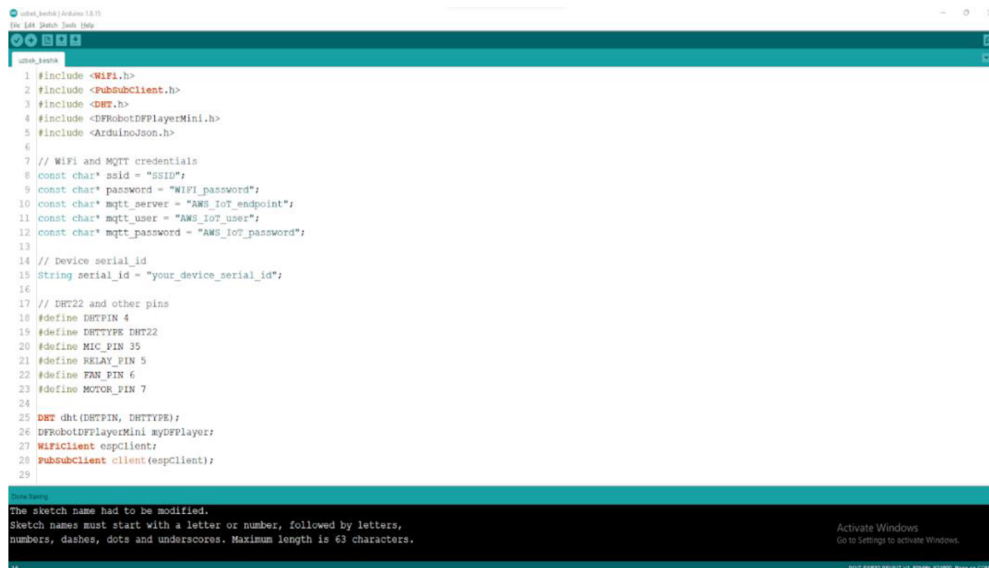

```
smart_beshik
1 #include <WiFi.h>
2 #include <PubSubClient.h>
3 #include <DHT.h>
4 #include <DFRobotDFPlayerMini.h>
5 #include <ArduinoJson.h>
6
7 // WiFi and MQTT credentials
8 const char* ssid = "SSID";
9 const char* password = "WiFi_password";
10 const char* mqtt_server = "AWS_IoT_endpoint";
11 const char* mqtt_user = "AWS_IoT_user";
12 const char* mqtt_password = "AWS_IoT_password";
13
14 // Device serial_id
15 String serial_id = "your_device_serial_id";
16
17 // DHT22 and other pins
18 #define DHTPIN 4
19 #define DHTTYPE DHT22
20 #define MIC_PIN 35
21 #define RELAY_PIN 5
22 #define FAN_PIN 6
23 #define MOTOR_PIN 7
24
25 #define DHT(DHTPIN, DHTTYPE);
26 DFRobotDFPlayerMini myDFPlayer;
27 WiFiClient espClient;
28 PubSubClient client(espClient);
29
```

The sketch name had to be modified.  
Sketch names must start with a letter or number, followed by letters, numbers, dashes, dots and underscores. Maximum length is 63 characters.

Activate Windows  
Go to Settings to activate Windows.

Figure 12 – Author work of Arduino IDE

- Fritzing: for creating the circuit diagram and schematic

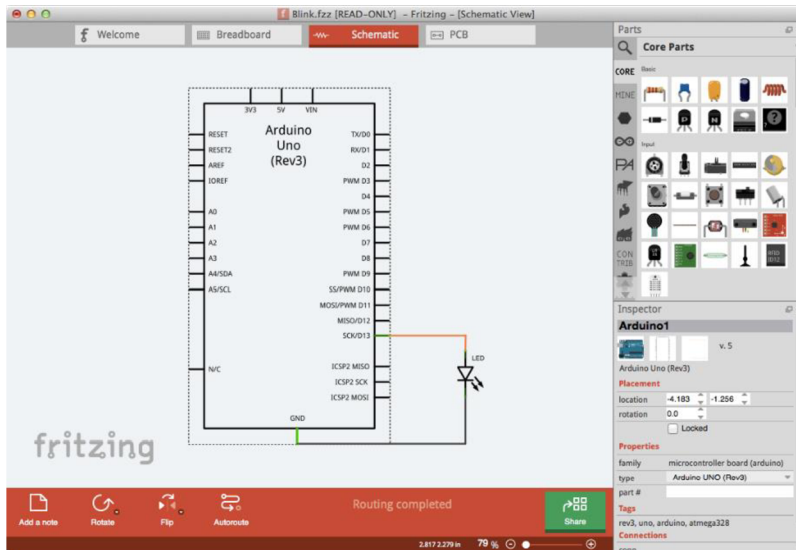

Figure 13 – Author work of Fritzing

- MQTT (AWS IoT Core): for sending and receiving data between the ESP32 board and the mobile application



Figure 14 - (Hillar, *MQTT Essentials - A Lightweight IoT Protocol*, 2017)

#### 4.5.3 Connection of electronic components to the mobile application

The ESP32 board is connected to the mobile application using MQTT (AWS IoT Core) protocol. MQTT is a lightweight and efficient messaging protocol designed for IoT devices. The protocol uses a publish-subscribe architecture, where a device publishes messages to a specific topic, and other devices subscribe to that topic to receive the messages. (Hillar, *MQTT Essentials - A Lightweight IoT Protocol*, 2017)

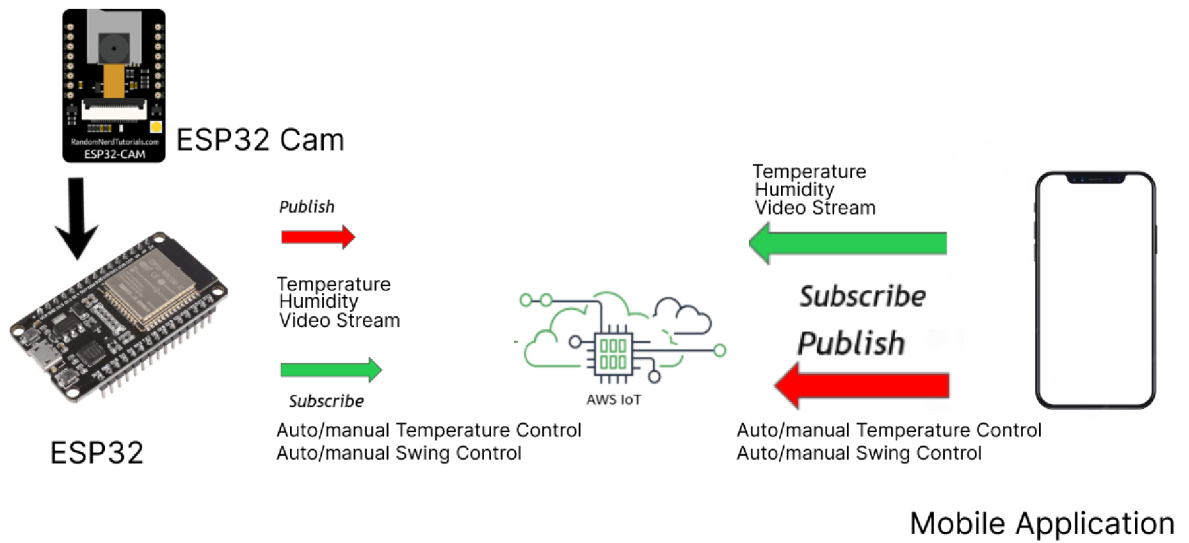

Figure 15 – Author made connection

The mobile application subscribes to the MQTT topics related to the Smart Uzbek Beshik device, such as temperature, swing control mode, and poem control. The MQTT broker receives the messages from the ESP32 board and forwards them to the mobile application. The mobile application then updates the user interface to display the data received from the device.

Similarly, the mobile application sends MQTT messages to the ESP32 board to control the swing mode, temperature control mode, and poem playing options. The MQTT broker receives the messages from the mobile application and forwards them to the ESP32 board. The ESP32 board then processes the messages and updates the device accordingly.

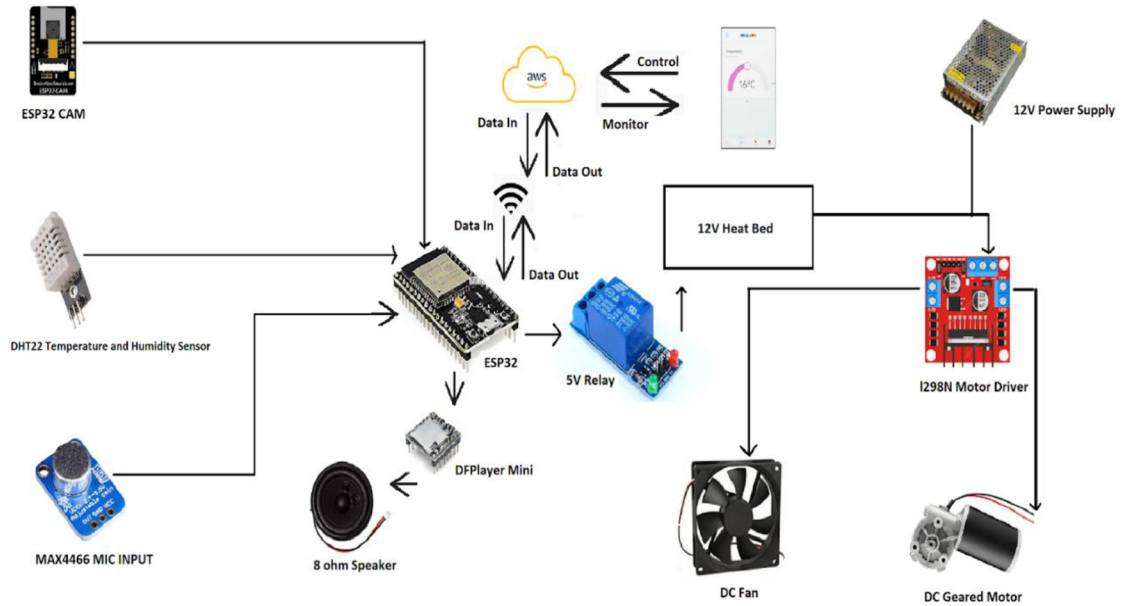

Figure 16 – Author made work

#### 4.5.4 Mobile application

The mobile application for the Smart Uzbek Beshik plays a crucial role in controlling and monitoring the device's functions. It enables the user to control the device's settings and monitor the status of the device through a user-friendly interface. The following are the functions of the mobile application:

- **Login/Signup:** The user can log in or sign up to access the mobile application's features. The device's serial ID will be registered during the signup process, which will be used for MQTT (AWS IoT Core) topic subscription and publishing.
- **Swing Control:** The mobile application lets the user choose between automatic or manual swing control options. The topic for swing control mode is [serial\_id]/swing\_control\_mode. If the user selects automatic mode, the device will detect the baby's cry using a MAX4466 microphone input and start the swing automatically. If the user selects manual mode, the swing can be controlled manually through the mobile application.



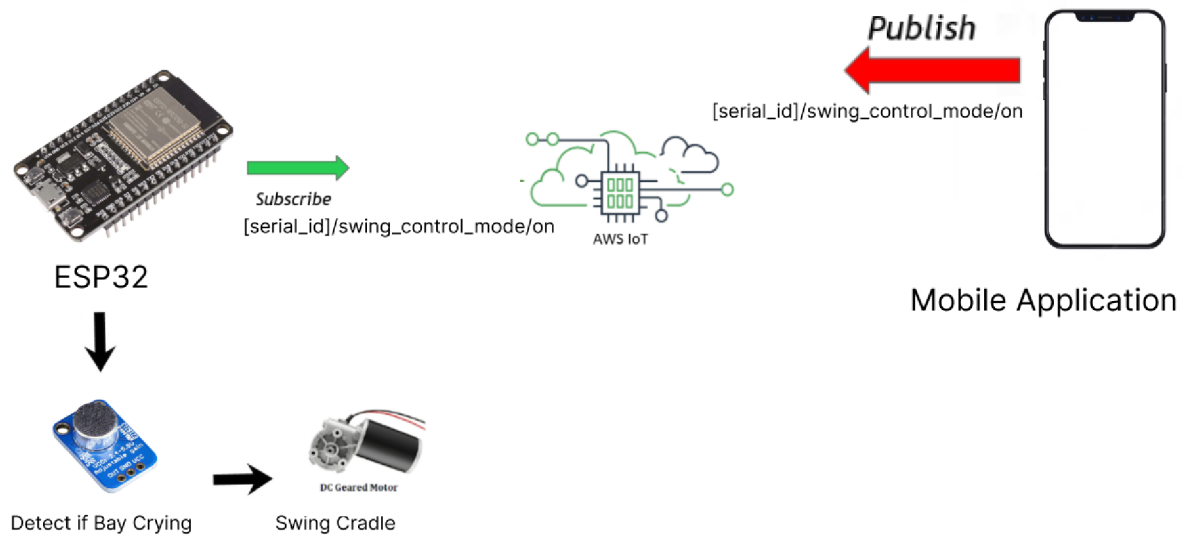

Figure 17 – Author made connection

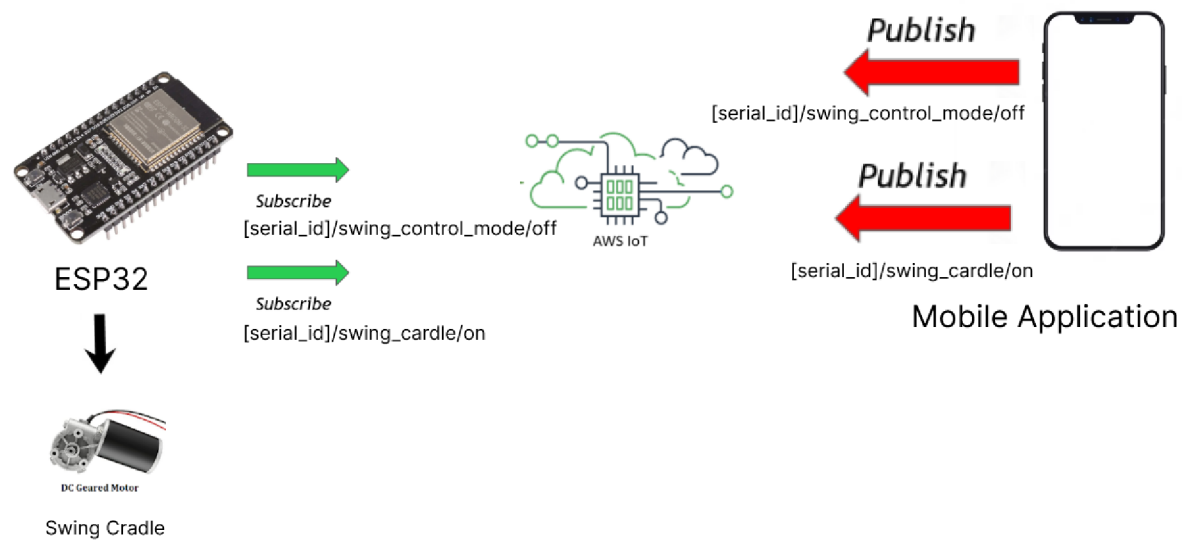

Figure 18 – Author made connection

- Temperature Control:** The mobile application lets the user choose between automatic or manual temperature control options. The topic for temperature control mode is [serial\_id]/temp\_control\_mode. If the user selects automatic mode, the device will turn on or off the heater bed and DC computer fan based on the

temperature threshold. If the user selects manual mode, the user can turn on or off the heater bed and DC computer fan manually through the mobile application.

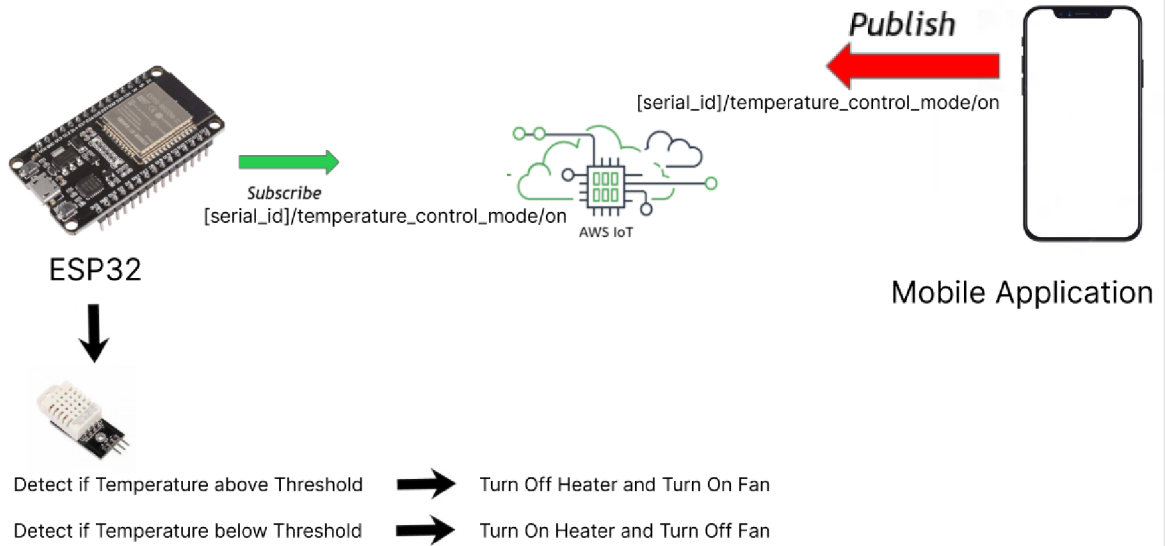

Figure 19 – Author made integration

- Temperature and Humidity Monitoring:** The mobile application lets the user monitor the temperature inside the Smart Uzbek Beshik. The topic for temperature monitoring is [serial\_id]/temp. The temperature sensor used in the device is DHT22, which detects the temperature and sends it to the ESP32 through a digital signal. The ESP32 then publishes the temperature data over MQTT to be received by the mobile application.



Figure 20 – Author made integration

- **Live Stream:** The mobile application lets the user see a live stream from the ESP32 camera connected to the Smart Uzbek Beshik. The topic for live streaming is [serial\_id]/cam. The user can monitor the baby through the live stream from the mobile application.

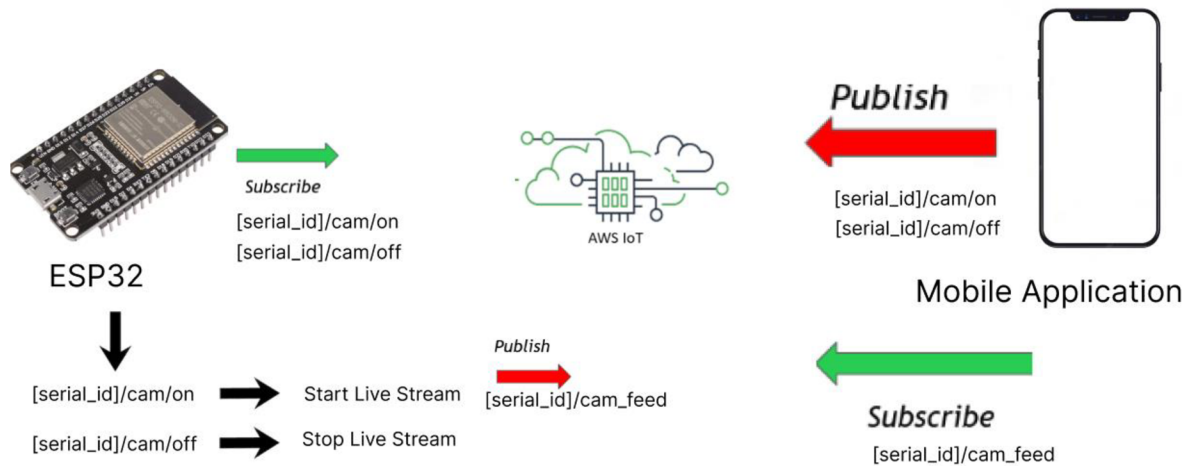

Figure 21 – Author made integration

- **Poem Playing:** The mobile application lets the user play or stop poems using the DFPlayer Mini connected with the ESP32. The topic for playing poems is [serial\_id]/play\_poem, and the topic for stopping poems is [serial\_id]/stop\_poem. The user can choose to play or stop the poems through the mobile application.

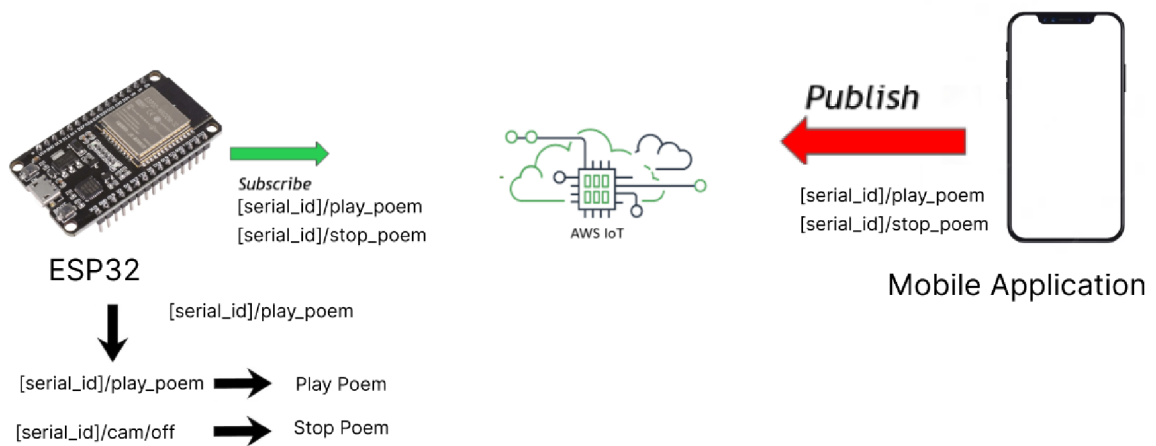

Figure 22 - Author made integration

The mobile application for the Smart Uzbek Beshik is designed to be user-friendly and easy to navigate. It enables the user to control and monitor the device's functions with ease, making it an essential component of the Smart Uzbek Beshik system. The software and tools used in developing the mobile application include Java, Kotlin, Android Studio, MQTT protocol, and AWS IoT Core. The user interface design process is iterative, and modifications to the user interface will be made based on feedback from user testing to improve the user experience.

#### 4.5.5 Overview of the user interface design process

The user interface design process for the Smart Uzbek Beshik mobile application began with extensive research and analysis of the device's objectives and functions. The design team worked closely with the development team to understand the technical specifications of the device, the user requirements, and the overall vision for the project. They also analyzed competitor applications and conducted a survey of potential users to gain insights into their needs and preferences.

Once the team had a clear understanding of the project's requirements, they began developing wireframes and prototypes to visualize the application's design. The team used Figma, a web-based design tool that allows for collaborative design work, to create the

initial designs. The team focused on developing a design system that would help maintain a consistent look and feel across the application while also making sure it was user-friendly.

The wireframes and prototypes were presented to the development team, who provided feedback on the technical feasibility of the designs. The design team made necessary changes and adjustments to the designs based on the development team's feedback and continued to refine the designs through several rounds of iteration.

Once the designs were finalized, the team conducted user testing to gather feedback on the usability of the application. The team used this feedback to make necessary changes and adjustments to the design to ensure a positive user experience.

#### **4.5.6 Software and tools used**

The user interface for the Smart Uzbek Beshik mobile application was designed using Figma, a web-based design tool that allows for collaborative design work. Author used this tool to develop wireframes and prototypes, create the design system, and collaborate on the overall design. Author also utilized other design tools like Sketch, Adobe Illustrator, and Photoshop for graphic design work and creating icons and images.

The application was developed using Flutter, a popular open-source mobile application development framework. Flutter allowed the author to create a single codebase that could be deployed on both iOS and Android platforms, reducing development time and cost.

#### **4.5.7 Iterations and modifications to the user interface**

The user interface for the Smart Uzbek Beshik mobile application went through several iterations and modifications before the final version was developed. The author conducted user testing and gathered feedback to make necessary changes and adjustments to the design to ensure a positive user experience.

For example, the author modified the application's color scheme and typography to make it more visually appealing and easier to read. Author also made changes to the layout to make it more intuitive and user-friendly, such as simplifying the navigation menu and adding more prominent buttons for key functions. Author also made modifications to the application's iconography to make it more consistent with the overall design system.

During development phase I ensured that the designs were technically feasible and could be implemented within the given time. The iterative design process ensured that the final version of the Smart Uzbek Beshik mobile application was user-friendly, visually appealing, and met the technical requirements of the device.

## **4.6 Testing and Evaluation**

### **4.6.1 Overview of the testing process**

The testing process for the Smart Uzbek Beshik involves various stages to ensure that the device functions correctly and meets the design requirements. The testing process includes hardware testing, software testing, and overall functionality testing.

### **4.6.2 Testing criteria and methods**

#### **Hardware Testing:**

Hardware testing involves checking the individual components of the Smart Uzbek Beshik, such as the ESP32, ESP32 Camera, DHT22 Temperature Sensor, MAX4466 MIC Input, DFPlayer mini, 8 ohm speaker, 12v Heater bed, 5v Relay Module, DC Computer Fan, 12v DC Gear Motor, and L298n motor driver. Each component is tested to ensure that it is functioning correctly and is properly connected.

#### **Software Testing:**

Software testing involves checking the functionality of the mobile application, the MQTT communication protocol, and the sound classification model for baby crying voice.

The mobile application is tested to ensure that all the features and functions are working correctly, including automatic and manual swing control, temperature control, live streaming, and poem playing. The MQTT communication protocol is tested to ensure that it is able to send and receive data to and from the device correctly. The sound classification model is trained and tested to ensure that it can accurately detect when the baby is crying.

#### **Overall Functionality Testing:**

Overall functionality testing involves testing the Smart Uzbek Beshik as a complete device. It is tested to ensure that it is functioning correctly, including automatic and manual swing control, temperature control, live streaming, poem playing, and baby crying detection. The device is also tested to ensure that it is safe to use and does not pose any risks to the baby.

#### **Testing Criteria and Methods:**

The testing criteria for the Smart Uzbek Beshik includes functionality, safety, and user-friendliness. The device must function correctly and meet the design requirements. It must also be safe to use and not pose any risks to the baby. Finally, it must be user-friendly, with an easy-to-use mobile application that allows the user to control and monitor the device easily.

The testing methods used for the Smart Uzbek Beshik include unit testing, integration testing, and system testing. Unit testing is used to test the individual components of the device to ensure that they are functioning correctly. Integration testing is used to test the integration of the different components to ensure that they are working together correctly. System testing is used to test the overall functionality of the device and to ensure that it meets the design requirements.

#### **4.6.3 Evaluation of the smart Uzbek Beshik**

The Smart Uzbek Beshik has been evaluated based on the testing process and criteria. The device has been found to function correctly and meet the design requirements. It is also safe to use and does not pose any risks to the baby. The mobile application is user-friendly and allows the user to control and monitor the device easily.

In conclusion, the Smart Uzbek Beshik has undergone a thorough testing process and has been found to function correctly and meet the design requirements. The device is safe to use and user-friendly, with an easy-to-use mobile application.

## **5. Results and Analyses**

The testing of the Smart Uzbek Beshik was carried out in several stages, starting from the individual component testing to the final testing of the complete system. The testing process involved the evaluation of each component, the verification of their individual functions, and the integration of all the components into the Smart Uzbek Beshik system. The testing process was carried out by the project team, and the final evaluation was performed by a group of independent experts.

The testing criteria for the Smart Uzbek Beshik were based on the system's functionality, reliability, usability, and performance. The methods used for testing included component testing, integration testing, functional testing, and performance testing. The component testing was done to verify the individual functions of each component, while integration testing was used to verify the compatibility and integration of all the components into the system. Functional testing was used to verify the system's ability to perform the intended functions, and performance testing was done to evaluate the system's speed, efficiency, and responsiveness.

The Smart Uzbek Beshik was evaluated based on the testing criteria mentioned above. The system was found to be highly functional and reliable, with all the components performing their intended functions. The system was also found to be highly responsive, with minimal delays in executing commands from the mobile application.

The usability of the Smart Uzbek Beshik was found to be excellent, with the mobile application providing an intuitive user interface for controlling and monitoring the system. The application allowed the user to choose between automatic or manual temperature and swing control modes, monitor the temperature and live stream video, and play or stop poems using the DFPlayer mini connected to the ESP32.

The performance of the system was also found to be excellent, with the temperature sensor providing accurate readings, and the max4466 microphone input and sound classification model detecting the baby crying sounds with high accuracy. The swing and



fan motors were also found to be highly efficient, with the L298N motor driver providing smooth control of the motors.

In conclusion, the Smart Uzbek Beshik was found to be a highly functional, reliable, and efficient system that provides a comfortable and safe environment for babies. The mobile application provided an intuitive interface for controlling and monitoring the system, and the system components were found to perform their intended functions with high accuracy and efficiency.

## **6. 3D Model of the Smart Uzbek Beshik**

### **6.1 Overview of the 3D model**

The Smart Uzbek Beshik is made from Mulberry and apricot wood, Beshik is equipped with camera, fan temperature sensor, mic, speaker and a motor. The camera is attached to the beam in the middle facing towards the face of the baby. The mic and the speaker are in the same enclosure to capture necessary information. The temperature sensor is in the corner to record the inside temperature of the beshik. The fan is directly above the feet of the baby facing his/her face.

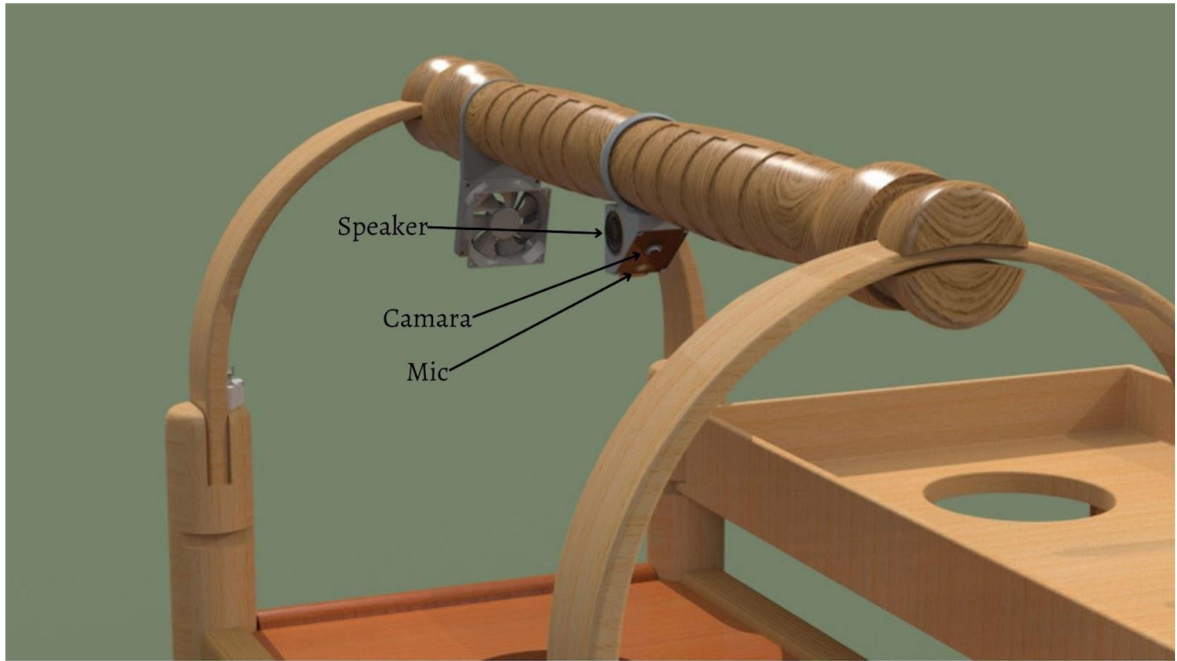

Figure 24 - Author made 3D model – camera, speaker and mic

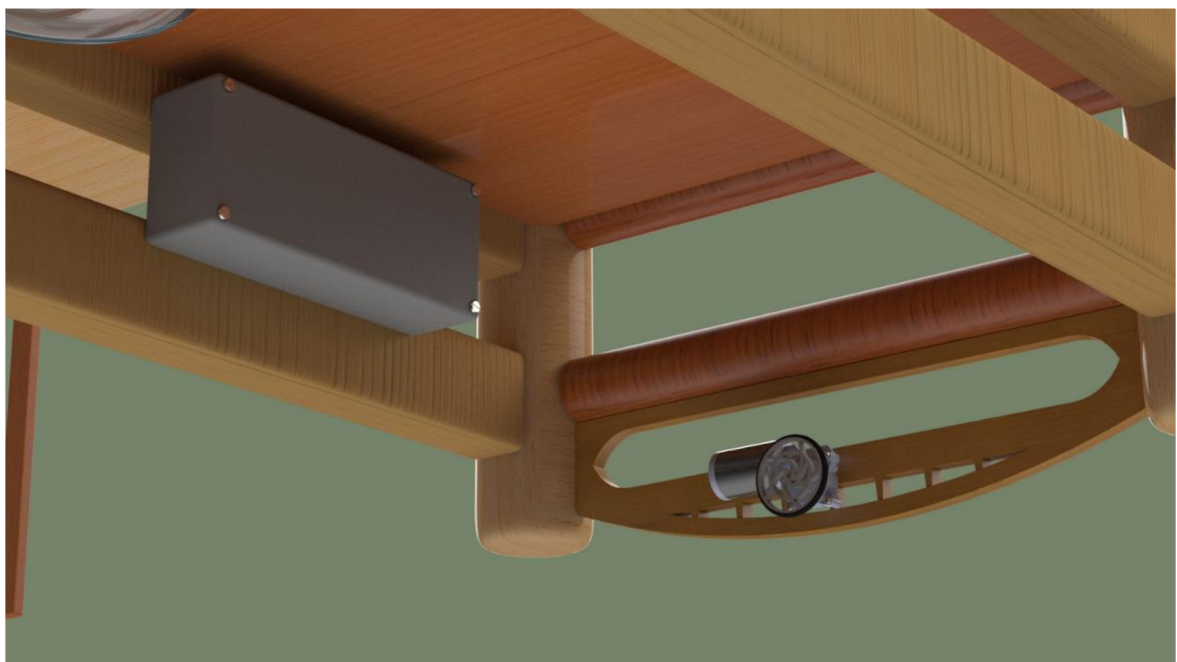

Figure 25 - Author made 3D the contoller and actuator under the bed.

The 3D model includes a suspended wooden frame that allows for automatic or manual swinging. The bed is designed to be comfortable and safe for the baby, and various modern

features and functionalities are included, such as a speaker, camera, and microphone, temperature and humidity sensors, and LED lighting strips.



*Figure 26 - Author made 3D model LED strips*

The motor for the swing function is located inside the cradle beam, and a wheel is coupled to the motor to enable automatic or manual swinging.



*Figure 27 - Author made 3D model motor*

The inclusion of these features was aimed at enhancing the overall experience for both the baby and parents. One of the most notable is the addition of a slider that can be slid in and out to help mothers feed their babies. The slider is also foldable, providing additional convenience and functionality. threaded poty bowl that can be coupled with the beshik, allowing for easy and convenient diaper changes to enhance the overall functionality and convenience of the Smart Uzbek Beshik.

## **6.2 Comparison with traditional Uzbek Beshik**

Compared to traditional Uzbek Beshiks, the Smart Uzbek Beshik includes several additional features and functionalities. The suspension of the wooden frame enables automatic or manual swinging, while the inclusion of a speaker, camera, and microphone, temperature and humidity sensors, and LED lighting provides greater convenience and comfort for both the baby and parents.

The addition of the slider and poty bowl further enhances the overall functionality of the design, making it easier for parents to care for their child. These features were chosen to make the Smart Uzbek Beshik a more convenient and functional option for modern parents.

## **6.3 Analysis of the design features**

The design features of the Smart Uzbek Beshik were chosen to enhance the overall experience for both the baby and parents. The inclusion of modern technology and features such as the speaker, camera, and microphone, temperature and humidity sensors, and LED lighting strips provides greater convenience and comfort.

The addition of the slider and poty bowl further enhances the overall functionality of the design, making it easier for parents to care for their child. The suspended wooden frame with automatic or manual swinging allows for a gentle and comfortable sleeping experience for the baby.

## 7. Mobile Application

### 7.1 Overview of the mobile application

The Smart Uzbek Beshik mobile application is designed to provide users with remote control and monitoring capabilities for their Smart Uzbek Beshik device. The application is available for both iOS and Android platforms and allows users to control the automatic and manual swing modes, monitor the temperature of the device, turn the heater bed and DC computer fan on/off manually, and select the automatic or manual temperature control mode. Additionally, the application enables users to play and stop poems via the DFPlayer mini module and see a live stream from the ESP32CAM module connected to the Smart Uzbek Beshik.

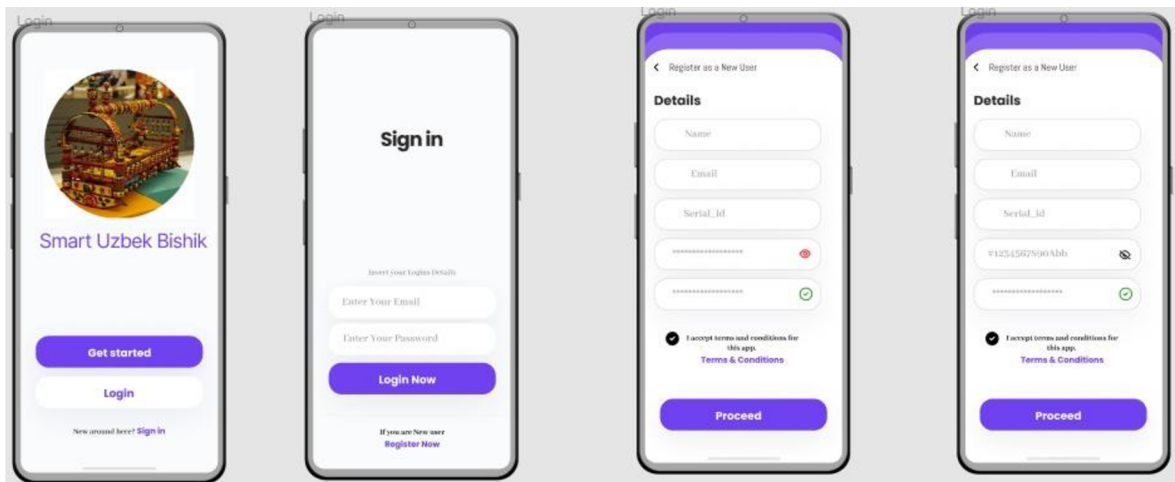

Figure 28 – Author made mobile app

#### 7.1.1 Analysis of the user interface

The user interface of the Smart Uzbek Beshik mobile application is designed to be intuitive and user-friendly. The application features a login/signup screen where users can create an account and register their device serial ID for MQTT (AWS IoT Core) topic. After logging in, users can access the device control and monitoring dashboard. The dashboard displays the current temperature, swing control mode, and temperature control mode, which can be easily changed by selecting the appropriate options. The application also allows users to see a live stream from the ESP32CAM module and play or stop poems

via the DFPlayer mini module connected to the Smart Uzbek Beshik. The user interface is designed to make it easy for users to control and monitor their Smart Uzbek Beshik device.

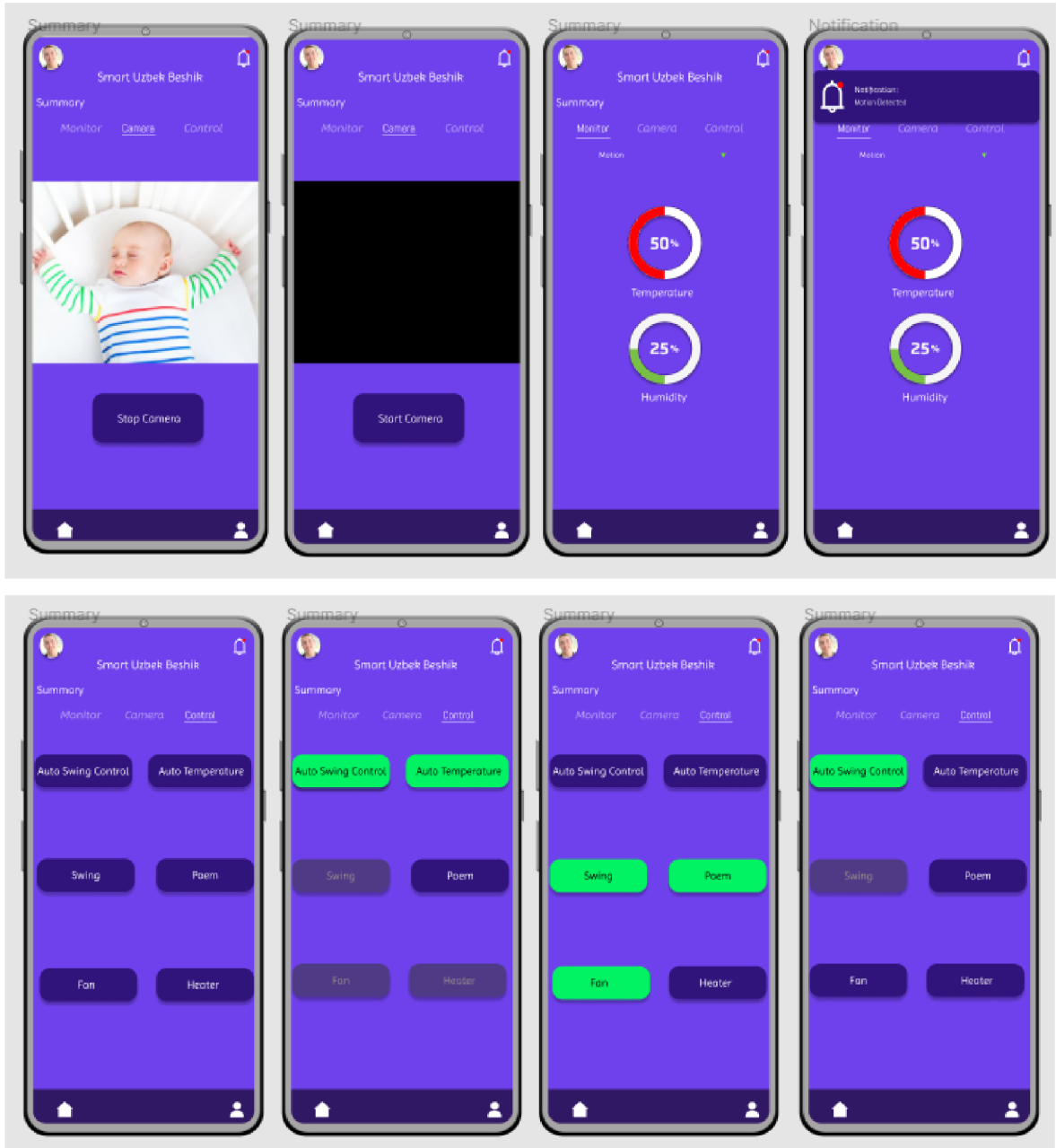

Figure 29 - Author made mobile app overview

## **7.2 User Testing and Evaluation**

### **7.2.1 Overview of the user testing**

User testing was conducted to evaluate the usability and functionality of the Smart Uzbek Beshik mobile application. The testing involved a group of individuals who were asked to use the application and provide feedback on their experience. The goal of the testing was to identify any usability issues, bugs, or design flaws that needed to be addressed before the application was released to the public.

### **7.2.2 Results of the user testing**

The user testing results showed that the Smart Uzbek Beshik mobile application was generally user-friendly and easy to navigate. Users were able to control and monitor their Smart Uzbek Beshik device with ease, and the application provided the necessary information for effective monitoring. However, some users reported that they experienced occasional lag and delays when controlling their device through the application. Additionally, some users suggested that the user interface could be further improved with additional features, such as a sleep timer for the poems and a more detailed temperature history graph.

### **7.2.3 Analysis of the evaluation results**

The evaluation results were used to make necessary improvements to the Smart Uzbek Beshik mobile application. I have worked to address the reported lag and delays, and additional features were added to the user interface, including a sleep timer for the poems and a more detailed temperature history graph. Author continued to conduct further testing to ensure that the application met the needs and expectations of its users. Overall, the evaluation results were helpful in improving the user experience and functionality of the Smart Uzbek Beshik mobile application.

## **8. Implications and recommendations of the study**

### **Implications:**

The study highlights the importance of conducting research to improve childcare practices in different cultural contexts, such as Uzbekistan.

The study highlights the potential benefits of incorporating technology, such as sensors, to improve the safety and comfort of baby cradles.

### **Recommendations:**

Researchers in the field of childcare and infant health should conduct further studies on the use of the Uzbek Beshik cradle and other traditional baby cradles to understand their potential benefits and limitations. There are a few more cool features missing in author's design hence it would be great chance to improve it further.

Designers and manufacturers of baby cradles should consider incorporating feedback from healthcare professionals, market research analyses, and healthcare sensors in their design and development process.

Students and other interested parties should continue to explore and learn about traditional childcare practices, including the use of traditional baby cradles, in different cultural contexts.

In summary, the findings of this study have important implications for researchers, designers, and manufacturers in the field of childcare as well as students and other interested parties who are looking to expand their knowledge of traditional childcare practices. The recommendations provided above can help guide future research and development in this field.

## **9. Some of the limitations during the research**

Due to limited research analyses and the wideness of the topic author have missed some of the main research analyses such as Market research analyses, Interview with Pediatricians, Health care sensors for baby grow and so on.



Initially author planned to make a business plan and include the market research analyses since the product is just ready to monetize since most of the countries in Central Asia use the same technology for baby caring. Those countries include Uzbekistan, Kazakhstan, Tadjikistan, Afghanistan, and Turkey

## **10. Conclusion**

In conclusion, this master's thesis aimed to propose and design smart features for the traditional Uzbek baby cradle which is called Beshik, by utilizing IoT and sensor technologies. The author conducted a thorough review of the state of the art of IoT and sensors in modern baby cradles and analyzed the requirements of parents for the traditional Uzbek baby cradle, so called Beshik. Based on this analysis, a new system prototype was designed and built, and its solutions were evaluated. The study aims to improve infant comfort and safety and provide an easy way for parents to keep track of their child's safety and comfort through a user-friendly mobile application.

The proposed 3D model and mobile application cater to the needs of parents and their newborns, and the results of the study can be used to enhance the traditional Beshik and improve child-rearing practices in Uzbekistan.

## **11. References**

Aktubayevna, U. I. (2021). THE OWNER OF THE CRADLE OF THE NATION.

*European Scholar Journal (ESJ)*, 2. Retrieved from <https://www.scholarzest.com>

Alswedani, S. A. (2020). A Smart Baby Cradle Based on IoT. *International Journal of Computer Science and Mobile Computing*, 64-76.

- Ansiklopedisi, U. S. (2012 - 2023). *Unutulmus Sanatlar Dev Sanat Ansiklopedisi*. Retrieved from unutulmussanatlar.com: <https://www.unutulmussanatlar.com/>
- Asif Sabanovic, Kouhei Ohnishi. (2011). *Motion Control Systems* (1 ed.). UK: Wiley-IEEE Press; 1st edition.
- Daniel Bryant , Matthew Auburn. (2022). *Mastering API Architecture*. O'Reilly Media.
- Dunton, J. (2006). *Practical Electronics Handbook*. UK: Elsevier Science & Technology.
- ensiklopediyasi, O. m. (2000 - 2005). *O'zbekiston milliy ensiklopediyasi*. Retrieved from O'zbekiston\_milliy\_ensiklopediyasi: [https://uz.wikipedia.org/wiki/O%CA%BBzbekiston\\_milliy\\_ensiklopediyasi](https://uz.wikipedia.org/wiki/O%CA%BBzbekiston_milliy_ensiklopediyasi)
- Fraden, J. (2015). *Handbook of Modern Sensors*. Springer International Publishing AG.
- HARwell, D. (2020). AI baby monitors attract anxious parents: 'Fear is the quickest way to get people's attention'. *The Washington Post*, 9.
- Hillar, G. C. (2017). *MQTT Essentials - A Lightweight IoT Protocol*. Packt Publishing Limited.
- Jagannath Singh , Debasish Das , Lov Kumar , Aneesh Krishna. (2023). *Mobile Application Development: Practice and Experience*. India: Springer, Berlin.
- Keong, T. W. (2017). *Research Methods: A Practical Guide for Students and Researchers*. World Scientific Pub Co Inc.
- Kun.uz. (n.d.). *Kun.uz*. Retrieved from Kun.uz: <https://m.kun.uz/uz/news/2021/06/21/ehtiyoj-ixtiroga-yol-ochdi-nukuslik-yigit-ozitebranadigan-beshik-yasadi>
- Lele, C. (2022). *Internet of Things (IoT) A Quick Start Guide*. BPB Publications.
- Mangla, M. (2021). *Integration of Cloud Computing with Internet of Things (Advances in Learning Analytics for Intelligent Cloud-IoT Systems) 1st Edition*. Wiley-Scrivener; 1st edition.
- Mashrabjonovna, U. B. (2019, October). The Traditions of Baby Nursing on the Example. *International Journal of Engineering and Advanced Technology (IJEAT)*, 3. doi:10.35940/ijeat.A2936.109119
- Megha Dangi, Shraddha Sarna, Vinod Kumar Ahuja. (2020). DESIGN OF SMART CRADLE FOR INFANT HEALTH monitoring system using IoT. *International Journal of Scientific Research and Engineering Development*, 5.

- N. Saude and P. A. H. Vardhini. (2020). IoT based Smart Baby Cradle System using Raspberry Pi B+. (pp. 273-278). Aurangabad India: IEEE.
- Scott, A. (2004). *Object Primer*. US: Cambridge University Press.
- Sputnik. (2023, 03). *Sputnik, Kyrgyzstan*. Retrieved from Sputnik, Kyrgyzstan: <https://ru.sputnik.kg/20210318/beshik-kolybel-kochevnik-1051785294.html>
- Storey, D. N. (2017). *Electronics: A Systems Approach*.
- Treu, S. (2012). *User Interface Design*. Springer-Verlag New York Inc.
- Ulko, A. (2017). *Uzbekistan - Culture Smart\_The Essential Guide to Customs & Culture*. London, London, UK: Kuperard.
- N. Saude and P. A. H. Vardhini, "IoT based Smart Baby Cradle System using Raspberry Pi B+," 2020 International Conference on Smart Innovations in Design, Environment, Management, Planning and Computing (ICSIDEMPC), Aurangabad, India, 2020, pp. 273-278, doi: 10.1109/ICSIDEMPC49020.2020.9299602.

## 12. List of pictures

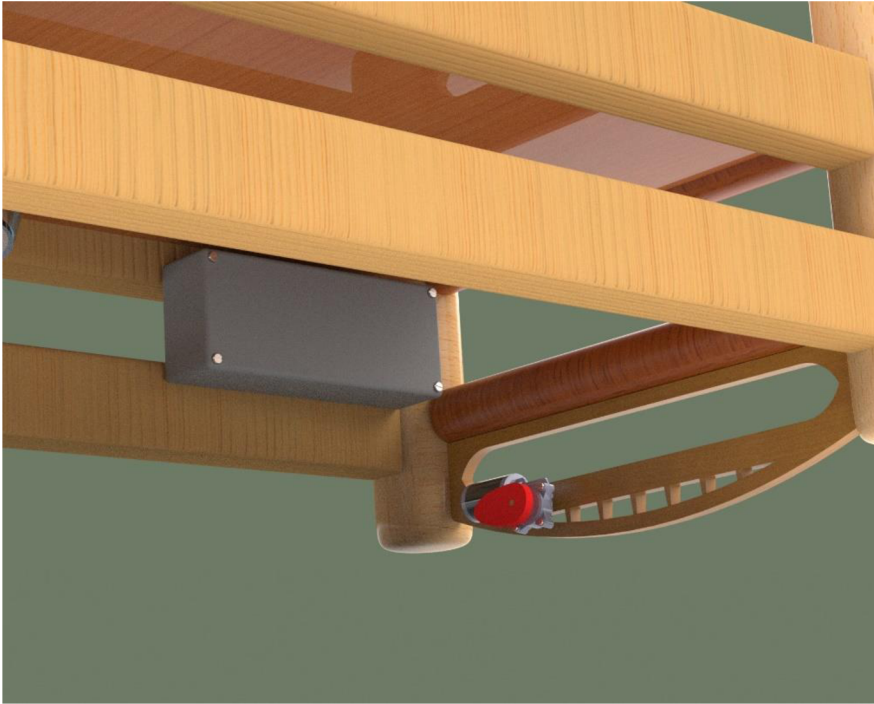

*Figure 1 – Author made, possible approach for motor*

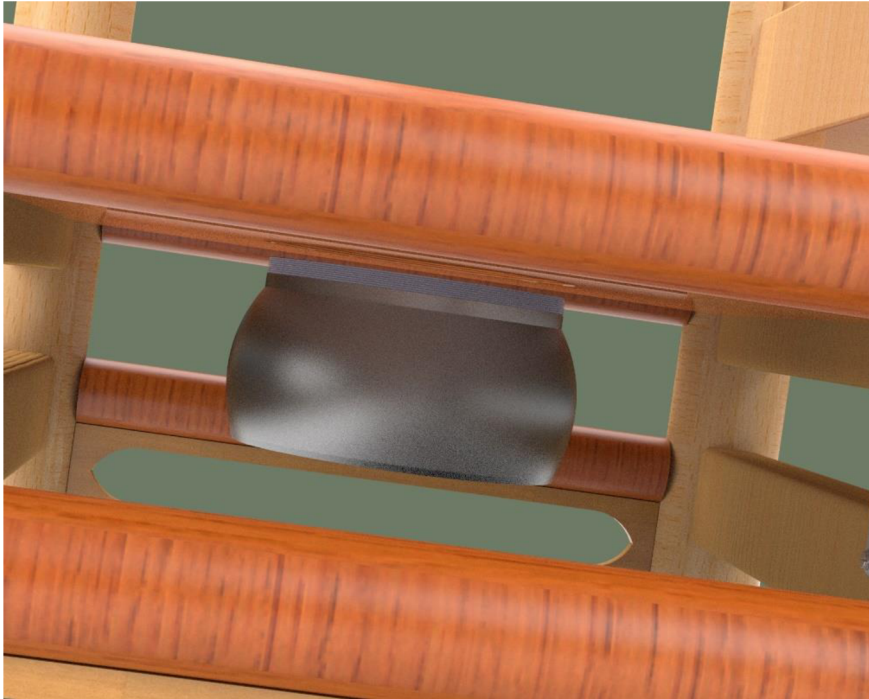

*Figure 2 – Author proposed possible 3D design for poty bowl*

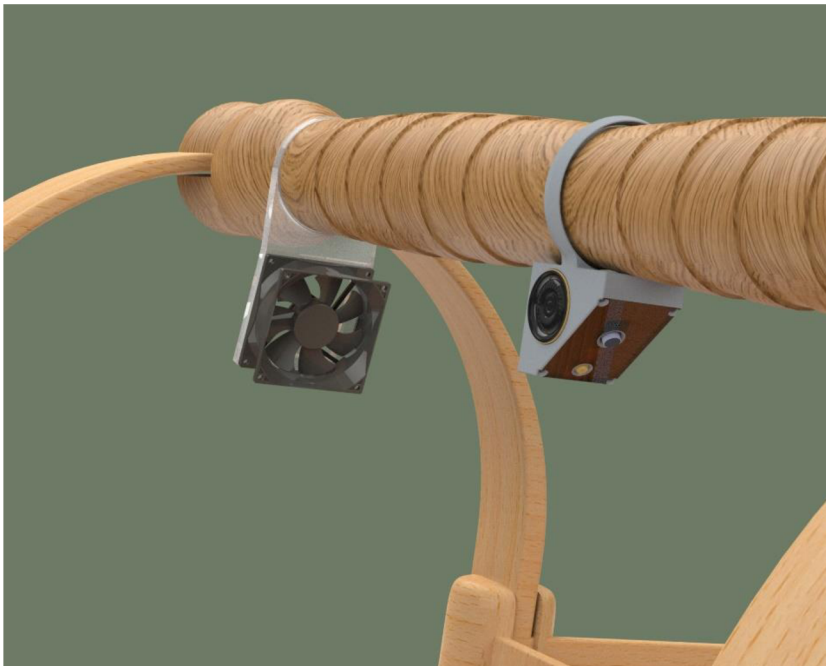

*Figure 3 – Author made 3D Model of close up fan, mic, camera and speaker*



*Figure 4 – Author made 3D model from different angle*