

**CZECH UNIVERSITY OF LIFE SCIENCES PRAGUE**

Faculty of Environmental Sciences

Department of Applied Ecology



*Bachelor Thesis*

**ASSESSMENT OF AEROBIC BIODEGRADABILITY  
OF FACE MASKS**

Supervisor: Ing. Lenka Wimmerová, MSc., Ph.D.

Student: Nena Šilić

© 2022 CULS Prague

# CZECH UNIVERSITY OF LIFE SCIENCES PRAGUE

Faculty of Environmental Sciences

## BACHELOR THESIS ASSIGNMENT

Nena Šilić

Environmental Engineering

Thesis title

**Assessment of aerobic biodegradability of face masks**

---

### Objectives of thesis

The overall aim of the bachelor thesis is to assess aerobic biodegradability of face masks. The theoretical part of the work will focus on the current state of the art in the field of waste management and biodegradability assessment, as well as on relevant environmental legislation and available standardized testing protocols. The practical part of the work will be performed on selected face masks using standardised biodegradability assessment protocols.

### Methodology

The bachelor work is experimental. Methodologically, it will be formed as a comprehensive literature review followed by a practical part performed in laboratory conditions in accordance with relevant standards. Standards may be modified if necessary for performing the laboratory experimental part.

**The proposed extent of the thesis**

50-60 pages incl. appendixes

**Keywords**

biodegradability, assessment, aerobic, face mask, waste, littering

---

**Recommended information sources**

BABAAHMADI, V., HOOMAN, A., NAEIMIRAD, M., RAMAKRISHNA, S., 2021: Biodegradable and multifunctional surgical face masks: A brief review on demands during COVID-19 pandemic, recent developments, and future perspectives. *Sci Total Env.* 798: 149233.

*Biodegradation and bioremediation*; A. Singh, O.P. Ward (eds.). London: SPRINGER, 2004. ISBN 3-540-21101-2.

CHOI, S., JEON, H., JANG, M. et al., 2021: Biodegradable, efficient and breathable multi-use face mask filter. *Adv. Sci.* 8: 2003155.

OECD, ©2021: OECD Guidelines for the testing of chemicals, section 3 – Environmental fate and behaviour. ISSN: 2074577X (online), <https://doi.org/10.1787/2074577x>.

SELVARANJAN, K., NAVARATNAM, S., PATHMANATHAN, R., RAVINTHERAKUMARAN, N., 2021: Environmental challenges induced by extensive use of face masks during COVID-19: A review and potential solutions. *Environmental Challenges* 3: 100039.

---

**Expected date of thesis defence**

2021/22 SS – FES

**The Bachelor Thesis Supervisor**

Ing. Lenka Wimmerová, MSc., Ph.D.

**Supervising department**

Department of Applied Ecology

---

Electronic approval: 11. 10. 2021

**prof. Ing. Jan Vymazal, CSc.**

Head of department

---

Electronic approval: 24. 11. 2021

**prof. RNDr. Vladimír Bejček, CSc.**

Dean

Prague on 23. 12. 2021

## Author's statement

I hereby declare that I have independently elaborated the bachelor/final thesis with the topic of: "*Assessment of aerobic biodegradability of face masks*", and that I have cited all of the information sources that I used in the thesis as listed at the end of the thesis in the list of used information sources.

I am aware that my bachelor/final thesis is subject to Act No. 121/2000 Coll., on copyright, on rights related to copyright and on amendments of certain acts, as amended by later regulations, particularly the provisions of Section 35 (3) of the act on the use of the thesis.

I am aware that by submitting the bachelor/final thesis I agree with its publication under Act No. 111/1998 Coll., on universities and on the change and amendments of certain acts, as amended, regardless of the result of its defense. With my own signature, I also declare that the electronic version is identical to the printed version and the data stated in the thesis has been processed in relation to the GDPR.

In Prague, date: .....

.....

## Acknowledgements

I would like to express deep gratitude to my supervisor Ing. Lenka Wimmerová, whose valuable advices, patience and noble guidance contributed tremendously to the successful completion of this thesis.

My respect also goes to other laboratory colleagues who contributed to evaluation of the experiment, and whose knowledge inspired to persist on the path. Special thanks to Marie Bee Bloom® for selflessly providing beneficial materials.

## Abstract

Face masks and respirators primarily made of synthetic polymers have, either due to regulative obligations or personal protection, become an essential item in the COVID-19 global pandemics. Frequently overlooked and neglected consequence of the ongoing situation is increasing plastic pollution and blooming waste accumulation in both marine and terrestrial environments.

Apropos that, an experimental laboratory work for observing biodegradability of facial protective equipment was conducted under aerobic conditions, without bioaugmentation or biostimulation, in order to simulate real-world processes.

During 120 days, the environmental fate of selected face masks, buried in jars with Cambisol of the Tiché údolí nature protected area, Prague, was observed through measurements of commonly accepted indices of biodegradation, like weight loss or carbon dioxide production from microbial respiration. Same as soil, masks were not pre-treated or manipulated in any way that could obstruct non-enhanced setting of the experiment. As expected, the inert polymeric face masks underwent no signs of biodegradation, while reference biodegradable face masks made of rice paper, showed signs of decomposition, although not ultimate mineralization.

Overall, biodegradability of face masks is relatively new, but highly contemporary topic that logically imposes itself in the current situation. This thesis wants to ensure that environmental considerations of legislations are taken into account by shedding light on the problem of persistency of masks in the environment.

**Keywords: biodegradability, assessment, aerobic, face mask, waste, littering**

## Table of contents

<b>1. INTRODUCTION</b> .....	<b>1</b>
<b>2. OBJECTIVES</b> .....	<b>2</b>
<b>3. LITERATURE REVIEW</b> .....	<b>3</b>
3.1 Current situation .....	<b>3</b>
3.2 Biodegradation .....	<b>6</b>
3.2.1 Aerobic biodegradation .....	<b>8</b>
3.2.2 Anaerobic biodegradation .....	<b>10</b>
3.2.3 Measures of biodegradability and environmental fate .....	<b>11</b>
3.2.4 Standardized tests of biodegradation .....	<b>13</b>
3.3 Face masks composition .....	<b>18</b>
<b>4. METHODOLOGY</b> .....	<b>21</b>
4.1 Preparation of test material .....	<b>21</b>
4.2 Inoculum preparation .....	<b>22</b>
4.2.1 Soil properties .....	<b>23</b>
4.3 Biodegradability test .....	<b>24</b>
4.3.1 Weight measurement .....	<b>25</b>
4.3.2 pH .....	<b>26</b>
4.3.3 DM, moisture content .....	<b>26</b>
4.3.4 C/N content .....	<b>27</b>
4.3.5 Biological activity .....	<b>28</b>
4.3.6 Microscope observation .....	<b>30</b>
4.3.7 FTIR analysis .....	<b>31</b>
<b>5. RESULTS</b> .....	<b>31</b>
5.1 Weight measurement .....	<b>32</b>
5.2 pH .....	<b>34</b>
5.3 DM, moisture content .....	<b>36</b>
5.4 C/N content .....	<b>38</b>

5.5 Biological activity .....	39
5.6 Microscope observation .....	41
5.7 FTIR analysis .....	42
<b>6. DISCUSSION</b> .....	<b>45</b>
<b>7. CONCLUSION</b> .....	<b>47</b>
<b>8. BIBLIOGRAPHY</b> .....	<b>48</b>
8.1 Internet sources .....	48
8.2 Legislative sources .....	49
8.3 Scientific publications .....	50
<b>APPENDICES</b> .....	<b>54</b>



## LIST OF ABBREVIATIONS

<b>AFNOR</b>	- French Standardization Association
<b>ASTM</b>	- American Society for Testing and Materials
<b>ATP</b>	- Adenosine triphosphate
<b>BDP</b>	- Biodegradable plastics
<b>BOD</b>	- Biochemical oxygen demand
<b>BPEJ</b>	- Rated soil ecological unit
<b>CDC</b>	- Centers for Disease Control and Prevention
<b>COD</b>	- Chemical oxygen demand
<b>ČZU</b>	- Czech University of Life Sciences
<b>DM</b>	- Dry matter
<b>DOC</b>	- Dissolved organic carbon
<b>EC</b>	- European Commission
<b>EU</b>	- European Union
<b>EPC</b>	- European Parliament and the Council
<b>FDA</b>	- The Food and Drug Administration
<b>FTIR</b>	- Fourier transform infrared spectroscopy
<b>FFP</b>	- Filtering facepiece
<b>ISO</b>	- International Organization for Standardization
<b>OECD</b>	- Organization of Economical Cooperation and Development
<b>OSHA</b>	- The Occupational Safety and Health Administration
<b>PBS</b>	- Polybutylene succinate
<b>PE</b>	- Polyethylene
<b>PP</b>	- Polypropylene
<b>PPE</b>	- Personal protective equipment
<b>TC</b>	- Total carbon
<b>ThOD</b>	- Theoretical oxygen demand
<b>TN</b>	- Total nitrogen
<b>TWA</b>	- Time-weighted average
<b>SEM</b>	- Scanning electron microscope



## 1. Introduction

Global COVID-19 pandemic has caused severe threat to the public health, but another frequently overlooked problem has to do with the burden it imposed on various spheres of the environment. Due to the outbreak, the production and consumption of mostly polymeric face masks multiplied several hundred times, and according to recent studies, it has been estimated that 129 billion of face masks are being produced every month on a global scale (Prata et al. 2020).

There are emerging ways to tackle the issue of increasing plastic footprint in terms of using biodegradable materials like hemp, bamboo and polybutylene succinate (PBS) for the production of face masks, or upscaling masks into construction material (Babaahmadi et al. 2021). However, respirators, medical and non-medical face masks sometimes end up being incinerated under medical waste, or more frequently they end up in the landfills, leaving them prone to transfer into the water bodies and soil. According to Knicker et Velasco-Molina (2021), if only 0.1% of those masks enter the soil, cca 361 t of polypropylene (PP) will be added to it, contributing to the pollution and microplastics input. There is shortage of information how these masks can naturally degrade in the soil, and this thesis resolves around the process of biodegradation of inherently slowly-biodegradable materials face masks are made of.



Fig.1 A discarded face mask

## 2. Objectives

Research aim of this bachelor thesis is to assess the biodegradability of commercially available plastic face masks, compare them to declared biodegradable masks, and to examine potential negative effects their degradation might have on the soil in the natural environment.

The literature review represents foundation for the experimental work by presenting current state-of-the-art in the field of biodegradability assessment, as well as relevant environmental legislation regarding plastics and face masks. The practical part, on the other hand, comprises of laboratory examining whether conventional face masks show any signs of biodegradation under natural conditions in the period of several months by measuring selected indicators of biodegradability without addition of nutrients or bacterial inoculum, which might alter the results.

### 3. Literature review

The literature review aims to describe biodegradation process in general, later narrow the topic to soil medium, present standardized tests focused on polymer biodegradation, and introduce common indices of biodegradation, which are later examined in the experimental part of the thesis. In addition, current situation regarding environmental legislation is presented in the context of the increased littering of face masks.

#### 3.1 Current situation

Over the past couple of decades, European Union (EU) has put great efforts into smart, sustainable, and inclusive growth in all spheres of life, so as the environmental one. Starting with adapting the United Nations' (UN) Sustainable Development Goals, over the European Strategy for Plastics in a Circular Economy, or perhaps a recent ban on single-use plastics, it is evident that smart waste management, rational utilization of resources and recycling are the driving forces for national strategies. The Basel Convention, and its 2019 Amendment brought significant changes to legal framework by presuming certain plastic wastes to be hazardous, thus ensuring its better management for both environment, and human health (UN, 2019).

However, due to global COVID-19 pandemics, and mandatory mask regulations that followed, there has been significant increase in the production, use, and littering of polymeric personal protective equipment (PPE). In fact, an image of discarded mask has become a common thing in the cities, and recent observation by Spennemman (2021) confirms the statement by identifying more than 300 tossed PPE during random walks in Australian city over the course of approximately 40 weeks. As a reference, there are estimations of approximately one and a half million tonnes of generated PPE waste each day of the pandemics on a global scale, and more than 3 billion pieces of wasted face masks (Benson et al. 2021).

Evidently, newly created policies, emerged by advising of official state authorities like The Occupational Safety and Health Administration (OSHA), The Food and Drug Administration (FDA), or Centers for Disease Control and Prevention (CDC), indirectly lead to an increase in plastic waste generation. In the first month of global pandemics,

there had been 84-fold increase in the consumption of face masks in comparison to the pre-pandemic levels (Roberts et al. 2021). No national consumption reduction measures were undertaken, but on the contrary, regulations enhanced PPE consumption. Even though intended for single use, face masks were not subjected to EU ban on single use plastics (EPC, 2019). However, negative health implications of reduced face mask wearing should also be taken into account.

Even though used protective face masks should be classified under medical waste, and should be treated separately, without ending in soil and water bodies, it is often not the case. There are several challenges in medical waste management. Firstly, such waste is easily incinerated, however that method causes dangerous emissions from various plasticizers and polymeric materials present in face masks. Pyrolysis and microwave technique are seen a more preferable option of managing since they provide good disinfection and lower emission rates, given that the microwave technique utilizes the least energy due to the lowest temperatures (Klemeš et al. 2020). Moreover, medical waste can be landfilled, but its hazardous nature might induce negative impact on the surrounding environment. Last, but not least, incinerating and landfilling waste without prior reusing and reducing isn't in accordance with EU's circular economy action plan, which aims at shifting linear consumption model to sustainable utilization of resources (EC, 2020).

According to green papers on the EU strategy on plastic waste in the environment, the biggest portion of plastic waste ends on the landfills, which should be changed, with the aim to reduce, reuse, recycle ('3R') before tossing away, thus positively influencing rational utilization of resources (EC, 2013). Since first leading principle of viable '3R' initiative of sustainable waste management - '*reduce*' – is not fully applicable to face masks due to obvious protective and hygienic reasons, reusing and recycling, along related upcycling is put under the spotlight.

A simple and effective method to reuse face masks consists of rotating them between each use, and letting them dry for more than 3 days, to disable the effect of the COVID-19 virus (Selvaranjan et al. 2021). Recycling face masks into new PPE is considered financially unfeasible, on top of decreasing filtering ability of recycled specimens. However, masks are successfully reprocessed into new objects, with the aim of reducing pandemic-induced waste. Recent venture by Saberian et al. (2021) included mixing pieces of face masks with a base or subbase concrete material used for pavements in

civil construction. According to researchers, adding 1% of weight of shredded face masks to the total mass of concrete for roads not only eliminates the quantity of discarded masks, but it increases strength and stiffness of the concrete aggregate, which makes this low-carbon mechanical recycling strategy efficient on more levels. Moreover, recent research claims that polymeric particles from masks could be recycled into bricks, insulating anti-humidity barriers, or adhesive bandage (Klemeš et al. 2020). Nowadays, private companies are increasingly recognizing opportunities, and recycle non-woven parts of face masks into plastic pellets, smelt metal parts into new forms etc. Therefore, waste is not waste until it is wasted. Seeing it as a resource is in perfect alignment with the European Strategy for Plastics in the Circular Economy since it reduces production and generation of new waste.



Fig.2 Recyclability symbols of plastics (ISO, 2001)



Fig.3 Face mask upcycling (adapted from Saberian et al. 2021; Torres et De-la-Torre, 2021)

If simply discarded without obeying '3R' principles of waste management, masks end up in the environment leaving it polluted. This is when the question of their natural attenuation becomes truly essential. As a response, conventional polymers can be replaced with alternative biodegradable plastics (BDP), not derived from petro-sources, but from plants' tissue. Without affecting conventional properties face masks should exhibit, biodegradable masks represent strong boost to mentioned international anti-plastic legislatives. However, health legislatives frequently condition usage of

conventional face masks, despite considerably lower carbon footprint of biodegradable plastics, with average 45 % less carbon dioxide (CO<sub>2</sub>) emissions than petro-plastic (Klemeš et al., 2020). On the other hand, government-imposed lockdowns temporarily decreased emissions, and indirectly implemented goals of EU climate agenda focused exactly on lowering greenhouse gas emission (EC, 2020). Overall, there is certainly space for improvement in the plastic waste management and policy-making in order to decrease littering and pollution of water and terrestrial areas by PPE.

### 3.2 Biodegradation

According to OECD (1997), biodegradation is defined as: '*Biodegradation is the process by which organic substances are decomposed by micro-organisms (mainly aerobic bacteria) into simpler substances such as carbon dioxide, water and ammonia.*' Therefore, the essence of biodegradation is in the transformative ability of materials, and their ability to be consumed by microorganisms at different biodegradability rates (Jørgensen, 2010).

Biodegradability is classified into four different types, namely ultimate, primary, ready, and inherent biodegradability (OECD, 2006). Ultimate biodegradability refers to complete mineralization of the observed material and its transformation into biomass, carbon dioxide, water and mineral salts. When specific screening tests for 'maximum' ultimate biodegradability are passed, then ready biodegradability assumes that those compounds rapidly and completely biodegrade in aquatic aerobic environment. Primary biodegradability or biotransformation implies change of specific properties and chemical structure of the observed substance. Finally, inherent biodegradability shows whether the tested compound has any potential to biodegrade, and is assigned to products which undergo more than 20% biodegradation (OECD, 2006).

Biodegradation may take place in any media, taking into consideration that conditions needed for the process are met. However, the most common medium is soil, followed by aqueous bodies, sediments and waste sludge. For each of these, standardized tests have been developed.

Natural attenuation can last from seconds to millions of years, depending on multiple complex factors such as virgin material from which the product was made of, chemical composition of the tested product and its additives, molecular weight, crystallinity and



other characteristics of test material (Nayak, 1999; Briassoulis et Mistriotis, 2018). Microorganisms' composition, abundance and activity also play great role in degradation processes. They are the ones enzymatically catalyzing complex chemical compounds. Discouraging fact is that the number of strains capable of naturally degrading recalcitrant synthetic polymers is quite limited. According to Mohanan et al. (2021), more than 90 genera of bacteria and fungi, among which are *Bacillus* sp., *Pseudomonas* sp., *Halomonas* sp. etc. have been identified to biodegrade petroleum-derived polymers such as polypropylene (PP) or polyethylene (PE). However, biodegradation depends on a variety of other abiotic factors. 'Non-living' variables such as temperature, moisture level, pH, oxygen saturation or climatic conditions can either alter or hold back the process. For instance, UV irradiance from the sun, or high moisture ambient levels might promote breakdown, while extreme pH values or low temperatures might offset desirable results because they are limiting microbes (Sivan, 2011).

While some materials biodegrade naturally and at a fast rate, other synthetic xenobiotic compounds exhibit opposite trends, and show resistance to decomposition, which further indicates persistence in the environment. Moreover, their persistence conditions easy magnification in the food chain, meaning that higher trophic levels will have higher contamination of the substances released during the process of degradation (Jørgensen, 2010). Non-biodegradable materials usually share similar traits like chlorinated molecules, molecules of excessive size, unusual bonds or substitutions. Widespread PE, commonly used plastic material, has high molecular weight, which makes its degradation process extremely time-extensive. In general, the higher the molecular weight, the lower the biodegradation rate is. Among other non-biodegradable materials can be found similar polymeric compounds, heavy metals, pesticides, radioactive substances etc. (Zaidi et Imam, 2008). On the contrary, biodegradable matter decomposes easily under the influence of various biotic or abiotic variables, leaving no room for biomagnification. Organic matter, biomass, sewage or dung are considered to be biodegradable.

Depending on the oxygen saturation, aerobic and anaerobic biodegradation can be distinguished. From a microbial perspective, aerobic biodegradation implies the use of oxygen for respiration and consumption of nutrients, as opposed to anaerobic, which happens in its absence, when organisms take advantage of other compounds to induce changes in morphological and chemical structure of degrading material.

### 3.2.1 Aerobic biodegradation

Based on the aerobic biodegradation equation (Ardisson et al. 2014):

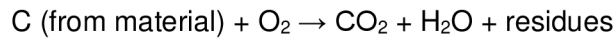

it is possible to see that the principle consists of oxygen consumption by the aerobic organisms and carbon dioxide production, followed by biosynthesis into biomass. Energy and carbon balances of aerobic biodegradation are presented in the following table.

Table 1 Energy and carbon balance of aerobic biodegradation (adapted from Wimmerová, 2021).

Efficiency	Energy balance	Carbon balance
Aerobic	40 % reaction heat lost	50% CO <sub>2</sub> produced

Aerobic biodegradability in soil is greatly dependent of the concentration of microorganisms necessary for the degradation process, characteristics of the soil matrix, climate in which degradation takes place, as well as season of the year. Microorganisms like fungi and bacteria play crucial role in the process of biodegradation. In order to start the process, certain concentration of microbes have to be present in the soil medium. With, or without human intervention, those microbes have to stick to the surface of the degrading material, and have to start utilizing the carbon of the product, in order for degradation to occur. There are a number of bacterial strains able to disintegrate certain products, however mixed microbial communities showed the best performance (Joutey et al. 2013).

Among the factors influencing microorganism-test material interaction are nutrient sources of nitrogen and phosphorus (Vyas et Dave, 2010), pH of the soil matrix, its temperature and moisture. Degradation occurs under different environmental conditions, but it has been recognized that for terrestrial systems it is the most effective for pH levels of soil in the range between 6.5 and 8.5, and temperature 20-28 °C, as it provides the most favorable conditions for the growth of mesophilic microorganisms. Figure 5 indicates that with rising temperatures, enzymatic activity of microbes rises as well, until it reaches optimum temperature, after which it again decreases. (Joutey et al. 2013; Pishedda et al. 2019).

Soils differ in their physical and chemical properties - moisture, temperature, texture, structure, cation exchange capacity, base saturation, organic matter & salt content. While some, like Andisols or Mollisols, are fertile with large amounts of organic matter, others like desert soils are very dry and sterile. Scientific consensus on 'the best soil for degradation' does not exist, as the overall outcome depends on intertwining biotic and abiotic factors.

Finally, aerobic biodegradation could occur naturally, when wastes or remains of dead animals and plants end up in the ground, or can be controlled, when official standards are applied to test biodegradation of certain material. ISO 17556:2019, or its equivalent ASTM D5988-18 are examples of international standards used to assess aerobic biodegradation of plastic materials in soil by measuring oxygen demand or evolved carbon dioxide (Ardisson et al. 2014). Further information on available tests are given in chapter 3.2.4.

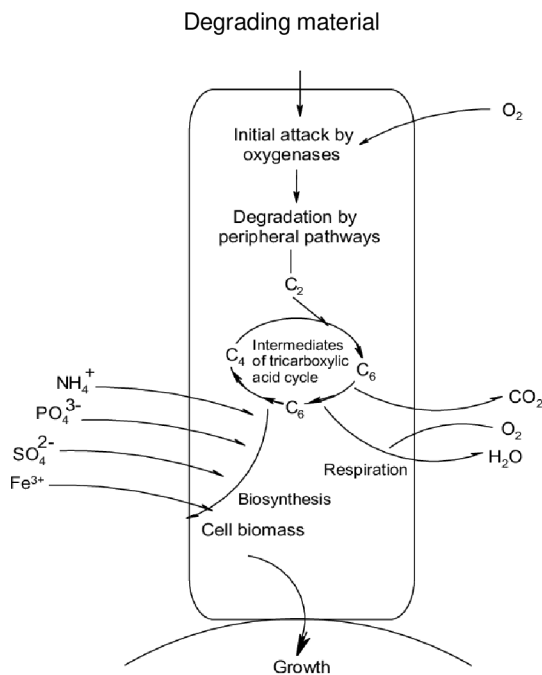

Fig. 4 Principle of aerobic biodegradation (Olajire et Essien, 2014)

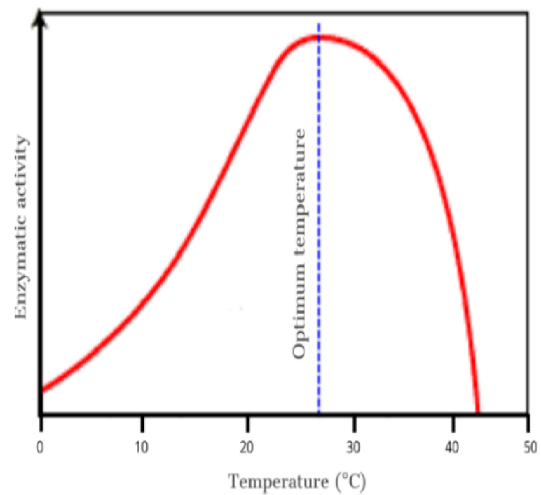
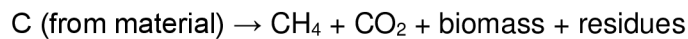

Fig. 5: Optimum temperature for mesophilic microorganisms in soil (adapted from Pischedda et al. 2019)

### 3.2.2 Anaerobic biodegradation

Anaerobic biodegradation is the breakdown of materials in the absence of oxygen, resulting in the production of biogas (methane and carbon dioxide) and biomass, with intermediate byproducts:



Those outputs are valuable resources which can be further utilized for electricity production or as nutrient-rich fertilizers. The digestion process itself starts with bacterial hydrolysis of degrading material, which transforms complex organic matter into soluble organic molecules, that can be consumed by acetogenic bacteria and turned into acetic acid. The last step, characterized by converting acetic acid and other intermediate molecules into highly flammable greenhouse gas methane, is referred to as methanogenesis. Energy and carbon balances of anaerobic biodegradation are presented in the following table.

Table 2 Energy and carbon balance of anaerobic biodegradation (adapted from Wimmerová, 2021).

Efficiency	Energy balance	Carbon balance
Anaerobic	3-5 % reaction heat lost	95 % CH <sub>4</sub> + CO <sub>2</sub> produced

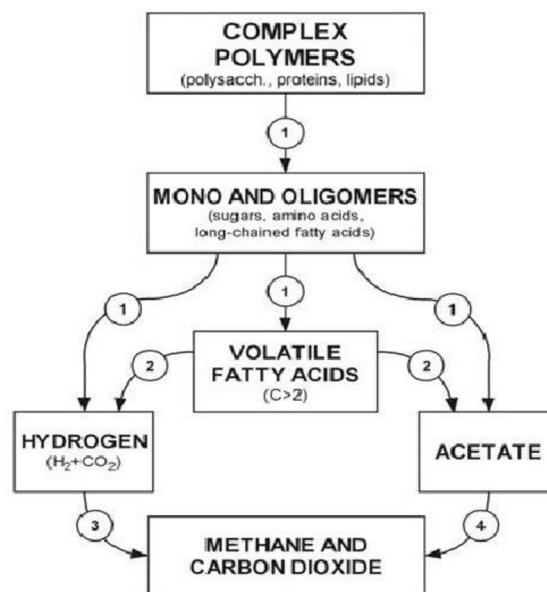

Fig. 6 Principle of anaerobic biodegradation (Dincă et al. 2014)

### 3.2.3 Measures of biodegradability and environmental fate

In order to assess and monitor biodegradation under controlled or natural conditions several strategies are being used. Since, in the most basic sense, biodegradation means disintegration, it does not surprise that weight loss is considered as one of the most used indices expressed with the following equation (Vimala et Mathew, 2016):

$$\text{Percentage of weight loss} = (\text{Initial weight} - \text{Final weight}) / \text{Initial weight} \times 100$$

If weight decreases, it is presumed that initial acclimation and stagnation period ended, and that biodegradation by microorganisms has started taking place. These microbes utilize carbon sources of the substrate and consequently convert it to CO<sub>2</sub> in the process of respiration. Therefore, another method to determine degradation rate is the measurement of evolved carbon dioxide production. Although Nash et Leith (2012) state that passive diffusion tubes are usually used to determine air pollutants, it is not excluded that they might serve as a powerful, yet simple tool to determine the amount of CO<sub>2</sub> evolved from the microbial attack during biodegradation process. Tubes do not require electrical power, nor gas sampling pump, but they simply operate on diffusion principle by measuring time-weighted average (TWA) of gas concentration (Gastec, ©2018). Another way of measuring CO<sub>2</sub> evolution is capturing exhaust gas in the plastic bag during biodegradation in the composting conditions, followed by measuring with the help of gas detectors (Nakasaki et al. 2000; Mohee et Unmar, 2007). Carbon dioxide evolution during anaerobic biodegradation presented by Müller et al. (2004) involved measurement of gas production using eudiometer and measuring gas pressure.



Fig. 7 Gastec passive Dosi - tubes (SKC, ©2018)

Furthermore, microbial respiration intensity is usually measured with titration technique, which assesses CO<sub>2</sub> evolved by microorganisms by the amount of titrated hydrochloric acid (HCl) into aqueous solution of potassium hydroxide (KOH), barium chloride (BaCl<sub>2</sub>) and phenolphthalein (C<sub>20</sub>H<sub>14</sub>O<sub>4</sub>). Respiratory action is also an important indicator of soil quality and fertility (Haney et al. 2008).

Observing pH change of the soil medium during degradation process is also of great importance. In general, pH can decrease, since some microbes produce acid which is excreted and lowers the pH value, or can undergo increase. During observations of attenuation of petro-hydrocarbons, Tang et al. (2012) observed alterations in pH, which initially increased, later decreased and remained stable.

The changes in mechanical and physical properties of the degraded material, as well as superficial structural deterioration are caused by microbial action (Restrepo-Flórez et al. 2014). One of the most precise devices for such measurements is scanning electron microscope (SEM), which scans the surface of a sample with focused beam of electrons, thus creating high resolution images. Therefore, SEM can be used to observe biodeterioration of topography and surface composition, but it lacks quantitative analysis, which can be provided with fluorescence microscopy (Harisson et al. 2018).

### **3.2.4 Standardized tests of biodegradation**

Standardized tests shall be comparatively analyzed based on different media in which biodegradation might take place. Authorized institutions like the Organization for Economic Co-operation and Development (OECD), the American Society for Testing and Materials (ASTM International) and the International Organization for Standardization (ISO) publish internationally recognized consensus standards, which are used by governments, industries, and independent laboratories to identify potential hazards and ensure safety and efficiency of various products and systems. Those biodegradation standards have predetermined criteria and steps which are followed to measure progress of biodegradation under set conditions. Each test varies, but in general, temperature, moisture, pH, and C/N ratio of the testing systems and its replicates are set to desired frames. This property greatly distinguishes standardized test from testing in the natural conditions, where minimum, or preferably no alterations are made. Even though some authors claim the opposite, standardized biodegradation tests are supposed to be

reliable, accurate and highly reproducible (Sommer et al. 1998; Briassoulis et Mistriotis, 2018, Rücker et al. 2008). Discrepancies between final results of duplicates can be explained by differences in the composition of the immersion matrix.

### Soil medium

The current state-of-the-art in the field of testing of biodegradability of polymeric materials in soil includes international standards ISO 17556:2019 (Plastics - Determination of the ultimate aerobic biodegradability of plastic materials in soil by measuring the oxygen demand in a respirometer or the amount of carbon dioxide evolved), equivalent to American ASTM D5988-18 (Standard test method for determining aerobic biodegradation of plastic materials in soil), and NF U52-001 (Biodegradable materials for use in agriculture and horticulture - Mulching products).

While ISO 17556:2019 and ASTM D5988-03 are designed to determine aerobic biodegradability of various plastics in contact with soil by measuring the oxygen consumption in a respirometer or the amount of evolved carbon dioxide, NF U52-001 by French Association for Standardization (AFNOR) focuses on increasingly popular biodegradable mulching products used in agriculture and horticulture (AFNOR, 2005; ASTM, 2018; ISO, 2019; Al-Salem et al. 2019). Selected test conditions are listed in Table 3.

**Table 3** Overview of standards for plastic biodegradation in soil medium (adapted from AFNOR, 2005; ASTM, 2018; ISO, 2019)

Standard	Inoculum	Condition	T (°C)	pH	Measurement indices	Test duration	Validity criteria
ISO 17556: 2019	Soil	Aerobic	24 ± 4	6-8	Oxygen demand; evolved CO <sub>2</sub>	6 months (max 2 years)	> 60 % biodegradation
ASTM D5988-18	Soil/soil + compost	Aerobic	21 ± 2	6-8	Oxygen demand; evolved CO <sub>2</sub>	Max 6 months	>70% theoretical CO <sub>2</sub> evolved
NF U52-001	Soil	Aerobic	24 ± 4	6-8	Evolved CO <sub>2</sub>	Max 12 months	> 60 % biodegradation

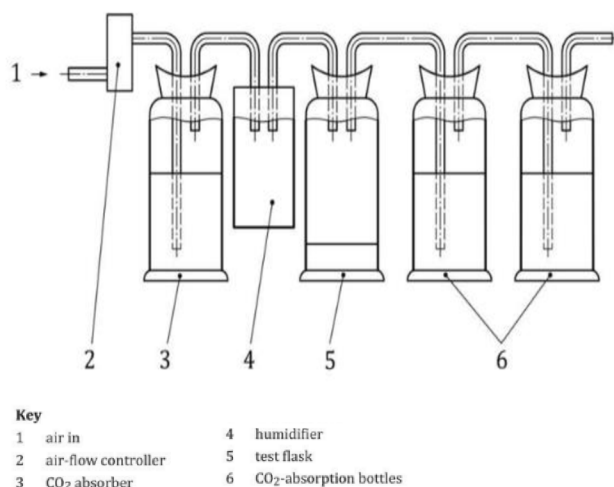
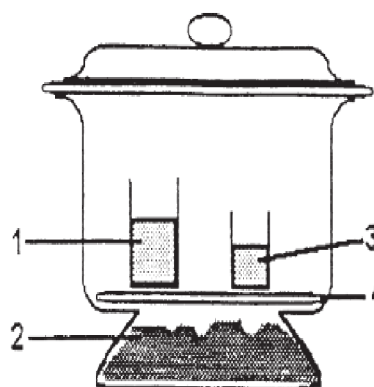

Fig. 8 Scheme of measuring evolved CO<sub>2</sub> (ISO, 2019)



Note 1—(1) Barium hydroxide solution or potassium hydroxide solution, (2) soil, (3) water, and (4) perforated plate.

Fig. 9 Soil-contact incubation apparatus (ASTM, 2018)

### Water bodies

Several standards by ISO and ASTM have been developed to test biodegradability in aqueous environment. Among the listed methods, ASTM D6691-09 (aerobic biodegradation of plastic materials in the marine environment by a defined microbial consortium or natural sea water inoculum) is the only standard used to specifically determine aerobic degradation of plastics in the halophilic inoculum, while other ISO standards, namely ISO 14851: 2019 (ultimate aerobic biodegradation of plastic materials in an aqueous system), ISO 14852:2021 (ultimate aerobic biodegradability of plastic materials in an aqueous medium), and EN ISO 9439:2000 (ultimate aerobic biodegradability of organic compounds in an aqueous medium) state the testing in different aqueous test media '*depending on the purpose of the test*'.

Provided standards are similar in terms of temperature, and test duration, with ISO 9439:2000 being the exception and lasting 28 days, while others can extend up to 180 days. For tests to be valid, biodegradation, tested either with CO<sub>2</sub> production or oxygen demand, has to be higher than 60% (Masoud, 2021; Al Salem, 2021). Selected test conditions are listed in Table 4.



**Table 4** Overview of standards for plastic biodegradation in water bodies (adapted from ASTM, 2009; ISO, 2019; ISO, 2021; EN ISO, 2000)

Standard	Inoculum	Condition	T (°C)	Measurement indices	Test duration	Validity criteria
ISO 14851:2019	Aqueous medium	Aerobic	23 ± 3	Oxygen demand	Max 6 months	> 60 % biodegradation
ISO 14852:2021	Aqueous medium	Aerobic	23 ± 3	Evolved CO <sub>2</sub>	Max 6 months	> 60 % biodegradation
EN ISO 9439:2000	Aqueous medium	Aerobic	20-25	Evolved CO <sub>2</sub>	28 days	> 60 % biodegradation
ASTM D6691-09	Marine environment	Aerobic	30 ± 1	Oxygen demand; evolved CO <sub>2</sub>	Max 6 months	> 60 % biodegradation

## Interface

ISO 19679:2020 (aerobic biodegradation of non-floating plastic materials in a seawater/sediment interface) is a specific standard standing in between solid and liquid phase. It measures aerobic biodegradation of non-floating plastics, i.e. plastics whose density is higher than seawater's density of approximately 1023.6 kg/m<sup>3</sup> at the interface between seawater and sandy sediment. Standard is performed under controlled laboratory conditions by measuring oxygen demand or evolved CO<sub>2</sub>. Figure 10 depicts setting of the experiment and simulates piece of plastic that had entered the sea and has fallen on the marine ground. Selected test conditions are listed in Table 5.

**Table 5** Overview of standard for plastic biodegradation at the interface (adapted from ISO, 2020)

Standard	Inoculum	Condition	T (°C)	Measurement indices	Test duration	Validity criteria
ISO 19679: 2020	Seawater/sediment interface	Aerobic	15-28°C	Oxygen demand; evolved CO <sub>2</sub>	Max 24 months	> 60 % biodegradation

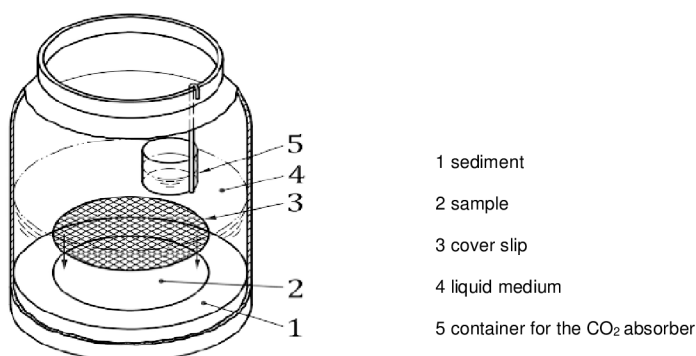

Fig. 10 Simulation of respirometric system of ISO 19679:2020 (ISO, 2020)

## Sludge

Standards ISO 13975:2012 (ultimate anaerobic biodegradation of plastic materials in controlled slurry digestion systems) and ISO 14853:2016 (ultimate anaerobic biodegradation of plastic materials in an aqueous system) are virtually the same in execution, with temperature being the distinguishing factor. Both are intended to assess ultimate anaerobic biodegradability of plastic materials by examining biogas production (carbon dioxide and methane). Tests are applicable to either natural or synthetic polymers, polymers containing various additive compounds e.g. dyes or plasticizers, but they exclude materials which might inhibit microorganisms present in the sludge inoculum. They might last for a period of maximum 90 days, and they're considered valid if the biodegradation of the tested material exceeds 70%. Selected test conditions are listed in Table 6.

Table 6 Overview of standards for plastic biodegradation in sludge (adapted from ISO, 2012; ISO, 2016)

Standard	Inoculum	Condition	T (°C)	Measurement indices	Test duration	Validity criteria
ISO 13975:2012	Sludge	Anaerobic	35 ± 3; 55 ± 5	Evolved CO <sub>2</sub> & CH <sub>4</sub>	Max 3 months	> 70 % biodegradation
ISO 14853:2016	Sludge	Anaerobic	35 ± 2	Evolved CO <sub>2</sub> & CH <sub>4</sub>	Max 3 months	> 70 % biodegradation

## Compost

Controlled composting tests imply biodegradation under aerobic conditions and high temperatures, with results being valid if exceeding 70% biodegradation. In order to maintain composting conditions, oxygen, moisture content, temperature and other parameters have to be monitored and kept within desirable limits.

ISO 14855:2012 (ultimate aerobic biodegradability of plastic materials under controlled composting conditions) and ASTM D5338-15 (aerobic biodegradation of plastic materials under controlled composting conditions) are considered the same, and the principle of the test is the measurement of evolved carbon dioxide from the polymeric material, merged with mature compost from the bioreactor (Funabashi et al. 2009). Selected conditions are listed in Table 7.

Table 7 Overview of standards for plastic biodegradation in compost (adapted from ISO, 2012;ASTM, 2015)

Standard	Inoculum	Condition	T (°C)	Measurement indices	Test duration	Validity criteria
ISO 14855:2012	Compost	Aerobic	58 ± 2	Evolved CO <sub>2</sub>	Max 6 months	> 70 % biodegradation
ASTM D5338-15	Compost	Aerobic	58 ± 2	Evolved CO <sub>2</sub>	Max 6 months	> 70 % biodegradation

## Current approaches for soil biodegradation

On top of the mentioned standardized test methods specially designed for biodegradation of plastic materials, OECD issued Guidelines for the Testing of Chemicals, used for regulatory safety testing and toxicology research (OECD 2006). The section 3, called Environmental fate and behavior deals with the topics of ready, inherent, and anaerobic degradability, and in the following table several standard methods shall be described.

Firstly, ready biodegradability under oxygen conditions is measured with six different methods of the OECD 301 standard. Test, which usually runs for 28 days, follows the principle of inoculating tested substance in aqueous medium and observing degradation by measuring parameters such as carbon dioxide evolution, chemical oxygen demand (COD) or dissolved organic carbon (DOC) for the tested sample, as well as reference duplicate or triplicate samples (OECD, 1992).

Furthermore, OECD 302 has three different methods for measuring inherent biodegradability, which differ in allowed test compound, execution of the test, measured

indices and test duration. Inherent biodegradability in soil is separated into another guideline OECD 304. Standard OECD 306 focused on biodegradability in seawater measures degradation rate over the period of 60 days by incubating dissolute test substance in the sea environment and measuring DOC. Finally, anaerobic biodegradability in sludge inoculum is measured using the OECD 311 standard test and its evolved gas method using. Selected test conditions are listed in Table 8.

**Table 8** Overview of OECD standards for biodegradation (adapted from OECD, 2003)

Standard	Inoculum	Condition	T (°C)	Measurement indices	Test duration	Validity criteria
OECD 301	Aqueous medium	Aerobic	20-26	Oxygen demand; evolved CO <sub>2</sub> /BOD	28 days	70% removal of DOC; 60% of ThOD or ThCO <sub>2</sub>
OECD 302	Aqueous medium	Aerobic	20-27	DOC; COD; BOD	28 or 365 days	> 70 % biodegradation
OECD 304	Soil	Aerobic	22 ± 2	Evolved CO <sub>2</sub>	Max 64 days	N/A
OECD 306	Sea water	Aerobic	15-20	DOC	Max 60 days	>70% DOC removal / >60% ThOD
OECD 311	Sludge	Anaerobic	35 ± 2	Evolved CO <sub>2</sub> and CH <sub>4</sub>	Max 60 days	> 60 % biodegradation

### 3.3 Face masks composition

Composition of disposable face masks varies greatly depending on their manufacturer. Eurostat lists 8 variants of facial protective equipment, split into 3 different groups: filtering facepiece (FFP2), respirator KN95, and disposable surgical masks (Eurostat, © 2021). Compositions of different face masks are given in Table 9. It is common practice to add various additives like dyes, biocides, antioxidants, flame retardants or plasticizers to inherently transparent PP to enhance desirable properties, however they are not stated in Eurostat’s composition report (Eurostat, © 2021). Such additives could persist in the environment or end up in the food chain (Karger-Kocsis, 1999; Tripathi, 2002). Moreover, rice paper mask by Marie Bee Bloom © (2021) is added to the table, as a representative of biodegradable masks. No official standardized biodegradation tests, nor certifications of biodegradability are publicly available to support the claim of this mask’s biodegradability.

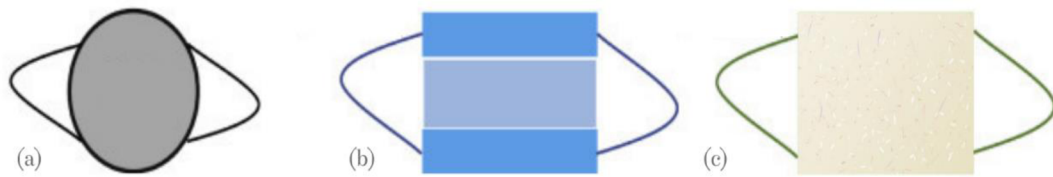

Fig. 11 Different types of masks: (a) respirator (b) surgical mask (c) rice paper mask  
(adapted from Selvaranjan et al. 2021)

Table 9 Composition of face masks (adapted from Eurostat, © 2021)

Mask type	FFP2	KN95	Surgical mask	Rice paper mask
Composition	100% PP non-woven fabric; 100% PP meltblown fabric; 100% PP spunbonded, hot air cotton; spandex and nylon ear band; aluminum nose bridge	Non-woven fabric; melt blown fabric; soft cotton	PP spunbond; PP meltblown	Rice paper; meadow mix seeds; sheep's wool; carton

From the material composition table it is evident that, excluding biodegradable masks, the protective gear is polymeric, mostly composed of polypropylene (PP). PP is synthetic organic polymer produced by polymerization of around 10,000-20,000 monomers of propylene, with the help of heat, high radiation energy or catalyst (Tripathi, 2002). Amorphous thermoplastics, like PP have disordered macromolecules, which make them easy to mould and thermally modify into fibers (Maddah, 2016). Further classification of plastics is given in Figure 12.

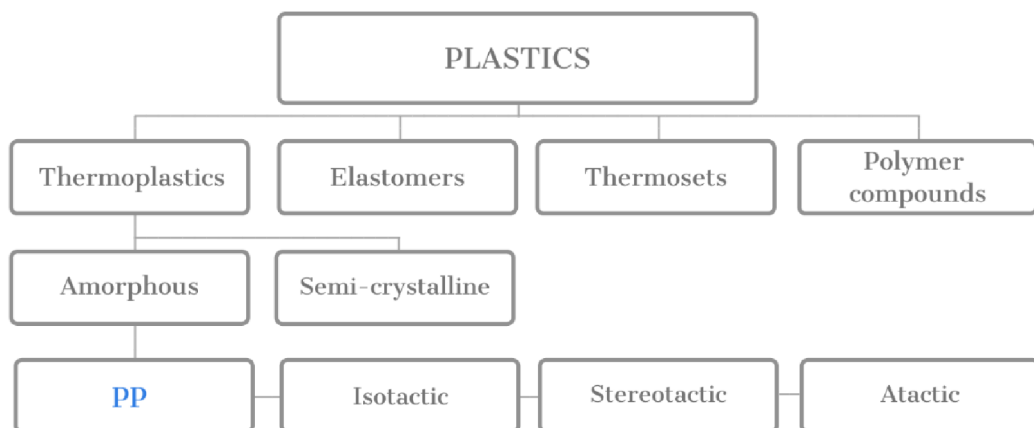

Fig. 12 Classification of plastics (adapted from Tripathi, 2002)

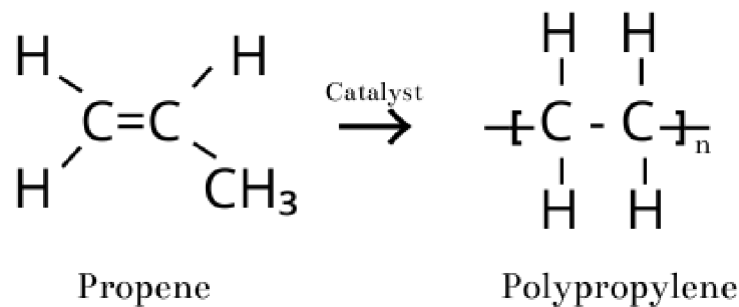

Fig. 13 Polymerization of propylene to polypropylene (adapted from Bhaiyat, 2017)

Polypropylene is known for its properties of durability, inertness, resistance to cracking and high temperatures, which make it a good material for hygienic masks. However, chemical and temperature resistance are a double-edged sword in the context of the environment, since they make PP highly resistant to biodegradation process, especially without pre-treatment with extra high temperatures or UV irradiation (Jeon et al. 2021). Moreover, ‘water-loving’ hydrophilic materials tend to degrade at a faster rate due to faster colonization of their surface by the microbes. PP is hydrophobic polymer showing very small water absorption capacity, and so far, only very limited number of bacteria is found to successfully participate in the degradation process. Among others, Mohanan et al. (2020) have identified *Aspergillus niger* from the plastic dumping site, *Sporosarcina globispora* from municipal compost waste, *Bacillus cereus* from mangrove sediments etc. to successfully participate in the biodegradation process of PP, with *Aspergillus* sp. having the highest efficiency and achieving 60% weight loss over 175 days.

Table 10 Selected properties of polypropylene (adapted from Tripathi, 2002)

Properties	PP fibers
Density	0.90-0.94 g/cm <sup>3</sup>
Reaction with water	Hydrophobic; 0.01% water absorption
Softening point	140-150°C
Melting point	160-175°C
Decomposition temperature	>300°C

## 4. Methodology

Experimental set-up of this thesis is based on the adjustment of standardized test ASTM D5988-18, and its equivalent ISO 17566:2019, with added or replaced methodological steps, which are described in the following sections. Test method consists of implementation of practical part carried out in the laboratory under natural conditions. The thesis is based on the hypothesis that selected face masks exhibit certain biodegradability rate. The methodological section is divided into three parts, thus covering three aspects of the experiment: tested PPE, inoculum, and setting of biodegradability test itself.

### 4.1 Preparation of test material

On September 27, 2021, testing media – three different face masks (respirator FFP2, surgical mask, rice paper mask) – were prepared for the experimental setting. Rice paper mask served as a reference biodegradable material. Composition of PPE is given in Table 9, but in general it is PP for respirator and surgical mask, rice paper for biodegradable mask. Non-used masks were used for the purpose of testing to avoid potential contamination (Figure 14). PPE was not UV pre-treated, additionally sterilized, cut into smaller pieces, nor dissolved, but simply put into 2,000 ml glass jars with soil medium after weighting to simulate natural conditions in which masks are often discarded intentionally or unintentionally, thus ending on the ground.



Fig. 14 Test material: a) respirator b) surgical face mask c) biodegradable face mask

## 4.2 Inoculum preparation

Due to aforementioned reasons, biodegradability of selected face masks was tested in soil medium. Besides soil characteristics, geological-pedological data was evaluated. Soil was sampled from forest Tiché Údolí, with given WGS84 coordinates: 50°08'46.6"N, 14°23'27.8"E. Tiché Údolí is a terrestrial nature protected area covering 1.12 km<sup>2</sup> and extending over Suchdol district in Prague, North part of Sedlec and South part of Roztoky.

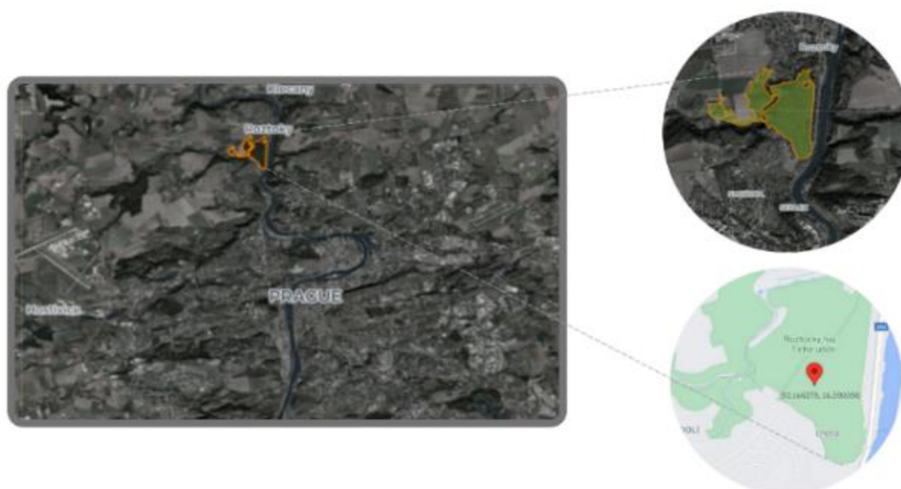

Fig. 15 Sampling location (DOPA Explorer, 2021; Google Maps, 2021)

Since it is found that after disposal plastic typically remains at soil depth of around 0.30 m, in total 8 kg of soil from Tiché Údolí was sampled below the organic (O) horizon at 27 cm depth using plastic bucket and a shovel (Ardisson et al. 2014). Upon extracting, soil was not manipulated with high heat, stored for significant periods of time, nor supplemented with nutrients, to avoid potential alteration of its biological composition, and consequently affecting testing results (Pramer et Bartha, 1972). Immediately after the sampling, soil medium was processed and refined in the laboratory. Screening through 5 mm sieve to discard larger stones or branches was followed by determining physical and biochemical properties of soil, which shall be presented in the following chapter.





Fig. 16 Inoculum preparation: a) soil sampling at Tiché Údolí b) soil sieving

#### 4.2.1 Soil properties

According to Soil Atlas of ČZU (2019) and BPEJ (2019) the very bottom of nature park is filled with a very thick layer of clay sediments. Cambisol, a shallow and infertile soil prevails above it (Kubíková et Molíková, 1980). However, it still supports forest of hornbeam (*Carpinus betulus*), winter oak (*Quercus petraea*) and summer oak (*Quercus robur*), which covers 77% of Tiché Údolí, and belongs to Central European mixed forests ecosystem. Available mean soil organic carbon data of 2.198 mg further supports fact about low fertility (DOPA Explorer, ©2021).

As for soil physical properties, color, texture and structure were visually examined, while moisture and dry matter content were measured with moisture meter and drying oven, and shall be presented in chapter 5, together with soil reaction i.e. pH, and microbial respiration. According to Munsell (2009) color chart, soil's brown color with very subtle yellowish-reddish subtone would best fit to 4/3 value and chroma on 10 YR Diagram. Cambisol samples are characterized by sandy loam texture and granular structure.

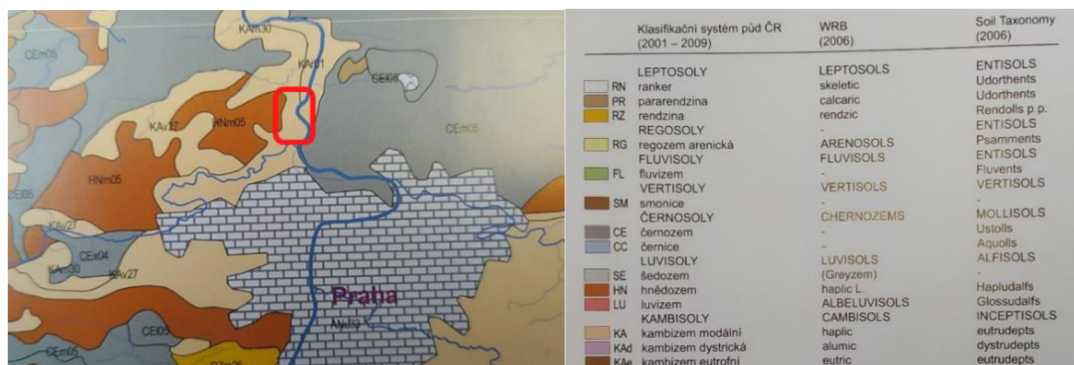

Fig. 17: Soil map (ČZU, 2019)

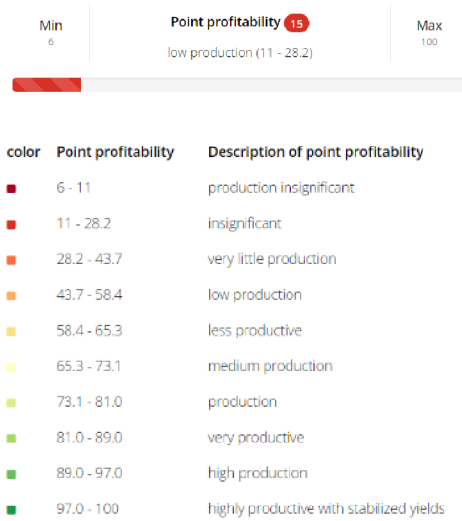

Fig. 18: Low production capacity of soil in Tiché Údolí  
(DOPA Explorer, ©2021)



Fig. 19: Vegetation of Tiché Údolí

### 4.3 Biodegradability test

On October 6, 2021 each out of total six glass jars received 1.2 kg of sampled soil. Duplicates of 3 different PPE (respirator, surgical mask, and biodegradable mask) were placed in the core of jars and completely buried inside. Interaction of material and soil was observed over the next 20 weeks, while keeping the experimental setting in thermostat at  $20 \pm 2^\circ\text{C}$  in the dark. Over the experimental time of 144 days, seven measurement points every three weeks on average were made in order to analyze the ability of face masks to biodegrade under aerobic conditions by expressing: change in pH of soil, dry matter, moisture and nutrient levels, microbial activity, weight loss and structural changes of tested face masks, FTIR analysis.



Fig. 20 Scheme of mask burial

### 4.3.1 Weight measurement

Estimation of weight change represents the most straight-forward physical indicator of biodegradation. Weight loss usually follows microbial surface erosion processes, which occur in the first stage of biodegradation process, after which deeper microbial attacks happen (Vieyra et al. 2013). During the experiment, two methods of determining weight loss were used:

- I. 'all-together' method
- II. 'individual' method

In the first method, weights of entire jars with soil and buried face masks were measured, and recorded in a table, which was expressed in percentage (%) of weight change in comparison to initial weight from the week 1. Weight loss was calculated according to the equation below. Real weight indicates real weight of the jar with soil and face mask at the end of each measurement, while expected weight indicates theoretical weight that should have occurred taking into account loss of soil caused by cumulative samplings for dry matter and titration measures. Therefore, cumulative loss of soil per each measuring week consisted of summed up losses of soil for respiration and DM measurements until that measuring week.

$$\text{Weight loss (\%)} = \frac{W - W_0}{W} \cdot 100 \quad \text{where: } W - \text{real weight (g)}$$
$$W_0 - \text{expected weight (g)}$$

Second method consisted of extracting the buried face mask, thorough dusting, and weighting them on a scale, recording the values. Weight of the mask was observed through the weeks, and final weight loss, after drying the masks for 8 hours at 35 °C in the oven was calculated according to the following equation:

$$\text{Weight loss (\%)} = \frac{W_0 - W}{W_0} \cdot 100 \quad \text{where: } W_0 - \text{initial dry weight (g)}$$
$$W - \text{weight after degradation (g)}$$

### 4.3.2 pH

Soil reaction i.e. pH was measured with the multi-parameter portable meter of MultiLine® Multi 3620 IDS (WTW, Germany) at five different points, with accompanying temperature values. Probe was inserted into each jar after the mask has been removed, and once the values stabilized, all of them were recorded in a table. Final results represent mean value of measurements under mean temperature of soil.

Soil-microbe relationship is reciprocal, meaning that soil pH does effect microorganisms present in it, but microbes also do effect soil pH and change their micro-habitats (Joutey et al. 2013). Moreover, optimum pH for all biodegradation processes does not exist, but it depends on the microorganism's demand and optimum conditions under which they are able to operate.

### 4.3.3 DM, moisture content

Dry matter testing was conducted using soil, petri dishes, scale, and an oven. Marked Petri dishes with 5 g of soil each were measured on a scale. Petri dishes with soil were transferred into the oven on 70°C for 24 hours overnight, after which they were allowed to cool. The weight after the drying was determined again. Dry matter content (DM) was calculated using the equation:

$$DM (\%) = (MD / MW) \cdot 100$$

where: DM - dry matter content (%)  
MD - weight of the dried sample (g)  
MW - weight of the original sample (g)

Dry matter content indirectly gives information about soil moisture; however, it is possible to obtain results of relative moisture content directly with moisture-measuring instrument. To do so, the probe of testo 635 temperature and humidity measuring instrument (testo, Czech Republic) was inserted into the soil at five different points, and the final result of percentage of relative moisture content and accompanying temperature represent mean value of five measurements.

Alongside pH, soil moisture is crucial for microbes, and successful biodegradation. While lack of moisture causes decreased rates of decomposition since organisms need water to survive, excess of moisture lowers soil aeration, and cause lack of oxygen to the organisms, which again slows down decomposition process.



Fig. 21 pH and moisture measurements

#### 4.3.4 C/N content

After drying soil samples in the oven for DM measurement, they were grinded using porcelain pestle and mortar, and transferred in plastic tubes for further analysis of total carbon (TC) and total nitrogen (TN) using Primacs TOC/TN (Skalar Analytical, the Netherlands) by Dr. Adam Sochacki, Department of Applied Ecology. Soil was not supplemented with additional nutrients, but solely changes in carbon and nitrogen concentrations were observed, since carbon and nitrogen are essential nutrients for biodegradation process. During biodegradation C is utilized as a food source for microbes, while N plays an important role for enzyme production (Ardisson et al. 2014). Carbon to nitrogen ratio was calculated using the equation:

$$C/N = \frac{TC (\%)}{TN (\%)}$$

where: C/N - carbon to nitrogen ratio

TC (%) - carbon content

TN (%) - nitrogen content



Fig. 22 Preparing soil for C/N analysis

### 4.3.5 Biological activity

Biological activity was determined with titration process, which measures microbial soil respiration, alongside passive CO<sub>2</sub> Dosi-tubes (Gastec no. 2D). Used test methods based on respirometry were adapted from various aforementioned standardized tests for measuring biodegradability.

#### Dosi-tubes

Gastec carbon dioxide passive Dosi-tubes are intended for measuring time-weighted average (TWA) gas concentration by utilizing natural diffusion of CO<sub>2</sub> without a gas sampling pump. Measurement was done by breaking Dosi-tube at the breaking line, and placing it horizontally onto the soil in the glass jar with buried face mask. When minimum 30 minutes, and maximum 10 hours have passed, Dosi-tubes were ready to be read. Initial color changes from red to yellow, and indicates Dosi-tube reading (% · hour). Average gas concentration was calculated using the equation:

$$\text{Average concentration (\%)} = \frac{\text{Dosi - tube reading (\% \cdot \text{hour})}}{\text{Sampling time (hours)}}$$

Tubes should be kept away from direct sunlight in dark and cool place, and used within temperature range 0 - 40°C. Correction factors for different temperatures are given in Table 11.

Table 11 Temperature correction for the passive Dosi-tubes no. 2D (Gastec, 2018)

Temperature (°C)	0	5	10	15	20	25	30	35	40
Correction Factor	1.3	1.25	1.2	1.1	1.0	1.0	1.0	0.95	0.9



Fig. 23 Observed color change from red to yellow

### Titration method

PPE in soil served as a carbon source which microorganisms metabolize to carbon dioxide during respiration process. Amount of evolved gas, therefore, might serve as an indicator of biodegradation and consumed test specimens (Ghatge et al. 2020). Methodology utilized in the measurement of evolved carbon dioxide consisted of the absorption of gas in alkaline solution of potassium hydroxide (KOH), and titrating with hydrochloric acid (HCl) to the indicator phenolphthalein (C<sub>20</sub>H<sub>14</sub>O<sub>4</sub>) end-point.

To perform the test, 50 g of soil sample was moistened with 10 ml of distilled water, and placed in a sealable container. Petri dish with 10 ml of 0.1 M KOH and 2 drops of phenolphthalein was placed on top of each soil sample, and the container was air-tightly closed and incubated in the thermostat at a temperature of 20±2°C for 24 hours. After incubation period, entire content from petri dish was transferred to the titration flask. To make sure there were no residues of liquid, petri dish was rinsed twice more with distilled water, which was also added to the titration flask. One ml of the aerated BaCl<sub>2</sub> solution, which makes the solution blurry, was added to the titration flask and the suspension was titrated with a solution of 0.1 M HCl until the color changes from pink or blurry to colorless. Used amounts of hydrochloric acid per each sample were recorded. Blank test was prepared in the same way, but without soil sample in the plastic container.

To evaluate the test, difference between titration amounts of control and soil samples was determined. Since it is assumed that 1 ml of 0.1 M KOH binds 2.2 mg of CO<sub>2</sub>, respiration per 50 g of soil with determined dry matter per 24 hours was calculated using the equation:

$$\text{Respiration (mg CO}_2\text{)} = (\text{control} - \text{soil sample}) \cdot 2.2 \text{ mg CO}_2$$

Results were recalculated to 100 g of soil with 100% DM per 24 hours simply by multiplication of results and ratio calculus. Final evaluation was based on Table 12.

Table 12 Evaluation of respiration (Žáčková et Čepeláková, 2006)

Result	Evaluation
<5	Weak
5 – 10	Small
10 – 40	Medium
40 – 150	Strong
>150	Very strong

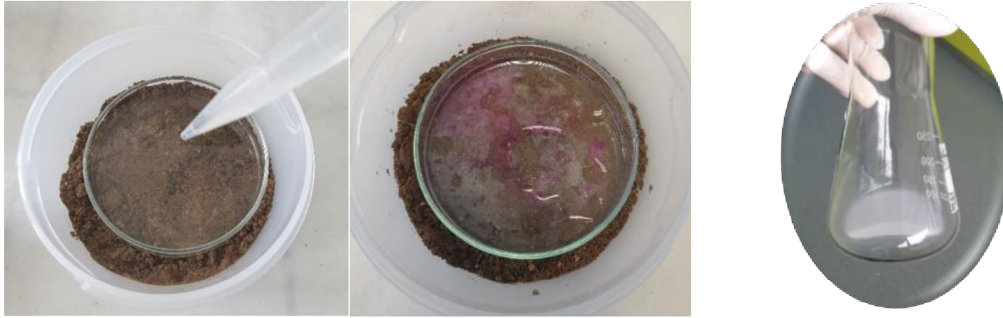

Fig. 24 Respiration measurement: a, b) before and after adding phenolphthalein  
c) blurry suspension after barium chloride addition

#### 4.3.6 Microscope observations

After the biodegradability assessment experiment termination, face masks were well undusted and put into clean Petri dishes to dry for 8 hours at 35°C. Comparing to original surgical mask and respirator, structural changes of test materials were observed using the optical stereomicroscope MSZ 5000-T-IL-TL, and video camera VOPC93 USB 2.0 (A. Krüss Optronik GmbH, Germany). Face masks were observed at expansion of 10 × 4 (enlargement of 40×) under the UV-Vis light using either transparent or black pad, as needed. Since microbial strains can deteriorate polymers' structure, or form a biofilm on their surface, any signs of changes in the form of holes, discoloration or erosion were observed (Ghatge et al. 2020).



Fig. 25 Used microscope equipment



#### 4.3.7 FTIR analysis

Fourier transform infrared spectroscopy (FTIR) is one of the techniques used for evaluation of degradation processes of tested face masks. It is based on absorbance of infrared radiation at a characteristic frequency, which gives information about structural characteristics of tested material (Kotova et al. 2021). Moreover, FTIR is used to detect intermediate products that occur during degradation process, which make it one of the common tools in biodegradability assessments.

Analysis was performed using FTIR Nicolet iS20 instrument with Omnic Spectra software by Dr. Martin Lexa, Faculty of Forestry and Wood Sciences, Department of Wood Processing and Biomaterials. Test enabled material analysis, alongside graphical representation of spectra, which is unique to distinctive chemical make-up of tested face masks. Moreover, standard curves of original, non-tested samples were compared with curves of tested samples in an attempt to observe degradation based on changes in the spectra.

### 5. Results

Findings presented in this thesis are based on the experimental work that was conducted in September 2021 and lasted until March 2022.

In the following results Jar I, II indicate duplicate jars containing soil with respirators, III and IV soil with surgical face masks, while V and VI stand for jars with soil and rice paper face masks. Results were observed on week 0 (pre-experiment week), 1st (starting week), 3rd, 5th, 7th, 10th, 15th, 20th (final week), 21st (week after completion of the experiment), as needed.

## 5.1 Weight measurement

### I. 'all-together' method

The following table was expressed in percentage (%) of weight change in regard to the initial weight, taking into account lost portion of soil that was taken for measurement of DM content, and respiration process, e.g. cumulative portion of soil that was lost for week 20 = cumulative 0.12 kg from week 10 (5 g from DM from week 3+ 5 g from DM from week 5 + 50 g from respiration from week 5 + 5 g from DM from week 7 + 5 g from DM from week 10 + 50 g from respiration from week 10) + 5 g soil for DM at the end of week 15 + 50 g soil for respiration from week 15 = 0.175 kg. Observed weight loss is negligible, and could be easily attributed to accidental soil losses during dusting procedures.

Table 13 Weight change from initial weight - 'all-together' method

Weight $\Delta$ from initial weight (%)	Week 1 (Initial weight)	Week 3	Week 5	Week 7	Week 10	Week 15	Week 20
Jar I	2.162 kg	/	- 0.23	- 0.43	- 0.62	- 0.78	- 1.12
Jar II	2.155 kg	/	- 0.18	- 0.33	- 0.34	- 0.49	- 0.86
Jar III	2.147 kg	/	- 0.09	- 0.34	- 0.70	- 0.79	- 0.97
Jar IV	2.144 kg	/	/	- 0.09	- 0.67	- 0.45	- 0.76
Jar V	2.146 kg	/	- 0.09	- 0.28	- 0.71	- 0.79	- 1.13
Jar VI	2.148 kg	- 0.13	- 0.23	- 0.43	- 0.90	- 0.94	- 1.17



Fig. 26 Weight change – 'all-together' method

## II. 'individual' method

Table 14 summarizes recorded weights of face masks during 20 weeks. Week 21 represents weight of masks after finalizing the experiment, and drying them for 8 hours at 35 °C. Final weight loss was calculated according to the formula given in chapter 4.3.1. Even though hydrophobic in nature, all of the polymeric masks, alongside biodegradable rice paper masks, showed weight increase due to accumulation of moisture from soil. After initial increase, the weight of water-saturated masks started to go down again between week 5 and 7. Final measurements done after drying PPE showed that respirators I, II did not undergo any weight loss, surgical face masks I, II lost 1 g each, or 0.29% and 0.28% of their weight respectively, while biodegradable masks I, II exhibited the highest loss of 9.70% for biodegradable mask I, and 9.33% for biodegradable mask II. Carton part of rice paper masks detached and disappeared completely in the process.

Table 14 Weight throughout the weeks – 'individual' method

Weight (g)	Week 1 (Initial weight)	Week 3	Week 5	Week 7	Week 10	Week 15	Week 20	Week 21 (final weight)
Respirator I	5.93	6.62	6.67	6.37	6.36	6.36	6.42	5.93
Respirator II	6.50	6.72	6.80	6.79	6.84	6.85	6.94	6.50
Surgical face mask I	3.49	3.89	3.93	3.78	3.86	3.76	3.79	3.48
Surgical face mask II	3.63	4.19	4.05	3.86	3.85	3.95	4.13	3.62
Biodegradable face mask I	2.37	3.45	2.87	2.51	2.51	2.50	2.51	2.14
Biodegradable face mask II	2.25	3.11	2.86	2.47	2.47	2.46	2.33	2.04

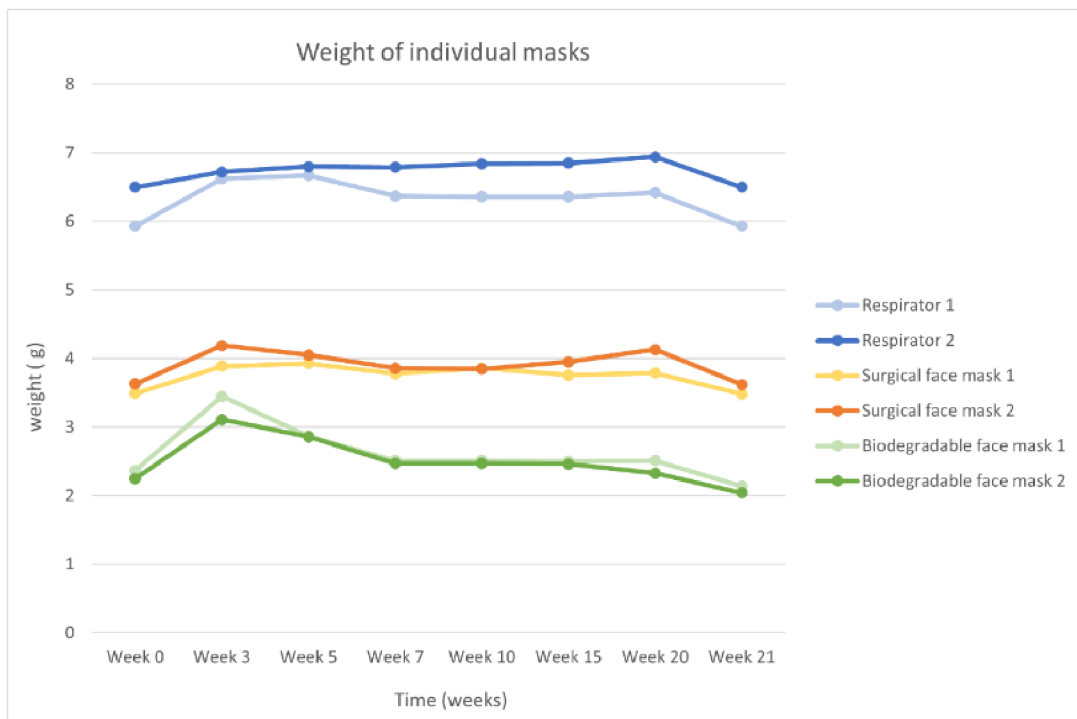

Fig. 27 Weight change of tested PPE

## 5.2 pH

Initial hydrogen ion concentration (pH) of soil matrix was rather acidic with mean pH of 3.5 at 21°C, which affected biodegradation activity overall, since near-neutral pH usually causes increase in most microbial populations, soil enzyme activities and adenosine triphosphate (ATP) levels. Lower soil pH usually indicates fungi, rather than bacteria prevalence, and furthermore can slow down nutrient release (Rousk et al. 2009; Rousk et al. 2010). All tested soil samples underwent initial increase from acidic pH of 3.5 from starting week to week 3, and subsequent fluctuations, as a result of microbial activity. Alterations are explained by the effect of different set of byproducts and wastes produced by the microbes during growth and metabolism under different pH conditions.

Effect of biological cultures on the pH of soil inoculum is presented graphically in the form of soil pH per each duplicate jar. Appendix 1 contains all recorded values of pH, whereas Table 15 presents mean values of pH per each jar.

Table 15 pH of soil

pH at T (°C)	Week 0	Week 3	Week 5	Week 7	Week 10	Week 15	Week 20
Jar I	3.5 ± 0.24 at 21 ± 0.11  (starting pre-experiment point)	4.0 ± 0.89 at 17.0 ± 0.72	4.7 ± 0.44 at 17.4 ± 0.45	4.6 ± 0.43 at 18 ± 0.31	4.5 ± 0.16 at 18.2 ± 0.2	4.7 ± 0.31 at 19.2 ± 0.48	4.8 ± 0.21 at 18.3 ± 0.63
Jar II		4.4 ± 0.20 at 17.5 ± 0.41	4.5 ± 0.13 at 18.8 ± 0.45	4.8 ± 0.30 at 18.7 ± 0.3	4.3 ± 0.05 at 18.4 ± 0.3	4.9 ± 0.24 at 18.5 ± 0.27	4.6 ± 0.17 at 18.9 ± 0.59
Jar III		4.7 ± 0.22 at 18.3 ± 0.29	4.2 ± 0.01 at 19.3 ± 0.09	4.7 ± 0.26 at 19.2 ± 0.12	4.1 ± 0.28 at 18.9 ± 0.3	5.0 ± 0.18 at 19.6 ± 0.09	4.7 ± 0.2 at 19.3 ± 0.16
Jar IV		4.4 ± 0.19 at 20 ± 0	4.3 ± 0.06 at 19.6 ± 0.15	4.3 ± 0.14 at 19.7 ± 0.07	4.4 ± 0.26 at 19.5 ± 0.4	4.8 ± 0.23 at 20 ± 0.07	4.6 ± 0.22 at 19.7 ± 0.44
Jar V		4.3 ± 0.11 at 20 ± 0.26	4.2 ± 0.43 at 20 ± 0.15	4.5 ± 0.29 at 19.8 ± 0.22	4.1 ± 0.08 at 20.5 ± 0.15	4.6 ± 0.13 at 20.8 ± 0.15	4.6 ± 0.28 at 21.1 ± 0.07
Jar VI		4.3 ± 0.12 at 20 ± 0.05	4.1 ± 0.13 at 21.5 ± 0.28	4.7 ± 0.31 at 20.9 ± 0.14	4.4 ± 0.3 at 20.5 ± 0.13	4.7 ± 0.2 at 21.6 ± 0.05	4.8 ± 0.27 at 21.2 ± 0.18

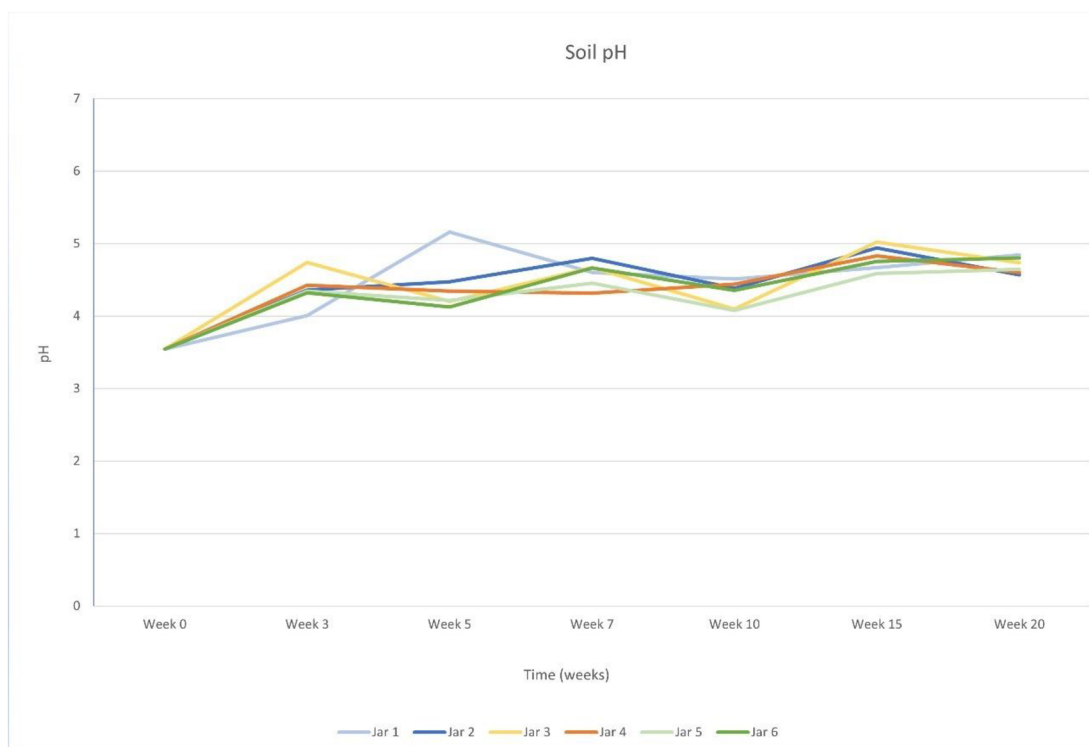

Fig. 28 Soil pH fluctuations

### 5.3 DM, moisture content

Negative correlation between dry matter and weight of all tested masks between week 0 and week 3 was observed. As DM decreased, weight of masks increased, supporting the fact that masks absorbed moisture from soil. After initial decrease, DM fluctuated, but did not change significantly. Overall, relative moisture content increased from starting point in week 0. Having in mind that end products of aerobic biodegradation are CO<sub>2</sub> and water, these results suggest that, even though at a very small level, the process of biodegradation started occurring. Table 16 presents DM (%) of soil. Appendix 2 contains all recorded values of relative moisture, whereas Table 17 presents mean values of relative moisture content (%) of soil.

Table 16 Dry matter content of soil

DM (%)	Week 0	Week 3	Week 5	Week 7	Week 10	Week 15	Week 20
Jar I	94.54 (starting pre-experiment point)	90.8	92.2	93.2	93.4	93.8	94.4
Jar II		93.2	91.6	93	92.8	93.2	94.4
Jar III		91.6	91.2	92.8	92.4	94	94.8
Jar IV		91.8	92.8	92.6	93	93.6	93.8
Jar V		92	92.8	93	93.1	94.2	94.2
Jar VI		92.4	93	92.6	93	94	94.2

Table 17 Relative moisture content of soil

Relative moisture content (%) at T(°C)	Week 0	Week 3	Week 5	Week 7	Week 10	Week 15	Week 20
Jar I	3 ± 0 at 21.8±0 (starting pre-exp. point)	3 ± 2.13 at 16.7±0.08	5.66±4.56 at 17.54±0.54	8.24±2.32 at 18.5±0.67	7.26±5.44 at 18.42±0.66	8.62±2.79 at 19.48±0.53	8.42±4.82 at 18.06±0.68
Jar II		10.78± 4.18 at 18.52 ±0.63	5.6± 4.03 at 18.48±0.22	8.16±4.72 at 19.34±0.43	8.6± 1.86 at 18.94±0.52	6.24±4.47 at 18.64±0.54	4.32 ±3.85 at 18.74±0.22
Jar III		5.78 ± 5.59 at 18.7±0.32	6.2 ±2.44 at 19.5±0.14	8.16±4.05 at 19.48±0.40	8.66±2.33 at 19.34±0.57	7.08 ± 4.59 at 19.3±0.28	3.46 ±2.31 at 19.34±0.23
Jar IV		8.32 ± 2.22 at 20.08±0.15	6.44±2.97 at 19.76±0.15	4.24±2.34 at 19.84±0.15	7.04±2.81 at 19.96±0.30	4.46±2.73 at 19.86±0.23	2.98 ±1.71 at 19.72±0.19
Jar V		8.08 ± 3.36 at 20.22±0.17	5.8± 2.56 at 20.38±0.13	1.56 ±1.05 at 19.7±0.1	5.28±0.65at 20.5±0.39	7.84±3.56 at 21.12±0.31	3.38 ±1.25 at 21.04±0.05
Jar VI		9.92 ± 4.0 at 20.6±0.38	3.83±2.41 at 21.08±0.08	4.38 ± 2.36 at 20.9±0.21	5.48±2.39 at 20.56±0.24	6.9 ±2.93 at 20.52±2.52	4.02 ±1.37 at 21.04±0.05

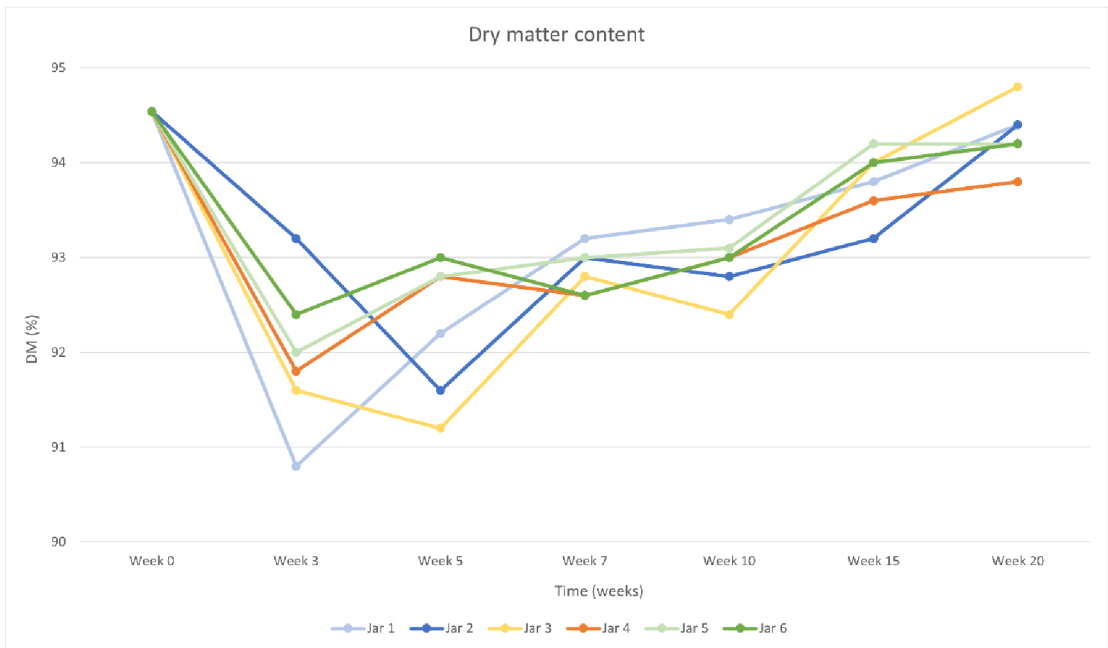

Fig. 29 Dry matter content of soil

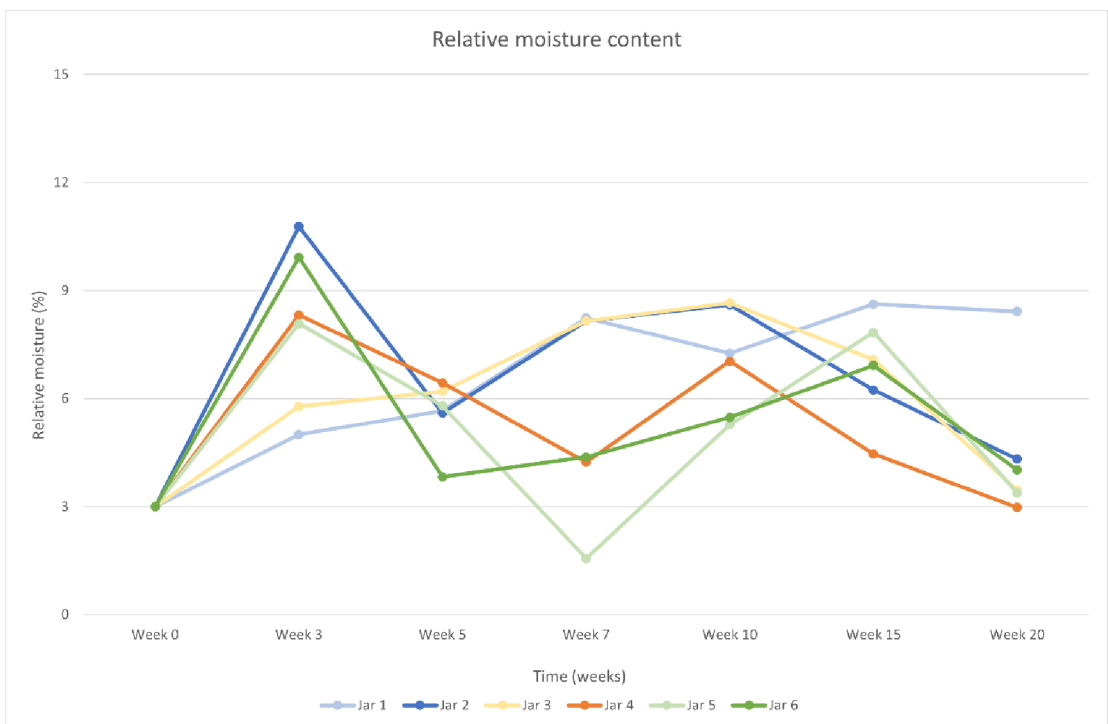

Fig. 30 Relative moisture content of soil

## 5.4 C/N content

Generally accepted best soil C/N ratio for most microorganism ranges between 20:1-40:1. Initial ratio for processed soil in this experiment was 132:1. Higher C:N ratio indicated longer time to decompose organic materials because of potential microbial immobilization (Chandra et Rustgi, 1998). Over the course of weeks, percentage of carbon decreased very slightly, while N increased, which caused C/N ratio to decrease significantly.

Table 18 Percentage of soil C and N

Sample	Week 0		Week 3		Week 5		Week 7		Week 10		Week 15		Week 20	
	C %	N %	C %	N %	C %	N %	C %	N %	C %	N %	C %	N %	C %	N %
Jar I	3.97	0.03	3.94	0.04	4.09	0.04	4.72	0.07	3.37	0.13	3.97	0.20	3.95	0.09
Jar II			4.17	0	4.19	0.04	3.83	0.13	3.76	0.22	4.08	0.04	3.65	0.21
Jar III			3.81	0.08	4.70	0.05	4.36	0.13	4.87	0.21	3.92	0.11	3.71	0.20
Jar IV			3.74	0.05	4.09	0.04	4.34	0.06	3.83	0.14	3.93	0.11	3.44	0.22
Jar V			4.14	0.07	3.39	0.07	4.08	0.13	3.46	0.21	3.42	0.12	3.85	0.22
Jar VI			4.15	0	4.50	0.04	4.34	0	4.03	0.23	4.36	0.15	3.98	0.23

Note: LOQ (limits of quality) were 2.69% for C and 0.23% for N, which obeys the standardized preciseness set for the used analytical method. LOD (limits of detection) were 0.81% for C and 0.07% for N, which shows that the N content was below the LOD of the used analytical method most of the time of the experiment.

Table 19 Soil C/N ratio

C/N	Week 0	Week 3	Week 5	Week 7	Week 10	Week 15	Week 20
Jar I	132:1 (starting pre-experiment point)	99:1	117:1	73:1	26:1	20:1	44:1
Jar II		42:1	105:1	30:1	17:1	102:1	17:1
Jar III		47:1	94:1	35:1	23:1	36:1	19:1
Jar IV		75:1	91:1	72:1	27:1	36:1	16:1
Jar V		59:1	48:1	31:1	16:1	29:1	18:1
Jar VI		42:1	99:1	44:1	18:1	29:1	17:1



## 5.5 Biological activity

### Dosi-tubes measurement

Calculated concentrations of TWA of CO<sub>2</sub> are given in Table 20. It is possible to observe that with time flow concentrations of evolved carbon dioxide decreased after initial increase, which indicated stronger microbial activity in the beginning, and its suppression throughout the weeks. Fall in the activity might be explained with change of abiotic conditions (pH, moisture, nutrient availability.)

Table 20 TWA of CO<sub>2</sub> concentrations from air in jars

CO <sub>2</sub> (%)	Week 0	Week 1	Week 3	Week 7	Week 10	Week 15	Week 20
Jar I	0.24 (starting pre-experiment point)	0.28	0.17	0.09	0.11	0.11	0.10
Jar II		0.26	0.18	0.12	0.09	0.14	0.09
Jar III		0.25	0.17	0.10	0.10	0.10	0.10
Jar IV		0.30	0.18	0.10	0.10	0.12	0.09
Jar V		0.35	0.14	0.11	0.11	0.11	0.11
Jar VI		0.38	0.14	0.09	0.09	0.09	0.13

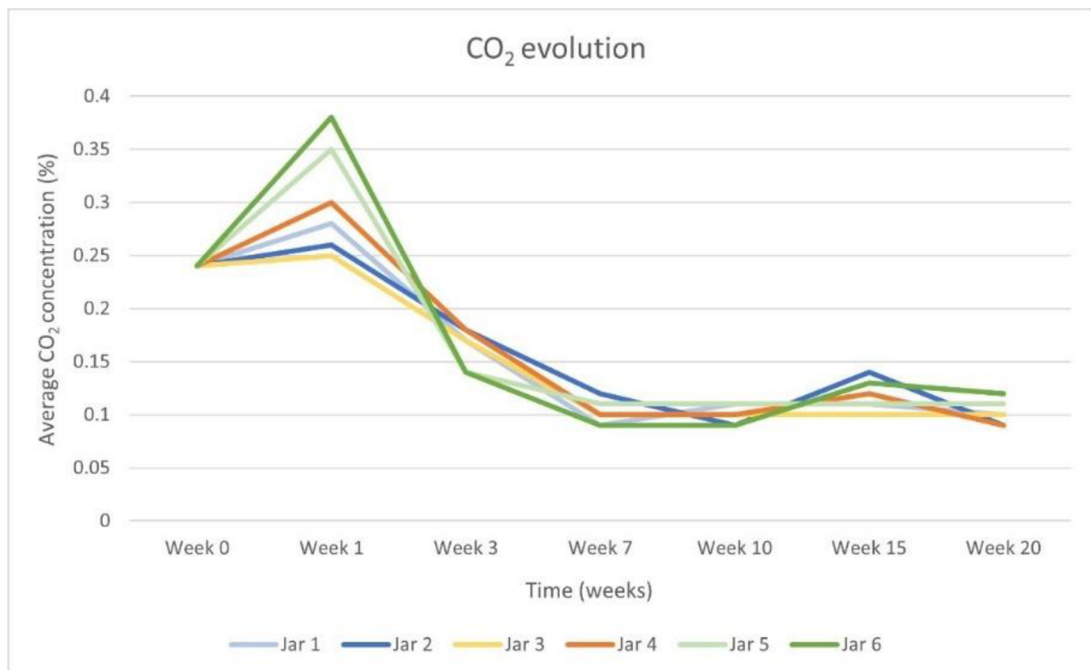

Fig. 31 TWA of CO<sub>2</sub> concentrations from air in jars - Dosi-tubes

## Titration

Respirometric tests of CO<sub>2</sub> production indicated weak respiration (results < 5). Some results were negative because of very low to no respiration, and therefore marked as 0. Same as for passive Dosi-tubes, carbon dioxide levels were lowering as time went by.

Table 21 Soil respiration (mg CO<sub>2</sub> per 100 g of soil per 24 h)

Respiration per 100 g of soil w/100% DM per 24h (mg CO <sub>2</sub> )	Week 0	Week 5	Week 10	Week 15	Week 20
Jar I	1.908 (starting pre-experiment point)	1.049	0	0	0.186
Jar II		0.808	0	0	0
Jar III		0.897	0.972	0.421	0.418
Jar IV		0.711	0	0	0
Jar V		0.878	0	0	0
Jar VI		0.911	0.526	0	0

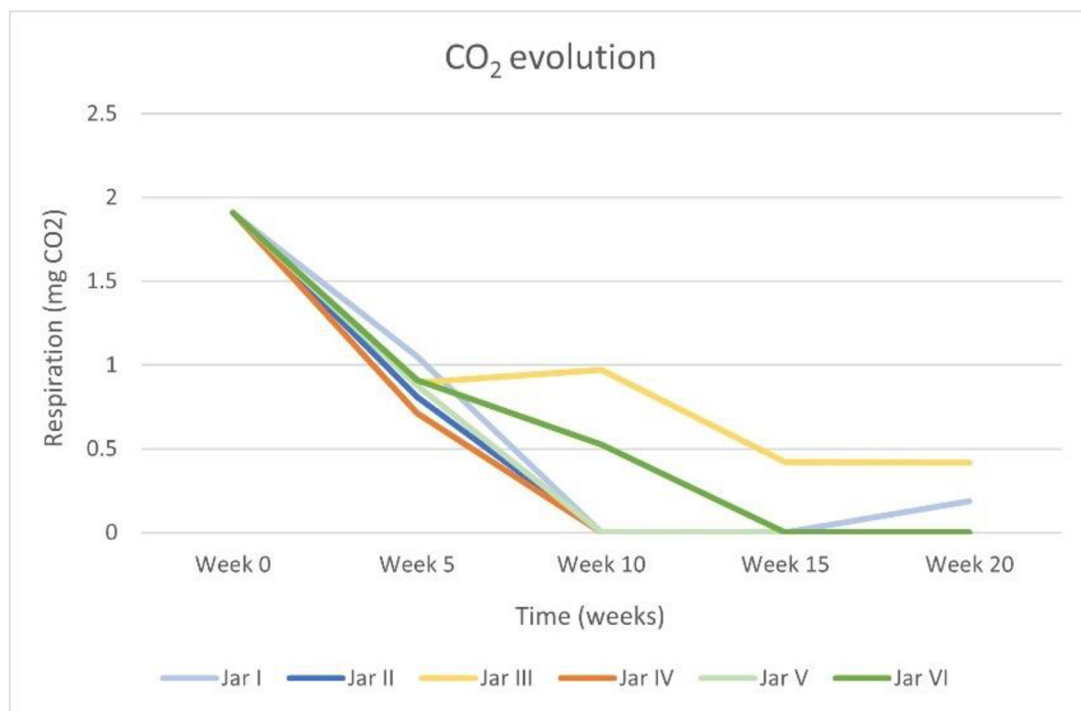

Fig. 32 CO<sub>2</sub> concentrations from soil in jars – Respiration

## 5.6 Microscope observations

Minor structural changes have been observed upon completion the experiment, drying and comparing all tested face masks, except biodegradable, with the original. In the case of respirator (Fig. 34), it can be noticed that microfibers changed color into green, which indicates influence of organic matter and acids, e.g. humic acid, which usually constitutes soil. Similar discoloration, but in lesser extent, was observed for respirators' inner structure of ear bands (Fig. 34). On the other hand, ear bands of surgical face masks turned yellow in color, but no color change was observed for polypropylene protective fibers (Fig. 35). Bigger light green holes are original parts of the mask, i.e. breathing holes, while minor white holes arose from fiber redistribution. Residues of soil are observed as microparticles in both respirator, and surgical face mask. Rice masks showed signs of structural holes, together with green color, and distressed ear band fibers; however the original mask was missing for comparison (Fig. 36).



Fig. 33 Tested specimens after final drying

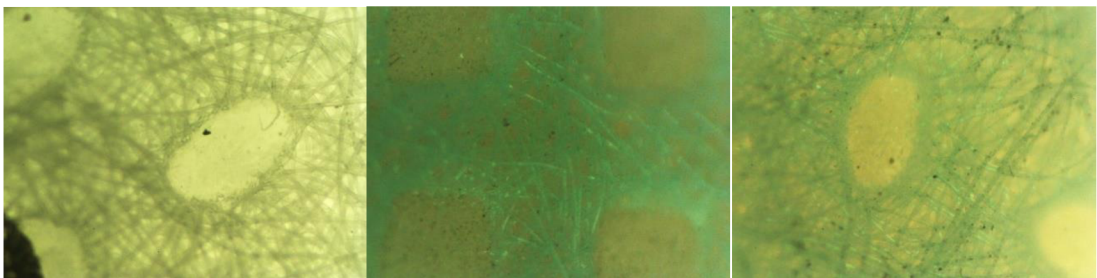

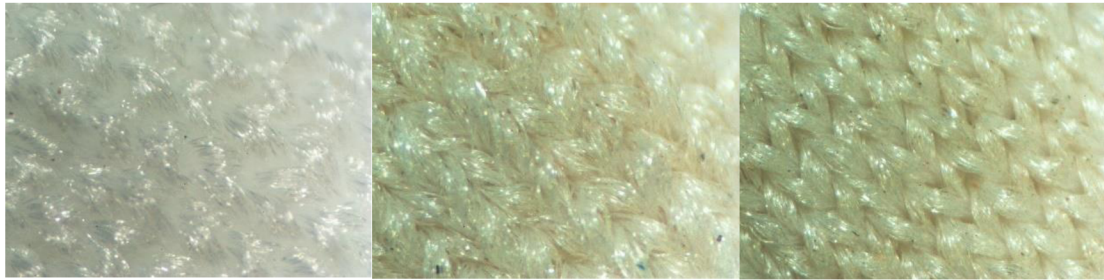

Fig. 34 Respirator: a) original at week 0 b, c) respirator I, II at week 21  
Respirators' ear band: d) original at week 0 e, f) respirator I, II at week 21

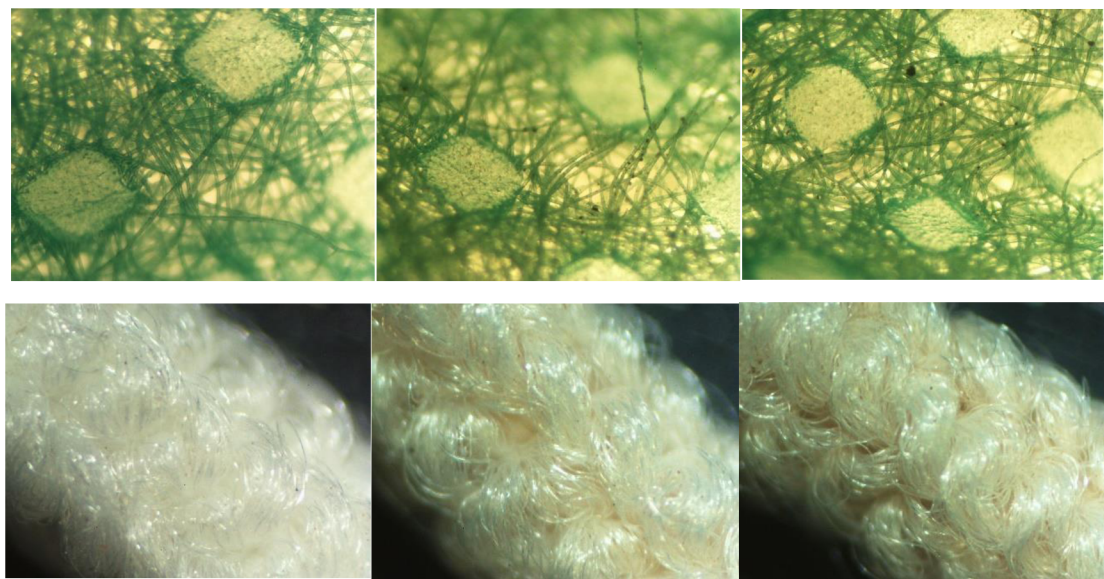

Fig. 35 Surgical face mask: a) original at week 0 b, c) surgical face mask I, II at week 21  
Surgical face masks' ear band: a) original at week 0 b, c) surgical face mask I, II at week 21

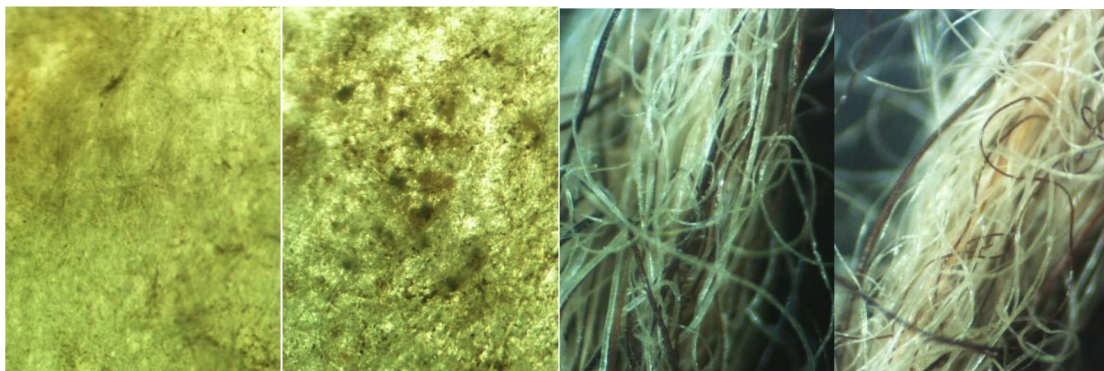

Fig. 36 Biodegradable face mask: a, b) biodegradable face mask I, II at week 21  
c, d) biodegradable face mask's ear band I, II at week 21 (Note: original mask missing for comparison)

## 5.6 FTIR analysis

FTIR analysis involved triplicate scans in the range of 4000–350  $\text{cm}^{-1}$ . Material was analyzed using available spectra, and given results confirmed composition of original, non-tested face masks. Measurements confirmed 95.47 % match of PP in the case of respirator, and 89.87 % match for surgical face mask. Rice paper face mask achieved on average 88.14 % match for cellulose, but only after the completion of the experiment. Besides the general composition, infrared spectroscopy of tested face masks showed presence of additional substances, like feldspar, calcite, or pegmatite, which are minerals that originated from soil matrix in which masks were buried. Different functional group regions, as well as fingerprints of different materials are clearly represented graphically in Appendices 3-7.

Comparative spectral analysis between originals of respirators and surgical face masks, that served as a control, and their tested duplicates indicates no decomposition process took place (Fig. 37-39). Changes in observed spectra were minimal. Gain of some new functional groups was caused by dirt of soil, but in general decomposition of fingerprints looked the same, without change in alkyl terminal or carbonyl group, which indicates no significant decomposition took place. Rice paper mask wasn't compared to the original due to its lack, but FTIR analysis confirmed presence of cellulose as main material.

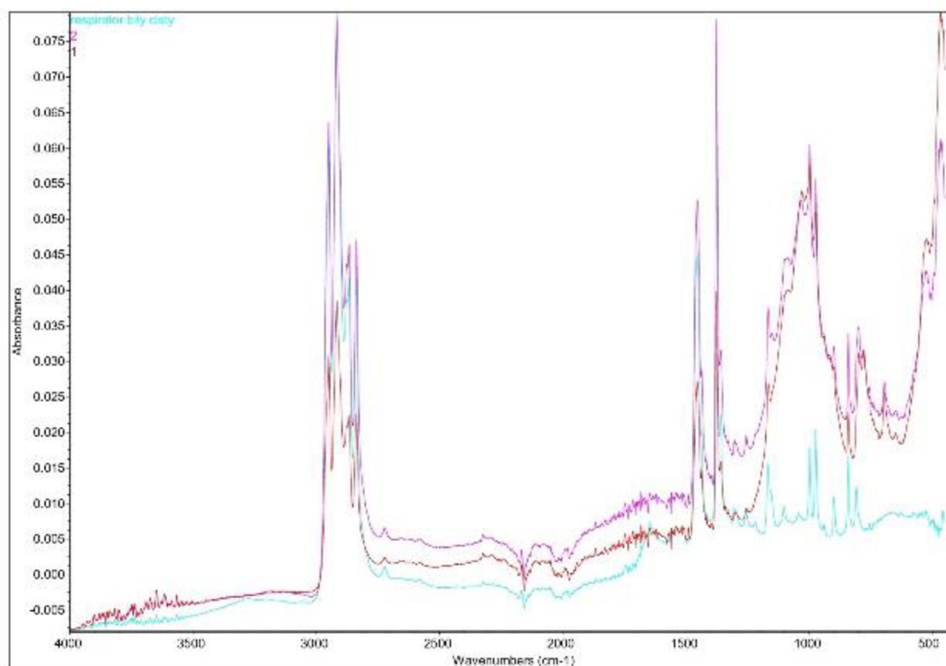

Fig. 37 Comparative FTIR analysis of respirators FFP2

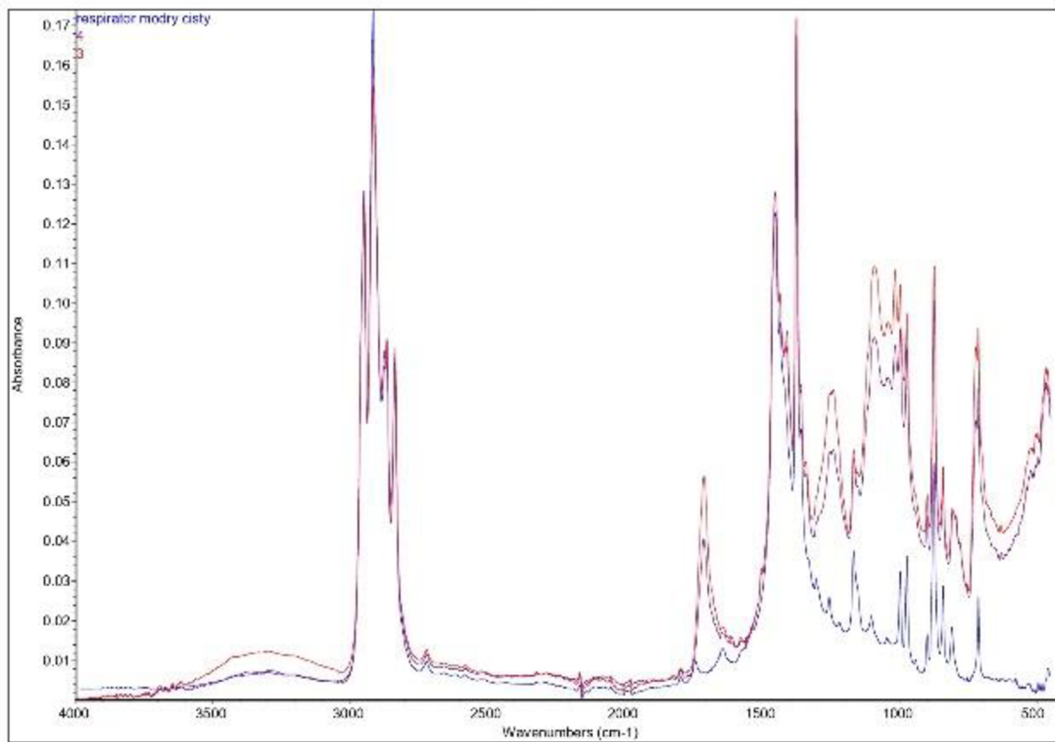

Fig. 38 Comparative FTIR analysis of surgical masks

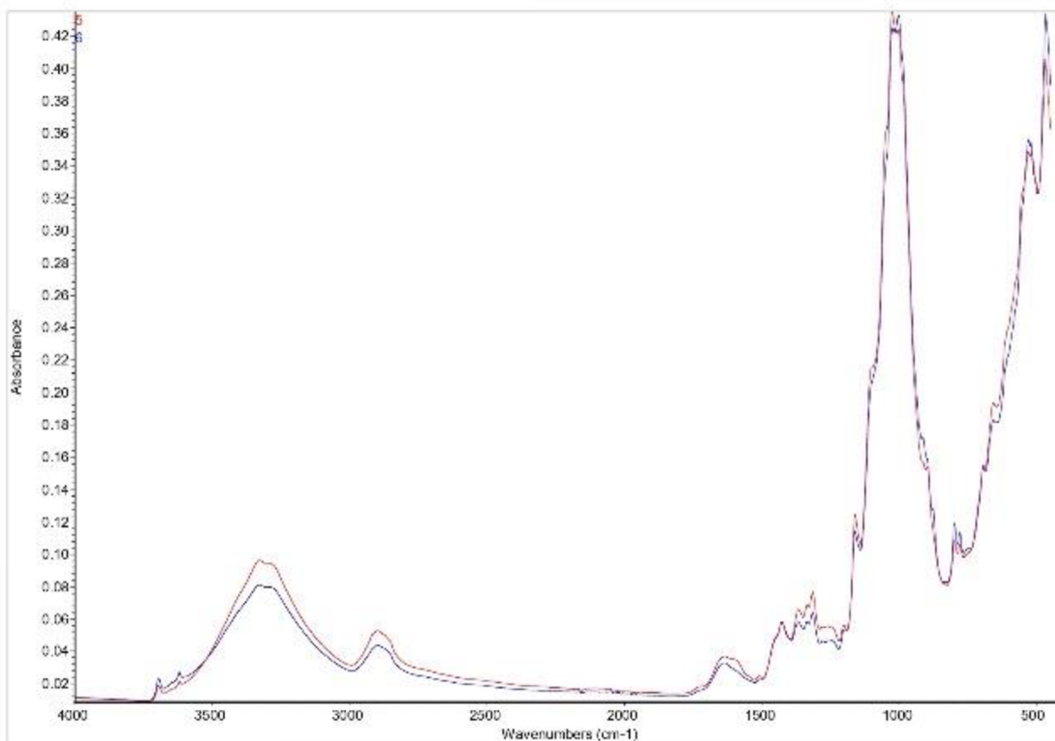

Fig. 39 Comparative FTIR analysis of rice paper masks

## 6. Discussion

Biodegradation process might take from seconds to millions of years. Plastic materials are known to persist for a long time when introduced into the environment. Some polymers like polyethylene or polypropylene are highly inert and resistant to degradation. In fact, studies have shown that they underwent negligible weight loss after 30 years of incubation in moist soil (Ghatge et al. 2020). This thesis, focused on assessment of biodegradability of mostly plastic face masks, was therefore conducted for a period of 5 months, even though some biodegradability tests last for as little as 28 days.

Overall, the given results are in accordance with previous research, and they confirmed that the biodegradability of plastic is very slow. No significant changes in terms of degradation were observed for polymeric specimens. Theoretically, rice paper, which is considered to be organic material and waste, should have been biodegraded in a short period of time. However, taking into consideration that the forest soil sample was lacking nutrients and that the conditions for the biodegradation that was occurring in natural conditions were favorable up to a point, but still far from ideal, this material did not fully degrade in the period of 120 days. Had the sample been bioaugmented by adding nitrogen, a significant nutrient for microbes, decomposition would have been achieved earlier (Briassoulis et Mistriotis, 2018). However, despite non-ideal conditions, these reference masks started to decompose, which is confirmed not only by measured indices, but also by simple visual examination at the end of the experiment.

Final experimental results were mostly straightforward, but pH and C/N fluctuations received somewhat more attention due to interesting results. It is considered that soil-microbe relationship is reciprocal, meaning that soil pH does effect microorganisms present in it, but microbes also do effect soil pH and change their micro-habitats (Joutey et al. 2013). Some organisms produce acid to the surrounding environment to outcompete their competitors, while others under acidic conditions produce more basic metabolites, which can explain initial increase of pH (Joutey et al. 2013). Moreover, Zhao et al. (2021) found that soil pH tends to increase when affected by polymer microplastics, which get released in the process of degradation. Ammonia in soil also causes initial increase of pH, but due to its instability, it is transformed into nitrates, which cause further acidification through the process of nitrification (Ardisson et al. 2014). This explains pH fluctuations. Microorganisms can also greatly affect nutrient levels, which is seen from experimental C/N fluctuations. The lower the C/N ratio, the more rapidly N will be released

into the soil, due to nitrifying bacteria within the soil matrix. Since face masks did absorb some moisture from the soil, it could make them a breeding ground for such bacteria. Additionally, decrease in C/N ratio could be due to the release of organic matter. Any residue of litter on top of the soil could also influence nutrient ratio, as some materials increase it, while others tend to decrease it. Since different materials degrade at different times, fluctuations could occur.

Conditions in which this experiment was processed were natural, with minimum traces of manipulation, rather to observe behavior of masks when they are littered in the environment, than to assess biodegradability in standardized conditions. Had standardized tests been followed, conditions of temperature, soil moisture, pH etc. would have been pre-determined. Having in mind that the conditions set in those tests are considered optimal for biodegradation, results could significantly differ, e.g. increased moisture content or pH level could lead to faster biodegradation (Funabashi et al. 2009). Therefore, standardized tests define set conditions. On the other hand, some authors set up various conditions to test effect of those conditions on biodegradation. Pishedda et al. (2019) thus examined how different temperature affects biodegradation of plastic, while Briassoulis et Mistriotis (2018) included different types of soil and different nutrient levels. Having this in mind, future research could involve quadruplicates instead of used duplicates and comparatively assess biodegradability in both natural and bioaugmented conditions.

Furthermore, it is possible to conduct the experiment with focus on microbiological aspect by targeting mask with a specific isolated organism, and observing colonization and degradation (Mohan et al. 2021). This thesis, however, did not put emphasis solely on microbiological aspect, but for future research I suggest isolating bacterial strain, to again comparatively observe biodegradation for quadruplicates attacked by natural mixed microbial communities versus isolated strain.

I believe that, for future directions special attention should be drawn to microplastics, which is confirmed to be released from disposable plastic face masks into the environment. Transfer of terrestrial microparticles to aquatic environment is yet another issue that should be taken into consideration when speaking about degradation processes, since those particles have the ability to assimilate into the food chain, and threaten sensitive organisms (Wang et al. 2021).



## 7. Conclusion

The outbreak of global COVID-19 pandemic caused not only international health emergency but has also put a burden on the environment. Increased production and usage of PPE, along improper disposal, led to increased terrestrial and marine pollution. This thesis confirmed that, once introduced to the environment, PPE could stay there for a long time. Assessment of face masks biodegradability in forest soil indicates no significant break-down under natural conditions after 120 days of inoculation period. Respirometric analysis revealed occurrence of microbes, however these organisms did not have enough power to fully degrade tested material in due time. Development of their colonies could be limited due to various factors, such as insufficient nutrients, or inadequate pH, however further microbiological studies would be needed to confirm this conclusion. Among the tested specimens, the biggest change was observed in the case of biodegradable masks, while respirators exhibited the greatest recalcitrance.

Overall, biodegradability of face masks is relatively new, but highly contemporary topic that logically imposes itself in the current situation of COVID-19. Up to date, solely one author conducted research on this topic, and therefore poorly addressed subject of assessment of biodegradability of face mask should be studied further, especially because of growing concern of littering the natural environment in the times of global pandemic. Special focus should be paid to variable abiotic conditions since they are considered to act as either limiting or stimulating factor for biodegradation processes. The aftermath of this research implies very low biodegradation rate, and consequent persistence of PPE in the environment. Moreover, the achieved experimental results pointed out to the need for better policy making in the context of PPE production, use, and littering.

## 8. Bibliography

### 8.1 Internet sources

BPEJ ©2019: eKatalog BPEJ (on-line) [cit.2021.10.10], available at <<https://bpej.vumop.cz/13716>>.

Briassoulis, D., Mistriotis, A., Wilde, B.D., & Noord, D.,2014: Standard testing methods & specifications for biodegradation of bio-based materials in soil (on-line) [cit.2022.1.20], available at <<http://www.geyseco.es/geystiona/adjs/comunicaciones/304/C06680001.pdf>>.

DOPA Explorer ©2021: Roztocký Háj - Tiché Údolí (on-line) [cit.2021.9.20], available at <<https://dopa-explorer.jrc.ec.europa.eu/wdpa/342982>>.

Dincă, M., Moiceanu, G., Paraschiv, G., Voicu, G., Ungureanu, N., Toma, L., Ionescu, M., 2014: The influence of heavy metals on biogas production during the anaerobic digestion process. TERE-RD (on-line). [cit.2022.1.10], available at <[https://www.researchgate.net/publication/281447718\\_THE\\_INFLUENCE\\_OF\\_HEAVY\\_METALS\\_ON\\_BIOGAS\\_PRODUCTION\\_DURING\\_THE\\_ANAEROBIC\\_DIGESTION\\_PROCESS](https://www.researchgate.net/publication/281447718_THE_INFLUENCE_OF_HEAVY_METALS_ON_BIOGAS_PRODUCTION_DURING_THE_ANAEROBIC_DIGESTION_PROCESS)>.

EUROSTAT ©2021: Covid – 19 masks (on-line) [cit.2021.7.15], available at <<https://www.eurostatgroup.com/en/270-covid-19-masks>>.

FDA ©2020: Personal Protective Equipment for Infection Control (on-line) [cit.2021.12.6], available at <<https://www.fda.gov/medical-devices/general-hospital-devices-and-supplies/personal-protective-equipment-infection-control>>.

GASTEC © 2018: No.2D – Instructions for Carbon Dioxide Passive Dosi-Tube (on-line) [cit.2021.9.20], available at <<https://www.gastec.co.jp/files/user/asset/pdf/en/instructionmanual/en/2D.pdf>>.

Knicker, H., Velasco-Molina, M., 2021: Biodegradability of single-use polypropylene-based face masks, littered during the COVID-19 pandemic – a first approach (on-line) [cit.2021.11.20], available at <<https://doi.org/10.5194/egusphere-egu21-1293>>.

Marie Bee Bloom © 2021: Biodegradable masks (on-line) [cit.2021.7.15], available at <<https://www.mariebeebloom.com/>>.

Munsell ©2009: SOIL-COLOR CHARTS. (on-line) [cit.2021.10.30], available at <<http://www.agri.kps.ku.ac.th/4jobb32/Doc/MunsellSoilColorChart.pdf>>.

OSHA ©2020: Personal Protective Equipment (on-line) [cit.2021.12.6], available at <<https://www.osha.gov/personal-protective-equipment>>.

SKC Ltd ©2018: Gastec (on-line) [cit.2021.9.20], available at <<https://www.skcltd.com/products2/gas-detection-tubes/gastec-passive-dosi-tubes.html>>.

## 8.2 Legislative sources

A new Circular Economy Action Plan For a cleaner and more competitive Europe, as amended. EC ©2020.

ASTM D6691-09 - Standard test method for determining aerobic biodegradation of plastic materials in the marine environment by a defined microbial consortium or natural sea water inoculum. ASTM ©2009.

ASTM D5338-15 - Standard test method for determining aerobic biodegradation of plastic materials under controlled composting conditions, incorporating thermophilic temperatures. ASTM ©2015.

ASTM D5988-18 - Standard test method for determining aerobic biodegradation of plastic materials in soil. ASTM ©2018.

Basel Convention on the Control of Transboundary Movements of Hazardous Wastes and Their Disposal, as amended. UN ©2019.

DIRECTIVE 2019/904 OF THE EUROPEAN PARLIAMENT AND OF THE COUNCIL of 5 June 2019 on the reduction of the impact of certain plastic products on the environment, as amended. EPC ©2019.

EN ISO 9439:2000 - Water quality - evaluation of ultimate aerobic biodegradability of organic compounds in aqueous medium - carbon dioxide evolution test. ISO ©2020.

Glossary of Environment Statistics, Studies in Methods, Series F, No. 67. UN ©1997.

GREEN PAPER On a European Strategy on Plastic Waste in the Environment, as amended. EC ©2013.

ISO/IEC JTC1/SC2/WG2 N2342 - Background information on Recycling Symbols. ISO ©2001.

ISO 13975:2012 - Determination of the ultimate anaerobic biodegradation of plastic materials in controlled slurry digestion systems — Method by measurement of biogas production. ISO ©2012.

ISO 14855 - 1:2012 - Determination of the ultimate aerobic biodegradability of plastic materials under controlled composting conditions — Method by analysis of evolved carbon dioxide — Part 1: General method. ISO ©2012.

ISO 14853:2016 – Determination of the ultimate anaerobic biodegradation of plastic materials in an aqueous system — Method by measurement of biogas production. ISO ©2016.

ISO 14851:2019 - Determination of the ultimate aerobic biodegradability of plastic materials in an aqueous medium — Method by measuring the oxygen demand in a closed respirometer. ISO ©2019.

ISO 17556:2019 - Plastics — Determination of the ultimate aerobic biodegradability of plastic materials in soil by measuring the oxygen demand in a respirometer or the amount of carbon dioxide evolved. ISO ©2019.

ISO 19679:2020 – Determination of aerobic biodegradation of non-floating plastic materials in a seawater/sediment interface - Method by analysis of evolved carbon dioxide. ISO ©2020.

ISO 14852:2021 - Determination of the ultimate aerobic biodegradability of plastic materials in an aqueous medium — Method by analysis of evolved carbon dioxide. ISO ©2021.

NF U52-001 - Biodegradable materials for use in agriculture and horticulture - Mulching products - Requirements and test methods. AFNOR ©2005.

Revised Introduction to the OECD Guidelines for Testing of Chemicals, Section 3, OECD Guidelines for the Testing of Chemicals, Section 3. OECD ©2006.

Test No. 301: Ready Biodegradability. OECD Guidelines for the Testing of Chemicals, Section 3. OECD ©1992.

Test No. 302A: Inherent Biodegradability: Modified SCAS Test, OECD Guidelines for the Testing of Chemicals, Section 3. OECD ©1981.

Test No. 302B: Inherent Biodegradability: Zahn-Wellens/ EVPA Test, OECD Guidelines for the Testing of Chemicals, Section 3. OECD ©1992.

Test No. 302C: Inherent Biodegradability: Modified MITI Test (II), OECD Guidelines for the Testing of Chemicals, Section 3. OECD ©2009.

Test No. 304A: Inherent Biodegradability in Soil, OECD Guidelines for the Testing of Chemicals, Section 3. OECD ©1981.

Test No. 306: Biodegradability in Seawater, OECD Guidelines for the Testing of Chemicals, Section 3. OECD ©1992.

Test No. 311: Anaerobic Biodegradability of Organic Compounds in Digested Sludge: by Measurement of Gas Production, OECD Guidelines for the Testing of Chemicals, Section 3. OECD ©2006.

### 8.3 Scientific publications

Al-Salem, S., Al-Nasser, A., Sultan, H., Karam, H., 2019: In Situ Aerobic Biodegradation In Soil Contact Using The Standard Test Method of ASTM D 5988-12. IOP Conference Series: Earth and Environmental Science. 291, pp. 012011-012016.

Al-Salem, S. 2021: Study of the Degradation Behaviour of Virgin and Biodegradable Plastic Films in Marine Environment Using ASTM D 6691. Journal of Polymers and the Environment. 10, pp.1-17.

Babaahmadi, V., Amid, H., Naeimirad, M., Ramakrishna, S., 2021: Biodegradable and multifunctional surgical face masks: A brief review on demands during COVID-19 pandemic, recent developments, and future perspectives. Science of The Total Environment. 798, pp. 149233-149245.

Bettas Ardisson, G., Tosin, M., Barbale, M., Degli-Innocenti, F., 2014: Biodegradation of plastics in soil and effects on nitrification activity. A laboratory approach. Frontiers in microbiology. 5, pp.1-7.

Bhaiyat, T., 2017: Effect of Fiber Loading on the Moisture Absorption and Mechanical Properties of Kenaf Fiber Reinforced Composites - MECN4006 Undergraduate Research Project. School of

Mechanical, Industrial and Aeronautical Engineering, Johannesburg. 42 pp. (research project). 'unpublished'.

Briassoulis, D., Mistriotis, A., 2018: Key parameters in testing biodegradation of bio-based materials in soil. *Chemosphere*. 207. pp 18-26.

Chandra, R., Rustgi, R., 1998: Biodegradable Polymers. *Progress in Polymer Science*. 23, pp. 1273-1335.

Funabashi, M., Ninomiya, F., Kunioka, M., 2009: Biodegradability Evaluation of Polymers by ISO 14855-2. *International Journal of Molecular Sciences*. 10, pp. 3635-54.

Ghatge, S., Yang, Y., Ahn, J.H., Hur, H.G., 2020: Biodegradation of polyethylene: a brief review. *Applied Biological Chemistry*. 63, pp.27-41.

Haney, R.L., Brinton, W., Evans, E., 2008: Soil CO<sub>2</sub> respiration: Comparison of chemical titration, CO<sub>2</sub> IRGA analysis and the Solvita gel system. *Renewable Agriculture and Food Systems*. 23, pp. 171 – 176.

Harrison, J., Boardman, C., O'Callaghan, K., Delort, A.M., Song, J., 2018: Biodegradability standards for carrier bags and plastic films in aquatic environments: A critical review. *Royal Society Open Science*. 5. 171792 – 171810.

Jeon, J.M., Park, S.J., Choi, T.R., Park, J.H., Yang, Y.H., Yoon, J.J., 2021: Biodegradation of polyethylene and polypropylene by *Lysinibacillus* species JJY0216 isolated from soil grove. *Polymer Degradation and Stability*. 191, pp. 109662-109670.

Jørgensen, S.E., 2010: *Ecotoxicology*. Academic Press, 402 pp.

Joutey, N.T., Wifak, B., Hanane, S., El Ghachtouli, N., 2013: Biodegradation: Involved Microorganisms and Genetically Engineered Microorganisms. *Biodegradation - Life of Science*.10, 279-320.

Klemeš, J.J., Fan, Y.V., Jiang, P., 2020: The energy and environmental footprints of COVID-19 fighting measures – PPE, disinfection, supply chains. *Energy*. 211, pp. 118701 -118710.

Karger-Kocsis, J., 1999: *Polypropylene: An A-Z Reference*. Kluwer Academic Publishers, 965 pp.

Klemeš, J.J., Fan, Y.V., Jiang, P., 2020: The energy and environmental footprints of COVID-19 fighting measures – PPE, disinfection, supply chains. *Energy*. 211, pp. 118701 -118710.

Kotova, I.B., Taktarova, Y.V., Tsavkelova, E.A., Egorova, M.A., Bubnov, I. A., Malakhova, D.V., Shirinkina, L.I., Sokolova T. G., Bonch-Osmolovskaya, E. A., 202: Microbial Degradation of Plastics and Approaches to Make it More Efficient. *Microbiology*. 90, pp. 671–701.

Kozák, J., Němeček, J., 2009: *Atlas půd České republiky*. 2 upravené vydání. ČZU Praha, Praha, 150 pp.

Kubíková, J., Molíková, M., 1980: Vegetace a květena Tichého údolí, Roztockého háje a Sedleckých skal na severozápadním okraji Prahy. *Bohemia centralis*. 10, pp.129-207.

Maddah, H.A., 2016: Polypropylene as a Promising Plastic: A Review. *American Journal of Polymer Science*. 6, pp. 1-11.

Masoud, L., 2021: *Engineered Polymeric Fibrous Materials*. Woodhead Publishing, 392 pp.

- Mohanan N., Montazer Z., Sharma P.K., Levin D.B., 2021: Microbial and Enzymatic Degradation of Synthetic Plastics. *Frontiers in Microbiology*. 11, pp. 580709-580731.
- Mohee, R., Unmar, G., 2007: Determining biodegradability of plastic materials under controlled and natural composting environments. *Waste Management*. 27, pp.1486-1493.
- Mueller, W.R., Frommert, I., Jörg, R., 2004: Standardized methods for anaerobic biodegradability testing. *Reviews in Environmental Science and Bio/Technology*. 3, pp.141-158.
- Nakasaki, K., Ohtaki, A., Takano, H., 2000: Biodegradable plastic reduces ammonia emission during composting. *Polymer Degradation and Stability*. 70, pp.185-188.
- Nash, D.G., Leith, D., 2010: Use of Passive Diffusion Tubes to Monitor Air Pollutants. *Journal of the Air & Waste Management Association*. 60, pp. 204-209.
- Nayak, P.L., 1999: Biodegradable Polymers: Opportunities and Challenges. *Journal of Macromolecular Science*, 39, pp.481-505.
- Olajire, A.A., Essien, J.P., 2014: Aerobic Degradation of Petroleum Components by Microbial Consortia. *Journal of Petroleum & Environmental Biotechnoloy*. 5, pp.195-217.
- Pischedda, A., Tosin, M., Degli-Innocenti, F., 2019: Biodegradation of plastics in soil: The effect of temperature. *Polymer Degradation and Stability*. 170, pp. 109017-109014.
- Pramer, D., Bartha, R. , 1972: Preparation and Processing of Soil Samples for Biodegradation Studies. *Environmental Letters*. 2, pp. 217-224.
- Prata, J., Patricio Silva, A.L. Walker, T., Duarte, A., Santos, T., 2020: COVID-19 Pandemic Repercussions on the Use and Management of Plastics. *Environmental Science & Technology*. 54, pp. 7760-7765.
- Restrepo-Flórez, J.M, Bassi, A., Thompson, M.R., 2014: Microbial degradation and deterioration of polyethylene – A review. *International Biodeterioration & Biodegradation*. 88, pp. 83-90.
- Roberts, K.P., Phang, S.C., Williams, J.B., Stringfellow A., de Bie, J., Kolstoe, S., Williams., I.D, Hutchinson, D., 2021. Increased personal protective equipment litter as a result of COVID-19 measures. *Nature Sustainability*. 10, pp.1-8.
- Rousk, J., Brookes, P., Bååth, E., 2009: Contrasting Soil pH Effects on Fungal and Bacterial Growth Suggest Functional Redundancy in Carbon Mineralization. *Applied and Environmental Microbiology*.75, pp.1589–1596.
- Rousk, J., Bååth, E., Brookes, P.C., Lauber, C.L., Lozupone, C., Caporaso, J.G., Fierer, N., 2010: Soil Bacterial and Fungal Communities across a pH Gradient in an Arable Soil. *The ISME Journal*. 4, pp. 1340–1351.
- Saberian, M., Li, J., Kilmartin-Lynch, S., Boroujeni, M., 2021. Repurposing of COVID-19 single-use face masks for pavements base/subbase. *The Science of the total environment*. 769, pp. 145527-145535.

- Selvaranjan, K., Navaratnam, S., Rajeev, P., Ravintherakumaran, N., 2021: Environmental challenges induced by extensive use of face masks during COVID-19: A review and potential solutions. *Environmental Challenges*. 3, pp. 100039-100050.
- Sivan A., 2011: New perspectives in plastic biodegradation. *Current Opinion in Biotechnology*. 22, pp.422-426.
- Sommer, H.M., Spliid, H., Holst, H., Arvin, E.. 1998: Examination of reproducibility in microbiological degradation experiments. *Biodegradation*. 9, pp. 65-82.
- Spennemann, D.H.R.,2021: COVID Face Masks: Policy Shift Results in Increased Littering. *Sustainability* 2021. 13, pp. 9875-9886.
- Tang, J., Lu, C., Sun, Q., Zhu, W., 2012: Aging effect of petroleum hydrocarbons in soil under different attenuation conditions. *Agriculture, Ecosystems & Environment*. 149, pp.109–117.
- Torres, F.G., De-la-Torre, G.E., 2021: Face mask waste generation and management during the COVID-19 pandemic: An overview and the Peruvian case. *Science of The Total Environment*. 786, pp. 147628-147639.
- Tripathi, D., 2002: Practical Guide to Polypropylene. Rapra Technology Limited, Shawbury, 104 pp.
- Vieyra, H., Aguilar-Méndez, M. A., San Martín-Martínez, E., 2013: Study of biodegradation evolution during composting of polyethylene–starch blends using scanning electron microscopy. *Journal of Applied Polymer Science*. 2, pp. 845-853.
- Vimala, P.P., Mathew, L., 2016: Biodegradation of Polyethylene Using *Bacillus Subtilis*. *Procedia Technology*. 24, pp. 232-239.
- Vyas, T., Dave, B., 2010: Effect of addition of nitrogen, phosphorus and potassium fertilizers on biodegradation of crude oil by marine bacteria. *Indian Journal of Marine Sciences*. 39, pp.143-150.
- Žáčková, P., Čepeláková, I., 2006. Determination of microbial respiration intensity. Standard operating procedure (SOP) 06.0.10. Dekonta, Dretovice, Czech Republic, 10 pp. 'unpublished'.
- Zaidi, B.R., Imam, S.H., 2008: Biodegradability. *Encyclopedia of Ecology*, pp. 357-366.
- Zhao T., Lozano Y.M., Rillig M.C., 2021: Microplastics Increase Soil pH and Decrease Microbial Activities as a Function of Microplastic Shape, Polymer Type, and Exposure Time. *Frontiers in Environmental Science*. 9, pp. 675803-675817.
- Wang, Z., An, C., Chen, X., Lee, K., Zhang, B., Feng, Q., 2021: Disposable masks release microplastics to the aqueous environment with exacerbation by natural weathering. *Journal of Hazardous Material*. 417, pp. 126036-126046.
- Wimmerová, L., 2021: Biodegradation & biomonitoring, 10. Czech University of Life Sciences, Faculty of Environmental Sciences, Prague, 25 pp. (study materials for the Ecotoxicology course). 'unpublished'.

## Appendices

### Appendix 1 pH of soil

pH at T (°C)	Week 0	Week 3	Week 5	Week 7	Week 10	Week 15	Week 20
Jar I		4.873 at 16 4.916 at 16.6 3.006 at 17.5 3.235 at 17.8 4.0 at 16.9	5.083 at 18 5.074 at 17.6 4.769 at 16.9 4.259 at 17 4.169 at 17.4	3.041 at 18.4 3.515 at 18.5 3.863 at 18.2 3.993 at 17.7 4.294 at 18.3	4.626 at 18.4 4.652 at 18.4 4.521 at 18 4.26 at 18 4.564 at 18.2	4.157 at 19.7 4.662 at 19.3 4.82 at 19.3 4.953 at 19.2 4.756 at 18.4	4.829 at 18.6 5.171 at 18.5 4.835 at 18.8 4.825 at 18.3 4.571 at 17.2
Jar II	3.222 at 20.9	4.63 at 17.9 4.568 at 17.1 4.415 at 17.6 4.117 at 17.8 4.318 at 17	4.622 at 18.9 4.561 at 18.5 4.409 at 18.8 4.3 at 19.4 4.476 at 18.2	5.131 at 19.1 5.122 at 18.8 4.833 at 18.9 4.453 at 18.3 4.442 at 18.6	4.387 at 18 4.412 at 18.5 4.316 at 18.8 4.328 at 18.4 4.385 at 18.4	4.873 at 18.3 5.324 at 18.2 4.995 at 18.1 4.823 at 18.8 4.689 at 18.4	4.795 at 18.6 4.703 at 19.3 4.431 at 18.1 4.515 at 19.6 4.394 at 19
Jar III	3.375 at 21 3.3709 at 21.1	5.10 at 18.8 4.797 at 18 4.62 at 18.4 4.565 at 18.4 4.603 at 18.3	4.188 at 19.6 4.218 at 19.7 4.196 at 19.7 4.189 at 19.5 4.218 at 19.7	4.737 at 19.3 4.499 at 19.3 4.711 at 19.2 4.381 at 19.2 4.501 at 19	3.652 at 19.1 4.0 at 19.2 4.142 at 18.8 4.218 at 18.5 4.402 at 18.7	4.801 at 19.6 5.252 at 19.7 5.102 at 19.7 5.057 at 19.5 4.898 at 19.7	4.649 at 19.1 5.068 at 19.5 4.792 at 19.3 4.6 at 19.3 4.567 at 19.5
Jar IV	3.844 at 21.1	4.747 at 20 4.44 at 20 4.45 at 20 4.32 at 20 4.233 at 20	4.29 at 19.9 4.367 at 20 4.302 at 20.1 4.455 at 20 4.303 at 19.7	4.493 at 19.7 4.418 at 19.7 4.305 at 19.6 4.288 at 19.7 4.072 at 19.8	4.833 at 20 4.409 at 19.7 4.530 at 19 4.22 at 19 4.2 at 19.6	4.979 at 20 4.895 at 19.9 5.006 at 20 4.446 at 20.1 4.8 at 20	4.743 at 19.3 4.839 at 20.2 4.664 at 19.9 4.292 at 20 4.469 at 19.2
Jar V	3.572 at 21	4.494 at 19.5 4.371 at 19.9 4.29 at 20.2 4.214 at 20 4.30 at 20	3.373 at 20.6 4.5 at 20.9 4.333 at 21 4.466 at 20.8 4.405 at 20.9	4.713 at 19.6 4.566 at 19.7 4.241 at 19.9 4.371 at 19.6 4.381 at 20.1	4.030 at 20.5 4.204 at 20.6 4.093 at 20.7 3.998 at 20.3 4.075 at 20.5	4.525 at 20.9 4.751 at 20.6 4.694 at 20.8 4.486 at 21 4.476 at 20.9	4.952 at 21 4.853 at 21.1 4.679 at 21.1 4.450 at 21.2 4.275 at 21.1
Jar VI		4.481 at 20 4.296 at 20 4.151 at 20 4.32 at 20.1 4.357 at 20.1	4.3 at 21.6 4.122 at 21.7 4.181 at 21.6 3.913 at 21.5 4.106 at 21	5.119 at 20.8 4.915 at 20.7 4.332 at 21 4.449 at 21 4.423 at 21	4.8 at 20.7 4.322 at 20.6 4.46 at 20.4 4.138 at 20.6 4.046 at 20.4	4.899 at 21.6 4.447 at 21.7 4.911 at 21.7 4.8 at 21.6 4.6 at 21.7	5.106 at 21.4 5.036 at 21.2 4.777 at 21 4.560 at 21.4 4.523 at 21.1

### Appendix 2 Moisture of soil

Moisture (%) at T (°C)	Week 0	Week 3	Week 5	Week 7	Week 10	Week 15	Week 20
Jar I	3 at 21.6	8.4 at 16.7 4.7 at 16.8 3.8 at 16.7 4.1 at 16.6	12.5 at 18.3 7.1 at 17.2 5.4 at 17 2.7 at 17 0.6 at 17.5	11.2 at 19.6 10.2 at 18.7 6.5 at 18.2 7.3 at 18 6 at 18	16.4 at 19.5 8.3 at 18.6 3.7 at 18 4 at 18 4 at 18	5.9 at 20.4 11.2 at 19.4 5.6 at 19.2 6.7 at 19.1 3.7 at 19.3	15.5 at 19.2 11.4 at 18 5.5 at 17.7 4.8 at 18 4.9 at 17.4
Jar II	3 at 21.6	15.6 at 19.5 15 at 18.8 9.5 at 18.2 7.5 at 18.1 6.7 at 18	11.6 at 18.8 7.6 at 18.4 4.2 at 18.2 1.5 at 18.5 3.1 at 18.5	14 at 20 12.8 at 19.5 6 at 19.2 4.7 at 19.1 4 at 18.9	4.1 at 19.8 8.6 at 19 6.5 at 18.8 4.8 at 18.6 4.5 at 18.5	12.1 at 19.3 8.4 at 18.7 8 at 18.1 1.1 at 19 1.6 at 18.1	11 at 19.1 4.2 at 18.7 4.2 at 18.5 7.4 at 18.7 0.8 at 18.7
Jar III	3 at 21.6	15 at 19.1 2.5 at 18.8 3.5 at 18.7 2.1 at 18.2 2.1 at 18.7	10.1 at 19.7 6.8 at 19.6 5.7 at 19.4 4.4 at 19.4 4 at 19.4	14.4 at 20.1 9.5 at 19.6 7.4 at 19.4 5.5 at 19.2 4 at 19.1	6.4 at 20.3 10.1 at 19.4 7.4 at 19.1 5.6 at 19 3.8 at 18.9	14.2 at 19.8 9 at 19.2 5.4 at 19.1 3.2 at 19.2 3.6 at 19.2	7.2 at 19.5 3 at 19.5 3.9 at 19.2 1.6 at 19 1.6 at 19.5



Jar IV	11.6 at 20 10.3 at 20 8.5 at 20.3 6.5 at 20	11 at 20 7.7 at 19.8 5.5 at 19.7 4.2 at 19.7 3.8 at 19.6	7.6 at 20.1 5.7 at 19.8 3.3 at 19.8 2.4 at 19.7 2.2 at 19.8	11.1 at 20.4 8.8 at 20 5.7 at 20 4.6 at 19.8 5 at 19.6	9 at 20.2 4.1 at 20 4.5 at 19.7 2.6 at 19.7 2.1 at 19.7	6.2 at 20.1 2.9 at 19.6 1.5 at 19.7 2.7 at 19.6 1.6 at 19.6
Jar V	13 at 20.4 7.4 at 20.3 6.1 at 20.2 5.8 at 20	9.5 at 20.6 6.3 at 20.4 5.7 at 20.3 4.4 at 20.3 3.1 at 20.3	2.8 at 19.8 2.5 at 19.6 1.1 at 19.6 1.1 at 19.7 0.3 at 19.8	3.4 at 21.1 4.3 at 20 3.2 at 20.5 2.9 at 20.5 2.6 at 20.4	13.7 at 21.6 9 at 21.2 7 at 21.1 6 at 20.9 4.5 at 20.8	5.6 at 21.1 3.7 at 21.1 3.2 at 21 2.1 at 21 2.3 at 21
Jar VI	17.7 at 21 11.5 at 21 8.3 at 20.5 6.5 at 20.3 5.6 at 20.2	9 at 21.2 5.3 at 21.1 4.5 at 21.1 3.3 at 21 2.2 at 21	8 at 21.2 5.5 at 21 3.3 at 20.9 2.7 at 20.7 2.4 at 20.7	8.6 at 20.9 7.2 at 20.7 5.1 at 20.4 3.5 at 20.5 3 at 20.3	11.6 at 22 8.4 at 17 6.1 at 21.4 6.8 at 21 3.7 at 21.2	6.2 at 21.1 4.4 at 21.1 3.7 at 21 3.1 at 21 2.7 at 21

### Appendix 3 FTIR analysis of original respirator FFP2

#### Multi-Component Search Results

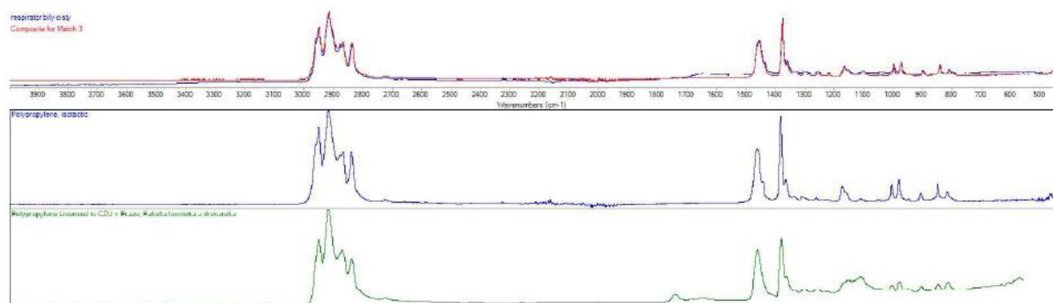

Match	Title	Cumulati ve	Composit e%	Folder	Filename	Index
3	Polypropylene, isotactic	94.85	34.90	HR Spectra Polymers and Plasticizers by ATR	c:\my documents\omnic\libs\sea464.lbd	67
	Polypropylene Licenced to CZU v Praze, Fakulta lesnicka a drevarska	95.47	65.10	HR Polymers Miracle	c:\my documents\omnic\libs\hrpolym.lbd	510

## Appendix 4 FTIR analysis of tested respirators I and II

### Multi-Component Search Results

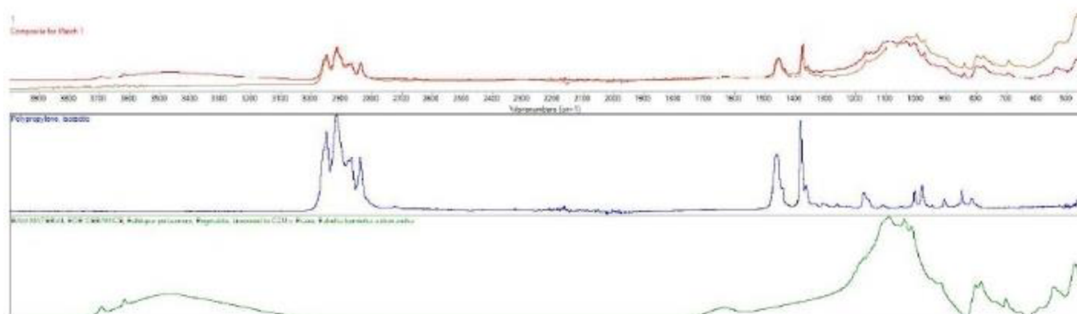

Match	Title	Cumulative	Composite	Folder	Filename	Index	
1	82.33	Polypropylene, isotactic	71.33	46.32	HR Spectra Polymers and Plasticizers by ATR	c:\my documents\omnic\libs\sea464.lbd	67
		RAW MATERIAL FOR CERAMICS, Feldspar potassium, Pegmatite, Licenced to CZU v Praze, Fakulta lesnicka a drevarska	82.33	53.68	HR Inorganics IV	c:\my documents\omnic\libs\hrin4mat.lbd	181

### Multi-Component Search Results

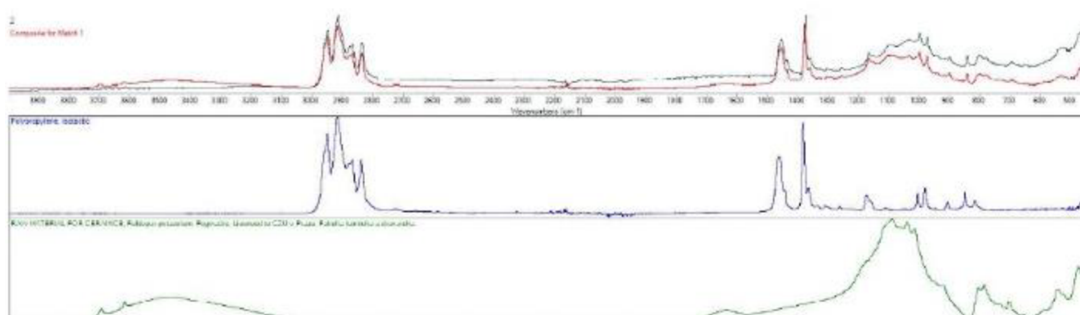

Match	Title	Cumulative	Composite	Folder	Filename	Index	
1	90.58	Polypropylene, isotactic	88.30	67.75	HR Spectra Polymers and Plasticizers by ATR	c:\my documents\omnic\libs\sea464.lbd	67
		RAW MATERIAL FOR CERAMICS, Feldspar potassium, Pegmatite, Licenced to CZU v Praze, Fakulta lesnicka a drevarska	90.58	32.25	HR Inorganics IV	c:\my documents\omnic\libs\hrin4mat.lbd	181

## Appendix 5 FTIR analysis of original surgical face mask

### Spectrum Search Results

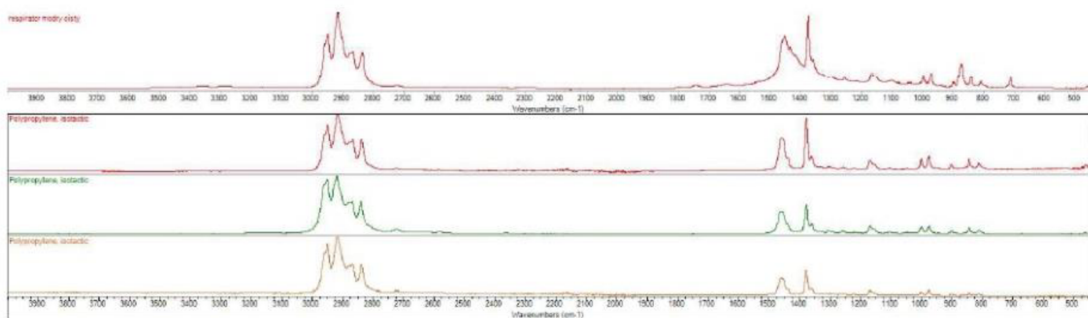

	Match	Title	Range	Folder	Filename	Index
1	92.88	Polypropylene, isotactic	4000.0-450.0	HR Specta Polymers and Plasticizers by ATR	c:\my documen ts\omnic\ libs\sea4 64.lbd	67
2	89.07	Polypropylene, isotactic	4000.0-450.0	HR Hummel Polymer and Additives	c:\my documen ts\omnic\ libs\sea4 06.lbd	942
3	87.66	Polypropylene, isotactic	4000.0-450.0	HR Specta Polymers and Plasticizers by ATR - corrected	c:\my documen ts\omnic\ libs\sea4 65.lbd	67

## Appendix 6 FTIR analysis of tested surgical face masks I and II

### Spectrum Search Results

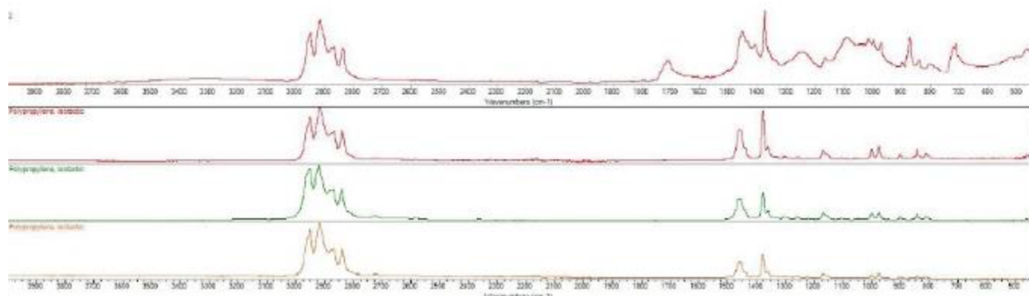

	Match	Title	Range	Folder	Filename	Index
1	85.18	Polypropylene, isotactic	4000.0-450.0	HR Specta Polymers and Plasticizers by ATR	c:\my documents\omnic\libs\sea464.lbd	67
2	81.57	Polypropylene, isotactic	4000.0-450.0	HR Hummel Polymer and Additives	c:\my documents\omnic\libs\sea406.lbd	942
3	79.88	Polypropylene, isotactic	4000.0-450.0	HR Specta Polymers and Plasticizers by ATR - corrected	c:\my documents\omnic\libs\sea465.lbd	67

### Multi-Component Search Results

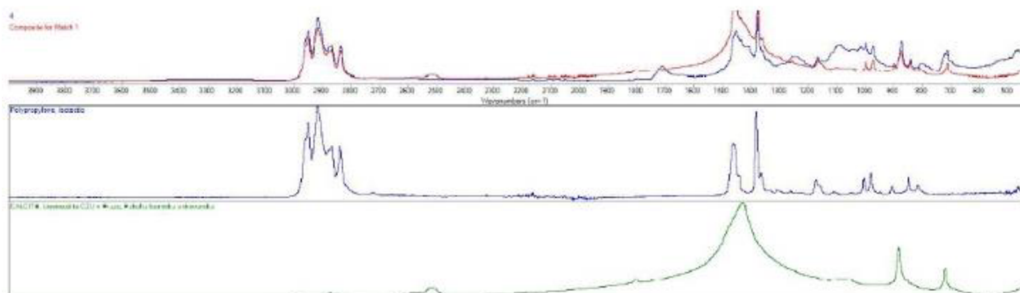

	Match	Title	Cumulative	Composite %	Folder	Filename	Index
1	86.91	Polypropylene, isotactic	77.81	50.37	HR Specta Polymers and Plasticizers by ATR	c:\my documents\omnic\libs\sea464.lbd	67
		CALCITE, Licenced to CZU v Praze, Fakulta lesnicka a drevarska	86.91	49.63	HR Inorganics I. - Minerals	c:\my documents\omnic\libs\hrin1min.lbd	102

## Appendix 7 FTIR analysis of tested rice paper masks I and II

### Spectrum Search Results

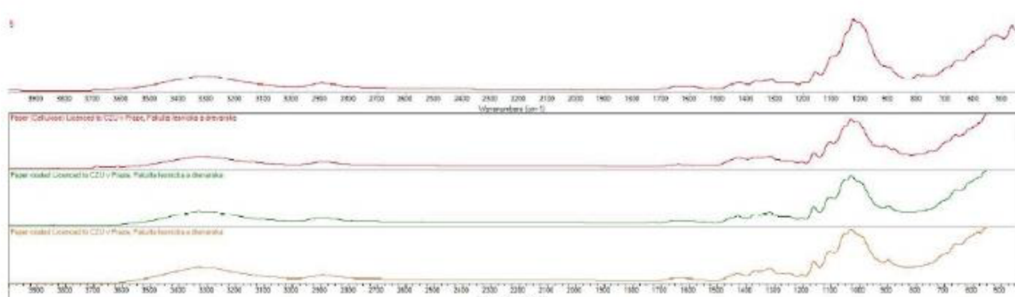

	Match	Title	Range	Folder	Filename	Index
1	91.72	Paper (Cellulose) Licenced to CZU v Praze, Fakulta lesnicka a drevarska	4000.0-542.0	HR Polymers Miracle	c:\my documen ts\omnic libs\hrpol ym.lbd	263
2	90.89	Paper coated Licenced to CZU v Praze, Fakulta lesnicka a drevarska	4000.0-542.0	HR Polymers Miracle	c:\my documen ts\omnic libs\hrpol ym.lbd	270
3	89.68	Paper coated Licenced to CZU v Praze, Fakulta lesnicka a drevarska	4000.0-542.0	HR Polymers Miracle	c:\my documen ts\omnic libs\hrpol ym.lbd	269

### Spectrum Search Results

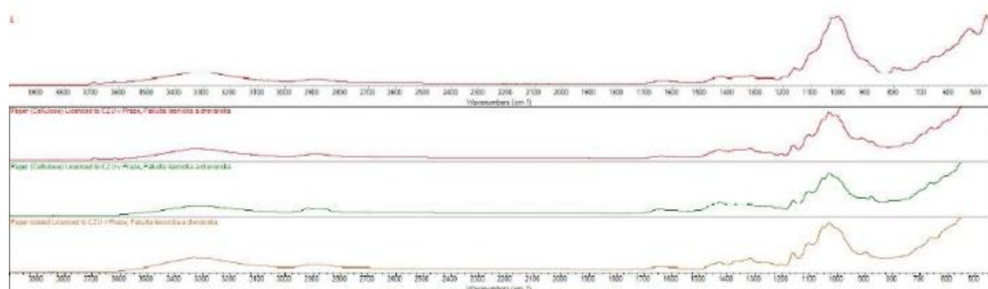

	Match	Title	Range	Folder	Filename	Index
1	88.59	Paper (Cellulose) Licenced to CZU v Praze, Fakulta lesnicka a drevarska	4000.0-542.0	HR Polymers Miracle	c:\my documen ts\omnic libs\hrpol ym.lbd	263
2	84.47	Paper (Cellulose) Licenced to CZU v Praze, Fakulta lesnicka a drevarska	4000.0-542.0	HR Polymers Miracle	c:\my documen ts\omnic libs\hrpol ym.lbd	256
3	83.50	Paper coated Licenced to CZU v Praze, Fakulta lesnicka a drevarska	4000.0-542.0	HR Polymers Miracle	c:\my documen ts\omnic libs\hrpol ym.lbd	270