



BRNO UNIVERSITY OF TECHNOLOGY

VYSOKÉ UČENÍ TECHNICKÉ V BRNĚ

FACULTY OF ELECTRICAL ENGINEERING AND COMMUNICATION

FAKULTA ELEKTROTECHNIKY A KOMUNIKAČNÍCH TECHNOLOGIÍ

DEPARTMENT OF FOREIGN LANGUAGES

ÚSTAV JAZYKŮ

ELECTRONIC CIGARETTES AND PUBLIC VIEW

ELEKTRONICKÉ CIGARETY A JAK JE VNÍMÁ OKOLÍ

BACHELOR'S THESIS

BAKALÁŘSKÁ PRÁCE

AUTHOR

AUTOR PRÁCE

Jan Škaryd

SUPERVISOR

VEDOUCÍ PRÁCE

Mgr. et Mgr. Hana Mihai

BRNO 2019

Bakalářská práce

bakalářský studijní obor **Angličtina v elektrotechnice a informatice**

Ústav jazyků

Student: Jan Škaryd

ID: 185917

Ročník: 3

Akademický rok: 2018/19

NÁZEV TÉMATU:

Elektronické cigarety a jak je vnímá okolí

POKYNY PRO VYPRACOVÁNÍ:

Cílem práce je vysvětlit a popsat princip elektronické cigarety, její části a funkce, porovnat elektronickou cigaretu s cigaretou klasickou, co se týče zdraví, návykovosti, ceny ap., a zjistit názory kuřáků el. cigaret oproti kuřákům klasickým.

DOPORUČENÁ LITERATURA:

Harrald, Chris. The Cigarette Book: The History and Culture of Smoking. Skyhorse Publishing, 2010.

Apperson, G.L. The Social History of Smoking. CreateSpace Independent Publishing Platform, 2015.

Fields, Victor. Electronic Cigarette: The Beginners Guide To e-Cigarettes, Vaping & E-Hookah. CreateSpace Independent Publishing Platform, 2016.

Termín zadání: 7.2.2019

Termín odevzdání: 28.5.2019

Vedoucí práce: Mgr. et Mgr. Hana Mihai

Konzultant:

doc. PhDr. Milena Krhutová, Ph.D.
předseda oborové rady

UPOZORNĚNÍ:

Autor bakalářské práce nesmí při vytváření bakalářské práce porušit autorská práva třetích osob, zejména nesmí zasahovat nedovoleným způsobem do cizích autorských práv osobnostních a musí si být plně vědom následků porušení ustanovení § 11 a následujících autorského zákona č. 121/2000 Sb., včetně možných trestněprávních důsledků vyplývajících z ustanovení části druhé, hlavy VI. díl 4 Trestního zákoníku č.40/2009 Sb.

Abstract

This bachelor's thesis is focused on both smokers of electronic and conventional cigarettes. The aim of this bachelor's thesis is to introduce and describe an electronic cigarette, its parts and compare its harmfulness with conventional cigarettes, especially in the current situation when smoking is not so fashionable in public as it used to be.

Based on the findings, it is noticeable that electronic cigarettes are trying to consolidate their position on the market, on the one side, for a relatively short period of time, but on the other, relatively well so far.

Abstrakt

Tato bakalářská práce je zaměřena jak na kuřáky elektronických, tak i konvenčních cigaret. Cílem této bakalářské práce je představit a popsat elektronickou cigaretu, její části a porovnat její škodlivost oproti cigaretě konvenční, zejména v aktuální situaci, kdy kouření na veřejnosti není tak moderní, jako tomu bylo dříve.

Na základě zjištěných údajů je patrné, že se elektronické cigarety snaží upevnit svou pozici na trhu sice poměrně krátkou dobu, ale zatím relativně úspěšně.

Keywords:

Electronic cigarette, conventional cigarette, tobacco, nicotine, harmful effects of smoking, anti-smoking situation

Klíčová slova:

Elektronická cigareta, konvenční cigareta, tabák, nikotin, škodlivé účinky kouření, protikuřácké období

ŠKARYD, J. *Electronic cigarettes and public view*. Brno. University of Technology,
Faculty of Electrical Engineering and Communication, 2019

Supervised by Mgr. et Mgr. Hana Mihai.

PROHLÁŠENÍ

Prohlašuji, že svoji bakalářskou práci na téma Elektronické cigarety a jak je vnímá okolí, jsem vypracoval samostatně pod vedením vedoucího bakalářské práce a s použitím odborné literatury a dalších informačních zdrojů, které jsou všechny citovány v práci a uvedeny v seznamu literatury.

Jako autor uvedené bakalářské práce dále prohlašuji, že v souvislosti s vytvořením této bakalářské práce jsem neporušil autorská práva třetích osob, zejména jsem nezasáhl nedovoleným způsobem do cizích autorských práv osobnostních a/nebo majetkových a jsem si plně vědom následků porušení ustanovení § 11 a následujících zákona č. 121/2000 Sb., o právu autorském, o právech souvisejících s právem autorským a o změně některých zákonů (autorský zákon), ve znění pozdějších předpisů, včetně možných trestněprávních důsledků vyplývajících z ustanovení části druhé, hlavy VI. díl 4 Trestního zákoníku č. 40/2009 Sb.

V Brně dne

.....

Podpis autora

Acknowledgments

I would like to thank Mgr. et Mgr. Hana Mihai for supervising.

Table of content

TABLE OF CONTENT.....	5
1 INTRODUCTION.....	9
2 HISTORY OF TOBACCO.....	11
2.1 TOBACCO IN EUROPE	11
2.1.1 <i>Jean Nicot</i>	12
3 ELECTRONIC CIGARETTE	13
3.1 THE PRINCIPLE OF ELECTRONIC CIGARETTES	13
3.2 HISTORY.....	13
3.2.1 <i>Herbert A. Gilbert</i>	13
3.2.2 <i>Lik Hon</i>	14
3.3 FIRST TYPES OF MODERN ELECTRONIC CIGARETTES	15
3.3.1 <i>Mouthpiece</i>	16
3.3.2 <i>Atomizer</i>	16
3.3.3 <i>Battery</i>	16
3.4 MODS / GRIPS.....	17
3.4.1 <i>Grip Batteries</i>	17
3.4.2 <i>Atomizer head</i>	18
3.5 SMOKELESS INHALING.....	18
4 E-LIQUID	20
4.1 NICOTINE	20
4.2 PROPYLENE GLYCOL (PG).....	20
4.3 VEGETABLE-GLYCERIN (VG)	21
4.4 FLAVOR.....	21
4.5 INHALED AEROSOL	21
4.5.1 <i>Methods of electronic smoking</i>	22
5 HARMFULNESS OF ELECTRONIC CIGARETTES	23
5.1 E-LIQUID	23
6 HARMFULNESS OF CONVENTIONAL CIGARETTES.....	24
6.1 SMOKE	25
6.1.1 <i>Passive smoking</i>	25
6.1.2 <i>Nicotine</i>	26
6.1.3 <i>Carbon monoxide</i>	26
6.1.4 <i>Toluene</i>	26
6.1.5 <i>Tar</i>	27
6.2 FILTERS	27
7 SMOKING SITUATIONS AND PROHIBITIONS	27
7.1 WORLD NO TOBACCO DAY	28
7.2 WORLD WARS.....	29
7.3 ADVERTISING	29
7.4 LEGISLATION.....	30

7.4.1	Warning labels.....	30
7.4.2	The law of excise duty.....	30
7.5	TORCHES OF FREEDOM.....	31
8	ELECTRONIC CIGARETTES AMONG ADOLESCENTS.....	31
9	QUESTIONNAIRE.....	32
9.1	BASIC DATA	32
9.2	QUITTING SMOKING.....	33
9.3	PRICES.....	37
10	STRUCTURE OF THE QUESTIONNAIRE.....	38
10.1	NON-SMOKERS	39
10.2	CONVENTIONAL SMOKERS	43
10.3	SMOKERS OF ELECTRONIC CIGARETTES.....	48
11	CONCLUSION.....	54
12	LIST OF FIGURES	55
13	LIST OF CHARTS.....	55
13.1	NON-SMOKERS	55
13.2	SMOKERS OF CONVENTIONAL CIGARETTES.....	56
13.3	SMOKERS OF ELECTRONIC CIGARETTES.....	56
14	LIST OF TEXT REFERENCES.....	57
15	FIGURES AND CHARTS REFERENCES	61

1 Introduction

Nowadays – at the beginning of modern times, more and more daily-used things are becoming electronic-based. Moreover, even electronic components themselves are steadily expanding inexorably to many spheres of our everyday lives. Such items can be found, for example, during listening to music, reading or help us to make a cup of coffee in the morning. Electronics try to enhance these items of everyday use to save our valuable time and to bring us a certain amount of comfort and luxury. Hence, it is no wonder that even cigarettes can be found in its electronic form.

Moreover, the Czech Republic is currently facing the situation when smoking is being prohibited outside, in public places and even inside vast majorities of restaurants. On 31 May 2017, a complete ban on smoking in public areas was introduced in the Czech Republic. Nevertheless, the law itself is unable to make people quit smoking. After all, even though smoking is a bad habit, and this law came into force, the tobacco business is still a very well prospering field - even if electronic cigarettes are not taken into account.

Since the time tobacco was discovered, there was immediately a significant number of people who began to smoke this dried herb, rolled in a paper tube. However, certain health risks are related to smoking. Electronic cigarettes may then represent the answer to these health problems as well as to the environment in general - cigarette ends lying on sidewalks and even to the unpleasant burning-cigarette smell. However, are electronic cigarettes worth it?

The goal of this work is to gather crucial information and introduce the essential aspects related to electronic cigarettes, its functionality, and use.

The aim of this bachelor's thesis is to introduce the principle of electronic cigarette and explain its main parts. Also, I would like to compare electronic cigarette with the conventional one in terms of health aspects, price, and others.

This work consists of a theoretical and a practical part. In the theoretical part, I will shortly describe a history of tobacco, its arrival to Europe as well as a brief history of electronic cigarettes and introduce various types of electronic cigarettes, where I also explain its principle and define the term "atomizer," where the evaporation occurs. Related to this, I will explain closely associated term "e-liquid" and what it is consisted of. Then I would like to state some of the harmful aspects of an electronic and a conventional cigarette. By the end of the theoretical part, I would like to mention the interesting aspects related to smoking in general. In the second part, with the connection to my questionnaire, I will compare public opinions on electronic cigarettes among conventional smokers, smokers of electronic cigarettes, and non-smokers.

2 History of tobacco

Smoking tobacco during history meant a slightly different method of using these dried leaves of the plant than today. As Kwass (2014) written, it was a particular sort of accompaniment during healing and meditation sessions used by shamans, enabling them better communication with spirits of their forebears or with an entry into a trance state through other dimensions. However, tobacco itself was not used merely as a single substance, but often with another, hallucinogenic substances.

Today it is a difficult task to accurately determine where and when tobacco has begun to be cultivated, in particular, for the need of smoking. Nonetheless, Walsh (2007) stated in his book that Paleolithic art from Europe dated to over 17,000 years ago and from South Africa dated even to 25,000 years ago. Simultaneously, this art is also accompanied by shamanic practices, and thus, there is a specific connection with smoking tobacco and other herbs.

2.1 Tobacco in Europe

Tobacco in Europe is with the highest probability related to the discovery of the continent of America, thus with the name of Christopher Columbus. As Červená (2011) has written, the first seeds of tobacco have arrived in European shores a few years after the American continent was explored. It happened so namely thanks to a tradesman Roman Pene in 1518 from Tobacco province, in San Domingo.

The location of Pene's discovery is also the reason for the name of this plant. Another expansion of tobacco was only a matter of time. The tobacco has spread to France and England first. It happened relatively soon after the ship arrived back.

Kubánek (2009) stated that one member of Columbus's ship crew, Rodrigo de Jéreza was trying to do what natives in America were doing - inhaling the smoke of dried leaves. Because of that he probably became the first documented European smoker. However, after the arrival back to Spain he was imprisoned by the inquisition after a short period of time because other people in his neighborhood were so terrified by the smoke coming out of his mouth, that he was marked as obsessed with the devil (Kubánek, 2009).

Even though smoking was in its early times available for wealthy people, mainly because of a high price of accessories and even because of the high price of tobacco itself, it

became very desired commodity after the arrival. The initial high price was, according to Cromý (2006), also one of the aspects why leaves of dried tobacco started to be crushed entirely and then snuffed by a nose. In such a state, tobacco has become less expensive and worth to money even to lower social classes.

Not after a long time, the plant has started to be cultivated individually at European's homes. This home cultivation was later reflected in significantly lower prices of both whole dried leaves and tobacco in a crushed state as well (Chromý, 2006).

The tobacco also has been widely used during battles throughout the world. Under a rule of Louis XIV, a pipe, flint, steel and a bag of tobacco were set as a part of the military equipment. Non-smoking soldiers then changed these rations profitably for other items or sold them in order to earn money for their families (O kouření a jeho účincích, 1909).

Regarding the area of the Czech Republic, the first person who contributed to the formation of the tobacco industry was Rudolf II. The enormous expansion of tobacco in the Czech Republic was achieved during the Thirty Years War, mainly because of foreign mercenaries (Chromý, 2006).

2.1.1 **Jean Nicot**

Thanks to a French diplomat, Jean Nicot, in 1561, snuff tobacco has appeared and become to use in French royal court as a treatment (Kwass, 2014). The leaves were crushed and turned into a powder which was subsequently inhaled by a nose, as stated above.

It is even believed that the queen of France has been given a letter, where Jean Nicot described a tobacco-based cure against several diseases as headache, or migraine (Rogers, 2019).

Because of this plant, Jean Nicot became famous even as a successful tradesman. In 1828 the essential alkaloid was firstly extracted and the addictive substance, as well as the plant itself, named after him.

3 Electronic cigarette

In this part, the history of electronic cigarettes is described as well as its main parts. It also contains essential information regarding its functionality.

3.1 The Principle of electronic cigarettes

The electronic cigarette is a device that represents a modern form of smoking. Correctly it is called a vaporizer (from Latin - vape = steam), which serves for the conversion of the substance of the liquid state to a gaseous state by the action of heat. These evaporated substances are then inhaled. During this process, no combustion occurs. Thus, it also means reduced health problems. Nonetheless, even this innovative method of smoking is unable to be used without certain risks.

3.2 History

The very first idea of an electronic cigarette was created by Joseph Robinson in 1927 (Robinson, 1927). However, Robinson's patent with a high probability was never commercialized, and there are many doubts, whether his prototype of this relatively primitive device was ever created, or remained in paper form only (LotoLabs, 2018). The first documented prototype of an electronic cigarette was then created by Herbert A. Gilbert in 1963 (Gilbert, 1963).

3.2.1 Herbert A. Gilbert

According to Gilbert (1927), his patent is named as “smokeless non-tobacco cigarette” and works on a principle of inhaling heated and chemically harmless flavored air. Even though the device was not suitable for inhalation of tobacco, Gilbert itself, in his patent counted on the production of such a device that corresponds to a conventional cigarette in both size and shape. Gilbert's cigarette consists of a replaceable cartridge with flavor situated on the bottom of the cigarette as well as a detachable battery heating as is noticeable from his patent (see Figure 2). The heating was designed in the form of a heating bulb, or a vacuum tube in such a way, that it passes through the entire inside of the device and the air then flows through internal threads in the device body, around the perimeter of the heating device (Gilbert, 1963).

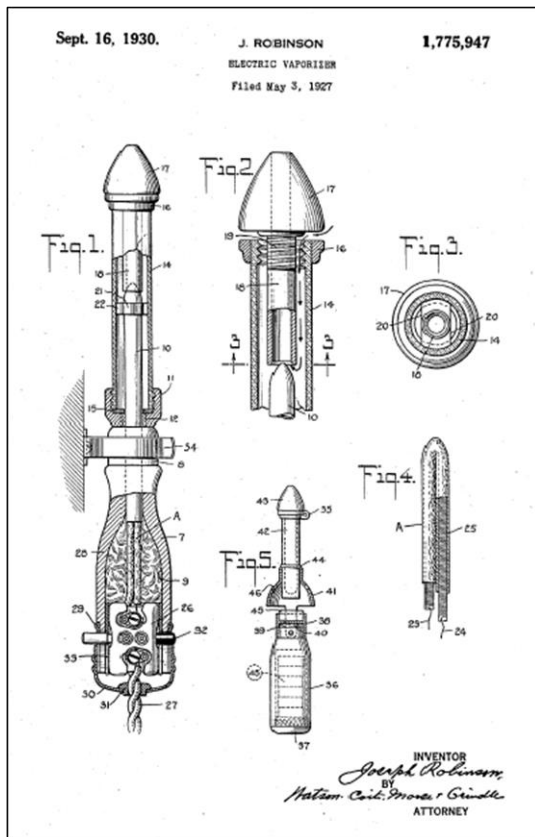

Figure 1 – Joseph Robinson's vaporizer

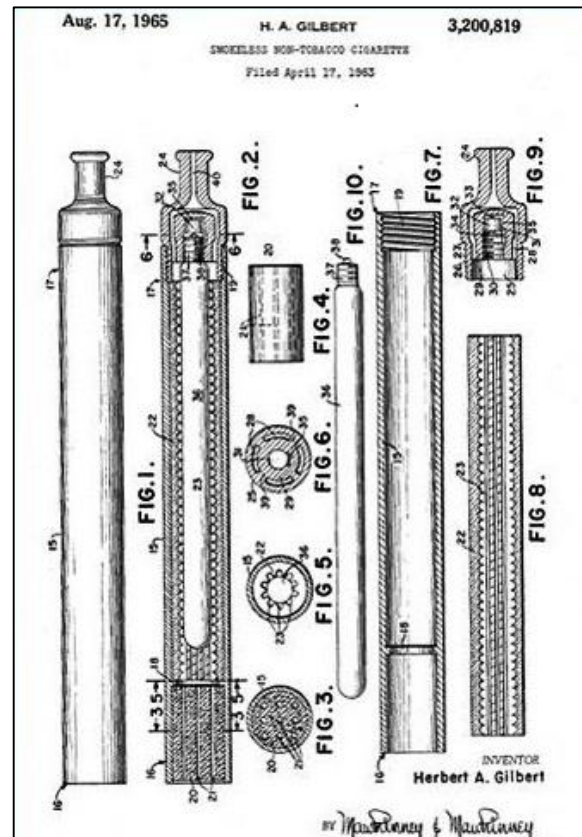

Figure 2 – Herbert A. Gilbert's smokeless non-tobacco cigarette

3.2.2 Lik Hon

Despite the fact, cigarettes based on non-tobacco principle have already existed relatively for a long time, for a vast majority of people were still unknown until a Chinese pharmacist Lik Hon. He appeared in 2003 with a patent of a new and a modern kind (Hon, 2003). This device then came into a vast awareness rapidly. Lik Hon also belongs among the responsible persons fighting for cleaner Olympic games in 2008 and even became known as the father of modern electronic cigarettes (Mika, 2016).

According to Nayir et al. (2016), Lik, as a passionate smoker consumed up to two packs of cigarettes a day. After his father died due to smoking, he tried to get rid of this habit using nicotine plasters as well, but this effort did not have a good ending. The idea came into his mind during one of his nightmares, as he dreamed of drowning in water that then turned into a giant cloud of vapor. (Fontem Ventures, 2015).

Lik Hon's patent is revolutionary mainly in order to allow smokers to inhale nicotine, whereas to reduce the inhalation of tar and other substances formed during combustion. Lately, he also came up with an idea of the built-in digital screen, which is useful to smokers of electronic cigarettes, mainly for monitoring the time of smoking, or battery charge status (Hon, 2003).

3.3 First types of modern electronic cigarettes

The appearance of very first electronic cigarettes is similar to conventional ones, or there was at least an effort of manufacturers to visualize conventional ones (in a significant number of cases the shape reminds a pen as well).

Nonetheless, electronic cigarettes are naturally heavier, because of battery. At first sight, the mouthpiece and the battery can be noticeably distinguished. Between these two parts, a device called an atomizer, or cartomizer (stated below) is situated, whereas, on the opposite side of the mouthpiece, a LED (Light-Emitting Diode) light reminding the burning cigarette is placed (cf. Ebbert, J. et al. 2015).

When the price of this device is taken into account, definitely not an enormous amount is discussed. Since it has been shown on the market for some time the price is naturally lower – for instance, according to vipelectroniccigarette.co.uk, electronic cigarette that is seen below (Figure 3) can be purchased for £10.99.



Figure 3 – One of the first types of electronic cigarettes

3.3.1 **Mouthpiece**

A mouthpiece can also be called a drip-tip (cf. Vapeklub, 2019a). As far as these types of electronic cigarette are concerned, the mouthpiece is also a part of the device, where an e-liquid is stored, in contrast with newer types of electronic cigarettes, where the e-liquid can be found in a transparent tank. The mouthpiece is cylindrical, made of plastic and its color is usually the same as a conventional cigarette filter – orange with the porous design to reminds conventional cigarette. In the area where the contact with the smoker’s mouth occurs, a little hole is situated, enabling inhaling.

3.3.2 **Atomizer**

An atomizer is the part of an electronic cigarette where an e-liquid is transformed into an aerosol (cf. Vapeklub, 2019a). Thus, it creates an impression of smoke. As stated above, considering the first types of electronic cigarettes, an atomizer part stores an e-liquid and a heating coil simultaneously. Therefore, it is called a cartomizer (a combination of the words “cartridge” and “atomizer”). Then, when inhaling, a cigarette recognizes the under-pressure state and automatically switches the circuit. At this moment, the coil starts to glow that is reflected as evaporation of an e-liquid.

3.3.3 **Battery**

The battery is typically charged via standard USB having a special adapter enabling the connection to a battery of the device that often differs according to the type of a cigarette. As shown in figure 3, the integrated battery is entirely “hidden” inside of the body of an electronic cigarette (cf. Vapeklub, 2019a). Concerning this type of e-cigarette, the essential feature of batteries for these types is the capacity, which is typically given in mAh (milliampere-hours) which says how long the battery will last, in contrast with Mods and Grips, where more current is needed, in order to produce such amount of smoke.

3.4 Mods / Grips

Behind these names are labeled powerful electronic cigarettes. (cf. Vapeklub, 2019a). A Mod or a Grip is a device with durable either an integrated or replaceable battery as well a tank with an e-liquid placed on the top is noticeable.

Mods or Grips offer a significant number of advanced features. They are primarily designed for heavy conventional or experienced electronic smokers. The shape of these devices is also different. Often, it has a screen that provides an uncomplicated adjustment of the performance of the device, where general information as a voltage, current, and resistance are displayed. The device contains a tank of a different size, where an e-liquid is stored. Inside of the tank, an atomizer head is situated (see Figure 4).

Concerning these devices, the price range is moving on a wide scale. Mods and grips are on the market for a relatively long time, and the essential aspect defining its price are various functions of the device or the power. According to vipelectroniccigarette.co.uk, the average one can be purchased around £50 - £60.

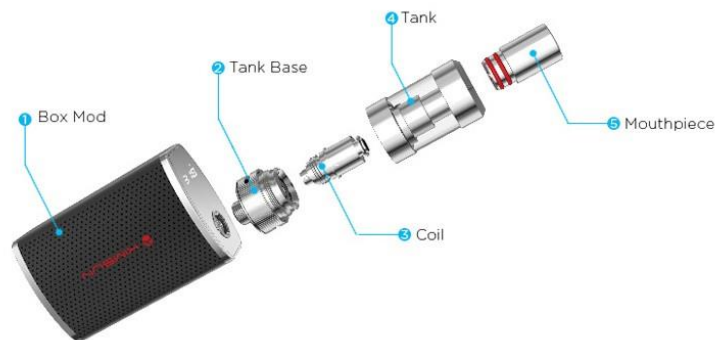

Figure 4 – The essential parts of an electronic atomizer (mod/grip)

3.4.1 Grip Batteries

Mods/Grips can provide much higher power, as stated above. (cf. Vapeklub, 2019a). For an accomplishment of a greater “smoke,” the device needs to be fed with powerful batteries, which are approximately up to three times stronger, than preceding types of electronic cigarettes that are mentioned above. Thus, in the body of a Mod can be sometimes

found even three or more batteries of 18650 type. These batteries have to dispose of relatively high current, even up to around 40 Amperes (Míka, 2016).

3.4.2 Atomizer head

Power is typically reflected as the amount of “smoke” that the device can evaporate. This phenomenon takes place in a replaceable atomizer head that is usually made from steel (cf. VapeRanks, 2012a). According to Míka (2016), an atomizer head consists of a spiral (mainly made of Canthal, Titanium, Stainless, Nickel or Nickel-chromium) with a specific resistance, in which a piece of natural wool is situated. After a tank is filled with e-liquid, the atomizer head is immersed, and the piece of wool is soaked after several minutes. The spiral inside of the atomizer head is then ready to be heated to such temperature at which an e-liquid evaporates.

Nonetheless, during e-smoking, attention has to be paid to the level of an e-liquid in the tank. In case a puff is taken with the insufficient amount of an e-liquid in the tank, the wool is not appropriately soaked and thus may become scorched. Such a devalued wool is reflected immediately in the taste when inhaling. The necessity of the atomizer head replacement then occurs. The act is called a dry hit.

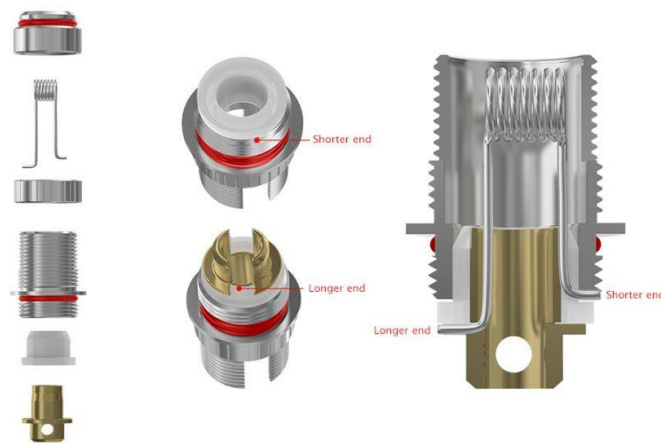

Figure 5 – The construction of an atomizer head

3.5 Smokeless inhaling

As smoking in indoor facilities has been banned, a significant number of companies naturally began to think about how to keep its already existing and profitable clientele. A device was created, situated between an electronic and a conventional cigarette (cf. IQOShop,

2017). These devices are considered and wondered as the healthiest way of inhaling only nicotine, without any other admixtures.

Inside of this device (see figure 6), a unique type cigarette is inserted, approximately with a half-length of a conventional cigarette. This device is designed for the heating purpose only, and consists of water, glycerin, and nicotine and minor additives as flavorings (IQOShop, 2017). The device then warms up the filling with a heat-blade (see figure 6) to the controlled temperature up to 350°C (660°F). The temperature that plays a crucial role – a conventional cigarette burns at 860°C (1600°F) (Quigley, Cobb, Hunt, 2004).

During warming up the tobacco filling, the nicotine is the only substance that should be released. Thus either any harmful substance nor ash should not be produced. The filling lasts approximately as a conventional cigarette and needs to be changed after one cycle of smoking. The cigarette needs to be recharged for a while in a recharge box before another filling is inserted. The rechargeable box is able to provide sufficient power for several cycles. According to the Philip Morris company, over 72% of smokers in Japan have already stopped smoking conventional cigarettes and switched to this device (Kristen, 2017).

In the same article Kirsten (2017) also noticed that this device is not the first breakthrough invention, that is labeled as a healthier way of smoking – “Filtered cigarettes were introduced in the 1950s, and so-called light cigarettes twenty years later. However, none of these products significantly reduced the health risks of smoking.”

Even according to Schober’s recent research (2019), certain health risks have appeared concerning this device. The comparable concentrations with e-liquid cigarettes were proven. The research also proved slightly increased the concentration of formaldehyde, and propylene glycol.



Figure 6 – Modern smokeless cigarette

With regard to these smokeless devices, the discussed price is slightly higher than e-liquid-filled devices. These devices can also be found in different versions offering various functions, or for instance, greater battery capacity, and others. The price, according to www.amazon.co.uk, for the whole packaging including the charging box is around £80

4 E-liquid

An e-liquid is another necessary component of electronic cigarette. Without an e-liquid, there is no smoke. Concerning conventional cigarettes, the phenomenon that is called smoke is in relation to electronic cigarettes an aerosol.

An e-liquid itself consists primarily of five ingredients (cf. VapeRanks 2012b) - water, flavor (aroma of e-liquid) and nicotine (which is optional). The other ingredients are Propylene glycol and Vegetable glycerine.

4.1 Nicotine

As stated above, considering electronic cigarettes, nicotine is an additive. On the market can be found e-liquids with zero nicotine content as well. Otherwise, the nicotine concentration in e-liquids is given either in percent or in milligrams in a particular volume (cf. Cotti., Nesson, Tefft, 2018). Relatively high-nicotine e-liquids can be seen, even higher than 20 mg/ml of nicotine concentration that is the highest value in serial production agreed by European Union (cf. VapeRank, 2012b).

Although 20mg/ml is probably a value, that is for a vast majority of e-smokers unreachable, regarding the intensity, e-liquids can be produced (mixed) home-made as well. The resulting e-liquid can thus reach much higher concentration by purchasing all of the necessary components.

4.2 Propylene glycol (PG)

This substance is an organic compound without any smell or any color. It is used ordinarily in food-industry as a stabilizer, a thickener, or in meat products as an additive to prevent the loss of the color, but also in the cosmetic and pharmaceutical industry (Féropotravina, 2017). Concerning electronic cigarettes, this compound carries the taste of an e-liquid (cf. VapeRank, 2012b).

Several preparation methods of the Propylene glycol exist. The most common is the oxidation process of propylene with water. The research of propylene glycol did not reveal any source of carcinogenicity on humans (Chauvel, Lefebvre, 1989).

4.3 Vegetable-glycerin (VG)

According to Kienhuis et al. (2015), the vegetable-glycerin is made by the extraction of plant oils (the most frequently from soy, coconut, and palm oil and is characterized by relatively high viscosity and stickiness. Because of this property, this substance is suitable rather for producing great clouds of “steam,” in contrast with PG.

Apart from that, the Vegetable-glycerin has a versatile use even in the home. It took its place as a natural-based polish for furniture as well as for wooden floors. This compound is also useful for cleaning stains on clothing (Féropotravina, 2017).

4.4 Flavor

Concerning an e-liquid, a significant number of brands on the market occurs. Each of them offers an even more significant number of various flavors, from basic ones as tobacco to exotic combinations of various fruits or food (cf. VapeRank, 2012b).

On numerous occasions, when a smoker starts to use his or her first electronic cigarette as a substitute device, typically decide to choose some of the tobacco flavors, reminding him or her the taste of conventional cigarettes.

Moreover, on the market can be found even the compounds itself (Propylene glycol and Vegetable Glycerin separately) and an enormous number of flavors, that can be mixed according to smoker’s ideas and taste. The home-made e-liquid then has specific properties, beginning with the ratio between PG and VG, therefore between the taste and the amount of the produced aerosol and ending with an enormous number of mixed flavors and nicotine contents.

4.5 Inhaled aerosol

Although it may not be distinguishable at first sight, it is distinguishable at first taste. The “smoke” or correctly called an aerosol that is inhaled has a different consistency in

contrast to the smoke from a conventional cigarette. For the vast majority of people, even for those who smoke conventional cigarettes for long years, it is a new experience. Thus, firsts “puffs” from an electronic cigarette are usually accompanied by coughing.

4.5.1 **Methods of electronic smoking**

As stated above, the primary aim of producing electronic cigarettes was to relieve smokers from harmful substances and thus replace the conventional ones. However, ways how the electronic cigarette is smoked slightly vary in contrast with conventional ones. It can be distinguished three, on the one hand, relatively close, but on the other hand, different methods of smoking – vaping (Vapeklub, 2019b).

The first one- the most frequent for smokers used to conventional cigarettes, is with the highest probability the classic method called “mouth to lung” (MTL). The evaporated steam is taken into a mouth and consequently inhaled. This method is typically applied to pen-shaped electronic cigarettes with relatively small power. Therefore, a common approach to this method is to buy Propylene glycol-based e-liquid, which will result, on the one hand, as a small amount of evaporated steam, however, on the other, full flavor taste.

As another, a “direct lung” (DL) method is stated. It means the evaporated steam is taken from electronic cigarette directly to the lungs. For this reason, the lower concentrations of e-liquids are recommended. This way of smoking is suitable for smokers intended to make steamy clouds but still to keep a substantial part of e-liquid flavor.

The third used method is called cloud-chasing. As previous, DL method, the principle remains the same – to take steam directly to the lungs. However, this method is primarily focused on making an enormous amount of steam. Concerning cloud-chasing, it is evident that this method is not concerned to satisfy the need for nicotine. Thus e-liquids with zero, or minimal nicotine content based on Vegetable-glycerin are recommended, in order not to inhale large quantities of nicotine. Cloud-chasing is also widely used mainly among younger generations, in order as a subject of entertainment or competitions.

5 Harmfulness of electronic cigarettes

According to Mašek (2014), concerning electronic cigarettes, as the most harmful aspect is denoted e-liquid. Although e-liquids are subjected to specific conditions that can be expressed by certificates various imitation of the original e-liquids exists. However, the difference is primarily noticeable in its price. “The composition of the original branded e-liquids is always declared on the label, and the basic compounds are basically the same for all brands” (Mašek, 2014). After all, an electronic cigarette should not produce any carcinogenic substances that could lead to cancer, nor does not damage the heart, which should mean no risk of heart disease.

A study of Ruyan manufacturer e-cigarette declares that smoking an electronic cigarette is up to 1,000 times less dangerous than smoking tobacco. (Laugesen, 2009)

There is a certain risk related to the use of electronic cigarettes. Like any other electronic devices containing batteries, an electronic cigarette may become overheated, and thus an explosion of batteries may occur. This risk is not of great importance, for example, even because of charge balancer. It balances the levels of the batteries, so they are charged evenly (Ives, 2018). However, this is one of the statements that is provided for all electronic devices. Nonetheless, the explosion may occur mainly because of improper device handling or incorrect operation.

5.1 E-liquid

The composition of "e-smoke" is slightly less dangerous, with a comparison with conventional smoke – due to the presence of burning. Even though electronic cigarettes are proven as a healthier way of smoking, specific health problems and risks can be distinguished even concerning this form of smoking, (Tierney P. et al., 2016).

The e-liquid may be considered as the most significant risk, especially in case of its ingestion. As stated above, the home-made e-liquids can reach high concentrations of nicotine (as well as other compounds), due to the curiosity of individuals, as stated above. Therefore, the ingestion of such a strong e-liquid, not only by little children may carry fatal consequences.

For instance, according to a study by Tierney et al. (2016), the research of the harmfulness of e-liquids determined the presence of flavor chemicals in the range 1-4%,

concerning chosen e-liquids. These chemicals include aldehydes, substances recognized as irritating to the respiratory mucosa, or vanillin (ethyl vanillin), identified as non-toxic in small doses. In small doses, vanillin is widely used in cosmetics, or as a food additive. Tierney et al. (2016) have also claimed that when given at high doses for a more extended time, anemia, diarrhea or lack of weight gain may be observed. Excluding nicotine, the potentially harmful substances in e-liquid can be then occasionally found in the flavor.

Flavors that are used in e-liquids are strictly tested for oral use, however not so strictly for inhalation use (Long, 2014). According to Bahl et al. (2012), the toxicity of e-liquid is often related to the amount and flavoring contained in it. Some of the flavorings may contain substance diacetyl that can be found in microwave popcorn, giving it a specific butter taste. Exposure to diacetyl is in several cases connected to bronchiolitis obliterans (obstruction of the smallest airways of the lungs) and thus indirectly linked to e-cigarettes (Pierce et al. 2014).

Based on Clapp and Jaspers findings (2018), few cases of mint-based e-liquids allergy exist. “Tierney and colleagues that identified and quantified the flavoring constituents in 30 popular e-cig products reported menthol concentrations ranging from 5.7 to 21.6 mg/ml” (Clapp, Jaspers, 2018). However, according to their findings, it is a value that is comparable to conventional menthol-based cigarettes. Thus, the component causing the allergy is not precisely defined. Moreover, the decomposition of e-liquid depends on used materials of the atomizer and the temperature. Concerning high temperatures, above 200 degrees of Celsius, inhalational toxicants can be found in varying amounts, depending on the composition of given e-liquid.

6 Harmfulness of conventional cigarettes

Since the tobacco plant has arrived at the shores of Europe, it started to spread immediately and with incredible speed. As stated above, the tobacco was considered as a tool for the treatment of diseases. Thus, in the beginning, nobody was thinking about the harmful effects of smoke that is inhaled. The first documented study of the harmful effects of tobacco has been attested by a French doctor, M. Bouisson, in 1859. He noticed that the majority of patients who were suffering from mouth cancer uses tobacco. According to M. Bouisson, cancer was caused by irritation of the tissue with tobacco fumes and heat (Hammond 1962).

6.1 Smoke

Smoke from conventional cigarettes contains more than 4000 compounds (excluding a cigarette paper and a filter); 92% of these compounds are in the gaseous state and 8% in the solid state (Hammond, 1962).

According to Novák (1980), the vast majority of these compounds can be dangerous for the human body, carcinogenic (approximately 60 compounds), or can damage our body cells. Also, it is suitable to distinguish cigarette smoke into two categories. The first one means the smoke that is exhaled by the smoker - such smoke is called mainstream smoke. During this process, part of cigarette smoke is absorbed by the body of a smoker, and the rest is exhaled into the environment. The other is called side-stream smoke or passive smoking. In this case, the smoke directly wafting from the end of a lit cigarette is meant (cf. Novák, 1980).

According to one of the leading companies that focus on cigarette production, based on the 21-days exposure to cigarette smoke has been proved that inhaling side-stream smoke is approximately four times more toxic in compare with mainstream cigarette smoke (Pradáčová, 2010).

6.1.1 Passive smoking

As stated above, by passive smoking is meant inhaling the smoke indirectly, that means inhalation of exhaled smoke from people nearby, or by inhaling the smoke that is wafting from the end of a burning cigarette. As Mašek (2014) stated, when a cigarette is smoked, a smoker absorbs about 15% of smoke, whereas the rest is released to the environment. Therefore, even passive smoking is considered to be harmful.

The exposure to the smoke is dangerous mainly in small, enclosed areas, for example, in a car. The concentration of smoke, dust particles, carbon monoxide, and other harmful substances in such places could be many times higher (Schick, Glantz, 2005). Passive smoking is then a significant health risk, especially for children. Passive smoking may also be one of the reasons why smoking parents often raised children with asthma or any other respiratory infections.

6.1.2 **Nicotine**

The well-known compound that is contained in tobacco is the nicotine. A certain amount of nicotine contained in cigarette smoke is primarily absorbed into the body by the mucous membrane of the respiratory tract. By inhalation of tobacco smoke, receptors in the brain are stimulated, and dopamine is consequently released, which can lead to a pleasant feeling of better thinking, spontaneity, and activity. According to Kubánek (2009), a person who suddenly stops smoking after a certain period of time may feel unpleasant symptoms. These include, for example, insomnia, anxiety, depression, disorientation, increased appetite, and consequently weight gain. Kubánek (2009) has also stated that nicotine also increases heart rate, blood pressure, and stimulates the digestive tract, and the fatal dose is about 60 mg for non-smokers. A smoking person as a periodic recipient is then able to withstand even higher values. Nicotine poisoning is according to Pradáčová (2010) manifested by the central nervous system failure with subsequent suffocation, and although it is a non-carcinogenic compound, it is highly addictive - it reaches the brain within 10 seconds after inhalation. A conventional cigarette contains about 8-10 milligrams of nicotine. Nonetheless, the vast majority of this amount is not absorbed by a human body and burns (about 1 mg of nicotine is absorbed into the body) (Kubánek, 2009).

6.1.3 **Carbon monoxide**

Another compound - carbon monoxide is the poison that is present in exhaust gases. As Patočka and Plucar have written (2009), it binds to hemoglobin blood pigment faster than oxygen, which reflects in lower oxygen transfer capacity. Carbon monoxide is colorless, odorless, and thus cannot even be noticed. Heavy smokers may have the blood oxygen transfer capacity reduced by up to 15% (Patočka, Plucar, 2009).

6.1.4 **Toluene**

Terry (2017) has written that toluene is a clear liquid having a sharp odor that is easily discernible in small amounts, evaporates quickly and typically used as a solvent. According to Terry, the amount of Toluene in the smoke also differs according to the composition of a cigarette as well as to the way the cigarette is smoked. The exhaled smoke by the smoker contains less toluene than the smoke wafting from the end of a lit cigarette - exhaled smoke may contain about 100 micrograms, whether wafting smoke can achieve values up to 10 times higher (Terry, 2017).

6.1.5 **Tar**

As Kubánek (2009) stated, tar could be labeled as the most dangerous compound regarding carcinogenic diseases. It is a partially combustible particulate matter that is produced by the act of burning. When a cigarette is smoked, tar forms a sticky layer inside of the lungs. This process is making the lungs unable to filtrate incoming toxins - up to 70% of tar that is inhaled remains in the lungs (Comby, 2007). These toxins thus may penetrate noticeably deeper and cause lung cancer, emphysema, or other lung problems.

6.2 **Filters**

Until 1952, cigarettes were smoked without filters (Kubánek, 2009). Harrald and Watkins (2010) in their book have stated that the first aspect that reminds filter was a cork mouthpiece designed for women - filters as are known today, were brought by Lorillard Tobacco company in 1952 that introduced Kent cigarettes. At first, they were not very credible innovation. Nonetheless, the growing awareness caused by the health risks of smoking has helped cigarette filters to enter the market soon.

Cigarette filters were introduced as a new and healthier way of smoking (Harrald and Watkins 2010). Thus naturally, a few years later were part of a vast majority of manufactured cigarettes.

As Kubánek (2009) stated, even though a cigarette filter absorbs a certain number of compounds as is tar, they are rather ineffective in filtering toxins such as carbon monoxide. Used cigarette filters that are lying on sidewalks then contain a significant amount of hazardous chemicals such as cadmium, arsenic, lead, copper, and others that are partially filtered out during smoking because of high temperatures and consequently partially further inhaled (Wexler, Anderson 2005).

7 Smoking situations and prohibitions

As the main reason for smoking-bans is stated the protection of people from the risk of passive smoking as already stated above. This ban also reduces the risk of fire in the workplace and support the idea that every worker is entitled to a healthy working environment as stated in the Czech Labor code (262/2006 Sb.)

Since the introduction of an electronic cigarette, there is a relatively large rivalry between e-cigarette manufacturers and the tobacco industry. Electronic cigarettes have excited a significant number of smokers, and some of them became to use the electronic version of smoking instead.

In early times the ecclesial government was against smoking. Thus the smoking was strictly prohibited, and this violation was subjected to high fines. However, the government then probably realized that tobacco could be a very profitable product. A various monopoly was imposed, and high taxes came into force. Thus, cigarettes cannot be banned entirely for one reason - very high profitability. Not only profitability from taxes on tobacco or cigarettes, but also on medical centers, that take care of smoking clientele.

The first mention of the smoking ban in the world is dated back to 1575, to Mexico - smoking was banned here in churches (Proctor, 1999). This happening was followed by Pope Clement VIII in 1600, who banned smoking in holy places worldwide (Rojek, 2010). The first ruler, who has publicly stood up against smoking, was the English and Scottish king James VI in 1604, and he also began taxing tobacco significantly (Harrald, Watkins, 2010). Nonetheless, smokers did not give up their habit.

In 1995 one of the anti-smoking laws (231/2001 Sb.) came into force in the Czech Republic. This law banned the advertising of tobacco products on television and later even on radio. The law also specified that advertisement is prohibited on large-scale advertising places around schools, playgrounds, and other similar sites, up to 300 meters away. In 2006 was banned even advertisement that promotes or is related to electronic cigarettes.

7.1 World No Tobacco Day

A no tobacco day is announced annually on May 31st all around the world. The Member States of the WHO (World Health Organization) declared 24 hours without tobacco, publicly known as World No Tobacco Day in 1987. This day was created as prevention against tobacco smoke, which can cause serious health problems as mentioned above. (Centers for disease control and prevention, 1990)

7.2 World wars

Only men from higher social classes were smoking before the First World War, mainly because of high prices, as stated above. Since October 1, 1941, tobacco stamps have been introduced to control cigarette rations in the war (Janouškovec & Brom, 2009). Thus cigarettes became to appear even among lower social classes and among their families. This allowance was at first 60 cigarettes per week, but not a long time after, since April 1943, the allowance had been reduced to 35 cigarettes per week (Janouškovec & Brom, 2009).

Even this slight reduction of allowance meant that cigarettes could cause certain unwanted or inappropriate aspects. From the point of view of the soldiers, cigarettes probably have represented an instrument that primarily helping them psychically to get over the problematic war situation. Thus, cigarettes were, on the one hand, able to reduce the amount of stress, but on the other, disturbed concentration and caused fatigue of soldiers, which was not very desirable, thus an effort to reduce tobacco and cigarettes has begun, in the end.

7.3 Advertising

As stated above, World Wars can be seen as a massive advertisement that silently supports smoking. The primary target of tobacco companies was, is and will be to earn money. Thus, tobacco companies tried to reach as many potential people as possible.

Moreover, because smoking among women was considered as a taboo at the beginning, smoking was primarily focused on men. Later, cigarette advertising has formed a significant number of patterns. In the movies, heroes and beautiful actresses can be seen while smoking. However, as studies of tobacco became more documented and widely known as harmful and dangerous, tobacco advertising began to be slightly on the decline, and the situation slowly but surely turned to the opposite side.

The conflict in this field has begun as censorship; a poster that represented a cover of album Abbey Road (1969) has been edited not to display a cigarette Paul McCartney is holding in his hand. (Janouškovec & Brom, 2009)

7.4 Legislation

Since the time all tobacco and tobacco-contained products are officially considered as potentially harmful, they are also subjected to specific rules.

7.4.1 Warning labels

In 1964 has been officially claimed that smoking causes cancer. Thus, since this time, particular influence exists in order to warn and protect smokers due to health aspects. (Komaroff, 2014)

According to Czech legal provisions, an advertisement for tobacco products must contain a clear warning of strict wording. As Kubánek (2009) stated, concerning any variety of a text type of advertisement, this text must be written by black color on a white background in such a way to achieve a total height of at least 80% of the height of the white background. Major warning labels of cigarette boxes can occur in two versions – “Smoking can kill.” and “Smoking seriously harms you and others around you.” These wordings must cover at least 30% of the displayed advertisement message of a most visible side, including a warning picture.

According to Kubánek (2009), also additional warning labels of cigarette boxes must be situated on a second most visible side and cover at least 40% of the displayed advertisement message, including a picture. As far as additional warning concerned, labels consist of phrases such as „Smokers die younger. “, “Smoking clogs the blood vessels and causes heart attacks and strokes.”, “Smoke contains benzene, nitrosamines, formaldehyde and hydrogen cyanides.” and others.

Nonetheless, a vast amount of smokers does not feel worried, but these warning labels are often used as collectible items instead.

7.4.2 The law of excise duty

According to Czech law of excise duty that came in law on 1.9. 2001 (40/1995 Sb.) is ordered cigarettes to be labeled with a uniform price stamp. Also, it is prohibited selling them at a price other than that stated on the stamp, in order to be sold to the end customer for the same price to prevent any fraud.

At the time when this law was in force for a relatively short time, newsagents tried to circumvent this law in many ways frequently, for instance, by selling a box of cigarettes together with lighters or matches, nonetheless, for a higher price.

According to the Czech law (353/2003 Sb.), importers and manufacturers can propose the Ministry of Finance every month for a price adjustment.

7.5 Torches of Freedom

As there always existed certain attempts against smoking throughout history, there were significant efforts to promote smoking as well. In 1929 a public relations campaign called “Torches of Freedom” labeled smoking as an act of female emancipation (Oxford University Press, 2015).

According to Christensen (2012), all began when journalist Edward Bernays (A nephew of Sigmund Freud), who has been working for Liggett and Myers, makers of Chesterfield cigarettes, was asked by American Tobacco Company to encourage women to start smoking. Several ladies then were hired to walk in public along New York’s streets on Easter Sunday and provocatively smoke while being photographed. Before this event, Edward Bernays told to press to expect that women would light up “torches of freedom” during the parade to show they were equal to men.

This happening then began to be relatively widely spoken, leading to a campaign which on the one hand, tried to sell cigarettes to women because this market had not been discovered yet and, on the other, which is the most important, it has connected cigarettes with freedom (Christensen, 2012).

8 Electronic cigarettes among adolescents

Although electronic cigarettes are often marketed as smoking devices that could stop smoking of conventional cigarettes, as stated above, e-liquids with a zero-nicotine content exists, offering a significant number of sweet and fruit flavors as well. These flavors are then attractive mainly among young adolescents. Another reason why adolescents decide to e-smoke is undoubtedly the amount of smoke.

Even though electronic cigarette has a certain potential to help smokers to break their habit, it may even cause the right opposite effect, concerning adolescents.

According to the Czech law (65/2017 Sb.) on tobacco products, it is forbidden to sell tobacco products, smoking accessories, and electronic cigarettes to a person under 18 years.

However, relatively young children can be seen smoking an electronic cigarette in the streets. It is primarily the young generation, that is influenced the most because e-smoking is primarily often seemed like a trend.

Electronic cigarettes were associated with a higher probability of conventional smoking among US adolescents. Therefore, a significant number of countries have decided to take appropriate action. Thus, it is not a surprising fact that e-cigarettes are subjected to specific regulations or even forbidden in a significant number of countries (Grana, Benowitz, Glantz, 2014).

9 Questionnaire

A questionnaire was created to determine the public opinion of electronic cigarettes. The questionnaire includes opinions of non-smokers, smokers of conventional and electronic cigarettes, and other devices. The questionnaire is anonymous and consists of 19 questions together. Based on the fact wheater a respondent is a non-smoker or a smoker of a particular product, specific questions were given. The questionnaire was answered by 128 respondents in Vysočina region and Brno.

9.1 Basic data

In the questionnaire, 79 people identified themselves as a smoker of tobacco products or any other electronic devices, whereas non-smoking people is 49 in total. Below (Chart 1 and Chart 2) the division of respondents according to their age difference can be seen.

First, it should be mentioned that although this questionnaire was posted publicly online, as well as given in paper version personally, the interest to answer was naturally expressed more by the younger generation. It does not mean that smoking is more frequent among younger people than among the older ones.

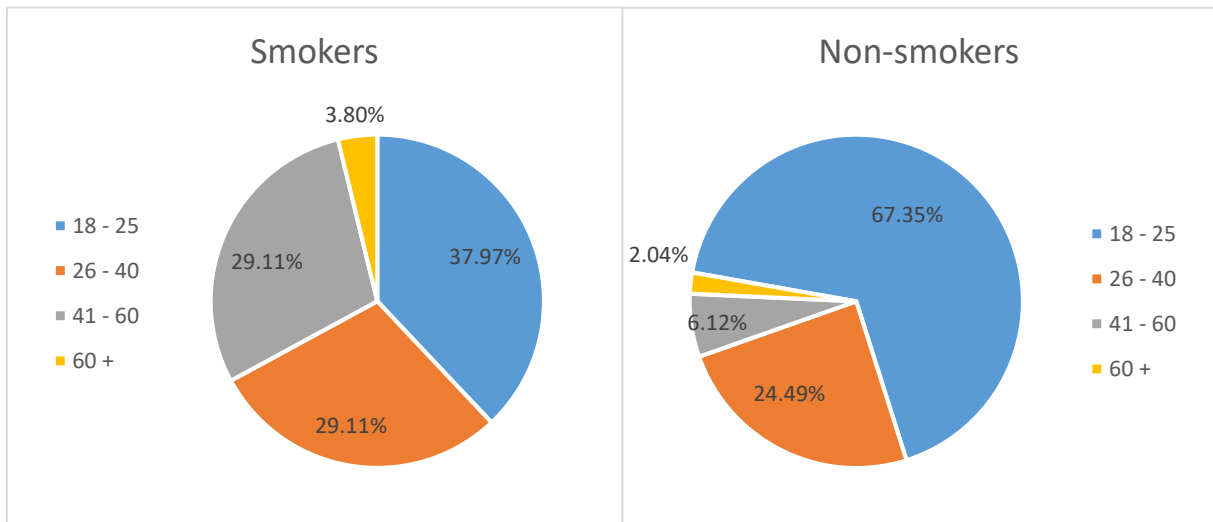

Chart 1 - Age of smokers

Chart 2 - Age of non-smokers

9.2 Quitting smoking

Today, at a time when it is proven that smoking can cause certain health problems, it can be said that a relatively significant number of people are still trying to get rid of smoking. It is evident that several ways how to stop smoking exist, although, this work is aimed at a public opinion - these charts are displaying general approaches rather than specific means.

In Chart 3 approaches of smokers of tobacco products as well as electronic cigarettes and non-smokers are distinguished on the scale from 1 to 5, in percent (100% of the same color always indicates one group of respondents on the whole scale)

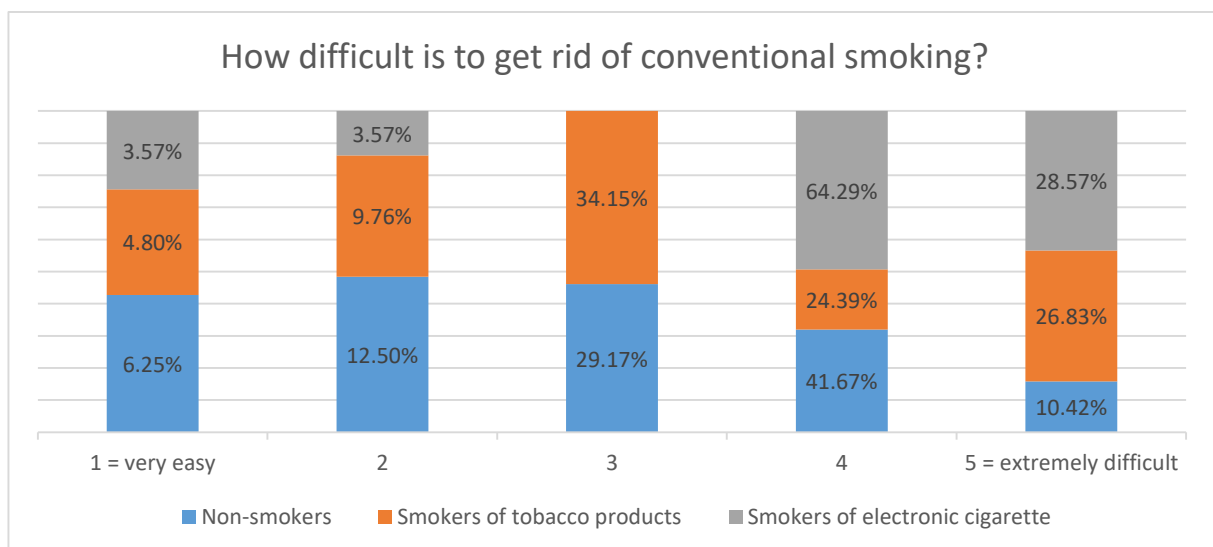

Chart 3 - How difficult is to get rid of conventional smoking?

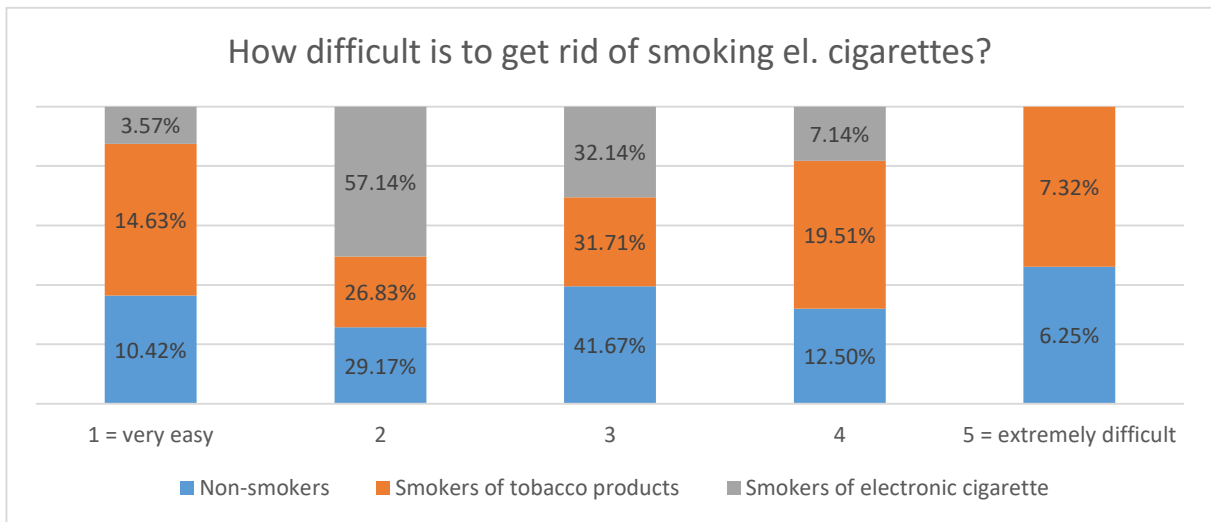

Chart 4 - How difficult is to get rid of smoking el. cigarette?

From these two charts (Chart 3 and 4), it is evident that smokers of conventional cigarettes or tobacco products consider quitting their habit as a relatively hard task (from 3 to 5 on the scale). The same opinion is shared among users of electronic cigarettes (from 4 to 5 on the scale) as well as among non-smokers (from 3 to 4 on the scale).

Concerning electronic cigarettes, the results are slightly lower on the scale, mainly according to users of electronic cigarettes, who consider living without their devices as less complicated (from 2 to 3 on the scale). Even non-smokers and conventional smokers consider abandoning addiction to electronic cigarettes slightly easier than quitting smoking tobacco products.

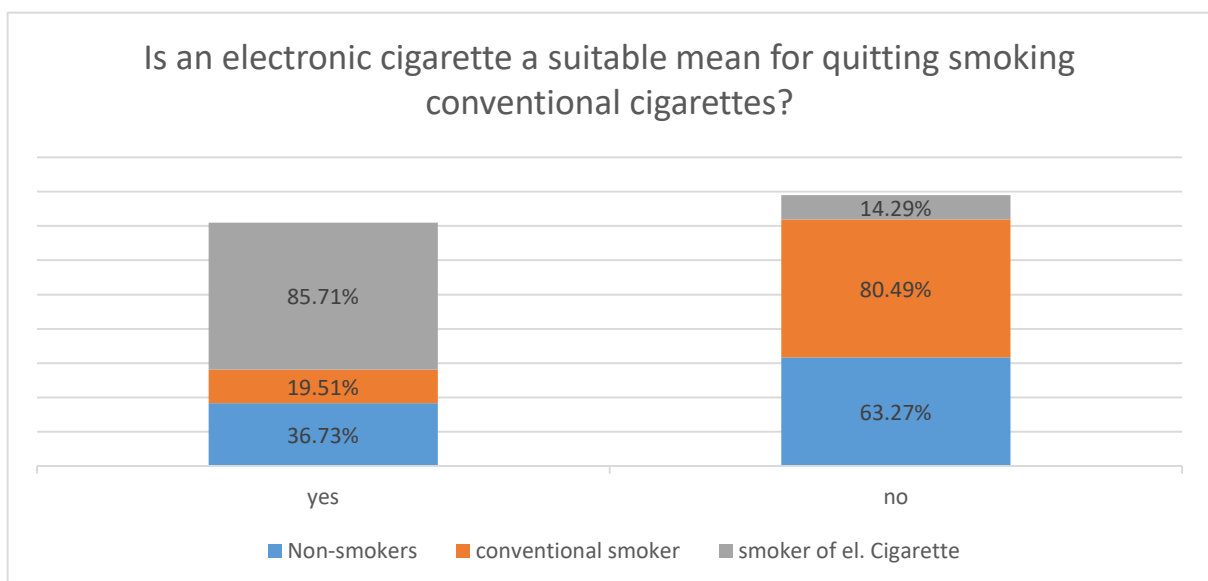

Chart 5 - Electronic cigarette as a suitable mean for quitting smoking conventional cigarettes?

Generally, it is said that for a heavy smoker of conventional cigarettes is suitable and maybe even more comfortable to switch to electronic one first, rather than quitting smoking immediately.

However, according to Chart 5, opinions seem to be inconsistent. While conventional smokers and non-smokers are against this statement, the vast majority of users of electronic cigarettes see this step as meaningful and useful.

Nonetheless, this leads to ambiguity among respondents. According to the vast majority of respondents quit to smoke conventional cigarettes is slightly harder than quite to smoke electronic ones. The electronic cigarettes as a suitable instrument for quitting smoking tobacco products were marked mostly by its users. However, conventional smokers and non-smokers do not see using an electronic cigarette as a device that could help get rid of tobacco products.

This fact is closely related to other aspects. More than 60% of respondents of tobacco products have already tried an electronic cigarette (see Chart 6), but despite relatively convincing advantages they stated, they are not interested.

Concerning all groups, the most significant advantages are a less unpleasant smell, lower harmfulness, and the possibility of flavors. Notably, a significant number of conventional smokers see electronic cigarettes as a healthier way of smoking, which could in particular with connection with other stated advantages possibly reflects as an oncoming effort to stop smoking.

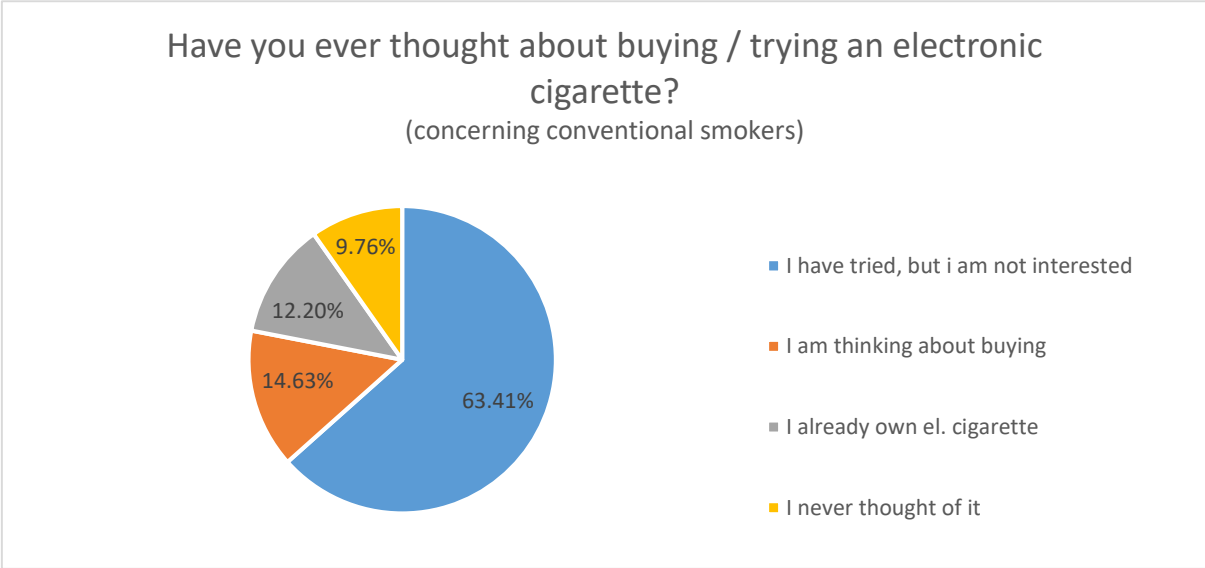

Chart 6 - Have you ever thought about buying / trying an electronic cigarette?

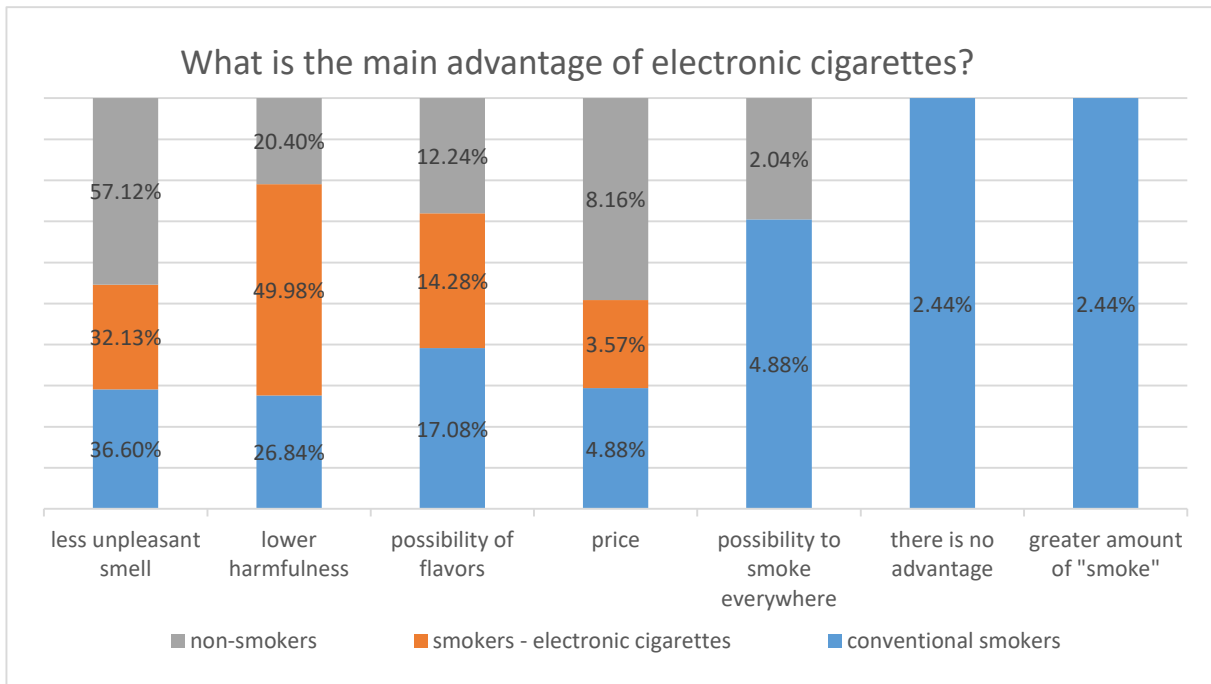

Chart 7 - What is the main advantage of electronic cigarettes?

Almost negligible minority stated the main advantage of an electronic cigarette as a possibility to use this device everywhere, which is, however, an untrue statement. As well as the statement that electronic cigarettes provide a greater amount of “smoke,” which is probably not precisely the key feature, but it rather could be seen as a variety of a trend. Moreover, these statements were stated by conventional smokers, who may not be familiar with the use of electronic cigarettes to such extent as smokers of electronic ones.

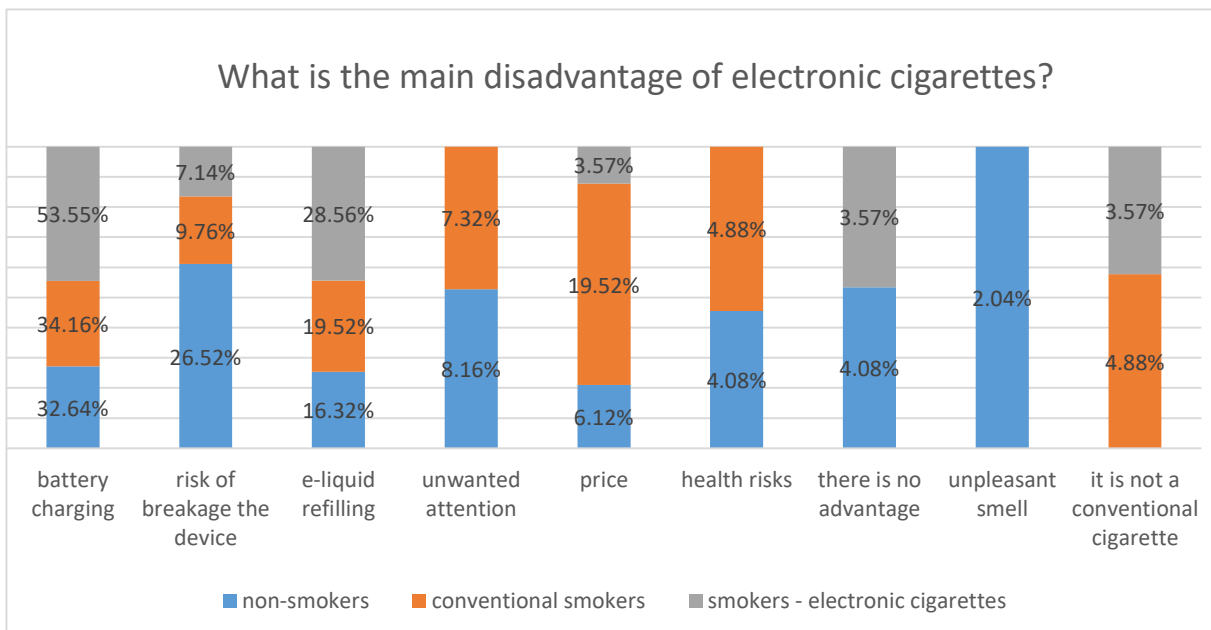

Chart 8 - What is the main disadvantage of electronic cigarettes?

On the other hand, concerning the disadvantages of electronic cigarettes, the impressions are also considerably contradictory. A significant number of non-smokers is afraid of breaking the device, which is undoubtedly a proper attitude to every single electronic device, which is then naturally related to battery charging. The more powerful is the device, the higher is the battery consumption – charging the batteries is the most uncomfortable aspect according to the majority of all groups.

Although electronic cigarettes can be purchased in different price categories, it seems its price is a disadvantage only for conventional smokers. Still, it is essential to mention that the future expenditure of electronic cigarettes is rather an individual aspect associated with the frequency of using the device and all of the used parts and products that are consumed and may differ significantly.

Chart 8 displays that 4% of non-smokers and almost 5% of conventional smokers consider the health risks of electronic cigarettes as the main disadvantage. On the other hand, none of the smokers of electronic cigarettes has marked this option as the main disadvantage. This decision probably reflects the fact that the users of electronic cigarettes are much more confident about the safety of their devices. Nonetheless, even such a statement is underestimated frequently, and a great number of people believe in its unconditional safety.

9.3 Prices

Concerning nicotine in e-liquids, it can be approximately stated how much is smoked, but the exact value that is absorbed by a human body is still more or less only an individual estimation. Nonetheless, concerning electronic cigarettes without nicotine content, it is a harder task. Thus, comparing a smoked pack of cigarettes with a particular volume of vaporized e-liquid is not very accurate, and thus, it is also problematic to compare an expenditure of conventional and electronic smokers.

Nonetheless, as is visible in Chart 9, smokers of electronic cigarettes that answered questionnaire approximately spent not more than 1500 Czech crowns. Thus in comparison with conventional cigarettes, the electronic ones seem less cost-intensive concerning the respondents.

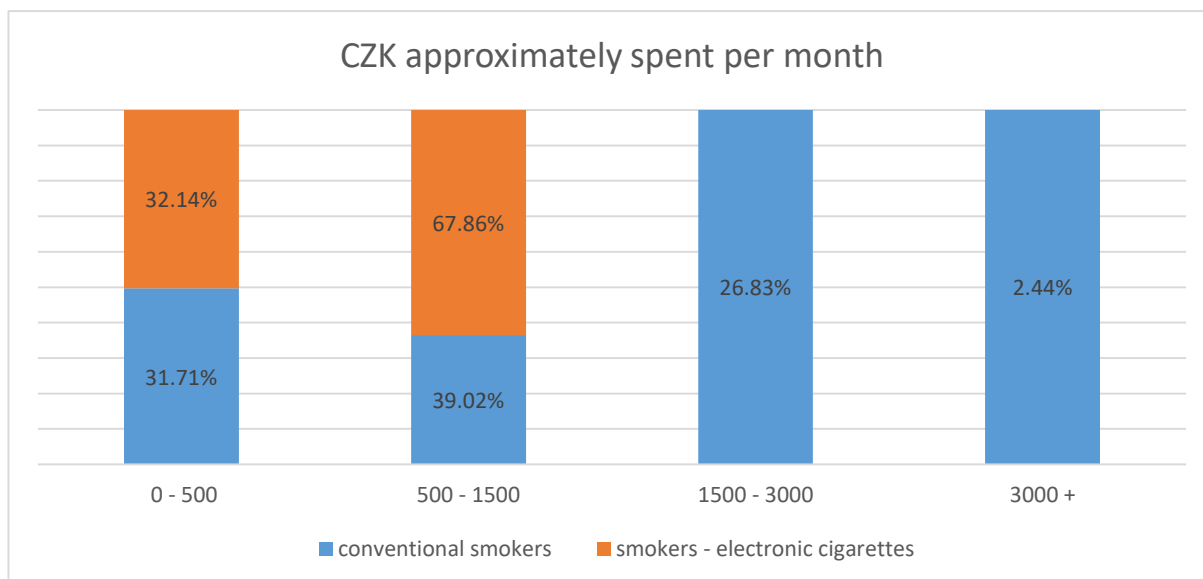

Chart 9 - CZK approximately spent per month

10 Structure of the questionnaire

Concerning the questionnaire, I have decided to choose a structuralized type, with individual respect to respondents, based on the first two questions – The first one is whether the respondent is a smoker or a non-smoker, and the second one is according to a type of smoking – electronic cigarettes, conventional cigarettes, IQOS, or other. From this reason is the questionnaire logically divided into smaller segments suitable for comparison.

Since only 7% of respondents chose IQOS or other, these opinions are included in groups of conventional cigarettes or electronic ones, according to the type of smoking.

1) Are you a smoker?

- Yes
- No

2) What kind of cigarette do you smoke?

- Conventional cigarettes (tobacco)
- Electronic cigarettes
- IQOS
- Other

10.1 Non-smokers

3) How difficult is to get rid of smoking conventional cigarettes?

1 = very easy, 5 = extremely hard

- 1
- 2
- 3
- 4
- 5

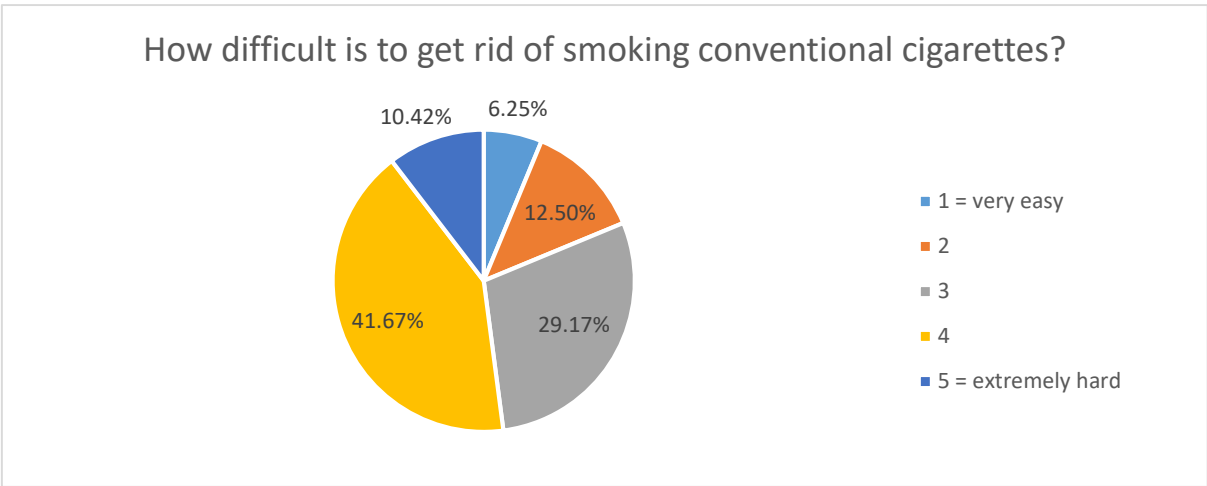

Chart 2. 1 - How difficult is to get rid of smoking conventional cigarettes?

4) How difficult is to get rid of smoking electronic cigarettes?

1 = very easy, 5 = extremely hard

- 1
- 2
- 3
- 4
- 5

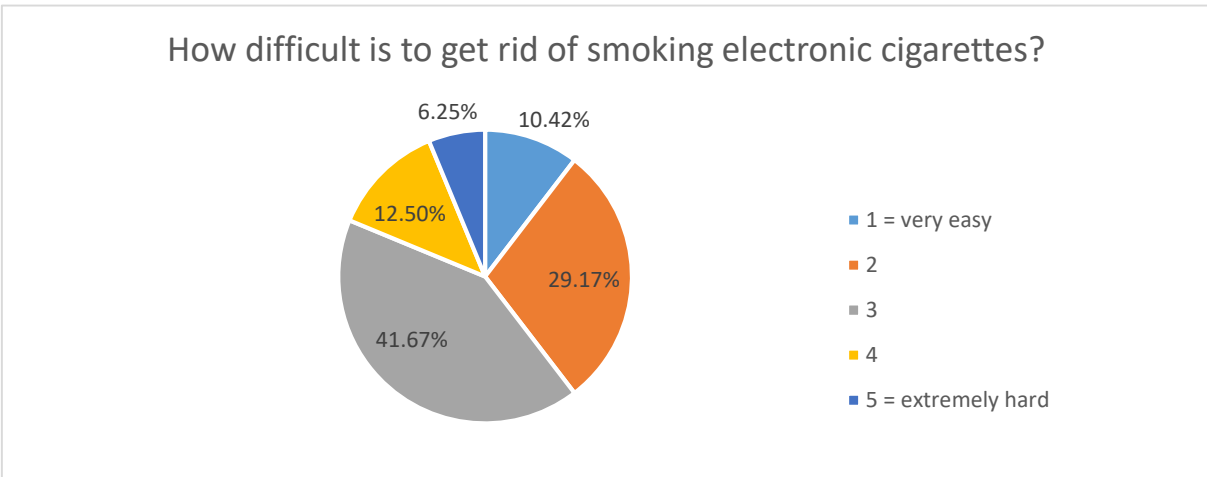

Chart 2. 2 - How difficult is to get rid of smoking electronic cigarettes?

5) Is an electronic cigarette a suitable means for quitting conventional cigarettes?

- Yes
- No

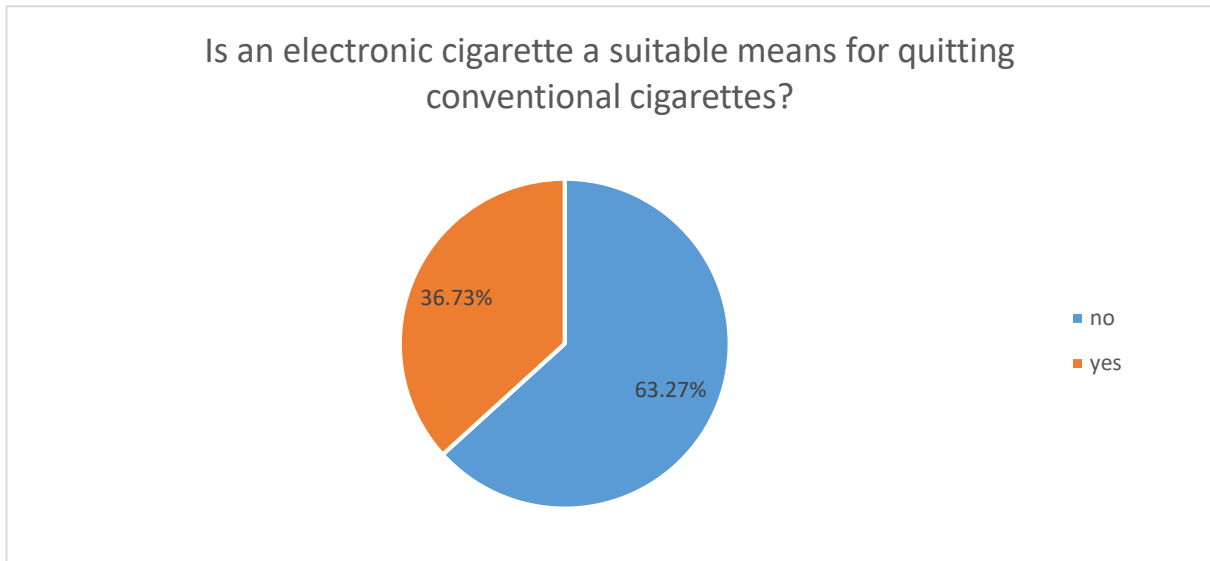

Chart 2. 3 - Is an electronic cigarette a suitable means for quitting conventional cigarettes?

6) What is the main advantage of electronic cigarettes, in contrast, with conventional ones?

- Price
- Lower harmfulness
- The greater amount of "smoke"
- Less unpleasant smell
- Lower harmfulness
- Own answer

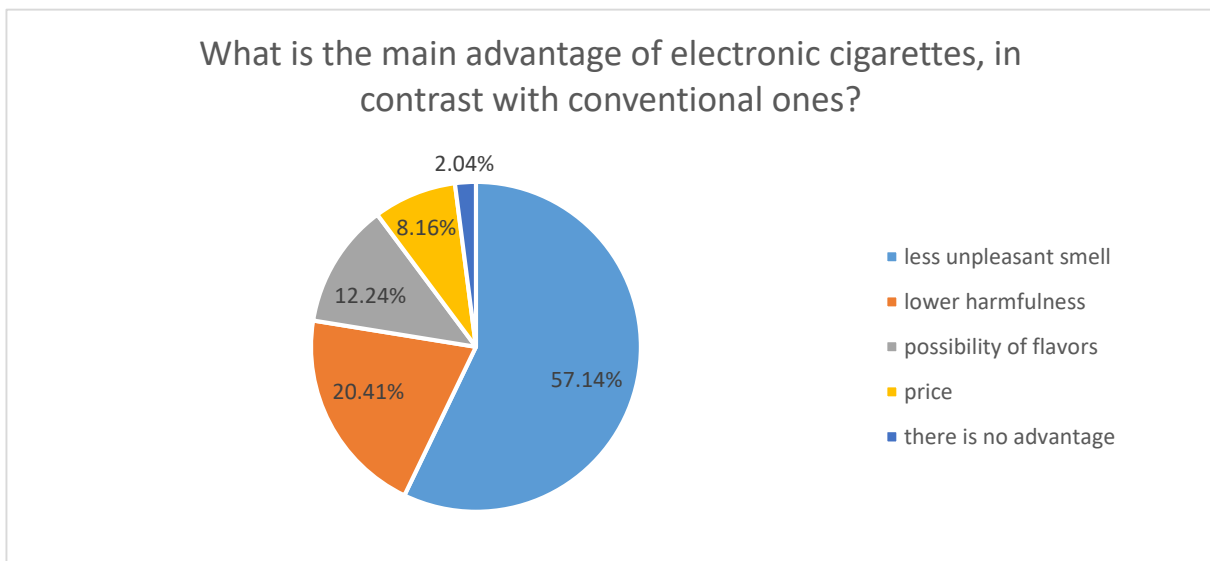

Chart 2. 4 - What is the main advantage of electronic cigarettes, in contrast with conventional ones?

7) What is the main disadvantage of electronic, in contrast with conventional ones?

- Price
- Battery charging
- E-liquid refilling
- Unwanted attention
- Risk of device breakage
- Own answer

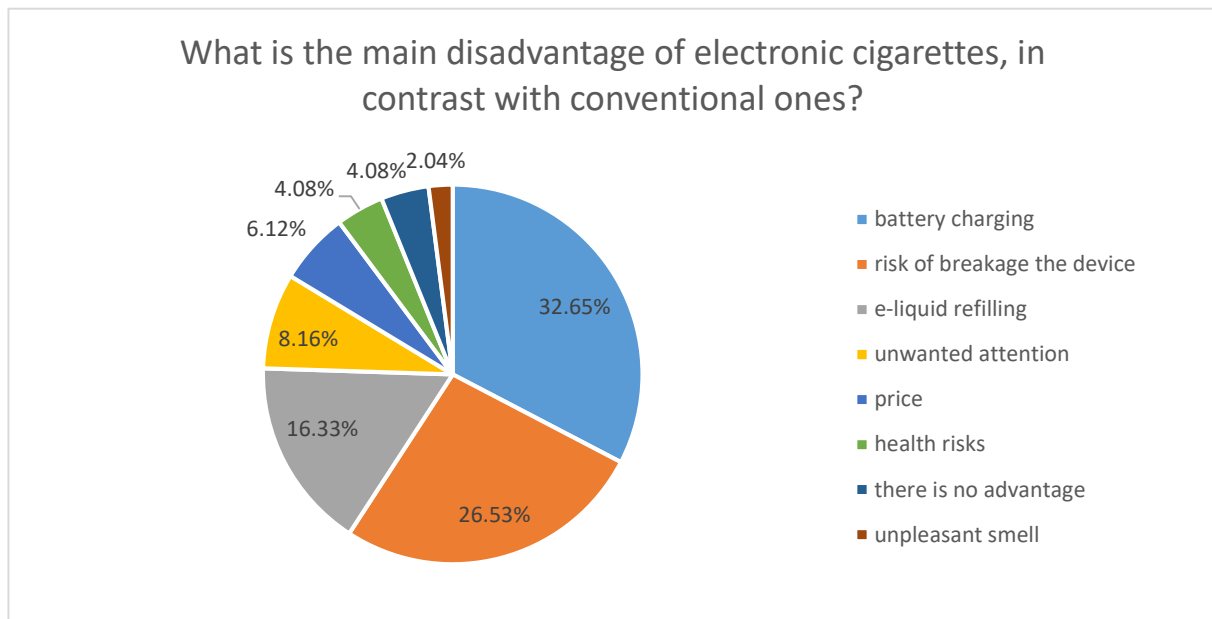

Chart 2. 5 - What is the main disadvantage of electronic cigarettes, in contrast with conventional ones?

8) Additional respondents' opinions

Electronic cigarettes are becoming "trends." Instead, some kind of educational way of their harmfulness should exist.

As a non-smoker, especially people smoking regular cigarettes bothers me - because of the smell.

Smoking conventional cigarettes, as well as electronic ones, is bad.

In my opinion, electronic cigarettes are used mainly by young people, which in the future reflects as smoking conventional ones.

9) Your gender?

- Man
- Woman

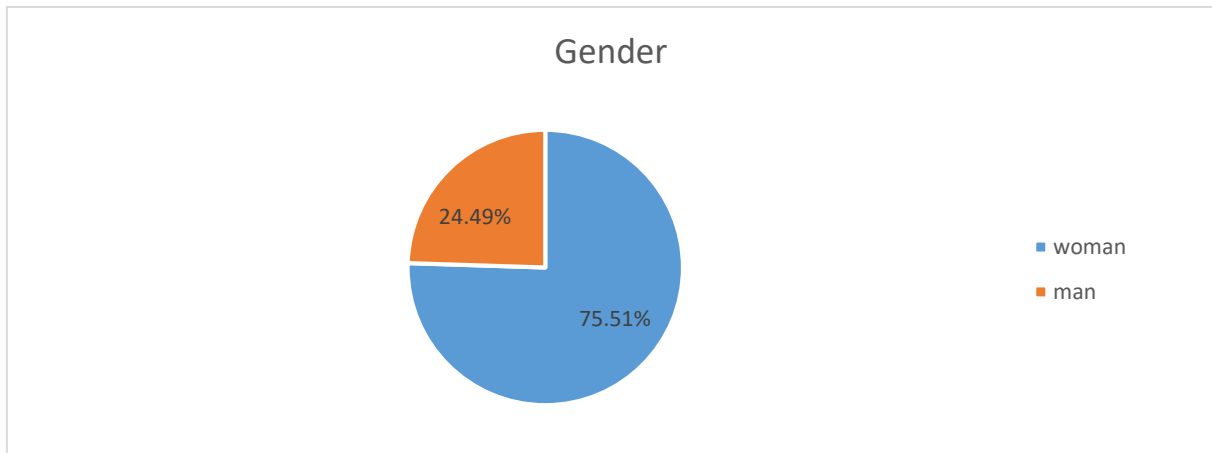

Chart 2. 6 - Gender

10) Your age?

- 18 – 25
- 26 – 40
- 41 – 60
- 60 and more

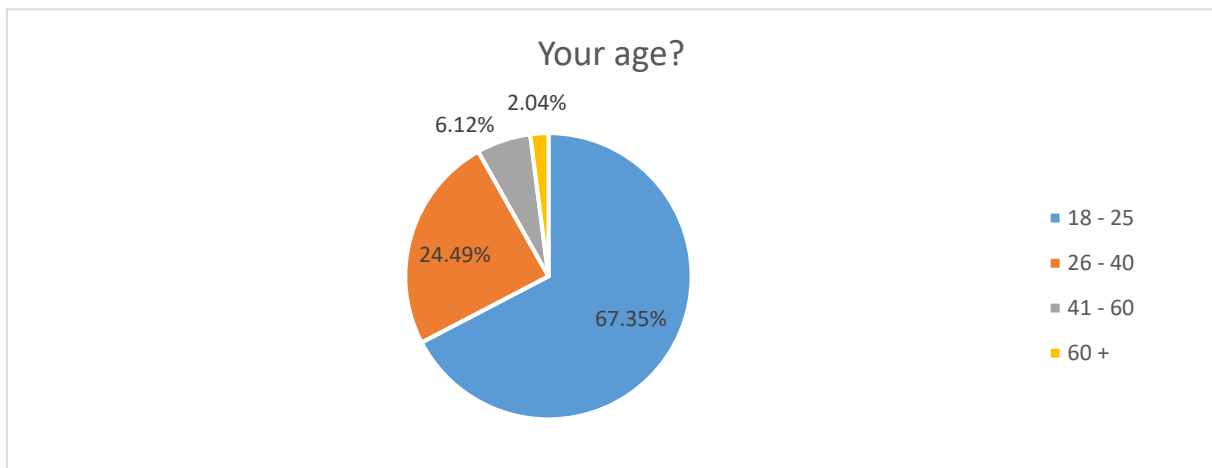

Chart 2. 7 – Your age?

10.2 Conventional smokers

3) Your approximate number of cigarettes smoked per day?

- 0 – 3
- 3 – 10
- 10 – 20
- 20 – 40

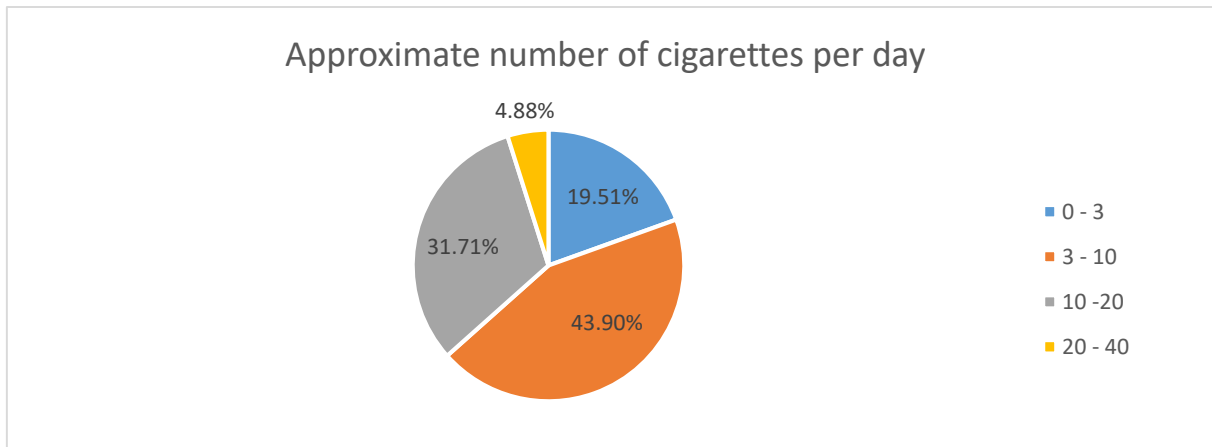

Chart 3. 1 – Approximate number of cigarettes smoked per day

4) Your favorite brand of cigarettes

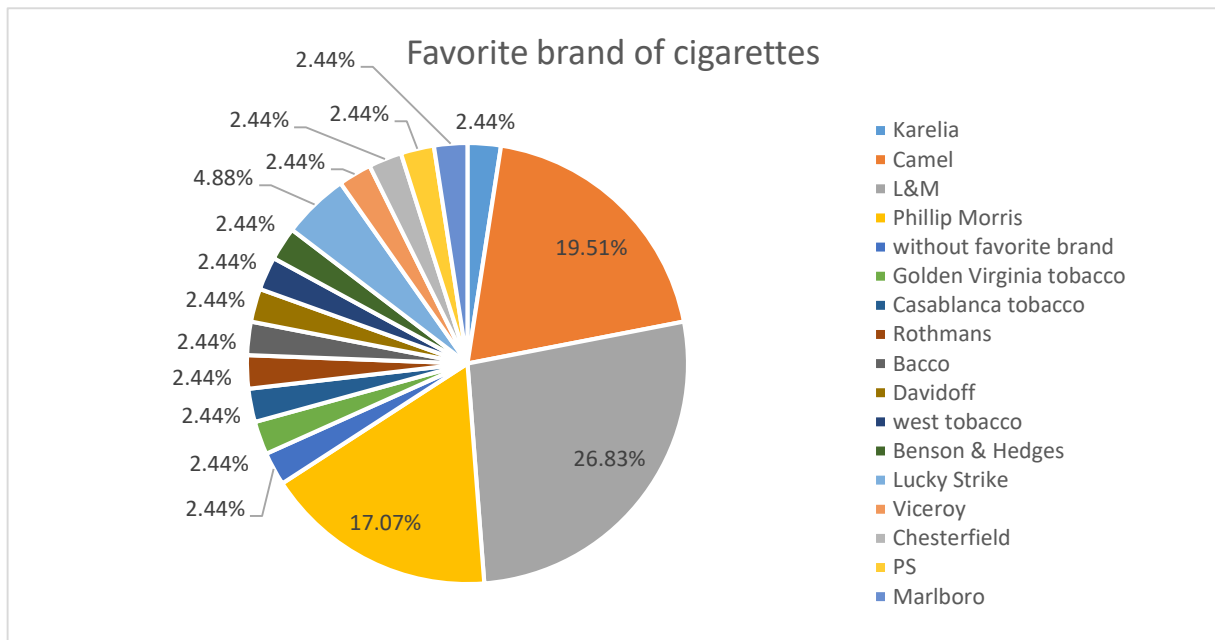

Chart 3. 2 - Favorite brand of cigarettes

5) How much do you spend monthly on this type of smoking?

- Up to 500 CZK
- 500 – 1500 CZK
- 1500 – 3000 CZK
- More than 3000 CZK

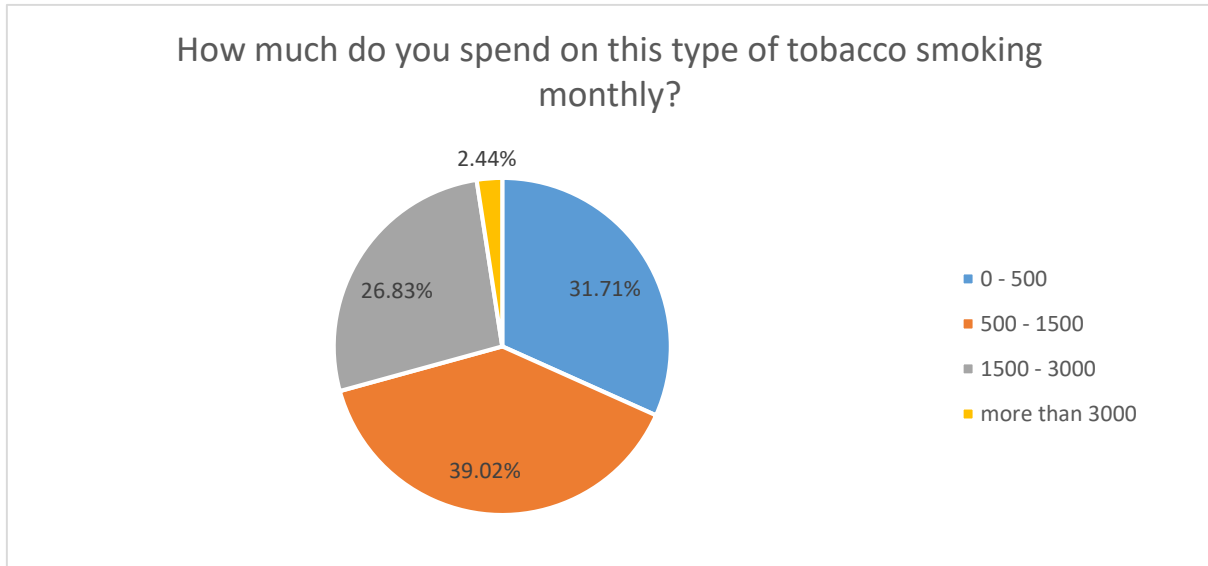

Chart 3. 3 - How much do you spend on this type of smoking monthly?

6) Have you ever thought about buying/trying an electronic cigarette?

- I have tried, but I am not interested.
- I am thinking about buying.
- I already own electronic cigarette.
- I have never thought of it.

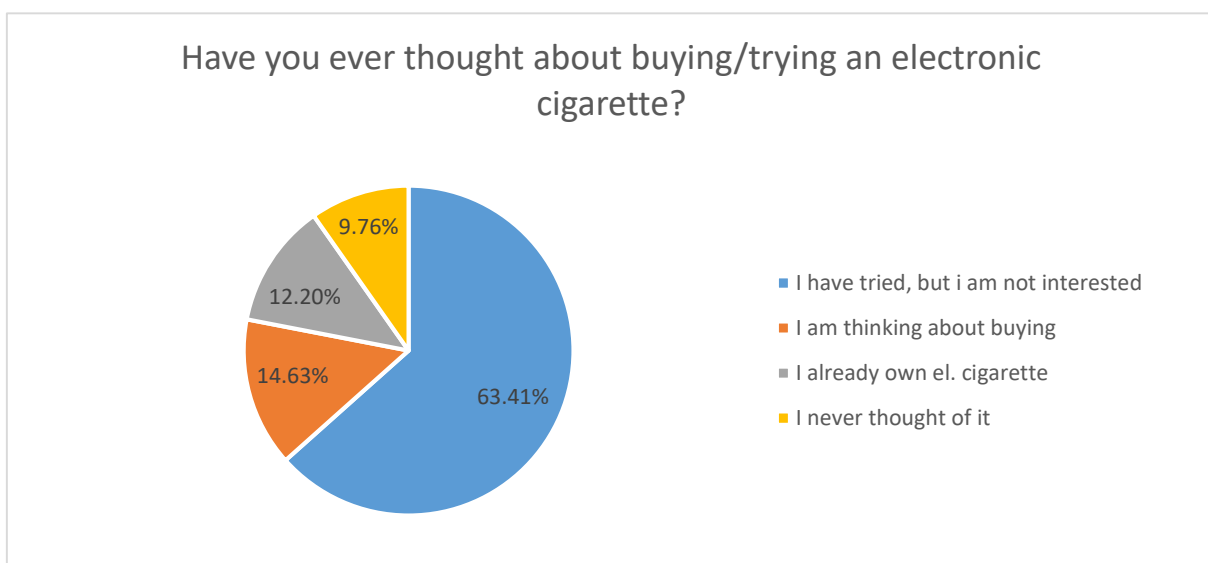

Chart 3. 4 - Have you ever thought about buying/trying an electronic cigarette?

7) How difficult is to get rid of smoking conventional cigarettes?

1 = very easy, 5 = extremely hard

- 1
- 2
- 3
- 4
- 5

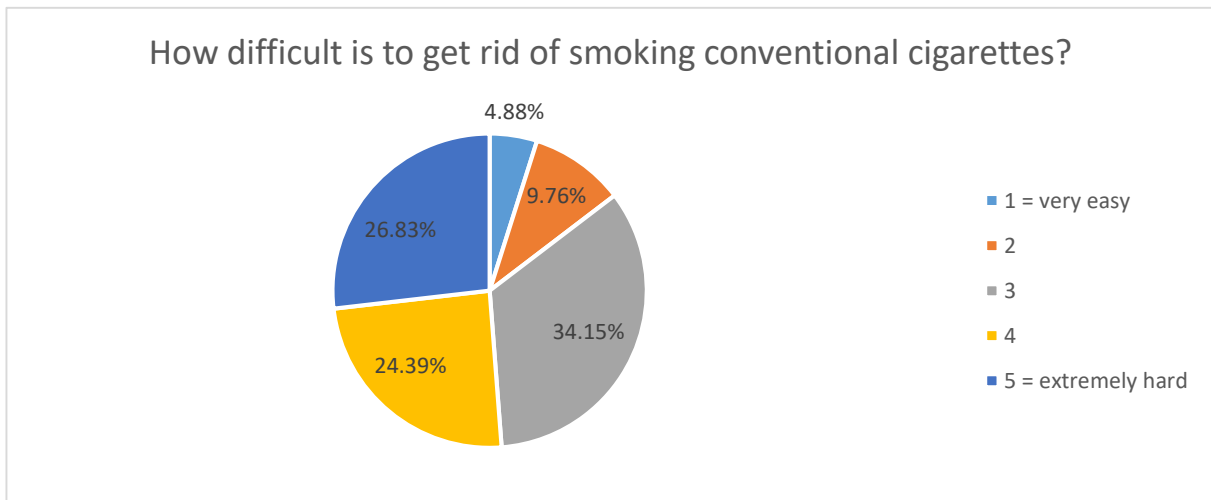

Chart 3. 5 - How difficult is to get rid of smoking conventional cigarettes?

8) How difficult is to get rid of smoking electronic cigarettes?

1 = very easy, 5 = extremely hard

- 1
- 2
- 3
- 4
- 5

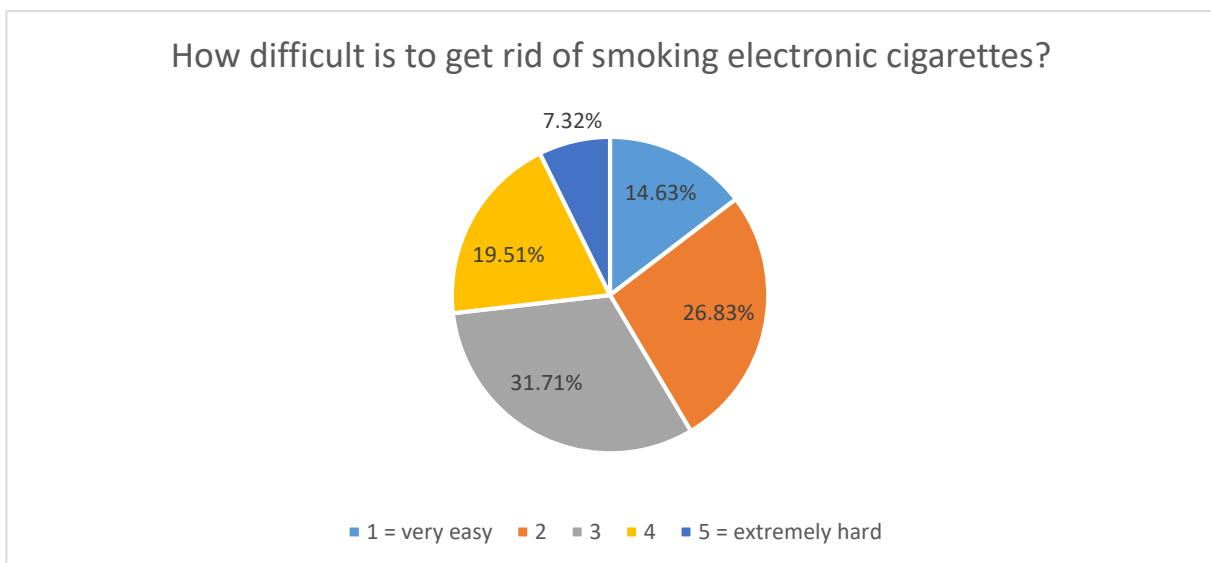

Chart 3. 6 - How difficult is to get rid of smoking electronic cigarettes?

9) Is an electronic cigarette a suitable means for quitting conventional cigarettes?

- Yes
- No

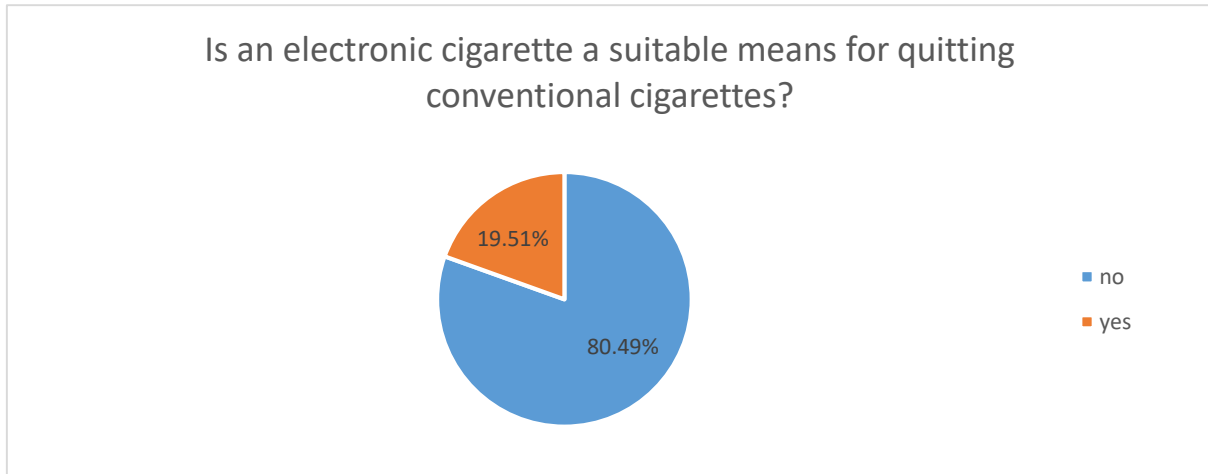

Chart 3. 7 - Is an electronic cigarette a suitable means for quitting conventional cigarettes?

10) What is the main advantage of electronic cigarettes, in contrast, with conventional ones?

- Price
- Lower harmfulness
- The greater amount of "smoke"
- Less unpleasant smell
- Lower harmfulness
- Own answer

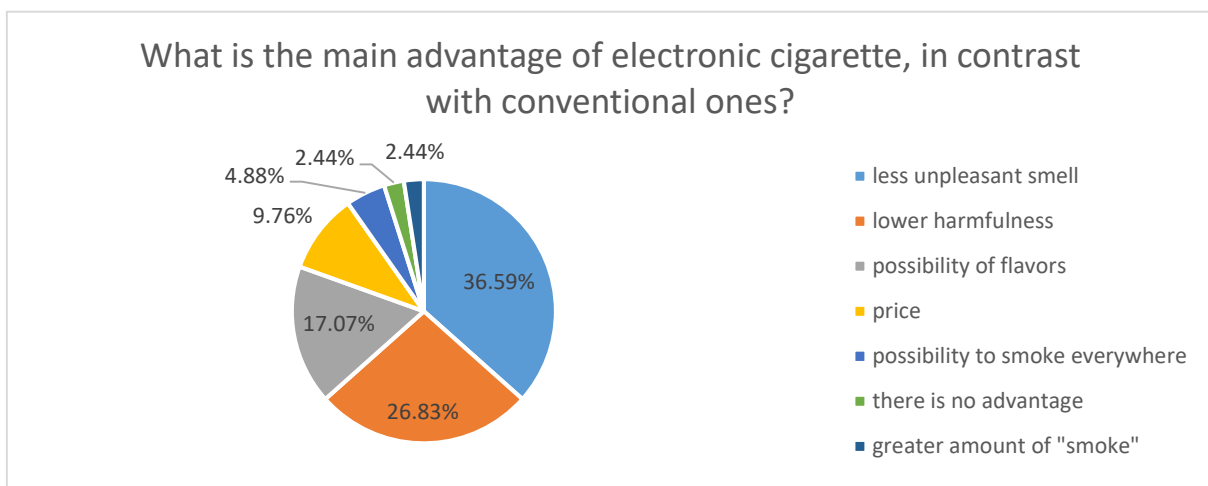

Chart 3. 8 - What is the main advantage of electronic cigarette, in contrast with conventional ones?

11) What is the main disadvantage of electronic, in contrast with conventional ones?

- Price
- Battery charging
- E-liquid refilling
- Unwanted attention
- Risk of device breakage
- Own answer

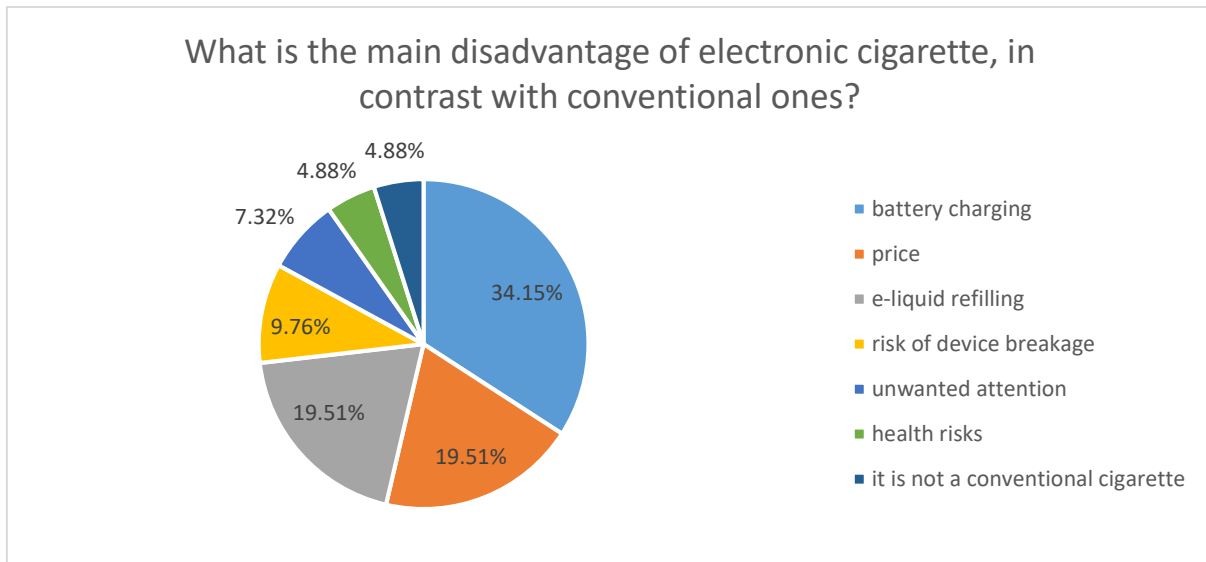

Chart 3. 9 - What is the main disadvantage of electronic cigarette, in contrast with conventional ones?

12) Additional respondent's opinions

It is better not to start smoking

13) Your gender?

- Man
- Woman

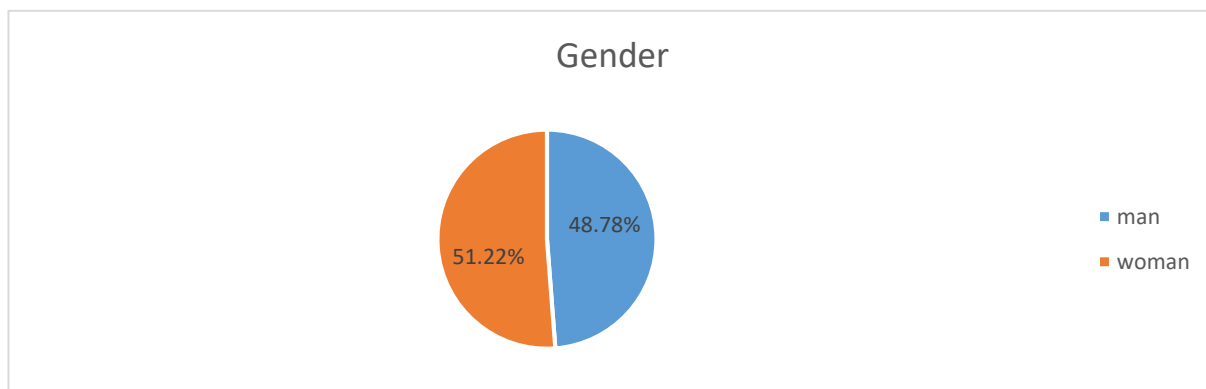

Chart 3. 10 - Gender

14) Your age?

- 18 – 25
- 26 – 40
- 41 – 60
- 60 and more

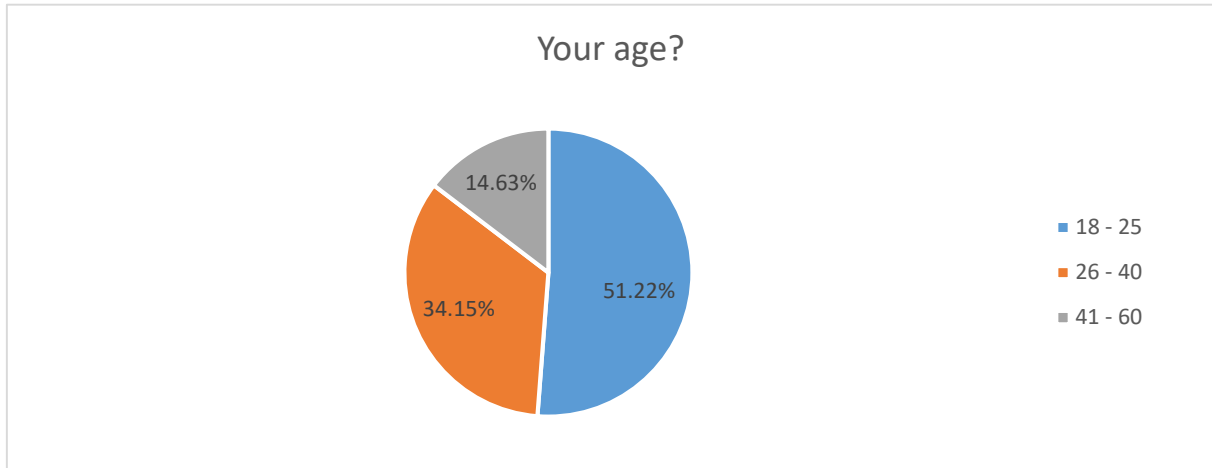

Chart 3. 11 – Your age?

10.3 Smokers of electronic cigarettes

3) What is the brand of your electronic cigarette?

- Joytech
- Smok
- Eleaf
- Vaporesso
- Own answer

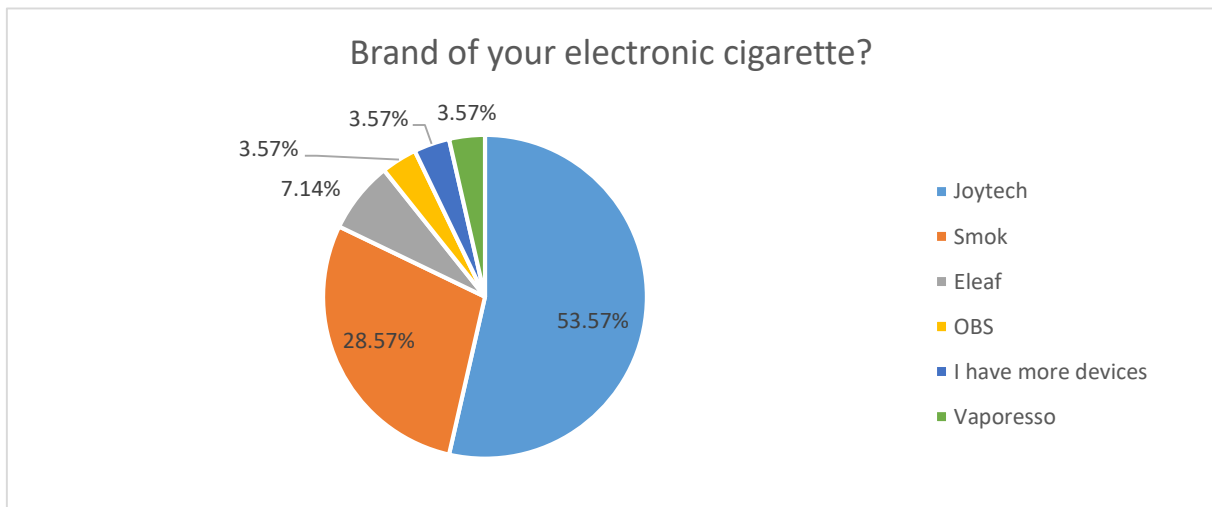

Chart 4. 1 - Brand of your electronic cigarette?

4) Concerning e-liquid, what is your nicotine content?

- 0 – 5 mg
- 6 – 10 mg
- 11 – 15 mg
- I do not know

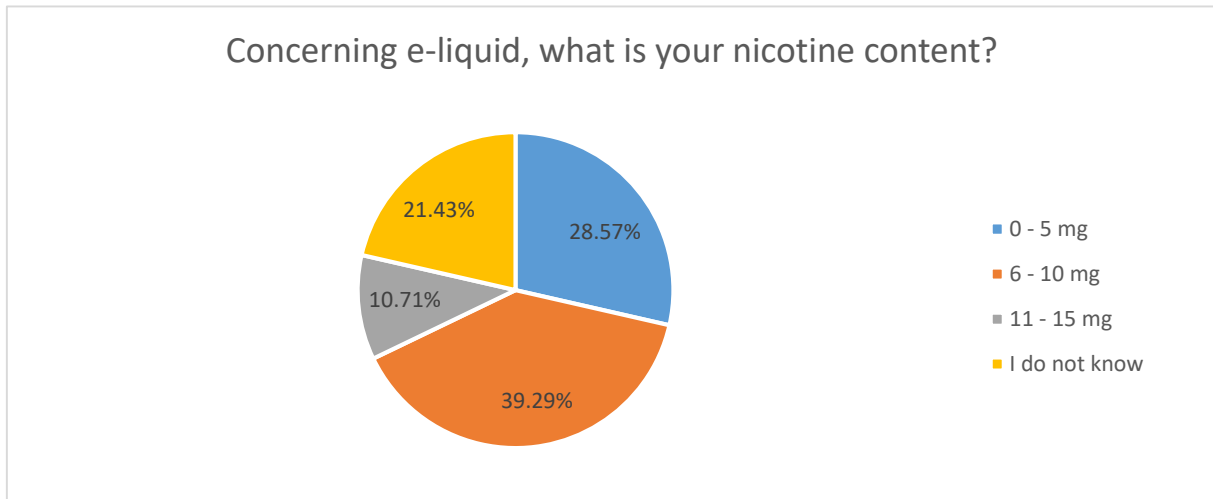

Chart 4. 2 - Concerning e-liquid, what is your nicotine content?

5) Concerning e-liquid, what is your favorite flavor?

- Fruit
- Menthol
- Tobacco
- Sweet

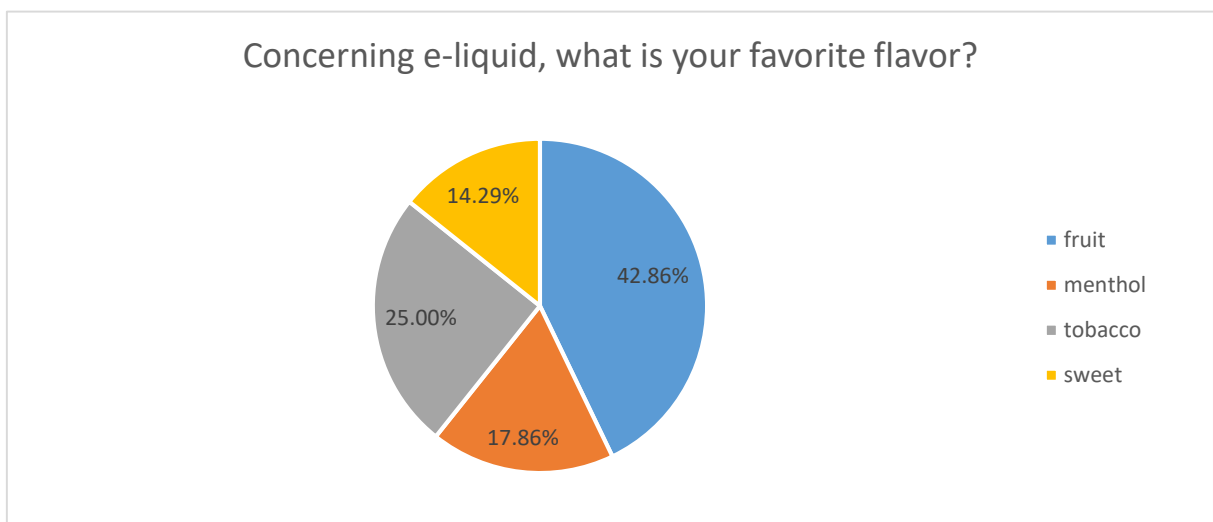

Chart 4. 3 - Concerning e-liquid, what is your favorite flavor?

6) How much do you spend on this type of smoking monthly?

- Up to 500 CZK
- 500 – 1500 CZK
- 1500 – 3000 CZK
- More than 3000 CZK

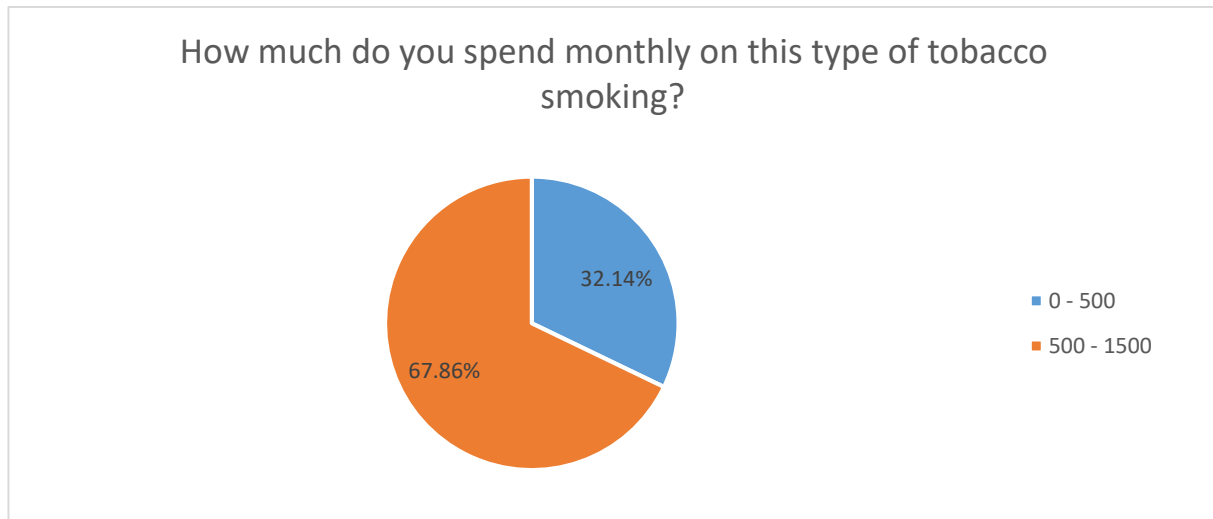

Chart 4. 4 - How much do you spend monthly on this type of tobacco smoking?

7) How difficult is to get rid of smoking conventional cigarettes?

1 = very easy, 5 = extremely hard

- 1
- 2
- 3
- 4
- 5

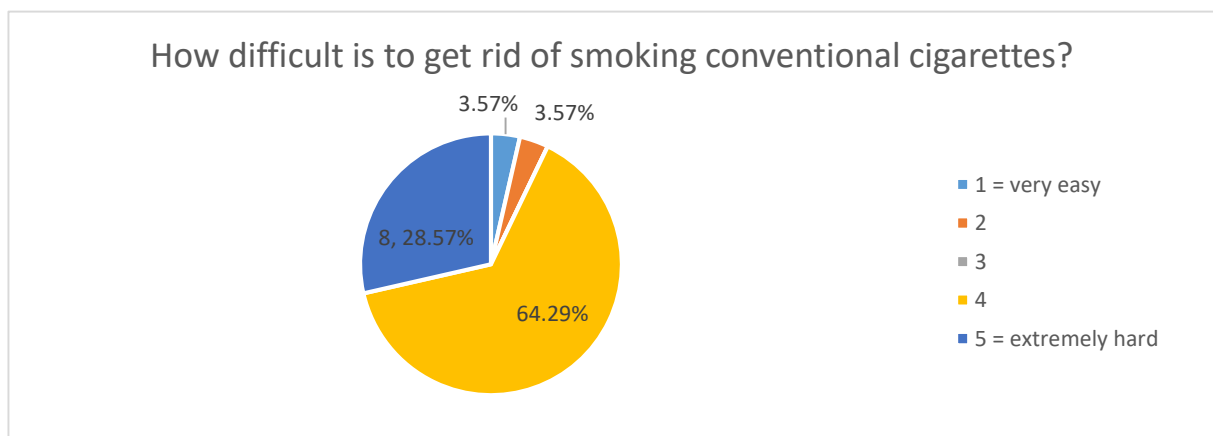

Chart 4. 5 - How difficult is to get rid of smoking conventional cigarettes?

8) How difficult is to get rid of smoking electronic cigarettes?

1 = very easy, 5 = extremely hard

- 1
- 2
- 3
- 4
- 5

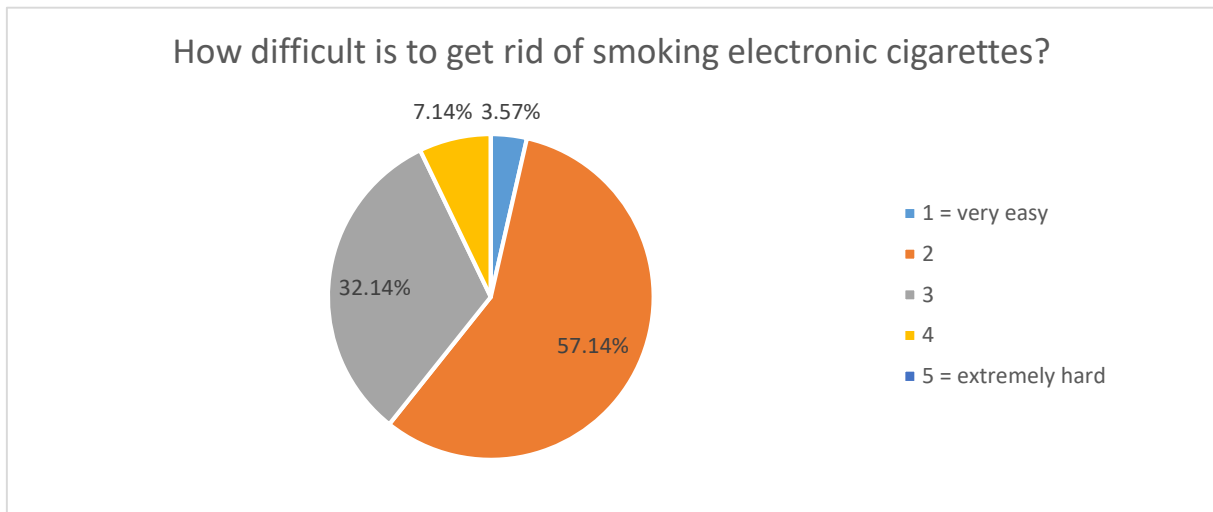

Chart 4. 6 - How difficult is to get rid of smoking electronic cigarettes?

9) Is an electronic cigarette a suitable means for quitting conventional cigarettes?

- Yes
- No

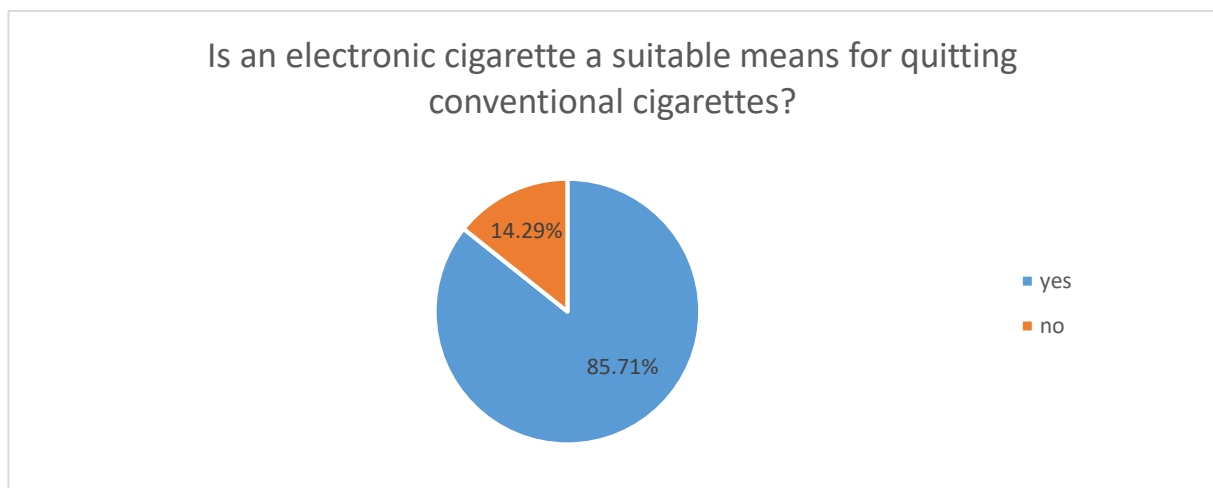

Chart 4. 7 - Is an electronic cigarette a suitable means for quitting conventional cigarettes?

10) What is the main advantage of electronic cigarette, in contrast, with conventional ones?

- Price
- Lower harmfulness
- The greater amount of "smoke"
- Less unpleasant smell
- Lower harmfulness
- Own answer

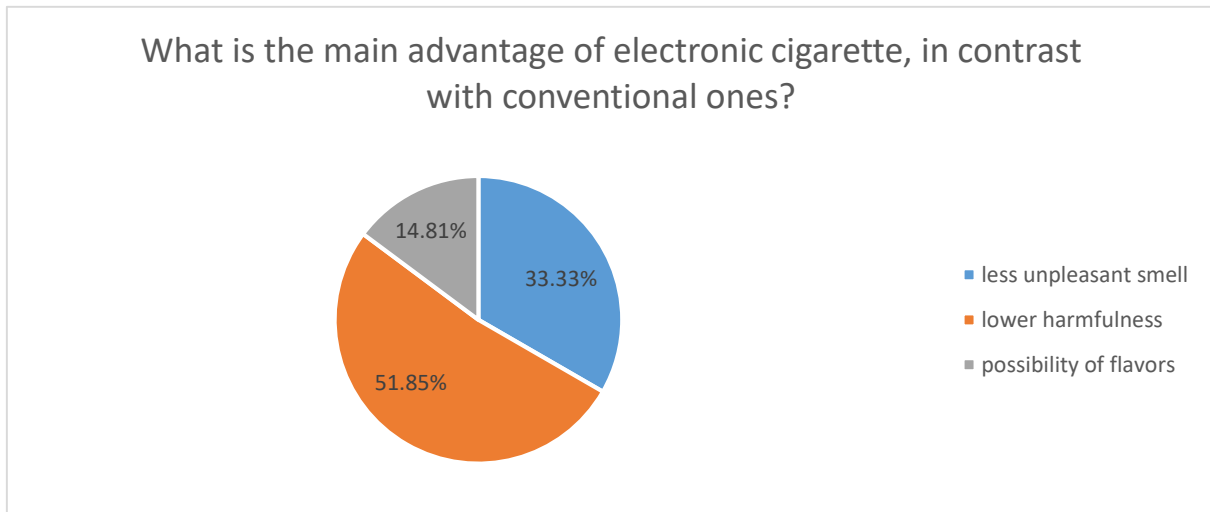

Chart 4. 8 - What is the main advantage of electronic cigarette, in contrast with conventional ones?

11) What is the main disadvantage of electronic cigarettes, in contrast with conventional ones?

- Price
- Battery charging
- E-liquid refilling
- Unwanted attention
- Risk of device breakage
- Own answer

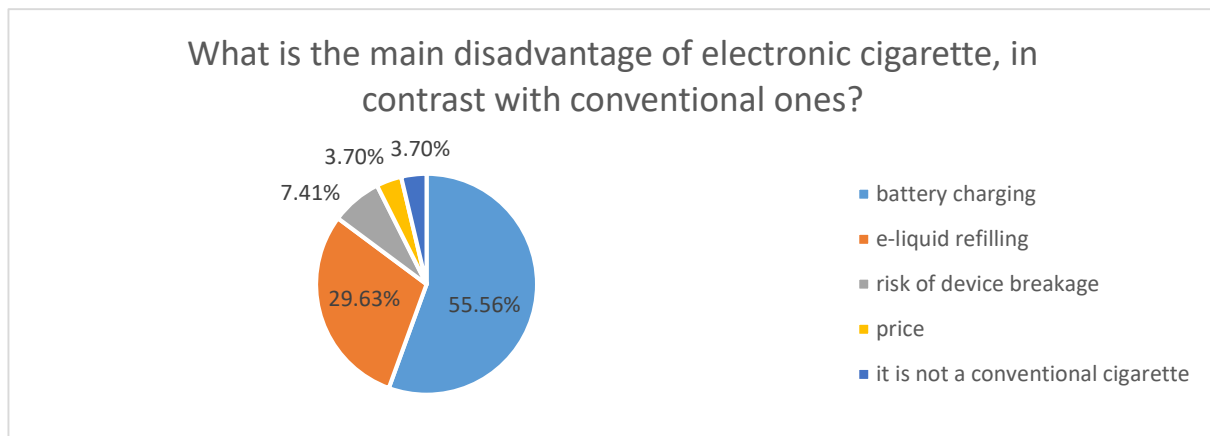

Chart 4. 9 - What is the main disadvantage of electronic cigarette, in contrast with conventional ones?

12) Additional respondents' opinions

The improvement is reflected mainly in breathing. Even my doctor has confirmed the improvement of my health.

It is still smoking.

13) Your gender?

- Man
- Woman

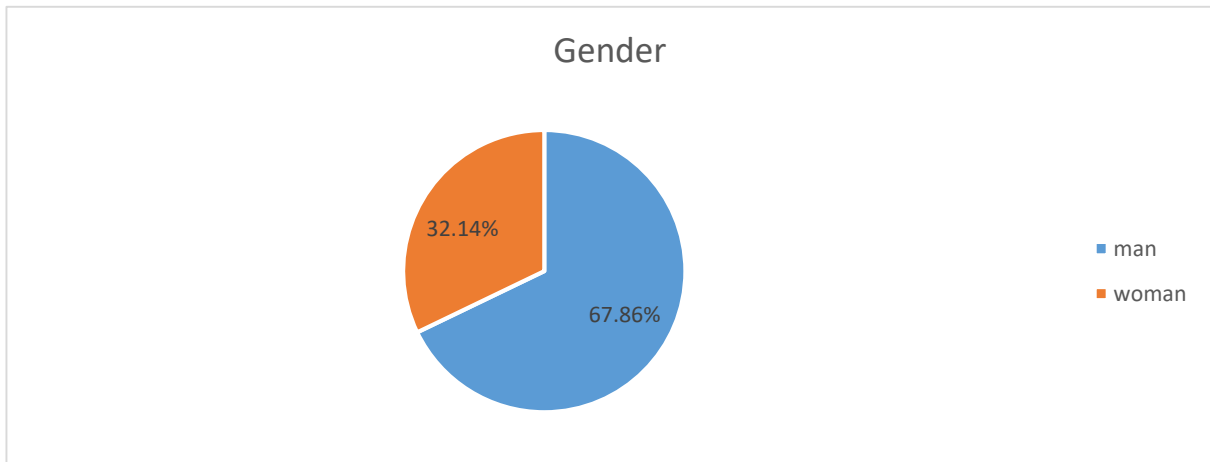

Chart 4. 10 - Gender

14) Your age?

- 18 – 25
- 26 – 40
- 41 – 60
- 60 and more

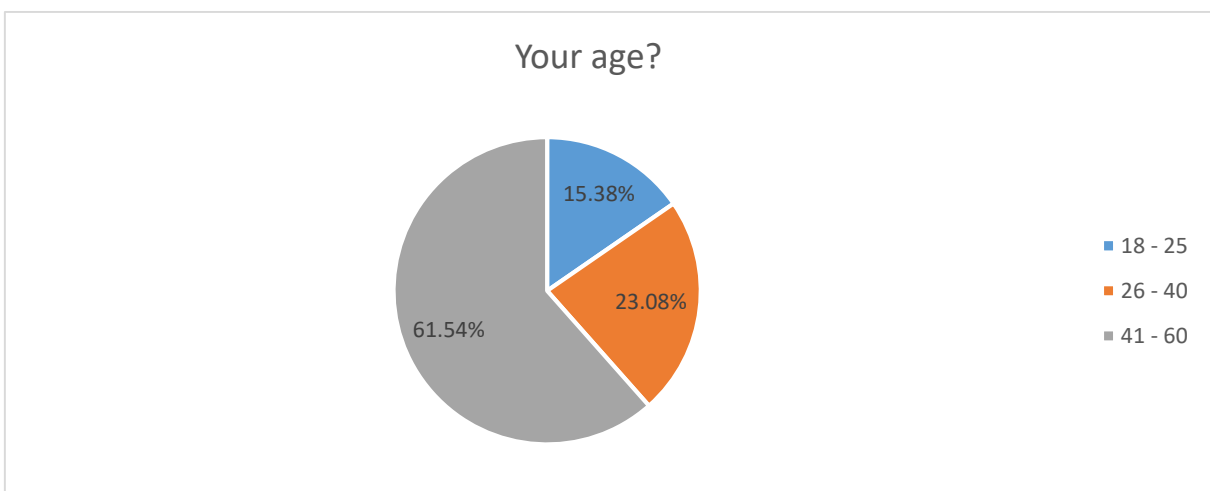

Chart 4. 11 – Your age?

11 Conclusion

In this work, the crucial milestones of both tobacco and electronic cigarettes were stated as well as the essential representatives of electronic devices. Composition of e-liquid was introduced, mentioning its most significant health risks, in contrast with the conventional cigarette. Also, the information related to smoking linked, for instance, with World War and female emancipation was specified as well as general aspects of the legislation. Then the questionnaire was introduced, and several public opinions were compared.

Through history, it was proven that nicotine and smoking, in general, may cause a minor positive psychical effect on the human body, for instance, a pleasant feeling, or reduction of stress. Nonetheless, a vast majority of researchers agree with the statement that any type of smoking is harmful to human health.

In the past, tobacco companies have claimed several times that they brought a healthier way of smoking to the market. However, major or minor health risks were proven, concerning of all the types, either tobacco-based or electronic cigarettes. Even though electronic cigarettes are not probably on the same level of harmfulness as are conventional cigarettes, mainly due to the absence of burning, it is undoubtedly an untrue statement that electronic devices are a healthy means of receiving nicotine.

Moreover, a significant amount of research has been done on this subject. However, short-term researches suggest rather individual health problems as allergies or, such, with indirect relation. From a long-term point of view, the health risks of electronic cigarettes are still predominantly considered to be unknown.

Concerning public meaning, I would say that electronic cigarettes are only at the beginning of its era. Still, it is an electronic device and from its essentiality is fighting with doubts of particular conventional smokers who are used to the conventional ones.

12 List of figures

<i>Figure 2 – Herbert A. Gilbert’s smokeless non- tobacco cigarette</i>	14
<i>Figure 1 – Joseph Robinson’s vaporizer</i>	14
<i>Figure 3 – One of the first types of electronic cigarettes</i>	15
<i>Figure 4 – The essential parts of an electronic atomizer (mod/grip)</i>	17
<i>Figure 5 – The construction of an atomizer head</i>	18
<i>Figure 6 – Modern smokeless cigarette</i>	19

13 List of Charts

<i>Chart 1 - Age of smokers</i>	33
<i>Chart 2 - Age of non-smokers</i>	33
<i>Chart 3 - How difficult is to get rid of conventional smoking?</i>	33
<i>Chart 4 - How difficult is to get rid of smoking el. cigarette?</i>	34
<i>Chart 5 - Electronic cigarette as a suitable mean for quitting smoking conventional cigarettes?</i>	34
<i>Chart 6 - Have you ever thought about buying / trying an electronic cigarette?</i>	35
<i>Chart 7 - What is the main advantage of electronic cigarettes?</i>	36
<i>Chart 8 - What is the main disadvantage of electronic cigarettes?</i>	36
<i>Chart 9 - CZK approximately spent per month</i>	38

13.1 Non-smokers

<i>Chart 2. 1 - How difficult is to get rid of smoking conventional cigarettes?</i>	39
<i>Chart 2. 2 - How difficult is to get rid of smoking electronic cigarettes?</i>	39
<i>Chart 2. 3 - Is an electronic cigarette a suitable means for quitting conventional cigarettes?</i>	40
<i>Chart 2. 4 - What is the main advantage of electronic cigarettes, in contrast with conventional ones?</i>	40
<i>Chart 2. 5 - What is the main disadvantage of electronic cigarettes, in contrast with conventional ones?</i>	41
<i>Chart 2. 6 - Gender</i>	42
<i>Chart 2. 7 – Your age?</i>	42

13.2 Smokers of conventional cigarettes

<i>Chart 3. 1 – Approximate number of cigarettes smoked per day.....</i>	<i>43</i>
<i>Chart 3. 2 - Favorite brand of cigarettes</i>	<i>43</i>
<i>Chart 3. 3 - How much do you spend on this type of smoking monthly?</i>	<i>44</i>
<i>Chart 3. 4 - Have you ever thought about buying / trying an electronic cigarette?</i>	<i>44</i>
<i>Chart 3. 5 - How difficult is to get rid of smoking conventional cigarettes?</i>	<i>45</i>
<i>Chart 3. 6 - How difficult is to get rid of smoking electronic cigarettes?.....</i>	<i>45</i>
<i>Chart 3. 7 - Is an electronic cigarette a suitable means for quitting conventional cigarettes?.....</i>	<i>46</i>
<i>Chart 3. 8 - What is the main advantage of electronic cigarette, in contrast with conventional ones?.....</i>	<i>46</i>
<i>Chart 3. 9 - What is the main disadvantage of electronic cigarette, in contrast with conventional ones?.....</i>	<i>47</i>
<i>Chart 3. 10 - Gender</i>	<i>47</i>
<i>Chart 3. 11 – Your age?</i>	<i>48</i>

13.3 Smokers of electronic cigarettes

<i>Chart 4. 1 - Brand of your electronic cigarette?.....</i>	<i>48</i>
<i>Chart 4. 2 - Concerning e-liquid, what is your nicotine content?</i>	<i>49</i>
<i>Chart 4. 3 - Concerning e-liquid, what is your favorite flavor?</i>	<i>49</i>
<i>Chart 4. 4 - How much do you spend monthly on this type of tobacco smoking?</i>	<i>50</i>
<i>Chart 4. 5 - How difficult is to get rid of smoking conventional cigarettes?</i>	<i>50</i>
<i>Chart 4. 6 - How difficult is to get rid of smoking electronic cigarettes?.....</i>	<i>51</i>
<i>Chart 4. 7 - Is an electronic cigarette a suitable means for quitting conventional cigarettes?.....</i>	<i>51</i>
<i>Chart 4. 8 - What is the main advantage of electronic cigarette, in contrast with conventional ones?.....</i>	<i>52</i>
<i>Chart 4. 9 - What is the main disadvantage of electronic cigarette, in contrast with conventional ones?.....</i>	<i>52</i>
<i>Chart 4. 10 - Gender</i>	<i>53</i>
<i>Chart 4. 11 – Your age?</i>	<i>53</i>

14 List of text references

Bahl et al. (2012), Comparison of electronic cigarette refill fluid cytotoxicity using embryonic and adult models [online]. Retrieved from:

<https://www.sciencedirect.com/science/article/pii/S0890623812002833>

Centers for disease control and prevention (1990), World no-tobacco day [online]. Retrieved from:

<https://www.cdc.gov/Mmwr/preview/mmwrhtml/00001591.htm>

Chauvel A. & Lefebvre G. (1989), *Petrochemical Processes*, Paris: Edition Technip. ISBN

9782710805632

Christensen W. (2012), Torches of Freedom: Women and Smoking Propaganda [online]. Retrieved from: <https://thesocietypages.org/socimages/2012/02/27/torches-of-freedom-women-and-smoking-propaganda/>

Chromý S. (2006), Historie tabáku

[online]. Retrieved from: <http://www.pestovanitabaku.prodejce.cz/historie.html>

Clapp P. & Jaspers I. (2018), Electronic Cigarettes: Their Constituents and Potential Links to Asthma

[online]. Retrieved from: <https://www.ncbi.nlm.nih.gov/pmc/articles/PMC5995565/>

Comby, B. (2007) *Jak se zbavit závislosti na tabáku*, Prague: Pragma ISBN 978-80-7349-077-5.

Cotti Ch. & Nesson E. & Tefft N. (2018), The relationship between cigarettes and electronic

cigarettes: Evidence from household panel data. *Journal of Health Economics* [online]. Retrieved

from: <https://www.sciencedirect.com/science/article/pii/S0167629618301565>

Červená L. (2011), *Tabákový průmysl: vybrané problémy*. Olomouc. Diplomová práce. Univerzita Palackého v Olomouci.

Ebbert, Jon O. et al. (2015), Counseling Patients on the Use of Electronic Cigarettes [online].

Retrieved from: [https://www.mayoclinicproceedings.org/article/S0025-6196\(14\)00989-6/fulltext](https://www.mayoclinicproceedings.org/article/S0025-6196(14)00989-6/fulltext)

Féropotravina, E1520 - Propylenglykol (2017) [online]. Retrieved from:

<http://www.ferpotravina.cz/seznam-ecek/E1520>

Féropotravina, E422 – Glycerol [online]. Retrieved from: [https://www.ferpotravina.cz/seznam-](https://www.ferpotravina.cz/seznam-ecek/E422)

[ecek/E422](https://www.ferpotravina.cz/seznam-ecek/E422)

Fontem Ventures (2015), The story of the e-cigarette [online]. Retrieved from:

<http://www.fontemventures.com/news/story-e-cigarette/>

Gilbert H. Smokeless non-tobacco cigarette (1963). Granted: 17.7.1965 [online]. Retrieved from:

<https://patents.google.com/patent/US3200819A/en>

Hammond, E. (1962). The Effects of Smoking. Scientific American [online]. Retrieved from

<http://www.jstor.org/stable/24936604>

Hon L. (2003), Electronic atomization cigarette. Granted 2013-03-12 [online]. Retrieved from:

<https://patents.google.com/patent/US8393331B2/en>

Harvanko A. (2019), Stimulus effects of propylene glycol and vegetable glycerin in electronic cigarette liquids [online]. Retrieved from:

<https://www.sciencedirect.com/science/article/pii/S0376871618307488>

Harrald Ch. & Watkins F. (2010), The cigarette book: the history and culture of smoking. New York: Skyhorse, ISBN 978-1-61608-073-0.

Ives L. (2018) How likely is your e-cigarette to explode? [online] Retrieved from:

<https://www.bbc.com/news/health-44161348>

IQOShop (2017), Co jsou cigarety IQOS? [online] Retrieved from: <https://iqoshop.cz/co-jsou-cigarety-iqos-a-kde-se-vzaly/>

Janouškovec P. & Brom V. (2009), Historie tabákového průmyslu [online]. Retrieved from:

<http://www.sberatel-ksk.cz/clanek-historie-tabakoveho-prumyslu-2009040006>

Kienhuis A. et al. (2015), Potential harmful health effects of inhaling nicotine-free shisha-pen vapor [online]. Retrieved from: https://www.researchgate.net/publication/279631197_Potential_harmful_health_effects_of_inhaling_nicotine-free_shisha_pen_vapor_A_chemical_risk_assessment_of_the_main_components_propylene_glycol_and_glycerol

Komaroff A. (2014) Surgeon General's 1964 report: making smoking history [online]. Retrieved from: <https://www.health.harvard.edu/blog/surgeon-generals-1964-report-making-smoking-history-201401106970>

Kristen A. (2017), Boj o "zdravé" cigarety [online]. Retrieved from: <https://www.info.cz/svet/boj-o-zdrave-cigarety-philip-morris-urady-zahltil-rozsahlou-studii-nezavislou-analyzu-v-usa-zadupal-14288.html>

Kubánek V. (2009) *Tabák a tabákové výrobky (historie, pěstování, zpracování, legislativa)*. Brno: Tribun EU, ISBN: 978-80-7399-898-1.

Kwass M. (2014) *Contraband: Louis Mandrin and the making of a global underground*. Massachusetts: Harvard University Press, 2014. ISBN 978-0-674-72683-3.

Laugesen M. (2009), E-cigarette Safety [online]. Retrieved from: <http://www.healthnz.co.nz/Dublin.htm>

Long G. (2014) Comparison of Select Analytes in Exhaled Aerosol from E-Cigarettes with Exhaled Smoke from a Conventional Cigarette and Exhaled Breaths [online]. Retrieved from: <https://www.mdpi.com/1660-4601/11/11/11177/htm>

LotoLabs (2018), How vaporizers have changed in the last 100 years [online]. Retrieved from: <https://lotolabs.com/how-vaporizers-have-changed-in-the-last-100-years>

Mašek P. (2014), Certifikace, kontrola a složení [online]. Retrieved from: <http://www.eliquid.cz/index.php?goto=3Gmh4kfW&sekce=3Gmh4kfW&lng=cz>

Míka P. (2016), *Elektronická cigareta*, Prague: Petr Míka. ISBN 978-80-260-9665-8

Nayir et al. (2016), Electronic cigarette (e-cigarette) [online]. Retrieved from: <https://www.sciencedirect.com/science/article/pii/S2452336416300188>

Novák M. (1980), Život a zdraví. O kouření [online]. Retrieved from: <http://www.digitalniknihovna.cz/mzk/uuid/uuid:b09916a0-1eba-11e3-a5bb-005056827e52>

O kouření a jeho účincích / abstinentům pro kuřáky podává J. J-K. (1909) Prague: Dědictví Komenského. Sbírká přednášek a rozprav z oboru výchovy a lidového vzdělání (vol.105).

Oxford University Press (2015), Edward Bernays's "Torches of Freedom" [online]. Retrieved from: <http://www.oxfordpresents.com/ms/kelleher/edward-bernayss-torches-of-freedom/>

Patočka J. & Plucar B. (2009). Vareniklin a odvykací léčba kouření. Prevence úrazů otrav a násilí [online]. Retrieved from: <http://casopis-zsfju.zsf.jcu.cz/prevence-urazu-otrav-a-nasili/administrace/clankyfile/20120410090745655252.pdf>

- Pierce et al. (2014), Diacetyl and 2,3-pentanedione exposures associated with cigarette smoking: implications for risk assessment of food and flavoring workers [online]. Retrieved from: <https://www.tandfonline.com/doi/full/10.3109/10408444.2014.882292?src=recsys>
- Pradáčová J. (2010) *Kouření a zdraví*. Prague: Liga proti rakovině, ISBN 978-80-254-8025-0.
- Proctor R. (1999), *The Nazi War on Cancer*. New Jersey: Princeton University Press, ISBN 0-691-07051-2
- Quigley Jr. L.F. & Cobb C.M. & Hunt Jr. E.E. (2004) Measurement of oral and burning zone temperatures during conventional and reverse cigarette smoking [online]. Retrieved from: <https://www.sciencedirect.com/science/article/pii/S0003996965900555>
- Rachel Grana & Neal Benowitz & Stanton A. Glantz. (2014), E-cigarettes [online]. Retrieved from: <https://www.ahajournals.org/doi/full/10.1161/CIRCULATIONAHA.114.007667>
- Robinson J. (1927), Electric vaporizer. Granted: 16.9.1927 [online]. Retrieved from: <https://patents.google.com/patent/US1775947A/en>
- Rogers, K. (2019), Jean Nicot. Encyclopædia Britannica [online]. Retrieved from: <https://www.britannica.com/biography/Jean-Nicot>
- Rojek Ch. (2010), *The labour of leisure: The culture of free time*. London: SAGE Publications Ltd ISBN 978-1-4129-4552-3
- Schick S. & Glantz S. (2005). Philip Morris toxicological experiments with fresh sidestream smoke: more toxic than mainstream smoke [online]. Retrieved from: <https://escholarship.org/uc/item/54b9m1sb>
- Terry M. (2017), Toluene in cigarette smoke is bad for your health [online]. Retrieved from: <https://www.verywellmind.com/toluene-in-cigarette-smoke-4121182>
- Tierney P. et al. (2016), Flavour chemicals in electronic cigarette fluids [online]. Retrieved from: <https://tobaccocontrol.bmj.com/content/25/e1/e10>
- Vapeklub (2019a). Slovníček pojmů [online]. Retrieved from: <https://vapeklub.sk/slovnicek-pojmov/>
- Vapeklub (2019b). MTL, DL, CCH – vysvětlení pojmů [online]. Retrieved from: <https://vapeklub.sk/mtl-dl-cch-pro-zacatecniky/>

VapeRanks (2012a). What is an Atomizer? [online] Retrieved from: <https://vaperanks.com/what-is-an-atomizer/>

VapeRanks (2012b). What is e-liquid? [online] Retrieved from: <https://vaperanks.com/what-is-e-liquid/>

Walsh R. (2007) *The world of shamanism: new views of an ancient tradition*. Woodbury: Llewellyn Publications, ISBN 978-0-7387-0575-0.

Wexler P. & Anderson B. (2005) *Encyclopedia of toxicology*. Oxford: Elsevier, ISBN 978-0-12-745354-5.

15 Figures and charts references

Figure 1, Joseph Robinson's vaporizer.

Retrieved from: <https://patents.google.com/patent/US1775947A/en>

Figure 2, Herbert A. Gilbert's smokeless non-tobacco cigarette. Retrieved from:

<https://patentimages.storage.googleapis.com/a8/a4/ef/28cea2ddb9f425/US3200819.pdf>

Figure 3, One of the first types of electronic cigarettes. Retrieved from:

<https://www.vipelectroniccigarette.ie/info/what-is-the-electronic-cigarette>

Figure 4, Essential parts of an electronic cigarette (Mod). Retrieved from:

<https://sc01.alicdn.com/kf/HTB1PzLnLFXXXXbdXFXXq6xXFXXm/200030165/HTB1PzLnLFXXXXbdXFXXq6xXFXXm.jpg>

Figure 5, The construction of an atomizer head. Retrieved from:

http://www.kourimelevne.cz/?1128,cz_joyetech-ego-one-clr-vt-ti-zhavici-hlava

Figure 6, Modern smokeless cigarette. Retrieved from: <https://www.180smoke.ca/heat-not-burn-kits>

All Charts are based on the personal author's data from the questionnaire

Škaryd, J. – Užívání konvenčních a elektronických cigaret, 2019. Retrieved from: www.vyplnto.cz.