



**BRNO UNIVERSITY OF TECHNOLOGY**

VYSOKÉ UČENÍ TECHNICKÉ V BRNĚ

**FACULTY OF CIVIL ENGINEERING**

FAKULTA STAVEBNÍ

**INSTITUTE OF BUILDING STRUCTURES**

ÚSTAV POZEMNÍHO STAVITELSTVÍ

**LIGHT GUIDE EVALUATION**

HODNOCENÍ TUBUSOVÉHO SVĚTLOVODU

**DOCTORAL THESIS**

DISERTAČNÍ PRÁCE

**AUTHOR**

AUTOR PRÁCE

Ing. AYODEJI OMISHORE

**SUPERVISOR**

VEDOUCÍ PRÁCE

Prof. Ing. JITKA MOHELNIKOVA, Ph.D.

BRNO 2020

### **Bibliographic citation**

OMISHORE, Ayodeji. *Light guide evaluation*. Brno, 2020. 107 pages. Doctoral thesis. Brno University of technology, Faculty of Civil Engineering. Supervisor Prof. Ing. Jitka Mohelníková, PhD.

## **ABSTRACT**

Light guide is a tubular skylight with mirrored internal surface. It is a lighting device bringing daylight into the interior of a building without windows or into rooms with insufficient daylight. It presents the potential for energy savings, opens the possibility to use places that are not well lit and offers opportunities for improving the visual comfort of the indoor environment.

This thesis reviews the potential of light guide system as a daylighting approach in building and presents results of experiments on performance of tubular skylight prototype. The main task of the thesis is focused on comparison of traditional light guide system and newly developed prototype, examination of its light transmittance and efficiency as well as its thermal behaviour in order to find possible improvements for applications in buildings.

Keywords: Lighting system, Daylighting, Light Guides

## **DECLARATION OF AUTHORSHIP OF THE DOCTORAL THESIS**

I declare that this doctoral thesis titled *Light guide evaluation* is my own work and the result of my own original research. I have clearly indicated the presence of quoted or paraphrased material and provided reference for all sources.

Brno, 03/02/2020

.....

Ing. Ayodeji Omishore

**DECLARATION OF CONFORMITY OF THE PRINTED AND ELECTRONIC FORM OF THE DOCTORAL THESIS**

I declare that the electronic form of the submitted doctoral thesis titled *Light guide evaluation* is identical to the submitted printed form.

Brno, 03/02/2020

.....  
Ing. Ayodeji Omishore

## Acknowledgement

The thesis experiments and article publications were carried out under the project No. LO1408 "AdMaS UP - Advanced Materials, Structures and Technologies", supported by Ministry of Education, Youth and Sports under the "National Sustainability Programme I" of Czech Republic, project APVV-0118-12 and VEGA 2/0042/17.

The author acknowledges:

- Prof. Ing. Jitka Mohelníková, Ph.D for invaluable advice, guidance, expert knowledge and constant encouragement.
- Doc. Ing. Stanislav Darula, CSc. from Slovak Academy of Sciences for his review and advice on the article about light guide efficiency published in journal Sustainable Lighting.
- Dr. Luisa Broras from London Metropolitan University for her co-supervision in the field of daylight evaluation.
- Doc. Ing. Miloš Kalousek, Ph.D. for his help with the infrared camera termovision monitoring.
- Ing. Denis Míček for his help with schemes of light reflection on the light guide parabolic concentrator.
- Ing. Jiří Částka for valuable advice and Lightway company for providing a prototype light guide.
- Ing. Viktor Zwiener, Ph.D. from company DEKPROJEKT s.r.o. who provided luminance meters for experiments.

# TABLE OF CONTENTS

ABSTRACT	ii
TABLE OF CONTENTS	vi
LISTS OF FIGURES	viii
LIST OF TABLES	xiii
1 INTRODUCTION	1
1.1 TOPIC OF THE THESIS	1
1.2 AIMS OF THE THESIS	2
1.3 THESIS STRUCTURE	2
2 OVERVIEWS OF THE STATE OF THE ART IN THE FIELD OF LIGHT GUIDE DAYLIGHTING	4
2.1 GENERALLY ABOUT SOLAR RADIATION	4
2.2 DAYLIGHT	5
2.2.1 Photometrical units and measures	5
2.3 DAYLIGHT AVAILABILITY	6
2.3.1 Climatic conditions	7
2.3.2 Light and health and well being	9
2.3.3 Energy saving	11
2.4 THE DEVELOPMENT OF SOLAR LIGHT GUIDE SYSTEMS	12
2.5 LIGHT GUIDE INVESTIGATIONS OVERVIEW	16
2.5.1 Introduction	16
2.5.2 Lighting /illumination	17
2.5.3 Tubular daylighting device (TDD) - light guide	17
2.5.4 Working mechanism of the light guide	19
2.5.5 Challenges of daylighting systems	20
2.5.6 Light guides – prediction methods	22
3 METHODS	25
3.1 LIGHT GUIDE PROTOTYPES	25
3.2 EXPERIMENTS	30
3.2.1 Experimental models	31
3.2.2 Daylight laboratory measurements	38
3.2.3 Thermal evaluation of the light guide – laboratory testing	40

3.2.4 Light guides comparative measurement – field testing	46
4 RESULTS	52
4.1 LABORATORY DAYLIGHT MEASUREMENTS	52
4.2 RESULTS OF THERMAL EVALUATION	63
4.3 IN-SITU COMPARABLE MEASUREMENTS RESULTS	70
4.4 RESULTS OF DAYLIGHT SIMULATIONS	73
4.5 SUMMARY OF DAYLIGHT ANALYSIS RESULTS	76
5 CONCLUSION	79
5.1 SUMMARY	79
5.2 RECOMMENDATIONS	82
REFERENCES	92
AUTHOR’S PUBLICATIONS	105
LIST OF SYMBOLS	106



## LIST OF FIGURES

Fig. 2.1:	Spectral distribution of sunlight and molecular absorption	4
Fig. 2.2:	Electromagnetic spectrum	5
Fig. 2.3:	Graph of photopic luminosity and scotopic luminosity function	6
Fig. 2.4:	Brno, Czech Republic climate data graph	8
Fig. 2.5:	Availability of global solar radiation on the area of the Czech Republic	8
Fig. 2.6:	Daylight comparison with LED, Halogen and Fluorescent light sources	10
Fig. 2.7:	Sunlight pattern passing through the light tube (schematic diagram of the light beam transported through the centre of the light guide)	19
Fig. 2.8:	Sunlight and skylight pattern passing through the light tube	20
Fig. 3.1:	Technical drawing of prototype light guide model 1	26
Fig. 3.2:	Primary parabola of prototype light guide model 1	27
Fig. 3.3:	Model 1 – major components and light path	28
Fig. 3.4:	Model 1 and 2 possible placement in building – design variations	29
Fig. 3.5:	Photograph of the construction of a container for the light guides installation for the field measurements	31
Fig. 3.6:	Chamber CH1 and prototype model 1 elevation	33
Fig. 3.7:	Chamber CH2 and prototype model 2 elevation	33
Fig. 3.8:	Placement of chamber CH1 and CH2 in the workshop under skylight	34
Fig. 3.9:	Construction of CH1	35
Fig. 3.10:	Construction of CH2	35
Fig. 3.11:	CH1 and CH2 placed in workshop under skylight	36
Fig. 3.12:	Collector (model 1)	36

Fig. 3.13:	Collector (model 1)	36
Fig. 3.14:	Collector (model 2)	37
Fig. 3.15:	Collector (model 2)	37
Fig. 3.16:	Tube (model 1)	37
Fig. 3.17:	Tube (model 2)	37
Fig. 3.18:	Components of the diffuser	37
Fig. 3.19:	Diffuser mounted on CH1 top	37
Fig. 3.20:	Measurements apparatus – luminance meter	38
Fig. 3.21:	Elevation of the chamber CH1 (dimensions in mm) and photographs of the light guide concentrating head installed in the chamber	39
Fig. 3.22:	Inside the measuring chamber CH1	40
Fig. 3.23:	Section of the test chamber CH1 with the light guide prototype and view of the head with the parabolic mirror	42
Fig. 3.24:	Photograph of the light guide under the IR lamp radiation and view to the light guide diffuser (inside the chamber)	43
Fig. 3.25:	Thermal sensors in the light guide profile	45
Fig. 3.26:	Photograph of the light guide with additional thermal insulation (mineral wool)	45
Fig. 3.27:	Tested light guides LG1 and LG2 – the roof installation	47
Fig. 3.28:	Container divided into two parts with both light guides installation	48
Fig. 3.29:	Assembly of LG1	48
Fig. 3.30:	Sky conditions during the monitored period (photographs, Omishore, A, 2017)	49
Fig. 3.31:	Installation of the tested light guides LG1 and LG2	50
Fig. 3.32:	Photograph of a view at LG1 and LG2 diffusers installed into the container's two identical parts, separated by black curtain	50
Fig. 3.33:	Dividing the container into two identical parts with LG1 and	51

LG2 installations for comparable simultaneous daylight measurements

Fig. 4.1:	Daylight illuminance at the input (at the entrance the the concentrating head) and output (inside the chamber), 25/05/2015	52
Fig. 4.2:	Daily profiles of illuminance on the input and output of the light guide for cloudy sky daylight illuminance, 02/05/2015	53
Fig. 4.3:	Daily profiles of illuminance on the input and output of the light guide for dynamic changes of daylight illuminance, 23/06/2015	53
Fig. 4.4:	Trend line of input and output illuminance measurements (cloudy and partly cloudy days in June 2015)	54
Fig. 4.5:	Horizontal illuminance – external and upper (input) data	55
Fig. 4.6:	Minimal, maximal, mean and median input illuminance	55
Fig. 4.7:	Daylight illuminance at the level of the CMP head and graphs of data daylight horizontal illuminance monitored in the chamber, 25/05/2015.	58
Fig. 4.8:	Light guide efficiency, clear day, 25/05/2015	59
Fig. 4.9:	Solar rays' reflections on the light guide parabolic concentrator	61
Fig. 4.10:	Direct daylight rays reflections on the light guide head	62
Fig. 4.11:	Direct daylight rays reflections on the light guide head	62
Fig. 4.12:	Direct daylight reflections on the mirror towards the light guide concentrator head	62
Fig. 4.13:	IR thermography of the light guide head after 10 minutes activation of the IR lamp	63
Fig. 4.14:	IR thermography of the light guide head after 100 minutes activation of the IR lamp	64
Fig. 4.15:	IR thermography – a distant view of light guide entire structure	65
Fig. 4.16:	IR thermography of the thermally insulated light guide (thermal insulation was demounted directly before the	66

	monitoring)	
Fig. 4.17:	IR camera photographs of the roof concentrating head and diffuser	66
Fig. 4.18:	Light guide temperature profiles	68
Fig. 4.19:	Correlation between temperatures measured at positions VI and VII	69
Fig. 4.20:	Examples of internal illuminance measured under LG1 and LG2 and external horizontal illuminance	71
Fig. 4.21:	Daily illuminance profiles and correlation graphs for illuminances of LG1 and LG2 (01/09/2017 and 02/09/2017)	72
Fig. 4.22:	Daily illuminance profiles and correlation graphs for illuminances of LG1 and LG2 (16/09/2017 and 20/09/2017)	72
Fig. 4.23:	Daily illuminance min, max, mean and median values (monitored from 22/08 to 23/09/2017)	73
Fig. 4.24:	Percentage of the difference of mean values of LG1 and LG2 illuminance measurements	73
Fig. 4.25:	Illuminance E [lx] under light guides LG1 and LG2 on 1 <sup>st</sup> September, 12:00	74
Fig. 4.26:	Illuminance E [lx] of light guides LP1 and LP2, for CIE overcast and clear sky on 21 <sup>st</sup> December and 21 <sup>st</sup> June	75
Fig. 4.27:	Light reflection on the light guide parabolic mirror	77
Fig. 4.28:	Dependence of the parabolic head rotation on solar altitude	78
Fig. 5.1:	Scheme of the sun tracking rotation of the parabolic head	83
Fig. 5.2:	a) thermal insulation collar between the tube and roof construction, b) double guides for daylighting and ventilation, c) additional glass unit	85
Fig. 5.3:	Nigeria – Lagos on the map	87
Fig. 5.4:	Example of an average length of daylight in Abuja, the federal capital of Nigeria	88
Fig. 5.5:	Example of sunrise, sunset and day length in Lagos, the largest city of Nigeria [150]	88

Fig. 5.6:	Daily profile of the elevation angle on 21st June	89
Fig. 5.7:	Annual profile of solar elevation angle, Lagos, local time 12:00	89
Fig. 5.8:	Example of dependance of the light guide head tilt on solar elevation	90
Fig. 5.9:	Optimal tilts for solar collector panels (calculated by [153])	90

## LISTS OF TABLES

Table 1:	Illuminance typical values	6
Table 2:	Daylight intensity in different conditions	7
Table 3:	Luminous efficacy value	9
Table 4:	Luminous efficacy value – Daylight and artificial light	10
Table 5:	Light transmittance efficiency of the LG1, 25/05/2015	58
Table 6:	Solar altitude, 21 <sup>st</sup> June	60
Table 7:	Temperature distribution on the light guide – positions 1 and 2 and 3 and 4	65
Table 8:	Temperature difference between internal and external parts of the light guide parabolic head	67
Table 9	Hologilm simulation and measured data on 01/09/2017	74

# **1 INTRODUCTION**

Most people spend a majority of time during the day in indoor environment, commercial or residential. Quality of interior environment of buildings is therefore extremely important for the human physiological and psychological development. One of the monitored aspects is lighting system. Lighting is an important factor in determining the way, how we experience buildings, internal environment as well as how we are able to respond to certain tasks. It is a key element of architectural and interior design. It comprises use of natural illumination of interiors from daylight and artificial light sources.

Artificial lighting for functional and/or aesthetic purposes is a major consumer of energy worldwide. Increasing concern about energy depletion, energy conservation and cost, which has been steadily rising and also adverse environmental impact of pollution, carbon emission and global warming, has led to a reappraisal of the use of daylight as an electric lighting substitute. Lighting and HVAC are two of the major energy end uses in a building. Properly incorporating sustainable and effective lighting into the facility's design is one of the best ways for energy conservation in buildings. The reason for daylighting preference is not only energy efficiency but also a positive impact on human health.

There are many systems for daylight collection and transportation in buildings. These daylighting devices have been developed with the aim of contributing to an efficacy energy savings. One of these devices is a light guide system which is a subject of the thesis investigation.

## **1.1 TOPIC OF THE THESIS**

With development of electrical lighting daylighting was no longer a priority. It is estimated that more than 90 % of our daily routines are happening indoors under artificial lights [1]. Many buildings, mostly office blocks, are hermetically sealed, fully air conditioned and artificially lit. However, financial and environmental factors today are bringing us back in the direction of daylighting, which is the subject of this thesis.

The light guide system offers energy saving and indoor climate comfort alternative to artificial lighting devices. The wide application of light guides in buildings is relatively new – the principle of the light transport on the internal reflective surfaces has been known for many years but the applications of light guides in common residential and commercial buildings is noticed for the last twenty or thirty years [1].

Initially, light guide systems were used at random and without knowledge of their optical properties. Lighting was predicted on the basis of empirical rules

and based on experience from earlier realizations. Problems have arisen mainly due to the lack of illumination under the cloudy sky conditions or, on the contrary, due to the glare on bright sunny days. There was no detailed research. Today, due to energy and environmental concerns to reduce energy consumption in a lighting system, light guides have been investigated and have become one of the energy-efficiency techniques widely applied in buildings. They also have a positive influence on visual comfort.

New highly reflective materials and light tube components are tested to increase the light guide efficiency. Several methods for predicting delivery and distribution of light into the interior are being developed. Systems are continually evolving and improving, and legislation and standards are not sufficient. Therefore, there is a need to examine them further. For this reason, the selected topic of the thesis aimed at the light guide prototype evaluation is actual and in compliance with current research tasks.

## **1.2 AIMS OF THE THESIS**

- Complete the comprehensive state of the art about the light guide systems development and overview of the evaluation methods for daylight illuminance and efficiency testing.
- Testing of the light guide prototype with mirrored concentrating head for light transmittance into the test chamber in laboratory conditions.
- Thermal evaluation of the light guide model under an infrared lamp radiation.
- Complete field daylight measurements for an evaluation of light efficiency of two light guides of same geometry and dimensions but with different roof collectors.
- Simulation case-study of daylight level on working plane for the light guides from the field measurements.
- Analysis of possible improvements of the light guide prototype for the optimised design of the daylight guide system.

## **1.3 THESIS STRUCTURE**

The thesis begins in Chapter 2 with an overview of the state of the art in the field of light guide daylighting. It describes the climatic conditions of Brno region in the Czech Republic, where experiments are undertaken and explains how daylighting plays an important role in the health and mental development of people. The development of solar light guide systems, numerous theoretical and mathematical models of light guide performance are described. The light guide was found to be a successful commercial product, in use all over the world.



Chapter 3 includes methodology and description of prototype models and experimental chambers, address measurements of the lighting devices and methods of testing.

The laboratory and fields measurement results are listed in Chapter 4.

Chapter 5 summarizes outputs, recommends improvements and completes the goals.

## 2 OVERVIEWS OF THE STATE OF THE ART IN THE FIELD OF LIGHT GUIDE DAYLIGHTING

### 2.1 GENERALLY ABOUT SOLAR RADIATION

The Sun is the source of an enormous amount of energy. A portion of this energy provides Earth with the light and heat necessary to support life. For centuries, before the advent of electricity, the sun was the primary source of light. All human activities were provided under the sun.

Sunlight's pure form has a temperature around 5,000 degrees Kelvin and a colour rendering index (CRI)<sup>1</sup> of 100. The solar radiation reaches the Earth with intensity of 1360 W/m<sup>2</sup> known as solar constant ( $E_{eo}$ )<sup>2</sup> [2]. Solar constant is calculated for mean distance and perpendicular rays. As sunlight comes into contact with the earth's atmosphere and is reflected and refracted by water and dust particles the color temperature actually changes throughout the day ranging from 5,000 - 6,000 Kelvin depending on the time of day and the amount of clouds in the sky (Fig.2.1). Because the sun can be considered a black body, the light it emits has a correlated colour temperature (CCT) of 6000 K.

Physically, radiation from the Sun - sunlight, is a mixture of electromagnetic waves ranging from infrared (IR) to ultraviolet rays (UV). It includes visible light (narrow band), which is in between IR and UV in the electromagnetic spectrum (Fig. 2.2).

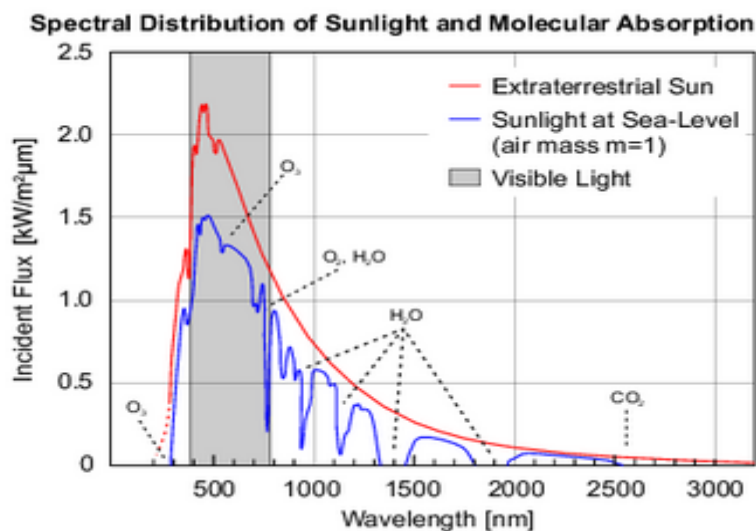

Fig. 2.1: Spectral distribution of sunlight and molecular absorption [3]

<sup>1</sup> Colour rendering index R - measure of the degree to which the psychophysical colour of an object illuminated by the test illuminant conforms to that of the same object illuminated by the reference illuminant, suitable allowance having been made for the state of chromatic adaptation. Abbreviation: "CRI" [2].

<sup>2</sup> Solar constant  $E_{eo}$  irradiance produced by the extraterrestrial solar radiation on a surface perpendicular to the Sun's rays at mean Sun-Earth distance [2].

## 2.2 DAYLIGHT

Light is a primary tool for perceiving the world and communicating within it. It describes our environments. Physical theory of light is based on wave (electromagnetic radiation) and particle (photons) theories [4]. From electromagnetic theory point of view the light is a visible spectrum of electromagnetic radiation in the spectral range between 380 nm to 780 nm [5]. The colour spectrum of the visible light range is shown in Fig. 2.2.

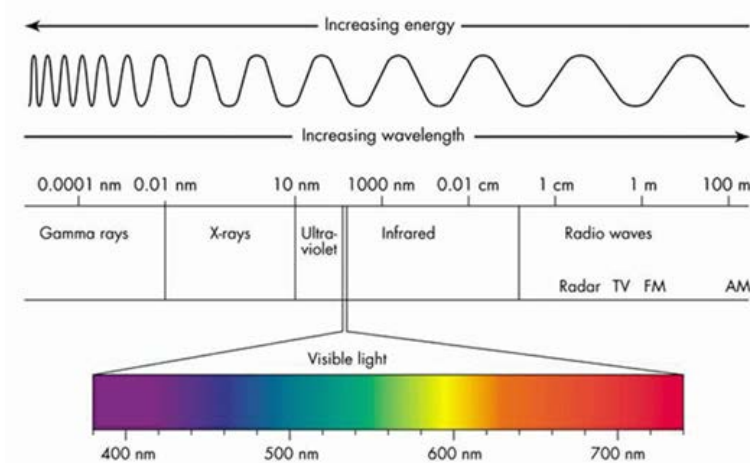

Fig. 2.2: Electromagnetic spectrum [6]

Visible spectrum ranges from blue light (at wavelength around 475 nm) through green, yellow and orange light (at 525, 575 and 625 nm) to red light (at 675 nm) and into violet (at 725 nm). White light is the combination of all of the wavelengths [3].

### 2.2.1 Photometrical units and measures

Photometry is the science of the measurement of light [6]. The human eye responds differently to light from different parts of the visible spectrum, therefore photometric measurements must take the luminosity function into account when measuring the amount of useful light. The radiated power of light, as perceived by the eyes, is measured in terms of the luminous flux  $\Phi$  [lm]. Lumen [lm] is the unit of the luminous flux.

The luminous flux radiated per solid angle in a defined direction is referred to as the light intensity  $I$  [ $\text{lm}\cdot\text{sr}^{-1} = \text{cd}$ ]. Candela [cd] is SI unit. The intensity of a light source in all directions of radiation is given by the light intensity distribution, generally represented as a light intensity distribution curve.

The luminous flux per unit area is the lighting intensity or illuminance  $E$  [ $\text{lx} = \text{lm}\cdot\text{m}^{-2}$ ].

Table 1: Illuminance typical values [7]

Global radiation (clear sky)	about 100000 lx
Global radiation (cloudy sky)	about 20000 lx
Optimum sight	max to 2000 - 3000 lx
Workplace	100 - 500 lx
Lighting orientation	20 lx
Street lighting	10 lx
Moonlight	0.2 lx

The standardized model of the eye's response to light as a function of wavelength is given by the luminosity function. The eye has two distinctive responses as a function of wavelength when it is adapted to light conditions (photopic luminosity function  $V_{\lambda}$  - light adapted eye) and dark conditions (scotopic luminosity function  $V_{\lambda}'$  - dark adapted eye), Fig. 2.3.

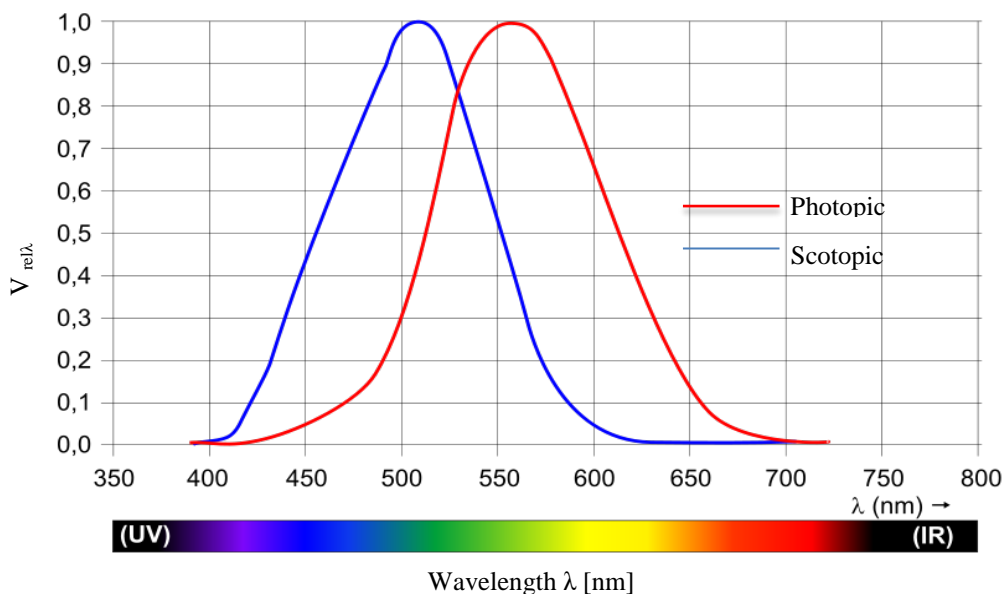

Fig 2.3: Graph of photopic luminosity and scotopic luminosity function [6] ( $V_{\lambda}$ ) curve for both eye responses, peak of  $V_{\lambda}$  is at 555 nm,  $V_{\lambda}'$  at 517 nm.

## 2.3 DAYLIGHT AVAILABILITY

Daylight or the 'light of day' is the natural light of global solar radiation during the daytime. This includes direct sunlight, diffuse sky radiation, and often both of these reflected from the ground surface and neighbouring obstructions as buildings, trees etc. [7]. Daylight level varies with location, time and season [8].

Table 2: Daylight intensity in different conditions [9]

Sky conditions	Horizontal external illuminance [lx]
Brightest sunlight	120000
Bright sunlight	110000
Shade illuminated by entire clear blue sky	20000
Typical overcast day, midday	10000-25000
Extreme of darkest storm clouds, midday	< 2000
Sunrise/sunset on a clear day (ambient illumination)	400
Fully overcast, sunset/sunrise	40
Extreme of darkest storm clouds, sunset/sunrise	< 1

There are standardized sky models under the international commission on illumination [9]. Traditional models are CIE overcast sky model and CIE clear sky model. New fifteen sky models were standardized for specification of luminance distribution of the sky in dependence on weather and climate, and it changes during the course of a day with the position of the sun [5].

### 2.3.1 CLIMATIC CONDITIONS

Daylighting in buildings is influenced the by climatic conditions of the locality and seasonal time. Information about climatic conditions of Brno region in the Czech Republic is available from the Brno Council data.

Locality: Brno, Czech Republic is at 49°9'N, 16°41'E, 246 m.

Under the Köppen climate classification [10], Brno has a borderline oceanic climate (Cfb) and a humid continental climate (Dfb) with cold winters and hot to warm summers. However, in last 20 years the temperature grows rapidly and summer days with temperature exceeding 30 °C are quite common. The average temperature is 9.4 °C, the average annual sunshine is 1771 hours, and the prevailing wind direction is northwest. The weather box below shows data between years 1961 and 1990.

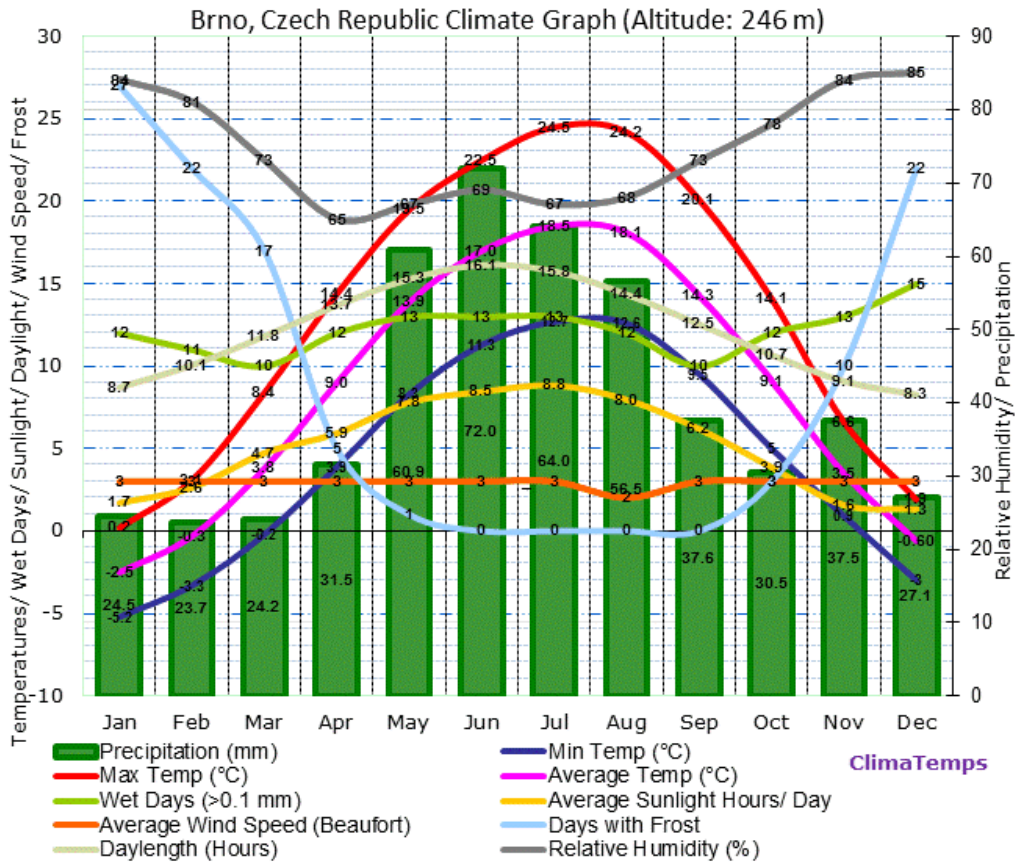

Fig.2.4: Brno, Czech Republic climate data graph [11]

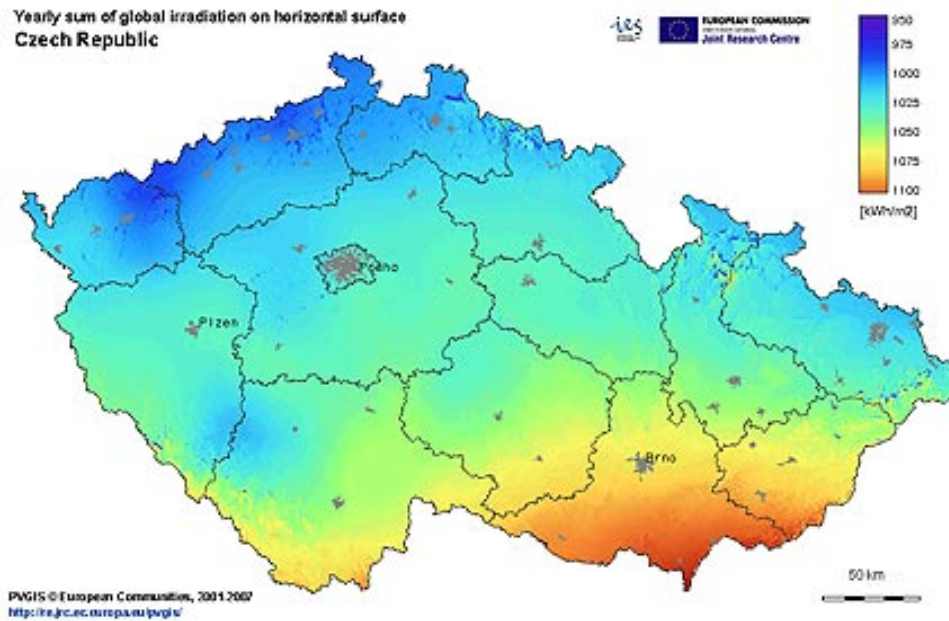

Fig. 2.5: Availability of global solar radiation on the area of the Czech Republic [12]

The daylight luminous flux can be determined for the preliminary estimation of daylighting studies from the global solar radiation in  $W.m^{-2}$  corrected with luminous efficacy value, Table 3.

Table 3: Luminous efficacy value [13]

Sky type	Luminous efficacy [lm/W]
Sunlight	70 – 105
Clear blue sky light	130
Overcast sky light	110

### 2.3.2 Light and health and well being

It would be a mistake to adopt energy efficiency only as the principal measure of good lighting. It is important, but it should be balanced against other factors leading to a comfortable and pleasing environment. Numerous studies indicate that daylighting has an important role in health and mental development of people. It is often forgotten that people are the major asset and expense of a company. If staff are visually impaired through inadequate working conditions and poor lighting, their productivity will deteriorate and output may decline on a scale far greater than the gains which might occur from the installation of more energy efficient (but less user friendly) lighting [14].

Physiologically, daylight is an effective stimulant to the human visual system and the human circadian rhythm. This process supplies us with an inner clock. When the circadian rhythm is upset due to lack of daylight, a multitude of problems may occur (depression, mood disturbances, hormonal imbalances, sleep disorders, affected may be blood pressure, heart rate, and metabolic function). Daylight is beneficial in preventing such afflictions as Seasonal Affective Disorder (SAD) commonly known as “winter blues” and even Sick Building Syndrome (SBS) [14]. The impact of light on human health has been the focus of many research projects in recent decades.

Electric light sources such as LED, fluorescent and halogen attempt to mimic the spectral qualities of daylight. They appear similar, but they are missing key components of natural light, the quality of the light is inferior when it comes to providing for our human biological need. The dynamic bands of energy (represented by colour bands in Fig. 2.6) are naturally aligned and predictably timed to enable both photopic/scotopic vision.

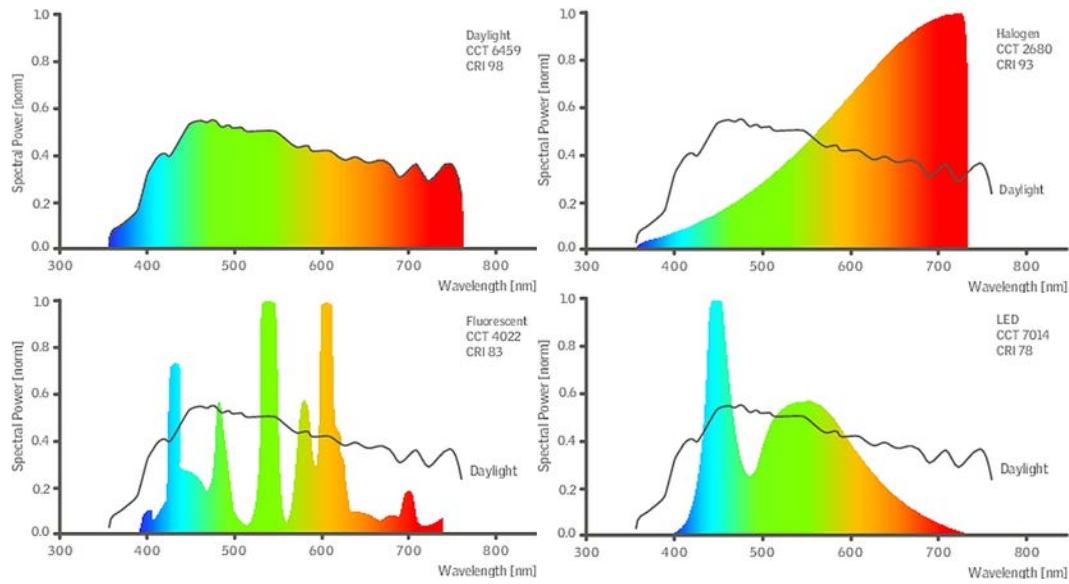

Fig. 2.6: Daylight comparison with LED, Halogen and Fluorescent light sources [13]  
 Note the lack of energy bandwidth for all power densities as compared to daylight.  
 For human health, wellbeing, sleep and productivity we need a light source which contains a full array of all energy bands.

Research [15] has shown that the daylight offers high luminous efficacy compared to majority of artificial lighting.

Table 4: Luminous efficacy value – Daylight and artificial light [13]

Source		Luminous efficacy (lm/W)
Daylight	Sunlight	70 – 105
	Clear blue skylight	130
	Overcast skylight	110
Artificial light	Global skylight	105
	Incandescent bulb	15
	Compact fluorescent	57 – 72

Daylighting is the controlled admission of natural light into a space. It helps to create a visually stimulating and productive environment for building occupants. Daylighting is chosen to save energy, to avoid adverse health effects of over-illumination by artificial light, and also for aesthetics. For centuries, daylight was the only efficient source of light available. Daylight stopped to be a critical design element with the advent of low-wattage fluorescent tubes in the 1930s, air conditioning, reflective glass and cheap energy.

Windows are the primary daylighting devices. Their function is to deliver



daylight and they offer ventilation, view and fresh air. They also increase the level of noise, glare and contribute to the occupant's distraction. The illuminance levels from windows decrease rapidly with distance from the window.

Today, for economic reasons, one of the most common building designs is high-rise, deep plan and compact building. In this type of building the penetration of daylight is through windows at the perimeter. The penetration of daylight decreases rapidly with distance from the window and also because of physical obstructions (internal walls and partitions). The surrounding buildings also reduce availability of daylight especially in very dense urban areas. Illumination is high near the glazing causing discomfort glare, high contrast and excessive brightness. The rest of the building and the core is lacking sufficient light and is left wholly to electric lighting. Top lighting (roof opening) in high-rise buildings is also not solution; it is applicable only for the highest storey. Consequence of this is the increase in the overall energy consumption. To bring light into these types of buildings, three strategies can be applied - improving the conventional techniques, developing new glazing systems and inventing innovative daylighting systems [16].

### **2.3.3 Energy savings**

Economy of every modern society is driven by energy use. Energy use brings us advantages such as convenience, comfort and prosperity, but it also brings us negative results such as pollution, global warming and impoverishment.

Conventional power generation uses fossil fuels (oil, coal and natural gas). These are non-renewable energy resources, which are being used up at an alarming rate. The challenge for the 21st century is to maximize the benefits gained from energy consumption while minimizing the costs incurred and also protecting the planet.

Energy is one of the most basic of human needs. Its use is closely tied to people's health and well-being. Energy use increases as population grows. There are disparities in the quantities of energy consumed and wealth generated from energy use. Responsibility to explore alternative (clean) energy sources is left mostly to the developed countries, who can afford it. Changing from conventional power to renewable energy is today considered necessary as we strive for a green and clean future. But it takes time, hence the concept of increasing energy efficiency.

The obvious way for energy saving in buildings is in exploiting daylight, which is the abundant, available and free source of light. Using daylight as the main source of light during day, when demand for electric lighting occurs at the same time as peak availability of natural light, energy consumption and costs

will decrease. Artificial lighting can be then dimmed or turned off in response to the amount of available daylight, while preventing occupant discomfort or other building loads from increasing. This can be done manually (not always done efficiently) or using optical lighting sensors. Sensors read the natural light coming in the room and adjust the artificial lighting automatically. Artificial lighting creates heat inside the building. To be able to dim or turn them off greatly reduces the cooling load.

## **2.4 THE DEVELOPMENT OF SOLAR LIGHT GUIDE SYSTEMS**

Piping light for illumination purposes is a concept which has been around for a long time. The idea to implement and utilize hollow light guides is an old idea. Many researchers in the Russia and the US theoretically considered the idea of transferring the artificial light from electric arc-discharge lamps via mirrored metal guides, and some of them even realized their ideas [17,18].

V. N. Čikolev (USSR) was one of the first to design and implement hollow light guides (1874) and publish the results (1880) [19]. Lighting system with hollow fiber optics in the form of mirrored tubes has been built. Light from powerful electric arc-discharge lamp installed on a special tower outside the building has been transported via these light guides and directed via semi-transparent mirrors into the rooms.

Almost simultaneously with Čikolev, M. T. Neal [20], R. W. Lake [21], E. J. Molera and J. C. Cebrian [22] and W. Wheeler [23] worked on the same problem. Neal and Lake had been awarded a patent in 1878, Wheeler in 1881 and Molera and Cebrian published their ideas in scientific and technical journals in 1879. All of these inventions were purely theoretical and probably never applied in practice. However, technical level of these first inventions in the field of lighting systems has been high.

A tubular light guide with a roof parabolic mirror for transportation of daylight into basement was patented by Hanneborg from Norway in 1901 [24].

In 1965, G. B. Bukhman [25] extended fundamental ideas of hollow light guides and their use not only to transmit light but also to illuminate the entire length of the light guide. In 1975 Aizenberg and Bukhman [26,27] patented two inventions of new systems essential for the further development of hollow fiber optics. These systems enable the transmittance of sunlight and artificial light via slotted light guides, as well as the use of thermal energy emitted by powerful light sources. Serial production of hollow light guides in the USSR was launched in 1980.

In 1990s many innovations of various light guide designs by different skylight manufacturers and investors have been developed. Light guides have

been patented in the USA by Sutton [28,29], Bixby [30], Chao [31] and O'Neil [32]. Johnson and Selkowitz (1986) [33] analyzed several light guides types (hollow reflective light guides, lens and prism guides and open light wells) and described the principles of their applications in buildings.

Numerous theoretical models have been attempted to address the transmittance efficiency of the light guides. Early developments concentrated on light transport, tubes reflective materials and sectional shapes. Tubular light guides of triangular cross section and their transmittance efficiency was experimentally assessed by Zastrow and Wittwer (1986) [34]. To improve the performance of light guides laser cut panels were added to the collector - Edmonds, Moore et al (1995) [35]. Swift and Smith (1995) [36] examined theoretically and experimentally the parameters affecting transmittance. Their interest was on tube lining material (silver and aluminium). They were the first researchers to make use of an integrating sphere with a scale model of light guide. McCluney (1990) [37] described the effect of absorption by water on the color of light. Ayers and Carter (1995) [38] published a review of remote source electric lighting system based on same technology as passive solar light guides. Comparison was made. Bouchet and Fontoynt (1996) [39] completed computer simulations of a light guide system. Mingozi (1996) [40] published table method for the light guide design evaluation. Shao, Riffat et al. (1997-2000) [41-47] in UK published daylighting performance studies of light guides in different weather conditions, in laboratory as well as in real buildings.

All papers published before 2000 investigated light guide performance based on different internal coating materials, tube lengths, diameters, shapes, elbows. Also different commercial products were investigated. The interest was mainly in the innovative systems. What was needed next was a mathematical model of light guide performance.

The first work about mathematical model of light guide performance was published by Zhang and Muneer (2000–2002) [48-50]. Their theoretical model was completed with coefficients determined by the data of light measurements. This publication was based on PhD thesis by Zhang [51]. Carter (2002) [52] evaluated tubular light guides of different dimensions and lengths and completed a light guide model.

Light guide measurements and evaluations were described by Callow (2003) [53] in his PhD thesis. His experiments were carried out in UK and Singapore. Jenkins and Munner (2003) [54–58] derived Luxplot package for calculation of illuminance on the working plane, Carter and Marwae (2004–2006) [17,59] published results of monitoring practical installations of tubular light guides.

An experimental and numerical analysis for evaluation of the daylight performances obtained by light guides with fixed collectors was carried out by

Chella et al (2006) [60], Baroncini et al. (2006) [61], Zazzini et al. (2006) [62]. Moving from the experience gained in the work of [60-62] Boccia et al. [63] developed two innovative devices which improve the performances of the traditional light guides. The first one is "Double Light Pipe" (DLP), the second one "Ventilated Double Light Pipe" (VDLP). DLP is able to transport daylight into two floors of underground building. VDLP allows transport of daylight into underground areas of a building and guarantees the necessary change of air by natural ventilation. Chella et al. (2007) [64] successfully installed DLP system in a historical building located in a small urban agglomerate in Italy.

Interpretation of empirical models and computer simulation studies were not fully consistent, therefore Technical Committee TC 3-30 Hollow Light Guides was established by the International Commission on Illumination CIE. Comprehensive investigation by a team of experts was completed over the decade 1993 - 2003 and the CIE 173:2006 Tubular Daylight Guidance Systems was published [11]. This document contains all common knowledge and information about tubular light guides systems and components and also measurement and design methods.

Swift et al. (2006) [65] incorporated a diffuse collector in the formulation of the guide light transmittance. Swift and Smith (2008) [66] extended their work to include rectangular sections mirrored light guides and irradiance distribution at the guide exit surface. Swift (2010) [67] derived an integrated ray-tracing expression for light transmittance of splayed rectangular guides, and Edmonds (2010) [68] followed up with expressions for the calculation of the beam and diffuse transmittance of light guide systems with different cross sections - rectangular, triangular, rhombic and hexagonal.

Computer simulations have also been used to predict the light transmittance of tubular light guides. Laouadi and Arsenault (2003) [69] developed the SkyVision computer program to address the optical performance of tubular light guides as well as conventional skylights with various shapes and glazing. SkyVision employs analytical models, based on the ray-tracing method, to compute the optical characteristics and energy saving potential of skylights. Kocifaj et al. (2008) [70] developed the computer program HOLIGILM for predicting the performance of light guides. Authors Kocifaj (2009) [71,72] and Kocifaj et al. (2010) [73] extended the HOLIGILM method to include ceiling diffuser with clear and diffusing elements and bended tubes. Darula et al. (2010) [74] applied the HOLIGILM to study daylight transmittance through a bended guide on a roof. Chirarattananon et al. (2010) [75] and Samuhattananon et al. (2011) [76] developed complex algorithms using the ray-tracing technique to compute light transmittance of cylindrical light tubes with and without bends. The use of non-imaging (anidolic) optics to capture, concentrate and transmit

the daylight through a guide was published by Scartezzini and Couret (2002) [77], Molteni et al. (2000) [78], Wittkopf et al. (2006) [79] and Linhart et al. (2010) [80].

The evaluation of the function of the light guide system and determination of design requirements was published by Mohelníková (2009) [81]. Detailed analytical method for evaluation of internal illumination from light guides on the basis of determined luminance of the diffuser was described by Mohelníková and Vajkay (2007) [82]. Kim JT, Kim G. (2010) [83] presented overview of two optical daylighting systems – light guides (collector with optical device) and sunlighting mirrors, both developed by authors. They also compared performance of commercial light guides of different diameters. Su et al. [84] published comparative monitoring of various sizes commercial light guides of different geometries under real sky conditions and proposed mathematical model. Lo Verso et al. (2011) [85] characterized photometric performances of tubular light guides in terms of light transmittance efficiency. An assessment approach was based on simulations and measurements in sun/sky simulator.

Mayhoub, Carter (2011) [86], Mayhoub (2014) [18] reviewed innovative daylight systems, described challenges, cost, utilization, difficulties and applications limitations. Mayhoub and Carter (2011) [87] developed a model to estimate direct luminous efficacy based on satellite data. The guidelines for daylight guidance systems application were published by Mayhoub (2012) [88] and Carter (2014) [89]. Light guides performance prediction was presented by Malet-Damour et al. (2014) [90]. Daylight computer simulation study focused on an evaluation of the light guide efficiency and illuminance distribution on the light guide base under overcast and clear sky conditions was presented by Darula et al. (2013) [91]. Improved more accurate calculation for the tubular light guide efficiency was presented by Kómar (2013) [92].

Comparative evaluation of two light guides was described by Plch et al. (2015) [93]. Potential of light guides systems, using materials easily available in Malaysian market, was published by Kadir et al. (2016) [94]. Assessment of light guides with respect to building physics (evaluation of constructions, structures and spaces with respect not only to daylighting, but also on thermo-technical conditions, moisture and many more) was presented by Vajkay et al. (2016) [95]. Ciugudeanu and Beu (2016) [96] published passive tubular daylight guidance system survey with field measurements as well as software stimulation results. Ellis et al. (2016) [97] described concept and algorithms implemented in EnergyPlus to simulate tubular daylighting devices and shelves. Two models were tested for daylighting, solar gains and conductive/convective gains. Gashinani et al. (2017) [98] examined innovative daylighting strategies for

improvement of performance in light wells. Case study of interior lighting using tubular daylighting devices (24 solar tunnels configurations and 12 cases with different number of skylights) was presented by Baglivo et al. (2017) [99].

A study on the analysis of vertical sky components (VSC) under the 15 CIE Standard Skies was conducted and numerical techniques for determining VSC were proposed by Li et al. (2016) [100]. A review of daylighting design and its implementation in buildings by Wong (2017) [101] examined and compared daylighting design principles, strengths and weaknesses of different daylighting systems and calculation methods. The vertical tubular light guides were tested in real weather conditions and results, compared with levels required by the CIE, were published by Malet-Damour (2017) [102]. Tsang et al. (2018) [103] presented a comprehensive study of straight light tube efficiency and illuminance distribution below ceiling level using HOLIGILM tool. The results obtained highlight importance of climate based approach. Based on the results a database of the optical parameters of different guides under different weather conditions can be created to characterize the optical properties of different light guides in different climatic zones. Petržala et al. (2018) [104] introduced an analytical solution to the optical efficiency of straight guides that is applicable to all aspect ratios. The results were compared with the results obtained from HOLIGILM calculations. Kadir et al. (2018) [105] presented and compared a study of daylighting performance of two light guide systems fitted with the laser-cut panel (LCP) placed at the entrance of the guides. LCP were installed with different tilt angle. Alibaba (2018) [106] published the results of performance of light guide (Solatube) installed in residential building in Nigeria. Mayhoub (2019) [107] presented a brief history of researches and developments into the Building core sunlighting systems (BCSS) over the last fifty years. A short description of the technologies and components of eighteen fully developed or commercialized systems were included. BCSS were classified and compared according to their design approaches to conclude the common features of the successful systems. Kim et al. (2019) [108] developed a method to predict indoor illuminance using the CIE standard sky model. The results were compared and verified with simulation values obtained by desktop Radiance program.

## **2.5 LIGHT GUIDE INVESTIGATIONS OVERVIEW**

### **2.5.1 Introduction**

Energy use is an important part of all human activities. As human activities accelerate, fossil fuels are depleted faster and faster. Energy consumption takes a huge toll on our environment. If nothing is done, global warming and its

affiliated changes will bring enormous consequences for people, economies and environment. Many countries therefore have decided to explore more efficient and environmentally friendly energy resources and to rely more on alternative renewable energy sources like solar, wind, hydropower, biomass, geothermal energy. Present research on the innovative daylighting device - light guide - that utilizes solar energy is a new effort towards this end.

### **2.5.2 Lighting /illumination**

Lighting /illumination is one of the sectors of power consumption in residential, commercial and industrial buildings. It is one of the areas which must be addressed for improving the energy efficiency and thereby reducing the energy consumption.

In 2014, the world consumed approximately 412 billion kWh of energy just for lighting and it is expected to increase to 4250 TWh by 2030. [109]

An optimal lighting system integrates artificial/electrical lighting system (electrical lamps and light fixtures) with natural lighting systems (daylight and sunlight). The motive for making best use of daylight as an electric lighting substitute is the rising monetary and environment costs associated with the current use of fossil fuels and also the rising cost of electricity. With new technological advances in lighting materials a new daylighting products have emerged. One of them is tubular skylight.

### **2.5.3 Tubular daylighting device (TDD) - light guide**

Tubular skylight or tubular daylighting device (TDD) is a device that can capture and transmit light from external artificial or natural light source to building interior for lighting purpose. The concept was originally developed by the Egyptians in ancient times. Commercial applications that used reflectors to transmit the light were developed in 1850's. The concept was rediscovered and patented in 1980's. [110]. Many light guide systems are today well established commercial products available and installed in many parts of the world. Each has its own characteristics, effectiveness, own patented technique how to make it and how to fix it, its cost and performance. Light guides can use as a light source artificial lighting, external daylight or both artificial and external daylight. Guides using external daylight are called solar light guides, solar light guides or often Tubular daylighting devices (TDDs).

Solar light guides can be passive zenithal, active zenithal and horizontal or vertical. Passive zenithal (most used and commercially available) are stationary. The illumination they provide is completely dependent on the geographical location, angle of the sun in the sky, the ever-changing local weather conditions, season, time of day and limited duration of optimal performance during the day.

Active zenithal systems, such as solar-tracking skylights, actively follow the sun and use mirrors to drive its illumination down into a interior of building. They do not depend on the sun position in order to create illumination. The mirrors adjust to track the sun, thereby increasing the effectiveness of the skylight [109].

Function of tubular daylighting device is to capture, collect and lead daylight into interior spaces that cannot be lit using conventional glazing, to spaces where daylight is insufficient and which require artificial lighting. Such places are: core spaces of multistory buildings, spaces distant from the building envelope, locations where more conventional daylighting apertures cannot be placed (underground areas, large plant areas).

Compared to traditional skylights and windows, they have the advantages of energy savings (small area relative to the amount of useful light they can admit), lower summer solar heat gains due to a less visual contact. The availability of natural light in internal environment also improves the occupants' well-being, avoiding over illumination effects.

There are three main components - collector, tube and diffuser:

- Daylight collector is fitted at the top end of the light guide. It is placed usually on the building roof or on the external walls. Placement should be such that there is a free collection of light, any obstruction of solar radiation from adjacent structures should be avoided. The roof placed collectors suit the deep plan building, the facade mounted ones are better for the multi-story buildings, but they are recommended to be south oriented [88]. Collector function is to gather sunlight and skylight from part or whole sky hemisphere and to seal the guide against ingress of dust and rain. The light guide collector is designed to meet the fire resistance requirements. It is self-cleaning due to its shape. The material is a single or multiple-layer transparent glass or plastic in various geometric shapes. It may contain optical features (prisms, reflectors or diffusing elements) to enhance the lighting output, especially at low sun altitude angles.
- The tube is the transport element. It is usually made from an aluminum sheet and can be straight-rigid, elbow-rigid or flexible. Natural light is more efficiently transported with the straight tubes. Bends cause light loss which is multiplied by the number of bends and their inclination. The tube interior surface is coated with special materials to highly reflect the visible component of sunlight and absorb the infrared component so that mainly visible light gets into the interior space. Commercially, there are coating materials with a light reflectivity ranging from 98% -99.5% available. Tube diameters varies from 250 – 1000 mm. The smaller



diameters are used for residential installations, the bigger ones then in commercial or industrial applications. The ratio of the length of guide (l) to its diameter (d) is its aspect ratio (l/d). The lower the aspect ratio, the more light will reach the interior space.

- Diffuser is made of single or multi-layer glass or plastic, varies in property and transparency (clear, opal) to meet different needs for light distribution within the room. Its shape can be flat, convex or concave, glazing can be prismatic, diffusing or lensed. Diffuser transmits light rays guided through the tube and uniformly illuminates a room without creating glare and colors distortion. Diffuser is mounted on the ceiling inside the room to be illuminated.

TDDs require the installation of sealing components at roof and at ceiling level to achieve high heat resistance and to prevent solar gain. They also keep dust, rain, snow, insects and noise out or the building interior.

### 2.5.4 Working mechanism of the light guide

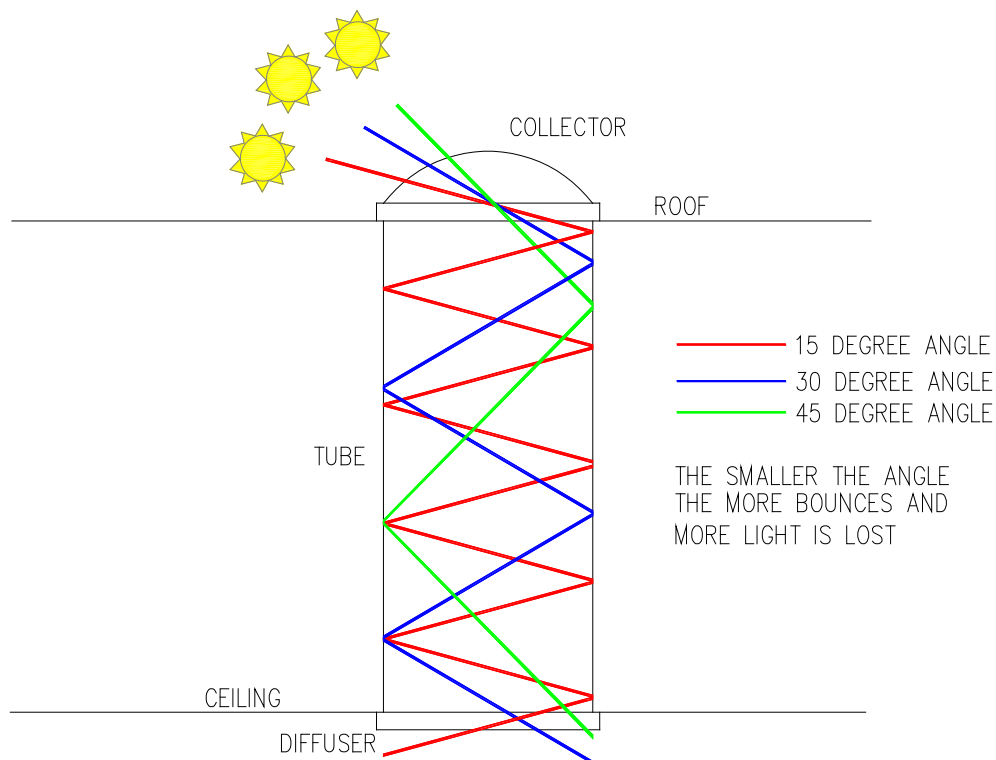

Fig. 2.7: Sunlight pattern passing through the light tube (schematic diagram of the light beam transported through the centre of the light guide) [110]

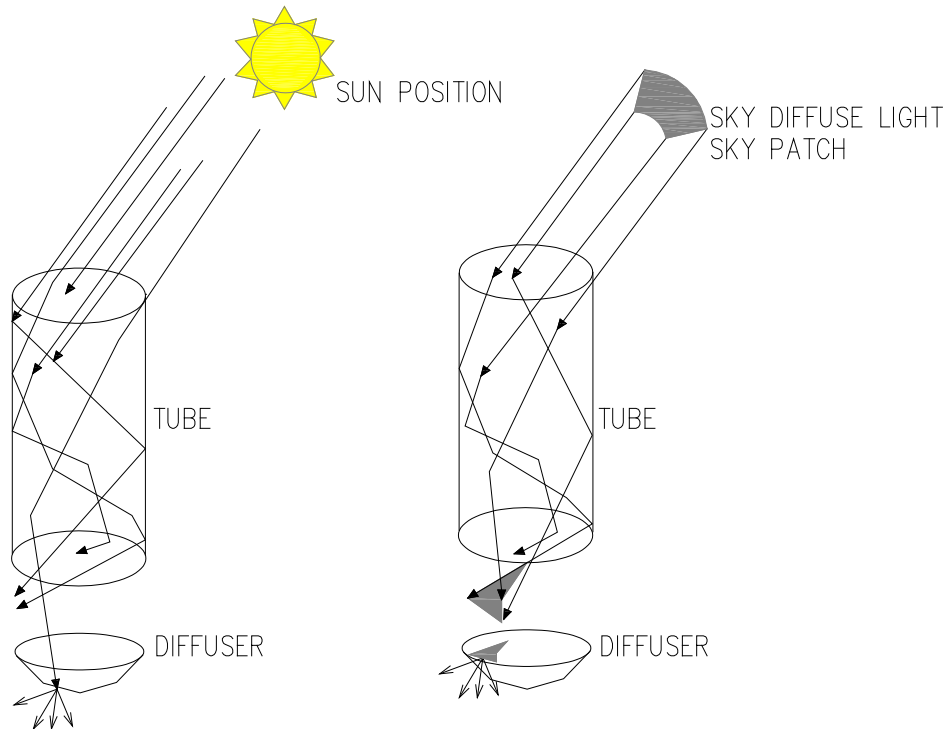

Fig. 2.8: Sunlight and skylight pattern passing through the light tube [51]

Sunlight and skylight are collected by a collector. There they are reflected in different directions depending on the angle of incidence (Fig. 2.7, Fig. 2.8). At low altitudes, larger number of reflections required to descent the entire light tube will reduce transmittance. The opposite effect can be observed at the higher altitudes of the sun (eg. in the summer at noon) when the number of reflections is smaller and light transmittance is therefore more efficient. Refraction phenomenon happens in light guide diffuser where diffused light is further diffused and finally scattered into the interior space. Sky illuminance distribution is affected by the sun's position, weather conditions - the clarity of the sky, the position of random clouds – it is a highly dynamic process.

### 2.5.5 Challenges of daylighting systems

The innovative daylighting systems are still facing challenges. They are the initial cost (components and optical material prices, technology complexity and ease of installation), application limitations (geographical location, time of measurement, sky condition, building form), technology challenges (to deliver more daylight over further distance via smaller guides) and user acceptance [16].

Daylighting is an area of significant research within the lighting industry. There are a variety of daylighting designs in the market, but limited information on how or where they are best utilized. If not properly utilized daylighting can result in ineffective lighting and unsatisfied consumers because of their visual

discomfort.

### **2.5.6 Light guides – prediction methods**

Light guides are used in all types of buildings throughout the world for daylighting, energy savings and benefits like improving mood, health, and better performance of the occupants. However, they are not the cheapest investment therefore attention should be paid to optimize their design to get the maximum effectiveness of their installation.

The effectiveness and accuracy of a daylighting studies rely on knowing the climate and light conditions available at a given place.

There are several methods describing light guide performance predictions. This part of thesis includes comparative calculation of models.

Before the selection and application of computation method the light guide shape factor – the Aspect Ratio AR must be defined (the ratio of the guide length  $l$  [m] over the guide diameter  $d$  [m]).

$$AR = l/d \quad (2.1)$$

The computation of light flow  $\Phi_e$  entering the light guide depends on light guide cross sectional area  $A$  and the total external illuminance  $E_e$  (CIE overcast sky global illuminance)

$$\Phi_e = E_e A \quad (2.2)$$

$$A = \pi r^2 \quad (2.3)$$

where

$A$  light guide cross sectional area [m<sup>2</sup>]

$\Phi_e$  luminous flux leaving the tube [lm]

$E_e$  external illuminance [lx]

$r$  tube radius [m]

### **CIE computational method**

Because of different methods and calculation procedures the International Commission on Illumination CIE established Technical Committee TC3-38 which completed comprehensive investigation of the light guidance topics and Tubular Daylight Guidance Systems was published [9].

CIE has mathematically developed 15 different sky conditions (five clear, five intermediate and five overcast sky types), which probably cover the whole spectrum of skies found in nature. Overcast and clear sky conditions are

typically used in software simulations.

The method allows the evaluation of the effectiveness of a wide range of configurations of passive light guide systems, including the effect of the bending. Transmittance tube efficiencies TTE values can be found in tables for different diameters, lengths, averages and reflectance or calculated using the following formula:

$$TTE = \frac{e^{\frac{1}{d}\tan\theta l n\rho}}{1 - \frac{1}{d}\tan\theta l n\rho} \quad (2.4)$$

where

- $\theta$  sky segment around the zenith with the most efficient effect of sky brightness, the angle is considered as  $30^\circ$
- $\rho$  light reflection factor on the inside of light guide surface, for computation it was estimated as 95%
- $l$  light guide length [m]
- $d$  light guide diameter [m]

The light transmittance efficiency EG is affected not only by the light transmittance efficiency through the TTE light guide tube by also by the loss due to the diffuser and the light guide collector. It is assumed that this value is not more than 0.63. Another loss coefficient is the effect of the outside environment pollution, typical for urban development. MF value is 0.76.

$$EG = TTE \tau_C \tau_D MF \quad (2.5)$$

where

- EG total light transmittance efficiency
- TTE light reflection factor on the inside of light guide surface
- $\tau_C$  light transmittance factor of the collector
- $\tau_D$  light transmittance factor of the diffuser
- MF maintenance factor

The light flow exiting the light guide  $\Phi_i$  depends on the light transmittance coefficient of the light guide EG and the light flow entering the light guide

$$\Phi_i = \Phi_e EG$$

The calculation of the illumination  $E_i$  below the diffusor equals to:

$$E_i = 0.494\Phi_i \frac{\cos^4\theta}{V^2} \quad (2.6)$$

$$\cos \theta = \frac{V}{\sqrt{V^2 + x^2}} \quad (2.7)$$

where

$E_i$  internal illuminance [lx]

$V$  vertical distance from the diffuser to the point of interest [m]

$\theta$  angle between the vertical line from the diffuser and the line joining the center of the diffuser with the point of interest [°]

### Luxplot package model

The authors of this model are Jenkins and Muneer [56]. Their model calculates light levels in two main stages. The first stage involves converting the external illuminance recorded outside into a luminous flux being emitted by the guide. The second stage associates this luminous flux with the internal illuminance at a given position. An average transmittance relationship was taken from the data produced by Joel Callow [53]. From the collected luminous flux data a simple relationship between transmittance and aspect ratio was obtained:

$$\tau_t = 0.82 e^{-0.11AR} \quad (2.8)$$

where

$\tau_t$  total guide permeability

0.82 this coefficient is a measure of the light loss through the top collector and diffuser

$$\text{Given that luminous flux } \Phi_i = \tau_t E \pi r^2 \quad (2.9)$$

where

$r$  the tube radius [m]

Combining the two equations they derived an expression for luminous flux:

$$\Phi_i = 0.82 E_{ex} e^{-0.11 AR} \pi r^2 \quad (2.10)$$

Internal illuminance  $E_i$

$$E_i = 0.494 \frac{\Phi_e}{V^2} \quad (2.11)$$

### **Tsangrassoulis method**

In this method the perfect diffuse luminous distribution from diffuser inside the interior is assumed. To estimate the luminance  $L$  of the diffuser the following equation is used:

$$L = \frac{E_e \tau_e}{\pi} \quad (2.12)$$

where

- $L$  luminance of the diffuser [ $\text{cd}/\text{m}^2$ ]
- $E_e$  illuminance reaching the diffuser [ $\text{lx}$ ]
- $\tau_e$  transmittance of the diffuser

Illuminance  $E_i$  at any point below the diffuser

$$E_i = \frac{\pi L r^2}{V^2 + r^2} \quad (2.13)$$

where

- $E_i$  internal illuminance [ $\text{lx}$ ]
- $V$  vertical distance from the diffuser to the point of interest [ $\text{m}$ ]
- $r$  tube radius [ $\text{m}$ ]

### **HOLIGILM (Hollow light guide interior illumination method)**

A physical model for interior illuminance calculation was developed [70]. It is a computer program, which is able to calculate the indoor illumination in a rectangular room using tubular light guides as light sources. It is based on the backward tracing of a light ray between the diffuser and the sky zone. The program allows to predetermine interior illuminance distributions close to reality using typical sky patterns standardized by CIE or ISO and sun luminance or parallel sun beam illuminance under actual sun position.

### 3. METHODS

The main task of the thesis is to test and evaluate a new special type of the light guide prototypes.

#### 3.1 LIGHT GUIDE PROTOTYPES

Two prototype light guide models were used for experimental studies and daylighting measurements before starting their commercial production. Both prototype models are passive solar tubular systems provided by the manufacturer [111]. Models were supplied unassembled, so the first step of the work was to prepare them for the planned measurement. The light guide prototypes are described below.

##### Prototype light guide model 1

This prototype model belongs to new systems of tubular passive light guides, where collector is provided with device permitting redirection of sun rays thus increasing the efficiency. It uses a pair of parabolic mirrors to form a concentrated beam of sunlight that is directed down to the tube of the light guide. Below is calculation of radius of reflective areas and focal point distances of both parabolas (Fig.3.1).<sup>1</sup>

Primary parabola, large sunlight collector, has a diameter  $D = 1200$  mm, focal length  $f = 466$  mm  $\rightarrow R = 2f = 2 \times 466 = 932$  mm. Secondary parabola, reflective component for concentrating the flow of sunlight into the tube, has an optical diameter  $D = 350$  mm, focal length is  $f = 153$ mm  $\rightarrow R = 2f = 2 \times 153 = 306$  mm.

---

<sup>1</sup> Technical drawing provided by [111], consulted with Ing. Jiří Částka [111]

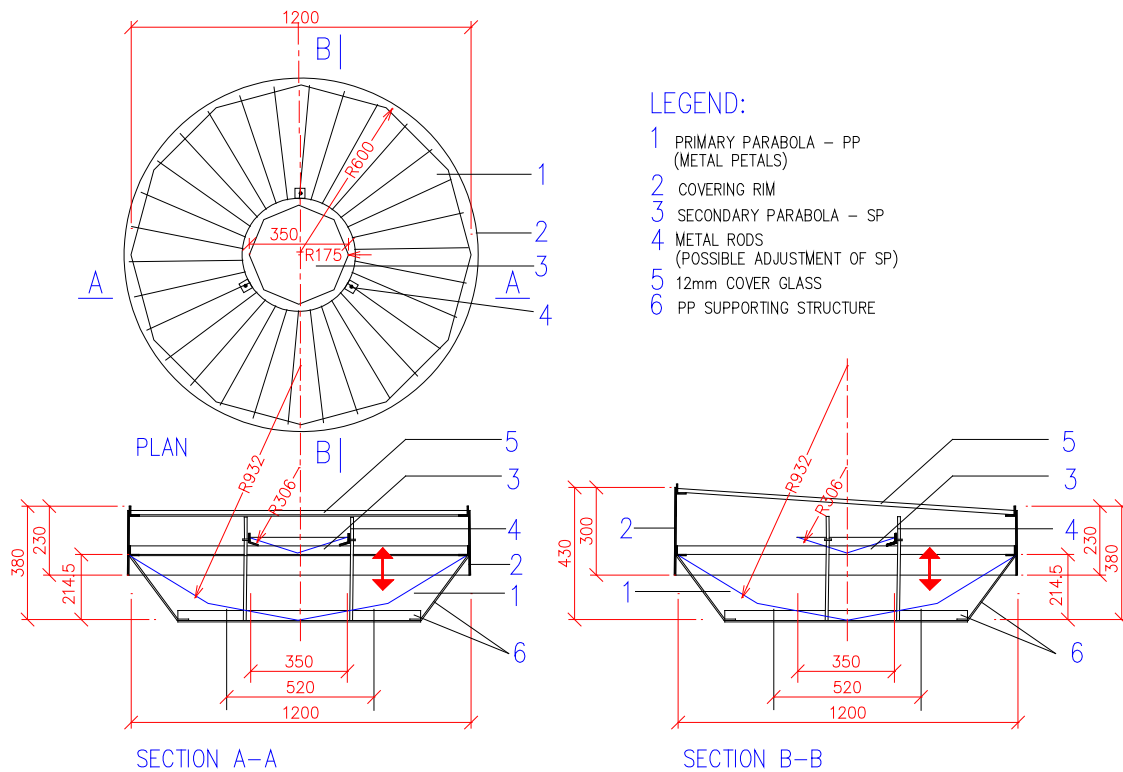

Fig. 3.1: Technical drawing of prototype light guide model 1 [111]

Transparent cover of the collector is made of the clear glass with antireflective coating. Its thickness is 12 mm. The cover seals the tube against the dust deposits, dirt accumulation and rain. The collector is designed to meet the fire resistance requirements. It is self cleaning due to its shape.

The primary collector is formed from several thin flat flexible metal peaces with shape similar to petals with highly reflective and blemishes free surfaces. Attached to their rear surface are thin steel connecting materials pulling the petal ends towards each other to form a parabola.

The secondary parabola is a small convex methalic element with highly reflective surface mounted near a focal point of the primary parabolic collector. It is supported by three slender metal rods, which are attached to the primary parabola. Through these rods an accurate adjustmentof the secondary parabola is possible by lowering or raising it to the desired position.The metallic fasteners are used to hold it there.

The tube of the light guide is rigid, made from hard aluminium sheet. Its interior surface is coated with highly reflective layer. Light transmittance efficiency is highest if the tube is short and straight. In longer, bended or flexible tubes a part of the transmited light is lost. To minimize the light losses a high reflectivity of the tube lining and glossy inner surface is crucial. This assumption was taken into consideration for the experimental work – the tube diameter is 520 mm and length 600 mm. The light reflectance of the tube



internal surface is  $\rho = 0.95$  [111]<sup>2</sup>. The tube end inside the chamber is covered with a translucent diffuser.

The light guide installation in buildings should be designed such way, that there is free space for receiving the light and any obstruction of solar radiation from adjacent structures should be avoided.

Fig. 3.2 below shows parameters and variables of parabola of prototype light guide model 1, Fig. 3.3 shows its major components and light path.

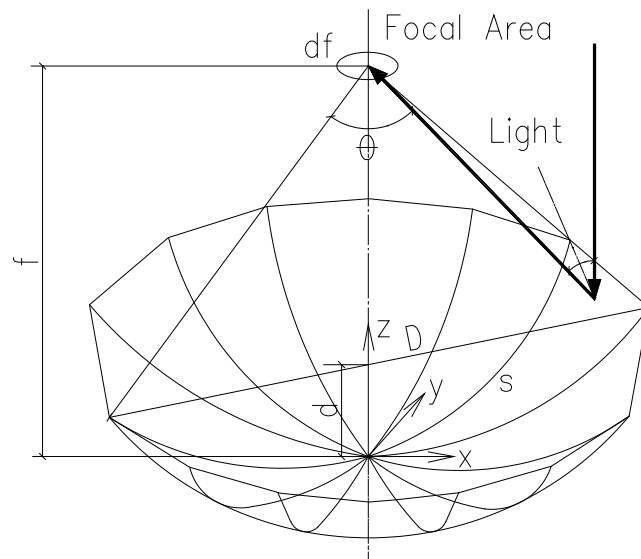

$D$  = dish diameter,  $d$  = dish depth,  $df$  = focal area diameter,  $f$  = focal length,  $s$  = parabolic arc length,  $x, y, z$  = coordinates,  $\theta$  = rim angle

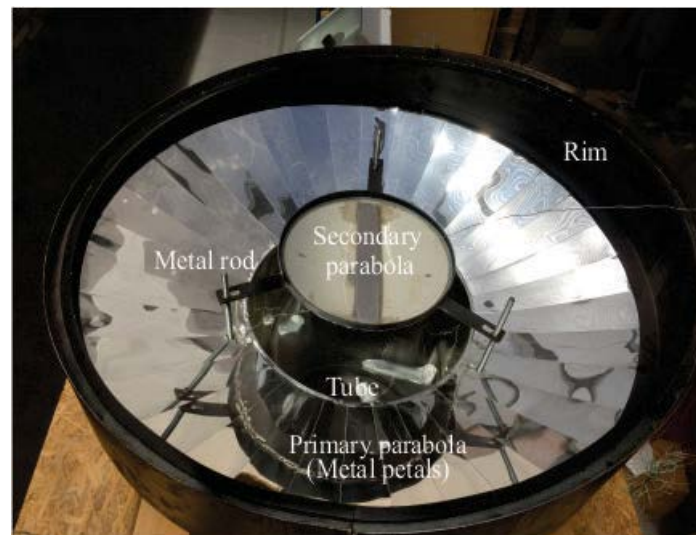

Fig. 3.2: Primary parabola of prototype light guide model 1 [111]

<sup>2</sup> The value of 0.95 was used with respect to material degradation, pollution factor and computational safety

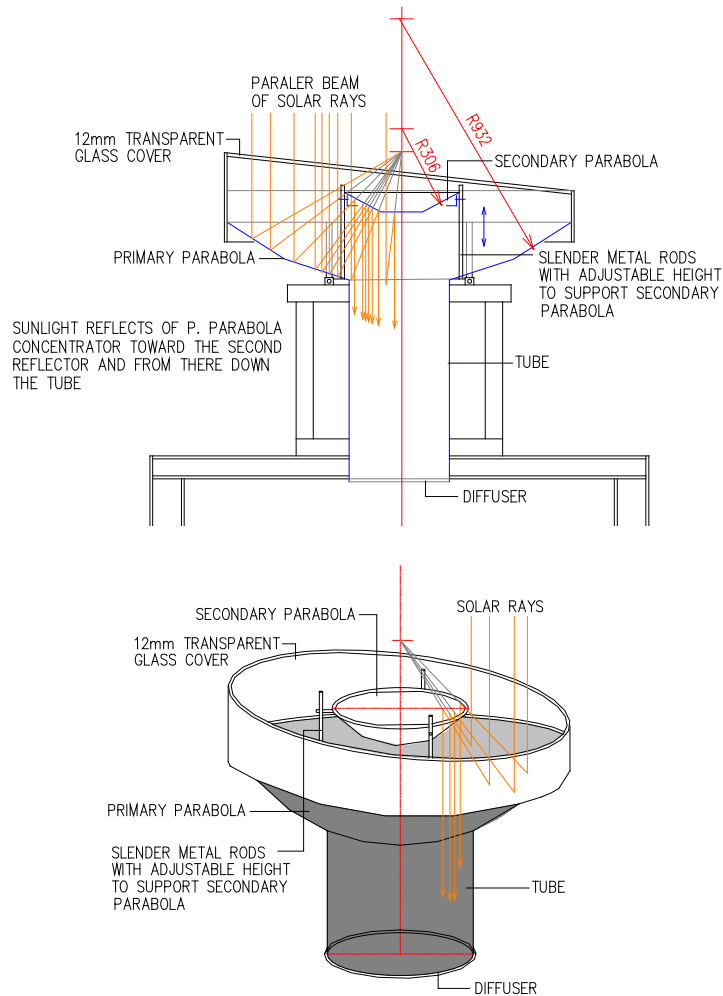

Fig. 3.3: Model 1 – major components and light path

### Prototype light guide model 2

This is a smaller prototype model. Light collector is usually placed on the exterior wall of the building. It uses a pair of parabolic mirrors aligned about the optical axis. The main gathering parabola contains a hole in the centre thus permitting the light to reach a diffuser. The main parabola (diameter 550 mm) and the secondary parabola (diameter 200 mm) are made from thin aluminium plate with highly reflective surface. Secondary parabola is placed under the transparent glass cover. The rigid tube for daylight transportation has a circular cross section with a 200 mm diameter, a length 600 mm and transparent glass diffuser unit at the end.

Fig. 3.4 shows the placement of model 1 on the roof and model 2 on façade. Façade placement is suitable for dark rooms in high-rise building, far from the roof, where leading tubes through several floors is impractical and in basements. They are recommended to be south or west oriented.

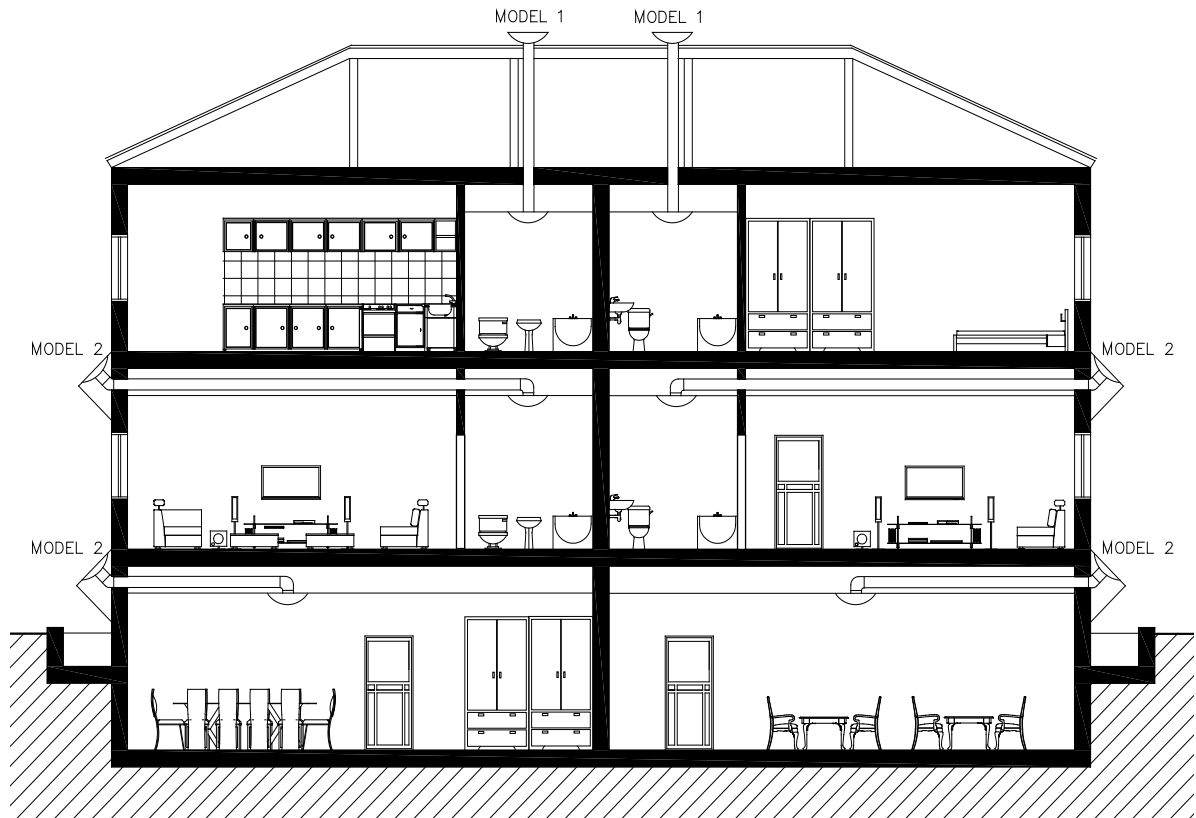

Fig. 3.4: Model 1 and 2 possible placement in building – design variations [111]

In case of façade mounted light guides the building appearance may be influenced by the collector size and shape.

The main problem with horizontal light guides is their size. They need to be small enough to fit with other building subsystems (HVAC ducts) which are placed within the ceiling space and are only about 500 mm deep. They might also conflict with the beams. The smaller the diameter of light tube the more difficult is the transportation of light to deep spaces. The longer the tube the more complicated the collection system needs to be.

The operational period of this system is limited to the time when sun is facing the façade. This also means that the system cannot be applicable in a high density area where neighbouring buildings shadow one another's façades.

## 3.2 EXPERIMENTS

Experimental solution is divided into two parts. First part deals with the creation of experimental models; the second is addressing measurements of the lighting devices.

Methods of the light guide evaluation tasks are as follows.

### **Task 1 – laboratory testing**

#### **1a) daylight measurements**

- Testing a new prototype of the light guide (mirrored concentrating head) for light transmittance in the test chamber in laboratory conditions.
- Light guide model 1 type and dimensions: pipe diameter – 0.52 m, concentrating head: two parabolas with mirror surface, the primary parabola: diameter 1.20 m, the secondary parabola: diameter 0.55 m.
- Test chamber made from plywood sheets on hard wood frame with internal dimensions 1.50 m x 1.50 m x 1.50 m. The light guide is installed in the central position over the chamber.
- Light sensors are placed on top of collector glazing, above (about 200 mm) the collector and inside the chamber at floor level.
- Control testing of the light guide model 2 and illuminance measurements in the test chamber 1.0 m x 1.0 m x 1.0 m.

#### **1b) thermal measurements**

- Thermal measurements of the light guide temperature distribution under infrared lamp activation under laboratory conditions.
- Temperature sensors were placed above (about 200 mm) the collector, on top of the collector, under diffuser, inside the tube and on reflective mirrors. Also temperature rise inside of the test chamber was monitored.
- Thermographic camera monitoring of the light guide prototype was carried out to determine potential overheating and fire risk places.

### **Task 2 – field testing**

- Complete field daylight measurements for an evaluation of light efficiency of two light guides of same geometry and dimensions, but with different roof collectors' instalations.
- Container 2.3 m x 4.6 m x 2.85 m divided into two identical parts (Fig. 3.5). Light guide LG1: roof collector with collecting mirror parabolic (CMP) head, metal tube diameter 0.52 m, length 0.6 m, diffuser. Light guide LG2: glass roof collector, metal tube diameter 0.52 m, length 0.6 m, diffuser.

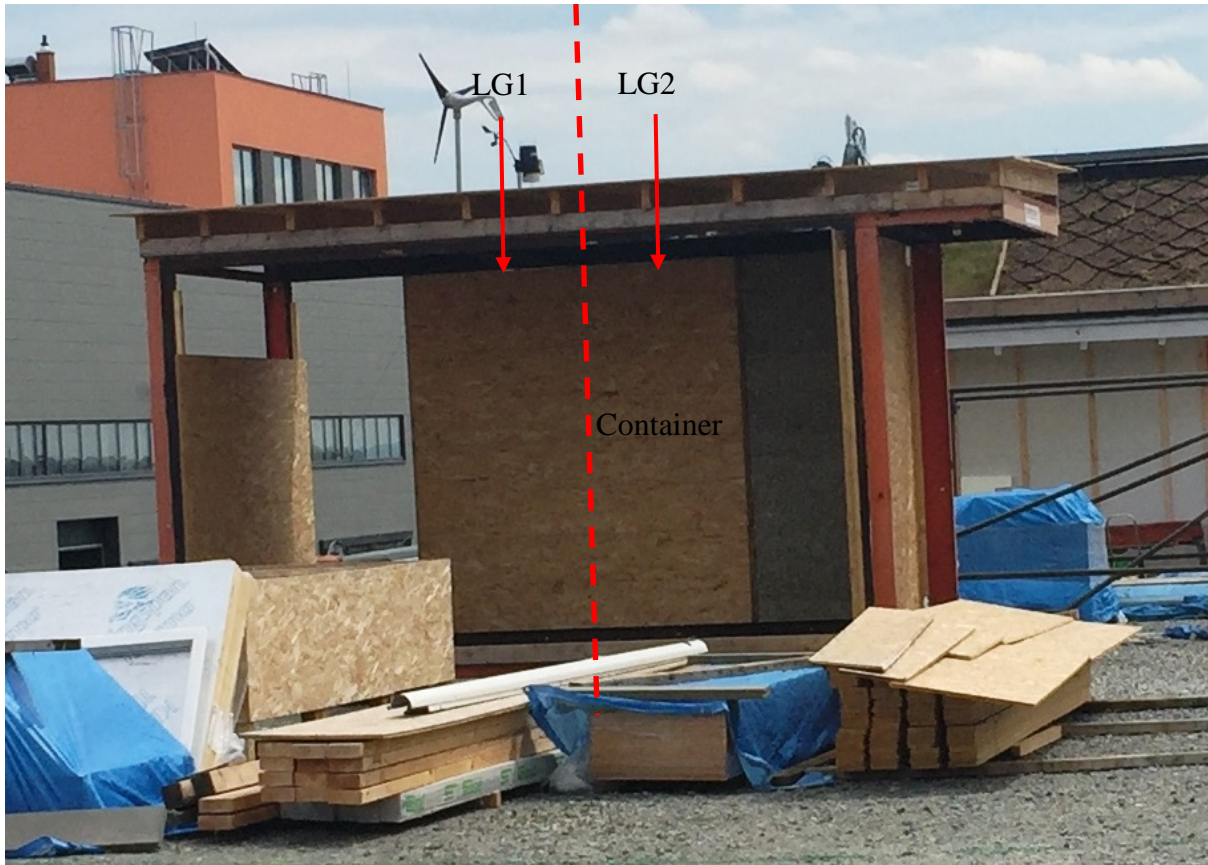

Fig. 3.5: Photograph of the construction of a container for the light guides installation for the field measurements

### **Task 3 - Daylight simulations**

- Daylight simulations using software HOLIGILM – daylight illuminance on the working plane 2.80 m under the diffuser was simulated to compare results of the in situ measurements and complete simulation scenarios under various sky conditions.

### **Task 4 – Results analysis**

- The general analysis of the monitored data and daylight simulation outputs is relevant for possible improvements of the tested light guide prototype optimised design.

### **3.2.1 Experimental models**

Experimental chambers were made for the light guide prototypes instalations. They were constructed so various measurements could be undertaken, processed and analysed.

#### **Description of chamber CH1**

The experimental chamber with side door for easy access to the interior (Fig. 3.6) was constructed from unpainted plywood sheets nailed to the hard wood

frame with internal dimensions of 1.50 m x 1.50 m x 1.50 m. The upper surface of the box has a circular hole in its center into which a light guide tube with a diameter of 0.520 m and 0.60 m length was placed. Light guide system was installed including a collector head and a diffuser.

### **Description of chamber CH2**

The smaller experimental chamber (Fig. 3.7) was made from unpainted plywood sheets on hard wood frame with internal dimensions of 1.00 m x 1.00 m x 1.00 m. One of the side panels was removable for easy access to the interior. A circular hole of 0.20 m diameter was cut on the roof of the enclosure for fixing the tube 0.60 m long, glass collector and diffuser.

All gaps between chamber walls joints in both chambers were covered with adhesive tape to seal the interior space from ingress of daylight. The light-enclosed space was created. Daylight was transferred into the chambers through the light guides only. Light guide systems - model 1 and model 2 - for the purpose of measurement were provided by the manufacturer [111].

The chambers were kept in same position during the experimental period. The purpose of the experimental chambers has been to monitor the progress of the interior lighting on the bottom surface of the chamber in the axis of the light guide, that is at a distance of 1.50 m from the center of the diffuser in CH1 and 1.00 m in CH2. At the same time with the measurements of internal illuminance measurements of external horizontal illuminance and temperature have been made. Both experimental chambers were placed in laboratory workshop under a big transparent skylight (Fig. 3.7, Fig. 3.10). This laboratory installation was selected to protect the illuminance meters against the rain, wind and dust to allow continual one minute monitoring of daylight illuminance of the whole experiment time period.

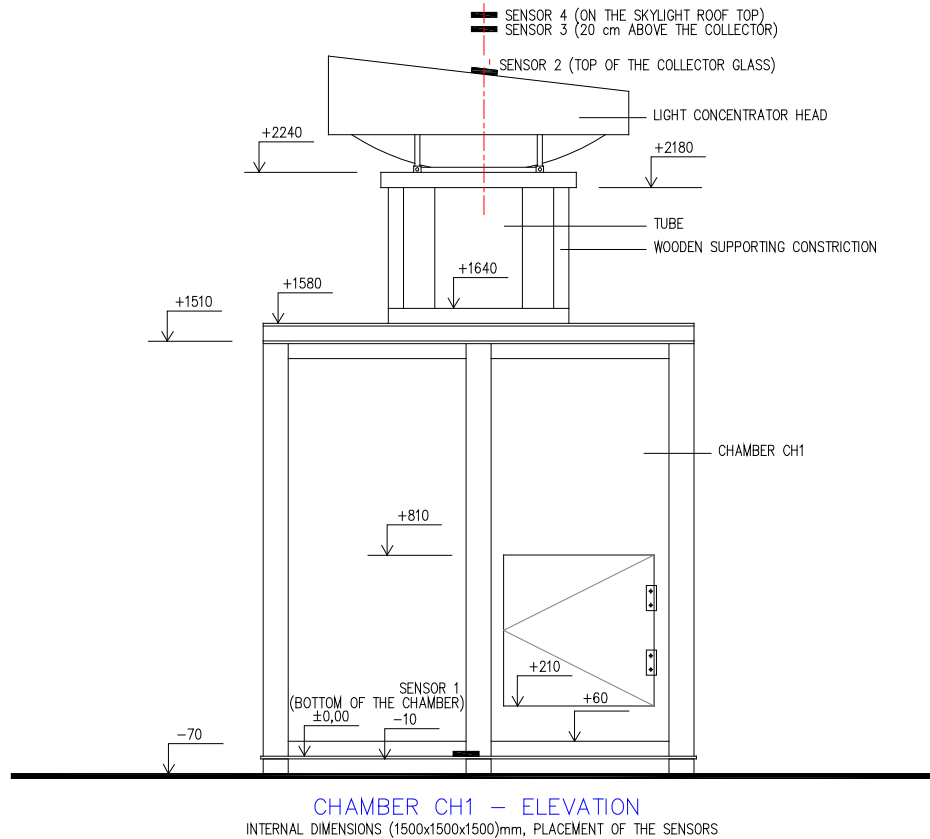

**Fig. 3.6: Chamber CH1 and prototype model 1 elevation**

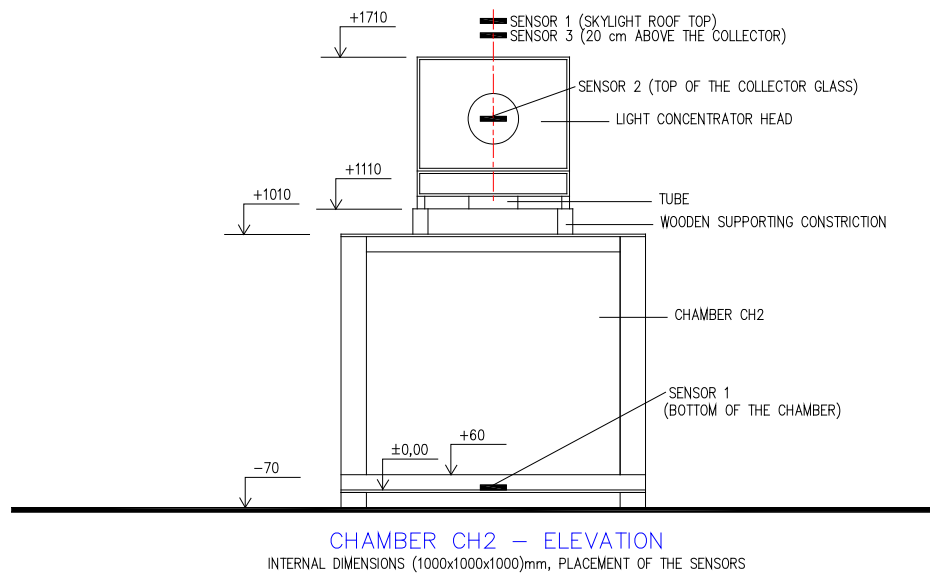

**Fig. 3.7: Chamber CH2 and prototype model 2 elevation**

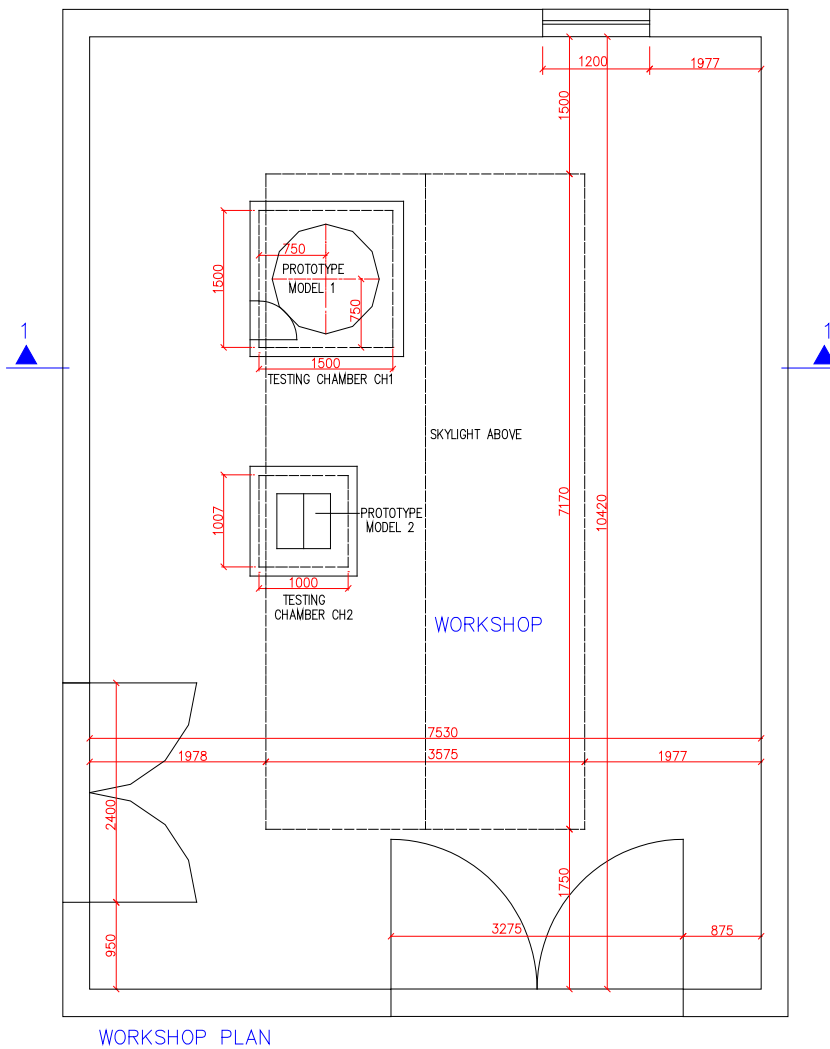
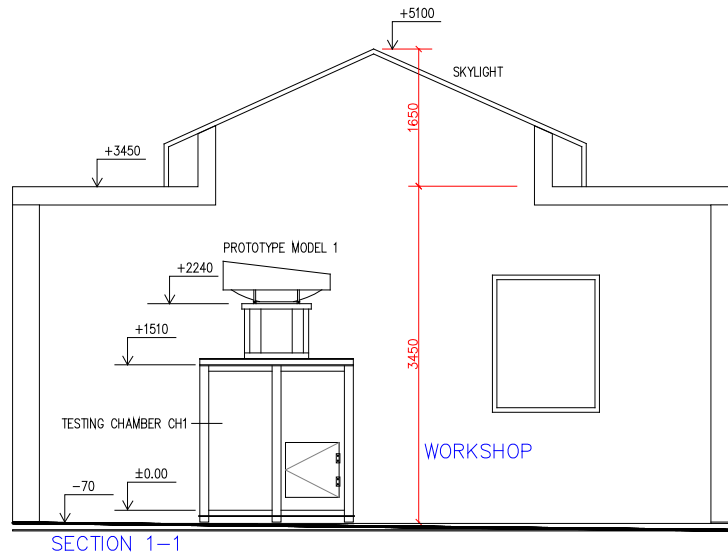

Fig. 3.8: Placement of chamber CH1 and CH2 in the workshop under skylight





Fig. 3.9: Construction of CH1



Fig. 3.10: Construction of CH2



Fig. 3.11: CH1 and CH2 placed in workshop under skylight



Fig. 3.12: Collector (model 1)

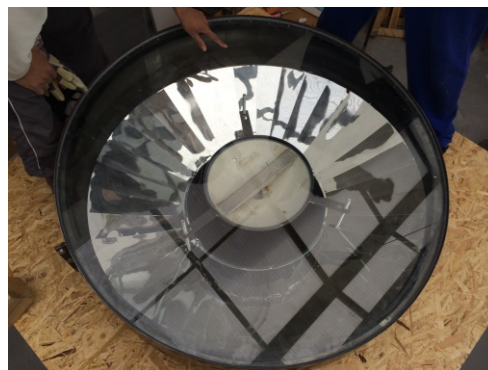

Fig. 3.13: Collector (model 1)

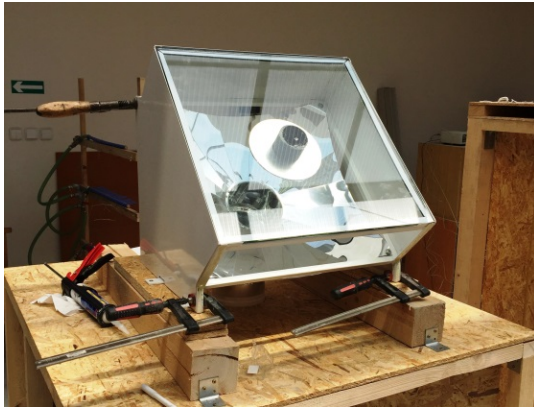

Fig 3.14: Collector (model 2)

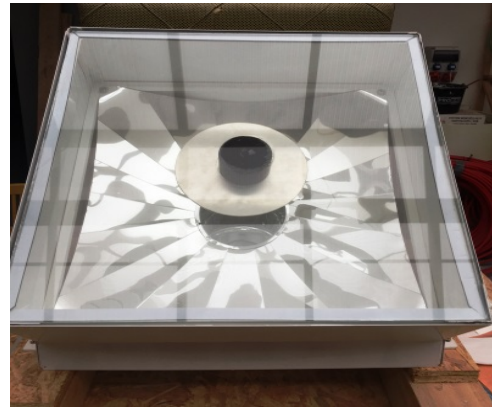

Fig. 3.15: Collector (model 2)



Fig. 3.16: Tube (model 1)



Fig. 3.17: Tube (model 2)

The tube is rigid (model 1) and rigid with elbow (model 2). Interior surface of the tube is coated with reflective layer. Length of tube length is 0.60m (model 1) and 0.60 m (model 2).

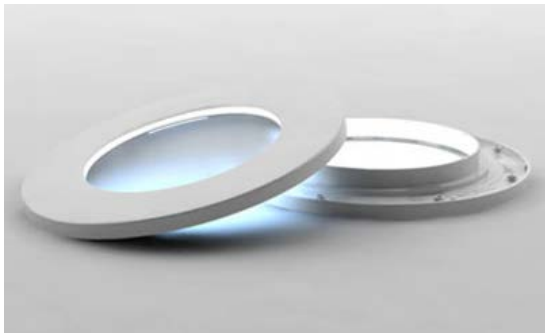

Fig. 3.18: Components of the diffuser



Fig. 3.19: Diffuser mounted on CH1 top



Fig. 3.20: Measurement apparatus – luminance meter

### 3.2.2 Daylight laboratory measurements

The experimental study of daylighting performance of the prototype light guide model 1 and 2 under varying climatic conditions (overcast, cloudy and sunny) of Brno was undertaken. The daylight illuminance measurements were carried out From April 2015 to August 2015.

Illuminance measurements were carried out under laboratory conditions using a set of calibrated Lux-meters Lutron LX 1128 SD.

The readings were taken for illumination at the bottom level of the chamber in the centre of its floor and on top of the collector glass. The luminance meters were placed on the workshop skylight roof above the collector, 200 mm above the glass of the collector head and inside the chamber under the diffuser (Fig. 3.6, Fig. 3.7). The external illuminance level data were also measured. They are important for the calculation of daylight luminous flux collected by the parabola. It gives information about the weather conditions. All measured data were processed. Graphs were plotted for illumination data obtained vs. time and a comparative study of the results obtained was done in Chapter 4 - Results.

#### Method of testing

The readings were taken for illumination at the reference plane at 1.50 m below the diffuser in the position of the light guide vertical axis and on top of the collector glass (Fig. 3.21).

Light level (illuminance) is the total luminous flux incident on a surface per unit area. The work plane is place, where the most important tasks in the room or space are performed.

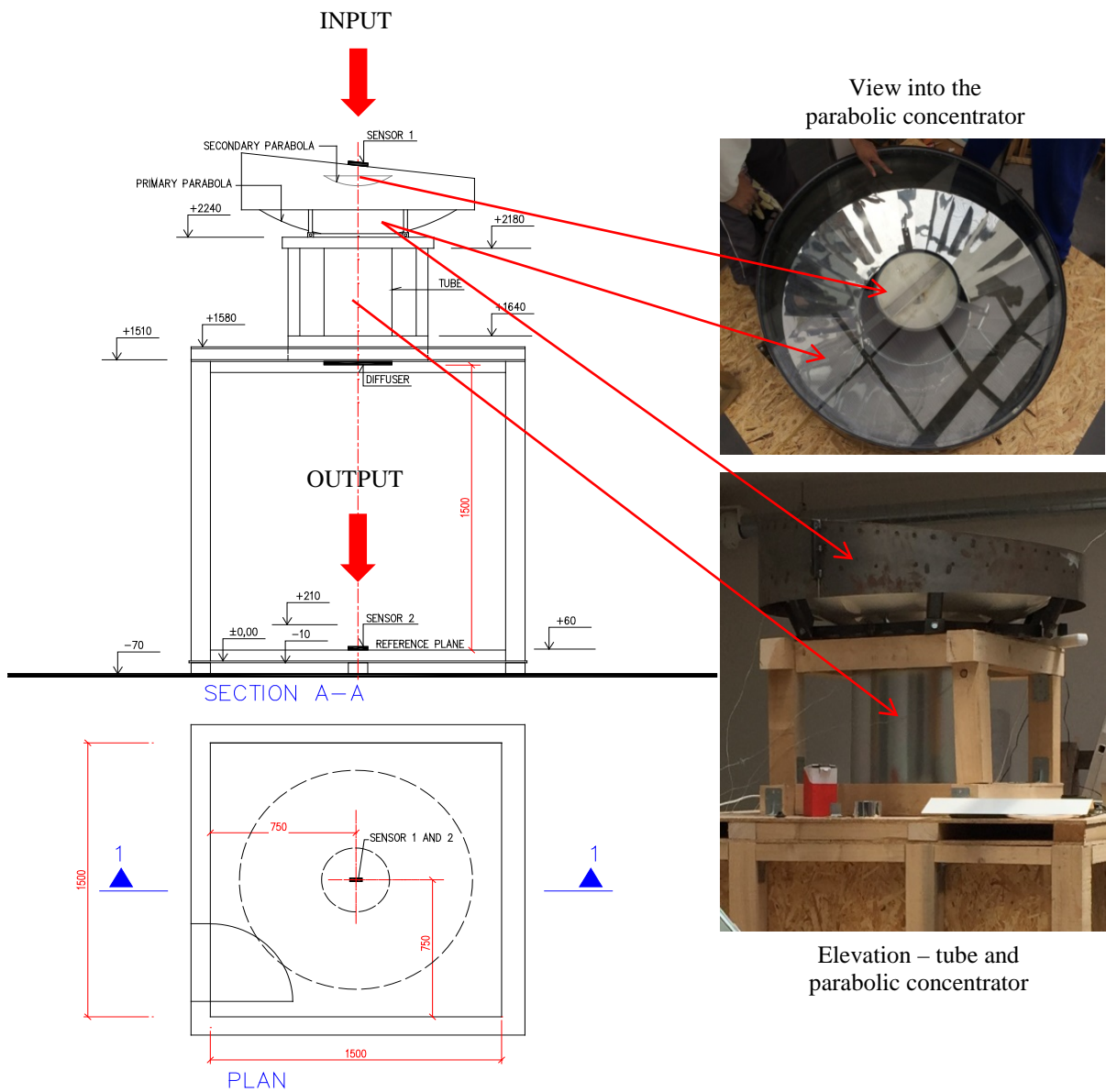

Fig. 3.21: Elevation of the chamber CH1 (dimensions in mm) and photographs of the light guide concentrating head installed in the chamber



Fig. 3.22: Inside the measuring chamber CH1

### 3.2.3 Thermal evaluation of the light guide – laboratory testing

#### Introduction

Trends of solar energy applications in buildings brought systems of light guides [112]. Light guides transmit solar radiation into interiors. They can improve daylight level in internal parts of buildings, which is very important for occupants' visual comfort [113,114]. In spite of many positive aspects for day lighting, the light guides installations in building constructions can cause condensation problem, which occurs when the light guide metal tube is placed in thermally insulated construction [115,116]. The experimental results indicated that dust and condensation worsen the day lighting performance of solar light guides [117].

On the other hand, solar radiation affecting light guides could represent potential risk of the system overheating. Overheating is due to the solar gain through the building fabric and transparent openings [118]. Solar radiation is transmitted through light guides due to multi-reflections. It is inevitably partly absorbed on the light guide components – roof collector, tube, and diffuser. Energy of absorbed solar radiation is distributed along the tube, and it influences its temperature profile.

Various types of light guide systems have applications in buildings [119]. Common passive light guides [36] are combined with ventilation pipes [47]. Special types of light guides with roof mirrors and parabolic concentrators increase both light transmittance and solar gain through the light guide [120,121]. The light guides with concentrating mirrors and collectors might be very efficient but high solar gain could significantly increase temperature which might be a potential problem for their installations on roofs. Increased

temperature of a light guide with the roof solar concentrating system could lead into potential fire risks as it is known from the PV collector roof installations [122,123]. The potential overheating problems was the reason why a new light guide prototype [111] was thermally tested.

Light guides have been subject of research. The research has been focused mainly on daylight evaluations [17,35,70,124]. Also, solar heat gains [125] were evaluated for tubular daylight devices. Less investigation was done for thermal evaluations of these systems. A literature review was done for the light guide thermal testing. The principles of heat transfer through tubular systems were studied [126]. The thermal evaluation of light guides is referenced for models or real installations. The experiments were completed for thermal characteristics determination of light guides of specific dimensions [53,127]. Studies of light guides thermal performance under tropical climatic conditions were solved [128]. Heat transfer and natural ventilation in light guides were studied on models. Computer fluid dynamic simulations aimed at the light guide thermal profiles were analysed [129-131]. The simulations and experimental studies were carried out for integrated daylight-ventilation tubes [132,133]. Energy of solar radiation absorbed into the light guide was specified for the EnergyPlus software simulations [134]. The thermal properties of glass samples are important values for the energy evaluations [135,136].

This experimental part of the thesis is focused on a thermal testing of the light guide prototype with the parabolic concentrator. The thermal analysis of the light guide gives information about conditions of their installations on roofs. The purpose for the testing was to evaluate how temperature of the tube is increasing in a response to solar radiation affecting the light guide. The contribution is to test surface temperature distribution and specify temperature profiles of the light guide for specification of overheating problems.

### **Method of testing**

The tested prototype model 1 was placed in chamber CH1. The temperature sensors were placed on the parabolic concentrator head and into the tube (Fig. 3.23) and connected to Almemo data logger (Fig. 3.25) for the temperature data recording.

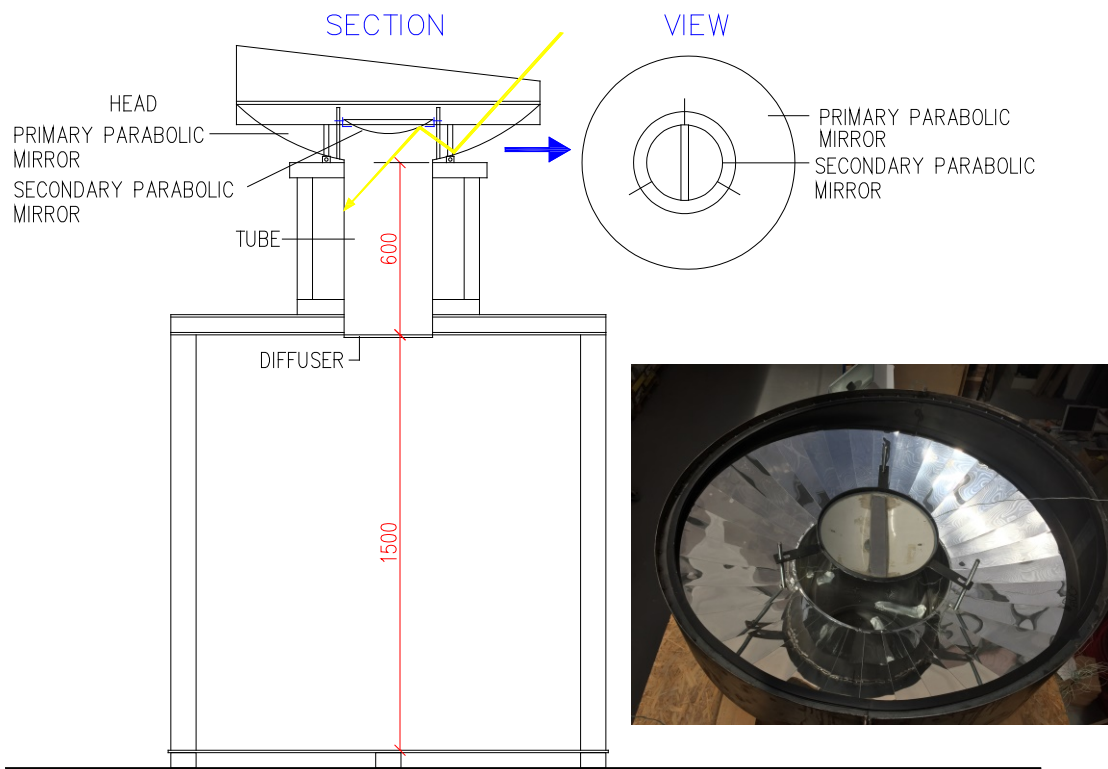

Fig. 3.23: Section of the test chamber CH1 with the light guide prototype and view of the head with the parabolic mirror

The light guide consists of the concentrating head with metal parabolic mirror (on the top), metal reflective tube (in the middle, length 0.60 m, diameter 0.52 m) and transparent diffuser at the inner end of the system. The parabolic mirror and tube are made from metal aluminium alloy sheets with mirrored internal surface. Thin silver layer sputtered on the aluminium substrate gives high surface reflectance of the light guide [111].

### **Infrared Thermography**

The temperature distribution on surfaces of the light guide was monitored by temperature measurements and infrared thermography [137-139] monitoring. The temperature profiles were tested as provided under laboratory conditions. The light guide was exposed to radiation of an infrared lamp of dimensions 200 x 750 x 400 mm (Fig. 3.24).





Fig. 3.24: Photograph of the light guide under the IR lamp radiation and view to the light guide diffuser (inside the chamber)  
 (Positions 1, 2, 3 - directions of IR camera monitoring, position 4 – on the diffuser, position 5 - placement of IR lamp [40], positions 1\*, 2\*, 3\* - on the metal rim of the light guide head).

The infrared lamp consists of three linear tubes of power 1500 W per each. The total power of the IR lamp is 4.5 kW [140]. The lamp photometric heat distribution is 11.0 m x 4.5 m [140]. The lamp simulates infrared radiation of solar shining. For common technical purposes the intensity of solar radiation affecting building surfaces and solar collectors is considered about  $1000 \text{ W/m}^2$ , which is installed (nominal) power for defined conditions according to ESTIF [141]. The ratio of the IR lamp power of exposed areas is 4.5 kW per area of the light guide concentrator head  $1.77 \text{ m}^2$ , cross sectional area of the tube is  $0.21 \text{ m}^2$ .

Infrared thermography was done with IR camera ThermaCAM PM695, the Flir system. The infrared monitoring system consists of an IR camera with a

built-in 24° lens, IR images – over 300,000 pixel resolution at  $640 \times 480$  [142]. The IR camera monitoring was completed for different positions (Fig. 3.24) round the light guide parabolic head to complete entire thermal profile of the exposed parts of the light guide. Distance between the IR camera objective and the measurement is from 1.0 m for detail monitoring and 2.0 m for overall views. The infrared thermography monitoring was carried out for two time intervals of the infrared lamp activation – for 10 minutes (it simulates a short period of insolation) and 100 minutes (long time activation). The purpose of the long-time thermal activation is to estimate how much the light guide surfaces' temperature could rise to the steady state thermal conditions.

The monitoring was completed for ambient temperature of 27 °C (ambient average temperature of the air and surfaces close to the light guide experimental setup). An average emissivity of neighbouring surfaces was 0.95 (surfaces of wall and ceiling plasters and facing and floor cement screed finishing). Emissivity of mirrored surfaces of the light guide prototype is 0.05 [143]. The thermal monitoring was compared to infrared thermography monitoring for heat transfer models [144] and the previous studies of computer simulations of light guides thermal profiles [129,130].

### **Temperature Measurement**

Temperature profiles were monitored by thermocouples connected with data-logger Almemo, Alhborn, 0.1 mV/digit, accuracy  $\pm 0.02\%$ ,  $\pm 1$  digit [145]. Thermocouples of type Ni-Cr-Ni of type K (measuring range -200 to 1200) [146] were used for the measurement. Total number of eight thermocouples was used. Seven sensors were installed on the light guide model and the eighth sensor monitored indoor temperature in the laboratory. Positions of the light guide thermocouples installation are shown in Fig. 3.25.

Temperatures were measured for one-minute time intervals. The measurements were completed with the laboratory controlled apparatuses. Indoor temperature data were controlled with temperature data from laboratory thermometer. The compared temperatures vary in interval  $\pm 2^\circ\text{C}$ . Some differences in temperature monitoring could be caused by aging of the thermocouple or when the thermocouple material is not homogenous.

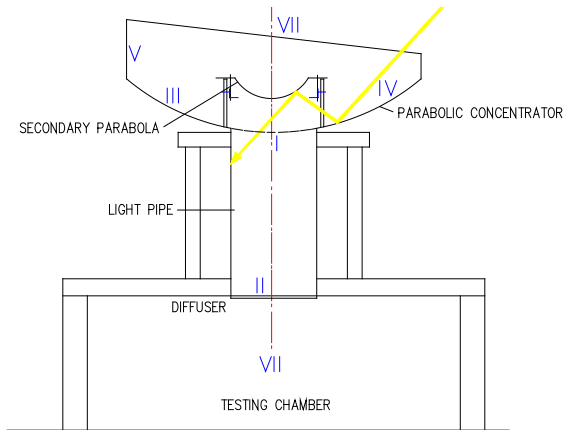

Figure 3.25 Thermal sensors in the light guide profile (I-VII positions of the thermal sensors installation and data logger Almemo for thermal sensors)

### Insulated light guide



Fig. 3.26: Photograph of the light guide with additional thermal insulation (mineral wool)

The infrared thermography and temperature measurements were also carried out for the light guide with additional thermal insulation 10 cm round the upper part of the light tube in the contact with the parabolic concentrator (Fig. 3.26).

The thermal insulation was used to simulate the real installation of the prototype model in thermally insulated building constructions.

### **3.2.4 Light guides comparative measurement - field testing**

#### **Introduction**

Recently, most research programmes have been focused on the light guiding systems. The light guiding systems components and their installation are key factors influencing the light guide efficiency [45]. Testing of light guides was mostly focused on the influence of tubes and their dimensions as well as reflectance of the daylighting inside the building interiors [52,59,84,147]. Theoretical studies focused on the description of light transmittance through the tubes with reflective surfaces are known. Also analytic descriptions, physical models as well as algorithms and computer simulations of various types of light guides were studied [54,69,70,75,76]. Light reflectance of the light guides is a factor influencing the efficiency. Also the roof transparent covers installation plays important role in the light guide design and applications.

Transparent covers at the top of light guides in roof installations are domes or collector heads. Domes are made of glass or transparent plastics like PMMA. Collector heads have glass cover over a system of mirrors and/or parabolic concentrators focussing light rays into the light guide tube [78,120,121]. The light focussing elements and reflecting parabolic head are used for enhancement of the light guiding systems efficiency. Applications of the light focussing and redirecting reflective elements should be considered in the context of the light guide geometry and its installation in the building constructions. Otherwise the very efficient light guides system but installed in less favourable position in the roof could decrease its efficiency as it is presented in this chapter.

This part of thesis demonstrates main results of field testing of two light guides with different roof installations. The study was aimed to find out how the prototype model will perform if installed in roof construction in less favourable condition than it was designed for and to compare its performance with the performance of common commercially available light guide system.

#### **Method of testing**

A comparative study was carried out for two light guides - one conventional (LG2) and the other one (LG1) with an innovative device in collector. They were equipped with identical tubes of length 0.60 m and diameter 0.52 m but a different collector installation. LG1 has the above mentioned concentrating mirror parabolic (CMP) head under a flat glass cover while light guide LG2 is with a common glass roof collector (Fig. 3.27). The tube of both light guides is rigid, made from hard aluminium sheet. Its interior surface is coated with highly reflective layer. The light reflectance of the tube internal surface is  $\rho = 0.95$ .

Both of the light guides have internal transparent plastic cover - diffuser. The diffusers scatter light into the test room.

LG1 and LG2 were installed into a container with flat roof (Fig. 3.28) with internal dimensions 2.30 m x 4.60 m and clearance height 2.85 m (Fig. 3.31). The container was divided into two identical parts, separated by black curtain (Fig. 3.32 and Fig. 3.33). The inner walls were also covered with black cloth, so only sky component of daylight transmitted through the light guide influences indoor illuminance level. Each light guide was installed over its own part. The container was placed in courtyard in open space away from surrounding buildings. There were no trees to shade the container. It was estimated that the light guides would receive all direct sunlight and diffuse light.

Daylight illuminance in both parts of the container was simultaneously monitored as well as external horizontal illuminance on container roof. A set of calibrated luminance meters Lutron LX-1128SD was used for the experiment. Daylight illuminance measurements were completed in one minute monitoring intervals for one month period between 22<sup>nd</sup> August and 23<sup>rd</sup> September 2017. The monitoring time period is characteristic with number of days with clear sky conditions and higher external illuminance levels. These conditions are more convenient for the intended comparative study. Luminance meters were positioned in the axes of the light guides and in the distance 2.80 m from the light pipe diffuser. The testing was completed in the temperate climatic region of city Brno, latitude 49°90', longitude 16°41' and altitude 246 m.



Fig. 3.27: Tested light guides LG1 and LG2 – the roof installation



Fig. 3.28: Container divided into two parts with both light guides installation

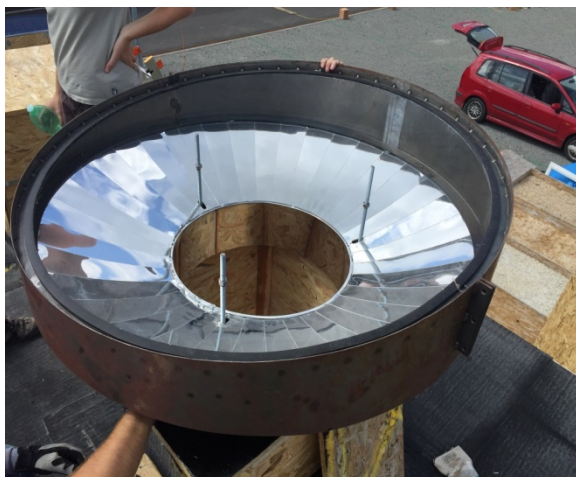

Fig. 3.29: Assembly of LG1

Daylight conditions during the external horizontal illuminance measurements were monitored for cloudy, partly cloudy and clear sky conditions.



Fig. 3.30: Sky conditions during the monitored period (photographs, Omishore, A, 2017)

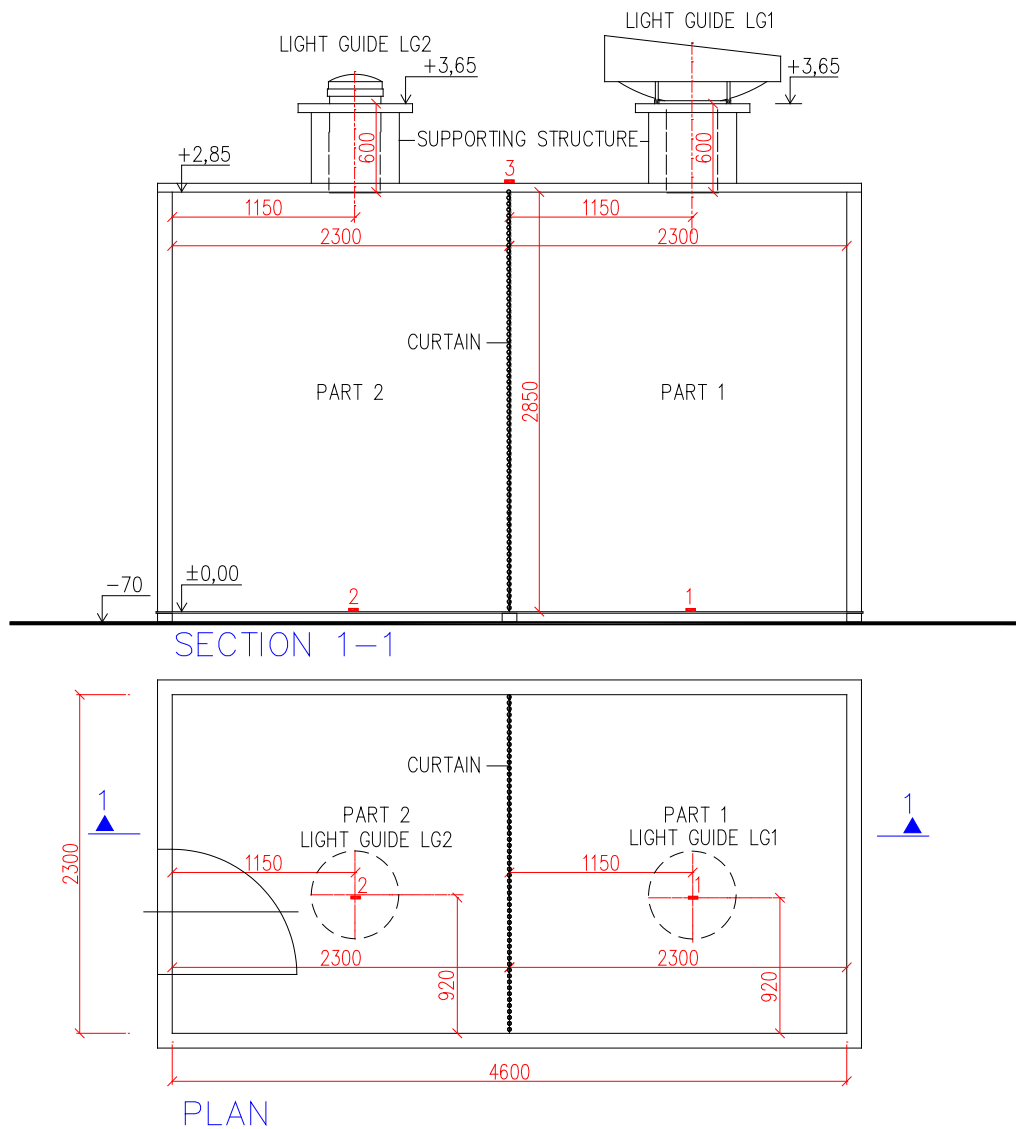

Fig. 3.31: Installation of the tested light guides LG1 and LG2  
 1 (resp. 2) – illuminance meters for LG1 (resp. LG2) light measurements, 3 – illuminance meter for external horizontal illuminance measurement



Fig. 3.32: Photograph of a view at LG1 and LG2 diffusers installed into the container's two identical parts, separated by black curtain



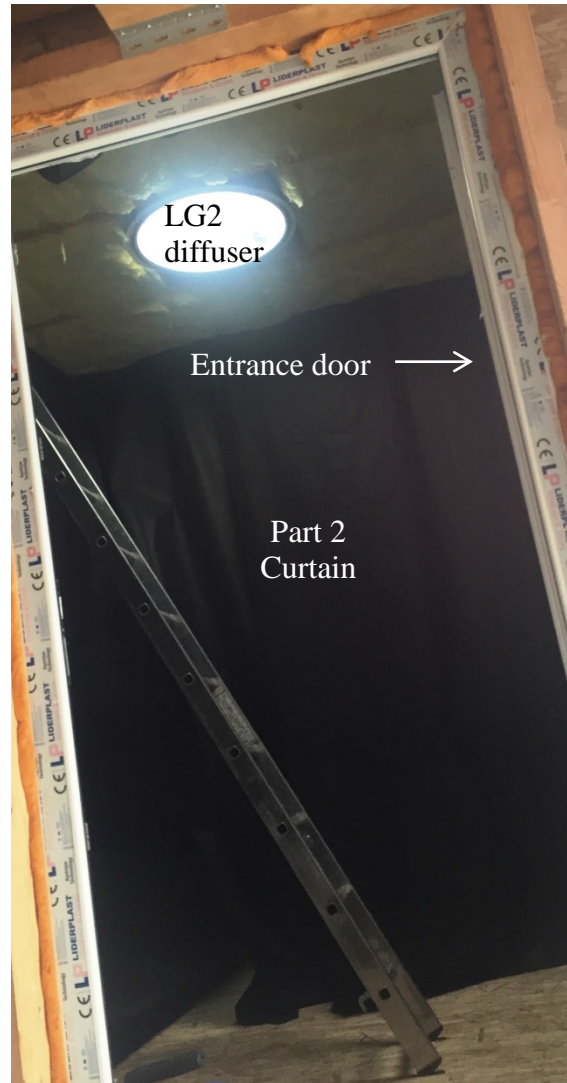
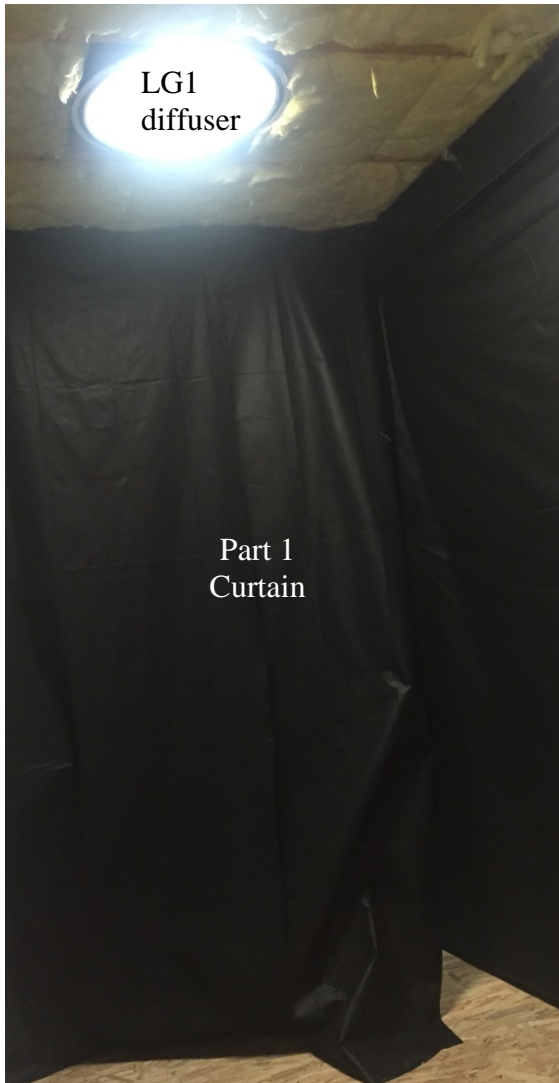

Fig. 3.33: Dividing the container into two identical parts with LG1 and LG2 installations for comparable simultaneous daylight measurements

## 4 RESULTS

### 4.1 LABORATORY DAYLIGHT MEASUREMENTS

The light guide with a light collecting mirror parabolic (CMP) head was proposed and tested in its prototype. The measuring instruments were installed in April 2015 and the data were recorded up to July 2015. Daylight illuminance at the light guide input and output is used for specification of the light guide system efficiency for different sky conditions. The illuminance measurement serves for specification of the light guide efficiency.

Profiles of daylight horizontal illuminance were measured at the input (at the entrance to the concentrator head) and the output (the floor of the chamber) shown in Fig. 3.21 - view to the parabolic mirror. Examples of daylight illuminance measurements have been selected for the most characteristic profiles of the locality - for nearly clear sky conditions with moving random clouds at noon on 25<sup>th</sup> May (Fig. 4.1), cloudy sky conditions with time intervals of low illuminance in the morning changed with higher illuminance level in the afternoon on 2<sup>nd</sup> May (Fig. 4.2) and also for conditions of dynamic changes in external illuminance on 23<sup>rd</sup> June (Fig. 4.3) when clear sky with solar shining alternates with overcast sky due to frequent moving clouds.

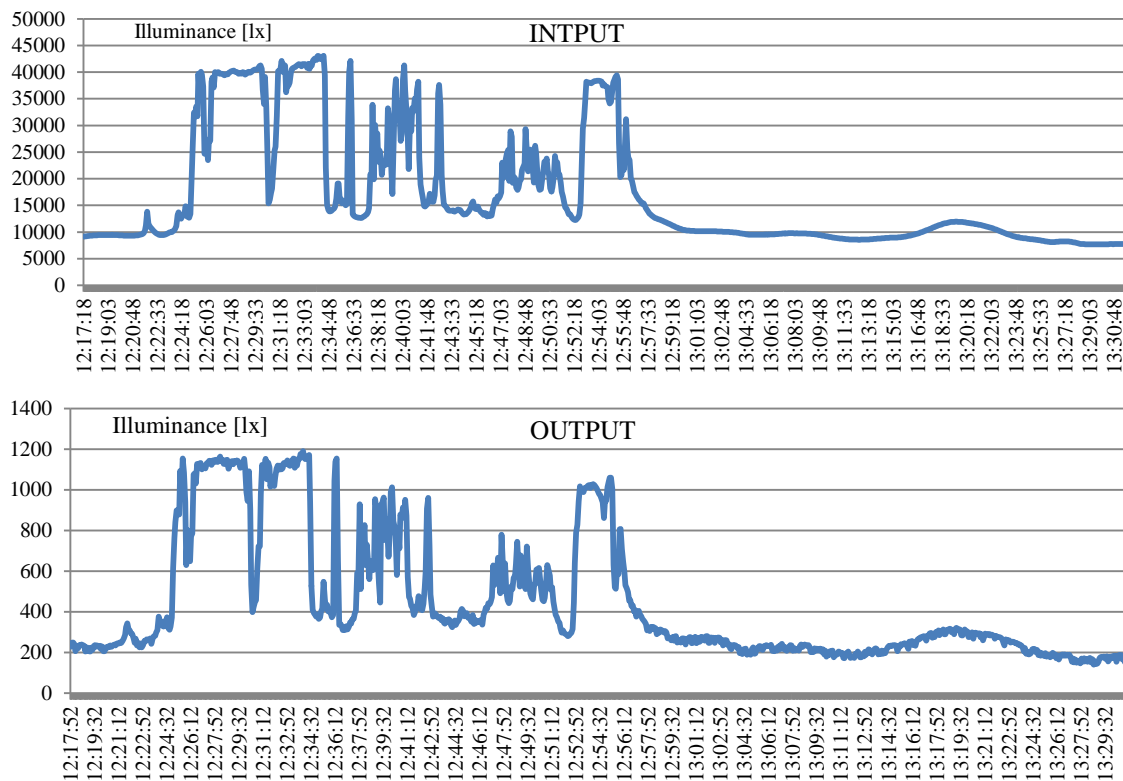

Fig. 4.1: Daylight illuminance at the input (at the entrance the the concentrating head) and output (inside the chamber), 25/05/2015.

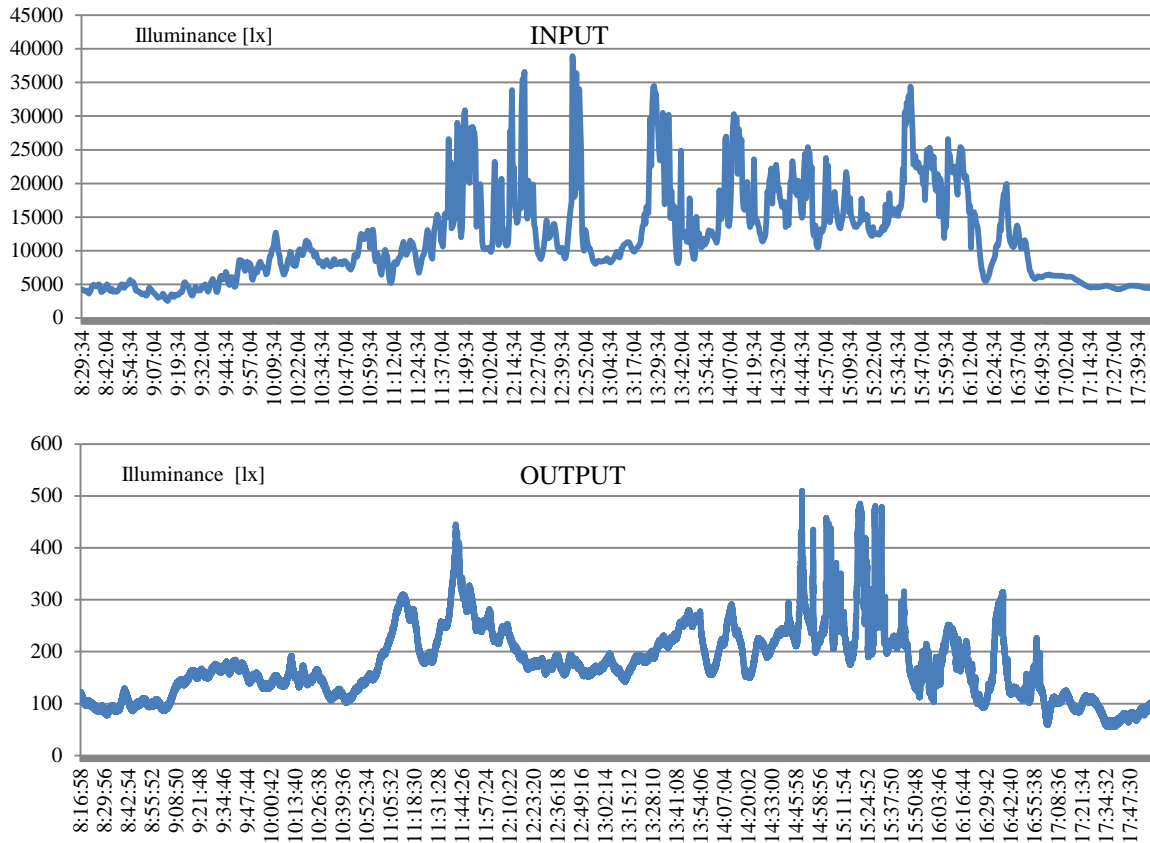

Fig. 4.2: Daily profiles of illuminance on the input and output of the light guide for cloudy sky daylight illuminance, 02/05/2015

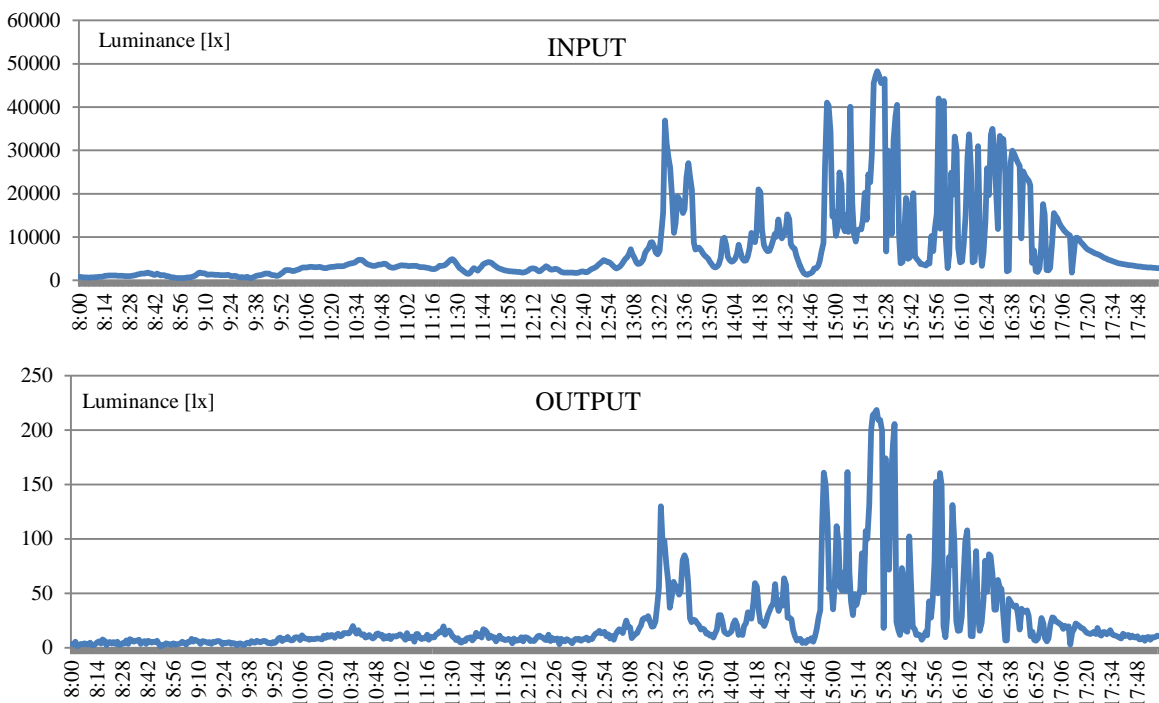

Fig. 4.3: Daily profiles of illuminance on the input and output of the light guide for dynamic changes of daylight illumination, 23/06/2015

The region of Brno city belongs to the central Europe region with frequent cloudy sky daylight conditions even in summer seasons. For this reason partly cloudy and cloudy sky conditions were selected for the light guide testing. The aim was to find whether the light transmittance for the unfavourable daylight situations of cloudy sky would be acceptable for the system's real application in building of this locality. The input and output illuminance measurements are compared in the trend-line (Fig. 4.4) for cloudy and partly cloudy days monitoring in June.

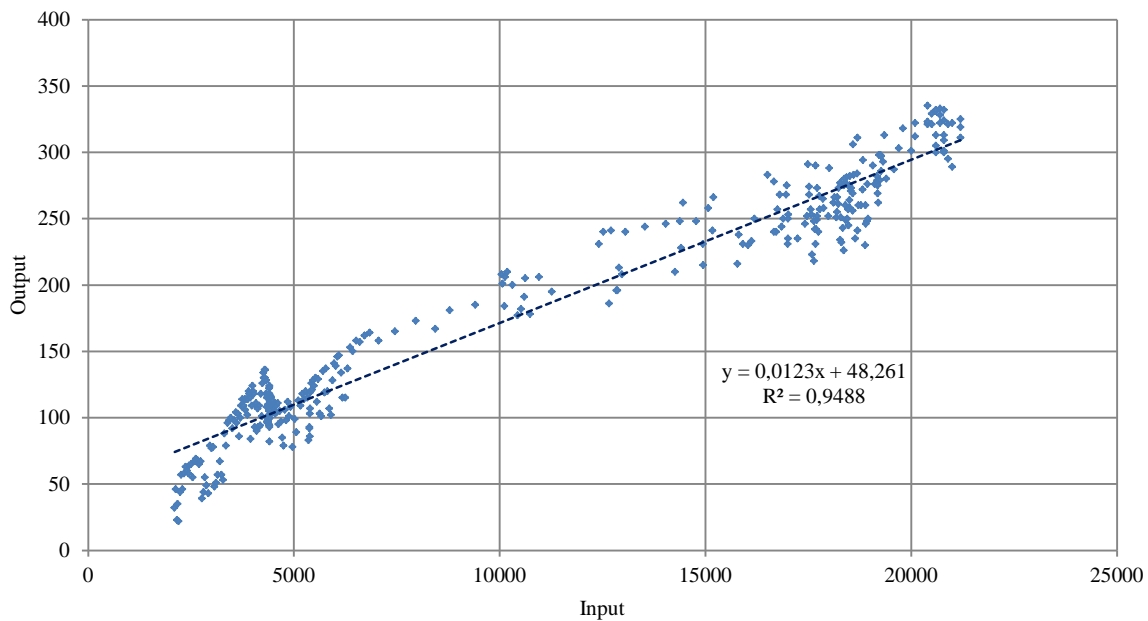

Fig. 4.4: Trend line of input and output illuminance measurements (cloudy and partly cloudy days in June 2015)

Light measurements were carried out under laboratory conditions. The chamber was placed in the laboratory under a large transparent skylight to protect it from rain, wind and dust, and to ensure that continuous daily measurements are available. Input illuminance data were controlled with external illuminance monitored on an unshaded horizontal plane. The external light sensor was placed near the glazed skylight of the laboratory roof. The differences between the external value and illuminance measured in the laboratory at the input to the light guide (above the concentrating head) are shown in Fig. 4.5. External illuminance was monitored at the beginning of the measurements on 7<sup>th</sup> April 2015.

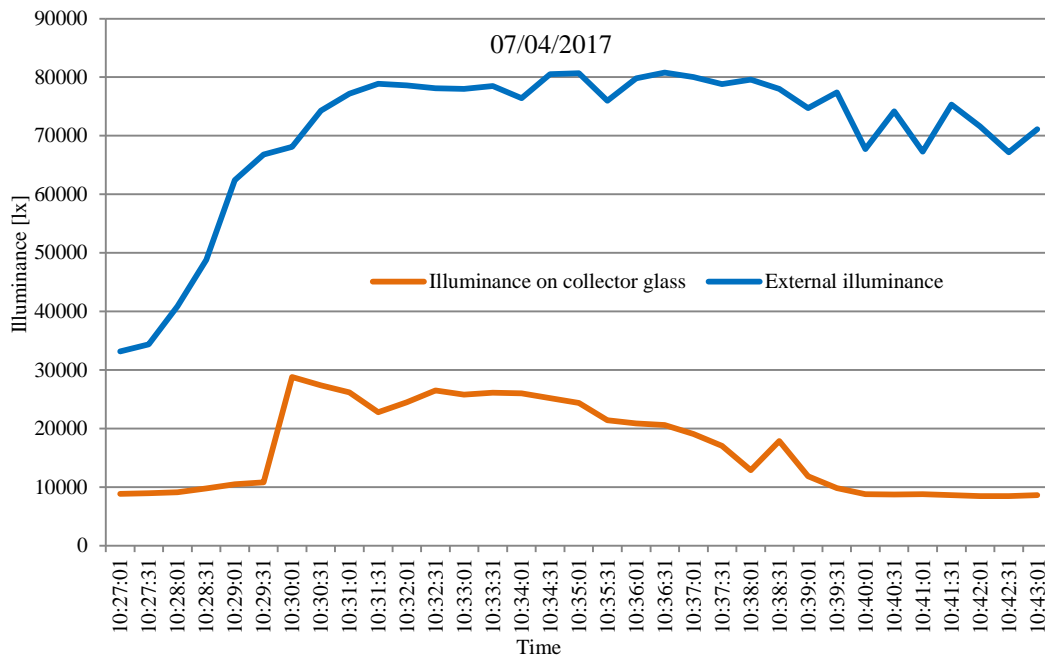

Fig. 4.5: Horizontal illuminance - external and upper (input) data

Measured illuminance data at the input of the light guide is shown for selected days during the monitoring period in Fig. 4.6 for minimal, maximal, mean as well as median daily values. Maximal values do not exceed 50000 lx, mean illuminance values are in interval between 5000 lx and 24000 lx. These values are in compliance with standards daylight data for the CZ climatic locality [13].

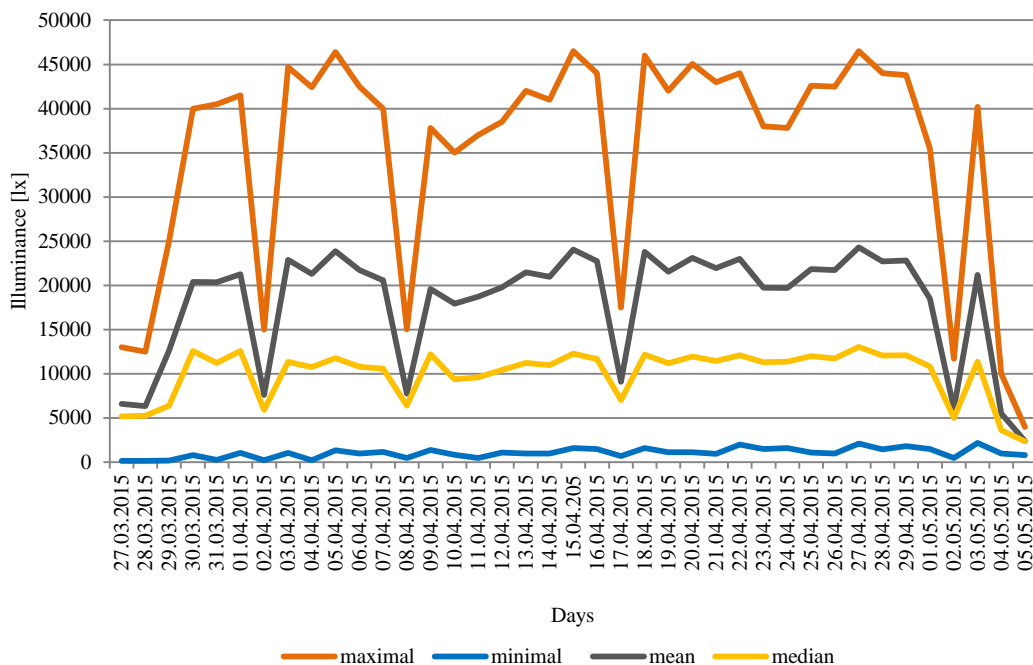

Fig. 4.6: Minimal, maximal, mean and median input illuminance

## Light guide efficiency

The illuminance data processing gives information about the light guide system efficiency. The luminous flux method applying measured illuminance at the entrance surface area and at the level of the output can be used for the determination of the light transmittance efficiency of the light guide system. Light level - illuminance is the total luminous flux  $\Phi_e$  [lm] incident on a surface per unit area. If illuminance  $E_e$  [lx] at the entrance of the system is known, the input luminous flux  $\Phi_e$  [lm] can be calculated [11]. To determine light transmittance efficiency  $\eta$  of the hollow light guide systems the luminous flux  $\Phi_i$  [lm] leaving diffuser - translucent component in the interior side has to be expressed.

The entrance surface area of the tube is calculated as:

$$S = \pi r^2 \text{ [m}^2\text{]} \quad (4.1)$$

The solid angle  $\omega$  of the translucent part of the diffuser can be calculated as:

$$\omega = 4\pi \sin^2\left(\frac{\alpha}{2}\right) \text{ [sr]} \quad (4.2)$$

$$\text{where } \alpha = \arctan\left(\frac{r}{h}\right) \text{ [deg]} \quad (4.3)$$

r - radius of the translucent part of the diffuser [m]

h - distance between diffuser and sensor on the horizontal plane [m]

The total light transmittance efficiency of the light guide system depends on the light transmittance of its components. The above mentioned experiments were focused on the study of the daylight transmittance throughout the complete system. In this case the measured data of illuminance at the level of the system input and at the level of the system output can be used for calculation of the light transmittance efficiency  $\eta$  of the sample. Then value of the incoming luminous flux  $\Phi_e$  (flux entering the guide system) is:

$$\Phi_e = E_e S \text{ [lm]} \quad (4.4)$$

where

$E_e$  is measured horizontal illuminance at the level of the primary parabola glass cover [lx].

The luminous flux  $\Phi_i$  leaving the light guide output at the level of the diffuser can be calculated applying equations (4.5) and (4.6). Then value of the luminous intensity I is:

$$I = \frac{E_i}{h^2} \text{ [cd]} \quad (4.5)$$

where

$E_i$  is measured illuminance on the reference plane in the chamber [lx]  
and the luminous flux  $\Phi_i$  will be:

$$\Phi_i = I \omega \text{ [lm]} \quad (4.6)$$

Finally, the light transmittance efficiency  $\eta$  of the complete guidance system is determined as a ratio of the output luminous flux to input luminous flux:

$$\eta = 100 \frac{\Phi_i}{\Phi_e} \text{ [%]} \quad (4.7)$$

The light transmittance efficiency of the light guide prototype sample was expressed for selected fragments of daily illuminance courses. Data were recorded on 25<sup>th</sup> May, 2015 at the level of the CMP head and simultaneously on the reference plane in the chamber (Fig. 4.7). Using radius of the tube  $r = 0.26$  m, distance between diffuser and reference plane  $h = 1.50$  m and formulae (4.1) to (4.7) the light transmittance efficiencies  $\eta$  of the guidance system consisting of the CMP head, 0.6 m length hollow tube and translucent diffuser, were calculated. The results with average values of  $\eta$  are summarised in Table 5 and shown in Fig. 4.8. The results indicate that light transmittance efficiency of the guidance system with the CMP head is very sensitive for angle of incident rays. The average value was only 2.49 percent, see Table 5. If the incident direct solar beams are not concentrated in the focus of the parabolic mirror, the high quantity of incident luminous flux is reflected back into the exterior space as it is shown in the Fig. 4.9. The input of the hollow tube is shaded by the small metallic convex parabola. This results into reduction of the light guide system efficiency under sunless skies when only diffuse light is transmitted.

Light guidance systems equipped with the CMP head require tracing facilities to direct parabolic mirror collector towards the sun position and then collect as much direct sunlight as can be collected.

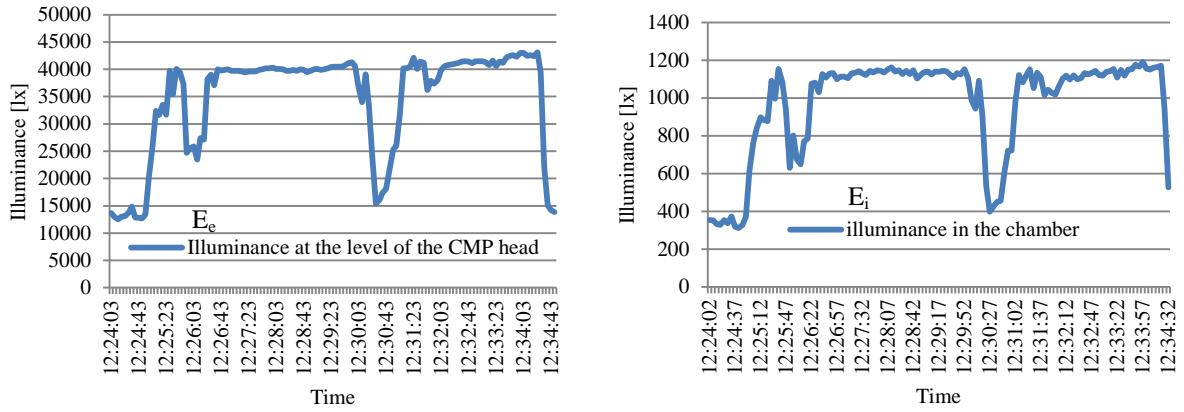

Fig. 4.7: Daylight illuminance at the level of the CMP head and graphs of data daylight horizontal illuminance monitored in the chamber, 25/05/2015.

The data of  $E_i$  and  $E_e$  served for the light guide efficiency specification, Table 5.

Table 5: Light transmittance efficiency of the LG1, 25/05/2015

Time hour	Horizontal illuminance		Luminous flux		Luminous efficiency $\eta$ [%]
	$E_i$ [lx]	$E_e$ [lx]	Output $\Phi_i$ [lm]	Input $\Phi_e$ [lm]	
12:25:00	878	33400	171.18	7093.21	2.413
12:25:30	1131	40000	220.51	8494.87	2.596
12:26:00	773	25600	150.71	5436.71	2.772
12:26:30	937	38300	182.68	8133.83	2.246
12:27:00	1104	40100	215.24	8516.10	2.527
12:27:30	1127	40300	219.73	8558.58	2.567
12:28:00	1116	39800	217.58	8452.39	2.574
12:28:30	1120	40000	218.36	8494.87	2.571
12:29:00	1127	40300	219.73	8558.58	2.567
12:29:30	1148	41200	223.82	8749.71	2.358
12:30:00	937	38300	182.68	8133.83	2.246
12:31:30	450	18300	87.73	3886.40	2.257
12:32:00	886	36800	172.74	7815.28	2.210
12:32:30	1152	41600	224.60	8834.66	2.542
12:33:00	1148	41200	223.82	8749.71	2.558
12:33:30	1131	40700	220.51	8643.53	2.551
12:34:00	1182	43400	230.45	9216.93	2.500
12:34:30	384	14100	74.87	2994.44	2.500
				average	2.491



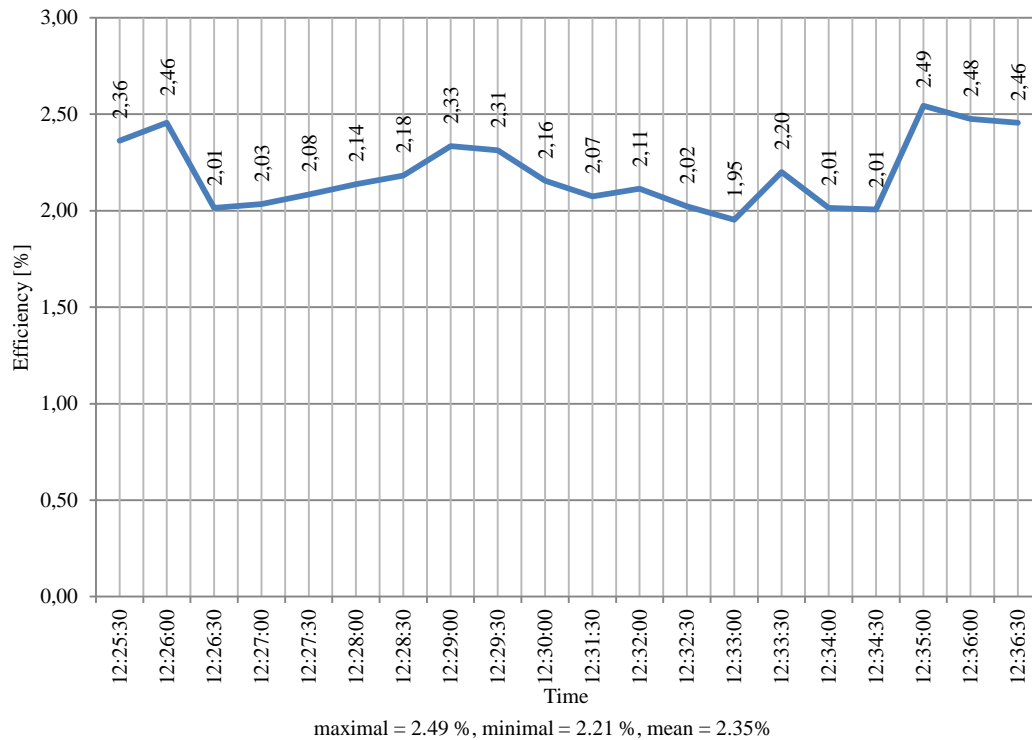

Fig. 4.8: Light guide efficiency, clear day, 25/05/2015

The light transmittance efficiency of the sample of the hollow light guide prototype with the CMP head was experimentally investigated under the laboratory conditions. The system was installed in a stable position with the orientation of the parabolic mirror towards the zenith. Two sources of daylight occur in the nature: the sun producing direct sun beams with very high intensity and the sky producing diffuse light of the lower intensity.

The purpose of the collector with the CMP head is to focus direct beams and using the small secondary parabola redirect them towards the highly reflective tube of the light guide. Experiments proved that if the collector is not tracking the sun position only a limited part of sun rays is redirected into the tube. The passive installation of the light guide prototype in the static position could be applied only in regions with hot climate and with high solar altitudes. The light transmittance efficiency of the system will significantly increase in the case of the tracking of the parabolic mirror to the intensive solar radiation position. An automatic operation of the tracking is recommended for the practical installations of this prototype model in buildings.

### Efficiency improvement opportunities

The light guide location and orientation was studied for reflection of direct solar rays. Day of summer solstice - 21<sup>st</sup> June was selected for the study. Solar altitude for locality of latitude 50° [148] is determined for morning time between 7:00 and 12:00 (Table 6). Direct solar rays affecting the light guide head (red lines) and reflected rays (blue lines) on mirror surface of the parabolic concentrator are shown in Fig. 4.9.

Table 6: Solar altitude - 21<sup>st</sup> June

Time	7:00	8:00	9:00	10:00	11:00	12:00
Solar altitude	27.224°	36.848°	46.205°	54.641°	60.98°	63.45°

The optimal design occurs when solar rays affecting the CMP head reflect vertically that is when solar altitude is 90° (Fig. 4.10). But in the central European region at latitude about 50° - maximal solar altitude is 63.45° for 21<sup>st</sup> July, noon time, it is not possible. Therefore it is necessary to move the concentrator position towards to daylight rays for enhancement of the light guide efficiency (Fig. 4.11). Completion of the concentrator head with additional mirror would increase efficiency of the light guide prototype system (Fig. 4.12).

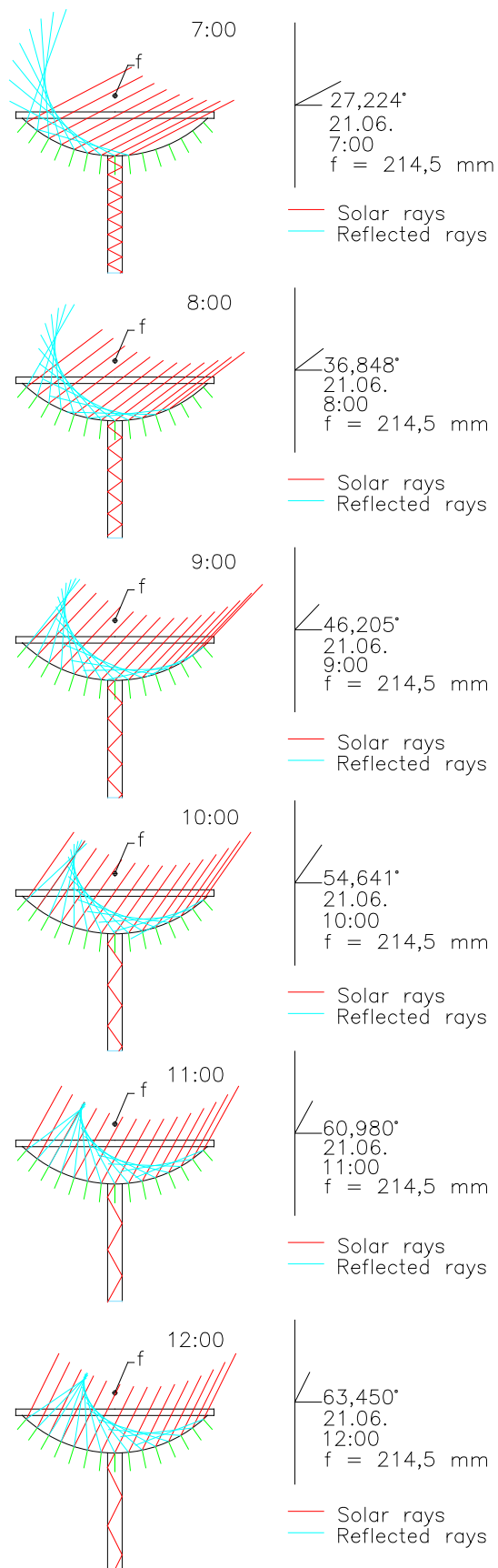

**21<sup>st</sup> June  
7:00 - 8:00**

Low solar altitude.  
Solar rays are reflected outside of the focus mirror.  
Multireflection transport of solar rays into the light tube.

**21<sup>st</sup> June  
9:00 - 10:00**

Higher solar altitude but solar rays are also reflected outside of the focus mirror.  
Number of reflections of solar rays into the light tube is reduced.

**21<sup>st</sup> June  
11:00 - 12:00**

The highest solar altitude.  
Solar rays are reflected close to the focus mirror.  
Number of reflections of solar rays into the light tube is sufficiently reduced.

Fig. 4.9: Solar rays' reflections on the light guide parabolic concentrator (f - focus of the parabolic concentrator, position of the secondary mirror of the CMP head)

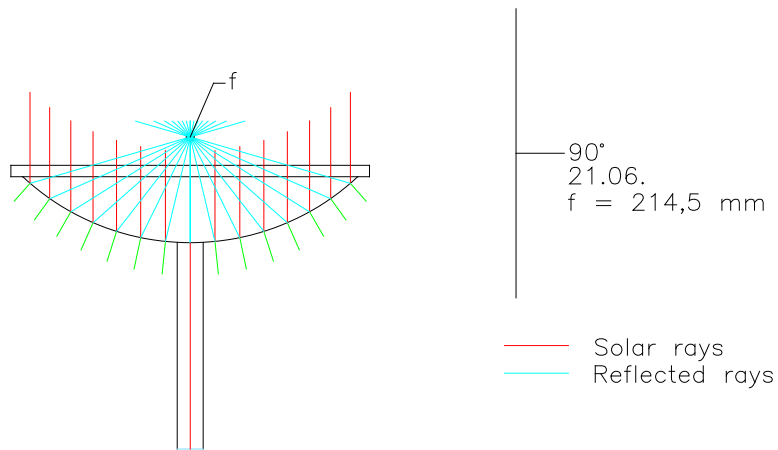

**Fig. 4.10: Direct daylight rays reflections on the light guide head**  
(f - focus of the parabolic concentrator, position of the secondary mirror of the CMP head)

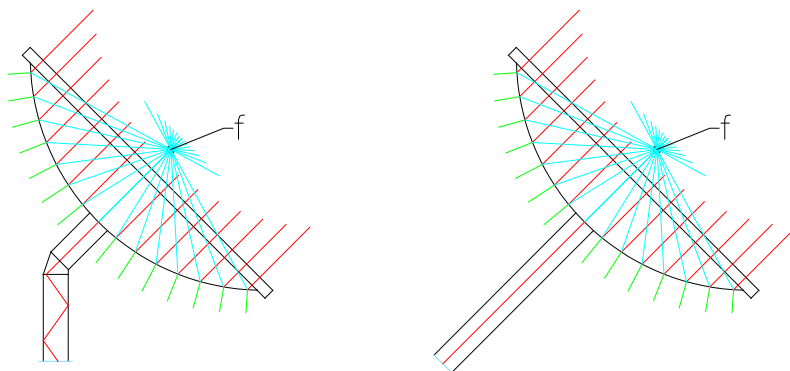

**Fig. 4.11: Direct daylight rays reflections on the light guide head**  
(f - focus of the parabolic concentrator, position of the secondary mirror of the CMP head)

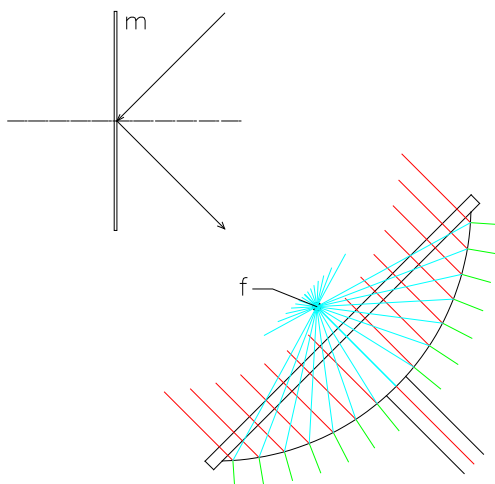

**Fig. 4.12: Direct daylight reflections on the mirror towards the light guide concentrator head**  
(m – additional mirror installation for solar rays redirecting into the CPM head, f - focus of the parabolic concentrator, position of the secondary mirror of the CPM head)

## 4.2 RESULTS OF THERMAL EVALUATION

### Infrared thermography

Infrared thermography was used for the thermal testing of the light guide. Testing was carried out for two time intervals of the infrared lamp activation – for 10 minutes (it simulates a short time period of insolation) and 100 minutes (long time activation). The monitoring was completed for background temperature of 27 °C. The average emissivity of adjacent surfaces was 0.95 (surfaces - wall and ceiling plasters, floor – cement screed). Monitoring was completed for various positions (Fig. 3.24) around the light guide parabolic head to complete the entire thermal profile of this part of the light guide. The results of temperature monitoring for a short period of time are shown in Fig. 4.13.

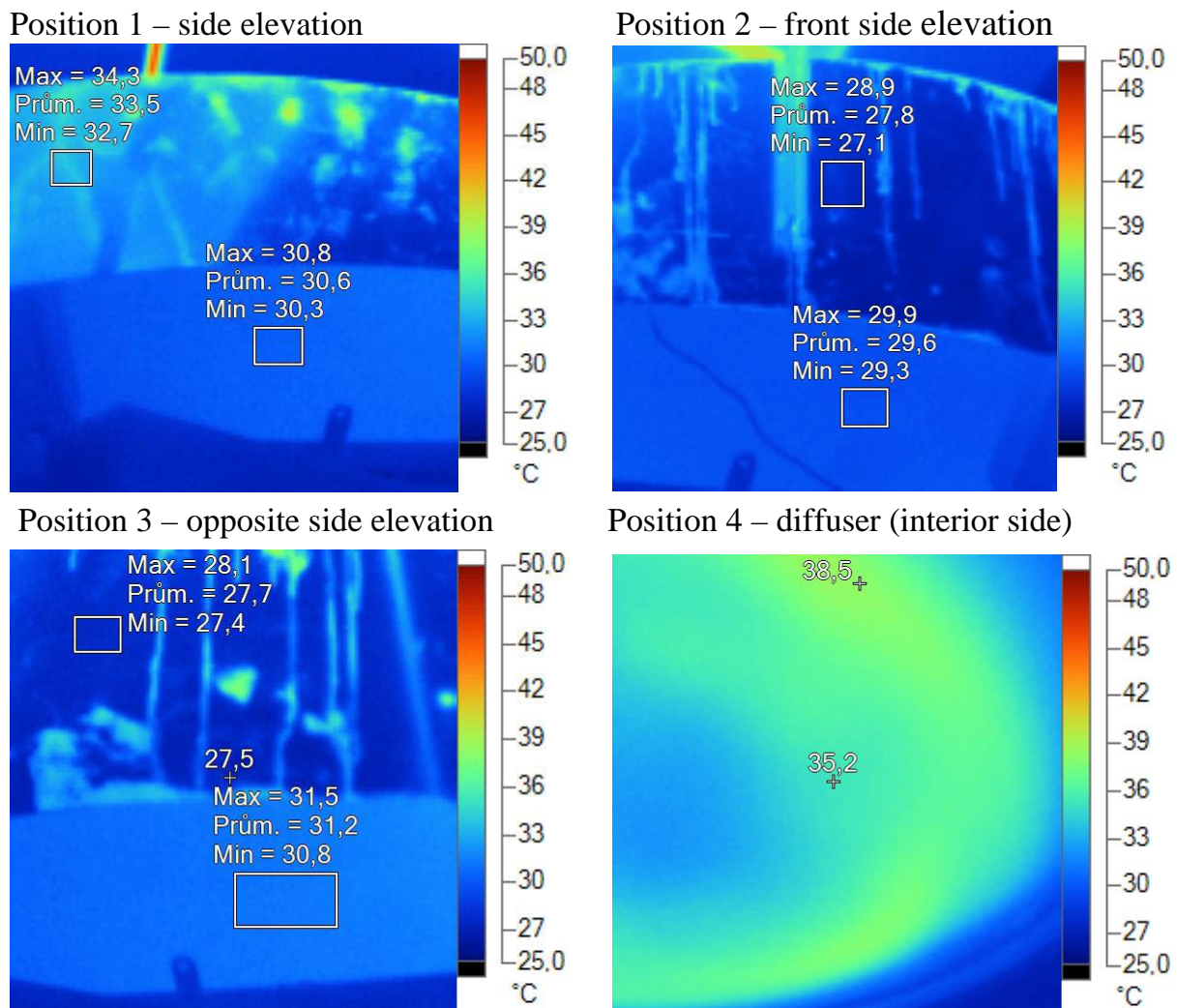
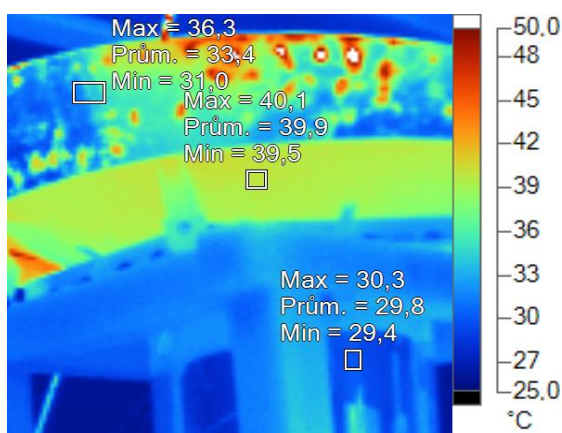

Fig. 4.13: IR thermography of the light guide head after 10 minutes activation of the IR lamp

The temperature measured at the concentrator head varies from 27.1 °C (minimal temperature, position 2) to 34.3 °C (maximal temperature, position 1). The light guide's diffuser temperature distribution was monitored from position 4 (diffuser surface temperature monitored in the chamber). The temperature at the centre of the diffuser was 35.2 °C. The temperature at the edge of the diffuser close to the metal rim was slightly higher, 38.5 °C.

The following measurement was carried out for the IR lamp activation for time interval of 100 minutes. The purpose of the long-time thermal activation is to estimate how much the light guide surfaces' temperature could rise to the steady state thermal conditions.

Position 1 – side elevation



Position 2 – front elevation

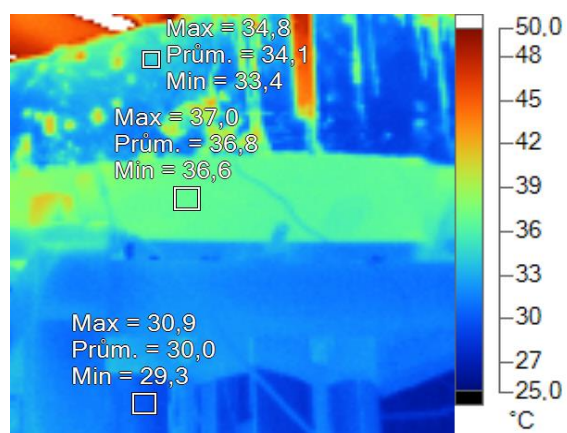

Position 3 – opposite side elevation

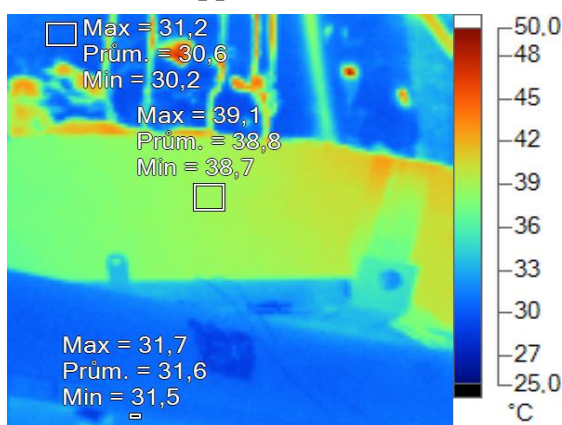

Position 4 – diffuser (interior side)

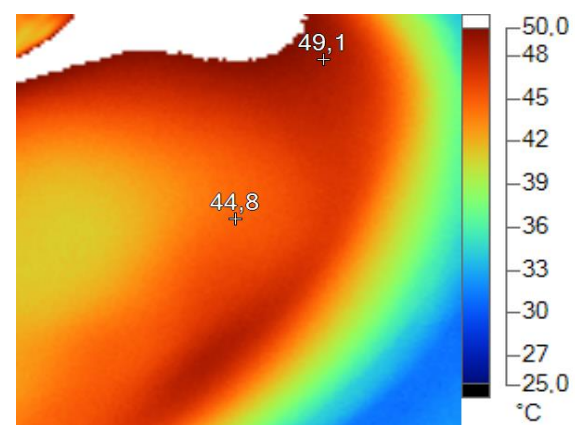

Fig. 4.14: IR thermography of the light guide head after 100 minutes activation of the IR lamp

Long-time IR lamp activation yielded higher temperature profiles (Fig. 4.14). The temperature rises up to 40.1 °C on the light guide surface. Results of the IR thermography for the non-insulated light guide monitoring from Fig. 4.13 and 4.14 are summarized in Table 7.

Table 7: Temperature distribution on the light guide - positions 1 and 2 and 3 and 4

Thermal activation	Surface temperature of the light guide [°C]										
	Position 1			Position 2			Position 3			Position 4	
	maximal	minimal	average	maximal	minimal	average	maximal	minimal	average	central	edge
10 minutes	30.8	30.3	30.6	29.9	29.3	29.6	31.5	30.8	31.2	35.2	38.5
100 minutes	40.1	39.5	39.9	37.0	36.6	36.8	39.1	38.7	38.8	44.8	49.1
Temperature rise [°C]	<b>9.3</b>	<b>9.2</b>	<b>9.3</b>	<b>7.1</b>	<b>7.3</b>	<b>7.2</b>	<b>7.6</b>	<b>7.9</b>	<b>7.6</b>	<b>9.6</b>	<b>10.6</b>

Thermal activation	Surface temperature of the light guide [°C]										Summary: Temperature rise: - parabolic concentrator (Position 1,2,3): from 7.1 to 9.3 °C - metal rim of the concentrator (Position 1*,2*,3*): from 2 to 7 °C - diffuser (inside of the box) from 9.6 to 10.6 °C
	Position 1*			Position 2*			Position 3*				
	maximal	minimal	average	maximal	minimal	average	maximal	minimal	average		
10 minutes	34.3	32.7	33.5	28.9	27.1	27.8	28.1	27.4	27.7		
100 minutes	36.3	31.0	33.4	34.8	33.4	34.1	31.2	30.2	30.6		
Temperature rise [°C]	<b>2.0</b>	-	-	<b>5.9</b>	<b>6.3</b>	<b>6.3</b>	<b>3.1</b>	<b>2.8</b>	<b>2.9</b>		

Summary of the infrared thermography monitoring gives results that temperature in steady state on the external surface of the light guide parabolic head is max. 40.1 °C (Table 7).

10 minutes IR lamp activation

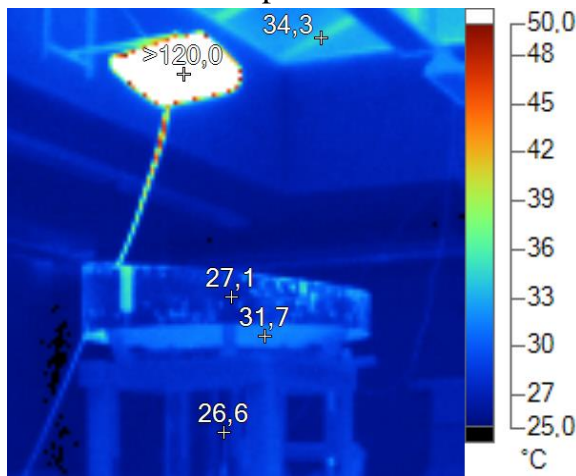

100 minutes IR lamp activation

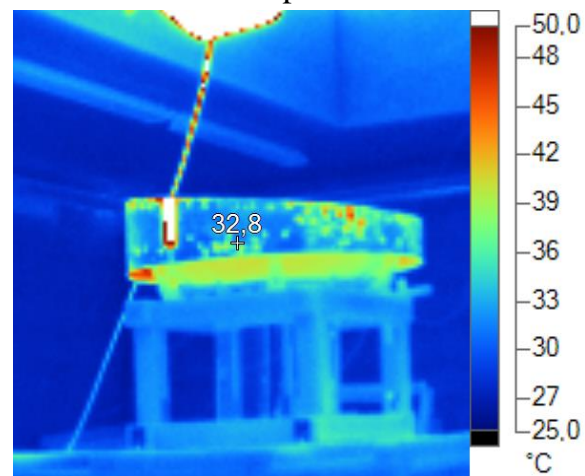

Fig. 4.15: IR thermography – a distant view of light guide entire structure

Thermal monitoring was repeated for 100 mm additional thermal insulation around the upper part of the light guide in contact with the parabolic concentrator. Under real conditions, the light guide is included in the thermally insulated roof structure. The temperature of the light guide in thermal insulation increased to a maximal temperature rise of 49.1 °C and 74.3 °C (Fig. 4.14 and Fig. 4.16).

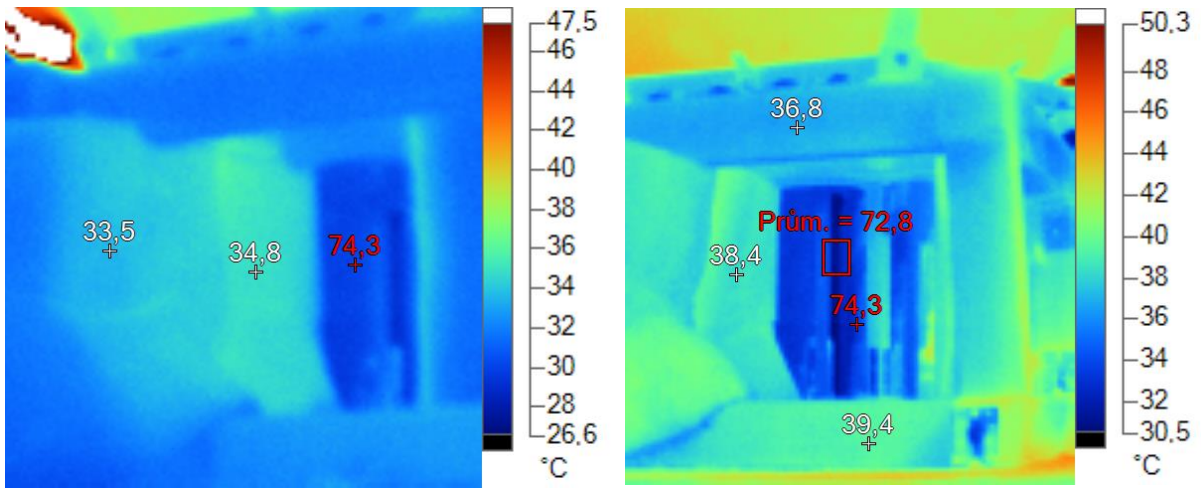

Fig. 4.16: IR thermography of the thermally insulated light guide (thermal insulation was demounted directly before the monitoring)

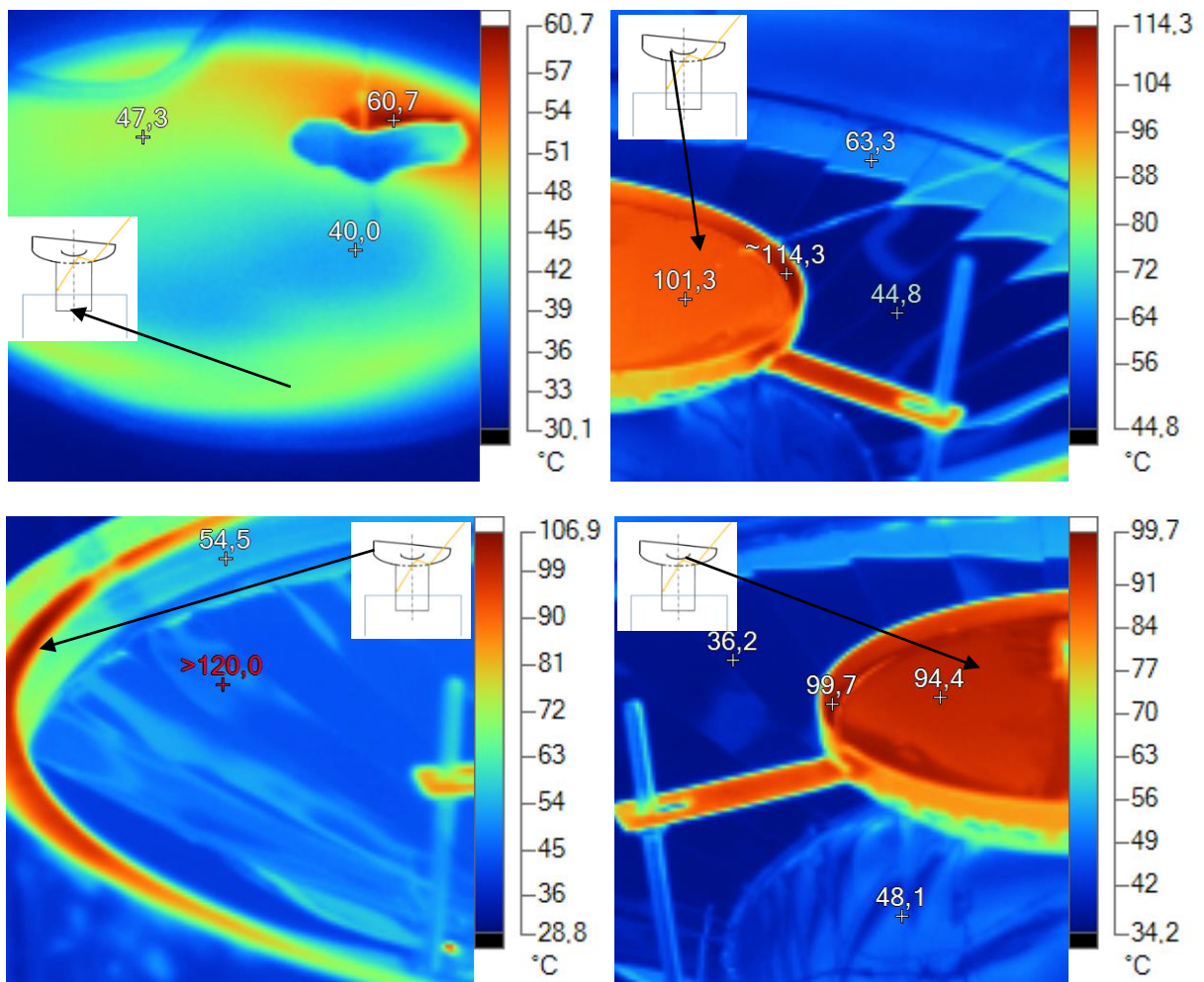

Fig. 4.17: IR camera photographs of the roof concentrating head and diffuser



Infrared thermography shows a significant increase in temperature in the case of an insulated light guide during the long-term thermal activation. The temperature of the insulated tube was increased to 74 °C (Fig. 4.16). The head surface temperature increased to more than 100 °C, in some parts to more than 120 °C (Fig. 4.17). There is a large temperature difference between the lower side of the parabolic concentrator with temperature about 40.1 °C and the top of the mirrored parabola with temperature about 100 °C and even more (Fig. 4.17 and Table 8).

Table 8: Temperature difference between internal and external parts of the light guide parabolic head

Internal surface - diffuser	External surface – parabolic mirror
Max. 60.7 °C	Max. 120 °C
Min. 30.3 °C	Min. 44.8 °C
Average 45.5 °C	Average 82.4 °C

The temperature profile (Fig. 4.18) in the light guide was also monitored during the activation of the IR lamp. Thermal sensors connected to the data logger were installed in the light guide profile for continuous thermal monitoring (Fig. 3.25). As expected, the high temperature is inside the chamber which is a non-ventilated space. The graph of temperature profile measurement (25/04/2016) is for thermally insulated light guide. The temperature drop (M02 sensor - position II) on the second day (26/04/2016) was caused by putting the thermal insulation layer on the light guide surface (at 11:30). Less infrared radiation was absorbed into the light guide from the external side due to thermal insulation. The parabolic concentrator surface temperature increase is about 16 °C to 18 °C. The temperature close to the glass cover at the top of the light guide system initially increased slowly, until the glass surface temperature was increased by 13 °C to 15 °C compared to the initial temperature at the start of the experiment. Thermocouple temperature measurement (M01) indicates the air temperature above the parabolic head, while thermography shows the temperature on the surface of the parabolic head. The correlation between the temperatures inside the chamber and the temperature close to the light guide head is shown in Fig. 4.19.

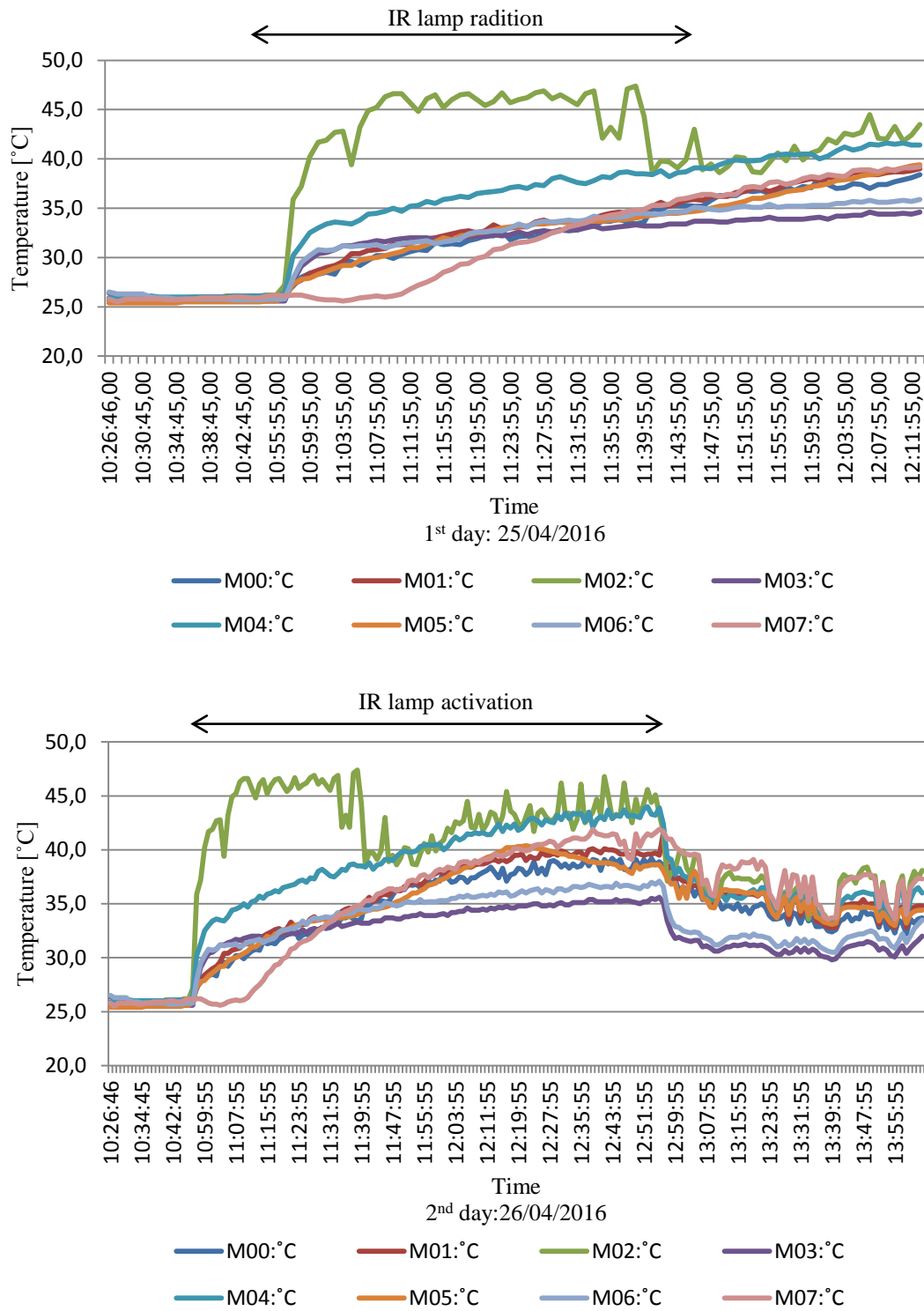

Fig. 4.18: Light guide temperature profiles

Notice: M00 – indoor air, M01 – Position I, M02 – Position II, M03 – Position III, M04 – Position IV, M05 – Position V, M06 – Position VI, M07 – Position VII.

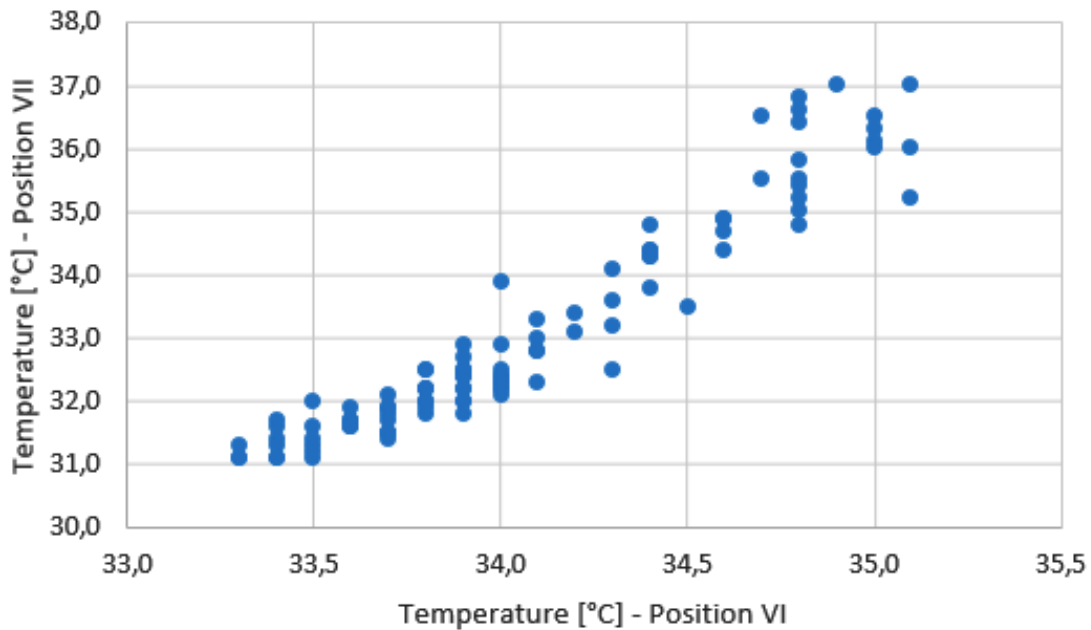

Fig. 4.19: Correlation between temperatures measured at positions VI and VII

Testing the light guide prototype provides an overview of temperature distribution under intense infrared radiation. The infrared thermography photographs show a very high temperature on the concentrator head. The temperature at the diffuser inside the chamber increased significantly as well. It appears that the air trapped inside the tube was warmed under infrared radiation.

The temperature was raised to 40 °C under the activation of an infrared lamp for light guide installation without the surface thermal insulation. In the case of a thermally insulated light tube, the surface temperature increased to 74°C and even more in some places. The highest temperature distribution was on the parabolic concentrator head (100 °C - 120 °C).

The above mentioned findings show potential problems with the light guide overheating under intensive solar radiation in summer seasons. For this reason, the light guide system application in real buildings should be carefully completed with details regarding the connections to roof and floor structures.

It is recommended to add thermal insulation layers around the light guide tube and underneath the parabolic concentrator. Insulation should be non-flammable and the joints of the light guide head, tube and diffuser should be perfectly sealed and fire resistant. In the case of extreme thermal loading, it is recommended to supplement the transparent parts of the light guide with fire-resistant laminated glass. The light guide system could be complemented by additional ventilated pipes to prevent overheating.

The contribution of the presented thermal evaluations of the light guide prototype is:

- testing the temperature distribution of the new light guide prototype,
- specification of temperature profiles of air inside of the light guide and close to the parabolic head,
- specification of potential overheating problems in building applications.

The further investigation and thermal testing of the light guide prototype is going to compare the presented results with the thermal monitoring of the prototype installed in a roof construction in a real building. It will be installed with the collector facing the south to maximize solar gain and the system efficiency and tested for potential places of overheating.

### **4.3 IN-SITU COMPARABLE MEASUREMENTS RESULTS**

Light comparable measurements were completed between August and September 2017. This period was selected to monitor the light guides' daylighting at the end of the summer season. The partly cloudy sky conditions are characteristic daylighting for climatic conditions of the selected locality. The illuminance measurement results provide an overview of daylight transmittance of the tested light guides.

Examples of illuminance under the light guides LG1 and LG2 compared to the simultaneously measured external horizontal illuminance are shown in Fig. 4.20. It is obvious that the illuminance under the light guide LG2 is higher compared to the daylight level under the light guide LG1. This is also visible in daily illuminance profiles for the characteristic days shown in Fig. 4.21 and Fig. 4.22. Measurements for partially cloudy sky give more correlated data (Fig. 4.21) compared to the illuminance under sky with dynamic illuminance variations (Fig. 4.22).

The values of mean, median, maximum and minimum values for the monitored period are summarized in the graph (Fig. 4.23). In summary, the percentage of the difference between the mean illuminance values from illuminance measurements under LG1 and LG2 is shown in the graph (Fig. 4.24).

The results of the presented measurements give information that all the time the LG1 transmitted more daylight compared to the LG2. In average the light transmittance is reduced by 37 percent as shown in Fig. 4.24. It means that the secondary parabola inside the LG1 prototype collector head is obstructive for daylighting during partially cloudy and cloudy sky conditions.

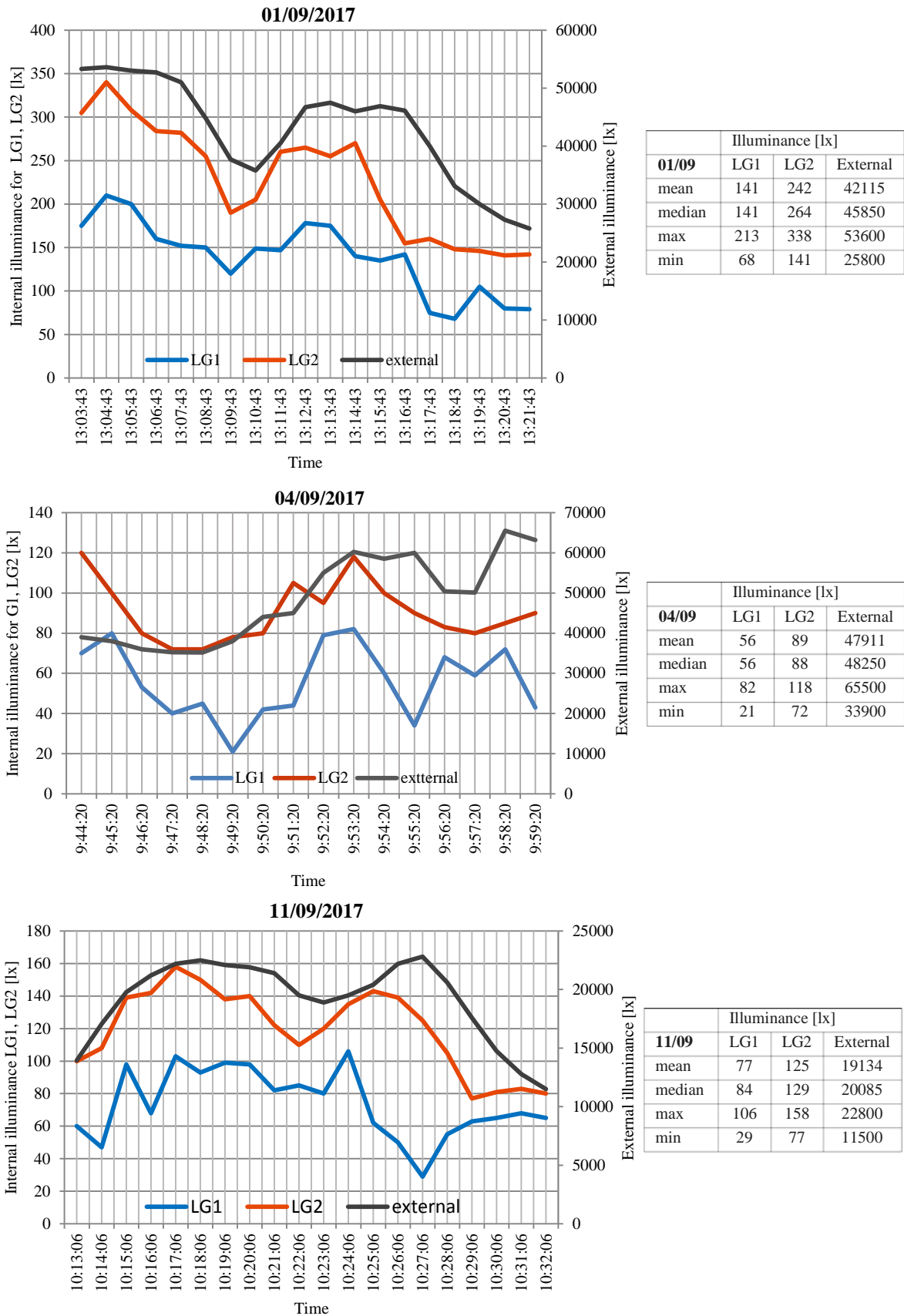

Fig. 4.20: Examples of internal illuminance measured under LG1 and LG2 and external horizontal illuminance

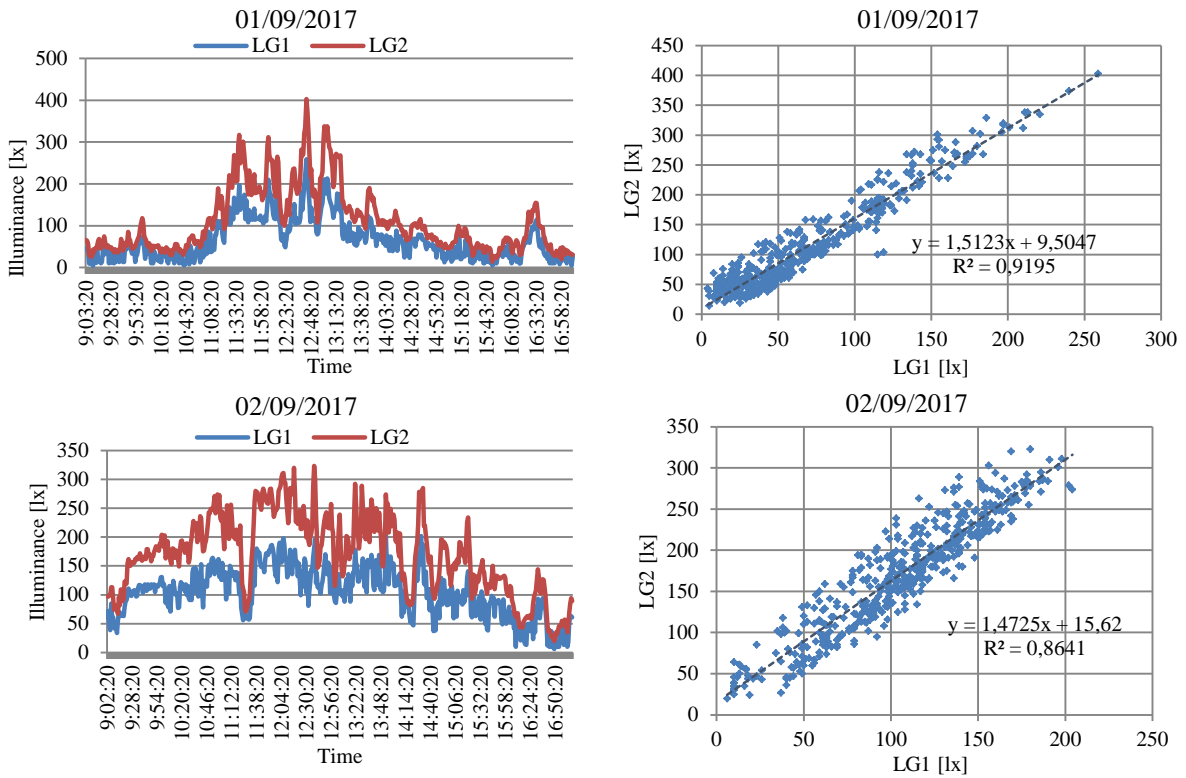

Fig. 4.21: Daily illuminance profiles and correlation graphs for illuminances of LG1 and LG2 (01/09/2017 and 02/09/2017)

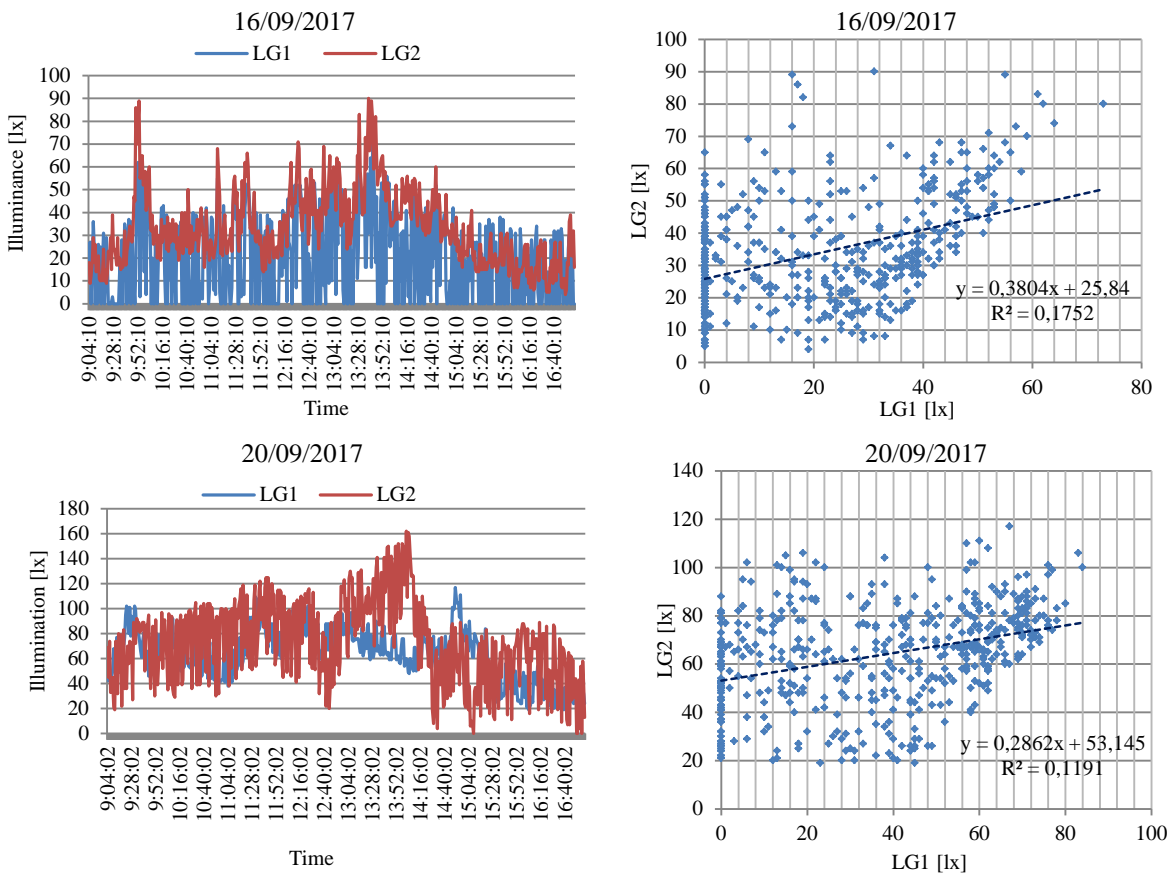

Fig. 4.22: Daily illuminance profiles and correlation graphs for illuminances of LG1 and LG2 (16/09/2017 and 20/09/2017)

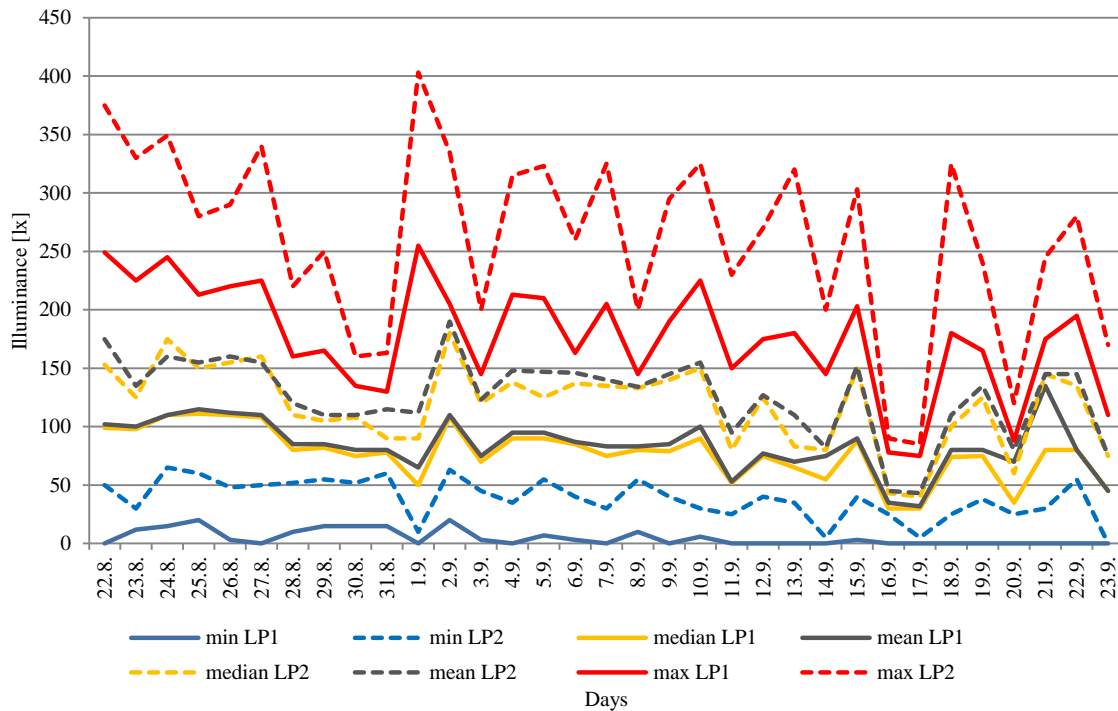

Fig. 4.23: Daily illuminance min, max, mean and median values (monitored from 22/08 to 23/09/2017)

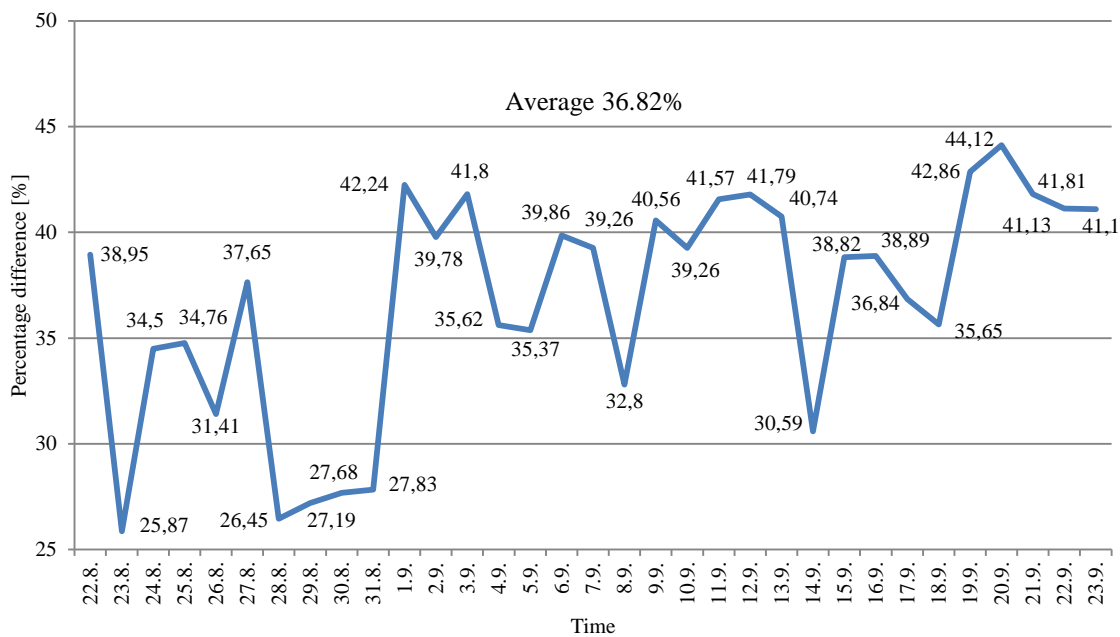

Fig. 4.24: Percentage of the difference of mean values of LG1 and LG2 illuminance measurements

## 4.4 RESULTS OF DAYLIGHT SIMULATIONS

Daylight simulations of the tested light guides LG1 and LG2 were run in software Holigilm [70]. The simulations were run on 1<sup>st</sup> September, overcast sky, to be compared with data from measurements on the same day at 12:00 (Fig. 4.25). Additionally, simulations were completed for two extreme situations

in the following daylight conditions: CIE overcast sky, CIE clear sky [6] and Solstice time on 21<sup>st</sup> December and 21<sup>st</sup> June, at daytime 12:00 (Fig. 4.26).

The parameters selected for the simulations are as follows:

- Dimensions of light guides LG1 and LG2 – tube length 0.60 m and diameter 0.52 m.
- Light reflectance of internal surface of the both tubes is  $\rho = 0.97$ .
- Light transmittance of ceiling diffusers of LG1 and LG2 is  $\tau = 0.75$ .
- The light transmittance of roof transparent covers of LG1 and LG2 is: roof collector with CMP head of LG1:  $\tau_1 = 0.53$ , roof spherical glass collector of LG2:  $\tau_2 = 0.90$ .

The light transmittance of the LG1 with the concentrator head is determined from the light transmittance of the glass collector decreased for reduction determined by the illuminance measurements in the test container, which is on average 37 percent.

Simulation outputs of internal horizontal illuminance at level 2.8 m bellow ceiling diffusers (the container floor level). The positions of the light guides LG1 and LG2 are in accordance with Fig. 3.32, it means  $x = 0.92$  m,  $y = 1.15$  m,  $z = 2.8$  m for coordinate system with 0.0 in the left hand side lower corner of the schemes in Fig. 4.25.

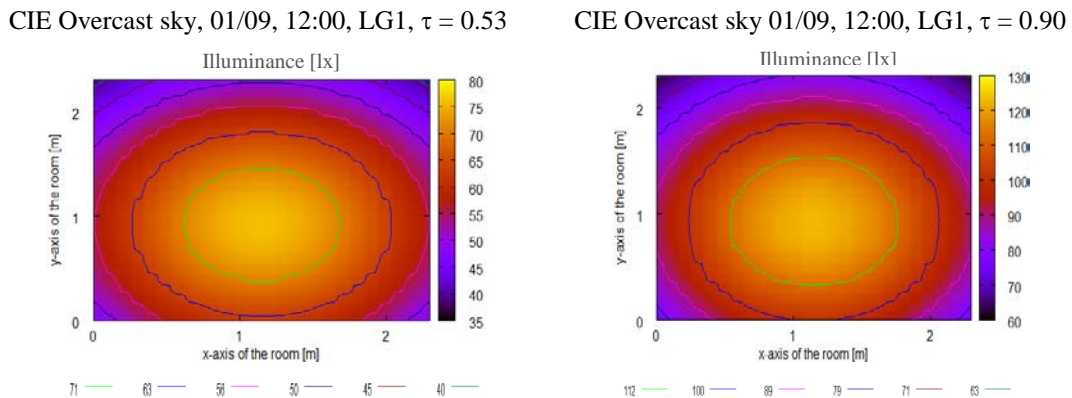

Fig. 4.25: Illuminance E [lx] under light guides LG1 and LG2 on 1<sup>st</sup> September, 12:00

Table 9: Hologilm simulation and measured data on 01/09/2017

Hologilm simulation		
	LG1	LG2
$E_{max}$ [lx]	71	112
$E_{min}$ [lx]	40	63
$U = E_{min}/E_{max}$	0.56	0.56
Measured data		
E [lx]	70	131



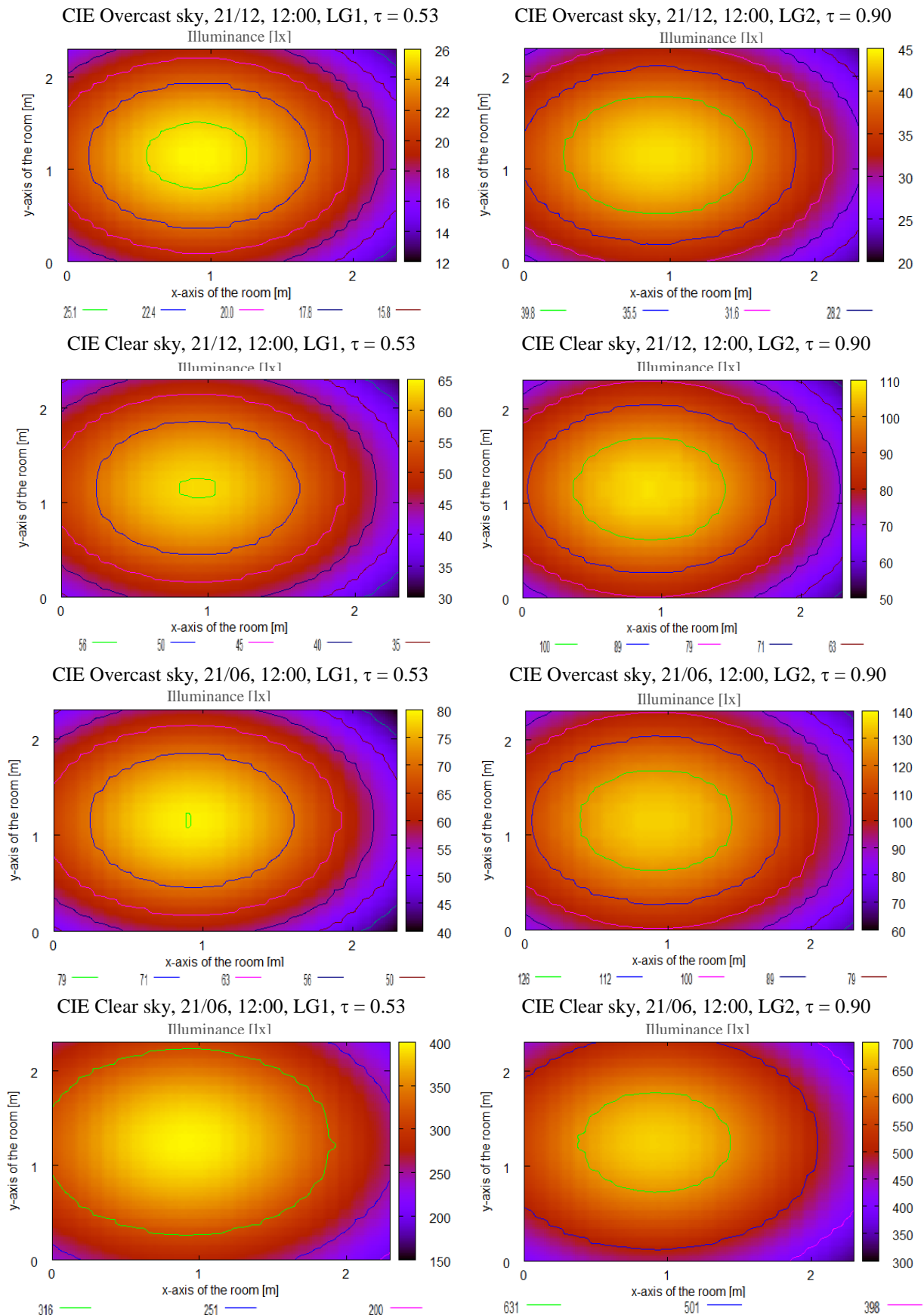

Fig. 4.26: Illuminance  $E$  [lx] of light guides LG1 and LG2, for CIE overcast and clear sky on 21<sup>st</sup> December and 21<sup>st</sup> June

## 4.5 SUMMARY OF DAYLIGHT ANALYSIS RESULTS

The simulation outputs are in accordance with the measured data. The simulations also confirm that the light guide prototype LG1 with the CMP head is less efficient system. Compared to the conventional light guide LG2 it provides a lower level of illumination on the working plane. The concentrator's secondary parabola represents an obstruction to daylight transmittance. This system, installed in static horizontal position, is less efficient, especially for overcast and partially cloudy sky conditions. Light transmittance is caused by multiple reflections inside the guide tube. When the light rays hit the concentrator head at low solar altitude, they are reflected off the mirror focus. The effect of the concentrator head is not fully utilized. It is recommended to complete the collector head with an automatic sun tracking system to activate its rotation towards the solar radiation in case of the clear sky.

An example of light reflection and redirection on the CMP head on 1<sup>st</sup> September at 9:00 and 12:00 is shown in Fig. 4.27. The CMP head position is 0° (horizontal), 25° and between 40°- 55°. The dependence of CMP head rotation to its optimal positions depends on the solar altitude, as is shown in Fig.4.28.

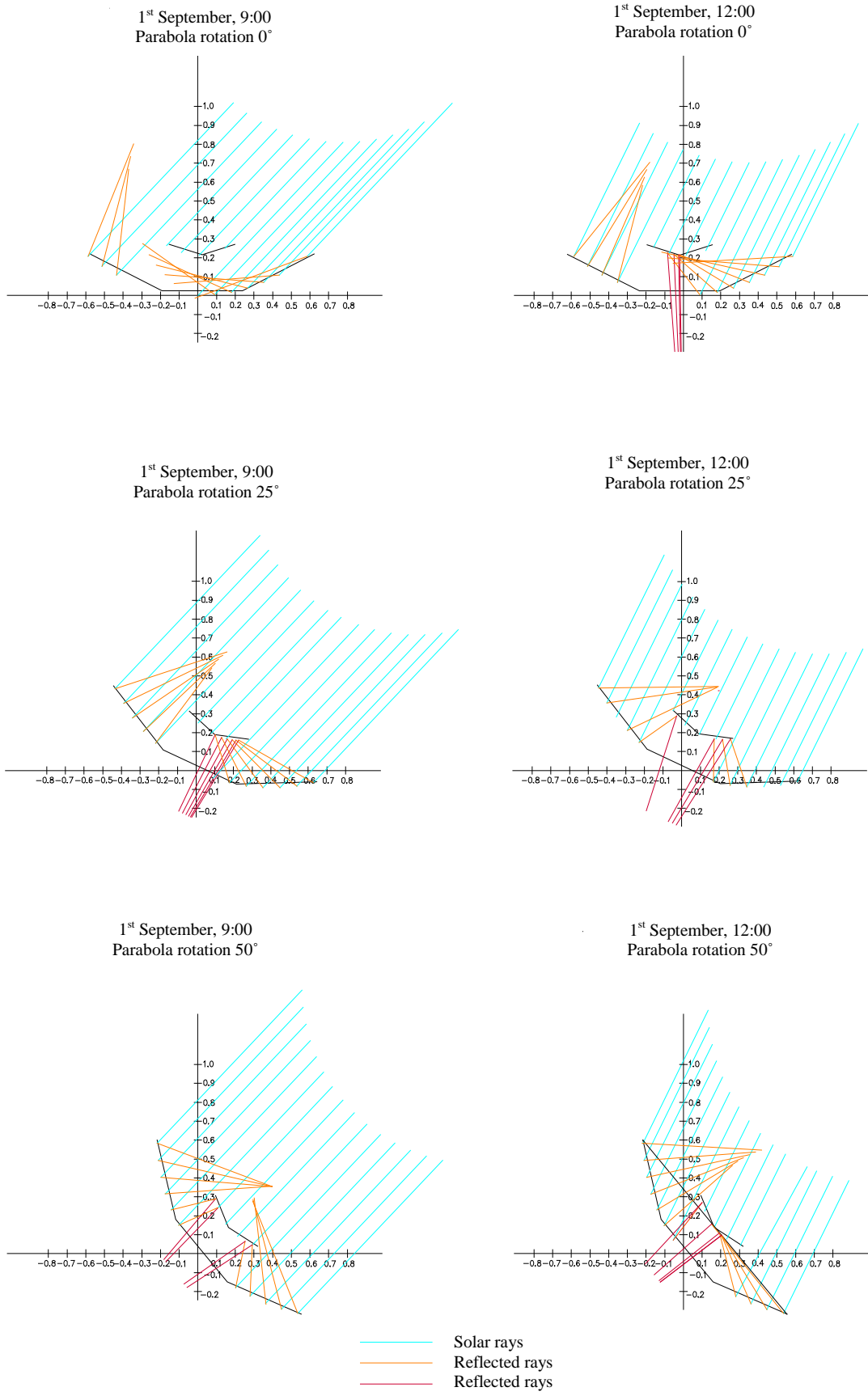

Fig. 4.27: Light reflection on the light guide parabolic mirror

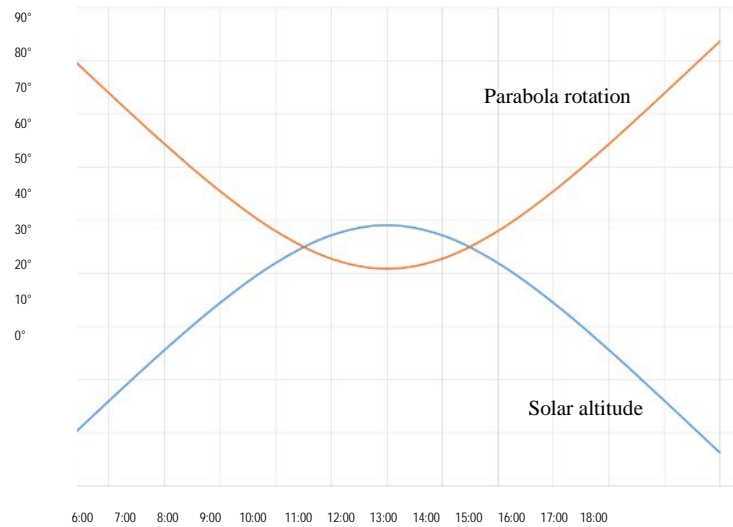

Fig. 4.28: Dependence of the parabolic head rotation on solar altitude

Two comparable light guides with different roof installations have been studied. The case study was focused on evaluation of the conventional light guide with a glass roof collector (spherical shape) and the new prototype with a light collecting mirror parabolic (CMP) head. The daylight illuminance data from the measurements show differences in light efficiency of the two tested light guides. It was proven that the roof installation with the spherical glass collector (LG2) has been more efficient than the prototype with the CMP head (LG1). The secondary parabola of the LG1 creates an obstruction to daylighting when installed in static horizontal position. The daylight illuminance level in the part 1 of the container illuminated by the LG1 was reduced about 37 percent compared to the illuminance level in the part 2 of the container illuminated by the LG2. The evaluation was carried out in a region with temperate climatic conditions with dominance of overcast and partly cloudy skies.

The daylight simulations in Holigilm software provides an overview of the tested light guides' daylight illuminance for one day measurement. The simulation outputs are in accordance with the measured data. The simulations also confirm that the light guide with the concentrator head LG1 is less efficient system that provides a lower illuminance level on the working plane indoors compared to the light guide LG2.

The installation of the light guide with CMP head should be more efficient in sloped roofs oriented towards the south. The light guide system LG1 would be most efficient in case when the light concentrator is equipped with sun tracking system. This would be more expensive solution compared to conventional light guides with spherical glass collectors. The sun-tracking light guide system is suitable for hot climates in installations exposed to intensive solar radiation.

## 5 CONCLUSION

### 5.1 SUMMARY

The study of the referenced publications from the light guide investigations overview provides information on the importance of light guides applications in buildings. There are many possibilities of improvements of the light guides' system components and their installations in real buildings. The results of laboratory and field measurements of daylight illuminance of the atypical prototype model show that the system has the potential of light efficiency improvement compared to conventional light guides. Laboratory and field measurements as well as computer simulations provide a chance to specify requirements for an optimised light guide prototype design.

The tested atypical prototype model represents a new light guiding system with a daylight concentrator device. The light transmittance efficiency of a prototype specimen with a collecting mirror parabolic (CMP) head was experimentally investigated under laboratory conditions. The system was installed in a stable position with orientation of the parabolic mirror towards zenith. The idea behind the CMP head construction is to collect and then focus solar rays into the focal point. A secondary mirror parabola located near the focus reflects these concentrated beams toward the highly reflective tube of the light guide.

The objective of the present experiments was to solve the following tasks:

- test the light guide prototype for light transmittance and determine its efficiency,
- compare the light transmittance of the prototype light guide with a conventional light guide of comparable dimensions and geometry,
- analyse the function of the prototype model and make recommendations for its possible improvement,
- find options for applications of the light guiding system in temperate climates,
- test the temperature distribution of the light guide prototype,
- specify the temperature profiles inside the light tube and near the mirror parabolic head,
- identify potential overheating problems in building applications.

## **Achievements**

The main achievement of the thesis appears to be the author's specification and implementation of the experimental method for the assessment of the atypical light guide prototype to evaluate its light transmittance and efficiency as well as its thermal behaviour. Based on the research carried out, such a comprehensive method of assessment was not found from the comprehensive review of state of the art published in studied scientific journals and databases. All author's presented experiments and data processing gave results which refer potentials of the tested light guide system in real buildings and pointed on design improvements for its practical applications. The following partial findings were achieved:

- Daylight illuminance measurements.
- Thermal testing.
- Comparative field study.

### **Daylight illuminance measurements**

The recorded illuminance measurements gave data for light transmittance of the light guide. The system light efficiency was determined as a ratio of luminous flux entering the light guide and luminous flux inside the test chamber. The measurements gave data for the light transmittance efficiency of the light guide. The light transmittance efficiency is an important indicator of the prototype model performance.

- The prototype experiments prove that if primary parabolic mirror is static and it is not tracking towards the sun position the light efficiency of the light guide is highly reduced. Only a limited part of sun rays affecting the light guide collector is redirected into the tube. When the CMP head is illuminated by the diffuse light the light transmittance efficiency is only 2.49 percent (average value). This indicates that the secondary parabola of the light guide with the CMP head in a static horizontal position is an obstacle to diffuse daylight. The light guide will increase its efficiency in real external conditions and for time with clear sky and direct solar radiation. The passive installation of a light guide prototype in the static position is suitable for regions with hot climates with intensive sun shining when high solar altitudes occur, for example in Nigeria. But in temperate climate regions, for example in the Czech Republic, the light guide systems should be design with respect of lower solar altitudes and for the prevailing skylight conditions without direct solar radiation because of dominant cloudy sky conditions.

## **Thermal testing**

- The thermal testing of an atypical prototype model gave an overview of temperature distribution under intensive infrared radiation. The infrared thermography photographs show very high temperature on the concentrator head. Also, the temperature in the diffuser inside the chamber increased significantly. It seems that the air trapped inside the tube was warmed under the infrared radiation. Data from temperature measurements show also significant temperature rise on the light guide surface in the response to the infrared radiation. The surface temperature rose up to 40°C due to the infrared lamp activation for light guide installation without thermal insulation. In the case of a thermally insulated light guide, the surface temperature increased to 74°C and in some places even more. The highest temperature distribution was on the CMP head (100 - 120°C). The above mentioned findings show potential problems with the light guide overheating under intensive solar radiation in summer seasons. For this reason, the light guide system application in real buildings should be carefully supplemented with details regarding the connection to roof and floor structures. It is recommended to add thermal insulation layers around the light guide and underneath the parabolic collector and make possible an efficient ventilation of the system to avoid overheating and minimise fire risks in real applications mainly in hot climates.

## **Comparative field study**

- The comparative field study was carried out for two light guides with different roof collector installation – a conventional light guide with a glass roof collector (spherical shape) and a prototype with CMP head. The daylight illuminance data from measurements show differences in light efficiency of the two tested light guides. It was proven that the roof installation with the spherical glass collector is more efficient than the variation with the CMP head. The secondary mirror parabolic head creates an obstruction for daylighting in this case of the static installation. Daylight illuminance level at the part illuminated by the light guide with CMP head has decreased by approximately 37 percent compared to the conventional light guide. These findings apply to the CMP head installed in a static horizontal position on a flat roof in a region with temperate climatic conditions, the prototype is then highly inefficient. The evaluation was carried out for region latitude 50° with dominance of overcast and partially cloudy skies.

- Daylight simulations in software Holigilm provided an overview of the tested light guides' daylight illuminance for two days of solstice on 21<sup>st</sup> December and 21<sup>st</sup> June. Simulations have shown that a less efficient system provides a lower illuminance level on the working plane. Under defined conditions, the illuminance level is reduced by 42 percent for overcast sky and more than 45 percent in case of clear sky during the summer season.

The results obtained from laboratory and field measurements show that the locality and its climatic conditions and the light guide installation placement play an important role in the light guides' specifications.

## **5.2 RECOMMENDATIONS**

Improvement suggestions of prototype efficiency are focused on increasing the prototype model performance and reduction of light guide dependence on sun elevation and azimuth angles. Suggestions for improvements of the prototype application in temperate climate are listed below.

- Removal of the overhanging edge around the primary mirror parabola of the CMP head. The height of the rim protecting the parabolic mirror from the sides is (100 - 200) mm. It could be cut to the level of covering glass or lowered to reduce shading.
- Elevating the CMP head above the roof structure and inclining it towards the sun ray propagation. During laboratory measurements, it was possible to adjust slightly the position of the CMP head by moving it about 100 mm upwards or downwards in the vertical direction using the metallic fasteners and inclining it about 5 degrees in one direction only. These small position changes did not affect the measurement results much. The required slope should be at least 25 – 45 degrees.
- A moving concentrator, system of mirror/set of mirrors, heliostats, or prismatic shells directing solar radiation into the tube during daytime would mean a positive improvement in the efficiency of this system but would increase the investment cost of the light guiding system.
- The placement of the parabolic concentrating head in the direction of the dominant solar irradiation, i.e. towards the south and west orientation. The CMP head installed in an inclination to the prevailing solar rays appears to be a less expensive variation acceptable, for example, for conventional residential buildings. It is also possible to position the light-transmitting tube perpendicular to the concentrator, but this would be a rather complex installation for buildings with solid floor structures. This type of light guide is more convenient for wooden lattice girder roofs. In



these roofs the light guide with oblique tube can be relatively easy mounted. In wooden constructions, the guide must be covered with non-flammable envelope. The roof concentrating mirror represents the place of potential overheating problems due to the concentration of solar radiation energy.

- The passive light guide system could be transformed into an active solar system. The active system involves a mechanical sun tracking device that actively focuses direct sunlight. It has the potential to collect the maximum daylight available at any time. The collector may stand free or be placed in an enclosed space. The free standing one has the potential to follow the sun's path throughout the day; the enclosure limits the tracking coverage angle. Tracking of the sun can be around one axis or two axes, depending on the geometry of the system. The prototype could be first tested using a simple rotating mechanism under the collector before an application of a more complex system was applied.

### Simple rotating mechanism

If the prototype light collector is elevated above the slope of a wooden roof construction, it can rotate in one direction at a constant speed moving  $9^\circ$  every hour, completing a quarter circle in 10 hours, e.g. from 7:00 am to 5:00 pm every day. Same applies to a flat roof construction equipped with a special supporting tracking structure. There it can rotate at a constant speed moving  $15^\circ$  every hour, completing a half circle in 12 hours, e.g. from 8:00 am to 8:00 pm every day, as shown in Fig. 5.1.

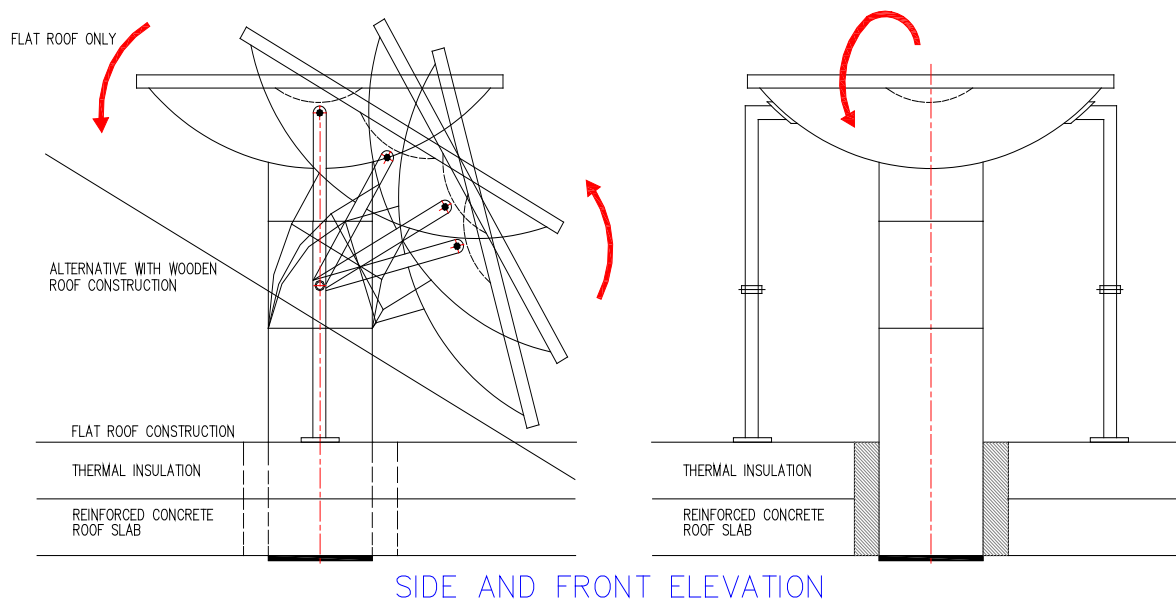

Fig. 5.1: Scheme of the sun tracking rotation of the parabolic head

### **Advanced rotating mechanism**

After testing the prototype using the simple mechanism described above, the more complex one can be tried – the sun tracking system that accurately follows the sun path to keep the collecting parabolic head perpendicular to sun's rays. Unfortunately, movable parts and motors results in a more complicated and expensive solution, more energy usage and maintenance. The system could incorporate solar cells that power the engine/motor to rotate the parabolic collector head.

It is important to find out whether this increases the performance of the active prototype model and whether performance exceeds costs. Decision must be made carefully to choose between performance and simplicity of the system. Further studies are necessary to access the economic viability of the active system.

### **Thermal solutions**

The thermal tests of the prototype model have shown an undesired effect of heat transfer along the tube. The heat, if not properly dispersed, can result in overheating problems. Therefore, appropriate ventilation and cooling techniques should be used. Some solutions to these problems are listed below:

- thermal insulation layer around the light guide tube and under the mirror parabolic head,
- double tubes (combining ventilation and illumination functions),
- additional glazing unit/units inside the tube for better thermal insulation and fire resistant units of glazing, thermal insulation and sealants. These components must be carefully designed because every additional glazing and insulation element could be helpful for overheating reduction but on the other hand they significantly reduce light transmittance of the light guiding system.

Thermal insulation layers around the light guide metal tube and underneath of the parabolic collector head should be provided (Fig. 5.2a). Insulation should be non-flammable, and the joints around the light guide parabolic head and diffuser should be perfectly sealed and fire resistant. In the case of extremely thermal loads transparent parts of the light guide are recommended to be completed with fire resistant glass.

To solve the overheating problem, the tubular light guide can be equipped with an additional tube (Fig. 5.2b), integrating the light guide for illumination and natural ventilation into one system. The tubes are concentric and create space to channel air flow. Daylight is transmitted through the guide and provides the lighting for the internal space during the day. The outer tube allows passive ventilation. It is recommended to use dichroic material in the

tube. The dichroic material will allow the infrared part of the solar radiation to be transmitted to the ventilation stack while the visible light is guided by the tube into a room.

Since the metal tube of the light guide is the weakest place of thermal protection in highly thermally insulated roofs, the prototype model can be equipped with an additional glass unit (Fig. 5.2c). The glass unit is placed inside the tube, embedded into the thermal insulation frame. This frame is connected to the main thermal insulated layer of the flat roof. The additional glass unit (single, double or triple) increases thermal resistance and reduce condensation risk. Unfortunately there is a negative effect - it reduces light transmittance due to light absorption in the glass unit/units and backward reflections.

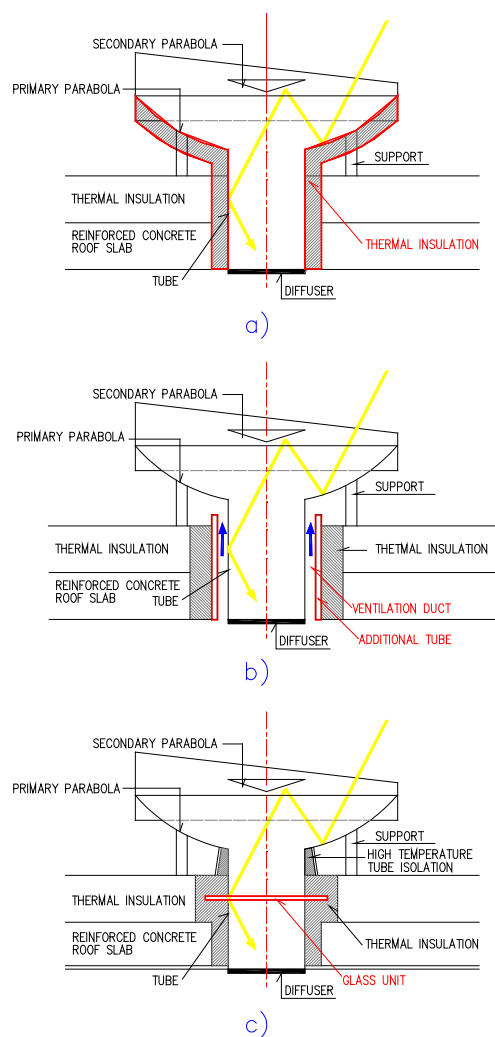

NOTE: MARKED RED INDICATES PROPOSED THERMAL SOLUTIONS

Fig. 5.2: a) thermal insulation collar between the tube and roof construction, b) double tubes for daylighting and ventilation, c) additional glass unit

- a) Thermal insulation layer around the light guide tube and under the mirror parabolic head to be provided to reduce thermal bridges.
- b) The tube of the light guide completed with additional tube to create the ventilation duct for elimination of overheating problems.
- c) Additional glass unit placed inside the tube to be provided for better thermal resistance and to reduce condensation risks of the light guide system. The additional glass unit could be equipped with a movable shading blind which allows glare and overheating protection during very intensive solar radiation periods.

### **Further investigations**

The further investigation and thermal testing of the light guide prototype is going to compare the presented results with the thermal monitoring of the prototype installed in a wooden roof construction. The installation will be with orientation of the CMP head towards the south to maximize solar gain. The system efficiency including testing for potential places of overheating in real building constructions will be done.

Testing of the atypical prototype model with fire resistant claddings applicable for tropical regions, for example Nigeria building industry, could be another part of the future work.

### **Testing of the light guide system application abroad**

The next task for the author will be to test the application of the light guide for Nigeria's climate conditions in collaboration with a structural engineering company in Lagos. Lagos is a large city and main port in Nigeria. Until 1975 it was the capital of Lagos State and until December 1991 it was the federal capital of Nigeria. Ikeja replaced Lagos as the state capital, and Abuja replaced Lagos as the federal capital. Lagos, however, remained the unofficial seat of many government agencies. The city's population is centred on Lagos Island, in Lagos Lagoon, on the Bight of Benin in the Gulf of Guinea. Lagos is Nigeria's largest city and one of the largest in sub-Saharan Africa [149].



Fig. 5.3: Nigeria – Lagos on the map [149]

In accordance with [150]: „Times for sunrise and sunset in Nigeria do not differ much all over the year. The reason is the only fair proximity to the Equator. So in summer the sun moves slightly to the north and in the winter slightly back to south, but without much change in the distance. E.g. in the Nordic countries of Europe the difference is much more extreme. With up to approximately 12:40 hours the longest days happen to be in June. In December a night in Abuja lasts almost 13 hours. In these days the sun in Abuja rises at 6:08. The Sunset can currently be watched at about 18:44 hr. in the early evening. “

### Average length of daylight in Abuja

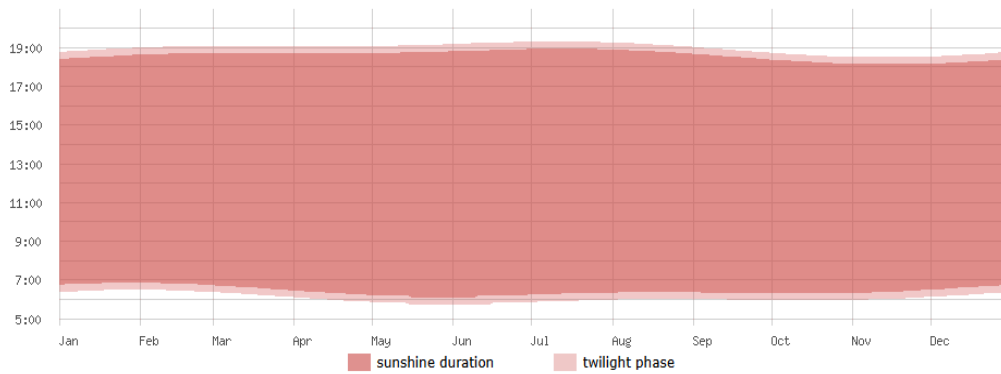

Fig. 5.4: Example of an average length of daylight in Abuja the federal capital of Nigeria [151]

### Lagos, Nigeria — Sunrise, Sunset, and Daylength, June 2019

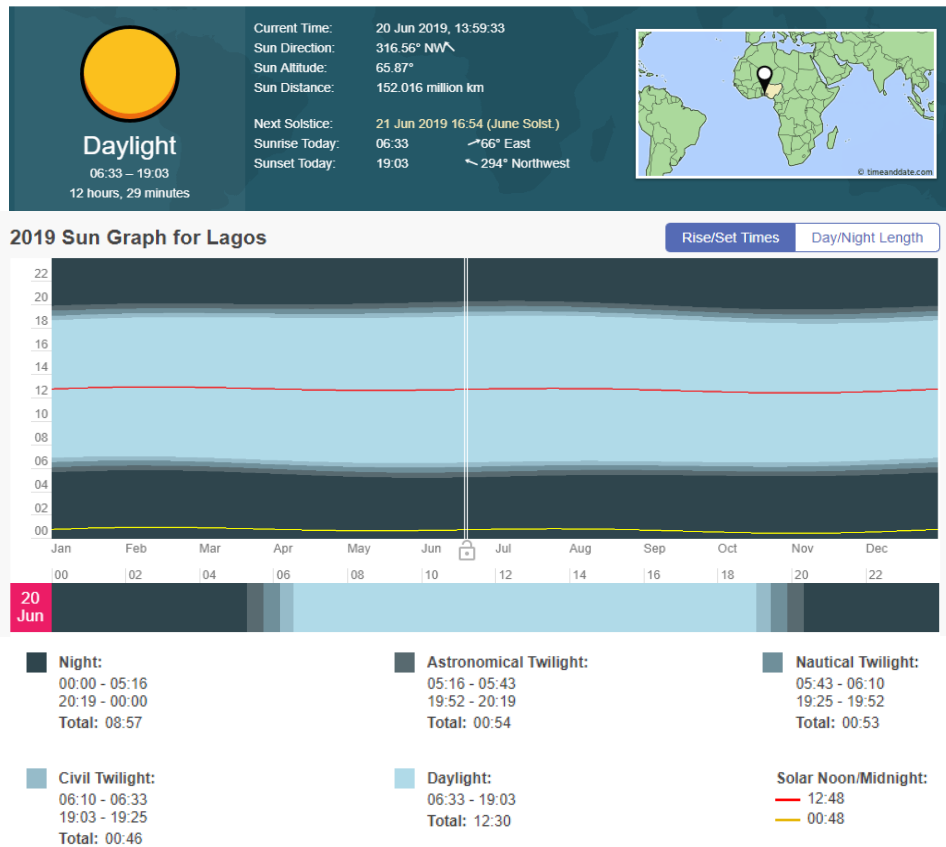

Fig. 5.5: Example of sunrise, sunset and day length in Lagos, the largest city of Nigeria [152]

It practically means that the tested light guide system represents a potential for its application in buildings in Nigeria regions. This is also obvious from the following data of solar elevation angle calculated for Lagos territory.

The solar elevation angle calculated using The Solar calculator program SolarBeam [153] for Lagos, Nigeria of latitude 6.524379 and longitude 3.379206.

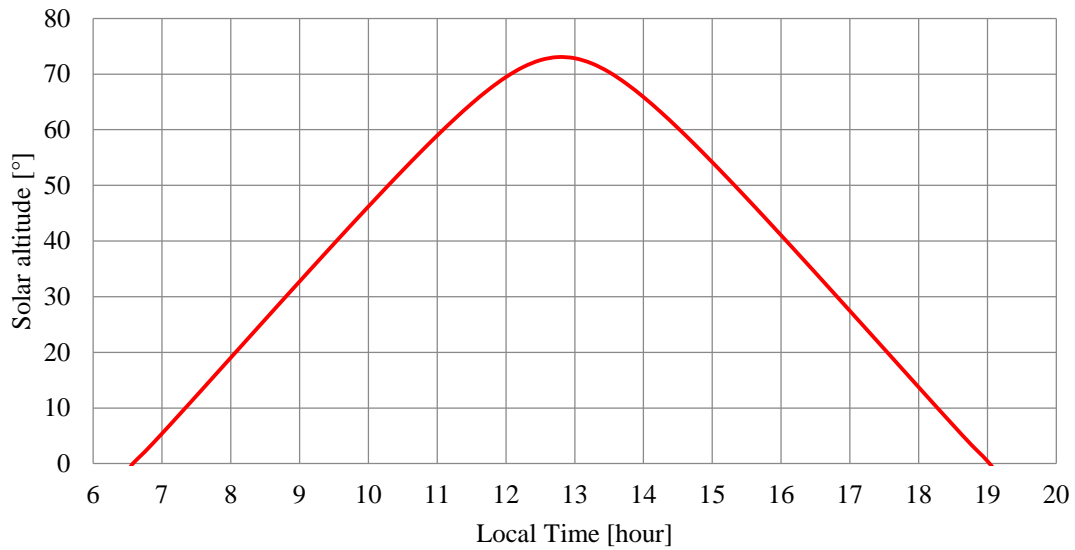

Fig. 5.6: Daily profile of the elevation angle on 21<sup>st</sup> June

An annual profile of solar elevation angle calculated for Lagos at daytime 12:00 using the solar calculator [154] is shown in Figure 5.7.

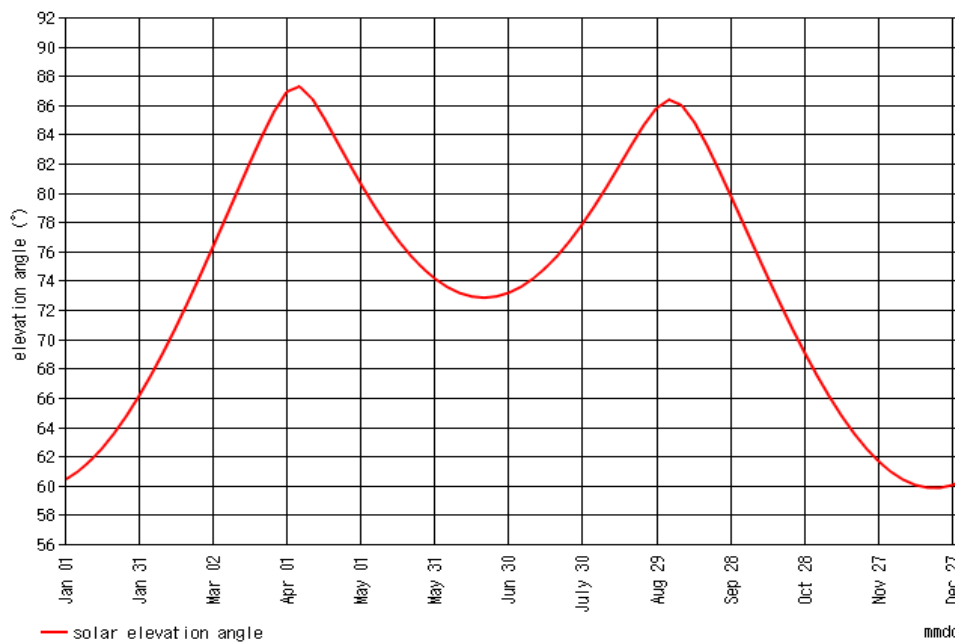

Fig. 5.7: Annual profile of solar elevation angle, Lagos, local time 12:00

The annual profile shows that the solar altitude varies between approximately 60° and 87°. For this high solar altitude the inclination of the CMP head of the tested light guide system could be in the position 3° to max 30° from the horizontal plane. It means that the light guide prototype would be more convenient for installation in Lagos climatic conditions compared to its installation in Central Europe.

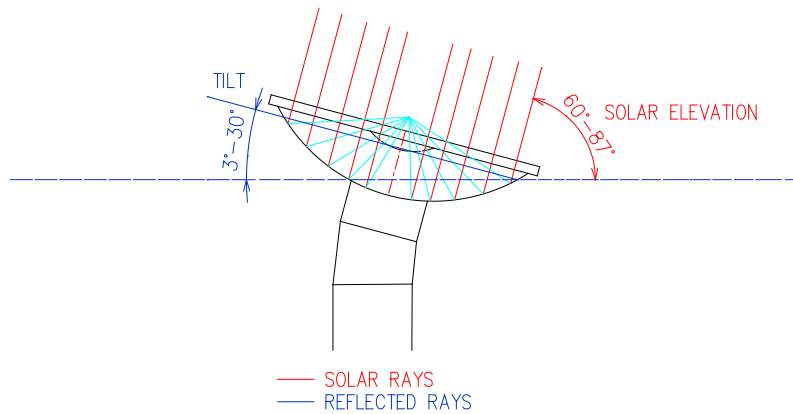

Fig. 5.8: Example of dependence of the light guide head tilt on solar elevation

The above mentioned finding is also in compliance with requirements for tilting of solar panels calculated for Lagos region using the solar angle calculator [155].

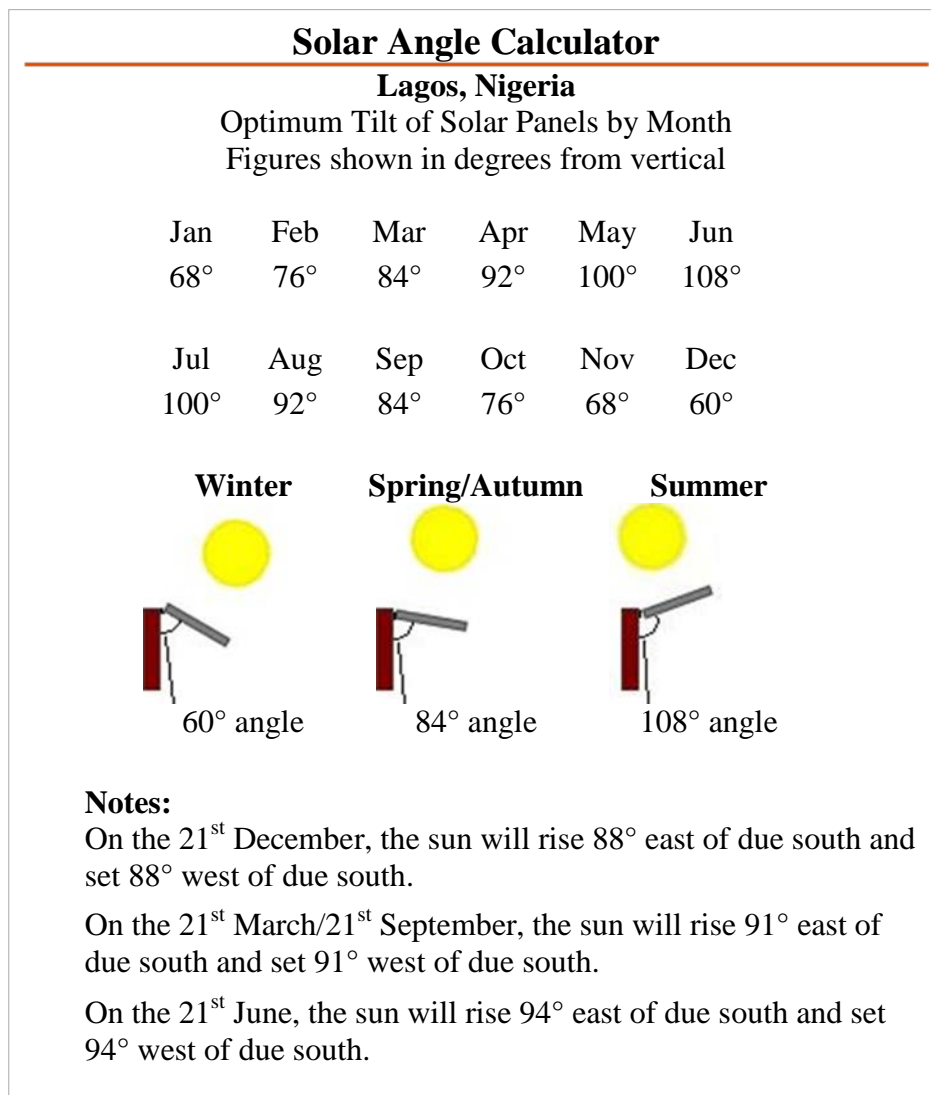

Fig. 5.9: Optimal tilts for solar collector panels (calculated by [155])



Due to the long hours of sunshine in a tropical environment, the use of light guides that bring natural light to buildings is a great advantage. The light guide models could be widely used in Nigeria, mainly in high-rise buildings, which present energy supply problems in major cities [156].

The light guide prototype could be very useful for daylighting of internal windowless parts, remote or poorly lit spaces. The most potential building types are commercial, educational, office and retail buildings, when availability of daylight corresponds with working hours and could alleviate the dependence on artificial lights.

Today, modern buildings have either severe external shading or highly reflective window wall glazing and internal blinds and therefore make little use of the high levels of abundant illuminance. Light guide systems may prove successful for such buildings and should be constructed in accordance with the principles of the development postulated in the Building Energy Efficiency in Nigeria by the Federal Ministry of Power, Work and Housing [157]. The provision of daylight in buildings will not only reduce energy consumption and associated cost, but also improve the quality of the occupants' visual comfort and create user-friendly environment.

## REFERENCES

- [1] Rosemann, A., Kaase, H. *Daylight for building interiors*. Proceedings of the CIE/ARUP Symposium on Visual Environment at the Royal Society, London, 2002, ISBN: 3901906169.
- [2] *CIE directive*  
<http://www.cie.co.at/publications/international-lighting-vocabulary>  
(10/01/2015)
- [3] *Spectral distribution of sunlight and molecular absorption*  
<http://www.new-learn.info/packages/clear/visual/daylight/index.html>  
(15/01/2015)
- [4] Ficker, T. *Handbook of building thermal technology, acoustics and daylighting*. CERM, 2004, ISBN: 8021426705, 9788021426702.
- [5] ISO 15469:2004(E)/CIE S 011/E:2003 *Spatial Distribution of Daylight - CIE Standard General Sky*.
- [6] Encyclopædia Britannica, *Encyclopedia Britannica Inc; 15th edition*. 2001, ISBN-10: 0852297874.
- [7] Plch, J., Mohelnikova, J. *Influence of colour of shading obstacles on indoor daylighting*. *Przeglad Elektrotechniczny*, 87(4), 2011, 35-37.
- [8] *Illuminance - Recommended light levels*  
<https://www.engineeringtoolbox.com/light-level-rooms-d708.html>  
(18/01/2015)
- [9] CIE 173. *Tubular daylight guidance systems technical report*. Vienna: CIE Central Bureau, 2006.
- [10] *Brno, Czech Republic Köppen Climate Classification*  
<https://www.weatherbase.com> (19/01/2015)
- [11] *Brno, Czech Republic, Climate graph (Altitude: 246 m)*  
<http://www.brno.climatemps.com> (19/01/2015)
- [12] *Solar resource maps of Czech Republic*  
<https://solargis.com/maps-and-gis-data/download/czech-republic>  
(20/01/2015)
- [13] Mardaljevic, J., Heschong, L., Lee, E. *Daylight metrics and energy savings*. *Lighting Research and Technology*, 41(3), 2009, 261-283.
- [14] Phillips, D. *Daylighting: Natural Light in Architecture*. Architectural Press, 2004, ISBN: 0750663235.

- [15] Carter, D. *Developments in tubular daylight guidance systems*. Building Research Information, 32(3), 2004, 220–34.
- [16] Mayhoub, M.S. *Innovative daylighting systems' challenges: A critical study*. Energy and Buildings, 80, 2014, 394-405.
- [17] Aizenberg, J.B. *Historie vývoje a užití dutých světlovodů*. Světlo, 10(1), 2001, 5–10.
- [18] Aizenberg, JB. *A brief history of light guides*. IAEEL Newsletter, 1, 1997, 1.
- [19] Čikolev, V.N. *Kanalizacija električeskogo světa*. Električestvo, 11, 1880, 168.
- [20] Neal, M.T. *Transmitting light, and apparatus therefor, patent USA, no. 902*, 1878.
- [21] Lake, W.R. *Lighting apparatus for mines, tunnels, etc., patent USA no. 2943*, 1878.
- [22] Molera, E.J, Cebrian, J.C. *The engineer of the Pacific*, 6, 1879, 1.
- [23] Wheeler, W. *Apparatus for lighting dwellings or other structures, patent USA no. 247.229*, 1881.
- [24] Hanneborg, O.B.H. *Apparatus for transmitting sunlight into basements or other stores, US patent no. 668,404*, 1901.
- [25] Buchman, G.B. *Ščelevoj svetovod*. Avtorskoje svidětělstvo SSSR no. 181023, 1965.
- [26] Aizenberg, J.B., Buchman, G.B. *Vzryvoopasnyj električeskij světilnik-světovod*. Avtorskoje svidětělstvo SSSR no. 468057, 1970.
- [27] Aizenberg, J.B., Buchman, G.B. *United States Patent no. 3.902,056. 26. Interior Lighting Fixture*. Light & Engineering, 8(2), 1975.
- [28] Sutton, S. *Australian patent no. 586359*, 1986.
- [29] Sutton, S. *Tubular skylight, USA patent no. 5,099,622*, 1992.
- [30] Bixby, B. *Tubular skylight systems, USA patent no. 6363667 (5,546,712)*, 1996.
- [31] Chao, B.L. *Assignee Solatube. USA patent 5.896.712.4*. California: international Ing. 1999.

- [32] O'Neil, M. *Cone shaped light tube; US patent no. 6,363,667*, 2002.
- [33] Johnson, K., Selkowitz, S. *Light guide design principles*. Proceedings of the second international daylighting conference, Long Beach, 1986, 182–98.
- [34] Zastrow, A., Wittwer, V. *Daylighting with mirror light pipes and with fluorescent planar concentrators*. Materials and Optics for Solar Energy Conversion and Advanced Lightning Technology. SPIE Proceedings, 692, 1986, 227.
- [35] Edmonds, I.R., Moore, G.I., Smith, G.B. *Daylighting enhancement with light pipes coupled to laser-cut light-deflecting panels*. Lighting Research and Technology, 27(1), 1995, 271.
- [36] Swift, P.D., Smith, G.B. *Cylindrical mirror light pipes*. Solar Energy Materials and Solar Cells; 36(2), 1995, 159-68.
- [37] McCluney, R. *Color-rendering of daylight from water-filled light pipes*. Solar Energy Materials, 1(21), 1990, 191-206.
- [38] Ayers, M.J., Carter, D.J. *Remote source electric lighting systems*. Lighting Research & Technology, 27(1) 1995, 1-15.
- [39] Bouchet, B., Fontoynt, M. *Daylight of underground spaces: design rules*. Energy and Buildings, 23, 1996, 293-8.
- [40] Mingozi, A. *Theoretical criteria and experimental models for the study of a daylighting system to collect transport natural light and for developing of simplified design method*. Proceedings of the 13th international conference PLEA 96, Belgium, 1996.
- [41] Shao, L., Riffat, S.B., Hicks, W., Yohannes, I. *A study of performance of light pipes under cloudy and sunny conditions in the UK*. Right Light, 1(4), 1997, 155-159.
- [42] Shao, L. *Mirror light-pipes: daylighting performance in real buildings*. Lighting Research Technology 30(1), 1998, 37-44.
- [43] Shao, L., Riffat, S.B., Yohannes I., Elmualin, A.A. *Measurement and modelling of light pipe for energy efficient lighting*. CIBSE national lighting conference, 1988.
- [44] Shao, L., Elmualin, A.A., Yohannes, I. *Mirror light pipes daylighting performance in real buildings*. Lighting Research Technology, 30(3), 1998, 37-40.

- [45] Oakley, G., Riffat, S.B., Shao, L. *Daylight performance of light pipes*. Solar Energy, 69(2), 2000, 89-98.
- [46] Elmualim, A.A., Smith, S., Riffat, S.B., Shao, L. *Evaluation of dichroic material for enhancing light pipe natural ventilation and daylighting in an integrated system*. Applied Energy, 62(4), 1999, 253-66.
- [47] Shao, L., Riffat, S.B. *Daylighting using light pipes and its integration with solar heating and natural ventilation*. Lighting Research Technology, 32(3), 2000, 133-9.
- [48] Zhang, X., Muneer, T. *Mathematical model for the performance of light pipes*. Lighting Research Technology, 32(3), 2000, 141-6.
- [49] Zhang, X. *Daylighting performance of tubular solar light pipes: measurement, modeling and validation*. Lighting Research Technology, 32(3), 2002, 40-52.
- [50] Zhang, X., Muneer, T., Kubie, J. *A design guide for performance assessment of solar light pipes*. Lighting Research and Technology, 34(2), 2002, 149-68.
- [51] Zhang, X. *Daylighting performance of tubular solar light pipes: measurement, modeling and validation*. PhD thesis, Napier University, Edinburgh, 2002.
- [52] Carter, D.J. *The measured and predicted performance of passive solar light pipe systems*. Lighting Research Technology, 34(1), 2002, 39-52.
- [53] Callow, J.M. *Daylighting using tubular light guide systems*. PhD thesis, The University of Nottingham, 2003.
- [54] Jenkins, D., Muneer, T. *Modelling light pipe performances – a natural daylighting solution*. Building & Environment, 38(7), 2003, 965-72.
- [55] Jenkins, D., Muneer, T. *An investigation into the properties of light pipes and windows as daylight providers*. Light & Engineering, 11(4), 2003, 28-9.
- [56] Jenkins, D., Muneer, T. *Light-pipe prediction method*. Applied Energy, 79(1), 2004, 77-86.
- [57] Jenkins, D., Zhang, X., Muneer, T. *Formulation of semi-empirical models for predicting the illuminance of light pipes*. Energy Conversion & Management, 46(13–14), 2005, 2288–300.

- [58] Jenkins, D., Muneer, T., Kubie J. *A design tool for predicting of performances of light pipes*. Energy and Buildings, 37(5), 2005, 485-92.
- [59] Marwaee, A., Carter, D.J. *A field study of tubular daylight guidance installations*. Lighting Research technology, 38(3), 2006, 241-58.
- [60] Chella, F., Zazzini, P., Carta, G. *Compared numerical and reduced scale experimental analysis on light pipes performances*. 5th International Conference on Sustainable Energy Technologies SET 2006, 263-268, Vicenza, Italy, August 30 - September 01, 2006.
- [61] Baroncini, C., Chella, F., Zazzini, P. *Experimental analysis of tubular light pipes performances: influence of the diffuser on inside distribution of light*. 5th International Conference on Sustainable Energy Technologies SET 2006, 219-224, Vicenza, Italy, August 30 - September 01, 2006.
- [62] Zazzini, P., Chella, F., Scarduzio, A. *Numerical and experimental analysis of light pipes' performances: comparison of the obtained results*. 23th Conference on Passive and Low Energy Architecture, 2, 2006, 219-224, Geneva, Switzerland, September 06 - 08, 2006.
- [63] Boccia, O., Chella, F., Zazzini, P. *Innovative devices for daylighting and natural ventilation in architecture*. [www.inchopen.com](http://www.inchopen.com). (10/04/2015)
- [64] Chella, F., Gentile, E., Zazzini, P. *Natural light in new underground areas of a historical building: an example of application of double light pipes in preservation of the architectonic heritage*. SET2007 - 6th International Conference on Sustainable Energy Technologies, Santiago, Chile, September 05 - 07, 2007.
- [65] Swift, P.D., Smith, G.B., Franklin, J. *Hotspots in cylindrical mirror lightpipes: description and removal*. Lighting Research and Technology, 38(1), 2006, 19-31.
- [66] Swift, P.D., Smith, G.B. *Rectangular-section mirror lightpipes*. Solar Energy and Solar Materials, 92(8), 2008, 969-975.
- [67] Swift, P.D. *Splayed mirror lightpipes*. Solar Energy, 84(2), 2010, 160-165.
- [68] Edmonds, I. *Transmission of mirror light pipes with triangular, rectangular, rhombic and hexagonal crosssection*. Solar Energy, 84(6),

- 2010, 928-938.
- [69] Laouadi, A., Arsenault, C.D. *Validation of skylight performance assessment software*. ASHRAE Transactions, 112(2), 2003, 1-13.
- [70] Kocifaj, M., Darula, S., Kittler, R. *Holigilm: hollow light guide interior illumination method – an analytic calculation approach for cylindrical light-tubes*. Solar Energy, 82(3), 2008, 247-59.
- [71] Kocifaj, M. *Analytical solution for daylight transmission via hollow lightpipes with transparent glazing*. Solar Energy, 83(2), 2009, 186-192.
- [72] Kocifaj, M. *Efficient tubular light pipe with two-component glazing with lambertian diffuser and clear glass*. Applied Energy, 86(7-8), 2009, 1031-1036.
- [73] Kocifaj, M., Kundracik, F., Darula, S., Kittler, R. *Theoretical solution for light transmission of a bended hollow light pipe*. Solar Energy, 84 (8), 2010, 1422-1432.
- [74] Darula, S., Kocifaj M., Kittler, R., Kundracik, F. *Illumination of interior spaces by bended hollow light guides: Application of the theoretical light propagation method*, Solar Energy 84(12), 2010, 2112-2119.
- [75] Chirarattananon, S., Hien, V.D., Chaiwiwatworakul, P., Chirarattananon, P. *Simulation of transmission of daylight through cylindrical light pipes*. Journal of Sustainable Energy and Environment, 1, 2010, 97-103.
- [76] Samuhatananon, S., Chirarattananon, S., Chirarattananon, P. *An experimental and analytical study of transmission of daylight through circular light pipes*. Leukos, 7(4), 2011, 203-219.
- [77] Scartezzini, J.L, Courret, G. *Anidolic daylighting systems*. Solar Energy, 73(2), 2002, 123-135.
- [78] Molteni, S.C., Couret, G., Paule, B., Michel, L., Scartezzini, J.L. *Design of anidolic zenithal lightguides for daylighting of underground spaces*.  
[http://ptp.irb.hr/upload/mape/kuca/15\\_Simone\\_Molteni\\_DESIGN\\_OF\\_ANIDOLIC\\_ZENITHAL\\_LIGHTGUIDES\\_FOR.pdf](http://ptp.irb.hr/upload/mape/kuca/15_Simone_Molteni_DESIGN_OF_ANIDOLIC_ZENITHAL_LIGHTGUIDES_FOR.pdf) (18/03/ 2015)
- [79] Wittkopf, S., Grobe, L.O., Geisler-Moroder, D., Compagnon, J.K., Linhart, F., Scartezzini, J.L. *Ray tracing study for non-imaging daylight*

- collectors*. Solar Energy 84(6), 2010, 986-996.
- [80] Dudley, W., Dorville, J.F. *Numerical study on the thermal performance of tubular light pipes under tropical climate. Case study from Jamaica*. [http://www.redes.unb.br.lasp/files/events/ICRERA\\_2014/98-Williams-Numerical-Study.pdf](http://www.redes.unb.br.lasp/files/events/ICRERA_2014/98-Williams-Numerical-Study.pdf). (18/03/2015)
- [81] Mohelníková, J. *Tubular light guide evaluation*. Building and environment, 44(10), 2009, 2193-2200.
- [82] Mohelníková, J., Vajkay, F. *Light guides as energy saving alternative for windowless interiors*. WSEAS Transactions on Environment and Development, 2(3), 2007, 45-49.
- [83] Kim, J.T., Kim, G. *Overview and new developments in optical daylighting systems for building and healthy indoor environment*. Building and Environment, 45(2), 2010, 256-269.
- [84] Su, Y., Khan, N., Riffat, S.B., Oakley, G. *Comparative monitoring and data regression of various sized commercial light pipes*. Energy and Buildings, 50, 2012, 308-314.
- [85] LoVerso, V.R.M., Pellegrino, A., Serra, V. *Light transmission efficiency of daylight guidance systems: An assessment approach based on simulations and measurements in a sun/sky simulator*. Solar Energy, 85(11), 2011, 2789-2801.
- [86] Mayhoub, M.S., Carter, D.J. *The costs and benefits of using daylight guidance to light office buildings*. Building and Environment, 46(3), 2011, 698-710.
- [87] Mayhoub, M.S., Carter, D.J. 2011. *A model to estimate direct luminous efficacy based on satellite data*. Solar Energy, 85(2), 234-248.
- [88] Mayhoub, M.S. *Guidelines for daylight guidance system application*. PLEA2012 - 28th Conference, Opportunities, Limits & Needs Towards an environmentally responsible architecture, Lima, Perú November 07-09, 2012.
- [89] Carter, D.J. *Tubular daylight guidance systems*. Lighting Research and Technology, 46(4), 2014, 369-387.
- [90] Malet-Damour, B., Boyer H., Facra A.H., Bojic, M. *Light Pipes Performance Prediction: inter model and experimental confrontation on vertical circular light-guides*. Energy Procedia, 57, 2014, 1977-



1986.

- [91] Darula, S., Kocifaj, M., Mohelníková, J. *Hollow light guide efficiency and illuminance distribution on the light-tube base under overcast and clear sky conditions*. *Optik*, 124(17), 2013, 3165-3169.
- [92] Kómar, L. *Directional reflectance and more accurate prediction of tubular light guide efficiency*. *Przeglad Elektrotechniczny*, ISSN 0033-2097, 89(6), 2013, 328-330.
- [93] Plch, J., Mohelníková, J., Král, J. *Light Pipe Comparative Measurement*. Proceedings of the 21st International Conference LIGHT SVĚTLO, 2015, 233-235. ISBN: 978-80-214-5244-2.
- [94] Kadir, A.A., Ismail, L.H., Kasim, N., Kaamin, M. *Potential of light pipes system in Malaysian climate*. *Materials Science and Engineering*, 160, 2016, 012071 doi:10.1088/1757-899X/160/1/012071 (10.2.2019)
- [95] Vajkay, F., Bečkovský, D., Tichomirov, V. *Assesment of tubular light guides with respect to building physics*. *Materials and technology*, 50(3), 2016, 409-412.
- [96] Ciugudeanu, C., Beu, D. *Passive tubular daylight guidance system survey*. *Procedia Technology*, 22, 2016, 690-696.
- [97] Ellis, P.G., Strand, R.K., Baumgartner, K.T. *Simulation of tubular daylighting devices and daylighting shells in EnergyPlus*. SimBuild, IBPSA-USA National Conference, Boulder, CO, August 04 - 06, 2004.
- [98] Gashinani, M.G., Saradj, F.M., Faizi, M. *Integration issues for using innovative daylighting strategies in light wells*. *Journal of applied engineering sciences*, 7(2), 2017, 31-38. doi: 10.1515/jaes-2017-0010 (20/12/2017)
- [99] Baglivo, C., Bonomolo, M., Beccali, M., Congedo, P.M. *Sizing analysis of interior lighting using tubular daylighting devices*. *Energy Procedia*, 126, 2017, 179-186.
- [100] Li, D.H.W., Li, C., Lou, S.W., Tsang, E.K.W., Lam, J.C. *Analysis of vertical sky components under various CIE standard general skies*. *Indoor and Built Environment*, 25(4), 1–9. [ibe.sagepub.com](http://ibe.sagepub.com) at City Univ of Hong Kong on May 15, 2015. (18/12/ 2017)
- [101] Wong, L. *A review of daylighting design and implementation in buildings*. *Renewable and Sustainable Energy Reviews*, 74, 2017, 959-

968.

- [102] Malet-Damour, B., Boyer, H., Guichard, S., Miranville, F. *Performance testing of light pipes in real weather conditions for a confrontation with Hemera*. Journal of Clean Energy Technologies, 5(1), 2017, 73-76.
- [103] Tsang, E.K.W., Kocifaj, M., Li D.H.W., Kundracik, F., Mohelníková, J. *Straight light pipes' daylighting: A case study for different climatic zones*. Solar Energy, 170, 2018, 56-63.
- [104] Petržala, J., Kocifaj, M., Kómar, L. *Accurate tool for express optical efficiency analysis of cylindrical light-tubes with arbitrary aspect ratios*. Solar Energy, 169, 2018, 264-269.
- [105] Kadir, A.A., Ismail, L.H., Kasim, N., Wahab I.A., Kaamin, M., Ngadiman, N.B., Rosli, M.S.B.M. *Improving the Performance of Light Pipe System Using Laser Cut Panel*. International Conference on Mechanical and Manufacturing Engineering (ICME2018). IOP Conf. Series: Journal of Physics: Conf. Series 1150, 2019, 012064, doi: 10.1088/1742-6596/1150/1/012064. (25/05/2019)
- [106] Alibaba, H.Z. *Achieving visual comfort through Solatube daylighting devices in residential building in Nigeria*. International Journal of Scientific & Engineering Research, 9(1), 2018, 118-125.
- [107] Mayhoub, M.S. *Fifty years of building core sunlighting systems – Eight lessons learned*. Solar Energy, 184, 2019, 440-453.
- [108] Kim, C.H., Kim, K.S. *Development of sky illuminance and daylight illuminance prediction methods for lighting Energy saving in office buildings*. Energies 12(4), 2019, 592. doi:10.3390/en12040592. www.mdpi.com/journal/energies. (10/04/2019)
- [109] *Light guides products*  
<http://ciralight.com/products> (15/01/2015)
- [110] *Light guides history*  
[http://www.solatube.com.au/corporate/about\\_history.php](http://www.solatube.com.au/corporate/about_history.php) (15/01/2015)
- [111] *Light guide prototype*  
<http://www.lightway.cz> - (05/01/2015)
- [112] Hough, T.P. *Trends in Solar Energy Research*. Nova Science Publisher, New York, 2006.
- [113] Boyce, P.R. *Human factors in daylighting*. CRC Press, Taylor Francis

Group, New York, 2014.

- [114] Robertson, K. *Daylighting Guide for Buildings. Daylighting Guide for Canadian Commercial Buildings*. NRCan, NRCC 2002. Online guide Lightswitch Wizard, NRCan, NRCC, 2003. [www.buildwiz.com](http://www.buildwiz.com). (18/09/2015)
- [115] Dumitrescu, L., Baran, I., Pescaru, R.A. *The influence of thermal bridges in the process of buildings thermal rehabilitation*. Procedia Engineering, 181, 2017, 682-689.
- [116] Baba, F., Ge, H. *Dynamic effect of thermal bridges on the energy performance of residential buildings in BC*. Energy and Buildings, 105, 2015, 106-118.
- [117] Wu, Y.P., Wang, X.D., Chen, Z.G., Zhang, C.Y. *Experimental Study on the Influence of Daylighting Performance of Solar Light Pipes by Dusts and Condensation*. Advanced Materials Research, 374-377, 2012, 1096-1099.
- [118] Dengel, A., Swainson, M., Ormandy, D., Ezratty, V. *Overheating in dwellings*. 116885 Overheating Guidance. BRE Watford 2016.
- [119] Tiwari, G.N., Tiwari, A. *Handbook of Solar Energy: Theory, Analysis and Applications*. Springer, Science+Business Media, Singapore, 2016.
- [120] Taengchum, T., Chirarattananon, S. *Tracing of daylight through circular light pipes with anidolic concentrators*. Solar Energy, 110, 2014, 818-829.
- [121] Nair, M.G., Ramamurthy, K., Ganesan, A.R. *Design of an anidolic concentrator and evaluation of daylight enhancement under an overcast sky*. Lighting Research & Technology 48(8), 2015, 917-929.
- [122] Fiorentini, L., Marmo, L., Danzi, E., Puccia, V. *Fire Risk Assessment of Photovoltaic Plants. A Case Study Moving from two Large Fires: from Accident Investigation and Forensic Engineering to Fire Risk Assessment for Reconstruction and Permitting Purposes*. Chemical Engineering Transactions, 48, 2016, 247-232.
- [123] Laukamp, H. et al. *PV fire hazard – Analysis and Assessment of Fire Incidents*. The 28th EU PVSEC, Paris, 2013.
- [124] Mohelníková, J. *Evaluation of indoor illuminance from light guides*. Light and Visual Environment, 32(1), 2008, 20-26.

- [125] McCluney, R. *Rating of Tubular Daylighting Devices for Visible Transmittance and Solar Heat Gain*. Final Report, FSEC-CR-1385-03, Florida Solar Energy Center, 2003.
- [126] Perčić, M., Lenić, K., Trp, A. *A three-dimensional numerical analysis of complete crossflow heat exchangers with conjugate heat transfer*. Engineering Review, 33(1), 2013, 23-40.
- [127] Harrison, S.J., McCurdy, G.G., Cooke, R. *Preliminary evaluation of the daylighting and thermal performance of cylindrical skylights*. Proceedings of International Daylight Conference 1998 Ottawa, 205-212.
- [128] Williams, D.A., Dorville, J.F. *Investigating the Thermal and Lighting Performance of Light Pipes for Sunny and Cloudy Conditions in Insular Tropical Climate*. Journal of Electrical Engineering, 2, 2014, 221-227.
- [129] Šikula, O., Mohelníková, J., Plášek, J. *Thermal CFD analysis of tubular light guides*. Energies, 6(12), 2013, 6304-6321.
- [130] Šikula, O., Mohelníková, J., Plášek, J. *Thermal analysis of light pipes for insulated flat roofs*. Energy and Buildings, 85, 2014, 436-444.
- [131] Varga, S., Oliveira, A.C. *Ventilation terminals for use with light pipes in buildings: a CFD study*. Applied Thermal Engineering, 20(18), 2000 1743-1752.
- [132] Tillenkamp, F. *Integrated Light Pipe/Passive Stack Ventilation/Solar Heating Cooling Unit on Pilot-Plant Scale (TRIPLESERVE Unit) and Related Know How*. Community Research and Development Information service; CORDIS: Winterthur, Suisse, 2003. [http://cordis.europa.eu/result/report/rcn/26896\\_de.html](http://cordis.europa.eu/result/report/rcn/26896_de.html) (15/06/2016)
- [133] Taengchum, T., Chirarattananon, S. Exell R.H.B., Kubaha, K., Chaiwiwatworaku, P. *A study on a ventilation stack integrated with a light pipe*. Applied Thermal Engineering, 50(1), 2013, 546-554.
- [134] *Daylighting Devices, Engineering Reference – EnergyPlus 8.0* <http://bigladdersoftware.com/epx/docs/8-0/engineering-reference/page-043.html> (15/07/2015)
- [135] Mohelníková, J. *Method for evaluation of radiative properties of glass samples*. Applied Thermal Engineering, 28(5-6), 2008, 388-395.

- [136] Athienitis, A.K., Samtamouris, M. *Thermal Analysis and Design of Passive Solar Buildings*. Earthscan, Routledge, Abingdon, 2013.
- [137] Balaras, C.A., Argiriou, A.A. *Infrared thermography for building diagnostics*. Energy and Buildings, 34(2), 2005, 171-183.
- [138] Barreira, E., de Freitas, V.P. *Evaluation of building materials using infrared thermography*. Construction and Building Materials, 21(1), 2007, 218-224.
- [139] Blecich, P., Franković, B., Lenić, K. *Application of Infrared Camera in Thermal Engineering*. Engineering Review, 29(1), 2009, 47-59.
- [140] Lamp RRW 4500 Quartz halogen infrared zone/spot heating, Red Rat Engineering, Ltd. (10/03/2016)
- [141] *European Solar Thermal Industry Federation - ESTIF*  
<http://solarheateurope.eu/welcome-to-solar-heat-europe/> (18/12/2017)
- [142] *Flir ThermaCAM PM695*  
<http://www.flir.com/legacy/view/?id=51533>. (10/03/2016)
- [143] *Thermoworks/Emissivity table*  
[http://www.thermoworks.com/emissivity\\_table](http://www.thermoworks.com/emissivity_table). (15/03/016)
- [144] Türler, D., Griffith B.T., Arasteh D.K. *Laboratory Procedures for Using Infrared Thermography to Validate Heat Transfer Models in Insulation Materials: Testing and Applications*, Third Volume, ASTM STP 1320, R. S. Graves and R. R. Zarr,Eds., American Society for Testing and Materials, 1997, 23-45.
- [145] *Data-Logger Almemo, Ahlborn*  
<https://www.ahlborn.cz/pristroje/merici-ustredny-almemo/> 15/03/2015)
- [146] BS EN 60584-1:2013 Thermocouples. EMF specifications and tolerances.
- [147] Li, D.H.W., Tsang, E. K.W., Cheung, K.L., Tam C.O., *An analysis of light-pipe system via full- scale measurements*. Applied Energy, 87(3), 2010, 799–805.
- [148] Standard SN 73 0581:2009 Oslunění budov a venkovních prostor - Metoda stanovení hodnot (Insolation of buildings and outdoor areas - The method of assesment the values), ÚNMZ, Prague 2009.
- [149] *Lagos - Nigeria*

- <https://www.britannica.com/place/Lagos-Nigeria> (17/12/2018)
- [150] *Keisan online calculator*  
[https://keisan.casio.com/keisan/googleMap.php?latitude=latit&longitude=longt&altitude=&lang=en&is\\_pc=1](https://keisan.casio.com/keisan/googleMap.php?latitude=latit&longitude=longt&altitude=&lang=en&is_pc=1) (17/12/2018)
- [151] *Sunrise and sunset in Nigeria*  
<https://www.worlddata.info/africa/nigeria/sunset.php> (07/01/2019)
- [152] *Lagos, Nigeria - Sunrise, Sunset, and Daylength*  
<https://www.timeanddate.com/sun/nigeria/lagos> (07/01/2019)
- [153] *Solar diagrams*  
<http://solarbeam.sourceforge.net/> (07/01/2019)
- [154] *Solar elevation and azimuth angles*  
<https://keisan.casio.com/exec/system/1224682277> (07/01/2019)
- [155] *Solar angle calculator*  
<http://www.solarelectricityhandbook.com/solar-angle-calculator.html>  
(07/01/2019)
- [156] *High rise building in a developing country*  
<https://www.irbnet.de/daten/iconda/CIB10316.pdf> (07/01/2019)
- [157] *Building Energy Efficiency Guideline for Nigeria*  
[https://energypedia.info/images/c/c7/Building\\_Energy\\_Efficiency\\_Guideline\\_for\\_Nigeria\\_2016.pdf](https://energypedia.info/images/c/c7/Building_Energy_Efficiency_Guideline_for_Nigeria_2016.pdf) (05/03/2019)

## AUTHOR'S PUBLICATIONS

Articles in reviewed foreign journals cited in the Web of Science (WoS) and SCOPUS databases:

- [1] Omishore, A., Kalousek, M., Mohelník, P. *Thermal Testing of The Light Pipe Prototype*. Engineering Review, 39(3), 2019, 283-291, (WoS).
- [2] Omishore, A., Mohelník, P., Míček, D. *Light pipe prototype testing*. Przegląd Elektrotechniczny, 04, 2018, 107-112. doi:10.15199/48.2018.04.27 (WoS, SCOPUS).

Articles in foreign reviewed journals:

- [3] Mohelníková, J., Darula, S., Omishore, A., Mohelník, P., Míček, D. *Light Guide Collector Prototype. Laboratory Testing*. International Journal of Sustainable Lighting IJSL, 19(2), 2017, 124-131, ISSN: 2586-1247. <https://doi.org/10.26607/ijsl.v19i2.81>.
- [4] Omishore, A., Mohelník, P., Míček, D. *Light Pipe Comparative Study*. SSP - Journal of Civil Engineering, 14(1), 2019; Sciendo, DOI: 10.1515/sspjce-2019-0002. [https://www.researchgate.net/publication/338687365\\_Light\\_Pipe\\_Comparative\\_Study](https://www.researchgate.net/publication/338687365_Light_Pipe_Comparative_Study).

Articles in a reviewed online database:

- [5] Omishore, A., Kalousek, M., Mohelník, P. *Sledování povrchových teplot na prototypu atypického světlovodu pod infračervenou lampou*. TZB-info/Stavba, 2018. <http://stavba.tzb-info.cz/okna-dvere/16902-sledovani-teploty-atypickeho-prototypu-svetlovodu-pod-infracervenou-lampou>.

Conference paper:

- [6] Omishore, A., Mohelník, P., Míček, D. *Hodnocení světelné propustnosti světlovodu*. Sborník přednášek z konference Inteligentní regiony. Společnost pro techniku prostředí, Brno, 2017, ISSN 978-80-02-02732-4, 41-46.

## LIST OF SYMBOLS AND ABBREVIATIONS

$\phi$	Luminous flux	lm
I	Luminous intensity	cd
L	Luminance	cd.m <sup>-2</sup>
E	Illuminance	lx
S	Surface area	m <sup>2</sup>
r	Light guide radius	m
d	Light guide diameter	m
l	Light guide length	m
h	Distance between diffuser and sensor on the horizontal plane	m
$\omega$	Solid angle	sr
$\Phi_e$	Luminous flux leaving the guide	lm
$\Phi_i$	Internal luminous flux	lm
$E_e$	External illuminance	lx
$E_i$	Internal illuminance internal	lx
V	Vertical distance from the diffuser to the point of interest	m
$\eta$	Light guide efficiency	%
$\rho$	Surface reflectance	-
$\tau_c$	Light transmittance for cupola	-
$\tau_D$	Light transmittance for diffuser	-
$\tau_t$	Total guide transmittance	-
$\theta$	Sky segment around the zenith with the most efficient effect of sky brightness	-
$\rho$	Light reflectance of the inside of light guide surface	-
A	Light guide cross sectional area	m <sup>2</sup>
AR	Aspect Ratio	-



TTE	Transmittance guide efficiency	-
EG	Total light efficiency	-
MF	Maintenance factor	-
$E_{eo}$	Solar constant	$W.m^{-2}$
$E_{vo}$	Luminous solar constant	lx
R	Colour rendering index (CRI)	-
$T_{cp}$	Correlated colour temperature (CCT)	K