



## **Master Thesis**

# **Design of new production line for system units**

*Study programme:* N0788A270005 Innovation and Industrial Engineering  
*Author:* **Zertehun Birhanu Teshome**  
*Thesis Supervisors:* Ing. František Koblasa, Ph.D.  
Department of Manufacturing Systems and Automation

Liberec 2023



## Master Thesis Assignment Form

### Design of new production line for system units

*Name and surname:* **Zertehun Birhanu Teshome**  
*Identification number:* S21000346  
*Study programme:* N0788A270005 Innovation and Industrial Engineering  
*Assigning department:* Department of Manufacturing Systems and Automation  
*Academic year:* 2022/2023

#### Rules for Elaboration:

The aim of the thesis is to design a manufacturing line of systems units in DZ Dražice while meeting both customer demand and company resource constraints.

The following procedure is recommended when processing the work

1. Introduction to principles of designing and optimizing material and information flows and design of manufacturing systems.
2. Analysis of the current state of the manufacturing system base on selected KPIs. The analysis will include a necessary technical description of the representative, material and information flow, customer demands and manufacturing system constraints.
3. Design of manufacturing system in chosen detail of the process operation.
4. Design of production plan (e.g. production levelling for set manufacturing constraints, production resources utilization)
5. Design of manufacturing workplaces and production line layout plan considering ergonomic and space constraints.
6. Evaluation of designed manufacturing system based on selected KPIs.

*Scope of Graphic Work:*  
*Scope of Report:* 50-65  
*Thesis Form:* printed/electronic  
*Thesis Language:* english

### **List of Specialised Literature:**

- [1] TOMPKINS, James A., John A. WHITE, Yavuz A. BOZER a J. M. A. TANCHOCO. *Facilities planning*. Fourth edition. Hoboken: John Wiley & Sons, [2010]. ISBN 978-0-470-44404-7.
- [2] STEPHENS, Matthew P. a Fred E. MEYERS. *Manufacturing facilities design and material handling*. Fifth edition. West Lafayette, Indiana: Purdue University Press, [2013]. ISBN 978-1-55753-650-1.
- [3] DORF, Richard C. a Andrew KUSIAK, ed. *Handbook of design, manufacturing and automation*. New York: Wiley-Interscience Publication, John Wiley & Sons, [1994]. ISBN 0-471-55218-6.
- [4] BAUDIN, Michel. *Lean assembly: the nuts and bolts of making assembly operations flow*. New York: Productivity Press, 2002. ISBN 1-56327-263-6.
- [5] IRANI, Shahrukh A., ed. *Handbook of cellular manufacturing systems*. New York: John Wiley, [1999]. ISBN 0-471-12139-8.

*Thesis Supervisors:* Ing. František Koblasa, Ph.D.  
Department of Manufacturing Systems and  
Automation

*Date of Thesis Assignment:* November 20, 2022  
*Date of Thesis Submission:* May 20, 2024

doc. Ing. Jaromír Moravec, Ph.D.  
Dean

L.S.

Ing. Petr Zelený, Ph.D.  
Head of Department

## Declaration

I hereby certify, I, myself, have written my master thesis as an original and primary work using the literature listed below and consulting it with my thesis supervisor and my thesis counsellor.

I acknowledge that my master thesis is fully governed by Act No. 121/2000 Coll., the Copyright Act, in particular Article 60 – School Work.

I acknowledge that the Technical University of Liberec does not infringe my copyrights by using my master thesis for internal purposes of the Technical University of Liberec.

I am aware of my obligation to inform the Technical University of Liberec on having used or granted license to use the results of my master thesis; in such a case the Technical University of Liberec may require reimbursement of the costs incurred for creating the result up to their actual amount.

At the same time, I honestly declare that the text of the printed version of my master thesis is identical with the text of the electronic version uploaded into the IS/STAG.

I acknowledge that the Technical University of Liberec will make my master thesis public in accordance with paragraph 47b of Act No. 111/1998 Coll., on Higher Education Institutions and on Amendment to Other Acts (the Higher Education Act), as amended.

I am aware of the consequences which may under the Higher Education Act result from a breach of this declaration.

December 6, 2023

Zertehun Birhanu Teshome

## ACKNOWLEDGMENT

I sincerely thank my supervisor **Ing. František Koblasa Ph.D.**, from the Department of Manufacturing Systems and Automation. His experience enabled me to complete the research and compose this thesis. I also thank **Ing. Petr Zeleny Ph.D.**, Hade of Department.

I would also like to thank Milan Šimáček Hade of Technology at Dražice-strojírna s.r.o. for his professional support during my research work.

I want to thank the Czech Ministry of Education, Youth, and Sport and the Czech Embassy in Addis Ababa, Ethiopia for helping to arrange my scholarship at the Technical University of Liberec.

I want to thank my friends and family for their unwavering love and support during my academic journey.

## ANNOTATION OF MASTERS THESIS

This Master's thesis focused on improving the layout design for a new production line at Dražice-strojírna s.r.o. With a focus on optimizing a process considering production volume and human factors. The assembly cell design supported by analytical tools and KPIs evaluation will follow a project-based methodology, it integrates Line Six Sigma, Ergonomics, Material flow rules, and process analysis. The thesis analyzes the current state, design assembly operations, and methods for work measurement analysis, and standardization. It includes time analysis, addresses line-balancing problems, and implements a spaghetti diagram for visualization process flow. This thesis concludes with a final evaluation, providing insights into effective production line design and improvement.

### Key Words

Lean, KPIs, optimization, assembly operations and time study, rebalancing, and re-layout.

## ANOTACE DIPLOMOVÉ PRÁCE

Diplomová práce se zaměřila na zdokonalení dispozičního řešení nové výrobní linky ve společnosti Dražice-strojírna s.r.o. Se zaměřením na optimalizaci procesu s ohledem na objem výroby a lidský faktor. Návrh montážní buňky podporovaný analytickými nástroji a vyhodnocováním KPI se bude řídit metodikou založenou na projektu, integruje Line Six Sigma, ergonomii, pravidla toku materiálu, analýzu procesů. Práce analyzuje současný stav, navrhuje montážní operace a metody pro analýzu měření práce a standardizaci. Zahrnuje časovou analýzu, řeší problémy s vyvažováním linek a implementuje špagetový diagram pro vizualizaci toku procesu. Tato práce je zakončena závěrečným zhodnocením, které poskytuje vhled do efektivního návrhu a zlepšování výrobních linek.

Klíčová slova

Štíhlá výroba, KPIs, optimalizace, montážní operace a časová studie, rebalancování a re-layout.

## Contents

1	INTRODUCTION.....	15
2	THEORETICAL PART .....	16
2.1	Optimization of Manufacturing System Methodologies .....	16
2.1.1	DMAIC Method .....	16
2.1.2	Plan- Do-Check- Act (PDCA).....	17
2.1.3	P/Q diagram analysis.....	18
2.1.4	Pareto Analysis.....	19
2.2	Design of Manufacturing Systems .....	20
2.2.1	Product (or Flow-line or Production-line) Layout.....	22
2.2.2	Process Oriented Layout.....	23
2.2.3	Group Technology (GT) (or Cellular) Layout.....	23
2.2.4	Fixed layout/ static product layout .....	24
2.3	Manufacturing system analysis .....	25
2.3.1	Value Stream Mapping.....	25
2.3.2	Process Analysis.....	26
2.3.3	Spaghetti diagram.....	28
2.4	Work analysis and standardization.....	28
2.4.1	Predetermined time systems .....	29
2.4.2	Movement Analysis.....	31
2.4.3	Standardization Based on Chromomeric .....	31
2.5	Assembly product analysis .....	32
2.5.1	Bill of Material .....	32
2.5.2	Assembly diagram.....	33
2.5.3	Precedence diagram.....	34
2.6	Line Balancing Problems .....	36
2.7	Standardization of manufacturing system .....	38



# FACULTY OF MECHANICAL ENGINEERING TUL

2.7.1	KPIs – Key Performance Indicators .....	38
2.7.2	Ergonomics.....	42
3	PRACTICAL PART.....	43
3.1	Company Introduction.....	44
3.2	Product description.....	46
3.3	Optimization Goal - KPI .....	46
3.4	Analysis of the current state of the production process .....	48
3.5	Technological Process .....	49
3.6	Bill of Material for Assembling System Unit Lucie.....	50
3.7	Assembly Diagram of System Unite Lucie .....	54
3.8	Dependency Diagram System unit LUCIE .....	55
3.9	Current State Assembly system unit layout.....	58
3.9.1	Process Analysis.....	59
3.9.2	Value-added and non-value-added Analysis of Current State.....	62
3.9.3	Spaghetti Diagram.....	64
3.10	Time Analysis of Assembly operations.....	66
3.10.1	Line Balancing Diagram of Current state.....	68
3.10.2	Analysis of the Bottleneck in the current Layout .....	70
4	Designing a New Layout for System Unite and Balancing.....	73
4.1	Line balancing Problems .....	73
4.2	Rebalancing and Designing layout .....	74
4.3	Process Diagram.....	81
4.4	Value added and non-value-added Analysis.....	82
4.5	Designing the layout of Assembly line.....	88
4.6	Layout Proposition .....	88
4.7	Suggested Layout A .....	89
4.7.1	Spaghetti Diagram.....	91
4.7.2	KPIs Calculation Variant A.....	92
4.8	Suggested layout B.....	94

# FACULTY OF MECHANICAL ENGINEERING TUL

4.8.1	Spaghetti Diagram.....	95
4.8.2	KPIs Calculation Variant B.....	96
4.9	Suggested Layout C.....	98
4.9.1	Spaghetti Diagram.....	99
4.9.2	KPIs calculation Variant C.....	100
4.10	Comparison of the system unit layouts.....	101
4.10.1	Multi-Criteria Analysis.....	101
4.10.2	Ergonomic .....	106
5	Conclusion.....	108
	References .....	110
	Appendices .....	112

## LIST OF FIGURES

Figure 1:DMAIC Progress [own].....	17
Figure 2: PDA process [2].....	18
Figure 3:A Pareto analysis diagram [5].....	19
Figure 4: Flow-line or Production-line [7].....	22
Figure 5: Bill of Material [2].....	32
Figure 6:Line Balancing Chart before and after improvement [1].....	37
Figure 7:Company Logo Družstevní závody Dražice-Strojírna s.r.o [18].....	44
Figure 8: View of the finished product (LUCIE 200) [13] .....	46
Figure 9:Over all Routing Diagram [Own] .....	48
Figure 10:LUCIE Water heater components assembly diagram [Own] .....	54
Figure 11:Dependency Diagram System unit LUCIE [Own] .....	55
Figure 12:Current State Assembly Line layout [Own] .....	58
Figure 13:Process Analysis Indicator [Own] .....	61
Figure 14:Percentage of activities VA & NVA[Own] .....	63
Figure 15:Current State layout Spaghetti Diagram [Own].....	64
Figure 16 Current state Balancing Diagram [Own] .....	68
Figure 17 Electro connection line balancing within 3 task group [Own] .....	71
Figure 18:Balancing diagram .....	80
Figure 19:Graphical representation of the new process diagram snapshot .....	82
Figure 20:VA / NVA Current State Analysis [Own] .....	87
Figure 21:Suggested Layout A [All dimensions are in Centimeter] [Own].....	89
Figure 22: Layout A Spaghetti diagram [Own].....	91
Figure 23: Stationary FIFO rack [20].....	93
Figure 24: Suggested Layout B [All dimensions are in Centimeter] [Own].....	94
Figure 25:Spaghetti Diagram for Suggested line layout B [Own] .....	95
Figure 26:FIFO Rack with Wheels [21].....	97
Figure 27: Layout Suggested C [All dimensions are in Centimeter] [Own].....	98
Figure 28: Spaghetti Diagram C [Own] .....	99
Figure 29: Multi-Criteria Analysis [Own].....	103
Figure 30:Euro Kraft Basic Scissor Lift Truck [22].....	107

## LIST OF TABLES

Table 1:Basic Most Sequence Model [3] .....	30
Table 2: Line balancing Problem [1].....	37
Table 3:Key performance Indicators [16] .....	39
Table 4: Key Performance Indicators [16] .....	40
Table 5:Key performance Indicators [16] .....	40
Table 6::Key performance Indicators [16] .....	41
Table 7:Selected KPIs [Own].....	47
Table 8:Internal Produce Items [Own].....	49
Table 9:Heating Element Bill of Material [19] .....	50
Table 10:Cover Bill of Material [19] .....	50
Table 11:Insulated Vessel Bill of Material [19].....	51
Table 12: Electro Connection Bill of Material [19] .....	52
Table 13:Container Bill of Material [19] .....	53
Table 14:Task Description and Used tool of Insulated Vessel [Own].....	56
Table 15:sk Description and Used tool of Heating Element [Own].....	56
Table 16:Table 15: Task Description and Used tool of Wirring [Own] .....	57
Table 17:Task Description and Used tool of Cover [Own].....	57
Table 18:Current State Process Analysis [Own].....	59
Table 19: Current state Process Analysis [Own].....	60
Table 20:Frequency of each process description [Own] .....	61
Table 21: Value added and Non value added Activitys[Own].....	62
Table 22:Frequency of Value-added and Non-Value-added [Own] .....	63
Table 23:Station one cycle time [Own].....	66
Table 24: Station three cycle time [Own] .....	66
Table 25:Station Four cycle time [Own].....	67
Table 26: Station two cycle time [Own] .....	67
Table 27:Takt Time and Demand [Own] .....	68
Table 28:Current Layout KPIs [Own].....	69
Table 29:Analysis of a bottleneck Electro Connection operation (G-1) [Own].....	70
Table 30:Analysis of a bottleneck Electro Connection operation (G-1) [Own].....	71

# FACULTY OF MECHANICAL ENGINEERING TUL

Table 31:Takt Time Calculation [Own] .....	73
Table 32: Operation time of The New Layout [Own].....	74
Table 33:Time Measurement [Own] .....	75
Table 34:Time Measurement of station 2 [Own] .....	75
Table 35:Time Measurement of station 3 [Own] .....	76
Table 36:Time Measurement of station 4 [Own] .....	77
Table 37:Time Measurement of station 5 [Own] .....	78
Table 38:Time Measurement of station 6 [Own] .....	79
Table 39:Time Measurement of station 7 [Own] .....	79
Table 40:Process diagram snapshot [Own] .....	81
Table 41: Value added and non-value-added Tasks [Own] .....	83
Table 42:Value added and non-value-added Tasks [Own] .....	84
Table 43:Value added and non-value-added Tasks [Own] .....	85
Table 44:Value added and non-value-added Tasks [Own] .....	86
Table 45: VA / NVA Current State Analysis [Own].....	87
Table 46: Operation and Predecessor in layout A[Own] .....	90
Table 47: KPI calculation Layout A[Own] .....	92
Table 48:KPIs Calculation of Layout B [Own].....	96
Table 49:KPIs Calculation of Layout C [Own].....	100
Table 50: Multi-Criteria Analysis [Own].....	102

## List of Abbreviation

5S	-	Sort, set in order, Shine, Standardize, Sustain
BVAT	-	Business value added time
CIM	-	Computer-Integrate Manufacturing
CO	-	Change Overtime
CT	-	Cycle Time
DMAIC		Define, Measure, Analyze, Design and Verify
FA	-	Factory Automation
GT	-	Group Technology
KPIs	-	Key Performance Indicators
MODAPTS	-	Modular Arrangement or Perming Time standard
MOST	-	Maynard Operation Sequence Technique
MTM	-	Methods Time Measurement
MCDM		Multi Criteria Decision Making
NVAT	-	Non-Value-added time
OEE	-	Overall Equipment Effectiveness
PDCE	-	Plan-Do-Check-Act
PFD	-	Personal, Fatigue, and delay
PLT	-	Production Lead Time
SMAD	-	Single Minute Exchange of Die
VA Index	-	Value Added Index
VAT	-	Value added time
WIP	-	Work in Progress

## 1 INTRODUCTION

This project deal with design of new production line for Dražice CZ s.r.o company for the new system unit. By analyses the current layout including the process flow in the line, by considering work process of each operation and time and motion study for each process and measure the line capacity, and design assembly line by considering sequence of operation, design of material flow value stream mapping, ergonomic, space constraints, and six sigma and 5s. A better design of a production system will increase the productivity and will elimination some None value-added items such wastes in the industries, unwanted motion, unwanted production line, etc.

In order to design production line for the system unit, common methods of production line design in manufacturing industries include solving line balancing problems.

Waste minimization and line balancing are inextricably linked. By reducing idle time, it reduces time to waste. Less time spent on services also results in lower overtime expenses. A balanced production line, thus, lowers the resources of the production line, for example, by reducing the number of workstations.

With more and more demands placed on production, companies are trying to expand the production line into so-called production lines for new system unit. A distinctive feature of such lines is, that at the input there is a material in the form of a semi-finished product and at the end of the line we have a water heater that can be dispatched immediately to the customer. All these facts are enjoyed by the management of Dražice CZ s.r.o. Realizes and gradually invests considerable amounts in the modernization of production (robotization, automation, optimization, etc.). The assignment of the diploma thesis consists in analyzing the existing production of the WATER HEATER and the subsequent design of a new Assembly line. The aim of the diploma thesis is to design assembly line for new system unit. The reason for the assignment was mainly an increase in demand for water heater from the customer.

## 2 THEORETICAL PART

This chapter will progressively introduce and explain the methods that are used in the diploma thesis. The goal is how to select representative. The theoretical part of this work is focused on acquainting the reader with methodologies used in the practical solution of the project described in this work. They are explained below basic concepts related to methods and project. Most of the tools and methods used in solving the described project are focused to eliminate waste, speed up the process and line balancing problem. Mentioned below the tools are based on the Lean methodology - i.e., Product portfolio Analysis, lean production, Six Sigma, DMAIC, Manufacturing system, Assembly operation design, Method of work measurement Analysis and standardizing, Ergonomics, Value stream mapping, methodology used. It was decided because it clearly and simply sets the direction and the progress of the project being developed. In the practical part, dealing with the Design of assembly line for new system unit the main one's tools used: time frames of the working day, creation of Spaghetti diagrams, and Pareto analysis. All tools are used to detect weaknesses, waste in the process, and for the subsequent design of a new layout of the entire workplace.

### 2.1 Optimization of Manufacturing System Methodologies

Two major methodologies are usually used in continues improvement environment. DMAIC is focusing on improvement projects, PDCA on itself continues improvement process.

#### 2.1.1 DMAIC Method

This method arose with the demand for constant improvement in various areas processes not only in production. The method is divided into 5 phases

1. *D-Define*: First of all, at the first stage it is necessary to define the goals that we want to achieve. We describe the state, assemble a team of workers, create a schedule and a solution procedure.
2. *M-Measure*: The aim is to collect the necessary information and data on the current solution (e.g., monitoring when manufacturing defects occur). This section also includes the compilation of a measurement system (MSA) and the determination of repeatability and reproducibility.
3. *A-Analyze*: The information and data that we have obtained in the previous paragraph, it is necessary to thoroughly analyze and evaluate. The goal is to uncover the underlying root causes of the problem.



4. *I-Improve*: At this point, the goal, after revealing the causes, is to create, try and possibly implement a suitable solution, with the help of which the causes of the appearance of defects will be eliminated.
5. *C-Control*: If the measures (solutions) put in place take hold (set out in the previous point. "I") and will help to eliminate the problem, it is necessary to ensure their compliance. It is opportune to it set out the length of the period for monitoring compliance.[1]

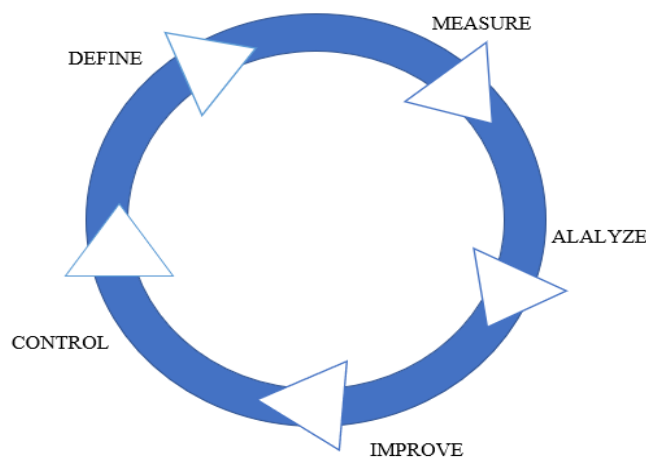

Figure 1:DMAIC Progress [own]

## 2.1.2 Plan- Do-Check- Act (PDCA)

The Deming cycle, commonly known as the Plan-Do-Check-Act technique, is scientific approach to manage change in 1950s, Dr. W. Edwards Deming created it. There are four parts to the "PDCA" cycle. [2]

- Plan – Recognize an opportunity or process that needs improvement.
- Do – Create a small test.
- Check – Analyze the results of the test.
- Act – Move forward based on those results.

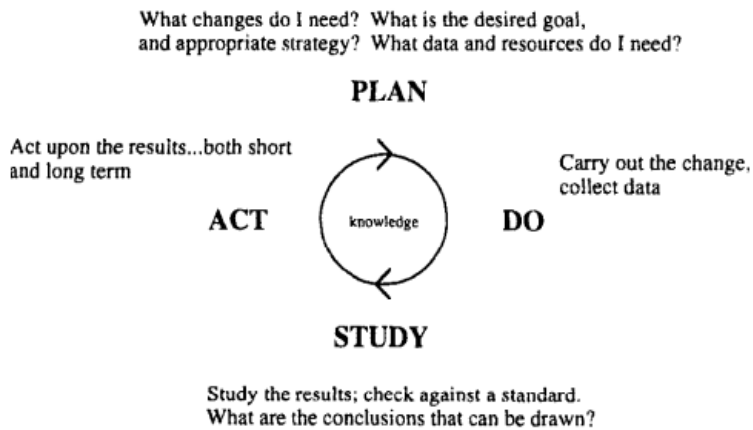

Figure 2: PDA process [2]

### 2.1.3 P/Q diagram analysis

In production design the relationship between a product is quality and the manufacturing process parameter is determined using the product or quality (P/Q) diagram analysis. Also, can identify optimal process parameters that result in the highest quality product and areas where product quality is suboptimal. Corrective measures can then be implemented, such as adjusting process parameters to improve product quality and reduce waste. This P/Q diagram analysis is an essential tool for designing a production to optimize product quality and production efficiency.

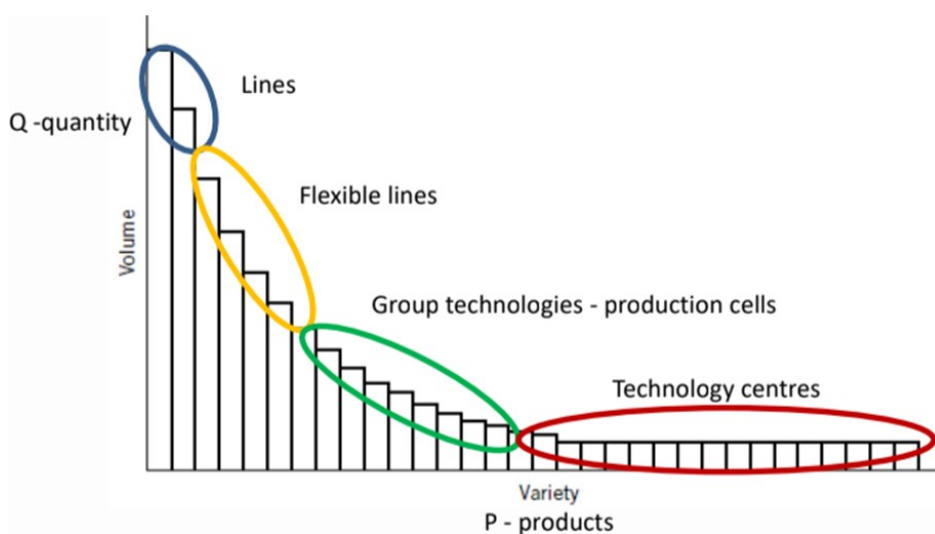

Figure 3: P/Q diagram [3]

## 2.1.4 Pareto Analysis

The Pareto Principle (also known as the 80-20 rule) states that for many phenomena, about 80% of the consequences are produced by 20% of the causes. According to Pareto's principle, there is in any group of elements causing some effect, a relatively small number of members that cause most of the effect. Pareto's principle is used as a method for decision-making or management. Managers plan, organize, lead teams and perform many other activities first of all, by making some decisions. However, a quick but unsuccessful decision causes losses, on the contrary, an effective decision can make a profit. Therefore, the investigator should be more focused on investigating the problem than to make a rash decision.

For a brief understanding of Pareto's 80:20 principle, need to clarify the distinction between efficiency and effectiveness. Effectiveness represents the extent to which they are planned activities implemented and planned results achieved. In other words, doing the right thing, that is, producing the desired benefit, purpose or effect. Efficiency represents the relationship between the results achieved and the resources used. It means that efficiency is the ratio between the outputs and the inputs of an activity or system.

Examples of Pareto's principle: Organization - 80 % of the work is done by 20 % of people, 20 % of meetings will bring 80 % useful thoughts. Quality - 20 % of defects cause 80 % of all problems. Shop - 80 % of sales are from 20 % of customers. Warehouses - 20 % of items occupy 80 % of warehouse space (ABC analysis). [4]

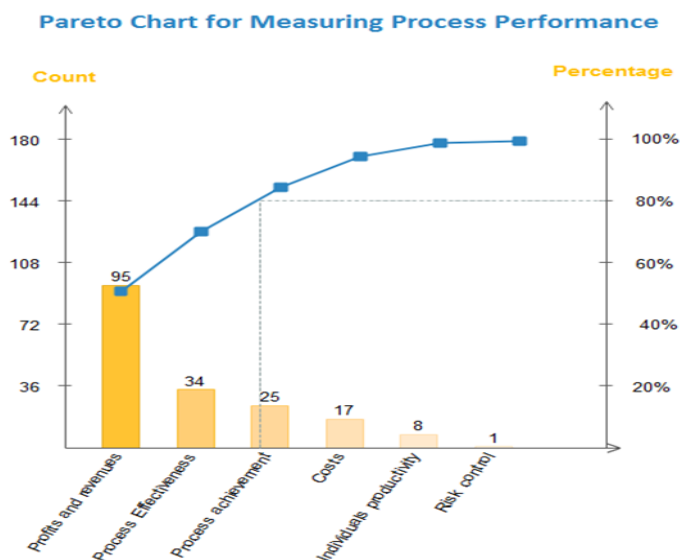

Figure 3:A Pareto analysis diagram [5]

A Pareto analysis diagram is a type of stratified graph, which is a factor in the development of a Pareto a certain amount of time according to the size of the time of the time of the time of the time of the time. This is a helping reveal the so-called essential minority of the element (vital few) and trivial majority (trivial many). A substantial minority are the factors that provide the most attention, as opposed to trivial ones most of these are factors that are well known, but these factors are relatively minor. Pareto analysis is applicable in many applications, but it is necessary to establish correct initial analysis and understand the problem. [6]

The Pareto diagram (Figure 3) is a form of graph that aids in illustrating the relative frequency or effect of several categories of defects. An improvement effort can be selected by using Pareto diagram to better understand the relative prevalence of various category. The y-axis of a Pareto diagram often shows frequency of occurrence. Overall, the pareto diagram is a valuable tool for prioritizing efforts to solve the most significant problems and prioritizing effects to address them. [6]

## 2.2 Design of Manufacturing Systems

Layout planning is commonly done in a compromise way, and a best layout plan is selected from among several alternatives. An effective method from the practical standpoint is **systematic layout planning** (SLP). The modified SLP pattern is represented in Figure. In this layout process five key factors are important: product (P), quantity (Q), routing (R), supporting services, and time. The layout decision proceeds as follows: (1) inputting these five data, (2) determining the flow of materials, investigating the activity relationships, (4) drawing a flow and activity relationship diagram, (5) determining space, (6) creating a space relationship diagram, (7) adjusting the diagram, (8) conducting an optimization analysis, and (9) evaluating and determining the best layout. [2]

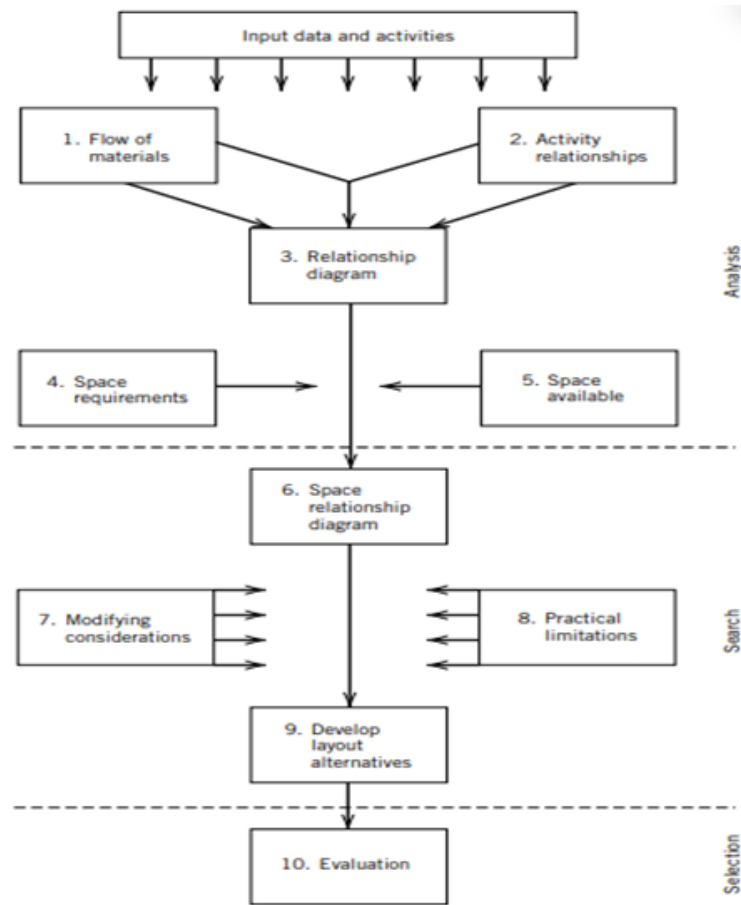

Figure 5: Systematic Layout Planning (SLP) procedure [2]

On bases of the input data and an understanding of the roles and relationships between activities, a material flow analysis and an activity relationship analysis (activity relationship chart) are performed. From the analyses performed, a relationship diagram is developed (Figure 5). The structure of manufacturing system, the plant layout pattern is basically decided by the relationship between the number of products  $P$  and the production quantity  $Q$  [Figure 3]. Some of the objectives of the plant layout process:

- Minimize investment in equipment.
- Minimize overall production time.
- Utilize existing space most effectively.
- Provide for employee convenience, safety, and comfort.
- Maintain flexibility of arrangement and operation.
- Minimize material handling cost.

- Minimize variation in types of material handling equipment.
- Facilitate the manufacturing process.
- Facilitate the organizational structure

Based on their product type and production requirements, the factory layouts are divided into four categories. Fixed layout/static product layout, Product layout / production-line layout, Process layout / functional layout, Group layout/group technology layout / cellular layout.[2]

## 2.2.1 Product (or Flow-line or Production-line) Layout.

In the case of a large Q:P ratio, continuous mass production is justified. Production facilities and auxiliary services are located according to the process route for producing the product, generating the linear material flow.

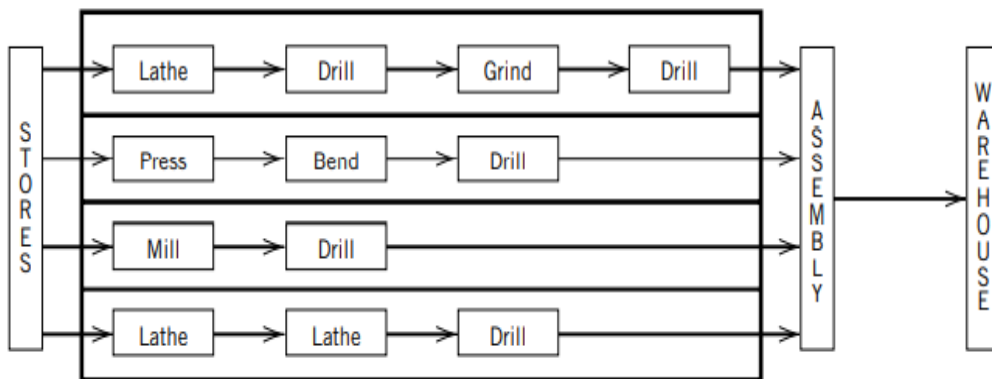

Figure 4: Flow-line or Production-line [7]

It results when processes are located according to the processing sequence for the product. Material flows directly from a workstation to the adjacent workstation. Product layouts are employed when one or a few standardized products with high volume are produced.

## 2.2.2 Process Oriented Layout

When a factory has a low Q:P ratio, jobbing, or small-lot (batch) Manufacturing, Similar type of machinery are grouped together as work centers in a single section. Here, there is an uneven material flow, which lowers production.

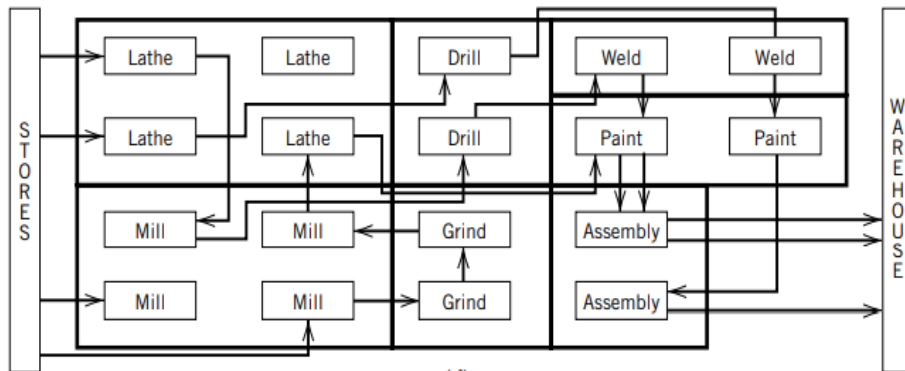

Figure 7: Process or Functional Layout [7]

A process layout groups all of the machines that are used in a specific process together. As much it made up of a group of processing divisions or calls. Process layouts are employed when the large number of distinctness, low value of products are produced. High level of interdependent flow define process layout .[7]

## 2.2.3 Group Technology (GT) (or Cellular) Layout

In the case of an average Q :P ratio, when a great variety of products can be grouped into several families, these families are manufactured as lots of similar parts, and machines are arranged to meet this type of production, thereby resulting in higher productivity. This is a pattern of layout between the above two patterns.

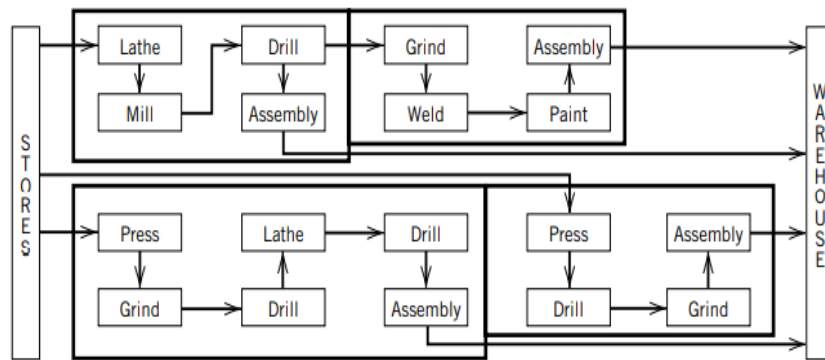

Figure 8: Group Technology or cellular layout [7]

It is applied when product layouts cannot be justified by the production volumes for individual goods. However, a product layout can be justified for the family by classifying products into logical product groups. The group layout typically has a high degree of interdepartmental flow; it is a compromise (middle term) between the product layout and the process layout. It possesses both the efficiency of the product layout and the flexibility of the process layout. [7]

**2.2.4 Fixed layout/ static product layout**

It is used when the product is too large or cumbersome (massive) to move through the various processing steps. Rather than taking the product to the processes, the processes are brought to the product.

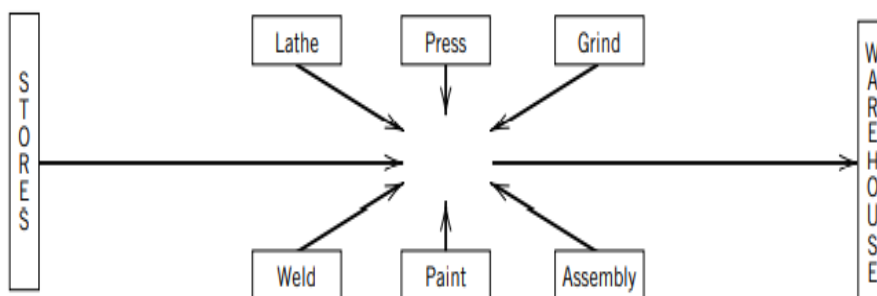

Figure 9: Fixed Production Layout [7]

**Layout Procedures**

Facility planners used different methods to develop layout alternative and this method can be grouped in to two main categories: construction type and improvement type. Constriction



layout methods involves creating a new layout from scratch. While improvement producers focus on enhancing existing layout to generate alternative. [2]

The most important single phase of the entire layout process. It incorporates the following.

1. Flow process, including operations, transportation, storage, and inspections
2. Standard times for each operation
3. Machine selection and balance
4. Manpower selection and balance
5. Material handling requirements.

## **2.3 Manufacturing system analysis**

Manufacturing system analysis is a systematic approach of all aspects within production system to enhance efficiency and productivity. It involves evaluating components, process and interaction using tools like process mapping and time study. The goal is to eliminate bottleneck and optimized process usage and improve overall performances. By integrating principle of lean manufacturing and considering factors like human ergonomics and environmental impact, this analysis aims to create an agile, cost effective and suitable manufacturing system. Continuous improvement is a key focus, ensuring a system remains responsive to change demand while maintaining high quality standard. [8]

### **2.3.1 Value Stream Mapping**

To analyze and optimize the complete process, firms utilize value stream mapping, a technique derived from lean manufacturing, to generate a visual guide of all the components required to deliver a product or service. Application: A value stream map is made by taking all the required personnel, procedures, data, and inventories and arranging them in a flowchart manner. Organizations can use lean concepts to cut waste in particular process areas by visualizing every component involved in producing a good or service. An example of a typical value stream map may be seen below. [9]

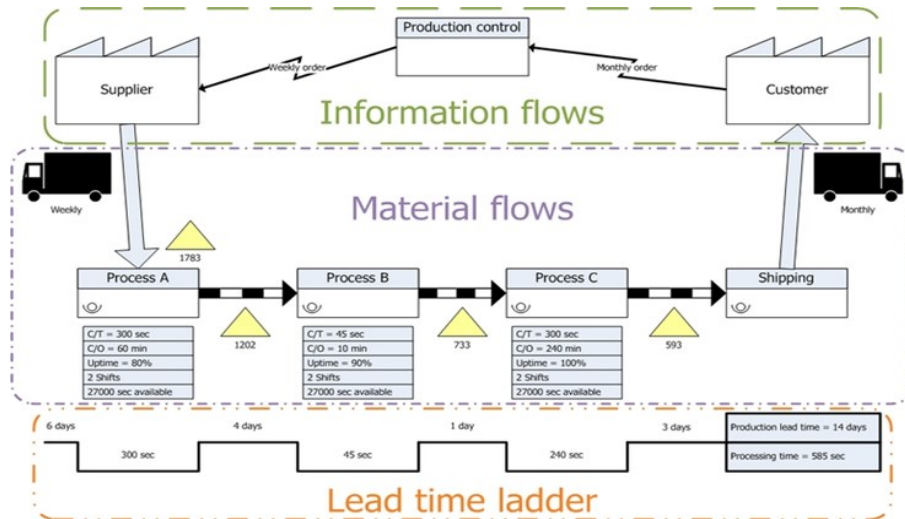

Figure 10: Value Stream Mapping [9]

There are 4 main steps in construction of a value stream map. They are as follows, Step 1. Define the current state: Map the existing process from start to finish and collect data on lead times and cycle time. Step 2. Create the future state: Design an optimized and improved version of the process and set the goals for enhanced efficiency and waste reduction. Step 3. Plan and implement the future state: Develop an action plan for implementing change. Step 4. Review and Continuously Improve: Monitor performance against goals, gather feedback and make ongoing adjustment, and used VSM as dynamic tool for continuous improvement. [10]

Applications: Value stream mapping can be applied to your organization by methods such as:

- Encouraging continuous improvement in processes
- Enabling culture change within an organization
- Facilitating clear collaboration and communication [10]

### 2.3.2 Process Analysis

Process analysis means the preparation of work detail plan; with the use of process flowcharting the main component of the process can be illustrated. The purpose of the process flow diagram is to document the procedural steps of the standard process, although it can also be used to design the "ideal" process. As such, it is useful to uncover possible duplications, delay points, and omissions and serves as a starting point for further methods and time studies. It is an essential tool for identifying opportunities for data collection and subsequent process improvement. Basic components of process flowcharting include operation, customer

decision points, and storage places. With the aid of these components, the process analysis starts. [7]

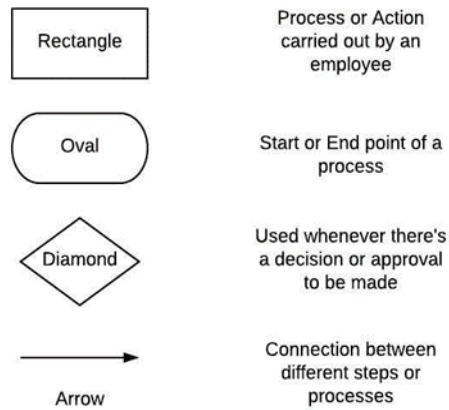

Figure 11: Process flow symbol [7]

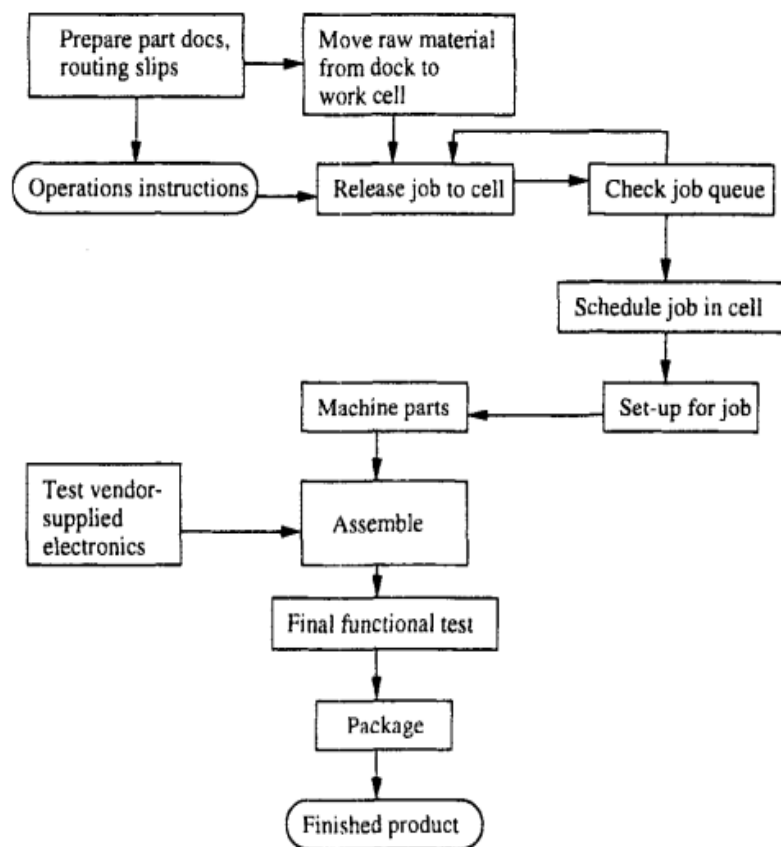

Figure 12: Process flow Diagram of electromechanical part [6]

The process flow diagram (Figure 12) can be used to construct the “ideal” process but it is primarily used to record the procedural phases of the standard process. As such it provides a foundation for other techniques and time studies and it helpful in identifying potentials duplication delay. Additionally, it provides a foundation technique and time study. It can be used to detail process change and convey the step of the process to other internal and external entities. It is a crucial structure for locating chances for data collection and ensuring process enhancement. Poor detail inflow diagram may be a sign that process expertise is lacking. [6]

### 2.3.3 Spaghetti diagram

Spaghetti diagram is a method used to display movement of elements in the system. It is part of the time studies that fall within the methodologies of the industrial engineering, commonly used tool Lean Six Sigma. The diagram can show the movements of people, materials or documentation, these flows they are depicted using lines that describe the movement of an object by a given system. The system is understood the environment in which the measured objects move, it can be a workplace, production hall or part of the building. So, the lines are plotted into the plan - layout of the given workplace. Different colors distinguish flows of movements of individual workers or products. An Indication diagram is shown in the below figure 13. [11]



Figure 13: Spaghetti diagram [11]

## 2.4 Work analysis and standardization

Work analysis and standardization are integral aspects of designing manufacturing layout. Work analysis involves a meticulous examination of tasks, workflow and job roles, identifying specific requirements and potential bottleneck. Standardization established consistence producers across manufacturing process together they inform the strategical

placement of workstation, machinery and materials in the layout, minimizing unnecessary movement and optimizing production flow. This integration approaches enhance efficiency reduces cost and facilitate adaptability to change demands ultimately contributing to a streamlined and organized manufacturing environment.

## **2.4.1 Predetermined time systems**

Some study of the current layout is necessary before designing a production plan in order to determine what needs to be determine what need to be add. Value Steam Mapping. Work flow analysis (Process Analysis), Direct measurements and predetermined time system, chronometry and Day screening, Standardization based on chronometry, MTM, MOST, Basic MOST, some of the analysis methods are explained below.

### Standardization based on MTM

- MTM 1 - Basic system
  - Detailed description and definition of individual activities, movements, etc.
  - mass and mass production (within 30 seconds)
- MTM 2 - More detailed
  - For each hand separately.
- MTM-SD (Standard Dated: MTM)
  - for serial production - stationary workplace
  - presses, welding shops and for manual work with a repeating cycle
- MTM-UAS (Universal's Analyzer system)
  - Batch production, long operating times (more than 4 minutes)
- MTM - MEK (MIM für die Enisle- und Kleines're flirting)
  - Measurement of a small number of repetitive activities in piece production
  - Long operating time (more than 21 minutes)
- Other standards (Logistics, Ergonomics)

### MOST

#### **Maynard Operation Sequence Technique**

- Does not process individual movements, but sequences of movements

(models)

- It divides the activities into four motion models of sequence.
- MOST uses uppercase letters and index numbers.
- Each indexed letter represents a certain type of movement.
- Each model is evaluated in dependence on difficulty [12]

### Basic MOST - Sequential model

**A** Motion Distance, **B** Body Moment, **G** Getting Control, **P** Place in location

**M** Controlled Motion, **X** Process Time, **I** Alignment

Basic MOST - Use of tools: A combination of general and controlled relocation to simplify the analysis of activities associated with the use of the tool. [13]

ABG ABP? ABP AND

ABG-get tool (Object)

ABP- place tool (Object)

F; L; C; S; M; R; T -use the tool ABP set a said-on object or tool A-return

<i>Activity</i>	<i>Sequence of models</i>
General movement	ABG - ABP - A
Controlled movement	ABG - MXI - A
Use of tools	ABG - ABP? - ABPA
Hand crane	ATK -FVL -VPT -AND

Table 1:Basic Most Sequence Model [3]

## 2.4.2 Movement Analysis

It is used in the process of creating more efficient processes. It is possible to improve standard motions and get positive market results by determining the duration of each procedure and allocating a certain amount of time to it. By figuring out the manufacturing product capacity, this increase productivity and efficiency and results in lower- cost, higher-quality product. [14]

*Three variables combine to produces the standard time:*

- Observed time: The amount of time required to finish the task.
- The performance rate factor: The rate at which the individual is working. While 100% of the time is slower than usual and 110% faster than usual. One skilled employee who has received observation and rating training computes this factor.
- Allowance for

$$\text{Standard Time} = (\text{Observed Time}) (\text{Rating Factor}) (1 + \text{PFD Allowance}) \quad (1)$$

## 2.4.3 Standardization Based on Chromomeric

- Specified working conditions (safety, quality).
- Defined workflow (workflow, tools, material, layout).
- Normal load (work the whole shift)
- Average employee experience (ability to perform work independently and check its correct execution).

Standard setting

$$T = OT * RF * (1 + PFD) \quad (2)$$

- **T** standard
- **OT** operation time determined by chronometry - **Observed Time**
- **RF** difficulty of work performed - **Rating Factor**
- Coefficient of safety - **P**ersonal needs, **F**atigue, and unavoi**D**able

**Delays allowance**

- **P** - individual - about 5% planned mandatory breaks do not count towards working hours!
- **F** - depending on the "ergonomics" of the workplace
- **D** - depending on machine failures, scrap, etc.

## 2.5 Assembly product analysis

Assembly product analysis is a vital manufacturing, systematically evaluating how components are assembled. It aims to optimize process, reduces production cost and improve product quantity by identifying and addressing areas of for enhancement in the assembly flow.

### 2.5.1 Bill of Material

A bill of materials, which includes details on the product structure in addition to the same information as a component list. It is known as a structure parts list. Product assembly level is typically indicated by a hierarchy in the product structure. The end product is typically indicated by level 0; subassemblies and components that feed directly into the final product are indicated by level 1; subassemblies and components that.

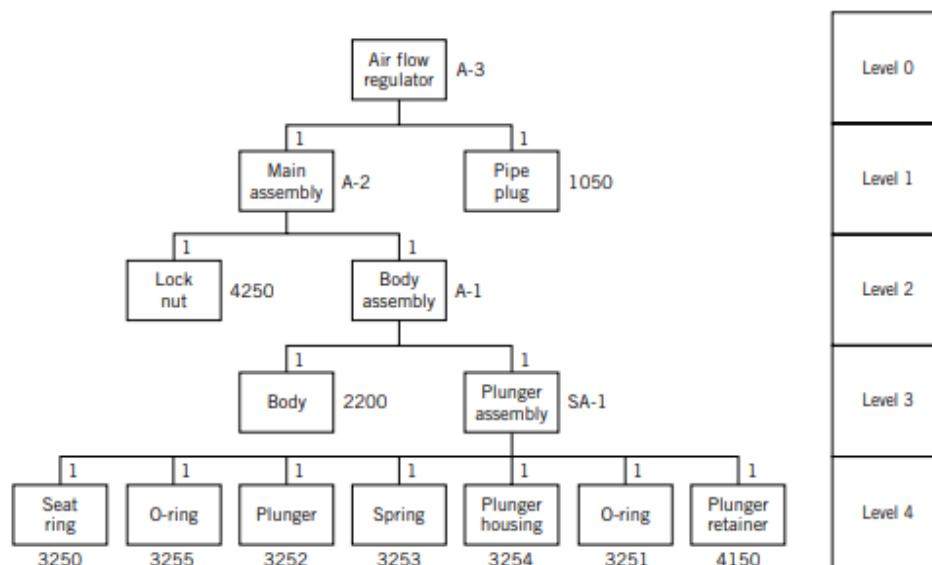

Figure 5: Bill of Material [2]

Following are make or buy decisions. Finance, Industrial engineering, marketing, process engineering, buying, and possibly human resources are among the departments that often contribute to these managerial decisions. A list of the things that are needed to be manufactured and purchased is the input that the facilities planner needs.



Selecting The requires Process: After the products to be produced within the company have been decided upon, choices must be taken regarding their manufacturing process. These choices are influenced by past performance, relevant specification, equipment production rates at the time of availability and anticipated future developments.

The steps in the process selection procedures are as follow: Describe elemental process in step 1. Step 2: Determine backup procedures for every procedure. Step 3: Examine other methods. Step 4: Create a uniform procedure. Step 5: Consider using different procedures. Step 6: Pick out procedures. [2]

Data	Production Example
Component name and number	Plunger housing—3254
Operation description and number	Shape, drill, and cut off—0104
Equipment requirements	Automatic screw machine and appropriate tooling
Unit times	Setup time—5 hr operation time—.0057 hr per component
Raw material requirements	1 in. dia. × 12 ft. aluminum bar per 80 components

Table 2: Route sheet data requirement [2]

## 2.5.2 Assembly diagram

How the product is assembled is the only process selection information that is not recorded. Figure 15 shows such documentation in the form of assembly chart. Making an assembly chart is simplest when starts with the finished product work way down to its constituent parts. [2]

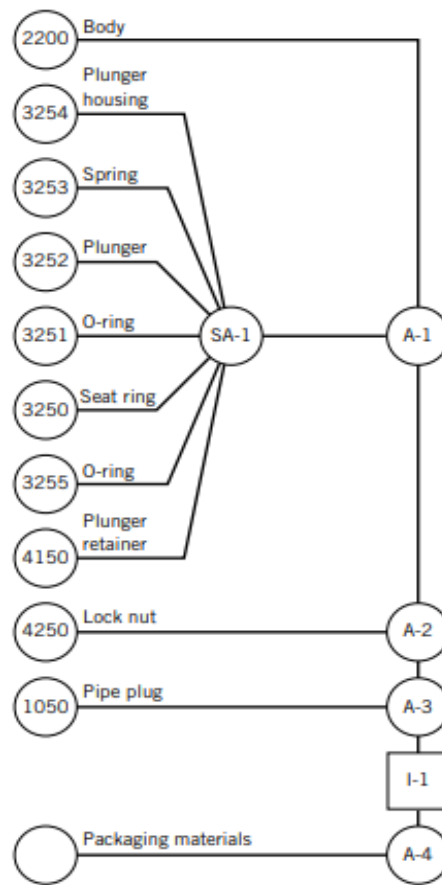

Figure 15: Assembly chart for an air flow regulator [2]

### 2.5.3 Precedence diagram

Often utilized in project planning, the precedence diagram is a directed network. In Figure 15, an air flow regulator precedence flowchart is shown. In the precedence diagram squares represent inspection and circles represent operations, while part numbers are displayed on the arcs. Figure 16 starts the procedure with a purchase operation, 0.100. Then, the components that need to be constructed first the body, plunger retainer as well as any supplies that have been acquired are shown in the diagrams center. The diagram central area represents the fabrication and assembly processes. [2]

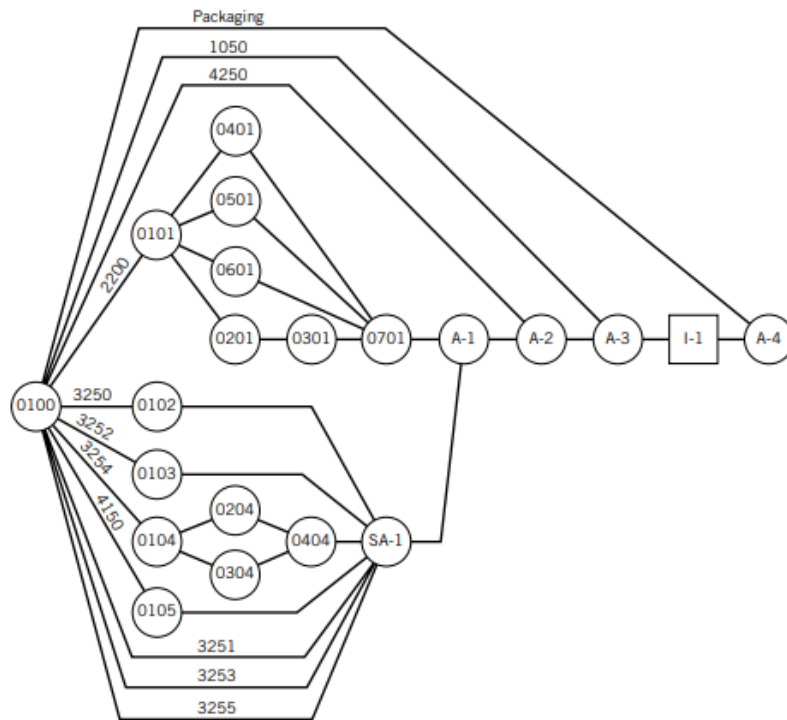

Figure 16: Precedence diagram for the air flow regulator [2]

The operations inspections and precedence relationship that must be upheld during the manufacturing and assembly of a product are decided in the precedent diagram. No decision about material handling or layout is implicit in the construction of the precedence diagram and no further restrictions are implicitly imposed or assumed on which part flows to which parts. The assembly and operation charts cannot be held to the same.

When the data is available the operation process chart can be enhanced with details on delays, storage, and transportation (including times and distances). This kind of graphic refers as a flow process chart or a process chart. Assembly charts and operation process charts may be viewed as analog models of the assembly process and the overall production process, respectively. As noted previously, circles and squares represent time, and horizontal connections represent sequential steps in the assembly of the product. [2]

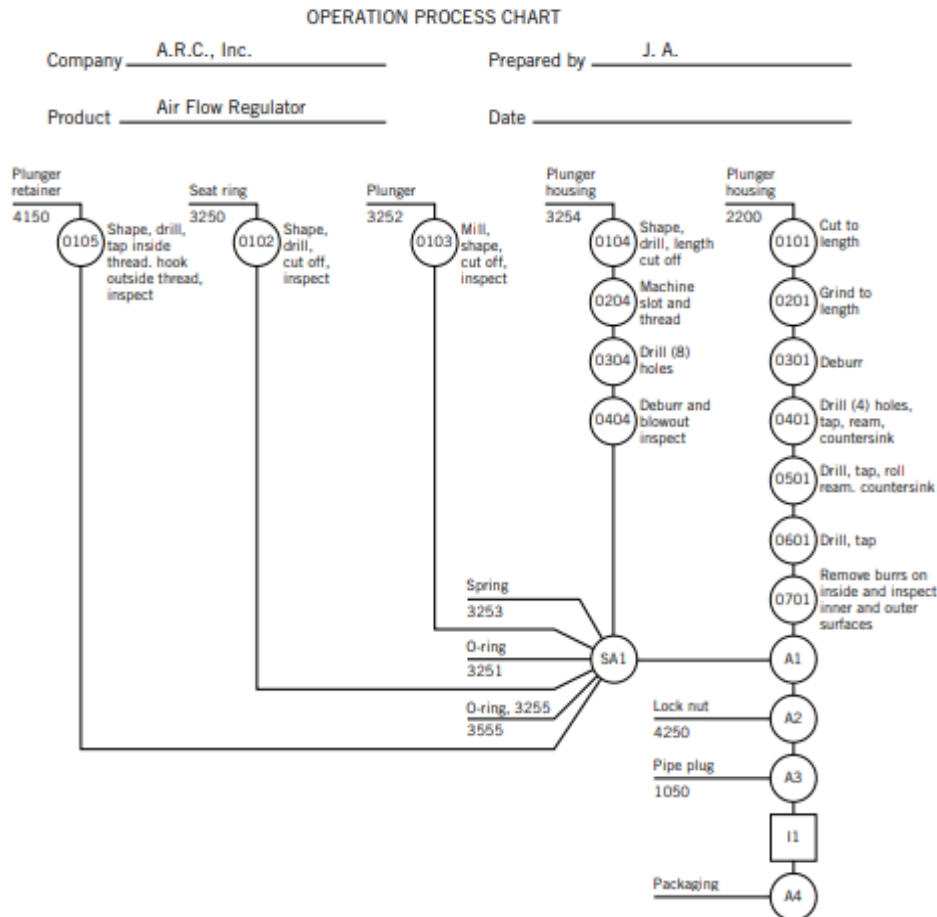

Figure 17: Operation process chart for the air flow regulator [2]

An alternative perspective, based on graph and network theory, analyzes the charts as network representations or, more precisely, as tree representations of a manufacturing process. The assembly chart and the operation process chart as particular instances of a wider graphical model called the precedence diagram is one way to approach the network viewpoint. [2]

## 2.6 Line Balancing Problems

Line balancing is a key concept in production and operation management that aims to optimize the efficiency of an assembly or production line. The primary goal is evenly distributing work load among workstation to minimize idle time and maximized productivity. This helps in achieving a smooth and efficient workflow, reducing bottleneck and improving overall system performance. The main steps for solving line balancing problems, identify

operation tasks and their time, establish task sequence and dependency, calculating desire time for the line, distributing tasks evenly among workstation, consider task and setup time for each workstation, adjust task assignment and iteratively for balance, Account for physical layout and tool availability, optimize for ergonomics and safety and implementing change and monitor efficiency. [1]

Table 2: Line balancing Problem [1]

	PROCESS 1	PROCESS 2	PROCESS 3	PROCESS 4	PROCESS 5
Available Work Time (sec/day)	81,000	81,000	81,000	81,000	81,000
Cust. Demand Rate (units/day)	55,000	55,000	55,000	55,000	55,000
<b>Takt Time (sec/unit)</b>	<b>1.473</b>	<b>1.473</b>	<b>1.473</b>	<b>1.473</b>	<b>1.473</b>
<b>Current Loading (sec/unit)</b>	<b>2.332</b>	<b>0.482</b>	<b>1.456</b>	<b>1.823</b>	<b>1.489</b>

The above table 2, shown five processes in the work cell given to only unit ABC and there is a gap between Customer takt time and current loading time.

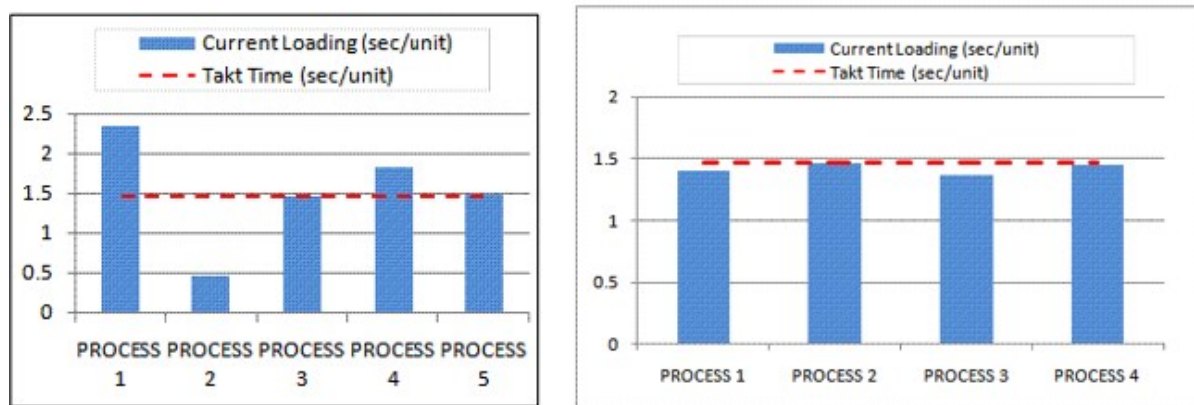

Figure 6:Line Balancing Chart before and after improvement [1]

Line balancing in manufacturing or assembly process involves distributing tasks among workstations to ensure an even workload, preventing underutilized stations. This optimization is crucial for meeting production target, minimizing time and reducing cost. Effective line balancing enhances efficiency, contribute to success of production system. [1]

## 2.7 Standardization of manufacturing system

As the fundamental basis for both operational effectiveness and product quality standardization of the manufacturing system is an essential tactic in today's industry. Manufacturers maintain consistent output increasing reliability and cutting cost through improved workflows by implementing standard producer's requirements and practices. Standardization creates a culture of continuous improvement, streamlines training, and makes regulatory complaints easier. Key components include process and product standardization is essential for modern manufacturing. [15]

### 2.7.1 KPIs – Key Performance Indicators

The abbreviation KPI (Key Performance Indicators) tells us which monitored indicators (parameters) we evaluate and then compare whether the investigated process has occurred to the desired improvement. Such parameters may include, for example: The continuous duration of the process units describing this indicator can be e.g., days, weeks, etc. This is e.g., the total time to which all time from delivery of semi-finished products to the dispatch of parts to the customer. The selected Manufacturing KPIs are elaborated on the given Table (3 up to 6).

Table 3 Provides an overview of Selected Manufacturing KPIs and their Explanation. This KPIs are essential Metrics used to assess and evaluate the performance and efficiency of manufacturing Process, by tracing these indicators can identify area of improvement and make informed decision to optimize manufacturing Operations.

The table Include each providing specific information.

*KPI Name:* This column lists the name or label of selected KPIs enabling easy identification and reference.

*Description:* The Description Column provides a brief explanation of each KPI. It highlights the particular aspect of manufacturing performance that the KPI measure and offers context for its Significance in assessing operational efficiency.

*Calculation:* In this column the table description from the formula or methodology used to calculate each KPI. It may include miasmatical equation for determining the value of the indicator.

Table 3:Key performance Indicators [16]

<i>KPI Code</i>	<i>Criteria</i>	<i>Criteria Abbreviation</i>	<i>Calculation and Unit</i>	<i>Description</i>	<i>Measure</i>	<i>Range</i>
C1	Cycle time	CT	$CT=RT/P$ P is the total units produced (parts) RT is the total run time for the parts produced (min)	Manufacturing Cycle Time is a related metric that measures the speed or time it takes to manufacture a given product. Calculate this metric by subtracting the process start time from the process end time.	Line balancing Diagram. Perform time studies.	85%, - 100%

<i>KPI Code</i>	<i>Criteria</i>	<i>Criteria Abbreviation</i>	<i>Calculation and Unit</i>	<i>Description</i>	<i>Measure</i>	<i>Range</i>
P1	Production Lead time	PLT	$PLT =WIP/TH$ Work in progress/ Throughput(min)	Production lead time is the period between a merchant's purchase order being placed and the manufacturer completing the order. A short production lead time, as it ensures customers get production quickly. - Production lead time indicator of continuous production time.	Simulation. & Value Stream Mapping.	

Table 4: Key Performance Indicators [16]

<i>KPI Code</i>	<i>Criteria</i>	<i>Criteria Abbreviation</i>	<i>Calculation and Unit</i>	<i>Description</i>	<i>Measure</i>	<i>Range</i>
TT1	Takt Time	T	$T = Ta/D$ Takt Time = Net Available Time / Customer's Daily Demand In minute	Takt time is the maximum permissible amount of time that can be spent manufacturing a product while still meeting a client's deadline	The Longest time of cycle time	85%-100%

<i>KPI Code</i>	<i>Criteria</i>	<i>Criteria Abbreviation</i>	<i>Calculation and Unit</i>	<i>Description</i>	<i>Measure</i>	<i>Range</i>
TPA	Total Production Area	PA	Calculating floor space when we have a square or rectangle room $PA = L * W$ In m2	The production area also called the area of operations, is the part of an organization that is dedicated to transforming resources or inputs into the final product that will reach the customer.	Measuring of Layout Property	standard

Table 5:Key performance Indicators [16]

<i>KPI Code</i>	<i>Criteria</i>	<i>Criteria Abbreviation</i>	<i>Calculation and Unit</i>	<i>Description</i>	<i>Measure</i>	<i>Range</i>
N1	Number of workers	NW	No operators needed = Cycle time/Takt	Calculate the number of operators may involve using labor standards and performance data, like a time-motion study, to determine the amount of time that is required for each activity, and then determining the number of operators needed based on the amount of time that each activity takes	Time-motion study or time study	85 %-100%



Table 6::Key performance Indicators [16]

<i>KPI Code</i>	<i>Criteria</i>	<i>Criteria Abbreviation</i>	<i>Calculation and Unit</i>	<i>Description</i>	<i>Measure</i>	<i>Range</i>
T1	Total traveling distance (a safe minimum mounting distance)	Ds	$Ds = [K \times (Ts + Tc + Tr)] + Dpf$ Ds = the minimum safe distance between safeguarding device and the hazard K= speed constant; 1.6 m/sec (63 inches/sec) minimum based on the movement being the hand/arm only and the body being stationary Ts = machine/equipment stopping time Tc = control system stopping time Tr = safeguarding device response time Dpf = maximum travel towards the hazard within the presence sensing safeguarding devices (PSSD) field that may occur before a stop is signaled. Depth penetration factors will change depending on the type of device and application.	Calculating the minimum safe mounting distance is vital to ensure worker safety. In addition, excessive mounting distances use up valuable floor space and can increase the time required to service machinery, which in turn reduces throughput.	From the Layout/ Spaghetti Diagram	85%-100%

These indicators ranging from the continuous duration of process units to various manufacturing metrics serves as benchmarks for assessing performances towards desired improvement. By regular monitoring and analyzing this indicator can enhances efficiency and continuously refine manufacturing process to achieve optimal outcome.

## 2.7.2 Ergonomics

Is the process of designing or rearranging positions, products, and systems to better suit the users themselves, as well as the study of people in their work environments? Its objective is to lessen the chance of accidents by enhancing work areas and surroundings.

Science underlies the field of ergonomics. It combines information from engineering, psychology, statistics, anatomy and physiology, and other fields to make sure that the designs play to the individuals' strengths..[17]

Ergonomics Process:

- Assess Risks
- Plan Improvements
- Measure Progress
- Scale Solutions

Benefits of Ergonomics

- Reduced risk of work-related injuries and illness
- Higher productivity
- Improved health
- Improved mental insight
- Better product quality
- Decreased pain
- Happy employee
- Improved employee engagement
- Better safety culture

## 3 PRACTICAL PART

The main objective of the diploma thesis is to design new assembly line including process optimization, and line balancing to meet the define volume production to evaluate the current production process, it is necessary to use the methods of Industrial Engineering, it is also necessary to understand the entire production process and its individual production operation.

### *Partial Objective of the thesis:*

- Elaboration of the theoretical part
- Description of the current Assembly process of the specific product
- Analysis of the current state of the manufacturing system based on the selected KPIs (Material and information flow, customer demand and manufacturing system constrains)
- Design of manufacturing system in chosen detail of the process operation.
- Design of production plan (production levelling for manufacturing constraints, production resources utilization.
- Designing of manufacturing work place and a new form of the assembly line and process considering space constraints.
- Evaluation of designed manufacturing system based on selected KPIs.

When designing a new form of the entire assembly production, it was first necessary to get to know the existing one thoroughly the manufacturing process of the product. During the study of the production, individual analyzes were carried out production sections with technical and managerial staff (technology, logistics, maintenance). All knowledge and comments from the participating workers were recorded and it was they are taken into account in the further course of work. After familiarization with the entire production followed compilation of record sheets and all necessary documents for measurement. All the prepared documents were used in the later measurement. The obtained results served together with insights from technical and managerial staff to build a new look production process. The result of the entire unification was the creation of proposals for production process.

## 3.1 Company Introduction

The establishment of Družstevní závody Dražice-Strojírna s.r.o. dates back to 1900, when it was established in 1900 establishment of a future cooperative enterprise the widow Marie Kyselová inserts a grain mill into the property of the company, thus establishing a limited liability company called "Grain warehouse, craft roller mill and bakery" in Dražice nad Jizerou. [18]



Figure 7: Company Logo Družstevní závody Dražice-Strojírna s.r.o [18]

In 1910–1917 The new management, headed by Václav Čančík, is turning to a very promising production and distribution of electricity on the recommendation of professor of Prague technology, Karel Novák. In 1910, a hydroelectric power plant with two turbines with an output of 300 HP was built. In 1917, 69 municipalities with 8,111 consumers were connected to the Dražice power plant. In 1939 The enterprise reaches its peak in the second half of the twenties. It employs 220 workers and owns 8 hydroelectric power plants on the Jizera River, a steam power plant, 2 mills and a distribution network to which 383 municipalities with 24,080 users are connected. The turnover for 1930 amounted to a respectable three-quarters of a billion CZK. In 1948 After the forced sale of the power grids and the subsequent nationalization of a significant part of the cooperative's property, the company refocused on products and services for the population with a focus on household and sports activities. In 1956 One of the programs became the custom production of water heaters under the leadership of a former tradesman Mr. Křovák. In 1972, the development of the combined water heater and its introduction into mass production was completed. At the end of the eighties, Družstevní kombinát Dražice produced about 13,000 combined water heaters per year and employed about 50 workers in this area. In 1989, the cooperative was divided into independent business firms. One of these companies is the private company Družstevní závody Dražice–strojírna, s.r.o., which took over the production of water heaters. In 2003, there is a sharp development in the production of water heaters. The assortment is expanded, the technology is modernized and production is constantly increased. A major modernization

# FACULTY OF MECHANICAL ENGINEERING TUL

took place at the end of 1997 with the construction of a new enameling line. The company becomes the largest seller of water heaters in the country and since 1994 begins to expand exports. The company exports to 16 countries throughout Europe. In 2003, the company produced 95 thousand heaters, and the number of workers was 190. In 2004, a new hall was built in preparation for the construction of a new enameling furnace. This furnace was then built in the summer of 2005, and allowed the company both to increase the capacity of the enamel factory and to allow for a better enameling process. The product range was also extended to include storage tanks and at the end of the year new types of angular water heaters were prepared. The company produced 115,000 water heaters and employed 210 workers. In 2006, 100% of the shares of Družstevní závody Dražice – strojírna s.r.o. were transferred to the Swedish company NIBE Industries AB, which thus became the sole owner of DZ Dražice.

In the summer of 2007, the capacity was expanded to two assembly lines and thus the capacity was increased to 150,000 pieces per year. DZ Dražice also started to offer NIBE heat pumps. Start of sale of solar sets, flow and stainless-steel heaters NIBE. In 2011, a hybrid heater with the possibility of connecting to photovoltaic panels was included in the assortment. A heater with intelligent control and many OKHE SMART functions was also introduced. In September 2014, a new model of the OKHE SMART EVO 3 boiler with the possibility of smartphone control was presented at the FOR-THERM trade fair. Since 2016, DZ Dražice have been producing a new range of OKHE and OKCE heaters and the OKHE SMART functions are further improved. In 2018 The range of electric heaters has been extended by a flat version – OKHE ONE. In 2020 the company marked by new small-volume HEATERS TO in models 5.1 and 10.1, and a new digitized warehouse with a capacity of up to 17,000 heaters was built in Luštěnice to produce pallets on which products are newly stored and dispatched. [13]

## 3.2 Product description

The assembly production line for the water heater "LUCIE 200" consists of manufactured devices (insulated vessel, wiring, heating element, cover) that are manufactured in Dražice and where the input for the semi-finished product comes from suppliers and is manually assembled by the operator in order to obtain the finished product.

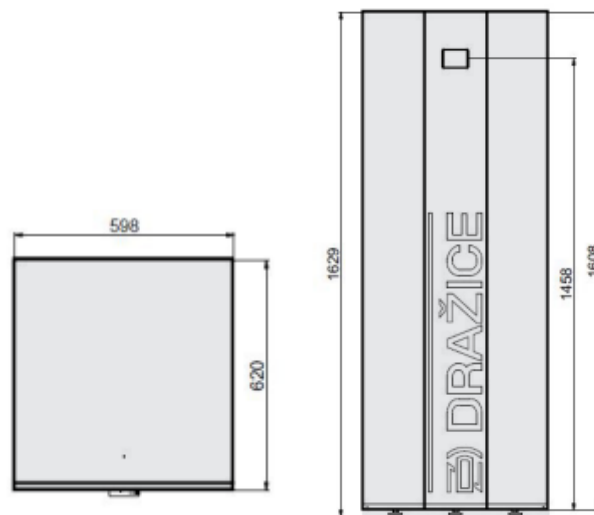

Figure 8: View of the finished product (LUCIE 200) [13]

## 3.3 Optimization Goal - KPI

A key Performance Indicator (KPI) is the specific quantifiable metric or data point that is used to evaluate and measure the performance efficiency a process. The performance of Industrial and Manufacturing process measured through the use of KPIs. Cycle time, Takt time Value added index, Total production Area Total traveling distance and number of workers are the main selected KPIs. Evaluating these criteria's is essential in order to improve the current state layout and while creating a new layout.

Table 7: Selected KPIs [Own]

<i>KPIs</i>	<i>Calculation</i>	<i>Evaluation Criteria</i>	<i>Target</i>
Cycle Time	Cycle Time = Total action Time / Number of Units Produced	Compare against reduction targets and identify processes causing delays or Bottleneck.	29 minutes
Takt Time	Takt Time = Available Production Time / Customer Demand	Ensure cycle time aligns with takt time to meet customer demand efficiently.	29 minutes
Value-Added Index	Value-Added Index = (Value-Added Time / Total Time) * 100	A higher index indicates more time spent on value-added activities, signaling efficiency.	>Current
Total Production Area	Measure the area used for production, storage, workstations, etc.	Assess space efficiency and minimize wastage.	Current
Total Traveling Distance	Measure distances traveled by workers, materials, and products	Reduce total traveling distance to save time and resources.	<Current
-Worker	= $\sum$ (Distance between each pair of consecutive workstations or tasks for the worker)	Measure and sum the distances between each pair of consecutive workstations the worker needs to access or perform.	<Current
-Product	= $\sum$ (Distance between each pair of consecutive locations for the product)	Measure and sum the distances between each pair of consecutive locations or stations that the product visits	<Current
Number of Workers	Count workers actively engaged in the production process	Match the workforce to new layout and production requirements, avoiding over or understaffing.	8

These formula and evaluation criteria (Table 7) provide a quantitative basis for assessing the performance of the current state layout and for guiding the design of the new layout to improve efficiency reduce cost and enhance productivity. Regularly monitoring these KPIs during and after the implementation of the new layout will help to track the effectiveness of the changes and make necessary adjustments.

### 3.4 Analysis of the current state of the production process

The production line for LUCIE "200" consists of cutting welding and pressing equipment as manly, where the input semi-finished product is assembled by production operators. Subsequently, the parts are transported to the production operation, figure 8 shows the current overall production process of the system unit. This Analysis can be used to identify areas for Improvement and develop a plan for implementing changes to the process.

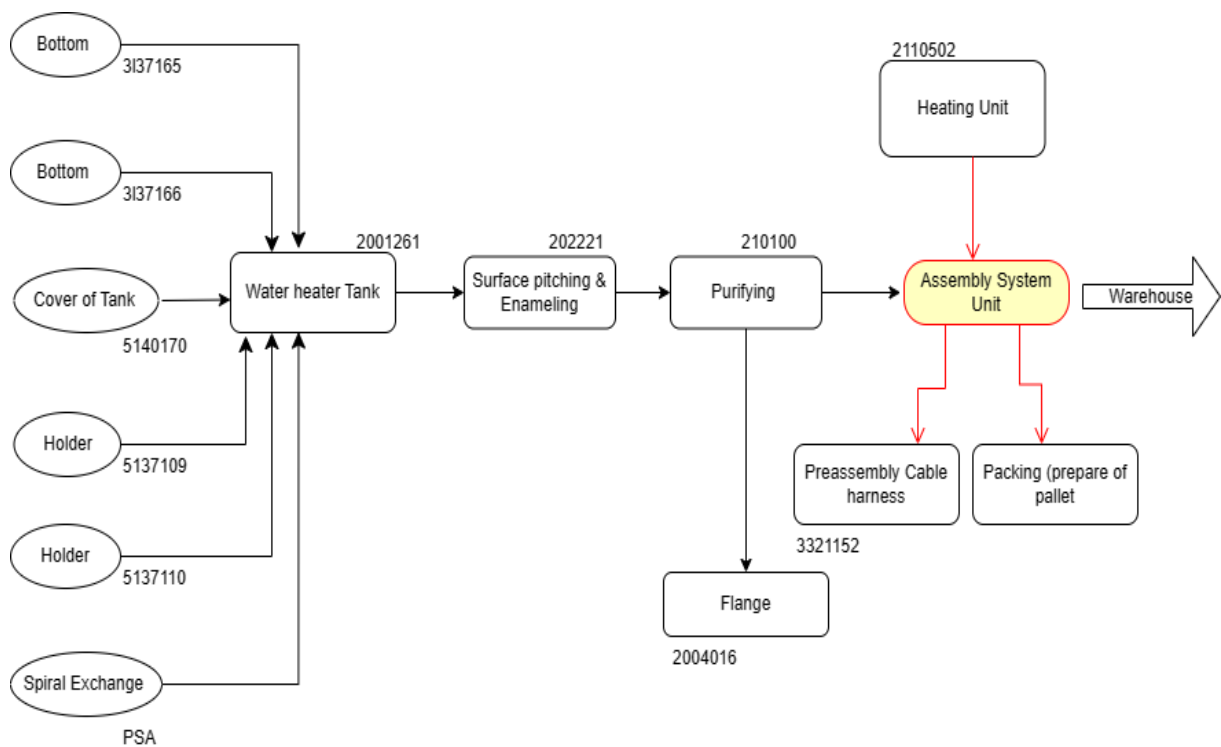

Figure 9:Over all Routing Diagram [Own]



3.5 Technological Process

Table 8:Internal Produce Items [Own]

<i>Item</i>	<i>Job Descriptions</i>	<i>Technology</i>
Bottom of tank	Press of Bott.	Automatic line Luštěnice
	Wase of Bott	Automatic line Luštěnice
	Welding	Welding station Drazice
Bottom of tank	Press of Bott.	Automatic line Luštěnice
	Wase of Bott	Automatic line Luštěnice
	Welding	Welding station Drazice
Cover of tank	Punch and press	Euromac punching station Drazice
Holder	Laser Cutting	Laser station Lustenice
	Bending	Bending press Lustenice
Holder	Laser Cutting	Laser station Lustenice
	Bending	Bending press Lustenice
Spiral Exchanger	Make Spiral	Circling station (“zakružovací stroj”)
Water heater tank	Welding reinforcements Spiral exchange, top spiral exchanger	Preassembly welding box
	Welding Spiral exchange to bottom of water heater	Preassembly welding box
	Welding of Heater	Welding line 2 Drazice
Pitching	Surface pitching and enameling	Enameling line Drazice
Flange	Pressing Sheet of metal	crank presser (building #7 Lustenice)
	Pressing hole	crank presser (building #7 Lustenice)
	Pressing flange	hydraulic presser (building #7 Lustenice)
	Making hone-in to flange	hydraulic presser (building #7 Lustenice)
	Welding of flange	Welding station (building #7 Lustenice)
	Weld of Bolt	Welding of bolt workplace Drazice
	Enameling	Enameling line Drazice
Purify	Purifying	foaming and assembly (building #3B Lustenice)
Heating Unit	Cutting	Hacksaw Station Building #5A Lustenice
	Welding	Welding station Building #7 in Lustenice
	Painting	Painting box Building #7 in Lustenice
	Pre-Assembly Heating unite	Assembly workplace for small heater water
Cable	Pre-assembly cable harness	Assembly workplace for small heater water

The technological process is briefly summarized or given an overview in a technological description. It gives context and an understanding of the process' significance within the larger manufacturing process by describing the process's function.

The technological process table is referred to as the Below Table portion. Key insights regarding the process, specific phase.

### 3.6 Bill of Material for Assembling System Unit Lucie

Bill of material for system unite Lucince the component is shown in each row of the table below. Each row represents a different component needed to assemble the system unit.

Table 9:Heating Element Bill of Material [19]

Part Name: **Heating unit**

<i>Position</i>	<i>Component ID</i>	<i>Component Name</i>	<i>Size/type</i>	<i>Needs. quantity</i>	<i>Unites</i>
10	3136952	Receptacle	EK 6kW	1.00	Pcs
20	2110348	Screw-on el. top. unit	TJ 2" - 6kW	1.00	Pcs

Table 10:Cover Bill of Material [19]

**Part name: Cover**

<i>Position</i>	<i>Component ID</i>	<i>Component Name</i>	<i>Size/type</i>	<i>Needs. quantity</i>	<i>Unites</i>
10	8900328	Palette	750x750	1.00	Pcs
20	8900513	Top plate	750x750	1.00	Pcs
40	8900701	Cutting off the batten	38x63x2000	4.00	Pcs
50	8900637	Cutting off the batten	23x95x675	2.00	Pcs
55	8900634	Cutting off the batten	23x95x750	1.00	Pcs
60	8900757	Cutting off the batten	23x95x460	2.00	Pcs
70	6283338	Polystyrene insert	670x100x40	1.00	Pcs
80	6283342	Polystyrene insert	670x100x20	1.00	Pcs

# FACULTY OF MECHANICAL ENGINEERING TUL

Table 11: Insulated Vessel Bill of Material [19]

<i>Part Name: Insulated vessel</i>					
<i>Position</i>	<i>Component ID</i>	<i>Component Name</i>	<i>Size/type</i>	<i>Need quantity</i>	<i>Unites</i>
20	2002221	Enameled container	LUCIE 200	1.00	Pcs
30	6231097	PLIXXOPOL RF 2415G	-	2.11	kg
40	6231101	PLIXXONAT N102	-	2.97	kg
50	6309225	Stopper	G 1 1/4" with seal SW 32	1.00	Pcs
60	6422542	Sump	TH 90 brass - G1/2"	2.00	Pcs
70	2004016	Flange (CZ)	Nozzle G 3/4"	1.00	Pcs
80	6273127	The sealing ring (CZ)	Diameter 140mm with collar	1.00	Pcs
90	6309200	Screw galvanized.	M10x25 lowered head	8.00	Pcs
100	6311132	Nut galvanized.	M10	8.00	Pcs
110	6309026	Rectifying screw	M12x50	3.00	Pcs
120	6199207	Anode (PL)	22x400	1.00	Pcs

# FACULTY OF MECHANICAL ENGINEERING TUL

Table 12: Electro Connection Bill of Material [19]

<i>Part Name: Wiring</i>					
<i>Position</i>	<i>Component ID</i>	<i>Component Name</i>	<i>Size/type</i>	<i>Need quantity</i>	<i>Unites</i>
10	5138613	Carrier	Wiring	1.00	Pcs
20	6309302	Screw to sheet metal galvanized.	3.9x9.5	4.00	Pcs
30	6406102	Relay	EATON Z-R230/16-10	3.00	Pcs
40	6405616	Thermostat (CZ)	EIKA v01	1.00	Pcs
50	6321855	Thermostat knob (CZ)	black c.v.452-41-00	1.00	Pcs
60	6341018	Wire Set (CZ)	LUCIE	1.00	Pcs
70	6309215	Screw galvanized.	M4x8	2.00	Pcs
80	6322097	Wiring cover	Heartbeat. fuses and thermostats	1.00	Pcs
90	6273110	Gasket	Thermostat shafts	1.00	Pcs
100	6345800	Terminal 2 wire	Through 4mm2	5.00	Pcs
110	6345801	Terminal 2 wire	Through 4mm2	2.00	Pcs
120	6345802	Terminal 2 wire	For a protective conductor 4mm2	3.00	Pcs
130	6345803	Ridge bridge	2004-402	3.00	Pcs
140	6345804	Sidewall	2004-1291 Terminal Thickness	1.00	Pc
150	6345805	Staple	222-413 3x2.5 with lever	2.00	Pcs
160	6283502	Cable tape	100x2.5	10.00	Pcs
170	6735681	Label	Attention under voltage	1.00	Pcs
180	6735682	Label	Clamp label	1.00	Pcs
190	6735679	Label	Grounding - set of 8pcs	0.25	kg
200	6735680	Label	Triangle - set of 4pcs	0.25	kg
210	6322908	Clip	RICHCO - SHR - C1	2.00	Pcs
220	6345711	Cable grommet	KSS SB-22	3.00	Pcs
230	6541913	Thermal fuse	TJ 2" HP 9kW	1.00	Pcs

# FACULTY OF MECHANICAL ENGINEERING TUL

Table 13: Container Bill of Material [19]

<i>Part Name: Container</i>					
<i>Position</i>	<i>Component ID</i>	<i>Component Name</i>	<i>Marking</i>	<i>Need Quantity</i>	<i>Unit</i>
10	5140170	Vessel shell	LUCIE 200	1.00	Psc
20	3137165	Bottom of the container	500- flange+2x35+ 3x28	1.00	Psc
30	3137166	Bottom of the container	500 - 5/4"+28 str	1.00	Psc
40	5141292	Spiral	33,7x19214	1.00	Psc
50	5155039	Registry reinforcement	10x1030	3.00	Psc
60	5141101	pipe	3/4"(26,2,5) x150mm	3.00	Psc
70	6319528	Socket	G 1/2" - 48	1.00	Psc
80	5137052	Stand	Leg 300 liters "SUPPORT"	3.00	Psc
90	6319527	Socket	G 1/2" - 29.5/24	2.00	Psc
100	5155050	Hinge	8x90	2.00	Psc
110	6319517	Socket	G1"x50mm	2.00	Psc
130	6312500	Rear left	wo. 1,0 Marathon 250 kg	0.38	kg
140	6312507	Welding wire	wo. 0,8 spool 15 kg	15	kg
150	6319429	Brass Socket	5/4" without recess	1.00	Psc
160	5137110	Holder	Rear left	1.00	Psc
170	5137109	Holder	Rear left	1.00	Psc
180	5137108	Holder	Rear left	1.00	Psc

## 3.7 Assembly Diagram of System Unite Lucie

A water heater assembly diagram is a visual representation of how water heater should be put together. It includes detailed illustrations of each component such as tank heating elements thermostat and valves as well as instruction on how they should be assembled. The part of a water heater and their recommended assembly are shown visually in a water heater assembly diagram. The tank heating element thermostat valves and other pieces are frequently illustrated along with instructions on how to connect them correctly.

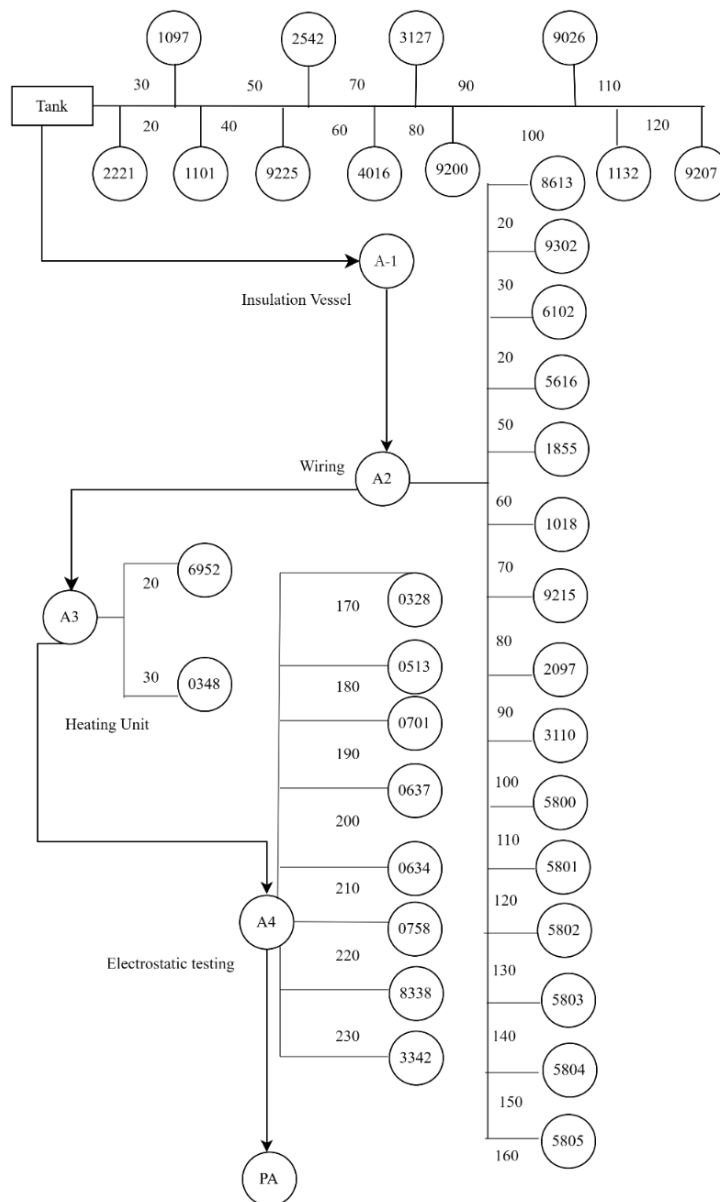

Figure 10:LUCIE Water heater components assembly diagram [Own]

The diagram could also indicate where the required gas pipeline and electrical wiring are located and how they should be connected. The diagrams below show the location and proper connection of all necessary components of the water heater.

### 3.8 Dependency Diagram System unit LUCIE

Dependency diagram is a type of diagram that shows the dependencies between different component and it visually represents the relationship between the component. The original state relationship between the components is shown in the diagram below.

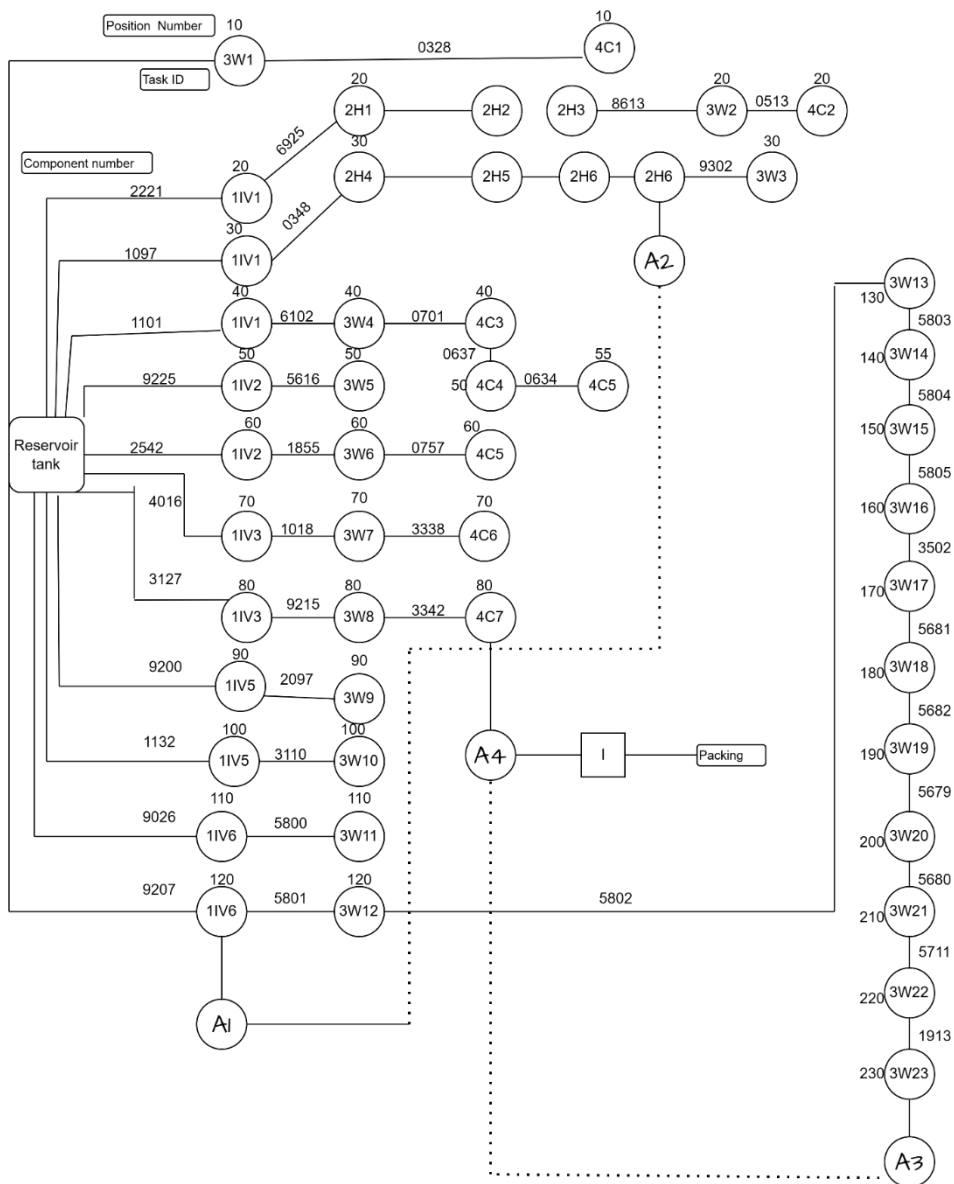

Figure 11:Dependency Diagram System unit LUCIE [Own]

# FACULTY OF MECHANICAL ENGINEERING TUL

Component are represented as nodes and dependencies are represented are edge connection the node. The direction of the edge indicates the direction of the edge indicates the direction of the dependency and the label on the edge indicates the type of dependency.

Table 14:Task Description and Used tool of Insulated Vessel [Own]

Operation Name & ID	Component Name& ID	Task Description	Use tools	Position	Task ID	Task Description
Insulated Vessel (IV)	2002221(Enameled container)	Assembling the carcass foundation	Hand drills Drill bits Grinding saddles screw driver	20	IV1	11
	6231097(PLIXXOPOL RF 241)	Transport of containers		30	IV2	2
	6231101(PLIXXONAT N102)	enamel container cleaning + sheet foaming, drilling holes, grinding of saddles		40	IV3	8.5
	6309225(Stopper)	Installation of drain valve, thread lubrication for U seals		50	IV4	3.7
	6422542(Sump)	grounding pin + pipes, blanking plugs + ground. tape		60	IV5	3.83
	2004016(Flange cover (CZ))	assembly of the frame assembly of metal sheets, riveting, plate and holders, installation of union seals		70	IV6	13
	6273127(The sealing ring (CZ))			80		
	6309200(Screw galvanized)			90		
	6311132(Nut galvanized)			100		
	6309026(Rectifying screw)			110		
6199207(Anode (PL))		120				

Table 15:sk Description and Used tool of Heating Element [Own]

Operation Name & ID	Component Name& ID	Task Description	Use tools	Position	Task ID	Task Description
Heatiing element (H)	3136952(Receptacle)	Rear plate assembly	Screw driver Pipe cutters Pipewrenche Flaring tools Pipe benders Torque wrenches Pipe threaders wrenches pliers drills	10	H1	3.4
	2110348(Screw-on el. top. unit)	Caliper installation		20	H2	2.5
		Evaporator assembly			H3	2
		pre-assembly of pipes (in a vice)			H4	4
		installation of pipeline deployment			H5	1
		Preparation of heating, cleaning from paint and threadVent installation			H6	9
		boiler assembly			H7	1



# FACULTY OF MECHANICAL ENGINEERING TUL

Table 16: Table 15: Task Description and Used tool of Wiring [Own]

Operation Name & ID	Component Name & ID	Task Description	Use tools	Position	Task ID	Task Description
Wiring (W)	5138613(Carrier)	Pump preparation Cables + strapping	Assembly key Screwdriver Cable pulling tools Wire connectors Cable ties Crimping tools Wire cutters Wire strippers	10	W1	2.75
	6309302(Screw to sheet metal galvanized.)	Installation of pump+ pipes		20	W2	4
	6406102(Relay)	installation of doors and tightening of joints		30	W3	9.6
	6405616(Thermostat (CZ))	Conductive paste lubrication for sensors and mounting, sensor assembly, pipe holders		40	W4	6.5
	6321855(Thermostat knob (CZ))	transport for leak test		50	W5	0.7
	6341018(Wire Set (CZ))	put on glands		60	W6	0.5
	6309215(Screw galvanized.)	9 joints test		70	W7	4
	6322097(Wiring cover)	disconnection		80	W8	0.5
	6273110(Gasket)	Installation of riveting circuit breaker and rivet pre-tensioning		90	W9	6
	6345800(Terminal 2 wire)	transport		100	W10	0.4
	6345801(Terminal 2 wire)	sensor installation		110	W11	2.5
	6345802(Terminal 2 wire)	installation of the heating frame		120	W12	3
	6345803(Ridge bridge)	pre-assembly of the control on a three-way		130	W13	3
	6345804(Sidewall)	pre-mounting the SMO panel on the board		140	W14	10.5
	6345805(Staple)	assembly of SMO into the carcass in two		150	W15	1.5
	6283502(Cable tape)	cable assembly		160	W16	34.5
	6735681(Label)	pre-assembly plastic tube shearing		170	W17	1
	6735682(Label)	mounting + plate on contactor, rivet		180	W18	1.7
	6735679(Label)	load on a trolley		190	W19	1
	6735680(Label)	Cabin test		200	W20	9
	6322908(Clip)	Removal from the cart		210	W21	1
	6345711(Cable grommet)	Final check		220	W22	1
	6541913(Thermal fuse)			230	W23	

Table 17: Task Description and Used tool of Cover [Own]

Operation Name & ID	Component Name & ID	Task Description	Use tools	Position	Task ID	Task Description
Cover(C)	8900328(Palette)	label printing	Hammer screwdriver Plastic wrapping machine	10	C1	2
	8900513(Top plate)	pre-assembly of the front part gluing		20	C2	15
	8900701(Cutting off the batten)	jacketings		40	C3	10.5
	8900637(Cutting off the batten)	sticking the label on the stepladder		50	C4	0.7
	8900634(Cutting off the batten)	packing from the stairs		55	C5	16
	8900757(Cutting off the batten)	Transport to the package		60	C6	0.7
	6283338(Polystyrene insert)	foil attachment		70	P1	0.34
	6283342(Polystyrene insert)	STD code and load		80	P2	1
		loading			P3	0.6

In this diagram where components are represented as nodes and their dependencies are represented as edge connections, the direction of the edge indicates the direction of the dependency. Such diagram can visually represent the relationships and dependencies between components in a system, helping to understand the overall structure and flow of the system.

### 3.9 Current State Assembly system unit layout

This current state of a system layout diagram visually shows each work station, the overall number of works, and the material flow in the system unit, aiming in understanding the overall structure and flow of the system. The assembly flow begins with tank identification and involves elements like FIFO rack, Pallet racking, Shelves, Forklifts, Pre-assembly tables, Cabinets, Tool Carts, Leakage testing and Electro testing with the placement of the final assembly on a Pallet for transportation. Figure (12) shows the current state layout of the system unite and assembly flow outline the various steps and station involves in the assembly process for the water heater.

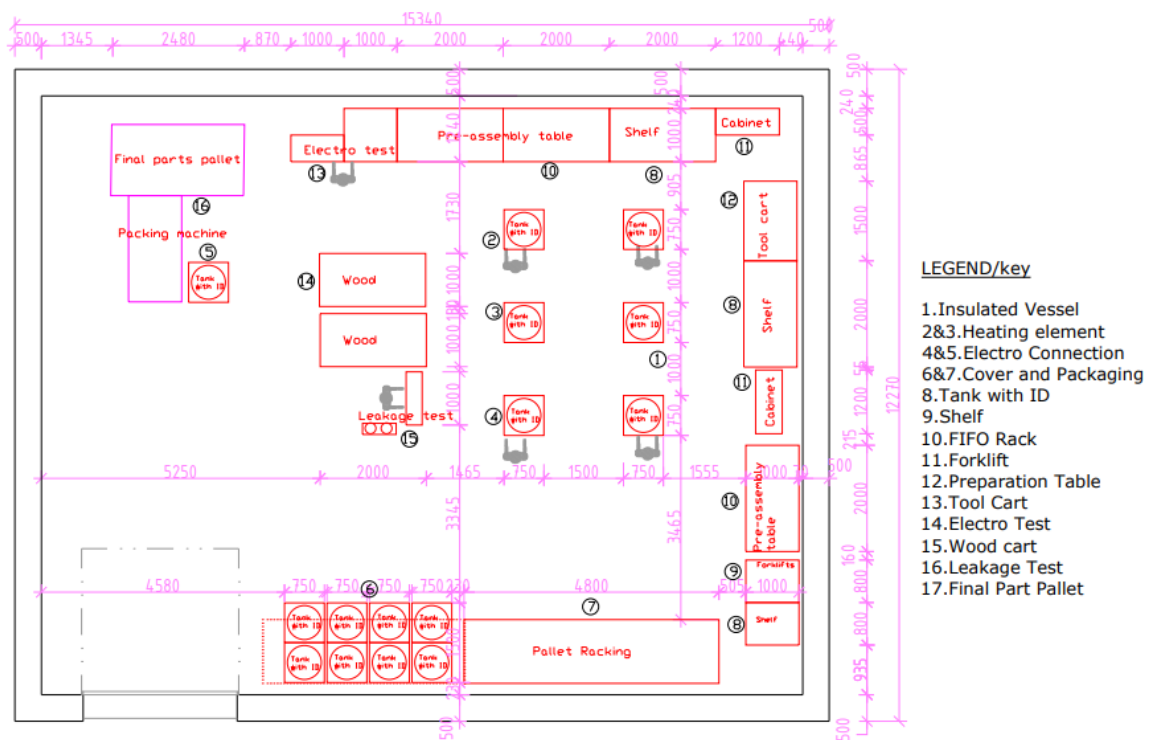

Figure 12:Current State Assembly Line layout [Own]

This Current state layout comprises several key Assembly stations and components. This includes Insulated vessel Station, Heating element station, Wiring (Electro connection) station, cover station and Packaging station. Each station contributes to the assembly process.

## 3.9.1 Process Analysis

The process analysis for the water heater LUCI 200 assembly production line is shown in below Table (18 & 19). The purpose of this analysis to illustrate the workflow within a single manufacturing cell. This analysis aids in identifying the main production area bottleneck.

Table 18: Current State Process Analysis [Own]

<i>Process Diagram</i>		<i>Process: Electrical Boiler Assembly</i>					
No.	Name of Activity	OP	TR	CH	WA	ST	Time (s)
1	Transport of containers	●	→	■	◐	▲	660
2	Enamel container cleaning + sheet foaming, drilling holes, grinding of saddles	●	→	■	◐	▲	120
3	Installation of drain valve, thread lubrication for U seals	●	→	■	◐	▲	510
4	Grounding pin + pipes, blanking plugs + ground. tape	●	→	■	◐	▲	222
5	Assembly of the frame assembly of metal sheets, riveting, plate and holders, installation of union seals	●	→	■	◐	▲	229.8
6	Rear plate assembly	●	→	■	◐	▲	204
7	Caliper installation	●	→	■	◐	▲	150
8	Evaporator assembly	●	→	■	◐	▲	120
9	Per-assembly of pipes (in a vice)	●	→	■	◐	▲	240
10	Installation of pipeline deployment	●	→	■	◐	▲	60
11	Preparation of heating, cleaning from paint, and thread Vent installation	●	→	■	◐	▲	540
12	Boiler assembly	●	→	■	◐	▲	60
13	Pump preparation Cables + strapping	●	→	■	◐	▲	165
14	Installation of pump+ pipes	●	→	■	◐	▲	240
15	Installation of doors and tightening of joints	●	→	■	◐	▲	576
16	Conductive paste lubrication for sensors and mounting, sensor assembly, and pipe holders	●	→	■	◐	▲	390
17	Transport for leak test	●	→	■	◐	▲	42
18	Put on cable glands	●	→	■	◐	▲	30
19	9 joints test	●	→	■	◐	▲	240
20	Disconnection	●	→	■	◐	▲	30

Table 19: Current state Process Analysis [Own]

21	Installation of riveting circuit breaker and rivet per-tension	●	→	■	◐	▲	360
22	Transport	●	→	■	◐	▲	24
23	Sensor installation	●	→	■	◐	▲	150
24	Installation of the heating frame	●	→	■	◐	▲	180
25	Per-assembly of the control on a three-way	●	→	■	◐	▲	180
26	Pte-mounting the SMO panel on the board	●	→	■	◐	▲	630
26	Assembly of SMO into the carcass in two	●	→	■	◐	▲	90
28	Cable assembly	●	→	■	◐	▲	2070
29	Pre-assembly plastic tube shearing	●	→	■	◐	▲	60
30	Mounting + plate on contractor, rivet	●	→	■	◐	▲	102
31	load on a trolley	●	→	■	◐	▲	60
32	Cabin test	●	→	■	◐	▲	540
33	Removal from the cart	●	→	■	◐	▲	60
34	Final check	●	→	■	◐	▲	60
35	label printing	●	→	■	◐	▲	120
36	per-assembly of the front part gluing	●	→	■	◐	▲	900
37	jacketing's	●	→	■	◐	▲	630
38	sticking the label on the stepladder	●	→	■	◐	▲	42
37	packing from the stairs	●	→	■	◐	▲	960
40	Transport to the package	●	→	■	◐	▲	42
41	foil attachment	●	→	■	◐	▲	20.4
42	STD code and load	●	→	■	◐	▲	60
43	Loading to Store	●	→	■	◐	▲	72
Frequency		31	6	2	1	1	12241

Each step in a single assembly station described in this process diagram. Activities are broken down into Operation (*OP*), transport (*TR*), inspection (*CH*), waiting (*WA*) and storage. Since each activity is given a time description it is feasible to calculate the duration of each step individually as well as the contribution to value.

Table 20: Frequency of each process description [Own]

<i>Process description Name</i>	<i>Process description abrivation</i>	<i>Frequency</i>	<i>Relative Frequency</i>	<i>Relative Frequency In % form</i>
Operation	<i>OP</i>	31	0.84	84
Transport	<i>TR</i>	6	0.16	16
Check	<i>CH</i>	2	0.05	5
Waiting	<i>WA</i>	1	0.03	3
Store	<i>ST</i>	1	0.03	3
Total		37	1	100

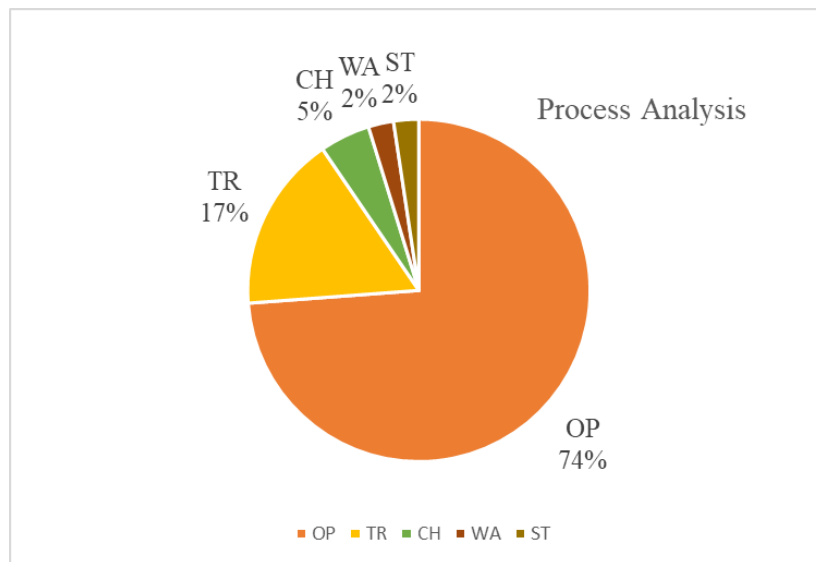

Figure 13: Process Analysis Indicator [Own]

The histogram, with a current 4-station takt time of 68 minutes compared to the customer takt time of 29 minutes, reveals a significant misalignment between the current production pace and the expected customer demand. This indicates the need for process optimization. Identifying and addressing the factors contributing to this gap is imperative to ensure that the operations meet customer expectations efficiently. This graph serves as a critical diagnostic tool, emphasizing aligning the processes with customer takt time to enhance both productivity and customer satisfaction

## 3.9.2 Value-added and non-value-added Analysis of Current State

Value-added activity directly benefits to customer or product while non-value-added activities are wasteful and should be minimize or eliminate in process analysis.

Table 21: Value added and Non value added Activities[Own]

<i>Task</i>	<i>Value-added or Non-value-added</i>	<i>Time (min)</i>
Transport of containers	Non-value-added	11
Enamel container cleaning + sheet foaming, drilling holes, grinding of saddles	Value-added	2
Installation of drain valve, thread lubrication for U seals	Value-added	8.5
Grounding pin + pipes, blanking plugs + ground. tape	Value-added	3.7
Assembly of the frame assembly of metal sheets, riveting, plate and holders, installation of union seals	Value-added	3.83
Rear plate assembly	Value-added	13
Caliper installation	Value-added	3.4
Evaporator assembly	Value-added	2.5
Pre-assembly of pipes (in a vice)	Value-added	2
Installation of pipeline deployment	Value-added	4
Preparation of heating, cleaning from paint, and thread Vent installation	Value-added	1
Boiler assembly	Value-added	9
Pump preparation Cables + strapping	Value-added	1
Installation of pump+ pipes	Value-added	2.75
Installation of doors and tightening of joints	Value-added	4
Conductive paste lubrication for sensors and mounting, sensor assembly, and pipe holders	Value-added	9.6
Transport for leak test	Non-value-added	6.5
Put on glands	Value-added	0.7
9 joints test	Value-added	0.5
Disconnection	Non-value-added	4
Installation of riveting circuit breaker and rivet pre-tensioning	Value-added	0.5
Transport	Non-value-added	6
Sensor installation	Value-added	0.4
Installation of the heating frame	Value-added	2.5
Pre-assembly of the control on a three-way	Value-added	3
Pre-mounting the SMO panel on the board	Value-added	3
Assembly of SMO into the carcass in two	Value-added	10.5
Cable assembly	Value-added	1.5
Pre-assembly plastic tube shearing	Value-added	34.5
Mounting + plate on the contactor, rivet	Value-added	1
Load on a trolley	Non-value-added	1.7
Cabin test	Value-added	1
Removal from the cart	Non-value-added	9
Final check	Value-added	1
Label printing	Value-added	1
Pre-assembly of the front part by gluing	Value-added	2
Jacketing	Value-added	15

Sticking the label on the stepladder	Value-added	10.5
Packing from the stairs	Value-added	0.7
Transport to package	Non-value-added	0.7
Foil attachment	Value-added	0.34
STD code and load	Non-value-added	1
Loading	Non-value-added	0.60

This table above shows the duration of various tasks involved in the electric water heating elements assembly process with distinction made between Value-added and Non-value-added activity.

Table 22: Frequency of Value-added and Non-Value-added [Own]

<i>VA/NVA</i>	<i>Frequency</i>	<i>Relative Frequency</i>	<i>Relative Frequency In % form</i>
VA	34	0.81	81
NVA	8	0.19	19
Total	42	1	100

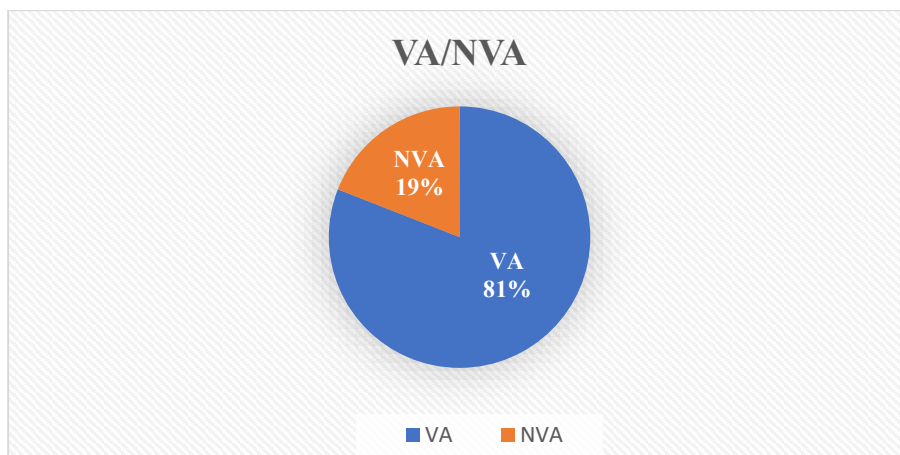

Figure 14: Percentage of activities VA & NVA [Own]

After determining the percentage of time spent on value-added tasks 81% and non-value-added tasks 19% are those tasks that do not contribute to the value proposition of the assembly process.

*Efficiency:* Indicates that 90% of operators time is spent on Value-added tasks suggest that the assembly process is relatively efficient. Value-added tasks are those that directly contribute to the creation of the final product.

*Improvement:* The 19% of time Spent on non-value-added tasks signifies that there is room for improvement in the assembly process. These tasks are activities that do not directly contribute to the proposition of the final product. Identifying non-value-added tasks allows for targeted efforts to reduce waste in the assembly process, optimization automation or improved training for operators to minimize the time spent on activities that do not add value.

### 3.9.3 Spaghetti Diagram

Spaghetti diagram is a visual representation of the movement or flow people, material through a process or a system. It is often used to process improvement and analysis to identify inefficiency, bottleneck and areas for improvement. The principle which are mentioned below align with the goal of efficient test process design. Spaghetti diagram can help highlighting area where this principle may not be met.

#### 3.9.3.1 Analysis of Spaghetti Diagram

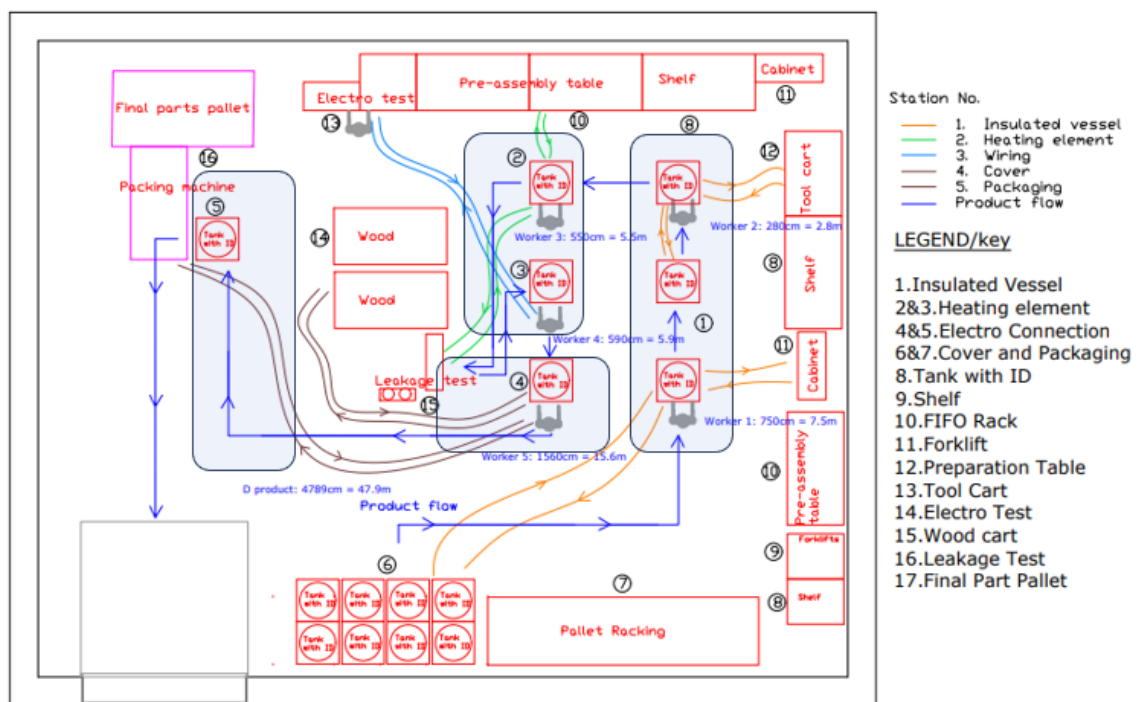

Figure 15: Current State layout Spaghetti Diagram [Own]

This Spaghetti diagram (Figure 15) shows a layout with One way flow (Station one), The initial station shows features one way flow system ensuring a unidirectional movement within designated area. This design promotes operational efficiency by preventing any back-and-forth travel enabling a streamlined and organized work flow. Insufficient width, there is a width constraint at station 2 and 3 potentially causing operational bottlenecks. The narrow



space may impede the smooth progression of activity at this station. To meet operational need, avoid congestion it is critical to widen the station space to address this issue. Crossing, station 2 and 3 present with challenge with a crossing point where the flow of activity intersects. This led to congestion and delay. To optimize operational efficiency, it is recommended to either redesign the layout o eliminate the crossing or implement effective management strategies to control the intersection and maintain a study work flow. Non continues layout (Last station), the last station in the layout is not seamlessly integrated indicating a disruption in the overall flow. A continues layout is crucial for preventing interruption so it is essential to assess the design of last station its seamlessly connects with the rest of layout facilitating a continuous and efficient workflow.

Addressing the need for a one-way flow at station 1, widening the space at station 2 and 3 eliminating or managing the crossing at station 3 and 4 and ensuring continuities at the last Station will collectively Contribute to more efficient and optimized operational environment.

### **3.9.3.2 Principle of Process design**

The principle of process design emphasizes the importance of creating efficient and streamlined workflow. Firstly, the analysis of the flow should be concise and should be focused on optimizing speed, ensuring that each step is executed swiftly to enhance overall productivity. Secondly, the flow should avoid unnecessary complexity with strict adherence to the principle of no crossing, minimize the risk of confusion in the process. Thirdly, each steps process must be sufficiently defined. Leaving no rooms for ambiguity and ensuring a clear understanding of responsibility at every stage. In addition, the process should be designed to be one way to avoid potential bottleneck. The width of the flow should be wide enough to accommodate the necessary tasks without causing cognition ensuring a soothe and efficient flow. Lasty, the process should be continues creating a seamless sequence of actions that promotes a consistence and uninterrupted workflow. By following this principles companies can design process that are not only effective but also conductive to optimal performance and resource utilization.

## 3.10 Time Analysis of Assembly operations

Time analysis of this assembly operation is used to evaluate and optimized the efficiency of product assembly process. It Involves analysis of time it takes to complete individual assembly task. Table (23 up to 27) shows a time analysis of measured data for the operators cycle for each assembly operation across 4 stations operated by 5 individuals. The importance of evaluating each stations performance to align with customer requirement and optimize operational efficiency.

Table 23: Station one cycle time [Own]

<i>Operation Sequences</i>	<i>Assembly S1 in (Minute)</i>	<i>Assembly S2 in (Minute)</i>	<i>Assembly S3 in (Minute)</i>	<i>Assembly S4 in (Minute)</i>
Transport of containers	11			
Enamel container cleaning + sheet foaming, drilling holes, grinding of saddles	2			
Installation of drain valve, thread lubrication for U seals	8.5			
Grounding pin + pipes, blanking plugs + ground. tape	3.7			
Assembly of the frame assembly of metal sheets, riveting, plate and holders, installation of union seals	3.83			
Total minutes	29.03			

Table 24: Station three cycle time [Own]

<i>Operation Sequences</i>	<i>Assembly S1 in (Minute)</i>	<i>Assembly S2 in (Minute)</i>	<i>Assembly S3 in (Minute)</i>	<i>Assembly S4 in (Minute)</i>
Cable assembly			34.5	
Pre-assembly plastic tube shearing			1	
Mounting + plate on contractor, rivet load on a trolley			1.7	
Cabin test			9	
Removal from the cart			1	
Total minutes			48.2	

# FACULTY OF MECHANICAL ENGINEERING TUL

Table 25: Station Four cycle time [Own]

<i>Operation Sequences</i>	<i>Assembly S1 in (Minute)</i>	<i>Assembly S2 in (Minute)</i>	<i>Assembly S3 in (Minute)</i>	<i>Assembly S4 in (Minute)</i>
Installation of doors and tightening of joints				9.6
Final check				1
label printing				2
Per-assembly of the front part gluing				15
jacketing's				10.5
Sticking the label on the stepladder				16
Packing from the stairs				9
Transport to the package				0.7
Foil attachment				0.34
STD code and load				0.6
Total minutes				64.74

Table 26: Station two cycle time [Own]

<i>Operation Sequences</i>	<i>Assembly S1 in (Minute)</i>	<i>Assembly S2 in (Minute)</i>	<i>Assembly S3 in (Minute)</i>	<i>Assembly S4 in (Minute)</i>
Rear plate assembly		3.4		
Caliper installation		2.5		
Evaporator assembly		2		
Per-assembly of pipes (in a vice)		4		
Installation of pipeline deployment		1		
Preparation of heating, cleaning from paint, and thread Vent installation		9		
Boiler assembly		1		
Pump preparation Cables + strapping		2.75		
Installation of pump+ pipes		4		
Conductive paste lubrication for sensors and mounting, sensor assembly, and pipe holders		6.5		
Transport for leak test		0.7		
Put on cable glands		0.5		
9 joints test		4		
Disconnection		0.5		
Installation of riveting circuit breaker and rivet per-tension		6		
Transport		0.4		
Sensor installation		2.5		
Installation of the heating frame		3		
Per-assembly of the control on a three-way		3		
Pre-mounting the SMO panel on the board		10.5		
Assembly of SMO into the carcass in two		1.5		
Total minutes		68.75		

This Analysis helps to identify bottleneck inefficiencies and opportunity for improvement ultimately leading to more productive assembly operation.

## 3.10.1 Line Balancing Diagram of Current state

Its id the process of allocating tasks to workstation on an assembly line in order to minimize idle time match production rate to takt time and shorten production cycle time. The electro-water assembly process involves four stations: An insulated vessel, heating element, wiring, and cover (and packaging), The Balancing Diagram of the Current State describes the current state of the assembly process, including the number of workers required at each station and the movement of workers between stations.

Table 27:Takt Time and Demand [Own]

Available workink time [430 minutes/shift]				
	Process 1	Process 2	Process 3	Process 4
Tack time minute/ unit	29	29	29	29
current laouding minute/unit	29.3	68.75	48.2	55.74

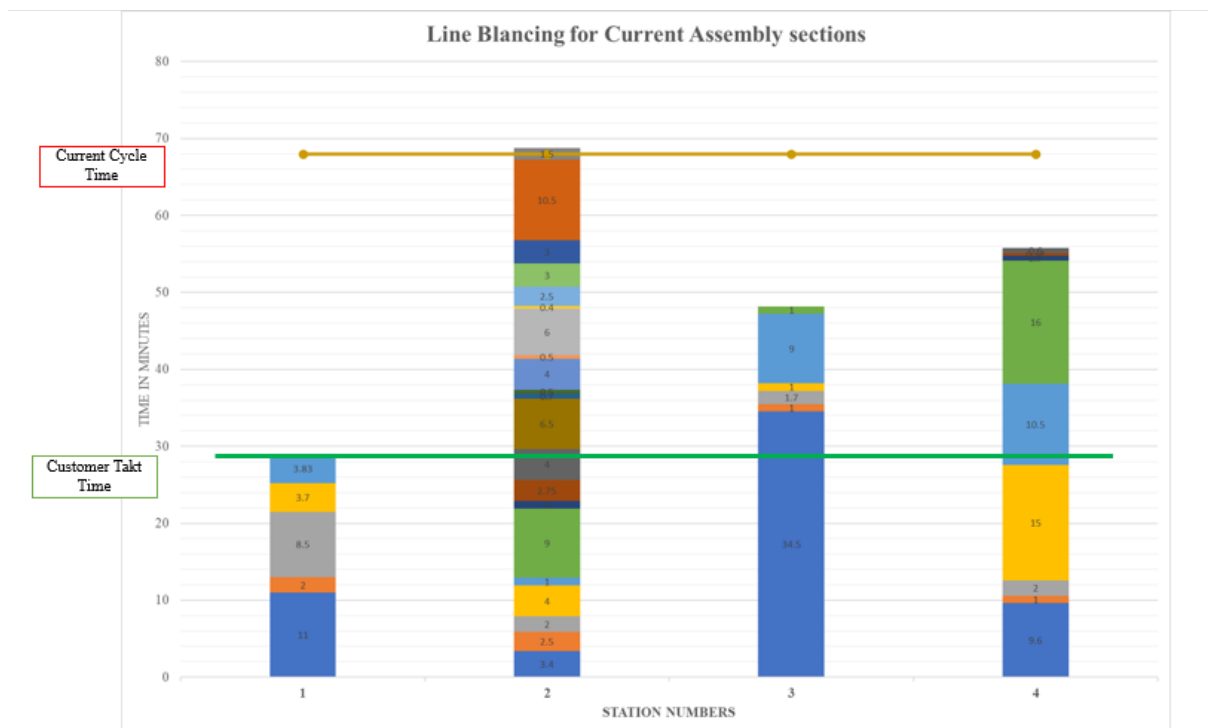

Figure 16 Current state Balancing Diagram [Own]

This Balancing Diagram shown above (Figure 16) It helps identify or visualize any bottlenecks in the assembly process and allows for the optimization of worker movement and allocation of resources. For improvement in the assembly process, such as reducing wait times between stations or adjusting the number of workers at each station.

Table 28:Current Layout KPIs [Own]

<i>KPI Code</i>	<i>Criteria</i>	<i>Criteria Abbreviation</i>	<i>Units</i>	<i>Values</i>
C1	Cycle time	C1	Minutes	68
TT	Takt Time	T	Min	29
VA	Value-Added Index	VA Index	%	0.81
TA	Total Production Area	TA	m <sup>2</sup>	208.3
TD	Total traveling distance (a safe minimum mounting distance)	Ds	Meter	85.2
	D-Worker	Dw	Meter	47.9
	D-Product	Dp	Meter	37.3
N1	Number of workers	NW	Person	5

$$\begin{aligned}
 \text{Balance Indicator (\%)} &= \frac{\text{total cycle time}}{\text{number of operators} * \text{Takt time}} * 100 \\
 &= \frac{68}{5 * 28.5} * 100 = 59.65 \%
 \end{aligned}
 \tag{3}$$

The current state balance indicator for production layout is approximately 59.65 % efficient. This means that this production line takes 59.56% longer to assemble the system unit than the customer demand or Tackt time.

It Indicates that this production line is not efficiently balanced and there is a significant gap between current production rate and the customer’s demand.

### 3.10.2 Analysis of the Bottleneck in the current Layout

Within this analysis the focus lies on the bottleneck occurring in the assembly water heater section, an instance where the smooth progress of assembling an electro component is hindered. By analysis of this point will unveil the underlying causes. Through addressing this bottleneck, the goal is to establish a streamlined pathway for assembling electro connections and leading to an overall improvement in the assembly of system unit performance. This analysis will also empower informed decisions for optimizing the electrical connection assembly operation.

This process mapping provides an overview of the assembly process of electric connection. With specific Focus on addressing the bottleneck in the assembly of electric connection operations. Improve electric component integration ultimately benefiting the entries operation. (Appendix No.7A)

Table 29:Analysis of a bottleneck Electro Connection operation (G-1) [Own]



<b>Electro-workshop (The wiring assembly)</b>					
<i>Steps</i>	<i>Description of individual procedures</i>	<i>Input components</i>	<i>Working Tools</i>	<i>Time/minute</i>	<i>Figures</i>
1	-Connecting the PWM (control) and power wires to the connectors on the circulation pump. -Connecting the wires lock the terminals with locking pins (the power cable is red, and the pump connector is white -Bending the black wire on the control cable and taping the "live" end with electrical tape.	6424040 - WILLO pump 6341598 - Power cable 6341599 PWM signal cable 6283502	Adhesive tape.	1.4	

Table 30: Analysis of a bottleneck Electro Connection operation (G-1) [Own]

Steps	Description of individual procedures	Input components	Working Tools	Time/minute	Figures
2	<p>-Cutting the third hole from the back and "squeezing" the cable gland on the SMO-20's left side partially out of the sheet.</p> <p>-Pulling the three-wire cable with terminals on both sides through the prepared cut hole in the cable gland in the wiring cover (2), through the flat end to SMO 20, from the set of wires (which comes together with the wiring)</p>	Connecting the SPLIT card's connector (on top) to its three poles	Cross Knife and Screwdriver	5	

To group the chart, I use 3 task groups based on Electro connection steps. 1<sup>st</sup> group based on description of individual procedure step 1 up to step 5 2<sup>nd</sup> group from step 6 to 11 and 3<sup>rd</sup> group from step 12 to 17, from the above table.

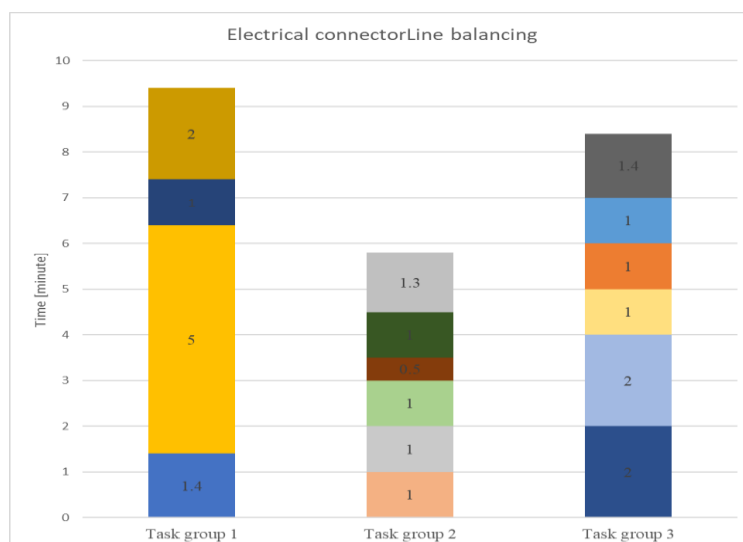

Figure 17 Electro connection line balancing within 3 task group [Own]

This analysis dedicated to addressing the bottleneck operation within the electoral connection assembly processes specifically in the electric component assembly section. This bottleneck affects the efficient assembly of electric component and the smooth progress of overall assembling process. Through a detailed examination of this issue and to identify the root causes and implement effective solution to optimize the overall assembly process.



#### 4 Designing a New Layout for System Unite and Balancing

When creating a layout there are a number of guidelines to follow. The first rule states that operators should be inside the operational cell, while material supplied to the cell from outside typically from the back of the machine or workstation. Simultaneously it is essential that operators are not completely enclosed within the product cell. Ensuring their safety and ease of movement. Additionally, it is essential to create layouts that avoid having operators' paths cross both for safety reasons and to optimize time efficiency. This was also achieved in part by incorporating gravity conveyors. Each operator should receive training for multiple positions to ensure flexibility and the ability to cover for missing operators when necessary.

Table 31:Takt Time Calculation [Own]

Total Cycle time	272 minutes			
Current state Takt time	Customer Demand	Production Per Day	One Product for Minutes	Theoretical minimum number of workstations
	75 per 5 Days	6	68 Minutes	5
Total Cycle time	206 minutes			
Customer Takt time	Customer Demand	Production Per Day	One Product for Minutes	Theoretical minimum number of workstations
	75 per 5 Days	15	29 Minutes	7

#### 4.1 Line balancing Problems

Line balancing is the process of assigning tasks to workstations in a production line such a way that the workload is evenly distributed among the workstation. The goal is to minimize idle time and create an efficient production process.

- Tools for Line Balancing: Process diagram, Assembly diagram and Dependency diagram.
- Creating a New line Balancing: By using the information from this diagram to allocate tasks to workstations in a way that minimize imbalance in workload. Considering factors like task duration, precedence relationship and operators' skills when making a new line balancing.

## 4.2 Rebalancing and Designing layout

Layout design and rebalancing refers to the process of optimizing workstation arrangement and task segregation within a workspace. After making necessary adjustments to task distribution for improved efficiency. By analyzing the duration of each activity and assigning tasks to achieve the customer takt time 29 min the current state processes should be rebalanced within 7 work station.

Table 32: Operation time of The New Layout [Own]

Operation Time								
Minute	28.33	28.65	28.5	29.1	28.5	28.84	28.3	
	1.station	2.station	3.station	4.station	5.station	6.station	7.station	
	11	3.4	9.6	3.7	4	2	9	
	2	2.5	1.5		6	10.5	15	
	8.5	2			2	16		
	3.83	4		1.4	3			
		1	1.4		3	0.34	1	
		1			10.5			
	1	1	2.5	5				
		2.75	3	1				
		4	10.5				1.3	
	1	6.5						
		0.5		2				
				2				
				2.5				
	1							
				1				
				1				
				0.5				
				5				
				2				
				2				

Key

- INSULATED VESSEL
- HEATING ELEMENT
- WIRING (Electro Connection)
- COVER Pallet preparation and packaging

Each operation Time are described in the tables below, seven station with 7 number of workers which to operate 5 main assembly process, Assembly of Insulated Vesile, Heating element, Electric connection cover and final packaging.

Table 33:Time Measurement [Own]

<i>Station One</i>		
<i>Steps</i>	<i>Operation Sequence</i>	<i>Duration</i>
1	Transport of containers	11
2	Enamel container cleaning + sheet foaming, drilling holes, grinding of saddles	2
3	Installation of drain valve, thread lubrication for U seals	8.5
4	Grounding pin + pipes, blanking plugs + ground. tape	3.8
	Making holes in the SMO-20 cable glands	1
5	Passing the cable with three black and one blue conductors through the cable gland (8.) on the SMO 20. Connecting the black wires according to the marking to the terminal board X2 at Positions: K1-2, K2-4, K3-6 (Wagon terminal) Connecting the blue wire to terminal board X-1 at position: 0.	1
6	Stretching of the temperature sensor (WITHOUT MARKING) from the electric boiler (the sensor is already located under the electric boiler) through the cable gland (11th). Winding the sensor on fingers, measure the end to reach positions: 9, and 10, and pull down with tightening or adhesive (electrician) tape and insert the coiled part behind the already connected wires. Inserting the ends through the back through the terminal block X-2 to positions 9 and 10 (BT63)	1
Total Duration		28.33

Table 34:Time Measurement of station 2 [Own]

<i>Station two</i>		
<i>Steps</i>	<i>Operation Sequence</i>	<i>Duration</i>
1	Rear plate assembly	3.4
2	Caliper installation	2.5
3	Evaporator assembly	2
4	Per-assembly of pipes (in a vice)	4
5	Installation of pipeline deployment	1
6	label printing	1
7	Boiler assembly	1
8	Pump preparation Cables and strapping	2.75
9	Installation of pump+ pipes	4
10	Conductive paste lubrication for sensors and mounting, sensor assembly, and pipe holders	6.5
11	Put on cable glands	0.5
Total Duration		28.65

Table 35: Time Measurement of station 3 [Own]

<i>Station three</i>		
<i>Steps</i>	<i>Operation Sequence</i>	<i>Duration</i>
1	Assembly of SMO into the carcass in two	1.5
2	Taking out a separate cable with three wires (black, red, and white) from the set of wires Connecting the wires to the terminal board on the SPLIT card in Position: Black – 3, Red – 2, White – 1. Connecting the other ends of the wires to the terminal board on SMO 20 to terminal board X-2 to Position: Black – 21(GND), Red – 20(B), White – 19(A).	1.4
3	Pre-assembly plastic tube shearing	2.5
4	Mounting + plate on contractor, rivet	3
5	Cabin test	10.5
6	Final check	9.6
Total Duration		28.5

Table 36: Time Measurement of station 4 [Own]

Station Four		
Steps	Operation Sequence	Duration
1	Grounding pin + pipes, blanking plugs + ground. tape	3.7
2	connecting the PWM (control) and power wires to the connectors on the circulation pump. Connecting the wires locks the terminals with locking pins (the power cable is red, and the pump connector is white Bending the black wire on the control cable and taping the "live" end with electrical tape.	1.4
3	"Cutting the third hole from the back and "squeeze" the cable gland on the SMO-20's left side partially out of the sheet. " Pulling the three-wire cable with terminals on both sides through the prepared cut hole in the cable gland in the wiring cover (2), through the flat end to SMO 20, from the set of wires (which comes together with the wiring) Connecting the SPLIT card's connector (on top) to its three poles	5
4	Making holes in the SMO-20 cable glands	1
5	Take a single, distinct wire (short black) from the set of wires, and then cut it through terminals 1 and 2 on the terminal board. removing the set's cage clamps. Connect the Cage terminal with one wire to the terminal board X-2 at position: 2	2
6	Passing Three-wire cable passes the cable gland (1.) on the SMO-20 and connects to the terminal board X-1 to the Position: Black - L, Blue - N, Yellow-green	2
7	Sensor installation	2.5
8	Passing the cable with three black and one blue conductors through the cable gland (8.) on the SMO 20. Connecting the black wires according to the marking to the terminal board X2 at Positions: K1-2, K2-4, K3-6 (Wago terminal) Connecting the blue wire to terminal board X-1 at position: 0.	1
9	Pull the control cable from the pump through the cable gland (6th) and connect the back via the terminal board (see photo) X-2 to the positions: Brown-1, Blue-2. Passing the two-wire cable (Attention to the marking) from the wire set through the cable gland (5.) and connect to the terminal board X-2 according to the marking positions: 17-17, 18-18	1
10	Passing the two-wire cable through the cable gland (7.) on the SMO-20. Connecting the shorter end with the mark "K1" to the Wago terminal. Connecting the longer end with the mark "4" to terminal block X-1 at position: 4	0.5
11	Installation of doors and tightening of joints	5
12	Through the cable gland (3.) on the SMO-20 Pass the power cable	2

# FACULTY OF MECHANICAL ENGINEERING TUL

Table 37: Time Measurement of station 5 [Own]

<i>Station Five</i>		
<i>Steps</i>	<i>Operation Sequence</i>	<i>Duration</i>
1	9 joints test	4
2	Installation of riveting circuit breaker and rivet per-tension	6
3	<p>Inserting one end through the back through the terminal block X-2 (top) at position 5 and the other into the back of connector 6</p> <p>Stretching the temperature sensor through the cable gland (9.) (marked with tape – 2x). Stretch the temperature sensor through the cable gland (9.) (marked with tape – 2x).</p> <p>Pull the sensor through the clip (under the wiring) and measure the length of the upper brass pit. Pass the sensor through the plastic holder in the sump. Apply a little heat transfer paste to the hole in the sump (to the bottom), insert the sensor into the sump (to the bottom of the applied paste), and secure it with a plastic holder.</p> <p>Winding of the sensor on our fingers, measure the end to reach positions: 4 and 6, pull down with tightening or adhesive (electrician) tape and insert the coiled part behind the already connected wires.</p> <p>Inserting the ends through the back through the terminal block X-2 (top) to positions 6 and 7 (BT7), the order does not matter.</p> <p>Connecting all wires, clamp the wires into a white plastic clip (the clip is part of SMO 20)</p> <p>Connecting all wires, clamp the wires into a white plastic clip (the clip is part of SMO 20)</p> <p>Passing the temperature sensor with the connector (WITHOUT MARKING) through the cable gland (14th).</p>	2
4	Installation of the heating frame	3
5	Per-assembly of the control on a three-way	3
6	Pte-mounting the SMO panel on the board	10.5
Total Duration		28.5

Table 38: Time Measurement of station 6 [Own]

Station Six		
Steps	Operation Sequence	Duration
1	Per-assembly of the front part gluing	2
2	Sticking the label on the stepladder	10.5
3	packing from the stairs	16
4	foil attachment	0.34
Total Duration		28.84

Table 39: Time Measurement of station 7 [Own]

Station Seven		
Steps	Operation Sequence	Duration
1	Passing the two-wire cable through the cable gland (7.) on the SMO-20. Connecting the shorter end with the mark "K1" to the Wago terminal. Connecting the longer end with the mark "4" to terminal block X-1 at position: 4	1
2	Stretching of the temperature sensor through the cable gland (10th) (marked with tape – 1x). Pull off the sensor through the clip (under the wiring) and measure the length of the lower brass pit. Pass the sensor through the plastic holder in the sump. Apply a little heat transfer paste to the hole in the sump (to the bottom), insert the sensor into the sump (to the bottom of the applied paste), and secure it with a plastic holder. Winding the sensor on your fingers, measure the end to reach positions: 5 and 6 (BT6), pull down with tightening or adhesive (electrician's) tape, and insert the coiled part behind the already connected wires. Inserting one end through the back through the terminal block X-2 (top) at position 5 and the other into the back of connector 6	1.3
3	Connecting the connector to the SPLIT card in position XJ 3 Placing the sensor on the down copper tube $\varnothing$ 16 mm with the G 3/4" end at the plate exchanger and glue it over with aluminum tape	2
4	Preparation of heating, cleaning from paint, and thread Vent installation	9
5	jacketing's	15
Total Duration		28.3

An analysis of time it takes to complete individual tasks or the entire assembly process. This helps in identifying bottleneck, inefficiencies, and opportunity and opportunity for improvements. Ultimately leading to more streamlined and productive assembly Operations. Time measurement and analysis it is a crucial tool in process improvement efforts to reduce production time and cost.





## 4.3 Process Diagram

This process diagram included all activity within seven work workstations, Activities are identified into Operation (P), Transport (T), Check (Ch), Waiting(W) and Storage (St). Each activity is described by time, it helps to show that the total time per each assembly process and the ratio of Value added and non-value-added activities can be determined in comparison of the current process diagram.

Table 40:Process diagram snapshot [Own]

Process: Assembling Electrical Boiler							
Operation: New Assembly line							
No.	Name of Activity	O	T	Ch	W	St	Time (min)
1	Transport of containers	●	→	■	◐	▲	11
2	Enamel container cleaning + sheet foaming, drilling holes, grinding of saddles	●	→	■	◐	▲	2
3	Installation of drain valve, thread lubrication for U seals	●	→	■	◐	▲	8.5
4	Grounding pin + pipes, blanking plugs + ground. tape	●	→	■	◐	▲	3.85
5	Making holes in the SMO-20 cable glands	●	→	■	◐	▲	1

In order to meet customer takt time and increase overall efficiency, a major improvement over the current system by this snapshot of new process of diagram (Table 40), the rest of the steps presents (Appendixes L) of this Document. Work flow became more balanced by distributing tasks evenly within the new station to eliminate the bottleneck in the electro connection operations. And efficient as a result of this switching, which requires increasing number of workers from 5 to 7 to mention each operation. A comprehensive overview displays the frequency of operation is includes specific time managements. Strategically arranged across workstations are operation, transport, checking, waiting and storing. The new process diagram shows a significant 24% increase in efficiency with total process time that is significantly less than the current one (272 minutes) at 206 minutes.

Frequency of each process description In %

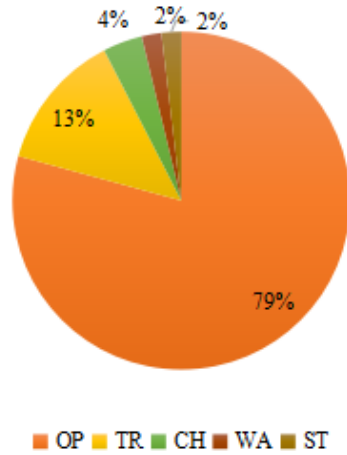

Figure 19: Graphical representation of the new process diagram snapshot

Through this the new process diagram creates an appropriate balance, ensuring that every work station matches the customer takt time, contribute efficiently to overall production process and meet the specific customer takt time.

#### 4.4 Value added and non-value-added Analysis

Analyzing a process to distinguish between value added and non-value activities is crucial for process improvement. Focus on optimizing non-value-added activities making the assembly process efficient and cost effective while ensuring that each step added value to final product. This contributes to overall process improvement and customer satisfaction.

Table 41: Value added and non-value-added Tasks [Own]

<i>No.</i>	<i>Activity Description</i>	<i>Value-Added</i>	<i>Non-Value Added</i>
1	Transport of containers		√
2	Enamel container cleaning + sheet foaming, drilling holes, grinding	√	
3	Installation of drain valve, thread lubrication for U seals	√	
4	Grounding pin + pipes, blanking plugs + ground. tape	√	
5	Making holes in the SMO-20 cable glands	√	
6	Passing the cable with three black and one blue conductor through. the cable gland (8.) on the SMO 20. Connecting the black wires...	√	
7	Stretching of the temperature sensor (WITHOUT MARKING) from	√	
8	Transport		√
9	Rear plate assembly	√	
10	Caliper installation	√	
11	Evaporator assembly	√	
12	Per-assembly of pipes (in a vice)	√	
13	Installation of pipeline deployment	√	
14	Label printing	√	
15	Boiler assembly	√	
16	Pump preparation Cables and strapping	√	
17	Installation of pump+ pipes	√	
18	Conductive paste lubrication for sensors and mounting, sensor... Assembly, and pipe holders		
19	Put on cable glands		√
20	Transport for Leak test		√
21	Assembly of SMO into the carcass in two.	√	
22	Take out a separate cable with three wires (black, red, and white from the set of wires. It is connecting the wires to the...	√	
21	Assembly of SMO into the carcass in two	√	

Table 42: Value added and non-value-added Tasks [Own]

22	Take out a separate cable with three wires (black, red, and... white) from the set of wires. It is connecting the wires to the... terminal board on the SPLIT card in Position: Black – 3, Red... – 2, White – 1. Connecting the other ends of the wires to the... terminal board on the SPLIT card in Position: Black – 3, Red... terminal board on the SPLIT card in Position: Black – 3, Red – 2, White – 1. Connecting the other ends of the wires to the... terminal board on SMO 20. to terminal board X-2 to Position: ... Black – 21(GND), Red – 20(B), White – 19(A).	√	
23	Pre-assembly plastic tube shearing	√	
24	Mounting + plate on contractor, rivet	√	
25	Cabin test	√	
26	Final check		√
27	Transport		√
28	Grounding pin + pipes, blanking plugs + ground. tape	√	
29	Connecting the PWM (control) and power wires to the connectors...	√	
30	Cutting the third hole from the back and "squeezing" the cable... on the SMO-20's left side partially out of the sheet. Pull the. Three-wire cable with terminals on both sides through the... prepared cut hole in the cable gland in the wiring cover (2), through the flat end to SMO 20, from the set of wires (which... comes together with the wiring). Connecting the SPLIT card's... connector (on top) to its three poles.	√	
30	Cutting the third hole from the back and "squeezing" the cable...	√	
31	Making holes in the SMO-20 cable glands	√	
32	Take a single, distinct wire (short black) from the set of wires. and then cut it through terminals 1 and 2 on the terminal board...Removing the set's cage clamps. Connect the Cage terminal with... one wire to the terminal board X-2 at position: 2.	√	
33	Passing Three-wire cable passes the cable gland (1.) on the SMO-20 and connects to the terminal board X-1 to the Position: Black - L, Blue - N, Yellow-green.	√	
34	Sensor installation	√	

Table 43: Value added and non-value-added Tasks [Own]

35	Passing the cable with three black and one blue conductors... through the cable gland (8.) on the SMO 20. Connecting the... black wires according to the marking to the terminal board X2... at Positions: K1-2, K2-4, K3-6 (Wago terminal). Connecting... the blue wire to terminal board X-1 at position: 0.	√	
37	Pull the control cable from the pump through the cable gland... (6th) and connect the back via the terminal board (see photo) ... X-2 to the positions: Brown-1, Blue-2. Passing the two-wire. Cable (Attention to the marking) from the wire set through... the cable gland (5.) and connect to the terminal board X-2... according to the marking positions: 17-17, 18-18.	√	
38	Passing the two-wire cable through the cable gland (7.) on the... SMO-20. Connecting the shorter end with the mark "K1" to the... Wago terminal. Connecting the longer end with the mark "4" to... terminal block X-1 at position: 4	√	
39	Installation of doors and tightening of joints	√	
40	Through the cable gland (3.) on the SMO-20 Pass the power cable. From the three-way valve and plug into the terminal board X4 to... The positions: Blue 2, Black3, Brown4	√	
41	Join Test	√	
42	Disconnection		√
43	Installation of riveting circuit breaker and rivet per-tension	√	
44	Installation of riveting circuit breaker and rivet per-tension	√	

Table 44: Value added and non-value-added Tasks [Own]

45	Inserting one end through the back through the terminal block... Stretching the temperature sensor through the cable gland (9.) ... Pull the sensor through the clip (under the wiring) and measure... Winding the sensor on our fingers, measure the end to reach... Inserting the ends through the back through the terminal block Connecting all wires, clamp the wires into a white plastic clip... Passing the temperature sensor with the connector (WITHOUT MARKING)	√	
46	Installation of the heating frame	√	
47	Per-assembly of the control on a three-way	√	
48	Pte-mounting the SMO panel on the board	√	
49	Transport		√
50	Per-assembly of the front part gluing	√	
51	Sticking the label on the stepladder	√	
52	Packing from the stairs	√	
53	Load on Trolley		√
54	Foil attachment	√	
55	Passing the two-wire cable through the cable gland (7.) on the...	√	
56	Stretching of the temperature sensor through the cable gland (10th). Inserting one end through the back through the terminal block...	√	
57	Connecting the connector to the SPLIT card in position XJ 3 Placing the sensor on the down copper tube ø 16 mm with the G3/4" end at the plate exchanger and glue it over with aluminum...	√	
58	Connecting the connector to the SPLIT card in position XJ 3 Place the sensor on the down copper tube ø 16 mm with the G... 3/4" end at the plate exchanger and glue it over with aluminum...	√	
59	Preparation of heating, cleaning from paint, and thread Vent...	√	
60	Jacketing's	√	
61	Loading		√

Table 41 up to 44 indicates that Certain tasks like sensor installation and cable connection directly contribute to the product assembly classifying them as value added. Conversely,

activity such as transportation and some preparation steps are labeled as non-value added. Analyzing and optimizing nonvalue added process could improve Assembly efficiency.

Table 45: VA / NVA Current State Analysis [Own]

VA/NVA	Frequency	Relative Frequency In %
<i>VA</i>	51	84
<i>NVA</i>	10	16
Total	61	100

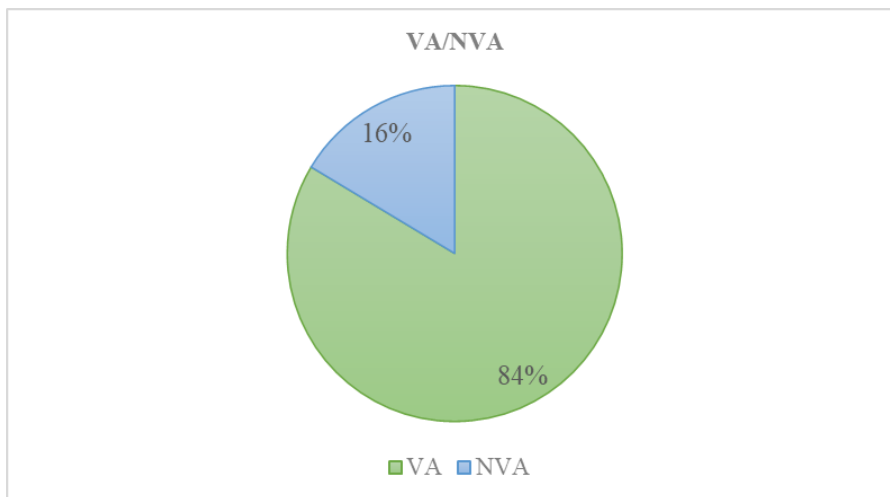

Figure 20:VA / NVA Current State Analysis [Own]

The outcome of Analysis indicates that after a new balancing there has been an improvement in the distribution of time spend on assembly tasks. The percentage of time allocated to value added tasks has increased from 81% to 84% suggesting a more efficient utilization of resources in activities that directly contribute to the value proportion of assembly process. Conversely the percentage of time spent on non-value-added tasks has decreased from 19% to 16% signifying a reduction in time allocated to activists that do not contribute significantly to overall value of Assembly process. This shift indicts an optimization effort aiming to enhance the efficiency and effectiveness of the assembly workflow.

## 4.5 Designing the layout of Assembly line

Two designs for a new layout arrangement will be presented in this chapter. For each variant design its layout will be shown with the arrangement of workstation, production equipment 's or used tools and number of operators will also be a showcased. The company can allocate the same 208,3 m<sup>2</sup> of space. The design of a new assembly line will consist of the same equipment and used devices will also be retained from the current Assembly line and they will only be arranged more appropriately.

## 4.6 Layout Proposition

Layout Proposition involves the strategical arrangement of workstation Machinery and other elements to optimize the efficiency and effectiveness of the assembly process. There are key of consideration for a layout proposition while designing Assembly line.

Linear flow; Linear arrangement workstation and machinery to create a smooth and continues flow of Assembly line. This layout is common in Assembly line where products product moves from one station to the next station to the next in sequential manner. Work Station Design; Designing workstation to accommodate the specific task involved in the assembly process ensure that workers have easy access to tool and material needs for their tasks. Balancing workstation; Balance workload across workstation to avoid bottleneck and ensure that each station has similar cycle time. This help maintain a consistence production pace. Conveyor system; Integrate conveyor system to facilitate the movement of product between workstations Conveys help automate materials handling and reduce the need for manual transportations. Maintenance Accessibility; Design the layout to allow easy access for maintenance personnel. This Crucial to minimize downtime and ensuring that Machinery and equipment can be quickly serviced or repaired. Space Utilization; Optimize the use of available space to prevent congestion and facilitate the smooth movement of product. Consider vertical space for storage or overhead conveyer system to maximized floor space Employee Ergonomics; Considering Ergonomic Principle in the design of workstation to ensure the comfort and safety the assembly line worker. This can contribute to increased productivity and to reduce risk of injuries.



## 4.7 Suggested Layout A

The first variant design for a redesigned assembly line Occupies a 208.3-meter square area and has seven workstations arranged strategically to maximize workflow. By purposefully allocated seven operators this layout design will achieve a balance between resource usage and operational efficiency. With a customer takt time of 29 minutes and to meet a daily product demand of 15 unites and achieve a weekly target of 75 unites over five days, the layout aims to balance production capacity and customer expectation.

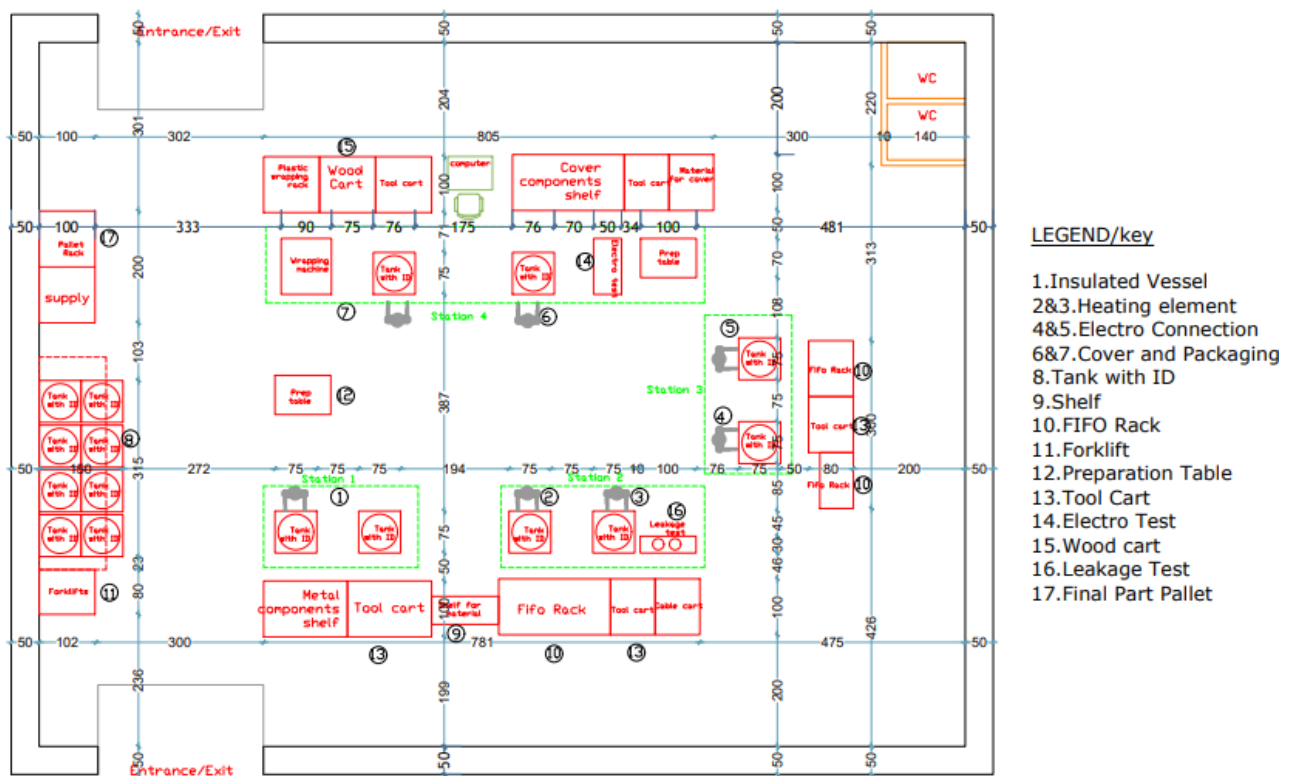

Figure 21: Suggested Layout A [All dimensions are in Centimeter] [Own]

This first design of Assembly line layout shown in Figure 20 consist of Installation of Insulated vessel, Heating element, Electro connection and Cove. The demination of this layout is in centimeter. The green rectangles on this layout shows each station of each Installation or Assembly process.

Table 46: Operation and Predecessor in layout A[Own]

<i>Operation description</i>	<i>Duration (Min)</i>	<i>Preceding Task</i>
1. IV	28.33	-
2. H & W	28.65	1,2
3. H	28.5	2,3
4 W	27.1	3
5. WC	28.5	4,5
6. C	28.84	5,6
7. PA	28.3	6
Total Time	206Minutes	

Working hours per Shift: 430 Minutes

Total Cycle time: 206 Minutes

Number of Workers: 7

Takt Time: 29 Minutes

$$\begin{aligned} \text{Balance Indicator (\%)} &= \frac{\text{total cycle time}}{\text{number of operators} * \text{Takt time}} * 100 \\ &= \frac{206}{7 * 29} * 100 = 100 \% \end{aligned} \tag{4}$$

The indicator shows This assembly line has well balanced and it is 100% Efficient.

The new layout suggestion A is shown in the figure Above and it has its own limitation and advantage to meet the required customer demand.

- *Advantage:* The layouts' ability to achieve customer takt time is a significant advantage. Customer takt time means that can adjust the production speed to match specific customer demand. Which is crucial for satisfaction and competitiveness.
- *Limitation:* However, there are some downsides to this layout. It does not have enough space for moving materials around which can lead to congestion and inefficiencies when transporting materials. Also, because workers have to around excessively it can pose safety risk. To make the most of the advantage of customer time, we need to find ways to address these issues effectively.

## 4.7.1 Spaghetti Diagram

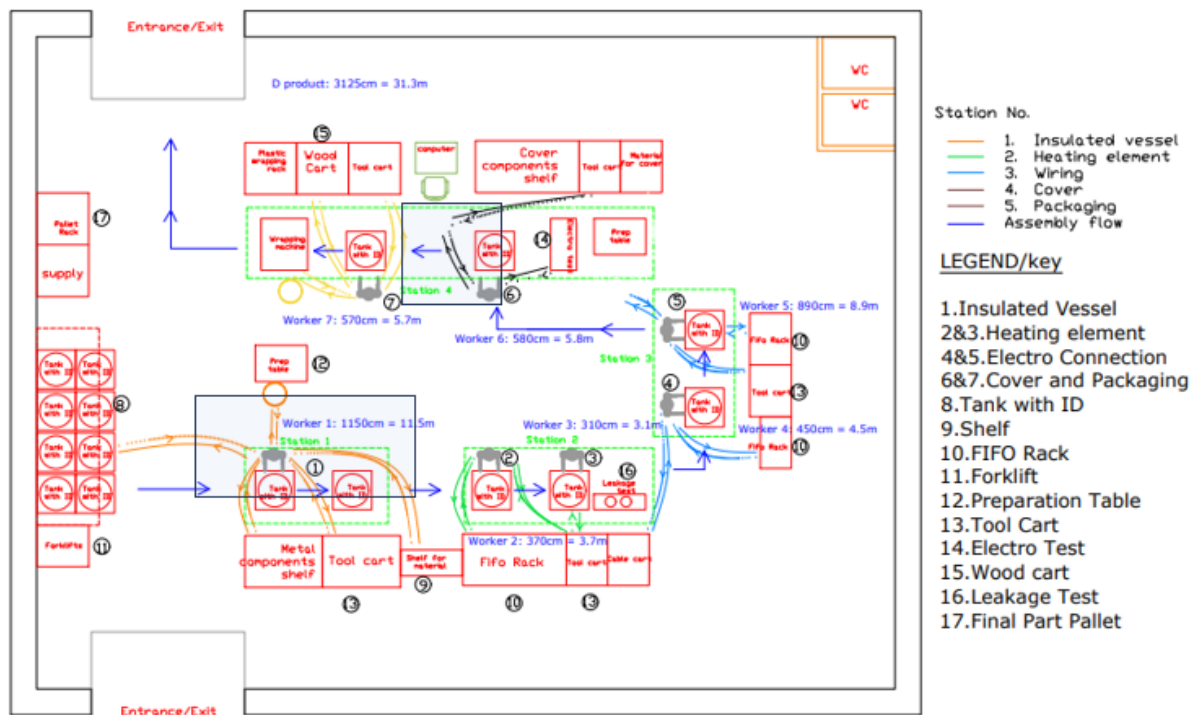

Figure 22: Layout A Spaghetti diagram [Own]

Figure 22 show the Spaghetti diagram of the first assembly line layout. This diagram shown together with product movement and worker movement. In the Insulated Vessel Installation Station. Tank will be transported to a place marking No.8 to 1. Metal guide will be prepared on place marking 12. After leakage test at Place marking No.6, Heating Element Installation. In places marking No.2 and 3. Electro Connection Installation section places marking No.4 and 5. Cable test at places Marking No.14. After Final checking Installation of the tank cover at Place marking No. 14. SOD code printing and Final packaging Place Marking No.7. After foil attachment. Removing the final product from the exit point of automatic plastic warping Machine. Repeating the process over and over again.

## 4.7.2 KPIs Calculation Variant A

Table 47: KPI calculation Layout A[Own]

<i>KPI Code</i>	<i>Criteria</i>	<i>Criteria Abbreviation</i>	<i>Units</i>	<i>The first variant Values</i>	<i>Current State Value</i>
C1	Cycle time	C1	Minutes	28.3	68
TT	Takt Time	T	Min	29	29
VA	Value-Added Index	VA Index	%	0.84	0.81
TA	Total Production Area	TA	m <sup>2</sup>	208.3	208.3
TD	Total traveling distance (a safe minimum mounting distance)	Ds	Meter	74.5	85.2
	D-Worker	Dw	Meter	31.3	47.9
	D-Product	Dp	Meter	43.2	37.3
N1	Number of workers	NW	Person	7	5

This table above (Table 47) presents Key performance indicators using the suggested line layout A for calculation. The Layout designed to highlight specific matrices and corresponding value. Provide view of Performance. And it is a valuable tool for analyzing the selected manufacturing KPIs and it supported information on decision making to select the productive type layout and it helps on strategical planning. Based on this key matrix customer takt time can meet this designed layout, with the same production area of the current state layout. Number of operators has increased from 5 to 7 after rebalancing the line in order to have efficient assembly line and to meet customer demand.

A FIFO rack type for Suggested layout A



Figure 23: Stationary FIFO rack [20]

For the Suggested layout A, the type of FIFO (First in, first out) rack that will be use is a stationary FIFO rack. This type of rack is fixed in place and cannot be easily moved. And it is typically designed to stay in one location for storage and retrieval of Items. Accessories of this type of rack more focused on optimizing storage spaces additional shelves and labeling system.

## 4.8 Suggested layout B

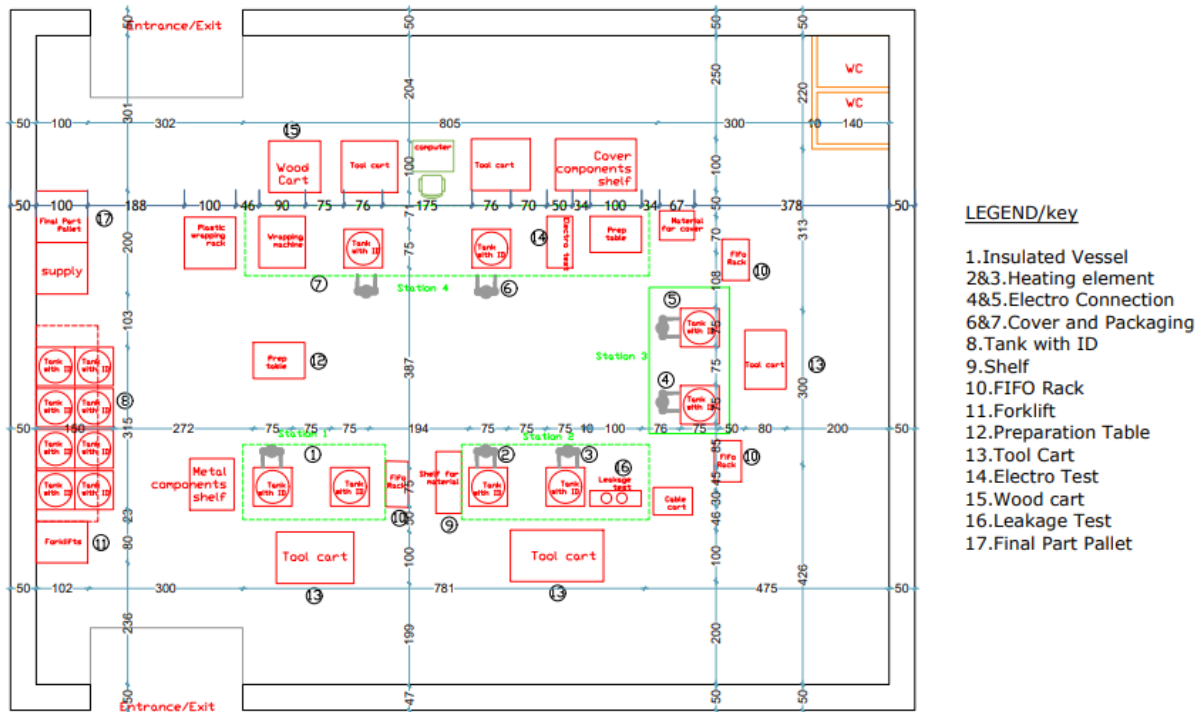

Figure 24: Suggested Layout B [All dimensions are in Centimeter] [Own]

The design of a new layout suggestion B is represented in the above Figure 24. The layout is U-shaped which is similar to the design of the previous new layout suggestion A. In terms of how the process flow proceeds through it. The main distinction between the two designs is the planned position of suppliers such as FIFO rack, tool cart, material shelf and other relevant elements near operator workstations. With this change the amount of space needed on the assembly floor will be significantly reduced since the amount of movements by workers throughout the assembly process is minimized.

## 4.8.1 Spaghetti Diagram

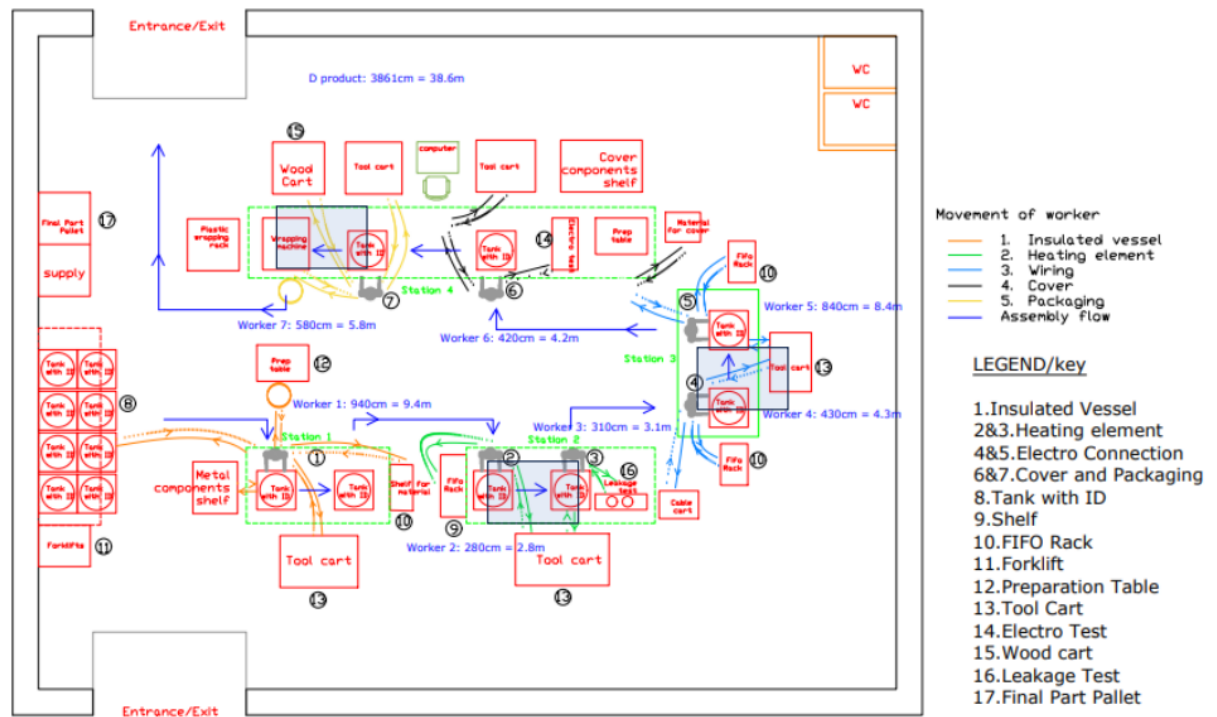

Figure 25: Spaghetti Diagram for Suggested line layout B [Own]

The spaghetti diagram for the suggested line layout B is shown in above (Figure 25). Along with worker and product movement, the location marked as 8 and 1 will be the destination of the Insulated vessel Installation Section. Tank will be transport into the first station and The Assembly process will begin. On location indicated by No.12, the metal guides will be ready. Heating Element Installation in Place No.2 and 3 following the leakage test at place Marking No.6. Section marking No. 4 and 5 for the installation of the Electro Connection. Place Marking No.14 for Cable test. Following to final check, Tank cover Installation at location No.14. Printing of SOD Code and final packaging put in Marking No.7. After foil attachment taking the final products out of the automatic plastic warping machine exit point. Carrying out the producer repeatedly.

This Diagram illustrates crossing at Place marking number 2,4, and 7 in this Assembly layout. Indicates potential crossing between worker and product flow. This point Violate the production design principle of smooth and streamlined material and production flow. Suggesting area of improvement in optimizing efficiency and reduce bottleneck.

4.8.2 KPIs Calculation Variant B

Table 48:KPIs Calculation of Layout B [Own]

<i>KPI Code</i>	<i>Criteria</i>	<i>Criteria Abbreviation</i>	<i>Units</i>	<i>The Second variant Values</i>	<i>Current State Value</i>
C1	Cycle time	C1	Minutes	28.3	68
TT	Takt Time	T	Min	29	29
VA	Value-Added Index	VA Index	%	0.84	0.81
TA	Total Production Area	TA	m <sup>2</sup>	208.3	208.3
TD	Total traveling distance (a safe minimum mounting distance)	Ds	Meter	76.6	85.2
	D-Worker	Dw	Meter	38	47.9
	D-Product	Dp	Meter	38.6	37.3
N1	Number of workers	NW	Person	7	5

Table 48, is similar to Table 46, displays key performance indicators using suggested layout B. while both table aid decision making and strategical planning. Table 35 differs in that shows less product movement but more worker movement compare to layout A. Consequently, the operators count increase from 5 to 7 compare to the current state layout to maintain efficient assembly line and meet customer demand.



A FIFO rack type for Suggested layout B



Figure 26:FIFO Rack with Wheels [21]

For Suggested Layout B the type of FIFO rack that will be used is a FIFO rack with wheels which is based on the layout design. This type of rack equipped with wheels, allowing it to easily moved from one location to another. The wheel provides mobility, making it more flexible for changing needs in the workstation. To prevent unintentional movement, a FIFO rack with wheel may have a locking mechanism on the wheel. This allows the worker to secures the rack in place when needed. Accessibility suited for workers where flexibility and Mobility is Important allowing easy reallocating of the track. And it includes features to enhance mobility such as handles for pushing or pulling and may have additional safety features for transport.

## 4.9 Suggested Layout C

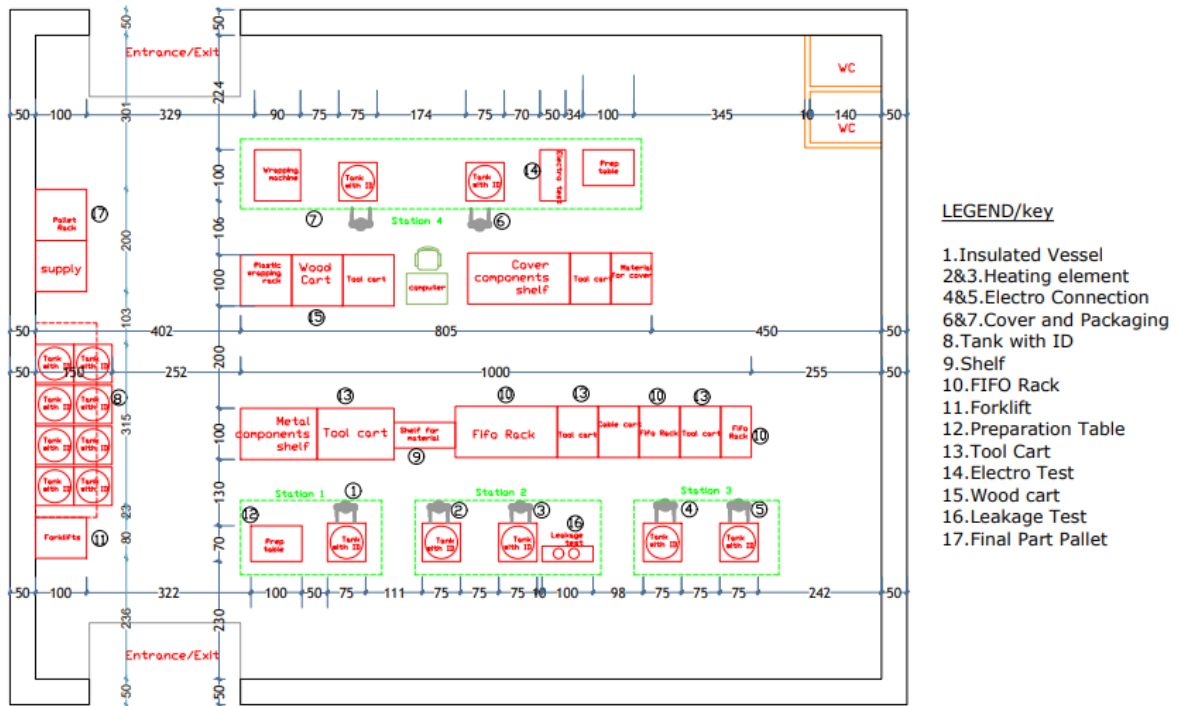

Figure 27: Layout Suggested C [All dimensions are in Centimeter] [Own]

The design of a new layout suggested C is represented in above Figure 27. The layout is Parallel shaped layout which is different to the design of the pervious new layout Suggestions A & B. And Which is similar in terms of how process flow precedes through it. This parallel layout consists of 7 stations and operated with 7 workers. Station one liable for the first assembly of Insulated tank. Station 2 and 3 work on the installation of Heating element simultaneously. In order to improve electro integration process station 4 and 5 split up of the electro connection using parallelize approach to enhance efficiency. The final stages of cover installations and packaging are carried out at station 6 and 7, shoeing a parallel work flow foe a smooth transition from every assembly process to the packaging phase.

Benefits And Limitation: This Parallel layout bring notable benefits by optimizing material flow and allowing for simultaneous progress in different stage. However potential limitation include challenge in adapting to change in production requirement and the risk of bottleneck if coordination not well managed. The linear nature of the layout may result in longer material handling distance. Affecting transport efficiency. Despite this consideration, this layout provides a structed and a streamlined approach. Enhancing over all assembly process and minimizing delays.

## 4.9.1 Spaghetti Diagram

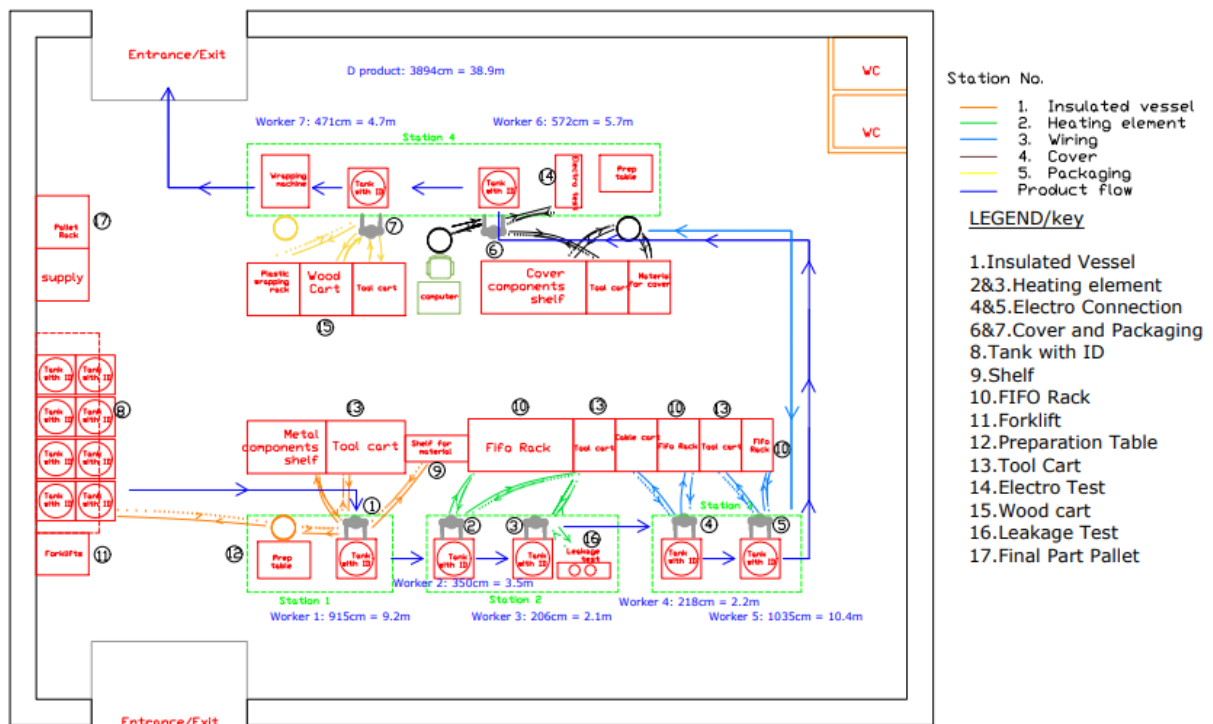

Figure 28: Spaghetti Diagram C [Own]

The spaghetti diagram for suggested line layout C (Figure 28) outlines worker and product movements. Stations 8 and 1 mark the destination for the Insulated Vessel Installation Section, initiating assembly. Noteworthy steps include metal guide preparation at No.12, Heating Element Installation at No.2 and 3, a leakage test at No.6, Electro Connection installation at Sections 4 and 5, Cable testing at No.14, and final checks at No.14 before Tank cover Installation. SOD Code printing and final packaging occur at No.7. The diagram indicates a single crossing point at Place Marking No.6, deviating from the smooth flow principle. This suggests areas for improvement to optimize efficiency and reduce potential bottlenecks in the production process.

4.9.2 KPIs calculation Variant C

Table 49:KPIs Calculation of Layout C [Own]

<i>KPI Code</i>	<i>Criteria</i>	<i>Criteria Abbreviation</i>	<i>Units</i>	<i>Values</i>	<i>Current Value</i>
C1	Cycle time	C1	Minutes	28.3	68
TT	Takt Time	T	Min	29	29
VA	Value-Added Index	VA Index	%	0.84	0.81
TA	Total Production Area	TA	m <sup>2</sup>	208.3	208.3
TD	Total traveling distance (a safe minimum mounting distance)	Ds	Meter	76	85.2
	D-Worker	Dw	Meter	37	47.9
	D-Product	Dp	Meter	38.9	37.3
N1	Number of workers	NW	Person	7	5

The above table 49 presented key performance indicators using suggested layout C. This evaluation contributes to decision making while selecting the best layout for assembly system unit, table 49 differs in that shows by illustrating reduced product and worker movement compared to suggested layout A and B and the current state layout as a result the operator counts increase from 5 to 7 when compares to the current layout. This layout adjustment is crucial to uphold an efficient assembly line and meet customer demand.

## 4.10 Comparison of the system unit layouts

Due to Space limitation, accommodating all assembly layouts within a single production unit is unfeasible. Therefore, it is crucial to identify the most appropriate layout for efficient production. To determine the optimal layout, comparing the layout according to predetermined criteria is part of the comprehensive. “Multi-criteria Analysis “must be conducted involving the comparison of layouts based on specific criteria.

### 4.10.1 Multi-Criteria Analysis

Multi- Criteria analysis is a decision-making approach for complex choices Involves Multi Criteria. MCA is also a systematic and transparent frame work that integrate weighting, ranking and performance matrix for comprehensive decision making in a complex scenario. *Key components*; Identification of Criteria: Define relevant Criteria for evaluation.

*Weighting process*: Assign weight to criteria based on their importance to reflect decision making priority.

*Ranking Process*: evaluate and the rank options for each criterion providing a criteria performance.

*Performance Matrix*: crating a matrix to visualize and compare the performance of each option across each criterion.

*Scoring*: Assign scores to potions aggregating them using various methods and calculate over all scores.

*Decision making and Interpretation*: Interpret results to make informed decision based on ranking and aggregated score. For the three proposed layout variant. I use MCA evaluation method to select the most suitable variant.

Table 50: Multi-Criteria Analysis [Own]

<i>KPI Code</i>	<i>Criteria</i>	<i>Criteria Abbreviation</i>	<i>Units</i>	<i>Current</i>	<i>A</i>	<i>% improve ment</i>	<i>B</i>	<i>% improve ment</i>	<i>C</i>	<i>% improve ment</i>
C1	Cycle time	C1	Minut	68	28.3	58.38%	28.3	58.38%	28.3	58.38%
TT	Takt Time (target	T	Min	29	29	0.00%	29	0.00%	29	0.00%
VA	Value-Added Index	VA Index	%	0.81	0.84	3.57%	0.83	2.41%	0.86	6.17%
TA	Total Production Area	TA	m <sup>2</sup>	208.3	208.3	0.00%	208.3	0.00%	208.3	0.00%
TD	Total traveling distance (a safe minimum mounting distance)	Ds	Meter	85.2	74.5	12.56%	76.6	10.09%	68.2	19.95%
	D-Worker	Dw	Meter	47.9	31	35.28%	38	20.67%	29.3	38.83%
	D-Product	Dp	Meter	37.3	43.2	-15.82%	38.6	-3.49%	38.9	-4.29%
N1	Number of	NW	Perso	5	7	-40.00%	7	-40.00%	7	-40.00%
						53.98%			48.07%	79.05%

### Key performance Indicators

- Cycle time: Current 68 minutes
- Varian A, B, C all shows a significant improvement, with 58.38% reduction.
- Tack time:29 minutes: variant A, B, C maintain the target time. By showing 0 % improvement
- Value add Index: Current 0.81 %  
 Varian A, B, C shows improvement with the percentage range 3.7% to 6.17%
- Total production Area: there are improvements in the total traveling distances for all variant.  
 (D-worker and D-Product) shows variations in improvement.
- Number of Worker: current 5  
 Varian A, B, C suggest an increasing to 7 workers

## Evaluation Criteria

- Cycle time and total production area are targets  
They are evaluated met or not meet, criteria in the objective function: Value added index, traveling distances and Number of Workers.
- VA/NVA and traveling Distances have same trend  
This implies the correlation or independency between these criteria.

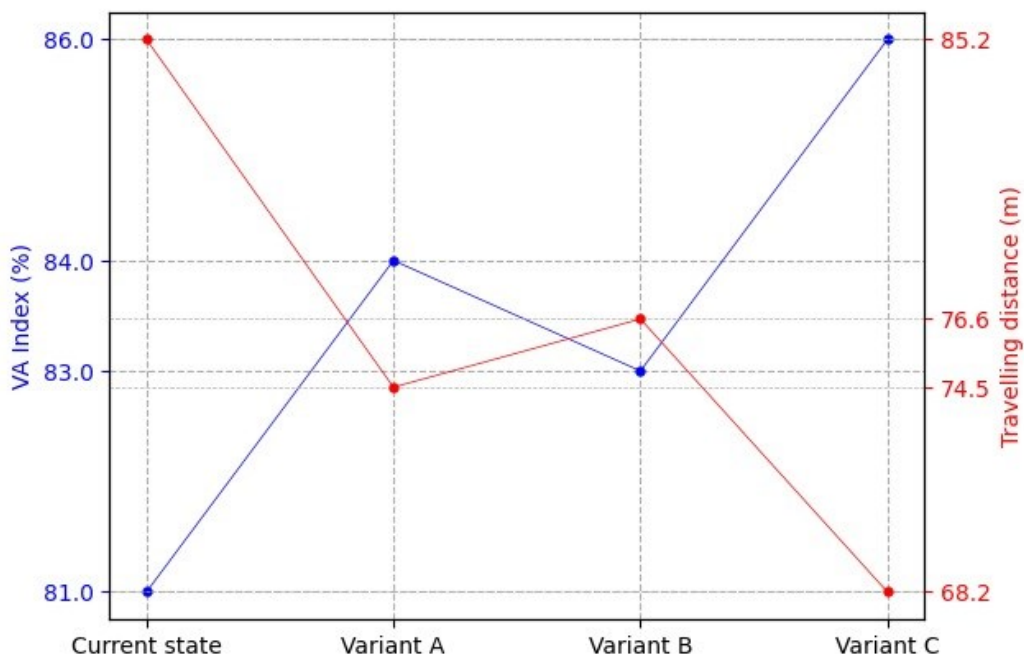

Figure 29: Multi-Criteria Analysis [Own]

Figure 29 shows how Efficiency is the common thread between VA/NVA and traveling distance. Both criteria exhibited a parallel trend as they prioritize the reduction of unnecessary movement or action. Traveling distances aims to minimize unwanted transportation of worker and product, while VA/NVA focuses on optimizing process by eliminating non-value-added tasks. This simultaneous trend highlighted the need for operational improvement, where enhancement in one area automatically support improvement in the other. The result is overall more efficient streamed line system.

# FACULTY OF MECHANICAL ENGINEERING TUL

## Multi criteria Decision Making (MCDM)

MCDM suggested variant A, B, C quantitative analysis is favoring these variants based on the specific criteria.

### Variant Considerations

- Layout A: Retain the same process of thinking during tool retiral, Tool and suppliers are close to the layout well
- Layout B: Close U shape facilitates teamwork among workers
- Layout C: Emphasized advantages in logistics within the cell while being closed off from the worker interface.

### Overall Criteria Analysis and Recommendation

- Efficiency improvement: Variants A, B, and C generally show improvement in various criteria, but there are trade-offs in the number of workers.
- Subjective criteria weight: The final decision is influenced by subjective criteria, indicating the importance of practical consideration and worker experiences.

The decision-making process involves in comprehensive evaluation of both quantitative and qualitative factors, with a focus on achieving a balance between efficiency improvement and practical consideration.

## **Advantages and Drawbacks of Variants A, B, and C**

### Variant A

Variant A presents a compelling case for efficiency improvement with a remarkable 58.38% cycle time improvement makes a strong case for efficiency improvement and promotes quicker and more efficient production cycles. Keeping in line with the Takt Time aim ensures that production flow is efficient and that the rate of production is in line with consumer demand. Positive reductions in total traveling distance, particularly for workers, further support streamlined processes. However, the option faces drawbacks in the form of a moderate improvement in the Value-Added Index (3.57%), potentially indicating room for further efficiency gains. Additionally, the decision to maintain the total production area without reduction limits its impact on overall operational optimization.



## Variant B

Variant B represents significant efficiency gains as it replicates Option A's remarkable 58.38% cycle time improvement. Improvements in the overall traveling distance, particularly for workers, lead to a general increase in efficiency. On the other hand, the whole production area remains unchanged and the Value-Added Index has improved somewhat (2.41%), much like Option A. Even while efficiency increases are achieved, the incremental improvements may not fully align with the paramount goals of maximizing efficiency and reducing cycle time.

## Variant C

Variant C aligns with efficiency goals by delivering a notable 58.38% improvement in cycle time. It is significant and suggests the highest improvement in the Value-Added Index at 6.17%, suggesting superior resource utilization and increased value in the production process. Positive changes in total traveling distance further contribute to heightened efficiency. However, the improvement in cycle time, while consistent with Options A and B, may not be as noticeable if cycle time is the primary focus. Moreover, like the other options, there is no change in the total production area. The decision to choose Option C might hinge on a strategic emphasis on maximizing both efficiency and value addition in the production process.

## **Variant Selection**

After a thorough comparison and analysis, Variant C emerges as the optimal choice, showcasing well-balanced workplaces and cost-effective implementation. The primary decision-making criterion, which centers on Cycle time reduction, the accuracy of flows, and the maximization of the Value-Added Index, proves to be pivotal. This criterion aligns seamlessly with efficiency goals, firmly favoring Variant C.

Variant C distinguishes itself with notable flow characteristics—short, well-distributed, and avoiding concentration in a single location. While all options exhibit comparable improvements in cycle time, Variant C stands out by achieving the highest enhancement in the Value-Added Index, signifying a substantial increase in value within the production process. Positive changes in total traveling distance are evident across all options, contributing to overall efficiency gains. While Options A, B, and C are all in line with efficiency and cycle

time reduction objectives, Variant C takes the lead, particularly when the emphasis is on maximizing the Value-Added Index alongside efficiency. The final decision should be made with meticulous consideration of the specific context, constraints, and strategic priorities of the organization. Based on this comprehensive assessment, Variant C is strongly recommended for subsequent implementation. The company can now progress to the design and planning phase of the implementation process.

## **4.10.2 Ergonomic**

The sciences of optimizing the workplaces for human well-being, is essential for enhancing productivity and reduces stress in workplaces. Important ergonomics improvements are mentioned below, each of which focuses on specific areas of work environment design.

### Ergonomics Improvement

1. Reducing walking distances:
  - Streamlined product layout: Minimizing walking distances for final product assembly.
  - Shift-wide Application: Extending ergonomics layout principle across the entire shift for sustained benefit.
2. Reduces psychological Burden:
  - Clear information: Reducing cognitive load through clear information dissemination
  - Addressing Lack of Information: To reduce the stress brought on by insufficient information.
3. Monotony Reduction:
  - Balancing diagram: Preventing monotony through well-defined balancing diagrams.
  - Process Variety: Incorporating Ergonomics Principles in process diagram and Electro Connection assembly descriptions diversify tasks.
4. Reduced Risk of Heavyweight Lifting:
  - Integration of Ergonomics Solutions: utilizing ergonomics designs to minimize the risk of heavy weight lifting.

These ergonomics Improvements collectively contribute to a workplace that not only minimizes stress and waking distances but also enhances overall job satisfaction and

efficiency. Based on this, the suggested layouts require a Euro Kraft Basic scissor Lift, instead of a normal Euro pallet Lifter.



Figure 30: Euro Kraft Basic Scissor Lift Truck [22]

This Euro Kraft Basic Scissor Lift Truck with manual hydraulics (Figure 30) is a valuable tool for station marking number 1, 5 and 6 workers Involved in tasks such as Metal guide. Installation, electro connection Installation, Cover installation, and pallet preparations on the water heater tank. Its adjustable platform allows for lifting control, reducing the need of bending of workers and manual lifting. It minimizes the risk of musculoskeletal strain. The lift truck stability-controlled moments control, contribute to a safer work environment, preventing accidents during assembly task. Overall, this scissor lift truck enhances efficiency, reduces the risk of injury, and promote Ergonomics practice for assembly line workers of the system unit. This Integrated Ergonomics ensure a harmonious balance between human capability and the demand of work environment.

## 5 Conclusion

The objective of this thesis was to conduct a comprehensive analysis of the assembly process and workplace at Dražice-strojírna s.r.o., with the specific aim of proposing enhancements for the assembly of the LUCIE 200 product type. The primary target was to streamline the assembly cycle time, reducing it from 68 minutes to 29 minutes to align with the customer demand of producing 15 products per day. The project was meticulously managed utilizing the DMAIC tool and Optimization of Manufacturing System Methodologies, with the results and recommendations subsequently presented to the company's management.

In the initial phase, a project plan was design, outlining the goal of reducing wasteful activities by 10%, minimizing walking distances by 10% and maximizing the assembly unit efficiency. The measurement phase involved a detailed analysis of the workplace and product, including the creation of dependency and spaghetti diagrams. Time studies were conducted for each assembly process during the working day, with active participation from the assembly technologist and five workers.

Moving into the analysis phase, the position of each component on the product and the duration of each assembly process were meticulously examined. The locations of assembly operations were reorganized into system units, and a thorough analysis of the current state assembly line was conducted to reduce the workload for assembly workers and minimize wasteful time during the process. The analysis revealed a potential 20% reduction in wasteful activities time. Activities were categorized based on sampled data, and a value analysis was conducted, represented through pie charts. Process diagrams and visualizations of product flows helped identify non-value-adding parts and analyze bottlenecks in the assembly process, leading to the re-balancing of the line.

The conclusion drawn was that a re-layout, coupled with minor improvements and an increase in the number of stations and workers, would be the most effective solution. The proposed new state required 7 workers and 7 stations, compared to the current 5 operators and 4 workstations, to meet the target of assembling 15 products per day by customer demand.

The evaluation included a Value-Add Index, showcasing significant improvement in Variants A, B, and C. The Current State Value Add Index stands at 81%, with Variants A, B, and C exhibiting improvements within the percentage range of 3.7% to 6.17%. Variant C emerged as

the optimal option, offering savings in both product and worker movement, optimal continuity in processes, and minimized workload for workers.

Further evaluation concluded that the arrangement of the third option resulted in a 20% reduction in distance compared to the original assembly layout, translating to a requirement of only 68.2 meters, as opposed to the original 85.2 meters, for the new arrangement to pass through the 7-assembly section for 4 main assembly operations. This minimized the workload for workers, and the use of conveyor machines in stations number 4 and 5 could eliminate additional travel for products and workers.

The improvement phase focused on designing new layouts, with Variant C chosen as the best option, showing a remarkable 58.38% reduction in cycle time and a substantial 79.1% improvement. Although the implementation was not completed, it is anticipated to achieve or exceed the target of reducing wasteful activities by 6%. The thesis concluded by describing the initial progress of the project and recommending control measurements to verify the objectives' achievement.

As a follow-up project, the implementation of a Euro Kraft Basic Scissor Lift Truck for workers involved in specific tasks is recommended to contribute to a workplace that minimizes stress and walking distances while enhancing overall job satisfaction and efficiency. The comprehensive analysis and viable solutions proposed in the thesis successfully achieved its objective.

## References

- [1] J. De Mast and J. Lokkerbol, ‘An analysis of the Six Sigma DMAIC method from the perspective of problem solving’, *International Journal of Production Economics*, vol. 139, no. 2, Art. no. 2, 2012.
- [2] J. A. Tompkins, J. A. White, Y. A. Bozer, and J. M. A. Tanchoco, *Facilities planning*. John Wiley & Sons, 2010.
- [3] F. Koblasa, ‘Lectures of Industrial engineering: Production design methodology’. 2020.
- [4] R. Koch, *The 80/20 Principle: The Secret of Achieving More with Less: Updated 20th anniversary edition of the productivity and business classic*. Hachette UK, 2011.
- [5] ‘Pareto Chart – A Six Sigma Tool for Measuring Process Performance’. [cit. 2023-12-10]. [Online]. Available: <https://www.edrawsoft.com/pareto-chart-sixsigma.html>
- [6] Rajurkar, K., Rechar C.Dorf, & Andrew Kusiak, *Handbook of Design, Manufacturing and Automation*, vol. 1994.
- [7] S. A. Irani, *Handbook of cellular manufacturing systems*. John Wiley & Sons, 1999.
- [8] K. Mahmood, T. Karaulova, T. Otto, and E. Shevtshenko, ‘Performance analysis of a flexible manufacturing system (FMS)’, *Procedia Cirp*, vol. 63, pp. 424–429, 2017.
- [9] C. Roser, *Mapování hodnotových toků, 4. část: Praktické typy pro VSM. In: Průmyslové Inženýrství.cz*. [cit. 2022-08-29]. [Online]. Available: <https://www.prumysloveinzenyrstvi.cz/mapovani-hodnotovych-toku-4-cast-prakticke-tipy-vsm/>
- [10] ‘10 Easy Steps to Complete a Value Stream Map’. SSDSI [cit. 2023-12-13]. [Online]. Available: <https://sixsigmadsi.com/value-stream-map/>
- [11] T. T. Allen, *Introduction to engineering statistics and lean six sigma: Statistical quality control and design of experiments and systems*. Springer, 2019.
- [12] A. Puvanasvaran, Y. Yap, and S. Yoong, ‘Implementation of Maynard operation sequence technique in dry pack operation-a case study’, *ARP Journal of Engineering and Applied Sciences*, vol. 14, no. 21, pp. 3732–3737, 2019.
- [13] F. Koblasa, *PI, Work - Measurement - Analysis - Standardization power pint*, vol. 2022.
- [14] ‘Time and Motion Study: Efficiency Tool that Improves Processes’. [Online]. Available: <https://checkify.com/blog/time-and-motion-study/>
- [15] Q. Li, H. Jiang, Q. Tang, Y. Chen, J. Li, and J. Zhou, ‘Smart Manufacturing Standardization: Reference Model and Standards Framework’, in *On the Move to Meaningful Internet Systems: OTM 2016 Workshops*, vol. 10034, I. Ciuciu, C. Debruyne,

H. Panetto, G. Weichhart, P. Bollen, A. Fensel, and M.-E. Vidal, Eds., in Lecture Notes in Computer Science, vol. 10034. , Cham: Springer International Publishing, 2017, pp. 16–25. doi: 10.1007/978-3-319-55961-2\_2.

- [16] ‘Top 10 Manufacturing KPIs’. [cit. 2023-12-07]. [Online]. Available: <https://manufacturing-software-blog.mrpeasy.com/manufacturing-performance-indicator/>
- [17] W. T. Singleton and W. H. Organization, ‘Introduction to ergonomics’, 1972.
- [18] ‘Company logo’. družstevní závody dražice-strojírna s.r.o. [cit. 2023-12-07]. [Online]. Available: <https://www.dzd.cz/en>
- [19] ‘Bill of Material’. Technology Department družstevní závody dražice-strojírna s.r.o.
- [20] *Stationary FIFO rack*. [cit. 2023-12-03]. [Online]. Available: FIFO Rack with Wheels - Search Images (bing.com)
- [21] ‘FIFO rack with Wheel’, LOGISTIC & INDUSTRIAL. [cit. 2023-12-05]. [Online]. Available: <https://www.cnking9.com/logistic-industrial/flex-flow-rack-pipe-fifo-rack-pipe-kj-rack-2.html>
- [22] ‘High-lift pallet truck, manual hydraulics – eurokraft basic’. [cit. 2023-12-10]. [Online]. Available: <https://www.export.kaiserkraft.com/stackers/high-lift-pallet-trucks/high-lift-pallet-truck-manual-hydraulics/fork-length-1140-mm/p/M1442585/>

Appendices



Appendix A :Analysis of a bottleneck Electro Connection operation (G-1) .....	113
Appendix B:Analysis of a bottleneck Electro Connection operation (G-1).....	114
Appendix C: Analysis of a bottleneck Electro Connection operation (G-2).....	115
Appendix D: Analysis of a bottleneck Electro Connection operation (G-2) .....	116
Appendix E: Analysis of a bottleneck Electro Connection operation (G-2).....	117
Appendix F: Analysis of a bottleneck Electro Connection operation (G-2) .....	118
Appendix G:Analysis of a bottleneck Electro Connection operations (G-3).....	119
Appendix H:Analysis of a bottleneck Electro Connection operation (G-3) .....	120
Appendix I:Analysis of a bottleneck Electro Connection operation (G-3) .....	120
Appendix J:Analysis of a bottleneck Electro Connection operation (G-3).....	121
Appendix K:Analysis of a bottleneck Electro Connection operation (G-3) .....	122
Appendix L Process Diagram.....	123
Appendix M: Process Diagram .....	124
Appendix N:Process Diagram .....	125
Appendix O: Process Diagram .....	126
Appendix P: Process Diagram.....	127
Appendix Q:Process Diagram .....	128
Appendix R:Process Diagram .....	129



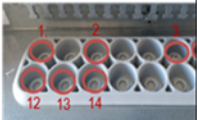

## Appendix A :Analysis of a bottleneck Electro Connection operation (G-1)

<i>Steps</i>	<i>Description of individual procedures</i>	<i>Input components</i>	<i>Working Tools</i>	<i>Time/minute</i>	<i>Figures</i>
3	-Making holes in the SMO-20 cable glands 1. Three-wire cable 2. Cable from the pressure sensor of the plate exchanger. 3. Power cable from three-way valve 4. Power cord from pump 5. Two-wire cable from a set of wires (17+18) 6. Pump control cable 7. Two-wire cable (K3+NO-4) 8. Four-wire cable (K1+K2+K3+Blue) 9. Four-wire cable (K1+K2+K3+Blue) 10. BT6 sensor (bottom sump) 11. Sensor BT63 (electric boiler) 12. Sensor with XJ 15 13. Sensor with plug XJ 12 14. Sensor with XJ 3	6322097	Phillips screwdriver	1	



## Appendix B: Analysis of a bottleneck Electro Connection operation (G-1)

<i>Steps</i>	<i>Description of individual procedures</i>	<i>Input components</i>	<i>Working Tools</i>	<i>Time/minute</i>	<i>Figures</i>
4	<p>-Take a single, distinct wire (short black) from the set of wires, and then cut it through terminals 1 and 2 on the terminal board.</p> <p>-Removing the set's cage clamps.</p> <p>-Connect the Cage terminal with one wire to the terminal board X-2 at position: 2</p>	5138613	Screwdriver. Wago 210-720	2	
5	<p>-Passing Three-wire cable passes the cable gland (1.) on the SMO-20 and connects to the terminal board X-1 to the Position: Black - L, Blue - N, Yellow-green</p>	6345800 6345801 6345802	Screwdriver. Wago 210-720	2	

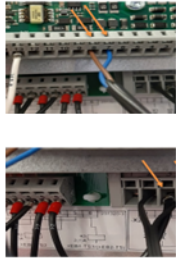
## Appendix C: Analysis of a bottleneck Electro Connection operation (G-2)

<i>Steps</i>	<i>Description of individual procedures</i>	<i>Input components</i>	<i>Working Tools</i>	<i>Time/minute</i>	<i>Figures</i>
6	-Through the cable gland (3.) on the SMO-20 Pass the power cable from the three-way valve and plug into the terminal board X4 to the positions: Blue 2, Black3, Brown4.		Screwdriver. Wago 210-720	2	
7	-Passing the cable with three black and one blue conductors through the cable gland (8.) on the SMO 20. -Connecting the black wires according to the marking to the terminal board X2 at Positions: K1-2, K2-4, K3-6 (Wago terminal). -Connecting the blue wire to terminal board X-1 at position: 0.	6735681 6735682	Screwdriver. Wago 210-720	1	
8	-Pull the control cable from the pump through the cable gland (6th) and connect the back via the terminal board (see photo) X-2 to the positions: Brown-1, Blue-2. -Passing the two-wire cable (Attention to the marking) from the wire set through the cable gland (5.) and connect to the terminal board X-2 according to the marking positions: 17-17, 18-18	6735679 6735680	Screwdriver. Wago 210-720	1	

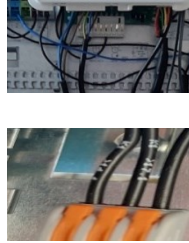
Appendix D: Analysis of a bottleneck Electro Connection operation (G-2)

<i>Steps</i>	<i>Description of individual procedures</i>	<i>Input components</i>	<i>Working Tools</i>	<i>Time/minute</i>	<i>Figures</i>
9	<p>-Passing the two-wire cable through the cable gland (7.) on the SMO-20.</p> <p>-Connecting the shorter end with the mark "K1" to the Wago terminal.</p> <p>-Connecting the longer end with the mark "4" to terminal block X-1 at position: 4</p>	5138613	Screwdriver 210-720	0.5	
10	<p>-Stretching of the temperature sensor through the cable gland (10th) (marked with tape – 1x).</p> <p>-Winding the sensor on a finger, measure the end to reach positions: 9, and 10, and pull down with tightening or adhesive (electrician) tape and insert the coiled part behind the already connected wires.</p> <p>-Inserting the ends through the back through the terminal block X-2 to positions 9 and 10 (BT63</p>	6345805	Screwdriver 210-720	1	



## Appendix E: Analysis of a bottleneck Electro Connection operation (G-2)

<i>Steps</i>	<i>Description of individual procedures</i>	<i>Input components</i>	<i>Working Tools</i>	<i>min</i>	<i>Figures</i>
11	<p>-Stretching of the temperature sensor through the cable gland (10th) (marked with tape – 1x).</p> <p>-Pull off the sensor through the clip (under the wiring) and measure the length to the lower brass pit. Pass the sensor through the plastic holder in the sump. Apply a little heat transfer paste to the hole in the sump (to the bottom), insert the sensor into the sump (to the bottom of the applied paste), and secure it with a plastic holder.</p> <p>-Winding the sensor on fingers, measure the end to reach positions: 5 and 6 (BT6), pull down with tightening or adhesive (electrician's) tape, and insert the coiled part behind the already connected wires.</p> <p>- Inserting one end through the back through the terminal block X-2 (top) at position 5 and the other into the back of connector 6</p>	<p>6422552 – Temperature sensor</p> <p>6309302, Heat-conducting paste</p>	<p>Screwdriver. Wago 210-720</p>	1.3	

## Appendix F: Analysis of a bottleneck Electro Connection operation (G-2)

<i>Steps</i>	<i>Description of individual procedures</i>	<i>Input components</i>	<i>Working Tools</i>	<i>min</i>	<i>Figures</i>
12	<p>-Stretching the temperature sensor through the cable gland (9.) (Marked with tape – 2x). Stretch the temperature sensor through the cable gland (9.) (Marked with tape – 2x).</p> <p>-Pull the sensor through the clip (under the wiring) and measure the length to the upper brass pit. Pass the sensor through the plastic holder in the sump. Apply a little heat transfer paste to the hole in the sump (to the bottom), insert the sensor into the sump (to the bottom of the applied paste), and secure it with a plastic holder.</p> <p>-Winding of the sensor on our fingers, measure the end to reach positions: 4 and 6, pull down with tightening or adhesive (electrician) tape and insert the coiled part behind the already connected wires.</p> <p>-Inserting the ends through the back through the terminal block X-2 (top) to positions 6 and 7 (BT7), the order does not matter.</p> <p>-Connecting all wires, clamp the wires into a white plastic clip (the clip is part of SMO 20)</p> <p>-Connecting all wires, clamp the wires into a white plastic clip (the clip is part of SMO 20)</p>	<p>6422552 – 6321855, Temperature sensor 6345711</p>	<p>Screwdriver. Wago 210- 720</p>	2	

## Appendix G: Analysis of a bottleneck Electro Connection operations (G-3)



<i>Steps</i>	<i>Description of individual procedures</i>	<i>Input components</i>	<i>Working Tools</i>	<i>Time/minute</i>	<i>Figures</i>
13	<p>-Passing the temperature sensor with the connector (WITHOUT MARKING) through the cable gland (14th).</p> <p>-Connecting the connector to the SPLIT card in position XJ 3</p> <p>-Placing the sensor on the down copper tube <math>\varnothing</math> 16 mm with the G 3/4" end at the plate exchanger and glue it over with aluminum tape.</p>	<p>6422559 – NTC temperature sensor with connector</p> <p>6345800</p> <p>6345801</p> <p>6345802</p> <p>Aluminium adhesive tape</p>	Aluminum adhesive tape	2	 
14	<p>-Stretching the temperature sensor with the connector (marked with tape – 1x) through the cable gland (13th).</p> <p>-Connecting the connector to the SPLIT card in position XJ 12</p> <p>-Placing the sensor on the upper copper pipe <math>\varnothing</math> 16 mm with the G 3/4" end at the plate exchanger and glue it over with aluminum tape.</p>	<p>6422559 – NTC temperature sensor with connector</p>	Aluminum adhesive tape, Screwdriver, Wago 210-720	1	



## Appendix H: Analysis of a bottleneck Electro Connection operation (G-3)



<i>Steps</i>	<i>Description of individual procedures</i>	<i>Input components</i>	<i>Working Tools</i>	<i>Time/minute</i>	<i>Figures</i>
15	<p>-Pulling the temperature sensor with the connector through the cable gland (12th) (marked with tape – 2x).</p> <p>-Connecting the connector to the SPLIT card in position XJ 15</p> <p>-Placing the sensor on the down copper tube <math>\varnothing</math> 12 mm at the plate exchanger and covering it with aluminum tape</p>	6422559 – NTC, 65419 13, temperature sensor with connector	Aluminum adhesive tape	1	

## Appendix I: Analysis of a bottleneck Electro Connection operation (G-3)

<i>Steps</i>	<i>Description of individual procedures</i>	<i>Input components</i>	<i>Working Tools</i>	<i>Time/minute</i>	<i>Figures</i>
16	<p>-Take out three separate long wires from the set of wires (black, blue, and yellow-green).</p> <p>- Connect the wires to terminal board X-1 on SMO 20 to Position: Black – 1, Blue – 0, Yellow-green -.</p> <p>- Connect the other ends of the wires to the terminal board on the SPLIT card to the Position: Black – 1, Blue – 2, Yellow-green – 3.</p> <p>-Wind the wires on your fingers, tighten them with tightening or adhesive (electrician's) tape, and insert the coiled part behind the wires.</p>	6273110, 6341018	Manual	1	 



## Appendix J: Analysis of a bottleneck Electro Connection operation (G-3)

<i>Steps</i>	<i>Description of individual procedures</i>	<i>Input components</i>	<i>Working Tools</i>	<i>Time/minute</i>	<i>Figures</i>
16	<p>-Take out three separate long wires from the set of wires (black, blue, and yellow-green).</p> <p>- Connect the wires to terminal board X-1 on SMO 20 to Position: Black – 1, Blue – 0, Yellow-green -.</p> <p>- Connect the other ends of the wires to the terminal board on the SPLIT card to the Position: Black – 1, Blue – 2, Yellow-green – 3.</p> <p>-Wind the wires on your fingers, tighten them with tightening or adhesive (electrician's) tape, and insert the coiled part behind the wires.</p>	6273110, 6341018	Manual	1	 

## Appendix K: Analysis of a bottleneck Electro Connection operation (G-3)

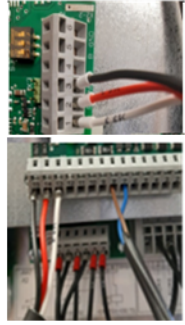

























































































<i>Steps</i>	<i>Description of individual procedures</i>	<i>Input components</i>	<i>Working Tools</i>	<i>Time/minute</i>	<i>Figures</i>
17	<p>-Taking out a separate cable with three wires (black, red, and white) from the set of wires</p> <p>-Connecting the wires to the terminal board on the SPLIT card in Position: Black – 3, Red – 2, White – 1.</p> <p>-Connecting the other ends of the wires to the terminal board on SMO 20 to terminal board X-2 to Position: Black – 21(GND), Red – 20(B), White – 19(A).</p>	6405616 6321855	Screwdriver. Wago 210-720	1.4	

# FACULTY OF MECHANICAL ENGINEERING TUL



































## Appendix L Process Diagram

Process: Assembling Electrical Boiler							
Operation: New Assembly line							
No.	Name of Activity	O	T	Ch	W	St	Time (min)
1	Transport of containers	●	→	■	◐	▲	11
2	Enamel container cleaning + sheet foaming, drilling holes, grinding of saddles	●	→	■	◐	▲	2
3	Installation of drain valve, thread lubrication for U seals	●	→	■	◐	▲	8.5
4	Grounding pin + pipes, blanking plugs + ground. tape	●	→	■	◐	▲	3.85
5	Making holes in the SMO-20 cable glands	●	→	■	◐	▲	1
6	Passing the cable with three black and one blue conductor through the cable gland (8.) on the SMO 20. Connecting the black wires according to the marking to the terminal board X2 at Positions: K1-2, K2-4, K3-6 (Wagon terminal). Connecting the blue wire to terminal board X-1 at position: 0.	●	→	■	◐	▲	1
7	Stretching of the temperature sensor (WITHOUT MARKING) from the electric boiler (the sensor is already located under the electric boiler) through the cable gland (11th). Winding the sensor on fingers, measure the end to reach positions: 9, and 10, and pull down with tightening or adhesive (electrician) tape and insert the coiled part behind the already connected wires. Inserting the ends through the back through the terminal block X-2 to positions 9 and 10 (BT63	●	→	■	◐	▲	1



































Appendix M: Process Diagram

8	Transport						0.4
9	Rear plate assembly						3.4
10	Caliper installation						2.5
11	Evaporator assembly						2
12	Per-assembly of pipes (in a vice)						4
13	Installation of pipeline deployment						1
14	label printing						1
15	Boiler assembly						1
16	Pump preparation Cables and strapping						2.75
17	Installation of pump+ pipes						4
18	Conductive paste lubrication for sensors and mounting, sensor assembly, and pipe holders						6.5
19	Put on cable glands						0.5
20	Transport						0.4
21	Assembly of SMO into the carcass in two						9.6
22	Take out a separate cable with three wires (black, red, and white) from the set of wires. It is connecting the wires to the terminal board on the SPLIT card in Position: Black – 3, Red – 2, White – 1. Connecting the other ends of the wires to the terminal board on SMO 20 to terminal board X-2 to Position: Black – 21(GND), Red – 20(B), White – 19(A).						1.5
23	Pre-assembly plastic tube shearing						1.4
24	Mounting + plate on contractor, rivet						2.5
25	Cabin test						3















## Appendix N: Process Diagram

26	check						10.5
26	Transport						0.4
28	Grounding pin + pipes, blanking plugs + ground. tape						3.7
29	connecting the PWM (control) and power wires to the connectors on the circulation pump. Connecting the wires locks the terminals with locking pins (the power cable is red, and the pump connector is white) Bending the black wire on the control cable and taping the "live" end with electrical tape						1.4
30	Cutting the third hole from the back and "squeezing" the cable gland on the SMO-20's left side partially out of the sheet. Pull the three-wire cable with terminals on both sides through the prepared cut hole in the cable gland in the wiring cover (2), through the flat end to SMO 20, from the set of wires (which comes together with the wiring). Connecting the SPLIT card's connector (on top) to its three poles						5
31	Take a single, distinct wire (short black) from the set of wires, and then cut it through terminals 1 and 2 on the terminal board. removing the set's cage clamps. Connect the Cage terminal with one wire to the terminal board X-2 at position: 2						2
32	Passing Three-wire cable passes the cable gland (1.) on the SMO-20 and connects to the terminal board X-1 to the Position: Black - L, Blue						2























































## Appendix O: Process Diagram

33	Sensor installation						2.5
34	Passing the cable with three black and one blue conductors through the cable gland (8.) on the SMO 20. Connecting the black wires according to the marking to the terminal board X2 at Positions: K1-2, K2-4, K3-6 (Wago terminal). Connecting the blue wire to terminal board X-1 at position: 0.						1
35	Pull the control cable from the pump through the cable gland (6th) and connect the back via the terminal board (see photo) X-2 to the positions: Brown-1, Blue-2. Passing the two-wire cable (Attention to the marking) from the wire set through the cable gland (5.) and connect to the terminal board X-2 according to the marking positions: 17-17, 18-18						1
36	Passing the two-wire cable through the cable gland (7.) on the SMO-20. Connecting the shorter end with the mark "K1" to the Wago terminal. Connecting the longer end with the mark "4" to terminal block X-1 at position: 4						0.5
37	Installation of doors and tightening of joints						5
38	Through the cable gland (3.) on the SMO-20 Pass the power cable from the three-way valve and plug into the terminal board X4 to the positions: Blue 2, Black3, Brown4.						2
39	Transport						0.4

Appendix P: Process Diagram

























40	9 joints test						4
41	Installation of riveting circuit breaker and rivet per-tension						6
42	<p>Inserting one end through the back through the terminal block X-2 (top) at position 5 and the other into the back of connector 6</p> <p>Stretching the temperature sensor through the cable gland (9.) (marked with tape – 2x). Stretch the temperature sensor through the cable gland (9.) (marked with tape – 2x).</p> <p>Pull the sensor through the clip (under the wiring) and measure the length of the upper brass pit. Pass the sensor through the plastic holder in the sump. Apply a little heat transfer paste to the hole in the sump (to the bottom), insert the sensor into the sump (to the bottom of the applied paste), and secure it with a plastic holder.</p> <p>Winding of the sensor on our fingers, measure the end to reach positions: 4 and 6, pull down with tightening or adhesive (electrician) tape and insert the coiled part behind the already connected wires. Inserting the ends through the back through the terminal block X-2 (top) to positions 6 and 7 (BT7), the order does not matter.</p> <p>Connecting all wires, clamp the wires into a white plastic clip (the clip is part of SMO 20)</p> <p>Connecting all wires, clamp the wires into a white plastic clip (the clip is part of SMO 20)</p>						2

Appendix Q:Process Diagram

43	Installation of the heating frame						3
44	Per-assembly of the control on a three-way						3
45	Pte-mounting the SMO panel on the board						10.5
46	Transport						0.4
47	Per-assembly of the front part gluing						2
48	Sticking the label on the stepladder						10.5
49	Packing from the stairs						16
50	foil attachment						0.34
51	Transport						0.4
52	Passing the two-wire cable through the cable gland (7.) on the SMO-20. Connecting the shorter end with the mark "K1" to the Wago terminal. Connecting the longer end with the mark "4" to terminal block X-1 at position: 4						9
53	Stretching of the temperature sensor through the cable gland (10th) (marked with tape – 1x). Pull off the sensor through the clip (under the wiring) and measure the length of the lower brass pit. Pass the sensor through the plastic holder in the sump. Apply a little heat transfer paste to the hole in the sump (to the bottom), insert the sensor into the sump (to the bottom						15



Appendix R:Process Diagram

54	Connecting the connector to the SPLIT card in position XJ 3 Placing the sensor on the down copper tube ø 16 mm with the G 3/4" end at the plate exchanger and glue it over with aluminum tape						1
55	Preparation of heating, cleaning from paint, and thread Vent installation						1.3
56	Transport to Packaging and STD code						0.7
57	jacketing's						2
58	Loading						1.2
Frequency		42	8	3	1	1	206