

BRNO UNIVERSITY OF TECHNOLOGY

Faculty of Electrical Engineering
and Communication

BACHELOR'S THESIS

Brno, 2019

Juan Velasquez



BRNO UNIVERSITY OF TECHNOLOGY

VYSOKÉ UČENÍ TECHNICKÉ V BRNĚ

FACULTY OF ELECTRICAL ENGINEERING AND COMMUNICATION

FAKULTA ELEKTROTECHNIKY
A KOMUNIKAČNÍCH TECHNOLOGIÍ

DEPARTMENT OF ELECTRICAL AND ELECTRONIC TECHNOLOGY

ÚSTAV ELEKTROTECHNOLOGIE

DESIGN OF A PHOTOVOLTAIC POWER SYSTEM WITH BATTERY STORAGE FOR HOUSEHOLD PURPOSES

NÁVRH FOTOVOLTAICKÉ ELEKTRÁRNY S BATERIOVÝM ÚLOŽIŠTĚM PRO DOMÁCNOST

BACHELOR'S THESIS
BAKALÁŘSKÁ PRÁCE

AUTHOR
AUTOR PRÁCE

Juan Velasquez

SUPERVISOR
VEDOUCÍ PRÁCE

doc. Ing. Jiří Vaněk, Ph.D.

BRNO 2019



Bakalářská práce

bakalářský studijní obor **Mikroelektronika a technologie**

Ústav elektrotechnologie

Student: Juan Velasquez

ID: 195647

Ročník: 3

Akademický rok: 2018/19

NÁZEV TÉMATU:

Návrh fotovoltaické elektrárny s bateriovým úložištěm pro domácnost

POKYNY PRO VYPRACOVÁNÍ:

Seznamte se s principem fotovoltaického děje a proveďte analýzu a rozbor používaných FV technologií pro výrobu FV článků. Proveďte rozbor technologií pro akumulátorové úložiště dle parametrů jednotlivých typů akumulátorů. Zaměřte se na vyhodnocení trhu v ČR (výhody, dotace, podmínky, legislativa). V praktické části práce navrhnete řešení FVE + akumulátorové úložiště pro domácnost dle konkrétního zadání.

DOPORUČENÁ LITERATURA:

Podle pokynů vedoucího práce.

Termín zadání: 4.2.2019

Termín odevzdání: 30.5.2019

Vedoucí práce: doc. Ing. Jiří Vaněk, Ph.D.

Konzultant:

doc. Ing. Jiří Háze, Ph.D.
předseda oborové rady

UPOZORNĚNÍ:

Autor bakalářské práce nesmí při vytváření bakalářské práce porušit autorská práva třetích osob, zejména nesmí zasahovat nedovoleným způsobem do cizích autorských práv osobnostních a musí si být plně vědom následků porušení ustanovení § 11 a následujících autorského zákona č. 121/2000 Sb., včetně možných trestněprávních důsledků vyplývajících z ustanovení části druhé, hlavy VI. díl 4 Trestního zákoníku č.40/2009 Sb.

Abstrakt

Cílem bakalářské práce je navrhnout fotovoltaický energetický systém na rodinném domu, jenž je odpojen od elektrické sítě. Práce dále obsahuje podrobné informace, jež by mohly pomoci pochopit, jak fotovoltaické systémy dodávají solární energii a které faktory mohou ovlivnit jejich účinnost. Byly použity dva různé programy k simulaci toho, jak by návrh vypadal po celý rok. Byly také zmíněny jejich výhody a nevýhody.

Klíčová slova

Fotovoltaické systémy, solární panely, izolovaný systém, čistá energie, elektrická energie.

Abstract

The aim of this bachelor's thesis is to design a solar photovoltaic energy system on a family house disconnected from the electrical grid. Furthermore, the thesis includes detailed information that might help understand how photovoltaic systems can supply energy and which factors may affect the efficiency of these. Two programs were used to simulate how the design would perform during a whole year. There were also mentioned their advantages and disadvantages.

Keywords

Photovoltaic systems, solar panels, isolated system, energy, electric power.

Rozšířený abstrakt

Sluneční energie je jedním z nejslibnějších zdrojů obnovitelné energie na světě. Ve srovnání s neobnovitelnými zdroji jsou výhody jasné: je neznečišťující, nemá žádné pohyblivé části a nevyžaduje velkou údržbu. Provoz nevyžaduje složité operace. Elektrárny mohou být instalovány distribuovaným způsobem, tak již i postavené budovy mohou bezpečně a tiše generovat vlastní energii. Nepotřebuje fosilní paliva, takže nevytváří provozní odpad. I přes technologický pokrok posledních let jsou náklady na instalaci fotovoltaického systému stále poměrně vysoké, zejména ve srovnání s výrobou elektřiny z fosilních paliv a někdy dokonce ve srovnání s jinými obnovitelnými zdroji.

Cílem této bakalářské práce je prostudovat různé aspekty solárního fotovoltaického energetického systému a získat představu o tom, jak co nejlépe využít možností tohoto zdroje energie. Společnost E. ON sdílela zkušební projekt pro rodinnou domácnost se sídlem ve Zlínském kraji v obci Zlobice, což je venkovská zóna, ve které je průměrná denní ozařování $2,989 \text{ kWh/m}^2/\text{den}$ a průměrná roční spotřeba energie se pohybuje kolem $4,161 \text{ MWh}$. Jednou ze základních podmínek je, že návrh musí být založen na systému odpojeném od elektrické sítě.

V první části práce byl proveden aktualizovaný přehled dosavadní literatury s odkazem na ekonomické vyhodnocení fotovoltaických scénářů. Cílem toho bylo zjistit, jak fotovoltaická energie může poskytovat významnou část elektrické energie s vysokým stupněm přizpůsobení poptávce, a to vše v rámci předvídatelného snížení v cenách, které umožní fotovoltaické energii ve střednědobém horizontu konkurovat ostatním současným technologiím, ale s mnohem menším dopadem na životní prostředí.

Přesně byl analyzován vývoj cen hlavních komponentů používaných ve fotovoltaických zařízeních, protože konečný úspěch nebo selhání výroby elektřiny pomocí fotovoltaické sluneční energie bývá určeno její schopností konkurovat v nákladech s jinými zdroji energie. Zvláštní pozornost byla věnována trhu s křemíkem a možnému vývoji ceny panelů, protože představují poměrně významné procento instalace jako celku, jakož i předvídatelný vývoj technologií.

Práce dále obsahuje podrobné informace, které by mohly pomoci pochopit, jak fotovoltaické systémy mohou dodávat energii a které faktory mohou ovlivnit jejich účinnost. Byly použity dva programy k simulaci toho, jak bude design fungovat po celý rok, PV * SOL a DEKSOFT. Rovněž byly zmíněny výhody a nevýhody každého softwaru s cílem ukázat, jak přesná jsou data získaná od každého z nich.

V závěrečné části práce byla zkoumána efektivita designu simulovaného systému a vyhodnocené výsledky analýzy. Ačkoliv fotovoltaické systémy jsou v krátkodobém horizontu dražší než jiné zdroje elektrické energie, dlouhodobě jsou nejen úspornější, ale zároveň i šetrnější k životnímu prostředí.

Extended Abstract

Solar energy is one of the most promising sources of renewable energy in the world. Compared to non-renewable sources, the advantages are clear: it is non-polluting, has no moving parts to analyze and does not require much maintenance. It does not require an extensive installation to operate. Power generators can be installed in a distributed way in which already built buildings can generate their own energy safely and silently. It does not consume fossil fuels. It does not generate much waste. Despite the technological progress of recent years, the costs of installing a photovoltaic system are still quite high, especially when compared to electricity generation from fossil fuels and sometimes even compared to other renewable sources.

The aim of this bachelor's thesis is to study the different aspects of a solar photovoltaic energy system and get an idea of how to get the most out of the capabilities of such energy source. The company E. ON has shared a trial project for a family household located in the Zlín Region of the Czech Republic in a village called Zlobice, which is a rural zone where the global average irradiance is $2,989 \text{ kWh/m}^2/\text{day}$ and the average annual energy consumption is around $4,161 \text{ MWh}$. One of the fundamental conditions is that the design must be based on a system disconnected from the electrical grid.

An updated review of the existing literature has been carried out, referring to the economic evaluation of photovoltaic scenarios, to see how photovoltaic energy can provide a significant part of electrical energy, with a high degree of adaptation to demand, all this within a foreseeable reduction in prices that will make photovoltaic energy able to compete in the medium term with the rest of current technologies, but with a much smaller environmental impact.

A clear mention has been made about the evolution of prices of the main components used in photovoltaic installations, since the final success or failure of electricity generation using photovoltaic solar energy will come determined by its ability to compete in cost with other energy sources. Special mention has been made of the silicon market and the possible evolution of the price of the panels, since they represent a very high percentage of the installation as a whole, as well as the foreseeable evolution of technologies.

Furthermore, the thesis includes detailed information that might help understand how photovoltaic systems can supply energy and which factors may affect the efficiency of these. Two programs were used to simulate how the design would perform throughout a whole year, PV*SOL and DEKSOFT. Advantages and disadvantage of each software were mentioned in order to have a clear picture of how accurate the data gather from each is.

In the final part of the work, the effectiveness of the design of the simulated system and the evaluated results of the analysis were examined. Although photovoltaic systems are more expensive in the short term than other sources of electricity, they are not only more economical in the long run, but also more environmentally friendly.

Bibliografická citace:

VELASQUEZ, J. *Návrh fotovoltaické elektrárny s bateriovým úložištěm pro domácnost*. Brno: Vysoké učení technické v Brně, Fakulta elektrotechniky a komunikačních technologií, 2019. 47 s. Vedoucí semestrální práce doc. Ing. Jiří Vaněk, Ph.D..

Prohlášení

Prohlašuji, že bakalářskou práci na téma *Návrh fotovoltaické elektrárny s bateriovým úložištěm pro domácnost* jsem vypracoval samostatně pod vedením vedoucí bakalářské práce s použitím odborné literatury a dalších informačních zdrojů, které jsou všechny citovány v práci a uvedeny v seznamu literatury na konci práce.

Jako autor uvedené bakalářské práce dále prohlašuji, že v souvislosti s vytvořením této bakalářské práce jsem neporušil autorská práva třetích osob, zejména jsem nezasáhl nedovoleným způsobem do cizích autorských práv osobnostních a/nebo majetkových a jsem si plně vědom následků porušení ustanovení § 11 a následujících zákona č. 121/2000 Sb., o právu autorském, o právech souvisejících s právem autorským a o změně některých zákonů (autorský zákon), ve znění pozdějších předpisů, včetně možných trestněprávních důsledků vyplývajících z ustanovení části druhé, hlavy VI. díl 4 Trestního zákoníku č. 40/2009 Sb.

V Brně dne:

.....

Juan Velasquez

Index

1.	Introduction.....	11
2.	Context.....	12
3.	Theory.....	15
3.1	Photovoltaic effect.....	15
3.2	Photovoltaic cells.....	17
3.2.1	Types of photovoltaic cells.....	18
3.2.2	Performance.....	19
3.2.3	Solar radiation.....	21
3.3	Photovoltaic modules.....	24
3.4	Generation Systems.....	26
3.4.1	Isolated photovoltaic systems.....	26
3.4.2	Photovoltaic systems connected to the network.....	28
3.5	Maintenance.....	28
3.5.1	Photovoltaic panel.....	29
3.5.2	Accumulators.....	29
4.	Design.....	30
4.1	Generalities.....	30
4.2	Design of an isolated photovoltaic system.....	31
4.2.1	Simulation software.....	32
4.2.1.1	PV*SOL.....	32
4.2.1.2	DEKSOFT.....	34
4.3	Simulation of the project using PV*SOL.....	36
4.3.1	3D model of the household.....	36
4.3.2	Irradiance.....	37
4.3.3	Temperature.....	39
4.3.4	Shading.....	39
4.3.5	Monocrystalline configuration.....	42
4.3.6	Polycrystalline configuration.....	44
	Conclusion.....	47

List of figures

Figure 2-1 Archimedes' Heat Ray [1]	12
Figure 2-2 Sun movement around the Earth [2]	12
Figure 2-3 Satellite with solar panels [3].....	13
Figure 2-4 Solar thermal panel [4].....	14
Figure 3-1 Structure of the atom. Neutral, positive and negative [5]	15
Figure 3-2 Crystal lattice of Si or Ge [6].....	15
Figure 3-3 Electrons and holes in the structure [7].....	16
Figure 3-4 P-N junction diagram [8]	17
Figure 3-5 Cross section of a solar cell [9].....	17
Figure 3-6 Concentrator photovoltaic system [11].....	18
Figure 3-7 Bifacial solar panel [12].....	18
Figure 3-8 Types of solar radiation [13].....	22
Figure 3-9 Movement of the sun [14].....	23
Figure 3-10 Solar irradiance [15].....	24
Figure 3-11 Cross section of a photovoltaic module [15]	25
Figure 3-12 System connected to a charge	26
Figure 3-13 System with a regulator and battery.....	27
Figure 3-14 System for direct and alternating current.....	27
Figure 3-15 System for alternating current.....	28
Figure 4-1 Plane of the roof, top view.	31
Figure 4-2 Production Forecast with consumption.....	33
Figure 4-3 Irradiance onto horizontal plane.....	33
Figure 4-4 Energy produced and consumed	35
Figure 4-5 Percentage of maximum hourly consumption.....	35
Figure 4-6 Planes of the set-up modules.....	36
Figure 4-7 3D model of the household (Northwest).....	36
Figure 4-8 3D model of the household (Southeast).....	37
Figure 4-9 Irradiance per module area.....	37
Figure 4-10 Irradiance onto tilted surface (Northwest)	38
Figure 4-11 Irradiance onto tilted surface (Southeast)	38
Figure 4-12 Temperature per module area.....	39

Figure 4-13 Shading frequency for the first of January	40
Figure 4-14 Shading frequency for the first of May	40
Figure 4-15 Shading frequency for the first of September	41
Figure 4-16 Shading on Southeast side.....	41
Figure 4-17 Shading on Northwest side	42
Figure 4-18 Parameters of monocrystalline simulation.....	42
Figure 4-19 Schematic diagram of the stand-alone PV system with backup generator	42
Figure 4-20 Explanation of each symbol in the schematic.....	43
Figure 4-21 Production forecast with consumption.....	43
Figure 4-22 Overview	44
Figure 4-23 Parameters for the polycrystalline simulation.....	44
Figure 4-24 Schematic diagram of the stand-alone PV system with backup generator	44
Figure 4-25 Explanation of each symbol in the schematic.....	45
Figure 4-26 Production forecast with consumption.....	45
Figure 4-27 Overview	46
Figure 4-28 PV generated energy	46

List of tables

Table 1 Performance of monocrystalline cells [24][25][26][27].	20
Table 2 Performance of polycrystalline cells [28][29].	20
Table 3 Modules in the market [24][25][30].	25

1. INTRODUCTION

Nowadays, the increase in population and the enormous dependence on fossil fuels, which are constantly increasing in price, have made energy generation one of the main problems to be solved. In countries where the cost of oil is very high, and they do not have affordable energy sources such as hydroelectric energy or nuclear power (€ 39.00 / MWh and € 44.37 / MWh, respectively [14]) they devote many resources to the investigation in alternative energy sources and they are applying them in all the scopes of the industry.

Within the renewable energy, the one that presents the greatest potential is solar energy. The amount of solar energy received by the earth's surface, has been calculated equivalent to 178000 *TW/year*, of which 30% are reflected to the atmosphere, 50% absorbed by the earth's surface and the remaining 20% allows the formation of winds, generate hydrological cycles and plants do the photosynthesis. The total energy consumption in the world in 2005 was 15 TW [15], thousands of times less than that received by the sun, so it is not unreasonable to think about using this type of energy to meet the requirements of society's energy need.

The project to be used as a subject of study will be a family house located in Zlobice, Czech Republic, which is a rural zone where the global average irradiance is 2,989 *kWh/m²/day*. The solar panels will be installed on the roof. The project will be analyzed according to the recommendations of the firm E.ON using two different software to simulate and get an idea of how effective the design may be.

2. CONTEXT

Solar energy has been used since ancient times by humanity, for example, Archimedes, in 212 BC, burned several Roman ships concentrating the sun's heat on them through mirrors, Leonardo da Vinci also designed a parabolic mirror to concentrate the heat of the sun, unfortunately it was not finished [17].



Figure 2-1 Archimedes' Heat Ray [1]

In the Architecture is where, in the nineteenth century, the use of solar energy has shown the best results by orienting the facades conveniently so that the sun enters the building and warms up its interior, especially on sunny winter days. For example, in homes oriented in the northern hemisphere, if you want the sun to enter through the windows of the house, they should be oriented to the south, southeast or southwest. In the following image you can observe the movement of the sun with respect to the position of a point in the northern hemisphere.

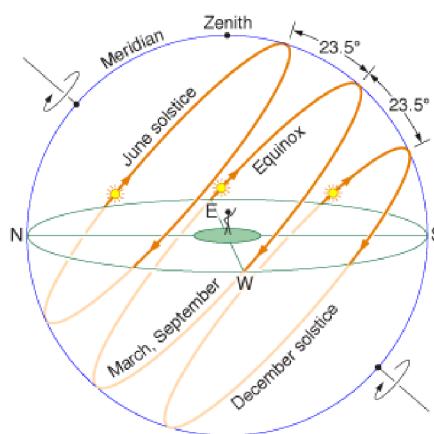

Figure 2-2 Sun movement around the Earth [2]

Hertz, in 1887, observed that the spark leapt more easily between two spheres of different potential when its surfaces were strongly illuminated by the light of another discharge, and later he verified that from a sheet of zinc negatively charged and attached to an electroscope, it quickly lost its charge when illuminated by an electric arc. From all this Hertz deduced that, under the action of the light, the zinc and in general all the metals emit negative charges [17].

In 1902 Einstein generalized the hypothesis made by Plank of the theory of the quanta or photons, which said that the photoelectric cells are devices based on the action of luminous radiations on certain metallic surfaces and their effect can be of three types:

- Photo-emissive effect or photo-external. Causes in the metal a liberation of electrons.
- Conductive photo effect or photo-internal. Modifies the electrical conductivity of the metal.
- Photovoltaic effect. Creates an electromotive force in the metal.

The first cell capable of efficiently converting sunlight into electrical energy was developed in 1954 by Chapin, Fuller and Pearson. Since this year these devices have been improved and perfected, being used mainly for the feeding of artificial satellites, for photo sensitizing some electronic equipment and for feeding small loads in remote places or of difficult access [17].



Figure 2-3 Satellite with solar panels [3]

Despite these small applications, it was not until the 1970s, due to the increase in the cost of oil, that the idea of using solar energy as an alternative for lower energy consumption was considered. Initially, small solar collectors were manufactured to heat the water and only for domestic use. See Figure 2-4.

Unfortunately, the stagnation of the price of conventional fuels, and the interests of the big companies that monopolize the production and consumption of energy, have contributed to stop the use of solar energy. Its use has been timidly fostered by governments and state institutions to date.

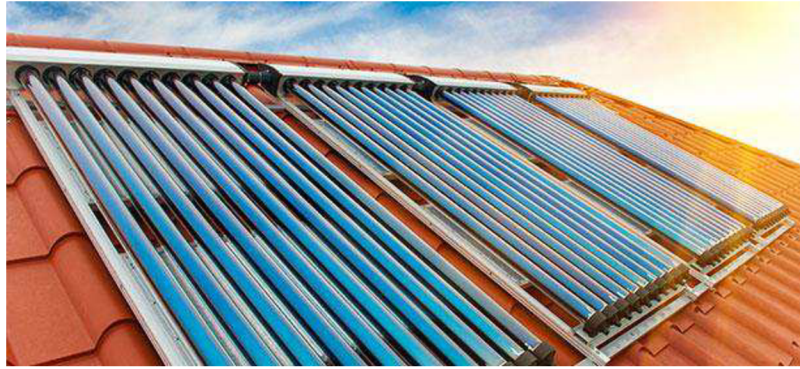

Figure 2-4 Solar thermal panel [4]

Thus, we come to this new millennium, a time when the very serious consequences of pollution, together with the desire for self-control of the energy consumed, have led to a growing desire to use clean and renewable energies, among which solar energy It occupies a prominent place.

At present the largest producer of photovoltaic solar energy is China, followed by Germany. But unfortunately, the energy produced is very small, in the case of Germany this production is only 0.03% of its total energy production.

For all this, it is necessary for countries that do not have regulations that encourage the use of this type of energy to start doing it. With this, they will achieve greater installed power and will also reduce the pollution produced by thermoelectric plants that are still very common in many countries.

3. THEORY

3.1 Photovoltaic effect

It is defined as the conversion of solar radiation into electricity, using semiconductor materials that have the property of absorbing photons and emitting electrons.

Matter is composed of atoms, which are formed by two parts that are electrons and the core with positive and negative electric charge respectively, thus forming a stable and electrically neutral set.

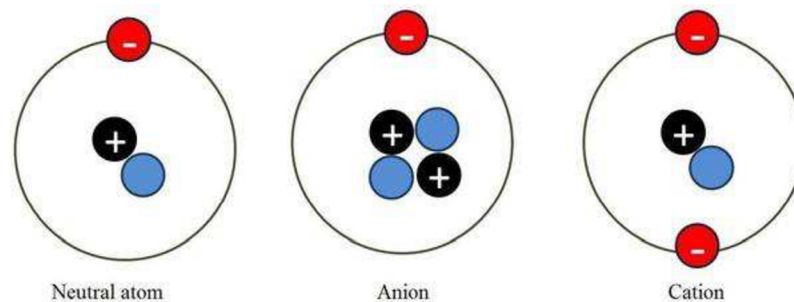

Figure 3-1 Structure of the atom. Neutral, positive and negative [5]

The electrons of the last level are called valence electrons and are those that interact with other electrons of other atoms to form a crystal lattice.

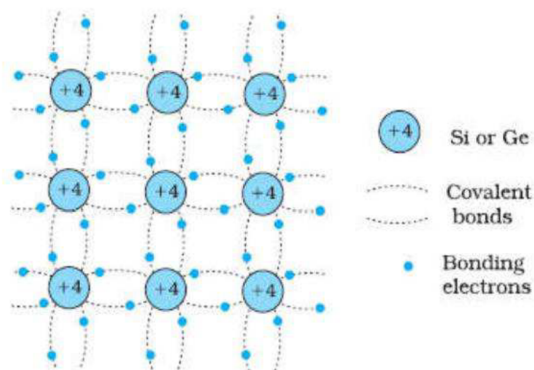

Figure 3-2 Crystal lattice of Si or Ge [6]

Electrically speaking we can divide the materials into three types:

- Conductors. Valence electrons are little linked and can move within a crystalline network with a small external agent.
- Semiconductors. Valence electrons are more linked to the nucleus but with a small amount of energy they can behave like conductors.
- Insulators. They have a very stable configuration and their valence electrons are very close to the nucleus and the energy necessary to separate them from this one is very large.

Lewis in 1926 called light atoms or small energy clusters as photons. According to this author, the rays of light are a flow of energy or also a rain of photons that crosses a certain section [18].

The materials used for the manufacture of photovoltaic cells are semiconductors since the energy that unites the valence electrons with the nucleus is similar to the energy of the photons of the solar rays. At the moment when the photons of solar radiation hit a semiconductor material, the bonds between the valence electrons and their nucleus are broken, being free to circulate through the semiconductor.

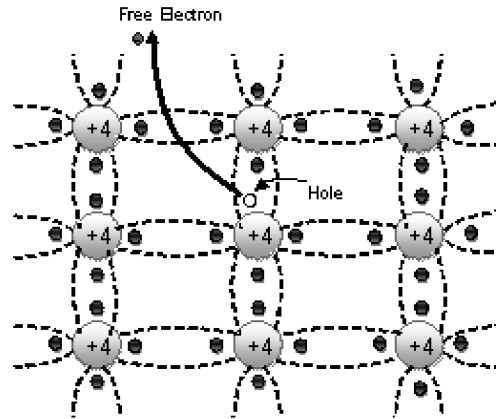

Figure 3-3 Electrons and holes in the structure [7]

The space left by the liberated electron is called a hole and has a positive electric charge of the same magnitude as the electron but of the opposite sign. In the areas where a semiconductor has been exposed to sunlight, this generation of gaps and release of electrons occurs. The problem initially was that the electrons released occupy the holes left by others, this means that the holes and electrons circulate in the same direction, restoring the broken bond without producing electrical current. So that this does not happen an electrical field must be generated inside the semiconductor, with this, the holes and the electrons will circulate in opposite directions producing an electric current.

The most used material for the manufacture of photovoltaic cells is silicon. A silicon photovoltaic cell is composed of two regions, to generate an electric field within it, what is done is to treat chemically different from the two regions.

The first one has replaced some silicon atoms by phosphorus atoms, which has 5 valence electrons, one more than silicon, leaving a free electron. On the other hand, silicon has been replaced by boron atoms, which have 3 valence electrons, one less than silicon, leaving a gap available. In this way, the electrons flow from the phosphorus-treated zone to the boron-treated zone and the holes flow in the opposite way, producing at the junction an electric field known as the p-n junction[18].

We must also consider that in order to release the electron from its nucleus and generate the electron-hole pair, we need a minimum amount of energy, which is called "prohibited bandwidth", it is represented by the letters E_g and its value is 1.5 electron volts (eV).

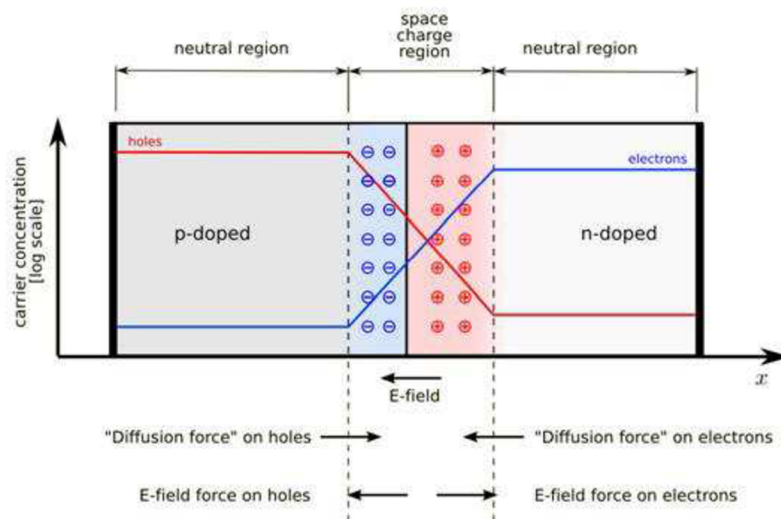

Figure 3-4 P-N junction diagram [8]

We must also consider that in order to release the electron from its nucleus and generate the electron-hole pair, we need a minimum amount of energy, which is called "prohibited bandwidth", it is represented by the letters E_g and its value is 1.5 electron volts (eV).

3.2 Photovoltaic cells

They are devices formed of semiconductor material, usually silicon, that are capable of transforming the sun's rays into electrical energy. Although silicon is the most abundant material in the earth after oxygen, since it is found in almost all rocks, for the manufacture of photovoltaic cells it is needed in its crystalline form and without imperfections. The process to bring silicon to its crystalline form is complex and expensive.

The photovoltaic cells are composed of a thin layer of n-type material (free electron) and another of thicker p-type material (available hole), at the junction of these layers the electric field is formed. In addition, an external conductor is placed that connects the negative layer to the positive one, thus generating the flow of electrons or electric current from the zone p to the zone n. The surface of zone n is that of the face that illuminates and while it is still illuminated by the sunlight there will be electric current, and its intensity will be proportional to the amount of light it receives [18].

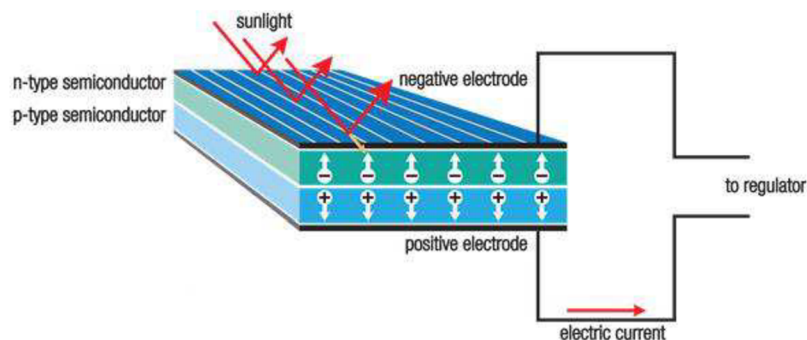

Figure 3-5 Cross section of a solar cell [9]

3.2.1 Types of photovoltaic cells

There are several types of photovoltaic cells and it depends on the semiconductor materials with which they have been manufactured and they are the following:

- **Gallium arsenide cells.** They are the most recommended for the manufacture of modules since in its monocrystalline version the yield reaches up to 28%. The main problem is the high cost of this material. Its main characteristics are its high absorption coefficient and its low efficiency losses at high temperatures, which is why it is widely used in concentration systems. Currently research is being done on combining gallium arsenide with silicon to reach yields of over 30% and successful results have been obtained [19].

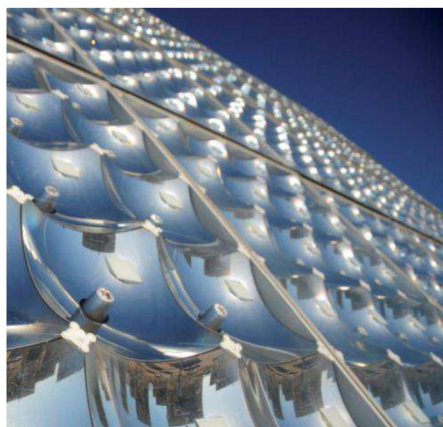

Figure 3-6 Concentrator photovoltaic system [11]

- **Cadmium sulfide and copper sulfide cells.** The advantage of this system is that very little material is used in a simple manufacturing process. On the contrary, its performance is very low, reaching in practice at values of 5%. The biggest problem is its degradation over time and the technology with which they are produced is not developed, so many studies are still needed to improve this technique [19].
- **Bifacial cells.** They are manufactured with a double union of type n^+p-p^+ so that the cell can absorb radiation on both sides, taking advantage of the one that is reflected from the ground. Its performance is higher than the monofacial cells, but its manufacturing costs also rise. For these reasons, they are currently in disuse [19].



Figure 3-7 Bifacial solar panel [12]

- **Amorphous silicon cells.** The great advantage of these is that the thickness of the photovoltaic cells can be 50 times thinner than that of monocrystalline silicon, they have a high degree of absorption and, being composed of less material, their manufacture is more economical. Its disadvantages are that its performance is less than 10%, much lower than those of monocrystalline silicon (15 - 18%), and its high degree of degradation when coming into contact with the sun. Currently they are widely used in calculators and watches where their durability is not a preponderant factor. At present, many variations in the manufacturing process are being investigated to make these cells more efficient and yields of up to 12.24% have already been achieved [19].
- **Polycrystalline silicon cells.** Its manufacturing process is similar to monocrystalline silicon but does not need a rigorous temperature control in its cooling stage. Its yield reaches 14%, its cost is slightly cheaper than monocrystalline, and its advantage is that square cells can be produced directly without the need for subsequent cuts. Previously, these cells were not widely used since the cost difference with respect to monocrystalline cells was minimal, but current studies indicate that there are new technologies that will make the polycrystalline cells return to compete with traditional technologies [19].
- **Monocrystalline silicon cells.** They are the most used cells at present, their structure is completely ordered. The process to reach monocrystallization requires a lot of time and energy, for this reason its high cost, there is also a very small demand for solar panels. It is obtained by doping pure silicon with boron and its yield reaches up to 18%. Currently, research is being carried out on low-cost processes that increase their performance by using silver nanoparticles, increasing it by 2.3% [19].
- **HIT (Heterojunction with Intrinsic Thin layer) cells.** These are the newest type of cells. It's basically a mono thin crystalline silicon wafer surrounded by ultra-thin amorphous Si layers. This type of cell has many advantages over the traditional ones, some of the most important are its significantly lower temperature coefficient and its higher efficiency.

3.2.2 Performance

The performance of the photovoltaic cells is defined as the result of the division between the maximum power of electrical generation and the light power that is applied on a photovoltaic cell. For example, if a cell has a performance of 10%, this means that for every 100 watts it receives, it only generates 10 watts. Currently in the European market there are modules with different performances, which are indicated in the following tables:

Table 1 Performance of monocrystalline cells [24][25][26][27].

Monocrystalline		
Producer	Model	Efficiency
Panasonic	HIT N325K KURO - black	19,4 %
	HIT N330 Powerful	19,7%
	HIT N245 Slim	19,4%
	HIT N295 compact	19,1%
SunPower	SPR-X21-255	21,57%
	SPR-X21-335	20,54%
	SPR-X21-335-BLK	20,54%
	SPR-X21-345	21,15%
	SPR-X21-345-COM	21,15%
	SPR-X20-445-COM	20,58%
Canadian Solar	HiDM CS1U-410MS	19,89%
	KuDymond CS3U-MS-FG	19,15%
	KuMax CS3U-0MS	19,15%
MEMC Singapore	SE-F325BZC-3Y	20,19%
Average		21,03%

Table 2 Performance of polycrystalline cells [28][29].

Polycrystalline		
Producer	Model	Efficiency
GPS	GPS 130	14,22%
	GPS 145	14,38%
	GPS 65Q	13,58%
	GPS 65L	13,86%
	GPS 73L	13,94%
	GPS 80Q	13,89%
Amerisolar	35-165Wp AS-6P18	16.73%
	210-245Wp AS-6P27	16.11%
	250-285Wp AS-6P30	17.52%
	240-285Wp AS-6P30 1500V	16.73%
	300-340Wp AS-6P	17.52%
	295-340Wp AS-6P 1500V	16.45%
Average		15,34%

The factors that make the performances of the photovoltaic cells are low are the following:

- Energy of the incident photons. It means that the photons of sunlight do not have enough energy to break the bond of the nucleus with the electron and do not allow the generation of the electron-hole pair. Or it can happen that the photons of light have too much energy, in this case what happens is that the excess energy is wasted in the form of heat. Due to this factor, up to 50% of the power generation of a cell can be lost.
- Recombination. For reasons attributable to the manufacturing process, a part of the released electrons is recombined with nearby holes without generating electric current. By this factor you can lose up to 15% of performance.
- Reflection. Sunlight is reflected by the cell, although it is currently being investigated in several coatings that lower the value of the losses to 10%.
- Temperature. Contrary to the common thought that the warmer the day, the better performance the photovoltaic system will perform, the high temperatures reduce the output power of the PV modules (low voltage). The power is equal to the product of the voltage and the current, with high temperatures the current increases but the number of electrons at rest is much smaller in the PV cell, which means lower voltage, therefore less power.
- Other reasons. By heating silicon, it is estimated that 2% is lost. Due to the shadows generated by the electrical contacts through which the released electrons circulate, losses of 10% are estimated.

After subtracting all these losses, we have as a result the percentage of performance of the photovoltaic cells. Nowadays, a lot of research is being carried out in order to lower these percentages of losses and achieve more efficient cells.

3.2.3 Solar radiation

It is important to understand the behavior of the solar radiation since it is the fuel of the photovoltaic cells and without it the photovoltaic effect would not occur. Solar radiation is a factor that depends on the position of the sun and the earth that move according to laws of physics and also depends on the atmosphere of the earth that possesses qualities that remain constant and others that are totally random.

To measure the solar radiation there are two conventional units used:

- **Irradiation.** It is the amount of energy received in a period of time and its unit of measure is $\frac{W \cdot h}{m^2}$.
- **Irradiance.** It is the power received in a moment and its unit of measure is $\frac{W}{m^2}$.

It is important to know that the irradiance emitted by the surface of the Sun is $63,500 \text{ kW/m}^2$, but outside the Earth's atmosphere only 1.37 kW/m^2 arrives, this is approximately 3.3 %. In addition, when solar radiation passes through the Earth's atmosphere, a loss of energy occurs due to reflection, diffusion and absorption phenomena. On average, the average irradiance that reaches the surface of the Earth is 630 W/m^2 .

There are three types of solar radiation depending on how they affect the surface of the earth and they are:

- **Direct Radiation.** It is the one that passing through the atmosphere comes directly from the Sun to a point on the Earth's surface.
- **Diffuse Radiation.** It is the one that passing through the atmosphere and having to go through obstacles like clouds, reaches the surface of the Earth.
- **Reflected Radiation or Albedo.** It is the one that passing through the atmosphere is reflected by the ground or any other surface nearby.

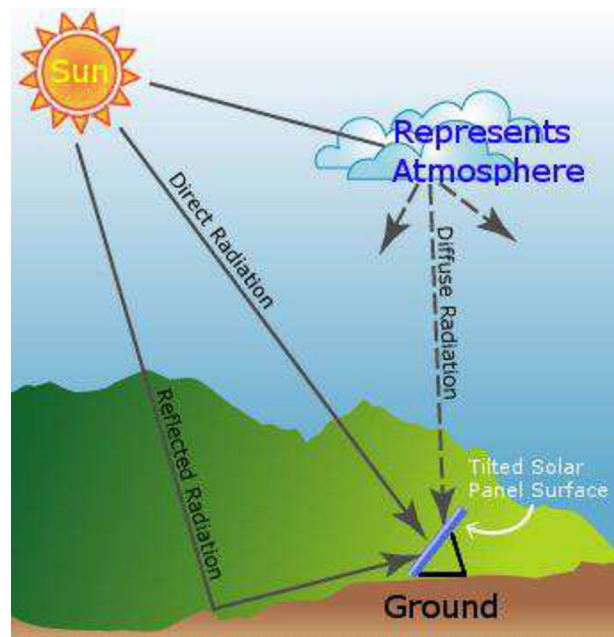

Figure 3-8 Types of solar radiation [13]

The amount of solar radiation that a point on the surface of the earth can receive depends on many factors:

- **Weather conditions.** The solar radiation in a same point of the Earth can vary if it is a cloudy or sunny day, in the second case the direct radiation can get to be 90% of the total.
- **Inclination of the collection system.** A horizontal plane receives the highest amount of direct radiation and the least amount of reflected radiation and vice versa. We must regulate the inclination of the sensor depending on the type of radiation that we want to capture.

- **Reflective surfaces.** In the case where the surfaces near the collector are more reflective, such as snow, for example, we will have more reflective radiation than if we have surfaces such as earth or grass.
- **Position of the Earth with respect to the Sun.** The best way to take advantage of the sun's radiation is to make the sun's rays strike the surface perpendicularly. The inclination in the axis of rotation of the Earth with respect to the plane of its orbit around the sun causes that a same point in the surface receives the solar rays to different inclinations. For these reasons the same point receives different irradiances depending on the time of year. In the following image you can see the movement of the sun in different latitudes.

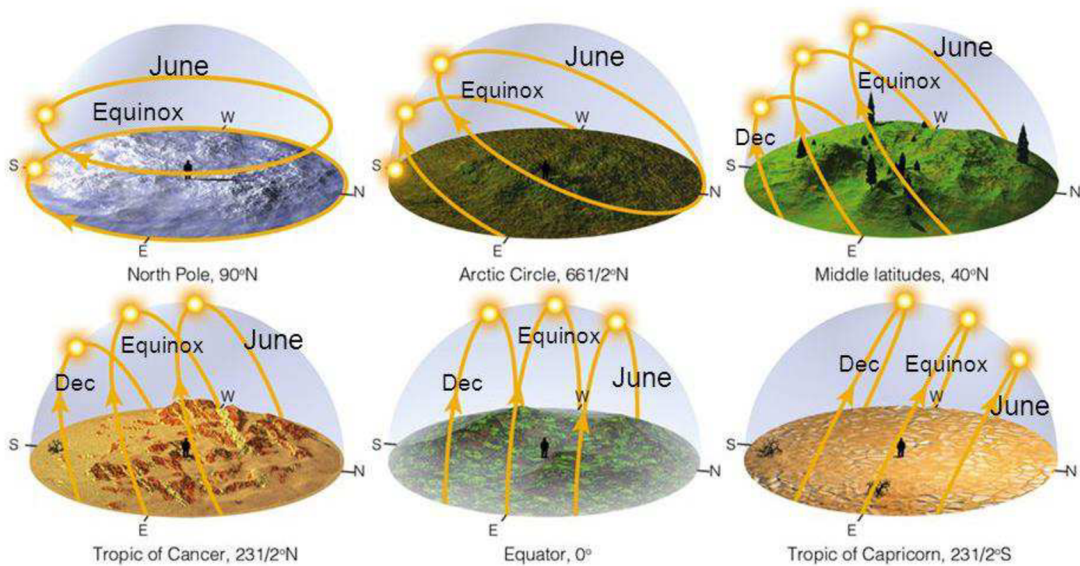

Figure 3-9 Movement of the sun [14]

In the following figure we will see the values of solar radiation in $\frac{kW \cdot h}{m^2 \cdot day}$ on the surface, taking into account the most favorable inclination in the most unfavorable month.

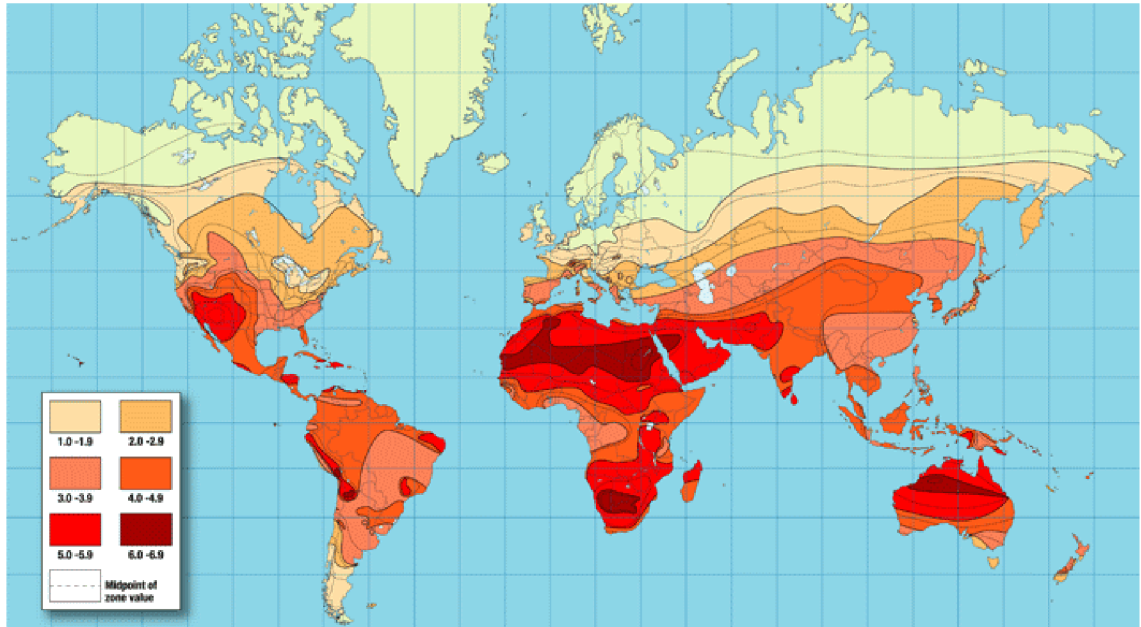

Figure 3-10 Solar irradiance [15]

In this image we can see that the zones that are located in the latitudes near the equator are the most favored by solar radiation, which indicates that they are the areas in which greater benefit can be obtained.

3.3 Photovoltaic modules

The modules or photovoltaic panels are structures that are composed of photovoltaic cells. They usually contain between 40 and 80 photovoltaic cells and their size varies between 0.80 m² and 2 m², but the most widely used is the 36-cell flat module composed of glass, EVA (Ethylene-vinyl-acetate) and TEDLAR (Polyvinyl fluoride) that produces enough voltage to power a 12 V battery.

Generally, it can be said that the modules are made up of the following components:

- **External cover.** It is tempered glass because it is resistant and allows the passage of solar radiation. Its function is to protect all panel components from atmospheric phenomena.
- **Encapsulating layers.** They are mainly silicone, ethyl-vinyl-acetylene (EVA) or polyvinyl butyral or any material that has good transmission of solar radiation and is not degraded by ultraviolet rays. Its function, apart from adhering the covers, is to cushion the possible vibrations and impacts.
- **Later protection.** It is usually made of acrylic materials, silicones, but currently the most used are: TEDLAR or EVA. It serves to protect the panel from atmospheric agents, mainly from humidity.
- **Support frame.** It is made of anodized aluminum or stainless steel. It serves to support the whole assembly and as a mechanical link between modules.

- **Electrical contacts.** These are copper cables that allow the energy delivered by the module to be collected and are located in the back of the module in a box that protects them from humidity. They can also be composed of protective elements such as bypass diodes that protect them from partial shadows.

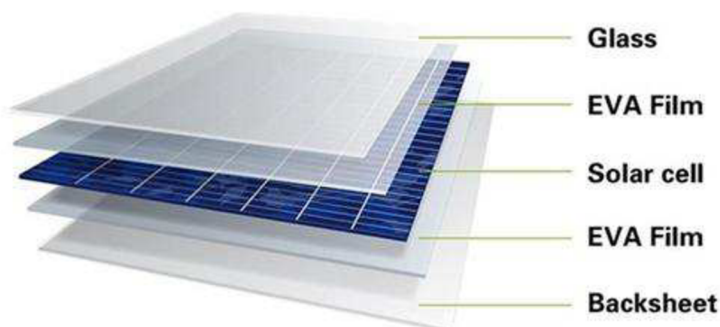

Figure 3-11 Cross section of a photovoltaic module [15]

If we talk in terms of power, in addition to the environmental factors of irradiation and temperature, the power that a module can deliver depends on the performance of its photovoltaic cells and the resistance of the load. In short, a photovoltaic generator is the union of several modules to meet certain energy needs.

The technology of photovoltaic panels is currently being developed a lot and this means that we have a great variety of companies that sell them, so it is important to know what types we currently have. In the following table you will find some of the most used modules in the European market.

Table 3 Modules in the market [24][25][30].

Brand	Model	Nominal power P_{max} [W]	Efficiency [%]	Nominal voltage V_{MPP} [V]	Nominal current I_{MPP} [A]	I_{cc} [A]	V_{oc} [V]
LG Electronics	LG280S1C-L4	280	17,05	31,0	8,90	9,39	38,6
	LG295S1C-A5	295	17,23	31,3	9,43	10,02	38,6
	LG300S1C-A5	300	17,52	31,7	9,47	10,07	38,9
	LG310N1C-G4	310	18,90	32,8	9,45	9,96	40,4
	LG330N1C-A5	330	19,28	33,7	9,80	10,45	40,9
	LG390N2W-A5	390	18,84	39,8	9,81	10,39	49,1
Panasonic	VBHN240SJ25	240	19,05	43,60	5,51	5,85	52,40
	VBHN245SJ25	245	19,46	44,30	5,54	5,86	53,00
	VBHN285SJ40	285	18,53-	52,00	5,49	5,91	63,50
	VBHN295SJ46	295	19,16	52,70	5,60	6,00	63,70
	VBHN325SJ47	325	19,44	57,60	5,65	6,03	69,60
	VBHN330SJ47	330	19,75	58,00	5,70	6,07	69,70
SunPower	SPR-E20-320	320	19,66	54,7	5,86	6,24	64,8
	SPR-X21-345	345	21,15	57,3	6,02	6,38	68,2
	SPR-MAX2-360	360	20,36	59,1	6,09	6,50	70,6
	SPR-MAX3-370	370	20,94	61,8	5,99	6,52	74,7
	SPR-MAX3-390	390	22,07	64,5	6,05	6,55	75,3
	SPR-MAX3-400	400	22,63	65,8	6,08	6,58	75,6

3.4 Generation Systems

3.4.1 Isolated photovoltaic systems

This type of system works mainly in areas of difficult access and that the public electric power network has not been able to reach. They are very reliable systems and can reliably generate energy for up to three days without the presence of sunlight. The applications of this system can be the following:

- In homes and buildings.
- Street lighting.
- Agricultural applications.
- Signage and works on the road.
- Isolated measurement or control systems.

According to the elements that compose them, photovoltaic systems can be divided into three types:

- **Directly connected to a charge.** It is the simplest of all. The photovoltaic generator is connected directly to a DC appliance. They are mainly used for pumping water.

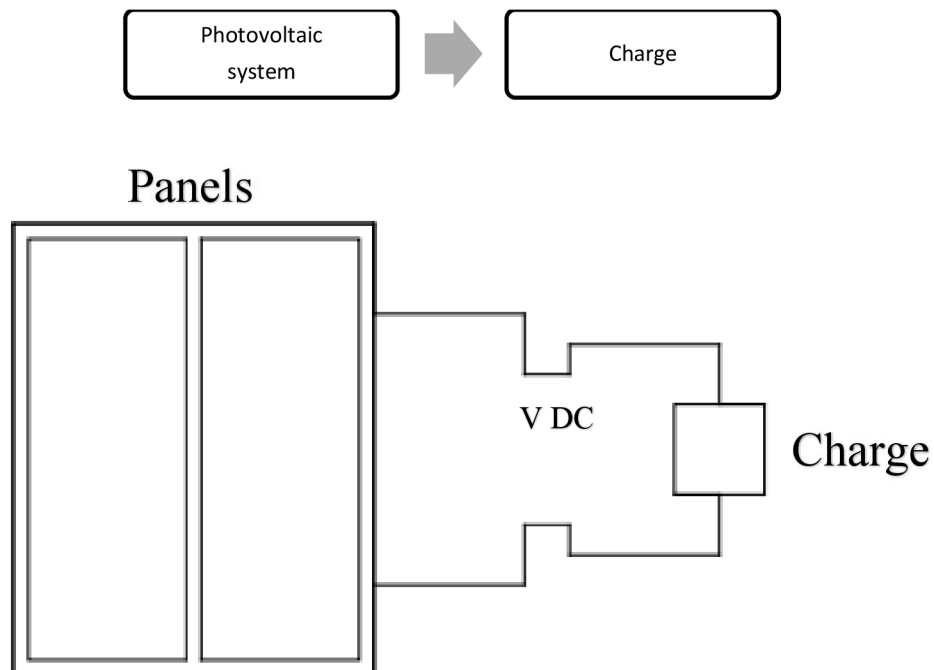

Figure 3-12 System connected to a charge

- **With regulator and battery.** It is used with modules that are usually 33 or 36 cells. The generator is connected to a charge regulator, then to the battery and this in turn to a DC motor. This system is widely used in public lighting.

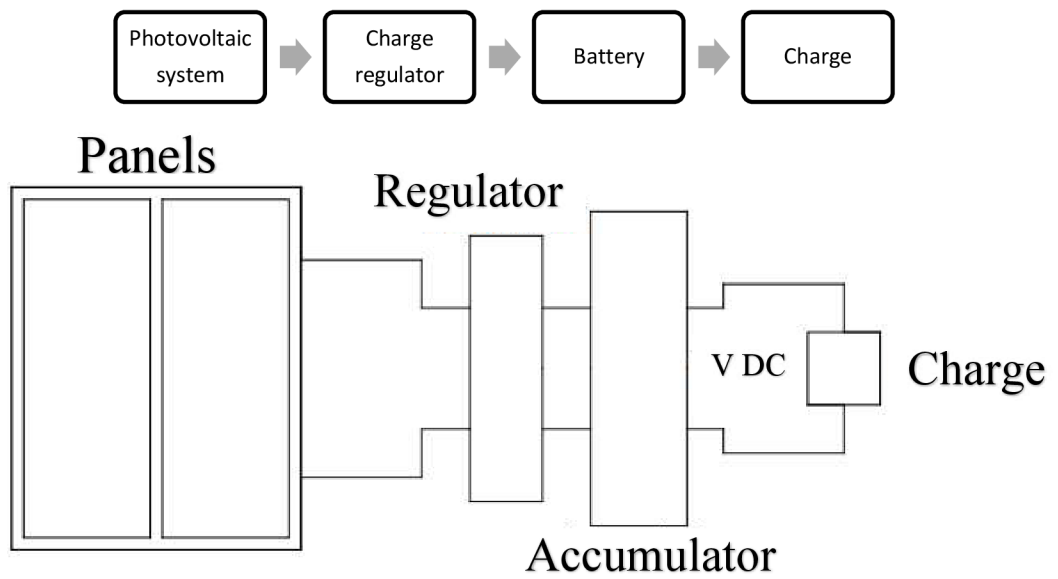

Figure 3-13 System with a regulator and battery

- **With regulator, battery and inverter.** It is used when the requirements are for energy in alternating current, although it can also be fed with DC power simultaneously. In the following schemes we can see how it works:

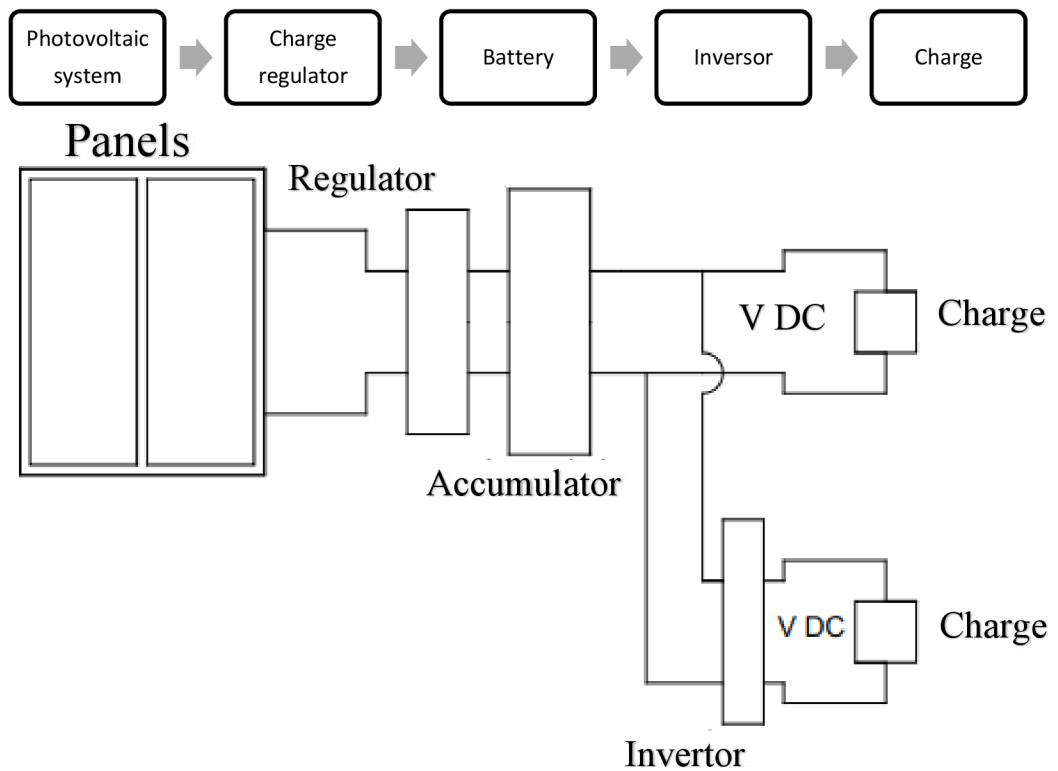

Figure 3-14 System for direct and alternating current

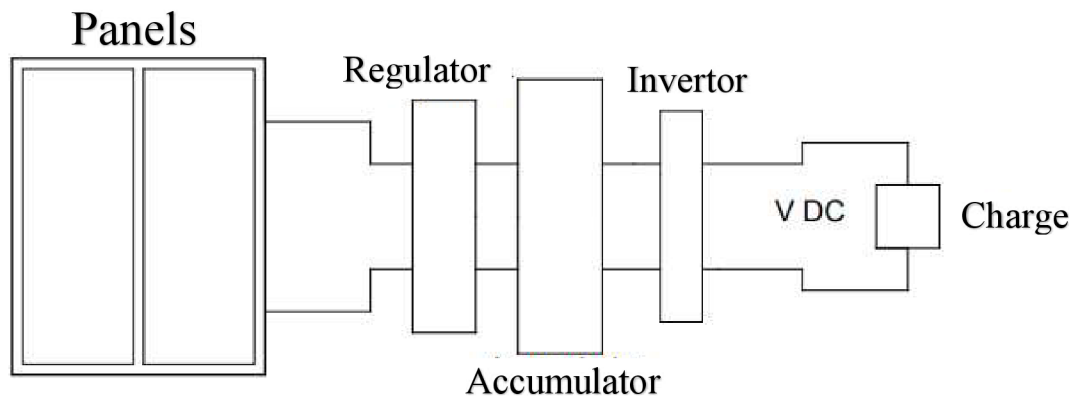

Figure 3-15 System for alternating current

The isolated photovoltaic system is very versatile and has many advantages such as:

- High reliability.
- Low operating costs.
- Environmental benefits.
- Modularity.
- Day and night operation.

3.4.2 Photovoltaic systems connected to the network

This system allows to deliver energy to the public network. In many countries there are laws that regulate all technical and economic aspects although in many countries with emerging economies this type of legislation still needs to be implemented.

The main advantages of this system are the following:

- Low maintenance costs.
- Little risk of breakdown.
- Environmental benefits.
- Investment recovery.

3.5 Maintenance

The maintenance of the system is very simple, although it is important to clarify that it depends a lot on the recommendations made by the manufacturer of each element, but general recommendations can be made [19].

3.5.1 Photovoltaic panel

It is the most important element of the system and the one that requires least maintenance work. The only thing that must be carried out is a cleaning of the surface of the same, since by action of the climate it can fill with dust, the frequency of this cleaning will depend on the place in which the system has been installed, for example, in desert places where a lot of dust is generated, its frequency will be higher.

3.5.2 Accumulators

The energy produced by the photovoltaic is constantly changing depending on many variables that change every day, by the minute (temperature, irradiance etc.). This affect the availability of energy and its autonomy. To avoid this misbehavior is necessary to implement accumulators or batteries.

The use of the accumulators allows the system to:

- Operate autonomously with its own electric source independent of the irradiance at the moment.
- Hold more energy than the modules can hold, storing it for further use in the future.
- Maintain a stable system under strict conditions to provide the appliances with the required voltage and current.

The maintenance of these elements is not complicated, but we must give a lot of importance because they can suffer breakdowns if it is not done. The main thing is the revision and filling with demineralized or distilled water, this activity must have a monthly frequency to ensure that the levels are within the allowed ranges.

4. DESIGN

4.1 Generalities

The maximum energy that a photovoltaic system can produce is given by the following expression:

$$E_{gen} = \eta_{gen} \cdot G_{d,\beta} \cdot A \dots \dots \dots \text{Eq. 1}$$

Where E_{gen} is the generated energy, η_{gen} is the generator performance, $G_{d,\beta}$ is the incident daily global radiation and A is the generator area.

This would be an ideal assumption, but in reality, there are energy losses by different factors, and these are:

- **By difference between nominal and real power.** This is given by the manufacturers of the modules; it is usually in the order of 10% with respect to the nominal power.
- **By dispersion of parameters.** These are produced when configuring modules connected in series or in parallel, these losses are between 2% and 5%.
- **By temperature of the modules.** The modules do not work at a constant temperature. The environmental temperature, incident radiation, encapsulation of the module, installation and wind speed are some of the factors on which the temperature of a panel depends. These losses are in the order of 3% per year.

In summary, if we take into account the set of losses, we should assume a value between 0.65 and 0.8. Therefore, Eq. 1 becomes:

$$E_{gen} = \eta_{gen} \cdot G_{d,\beta} \cdot A \cdot L_G \dots \dots \dots \text{Eq. 2}$$

Where L_G , is the global losses.

4.2 Design of an isolated photovoltaic system

The aim of the project is to energize a one-floor family house located in Zlobice, Kroměříž in Zlínský kraj, in which the average annual energy consumption is around 4,161 MWh. The plane from the top is shown in the next figure.

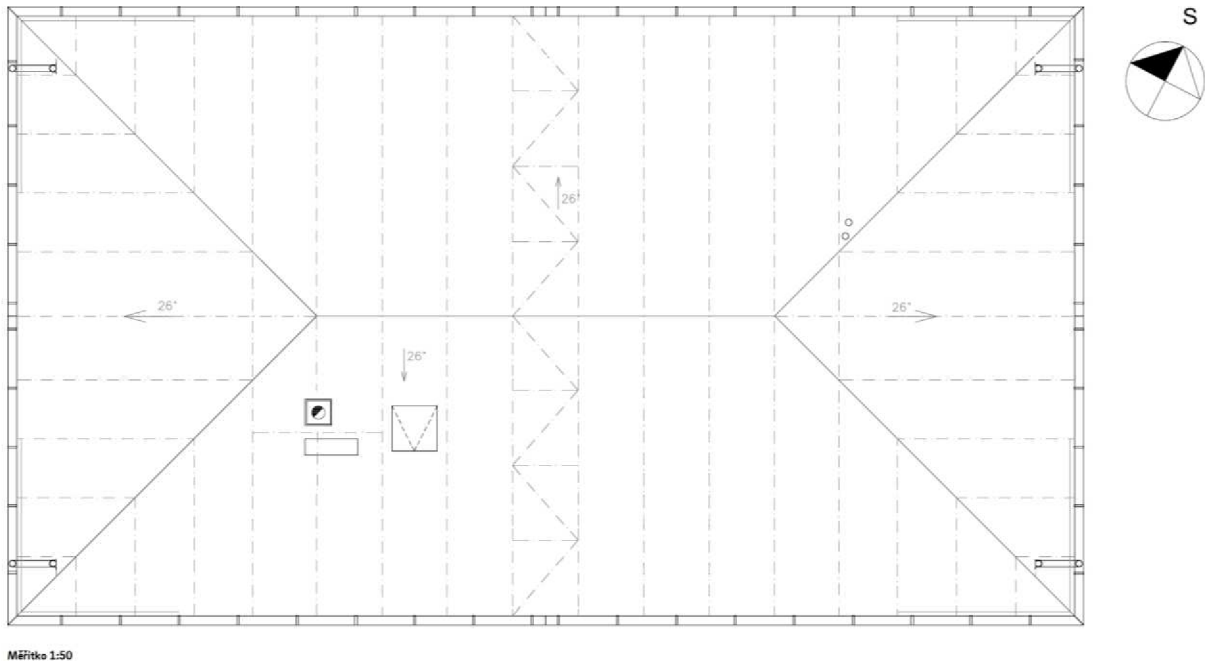

Figure 4-1 Plane of the roof, top view.

To do so, the company E.ON asked to meet some conditions, the ones that concerns the most are:

- Maximum power of the photovoltaic system up to 10 kWp.
- The efficiency of the inverter must be at least of 94%.
- The efficiency of the photovoltaic panels must be at least of 15% (polycrystalline).

4.2.1 Simulation software

To simulate the behavior of the designed system will be used two programs: PV*SOL and DEKSOFT (FVE).

4.2.1.1 PV*SOL

It is very precise and takes into account parameters as the shading, which is very important to analyze the results and calculations performed. It also has a 3D module that helps the user create and check the design, it also shows the physic real location where the design is intended to be used. It is a six steps program in which you need to set different parameters to get the desired system configuration.

1. **Project Data.** The basic information is entered, such as date, author name and project name.
2. **System type, Climate and Grid.** Is chosen what kind of system is to be designed, in this case a stand-alone PV system
3. **Consumption.** The consumption profile is set, there are some predefined profiles, but in this case, there was set a constant annual consumption around the 4,2 MWh.
4. **3D Design.** This is the module that makes the difference from other software. It's possible to build a model of the physic building and place it in the address where it's supposed to be, also place the modules where they are meant to be, as well choosing what type of module are to be used. The cabling is also done in this module, there are different kind of configurations which may be more suitable for different situations.
5. **Battery Inverter and Battery.** The system is configured. It's possible to choose from a wide database of inverters and batteries. It's also possible to create a new type changing the default values set.
6. **Cables.** Aspects such as cable losses are set in this step. It's also possible to add safety devices like fuses, grounding or circuit breakers.
7. **Plans.** The planes of the roof and configuration of the modules are shown in this step with the possibility of checking and exporting them.
8. **Financial Analysis.** A complete bill of materials showing each component price and its durability through the years.

9. Results. The results are shown, graphs and schematics. As well some information about the performance of each component and the modules in detail.

10. Presentation. Shows the results in a format predefined by the software, it's very clean but only accessible for the licensed full version.

In the figure 4-2 is shown the production and consumption of energy during the year, it's clear how the energy generated is much more during the summer than the winter due to the solar exposure.

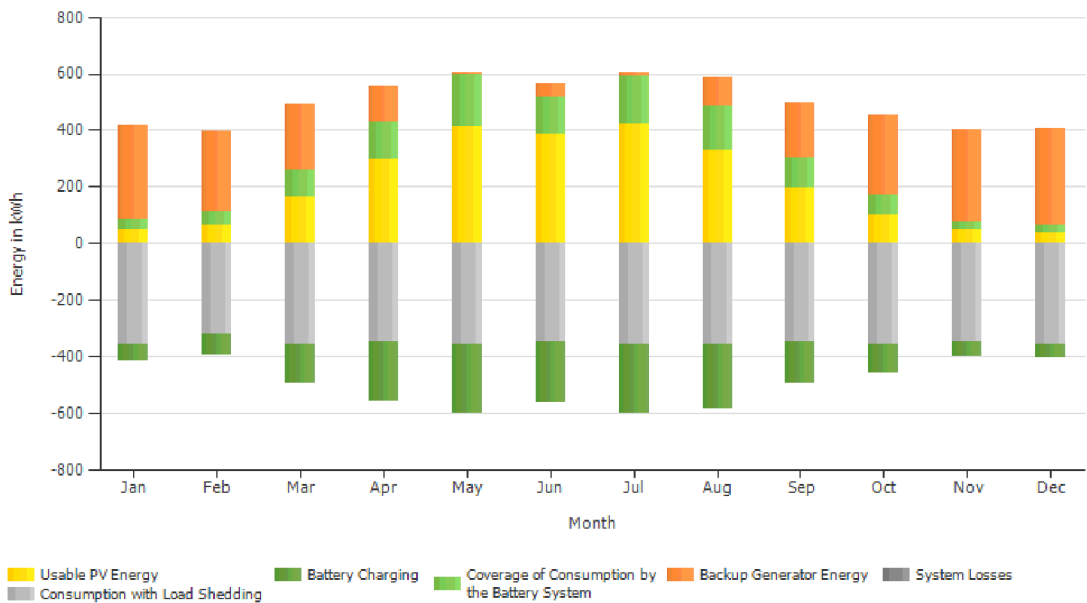

Figure 4-2 Production Forecast with consumption

In the figure 4-3 is shown the irradiance during the 365 days of the year, once again the season determine the solar exposition, therefore the energy received.

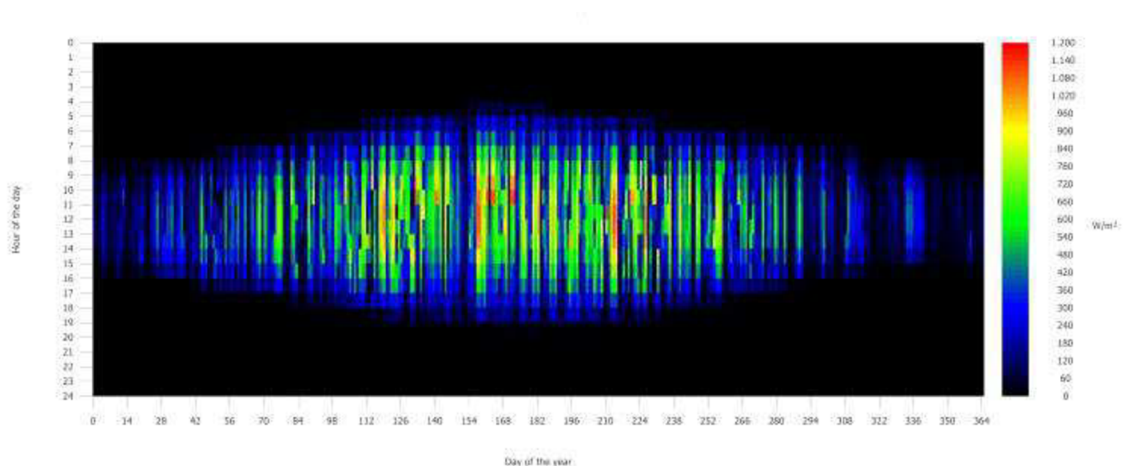

Figure 4-3 Irradiance onto horizontal plane

4.2.1.2 DEKSOFT

The advantage of this software is that it has very detailed information about Czech Republic which makes it adequate to use in this project. It also is simple to use, just a few steps and you can get an overall approximation of what you plan to do. For this reason, it's not so easy to let it take into account detailed parameters that may affect the final report in which the information is presented. Nonetheless, is precise enough to carry on with this project. There are 7 principal steps to realize a calculation and get the results:

1. **Basic Information.** The basic data, such as project name, address of the building and its description, is set.
2. **Calculation parameters.** The parameters to make the calculations are set, such as period of time and losses in the system, also the location to get the about the climate data.
3. **Power consumption profile.** The maximum power consumption is set and then a database listed on the software can be chosen to precisely get the information about the location. There are enough for each area of the Czech Republic, which keeps it updated with real data.
4. **Photovoltaic panels.** The number and type of panels are set in this step. Once that is set.
5. **Inverter.** The inverter is chosen from a database, in case of needed, it's possible to change some of its parameters.
6. **Battery.** The battery is chosen just as the inverter and it can also be changed if needed.

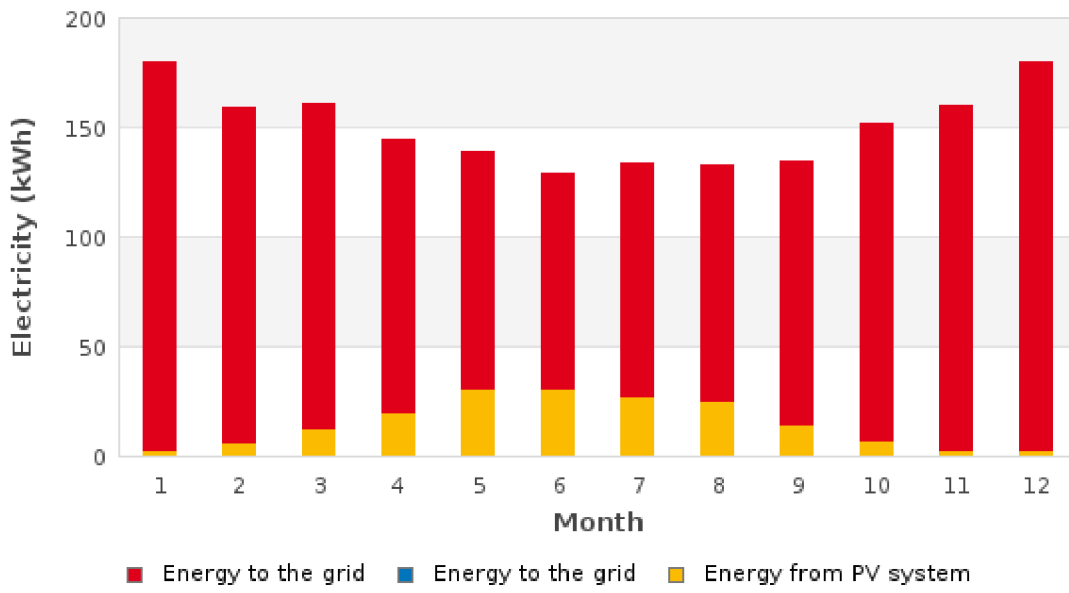

Figure 4-4 Energy produced and consumed

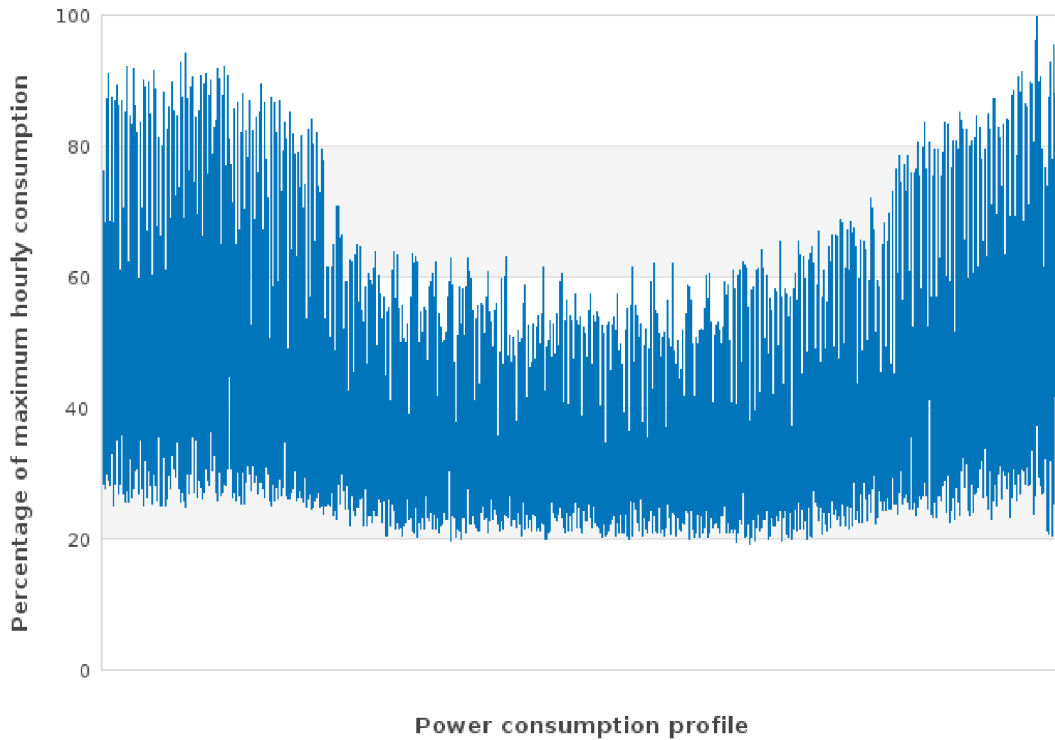

Figure 4-5 Percentage of maximum hourly consumption

4.3 Simulation of the project using PV*SOL

As discussed in the past few pages, PV*SOL has better capabilities for what the project requires, therefore it's going to be used to run some simulations and estimate the behavior of the stand-alone PV system.

The following figures show the set-up plane for the module on the roof of the household.

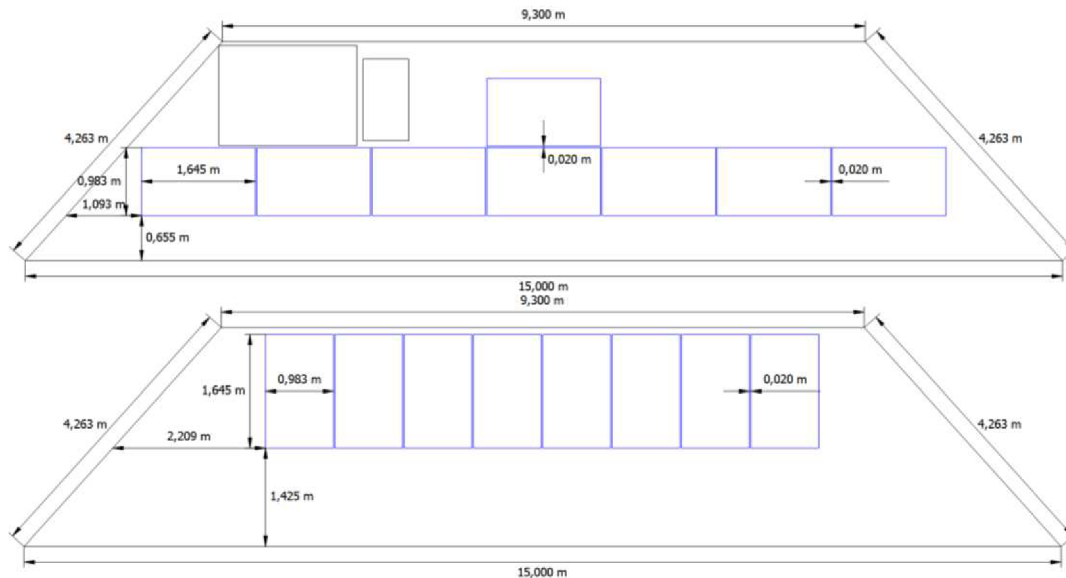

Figure 4-6 Planes of the set-up modules

4.3.1 3D model of the household

Here is shown the 3D model of the household in the actual location of Zlobice, Czech Republic. The map was imported and then some calculations were made to get the actual size of the building from the map, these calculations were done just to get the size of a pixel in meters (IS) and then calculate the real dimensions of the house.

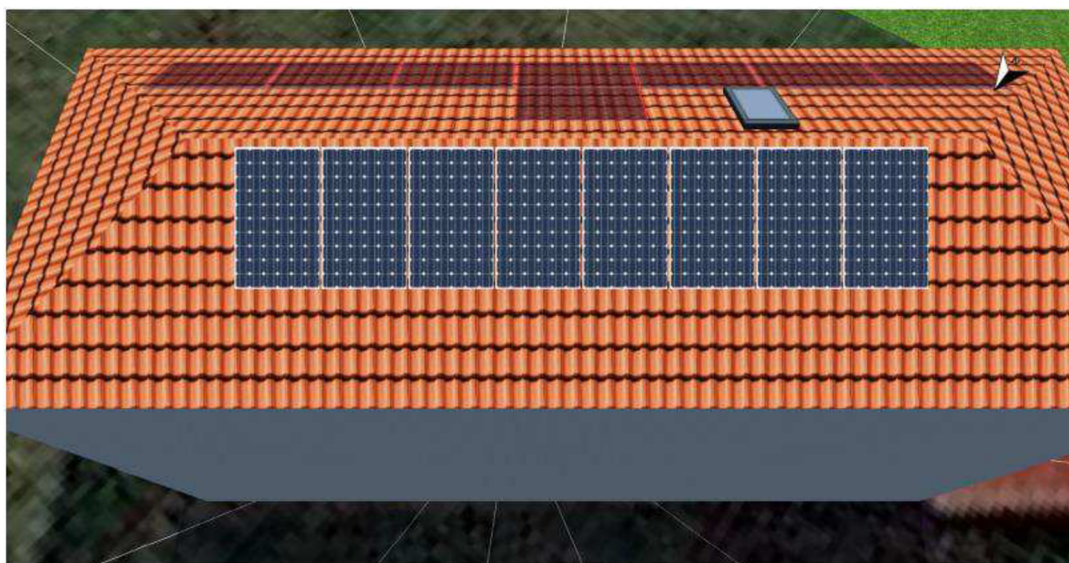

Figure 4-7 3D model of the household (Northwest)



Figure 4-8 3D model of the household (Southeast)

4.3.2 Irradiance

As mentioned above in the theory, the irradiance plays a fundamental paper in the PV system, is the most important parameter since it's the one that conditions how much energy the system will take.

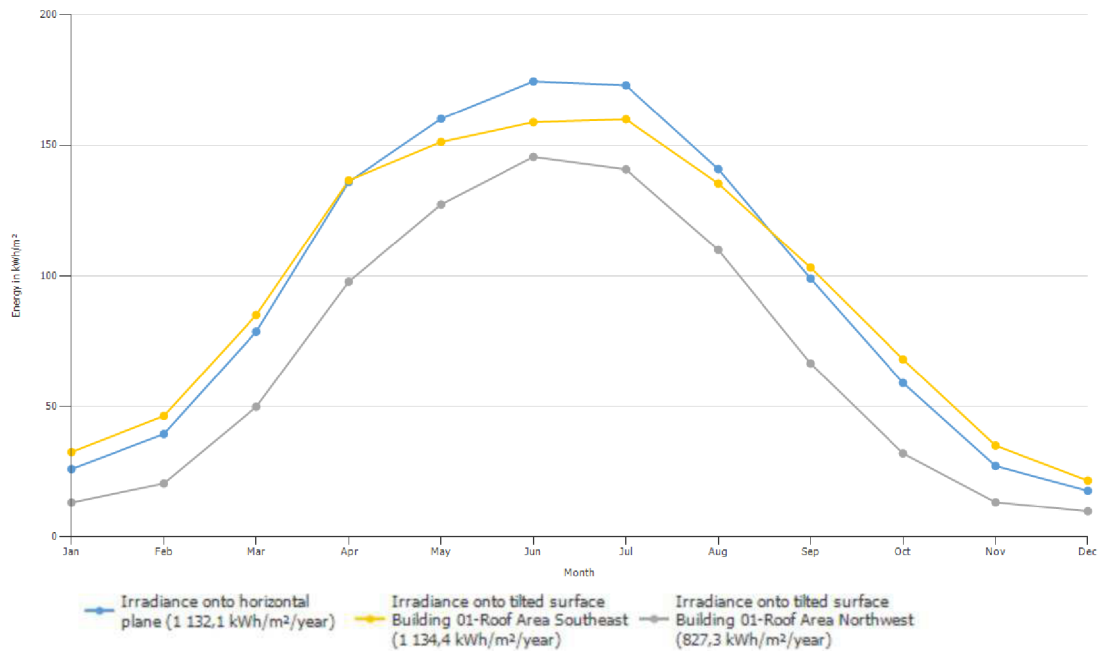

Figure 4-9 Irradiance per module area

From the figure above, it is possible to observe the behavior of the irradiance onto the surface of the modules. It is shown that during the months between April and the middle of August the irradiance is significantly higher, which means that during this period the PV system will be able to collect more energy. The following two figures show precisely the irradiance on each of the module areas set.

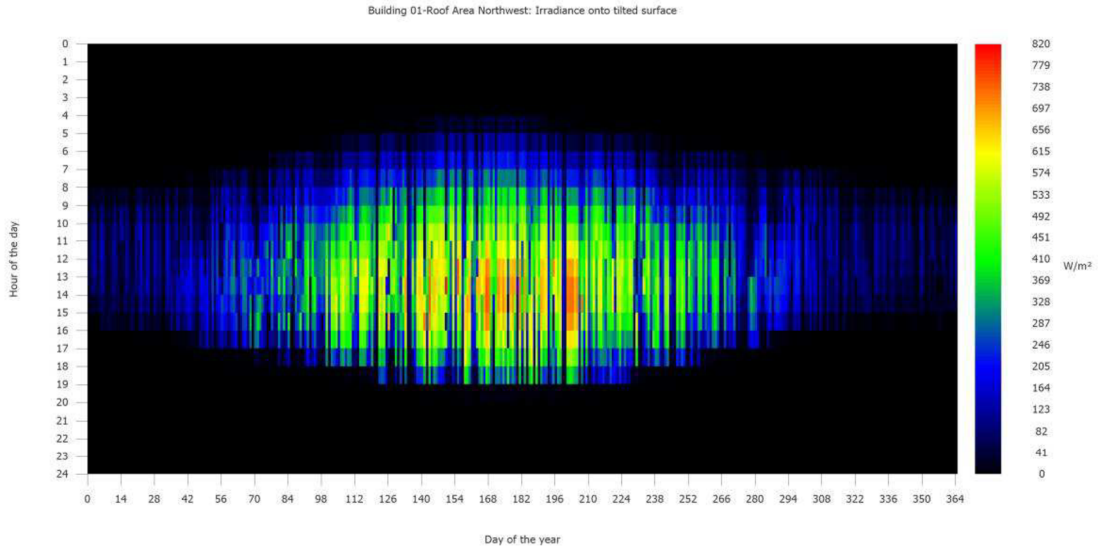

Figure 4-10 Irradiance onto tilted surface (Northwest)

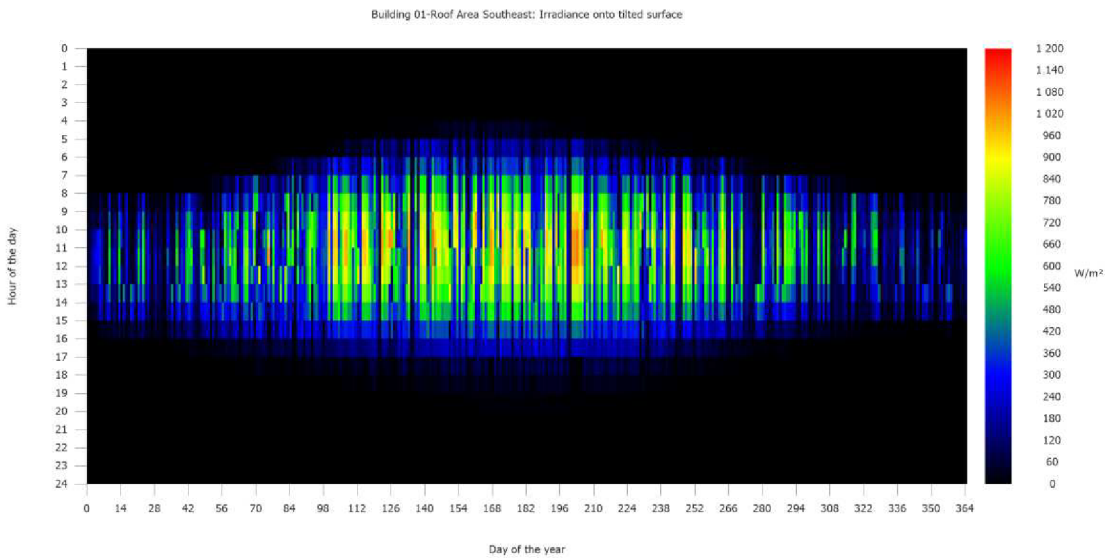

Figure 4-11 Irradiance onto tilted surface (Southeast)

4.3.3 Temperature

The temperature of the PV system affects directly the performance of the conversion of energy, therefore the output power. The average module absorbs around the 80% of the irradiance, part of this becomes electrical energy, but the rest becomes heat. The heat reduces the efficiency of the module. The higher the temperature the lower the voltage.

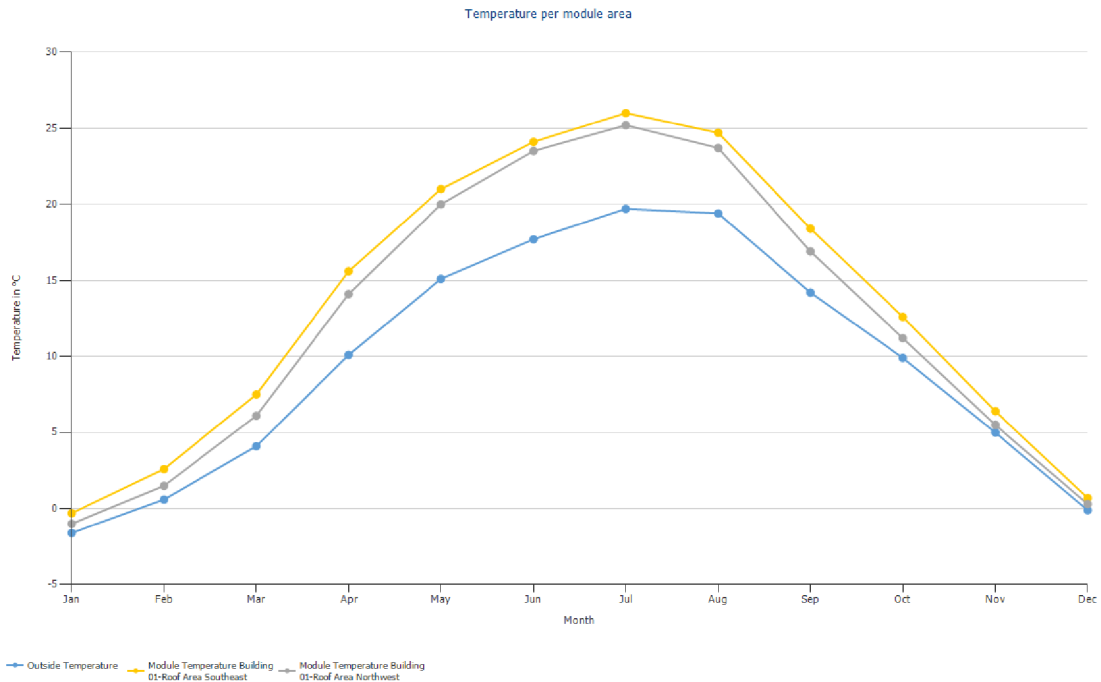

Figure 4-12 Temperature per module area

4.3.4 Shading

Before deciding which panels to use or how many batteries are required for the PV system, is important to take into consideration the shading of the surface where the panels will be placed.

This parameter is very important for the design of any PV system, it affects drastically the performance of the modules. This parameter may vary a lot depending on the location. The main goal is to avoid shadows of all kind.

In the case of this project, the panels will be mounted on the roof of a one-story house with an angle of 26°. First some pictures of how the sun irradiates the surface at different times of the day and different dates.

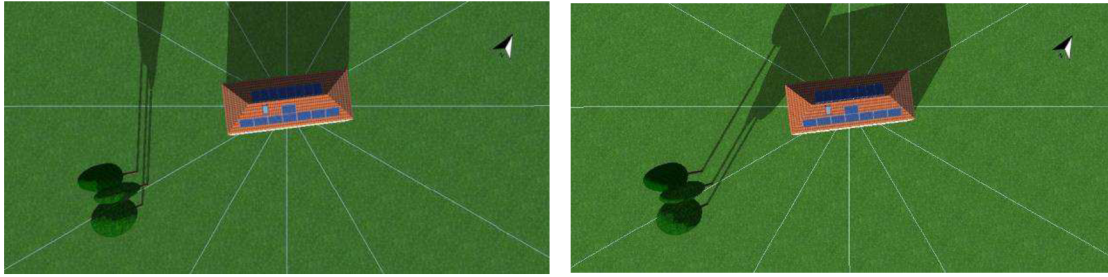

10:00

12:00

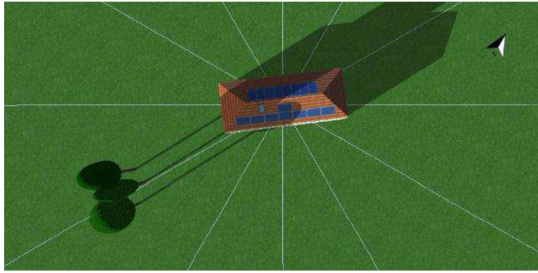

14:00

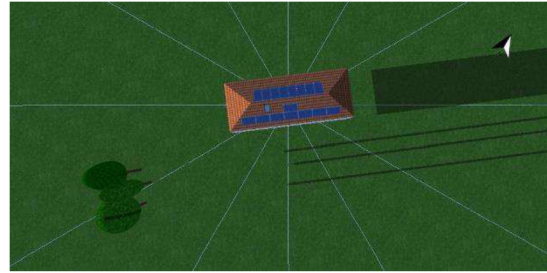

16:00

Figure 4-13 Shading frequency for the first of January

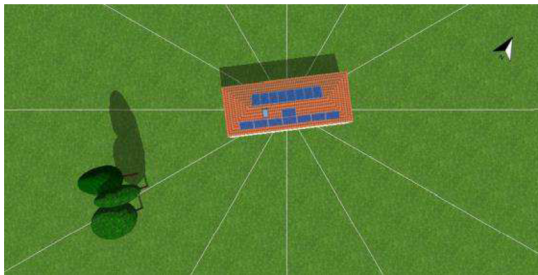

10:00

12:00

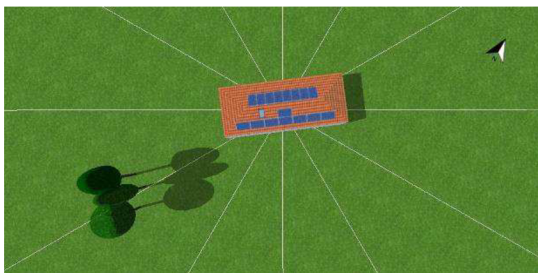

14:00

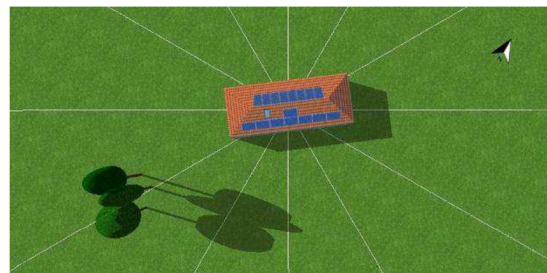

16:00

Figure 4-14 Shading frequency for the first of May

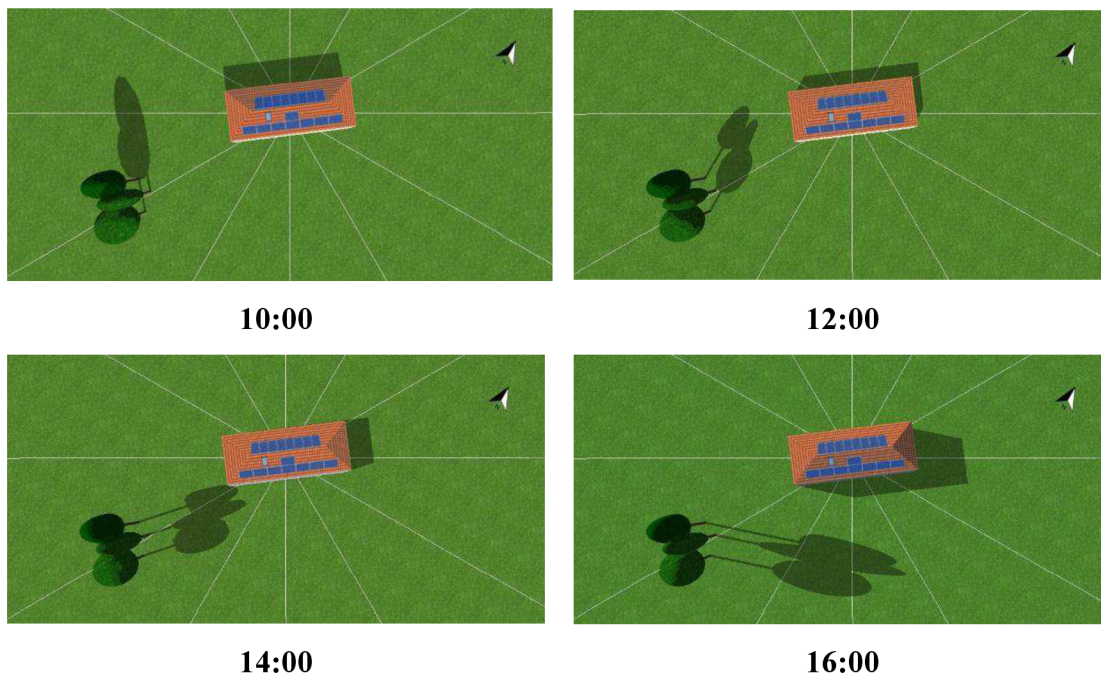

Figure 4-15 Shading frequency for the first of September

As seen in the figures there are not many objects blocking the irradiance from the sun, there are just a few trees next to the house, but they don't affect much the performance of the panels.

The chosen climate data is from Holešov, since is the closest town with documented data. This will give approximate information of the irradiance over the surface of the town during the year.

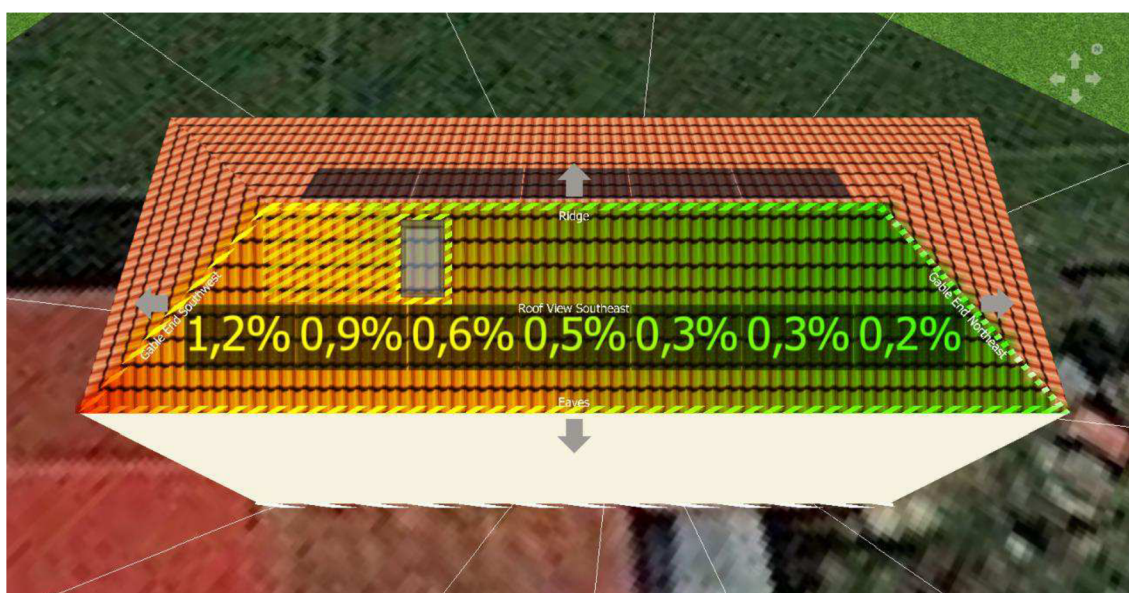

Figure 4-16 Shading on Southeast side

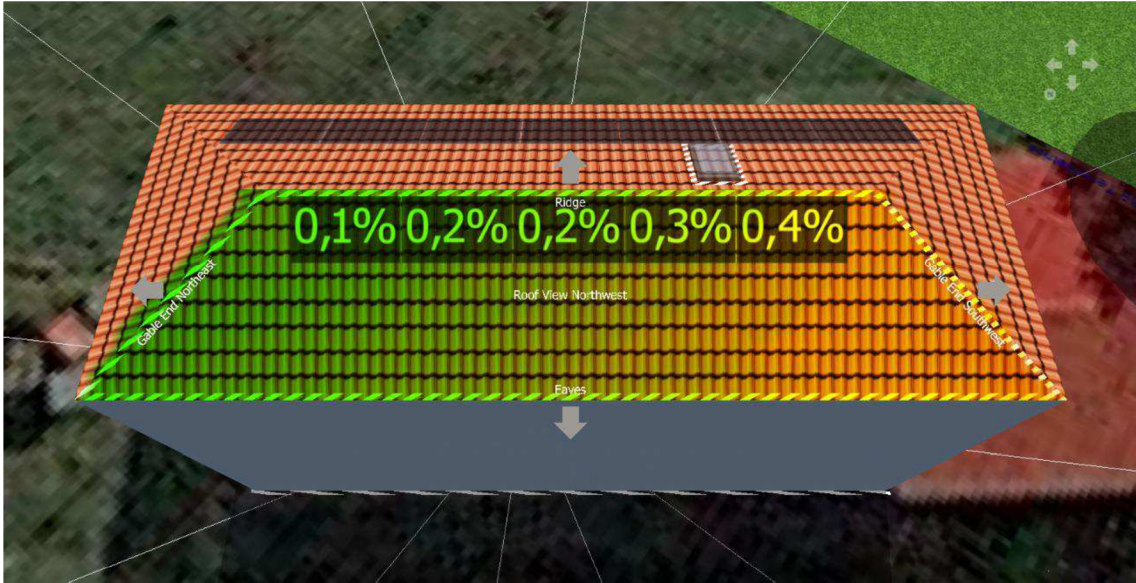

Figure 4-17 Shading on Northwest side

These values on each panel represent the percentage of the annual reduction of the direct irradiance onto the horizontal plane of the panel under a normal clear day.

4.3.5 Monocrystalline configuration

The first ran simulation was for a monocrystalline panel, which had very good results regarding efficiency and performance. It also had an expected increased price over the estimated budget.

3D, Stand-alone PV System with Backup Generator	
Climate Data	HOLESOV, CZE (1991 - 2010)
PV Generator Output	4 kWp
PV Generator Surface	25,9 m ²
Number of PV Modules	16
Number of Inverters	1
Number of Battery Inverters	3
Number of Batteries	2

Figure 4-18 Parameters of monocrystalline simulation

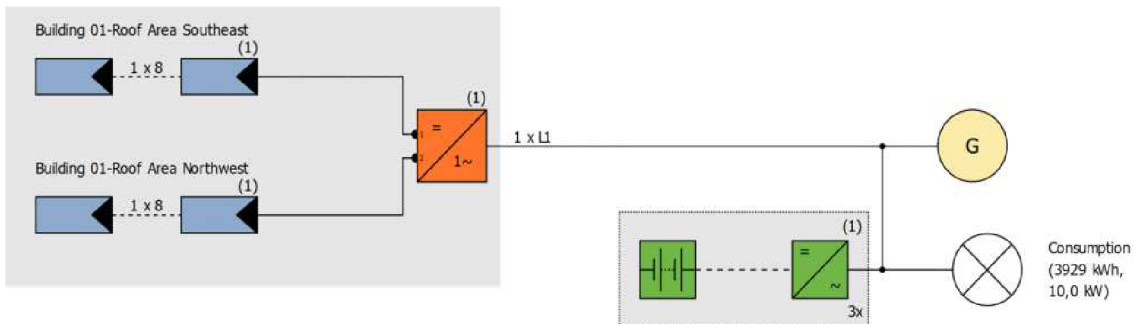

Figure 4-19 Schematic diagram of the stand-alone PV system with backup generator

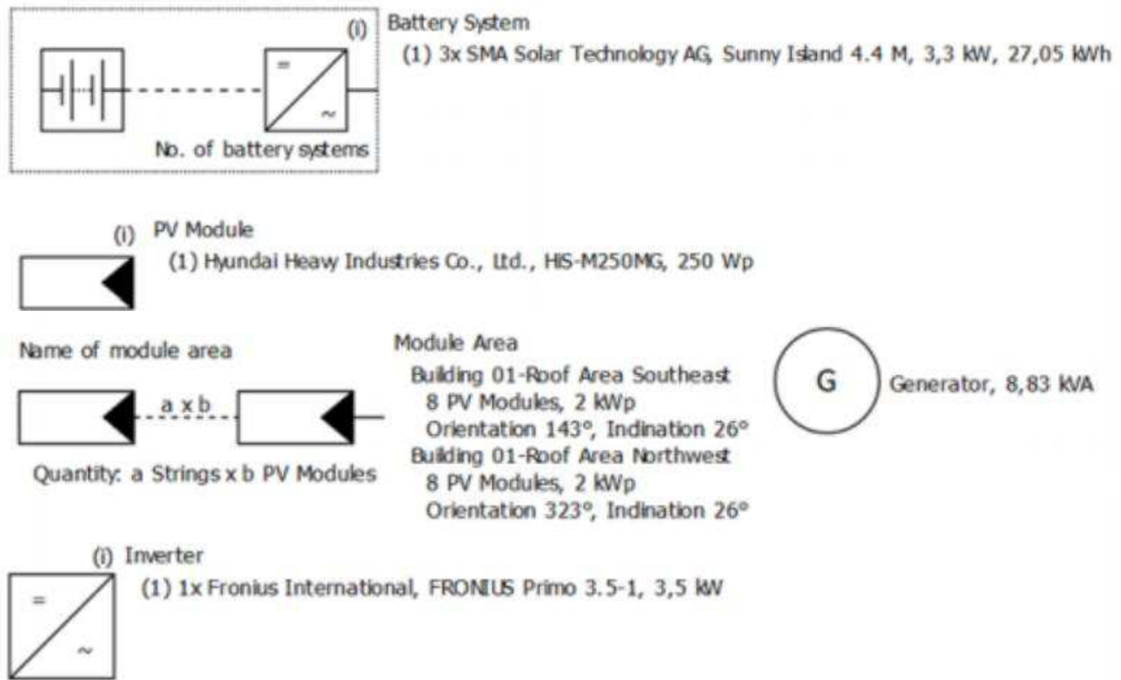

Figure 4-20 Explanation of each symbol in the schematic

In the Figure 4-19 Schematic diagram of the stand-alone PV system with backup generator is shown the schematic diagram for the monocrystalline configuration, and below it, the description of each symbol. For the simulation were used a Fronius inverter for the solar panels, a SMA battery system, a backup generator and a Hyundai monocrystalline solar panel (efficiency 20,89%).

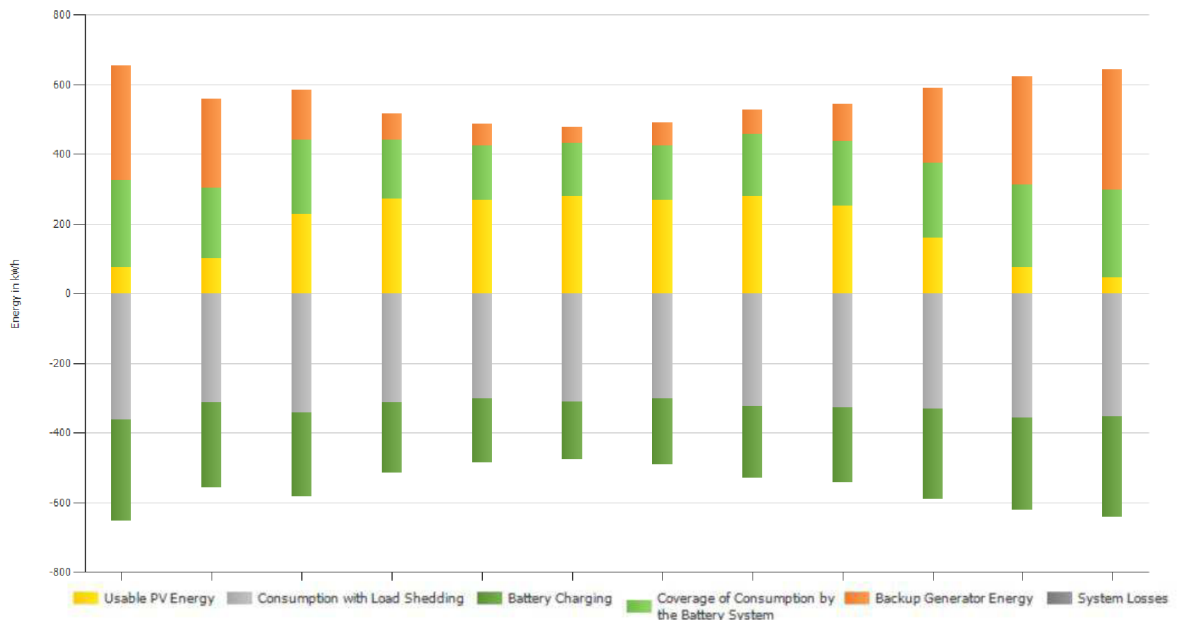

Figure 4-21 Production forecast with consumption

Financial Analysis		Tech. Quality of the PV System	
Fuel Costs	19 950,90 Kč/year	PV Generator Energy (AC grid)	2 307 kWh/year
Total Investment Costs	472 000,00 Kč	Spec. Annual Yield	845 kWh/kWp
Specific Costs	11,08 Kč/kWh	Performance Ratio (PR)	80,5 %
System Integration		Solar Fraction	53,3 %
System Efficiency	72,8 %		

Figure 4-22 Overview

In the figure above is shown the summary of the simulation. It gives information about the system efficiency, which was 72,8%; the total investment, which is just an estimated value, since the prices of some components were approximated, and some others depend on the currency exchange, this value is around the 472 000,00 Kč; also gives information about the performance ratio which is 80,5% and the PV generated energy: 2307 kWh/year.

4.3.6 Polycrystalline configuration

The second simulation was for a polycrystalline panel, which performed surprisingly well. The cost of this configuration wasn't as low as expected, but still gave some very good results.

3D, Stand-alone PV System with Backup Generator

Climate Data		HOLESOV, CZE (1991 - 2010)
PV Generator Output		4 kWp
PV Generator Surface		26,6 m ²
Number of PV Modules		16
Number of Inverters		1
Number of Battery Inverters		3
Number of Batteries		2

Figure 4-23 Parameters for the polycrystalline simulation

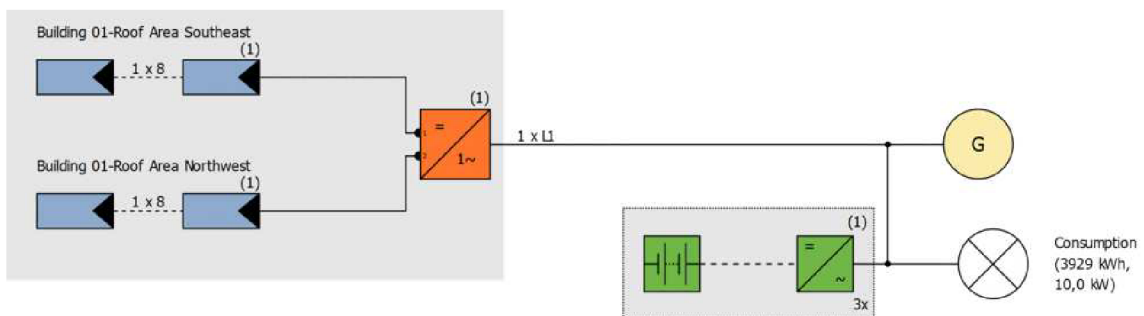

Figure 4-24 Schematic diagram of the stand-alone PV system with backup generator

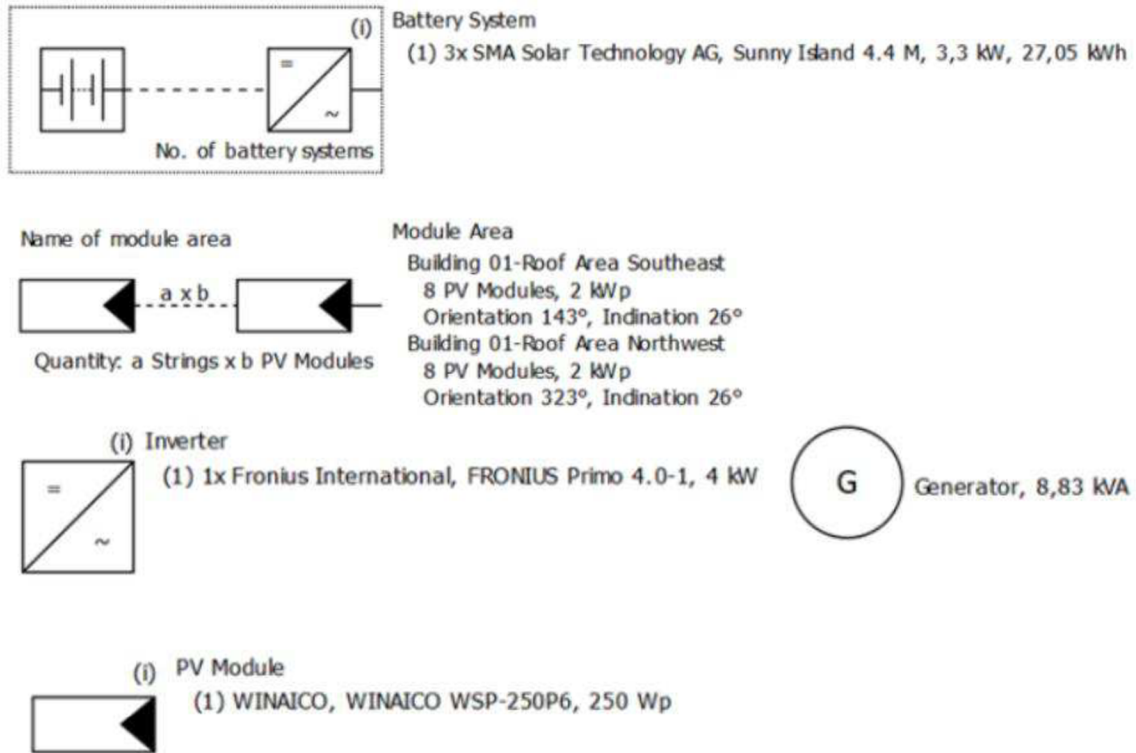

Figure 4-25 Explanation of each symbol in the schematic

In the Figure 4-24 Schematic diagram of the stand-alone PV system with backup generator is shown the schematic diagram for the polycrystalline configuration, and below it, the description of each symbol.

For the polycrystalline simulation were used a Fronius inverter, a backup generator, a SMA battery system and a WINAICO solar panel (efficiency 18,9%).

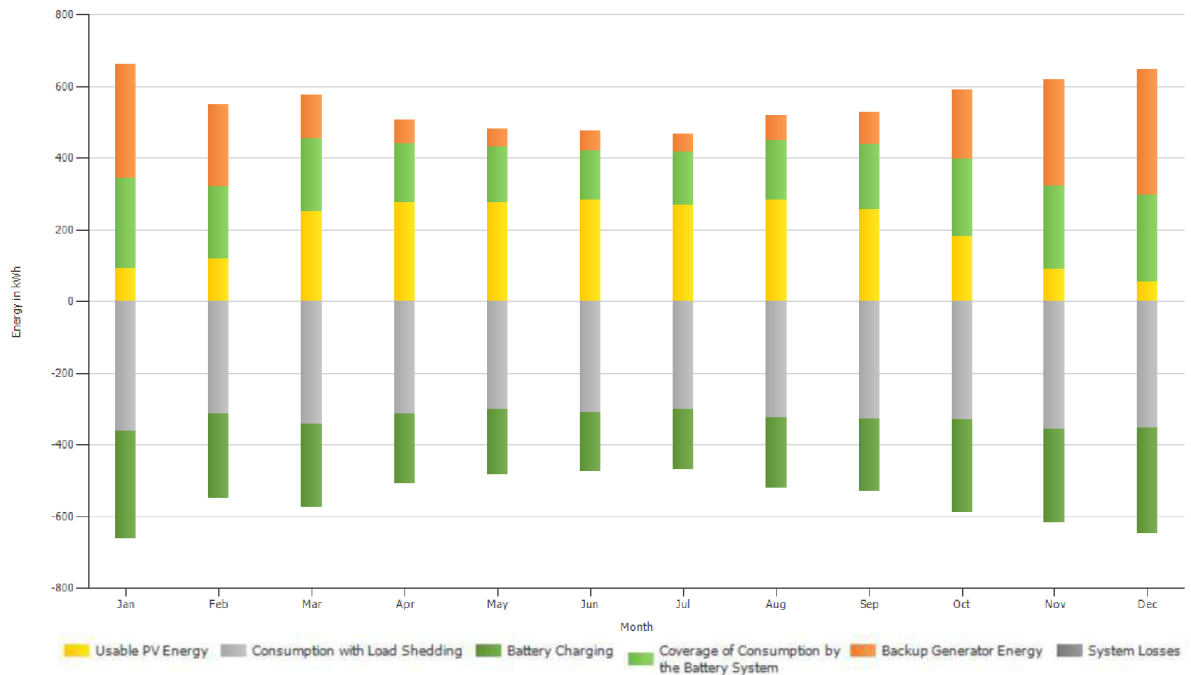

Figure 4-26 Production forecast with consumption

Financial Analysis		Tech. Quality of the PV System	
Fuel Costs	19 639,80 Kč/year	PV Generator Energy (AC grid)	2 354 kWh/year
Total Investment Costs	407 000,00 Kč	Spec. Annual Yield	874 kWh/kWp
Specific Costs	10,17 Kč/kWh	Performance Ratio (PR)	83,3 %
System integration		Solar Fraction	
System Efficiency	71,7 %	Solar Fraction	54,3 %

Figure 4-27 Overview

In the figure above is shown the summary of the simulation for the polycrystalline module. It gives information about the system efficiency, which was 71,7%; the total investment, which is just an estimated value, since the prices of some components were approximated, and some others depend on the currency exchange, this value is around the 407 000,00 Kč; also gives information about the performance ratio which is 83,3% and the PV generated energy: 2354 kWh/year.

Since the project requires a polycrystalline module, it is important to keep in mind the requirements asked by the company E. ON to design the system.

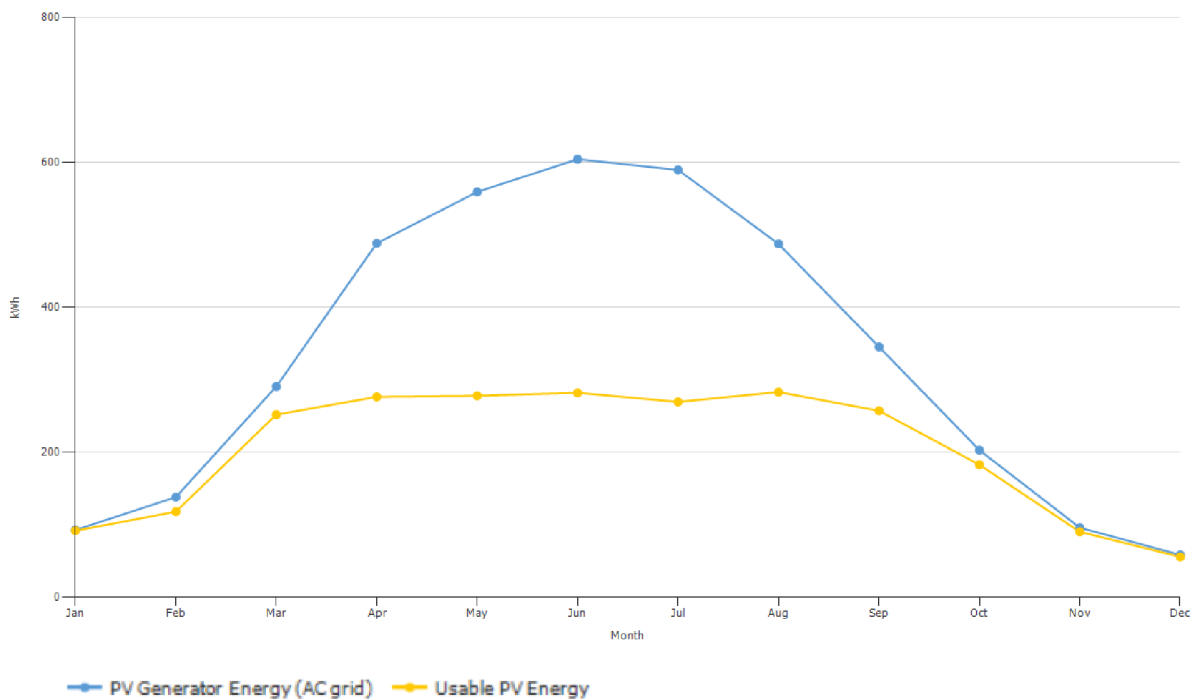

Figure 4-28 PV generated energy

Conclusion

Solar energy is one of the most promising sources of renewable energy in the world. Compared to non-renewable sources, the advantages are clear: it is non-polluting, has no moving parts to analyze and does not require much maintenance. It does not require an extensive installation to operate. Power generators can be installed in a distributed way in which already built buildings can generate their own energy safely and silently. It does not consume fossil fuels. It does not generate waste. Despite the technological progress of recent years, the costs of installing a photovoltaic system are still quite high, especially when compared to electricity generation from fossil fuels and sometimes even compared to other renewable sources.

The way how the solar energy is obtained by the photovoltaic panels was explained very detailed as all the physical phenomena that make it possible. Then different types of photovoltaic cells were exposed and compared to understand in which cases each of them they are more suitable. There were also tables in which were compared different aspects of the photovoltaic modules, mostly European suppliers.

The aim of this thesis was to analyze the functioning of photovoltaic systems and explain the basic concepts about them to design an isolated which must meet the conditions set by the firm E.ON for a family house located in Zlobice. Two simulations were performed in two different software, PV*SOL and DEKSOFT.

The software PV*SOL is more professional and precise since it has the ability to set much more parameters than DEKSOFT. Nonetheless this second one, has the advantage of being constantly updated for Czech Republic, which is the country of interest in this particular case. From an objective point of view, PV*SOL seems to achieve much more than DEKSOFT by giving the user more options.

After running the simulations, with the monocrystalline and with the polycrystalline modules, it was shown that for the particular design for a family house, the better option is to use polycrystalline cells. The difference in efficiency between mono and poly (1,1%) was very low and the price of poly was significantly lower (407 000,00 Kč) than the mono (472 000,00 Kč), a difference of 65 000 Kč (around 2 500 €). The prices of the equipment were approximated and taken from the PV*SOL database.

It was never the aim of this thesis to describe all the topics in great detail but rather to give a comprehensive overview for those who are interested in photovoltaic systems while lacking the general understanding of this area.

Literature

- [1] The Worlds of David Darling. [<http://othereal.ru/wp-content/uploads/2012/02/21-1.jpg>]. Accessed 10th of November 2018.
- [2] Understanding Astronomy. 2011. [<https://physics.weber.edu/schroeder/ua/SunOnCelestialSphere.png>]. Accessed 10th of November 2018.
- [3] Avery Thompson.2012. [<http://averythompson.net/>] Accessed 10th of November 2018.
- [4] Solar American Solutions. 2018. [<http://www.solaramericasolutions.com/wp-content/uploads/2015/06/solar-collector-panel.jpg>]. Accessed 10th of November 2018.
- [5] TN Elektro. 2015. [https://www.tneutron.net/elektro/wpcontent/uploads/sites/2/2015/08/image_thumb4.png]. Accessed 10th of November 2018.
- [6] Toppr. 2014. Intrinsic Semiconductor. [<https://www.toppr.com/guides/physics/semiconductor-electronics-materials-device-and-simple-circuits/intrinsic-semiconductor/>]. Accessed 10th of November 2018.
- [7] Dron Study. 2018. Semiconductors Physics. [<https://www.dronstudy.com/book/chapter-notes-semiconductors-physics-class-12/>]. Accessed 15th of November 2018.
- [8] Stack Exchange. 2015. [<https://electronics.stackexchange.com/questions/195006/quick-junction-pn-junction-diode-clarification>]. Accessed 15th of November 2018.
- [9] E. A. Cabrerizo, Instalaciones Solares Fotovoltaicas, Sevilla: Progensa, 2002
- [10] D. P. B. I. Vishnuvardhanan Vijayakumar, «Optical and electronic simulation of gallium arsenide/silicon tandem four terminal solar cells» Solar Energy, pp. 6, 7, 2013.
- [11] Renewable Energy Focus. 2011. [<http://www.renewableenergyfocus.com/view/18817/smoke-and-mirrors-solar-pv-csp-and-cpv/>]. Accessed 15th of November 2018.
- [12] Firstgreen Consulting Private Limited. 2013. Bifacial Series – Glass-To-Glass Photovoltaic Module. [<https://firstgreenconsulting.wordpress.com/2013/06/28/bifacial-series-glass-to-glass-photovoltaic-module/>]. Accessed 15th of November 2018.
- [13] The Off Grid Tiny House. 2015. [<http://theoffgridtinyhouse.com/how-to-size-solar-panels-for-tiny-houses>]. Accessed 18th of November 2018.
- [14] Slide Player. 2016. [<https://slideplayer.com/slide/4182839/>]. Accessed 18th of November 2018.
- [15] Alte Store.2017. [<https://www.altestore.com/howto/solar-insolation-map-world-a43/>]. Accessed 18th of November 2018.
- [16] Indiamart. 2017. [<https://www.indiamart.com/proddetail/solar-eva-sheet-15825845397.html>]. Accessed 22th of November 2018.

- [17] Arise Energy Solutions. 2009. History of Photovoltaic (PV) Solar Energy. [<http://ariseenergy.com/training-education/history-of-pv-solar-energy>]. Accessed 22th of November 2018.
- [18] LUQUE, A. a Steven HEGEDUS. *Handbook of photovoltaic science and engineering*. 2nd ed. Chichester, West Sussex, U.K.: Wiley, 2011. ISBN 0470721693.
- [19] DUNLOP, James P. *Photovoltaic systems*. 3rd ed. Orland Park, Illinois: American Technical Publishers, c2012. ISBN 978-1-935941-05-7.
- [20] ASE Energy. 2018. [<https://www.ase-energy.com/index.cfm>]. Accessed 29th of November 2018.
- [21] Atersa Grupo Elecnor. 2018. [<http://www.atersa.com/>]. Accessed 20th of November 2018.
- [22] BP. 2018. [<https://www.bp.com>]. Accessed 20th of November 2018.
- [23] Conergy. 2018. [<http://asia.conergy.com/>]. Accessed 20th of November 2018.
- [24] Panasonic. 2019. [<https://Panasonic.net/lifesolutions/solar/>]. Accessed 23th of March 2019.
- [25] SunPower. 2019. [<https://us.sunpower.com/>]. Accessed 23th of March 2019.
- [26] CanadianSolar. 2019. [<https://www.canadiansolar.com/>]. Accessed 23th of March 2019.
- [27] SunEdison. 2019. [<http://www.sunedison.com/>]. Accessed 23th of March 2019.
- [28] Energy GPS. 2019. [<http://www.energygps.com/>]. Accessed 23th of March 2019.
- [29] Amerisolar. 2019. [<https://www.weamerisolar.eu/>]. Accessed 23th of March 2019.
- [30] LG Electronics. 2019 [<https://lg.com/>]. Accessed 23th of March 2019.
- [31] Valentin SoftwareGmbH. 2019 [<https://www.valentin-software.com/en/products/photovoltaic/57/pvsol-premium>]. Accessed 23th of March 2019.