



Fakulta rybnářství
a ochrany vod
Faculty of Fisheries
and Protection
of Waters

Jihočeská univerzita
v Českých Budějovicích
University of South Bohemia
in České Budějovice



Fakulta rybnářství
a ochrany vod
Faculty of Fisheries
and Protection
of Waters

Jihočeská univerzita
v Českých Budějovicích
University of South Bohemia
in České Budějovice

2022



Doctoral thesis

The effect of polyploidization and hybridization on reproductive physiology in fish

Vliv polyploidizace a hybridizace na fyziologii reprodukce u ryb

The effect of polyploidization and hybridization on reproductive physiology in fish



Doctoral thesis by
Tomáš Tichopád

Tomáš Tichopád



Fakulta rybnářství
a ochrany vod
Faculty of Fisheries
and Protection
of Waters

Jihočeská univerzita
v Českých Budějovicích
University of South Bohemia
in České Budějovice

The effect of polyploidization and hybridization on reproductive physiology in fish

Vliv polyploidizace a hybridizace na fyziologii reprodukce u ryb

Doctoral thesis by Tomáš Tichopád

I, Tomáš Tichopád, thereby declare that I wrote the Ph.D. thesis myself using the results of my own work or the collaborative work of colleagues and me and with the help of other publication resources which are properly cited.

I hereby declare that in accordance with the § 47b Act No. 111/1998 Coll., as amended, I agree with publicizing of my Ph.D. thesis in full version electronically in a publicly accessible part of the STAG database operated by the University of South Bohemia in České Budějovice on its web sites, with keeping my copyright to the submitted text of this Ph.D. thesis. I also agree that the same electronic way, in accordance with above mentioned provision of Act No. 111/1998 Coll., was used for publicizing reviews of supervisor and reviewers of the thesis as well as a record about the progress and result of the thesis defence. I also agree with compering the text of my Ph.D. thesis with a database of theses "Theses.cz" operated by the National Register of university theses and a system for detecting plagiarisms.

In Vodňany 16th May, 2022

Supervisor:

Assoc. Prof. Martin Pšenička
University of South Bohemia in České Budějovice (USB)
Faculty of Fisheries and Protection of Waters (FFPW)
Zátiší 728/II, 389 25 Vodňany, Czech Republic

Consultant:

Karel Janko, Ph.D.
Institute of Animal Physiology and Genetics
Czech Academy of Sciences
Rumburská 89, 277 21 Liběchov, Czech Republic

Head of Laboratory of Germ Cells:

Assoc. Prof. Martin Pšenička

Dean of Faculty of Fisheries and Protection of Waters:

Prof. Pavel Kozák

Board of doctorate study defence with reviewers:

Prof. Lukáš Kalous – head of the board
Prof. Petr Ráb – board member
Assoc. Prof. Pavel Horký – board member
Assoc. Prof. Jiří Patoka – board member
Assoc. Prof. Martin Kocour – board member
Assoc. Prof. Tomáš Polícar – board member
Assoc. Prof. Zdeněk Adámek – board member

Prof. Katsutoshi Arai, Hokkaido University, Japan – thesis reviewer

Assoc. Prof. Peter Mikulíček, Comenius University in Bratislava, Slovakia – thesis reviewer

Date, hour, and place of Ph.D. defence:

15th September 2022 at 11.30 a.m., in USB, FFPW, RIFCH, Vodňany, Czech Republic

Name: M.Sc. Tomáš Tichopád

Title of thesis:

The effect of polyploidization and hybridization on reproductive physiology in fish
Vliv polyploidizace a hybridizace na fyziologii reprodukce u ryb

Ph.D. thesis, USB FFPW, RIFCH, Vodňany, 2022, 96 pages, with the summary in English and Czech..

ISBN 978-80-7514-161-3

Graphic design & technical realisation: Tiskárna Brázda, www.TiskarnaBrazda.cz

CONTENT

CHAPTER 1

5

General introduction

CHAPTER 2

23

Clonal gametogenesis is triggered by intrinsic stimuli in the hybrid's germ cells but is dependent on sex differentiation

CHAPTER 3

37

Spermatozoa morphology and reproductive potential in F1 hybrids of common carp (*Cyprinus carpio*) and gibel carp (*Carassius gibelio*)

CHAPTER 4

47

Meiosis suppression in the unisexual Amazon molly, *Poecilia formosa*

CHAPTER 5

67

Production and use of triploid zebrafish for surrogate reproduction

CHAPTER 6

81

General discussion

83

English summary

90

Czech summary

91

Acknowledgements

92

List of publications

93

Training and supervision plan during study

94

Curriculum vitae

96

CHAPTER 1

GENERAL INTRODUCTION

1. Polyploidization and hybridization in the evolution of organisms

1.1. Polyploidy in general

Polyploidy, also known as whole genome duplication, is a condition of an organism in which all cells possess more than two copies of chromosomal sets ($3n =$ triploidy, $4 =$ tetraploidy, etc.). This genetic phenomenon is prevalent in plants. Nonetheless, many vertebrates, mainly fishes and amphibians, can also tolerate such drastic genomic changes (Mable, 2004) with no serious physiological consequences. For example, some polyploids tend to have the same body mass as their diploid relatives; however, polyploidy often affects the cell size; therefore, these polyploids have a lower number of cells as compensation for their size (Benfey, 1999; Piferrer et al., 2009). This could be advantageous for cells with higher metabolism demand (Stillwell and Benfey, 1996). On the other side, increased cell size can lead to reducing the surface area to volume ratio, which negatively affects biochemical processes leading to lower metabolic performance (Ballarin et al., 2004). In some cases, polyploidy can induce a heterosis effect leading to massive phenotype changes, although this trait is more typical for plants (Chen, 2010).

On the molecular level, an important effect concerning the final polyploid phenotype is gene redundancy (Comai, 2005). With a higher number of chromosomes, there is a higher chance that the harmful alleles will not be expressed in favor of an individual polyploid. Masked alleles could have tendencies to accumulate in polyploids. This necessarily does not have to be negatively interpreted. Firstly, most of the duplicated genes, including mutated ones, are silenced (Lynch and Conery, 2000), i.e., nonfunctionalization of the gene. Secondly, the mutations can be responsible for neofunctionalization, which means that they acquire a new function. That is highly advantageous in the form of adaptation because diploid genes cannot be relaxed, especially on vital cell processes thus, diploids have lower change to adapt in the hostile environment. The change of the gene function does not have to be radical but can slightly be different from the origin one therefore gene undergoes subfunctionalization. In summary, polyploidy have an important evolutionary role.

1.2. The historical importance of polyploidy

The term paleopolyploidy refers to organisms that underwent genome duplications in the distant past but return to a diploid state via a rediploidization event (Lien et al., 2016). The most known example of ancient genome duplication is coming from plants in which all spermatophytes (seed plants) and angiosperms (flowering plants) were paleopolyploids 319 and 192 million years ago, respectively (Jiao et al., 2011). Actinopterygii is perhaps the most common group famous for paleopolyploidization in the vertebrate lineage. The most apparent evidence is the conserved karyotype of ray-finned fishes since most of them have 48 or 50 chromosomes in a diploid state. The exact number of paleopolyploid events is unknown due to the very high number of ray-finned fish species. However, investigation of several species suggests that at least 7–20 polyploidizations happened (Mank and Avise, 2006), but this number may grow in the future with more studies. The number of events differs based on the phylogenetic timing of species (Hoegg et al., 2004), so “early” species such as Ostariophysii (which includes both economically and scientifically important fish like common carp, zebrafish, loaches, catfish, etc.) probably underwent more genome duplications than “the latest” group like Eupercaria (perches, black basses, pufferfishes, etc.). In any case, paleopolyploidization is probably one of the crucial factors responsible for the high diversification of fish taxa.

1.3. Origin of polyploidy and link to hybridization

Polyploidy can be formed by various processes. The two most common terms associated with the origin of polyploidy are autopolyploidy and allopolyploidy (Doyle and Egan, 2010). The term autopolyploidy refers to an increase in chromosome sets within one species. That is usually accomplished by aberrancies during the cell division of germ cells, polyspermy, or failure in the first cleavage of an embryo, Figure 1. Besides spontaneous autopolyploidy, an application of hydrostatic pressure, cold shock, or heat shock during meiosis I or meiosis II prevents the extrusion of the first or second polar body creating artificial autopolyploid. Researchers in fishery fields often focus on artificial autopolyploidy, i.e., polyploidy induced in economically significant aquaculture organisms in order to use advantageous traits of polyploid fish (Zhou and Gui, 2017), such as lower incidence of diseases or induction of sterility thus termination of sexual maturation and reduction of territorial behavior. On the other side, allopolyploidy describes a situation where polyploidy arises as a result of hybridization between two or more species. There have been documented or theorized various pathways responsible for allopolyploidy, Figure 2. Nevertheless, the genome addition hypothesis (GAH, Figure 2A) appears prevalent in the animal world (Choleva and Janko, 2013). GAH starts with the hybridization of two parental species with diploid F1 offspring as a result. This F1 generation will produce unreduced diploid gametes that, if properly fertilized with the haploid gamete from parental sexual species, F2 offspring will result in increased ploidy level producing triploids (Choleva and Janko, 2013). In some cases, triploid offspring can formulate triploid gamete that can be again backcrossed with parental sexual species resulting in tetraploid formation. The most prevalent level of ploidy in natural animal populations is triploidy (Otto and Whitton, 2000); however, some organisms can reach much higher ploidy levels like sturgeons which can reach even dodecaploidy (Kim et al., 2005). The reason behind stable populations of allotriploids is the change in their reproduction mode, from sexual to asexual (or hemiclonal) reproduction forming unisexual lineages.

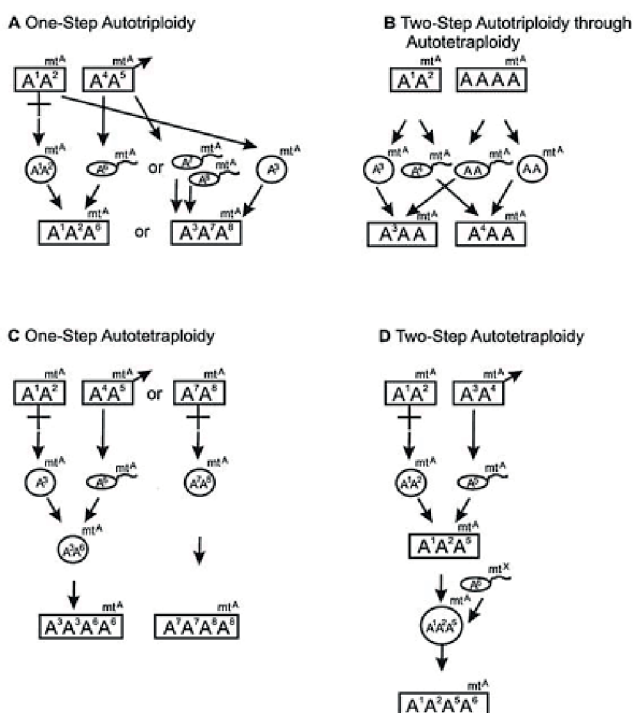

Figure 1. Origin of animal polyploidy within one species (autopolyploidization). A–D descriptions of hypotheses on the origin of autotriploid and autotetraploid organisms. Capitals describe nuclear genomes. Numbers describe different copies of individual genomes. The superscript illustrates letters represent the maternally transmitted mtDNA haplotype of the respective nuclear genomes. Natural populations for given hypotheses are well documented in Choleva and Janko (2013), from which the figure is reprinted with the permission of S. Karger AG, Basel.

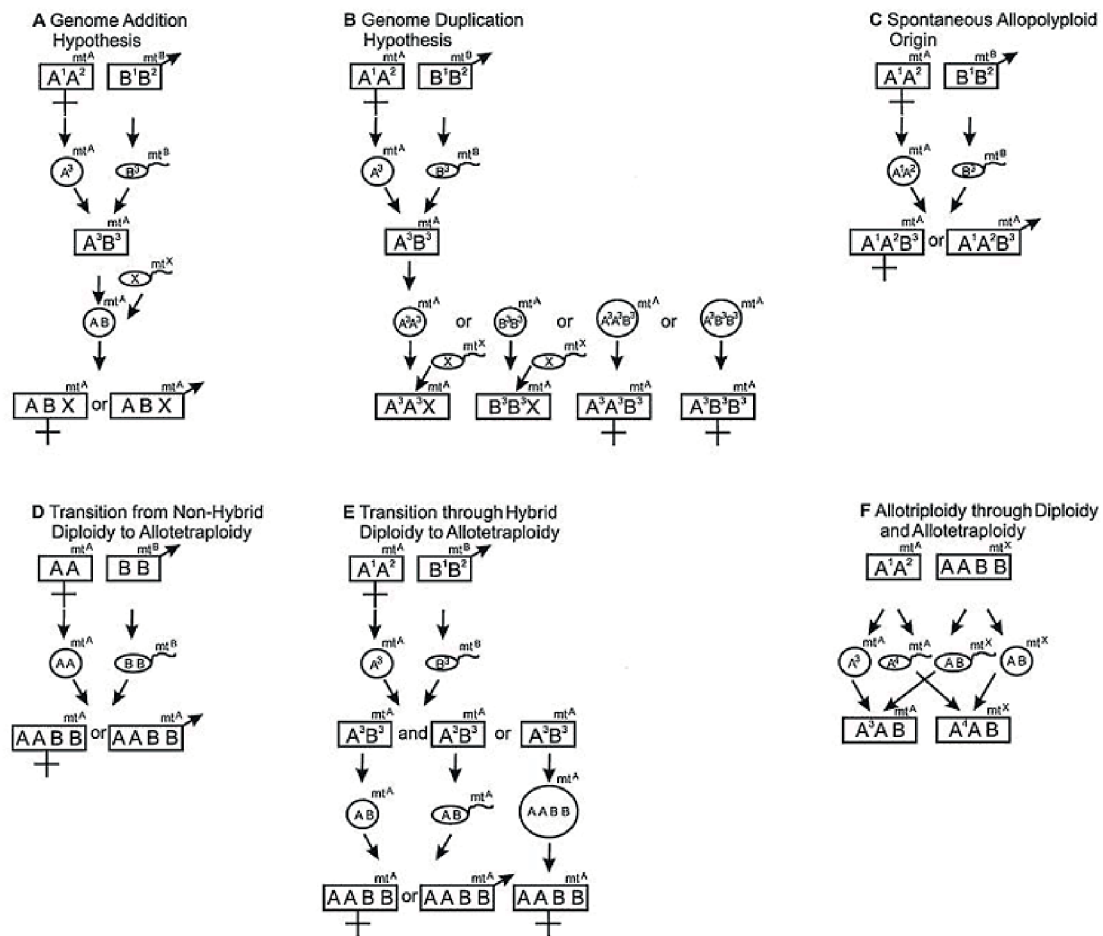

Figure 2. Hybrid origins of allopolyploidy in animals. A–F descriptions of hypotheses on the origin of allotriploid and allotetraploid organisms. Capitals illustrate nuclear genomes, regardless of the mode of inheritance; different letters indicate different species. Numbers indicate different copies of individual genomes. The superscript capital letters represent the maternally transmitted mtDNA haplotype of the respective nuclear genomes. Natural populations for given hypotheses are well documented in Choleva and Janko (2013), from which the figure is reprinted with the permission of S. Karger AG, Basel.

1.4. The link between hybridization and asexual reproduction

Almost all eukaryotic organisms, vertebrates included, pass their genetic information via haploid gametes, which during merging, give rise to a diploid zygote. An essential part of sexually reproducing species is meiosis or, more precisely, genetic recombination and segregation, which is an exchange of genetic material between homologous chromosomes in gametes. Each haploid gamete then possesses a unique gene set passed to offspring from both parents during fertilization leading to genetic diversity and evolutionary benefits. This is both advantageous and disadvantageous at the same time because an organism can benefit from favorable traits, but its offspring will not inherit them in the identical state as its parents, the so-called recombination load (Charlesworth and Charlesworth, 1975).

However, there are more ways to reproduce, and the so called asexuality represents an interesting alternative to sexual reproduction as it results in clonal progeny. Modes of asexuality vary depending on parental gamete participation or absence during fertilization, e.g., parthenogenesis, gynogenesis, androgenesis, and hybridogenesis. Parthenogenesis is the form of asexuality in which an egg transit into an embryo without the presence of sperm.

Naturally, due to the missing paternal genome, oocytes are already produced in a diploid state. True parthenogenesis was formerly described in lizards of genera *Lacerta* (Macculloch et al., 1997) and *Cnemidophorus* (Moore et al., 1985), but due to the taxonomical reassignments, these lizards are currently in genera *Darevskia* (Freitas et al., 2016) and *Aspidoscelis* (Manríquez-Morán et al., 2014). Gynogenesis represents a form of asexual reproduction in which females do not require the presence of a male to activate the development of eggs, but the sperm cells themselves do not incorporate their genetic material into future offspring. Therefore, the resulting progeny contains only the maternal genome. As in the previous case, a produced egg already has to be in the diploid state. In nature, especially among fishes, females who reproduce gynogenetically have a hybrid origin, such as the genus *Cobitis* (Janko et al., 2007), *Poecilia* (Mateos and Vrijenhoek, 2005; Schultz, 1969), and *Carassius* (Gui and Zhou, 2010). Androgenesis requires the presence of both parents and fusion of their gametes, but the maternal genome is eliminated after fertilization, and the paternal genome takes control over development, thus creating paternal clone offspring. The only documented case of natural androgenesis in aquatic animals is shellfish of *Corbicula* spp. (Pigneur et al., 2012). Last but not least, hybridogenesis is a hemiclonal form of reproduction in hybrids in which the genome of one parental species is selectively discarded during gametogenesis, producing gametes only from one species (without recombination) which is renewed by standard mating with sexual species (standard recombination). An offspring of described reproduction is partially asexual from a hybrid parent and partly sexual from parental species. Interestingly, this individual will, during gametogenesis, exclude the genome which participated in the recombination (Doležalková-Kašánková et al., 2021). Hybridogenesis was documented in water frogs of genus *Pelophylax* and Australian carp gudgeon of genus *Hypseleotris* (Schmidt et al., 2011). Therefore, in vertebrates, asexuality origin is directly linked with hybridization, and due to the production of unreduced gametes, it is a plausible way to the source of animal polyploidy, Figure 2.

The favorable traits are entirely passed to the next generation, which theoretically represents a considerable advantage. Nevertheless, the lack of efficient recombination also leads to the main disadvantage of asexuality, whereby asexuals' reaction to selection pressures should be theoretically worse than in sexually reproducing species. Moreover, offspring of asexuals are loaded with mutations directly inherited from their parents without the possibility to remove them from the genome via recombination and segregation (Muller, 1932). This genetic load thus should lead to genomic decay and eventually send the whole population to extinction. Yet, it appears some asexual species like *Cobitis* asexual complex (Janko et al., 2007) or *Poecilia formosa* (hybrid species of *P. mexicana* and *P. latipinna*) do not suffer these consequences (Loewe and Lamatsch, 2008; Warren et al., 2018; Kočí et al., 2020), despite the fact that the oldest asexual lineage of *Cobitis* is approximately 0.3 million years old (Janko et al., 2005), while *P. formosa* is dated circa 0.1–0.2 million years ago (Warren et al., 2018). Possibly explanation can lie in polyploidization as *Cobitis* asexuals often occur as triploids. As mentioned before, triploids can mask harmful mutations.

2. Genetical consequences of hybridization and polyploidization

Both polyploidization and hybridization can induce a shift from sexual to asexual reproduction or sterility. However, the exact mechanisms together with the final decision on reproductive mode are not well known. It has been proposed that shifts to different reproduction strategies or sterility are triggered by orthologous copies of genes, gene regulatory networks, or incompatibilities of chromosomes that are formed between two different genomes in case of hybridization and/or addition of extra chromosome sets in the conserved diploid state.

2.1. Genic level

One of the first hypotheses describing hybridization consequences was the Bateson-Dobzhansky-Muller (DBM) model, explaining the sterility of hybrids in terms of natural selection and speciation (Bateson, 1909; Dobzhansky, 1936; Muller, 1942). It describes the situation where the ancestral population of one species is divided into two different populations, which are, over time, exposed to different selection pressures. Therefore, each population prioritizes different alleles under selection, and two new species arise. The functional crosstalk among genes from the ancestral population is now disrupted in newly formed hybrids, causing aberrancies in meiosis. Similarly, Alfred Ernst suggested that the longer two species were separated before the hybridization event, the more likely they awake asexuality (Ernst, 1918) until the particular point where hybridization between two species leads to complete sterility, or it is not even possible anymore. Finally, the balance hypothesis suggests that hybrids possess a certain number of misregulations during meiosis; however, not enough to completely disrupt it (Moritz et al., 1989). In general, it can be presumed that reproduction programs have unique timing for the execution. Therefore, newly assembled gene machinery from two species can have different ontogeny timing in hybrids, thus leading to asynchronous expressions and resulting in asexuality (Carman, 1997).

2.2. Chromosomal level

The DBM model is often described as the independent work of three authors; however, Bateson's addition to the model is the description on the chromosomal level (although the first observation of chromosome movement during mitosis is dated to 1879 by Walther Flemming, it took several decades to establish scientific background which is currently known and accepted). Decreased compatibility of homologous chromosomes means that chromosomes from two different species cannot make proper pairing between homologous chromosomes in hybrids (De Storme and Mason, 2014), thus either terminating meiosis completely (in case of sterility) or creating aneuploid and polyploid germ cells (in case of semi-sterility and semi-fertility). Nonetheless, some hybrid and polyploid organisms developed a pathway to prevent disruption of meiosis and improper pairing. The most known mechanism, *sensu lato*, is premeiotic endoreplication (PMER). It describes the situation in which chromosomes in oocytes duplicate before meiosis; therefore, pairing is accomplished between duplicated sister chromosomes rather than homologous chromosomes (Lutes et al., 2010; Kuroda et al., 2018). This process is therefore responsible for the clonality of hybrid offspring and provides an elegant solution for chromosome pairing in cells with the odd number of chromosome sets. There are four potential mechanisms behind PMER (Ullah et al., 2009). 1) Fusion of germ cells ($2n$ cell + $2n$ cell = $4n$ cell) in which two cells with their complete genetic information

fuse into one big cell. 2) Endoreduplication describes the process in which the cell cycle is composed of two S-phases during one cell cycle but without the initiation of mitosis. 3) Endomitosis is described by the absence of the nuclear membrane and spindle, thus producing one enormous $4n$ nucleus. 4) Acytokinetic mitosis completes karyokinesis without performing cytokinesis, thus leaving the cell with two nuclei. Although PMER is prevalent in asexual animals from the genus *Cobitis* (Dedukh et al., 2021; Tichopád et al., 2022), *Misgurnus* (Itono et al., 2006; Kuroda et al., 2018) or *Oryzias* (Shimizu et al., 2000), the exact mechanisms are not usually known. Having said that, there is documented case of cell fusion in gynogenetic diploid hybrids of red crucian carp (*Carassius auratus* red var.) × common carp (*Cyprinus carpio*) (Wang et al., 2016).

2.3. The effect of sex

Interestingly, the decision about the successful transition to another mode of reproduction in hybrids appears to be sex-specific. One hundred years ago, J.B.S. Haldane noticed that “F1 offspring of a cross between two animal species or races one sex is absent, rare, or sterile, that sex is always the heterozygous sex” (Haldane, 1922) which was later categorized as Haldane’s rule. Today, the rule applies to the majority species with exceptions such as *Drosophila* (Sawamura, 1996) or *Teleogryllus* (Moran et al., 2017). Moreover, the rule is most prevalent in regard to sterility than viability (Wu et al., 1996). At present, the composite theory is the most popular explanation of Haldane’s phenomenon, which says that there are different genetic causes between hybrid inviability and sterility (Orr, 1993; Wu and Davis, 1993). Subdivisions are not exclusively restricted and can act together coincidentally in different organisms.

The essential part of the composite theory is the dominance theory (Turelli and Orr, 1995). In XX/XY determination system, males have only one X chromosome and thus cannot avoid recessive alleles arising from the merge of diverged genomes in hybrids. On the other side, females will possess two X chromosomes from each species and thus will be affected by dominant X alleles only. Another important part of the composite theory is the faster male model, which predicts the faster evolution of males due to the higher sexual selection in comparison to females (Wu and Davis, 1993). Therefore, a higher number of newly acquired traits in male parental species linked to the Y chromosome cause aberrancies in hybrid gene regulations. Nonetheless, this model applies only on XX/XY sex determination, but it cannot operate with the ZZ/ZW sex chromosomes.

On the other side, the faster-X model predicts (Wu and Davis, 1993) the faster evolution of the X chromosome due to two aspects. Firstly, the number of X chromosomes in the population is higher than Y chromosomes (in a population with a sex ratio of 1:1, there will be 3 X chromosome copies per 1 Y chromosome copy); thus, mutations accumulate faster. Secondly, if such a mutation appears, they tend to become recessive alleles due to the XX homozygosity in parental species and adapt to new advantageous functions over time (Charlesworth et al., 1987). In male hybrids, these “quickly” evolved alleles would cause genetic breakdown because they would be the only alleles expressed.

Finally, the meiotic drive is a theoretical approach supporting both determination systems XX/XY and ZZ/ZW. The meiotic drive is further divided into two types: female (chromosomal) and male (genic) (McDermott and Noor, 2010). In the case of females, germ cell chromosomes compete for presence in the final oocyte. During these chromosomal competitions in parental species, aligning sequences are affected by natural selection, thus evolving faster and disrupting meiosis in hybrid males (McKee, 1998). In males, inherited female alleles have tendencies to shift the abundance of X chromosomes in spermatozoa (McDermott and Noor,

2010). Like in the case of females, increased divergence between parental species due to allelic competition can cause aberrant behavior in hybrid male spermatogenesis.

2.4. Effects of hybridization and polyploidization on gene expression and phenotypic traits of nonadditive gene expression

In general, allopolyploidy causes a genomic shock phenomenon (McClintock, 1984) which means that retroelements are demethylated, sudden changes in gene imprinting, and de/activation of homologous genes. However, little is known about how it affects activity and the size of the transcriptome. There are few studies about relative transcription (Coate and Doyle, 2010; Matos et al., 2015) size based on a few genes rather than the whole transcriptome. From what is known, allopolyploidy cells are partially able to compensate for the increase of genetic material in Iberian cyprinid *Squalius alburnoides* (Matos et al., 2015). In other words, these allotriploid fish cope with gene dosage by increasing dosage compensation. It is necessary to mention that gene compensation was not precise as allotriploids produced slightly fewer transcripts than allodiploids, probably either due to the additivity of genes or increased cell size (Matos et al., 2015).

Duplication of divergent parental genomes and duplication of genes can often result in bias of parental gene additivity (additivity is described as the arithmetic average of the parental expression levels). Nonadditivity expressions can be divided into three groups (Yoo et al., 2014): 1) There is no difference between the expression level of allopolyploid and parental species; thus, one parental genome dominates the other one; 2) allopolyploid expression is either higher or lower in comparison to both parental species also called transgressive expression, or 3) one species parental species contributes more to the total expression than the other one. Bartoš et al. (2019) examined the effect of additivity and nonadditivity in eggs from asexual hybrid and allopolyploid fish from the genus *Cobitis*. In the *Cobitis* genus, hybrids of *C. elongatoides* and *C. taenia* are asexual (PMER pathway) in the case of females (Janko et al., 2007; Dedukh et al., 2020) but sterile in the case of males (Vasil'ev et al., 2003; Choleva et al., 2012). It has been found that additivity in hybrids is completely overrun by nonadditivity, as 83% of genes fell into the dominance category. When compared to somatic liver tissue, dominance was again the main inherited trait from parental species. In contrast, triploids of mother *Ctenopharyngodon idellus* × father *Megalobrama amblycephala* transgressive category contained 13% genes, circa 57% belonged to dominance category, and 30% showed additivity effect (Ren et al., 2017).

2.5. Emergent topics

The issues of hybridization, polyploidy and aberrant reproductive modes have all attracted a biological audience for centuries, and research into them has been considerably boosted by recent advances in nanotechnologies and the next generation sequencing methods, which have led to discoveries of various mechanisms underlying these phenomena. It has thus been shown that both polyploidization and hybridization represent drastic changes to the genomic constitution, potentially even awaking alternative reproductive pathways, like asexuality. Unfortunately, given the tight interlink among these phenomena, it is often difficult to disengage the causes and consequences of genome merging and multiplications since many polyploids are also hybrids at the same time. Also, many analyzed polyploids are paleopolyploids or at least have been evolving for many generations, which clearly might have

led to the modification of their genomes. Hence, a vital question of contemporary evolutionary biology and genetics is to disentangle which of the observed patterns are causally related to either hybridization or polyploidy, which evolve subsequently after the formation of allo/polyploid lineage, and how does the asexual reproductive mode contribute to observed patterns.

These patterns are unlikely to be resolved solely by in-depth studies of individual model taxa, but a comparative approach is needed, which is precisely the aim of the present thesis. The especially main advantage was the fact that during this thesis, I got access to established multigeneration strains of several model organisms, which gave me the possibility not only to address some fundamental questions but also to develop methods that will be useful for other comparative approaches.

3. The aims of the thesis

The overall aim of this thesis was to obtain insight into the generalizability of some patterns mentioned above by a comparative analysis of four fish taxa, which have been affected by hybridization, polyploidy, and to some extent, asexual reproduction. Specifically, we tested the following questions; 1) to what extent does asexual reproduction depend on genetic or phenotypic sex determination; 2) how the switch to asexuality is linked with alterations of gene expression. In addition, 3) we have optimized protocols for the establishment of autotriploid fish strains, which will be of particular interest for further studies disentangling the effects of polyploidization from those of hybridization. These three major aims have been achieved by comparison of four principal animal models. Allopolyploid loaches of genus *Cobitis*, females reproduce gynogenetically using PMER while males are sterile due to the arrest in meiosis I (Janko et al., 2007; Dedukh et al., 2020). Similar to *Cobitis*, female hybrids of common carp *Cyprinus carpio* and gibel carp *Carassius gibelio* produce unreduced eggs but males appear sterile (Cherfas et al., 1994). The question arises if there are similarities between male species in terms of sterility. Yet, it is not known what elements regulate PMER and what is the reason behind this one sex exclusivity. Surprisingly, it seems that genetic expression is not affected by the change of reproductive mode as transcriptomic investigation of *Cobitis* female revealed only minor changes in biological pathways. Moreover, most of the genes were expressed under the dominance of one parental species (Bartoš et al., 2019). On the other hand, gynogenetic *Poecilia formosa* shows additive expression (reanalyzed from Schedina et al., 2018; Lu et al., 2021). It seems that parental expression inheritance varies among gynogenetic fish, and further examination of unreduced gametes production is needed. In the case of allopolyploids, it is problematic to distinguish between effect of hybridization and polyploidization. Therefore, the investigation of autopolyploidy could partially distinguish among effects of both processes. Unfortunately, autopolyploidy is not prevalent in animal kingdom or at least not often detected as allopolyploidy (Soltis et al., 2010). The possible solution could lie in artificial polyploidy for which successful protocol must be established and tested which is usually done in model organisms like zebrafish.

We focused on the *Cobitis* model of asexuals (Janko et al., 2007), which had been investigated from cytogenetic, genomic, and transcriptomic sides leading and seemed to be composed of asexually reproducing female hybrids and sterile hybrid males. In the first study, I addressed question number 1 and performed gonial cell transplantation between sexual and asexual strains and between sexes to understand whether asexuality/sterility are linked to genetic or phenotypic sex differentiation.

I subsequently focused on *Carassius gibelio* model, in which sex determination has been previously described by (M. Lu et al., 2021), and investigated the patterns of male hybrid sterility to test whether patterns observed in *Cobitis* loaches might have some general validity or are taxa specific. Next, in testing question number 2, I contributed to a study of asexual hybrids *P. formosa* by a transcriptomic comparison of gonad-wide gene expression. Since *Poecilia* seems to have a different type of gynogenesis than *Cobitis*, it may be considered a suited alternative model to understand whether transcriptomic changes associated with sexuality have a prevalently case-specific basis or reflect some general trends. Finally, 3) we focused on the widely studied fish model, the zebrafish, to optimize the protocol for autotriploidization, which I consider a vital step in disentangling the effects of hybridization from those of polyploidy. Unfortunately, due to objective time restrictions, I was not able to apply the achieved protocol on *Cobitis* loaches, but we not only conducted the reproducible protocol to produce autotriploid fish but we also further examined an interesting link between polyploidy and sex. These aforementioned results are currently published in three papers and

in the form of one submitted manuscript, which is under revision.

Specifically:

- 1) Investigate the role of somatic tissue on PMER activation in loach species.
- 2) Investigate the sterility and reproductive potential of F1 hybrids of common carp and gibel carp.
- 3) Investigate unisexual species Amazon molly using cytogenetic and transcriptomic analysis.
- 4) Establish a successful protocol for triploid zebrafish production to investigate the reasons behind its sex-ratio shift.

References

- Ballarin, L., Dall'Oro, M., Bertotto, D., Libertini, A., Francescon, A., Barbaro, A., 2004. Haematological parameters in *Umbrina cirrosa* (Teleostei, Sciaenidae): a comparison between diploid and triploid specimens. *Comp. Biochem. Physiol. A. Mol. Integr. Physiol.* 138, 45–51.
- Bartoš, O., Röslein, J., Kotusz, J., Paces, J., Pekárik, L., Petrtýl, M., Halačka, K., Štefková Kašparová, E., Mendel, J., Boroń, A., Juchno, D., Leska, A., Jablonska, O., Benes, V., Šídová, M., Janko, K., 2019. The legacy of sexual ancestors in phenotypic variability, gene expression and homoeolog regulation of asexual hybrids and polyploids. *Mol. Biol. Evol.* 36, 1902–1920.
- Bateson, W., 1909. Heredity and variation in modern lights. In: Seward A.C. (Ed.), *Darwin and modern science*. Cambridge University Press, Cambridge, pp. 88–101.
- Benfey, T.J., 1999. The physiology and behavior of triploid fishes. *Reviews Fish. Sci.* 7, 39–67.
- Carman, J.G., 1997. Asynchronous expression of duplicate genes in angiosperms may cause apomixis, bispory, tetraspory, and polyembryony. *Biol. J. Linn. Soc.* 61, 51–94.
- Charlesworth, B., Charlesworth, D., 1975. An experimental on recombination load in *Drosophila melanogaster*. *Genet. Res.* 25, 267–274.
- Charlesworth, B., Coyne, J.A., Barton, N.H., 1987. The relative rates of evolution of sex chromosomes and autosomes. *Am. Nat.* 130, 113–146.
- Chen, Z.J., 2010. Molecular mechanisms of polyploidy and hybrid vigor. *Trends Plant. Sci.* 15, 57–71.
- Cherfas, N.B., Gomelsky, B.I., Emelyanova, O.V., Recoubratsky, A.V., 1994. Induced diploid gynogenesis and polyploidy in crucian carp, *Carassius aratus gibelio* (Bloch), X common carp, *Cyprinus carpio* L., hybrids. *Aquac. Fish.* 25, 943–954.
- Choleva, L., Janko, K., 2013. Rise and persistence of animal polyploidy: evolutionary constraints and potential. *Cytogenet. Genome Res.* 140, 151–170.
- Choleva, L., Janko, K., De Gelas, K., Bohlen, J., Šlechtová, V., Rábová, M., Ráb, P., 2012. Synthesis of clonality and polyploidy in vertebrate animals by hybridization between two sexual Species. *Evolution* 66, 2191–2203.
- Coate, J.E., Doyle, J.J., 2010. Quantifying whole transcriptome size, a prerequisite for understanding transcriptome evolution across species: an example from a plant allopolyploid. *Genome Biol. Evol.* 2, 534–546.
- Comai, L., 2005. The advantages and disadvantages of being polyploid. *Nat. Rev. Genet.* 6, 836–846.
- De Storme, N., Mason, A., 2014. Plant speciation through chromosome instability and ploidy change: Cellular mechanisms, molecular factors and evolutionary relevance. *Curr. Plant Biol.* 1, 10–33.
- Dedukh, D., Majtánová, Z., Marta, A., Pšenička, M., Kotusz, J., Klíma, J., Juchno, D., Boroń, A., Janko, K., 2020. Parthenogenesis as a solution to hybrid sterility: the mechanistic basis of meiotic distortions in clonal and sterile hybrids. *Genetics* 215, 975–987.
- Dedukh, D., Marta, A., Janko, K., 2021. Challenges and costs of asexuality: variation in premeiotic genome duplication in gynogenetic hybrids from *Cobitis taenia* complex. *Int. J. Mol. Sci.* 22, 12117.
- Dobzhansky, T., 1936. Studies on hybrid sterility. ii. localization of sterility factors in *Drosophila pseudoobscura* hybrids. *Genetics* 21, 113–135.

- Doležalková-Kaštánková, M., Mazepa, G., Jeffries, D.L., Perrin, N., Plötner, M., Plötner, J., Guex, G.-D., Mikulíček, P., Poustka, A.J., Grau, J., Choleva, L., 2021. Capture and return of sexual genomes by hybridogenetic frogs provides clonal genome enrichment in a sexual species. *Sci. Rep.* 11, 1–10.
- Doyle, J.J., Egan, A.N., 2010. Dating the origins of polyploidy events. *New Phytol.* 186, 73–85.
- Ernst, A., 1918. Bastardierung als ursache der apogamie im pflanzenreich. Eine hypothese zur experimentellen vererbungs- und abstammungslehre. G. Fischer, Jena.
- Freitas, S., Rocha, S., Campos, J., Ahmadzadeh, F., Corti, C., Sillero, N., Ilgaz, Ç., Kumlutaş, Y., Arakelyan, M., Harris, D.J., Carretero, M.A., 2016. Parthenogenesis through the ice ages: A biogeographic analysis of Caucasian rock lizards (genus *Darevskia*). *Mol. Phylogenet. Evol.* 102, 117–127.
- Gui, J., Zhou, L., 2010. Genetic basis and breeding application of clonal diversity and dual reproduction modes in polyploid *Carassius auratus gibelio*. *Sci. China Life. Sci.* 53, 409–415.
- Haldane, J.B.S., 1922. Sex ratio and unisexual sterility in hybrid animals. *Journ. Gen.* 12, 101–109.
- Hoegg, S., Brinkmann, H., Taylor, J.S., Meyer, A., 2004. Phylogenetic timing of the fish-specific genome duplication correlates with the diversification of teleost fish. *J. Mol. Evol.* 59, 190–203.
- Itono, M., Morishima, K., Fujimoto, T., Bando, E., Yamaha, E., Arai, K., 2006. Premeiotic endomitosis produces diploid eggs in the natural clone loach, *Misgurnus anguillicaudatus* (Teleostei: Cobitidae). *J. Exp. Zool. A Ecol. Genet. Physiol.* 305A, 513–523.
- Janko, K., Culling, M.A., Ráb, P., Kotlík, P., 2005. Ice age cloning-comparison of the Quaternary evolutionary histories of sexual and clonal forms of spiny loaches (*Cobitis*; Teleostei) using the analysis of mitochondrial DNA variation. *Mol. Ecol.* 14, 2991–3004.
- Janko, K., Bohlen, J., Lamatsch, D., Flajshans, M., Epplen, J.T., Ráb, P., Kotlík, P., Šlechtová, V., 2007. The gynogenetic reproduction of diploid and triploid hybrid spined loaches (*Cobitis*: Teleostei), and their ability to establish successful clonal lineages--on the evolution of polyploidy in asexual vertebrates. *Genetica* 131, 185–194.
- Jiao, Y., Wickett, N.J., Ayyampalayam, S., Chanderbali, A.S., Landherr, L., Ralph, P.E., Tomsho, L.P., Hu, Y., Liang, H., Soltis, P.S., Soltis, D.E., Clifton, S.W., Schlarbaum, S.E., Schuster, S.C., Ma, H., Leebens-Mack, J., dePamphilis, C.W., 2011. Ancestral polyploidy in seed plants and angiosperms. *Nature* 473, 97–100.
- Kim, D.S., Nam, Y.K., Noh, J.K., Park, C.H., Chapman, F.A., 2005. Karyotype of North American shortnose sturgeon *Acipenser brevirostrum* with the highest chromosome number in the Acipenseriformes. *Ichthyol. Res.* 52, 94–97.
- Kočí, J., Röslein, J., Pačes, J., Kotusz, J., Halačka, K., Koščo, J., Fedorčák, J., Iakovenko, N., Janko, K., 2020. No evidence for accumulation of deleterious mutations and fitness degradation in clonal fish hybrids: Abandoning sex without regrets. *Mol. Ecol.* 29, 3038–3055.
- Kuroda, M., Fujimoto, T., Murakami, M., Yamaha, E., Arai, K., 2018. Clonal reproduction assured by sister chromosome pairing in dojo loach, a teleost fish. *Chromosome Res.* 26, 243–253.
- Lien, S., Koop, B.F., Sandve, S.R., Miller, J.R., Kent, M.P., Nome, T., Hvidsten, T.R., Leong, J.S., Minkley, D.R., Zimin, A., Grammes, F., Grove, H., Gjuvsland, A., Walenz, B., Hermansen, R.A., von Schalburg, K., Rondeau, E.B., Di Genova, A., Samy, J.K.A., Olav Vik, J., Vigeland, M.D., Caler, L., Grimholt, U., Jentoft, S., Inge Våge, D., de Jong, P., Moen, T., Baranski, M., Palti, Y., Smith, D.R., Yorke, J.A., Nederbragt, A.J., Tooming-Klunderud, A., Jakobsen, K.S., Jiang, X., Fan, D., Hu, Y., Liberles, D.A., Vidal, R., Iturra, P., Jones, S.J.M., Jonassen, I., Maass, A., Omholt, S.W., Davidson, W.S., 2016. The Atlantic salmon genome provides insights into rediploidization. *Nature* 533, 200–205.

- Loewe, L., Lamatsch, D.K., 2008. Quantifying the threat of extinction from Muller's ratchet in the diploid Amazon molly (*Poecilia formosa*). *BMC Evol. Biol.* 8, 1–20.
- Lu, M., Li, X.-Y., Li, Z., Du, W.-X., Zhou, L., Wang, Y., Zhang, X.-J., Wang, Z.-W., Gui, J.-F., 2021. Regain of sex determination system and sexual reproduction ability in a synthetic octoploid male fish. *Sci. China Life Sci.* 64, 77–87.
- Lu, Y., Bierbach, D., Ormanns, J., Warren, W.C., Walter, R.B., Schartl, M., 2021. Fixation of allelic gene expression landscapes and expression bias pattern shape the transcriptome of the clonal Amazon molly. *Genome Res.* 31, 372–379.
- Lutes, A.A., Neaves, W.B., Baumann, D.P., Wiegraebe, W., Baumann, P., 2010. Sister chromosome pairing maintains heterozygosity in parthenogenetic lizards. *Nature* 464, 283–286.
- Lynch, M., Conery, J.S., 2000. The evolutionary fate and consequences of duplicate genes. *Science* 290, 1151–1155.
- Mable, B.K., 2004. "Why polyploidy is rarer in animals than in plants": myths and mechanisms. *Biol. J. Linn. Soc.* 82, 453–466
- Macculloch, R.D., Murphy, R.W., Kupriyanova, L.A., Darevsky, I.S., 1997. The Caucasian rock lizard *Lacerta rostombekovi*: a monoclonal parthenogenetic vertebrate. *Biochem. Syst. Ecol.* 25, 33–37.
- Mank, J.E., Avise, J.C., 2006. Phylogenetic conservation of chromosome numbers in Actinopterygian fishes. *Genetica* 127, 321–327.
- Manríquez-Morán, N.L., Cruz, F.R.M. la, Murphy, R.W., 2014. Genetic variation and origin of parthenogenesis in the *Aspidoscelis cozumela* complex: evidence from mitochondrial genes. *Zoolog. Sci.* 31, 14–19.
- Mateos, M., Vrijenhoek, R.C., 2005. Independent origins of allotriploidy in the fish genus *Poeciliopsis*. *J. Hered.* 96, 32–39.
- Matos, I., Machado, M.P., Schartl, M., Coelho, M.M., 2015. Gene expression dosage regulation in an allopolyploid fish. *PLoS One* 10:e0116309
- McClintock, B., 1984. The significance of responses of the genome to challenge. *Science* 226, 792–801.
- McDermott, S.R., Noor, M.A.F., 2010. The role of meiotic drive in hybrid male sterility. *Philos. Trans. R. Soc. Lond. B. Biol. Sci.* 365, 1265–1272.
- McKee, B.D., 1998. Pairing sites and the role of chromosome pairing in meiosis and spermatogenesis in male *Drosophila*. *Curr. Top. Dev. Biol.* 37, 77–115.
- Moore, M.C., Whittier, J.M., Crews, D., 1985. Sex steroid hormones during the ovarian cycle of an all-female, parthenogenetic lizard and their correlation with pseudosexual behavior. *Gen. Comp. Endocrinol.* 60, 144–153.
- Moran, P.A., Ritchie, M.G., Bailey, N.W., 2017. A rare exception to Haldane's rule: Are X chromosomes key to hybrid incompatibilities? *Heredity* 118, 554–562.
- Moritz, C., Brown, W., Densmore, L. 3rd, Wright, J., Vyas, D., Donnellan, S., Adams, M., Baverstock, P., 1989. Genetic diversity and the dynamics of hybrid parthenogenesis in *Cnemidophorus* (Teiidae) and *Heteronotia* (Gekkonidae). *Evolution and ecology of unisexual vertebrates* 466, 87–112.
- Muller, H.J., 1942. Isolating mechanisms, evolution and temperature. In: Dobzhansky, T. (Ed.), *Biological Symposium* 6, Lancaster, pp. 71–125.
- Muller, H.J., 1932. Some genetic aspects of sex. *Am. Nat.* 66, 118–138.

- Orr, H.A., 1993. Haldane's rule has multiple genetic causes. *Nature* 361, 532–533.
- Otto, S.P., Whitton, J., 2000. Polyploid incidence and evolution. *Annu. Rev. Genet.* 34, 401–437.
- Piferrer, F., Beaumont, A., Falguière, J.-C., Flajšhans, M., Haffray, P., Colombo, L., 2009. Polyploid fish and shellfish: Production, biology and applications to aquaculture for performance improvement and genetic containment. *Aquaculture* 293, 125–156.
- Pigneur, L.-M., Hedtke, S.M., Etoundi, E., Van Doninck, K., 2012. Androgenesis: a review through the study of the selfish shellfish *Corbicula* spp. *Heredity* 108, 581–591.
- Ren, L., Tang, C., Li, W., Cui, J., Tan, X., Xiong, Y., Chen, J., Wang, Jun, Xiao, J., Zhou, Y., Wang, Jing, Tao, M., Zhang, C., Liu, S., 2017. Determination of dosage compensation and comparison of gene expression in a triploid hybrid fish. *BMC Genom.* 18, 1-14.
- Sawamura, K., 1996. Maternal effect as a cause of exceptions for Haldane's rule. *Genetics* 143, 609–611.
- Schedina, I.M., Groth, D., Schlupp, I., Tiedemann, R., 2018. The gonadal transcriptome of the unisexual Amazon molly *Poecilia formosa* in comparison to its sexual ancestors, *Poecilia mexicana* and *Poecilia latipinna*. *BMC Genom.* 19, 1–18.
- Schmidt, D.J., Bond, N.R., Adams, M., Hughes, J.M., 2011. Cytonuclear evidence for hybridogenetic reproduction in natural populations of the Australian carp gudgeon (*Hypseleotris*: Eleotridae). *Mol. Ecol.* 20, 3367–3380.
- Schultz, R.J., 1969. Hybridization, unisexuality, and polyploidy in the Teleost Poeciliopsis (Poeciliidae) and other vertebrates. *Am. Nat.* 103, 605–619.
- Shimizu, Y., Shibata, N., Sakaizumi, M., Yamashita, M., 2000. Production of diploid eggs through premeiotic endomitosis in the hybrid Medaka between *Oryzias latipes* and *O. curvinotus*. *Zool. Sci.* 17, 951–958.
- Soltis, D.E., Buggs, R.J.A., Doyle, J.J., Soltis, P.S., 2010. What we still don't know about polyploidy. *Taxon* 59, 1387–1403.
- Stillwell, E.J., Benfey, T.J., 1996. Hemoglobin level, metabolic rate, opercular abduction rate and swimming efficiency in female triploid brook trout (*Salvelinus fontinalis*). *Fish Physiol. Biochem.* 15, 377–383.
- Tichopád, T., Franěk, R., Doležálková-Kaštánková, M., Dedukh, D., Marta, A., Halačka, K., Steinbach, C., Janko, K., Pšenička, M., 2022. Clonal gametogenesis is triggered by intrinsic stimuli in the hybrid's germ cells but is dependent on sex differentiation. *Biol. Reprod.* corrected proof.
- Turelli, M., Orr, H.A., 1995. The Dominance theory of Haldane's rule. *Genetics* 140, 389–402.
- Ullah, Z., Lee, C.Y., DePamphilis, M.L., 2009. Cip/Kip cyclin-dependent protein kinase inhibitors and the road to polyploidy. *Cell Div.* 4, 1–15.
- Vasil'ev, V.P., Akimova, N.V., Emel'yanova, N.G., Pavlov, D.A., Vasil'eva, E.D., 2003. Reproductive capacities in the polyploid males of spined loaches from the unisexual-bisexual complex, occurred in the Moscow River. *Folia Biol.* 51, 67–73.
- Wang, J., Liu, Q., Luo, K., Chen, X., Xiao, J., Zhang, C., Tao, M., Zhao, R., Liu, S., 2016. Cell fusion as the formation mechanism of unreduced gametes in the gynogenetic diploid hybrid fish. *Sci. Rep.* 6, 31658.

- Warren, W.C., García-Pérez, R., Xu, S., Lampert, K.P., Chalopin, D., Stöck, M., Loewe, L., Lu, Y., Kuderna, L., Minx, P., Montague, M.J., Tomlinson, C., Hillier, L.W., Murphy, D.N., Wang, J., Wang, Z., Garcia, C.M., Thomas, G.C.W., Volff, J.-N., Farias, F., Aken, B., Walter, R.B., Pruitt, K.D., Marques-Bonet, T., Hahn, M.W., Kneitz, S., Lynch, M., Schartl, M., 2018. Clonal polymorphism and high heterozygosity in the celibate genome of the Amazon molly. *Nat. Ecol. Evol.* 2, 669–679.
- Wu, C.I., Davis, A.W., 1993. Evolution of postmating reproductive isolation: the composite nature of Haldane's rule and its genetic bases. *Am. Nat.* 142, 187–212.
- Wu, C.I., Johnson, N.A., Palopoli, M.F., 1996. Haldane's rule and its legacy: Why are there so many sterile males? *Trends Ecol. Evol.* 11, 281–284.
- Yoo, M.-J., Liu, X., Pires, J.C., Soltis, P.S., Soltis, D.E., 2014. Nonadditive gene expression in polyploids. *Annu. Rev. Genet.* 48, 485–517.
- Zhou, L., Gui, J., 2017. Natural and artificial polyploids in aquaculture. *Aquac. Fish.* 2, 103–111.

CHAPTER 2

CLONAL GAMETOGENESIS IS TRIGGERED BY INTRINSIC STIMULI IN THE HYBRID'S GERM CELLS BUT IS DEPENDENT ON SEX DIFFERENTIATION

Tichopád, T., Franěk, R., Doležálková-Kaštánková, M., Dedukh, D., Marta, A., Halačka, K., Steinbach, C., Janko, K., Pšenička, M., 2022. Clonal gametogenesis is triggered by intrinsic stimuli in the hybrid's germ cells but is dependent on sex differentiation. Biol. Reprod. ioac074.

It was allowed by publisher on 5th May 2022 to include the paper in this Ph.D. thesis (license no. 5302450048195).

My share on this work was about 45%.

Clonal gametogenesis is triggered by intrinsic stimuli in the hybrid's germ cells but is dependent on sex differentiation[†]

Tomáš Tichopád^{1,*}, Roman Franěk¹, Marie Doležálková-Kašánková², Dmitrij Dedukh²,
Anatolie Marta^{2,3,4}, Karel Halačka^{2,5}, Christoph Steinbach¹, Karel Janko^{2,6,*} and Martin Pšenička¹

¹Faculty of Fisheries and Protection of Waters, South Bohemian Research Center of Aquaculture and Biodiversity of Hydrocenoses, University of South Bohemia in Ceske Budejovice, Vodňany, Czech Republic

²Laboratory of Fish Genetics, Institute of Animal Physiology and Genetics, Academy of Sciences of the Czech Republic, Liběchov, Czech Republic

³Department of Zoology, Faculty of Science, Charles University in Prague, Prague, Czech Republic

⁴Institute of Zoology, Chisinau, Moldova

⁵Institute of Vertebrate Biology, Academy of Sciences of the Czech Republic, Brno, Czech Republic

⁶Department of Biology and Ecology, Faculty of Science, University of Ostrava, Ostrava, Czech Republic

*Correspondence: Faculty of Fisheries and Protection of Waters, South Bohemian Research Center of Aquaculture and Biodiversity of Hydrocenoses, University of South Bohemia in Ceske Budejovice, Zátíší 728/II, 389 25 Vodňany, Czech Republic; E-mail: tichopad@frov.jcu.cz; Laboratory of Fish Genetics, Institute of Animal Physiology and Genetics, Academy of Sciences of the Czech Republic, Liběchov, Czech Republic; E-mail: janko@iapg.cas.cz

[†]Grant Support: This research was funded by Institutional Research Concept RVO67985904 and by Czech Science Foundation, Projects No. 17-09807S (to M.P. and K.H.) and 19-21552S (to Lab. of Fish Genetics). The transplantation and fish manipulation were financially supported by the Ministry of Education, Youth and Sports of the Czech Republic—project CENAKVA (LM2018099) and Biodiversity (CZ.02.1.01/0.0/0.0/16_025/0007370).

Abstract

Interspecific hybridization may trigger the transition from sexual reproduction to asexuality, but mechanistic reasons for such a change in a hybrid's reproduction are poorly understood. Gametogenesis of many asexual hybrids involves a stage of premeiotic endoreplication (PMER), when gonial cells duplicate chromosomes and subsequent meiotic divisions involve bivalents between identical copies, leading to production of clonal gametes. Here, we investigated the triggers of PMER and whether its induction is linked to intrinsic stimuli within a hybrid's gonial cells or whether it is regulated by the surrounding gonadal tissue. We investigated gametogenesis in the *Cobitis taenia* hybrid complex, which involves sexually reproducing species (*Cobitis elongatoides* and *C. taenia*) as well as their hybrids, where females reproduce clonally via PMER while males are sterile. We transplanted spermatogonial stem cells (SSCs) from *C. elongatoides* and triploid hybrid males into embryos of sexual species and of asexual hybrid females, respectively, and observed their development in an allospecific gonadal environment. Sexual SSCs underwent regular meiosis and produced normally reduced gametes when transplanted into clonal females. On the other hand, the hybrid's SSCs lead to sterility when transplanted into sexual males but maintained their ability to undergo asexual development (PMER) and production of clonal eggs, when transplanted into sexual females. This suggests that asexual gametogenesis is under complex control when somatic gonadal tissue indirectly affects the execution of asexual development by determining the sexual differentiation of stem cells and once such cells develop to female phenotypes, hybrid germ cells trigger the PMER from their intrinsic signals.

Significance Statement

Although sexual reproduction is a dominant trait among all eukaryotes, many taxa have evolved the ability to reproduce asexually. While asexuality often appears to be linked to interspecific hybridization, it remains unknown how the coexistence of diverged genomes may initiate such a swap in reproduction. In our study, we transplanted germ cells between asexual hybrids and their parents. On the one hand, the ability of clonal gametogenesis occurred exclusively in hybrid germ cells, suggesting that asexual development is directly triggered by the hybrid genomic constitution of the cell. On the other hand, clonality was observed only in cells transplanted into females, suggesting that the execution of clonal development is influenced by signals from the gonadal environment and regulated by somatic factors.

Keywords: asexuality, hybridization, gonial stem cell transplantation, premeiotic endoreplication

Introduction

Although sexual reproduction is a predominant characteristic of all multicellular eukaryotes, based on conserved molecular machinery controlling meiotic divisions, it has been disrupted many times. This has resulted in a variety of the so-called asexual reproductive modes that occur in most animal and plant phyla. Asexual lineages not only allow key questions about ultimate advantages and disadvantages of sex to be tested, but also due to their clonal multiplication, unusual gametogenic, and developmental pathways, they have proved

to be appealing models for many biological disciplines concerned with ecology, cell biology, and molecular genetics [1]. Yet, despite intensive research in asexual organisms, frustratingly large gaps remain in our understanding of mechanisms that trigger such a switch from sex to various forms of asexuality. This is apart from some straightforward cases, such as *Wolbachia*-induced asexuality [2] or the presence of candidate “asexuality genes” in a few model taxa [3, 4].

A promising class of theories aiming to identify some common mechanisms underlying the emergence of asexuality

Received: December 8, 2021. Revised: March 8, 2022. Accepted: April 5, 2022

© The Author(s) 2022. Published by Oxford University Press on behalf of Society for the Study of Reproduction. All rights reserved. For permissions, please e-mail: journals.permissions@oup.com

builds on the fact that many asexual organisms are of hybrid origin. It has been proposed that abandonment of sex may be stimulated by aberrant interactions between orthologous copies of individual genes [5, 6], chromosomes [7], or even entire regulatory networks brought together by hybridization between distinct but not co-adapted genomes [8]. Unfortunately, the scarcity of empirical studies prevents any clear-cut conclusions about the role of hybridization in triggering asexuality. Indeed, if hybridization is supposed to initiate asexuality, it is difficult to explain why independently arisen hybrids in unrelated taxa would share similar distortion of gametogenic or meiotic mechanisms, such as PMER.

For instance, one gametogenic pathway that is relatively common among independently arisen asexual animals and plants in *sensu lato* is premeiotic endoreplication (PMER) [9–16]. This pathway, depicted in Figure 1, is characterized by duplication of chromosomes in oogonia before meiosis. Consequently, subsequent meiotic divisions occur in a polyploid gamete with bivalents forming between homologues. Such a process alleviates potential problems in pairing of orthologous chromosomes in hybrids [9, 17] and simultaneously leads to the production of clonal progeny because bivalent pairing and crossovers occur between duplicated copies of chromosomes, which are identical sister copies.

Analysis of the speciation process in spined loaches (*Cobitis*; Actinopterygii) demonstrated that emergence of hybrid asexuality mechanistically coincided with hybrid sterility [9, 20]. Hence, the emergence of asexual gametogenesis in general, and PMER in particular, may represent an alternative type of reproductive incompatibility promoting speciation among hybridizing species [20, 21]. There are notable analogies between the emergence of hybrid asexuality and classical speciation models assuming the accumulation of postzygotic reproductive incompatibilities. Indeed, the emergence of both hybrid asexuality and sterility effectively restricts interspecific gene flow thereby promoting speciation and scale with genomic divergence between parental species. Furthermore, in a similar way to hybrid sterility, asexual gametogenesis also arises asymmetrically with respect to the sex of the hybrids so that most known asexual vertebrates exhibit strongly female-biased sex ratios for which they are sometimes also referred to as “all-female” or “unisexual” [22, 23].

Unfortunately, there are only a few studies investigating functional differences between male and female hybrids in taxa where asexuality occurs. Available data indicate that when hybrid females are fertile and asexual (often employing PMER), their hybrid brothers are usually sterile [11, 21, 24]. However, some exceptions exist, e.g., in hybridogenetic taxa like *Pelophylax* [25] or *Squalius* [26]. Crossing experiments within several asexual complexes of fishes and reptiles further demonstrate that asymmetry between female hybrid asexuality and male sterility is directly linked to the merging of parental genomes and already occurs in the F1 hybrid generation [9, 11, 27–29]. Yoshikawa *et al.* [30] further examined *Misgurnus* spp. (loaches), where hybrid females typically reproduced clonally with PMER and artificially reverted clonal diploid female progenies into males. They reported that PMER occurred also in spermatogonia of these artificially sex-reverted males from females, which was surprising since natural *Misgurnus* male hybrids are sterile [11]. Such a finding therefore indicates that asexual gametogenesis is somehow linked to one sex (females) and

seems to depend on genetic sex determination rather than on phenotypic sex.

PMER thus appears to be a crucial cellular deviation in the evolution of many natural hybrid and allopolyploid lineages, making it important in furthering our understanding of genetic and cellular mechanisms that underly its occurrence. Unfortunately, how and why the hybrid germ cells switch their developmental pathway toward PMER are unknown. For instance, it remains unclear whether PMER results from endomitosis, which involves mitotic replication of chromosomes without cell division, or endoreduplication, i.e., replication of chromosomes without initiation of mitosis. It has been shown that red crucian carp \times common carp [*Carassius auratus* (red variety) \times *Cyprinus carpio*] hybrids produce tetraploid oogonia by germ cell fusion, rather than by multiplication of their chromosomes [31].

Loaches of the family Cobitidae (Cypriniformes, Teleostei) have been shown to be a suitable model organism to understand the mechanisms underlying hybrid sterility and asexuality [10, 17, 20, 30, 32]. In particular, the so-called *Cobitis taenia* hybrid complex is distributed in Europe and comprises sexual species of *C. taenia* (TT) and *Cobitis elongatoides* (EE) that diverged \sim 9 million years ago [20] but are frequently hybridizing, producing sterile males and hybrid females, which reproduce clonally using PMER [9, 28]. Hybrid females are gynogenetic, and hence, sperm is required to trigger their gametes' development, but this does not generally contribute to the progeny's genome, resulting in the formation of clonal progeny. Maternal species of the most known natural clones is *C. taenia* but reciprocal hybridization has also been documented [33]. Nonetheless, in reciprocal crossing, there are no differences in the phenotype of hybrid offspring; thus, the progeny of *C. elongatoides* female and *C. taenia* male will have the same morphological traits and sex mode as the progeny of *C. taenia* female and *C. elongatoides* male. Hybrid's oocytes may sometimes incorporate the sperm's genome leading to a new generation of triploid progeny. These may be either sterile in case of triploid males or fertile and gynogenetic in case of females with a triploid genome composition (Figure 1). Analogous process of sperm incorporation may lead to the formation of tetraploids, which are generally inviable and do not develop into adults [19], albeit rare exceptions of clonal tetraploid females have been found in nature [18]. Consequently, natural populations of triploid loaches are generally composed of sexual host species (often occurring in a minority), diploid, and mainly triploid clonal hybrid females [34].

In this study, we investigated whether the initiation of PMER is autonomously regulated in the hybrid's germ cells or whether it depends on extrinsic stimuli from surrounding somatic cells and the tissue in which they occur. We also tested whether PMER is strictly confined to female sex determination, or whether the germline originating from males may also undergo such a pathway. To do so, we performed the following study, the design of which is depicted in Figure 2. We transplanted testicular cells containing spermatogonial stem cells (SSCs) between sexually reproducing species and their asexual hybrids from the *C. taenia* hybrid complex and investigated the development of such cells in the host's body. Specifically, we extracted SSCs from *C. elongatoides* males (sexual species) and sterile allotriploid males with the *C. elongatoides-taenia-taenia* genomic constitution (see Figure 1 for an explanation of the hybrid origins). These cells were

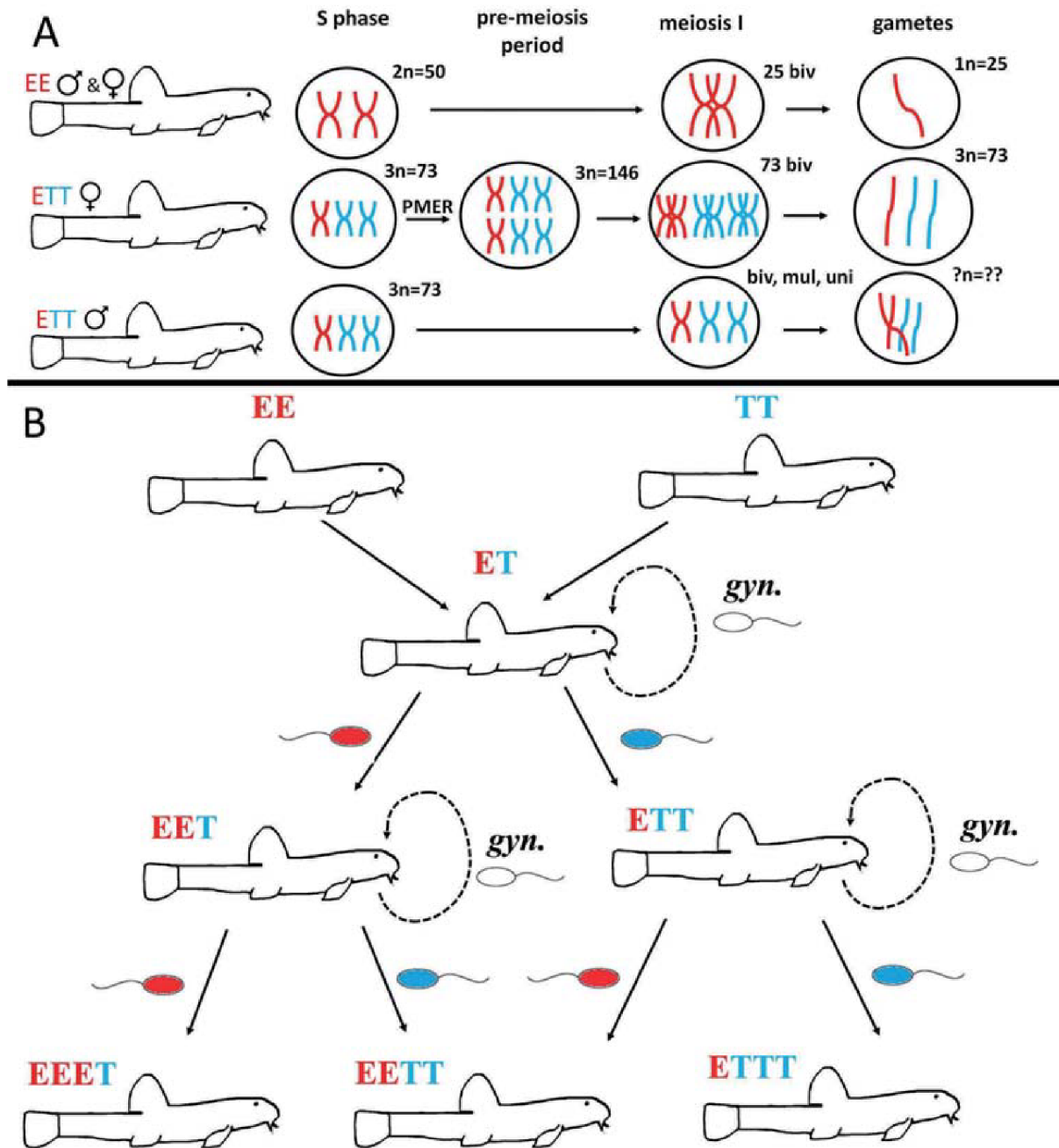

Figure 1. *Cobitis taenia* (TT) and *C. elongatoides* (EE) hybridization scheme. (A) Gametogenesis in EE, triploid ETT female and male. Red color represents chromosomes derived from parental species EE, blue those from parental species TT. In hybrid females, the PMER results in doubling of chromosomes and pairing between identical copy produces proper bivalents with crossovers. However, in males, PMER does not occur. Therefore, chromosomes cannot properly pair leading to bivalents (biv), multivalents (mul), and univalents (uni). Parental species produce haploid gametes, hybrid females produce clonal eggs and males either cannot finish meiosis properly or final spermatozoa are often aneuploid or polyploid with disrupted motility. (B) F1 diploid hybrids are produced by natural or artificial spawning between TT (48 chromosomes) and EE (50 chromosomes) individuals. ET diploid hybrid males are sterile, whereas hybrid diploid females are fertile using gynogenesis (*gyn.*) as reproductive mode and can establish natural populations [18]. In some cases, sperm from parental species can fertilize an egg giving rise to the triploid hybrids ETT (73 chromosomes) or EET (74 chromosomes) depending on sperm donor, where males are again sterile and females are gynogenetically fertile. Again, triploid females are able to establish stable only female population. Fertilization of triploid eggs is also possible but natural occurrence of EEET (99 chromosomes), EETT (98 chromosomes), and ETTT (97 chromosomes) is very rare and tetraploids appear unable to reproduce [19].

reciprocally transplanted into juvenile recipients of both sexes that were sterilized by oligonucleotide morpholino (MO) treatment prior to transplantation. Therefore, two groups of fish were obtained: 1) triploid recipients of gonial cells

from diploid donors (hereafter called TrDd) and 2) diploid recipients of gonial cells from triploid donors (hereafter called DrTd). Recipients were kept until adulthood and allowed to spawn in order to investigate their fertility and inheritance

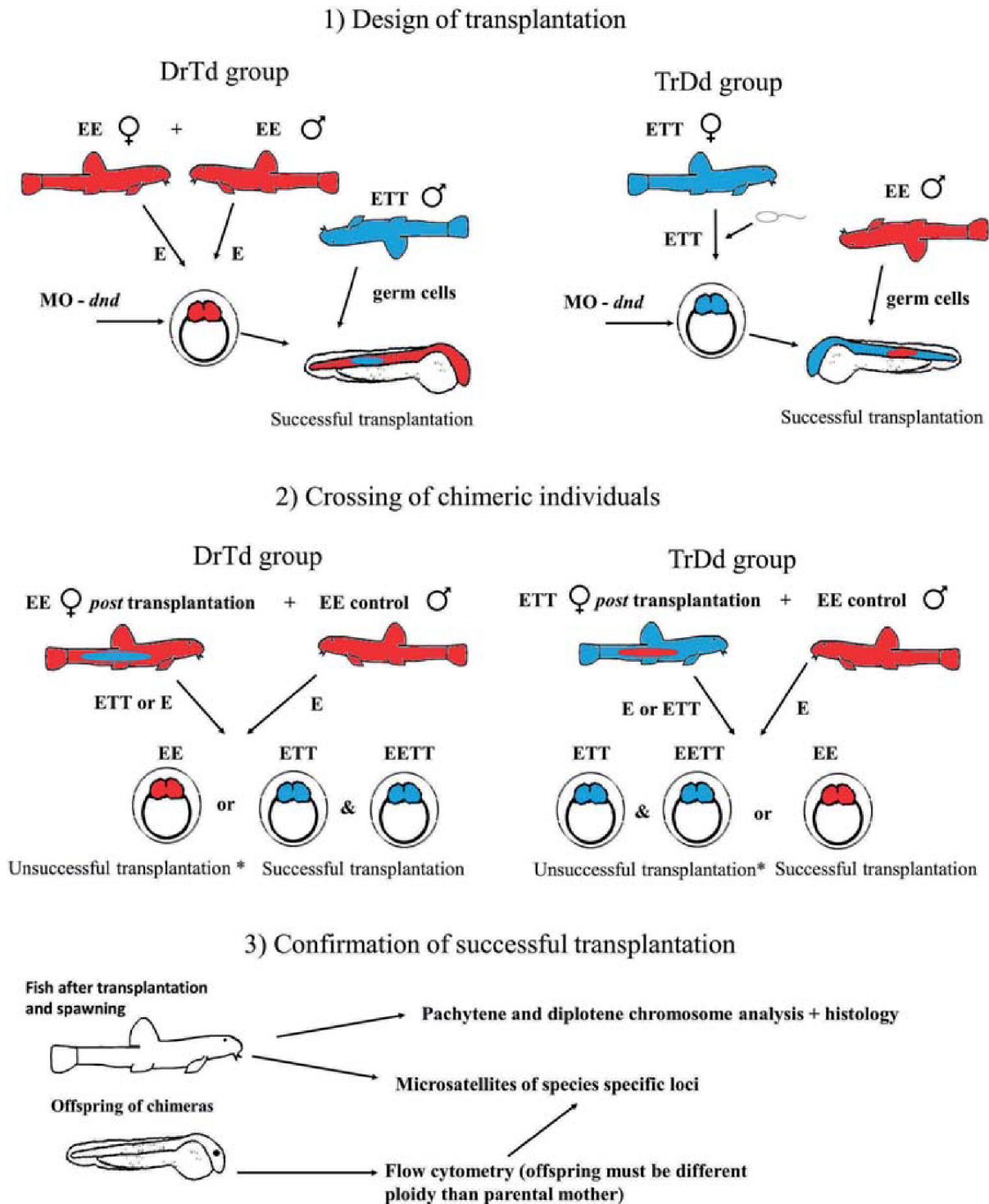

Figure 2. The experimental design. (1) The design of reciprocal transplantation between two groups: diploid recipient and triploid donor (DrTd) and triploid recipient and diploid donor (TrDd). In the DrTd group, parental species of *C. elongatoides* (EE—red color) were spawned and their early embryos (2-cell stage) were injected with MO against the *dnd* gene to terminate development of parental gonads. Transplantation was undertaken using the germ stem cells from adult allotriploid male *C. elongatoides-taenia-taenia* (ETT—blue color). In the second group TrDd, eggs of ETT females were activated with goldfish (*C. auratus*) (sperm symbol). Embryos were treated with anti-*dnd* MO and later transplanted with germ cells from adult EE males. (2) Two years after transplantation, experimental fish from both groups were spawned with the EE males. In the DrTd group, EE fish after successful transplantation should produce triploid ETT eggs where two scenarios can occur: either eggs are activated only (gynogenesis) producing ETT offspring or sperm can be incorporated into the eggs thus producing EETT. In the TrDd group, successfully transplanted ETT fish should produce haploid E gamete that must be fertilized with sperm and produce parental species EE. *In the case of unsuccessful MO treatment and transplantation, fish would produce their natural biotype, i.e., haploid eggs in the case of parental species and triploid eggs in case of hybrids. (3) Confirmation of successful transplantation. Offspring of chimeric fish from the DrTd group carried the *C. taenia* microsatellite loci in the case of successful transplantation. On the other hand, *C. taenia* loci were absent in offspring from the TrDd group.

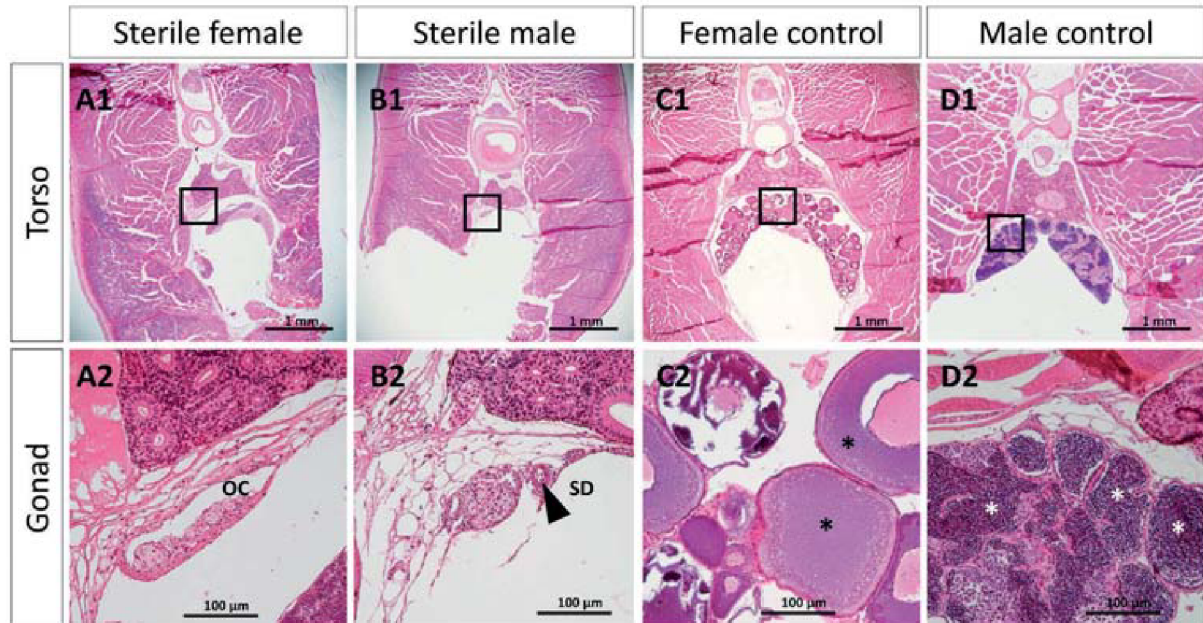

Figure 3. Results of histology analysis after MO-*dn*d treatment designed for *C. taenia* in *C. elongatoides*. A1 shows the whole-body histology of a sterile female after MO treatment. A2 is a magnification of the ovarian cavity (OC). B1 shows the whole body histology of a sterile male after MO treatment. B2 black arrowhead shows enlarged fragment from B1 of the sperm duct (SD), i.e., the connection between each testis to a urogenital opening, the testes themselves are not present. C1 and C2 show fertile females with vitellogenic eggs (black asterisks), whereas D1 and D2 show fertile males with gametes (white asterisks).

patterns in their progeny. After spawning, the recipients' gonads were investigated using cytogenetic methods to check for meiotic patterns and potential presence of PMER.

Results

Transplantation efficiency

We collected 31 representative fish of both experimental groups for further examinations, which included experimental crossing, histology, and cytogenetic analysis of meiotic chromosomes. In total, we examined 23 fish of the DrTd group (12 females and 11 males) and eight fish of the TrDd group (only females). Among these, we observed that four out of 12 DrTd females were not sterilized completely due to MO failure, six were sterilized but without successful transplantation (Figure 3) and two appeared as germline chimeras after successful sterilization and transplantation. Similarly, sterilization failed in four out of 11 DrTd males. In five we observed sterilization without transplantations (Figure 3) and two appeared as successful chimeras. In the TrDd group, six hybrid females were successfully sterilized and transplanted (Table 1), whereas two were successfully sterilized but with no success in transplantation.

Genetic profiling of experimental fish and their offspring based on microsatellite markers

Genetic profiling of fish was performed by analyses of selected species specific (*C. elongatoides* vs. *C. taenia*) microsatellite loci. Since we used two types of fish, diploid *C. elongatoides* and triploid *C. elongatoides-taenia-taenia*, the success of transplantation was indicated by the presence of *C. taenia* specific loci in the juveniles of the DrTd group analyzed (where parental species *C. elongatoides* produce juveniles with

C. taenia loci) or by its absence in juveniles of TrDd (where hybrids *C. elongatoides-taenia-taenia* produce juveniles without *C. taenia* loci). Altogether, from 10 potential chimeric females (six *C. elongatoides* and four *C. elongatoides-taenia-taenia*), we obtained 136 juvenile individuals for analysis. Successful transplantation was confirmed in two out of six diploid *C. elongatoides* females of the DrTd group, which altogether produced 23 juveniles with a foreign allelic profile corresponding to the donor's genotype (ETT). Moreover, in six out of these 23 juveniles, we observed incorporation of paternal *C. elongatoides* sperm, leading to an increased ploidy level of progeny (EETT). This confirms their successful transplantation and demonstrates that such transplanted oogonia maintain their ability to produce clonal progenies. In the remaining four *C. elongatoides*, transplantation was not successful. In a reciprocal experiment, four *C. elongatoides-taenia-taenia* females from the TrDd group yielded 47 juveniles, whose genotype corresponded to one haploid set of their *C. elongatoides* donor and a second haploid set of the *C. elongatoides* father. This indicated successful transplantation in the TrDd group and suggested that *C. elongatoides* germ cells transplanted into ETT females conserved the ability to properly divide into apparently normal EE-type gametes.

Histology

Histological analysis of germline chimeras was mostly directed to the males because hybrid male sterility in *C. elongatoides* × *C. taenia* is represented by meiotic arrest leading to an aberrant germ cell population, lacking functional spermatozoa. Therefore, it was possible to obtain supporting evidence of successful transplantation in diploid males (Figure 4A) when compared with gonadal tissue from diploid (Figure 4B) and triploid controls (Figure 4C). The DrTd males

Table 1. Summary of the chimeric experiment. DrTd group, diploid recipient, triploid donor; TrDd group, triploid recipient, diploid donor; Biotype EE, parental species diploid *C. elongatoides*; ETT, triploid hybrid of *C. elongatoides-taenia-taenia*. Genetic profiling is based on microsatellite loci from chimeric offspring where the first number represents embryos derived from the recipient germline and the second number from the donor germline (i.e., successful transplantation). Note that the term “ordinary” in the histology analysis column stands for no difference from the control groups. We show only successful chimeric fish

Sex of recipient	Biotype of recipient	Biotype of donor	Genetic profiling of offspring (donor derived/recipient derived)	Pachytene analysis	Histology analysis
DrTd group					
F	EE	ETT	ETT 16 and EE 0	73 bivalents	Ordinary gonad with eggs
F	EE	ETT	ETT 7 and EE 0	Not done	NA
M	EE	ETT	No success in spawning	Bivalents with univalents	Reduced number of germ cells: no spermatozoa
M	EE	ETT	No success in spawning	Bivalents and univalents	Reduced number of germ cells: no spermatozoa
TrDd group					
F	ETT	EE	No success in spawning	25 bivalents	Ordinary gonad with eggs
F	ETT	EE	EE 8 and 0 ETT	25 bivalents	ordinary gonad with eggs
F	ETT	EE	EE 7 and 0 ETT	25 bivalents	ordinary gonad with eggs
F	ETT	EE	EE 17 and 0 ETT	Not done	NA
F	ETT	EE	EE 15 and 0 ETT	Not done	Ordinary gonad with eggs
F	ETT	EE	No success in spawning	25 bivalents	NA

and triploid control males contained germ cells in premeiotic stages and a small number of postmeiotic abnormal cells, whereas diploid controls contained mainly spermatozoa. However, histology itself was not used as an indicator of successful transplantation.

Meiosis analysis of chimeric fish

To investigate the particular gametogenic mechanisms adopted by the fish and their gametes, we analyzed 67 pachytene spreads obtained from two *C. elongatoides* sperm lacking males in the DrTd group. We observed abnormal pairing with several bivalents and univalents (Figure 4D) and compared these with controls from 2n and F1 3n males (Figure 4E and F, respectively). We did not observe any cells with duplicated genomes. We additionally checked another six males from the same group; however, we did observe cells with 25 bivalents during pachytene, suggesting no success in transplantation. In females from the DrTd group, we did observe oocytes not only with improper pairing (Figure 4G) but also with duplicated genomes as 73 bivalents indicating the occurrence of PMER in chimeric fish during gametogenesis (Figure 4H). Figure 4I shows pachytene chromosomes from the 2n female controls. We did not find mispaired chromosomes in cells that underwent PMER. From four chimeric triploid females in the DdTr group, we successfully observed diplotene chromosomes with 25 bivalents (Figure 4J), and for one female, we additionally managed to obtain chromosomes during both the pachytene and diplotene (4K) stages. In total, we examined 61 oocytes that included 25 bivalents of *C. elongatoides*. This suggests successful transplantation followed by the normal formation of haploid gametes of *C. elongatoides*. Triploid control fish can be seen in Figure 4L with 73 bivalents.

Discussion

Although asexual organisms are important models for many biological disciplines, the mechanisms triggering clonal reproduction of gametes remain generally unclear. To test whether

stimuli for asexual development are intrinsic to differentiating germ cells or depend on their gonadal environment, we performed reciprocal transplantation of spermatogonial cells between triploid hybrids (*C. elongatoides-taenia-taenia*) and one of their parental sexual species (*C. elongatoides*). To sterilize the recipients' gonads, we used MO antisense RNA, which is a routinely applied procedure in many cell transplantation experiments. This was quite challenging when used in hybrids and allopolyploids because of the need to successfully target all gene copies coming from diverged parental subgenomes in a hybrid [36]. Nevertheless, although *Cobitis* hybrids combine genomes that diverged as long as ~9 Mya [20], we achieved a reasonable rate of successful sterilization ranging between 65 and 100%, which is comparable to other studies [37, 38] and indicated that our MO design based on one parental genome is sufficient to target all orthologous alleles in such situations.

After their successful transplantation, we recognized that male germ stem cells from male donors, either *C. elongatoides* or the triploid hybrid, transdifferentiated into oogonia when transplanted into female recipients. This demonstrated that both types of male germ stem cells were sensitive to the gonadal environment and their sexual differentiation is largely driven by the recipient's body. This observation is consistent with a hypothesis that fish germ stem cells are sexually plastic (so-called sexually bipotent) and after transplantation, they may transdifferentiate into both oocytes and spermatogonia, respectively, depending on the particular gonadal environment they occur in [39–42]. By contrast, we found no effect of the recipient's gonadal environment on the ability or inability of transplanted germ cells to undergo clonal development. In particular, *C. elongatoides* male stem germ cells transplanted into ETT female recipients consistently developed into reduced oocytes that gave rise to recombining pure-bred progeny, whereas triploid male stem germ cells demonstrated the ability of PMER when transplanted into *C. elongatoides* females and produced purely clonal progeny, or tetraploid progeny with clonally transmitted maternal genome and incorporated sperm. This suggests that ability to undergo PMER is inherent

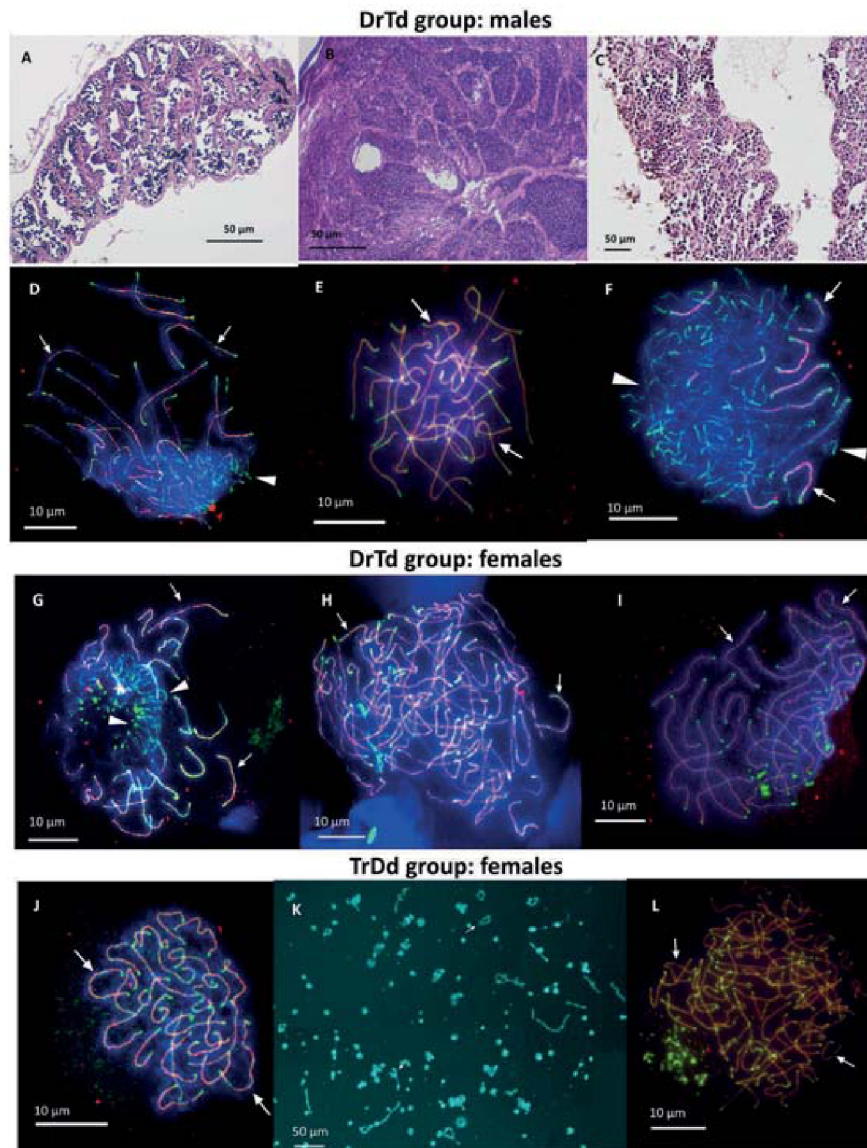

Figure 4. Results of histology and pachytene analysis from a diploid recipient with a triploid donor (DrTd, figures A–I), and a triploid recipient with a diploid donor (TrDd, figures J–L). A–C shows comparisons of histology of diploid chimeric fish (A) with a diploid control (B) and a triploid control (C). Diploid chimeric male (D) had an improper pairing during the pachytene stage leading to many univalents, whereas the diploid control (E) shows 25 bivalents in proper pairing. The triploid male control (F) also had improper pairing, which is like the diploid chimeric fish. Pachytene analysis of the female in the DrTd group shows a phenomenon typical of triploid females described by Dedukh et al. [9, 35], i.e., either improper pairing (G) or properly paired 73 bivalents as result of PMER (H). The diploid female control (I) shows 25 bivalents. (J) and (K) show the pachytene and diplotene chromosome analysis of triploid fish from the TrDd group, respectively, in triploid fish from the TrDd group, while triploid control fish possess 73 bivalents (L). SCs were immunolabeled with antibodies against SYCP3 protein (green) and SYCP1 protein (red); chromosomes are stained with DAPI (blue). Synapsed chromosomes show both SYCP3 and SYCP1 (localization indicated by white arrows), whereas asynapsed chromosomes exhibit only SYCP3 staining (white arrowheads). In microphotograph (K), diplotene chromosomes are stained with DAPI (cyan).

to the hybrid constitution of the asexual gonial cells rather than being affected by their gonadal environment.

Our data also provided interesting insight into asymmetrical reproduction patterns of hybrids with respect to sex, since the hybrids' spermatogonia transplanted into *C. elongatoides* males apparently didn't express the ability of PMER and arrested their development in metaphase I due to abnormal pairing of orthologous chromosomes. This result is in exact agreement with previous analyses of natural and experimental

ET and ETT hybrids [9, 35], which reported that PMER is confined to hybrid females and occurs already in the F1 generation, whereas all hybrid males are sterile with spermatogonia arrested at metaphase I [9, 28, 32, 43]. How and why should the sex affect the initiation of PMER remains unclear, however. Our data demonstrated that gonial cells originating from male-determined juveniles are able to undergo PMER and develop into clonal progeny when transplanted into the ovary where they transdifferentiate into oogonia. This implies that

in *Cobitis* hybrids, the ability of PMER reflects the phenotypic sex of gonads and does not necessarily depend on genetic sex determination. By contrast, investigation of hybrids from the related genus *Misgurnus*, Yoshikawa et al. [30, 44] demonstrated that female hybrids that were sex-reversed into males maintained the ability to produce unreduced fertile sperm via PMER, whereas natural hybrid males remained sterile [11]. This would suggest that the cell's capability of PMER may depend on genetic sex determination even when developing into male phenotypes.

The apparent discrepancy between our and Yoshikawa et al. study [30] may be due to several reasons. First, asexual hybrids in both genera evolved independently from different parental species and hence the particular type of cell deregulation leading to PMER may be different. Second, there are to date no robust data on genetic sex determination in Cobitidae, albeit male heterogamy (X1X2Y and XO, respectively) has been indicated in two species of the family [45, 46]. Hence, the type of sex determination may vary between both *Cobitis* and *Misgurnus* genera. Finally, Yoshikawa et al. [30] investigated the development of female-originated gonial cells in phenotypic males, whereas we explored the fate of male-originated gonial cells transplanted into recipients of both sexes. It is thus theoretically possible that hybrid primordial germ cells genetically determined as females maintain their capability of PMER even when turned into spermatogonia (as in Yoshikawa et al. [30]), whereas primordial germ cells genetically determined as males gain such a capability only when turned into female phenotypes and produce sterile gametes when maintaining their original sex (as in present study).

Either way, our findings, together with previously gathered information about germ cell development in fishes, and in Cobitidae in particular, lead us to propose the following hypothesis related to the triggering of asexuality: the capability of clonal gametogenesis (at least the one based on PMER) is rather independent of the gonadal environment and appears triggered by intrinsic stimuli within asexual gonial cells, which is causally linked to the hybrid constitution of their genomes. Nonetheless, the very execution of PMER appears to be primarily bound to an oogonial developmental pathway. It is at this level when the gonadal environment affects development and asexuality, since primordial germ cells are sexually bipotent and their differentiation into oogonia is decisively affected by the environment in which they occur. Once the developmental pathway into male or female germlines is decided, the hybrid's gonial cells develop into sterile spermatocytes, whereas the testes or fertile oocytes are capable of PMER while in the ovary. This hypothesis implies two sets of crucial questions for future research in asexual organisms: (1) how does the hybridization per se trigger PMER? and (2) why is it usually linked to one sex in hybrids? With currently available knowledge, we may so far offer only speculative answers.

First, PMER occurs already in F1 generations [9, 28, 35], and hence, it is unlikely that this trait evolves by accumulated mutations during evolution of hybrid populations. Instead, it is more likely that the execution of PMER is based on developmental programs that have already existed in cells of sexual progenitors of hybrid asexuals but are just triggered by the hybrid nature of the gamete. Possibly, the initiation of PMER is driven by accumulated incompatibilities between genomes brought together by hybridization, which fail to properly regulate gametic development and cell division leading to aberrant chromosome duplications [5, 6, 20]. For instance, the

very nature of PMER, i.e., multiplication of the genome without cell division, makes it at least superficially analogous to endopolyploidy, which is a common mechanism how various organisms, including fishes, modify the genomic content of specific cell types or tissues. Cellular mechanisms ensuring the alternation of S and G phases are relatively conserved among various animal lineages [47], suggesting that cells of most organisms are capable of endopolyploidy under the proper regulatory stimulus [48]. Extrapolating Carman's model [8] of asexuality, it is possible that PMER occurs in hybrid lineages when a particular type of misregulation between admixed parental subgenomes generates endopolyploidy specifically in gonial tissue, leading to stabilization of clonal lineage. The situation may be quite complex, however, and the result may crucially depend on other traits than hybridization, e.g., the hybrid's ploidy affecting the stoichiometric ratio of orthologous alleles and their products. For instance, in *Poeciliopsis* spp. (mollies), diploid hybrids are hybridogenetic (i.e., clonally transmit only one parental genome and exclude the other's before meiosis), whereas triploid hybrids between the same parental species change the reproductive mode to gynogenesis and clonality [49]. Similarly, diploid hybrid *Misgurnus* spp. reproduce gynogenetically via PMER, whereas tetraploid hybrids between the same parental species produce reduced gametes [32].

The second question may have a lot in common to fundamental differences between male and female types of gametogenesis. Such differences may translate into the timing of DNA methylation in male and female gametogenesis [50, 51]. There is also evidence for differences in patterns of epigenetic regulation between SSCs and derived oocytes from SSCs [52], which suggest an artificial epigenetic restart of our transplanted SSCs. It may thus be proposed that in the hybrid's spermatogonia transplanted into female recipients, the cell-cell communication between female somatic cells and transplanted SSCs has led to the establishment of gonadal tissue according to the recipient's sex determination [53], thus epigenetic reprogramming to female-like patterns and ultimate awakening of PMER. In that scenario, the SSCs transplanted into male recipients would not undergo such a process. They would thus not gain the ability of PMER.

The present findings demonstrated that the investigation of gametic development is likely to provide crucial insights in understanding asexual reproduction and the establishment of interspecific reproductive barriers in the speciation process. Namely, this study indicated that ability to perform asexual gametogenesis via PMER is causally linked to hybrid composition of gonial cells and is triggered by factors intrinsic to these cells and developmental programs inherited from parental species. On the other hand, it also appears that the execution of PMER is exclusive to the female germline, whose determination apparently depends on cell-cell communication with surrounding gonadal tissue. Thus, even in hybrid females, whose fertility is restored by PMER, the sex-specific factors of surrounding somatic tissue that control gametic development contribute to the postzygotic barrier, since PMER prevents the hybrid's effective backcrossing to parental species.

Materials and methods

Experimental protocol was approved by Ministry of Agriculture of the Czech Republic (reference number: 55187/2016-MZE-17214).

Sterilization by dead end antisense oligonucleotide
MO oligonucleotide was designed based on the *dnd* gene sequence of *Misgurnus anguillicaudatus* (AB531494.1). The *dnd* gene sequence of *C. taenia* obtained from DDBJ/EMBL/GenBank transcriptome (GGJF00000000.1) was aligned against AB531494.1 by muscle software v.3.8.1551 to validate specificity to the *Cobitis* genus. Alignment with the highlighted MO target and phylogenetic maximum likelihood tree was performed with iqtree, 1.6.10 [54] and approximate Bayes test [55]. MFP + MERGE model selection was based on the *dnd* gene of *M. anguillicaudatus* (AB531494.1), *Danio rerio* (AY225448.1), *Carrasius auratus* (JN578697.1:44-1140), *Gobiocypris rarus* (KM044011.1), *Paedocypris progenetica* (KY828447.1), *Sinocyclocheilus rhinoceros* (XM_016576295.1), and *Rhodeus ocellatus* (MG995743.1). SNPs were checked at probe position for any interspecific variability. MO oligonucleotide was synthesized by Gene Tools, LLC (Philomath, Oregon, USA). The final *dnd*-MO sequence was 5'-GATCTGCTCCTTC CATTGCGTTTGC-3'.

The final solution for sterility induction was composed of 100 μ M of MO and 300 ng/ μ l of mRNA in combination with GFP and zebrafish (*D. rerio*) nos1 3'UTR and diluted in 0.2 M KCl [56]. The control group solution received only 300 ng/ μ l of mRNA diluted in 0.2 M KCl. Solutions were loaded into a microcapillary mounted on a micromanipulator (M-152 Narishige, Japan) with an automatic microinjector (FemtoJet Eppendorf, Germany). Each embryo was injected into a blastodisc at the 1- to 4-cell stage. Altogether, 50 embryos were injected in each group.

Histology analysis

Either whole body segments or gonadal tissue were fixed overnight in Bouin's fixative. Specimens were immersed in 70% ethanol, dehydrated and cleared in an ethanol-xylene series, embedded into paraffin blocks, and cut transversally into 4- μ m-thick sections using a rotary microtome (Leica RM2235; Wetzlar, Germany). Paraffin slides were stained with hematoxylin and eosin by using a staining machine (Tissue-Tek DRS 2000; Sakura Finetek USA, Inc., Torrance, California) according to standard procedures. Histological sections were photographed using a microscope (Nikon Eclipse Ci; Tokyo, Japan) with a mounted camera (Canon EOS 1000D; Ōta, Tokyo, Japan). In the case of MO treated fish, the sex identification was based on Fujimoto *et al.* [37] and Goto *et al.* [57].

Induction of germline chimeras and donor-derived gametes production

Five diploids *C. elongatoides* and two triploids *C. elongatoides-taenia-taenia* donor male specimens were over anesthetized in tricaine solution (MS222), disinfected with 70% ethanol, and decapitated. The body cavity was carefully opened, and the gonads were removed and placed in ice-cold phosphate-buffered saline (PBS). Testes were cut into smaller fragments to allow leakage of the sperm and serially washed in PBS. Gonad fragments were transferred into 15 ml tubes and well chopped with scissors. Gonadal tissue was enzymatically digested in 5 ml of PBS with 0.15% trypsin with a laboratory shaker at room temperature for 1.5 h. DNase I (Sigma Aldrich 10104159001; Merck, Burlington, MA, USA) (aliquoted to 5% stock solution in RNase free water) was added continuously when clumping was observed. Afterward,

digestion was terminated by the addition of 5 ml L15 with 20% fetal bovine serum, filtrated through 30- μ m filters, and centrifuged at 400 g for 10 min. The supernatant was removed, and the pellet was carefully resuspended. The cell suspension was loaded into a pulled glass microcapillary mounted on a micromanipulator with a pneumatic injector.

Sterilized recipients were anesthetized in 0.05% tricaine solution, placed on an agar coated Petri dish and cells were injected into the coelomic cavity. Recipients were transferred into fresh water to recover. Germline chimeras were cultured at room temperature in aquaria with controlled cooling and water filtration and fed *ad libitum* with brine shrimps (*Artemia* sp.), bloodworms (*Tubifex* sp.), and a dry diet. Two groups of chimeras were made: 1) diploid recipient and triploid male donor (DrTd) and 2) triploid recipient and diploid male donor (TrDd).

Spawning

Potential chimeric fish (either *C. elongatoides* recipient with triploid's transplant, or triploid recipients with *C. elongatoides* transplant) as well as controls (*C. elongatoides*) were reared in standardized conditions and 6 months prior to spawning, water temperature was slowly decreased (-2°C per day) to 14°C and kept at this level for 3 months. In the following 3 months, water temperature was increased ($+2^{\circ}\text{C}$ per day) to final temperature of 22°C and kept till spawning with increased bloodworm feeding. Transplanted fish were exactly 2 years old at the time of spawning. Transplanted fish (Supplementary Data 1) together with control fish (*C. elongatoides*) were injected twice (24 and 12 h prior to spawning) with Ovopel (Interfish Kf, Budapest, Hungary). A solution for the first injection was made from one Ovopel pill per 20 ml of 0.9% NaCl. The solution for the second injection was made from one Ovopel pill per 5 ml of 0.9% NaCl. In both cases, the volume of the Ovopel solution directly injected into a fish body was 0.05 ml per 10 g of fish weight. Eggs were carefully removed from spined loaches and put in a dried Petri dish (Supplementary Data 1). Sperm were added to the eggs together with fresh water. The number of fish in each group was as follows: 14 fish in the DrTd group (six females, eight males), eight fish in TrDd (eight females, zero males), and six males and four females of *C. elongatoides* as controls.

Identification of germline chimeras

In this study, we used parental species *C. elongatoides* (EE—composition of genomes) and triploid hybrids between *C. elongatoides* and *C. taenia* (ETT). Diploid parental species produce haploid gametes, whereas hybrids produce oocytes that contain both genomes; therefore, presence/absence of *C. taenia* (TT) species in offspring can prove the success of transplantation. Successfully transplanted 2n EE fish will produce ETT eggs, whereas 3n ETT fish will produce haploid eggs with genome E. Indication of five specific loci Cota068, Cota111, Cota010, Cota093, Cota032 of *C. taenia* [58] in offspring from parental species of EE means that diploid fish possess hybrid gonads. On the other hand, triploid fish ETT producing haploid eggs represent the occurrence of diploid gonads in triploid fish. To support our results, we also used flow cytometry analysis and meiosis analysis on both parental species and offspring.

DNA extraction and analysis of microsatellites

Whole genomic DNA from individuals tested (*C. elongatoides* and *C. elongatoides-taenia-taenia*) were extracted from a dorsal fin in adults or part of larvae using a commercial Tissue DNA Isolation Kit (Geneaid Biotech, Taipei, Taiwan) following the manufacturer's protocol. Genotype determination in the fishes was performed by analyses of selected microsatellite species specific loci [28, 58]. Fragment-length analyses were performed on an ABI 3730 Avant capillary sequencer (Applied Biosystems, Foster City, CA, USA) with an internal size standard (GeneScan-500 LIZ, Thermo Fisher Scientific, Waltham, MA, USA); the alleles were scored manually with GeneMapper v. 3.7 (Applied Biosystems, Zug, Switzerland).

Flow cytometry analysis

The level of ploidy was determined as the relative DNA content of fin clip cells via flow cytometry (Partec CCA I; Partec GmbH, Munster, Germany with a UV mercury lamp for excitation and an emission level of 435/500 nm) using standard CyStain[®] DNA 1-step solution (Sysmex CZ s.r.o., Brno, Czech Republic) containing 49.6-diamidino-2-phenylindol (DAPI). As a reference standard, we used a fin clip of diploid *C. elongatoides*.

Pachytene chromosomes with immunofluorescent staining

Pachytene chromosomes were obtained from males and females according to protocols described by Moens [59] and Araya-Jaime *et al.* [60]. Ovaries were homogenized manually in 1× PBS solution. Afterward, 20 μl of cells suspension was put on SuperFrost[®] slides (Menzel Gläser; Thermo Fisher Scientific) followed by addition of 40 μl of 0.2 M sucrose and 40 μl of 0.2% Triton ×100 for 7 min. The samples were fixed for 16 min by adding 400 μl of 2% PFA. Testes were homogenized manually followed by dropping 1 μl of suspension into 30 μl of hypotonic solution (1/3 of 1× PBS) and then dropped onto SuperFrost[®] slides (Menzel Gläser; Thermo Fisher Scientific). The samples were fixed in 400 μl of 2% PFA for 4 min. After fixation, slides with the pachytene samples from males and females were air dried and washed in 1× PBS.

Slides were stored until immunofluorescent staining of synaptonemal complexes (SC). Lateral components of SCs were visualized by rabbit polyclonal antibodies (ab14206, Abcam) against SYCP3 protein, whereas the central component of SCs was detected by chicken polyclonal antibodies against SYCP1 protein (a gift from Sean M. Burgess). Fresh slides were incubating with 1% blocking reagent (Roche) in 1× PBS and 0.01% Tween-20 for 20 min followed by the addition of primary antibody for 1 h at room temperature. Slides were washed 3 times in 1× PBS at RT and incubated in the combination with secondary antibodies Alexa 488-conjugated goat anti-rabbit IgG (H+L) (Molecular Probes) and Alexa-594-conjugated goat anti-chicken IgG (H+L) (Molecular Probes) for 1 h at RT. Slides were washed in 1× PBS and mounted in Vectashield/DAPI (1.5 mg/ml) (Vector, Burlingame, CA, USA).

Diplotene chromosomal samples (also known as “lampbrush chromosomes”) were prepared from parental and hybrid females according to an earlier published protocol [61]. Vitellogenetic oocytes of 0.5–1.5 mm in diameter were taken from females in the OR2 saline [82.5 mM NaCl, 2.5 mM

KCl, 1 mM MgCl₂, 1 mM CaCl₂, 1 mM Na₂HPO₄, 5 mM HEPES (4-(2-hydroxyethyl)-1-piperazineethanesulfonic acid); pH 7.4]. Isolation of the oocytes' nuclei was performed manually in the isolation medium “5:1” (83 mM KCl, 17 mM NaCl, 6.5 mM Na₂HPO₄, 3.5 mM KH₂PO₄, 1 mM MgCl₂, 1 mM DTT (dithiothreitol); pH 7.0–7.2) using jeweler forceps (Dumont, Switzerland). Nuclear envelopes were manually removed in a quarter strength “5:1” medium with the addition of 0.1% paraformaldehyde and 0.01% 1 M MgCl₂ in glass chambers attached to a slide. After this procedure, we obtained chromosome samples from individual oocytes in each chamber. Slides with oocyte nuclei contents were subsequently centrifuged for 20 min at +4°C, 4000 rpm, fixed for 30 min in 2% paraformaldehyde in 1× PBS, and post-fixed in 70% ethanol overnight (at +4°C).

Pachytene and diplotene chromosomes were investigated using a Provis AX70 Olympus microscope with standard fluorescence filter sets. Microphotographs were captured by CCD camera (DP30W Olympus; Tokyo, Japan). Olympus Acquisition Software was used for capturing the images followed by their adjustment and arrangement in Adobe Photoshop, CS6 software.

Supplementary material

Supplementary material is available at *BIOLRE* online.

Data availability

Data available on request.

Author contributions

T.T. performed experiment management, fish care, spawning, sampling, results interpretation, and draft preparation. R.F. performed MO injection, transplantation, and spawning. M.D.K. performed and analyzed microsatellites data. D.D. and A.M. performed meiotic investigations. K.H. was responsible for fish collection, identification, and ploidy measurement. C.S. performed histology. K.J. and M.P. conceived the study, participated on crossing experiments and analysis of progeny, and co-drafted the manuscript with T.T.

Acknowledgments

Prof. Sean M. Burgess for sharing primary antibodies against SYCP1.

Conflict of interest

The authors have declared that no conflict of interest exists.

References

1. Laskowski KL, Doran C, Bierbach D, Krause J, Wolf M. Naturally clonal vertebrates are an untapped resource in ecology and evolution research. *Nat Ecol Evol* 2019; 3:161–169.
2. Pike N, Kingcombe R. Antibiotic treatment leads to the elimination of *Wolbachia* endosymbionts and sterility in the diploid collembolan *Folsomia candida*. *BMC Biol* 2009; 7:54.
3. Catanach AS, Erasmuson SK, Podivinsky E, Jordan BR, Bicknell R. Deletion mapping of genetic regions associated with apomixis in *Hieracium*. *Proc Natl Acad Sci* 2006; 103:18650–18655.
4. Noyes RD, Baker R, Mai B. Mendelian segregation for two-factor apomixis in *Erigeron annuus* (Asteraceae). *Heredity* 2007; 98: 92–98.

5. Moritz C, Brown W, Densmore L 3rd, Wright J, Vyas D, Donnellan S, Adams M, Baverstock P. Genetic diversity and the dynamics of hybrid parthenogenesis in Cnemidophorus (Teiidae) and Heteronotia (Gekkonidae). *Evol Ecol Unisexual Vertebr* 1989; **466**: 87–112.
6. Wetherington JD, Kotora KE, Vrijenhoek RC. A test of the spontaneous heterosis hypothesis for unisexual vertebrates. *Evol Int J Org Evol* 1987; **41**:721–731.
7. De Storme N, Mason A. Plant speciation through chromosome instability and ploidy change: cellular mechanisms, molecular factors and evolutionary relevance. *Curr Plant Biol* 2014; **1**:10–33.
8. Carman JG. Asynchronous expression of duplicate genes in angiosperms may cause apomixis, bispority, tetraspority, and polyembryony. *Biol J Linn Soc* 1997; **61**:51–94.
9. Dedukh D, Majtánová Z, Marta A, Pšenička M, Katusz J, Klíma J, Juchno D, Boron A, Janko K. Parthenogenesis as a solution to hybrid sterility: the mechanistic basis of meiotic distortions in clonal and sterile hybrids. *Genetics* 2020; **215**:975–987.
10. Itono M, Morishima K, Fujimoto T, Bando E, Yamaha E, Arai K. Premeiotic endomitosis produces diploid eggs in the natural clone loach, *Misgurnus anguillicaudatus* (Teleostei: Cobitidae). *J Exp Zool A Comp Exp Biol* 2006; **305A**:513–523.
11. Kuroda M, Fujimoto T, Murakami M, Yamaha E, Arai K. Aberrant meiotic configurations cause sterility in clone-origin triploid and inter-group hybrid males of the Dojo Loach, *Misgurnus anguillicaudatus*. *Cytogenet Genome Res* 2019; **158**:46–54.
12. Lutes AA, Neaves WB, Baumann DP, Wiegand W, Baumann P. Sister chromosome pairing maintains heterozygosity in parthenogenetic lizards. *Nature* 2010; **464**:283–286.
13. Macgregor HC, Uzzell TM. Gynogenesis in salamanders related to *Ambystoma jeffersonianum*. *Science* 1964; **143**:1043–1045.
14. Mason AS, Pires JC. Unreduced gametes: meiotic mishap or evolutionary mechanism? *Trends Genet* 2015; **31**:5–10.
15. Stenberg P, Saura A. Meiosis and its deviations in polyploid animals. *Cytogenet Genome Res* 2013; **140**:185–203.
16. Stöck M, Ustinova J, Betto-Colliard C, Scharl M, Moritz C, Perrin N. Simultaneous Mendelian and clonal genome transmission in a sexually reproducing, all-triploid vertebrate. *Proc R Soc B Biol Sci* 2012; **279**:1293–1299.
17. Kuroda M, Fujimoto T, Murakami M, Yamaha E, Arai K. Clonal reproduction assured by sister chromosome pairing in dojo loach, a teleost fish. *Chromosome Res* 2018; **26**:243–253.
18. Janko K, Katusz J, De Gelas K, Šlechtová V, Opoldusová Z, Drozd P, Choleva L, Popiolek M, Baláž M. Dynamic formation of asexual diploid and polyploid lineages: multilocus analysis of cobitis reveals the mechanisms maintaining the diversity of clones. *PLoS One* 2012; **7**:e45384.
19. Juchno D, Jablůnska O, Boron A, Kujawa R, Leska A, Grabowska A, Nynca A, Swigońska S, Król M, Spóz A, Laskowska N, Lao M. Ploidy-dependent survival of progeny arising from crosses between natural allotriploid Cobitis females and diploid *C. taenia* males (Pisces, Cobitidae). *Genetica* 2014; **142**:351–359.
20. Janko K, Pačes J, Wilkinson-Herbots H, Costa RJ, Roslein J, Drozd P, Iakovenko N, Rídl J, Hroudová M, Kočí J, Reifová R, Šlechtová V et al. Hybrid asexuality as a primary postzygotic barrier between nascent species: on the interconnection between asexuality, hybridization and speciation. *Mol Ecol* 2018; **27**:248–263.
21. Stöck M, Dedukh D, Reifová R, Lamatsch DK, Starostová Z, Janko K. Sex chromosomes in meiotic, hemiclinal, clonal and polyploid hybrid vertebrates: along the 'extended speciation continuum'. *Philos Trans R Soc B* 2021; **376**:20200103.
22. Lamatsch D, Stöck M. Sperm-dependent parthenogenesis and hybridogenesis in teleost fishes. In: Schön I, Martens K, Dijk P (eds.), *Lost Sex: The Evolutionary Biology of Parthenogenesis*. Dordrecht: Springer Netherlands; 2009: 399–432.
23. Vrijenhoek RC. UNISEXUAL FISH: model systems for studying ecology and evolution. *Annu Rev Ecol Syst* 1994; **25**:71–96.
24. Spangenberg V, Arakelyan M, Galoyan E, Matveevsky S, Petrosyan R, Bogdanov Y, Danielyan F, Kolomiets O. Reticulate evolution of the rock lizards: meiotic chromosome dynamics and spermatogenesis in diploid and triploid males of the genus *Darevskia*. *Genes* 2017; **8**:149.
25. Doležalková-Kaštánková M, Mazepa G, Jeffries DL, Perrin N, Plötner M, Plötner J, Guex G-D, Mikulíček P, Poustka AJ, Grau J, Choleva L. Capture and return of sexual genomes by hybridogenetic frogs provides clonal genome enrichment in a sexual species. *Sci Rep* 2021; **11**:1633.
26. Sousa-Santos C, Collares-Pereira MJ, Almada V. Fertile triploid males: an uncommon case among hybrid vertebrates. *J Exp Zool Part Ecol Genet Physiol* 2007; **307**:220–225.
27. Schultz RJ. Gynogenesis and triploidy in the viviparous fish *Poeciliopsis*. *Science* 1967; **157**:1564–1567.
28. Choleva L, Janko K, De Gelas K, Bohlen J, Šlechtová V, Rábová M, Ráb P. Synthesis of clonality and polyploidy in vertebrate animals by hybridization between two sexual species. *Evolution* 2012; **66**: 2191–2203.
29. Cole CJ, Taylor HL, Neaves WB, Baumann DP, Newton A, Schnitker R, Baumann P. The second known tetraploid species of parthenogenetic tetrapod (Reptilia: Squamata: Teiidae): description, reproduction, comparisons with ancestral taxa, and origins of multiple clones. *Bull Mus Comp Zool* 2017; **161**:285–321.
30. Yoshikawa H, Morishima K, Fujimoto T, Saito T, Kobayashi T, Yamaha E, Arai K. Chromosome doubling in early spermatogonia produces diploid spermatozoa in a natural clonal fish. *Biol Reprod* 2009; **80**:973–979.
31. Wang J, Liu Q, Luo K, Chen X, Xiao J, Zhang C, Tao M, Zhao R, Liu S. Cell fusion as the formation mechanism of unreduced gametes in the gynogenetic diploid hybrid fish. *Sci Rep* 2016; **6**:31658.
32. Morishima K, Yoshikawa H, Arai K. Diploid clone produces unreduced diploid gametes but tetraploid clone generates reduced diploid gametes in the *Misgurnus Loach*1. *Biol Reprod* 2012; **86**:33.
33. Janko K, Kotlík P, Ráb P. Evolutionary history of asexual hybrid loaches (Cobitis: Teleostei) inferred from phylogenetic analysis of mitochondrial DNA variation. *J Evol Biol* 2003; **16**:1280–1287.
34. Janko K, Bohlen J, Lamatsch D, Flajshans M, Epplen JT, Ráb P, Kotlík P, Šlechtová V. The gynogenetic reproduction of diploid and triploid hybrid spined loaches (Cobitis: Teleostei), and their ability to establish successful clonal lineages—on the evolution of polyploidy in asexual vertebrates. *Genetica* 2007; **131**:185–194.
35. Dedukh D, Marta A, Janko K. Challenges and costs of asexuality: variation in premeiotic genome duplication in gynogenetic hybrids from *Cobitis taenia* complex. *Int J Mol Sci* 2021; **22**:12117.
36. Wang F, Shi Z, Cui Y, Guo X, Shi Y-B, Chen Y. Targeted gene disruption in *Xenopus laevis* using CRISPR/Cas9. *Cell Biosci* 2015; **5**:15.
37. Fujimoto T, Nishimura T, Goto-Kazeto R, Kawakami Y, Yamaha E, Arai K. Sexual dimorphism of gonadal structure and gene expression in germ cell-deficient loach, a teleost fish. *Proc Natl Acad Sci* 2010; **107**:17211–17216.
38. Linhartová Z, Saito T, Kašpar V, Rodina M, Prášková E, Hagihara S, Pšenička M. Sterilization of sterlet *Acipenser ruthenus* by using knockdown agent, antisense morpholino oligonucleotide, against dead end gene. *Theriogenology* 2015; **84**:1246–1255.e1.
39. Franěk R, Kašpar V, Shah MA, Gela D, Pšenička M. Production of common carp donor-derived offspring from goldfish surrogate broodstock. *Aquaculture* 2021; **534**:736252.
40. Franěk R, Marinović Z, Lujčić J, Urbányi B, Fučíková M, Kašpar V, Pšenička M, Horváth Á. Cryopreservation and transplantation of common carp spermatogonia. *PLoS One* 2019; **14**:e0205481.
41. Morishima K, Oshima K, Horie S, Fujimoto T, Yamaha E, Arai K. Clonal diploid sperm of the diploid-triploid mosaic loach, *Misgurnus anguillicaudatus* (Teleostei: Cobitidae). *J Exp Zool A Comp Exp Biol* 2004; **301A**:502–511.
42. Nóbrega RH, Greebe CD, van de Kant H, Bogerd J, de França LR, Schulz RW. Spermatogonial stem cell niche and spermatogonial stem cell transplantation in zebrafish. *PLoS One* 2010; **5**:e12808.

43. Janko K, Flajšhans M, Choleva L, Bohlen J, Šlechtová V, Rábová M, Lajbner Z, Šlechta V, Ivanova P, Dobrovolov I, Culling M, Persat H *et al.* Diversity of European spined loaches (genus *Cobitis* L.): an update of the geographic distribution of the *Cobitis taenia* hybrid complex with a description of new molecular tools for species and hybrid determination. *J Fish Biol* 2007; 71:387–408.
44. Yoshikawa H, Morishima K, Kusuda S, Yamaha E, Arai K. Diploid sperm produced by artificially sex-reversed Clone loaches. *J Exp Zool* 2007; 307A:75–83.
45. Saitoh K. Multiple sex-chromosome system in a loach fish. *Cytogenet Cell Genet* 1989; 52:62–64.
46. Vasil'eva ED, Vasil'ev VP. Sibling species in genus *Cobitis* (Cobitidae). *Cobitis rossomeridionalis* sp. nova. *J Ichthyol* 1998; 38:580–590.
47. Edgar BA, Orr-Weaver TL. Endoreplication cell cycles: more for less. *Cell* 2001; 105:297–306.
48. Neiman M, Beaton MJ, Hessen DO, Jeyasingh PD, Weider LJ. Endopolyploidy as a potential driver of animal ecology and evolution. *Biol Rev Camb Philos Soc* 2017; 92:234–247.
49. Cimino MC. Meiosis in triploid all-female fish (Poeciliopsis, Poeciliidae). *Science* 1972; 175:1484–1486.
50. Labbé C, Robles V, Herraez MP. Epigenetics in fish gametes and early embryo. *Aquaculture* 2017; 472:93–106.
51. Sun Y-C, Wang Y-Y, Ge W, Cheng S-F, Dyce PW, Shen W. Epigenetic regulation during the differentiation of stem cells to germ cells. *Oncotarget* 2017; 8:57836–57844.
52. Wang L, Cao J, Ji P, Zhang D, Ma L, Dym M, Yu Z, Feng L. Oocyte-like cells induced from mouse spermatogonial stem cells. *Cell Biosci* 2012; 2:27.
53. Windley SP, Wilhelm D. Signaling pathways involved in mammalian sex determination and gonad development. *Sex Dev* 2015; 9:297–315.
54. Nguyen L-T, Schmidt HA, von Haeseler A, Minh BQ. IQ-TREE: a fast and effective stochastic algorithm for estimating maximum-likelihood phylogenies. *Mol Biol Evol* 2015; 32:268–274.
55. Anisimova M, Gil M, Dufayard J-F, Dessimoz C, Gascuel O. Survey of branch support methods demonstrates accuracy, power, and robustness of fast likelihood-based approximation schemes. *Syst Biol* 2011; 60:685–699.
56. Saito T, Fujimoto T, Maegawa S, Inoue K, Tanaka M, Arai K, Yamaha E. Visualization of primordial germ cells in vivo using GFP-nos1 3'UTR mRNA. *Int J Dev Biol* 2006; 50:691–699.
57. Goto R, Saito T, Takeda T, Fujimoto T, Takagi M, Arai K, Yamaha E. Germ cells are not the primary factor for sexual fate determination in goldfish. *Dev Biol* 2012; 370:98–109.
58. de Gelas K, Janko K, Volckaert FAM, de Charleroy D, van Houdt JKJ. Development of nine polymorphic microsatellite loci in the spined loach, *Cobitis taenia*, and cross-species amplification in the related species *C. elongatoides*, *C. taurica* and *C. tanaitica*. *Mol Ecol Resour* 2008; 8:1001–1003.
59. Moens PB. Zebrafish: chiasmata and interference. *Genome* 2006; 49:205–208.
60. Araya-Jaime C, Serrano ÉA, de Andrade Silva DMZ, Yamashita M, Iwai T, Oliveira C, Foresti F. Surface-spreading technique of meiotic cells and immunodetection of synaptonemal complex proteins in teleostean fishes. *Mol Cytogenet* 2015; 8:4.
61. Gall JG, Murphy C, Callan HG, Wu ZA. Lampbrush chromosomes. *Methods Cell Biol* 1991; 36:149–166.

CHAPTER 3

SPERMATOOA MORPHOLOGY AND REPRODUCTIVE POTENTIAL IN F1 HYBRIDS OF COMMON CARP (*Cyprinus carpio*) AND GIBEL CARP (*Carassius gibelio*)

Tichopád, T., Vetešník, L., Šimková, A., Rodina, M., Franěk, R., Pšenička, M., 2020. Spermatozoa morphology and reproductive potential in F1 hybrids of common carp (*Cyprinus carpio*) and gibel carp (*Carassius gibelio*). *Aquaculture* 521, 735092.

According to the general rules concerning copyright agreement between the authors and publisher, it is allowed to reuse the paper in Ph.D. theses of the authors (<https://www.elsevier.com/about/policies/copyright>).

My share on this work was about 60%.



Spermatozoa morphology and reproductive potential in F1 hybrids of common carp (*Cyprinus carpio*) and gibel carp (*Carassius gibelio*)



Tomáš Tichopád^{a,*}, Lukáš Vetešník^b, Andrea Šimková^c, Marek Rodina^a, Roman Franěk^a, Martin Pšenička^a

^a University of South Bohemia in Ceske Budejovice, Faculty of Fisheries and Protection of Waters, South Bohemian Research Center of Aquaculture and Biodiversity of Hydrocenoses, Zátisť 728/II, 389 25 Vodňany, Czech Republic

^b Institute of Vertebrate Biology, Academy of Sciences of the Czech Republic, v.v.i., Květná 8, 603 65 Brno, Czech Republic

^c Department of Botany and Zoology, Faculty of Science, Masaryk University, Kotlářská 2, 611 37 Brno, Czech Republic

ARTICLE INFO

Keywords:

Cyprinids
F1 generation
Fish sterility
Hybridization
Reproductive output

ABSTRACT

Sterility and semi-sterility often occur as a result of interspecific hybridization; however, the exact cause of sterility varies across the all animal kingdom; therefore, it is in the interest of scientists to examine every hybrid species separately. In the present study, the morphology of the spermatozoa of diploid F1 hybrids of *Cyprinus carpio* and *Carassius gibelio* was examined and compared with their parents. Hybrid spermatozoa showed great variability in head and flagellum lengths. These spermatozoa were diploid and triploid often with morphological abnormalities such as multiple flagella and nuclei. They were motile within two minutes after water activation which was almost two times longer than their parental species. We also analysed the reproductive output of F1 hybrids together with parental species in both parent positions via artificial spawning. Overall, the reproductive output of the hybrid × hybrid combination was the lowest; however, the hybrids were able to produce a small number of offspring documenting the viability of the F2 generation.

1. Introduction

Interspecific hybridization has been described as one of the genetical improvement methods in aquaculture with the aim to obtain advantageous heterosis effect, i.e. the phenotype superior to those of parental species. It has been reported that hybridization affects survival rate (Bakos, 1979; Wohlfarth, 1993), sex ratio (Wolters and DeMay, 1996; Yamazaki, 1983), growth rate (Bakos, 1979; Nwaduokwe, 1995), parasitic diseases (Dorson et al., 1991; Hines et al., 1974; Šimková et al., 2013), and environmental tolerance to lower temperatures or salinity (Scheerer and Thorgaard, 1983; Verdegem et al., 1997). Nonetheless, due to the unpredictable compatibility of two already divergent genetic regulatory networks (Davidson and Levin, 2005), it is difficult to predict the final phenotypes of artificial hybridization. The main factor limiting the viability or sterility of resulting hybrid progeny is the relative time when the two species underwent speciation from a common ancestor (Janko et al., 2019; Zhang et al., 2014). Besides aquaculture concerns, interspecific hybridization in fish has been shown to cause shifts to asexual or partially asexual reproductive modes such as parthenogenesis, gynogenesis or hybridogenesis (Janko et al., 2018). Alteration of the ploidy level and/or the occurrence of sterility

due to hybridization were also documented in several fish species (Hu et al., 2019; Piferer et al., 2009). Sterility often occurs after hybridization (Bartley et al., 2000); however, in the case of interspecific hybridization, the molecular background of sterility is dependent on various factors such as influence of meiotic drive or speciation genes, (Orr and Presgraves, 2000) which results in different causes of sterility in different organisms. Hybrids of marine fish blue drum (*Nibea mitsukurina*) and white croaker (*Pennahia argentata*) are sterile because of the mitotic arrest of primordial germ cells (Yoshikawa et al., 2018), but there are more reasonable causes of sterility such as the aberrant behaviour of homologous chromosomes during meiosis (Ponjarat et al., 2019; Shimizu et al., 1997). In some species, sterility also appeared to be sex dependent in accordance with Haldane's rule (Haldane, 1922) which says that a heterozygous sex (XY males or ZW females, depending on the type of sex determination) is more predisposed to sterility. Typical examples can be found in *Cobitis* sp., where hybrids *C. taenia* and *C. elongatoides* produce sterile males but asexual, fertile females (Choleva et al., 2012).

Hybrid sterility could serve generally as a prevention of gene transmission by germline into the next generations of wild populations and thus could protect them from genetical contamination (Fujimoto

* Corresponding author.

E-mail address: tichopad@frov.jcu.cz (T. Tichopád).

<https://doi.org/10.1016/j.aquaculture.2020.735092>

Received 19 November 2019; Received in revised form 5 February 2020; Accepted 7 February 2020

Available online 07 February 2020

0044-8486/ © 2020 Elsevier B.V. All rights reserved.

et al., 2008). Indeed, it is necessary to mention the exceptional potential of sterile hybrids for aquaculture as many concerns have been raised due to escapes of domesticated fish from fish farms into open waters with further genetic and ecological consequences on wild population (Wringe et al., 2018; McGinnity et al., 2003); therefore, the examination of the reproduction potential of hybrids in aquaculture is very important.

Common carp (*Cyprinus carpio*) is the oldest domesticated fish in the world (Balon, 2004), and thus the preservation and manipulation of genetic integrity are important factors in carp breeding and production (Vandeputte, 2003). The gibel carp (*Carassius gibelio*) is a fish that is extremely tolerant to environmental stress such as a low concentration of oxygen, eutrophication and high turbidity (Ruppert et al., 2017); furthermore, due to its extreme tolerance, it is considered as successful invasive fish (Lusková et al., 2010). In the wild, gibel carp and common carp naturally hybridize (Šimková et al., 2015; Šimková et al., 2013) producing the F1 generation of diploid males and females. Artificial backcrossing has also been performed, resulting in triploid hybrids, including sterile males and fertile females (Balashov et al., 2017). The identification of F1 hybrids of common carp and the species of *Carassius* using molecular markers is well established (Hänfling et al., 2005); however, the reproductive potential of diploid male hybrids of common carp and gibel carp in nature is not well documented.

One of the most reliable biomarkers for the quality assessment of spermatozoa is their motility (Alavi and Cosson, 2005; Gallego and Asturiano, 2018), which has a direct connection with fertilizing capability. Other considerably useful biomarkers are morphological and morphometric parameters of spermatozoa (Figueroa et al., 2016). Head length, midpiece length, and flagellum length have been considered the most important morphological parameters since they reflect the amount of genetic material, sperm movement and fertilization rate (Cosson, 2004). Besides classic biomarkers, genetic expression of selected genes can also provide information about sperm maturity (*hsps 8* gene), fertility (*bdnf* gene) or sperm physiology (*lepa* gene) (Figueroa et al., 2018). The aim of the present study was to analyse the morphological parameters, viability, motility and reproductive performance of spermatozoa of F1 hybrids and compare them with their parental species: *C. carpio* and *C. gibelio*.

2. Materials and methods

The study was conducted at the Institute of Vertebrate Biology, Academy of Sciences of the Czech Republic. The facility is authorized to perform experiments on animals (Act no. 246/1992 Coll., ref. number 16OZ21519/2016–17,214). Lukáš Vetešník owns the certificate (CZ 01292), giving him the capacity to conduct and manage experiments involving animals according to section 15d paragraph 3 of Act no. 246/1992 Coll.

2.1. Experimental fish

All adult specimens between three and five years old (five females of common carp, five males of common carp, five females of gibel carp, five males of gibel carp, six females of F1 hybrid and eight males of F1 hybrid) were collected while harvesting the Mlýnský fishpond (48°47'15"N, 16°49'21"E; Danube River Basin, the Czech Republic). The fish were separated into two tanks according to their sex and stimulated for ovulation/spermiation by means of conventional *i.m.* administration of carp pituitary (females received two doses, 0.3 and 2.7 mg/kg, 24 h and 12 h before propagation, respectively; males received 1 mg/kg 24 h before propagation) and by consequent increasing the water temperature to 22 °C (Kocour et al., 2005; Linhart et al., 2003). Sperm and oocytes were collected in accordance with Linhart et al. (2003). Eight diploid hybrid specimens, five gibel carp specimens and five common carp specimens were analysed for total numbers of sperm cells in 1 µl via a Bürker counting chamber with 20 squares (Fisher Scientific,

Table 1

Summary of the number of spermatozoa and GSI, presented as means with SD, in common carp, gibel carp and their F1 hybrids. Superscript letters indicate statistical significance (Dunn's test, $p < .05$).

Species	No. spermatozoa in 1 µl (± SD)	GSI% (± SD)
F1 hybrids	4.99e+03 (± 6.35e+03)	1.9 (± 0.7) ^a
Gibel carp	1.73e+07 (± 1.89e+06)	2.8 (± 0.2) ^{a,b}
Common carp	3.08e+07 (± 5.02e+06)	3.3 (± 0.2) ^b

Sweden). After measuring, the fish were killed and sampled, and gonadosomatic index (GSI) figures were calculated as the weight of the gonads divided by the weight of the whole fish body.

2.2. Sperm motility and velocity

To assess the percentage of sperm motility and velocity in µm/s, sperm was diluted in a drop of distilled water containing 0.1% of BSA (to avoid sperm stickiness on a glass slide). Sperm motility was analysed from video recordings taken at 25 frames per second with a CCD video camera (SONY DXC-970MD, Japan) mounted on a dark-field microscope with a magnification of 200× (NIKON Optiphot 2, Japan). The successive positions of the recorded sperm heads were measured from five successive video frames taken at 15, 30, 45, 60, 75, 120 s post activation using a video recorder (SONY SVHS, SVO-9500 MDP, Japan) and analysed with a micro image analyser (Olympus Micro Image 4.0.1. for Windows).

2.3. Electron microscopy

The sperm from five gibel carps, three common carps and four F1 hybrids were fixed with 2.5% glutaraldehyde in 0.1 M phosphate buffer (PB) for 24 h at 4 °C and washed three times in PB. The samples for scanning electron microscopy (SEM) examination were stuck on poly-L-lysine-coated glass slides, post-fixed with 4% osmium tetroxide for 2 h at 4 °C, washed three times in PB, dehydrated through an acetone series (30, 50, 70, 90, 95 and 100% acetone for 15 min), dried with a Pelco CPD 2 critical point dryer, coated with gold under vacuum with SEM coating unit E5100 (Polaron Equipment) and studied using a JSM 6300 scanning electron microscope (JEOL). The samples for transmission electron microscopy (TEM) were embedded into low melting temperature agar, dehydrated through the acetone series and embedded in resin (Polybed 812). A series of ultrathin sections were cut using a UCT ultramicrotome (Leica), double-stained with uranyl acetate and lead citrate and observed using a 1010 transmission electron microscope (JEOL).

2.4. Ploidy determination in sperm and offspring

The sperm and blood of the studied species (gibel carps, common carps and F1 hybrids) were subjected to relative DNA content determination. Fresh blood of diploid *Carassius auratus* was used as a reference standard. Ploidy level of the studied species was estimated based on sperm and blood samples mixed with 2 ml CyStain DNA 1 step staining solution (DAPI - 4', 6'-diamidino-2-phenylindol) and measured by means of flow cytometry (Partec CCA I; Partec GmbH, Münster, Germany). At least 2000 nuclei were analysed per sample using a 0.1 µl/s flow-through rate. The evaluations were done in duplicates.

2.5. Fertilization rate, hatching rate and offspring viability

Fertilization rate, hatching rate and offspring viability were assessed in the following nine parental combinations: 1) common carp pairs, 2) gibel carp pairs, 3) female common carp × male gibel carp pairs, 4) female gibel carp × male common carp pairs, 5) female common carp

Spermatozoa morphology and reproductive potential in F1 hybrids of common carp (*Cyprinus carpio*) and gibel carp (*Carassius gibelio*)

T. Tichopád, et al.

Aquaculture 521 (2020) 735092

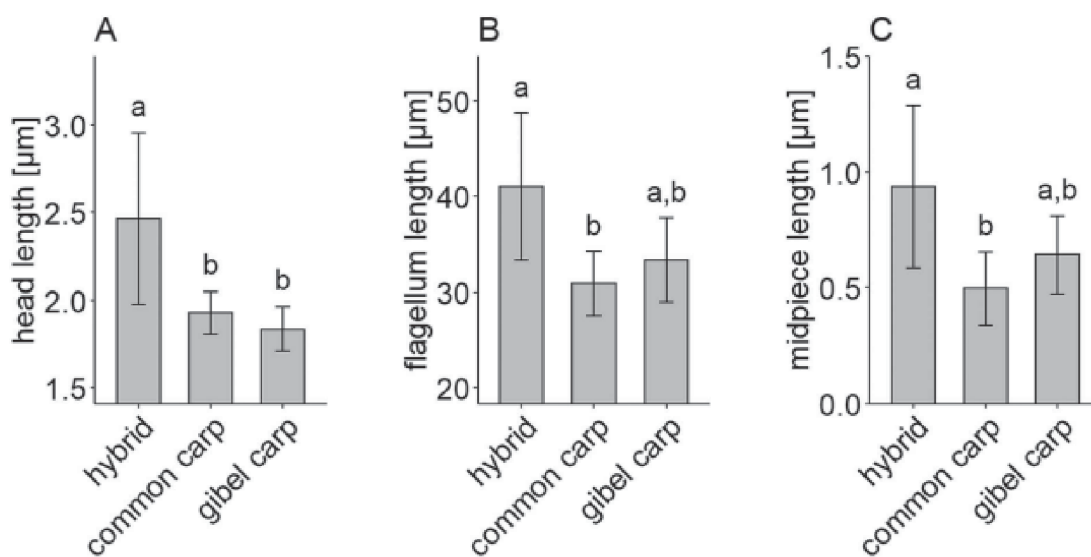

Fig. 1. The selected morphological parameters of spermatozoa from gibel carp ($n = 60$), common carp ($n = 36$) and their F1 hybrids ($n = 48$). Overview of head length (A), flagellum length (B) and midpiece length (C). All data are presented as mean \pm SD. The different letters above the SD bars indicate statistical significance (Tukey's HSD test, $p < .05$).

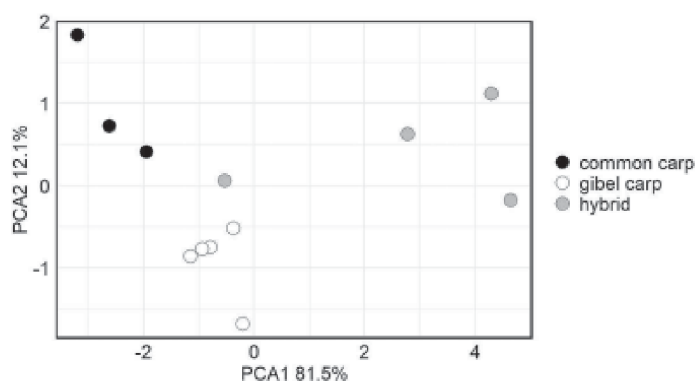

Fig. 2. Principal component analysis of morphological characteristics of sperm from gibel carp ($n = 60$), common carp ($n = 36$) and their F1 hybrids ($n = 48$). The following parameters were included: nucleus length, central nucleus width, midpiece length, anterior midpiece width, posterior midpiece width and flagellum length.

× F1 male hybrid pairs, 6) female gibel carp × F1 male hybrid pairs, 7) female F1 hybrid x male common carp pairs, 8) female F1 hybrid x male gibel carp pairs and 9) F1 hybrid pairs. The weight of eggs in one pair spawning was 0.4 g (280–330 eggs), and fertilization was performed with 10 μ l of sperm from parental species and 20 μ l of sperm from hybrids (supplementary data). The embryos were incubated in the incubator with water temperature 19.5 °C. The percentages of fertilized eggs and hatched embryos were evaluated one day (6th embryonic step, 19.5 ATUs) and four days post fertilization (9th embryonic step, 78 ATUs), respectively (Peñáz et al., 1983). Six days post fertilization (beginning of larvae period, 117 ATUs), the percentages of viable larvae with and without malformations were counted.

2.6. Data analysis

GSI data among the fish group of hybrids (eight specimens), common carps (five specimens) and gibel carps (five specimens) were compared by the Kruskal Wallis test followed by the post-hoc Dunn's test. Counted numbers of mitochondria in each spermatozoon ($n = 90$) were compared between parental species and F1 hybrids using Wilcoxon rank-sum test. Measured lengths of the head, flagellum and

midpiece compartments of the spermatozoa were log-transformed, and the effects of the fish groups were analysed separately for every parameter by one-way factorial ANOVA, where fish species was treated as a fixed effect, while individual fish was set as a random effect (5 specimens of gibel carp, 3 specimens of common carp and 4 specimens of F1 hybrids with 12 spermatozoa measurements from each fish). The principal component analysis (PCA) was computed, including the following parameters for the spermatozoa: nucleus length, central nucleus width, midpiece length, anterior midpiece width, posterior midpiece width and flagellum length.

Measured percentages of the mobility of the spermatozoa from each fish were fitted using logistic regression with quasibinomial distribution. The significance of fish group, time and interaction of fish group and time on mobility were tested by F test type III. Velocity measurements were log-transformed, and significance of fish group, time and their interaction were tested using factorial two-way ANOVA type III. Fertilization rates, hatching rates and viability of larvae were fitted separately by logistic regression. The significance of the model parameter (fish group) was tested again by F tests in each model. In all analyses, the significance level was set as 0.05, and the post-hoc Tukey's test was used for pairwise comparisons (except the Kruskal Wallis test).

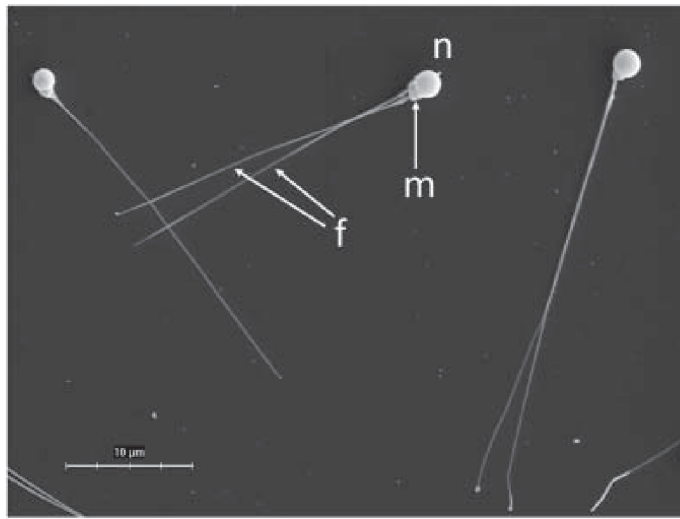

Fig. 3. SEM images of F1 hybrid spermatozoa showing nucleus (n), midpiece (m) and flagellum (f). Two spermatozoa possess two flagella.

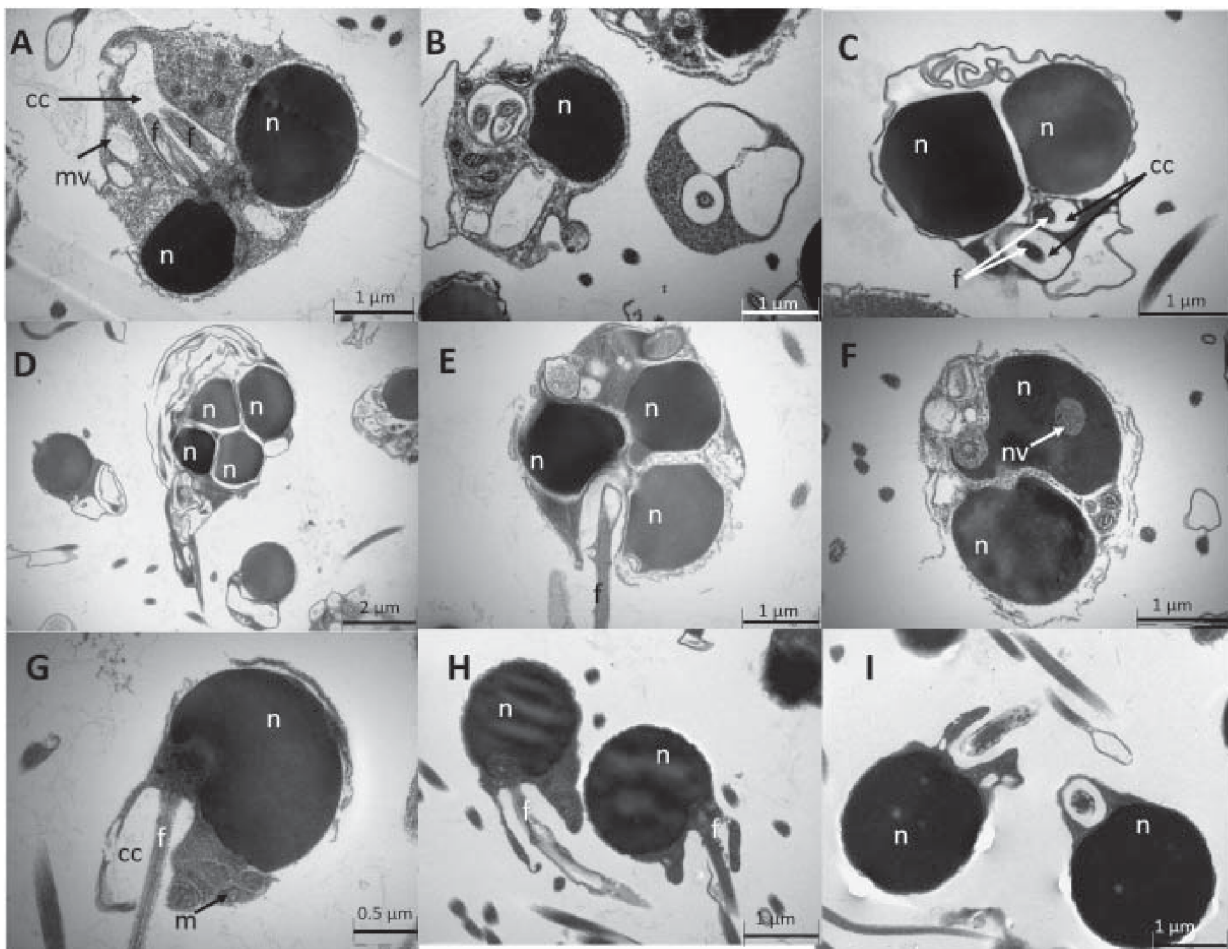

Fig. 4. TEM images of spermatozoon in hybrids (A-G), gibel carp (H) and common carp (I) with nuclei (n), nuclear vesicle (nv), flagellum (f), cytoplasmic channel (cc), midpiece vesicles (mv) and mitochondria (m).

Spermatozoa morphology and reproductive potential in F1 hybrids of common carp (*Cyprinus carpio*) and gibel carp (*Carassius gibelio*)

T. Tichopád, et al.

Aquaculture 521 (2020) 735092

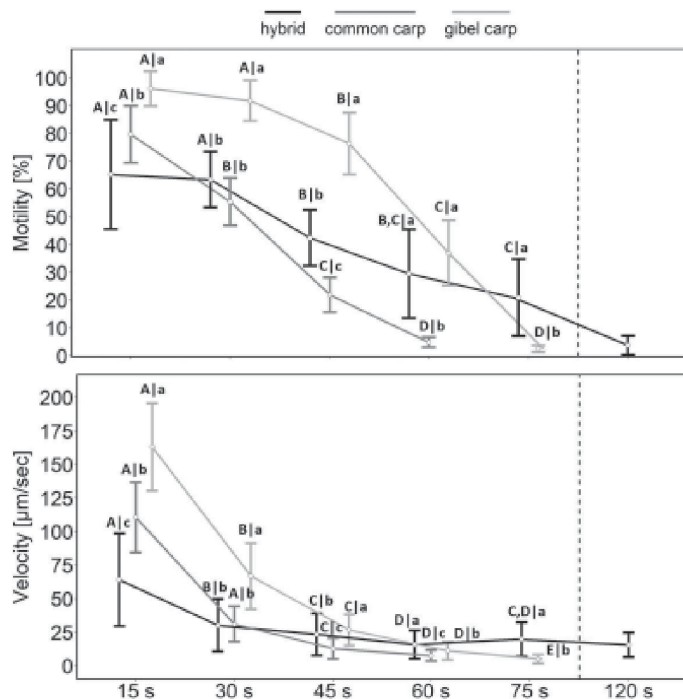

Fig. 5. Sperm motility (mo) and velocity (ve) of common carp (mo $n = 36$, ve $n = 333$), gibel carp (mo $n = 45$, ve $n = 395$) and their hybrids (mo $n = 35$, ve $n = 271$). All data are presented as mean \pm SD. The different letters above the SD bars indicate statistical significance (Tukey's HSD test, $p < .05$). The majuscules represent the comparison of each species or hybrids separately via time. The minuscules represent the comparisons of all fish separately at each time. Data at 120 s, separated by dashed lines, were not included in the statistical analysis.

All analyses were performed in R software version 3.6.0.

3. Results

3.1. Reproduction parameters and ploidy level

Hybrids produced a smaller number of spermatozoa than their parental species (Table 1). The GSI of the males was smaller in the hybrids than in the parental species (KW test: $p < .05$, followed by multiple comparisons: $p < .05$, Table 1). ANOVA showed significant differences in the head length ($p < .05$, Fig. 1A), flagellum length ($p < .05$, Fig. 1B) and midpiece length ($p < .05$, Fig. 1C) of the spermatozoa of the tested groups.

The first axis of PCA, accounting for 81.5% of total variance, separated common carp, gibel carp and hybrids (with the exception of one hybrid specimen, which was grouped with gibel carp). The second axis accounted for 12.1% of total variance and separated common carp and gibel carp; two hybrid specimens overlapped with common carp (Fig. 2). PCA showed great variability in spermatozoa parameters, especially within hybrids. SEM and TEM of the spermatozoa showed numerous abnormalities in the hybrid spermatozoa, such as multiple nuclei and multiple flagella in one or two cytoplasmic channels (Figs. 3, 4), and a higher number of mitochondria. An average number of mitochondria in hybrid spermatozoa was 4.4 ± 2.0 while spermatozoa of parental species was 2.0 ± 1.2 (p -value $< .05$). All parents (common carp, gibel carp and F1 hybrids) included in this study were diploid; nonetheless, hybrid spermatozoa showed aneuploid, haploid, diploid and triploid states, while the sperm cells of the parental species were haploid (data not shown) according to flow cytometry.

3.2. Velocity and motility

The spermatozoa motility and velocity measured after water sperm activation are shown in Fig. 5. Significant effects of fish group (common carp, gibel carp and their F1 hybrids), time and interaction of time and fish group were found on both motility and velocity ($p < .05$, see Fig. 5

for Turkey's tests). The spermatozoa of common carp stopped their movements after 60 s, while the spermatozoa of gibel carp moved for 75 s. Some of the hybrid spermatozoa were able to move for two minutes. Parental spermatozoa velocity rapidly decreased with time, while the velocity of the hybrids was slow throughout the entire time of observation with almost constant speed from 30 s to 120 s.

3.3. Fertilization rate, hatching rate and offspring viability

The effects of the parental species combinations on fertilization rate, hatching rate and offspring viability were significant (fertilization analysis: $p < .05$, hatching analysis: $p < .05$, viability analysis: $p < .05$, Fig. 6). The fertilization rate reached the lowest values in parental combinations with at least one hybrid parent (ranging from no fertilization success to fertilization rate equal to 75%). In contrast, the hatching rate reached the lowest values in the group containing female gibel carps with hybrid males (18–61%), and offspring viability was the lowest for the group of hybrid females with male common carp males (20–70%). All measured traits; fertilization rate, hatching rate and offspring viability—were highest in the common carp and gibel carp parents (fertilization rate: 91–98%, hatching rate: 94–99%, offspring viability: 97–99%). Overall, the fertilization rate was the highest in the combinations of pure breeds (common carp or gibel carp). Offspring viability was the highest in the offspring of pure breed fish (common carp or gibel carp). The highest differences in viability were found between groups containing hybrids in at least one parental position and groups containing pure breeds in both parental positions. The viability of F2 hybrid offspring after one year has been 1% (supplementary data).

4. Discussion

In our study, diploid F1 hybrids of common carp and gibel carp showed reduced testicular development, which corresponds to the low number of spermatozoa in comparison to the parental species. Similar findings were documented across many fish taxa, i.e. crosses between grass carp and big head carp (*Aristichthys nobilis*) (Allen and

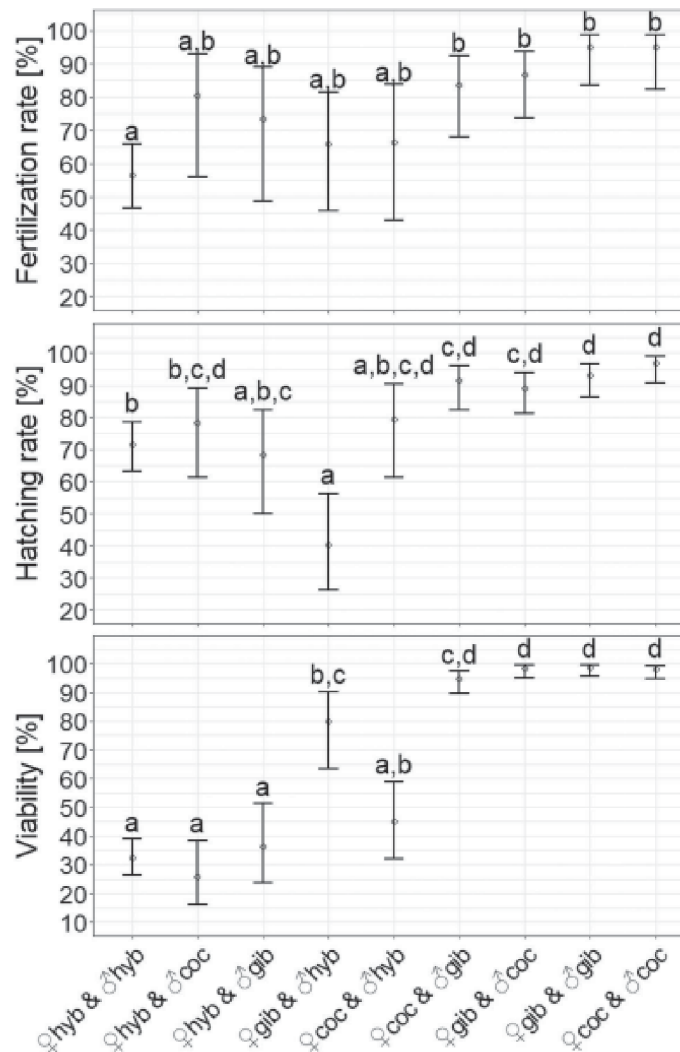

Fig. 6. Fertilization rate (24 hpf), hatching (4 dpf) and viability (6 dpf) in different parental combinations presented as estimated marginal means with 95% confidence intervals for each group ($n = 49$). The letters for the species are as follows: hyb (hybrids), coc (common carp) and gib (gibel carp). The letters above the bars indicate statistical differences (Tukey's HSD test, $p < .05$).

Wattendorf, 1987), brown trout (*Salmo trutta*) and brook trout (*Salvelinus fontinalis*) (Scheerer and Thorgaard, 1983) and muskellunge (*Esox masquinongy*) and northern pike (*Esox lucius*) (Brecka et al., 1995). Moreover, in our case, if hybrids were not completely sterile, the spermatozoa showed various morphological abnormalities, such as large heads, multiple nuclei or longer and multiple flagella in comparison with the parental species. Interestingly, similar findings were observed in hybrids of common carp and goldfish (Kucinski et al., 2015); autopolyploid fish, such as rainbow trout (*Oncorhynchus mykiss*) (Carrasco et al., 1998); tench (*Tinca tinca*) (Linhart et al., 2006); allopolyploid spiny loach (*C. elongatoides-taenia* complex) (Majtánová et al., 2016); and hybrids of *Misgurnus anguillicaudatus* and *M. mizolepis* (Zhao et al., 2016), which also supported close connections between fish sterility and both hybridization and polyploidization. Morphological anomalies in multiple nuclei are probably caused by asynapsis of chromosomes with following arrests during meiosis (Li et al., 2015); indeed, the longer heads of spermatozoa in F1 hybrids were probably connected with the higher amount of chromosomal DNA in the cells, which was caused by an unreduced number of chromosomes in the

sperm cells, which led to polyploid/aneuploidy gametes. Zhao et al. (2014) presented the similar relationship between head lengths and number of chromosomes in allopolyploid spermatozoa from natural allopolyploids of *Misgurnus loaches*. A higher variance in the compartment lengths of spermatozoa produced by F1 hybrids suggests that aberrations in chromosome a/synapsis and segregation can pass meiosis checkpoints in different states of ploidy in contrast to mammalian spermatogenesis, where damaged spermatozoa are eliminated (Hamer et al., 2008). The spermatozoa anomalies of F1 hybrids significantly affect their viability and performance, which has already been observed in fish hybrids of *M. anguillicaudatus* and *M. mizolepis* (Fujimoto et al., 2008) and hybrids of *Lepomis cyanellus* and *L. macrochirus* (Wills and Sheehan Jr, 2000). The sperm cells of F1 hybrids moved for two minutes after activation; however, the prolonged motility duration was likely compensated by the low percentage of motile sperm and velocity in comparison to the parental species. It seems that, if spermatozoa are not completely disrupted as a result of incomplete meiosis, they possess higher amounts of energy. Polyploid sperm cells showed an increased number of mitochondria in the midpiece part, which could compensate

Spermatozoa morphology and reproductive potential in F1 hybrids of common carp (*Cyprinus carpio*) and gibel carp (*Carassius gibelio*)

T. Tichopád, et al.

Aquaculture 521 (2020) 735092

for the larger size of hybrid spermatozoa (Dong et al., 2005; Zhao et al., 2014). Nonetheless, in our study, a higher number of mitochondria was linked with hybridization of diploid parents and not with autopolyploid or allopolyploid parents, as previously documented (Alavi et al., 2013; Pšenička et al., 2011; Pšenička et al., 2010), where polyploid fishes produced aneupolyploid or polyploid gametes. An important question arises what is an involvement of these processes when producing diploid or polyploid spermatozoa, and if there are differences among spermatozoa from diploid hybrid parents, allopolyploid parents and autopolyploid parents. It seems that the reason behind diploid spermatozoa is not so important as the resulting level of ploidy of spermatozoa since they show the similar patterns. Besides energy storage, according to (Cosson, 2004), flagellum length is also positively correlated with the motility; this is in agreement with our findings, as flagellum midpiece lengths were larger and the movement of spermatozoa was longer in F1 hybrids than in common carp and gibel carp.

The second part of the analyses of the sperm was performed via assessment of fertilization rate, hatching rate and offspring viability, i.e. viability of hatched embryos, in parental combinations, including males and females of common carp, gibel carp and F1 hybrids in different crossed combinations. The fertilization rate of groups containing hybrids in both parent positions was significantly lower than the groups containing either common carp or gibel carp in both parent positions. The analysis of offspring viability showed low viability in all combinations when a hybrid was present in at least one parental position except for one pair comprised of a female gibel carp and a male hybrid; however, the hatching rate of this pair was low and comparable to the pair of two hybrid parents. This seems to indicate that embryos with malformations resulting from this crossbreeding were not probably even hatched. The lowest fertilization rate was found in the pairs of hybrid parents, where the gametes were probably affected with the highest genetic incompatibilities during gametogenesis (Ortiz-Barrientos et al., 2007). Analysis of the reproductive output of different parental combinations obtained by artificial spawning showed that both the females and the males hybrids were semi-fertile or sterile, which means that sterility was not sex dependent in our F1 hybrids, therefore, Haldane's rule is not applicable (Schilthuizen et al., 2011) in common carp and gibel carp hybrids. Concerning the hybrid offspring representing the F2 generation, i.e. offspring resulting from hybrid × hybrid crossbreeding, a small number of offspring were able to survive, although most of them did not survive two months after hatching (supplementary data 3.) probably because of outbreeding depression (Emlen, 1991; Lynch, 1991).

To conclude, our study showed that F1 hybrids of common carp and gibel carp produced a small number of viable offspring. Therefore, using common carp and gibel carp F1 hybrids in aquaculture to achieve sterile fish for genetic manipulation (in order to increase economic profits) would present a potential risk to wild populations of fish and endanger local ecosystems if they escaped from fish farms. Alternative possibilities include producing multiple hybrid generations, as reproductive ability can change in later generations (Liu et al., 2001), or inducing sterility through molecular methods, such as gene knock down using morpholino (Wong and Zohar, 2015) or knock out using CRISPR/Cas9 (Baloch et al., 2019). Gene expression of selected genes from sperm cells produced by hybrids could provide information about molecular biomarkers in assessment of gametes quality (Figueroa et al., 2018) or explain gene regulatory networks in spermatozoa (Hu et al., 2017). F1 hybrids can be also used in fish breeding programmes creating new types of breeds with unique genetic traits. We also highlight the need to carefully study the gametogenesis of hybrid and polyploid fish separately, as the probable disruption of gametogenesis may represent the important mechanisms of post-zygotic isolation.

Acknowledgements

The study was supported by Czech Science Foundation, project No.

19-10088S. The analysis of sperm quality were financially supported by the Ministry of Education, Youth and Sports of the Czech Republic - project CENAKVA (LM2018099) and Biodiversity (CZ.02.1.01/0.0/0.0/16_025/0007370).

Declaration of Competing Interest

The authors declare that they have no known competing financial interests or personal relationships that could have appeared to influence the work reported in this paper.

Appendix A. Supplementary data

Supplementary data to this article can be found online at <https://doi.org/10.1016/j.aquaculture.2020.735092>.

References

- Alavi, S.M.H., Cosson, J., 2005. Sperm motility in fishes. I. Effects of temperature and pH: a review. *Cell Biol. Int.* 29, 101–110. <https://doi.org/10.1016/j.cellbi.2004.11.021>.
- Alavi, S.M.H., Drozd, B., Hatef, A., Flajšhans, M., 2013. Sperm morphology, motility, and velocity in naturally occurring polyploid European weatherfish (*Misgurnus fossilis* L.). *Theriogenology* 80, 153–160. <https://doi.org/10.1016/j.theriogenology.2013.04.009>.
- Allen, S.K., Wattendorf, R.J., 1987. Triploid grass carp: status and management implications. *Fisheries* 12, 20–24. [https://doi.org/10.1577/1548-8446\(1987\)012<0020:TGCSAM>2.0.CO;2](https://doi.org/10.1577/1548-8446(1987)012<0020:TGCSAM>2.0.CO;2).
- Bakos, J., 1979. Crossbreeding Hungarian races of common carp to develop more productive hybrids, in: *advances in aquaculture*. Food Fisheries News Books, Farnham, Surrey, UK 1979, 635–642.
- Balashov, D.A., Recoubratsky, A.V., Duma, L.N., Ivanekha, E.V., Duma, V.V., 2017. Fertility of triploid hybrids of Prussian carp (*Carassius gibelio*) with common carp (*Cyprinus carpio* L.). *Russ. J. Dev. Biol.* 48, 347–353. <https://doi.org/10.1134/S1062360417050034>.
- Baloch, A.R., Franěk, R., Tichopád, T., Fučíková, M., Rodina, M., Pšenička, M., 2019. Dnd1 knockout in sturgeons by CRISPR/Cas9 generates germ cell free host for surrogate production. *Animals* 9, 174. <https://doi.org/10.3390/ani9040174>.
- Balon, E.K., 2004. About the oldest domesticates among fishes. *J. Fish Biol.* 65, 1–27. <https://doi.org/10.1111/j.0022-1112.2004.00563.x>.
- Bartley, D.M., Rana, K., Immink, A.J., 2000. The use of inter-specific hybrids in aquaculture and fisheries. *Rev. Fish Biol. Fish.* 10, 325–337. <https://doi.org/10.1023/A:1016691725361>.
- Brecka, B.J., Kohler, C.C., Wahl, D.H., 1995. Effects of dietary protein concentration on growth, survival, and body composition of muskellunge *Esox musquinongy* and Tiger muskellunge *Esox masquinongy* × *E. lucius* fingerlings. *J. World Aquacult. Soc.* 26, 416–425. <https://doi.org/10.1111/j.1749-7345.1995.tb00837.x>.
- Carrasco, L.A., Doroshov, S., Penman, D.J., Bromage, N., 1998. Long-term, quantitative analysis of gametogenesis in autotriploid rainbow trout, *Oncorhynchus mykiss*. *J. Reprod. Fertil.* 113, 197–210. <https://doi.org/10.1530/jrf.0.1130197>.
- Choleva, L., Janko, K., De Gelas, K., Bohlen, J., Šlechtová, V., Rábová, M., Ráb, P., 2012. Synthesis of clonality and polyploidy in vertebrate animals by hybridization between two sexual species. *Evolution* 66, 2191–2203. <https://doi.org/10.1111/j.1558-5646.2012.01589.x>.
- Cosson, J., 2004. The ionic and osmotic factors controlling motility of fish spermatozoa. *Aquac. Int.* 12, 69–85. <https://doi.org/10.1023/B:AQUJ.0000017189.44263.bc>.
- Davidson, E., Levin, M., 2005. Gene regulatory networks. *Proc. Natl. Acad. Sci. U. S. A.* 102, 4935. <https://doi.org/10.1073/pnas.0502024102>.
- Dong, Q., Huang, C., Tiersch, T.R., 2005. Spermatozoal ultrastructure of diploid and tetraploid Pacific oysters. *Aquaculture* 249, 487–496. <https://doi.org/10.1016/j.aquaculture.2005.03.009>.
- Dorson, M., Chevassus, B., Torhy, C., 1991. Comparative susceptibility of three species of char and of rainbow trout × char triploid hybrids to several pathogenic salmonid viruses. *Dis. Aquat. Org.* 11, 217–224. <https://doi.org/10.3354/dao011217>.
- Emlen, J.M., 1991. Heterosis and outbreeding depression: a multi-locus model and an application to salmon production. *Fish. Res.* 12, 187–212. [https://doi.org/10.1016/0165-7836\(91\)90095-W](https://doi.org/10.1016/0165-7836(91)90095-W).
- Figueroa, E., Valdebenito, I., Fariás, J.G., 2016. Technologies used in the study of sperm function in cryopreserved fish spermatozoa. *Aquac. Res.* 47, 1691–1705. <https://doi.org/10.1111/are.12630>.
- Figueroa, E., Lee-Estévez, M., Valdebenito, I., Fariás, J.G., Romero, J., 2018. Potential biomarkers of DNA quality in cryopreserved fish sperm: impact on gene expression and embryonic development. *Rev. Aquac. n/a*. <https://doi.org/10.1111/raq.12323>.
- Fujimoto, T., Yasui, G.S., Yoshikawa, H., Yamaha, E., Arai, K., 2008. Genetic and reproductive potential of spermatozoa of diploid and triploid males obtained from interspecific hybridization of *Misgurnus anguillicaudatus* female with *M. mizolepis* male. *J. Appl. Ichthyol.* 24, 430–437. <https://doi.org/10.1111/j.1439-0426.2008.01131.x>.
- Gallego, V., Asturiano, J.F., 2018. Fish sperm motility assessment as a tool for aquaculture research: a historical approach. *Rev. Aquac.* 11, 697–724. <https://doi.org/10.1111/raq.12253>.
- Haldane, J.B.S., 1922. Sex ratio and unisexual sterility in hybrid animals. *J. Genet.* 12,

- 101–109. <https://doi.org/10.1007/BF02983075>.
- Hamer, G., Novak, I., Kouznetsova, A., Höög, C., 2008. Disruption of pairing and synapsis of chromosomes causes stage-specific apoptosis of male meiotic cells. *Theriogenology* 69, 333–339. <https://doi.org/10.1016/j.theriogenology.2007.09.029>.
- Hänfling, B., Bolton, P., Harley, M., Carvalho, G.R., 2005. A molecular approach to detect hybridisation between crucian carp (*Carassius carassius*) and non-indigenous carp species (*Carassius* spp. and *Cyprinus carpio*). *Freshw. Biol.* 50, 403–417. <https://doi.org/10.1111/j.1365-2427.2004.01330.x>.
- Hines, R.S., Wohlfarth, G.W., Moav, R., Hulata, G., 1974. Genetic differences in susceptibility to two diseases among strains of the common carp. *Aquaculture* 3, 187–197. [https://doi.org/10.1016/0044-8486\(74\)90112-4](https://doi.org/10.1016/0044-8486(74)90112-4).
- Hu, F., Xu, K., Zhou, Y., Wu, C., Wang, S., Xiao, J., Wen, M., Zhao, R., Luo, K., Tao, M., Duan, W., Liu, S., 2017. Different expression patterns of sperm motility-related genes in testis of diploid and tetraploid cyprinid fish. *Biol. Reprod.* 96, 907–920. <https://doi.org/10.1093/biolre/i0x010>.
- Hu, F., Fan, J., Qin, Q., Huo, Y., Wang, Y., Wu, C., Liu, Q., Li, W., Chen, X., Liu, C., Tao, M., Wang, S., Zhao, R., Luo, K., Liu, S., 2019. The sterility of allotriploid fish and fertility of female autotriploid fish. *Front. Genet.* 10. <https://doi.org/10.3389/fgene.2019.00377>.
- Janko, K., Pačes, J., Wilkinson-Herbots, H., Costa, R.J., Roslein, J., Drozd, P., Iakovenko, N., Rídl, J., Hroudová, M., Kočí, J., Reifová, R., Šlechtová, V., Choleva, L., 2018. Hybrid asexuality as a primary postzygotic barrier between nascent species: on the interconnection between asexuality, hybridization and speciation. *Mol. Ecol.* 27, 248–263. <https://doi.org/10.1111/mec.14377>.
- Janko, K., Eisner, J., Mikulíček, P., 2019. Sperm-dependent asexual hybrids determine competition among sexual species. *Sci. Rep.* 9, 722. <https://doi.org/10.1038/s41598-018-35167-z>.
- Kocour, M., Gela, D., Rodina, M., Linhart, O., 2005. Testing of performance in common carp *Cyprinus carpio* L. under pond husbandry conditions I: top-crossing with Northern mirror carp. *Aquac. Res.* 36, 1207–1215. <https://doi.org/10.1111/j.1365-2109.2005.01340.x>.
- Kucinski, M., Demska-Zakes, K., Zarski, D., Liszewski, T., Fopp-Bayat, D., Jankun, M., Furgala-Selezniow, G., 2015. The morphological, histological and cytogenetic characteristics of goldfish *Carassius auratus* (L.) × common carp *Cyprinus carpio* (L.) hybrids. *Caryologia* 68, 77–83. <https://doi.org/10.1080/00087114.2015.1021154>.
- Li, Y.-J., Gao, Y.-C., Zhou, H., Ma, H.-Y., Li, J.-Q., Arai, K., 2015. Meiotic chromosome configurations in triploid progeny from reciprocal crosses between wild-type diploid and natural tetraploid loach *Misgurnus anguillicaudatus* in China. *Genetica* 143, 555–562. <https://doi.org/10.1007/s10709-015-9853-2>.
- Linhart, O., Rodina, M., Gela, D., Kocour, M., Rodriguez, M., 2003. Improvement of common carp artificial reproduction using enzyme for elimination of egg stickiness. *Aquat. Living Resour.* 16, 450–456. [https://doi.org/10.1016/S0990-7440\(03\)00083-4](https://doi.org/10.1016/S0990-7440(03)00083-4).
- Linhart, O., Rodina, M., Flajšhans, M., Mavrodiev, N., Nebesarova, J., Gela, D., Kocour, M., 2006. Studies on sperm of diploid and triploid tench, *Tinca tinca* (L.). *Aquac. Int.* 14, 9–25. <https://doi.org/10.1007/s10499-005-9010-5>.
- Liu, S., Liu, Y., Zhou, G., Zhang, X., Luo, C., Feng, H., He, X., Zhu, G., Yang, H., 2001. The formation of tetraploid stocks of red crucian carp × common carp hybrids as an effect of interspecific hybridization. *Aquaculture* 192, 171–186. [https://doi.org/10.1016/S0044-8486\(00\)00451-8](https://doi.org/10.1016/S0044-8486(00)00451-8).
- Lusková, V., Lusk, S., Halačka, K., Vetešník, L., 2010. *Carassius auratus gibelio*—the most successful invasive fish in waters of the Czech Republic. *Russ. J. Biol. Invasions* 1, 176–180. <https://doi.org/10.1134/S2075111710030069>.
- Lynch, M., 1991. The genetic interpretation of inbreeding depression and outbreeding depression. *Evolution* 45, 622–629. <https://doi.org/10.1111/j.1558-5646.1991.tb04333.x>.
- Majtánová, Z., Choleva, L., Symonová, R., Ráb, P., Kotusz, J., Pekárik, L., Janko, K., 2016. Asexual reproduction does not apparently increase the rate of chromosomal evolution: karyotype stability in diploid and triploid clonal hybrid fish (*Cobitis*, Cypriniformes, Teleostei). *PLoS One* 11, e0146872. <https://doi.org/10.1371/journal.pone.0146872>.
- McGinnity, P., Prodöhl, P., Ferguson, A., Hynes, R., Maoiléidigh, N., Baker, N., Cotter, D., O’Hea, B., Cooke, D., Rogan, G., Taggart, J., Cross, T., 2003. Fitness reduction and potential extinction of wild populations of Atlantic salmon, *Salmo salar*, as a result of interactions with escaped farm salmon. *Proc. R. Soc. Lond. B Biol. Sci.* 270, 2443–2450. <https://doi.org/10.1098/rspb.2003.2520>.
- Nwaduikwe, O.F., 1995. Hatchery propagation of five hybrid groups by artificial hybridization of *Clarias gariepinus* and *Heterobranchius longifilis* using dry, powdered carp pituitary hormone. *J. Aquac. Tropics* 10, 1–11.
- Orr, H.A., Presgraves, D.C., 2000. Speciation by postzygotic isolation: forces, genes and molecules. *BioEssays News Rev. Mol. Cell. Dev. Biol.* 22, 1085–1094. [https://doi.org/10.1002/1521-1878\(200012\)22:12<1085::AID-BIES6>3.0.CO;2-G](https://doi.org/10.1002/1521-1878(200012)22:12<1085::AID-BIES6>3.0.CO;2-G).
- Ortiz-Barrientos, D., Counterman, B.A., Noor, M.A.F., 2007. Gene expression divergence and the origin of hybrid dysfunctions. *Genetica* 129, 71–81. <https://doi.org/10.1007/s10709-006-0034-1>.
- Peňáz, M., Prokeš, M., Kouřil, J., Hamáčková, J., 1983. Early development of the carp, *Cyprinus carpio*. *Acta Sc. Nat. Brno* 17, 1–39.
- Piferrer, F., Beaumont, A., Falguière, J.-C., Flajšhans, M., Haffray, P., Colombo, L., 2009. Polyploid fish and shellfish: production, biology and applications to aquaculture for performance improvement and genetic containment. *Aquaculture* 293, 125–156. <https://doi.org/10.1016/j.aquaculture.2009.04.036>.
- Ponjarat, J., Singchat, W., Monkheang, P., Suntronpong, A., Tawichasri, P., Sillapaprayoon, S., Ogawa, S., Muangmai, N., Baicharoen, S., Peyachoknagul, S., Parhar, I., Na-Nakorn, U., Srikulnath, K., 2019. Evidence of dramatic sterility in F1 male hybrid catfish [male *Clarias gariepinus* (Burchell, 1822) × female *C. macrocephalus* (Günther, 1864)] resulting from the failure of homologous chromosome pairing in meiosis I. *Aquaculture* 505, 84–91. <https://doi.org/10.1016/j.aquaculture.2019.02.035>.
- Pšenička, M., Flajšhans, M., Hulák, M., Kašpar, V., Rodina, M., Borishpolets, S., Linhart, O., 2010. The influence of ploidy level on ultrastructure and motility of tench *Tinca tinca* (L.) spermatozoa. *Rev. Fish Biol. Fish.* 20, 331–338. <https://doi.org/10.1007/s11160-009-9135-0>.
- Pšenička, M., Kašpar, V., Rodina, M., Gela, D., Hulák, M., Flajšhans, M., 2011. Comparative study on ultrastructure and motility parameters of spermatozoa of tetraploid and hexaploid Siberian sturgeon *Acipenser baerii*. *J. Appl. Ichthyol.* 27, 683–686. <https://doi.org/10.1111/j.1439-0426.2011.01685.x>.
- Ruppert, J.L.W., Docherty, C., Neufeld, K., Hamilton, K., MacPherson, L., Poesch, M.S., 2017. Native freshwater species get out of the way: Prussian carp (*Carassius gibelio*) impacts both fish and benthic invertebrate communities in North America. *R. Soc. Open Sci.* 4, 170400. <https://doi.org/10.1098/rsos.170400>.
- Scheerer, P.D., Thorgaard, G.H., 1983. Increased survival in salmonid hybrids by induced Triploidy. *Can. J. Fish. Aquat. Sci.* 40, 2040–2044. <https://doi.org/10.1139/f83-235>.
- Schilthuisen, M., Giesbers, M.C.W.G., Beukeboom, L.W., 2011. Haldane’s rule in the 21st century. *Heredity* 107, 95–102. <https://doi.org/10.1038/hdy.2010.170>.
- Shimizu, Y., Shibata, N., Yamashita, M., 1997. Spermiogenesis without preceding meiosis in the hybrid medaka between *Oryzias latipes* and *O. curvirostris*. *J. Exp. Zool.* 279, 102–112. [https://doi.org/10.1002/\(SICI\)1097-010X\(19970901\)279:1<102::AID-JEZ10>3.0.CO;2-A](https://doi.org/10.1002/(SICI)1097-010X(19970901)279:1<102::AID-JEZ10>3.0.CO;2-A).
- Šimková, A., Dávidová, M., Papoušek, I., Vetešník, L., 2013. Does interspecies hybridization affect the host specificity of parasites in cyprinid fish? *Parasit. Vectors* 6, 95. <https://doi.org/10.1186/1756-3305-6-95>.
- Šimková, A., Vojtek, L., Halačka, K., Hyřil, P., Vetešník, L., 2015. The effect of hybridization on fish physiology, immunity and blood biochemistry: a case study in hybridizing *Cyprinus carpio* and *Carassius gibelio* (Cyprinidae). *Aquaculture* 435, 381–389. <https://doi.org/10.1016/j.aquaculture.2014.10.021>.
- Vandeputte, M., 2003. Selective breeding of quantitative traits in the common carp (*Cyprinus carpio*): a review. *Aquat. Living Resour.* 16, 399–407. [https://doi.org/10.1016/S0990-7440\(03\)00056-1](https://doi.org/10.1016/S0990-7440(03)00056-1).
- Verdegem, M.C.J., Hilbrands, A.D., Boon, J.H., 1997. Influence of salinity and dietary composition on blood parameter values of hybrid red tilapia, *Oreochromis niloticus* (Linnaeus) × *O. mossambicus* (Peters). *Aquac. Res.* 28, 453–459. <https://doi.org/10.1046/j.1365-2109.1997.00880.x>.
- Wills, P.S., Sheehan Jr., R.J., 2000. Reduced reproductive capacity in diploid and triploid hybrid sunfish. *Trans. Am. Fish. Soc.* 129, 30–40. [https://doi.org/10.1577/1548-8659\(2000\)129<0030:RRICDA>2.0.CO;2](https://doi.org/10.1577/1548-8659(2000)129<0030:RRICDA>2.0.CO;2).
- Wohlfarth, G.W., 1993. Heterosis for growth rate in common carp. *Aquaculture* 113, 31–46. [https://doi.org/10.1016/0044-8486\(93\)90338-Y](https://doi.org/10.1016/0044-8486(93)90338-Y).
- Wolters, W.R., DeMay, R., 1996. Production characteristics of striped bass × white bass and striped bass × yellow bass hybrids. *J. World Aquacult. Soc.* 27, 202–207. <https://doi.org/10.1111/j.1749-7345.1996.tb00270.x>.
- Wong, T.-T., Zohar, Y., 2015. Production of reproductively sterile fish by a non-transgenic gene silencing technology. *Sci. Rep.* 5, 15822. <https://doi.org/10.1038/srep15822>.
- Wringe, B.F., Jeffery, N.W., Stanley, R.R.E., Hamilton, L.C., Anderson, E.C., Fleming, I.A., Grant, C., Dempson, J.B., Veinott, G., Duffy, S.J., Bradbury, I.R., 2018. Extensive hybridization following a large escape of domesticated Atlantic salmon in the Northwest Atlantic. *Commun. Biol.* 1, 1–9. <https://doi.org/10.1038/s42003-018-0112-9>.
- Yamazaki, F., 1983. Sex control and manipulation in fish. *Aquaculture, Genetics in Aquaculture* 33, 329–354. [https://doi.org/10.1016/0044-8486\(83\)90413-1](https://doi.org/10.1016/0044-8486(83)90413-1).
- Yoshikawa, H., Xu, D., Ino, Y., Yoshino, T., Hayashida, T., Wang, J., Yazawa, R., Yoshizaki, G., Takeuchi, Y., 2018. Hybrid sterility in fish caused by mitotic arrest of primordial germ cells. *Genetics* 209, 507–521. <https://doi.org/10.1534/genetics.118.300777>.
- Zhang, Z., Chen, J., Li, L., Tao, M., Zhang, C., Qin, Q., Xiao, J., Liu, Y., Liu, S., 2014. Research advances in animal distant hybridization. *Sci. China Life Sci.* 57, 889–902. <https://doi.org/10.1007/s11427-014-4707-1>.
- Zhao, Y., Saito, T., Pšenička, M., Fujimoto, T., Arai, K., 2014. Comparison of spermatozoa parameters, fine structures, and energy-related factors among tetraploid, hyper-tetraploid, and hyper-triploid loaches (*Misgurnus anguillicaudatus*). *J. Exp. Zool. Part Ecol. Genet. Physiol.* 321, 198–206. <https://doi.org/10.1002/jez.1851>.
- Zhao, Y., Fujimoto, T., Pšenička, M., Saito, T., Arai, K., 2016. Non-motile tetraploid spermatozoa of *Misgurnus loach* hybrids. *Fish. Sci.* 82, 127–135. <https://doi.org/10.1007/s12562-015-0939-7>.

CHAPTER 4

MEIOSIS SUPPRESSION IN THE UNISEXUAL AMAZON MOLLY, *Poecilia formosa*

Dedukh, D., da Cruz, I., Kneitz, S., Marta, A., Ormanns, J., Tichopád, T., Lu, Y., Alsheimer, M., Janko, K., Scharl, M. Meiosis suppression in the unisexual Amazon molly, *Poecilia formosa*. Manuscript.

My share on this work was about 10%.

Meiosis suppression in the unisexual Amazon molly, *Poecilia formosa*

Dmitrij Dedukh^{1*}, Irene da Cruz^{2*}, Susanne Kneitz³, Anatolie Marta^{1,4}, Jenny Ormanns³, Tomáš Tichopád^{1,5}, Yuan Lu⁶, Manfred Alsheimer⁷, Karel Janko^{1,8}, Manfred Scharl^{2,6}

- ¹ Laboratory of Fish Genetics, Institute of Animal Physiology and Genetics, Czech Academy of Sciences, Liběchov 277 21, Czech Republic
- ² Developmental Biochemistry, Biocenter, University of Wuerzburg, Am Hubland, 97074 Wuerzburg, Germany
- ³ Biochemistry and Cell Biology, Biocenter, University of Wuerzburg, Am Hubland, 97074 Wuerzburg, Germany
- ⁴ Institute of Zoology, MD-2028, Academiei 1, 2001 Chisinau, Moldova
- ⁵ University of South Bohemia in České Budějovice, Faculty of Fisheries and Protection of Waters, South Bohemian Research Center of Aquaculture and Biodiversity of Hydrocenoses, Zátíší 728/II, 389 25 Vodňany, Czech Republic
- ⁶ Genetic Stock Center, Texas State University, San Marcos, Texas 78666, USA
- ⁷ Cell and Developmental Biology, Biocenter, University of Wuerzburg, Am Hubland, 97074 Wuerzburg, Germany
- ⁸ Department of Biology and Ecology, Faculty of Science, University of Ostrava, Chittussiho 10, 710 00 Ostrava, Czech Republic

*These authors contributed equally to the work

Correspondence to: Manfred Scharl
Tel: +49 931 3184149
Email: phch1@biozentrum.uni-wuerzburg.de

Abstract

Unisexual reproduction, which generates clonal offspring, is an alternative strategy to sexual breeding and occurs even in vertebrates. A wide range of non-sexual reproductive modes exist, and one of the least understood questions is how such pathways emerged and how they mechanistically proceed. The Amazon molly, *P. formosa*, needs sperm from males of related species to trigger the parthenogenetic development of diploid eggs. However, the mechanism of how the unreduced female gametes are produced remains unclear.

Cytological analyses revealed that the chromosomes of primary oocytes initiate pachytene but do not proceed to bivalent formation and recombination. Comparing ovary transcriptomes of *P. formosa* and its sexual parental species *P. mexicana* revealed differentially expressed meiotic genes involved in the generation of double-strand breaks, synapsis, and regulation of prophase I progression. *Spo11*, which marks the initiation of recombination, is significantly downregulated compared to *P. mexicana*. Several meiosis genes show biased expression towards one of the two alleles from the parental genomes.

Results show that in the Amazon molly diploid oocytes are generated by apomixis due to a failure in the formation of synapsed homologous chromosomes. This is connected to dysregulation of important players of meiosis either on the transcriptional level and/or hybrid dysgenesis because of compromised interaction of proteins from diverged genomes. We hypothesize that downregulation of *spo11* at the earliest step of meiosis has been the critical step in the evolution of ameiosis, while other changes are connected to adaptive refinement or downstream responses to the switch from meiosis to mitosis.

Keywords: Meiosis; parthenogenesis; synaptonemal complex; recombination; transcriptome; oogenesis

Introduction

Asexuality is an exceptional and rare mode of reproduction in vertebrates. Understanding the genetic basis and molecular mechanisms of asexuality and why it persists in some species is not only of interest to comprehend the biology of those peculiar biotypes but also contributes to the understanding of the mechanisms and evolution of sexual reproduction. Asexuality has the advantage of faster exponential population growth (Loewe and Lamatsch, 2008) and the avoidance of the two-fold cost of sex (Maynard Smith, 1978). However, generating genetically identical individuals has main disadvantages: its consequences are low genetic diversity (known as the "Red Queen" effect) and decay of fitness due to the accumulation of deleterious mutations (described by "Muller's ratchet" (Van Valen, 1973; Bell, 1982)). These drawbacks are considered to outweigh the positive features of clonal propagation (Lynch et al., 1995; Neiman et al., 2010; Lively and Morran, 2014). Due to the predicted importance of those negative consequences and considering that the changes in cellular mechanisms required for asexual reproduction would be complicated, for a long time, it was held impossible that vertebrates could be parthenogenetic. This perception, however, changed when in 1932, the Amazon molly, *Poecilia formosa*, was detected as the first vertebrate to reproduce by "a form of apparent parthenogenesis" in nature (Hubbs and Hubbs, 1932). To date, approximately 100 fish, amphibian, and reptile biotypes are known, which obligatorily or transiently skip genetic recombination, while the phenomenon, as a natural process, appears to be absent in endotherm vertebrates (Avise, 2008; Stöck et al., 2021).

The so called 'asexual organisms' in general, and vertebrates in particular, employ a plethora of varying cytological mechanisms to achieve the production of unreduced gametes or at least partially clonal inheritance. Among these, several mechanisms appear to have emerged many times independently among unrelated lineages (Stenberg and Saura, 2009). One such mechanism assumes suppression of karyokinesis and cytokinesis in oogonia during the last premeiotic mitoses. This yields a primary oocyte with twice the number of chromosome sets, which form twice the number of bivalents during pachytene, followed by two regular meiotic divisions. This process, termed pre-meiotic endoreduplication, results in an ovum with the somatic number of chromosomes and clonal genomic constitution. Because of the occasional pairing of homologous chromosomes, which then recombine, it is an automictic form of asexuality. It is relatively widespread among clonal animals (Stenberg and Saura, 2009). In vertebrates, it occurs in triploid forms of some *Ambystoma* salamanders (Macgregor and Uzzell, 1964; Cuellar, 1976), diploid and triploid lizards from the genus *Aspidocelis* (Cuellar, 1971), in Batura toads (Stöck et al., 2002), and in teleost fishes in triploid *Poeciliopsis monacha 2-lucida* (Cimino, 1972), in diploid and triploid hybrids of *Cobitis* (Dedukh et al., 2020) and *Misgurnus* species (Itono et al., 2006). Another automictic mechanism that can restore a diploid egg while retaining meiosis during the parthenogenetic development is the fusion of the oocyte after the first reduction division with the first or second polar body. This mechanism explains the process of facultative parthenogenesis observed in some sharks (Chapman et al., 2007), Komodo dragons, and snakes (Card et al., 2021). It is widespread among plants and is known for insects, crustaceans, and tardigrades (Stenberg and Saura, 2009). Interestingly, this automictic process has been observed regularly in laboratory-produced hybrids of *P. mexicana* and *P. latipinna* (Lampert et al., 2007) and could be seen as the primordial mechanism from which oogenesis in *P. formosa* evolved. Finally, asexuality can be fully apomictic, with meiosis being totally suppressed and the oocyte being produced by mitosis. Apomixis and endoreduplication do not lead to genetic variation in the resultant clonal population. Automixis by fusion of the products of the meiotic division, however, can lead to variable offspring because segregation and recombination take place between nonidentical homologous chromosomes.

Since its discovery, *P. formosa* has become a paradigmatic model for studies on asexuality (Schlupp, 2005; Lampert and Scharl, 2008). It is an all-female species that reproduces by gynogenesis, a form of parthenogenesis. This mode of reproduction still requires the presence of males. Males of related sexual species provide sperm as a trigger to physiologically activate the development of the embryo from a diploid egg without contributing genetically to the offspring. The sperm DNA is usually degraded before karyogamy can occur, which guarantees clonality – with only extremely rare exceptions. Minute parts of the paternal genome can persist as microchromosomes, which behave like B-chromosomes in the soma and the germline. In other rare cases, the sperm exclusion mechanism fails completely, and a triploid Amazon molly develops (for reviews on the reproductive biology of *P. formosa* see Schlupp, 2005; Lampert and Scharl, 2008). Genealogically, *P. formosa* is derived from two sexual species. All individuals of today's *P. formosa* stem from a single interspecific hybrid of two distantly related *Poecilia* species, *P. mexicana* as the maternal and *P. latipinna* as the paternal ancestor (Stöck et al., 2010; Warren et al., 2018). This raises the question of how sexual reproduction was lost in the "prima Eva" of all Amazon mollies and how diploid clonal lineages are perpetuated.

However, despite *P. formosa* being a paradigmatic organism for studies on the origins and evolutionary consequences of asexuality, there is no consensus on how sexual reproduction was lost in the "prima Eva" of all Amazon mollies and how diploid clonal lineages are perpetuated. For this, several hypotheses can be envisaged in analogy to the above-mentioned case from

other asexual animals. With respect to the mechanism of oocyte formation in *P. formosa* cytological data were first interpreted as evidence for premeiotic endoreduplication. Later, however, on the basis of DNA quantification by the same authors, this hypothesis was rejected, and apomixis was ascribed to the Amazon molly (Monaco et al., 1981; Rasch et al., 1982). Despite the huge methodological progress in the last 30 years, the deconvolution of the asexual reproductive mechanism of Amazon molly was not re-visited again. In this work, we show by cytogenetic analyses using immunodetection of synaptonemal components and a recombination marker and whole mount oocytes that the chromosomes of *P. formosa* primary oocytes take the preparatory steps of meiosis I but do not proceed to bivalent formation and recombination. Furthermore, transcriptome analyses uncovered that most of the meiotic genes are expressed in a similar pattern in the asexual ovary of *P. formosa* and the sexual parental species *P. mexicana* except for key genes involved in the generation of regulation of double-strand breaks, synapsis, and regulation of prophase I progression.

Materials and methods

Animals: All fish were reared under standard conditions for Poeciliid fish husbandry (Kallman 1975) with a light/dark cycle of 14/10 h at 26 °C in the fish facility of the Biocentre at the University of Würzburg, Germany. Animals were kept and sampled in accordance with the applicable EU and German national legislation governing animal experimentation. In particular, all experimental protocols were approved through an authorization (FB VVL 568/201-2792/20) of the Veterinary Office of the District Government of Lower Franconia, Germany, in accordance with the German Animal Protection Law (TierSchG).

Fish from the following laboratory lines were used:

Poecilia formosa, WLC #4698 (laboratory strain Pfl), #4394 (origin Rio Purificacion, Tamps. Mexico VI/17), #1341 (origin Ciudad Mante, Tamps. Mexico III/2), #1304 (laboratory strain Pfl)
Poecilia mexicana, WLC#1353 (origin Laguna del Champayan, Tamps. Mexico IV/5)

Hybrids: Ovary transcriptome data from a previous study analyzing F1 hybrids from crossing virgin *P. mexicana* female with a *P. latipinna* male (Lu et al., 2021) were used.

RNA extractions and transcriptome sequencing: Ovaries from four adult non-pregnant *P. formosa* and *P. mexicana* were dissected at days 0–3 after giving birth during the time when the next clutch of oocytes matures. Total RNA was isolated using TRIzol Reagent (Thermo Fisher Scientific, Waltham, USA) according to the supplier's recommendation. Custom eukaryotic strand-specific sequencing (BGI, Shenzhen, China) of TruSeq libraries generated 30–35 million 150 bp paired-end clean reads for each sample on the BGISEQ platform. To validate the replicates, PCA analysis was done by DESeq2 (Love et al., 2014) (**Figure S1**).

Differential gene expression analysis: After duplicate and barcode removal, reads were aligned to the *P. formosa* genome version 5.1.2 (GCA_000485575.1) using the STAR aligner version 2.5 (-runMode alignReads -quantMode GeneCounts) (Dobin et al., 2013). A gene was considered as expressed if it had more than ten reads aligned. Based on the counts of the aligned reads, differentially expressed genes between *P. formosa*, *P. mexicana* and F1 hybrids (*Pmex/P.lat*) were obtained using DESeq2 (Love et al., 2014). A gene was defined as differentially expressed if the log₂ fold change (FC) is >|2| and a p-adj <0.05. For focussing on genes with known function during meiosis and germ cell development genes, we retrieved the IDs of the female meiotic genes from the meiosis online database (<https://mcg.ustc.edu.cn/bsc/meiosis/index.html>) (Li et al., 2014) (**Table S1**). Functional clustering was performed by the Database for Annotation, Visualization and Integrated Discovery (DAVID, <https://david.ncifcrf.gov/>) using human homologues.

Allele biased expressed gene analysis: To evaluate the differences in relative expression between parental alleles, the reads from *P. formosa* ovaries were mapped using Bowtie2 (Langmead et al., 2009) against both parental gene sequences (i.e., *P. latipinna* and *P. mexicana*) that are homologous to *P. formosa* (Lu et al., 2021). Uniquely mapped reads were retrieved, and transcript abundances were estimated as Transcripts per million (TPM) using Salmon (Patro et al., 2017). Genes with $TPM \geq 1$ were considered as expressed and were included in further analyses.

The frequency of parental allele biased expression for the differential expressed and meiotic genes was estimated as follows:

$$A_{P_{lat}} = \sum TPM_{P_{lat}} / (\sum TPM_{P_{lat}} + \sum TPM_{P_{mex}})$$

$$A_{P_{mex}} = \sum TPM_{P_{mex}} / (\sum TPM_{P_{mex}} + \sum TPM_{P_{lat}})$$

where A is *P. latipinna* or *P. mexicana* parental allele and TPM is the expression value determined for each parental allele. A gene was determined as *P. latipinna* or *P. mexicana* allele expression biased if the frequency was over 60%.

A protein interaction network was produced for the meiosis genes identified with allelic expression bias by applying the STRING database and visualized using Cytoscape software 3.9.0. (von Mering et al., 2003; Shannon et al., 2003).

Pachytene chromosomes and immunofluorescent staining: Pachytene chromosomes were obtained from juvenile females (1–14 days after birth) using a modification of the protocol described in (Peters et al., 1997). Ovaries were placed in 100 l of 100 mM sucrose and incubated for 10 min followed by preparation of cell suspension. The suspension was immediately dropped on SuperFrost® slides (Menzel Gläser), which had been dipped in a fresh 1% paraformaldehyde (PFA) pH 8,5 solution containing 0.15% Triton X-100. Cells were distributed by the gentle inclination of the slide. Slides were placed in a humid chamber for at least one hour. Afterward, slides were dried and washed in phosphate buffered saline (1xPBS; 4.3 mM Na_2HPO_4 , 1.43 mM KH_2PO_4 , 2.7 mM KCl, 137 mM NaCl, pH 7.4) and stored at 4 °C in 1xPBS for immunofluorescent staining procedure not longer than one week.

The following primary antibodies were used to detect lateral and central components of synaptonemal complexes (SC): rabbit polyclonal antibodies (ab14206, Abcam) against SYCP3 protein and chicken polyclonal antibodies (a gift from Sean M. Burgess (Blokhina et al., 2019)) against SYCP1 protein correspondingly. Recombination loci were detected with mouse monoclonal antibodies (ab14206, Abcam) against MLH1 protein. Prior to adding the antibodies, fresh slides were incubated with 1% blocking reagent (Roche) in 1xPBS containing 0.01% Tween-20 for 20 min. Antibodies were added in concentrations according to the manufacturers' specifications for 1 hour at RT. Slides were washed three times in 1xPBS at RT and incubated with secondary antibodies Alexa-488-conjugated goat anti-rabbit IgG (H+L) (Thermo Fisher Scientific), Alexa-594 goat anti-chicken IgY (H+L) (Thermo Fisher Scientific), and Alexa-594-conjugated goat anti-mouse IgG (H+L) (Thermo Fisher Scientific) for one hour at RT. Slides were washed three times in 1xPBS and mounted in Vectashield/DAPI (1.5 mg/ml) (Vector, Burlingame, Calif., USA).

Confocal laser scanning microscopy: Classical analysis of diplotene chromosomal spread preparations was almost impossible due to the small size of the oocyte nuclei, preventing any microsurgical manipulations. Thus, we investigated the intact oocyte nucleus of *P. formosa* and *P. mexicana* individuals. Nuclei were isolated with fine forceps from oocytes of 0.5–1 mm diameter in isolation medium (83 mM KCl, 17 mM NaCl, 6.5 mM Na_2HPO_4 , 3.5 mM KH_2PO_4 , 1 mM $MgCl_2$, 1 mM DTT (dithiothreitol). Isolated nuclei were transferred to an isolation medium containing 1 M TO-PRO™-3 Iodide (Thermo Fisher Scientific). Confocal laser scanning microscopy was carried out with a Leica TCS SP5 microscope based on a Leica DMI 6000 CS inverted microscope. Specimens were examined by the XYZ scanning technique using HC PL APO 20× objective and HeNe laser (633 nm).

Images were captured and processed using LAS AF software (Leica Microsystems, Germany); 3D reconstructions were made using Imaris 5.0.1 (Bitplane, AG) software.

Wide-field and fluorescence microscopy: Immunostained meiotic chromosomes were analyzed using aProvis AX70 Olympus microscope equipped with standard fluorescence filter sets. Microphotographs of chromosomes were captured by a CCD camera (DP30W Olympus) using Olympus Acquisition Software. Microphotographs were finally adjusted and arranged in Adobe Photoshop, CS6 software.

Results

Bivalent formation does not occur during meiosis of the asexual *Poecilia formosa*

To investigate the ability of *P. formosa* females to form bivalents, we performed immunostaining of chromosomal spreads during pachytene with antibodies against central (SYCP1) and lateral (SYCP3) components of the synaptonemal complex (SC). It has been shown that SYCP3 is localized on both bivalents and univalents while SYCP1 accumulates only on bivalents (Iwai et al., 2006; Bisig et al., 2012; Blokhina et al., 2019). In the sexual *P. mexicana* females, representing the maternal ancestor of *P. formosa*, we detected normal pairing and formation of 23 bivalents with no evidence of univalents or aberrant pairing (**Figure 1A**). To check for the presence of recombination loci antibodies against MLH1 proteins were used. MLH1 protein is an indicator of recombination and accumulates only on synapsed chromosomes (Kolas, et al., 2005; Moens 2006). One to two recombination spots per bivalent were observed (**Figure 1B**). Conversely, in *P. formosa* we detected accumulation only of SYCP3 but not SYCP1 protein, suggesting that synapsis is incomplete and, consequently, bivalents are not formed during the pachytene stage. We observed 46 univalents in accordance with the diploid number of chromosomes in this species (**Fig. 1D**). Consistent with this, on pachytene spreads from *P. formosa* oocytes stained with antibodies against MLH1 protein, no recombination loci were detected (**Figure 1E**), which further confirms the presence of univalents only and absence of crossovers.

To validate that regular chromosome pairing is incomplete and chromosomes remain univalent during *P. formosa* meiotic prophase I, we then studied the oocytes during the diplotene stage. Analysis of nuclei of intact oocytes revealed the presence of bivalents in oocytes of *P. mexicana*, while only univalents were detected in oocytes of *P. formosa* (**Figure 1C, F**).

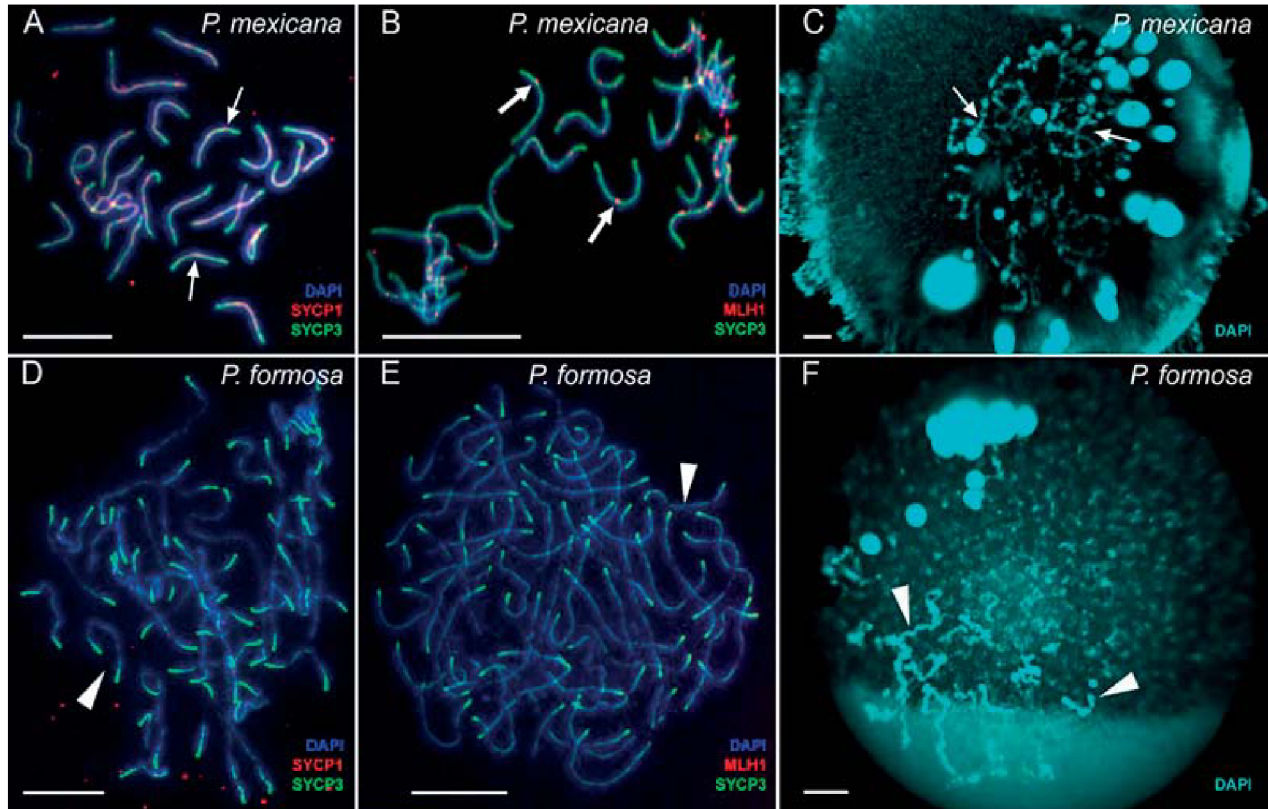

Figure 1. Meiotic chromosomes of *P. mexicana* (A, B, C) and *P. formosa* (D, E, D) during pachytene (A, B, D, E) and diplotene (C, F). Staining for lateral (SYCP3) and central (SYCP1) components of synaptonemal complexes clearly show the presence of 23 bivalents (indicated by arrows) in *P. mexicana* (A) and 46 univalents (indicated by arrowheads) in *P. formosa* (D). MLH1 immunostaining (thick arrows) demonstrates the occurrence of recombination in *P. mexicana* (B), while no recombination loci were detected in *P. formosa* (E). 3D reconstruction of *P. mexicana* (C) and *P. formosa* (F) diplotene oocyte nuclei after confocal microscopy showing the presence of bivalents (indicated by arrows) and univalents (indicated by arrowheads), correspondingly.

Meiotic genes differentially expressed between sexual and asexual ovaries

To understand the molecular mechanism of why meiosis is initiated but does not proceed to meiotic recombination and formation of bivalents, we first performed comparative transcriptome analyses of ovaries of *P. formosa* and its sexual parental species *P. mexicana*. This revealed 1045 differentially expressed protein coding and 228 lncRNA encoding genes, of which 954 were up and 319 downregulated in *P. formosa* vs. *P. mexicana* (Figure 2A). The upregulated protein coding genes were enriched for GO terms related to neural receptors, channels and transporters and calcium signaling (Figure S2), while the downregulated genes were enriched for cell adhesion and signaling (Figure S2). For more in-depth analyses, we generated a manually curated list of 244 genes known to be involved in the stages of female meiosis and oogenesis (Table S1). We found five downregulated genes, four of which are known to be exclusively expressed and thus specific to meiotic prophase I: *spo11*, *tex12*, *sds* and *syce3*. In addition to these prophase I specific genes, *agt*, a gene involved in the re-entry of metaphase I arrested oocytes in mammals, was also downregulated. Of the seven upregulated genes, all are essential for the first meiotic division: *lin28a*, *smc6*, *cbx1*, *lhcg*, *tp73*, *fmn2* and *aurkb* (Table 1).

Table 1. Meiosis genes differentially expressed between *P.fomosa* (Pf), F1 hybrids, and *P. mexicana* (Pmex). Changes in expression level are denoted as up, down or equal in relation to *P. formosa* or F1 hybrids.

Gene symbol	Pf vs Pmex	Pf vs F1 hybrids	F1 hybrids vs Pmex	Gene name
tex12	down	down	equal	testis expressed 12
nppc	equal	up	down	natriuretic peptide C
syce3	down	down	equal	synaptonemal complex central element protein 3
agt	down	equal	down	angiotensinogen
lhcgrr	up	up	equal	luteinizing hormone/choriogonadotropin receptor
tesc	up	equal	up	tescalcin a
tp73	up	equal	up	tumor protein p73
lin28a	up	equal	up	lin-28 homolog Aa
psmc3ip	up	equal	up	PSMC3 interacting protein
mei1	equal	down	up	meiotic double-stranded break formation protein 1
pacsin1	up	equal	up	protein kinase C and casein kinase substrate in neurons 1
smc6	up	equal	up	structural maintenance of chromosomes 6
sds	down	down	equal	serine dehydratase
spo11	down	down	equal	Spo11 initiator of meiotic double stranded breaks
aurkB	up	equal	up	aurora kinase B-like
pmp22	equal	up	equal	peripheral myelin protein 22b
camk2b	up	up	equal	calcium/calmodulin dependent protein kinase II beta
cbx1	up	equal	up	chromobox 1
aldh1a2	equal	up	equal	aldehyde dehydrogenase 1 family, member A2
spyda-like	equal	down	down	speedy protein A
spyda	equal	up	down	speedy/RINGO cell cycle regulator family member A
fmn2	up	equal	equal	formin 2

Except for these genes, all the other genes involved in meiosis and oogenesis were expressed at equal level in the ovaries of the asexual *P. formosa* and its sexual congener.

To separate gene expression changes connected to obligate apomixis from DEGs associated with the hybrid situation or automixis, we next analyzed meiotic gene expression in F1 hybrids produced from crossing *P. mexicana* females with *P. latipinna* males. Examining the ovary transcriptomes of F1 hybrids vs *P. mexicana* uncovered 923 upregulated and 520 downregulated genes (Figure 2B). Of these, 12 have a specific function in meiosis. The upregulated genes include *tp73*, *smc26*, *lin28a*, *cbx1*, *psmc3ip*, *aurkb*, which were also upregulated in the *P. formosa* ovary, plus *tesc*, *pacscin1* and *mei1*. The downregulated genes were *spdy*, *agt* and *nppc* that are also down in *P. formosa* ovaries in relation to the sexual parental species. Comparing the F1 hybrid to *P. formosa* revealed 1,560 upregulated and 309 downregulated genes (Figure 2C). Applying the filter for female meiosis genes, we detected in the hybrids above $\log_2FC \geq 2$ six genes that were downregulated (*aldh1a2*, *camk2b*, *pmp22*, *nppc*, *lhcg*, *spdyda*) and one (*syce3*) up. Of note, *tex12*, *spdyda-like*, *sds*, and *spo11* are also upregulated in the hybrids $>\log_2FC \geq 1.8$ (Table 1). In summary, there are four genes that are exclusively downregulated in the apomictic ovary of *P. formosa* in comparison with the automictic F1 and sexual *P. mexicana*: *spo11*, *scye3*, *tex 12* and *sds*.

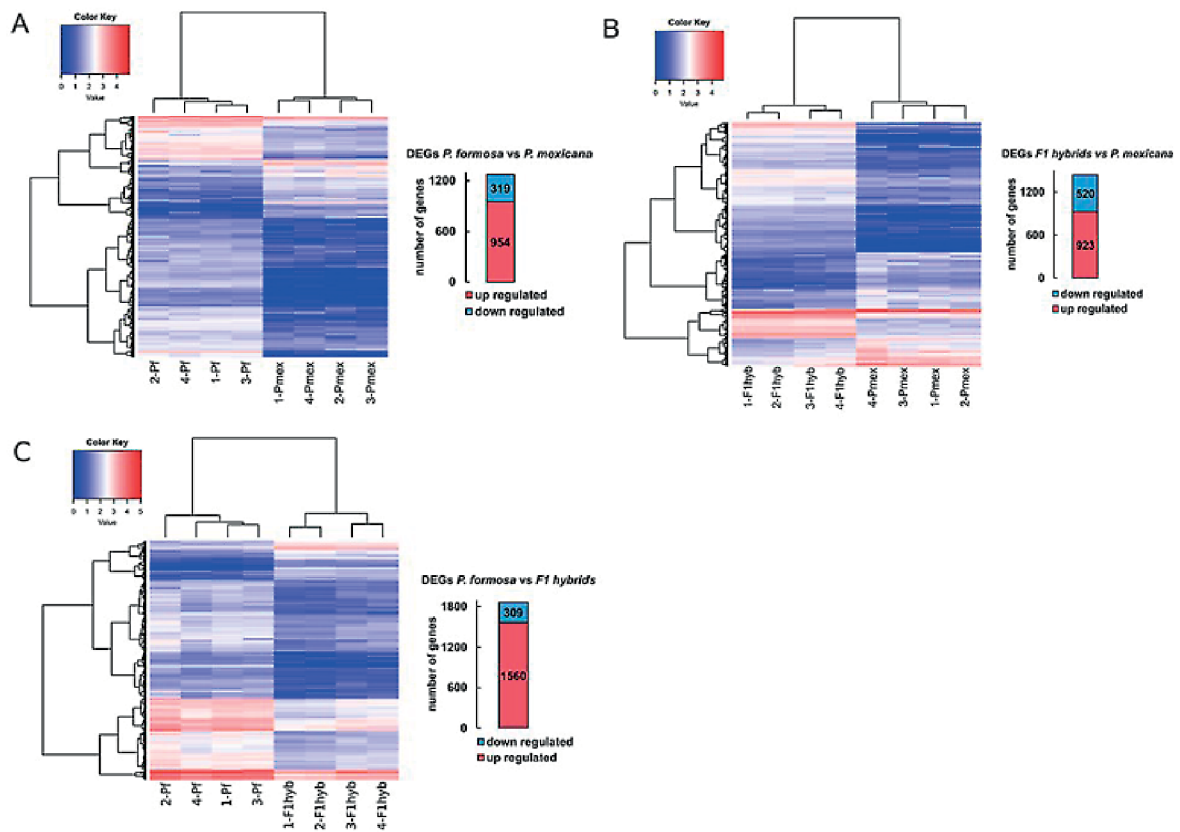

Figure 2. Differentially expressed genes between *P. formosa*, *P. mexicana* and F1 hybrids. Heatmaps and bar plots represent the DEGs between *P. formosa* and *P. mexicana* (A), F1 hybrids (female *P. mexicana* and male *P. latipinna*) vs *P. mexicana* (B) and *P. formosa* vs F1 hybrids (C). The blue color represents lowly expressed genes, and the red color represents highly expressed genes

Parental allele biased expression in *P. formosa* ovaries

The Amazon molly is a hybrid between two distantly related species. Hence allele biased expression or even allele-specific transcription could affect the gene expression profile during meiosis. To approach this question, we assessed the unequal expression of the two parental alleles of ovary genes. For a total of 719 genes differentially expressed between *P. formosa* and *P. mexicana* the parental orthologs could be identified. Allelic expression bias was defined if more than 60% expression came from one parental allele. As a result, 55% displayed a parental bias for the *P. latipinna* allele, 22% towards the *P. mexicana* allele and 23% were equally expressed from both parental alleles (Figure 3A). This strong bias towards *P. latipinna* is a specific feature of the differentially expressed ovary genes because the genome wide transcriptome of the *P. formosa* ovary does not show a bias to one of the parental species (Figure 3).

While the majority of meiosis genes displayed equal distribution of both alleles, 36 genes are biased towards the *P. latipinna* parental genome and 42 towards the *P. mexicana* parent (Figure 3B, Table S2). Interestingly, at the top of *P. mexicana* biased alleles (>90%), there is *dmrt1*, an important regulator of male sex determination, but also oogenesis (Zarkower and Murphy, 2021). The *sds* gene is not only differentially expressed but also *mexicana*-allele biased. For *P. latipinna*-biased genes, we found four that are also differentially expressed: *tp73*, *lin28*, *smc6*, *syce3* (Table S2).

When the meiotic genes showing allelic expression bias were included in a protein interaction network, many proteins that have an opposite expression bias towards the parental genomes were found as direct interactors, e.g., the synaptonemal complex proteins Syce3 and Sycp2 with Syce1 or the signaling protein Akt1 with the DNA repair protein Brca1 (Figure 3C). Central to the network, which is characterized by allele biased expression, are proteins that function in DNA repair and recombination.

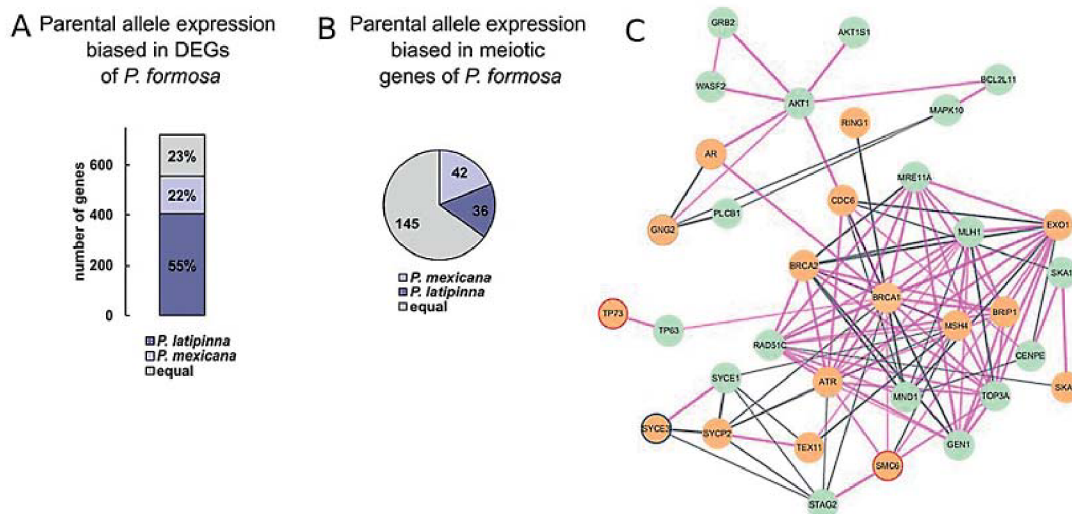

Figure 3. Allele specific gene expression. (A) Stacked bar graphs indicate the percentage of DEGs that are equally expressed or show parental allelic expression bias. (B) Meiotic genes in allele-specific expression categories as a percentage of the total number. (C) Protein interaction network of meiotic genes. The nodes represent the specific protein colored according to the parental expression bias (*P. latipinna* in grey, *P. mexicana* in purple). The edges and colors represent the type of evidence to predict protein-protein interactions. Lines in black: co-expression evidence and pink: experimental evidence. Nodes with blue or red borders indicate downregulated and upregulated genes, respectively.

Discussion

The cytogenetic analyses by staining of the lateral element protein Sycp 3 revealed that in *P. formosa*, oocyte chromosomes are forming axial elements of the synaptonemal complex (SC) but do not align and reach synapsis during a pachytene-like stage. Our results corroborate previous observations of SC formation during the early prophase of unisexual *Poecilia formosa* performed by electron microscopy (Monaco et al., 1984). The absence of Mlh1 immunostaining confirms absence of meiotic recombination. Consequently, in the diplotene stage, only univalents with no chiasmata were detected. We were unable to follow up on the chromosome behavior at the anaphase stage, so we yet cannot confirm from cytogenetics that chromatids rather than homologs are separated. However, the genomic data show that the mature eggs fully retain both parental genomes (Warren et al., 2018). The assembly of the *P. formosa* genome revealed no signs of recombination, and both parental haplotypes could be separately assembled at the whole genome level (<https://www.ncbi.nlm.nih.gov/assembly/?term=Poecilia+formosa>). In conclusion, our data are in agreement with a mechanism where meiosis is skipped, and a diploid egg is formed by apomixis.

Gamete formation with skipped meiosis (apomictic parthenogenesis) has been suggested for egg formation in triploid hybrids from *Carassius langsdorfi* and *C. gibelio* species complexes (Kobayasi, 1976; Yamashita et al., 1993; YANG et al., 1999). However, here the first meiotic division is prevented due to the emergence of a tripolar spindle resulting in the failure of the first polar body extrusion. Nevertheless, in contrast to *P. formosa*, in *C. gibelio*, chromosomal pairing and recombination have been observed at least between some homologous chromosomes (Zhang et al., 1992). In *P. formosa*, oocytes with univalents are able to proceed beyond pachytene, suggesting the absence of a pachytene checkpoint.

Ameiotic formation of oocytes is well reflected in the transcriptome data. Genes involved in the processes of homologue pairing, synapsis, and recombination are differentially expressed between the asexual *P. formosa* and the sexual parental *P. mexicana*. Of special relevance are four genes that are downregulated in the apomictic ovary compared to the automictic and sexual ovaries: *spo11*, *syce3*, *sds* and *tex12*. The *spo11* gene, which marks the initiation of recombination at the onset of meiosis (de Massy, 2013), is significantly downregulated compared to the sexual parent and also to the F1 hybrids, which are known to complete meiosis I. This finding is consistent with previous gonadal transcriptome analysis of *P. formosa* (Schedina et al., 2018), in which the number of *spo11* transcripts is lower in comparison to its sexual ancestor *P. mexicana*. The *Spo11* exonuclease protein is required for induction of recombination and pairing of meiotic chromosomes (de Massy, 2013). In *spo11* knock-out mice, spermatocytes arrest prior to pachytene with little or no synapsis while oocytes reach the diplotene stage (Baudat et al., 2000; Romanienko and Camerini-Otero, 2000).

Also, the *sds* gene, which is a meiosis-specific cyclin regulating normal homolog synapsis and bivalent formation (Azumi et al., 2002) is downregulated in *P. formosa* compared to *P. mexicana* and F1 hybrids.

From the next stage, chromosome synapsis in meiosis prophase 1, we found that *syce3* and *tex12*, which are major components of the transverse filaments of SC and essential to complete and stabilize full synapsis between homologous chromosomes (Hamer et al., 2008; Schramm et al., 2011), are downregulated in *P. formosa*. These findings support the notion that although the initiation of axial element assembly of all chromosomes of *P. formosa* appears to be normal, the lack of synapsis appears to be a consequence of the failure to initiate meiotic recombination, most likely because of the lack of Spo11 that is essential for meiotic double-strand breaks (DBS) (Baudat et al., 2000; Romanienko and Camerini-Otero, 2000). It has been shown that the expression level of Spo11 determines the number of DBS

and that a sufficient number of DBS are needed to support normal synapsis of chromosomes (Qu et al., 2021).

Several genes (*tp73*, *fmn2*, *smc6*, *aurkb*, *spdyda*, *pacsin1*) are involved in cell cycle progression (Viveiros et al., 2004; Dumont et al., 2007; Shuda et al., 2009; Farmer et al., 2011; Gebel et al., 2017; Gonzalez and Nebreda, 2020) are upregulated in *P. formosa* and the hybrids. Among them *tp73*, *aurkb* and *fmn2* control the progression of meiosis I through the regulation of the correct spindle assembly to properly attach sister chromatids to microtubules (Tomasini et al., 2009) and the assembly of microtubule-independent chromatin positioning during metaphase I (Dumont et al., 2007).

Interestingly, *spdyda* encoding the essential meiotic cell cycle regulator and the component of the maturation promoting complex Speedy/Ringo (Ferby et al., 1999) has already previously been noted by its copy number increase in *P. formosa* compared to its sexual progenitors (Warren et al., 2018). Also, the copy number of *aurkb*, a meiotic chromosome segregation regulator enriched at the kinetochores in metaphase I (Shuda et al., 2009), is increased in *P. formosa* compared to the sexual parental species.

Although all these genes are critical for meiosis I, it is not possible to make inferences about whether their altered expression is a cause or a consequence of the ameiotic development of oocytes.

Besides genes that function in the early steps of meiosis, several genes encoding hormone receptors (*nppc*, *lhcg*) (Zhang et al., 2001; Kawamura et al., 2011) and proteins from calcium signaling (*camk2b*, *tesc*) (Mochida and Hunt, 2007; Backs et al., 2010) were upregulated, while the G-protein coupled receptor ligand *agt* (Honorato-Sampaio et al., 2012) was downregulated, but all these expression changes appear to be more related to later stages of oocyte maturation in *P. formosa* and the F1 hybrids.

An earlier study on gene expression changes in ovaries of *P. formosa* compared with the sexual ancestors noted an overall downregulation of meiotic gene expression (Schedina et al., 2018). From the upregulated genes, *fmn2* and *spdyda* overlap with our study.

Allelic bias in expression or even allele specific expression could cause either a qualitative difference or, in particular, in cases of interacting proteins, which can lead to a dysfunction of the protein complex. In a hybrid genome, genes have to interact that underwent lineage-specific diverging evolution in the parental species. If they evolved divergent amino acid sequences, this should interfere with the function of the complex, a phenomenon is known as the Bateson-Dobzhansky-Muller (BDM) model of hybrid incompatibility (Orr, 1996). Even in cases when high heterozygosity may be generally beneficial for the evolution of hybrid species, in order to avoid such incompatibility, it may be advantageous to preferentially express one parental allele or even lose the other allele from the genome, especially for genes participating in multimeric protein complexes (Smukowski Heil et al., 2019; Janko et al., 2021). Interestingly, in *P. formosa* approximately one-third of the meiosis genes show allelic expression bias. The interaction network of the differentially expressed meiosis genes may thus be either considerably affected by a hybrid incompatibility effect. Even if single improper interactions may only marginally interfere with protein functions, the multitude of such interactions will amount to and disrupt the regulatory network of meiosis. Alternatively, allele biased expression could indicate a BDM dysgenesis avoidance mechanism to complete oogenesis in a hybrid.

Conclusions

The cytogenetic analyses indicate that in the Amazon molly the production of unreduced eggs occurs by apomixis due to a failure in the very first steps of meiotic prophase I, leading to the univalent formation and no recombination. The gene expression analyses uncovered a dysregulation and imbalance of several gene expressions known to have a function in meiosis. Two of them have also been noted in a previous study (Schedina et al., 2018). Given the critical function of *Spo11* as the initiator of all processes that occur downstream during meiotic phase I, we forward one hypothesis that the downregulation of *spo11* in *P. formosa* may have been the initial event to switch meiosis I to a mitosis-like germ cell division. This allowed the first *P. mexicana*/*P. latipinna* hybrid to become parthenogenetic and thus the founder of the asexual lineage (Stöck et al., 2010; Warren et al., 2018). The expression disequilibrium in the later acting genes could then be a sign of degeneration of the meiotic processes or reflect functional redundancy or selected changes, which improve the process.

All of the many attempts to replicate the formation of *P. formosa* by crossing *P. mexicana* females with *P. latipinna* males have failed. Despite female laboratory hybrids from the Amazon molly's parental species producing diploid eggs, they are not gynogenetic (Lampert et al., 2007). Thus, additional conditions are required. An explanation comes from the rare formation hypothesis for the origin of *P. formosa*, postulating that the right combination of parental alleles that have to come together in the first hybrid is rare (Stöck et al., 2010; Warren et al., 2018). This implicates a polygenic cause for the ability to produce diploid ameiotic oocytes. Under this hypothesis, many of the identified genes may work together in bringing in generating diploid germ cells. Expression changes and incompatibilities in meiosis genes are likely necessary to cause transitions from sexual to parthenogenetic reproduction in hybrid individuals.

Availability of data and material

All data referred to are included in the manuscript or.

The datasets generated during and/or analyzed during the current study are available in the supplementary materials and have been submitted to the NCBI BioProject database under accession number PRJNA79176.

Abbreviations

SC: synaptonemal complex
DSB: double-strand breaks
DEGs: differentially expressed genes
lncRNA: long non-coding RNA
FC: fold change
PCA: principal component analysis
TPM: transcript per million

References

- Avise, J.C., 2008. Clonality – The genetics, ecology, and evolution of sexual abstinence in vertebrates. Oxford University Press, Oxford.
- Azumi, Y., Liu, D., Zhao, D., Li, W., Wang, G., Hu, Y., Ma, H., 2002. Homolog interaction during meiotic prophase I in *Arabidopsis* requires the SOLO DANCERS gene encoding a novel cyclin-like protein. *Embo J.* 21, 3081–3095.
- Backs, J., Stein, P., Backs, T., Duncan, F.E., Grueter, C.E., McAnally, J., Qi, X., Schultz, R.M., Olson, E.N., 2010. The gamma isoform of CaM kinase II controls mouse egg activation by regulating cell cycle resumption. *Proc. Natl. Acad. Sci. USA* 107, 81–86.
- Baudat, F., Manova, K., Yuen, J.P., Jasin, M., Keeney, S., 2000. Chromosome synapsis defects and sexually dimorphic meiotic progression in mice lacking *Spo11*. *Mol Cell* 6, 989–998.
- Bell, G., 1982. The masterpiece of nature: The evolution and genetics of sexuality. University of California Press, Berkeley.
- Bisig, C.G., Guiraldelli, M.F., Kouznetsova, A., Scherthan, H., Höög, C., Dawson, D.S., Pezza, R.J., 2012. Synaptonemal complex components persist at centromeres and are required for homologous centromere pairing in mouse spermatocytes. *PLOS Genetics* 8, e1002701.
- Blokhina, Y.P., Nguyen, A.D., Draper, B.W., Burgess, S.M., 2019. The telomere bouquet is a hub where meiotic double-strand breaks, synapsis, and stable homolog juxtaposition are coordinated in the zebrafish, *Danio rerio*. *PLOS Genetics* 15, e1007730.
- Card, D.C., Vonk, F.J., Smalbrugge, S., Casewell, N.R., Wüster, W., Castoe, T.A., Schuett, G.W., Booth, W., 2021. Genome-wide data implicate terminal fusion automixis in king cobra facultative parthenogenesis. *Sci. Rep.* 11, 7271–7271.
- Chapman, D.D., Shivji, M.S., Louis, E., Sommer, J., Fletcher, H., Prodöhl, P.A., 2007. Virgin birth in a hammerhead shark. *Biol. Lett.* 3, 425–427.
- Cimino, M.C., 1972. Meiosis in triploid all-female fish (Poeciliopsis, Poeciliidae). *Science* 175: 1484–1486.
- Cuellar, O., 1971. Reproduction and the mechanism of meiotic restitution in the parthenogenetic lizard *Cnemidophorus uniparens*. *J. Morphol.* 133, 139–165.
- Cuellar, O., 1976. Cytology of meiosis in the triploid gynogenetic salamander *Ambystoma tremblayi*. *Chromosoma* 58, 355–364.
- de Massy, B., 2013. Initiation of meiotic recombination: how and where? Conservation and specificities among eukaryotes. *Annu. Rev. Genet.* 47, 563–599.
- Dedukh, D., Majtánová, Z., Marta, A., Pšenička, M., Kotusz, J., Klíma, J., Juchno, D., Boron, A., Janko, K., 2020. Parthenogenesis as a solution to hybrid sterility: the mechanistic basis of meiotic distortions in clonal and sterile hybrids. *Genetics* 215, 975–987.
- Dobin, A., Davis, C.A., Schlesinger, F., Drenkow, J., Zaleski, C., Jha, S., Batut, P., Chaisson, M., Gingeras, T.R., 2013. STAR: ultrafast universal RNA-seq aligner. *Bioinformatics* 29, 15–21.
- Dumont, J., Million, K., Sunderland, K., Rassinier, P., Lim, H., Leader, B., Verlhac, M-H., 2007. Formin-2 is required for spindle migration and for the late steps of cytokinesis in mouse oocytes. *Dev. Biol.* 301, 254–265.
- Farmer, S., San-Segundo, P.A., Aragón, L., 2011. The Smc5–Smc6 complex is required to remove chromosome junctions in meiosis. *PloS One* 6, e20948.

- Ferby, I., Blazquez, M., Palmer, A., Eritja, R., Nebreda, A.R., 1999. A novel p34cdc2-binding and activating protein that is necessary and sufficient to trigger G2/M progression in *Xenopus* oocytes. *Genes Dev.* 13, 2177–2189.
- Gebel, J., Tuppi, M., Krauskopf, K., Coutandin, D., Pitzius, S., Kehrlöesser, S., Osterburg, C., Dötsch, V., 2017. Control mechanisms in germ cells mediated by p53 family proteins. *J. Cell Sci.* 130, 2663–2671.
- Gonzalez, L., Nebreda, A.R., 2020. RINGO/Speedy proteins, a family of non-canonical activators of CDK1 and CDK2. In: *Seminars in Cell & developmental Biology*, Elsevier, vol. 107, pp. 21–27.
- Hamer, G., Wang, H., Bolcun-Filas, E., Cooke, H.J., Benavente, R., Höög, C., 2008. Progression of meiotic recombination requires structural maturation of the central element of the synaptonemal complex. *J. Cell Sci.* 121, 2445–2451.
- Honorato-Sampaio, K., Pereira, V.M., Santos, R.A., Reis, A.M., 2012. Evidence that angiotensin-(1-7) is an intermediate of gonadotrophin-induced oocyte maturation in the rat preovulatory follicle. *Exp. Physiol.* 97, 642–650.
- Hubbs, C.L., Hubbs, L.C., 1932. Apparent parthenogenesis in nature, in a form of fish of hybrid origin. *Science* 76, 628–630.
- Itono, M., Morishima, K., Fujimoto, T., Bando, E., Yamaha, E., Arai, K., 2006. Premeiotic endomitosis produces diploid eggs in the natural clone loach, *Misgurnus anguillicaudatus* (Teleostei: Cobitidae). *J. Exp. Zool. A Comp. Exp. Biol.* 305, 513–523.
- Iwai, T., Yoshii, A., Yokota, T., Sakai, C., Hori, H., Kanamori, A., Yamashita, M., 2006. Structural components of the synaptonemal complex, SYCP1 and SYCP3, in the medaka fish *Oryzias latipes*. *Exp. Cell Res.* 312, 2528–2537.
- Janko, K., Bartoš, O., Kočí, J., Roslein, J., Drdová, E.J., Kotusz, J., Eisner, J., Mokrejš, M., Štefková-Kašparová, E., 2021. Genome fractionation and loss of heterozygosity in hybrids and polyploids: mechanisms, consequences for selection, and link to gene function. *Mol. Biol. Evol.* 38, 5255–5274.
- Kallman, K.D., 1975. The platyfish, *Xiphophorus maculatus*. In: King, R. (Ed.), *Handbook of Genetics*, Vol. 4, Springer, Boston, MA, pp. 81–132.
- Kawamura, K., Cheng, Y., Kawamura, N., Takae, S., Okada, A., Kawagoe, Y., Mulders, S., Terada, Y., Hsueh, A.J.W., 2011. Pre-ovulatory LH/hCG surge decreases C-type natriuretic peptide secretion by ovarian granulosa cells to promote meiotic resumption of pre-ovulatory oocytes. *Hum. Reprod.* 26, 3094–3101.
- Kobayasi, H., 1976. A cytological study on the maturation division in the oogenic process of the triploid ginbuna (*Carassius auratus langsdorffii*). *Jpn. J. Ichthyol.* 22, 234–240.
- Kolas, N.K., Svetlanov, A., Lenzi, M.L., Macaluso, F.P., Lipkin, S.M., Liskay, R.M., Greally, J., Edelman, W., Cohen, P.E., 2005. Localization of MMR proteins on meiotic chromosomes in mice indicates distinct functions during prophase I. *J. Cell Biol.* 171, 447–458.
- Lampert, K.P., Scharl, M., 2008. The origin and evolution of a unisexual hybrid: *Poecilia formosa*. *Philos Trans. R. Soc. Lond. B Biol. Sci.* 363, 2901–2909.
- Lampert, K.P., Lamatsch, D.K., Fischer, P., Epplen, J.T., Nanda, I., Schmid, M., Scharl, M., 2007. Automictic reproduction in interspecific hybrids of poeciliid fish. *Curr. Biol.* 17, 1948–1953.
- Li, H., Meng, F., Guo, C., Wang, Y., Xie, X., Zhu, T., Zhou, S., Ma, H., Shan, H., Kong, H., 2014. MeioBase: a comprehensive database for meiosis. *Front. Plant Sci.* 5.
- Lively, C.M., Morran, L.T., 2014. The ecology of sexual reproduction. *J. Evol. Biol.* 27, 1292–1303.

- Loewe, L., Lamatsch, D.K., 2008. Quantifying the threat of extinction from Muller's ratchet in the diploid Amazon molly (*Poecilia formosa*). *BMC Evol. Biol.* 8, 88.
- Love, M.I., Huber, W., Anders, S., 2014. Moderated estimation of fold change and dispersion for RNA-seq data with DESeq2. *Genome Biol.* 15, 550.
- Lu, Y., Bierbach, D., Ormanns, J., Warren, W.C., Walter, R.B., Scharf, M., 2021. Fixation of allelic gene expression landscapes and expression bias pattern shape the transcriptome of the clonal Amazon molly. *Genome Res.* 31, 372–379.
- Lynch, M., Conery, J., Burger, R., 1995. Mutational meltdowns in sexual populations. *Evolution* 49, 1067–1080.
- Macgregor, H.C., Uzzell, T.M., 1964. Gynogenesis in salamanders related to *Ambystoma jeffersonianum*. *Science* 143, 1043–1045.
- Maynard Smith, J., 1978. *The Evolution of Sex*. Cambridge University Press.
- Mochida, S., Hunt, T., 2007. Calcineurin is required to release *Xenopus* egg extracts from meiotic M phase. *Nature* 449, 336–340.
- Moens, P.B., 2006. Zebrafish: chiasmata and interference. *Genome* 49, 205–208.
- Monaco, P.J., Rasch, E.M., Balsano, J.S., 1981. Nucleoprotein cytochemistry during oogenesis in a unisexual fish, *Poecilia formosa*. *Histochem J* 13, 747–761.
- Monaco, P.J., Rasch, E.M., Balsano, J.S., 1984. Apomictic reproduction in the Amazon molly, *Poecilia formosa*, and its triploid hybrids. In: Turner, B.J. (Ed.), *Evolutionary Genetics of Fishes*, Plenum Press, New York, pp. 311–318.
- Neiman, M., Hehman, G., Miller, J.T., Logsdon, J.M., Jr., Taylor, D.R., 2010. Accelerated mutation accumulation in asexual lineages of a freshwater snail. *Mol Biol Evol* 27, 954–963.
- Orr, H.A., 1996. Dobzhansky, Bateson, and the genetics of speciation. *Genetics* 144, 1331–1335.
- Patro, R., Duggal, G., Love, M.I., Irizarry, R.A., Kingsford, C., 2017. Salmon provides fast and bias-aware quantification of transcript expression. *Nat Methods* 14, 417–419.
- Peters, A.H.F.M., Plug, A.W., van Vugt, M.J., de Boer, P., 1997. Short communications a drying-down technique for the spreading of mammalian meiocytes from the male and female germline. *Chromosome Res.* 5, 66–68.
- Qu, W., Liu, C., Xu, Y.-T., Xu, Y.-M., Luo, M.-C., 2021. The formation and repair of DNA double-strand breaks in mammalian meiosis. *Asian J. Androl.* 23, 572.
- Rasch, E., Monaco, P.J., Balsano, J.S., 1982. Cytophotometric and autoradiographic evidence for functional apomixis in a gynogenetic fish, *Poecilia formosa* and its related, triploid unisexuals. *Histochem.* 73, 515–533.
- Romanienko, P.J., Camerini-Otero, R.D., 2000. The mouse Spo11 gene is required for meiotic chromosome synapsis. *Mol. Cell* 6, 975–987.
- Schedina, I.M., Groth, D., Schlupp, I., Tiedemann, R., 2018. The gonadal transcriptome of the unisexual Amazon molly *Poecilia formosa* in comparison to its sexual ancestors, *Poecilia mexicana* and *Poecilia latipinna*. *BMC Genomics* 19, 12.
- Schlupp, I., 2005. The evolutionary ecology of gynogenesis. *Annu. Rev. Ecol. Evol. Syst.* 36, 399–417.
- Schramm, S., Fraune, J., Naumann, R., Hernandez-Hernandez, A., Höög, C., Cooke, H.J., Alsheimer, M., Benavente, R., 2011. A novel mouse synaptonemal complex protein is essential for loading of central element proteins, recombination, and fertility. *PLOS Genetics* 7, e1002088.

- Shannon, P., Markiel, A., Ozier, O., Baliga, N.S., Wang, J.T., Ramage, D., Amin, N., Schwikowski, B., Ideker, T., 2003. Cytoscape: a software environment for integrated models of biomolecular interaction networks. *Genome Res.* 13, 2498–2504.
- Shuda, K., Schindler, K., Ma, J., Schultz, R.M., Donovan, P.J., 2009. Aurora kinase B modulates chromosome alignment in mouse oocytes. *Mol. Reprod. Dev.: Incorporating Gamete Research* 76, 1094–1105.
- Smukowski, Heil, C.S., Large, C.R., Patterson, K., Hickey, A.S.-M., Yeh, C.-L.C., Dunham, M.J., 2019. Temperature preference can bias parental genome retention during hybrid evolution. *PLoS Genet.* 15, e1008383.
- Stenberg, P., Saura, A., 2009. Cytology of asexual animals. In: Schön, I. et al. (Eds), *Lost Sex: The Evolutionary Biology of Parthenogenesis*, Springer Netherlands, Dordrecht, pp. 63–74.
- Stöck, M., Lamatsch, D.K., Steinlein, C., Epplen, J.T., Grosse, W.R., Hock, R., Klapperstück, T., Lampert, K.P., Scheer, U., Schmid, M., et al., 2002. A bisexually reproducing all-triploid vertebrate. *Nat. Genet.* 30, 325–328.
- Stöck, M., Lampert, K.P., Moller, D., Schlupp, I., Scharf, M., 2010. Monophyletic origin of multiple clonal lineages in an asexual fish (*Poecilia formosa*). *Mol. Ecol.* 19, 5204–5215.
- Stöck, M., Dedukh, D., Reifová, R., Lamatsch, D.K., Starostová, Z., Janko, K., 2021. Sex chromosomes in meiotic, hemiclinal, clonal and polyploid hybrid vertebrates: along the 2018; extended speciation continuum'. *Philos. Trans. R. Soc. B-Biol. Sci.* 376, 20200103.
- Tomasini, R., Tsuchihara, K., Tsuda, C., Lau, S.K., Wilhelm, M., Rufini, A., Tsao, M.S., Iovanna, J.L., Jurisicova, A., Melino, G. et al., 2009. TAp73 regulates the spindle assembly checkpoint by modulating BubR1 activity. *Proc. Natl. Acad. Sci. USA* 106, 797–802.
- Van Valen, L., 1973. A new evolutionary law. *Evolutionary Theory* 1, 1–30.
- Viveiros, M.M., O'Brien, M., Eppig, J.J., 2004. Protein kinase C activity regulates the onset of anaphase I in mouse oocytes. *Biol. Reprod.* 71, 1525–1532.
- von Mering, C., Huynen, M., Jaeggi, D., Schmidt, S., Bork, P., Snel, B., 2003. STRING: a database of predicted functional associations between proteins. *Nucleic Acids Res.* 31, 258–261.
- Warren, W.C., Garcia-Perez, R., Xu, S., Lampert, K.P., Chalopin, D., Stock, M., Loewe, L., Lu, Y., Kuderna, L., Minx, P., et al., 2018. Clonal polymorphism and high heterozygosity in the celibate genome of the Amazon molly. *Nat. Ecol. Evol.* 2, 669–679.
- Yamashita, M., Jiang, J., Onozato, H., Nakanishi, T., Nagahama, Y., 1993. A tripolar spindle formed at meiosis i assures the retention of the original ploidy in the gynogenetic triploid crucian carp, *Ginbuna Carassius auratus langsdorfii*: (fish oocytes/gynogenesis/meiosis/spindle formation/histone H1 kinase). *Dev. Growth Diff.* 35, 631–636.
- Yang, Za., Li, Qh., Wang, Yf., Gui, J.F., 1999. Comparative investigation on spindle behavior and MPF activity changes during oocyte maturation between gynogenetic and amphimictic crucian carp. *Cell Res.* 9, 145–154.
- Zarkower, D., Murphy, M.W., 2021. DMRT1: An ancient sexual regulator required for human gonadogenesis. *Sex. Dev.* doi:10.1159/000518272.
- Zhang, F., Oshiro, T., Takashima, F., 1992. Chromosome synapsis and recombination during meiotic division in gynogenetic triploid ginbuna, *Carassius auratus langsdorfii*. *Jpn. J. Ichthyol.* 39, 151–155.
- Zhang, F.P., Poutanen, M., Wilbertz, J., Huhtaniemi, I., 2001. Normal prenatal but arrested postnatal sexual development of luteinizing hormone receptor knockout (LuRKO) mice. *Mol Endocrinol* 15: 172–183.

Acknowledgements

The authors thank the aquarium team of the Biocentre of the University of Würzburg for breeding and taking care of the fish.

Funding

IDC was supported by a SCIENTIA fellowship from the Bayerische Gleichstellungsförderung (BFG). MS was supported by Deutsche Forschungsgemeinschaft. DD was funded by the Czech Science Foundation (grant PPLZ L200452002). KJ, DD, and AM were also supported by the Czech Science Foundation project No. 21-25185S and by the Ministry of Education, Youth and Sports of the Czech Republic (grant no. 539 EXCELLENCE CZ.02.1.01/0.0/0.0/15_003/0000 460 OP RDE). Institute of Animal Physiology and Genetics receives support from Institutional Research Concept RVO67985904.

Contributions

MS and KJ designed the study. DD and AM performed cytogenetic experiments. JO extracted and provided the RNA. IDC, SK, YL, and TT analyzed the RNA-seq data. MA interpreted data. MS, IDC, and DD wrote the draft. All authors commented on the manuscript and contributed to the final version.

Conflict of interest

The authors declare that they have no competing interests.

CHAPTER 5

PRODUCTION AND USE OF TRIPLOID ZEBRAFISH FOR SURROGATE REPRODUCTION

Franěk, R., Tichopád, T., Fučíková, M., Steinbach, C., Pšenička, M., 2019. Production and use of triploid zebrafish for surrogate reproduction. *Theriogenology* 140, 33–43.

According to the general rules concerning copyright agreement between the authors and publisher, it is allowed to reuse the paper in Ph.D. theses of the authors (<https://www.elsevier.com/about/policies/copyright>).

My share on this work was about 15%.



Contents lists available at ScienceDirect

Theriogenology

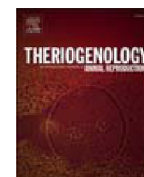
journal homepage: www.theriojournal.com

Production and use of triploid zebrafish for surrogate reproduction

Roman Franěk*, Tomáš Tichopád, Michaela Fučíková, Christoph Steinbach, Martin Pšenička

University of South Bohemia in České Budějovice, Faculty of Fisheries and Protection of Waters, South Bohemian Research Center of Aquaculture and Biodiversity of Hydrocenoses, Zátíší 728/II, 389 25, Vodňany, Czech Republic

ARTICLE INFO

Article history:

Received 3 April 2019
Received in revised form
29 July 2019
Accepted 12 August 2019
Available online 13 August 2019

Keywords:

Zebrafish
Chromosome manipulation
Triploid
Germ cell transplantation
Surrogate reproduction

ABSTRACT

We report for the first time, a comparison of two approaches for artificially induced triploidy in zebrafish (*Danio rerio*) using cold shock and heat shock treatments. Of the two methods, heat shock treatment proved more effective with a triploid production rate of 100% in particular females. Subsequently, triploid zebrafish larvae were used as recipients for intraperitoneal transplantation of ovarian and testicular cells originating from vas:EGFP strain in order to verify their suitability for surrogate reproduction. Production of donor-derived sperm was achieved in 23% of testicular cell recipients and 16% of ovarian cell recipients, indicating the suitability of triploids as surrogate hosts for germ cell transplantation. Success of the transplantation was confirmed by positive GFP signal detected in gonads of dissected fish and stripped sperm. Germline transmission was confirmed by fertilization tests followed by PCR analysis of embryos with GFP specific primers. Reproductive success of germline chimera triploids evaluated as fertilization rate and progeny development was comparable to control groups.

© 2019 Elsevier Inc. All rights reserved.

1. Introduction

Surrogate reproduction in fish via intraperitoneal germ cell transplantation (GCT) is a promising technology for aquaculture production and endangered species conservation due to the use of germline recipient species with more favourable breeding characteristics [1]. This involves the injection of germ cells from donor fish into a recipient larvae. The transplanted cells maintain the ability to migrate to the gonadal ridge and colonize the developing gonad and can later proliferate and produce donor-derived gametes [2]. To guarantee the viability of this technology, one of the main prerequisites for successful propagation of donor-derived gametes only from a surrogate is sterility of the host prior to GCT, ensuring no contamination of endogenous source gametes during fertilization. However, the factors affecting the large variability of success in GCT and donor-derived gamete production are not well understood. Though it can be speculated, that the gonad is space limited and the host and donor germline cells may compete to fill this niche. Additionally, transplanted germ cells may have altered

settlement location when they migrate towards germ cell-free niche, which is first occupied by endogenous germ cells. This competition is a potential factor that may consequentially affect the production capacity of donor-derived gametes [3]. To date, germ cell technologies have been applied in a wide range of fish species such as salmonids [4,5], cyprinids [6–8], Nile tilapia [9–11], medaka [12], sturgeons [13–16], and several marine fish species [2,17]. Zebrafish can serve as a valuable model for sterility research with the application of several distinct methods for sterility induction [3]. Early elimination of primordial germ cells (PGCs) can be achieved using gene knock out approaches such as Zinc Finger Nucleases against *dead end (dnd)* gene [18], or gene knockdown with *dnd* antisense morpholino oligonucleotide [19,20]. Both methods require microinjection into embryos in the time-limited 1–4 cell stage, thus an alternative approach using bath immersion *in vivo* morpholino against *dnd* can be more convenient in the case of large scale application [21]. Sterility was achieved via PGC depletion in transgenic zebrafish with artificially induced nitroreductase expression in PGCs exclusively using immersion into metronidazole enzyme which was converted into toxic metabolites and only PGCs were targeted by toxicity [22]. Similarly, sterility was achieved via PGCs migration disruption in transgenic zebrafish strain with SDF1 expression controlled by a heat shock protein. Regular event of PGCs migration is beside other mechanism guided

* Corresponding author. Zátíší 728/II, 389 25, Vodňany, Czech Republic.
E-mail addresses: franek@frov.jcu.cz (R. Franěk), tichopad@frov.jcu.cz (T. Tichopád), fucikova@frov.jcu.cz (M. Fučíková), steinbach@frov.jcu.cz (C. Steinbach), psenicka@frov.jcu.cz (M. Pšenička).

by SDF1 gradient towards the genital ridge, however, heat treatment caused throughout expression of SDF1 resulting in migration failure and production of sterile fish [23]. A cytostatic drug such as busulfan was used successfully in combination with thermal treatment, however, this method was developed only for adult fishes, because intraperitoneal administration is necessary [24]. All aforementioned methods for sterilization can be regarded as relatively time, knowledge, and resource intensive. Alternatively, sterile hybrids can be produced more simply with mate pairing or fertilization approaches. In zebrafish this is achieved by *in vitro* fertilization of zebrafish eggs with sperm from (*Danio albolineatus*) resulting in infertile hybrids [25]. Artificially induced triploidy also results in hosts suitable for application in surrogate reproduction technology [2,10,16]. The production of triploids and sterile hybrids are currently the only methods of creating sterile surrogates for GCT in fish species without identified genes to apply transgenic or gene silencing approaches [26]. These technologies are also more suitable when large quantities of sterile recipients are needed, or when the composition of the egg chorion does not permit easy microinjection of compounds for gene knockdown or knockout such as in many marine fish species [27,28]. Three sets of chromosomes in artificially induced triploids cannot proceed through meiosis and gamete maturation regularly, resulting in gametogenesis arrest or aneuploid gamete production further incompatible with the proper embryonic development [25]. Triploids can be induced by pressure or temperature treatment or electric shock resulting in inhibition of second polar body extrusion. However, all aforementioned physical treatments, require equipment such as pressure chamber and thermostat respectively [26–31]. Therefore, an alternative technique using cold shock could be convenient from point of the material equipment and, might has a less deleterious effect on the survival but with the same efficiency of triploid induction rate as the heat shock treatment.

Method for triploid zebrafish production using heat shock treatment was published already [32]. However, we did not succeed satisfactorily using the abovementioned heat shock protocol in our laboratory. Therefore, we revised the procedure for heat shock treatment and compared it with cold shock to identify an optimal condition for triploid zebrafish production with respect to achieve the highest survival and produce triploid fish. Suitability of triploid fish as surrogate recipients was tested by intraperitoneal transplantation by testicular and ovarian cells from vas:EGFP strain and subsequent production of donor-derived gametes with fertility tests confirmed by fluorescent microscopy and DNA analysis.

2. Material and methods

The study was conducted at the Faculty of Fisheries and Protection of Waters (FFPW), University of South Bohemia in České Budějovice, Vodňany, Czech Republic. The facility has the competence to perform experiments on animals (Act no. 246/1992 Coll., ref. number 160Z19179/2016–17214). The methodological protocol of the current study was approved by the expert committee of the Institutional Animal Care and Use Committee of the FFPW according to the law on the protection of animals against cruelty (reference number: MSMT-6406/119/2). The study did not involve endangered or protected species. Martin Psenicka owns the certificate (CZ 00673) giving capacity to conduct and manage experiments involving animals according to section 15d paragraph 3 of Act no. 246/1992 Coll.

2.1. Fish and gamete collection

Reproductively mature AB-line zebrafish were purchased from the European Zebrafish Resource Center (Germany), and vas:EGFP-

line were purchased from University of Liège, Belgium. Zebrafish broodstock were maintained in a zebrafish housing system (ZebTEC Active Blue) at 28 °C, 14L:10D photoperiod, and fed twice daily with Tetramin flakes and once daily with *Artemia* nauplii. Breeding pairs were placed into the spawning chambers the afternoon before the spawning (one male and one female) and separated with a barrier. On the light onset of the next day, the barrier was removed and fish were observed for oviposition. Breeding pairs were immediately transferred into the laboratory. Gametes for *in vitro* fertilization were obtained after anaesthesia in 0.05% tricaine solution (Ethyl 3-aminobenzoate methanesulfonate). Sperm from at least 5 males were pooled together in 50 µl of Kurokura 180 solution [33], eggs were collected from each female separately and fertilized promptly. Fertilized eggs were divided into control and treatment groups and were cultured at 28.5 °C.

2.2. Triploid induction and rearing

Cold shock (CS) treatment for the given time was conducted with fertilized eggs in a plastic strainer placed in a Styrofoam box with 2 L of ice chilled water. Heat shock (HS) treatment was conducted in a plastic strainer placed in a 5 L recirculated water bath with thermostat under varying conditions. Parameters used in all CS and HS trials are summarized in Table 1.

The remainder of the intact fertilized eggs from each female was kept as non-treated control. Females (n = 7) producing eggs with fertilization rate in control below 65% were regarded as having bad quality and were excluded from results and replaced by new females. Swim-up larvae were fed by paramecium for one week, later with *Artemia* nauplii *ad libitum* and held until the first month in an incubator in plastic boxes. Fish were then transferred into a zebrafish housing system and were kept until reaching maturity. Five females with separately fertilized eggs were used as replicates. Eggs from each female were divided into the same approximate portions of 3 (4) groups according to tested variables in performed treatment and one untreated control at 28.5 °C. Survival was recorded as the percentage of swim-up embryos at 6 days post fertilization.

2.3. Flow cytometry

Surviving swim-up stage larvae were analysed for triploidy confirmation in order to obtain results representing only viable triploids. Whole larvae (euthanized by tricaine overdosing) or later on fin clips were processed using a kit for nuclei staining CyStain UV Precise T (Sysmex Partec GmbH, Germany) according to the manufacturer's protocol. The relative DNA content was determined using a CyFlow Ploidy Analyzer (Sysmex Partec GmbH, Germany) against samples from diploid control groups. Ten larvae were analysed from each female in each treatment and group.

Table 1
Variables tested during optimization of triploid zebrafish production.

Treatment	Temperature	Duration time	Initiation time
Cold shock			
CS temperature	3, 6, 9 °C	5 min	1 mpf
CS duration	6 °C	5, 10, 15 min	1 mpf
CS initiation time	6 °C	5 min	0.5, 1 mpf
Heat shock			
HS temperature	41, 41.4, 42 °C	2 min	2 mpf
HS duration	41.4 °C	1, 2, 3, 4 min	2 mpf
HS initiation	41.4 °C	2 min	1, 2 mpf

mpf – minute post fertilization.

2.4. Transplantation

Male and female germ cell donors from vas:EGFP line were euthanized by tricaine overdose, decapitated, and the body was washed with 70% ethanol. Testes from two donors were excised aseptically. Each testis was cut into 4–6 fragments and washed several times in phosphate buffered saline (PBS) in order to remove leaking sperm. Medium for testicular tissue digestion contained 0.1% trypsin, 0.05% DNase dissolved in PBS. Fragments were collected by a pipette and transferred into 2 mL tube with 1 mL of digestion medium and were further minced with scissors and placed on a laboratory shaker for 50 min at 22 °C. Digestion was terminated by addition of 1 mL L-15 and 10% FBS (v:v). The suspension was filtrated through a 30 µm nylon filter (CellTrics® Systeem, Germany) and centrifuged at 0.3 g for 10 min. The supernatant was removed and the pellet was resuspended in 40 µL L-15 with 10% FBS. Female germ cells were collected from juvenile donors (2 months, n=5 per one transplantation trial) and digested as described for testicular cells. After centrifugation, ovarian cells suspension was washed and filtrated through 30 µm filter two times to remove excess of debris.

Triploid recipients produced by optimized HS procedure were anaesthetized at 7 dpt in 0.05% tricaine and placed on Petri dish coated with 1% agar. Testicular and ovarian cell suspension was loaded into the glass capillary attached to MN-153 micromanipulator (Narishige) and FemtoJet® 4x injector (Eppendorf). Triploid recipients were injected by approximately 3000–5000 testicular cells (TC group) or 500 ovarian cells (OC group) per individual. Fish were handled and transplanted at room temperature (22 °C). Each transplantation trial for TC and OC groups consisted of 30 transplanted fish when triploid recipients originated from the same batch in both groups. The remaining triploids and diploids were kept as a control and no operation was conducted on them. Transplanted fish were left to recover in dechlorinated tap water in an incubator at 24 °C and were not fed for 18 h. Survival and colonization rate of transplanted cells was monitored until adulthood. Fish were observed and photographed under a fluorescent stereomicroscope (Leica M205 FA) with fluorescent filters DAPI/FITC/TRITC (order no 10450614) or GFP (order no 10450469) equipped with a camera (Leica DMC 6200).

2.5. Production of donor-derived gametes

All adult surviving fish were screened for positive GFP signal in testis. GFP positive germline chimeras were set into spawning chamber afternoon (two or three males and separated one female). Males were anaesthetized the following morning and sperm was collected and observed under an inverted fluorescent microscope (Olympus IX 83) with a camera (Hamatsu C10600) to detect positive GFP signal in sperm. All fish producing GFP positive sperm from each transplantation trial were pooled together into one TC and one OC group and left to recover for 4 weeks.

Randomly selected fish from pooled TC and OC groups (10 fish per group) were propagated by semi-natural mating and *in vitro* fertilization. Semi-natural mating was conducted in spawning chambers when one germline chimera triploid male and two AB females in reproductive condition were set together in the afternoon and separated with a barrier. Next day at the onset of light, a barrier was removed and fish were allowed to spawn for 3 h. Spawning eggs were collected and the survival rate was monitored. Swim-up larvae from each group were pooled and 10 individuals were selected randomly and used for PCR analysis to verify the efficiency of germline transmission. Used germline chimeras in semi-natural mating were separated and were not used for following *in vitro* fertilization. Procedure for *in vitro* fertilization

was the same as described for AB line (2.1). Sperm collected from each chimeric male was stored separately in Kurokura 180 solution. Eggs were stripped from AB females (n=4), gently mixed, divided into equivalent portions, and fertilized with sperm from chimeric triploid males individually. Control group for semi-natural and *in vitro* fertilization consisted of AB females and vas:EGFP males. Survival of produced embryos was monitored. Offsprings from each group were pooled together and 10 randomly selected larvae were used for PCR analysis. DNA was extracted from larvae by PureLink™ Genomic DNA Mini Kit (Invitrogen™). GFP forward primer 5'-ACGTAAACGCCACAAGTTC-3', reverse primer 5'-AAGTCGTGCTGCTTCATGTG-3'. Primers were tested for specificity. The reaction mixture for PCR contained 1 µL template cDNA, 0.5 µL forward and 0.5 µL reverse primer, 5 µL PPP Master Mix (Top-Bio) and 3 µL PCR H2O (Top-Bio). Reaction conditions were 30 cycles of 94 °C for 30 s, 58 °C for 30 s and 72 °C for 30 s. Products were analysed on gel electrophoresis on 2% agarose gel on a UV illuminator.

2.6. Histology analysis

Euthanized zebrafish triploids and diploid controls were fixed overnight in Bouin's fixative. Samples were immersed in 70% ethanol, dehydrated and cleared in ethanol-xylene series, embedded into paraffin blocks, and cut into 4 µm thick sections using a rotary microtome (Leica RM2235). Paraffin slides were stained with hematoxylin and eosin by using a staining machine (Tissue-Tek DRS 2000) according to standard procedures. Histological sections were photographed and evaluated using a microscope (Nikon Eclipse Ci) with mounted camera (Canon EOS 1000D).

2.7. Statistical analysis

Survival of embryos was analysed by logistic regression with mixed effects where the treatment was set as fixed effect while females were set as a random effect with different intercepts (as mentioned above, eggs in each group were obtained from five females). Post hoc Tukey's test was performed to find out significant differences among groups of different treatment. The effect of treatment on a number of triploids was analysed by Friedman test where individual females were set as blocks. Differences among groups were analysed by Post-hoc Conover test with Benjamini-Hochberg correction [34]. All analyses were performed in R software (3.5.2).

3. Results

3.1. Production of triploid recipients for surrogate reproduction

The testing of CS revealed that exposure in 6 °C water bath resulted in significantly higher triploid production and survival in comparison to CS at 3 °C (Fig. 1A). Few triploids were also produced at 3 °C CS, but lower temperature was more detrimental to early embryonic development when even swim-up embryos exhibited malformations (Supplementary Fig. 1). Cold shock conducted at 9 °C was less effective for triploid induction. Testing of prolonged CS duration yielded comparable fraction of detected triploids in all tested durations, however, survival rate was more favourable in the 5 and 10 min duration CS treatment (Fig. 1B). Optimized CS temperature (6 °C) and duration (5 min) were used further to test different initiation times after fertilization. Triploid induction rate was improved significantly when CS was initiated at 30 s post fertilization (Fig. 1C).

The effect of HS on triploid induction rate was tested at different temperatures and shock durations during the first trial. HS

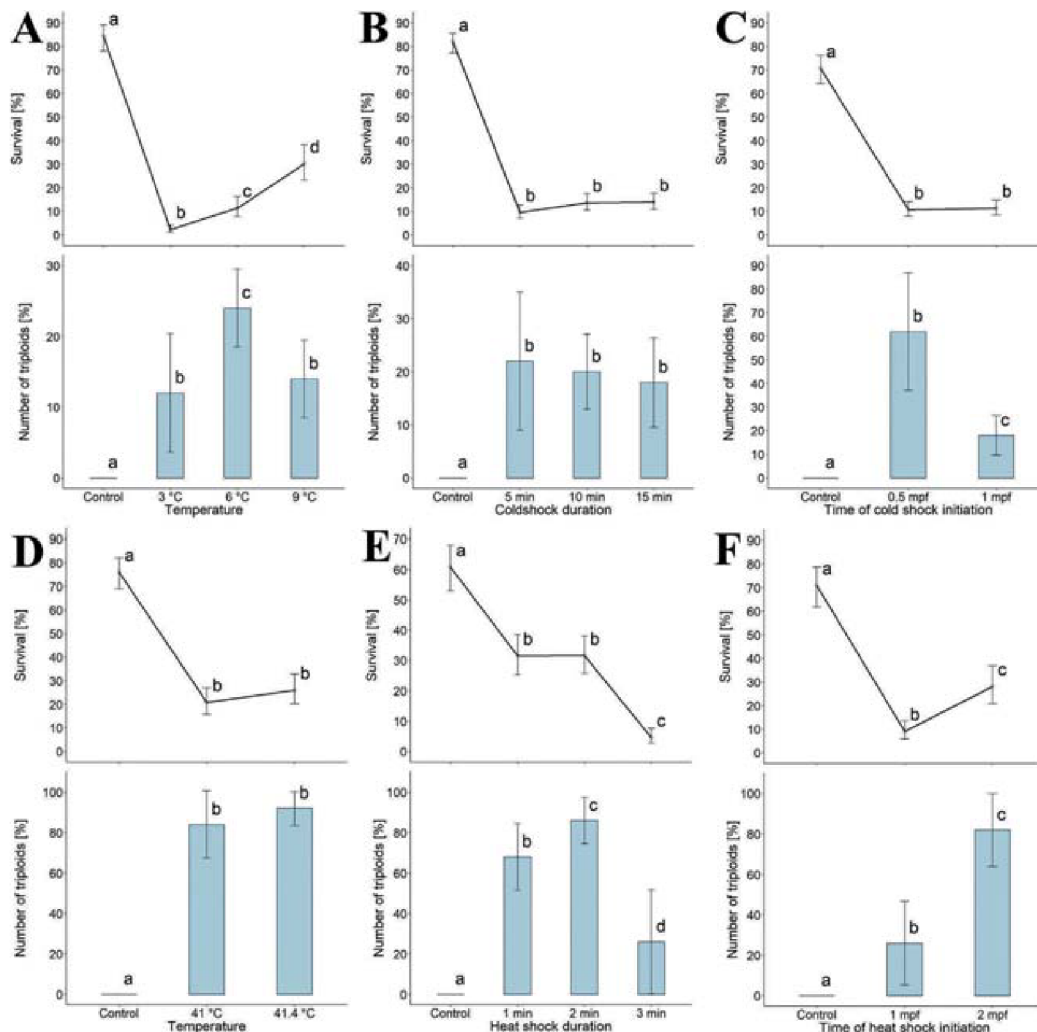

Fig. 1. Survival and success rate of triploid induction using cold shock (A–C) and heat shock treatment (D–F). A) Cold shock (CS) conducted at 3, 6 and 9 °C, initiated 1 min post fertilization with duration 5 min. B) CS conducted for 5, 10 and 15 min at 6 °C initiated 1 min post fertilization. C) CS initiated at 0.5 and 1 min post fertilization, for 5 min at 6 °C. D) Heat shock (HS) conducted at 41, 41.4 °C for 2 min initiated 2 min post fertilization. E) HS conducted for 1, 2 and 3 min at 41.4 °C initiated 2 min post fertilization. F) HS initiated 1 and 2 min post fertilization for 2 min at 41.4 °C. The figure shows mean and confidence intervals (for survival) or SD lines (for number of triploids). Different letters indicate statistical significance (Tukey's HSD, $p < 0.05$). Control groups were not treated and constantly held at 28.5 °C. D) Results from treatment at 42 °C were excluded because of total mortality of treated embryos. E) Results from heat shock duration for 4 min were excluded because of total mortality of treated embryos.

treatment at 42 °C was lethal for all embryos (data not shown) and viable triploids were produced only at 41 and 41.4 °C (Fig. 1D). Viability and triploid yield was slightly in favour of HS at 41.4 °C, and was used in the second HS trial assessing optimal HS duration. The percentage of triploids detected was significantly higher at HS lasting 1 and 2 min, and further HS prolongation resulted in significantly decreased survival rate only (Fig. 1E). The last HS trial tested different initiation times at 41.4 °C lasting 2 min. Treatment initiated 2 mpf (minutes post fertilization) yielded significantly higher survival as well as triploid induction rate in comparison to 1 mpf (Fig. 1F). Additionally, embryos treated at 1 mpf had less expanded chorion (Supplementary Fig. 2) and most of them did not hatch even when embryos appeared to develop normally. Therefore, HS-treatment at 41.4 °C, initiated 2 mpf, and lasting 2 min was identified as the optimal protocol for triploid induction (Supplementary Fig. 3) and was used to produce recipients for GCT in following experiment.

3.2. Germline chimera generation and reproduction

Despite the relatively invasive transplantation and the presence of exogenous cells, the survival rate was similar among transplanted triploids, non-transplanted triploids and control diploids (Table 2). Transplanted testicular and ovarian cells from vas:EGFP donors (Fig. 2) into triploid recipients exhibited strong GFP signal after transplantation (Fig. 3A). At 1 week post transplantation (wpt), the genital ridge of transplanted fish showed various patterns of germ cell colonization. These patterns were characterized as: 1) large number of transplanted cells surrounded whole gas bladder (Figs. 3B), 2) 5–20 cells located in the genital ridge close to the posterior part of the gas bladder, and 3) few individual cells located alongside the genital ridge. All patterns of colonization were represented in equivalent ratios. Transplanted ovarian cells were mostly found as a few or individual cells alongside the genital ridge, probably due to the lower number of transplanted cells. More

Table 2
Overall results from testicular and ovarian germ cell transplantation into triploid zebrafish recipients.

Trial	Group	I.				II.				III.			
		TC	OC	3n C	2n C	TC	OC	3n C	2n C	TC	OC	3n C	2n C
Transplanted		30	30	30	30	30	30	30	30	30	30	30	30
24 hpt	Survival	29	28	29	30	28	29	30	30	29	29	30	30
1 wpt	Survival total	27	26	28	29	28	26	28	28	27	26	26	27
	GFP +	22	18	–	–	15	16	–	–	24	15	–	–
2 wpt	Survival Total/GFP	24/20	22/17	26/-	28/-	24/13	23/14	24/-	26/-	23/21	21/11	25/-	26/-
	GFP+	16	12	–	–	11	10	–	–	20	9	–	–
4 wpt	Survival Total/GFP	23/16	20/11	24/-	27/-	24/11	20/9	22/-	26/-	18/17	19/8	22/-	26/-
	GFP+	14	10	–	–	11	7	–	–	13	8	–	–
10 wpt	Survival Total/GFP	23/14*	19/10*	24/-*	26/-*	24/11	18/7	22/-	26/-	18/13	19/8	22/-	23/-
	GFP+	12	8	–	–	9	7	–	–	11	8	–	–
Adult	Survival Total/GFP	22/13	18/9	24/-	26/-	22/9	18/7	22/-	26/-	18/11	19/8	22/-	23/-
	GFP+	13	9	–	–	9	7	–	–	11	8	–	–
	GFP + sperm	11	7	–	–	7	5	–	–	9	7	–	–

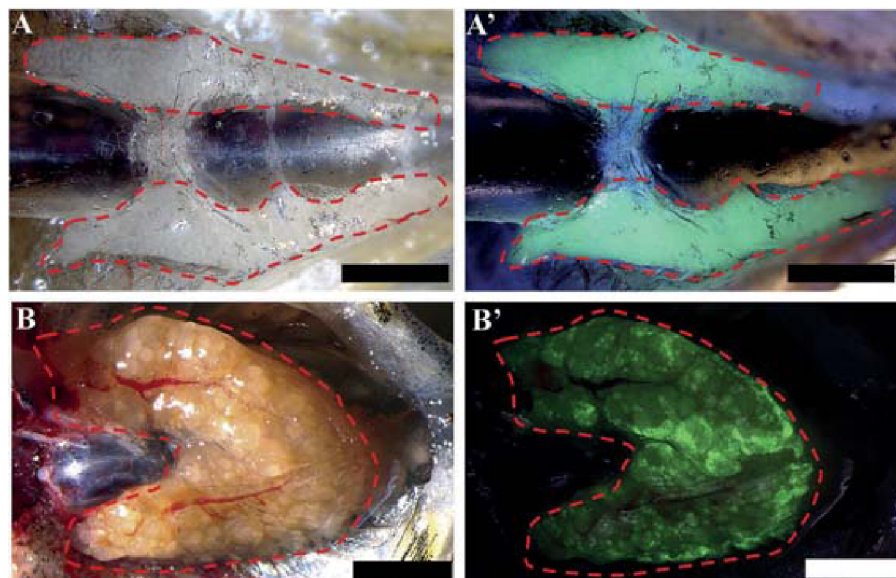

Fig. 2. Donors used for germ cell transplantation into triploid surrogate recipients. Ventral view on dissected vas:EGFP donors, A) male, testis are apparent by their white colour (bright field), A') fluorescent photo of testis with strong expression of GFP signal. B) female, ovaries, bright field and B') fluorescent caption of ovaries with strong GFP expression. Gonads are depicted by red broken lines. Both fluorescent images were taken using DAPI/FITC/TRITC filter. Scale bars = 3 mm. (For interpretation of the references to colour in this figure legend, the reader is referred to the Web version of this article.)

than half of the positive germline chimeras receiving testicular cells exhibited bilateral colonization in the genital ridges. Noticeable proliferation of transplanted cells started at 7–12 dpt in the majority of positive germline chimeras. Observation of transplanted fish at 2–3 wpt showed GFP positive cells proliferating and forming clusters alongside the gas bladder (Fig. 3C and D) or anterior progression in cells originally colonizing posterior part of the gas bladder. Later observation of gonadal development was difficult due to deposits of fat cells surrounding gonads, however, further proliferation was apparent according to expansion of tissues with GFP expression (Fig. 3E). Fish were screened at 10 wpt for the presence of GFP signal in gonads (Fig. 4A, B, C) and finclips of positive germline chimeras were taken for flow cytometry examination and triploidy of all positive chimeras was confirmed. All chimeras developed into phenotypic males regardless of the origin of transplanted cells (testicular or ovarian) (Fig. 5). Colonization rate assessed by 10 wpt was greater in TC groups in comparison to OC groups (Table 2).

Table 2 displays the results of germ cell transplantation into triploid recipients. TC – triploid recipients transplanted with testicular cells, OC – triploid recipients transplanted with ovarian cells, 3n C – remainder of the triploid recipients from the batch used for transplantation, 2n C – part of embryos not treated with heat shock to induce triploidy. Success of the transplantation was evaluated as a total number of surviving fish until adulthood with detected positive GFP signal (GFP+) in their gonads evaluated *in vivo* and successful collection of GFP positive sperm from adult germline chimeras (GFP + sperm). From 1 wpt until adult whole group was always screened for positive GFP signal and subdivided into positive and negative group (survival total/GFP) in order to be able to distinguish potential loss of signal from mortality. Survival Total/GFP represents number of fish surviving from previous screening counted before next screening. * Two GFP positive individuals from TC and OC and from 3n and 2n control groups were sacrificed for gonad observation.

Hpt – hours post-transplantation, wpt – weeks post-

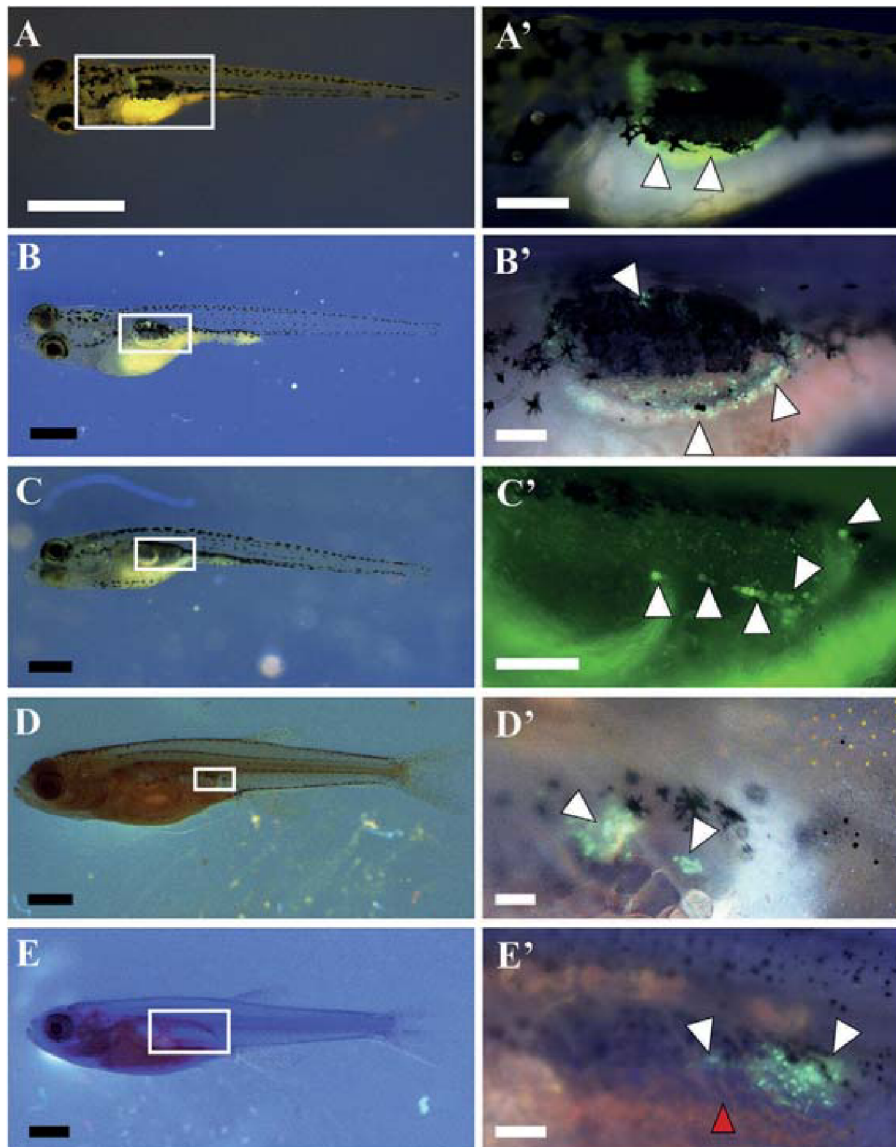

Fig. 3. Patterns of colonization after vas:EGFP germ cells transplantation into triploid recipients. A) Recipient 24 h post-transplantation, most of the transplanted cells are retaining strong GFP signal (A'). B) Recipient 1-week post-transplantation (wpt), GFP signal from transplanted cells is spread around the gas bladder when individual cells expressing GFP can be distinguished (B'). C) Recipient 2 wpt, GFP positive cells are creating alignment alongside the genital ridge (C'). D) Recipient 3 wpt, GFP positive cells are forming clusters (D'). E) Recipient 4 wpt, cells in clusters are further proliferating, however clear view on the cells is obscured due to formed fat cells (red arrow) (E'). Pictures in the left column (A–E) represent view on whole fish with white rectangles depicting magnified view on vas:EGFP transplanted cells presented in the right column (A'–E') with GFP positive cells indicated by white arrowheads. All images were taken with DAPI/FITC/TRITC filter with exception of C' taken with GFP filter. Scale bars A, E' = 1 mm, A' = 200 μ m, B', C', D' = 500 μ m, B, C, D, E = 2 mm. (For interpretation of the references to colour in this figure legend, the reader is referred to the Web version of this article.)

transplantation.

The majority of GFP positive triploid germline chimeras produced sperm, with GFP signal detected in all collected samples (Table 2, Fig. 6) and were able to fertilize AB strain eggs during semi-natural as well as *in vitro* fertilization. Overall, reproductive performance of triploid germline chimeras was similar to diploid control males from vas:EGFP strain. However, both tests showed that all control males from vas:EGFP had better performance evaluated as fertilization rate, survival at 24 hpf, and swim-up rate, while germline chimeras transplanted by ovarian cell had the lowest survival rate (Tables 2 and 3). Later PCR analysis confirmed

100% germline transmission, when GFP specific amplicon was detected (Tables 3 and 4, Supplementary Fig. 4).

Table 3 displays overall results of fertilization test when sperm collected from randomly chosen triploid germline chimera males transplanted with testicular or ovarian cells was used to fertilize pooled eggs obtained by stripping from four females from AB strain. Fertilization rate, survival 24 hpf and swim-up rate are expressed in total numbers/percentage of swim-up larvae at 6 days post fertilization calculated from number of eggs used for fertilization. The PCR - GFP column shows results of detection of GFP specific amplicon in 10 randomly selected swim-up larvae from pool in

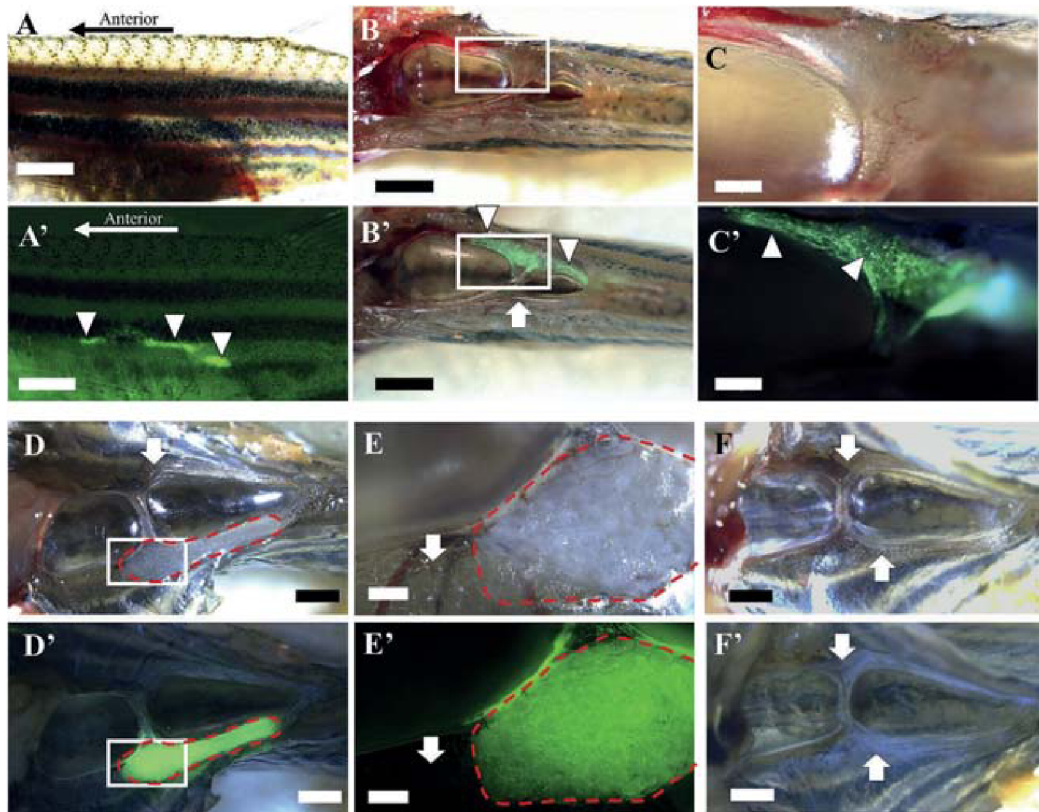

Fig. 4. Gonadal development in juvenile and adult triploid germline chimera. A-C) observation of gonadal development at 10 weeks post-transplantation, positive colonization could be detected *in vivo* according to GFP signal expression through the body wall indicated by white arrowheads (A'). B) Bright field view on the dissected individual from figure A. B') Fluorescent image, testis indicated by white arrow is non-colonized, while white arrowheads are indicating colonized testis according to GFP signal expression. White rectangles on B and B' are depicting magnified view on C and C'. D-E) Adult germline chimera. D) Ventral view on dissected body cavity, non-colonized testis is indicated by white arrow and colonized testis is apparent by white colour and indicated by red broken line. D') Fluorescent view with strong GFP expression in the colonized testis indicated by red broken line. E and E') Magnified view on the anterior part of the colonized testis from picture D and D' respectively. E) Colonized part is apparent by white colour (red broken line) and non-colonized part is transparent (arrow). E') Pattern of GFP signal is corresponding with colonized part of the testis (red broken line). F) Non-transplanted triploid control with transparent testis (arrows) and no detected GFP signal (F'). Images A-F were taken using brightfield, A' with GFP filter, B'-F' with DAPI/FITC/TRITC filter. Scale bars A – B', D – D', F – F' = 2 mm, C – C', E – E' = 500 µm. (For interpretation of the references to colour in this figure legend, the reader is referred to the Web version of this article.)

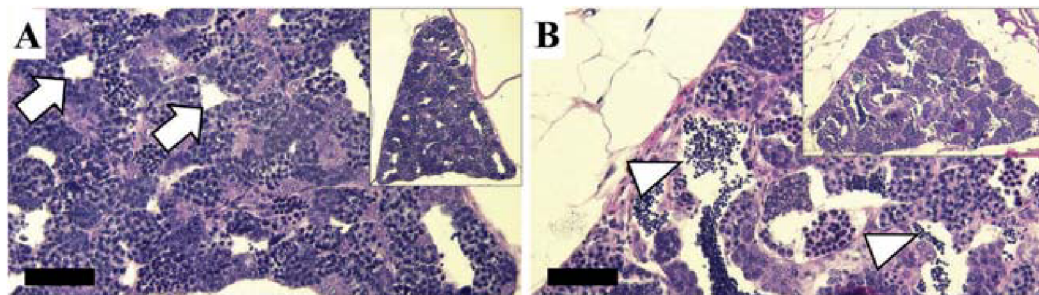

Fig. 5. Photomicrographs of histological sections of zebrafish testis. A) Triploid individual, empty lumen is pointed out by arrow. B) Diploid control male, lumens with spermatozoa are pointed out by arrows. View on whole testis is in right upper corner. Scale bars = 50 µm.

each group. Summarized results from survival rates are expressed in % as mean \pm SD. TC – recipients transplanted with testicular cells from vas:EGFP strain, OC – recipients transplanted with ovarian cells from vas:EGFP strain. Control – offspring from cross between vas:EGFP males and AB females.

Table 4 displays overall results of the fertilization test when germline chimeric males previously confirmed for GFP sperm

production were randomly selected (10 males from each group) and set individually with two AB females and allowed to spawn. Note that only successful spawnings were included in this table. Five males from TC and OC, and three males from C group did not induce oviposition. Fertilization rate, survival 24 hpf and swim-up rate is expressed in total numbers/percentage of swim-up larvae at 6 days post fertilization calculated from number of eggs used for

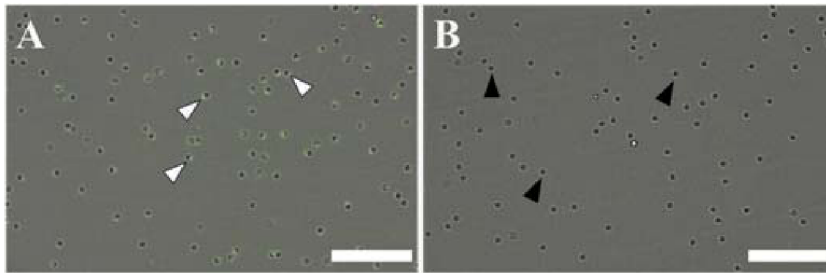

Fig. 6. Analysis of germline transmission in triploid surrogates. A) Fluorescent photomicrograph of sperm collected from triploid zebrafish germline chimera transplanted by testicular cells. White arrowheads indicate the head of donor-derived spermatozoa with positive GFP signal. B) Sperm collected from control diploid AB line male with no detected GFP expression (black arrowheads). Scale bars = 40 μ m.

Table 3

In vitro fertilization test of triploid germline chimeras producing donor-derived sperm.

Group	Male	Eggs	Fertilization rate	Survival 24 hpf	Swim-up rate	GFP PCR
TC	m1	39	32/82.1%	25/64.1%	21/53.8%	10/10
	m2	66	60/90.9%	55/83.3%	49/74.2%	
	m3	85	65/76.5%	58/68.2%	51/60%	
	m4	52	46/88.5%	40/76.9%	34/65.4%	
	m5	64	54/84.5%	47/73.4%	37/57.8%	
	Σ	306	84.5 \pm 5%	73.2 \pm 6.7%	62.3 \pm 7.1%	
OC	m1	56	46/82.1%	46/82.1%	42/75%	10/10
	m2	41	35/85.4%	31/75.6%	18/43.9%	
	m3	87	84/96.6%	72/82.8%	59/67.8%	
	m4	67	49/73.1%	41/61.2%	32/47.8%	
	m5	43	31/72.1%	25/58.1%	15/34.9%	
	Σ	294	81.9 \pm 8.9%	72 \pm 10.4%	53.9 \pm 15.1%	
Control	m1	68	56/82.4%	51/75%	50/73.5%	10/10
	m2	36	32/88.9%	29/80.6%	25/69.4%	
	m3	84	77/91.7%	72/85.7%	63/75%	
	m4	32	29/90.6%	22/68.8%	17/53.1%	
	m5	40	39/97.5%	31/77.5%	27/67.5%	
	Σ	260	90.2 \pm 4.9%	77.5 \pm 5.7%	67.7 \pm 7.8%	

Table 4

Fertilization test of triploid germline chimeras after semi-artificial mating with AB females.

Group	Male	Eggs	Fertilization rate	Survival 24 hpf	Swim-up rate	PCR - GFP
TC	m1	149	82/55%	73/49%	69/46.3%	10/10
	m2	76	55/72.4%	48/63.2%	32/42.1%	
	m3	134	82/61.2%	70/52.2%	62/46.3%	
	m4	52	38/73.1%	35/67.3%	28/53.8%	
	m5	82	51/62.2%	44/53.7%	34/41.5%	
	Σ	493	64.8 \pm 6.9%	57.1 \pm 7%	46 \pm 4.4%	
OC	m1	79	55/69.6%	38/48.1%	32/40.5%	10/10
	m2	37	23/62.2%	21/56.8%	18/48.6%	
	m3	63	39/61.9%	34/54%	20/31.7%	
	m4	108	72/66.7%	68/63.8%	53/49.1%	
	m5	97	42/43.3%	30/30.9%	24/24.7%	
	Σ	384	60.7 \pm 9.2%	50.5 \pm 10.9%	38.9 \pm 9.5%	
Control	m1	114	95/83.3%	87/76.3%	70/61.4%	10/10
	m2	89	61/68.5%	49/51.1%	44/49.4%	
	m3	74	52/70.3%	49/62.2%	43/58.1%	
	m4	82	43/52.4%	38/46.3%	32/39%	
	m5	34	28/82.4%	25/73.5%	22/64.7%	
	m6	98	65/66.3%	58/59.2%	45/45.9%	
	m7	56	38/67.9%	32/57.1%	24/42.9%	
	Σ	547	70.2 \pm 9.7%	61.4 \pm 9.7%	51.6 \pm 9.1%	

fertilization. GFP PCR column shows results of detection of GFP specific amplicon in 10 randomly selected swim-up larvae from pool in each group. Summarized results from survival rates are expressed in % as mean \pm SD. TC – recipients transplanted with

testicular cells from vas:EGFP strain, OC – recipients transplanted with ovarian cells from vas:EGFP strain. Control – offspring from cross between vas:EGFP males and AB females.

4. Discussion

Cold and heat shock treatments were tested in zebrafish in order to optimize the method for triploid production. The produced triploids were then used as sterile recipients for surrogate reproduction. Heat shock treatment with temperature 41.4 °C starting at 2 mpf, lasting 2 min was identified as the most suitable for reliable triploid zebrafish production. All artificially induced triploids developed into sterile phenotypic males. We further tested their suitability as surrogate parents for the transplantation of testicular and ovarian cells. Colonization rates were in favour of testicular cells, however, only male triploid germline chimeras, which were fertile and capable to mate with females from AB strain, were produced.

4.1. Triploid induction

The first triploid induction in zebrafish was reported by Kavumpurath and Pandian [32], when fertilized eggs were treated at 2.5 mpf at 41 °C, for 4 min. However, this conditions resulted in complete mortality in our attempts. Other studies used the aforementioned protocol with slight modification such as at 2.5 mpf at 41 °C, for 2 min [35]; or 2 mpf at 41 °C, for 2 min [36]. Our results suggest that only heat shock treatment is suitable for effective triploid production. Only a partial fraction of triploid swim-up larvae was obtained after optimized cold shock treatment, and survival was significantly higher after HS compared to CS. All adult triploids developed into phenotypic males with testis almost free of spermatozoa, while the testicular lumen of control diploid males were observed to be filled with spermatozoa. Apparently, a large proportion of germ cells in triploid testis were observed to be arrested in pachytene of the first meiosis and is the result of odd chromosome number exhibiting in disorganized synapsis [37]. These results confirm previous findings that reported all triploid zebrafish males with the notable exception where a few female individuals were produced. In our study, no triploid females were detected. Only male occurrence in artificially induced triploids is rare in fish, and is documented in zebrafish [36] and Rosy bitterling [38] only.

4.2. Surrogate reproduction

Artificially induced triploids have been used successfully as recipients for surrogate gamete production in several fish species such as masu salmon [4], grass puffer [17], medaka [12], rainbow trout [39,40] and nibe croaker [2]. This study provided the first report of zebrafish triploid swim-up larvae suitability as recipients for intraspecific GCT and donor-derived gametes production. As previously described, triploid zebrafish developed into males only [36], even after rescuing their fertility by transplantation of testicular or ovarian cells presented in this study.

Germ stem cells have been proved to be bipotential gamete precursors as they can develop in recipients gonads into female or male germ cells according to the recipient's sex [5]. Spermatogonia transplantation in species with male heterogamety resulted in partial production of YY rainbow trout supermales after mating male and female germline chimeras. This approaches could serve as an alternative for mono sex culture production which is normally achieved by production and subsequent mating of androgenetic or gynogenetic stocks [41].

Sex control in zebrafish is more complicated as seen in some families that can produce extremely sex-biased offspring in which the percentage of males can vary from 4.8% to 97.3% [42], or from 0% to 75% when fish were challenged to unfavourable or effluent conditions [43]. This phenomenon is attributed to polygenic sex

determination with the further influence of the surrounding environment [44,45]. Moreover, two zebrafish lines have been shown to lack sex-linked loci [46]. Thus, a different subpopulation of zebrafish can produce progeny of variable sex ratios.

Theoretically, part of the progeny produced using sperm from triploid germline chimeras transplanted by ovarian cells should after fertilization of normal eggs yield a fraction of WW super female progeny, which could be an interesting model for other fish species possessing female heterogamety sex determination. Then, induction of triploidy with of eggs obtained from WW females fertilized with sperm from triploid germline chimera possessing W or Z chromosome should yield a fraction of WWW super female triploids, which could provide more insights into sex determination in zebrafish and only triploid male occurrence.

Application of zebrafish recipients in surrogate reproduction resulted in only male germ line chimera production independent of the method of sterilization and germline transfer used such as transplanting blastomeres, single PGCs or adult germ stem cell [18,47,48]. Production of fertile zebrafish female chimeras seems to be not possible currently. The reason for the absence of germline chimera females is attributed to sterilization of recipients by PGCs depletion. In zebrafish, certain numbers of PGCs are required to maintain ovarian fate [20]. When taking into account that very few transplanted cells are capable of colonization of the recipient's gonad, such low number of cells bellow a threshold (3–29 PGCs) cannot maintain ovarian fate. Moreover, it has been shown that female germ cell presence is essential even in adulthood to maintain ovarian fate and prevent sex reversal into functional males [49].

In conclusion, to carry out whether and how to produce zebrafish germline chimeras producing eggs, following possibilities have not been tested yet. 1) Hormonal treatment optimization for zebrafish germline chimeras as was first attempted by Saito et al. [51] on zebrafish x pearl danio hybrid when 3/4 fish developed as females but were not able to produce eggs. 2) Increasing the number of germ cells colonizing the recipient gonad might have influence on sex differentiation in germ line chimera as was proven for a number of PGCs, since so far it was shown that only a few individual cells are colonizing gonads after transplantation. 3) Co-transplantation of female germ stem cells with early oocytes could also act supportively for female sex differentiation in germline chimera, however, this method has not been tested yet. 4) Essentiality of *dmrt1* and *amh* gene for proper male development have been reported recently in zebrafish [50,51], thus DNA and RNA interfering approaches such knockdown or knock out could influence sex ratio in germline chimeras in favour of females.

In the presented study, few spermatozoa were observed in the histological section of triploids. It has been reported that some of triploid zebrafish could fertilize zebrafish eggs, however, their reproductive success is extremely low (about 1% fertilization rate) while resulting embryos are aneuploids [36]. As expected, odd chromosome number is likely to cause synapsis disorganization [37] resulting in aneuploid sperm production with morphological abnormalities reported in bitterling [52]. Thus, spermatogenesis in triploid zebrafish is likely to be heavily impaired, however, some motile spermatozoa could be produced and fertilize eggs when they are not facilitated to competence with normal haploid spermatozoa. We suppose that the number of donor-derived spermatozoa from triploid surrogates is likely to override the negligible number of host-derived spermatozoa during fertilization competence because all PCR analysed embryos from fertilization tests were from donor-derived sperm exclusively in our study. Similar results were reported on triploid rainbow trout [39] and triploid Nibe croaker surrogates [2]. In several other species, triploids were shown to produce considerable amount of spermatozoa as reported

in Atlantic salmon, however, sperm characteristics were poor in comparison to sperm from diploid males [53]. A similar situation was reported in common carp triploid males producing spermatozoa incompatible with regular embryonic development [54]. Triploids of cod [55] and tench [56] also produced sperm with velocity comparable to sperm from diploids. Thus, triploid surrogates might not be convenient in all fish species for donor-derived progeny production when the relative number of host-derived gametes could be considerably large or their physiological characteristics are comparable to normal haploid spermatozoa. However, competence between endogenous and exogenous germ cells needs to be investigated in abovementioned species capable of producing larger amounts of sperm.

5. Conclusion

Surrogate reproduction via germ cell transplantation into zebrafish triploid developed in this study can potentially serve as an alternative method of zebrafish gene resource banking since it can be combined with a convenient method of spermatogonia cryopreservation by needle immersed vitrification [57]. Currently, thousands of mutants, transgenic lines, and CRISPR/Cas9, ZFN or TALEN genetically engineered strains have been generated in zebrafish which makes gene banking of the utmost importance [58–60]. Similarly, triploid males can be used as recipients to improve sperm production when originally few individuals are available for breeding or a given line suffers from poor reproductive performance as was shown in medaka when the reproductive performance of an inbred strain was improved by transplantation into triploid surrogates [12]. From our experience, number of early-stage germ cells obtained from testes originating from single adult zebrafish male is sufficient for intraperitoneal transplantation into at least 40–50 individuals. Thus, considering that at least 23% of transplanted triploid zebrafish produced donor sperm (TC group), at least 10 fertile triploid males can be recovered using testes from a single donor. It is noteworthy to point out that triploid zebrafish germline chimeras in our study were capable of mating with females from AB line in common spawning chambers, and their reproductive characteristics were comparable to mating with normal diploid males. The described HS protocol for triploid production is a simple method for sterile zebrafish production which does not require microinjection in embryos for delivery of compounds for gene knockdown or knock out to ensure sterilization. However, only sperm production from using PGCs depleted or hybrid recipient leaves an issue which needs to be addressed in order to produce donor-derived eggs from zebrafish recipient.

Contribution and disclosure

RF and MP: conceptualization, designing of the study, performing experiments, data collection and funding acquisition, TT: data collection and analysis, MF and CS: ploidy analysis and histology sections. All authors contributed on manuscript drafting and approved the submitted version.

Declarations of interest

None.

Acknowledgements

Samuel Janofsky is acknowledged for help with English editing. The study was financially supported by the Ministry of Education, Youth and Sports of the Czech Republic, projects CENAKVA (LM2018099), Biodiversity (CZ.02.1.01/0.0/0.0/16_025/0007370), by

the Grant Agency of the University of South Bohemia in České Budějovice GAJU 034/2017/Z. The Czech Science Foundation (project No. 17-19714Y) and NAZV QK1910248.

Appendix A. Supplementary data

Supplementary data to this article can be found online at <https://doi.org/10.1016/j.theriogenology.2019.08.016>.

References

- [1] de Siqueira-Silva DH, Saito T, dos Santos-Silva AP, da Silva Costa R, Psenicka M, Yasui GS. Biotechnology applied to fish reproduction: tools for conservation. *Fish Physiol Biochem* 2018;44:1469–85. <https://doi.org/10.1007/s10695-018-0506-0>.
- [2] Yoshikawa H, Takeuchi Y, Ino Y, Wang J, Iwata G, Kabeya N, et al. Efficient production of donor-derived gametes from triploid recipients following intra-peritoneal germ cell transplantation into a marine teleost, Nibe croaker (*Nibea mitsukurii*). *Aquaculture* 2017;478:35–47. <https://doi.org/10.1016/j.aquaculture.2016.05.011>.
- [3] Goto R, Saito T. A state-of-the-art review of surrogate propagation in fish. *Theriogenology* 2019;133:216–27. <https://doi.org/10.1016/j.theriogenology.2019.03.032>.
- [4] Okutsu T, Shikina S, Kanno M, Takeuchi Y, Yoshizaki G. Production of trout offspring from triploid salmon parents. *Science* 2007;317:15–7. 80.
- [5] Yoshizaki G, Lee S. Production of live fish derived from frozen germ cells via germ cell transplantation. *Stem Cell Res* 2018;29:103–10. <https://doi.org/10.1016/j.scr.2018.03.015>.
- [6] Franěk R, Marinović Z, Lujčić J, Urbányi B, Fučíková M, Kašpar V, et al. Cryopreservation and transplantation of common carp spermatogonia. *PLoS One* 2019;14:e0205481. <https://doi.org/10.1371/journal.pone.0205481>.
- [7] Octavera A, Yoshizaki G. Production of donor-derived offspring by allogeneic transplantation of spermatogonia in Chinese rosy bitterling. *Biol Reprod* 2018;0:1–10. <https://doi.org/10.1093/biolre/iy236>.
- [8] Franěk R, Tichopád T, Steinbach C, Xie X, Lujčić J, Marinović Z, et al. Preservation of female genetic resources of common carp through oogonial stem cell manipulation. *Cryobiology* 2019;78–85. <https://doi.org/10.1016/j.cryobiol.2019.01.016>.
- [9] Farlora R, Hattori-Ihara S, Takeuchi Y, Hayashi M, Octavera A, Alimuddin, et al. Intraperitoneal germ cell transplantation in the Nile tilapia *Oreochromis niloticus*. *Mar Biotechnol* 2014;16:309–20. <https://doi.org/10.1007/s10126-013-9551-y>.
- [10] Lacerda SMSN, Batlouni SR, Costa GMJ, Segatelli TM, Quirino BR, Queiroz BM, et al. A new and fast technique to generate offspring after germ cells transplantation in adult fish: the Nile tilapia (*Oreochromis niloticus*) model. *PLoS One* 2010;5:1–9. <https://doi.org/10.1371/journal.pone.0010740>.
- [11] Lacerda S, Batlouni S, Silva S, Homem C, França L. Germ cells transplantation in fish: the Nile-tilapia model. *Anim Reprod* 2006;3:146–59.
- [12] Seki S, Kusano K, Lee S, Iwasaki Y, Yagisawa M, Ishida M, et al. Production of the medaka derived from vitrified whole testes by germ cell transplantation. *Sci Rep* 2017;7:43185. <https://doi.org/10.1038/srep43185>.
- [13] Psenicka M, Saito T, Rodina M, Dzyuba B. Cryopreservation of early stage Siberian sturgeon *Acipenser baerii* germ cells, comparison of whole tissue and dissociated cells. *Cryobiology* 2016;72. <https://doi.org/10.1016/j.cryobiol.2016.02.005>, 199–122.
- [14] Linhartová Z, Saito T, Kašpar V, Rodina M, Prášková E, Hagihara S, et al. Sterilization of sterlet *Acipenser ruthenus* by using knockdown agent, antisense morpholino oligonucleotide, against dead end gene. *Theriogenology* 2015;84:1246–55. <https://doi.org/10.1016/j.theriogenology.2015.07.003>.
- [15] Ye H, Li C-J, Yue H-M, Du H, Yang X-G, Yoshino T, et al. Establishment of intraperitoneal germ cell transplantation for critically endangered Chinese sturgeon *Acipenser sinensis*. *Theriogenology* 2017;94:37–47. <https://doi.org/10.1016/j.theriogenology.2017.02.009>.
- [16] Baloch AR, Franěk R, Tichopád T, Fučíková M, Rodina M, Psenicka M, et al. Dnd1 knockout in sturgeons by CRISPR/Cas9 generates germ cell free host for surrogate production. *Animals* 2019;9:174. <https://doi.org/10.3390/ani9040174>.
- [17] Hamasaki M, Takeuchi Y, Yazawa R, Yoshikawa S, Kadomura K, Yamada T, et al. Production of tiger puffer *Takifugu rubripes* offspring from triploid grass puffer *Takifugu niphobles* parents. *Mar Biotechnol* 2017;19:579–91. <https://doi.org/10.1007/s10126-017-9777-1>.
- [18] Li Q, Fujii W, Naito K, Yoshizaki G. Application of *dead end* -knockout zebrafish as recipients of germ cell transplantation. *Mol Reprod Dev* 2017. <https://doi.org/10.1002/mrd.22870>.
- [19] Slanchev K, Stebler J, de la Cueva-Méndez G, Raz E. Development without germ cells: the role of the germ line in zebrafish sex differentiation. *Proc Natl Acad Sci U S A* 2005;102:4074–9. <https://doi.org/10.1073/pnas.0407475102>.
- [20] Tzung KW, Goto R, Saju JM, Sreenivasan R, Saito T, Arai K, et al. Early depletion of primordial germ cells in zebrafish promotes testis formation. *Stem Cell Rep* 2015;4:61–73. <https://doi.org/10.1016/j.stemcr.2014.10.011>.
- [21] Wong T-T, Zohar Y. Production of reproductively sterile fish by a non-

- transgenic gene silencing technology. *Sci Rep* 2015;1–6. <https://doi.org/10.1016/j.jygcn.2014.12.012>.
- [22] Zhou L, Feng Y, Wang F, Dong X, Jiang L, Liu C, et al. Generation of all-male-like sterile zebrafish by eliminating primordial germ cells at early development. *Sci Rep* 2018;8:1–12. <https://doi.org/10.1038/s41598-018-20039-3>.
- [23] Wong TT, Collodi P. Inducible sterilization of zebrafish by disruption of primordial germ cell migration. *PLoS One* 2013;8:1–8. <https://doi.org/10.1371/journal.pone.0068455>.
- [24] Nóbrega RH, Greebe CD, van de Kant H, Bogerd J, de França LR, Schulz RW. Spermatogonial stem cell niche and spermatogonial stem cell transplantation in zebrafish. *PLoS One* 2010;5:1–16. <https://doi.org/10.1371/journal.pone.0012808>.
- [25] Tiwary BK, Kirubakaran R, Ray AK. The biology of triploid fish. *Rev Fish Biol Fish* 2004;14:391–402. <https://doi.org/10.1007/s11160-004-8361-8>.
- [26] Arai K. Genetic improvement of aquaculture finfish species by chromosome manipulation techniques in Japan. *Aquaculture* 2001;197:205–28. [https://doi.org/10.1016/S0044-8486\(01\)00588-9](https://doi.org/10.1016/S0044-8486(01)00588-9).
- [27] Hulata G. Genetic manipulations in aquaculture: a review of stock improvement by classical and modern technologies. *Genetica* 2001;111:155–73. <https://doi.org/10.1023/A:1013776931796>.
- [28] Felip A, Zanuy S, Carrillo M, Piferrer F. Induction of triploidy and gynogenesis in teleost fish with emphasis on marine species. *Genetica* 2001;111:175–95. <https://doi.org/10.1023/A:1013724322169>.
- [29] Zhou L, Gui J. Natural and artificial polyploids in aquaculture. *Aquacult Fish* 2017;2:103–11. <https://doi.org/10.1016/j.aaf.2017.04.003>.
- [30] Piferrer F, Beaumont A, Falguière JC, Flajshans M, Haffray P, Colombo L. Polyploid fish and shellfish: production, biology and applications to aquaculture for performance improvement and genetic containment. *Aquaculture* 2009;293:125–56. <https://doi.org/10.1016/j.aquaculture.2009.04.036>.
- [31] Hassan A, Okomoda VT, Pradeep PJ. Triploidy induction by electric shock in red hybrid tilapia. *Aquaculture* 2018;495:823–30. <https://doi.org/10.1016/j.aquaculture.2018.06.074>.
- [32] Kavumpurath S, Pandian TJ. Induction of triploidy in the zebrafish, *Brachydanio rerio* (Hamilton). *Aquacult Res* 1990;21:299–306. <https://doi.org/10.1111/j.1365-2109.1990.tb00468.x>.
- [33] Rodina M, Cosson J, Gela D, Linhart O. Kurokura solution as immobilizing medium for spermatozoa of tench (*Tinca tinca* L.). *Aquacult Int* 2004;12:119–31. <https://doi.org/10.1023/B:AQUI.0000017192.75993.e3>.
- [34] Benjamini Yoav, Hochberg Y. Controlling the false discovery rate a practical and powerful approach to multiple testing. *J R Stat Soc* 1995;57:289–300. <https://doi.org/10.2307/2346101>.
- [35] Mizgirev IV, Majorova IG, Gorodinskaya VM, Khudoley VV, Revskoy SY. Carcinogenic effect of N-nitrosodimethylamine on diploid and triploid zebrafish (*Danio rerio*). *Toxicol Pathol* 2004;32:514–8. <https://doi.org/10.1080/01926230490496311>.
- [36] Delomas TA, Dabrowski K. Why are triploid zebrafish all male? *Mol Reprod Dev* 2018;85:612–21. <https://doi.org/10.1002/mrd.22998>.
- [37] Feitsma H, Leal MC, Moens PB, Cuppen E, Schulz RW. Mlh1 deficiency in zebrafish results in male sterility and aneuploidy as well as triploid progeny in females. *Genetics* 2007;175:1561–9. <https://doi.org/10.1534/genetics.106.068171>.
- [38] Ueno K, Arimoto B. Induction of triploids in *Rhodeus ocellatus ocellatus* by cold shock treatment of fertilized eggs. *Experientia* 1982;38:544–6. <https://doi.org/10.1007/BF02327041>.
- [39] Lee S, Katayama N, Yoshizaki G. Generation of juvenile rainbow trout derived from cryopreserved whole ovaries by intraperitoneal transplantation of ovarian germ cells. *Biochem Biophys Res Commun* 2016;478:1478–83. <https://doi.org/10.1016/j.bbrc.2016.08.156>.
- [40] Lee S, Iwasaki Y, Shikina S, Yoshizaki G. Generation of functional eggs and sperm from cryopreserved whole testes. *Proc Natl Acad Sci U S A* 2013;110:1640–5. <https://doi.org/10.1073/pnas.1218468110>.
- [41] Okutsu T, Shikina S, Sakamoto T, Mochizuki M, Yoshizaki G. Successful production of functional Y eggs derived from spermatogonia transplanted into female recipients and subsequent production of YY supermales in rainbow trout, *Oncorhynchus mykiss*. *Aquaculture* 2015;446:298–302. <https://doi.org/10.1016/j.aquaculture.2015.05.020>.
- [42] Liew WC, Bartfai R, Lim Z, Sreenivasan R, Siegfried KR, Orban L. Polygenic sex determination system in zebrafish. *PLoS One* 2012;7:e34397. <https://doi.org/10.1371/journal.pone.0034397>.
- [43] Lawrence C, Ebersole JP, Kesseli RV. Rapid growth and out-crossing promote female development in zebrafish (*Danio rerio*). *Environ Biol Fish* 2008;81:239–46. <https://doi.org/10.1007/s10641-007-9195-8>.
- [44] Nagabhushana A, Mishra RK. Finding clues to the riddle of sex determination in zebrafish. *J Bio Sci* 2016;41:145–55.
- [45] Liew WC, Orbán L. Zebrafish sex: a complicated affair. *Briefings Funct. Genomics* 2014;13:172–87. <https://doi.org/10.1093/bfpg/elt041>.
- [46] Wilson CA, High SK, McCluskey BM, Amores A, Yan Y, Titus TA, et al. Wild sex in zebrafish: loss of the natural sex determinant in domesticated strains. *Genetics* 2014;198:1291–308. <https://doi.org/10.1534/genetics.114.169284>.
- [47] Kawakami Y, Goto-Kazeto R, Saito T, Fujimoto T, Higaki S, Takahashi Y, et al. Generation of germ-line chimera zebrafish using primordial germ cells isolated from cultured blastomeres and cryopreserved embryoids. *Int J Dev Biol* 2010;54:1491–9. <https://doi.org/10.1387/ijdb.093059yk>.
- [48] Saito T, Goto-Kazeto R, Arai K, Yamaha E. Xenogenesis in teleost fish through generation of germ-line chimeras by single primordial germ cell transplantation. *Biol Reprod* 2008;78:159–66. <https://doi.org/10.1095/biolreprod.107.060038>.
- [49] Dranow DB, Tucker RP, Draper BW. Germ cells are required to maintain a stable sexual phenotype in adult zebrafish. *Dev Biol* 2013;376:43–50. <https://doi.org/10.1016/j.ydbio.2013.01.016>.
- [50] Webster KA, Schach U, Ordaz A, Steinfeld JS, Draper BW, Siegfried KR. *Dmrt1* is necessary for male sexual development in zebrafish. *Dev Biol* 2017;422:33–46. <https://doi.org/10.1016/j.ydbio.2016.12.008>.
- [51] Lin Q, Mei J, Li Z, Zhang X, Zhou L, Gui J-F. Distinct and cooperative roles of *amh* and *dmrt1* in self-renewal and differentiation of male germ cells in zebrafish. *Genetics* 2017;207:1007–22. <https://doi.org/10.1534/genetics.117.300274>.
- [52] Kawamura K, Ueda T, Aoki K, Hosoya K. Spermatozoa in triploids of the rosy bitterling *Rhodeus ocellatus ocellatus*. *J Fish Biol* 1999;55:420–32. <https://doi.org/10.1006/jfbi.1999.1008>.
- [53] Murray DS, Kainz MJ, Hebberecht L, Sales KR, Hindar K, Gage MJG. Comparisons of reproductive function and fatty acid fillet quality between triploid and diploid farm Atlantic salmon (*Salmo salar*). *R Soc Open Sci* 2018;5:180493. <https://doi.org/10.1098/RSO5.180493>.
- [54] Cherfas NB, Gomelsky B, Ben-Dom N, Peretz Y, Hulata G. Assessment of triploid common carp (*Cyprinus carpio* L.) for culture. *Aquaculture* 1994;127:11–8. [https://doi.org/10.1016/0044-8486\(94\)90187-2](https://doi.org/10.1016/0044-8486(94)90187-2).
- [55] Feindel NJ, Benfey TJ, Trippel EA. Competitive spawning success and fertility of triploid male Atlantic cod *Gadus morhua*. *Aquac Environ Interact* n.d.;1:47–55. doi:10.2307/24864017.
- [56] Linhart O, Rodina M, Flajshans M, Mavrodiev N, Nebesarova J, Gela D, et al. Studies on sperm of diploid and triploid tench, *Tinca tinca* (L.). *Aquacult Int* 2006;14:9–25. <https://doi.org/10.1007/s10499-005-9010-5>.
- [57] Marinović Z, Lujčić J, Kása E, Csenki Z, Urbányi B, Horváth Á. Cryopreservation of zebrafish spermatogonia by whole testes needle immersed ultra-rapid cooling. *J Vis Exp* 2018;2–7. <https://doi.org/10.3791/56118>.
- [58] Geisler R, Köhler A, Dickmeis T, Strähle U, Strähle U, Scholz S, et al. Archiving of zebrafish lines can reduce animal experiments in biomedical research. *EMBO Rep* 2016;18:128–32. <https://doi.org/10.15252/embr.201643561>.
- [59] Robles V, Cabrera E, Paz Herráez M. Germplasm cryobanking in zebrafish and other aquarium model species. *Zebrafish* 2009;6:281–93. <https://doi.org/10.1089/zeb.2009.0592>.
- [60] Agca Y. Genome resource banking of biomedically important laboratory animals. *Theriogenology* 2012;78:1653–65. <https://doi.org/10.1016/j.THERIOGENOLOGY.2012.08.012>.

CHAPTER 6

GENERAL DISCUSSION

ENGLISH SUMMARY

CZECH SUMMARY

ACKNOWLEDGEMENTS

LIST OF PUBLICATIONS

TRAINING AND SUPERVISION PLAN DURING STUDY

CURRICULUM VITAE

General discussion

For the last century, many phenomena in reproduction modes have been observed. One of the crucial roles in evoking changes in reproductive pathways belongs to hybridization and polyploidization. Genome merging can cause positive and negative radical changes such as induction of new traits, genomic shock, or chromosomal imbalances. Therefore, it is not surprising that many hybrids cannot perform meiosis in a traditional manner due to the many genetic and chromosomal imbalances and awake to preserve secondary pathways like asexuality to pass their genetic material to the next generations. However, the exact mechanisms behind the switch to asexuality are unknown; moreover, due to the various types of asexuality, these mechanisms differ between even closely related species. Similarly, the addition of a chromosomal set can cause direct genic and chromosomal aberrations and affect the reproduction systems. In the case of allopolyploids, these changes are even more multiplied. For these reasons, every hybrid, polyploid, or allopolyploid represents a unique model worth investigating.

1.1. *Cobitis* as an asexual model of premeiotic endoreplication

The hybrid asexual complex of *C. taenia* and *C. elongatoides*, which diverged ~ 9 million years ago, represents a unique opportunity to directly compare sexual and asexual species. Gametogenesis in *Cobitis* hybrid females is executed through the PMER pathway (Dedukh et al., 2020). On the other side, males do not possess any mechanism which would prevent aberrant pairing of diverged homologous chromosomes and the following meiotic arrest. Interestingly, only ~ 8% of oogonia are able to undergo PMER, whereas the rest of oogonia awaits the same fate as hybrids' spermatogonia (Dedukh et al., 2021).

The exact mechanism of PMER is unknown; nevertheless, allogenic transplantation of male germ cells revealed two important facts (Chapter 2). Firstly, when stem germ cells of male donors are transdifferentiated into female germ cells, they acquire the ability to perform PMER. Secondly, the decision about undergoing PMER lies within the germ cells as allotriploid females with diploid gonad produced haploid eggs, while diploid of *C. elongatoides* with allotriploid gonad produced unreduced triploid egg via PMER. These findings suggest that PMER is dependent on the female body environment, but the execution itself lies within the germ cells. In our work, it is not apparent how exactly the female pathway awakes PMER from male gonial cells. Transplantation of triploid gonial cells into diploid males results in meiotic arrest and sterility. In the related genus of *Misgurnus*, the experiments showed that clonal females artificially sex reversed to males resulted in spermatogenesis with diploid spermatozoa (Yoshikawa et al., 2009, 2007). Although it appears in contrast to our results, it is necessary to point out a few factors. Despite the fact that *Cobitis* and *Misgurnus* genus are related, they can have different sex determination systems because it has not been determined in *C. taenia* and *C. elongatoides* yet; thus, females sex reversed to males can somehow preserve the ability to produce clonal sperm cells, while *Cobitis* sex determination system cannot allow it. Secondly, both species can have different PMER mechanisms, which would also be tolerant of the sex determination effect. Finally, the difference between transplantation of gonial cells and sex reverse can affect epigenetics in an antagonist way. For example, transplanted cells could undergo complete epigenetic restart (Labbé et al., 2017), but sex reversed individuals could not have.

1.2. Common carp and gibel carp F1 hybrids

Although common carp (*Cyprinus carpio*) attractiveness lies in aquaculture research and gibel carp (*Carassius gibelio*) represents one of the most successful invasive species (Verreycken et al., 2007; Lusková et al., 2010; Perdikaris et al., 2012; Ribeiro et al., 2015). There was an opportunity to examine the reproductive potential of their F1 hybrids (Chapter 5). *Cyprinus* and *Carassius* taxa diverged ~ 25.8 million years ago (Rabosky et al., 2013). Investigations of F1 hybrids revealed that males are either wholly sterile or they produce aneuploid (fewer chromosomes than in the haploid cell) and polyploid spermatozoa with other aberrancies such as large and/or multiple nuclei and multiple flagella. Although velocity and motility lasted longer in hybrids, it does not probably represent any advantages in the fertilization process as both velocity and motility were significantly lower, and the begging of the measurement compared to parental species. Therefore, it can be assumed that sperm of parental species would be more successful in the competitive environment. Similar abnormalities of hybrid spermatozoa were also observed in male loach hybrids of *C. elongatoides* and *C. taenia* (Dedukh et al., 2020) and others, such as male hybrids of goldfish (*Carassius auratus*) and common carp (Kucinski et al., 2015), and male hybrids of *Misgurnus anguillicaudatus* and *M. mizolepis* (Zhao et al., 2016). Interestingly, all mentioned hybrid species possess the PMER pathway in the case of females (Itono et al., 2006; Wang et al., 2016; Dedukh et al., 2020). The investigation of oogonia in Chapter 5 was not performed unfortunately, so there is no record of ploidy level in the experiment. Nevertheless, considering data obtained from the spawning, it does not seem that hybrid females possess natural gynogenesis due to the high mortality rate in backcrosses. On the other side, induced gynogenesis (usage of genetically inactivated sperm from parental species) of investigated hybrids is possible (Cherfas et al., 1994), so F1 females also produce unreduced gametes. It seems that mechanisms responsible for diploid and polyploid eggs are highly conserved in speciation events, given the fact that goldfish probably originated from gibel carp (Chen et al., 2020), but certain conditions must be applied to awake them in wild populations.

1.3. *Poecilia formosa* as unprecedented model in fish asexuality

Amazon molly is another example of the gynogenetic asexual model organism, but in contrast to *Cobitis* hybrids, it has been declared an autonomous species. Genealogically, *Poecilia formosa* has arisen via a hybridization event from *P. mexicana* and *P. latipinna* as maternal and paternal ancestors, respectively (Stöck et al., 2010). However, creating artificial F1 hybridization of *P. mexicana* and *P. latipinna* will not produce *P. formosa* as offspring cannot produce gynogenetically (Lampert et al., 2007).

Cytogenetic investigation of meiosis supported with transcriptome profiling (Chapter 3) revealed a surprising outcome. Rather than perform PMER, *P. formosa* initiates meiosis but does not perform homologous pairing continuing only with univalent chromosomes. Our study is limited to only the pachytene stage; therefore, the behavior of chromosomes in the next meiotic stages is not known. Given the fact that *P. formosa* is reproducing clonally, retaining both parental genomes (Warren et al., 2018), it can be presumed that meiosis is initiated in order to activate egg final formation and maturation, but pairing, recombination, and division are skipped in order to produce clonal eggs. The transcriptomic investigation supports cytogenetic analysis as only the first meiotic genes were expressed in *P. formosa*. Genes connected with recombination and further meiosis process were down regulated. In other fish, apomixis was suggested in allotriploids of *Carassius gibelio* and *C. langsdorfi* (Yang

et al., 1999), but due to the occurrence of triploidy, meiosis is terminated by the inability of the first polar body to extrude the egg; moreover, pairing and recombination are not entirely terminated (Zhang et al., 1992) like in *P. formosa* case. Therefore, *P. formosa* represents a unique model organism reproducing via a combination of apomixis followed by gynogenesis. This uniqueness lies in the fact that other gynogenetic investigations are not able to detect differences in meiotic genes as their meiosis is successfully started and finished, as presented in Bartoš et al., (2019), even the final oocyte is in a diploid or triploid state.

1.4. Zebrafish as autopolyploidy model

Zebrafish is the most famous model fish organism due to its easy manipulation, external fertilization, high fecundity, rapid development, and visually attractive embryogenesis. Therefore, it has been subjected to many germ cell manipulations, including surrogate reproduction. The recent protocol (Chapter 4) revealed the effectiveness of heat shock for successful autopolyploidization. Although autogenic transplantation into sterile triploid zebrafish was proven successful by the given protocol, another interesting outcome regarding polyploidy in zebrafish was confirmed; all triploid zebrafish were confirmed as males (Kavumpurath and Pandian, 1990; Delomas and Dabrowski, 2018). The autopolyploidization causing shifts in sex ratio was also observed in *Rhodues ocellatus* (Ueno and Arimoto, 1982), but the mechanism is unknown.

The first proposed argument for the triploid zebra maleness phenomenon was the simple inability of females to tolerate ploidy (Kavumpurath and Pandian, 1990). However, zebrafish start with ovarian tissue and a few oocytes before apoptosis activation by 30 days post-hatching and switch to the male pathway (Pradhan and Olsson, 2014), so triploidy does not affect egg production. In zebrafish, the presence of primordial germ cells affects the final sex decision. A sufficient number of PGCs is needed for the promotion of ovarian fate; otherwise, sexual fate follows the male's pathway (Dai et al., 2015). Since triploid zebrafish are not morphologically different from diploids, and it is known that polyploidy compensates for increased cell size with the lower number of cells, hypothetically, triploids cannot acquire a sufficient number of primordial germ cells to activate the female gametogenesis pathway. Interestingly, the application of the hormonal treatment on triploid males does not awaken the female pathway in contrast to diploid females (Delomas and Dabrowski, 2018). Even though in several experiments, zebrafish triploids were only males, recently, one study presented an exception to this rule with the formation of female triploids (Peng et al., 2020). A possible explanation can lie in the genetic variability of laboratory strains, as zebrafish popularity cost a high price in the form of genetic diversity of laboratory strains compared to wild type strains (Whiteley et al., 2011; Suurväli et al., 2020). Moreover, till now, zebrafish sex determination is not known, but it is considered a complex model determined by multiple genes, the environment, and the lack of sex chromosomes (Liew and Orbán, 2014). It is possible by simple coincidence that, in some cases, juvenile triploids will possess enough primordial germ cells to promote femaleness; therefore, the cell size/number of cells hypothesis could also apply to the Peng et al. (2020) study. This is also supported by the fact that Peng et al. (2020) used hundreds of eggs for triploid induction in contrast to other studies.

Conclusion

More than a century of empirical research has demonstrated that hybridization and polyploidization have various phenotypic effects on organisms, with potentially profound impacts on their reproduction, ranging from inviability or complete sterility to different asexual pathways. Probably the main factor affecting the likelihood of a hybrid's switching to asexuality is the genetic distance between its parental species (Ernst, 1918). However, why this should be, remains unclear. Several theories elaborated on this concept proposing that the correlation between genetic divergence and the likelihood of asexuality may result from: 1) decreasing sequence homology among divergent hybridizing species; thus, the production of non-haploid gametes (De Storme and Mason, 2014); 2) differently timed gene expression in reproductive pathways of two parental species, which will be incompatible in F1 hybrids (Carman, 1997); 3) accumulations of aberrancies in epistatically interacting genes thereby altering classic sexual pathway (Moritz et al., 1989). These propositions are not mutually exclusive and might act combined or even altogether as there are several asexual modes such as parthenogenesis, gynogenesis, and hybridogenesis. This work provided insights into several questions about the interconnection between hybridization, polyploidy, and asexual reproduction.

First, by performing cross-transplantation of germ cells between sexual and asexual loaches, it was demonstrated that clonal reproduction is indeed tightly linked with hybrid sex, but in a quite different way than expected because, rather than reflecting strict genetic sex determination, it is confined to the female gonial pathway. On the other hand, performed experiments on male hybrids of another model organism, the hybrids between common carp and gibel carp, demonstrated that other traits related to hybridization might have quite common phenotypic patterns. Namely, the reproductive potential of such hybrids was low without any secondary pathways in motion of their sperm and thereby matched the data observed in many other fish hybrids where female asexuality also occurs.

Second, by comparing ovarian expression data between *Cobitis* and *Poecilia* asexuals, it has been shown that each asexual mode can have its own molecular pathway. Both loach *Cobitis elongatoides-taenia-taenia* and Amazon molly *Poecilia formosa* hybrids reproduce gynogenetically, but their strategy for unreduced egg production is different. Loaches perform premeiotic endoreduplication in order to pair sister chromatids during meiosis to avoid pairing of homologous chromosomes, which in males without PMER results in sterility. On the other hand, Amazon's molly strategy lies in meiosis suppression, thus avoiding chromosomal pairing entirely. The termination of meiosis is the crucial process of understanding the formation of sex.

Finally, it was attempted to streamline the protocols for the establishment of autoploid (triploid) fish strains, which may be very useful for closely focused studies aiming at disentangling the effects of hybridization from those of polyploidization *per se*. Not only have the task was successful, but it also confirmed a very interesting pattern of impact of autotriploidy on the sex of progeny, which opened unexpected questions about the importance of autoploidization in fish and its effect on sex differentiation.

The outlook for the future derived from the results presented in this work will be further examination of gametogenic pathways on the cytogenetic and molecular levels. Mainly, single cell RNA sequencing can open a new door to an understanding of basic molecular processes. In *Cobitis*, it could describe genes responsible for the switch to the PMER pathway. In *Poecilia*, it could explain the evolutionary question about the formation of sexuality. In *Danio*, the combination of hormone treatment and RNA sequencing could enlighten knowledge about gene regulatory pathways responsible for sex differentiation and sex change. In F1 hybrids of common carp and gibel carp, it could not only find out genes accountable for sterility but also show the parent-specific expression during gametogenesis.

References

- Bartoš, O., Röslein, J., Kotusz, J., Paces, J., Pekárik, L., Petrtýl, M., Halačka, K., Štefková Kašparová, E., Mendel, J., Boroń, A., Juchno, D., Leska, A., Jablonska, O., Benes, V., Šídová, M., Janko, K., 2019. The legacy of sexual ancestors in phenotypic variability, gene expression and homoeolog regulation of asexual hybrids and polyploids. *Mol. Biol. Evol.* 36, 1902–1920
- Carman, J.G., 1997. Asynchronous expression of duplicate genes in angiosperms may cause apomixis, bispority, tetraspority, and polyembryony. *Biol. J. Linn. Soc.* 61, 51–94.
- Chen, D., Zhang, Qing, Tang, W., Huang, Z., Wang, G., Wang, Yongjun, Shi, J., Xu, H., Lin, L., Li, Z., Chi, W., Huang, L., Xia, J., Zhang, X., Guo, L., Wang, Yuanyuan, Ma, P., Tang, J., Zhou, G., Liu, M., Liu, F., Hua, X., Wang, B., Shen, Q., Jiang, Q., Lin, J., Chen, X., Wang, H., Dou, M., Liu, L., Pan, H., Qi, Y., Wu, B., Fang, J., Zhou, Y., Cen, W., He, W., Zhang, Qiuji, Xue, T., Lin, G., Zhang, W., Liu, Z., Qu, L., Wang, A., Ye, Q., Chen, J., Zhang, Y., Ming, R., Van Montagu, M., Tang, H., Van de Peer, Y., Chen, Y., Zhang, J., 2020. The evolutionary origin and domestication history of goldfish (*Carassius auratus*). *Proc. Natl. Acad. Sci.* 117, 29775–29785.
- Cherfas, N.B., Gomelsky, B.I., Emelyanova, O.V., Recoubratsky, A.V., 1994. Induced diploid gynogenesis and polyploidy in crucian carp, *Carassius aratus gibelio* (Bloch), X common carp, *Cyprinus carpio* L., hybrids. *Aquac. Fish.* 25, 943–954
- Dai, X., Jin, X., Chen, X., He, J., Yin, Z., 2015. Sufficient numbers of early germ cells are essential for female sex development in zebrafish. *PLOS ONE* 10, e0117824.
- De Storme, N., Mason, A., 2014. Plant speciation through chromosome instability and ploidy change: Cellular mechanisms, molecular factors and evolutionary relevance. *Curr. Plant Biol.* 1, 10–33.
- Dedukh, D., Majtánová, Z., Marta, A., Pšenička, M., Kotusz, J., Klíma, J., Juchno, D., Boron, A., Janko, K., 2020. Parthenogenesis as a solution to hybrid sterility: the mechanistic basis of meiotic distortions in clonal and sterile hybrids. *Genetics* 215, 975–987.
- Dedukh, D., Marta, A., Janko, K., 2021. Challenges and Costs of Asexuality: Variation in Premeiotic Genome Duplication in Gynogenetic Hybrids from *Cobitis taenia* Complex. *Int. J. Mol. Sci.* 22, 12117
- Delomas, T.A., Dabrowski, K., 2018. Why are triploid zebrafish all male? *Mol. Reprod. Dev.* 85, 612–621.
- Ernst, A., 1918. Bastardierung als Ursache der Apogamie im Pflanzenreich. Eine Hypothese zur experimentellen Vererbungs- und Abstammungslehre. G. Fischer, Jena.
- Itono, M., Morishima, K., Fujimoto, T., Bando, E., Yamaha, E., Arai, K., 2006. Premeiotic endomitosis produces diploid eggs in the natural clone loach, *Misgurnus anguillicaudatus* (Teleostei: Cobitidae). *J. Exp. Zoolog. Part A Comp. Exp. Biol.* 305A, 513–523.
- Kavumpurath, S., Pandian, T.J., 1990. Induction of triploidy in the zebrafish, *Brachydanio rerio* (Hamilton). *Aquac. Res.* 21, 299–306.
- Kucinski, M., Demska-Zakes, K., Zarski, D., Liszewski, T., Fopp-Bayat, D., Jankun, M., Furgala-Selezniow, G., 2015. The morphological, histological and cytogenetic characteristics of goldfish *Carassius auratus* (L.) × common carp *Cyprinus carpio* (L.) hybrids. *Caryologia* 68, 77–83.
- Labbé, C., Robles, V., Herraes, M.P., 2017. Epigenetics in fish gametes and early embryo. *Aquaculture, Recent advances in fish gametes and embryo research* 472, 93–106.

- Lampert, K.P., Lamatsch, D.K., Fischer, P., Epplen, J.T., Nanda, I., Schmid, M., Schartl, M., 2007. Automictic reproduction in interspecific hybrids of Poeciliid fish. *Curr. Biol.* 17, 1948–1953.
- Liew, W.C., Orbán, L., 2014. Zebrafish sex: a complicated affair. *Brief. Funct. Genomics* 13, 172–187.
- Lusková, V., Lusk, S., Halačka, K., Vetešník, L., 2010. *Carassius auratus gibelio* — The most successful invasive fish in waters of the Czech Republic. *Russ. J. Biol. Invasions* 1, 176–180.
- Moritz, C., Brown, W., Densmore, L. 3rd, Wright, J., Vyas, D., Donnellan, S., Adams, M., Baverstock, P., 1989. Genetic diversity and the dynamics of hybrid parthenogenesis in *Cnemidophorus* (Teiidae) and *Heteronotia* (Gekkonidae). *Evolution and Ecology of Unisexual Vertebrates* 466, 87–112.
- Peng, L., Fu, W., Wu, X., He, S., Zhao, H., Liu, J., Liu, W., Xiao, Y., 2020. Bisexual fertile triploid zebrafish (*Danio rerio*): a rare case. *Mar. Biotechnol.* 22, 443–455.
- Perdikaris, C., Ergolavou, A., Gouva, E., Nathanailides, C., Chantzaropoulos, A., Paschos, I., 2012. *Carassius gibelio* in Greece: the dominant naturalised invader of freshwaters. *Rev. Fish. Biol. Fish.* 22, 17–27.
- Pradhan, A., Olsson, P.-E., 2014. Juvenile ovary to testis transition in zebrafish involves inhibition of Ptges. *Biol. Reprod.* 91, 1–15.
- Rabosky, D.L., Santini, F., Eastman, J., Smith, S.A., Sidlauskas, B., Chang, J., Alfaro, M.E., 2013. Rates of speciation and morphological evolution are correlated across the largest vertebrate radiation. *Nat. Commun.* 4, 1–8.
- Ribeiro, F., Rylková, K., Moreno-Valcárcel, R., Carrapato, C., Kalous, L., 2015. Prussian carp *Carassius gibelio*: a silent invader arriving to the Iberian Peninsula. *Aquat. Ecol.* 49, 99–104.
- Stöck, M., Lampert, K.P., Möller, D., Schlupp, I., Schartl, M., 2010. Monophyletic origin of multiple clonal lineages in an asexual fish (*Poecilia formosa*). *Mol. Ecol.* 19, 5204–5215.
- Suurväli, J., Whiteley, A.R., Zheng, Y., Gharbi, K., Leptin, M., Wiehe, T., 2020. The Laboratory Domestication of Zebrafish: From Diverse Populations to Inbred Substrains. *Mol. Biol. Evol.* 37, 1056–1069.
- Ueno, K., Arimoto, B., 1982. Induction of triploids in *Rhodeus ocellatus* by cold shock treatment of fertilized eggs. *Experientia.* 38, 544–546
- Verreycken, H., Anseeuw, D., Van Thuyne, G., Quataert, P., Belpaire, C., 2007. The non-indigenous freshwater fishes of Flanders (Belgium): review, status and trends over the last decade. *J. Fish Biol.* 71, 160–172.
- Wang, J., Liu, Q., Luo, K., Chen, X., Xiao, J., Zhang, C., Tao, M., Zhao, R., Liu, S., 2016. Cell fusion as the formation mechanism of unreduced gametes in the gynogenetic diploid hybrid fish. *Sci. Rep.* 6, 1–12.
- Warren, W.C., García-Pérez, R., Xu, S., Lampert, K.P., Chalopin, D., Stöck, M., Loewe, L., Lu, Y., Kuderna, L., Minx, P., Montague, M.J., Tomlinson, C., Hillier, L.W., Murphy, D.N., Wang, J., Wang, Z., Garcia, C.M., Thomas, G.C.W., Volff, J.-N., Farias, F., Aken, B., Walter, R.B., Pruitt, K.D., Marques-Bonet, T., Hahn, M.W., Kneitz, S., Lynch, M., Schartl, M., 2018. Clonal polymorphism and high heterozygosity in the celibate genome of the Amazon molly. *Nat. Ecol. Evol.* 2, 669–679.
- Whiteley, A.R., Bhat, A., Martins, E.P., Mayden, R.L., Arunachalam, M., Uusi-Heikkilä, S., Ahmed, A.T.A., Shrestha, J., Clark, M., Stemple, D., Bernatchez, L., 2011. Population genomics of wild and laboratory zebrafish (*Danio rerio*). *Mol. Ecol.* 20, 4259–4276.

- Yang, Z.A., Li, Q.H., Wang, Y.F., Gui, J.F., 1999. Comparative investigation on spindle behavior and MPF activity changes during oocyte maturation between gynogenetic and amphimictic crucian carp. *Cell. Res.* 9, 145–154.
- Yoshikawa, H., Morishima, K., Fujimoto, T., Saito, T., Kobayashi, T., Yamaha, E., Arai, K., 2009. Chromosome doubling in early spermatogonia produces diploid spermatozoa in a natural clonal fish. *Biol. Reprod.* 80, 973–979.
- Yoshikawa, H., Morishima, K., Kusuda, S., Yamaha, E., Arai, K., 2007. Diploid sperm produced by artificially sex-reversed Clone loaches. *J. Exp. Zool. A. Ecol. Genet. Physiol.* 307A, 75–83.
- Zhang, F., Oshiro, T., Takashima, F., 1992. Chromosome synapsis and recombination during meiotic division in gynogenetic triploid ginbuna, *Carassius auratus langsdorffi*. *J. Ichthyol.* 39, 151–155
- Zhao, Y., Fujimoto, T., Pšenička, M., Saito, T., Arai, K., 2016. Non-motile tetraploid spermatozoa of *Misgurnus* loach hybrids. *Fish. Sci.* 82, 127–135.

English summary

Sexual reproduction is one of the most common traits of eukaryotes and one of the most debated topics in biology. It involves complicated gene regulatory networks coordinating meiotic division, recombination, and the production of haploid gametes. Although these pathways are highly conserved, they have been repeatedly modified in many ways throughout the evolution of life forms. Interspecific hybridization and polyploidization are well known to alter the reproductive potential of an individual, and both phenomena are commonly linked with the so-called asexuality, i.e., the production of (partly) clonal gametes. Asexuality has attracted considerable attention as an excellent model to study the evolutionary dis/advantages of sex. Because of numerous associations with polyploidy, asexuals have also been considered as potential missing links in the formation of polyploid species. Nevertheless, asexual eukaryotic lineages are not an easily definable group. They are distributed throughout the tree of life and employ a broad spectrum of independently arisen mechanisms for gamete production. These mechanisms can noticeably differ even between closely related taxa, ranging from entirely ameiotic processes to those involving distorted meiotic divisions, which have different evolutionary consequences for each asexual lineage. It is therefore vital to understand whether there are any general rules followed in the processes leading to the abandonment of sexual reproduction or induction of sterility.

This thesis investigates the effect of hybridization and polyploidy on reproductive modifications in several fish taxa. The first investigation was focused on the regulation of unreduced gamete production in asexual allotriploid females of *Cobitis elongatoides-taeniataenia*. Naturally, it is accomplished via premeiotic endoreduplication (PMER) and followed by the pairing of sister chromatids. It has been discovered that the regulation of PMER is a female's exclusive trait, but the PMER execution depends on germ cell hybrid origin. Therefore, the asexuality phenotype in *Cobitis* is linked to phenotypic sex differentiation. Secondly, the spermatozoa characteristics of F1 hybrids of common carp and gibel carp were examined to evaluate morphological malfunctions. Males showed classical hybrid dysgenesis as their reproductive potential was negatively affected by the hybridization event, probably due to the high divergence between species. Although most of the spermatozoa were aneuploid or polyploid, a small fraction of spermatozoa was capable of fertilization and gave rise to F2 hybrid offspring. Thirdly, germ cells of ancestral hybrid *Poecilia formosa* were examined to confirm the PMER pathway; however, it was discovered that this species only initiates first meiotic genes, but meiosis itself is skipped. Therefore, *P. formosa* represents a rare exception to apomixis in fish taxa. Finally, a successful and effective protocol for triploid zebrafish production was established. Although the primary goal of this protocol was the establishment of sterile recipients for transplantation purposes, it represents an excellent opportunity for research of autopolyploidization effect on sex differentiation as all produced triploid zebrafish were confirmed as males.

Czech summary

Pohlavní rozmnožování je jedním z nejběžnějších rysů eukaryot a také jedním z nejdiskutovanějších témat v biologii. Zahrnuje komplikované genové regulační sítě koordinující meiotické dělení, rekombinaci a produkci haploidních gamet. Ačkoli jsou tyto dráhy vysoce konzervované, byly v průběhu evoluce opakovaně mnoha způsoby modifikovány. Je dobře známo, že mezidruhovná hybridizace a polyploidizace mění reprodukční potenciál organismu a oba jevy jsou běžně spojeny s asexualitou, tj. produkce klonálních gamet. Asexualita přitáhla značnou pozornost jako vynikající model pro studium evolučních výhod a nevýhod sexuálního rozmnožování a kvůli četným asociacím s polyploidii jsou asexuální organismy také považovány za potenciální chybějící články při tvorbě polyploidních druhů. Nicméně asexuální eukaryotické linie nejsou snadno definovatelnou skupinou. Jsou distribuovány po celém stromu života a využívají široké spektrum nezávisle vzniklých mechanismů pro produkci klonálních gamet. Tyto mechanismy se mohou znatelně lišit i mezi blízkými příbuznými taxony, od zcela ameiotických procesů po procesy zahrnující signifikantní modifikace v meiotickém dělení, které mají různé evoluční důsledky pro každou asexuální linii. Je proto důležité porozumět tomu, zda existují nějaká obecná pravidla v procesech vedoucích k opuštění sexuálního rozmnožování, ale i indukci sterility.

Tato práce zkoumá vliv hybridizace a polyploidie na modifikace gametických buněk u několika taxonů ryb. První výzkum byl zaměřen na regulaci produkce neredukovaných gamet u asexuálních allotriploidních samic *Cobitis elongantoides-taenia-taenia*. Přirozeně je toho dosaženo prostřednictvím premeiotické endoreduplikace (PMER) a následným párováním sesterských chromatid. Bylo zjištěno, že regulace PMER je výlučným znakem samic, nicméně provedení PMER závisí na hybridním původu zárodečných buněk. Z tohoto důvodu je fenotyp asexuality u sekavců spojen s fenotypovou diferenciací pohlaví. Za druhé byly zkoumány charakteristiky spermií F1 hybridů kapra obecného a karasa stříbřitého za účelem vyhodnocení morfologických poruch spermií. Samci vykazovali klasickou hybridní dysgenezi, protože jejich reprodukční potenciál byl negativně ovlivněn hybridizací pravděpodobně kvůli velké divergenci mezi druhy. Ačkoli většina spermií byla aneuploidní nebo polyploidní, malá část spermií byla schopna oplození a dala vzniknout F2 generaci. Za třetí byly zkoumány zárodečné buňky ancestrálního hybridu *Poecilia formosa* za účelem popsání PMER dráhy, nicméně bylo zjištěno, že tento druh pouze exprimuje počáteční meiotické geny, ale samotná meióza neprobíhá. Proto *P. formosa* představuje vzácnou výjimku apomixie u ryb. Nakonec byl publikován protokol zaměřený na produkci triploidních zebříček *Danio rerio*. Přestože hlavním cílem této práce bylo vytvoření sterilních recipientů pro účely transplantace zárodečných buněk, triploidní zebříčky rovněž představují vynikající příležitost pro studium vlivu autopolyploidizace na sexuální diferenciaci, neboť všechny triploidní zebříčky byly potvrzeny jako samci.

Acknowledgments

I would first like to thank my supervisor, Associate Professor Martin Pšenička, whose expertise was invaluable in formulating the research questions and methodology. I am highly grateful for our friendly relationship and the personal support in my academic endeavors.

I would also like to significantly thank my consultant, Dr. Karel Janko, for his valuable mentoring throughout my studies. You provided me with the tools and friendship I needed to choose the right direction, successfully complete my research, and shape my future scientific life.

I would like to express my warm feelings to Dr. Roman Franěk, whose cooperation on my projects was irreplaceable.

I am thankful to the Laboratory of Fish Genetics and all its member's staff for all the thoughtful guidance. I would also express my thanks to Dr. Lukáš Vetešník and Professor Andrea Šimková for all the advice.

Finally, my deepest gratitude belongs to my beloved fiancé Anna for her honest devotion, unlimited support, never-ending patience, fresh insights, and the management of our two great feline companions, Vlasta and Lucka.

I appreciate the financial support from the following projects contributing to the funding of different parts of the research summarized in this thesis:

- Ministry of Education, Youth and Sports of the Czech Republic: projects CENAKVA (No. CZ.1.05/2.1.00/01.0024) and CENAKVA II (No. LO1205 under the NPU I program), project Biodiversity (CZ.02.1.01/0.0/0.0/ 16_025/0007370).
- Czech Science Foundation, projects No 17-09807S, 19-21552S, 19-10088S & 21-25185S.

List of publications

Peer-reviewed journals with IF

- Hubálek, M., Kašpar, V., **Tichopád, T.**, Rodina, M., Flajšhans, M., 2022. How do suboptimal temperatures affect polyploid sterlet *Acipenser ruthenus* during early development? *Journal of Fish Biology* 101: 77–91. (IF 2021 = 2.504)
- Tichopád, T.**, Franěk, R., Doležálková Kaštánková, M., Dedukh, D., Marta, A., Halačka, K., Steinbach, C., Janko, K., Pšenička, M., 2022. Clonal gametogenesis is triggered by intrinsic stimuli in the hybrid's germ cells but is dependent on sex differentiation. *Biology of Reproduction: ioac074*. (IF 2021 = 4.141)
- Shah, M.A., Saito, T., Šindelka, R., Iegorova, V., Rodina, M., Baloch, A.R., Franěk, R., **Tichopád, T.**, Pšenička, M., 2021. Novel technique for definite blastomere inhibition and distribution of maternal RNA in sterlet (*Acipenser ruthenus*) embryo. *Fisheries Science* 87: 71–83. (IF 2021 = 2.148)
- Xie, X., **Tichopád, T.**, Langerová, L., Abaffy, P., Šindelka, R., Franěk, R., Fučíková, M., Steinbach, C., Shah, M.A., Šauman, I., Chen, F., Pšenička, M., 2021. Isolation and characterization of highly pure type A spermatogonia from sterlet (*Acipenser ruthenus*) using flow-cytometric cell sorting. *Frontiers in Cell and Developmental Biology* 9: 772625. (IF 2020 = 6.081)
- Tichopád, T.**, Vetešník, L., Šimková, A., Rodina, M., Franěk, R., Pšenička, M., 2020. Spermatozoa morphology and reproductive potential in F1 hybrids of common carp (*Cyprinus carpio*) and gibel carp (*Carassius gibelio*). *Aquaculture* 521: 735092. (IF 2020 = 4.242)
- Baloch, A.R., Fučíková, M., Rodina, M., Metscher, B., **Tichopád, T.**, Shah, A.M., Franěk, R., Pšenička, M., 2019. Delivery of iron oxide nanoparticles into primordial germ cells in sturgeon. *Biomolecules* 9: 333. (IF 2019 = 4.082).
- Franěk, R., **Tichopád, T.**, Fučíková, M., Steinbach, C., Pšenička, M., 2019. Production and use of triploid zebrafish for surrogate reproduction. *Theriogenology* 140: 33–43. (IF 2019 = 2.094)
- Baloch, A.R., Franěk, R., **Tichopád, T.**, Fučíková, M., Rodina, M., Pšenička, M., 2019. Dnd1 knockout in sturgeons by CRISPR/Cas9 generates germ cell free host for surrogate production. *Animals* 9: 174. (IF 2019 = 2.323)
- Franěk, R., **Tichopád, T.**, Steinbach, C., Xie, X., Lujić, J., Marinović, Z., Horváth, Á, Kašpar, V., Pšenička, M., 2019. Preservation of female genetic resources of common carp through oogonial stem cell manipulation. *Cryobiology* 87:78–85. (IF 2019 = 2.094)

Training and supervision plan during study

Name	M.Sc. Tomáš Tichopád
Research department	2017–2022: Laboratory of Germ Cells of FFPW
Supervisor	Assoc. Prof. Martin Pšenička
Period	2 nd October 2017 until 15 th September 2022
Ph.D. courses	Year
Pond aquaculture	2018
Hydrobiology	2018
Ichthyology and fish taxonomy	2018
Biostatistics	2018
Basic of scientific communication	2019
English language	2020
Scientific seminars	Year
Seminar days of RIFCH and FFPW	2018
	2019
	2020
	2021
International conferences	Year
Tichopád, T., Vetešník, L., Šimková, A., Rodina, M., Franěk, R., Pšenička, M., 2021. Spermatozoa morphology and reproductive potential in f1 hybrids of common carp and gibel carp Aquaculture Europe 2021 (poster presentation).	2021
Tichopád, T., Roslein J., Bartoš, O., Franěk, R., Zikmundová, A., Pšenička, M., Janko, K. 2019. Characterization of male sterility in hybrids of Cobitis genus. International Workshop on the Biology of Fish Gametes, 2–6 September 2019, Rennes, France. pp 44 (poster).	2019
Franěk, R., Saito, T., Tichopád, T., Pšenička, M., 2019. Intraperitoneally grafted blastomeres can differentiate into functional gametes in zebrafish. 7th International Workshop on the Biology of Fish Gametes, 2–6 September 2019, Rennes, France, p. 85. (poster)	2019
Franěk, R., Tichopád, T., Fučíková, M., Steinbach, C., Pšenička, M., 2019. Production and use of triploid zebrafish for surrogate reproduction. 7th International Workshop on the Biology of Fish Gametes, 2–6 September 2019, Rennes, France, p. 109. (poster)	2019
Franěk, R., Saito, T., Tichopád, T., Fučíková, M., Marinović, Z., Lujčić, J., Horváth, Á., Kašpar, V., Pšenička, M., 2019. Germ cell manipulation as a tool for common carp isogenic lines production and management. 7th International Workshop on the Biology of Fish Gametes, 2–6 September 2019, Rennes, France, p. 110. (poster)	2019
Baloch, A.R., Fučíková, M., Rodina, M., Metscher, B., Tichopád, T., Shah, M.A., Franěk, R., Pšenička, M., 2019. Labelling of primordial germ cells in sturgeon using iron oxide nanoparticles. 7th International Workshop on the Biology of Fish Gametes, 2–6 September 2019, Rennes, France, p. 117. (poster)	2019
Franěk, R., Tichopád, T., Pšenička, M., 2019. Intraperitoneally grafted blastomeres can differentiate into functional gametes in zebrafish. Zoologické dny, Brno, Česká republika 7–8. února 2019.	2019

Franěk, R., Tichopád, T., R., Baloch, A.R., Marinović, Z., Lujčić, J., Urbányi, B., Horváth, Á., Kašpar, V., Pšenička, M., 2018. Generation and management of isogenic lines of common carp using manipulation with germ stem cells. Sustaining iconic diadromous fishes: The potential and pitfalls of cultivation Arendal, Norway. 17–19 June, 2018. 2018

Franěk, R., Tichopád, T., R., Baloch, A.R., Marinović, Z., Lujčić, J., Urbányi, B., Horváth, Á., Kašpar, V., Pšenička, M., 2018. Cryopreservation and transplantation of common carp germ stem cells into goldfish. 11th International Symposium on Reproductive Physiology of Fish, June 3–8. 2018, p. 131. 2018

Pedagogical activities	Year
<ul style="list-style-type: none"> • Leading of Summer school project entitled “R workshop focused on RNAseq data analysis in fisheries science”. 	2021
<ul style="list-style-type: none"> • Statistical consultant of Dissertation thesis of Dipl.-Ing. Martin Hubálek entitled “Polyploidization capacity of sturgeons and its influence on fitness”. 	2020–2022

Curriculum vitae**PERSONAL INFORMATION**

Name: Tomáš
Surname: Tichopád
Title: Magister (Master's degree)
Born: 13th February 1992, Ostrava, Czech Republic
Nationality: Czech
Languages: English (B2 level – FCE certificate), Czech (native speaker)
Contact: tichopad@frov.jcu.cz; tomeksilentfall@gmail.com; thomas58@seznam.cz

RESEARCH INTEREST

- Polyploidization and hybridization
- Evolution of reproduction
- Molecular biology of sex

EDUCATION

2017 – present Ph.D. student in Fishery, Faculty of Fisheries and Protection of Waters, University of South Bohemia, České Budějovice, Czech Republic
2015–2017 Master student in Experimental Biology, Faculty of Science, University of Ostrava, Ostrava, Czech Republic
2012–2015 Bachelor student in Experimental Biology, Faculty of Science, University of Ostrava, Ostrava, Czech Republic

PROFESSIONAL EXPERIENCE

2022 – present Worker in bioinformatics, Laboratory of Genomics and Bioinformatics, Institute of Molecular Genetics, Czech Academy of Sciences, Prague, Czech Republic
2020 – present Worker in biological sciences, Laboratory of Fish Genetics, Institute of animal physiology and genetics, Czech Academy of Sciences, Liběchov, Czech Republic
2018 – present Worker in biological sciences, Laboratory of germ cells, Faculty of Fisheries and Protection of Waters, University of South Bohemia, České Budějovice, Czech Republic

COMPLETED COURSES

Basic of Scientific Communication, Ichthyology and Fish Taxonomy, Pond Aquaculture, English Language, Statistical course, Hydrobiology