

Mendel University in Brno

Faculty of Forestry

Department of forest protection and wildlife management



## Wildfires in Spain and Czech Republic

Diploma thesis

Supervisor:

Doc. Ing. Petr Čermák, Ph.D.

Bc. Adrián Francisco Rumbo Cabanilles



## Statutory Declaration

Herewith I declare that I have written my final thesis: Wildfires in Spain and Czech Republic by myself and all sources and data used are quoted in the list of references. I agree that my work will be published in accordance with Section 47b of Act No. 111/1998 Sb. On Higher Education as amended thereafter and in accordance with the *Guidelines on the Publishing of University Student Theses*.

I am aware of the fact that my thesis is subject to Act. No. 121/2000 Sb., the Copyright Act and that the Mendel University in Brno is entitled to close a licence agreement and use the results of my thesis as the “School Work” under the terms of Section 60 para. 1 of the Copyright Act.

Before closing a licence agreement on the use of my thesis with another person (subject) I undertake to request for a written statement of the university that the licence agreement in question is not in conflict with the legitimate interests of the university, and undertake to pay any contribution, if eligible, to the costs associated with the creation of the thesis, up to their actual amount.

In Brno on: April 2016.

Bc. Adrián Francisco Rumbo Cabanilles

## Acknowledgments

Most of all, I want to thank my supervisor doc. Ing. Petr Čermák, Ph.D. for his advice and help and advice. Furthermore, I want to thank the close people who supported me through my journey in making this thesis.

## Table of contents

List of figures.....	IV
List of tables .....	VI
Abstract .....	1
Chapter I: Introduction .....	2
Chapter II: Literature Review .....	3
Forest fires.....	3
Causes .....	4
Classification of the causes .....	4
Structural causes .....	5
Immediate causes .....	6
Fuel .....	7
Characteristics.....	7
Availability .....	15
Fuel combination .....	15
Combustion.....	23
Spreading.....	27
Type of forest .....	31
Climatic conditions .....	32
Species composition.....	35
Regeneration and response to fire.....	40
Chapter III: Methodology.....	43
Chapter IV: Results .....	44
Statistics of forest fires .....	44
Statistics in Spain.....	46
Statistics in Czech Republic .....	52
Fire management.....	56

Fire management in Spain .....	57
Fire management in Czech Republic .....	59
Silvicultural practices to reduce the impact of forest fires .....	61
New techniques to identify and prevent wildfires .....	64
Climate change .....	67
Chapter V: Conclusion .....	71
References .....	72
Annex .....	76

## List of figures

Figure 1 Surface area – volume relation. ....	9
Figure 2 Uniform horizontal continuity (left) and non-uniform horizontal continuity (right).11	
Figure 3Uniform vertical continuity (left) and non-uniform vertical continuity (right). ....	11
Figure 4 Average monthly (top) and hourly (bottom) distribution of wildfires in Europe. Data extracted from the fire database of European Forest Fire Information System (EFFIS) (Period 1998-2007; 21 countries).....	13
Figure 5 Heat distribution by radiation. ....	29
Figure 6 Effect of slope in fire spreading.....	30
Figure 7 Map of biomes in Europe. ....	32
Figure 8 Köppen climate classification in Europe.....	33
Figure 9 Natural vegetation formations in Europe. ....	36
Figure 10 Potential natural vegetation types of Europe.....	38
Figure 11 Annual burnt forest area (percentage over the total forest area). Mean values for the interval 1998-2007. ....	45
Figure 12 Number of fires by year and 10km <sup>2</sup> in wildland. Mean values for the interval 1998-2007.....	46
Figure 13 Overlapping burnt area with number of fires in Spain for the period 1980-2013. Source Schmuck et al. 2014. ....	47
Figure 14 Wildfires distribution by Autonomic Community in 2012. Left axis represents area affected in hectares. Right axis represents the number of fires. ....	49
Figure 15 Rainfall against number of fires in Spain for the period 1980-2012. Source: Climatic Research Unit (CRU) of University of East Anglia (UEA). ....	52

Figure 16 Overlapping burnt area with number of fires in the Czech Republic for the period 1995-2014. Source Schmuck et al. 2014. (Years 1995-2005). Statistical Yearbook 2014, Fire and Rescue service in the Czech Republic (years 2006-2014)..... 53

Figure 17 Number of fires by municipalities (up) and number of fires by districts (down) in Czech Republic, 1992-2004) Source Kula and Jankovská 2013. .... 54

Figure 18 Rainfall against number of fires in the Czech Republic for the period 1995-2012. Source: Climatic Research Unit (CRU) of University of East Anglia (UEA). .... 56

Figure 19 Waspnote wireless sensor. Source Solobera, 2010. .... 65

Figure 20 FireWatch tower system representation of how it works. .... 66

Figure 21 Example of drone with infrared video camera (RPAS MCFLY-IR). Source Drone Technology. .... 67

Figure 22 Actual (left) and future (right) (2050-2080) climatic adequacy of the three most abundant tree species in the Spanish forests..... 69



## List of tables

Table 1 Classification of fuel by size. ....	10
Table 2 Fuel classification by size and delay time .....	13
Table 3 Guide to estimate the moisture content of live fuel.....	15
Table 4. Combustion process summary. ....	25
Table 5 Heat of combustion of some woods. ....	26
Table 6 Calorific power classification of Mediterranean and central European species .....	26
Table 7 Cross-links of the category level with natural forest vegetation types in Europe.....	37
Table 8 Rough estimate of relative frequency of ICP categories. ....	38
Table 9 Species composition in Spain. ....	
Table 10 Species composition in Czech Republic.....	39
Table 11 Evolution of n° of fires including large wildfires for the period 1990-2010 Source: MAGRAMA 2012. ....	48
Table 12 Main species affected by fires in the period 2001-2010 by Region.....	50
Table 13 Causes of fires in Spain for the period 2001-2010. Source MAGRAMA 2012. ....	51
Table 14 Causes of forest fires and burnt area in the Czech Republic (1992-2004). Source Kula and Jankovská, 2013.....	55

## Abstract

Wildfires have been increasing in importance through the last two decades in the Mediterranean region. The scope of this thesis is to describe and understand the causes, fuel and spreading of the fire with the aim of comparing the Mediterranean wildfires to central European wildfires. The countries selected for this comparison are Spain and the Czech Republic.

Although the wildfires in Spain are ten times more numerous and burn one hundred times more forest area, the distribution is more or less similar to the wildfires in the Czech Republic. Because of this similarity, the notion of climate change should be addressed with the correspondent importance. The shift in species and climatic conditions will approach the Czech Republic to actual conditions in Spain, increasing the risk of fire and loss of habitats due to the lack of post-fire regeneration that central European species have. In the same scope, Spain would face increased recurrence of fires and the desertification risk that the deforestation would increase. Therefore, the use of new technologies available should be necessary in the identification of the fire in the early stages and the fighting labours.

Key words: Wildfires, Climate change, Spain, Czech Republic.

## Chapter I: Introduction

The problematic of forest fires or wildfires has been a big problem in Spain for quite a long time. In the last two decades, the problem has increased exponentially and has grown into a serious Estate matter.

To understand how a forest fire begins is necessary to analyse how the combustion and ignition of the wood takes place. The reviewing of the causes that start the fire is also important; because the aim of this thesis is to identify the flaws in the fire management system of the two countries studied, Spain and the Czech Republic, and propose methods of identification and prevention of the fires.

Later in the thesis will be done a comparison of the wildfires occurrence in Spain and the Czech Republic and the reason why this is like that. The type of forest and the climate are the major factors and the biggest difference is the readiness of the species to regenerate after fire.

The comparison of the countries will be done with fire statistics, using the number of fires and the hectares burnt in each specific year, afterwards will be compared with annual rainfall to see if there is any relation with the number of fires and the amount of rain.

The next step will be to review the fire management of each country and propose silvicultural practices to reduce the impact of the fires and the rate of ignition, accompanied by new technologies such as drones to improve the fire detection in the early stages.

The last part will be a climate change evaluation where scenarios will be taken into account to see which effects would have the fires in those new conditions and changed vegetation. Due to the threat of the climate change, climatic conditions in the Czech Republic could be what we have today in the Mediterranean and knowing how fire behaves in this region would be a great advantage in planning strategies against fires in the future.

## Chapter II: Literature Review

In this chapter will be given information regarding forest fires such as the causes, the type of fuel present in the forest and the spreading models. Afterwards will be presented the description of the forest ecosystems present in Spain and the Czech Republic for further differentiation.

### Forest fires

A wildfire or wildland fire is an uncontrolled fire in an area of combustible vegetation that occurs in the countryside area. Depending on the type of vegetation that is burned, a wildfire can also be classified as a brush fire, bush fire, forest fire, desert fire, grass fire, hill fire, peat fire, vegetation fire, or veld fire (FAO 2005). However, not all the fires that occur in the wild are wildfires such as prescribed fires, which are intentionally ignited fires by management under an approved plan to meet specific objectives (FAO 2015).

The role of fire in the wild is not always bad. In some ecosystems, like the marshes in the Spanish east coast of Valencia require fire to maintain balance of biodiversity and dynamics. Such species like *Phragmites communis* grow at such speed that in few years will occupy most of the water and land area making it impossible for other plant species to grow. This result in a loss of biodiversity, not only from vegetation but also from fauna linked to the plant species that was displaced by the reed. For this reason, fire is used to control the population of reed that naturally would have been controlled by floods.

However, every year, wildfires destroy millions of hectares of forest woodlands and other vegetation, causing the loss of many human and animal lives and huge economic damage (FAO 2015).

Originally, fire has been an important part of society and used since dawn of mankind. Used mostly in rural areas as part of traditional agriculture, the use of fire has been decreasing since

industrialization and urbanization for decades (FAO 2007). Nowadays, the tendency to use fire has started to increase due to the inclusion of the fire in management plans (Silva, Rego, Fernandes, Rigolot, 2010). FAO has coordinated the development of the fire management voluntary guidelines, which are aimed to improve the approach to fire management of stakeholders. The definition of integrated fire management as stated by FAO is:

“Integrated fire management (IFM) includes the integration of science and fire management approaches with socio-economic elements at multiple level. As such, it implies a holistic approach to addressing fire issues that consider biological, environmental, cultural, social, economic and political interactions (Myers, 2006)”.

## Causes

Lately, the number of forest fires has been increasing, causing in society the general opinion that the only way to control this phenomenon and reduce damage and social alarm that they produce is prevention. Therefore, the first thing to do to fight against the fires is to determine with certainty what provokes them.

Generally, socio-economic factors of rural population, biophysical factors from the climate and structural aspects of the big cities have been identified as possible causes. (Porrero, 2001). However, as Porrero writes in his book these generalisations are not valid, when reasoning have to be made with objective information, as detailed as possible, in order to manage each particular area.

One of the methods used to investigate the source of a forest fire is the method of physical evidence. This technique allows us to reconstruct the evolution of a forest fire using its behaviour in order to find the initial point, helping us determine who or what caused it.

## Classification of the causes

The causes of forest fires can be divided in two groups (Porrero, 2001):

- Structural causes: These causes depend from intrinsic factors from nature like permanent conditions or ecological and social conditions.
- Immediate causes: they derive from anthropic behaviour or natural agents.

## Structural causes

They are very difficult to modify, sometimes impossible and the most common ones are the following ones.

- Climatic characteristics. Drought, high summer temperatures, strong winds.
- High flammability. The plant species from Mediterranean area are highly flammable.
- Big accumulation of fuel. It is produced as consequence of diminishing the extraction volume or changes in rural population habits.
- Extended use of fire. Used traditionally as agricultural and cattle raising tool (most common burning agricultural residues).
- Massive tourism. During the vocational period, high amounts of people come to visit the forest and tend to misuse the fire.
- Unfamiliarity with the use of fire. A big part of the population does not know of the fragility of the forest ecosystems.
- Poor conservationist spirit of the rural population. It is a constant disagreement between the forestry and the agricultural and cattle raising interests.
- Seasonality of the phenomenon. The false consideration of the problem of the forest fires as a seasonal one conditions the economic budget assigned to its control and difficult the maintenance of the professional structures.
- Territorial dispersion. The danger areas are very disperse in space and therefore makes the inversion in defence systems very expensive and their success lower.

## Immediate causes

Forest fires produced by natural agents or derived from human behaviour are from three types (Porrero, 2001):

- Originated by lightning. Consequence of dry storms, in the Mediterranean very common during summer.
- Originated by negligence. These are the produced by careless actions that do not pursue the apparition of forest fire in which the right precaution have been taken. Inside this category are enclosed the fires originated by
  - Burning pasture.
  - Burnings in forest plots.
  - Burning in non-forest plots.
  - Forest exploitations.
  - Bonfires and campfires for heating, light or cooking.
  - Burning residues from silvicultural works.
  - Smokers.
  - Burning trash containers.
  - Agricultural or forestry machinery work.
- From deliberate origin. Generally, M.A. Porrero considers that vengeance or grudges, with multiple motivations, can end up in forest fires. The most common are the induced to:
  - Drive away animals that damage crops and cattle.
  - Show disconformity with the game boundaries.
  - Obtain game.
  - Force the increase of public investment in the forest areas.

- Obtain wages derived from the extinction of the fire and posterior restoration.
- Protest against the limitations of criteria and management of protected areas.
- Provoke social or political disconformity or for vengeance between criminals or to attract police attention.
- Satisfy their instinct (pyromaniacs).

The European Forest Fire Information System (EFFIS) classifies the causes with codes in order to organise all countries with the same categories. The original four categories stored in the Common Core database were expanded in 2009 to six unambiguous and detailed definition of fire causes (EFFIS, 2012).

The classification is made in two levels and in the case of the negligence and voluntary classes a third level was added. The categories described are unknown, natural, accident, negligence, voluntary and rekindle that is a wildfire caused latent heat or re-ignition of a previous fire in the area.

## Fuel

Fire is the result of a physiochemical process known as combustion. In combustion, a substance, the fuel, reacts with oxygen, the oxidizer, and releases heat and exhaust gases (NASA definition).

As defined in the manual for forest fires (Porrero, 2001), forest fuel is all mater from vegetal origin that has the ability to burn. Even though all vegetal matter can burn, what differentiates them is their flammability, closely related to their moisture content.

## Characteristics

Fuel characteristics depend on various factors, these will determine how difficult it will be to ignite and cause a fire. In the manual are classified as it follows:



- Exposition. Fuel that are situated in shady slopes will have more moisture than the ones situated in sunny slopes.
- Height above sea level. Important factor that influences the development of vegetation. Generally, fuel amount diminishes with altitude.
- Latitude. Influences climate, and therefore the type of vegetation (fuel) that will grow in the region.
- Climate. Regulates environmental conditions, like hydric regime, temperature and therefore the amount of vegetal matter that will grow.
- Soil. On it will grow different species according to profile and characteristics.
- Age of vegetation (density and species). Determines the characteristics of the fuel.
- Activities and previous management. Depending of the previous management, the amount of biomass will influence the amount of existing fuel.

The type of fuel can be further classified into vitality and location. As vitality, they can be dead (fallen branches, dead leaves, dry pasture) or alive (grass, shrubs, trees). As location, underground (roots and other materials inside the soil), on surface (leaves, needles, branches, shrubs or young trees, trunks,) all matter that grows under 1.5m tall from the soil and the last one aerial, branches, foliage, moss, and all matter that is located over 1.5m from the soil.

These characteristics of the environment are involved with forest fires in a bigger scale or as a whole, but to further describe fuel present in an area is necessary to classify it by its core characteristics such as amount, shape and size, compaction, horizontal and vertical continuity, wood density, chemical substances and most important fuel moisture.

## Amount

The amount of fuel is the weight of dry fuel per unit of area (most often  $\text{kg}/\text{m}^2$ , tonnes/ha). The bigger the amount of fuel, the bigger the intensity of the fire and if the fuel is reduced to half, the intensity is reduced to a quarter part (Porrero, 2001).

The amount of fuel available depends of the type of vegetation:

- Desert: 0-3 MT/ha.
- Pasture and shrubs: 2 to 12 MT/ha.
- Thicket or scrub: 20 to 100 MT/ha.
- Forest waste: thinning 70 MT/ha. Exploitation up to 250 MT/ha.

## Shape and size

The size of fuel is important because it gives us the relation between the surface area of the particle and its volume. From physics, we know that the smaller the size of the particle the bigger will be the surface area for the same volume. A good example of this is a dice, if we have a one cubic metre dice, each of the six faces will have a surface of one square meter, therefore, the surface are will be of six square meters. If we then, cut the dice in half, the new surface area will be eight square metres (both one square meter sides from the cut add to the previous six), but the volume will be the same. The following figure explains better this relation.

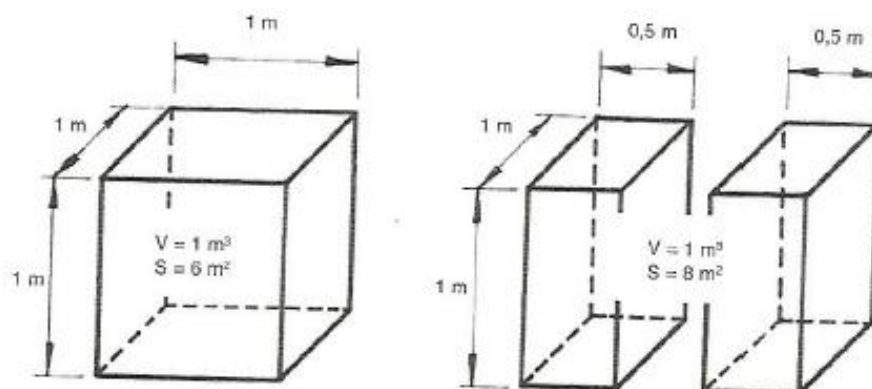

Figure 1 Surface area – volume relation.

As an example, a little twig with 13 mm diameter has 308 m<sup>2</sup>/m<sup>3</sup> while pine needles have 5.600 m<sup>2</sup>/m<sup>3</sup> and pasture has 6000 m<sup>2</sup>/m<sup>3</sup>. This means that the thinner the fuel, the bigger the relation area/volume and therefore, bigger surface area from which they absorb and expel water, changing rapidly their moisture and also absorbing heat from close burning fuel, reaching ignition temperatures faster. Thinner fuel not only ignites easier but also burns faster and usually consume itself completely.

Table 1 shows a classification by size, in which particles from the same category produce similar effects in fire behaviour. It is important to know the size and the amount of each category to know how much fuel can fly and produce secondary outbreaks.

*Table 1 Classification of fuel by size.*

Size of fuel	Description
Thin or light	< 5mm diameter. Leaves, pine needles, pasture, decomposition layer.
Normal	5-25 mm diameter. Twigs, small stems (shrubs).
Medium	25-75 mm diameter. Branches.
Thick or heavy	>75 mm diameter. Stumps, logs, thick branches.

## Compaction

Compaction is the space between fuel particles. Bigger space between particles means less compaction and therefore, bigger amount of air. Compaction affects the rate of drying, being a lot faster in less compacted fuel, and the speed of propagation of the fire, having more air means more oxygen for the fire to burn.

## Continuity

Continuity is the distribution of fuel in the area. Horizontal continuity is the distribution in the horizontal plane, while vertical continuity is the distribution in height. This distribution influences where and how fast the flames will spread.

The most important conditions of continuity can be summarized to two, uniform and non-uniform. In uniform continuity, there is no interruption in the line of fuel so the flames spread without barriers meanwhile in non-uniform continuity the fuel is dispersed or surrounded by clear area or non-flammable vegetation.

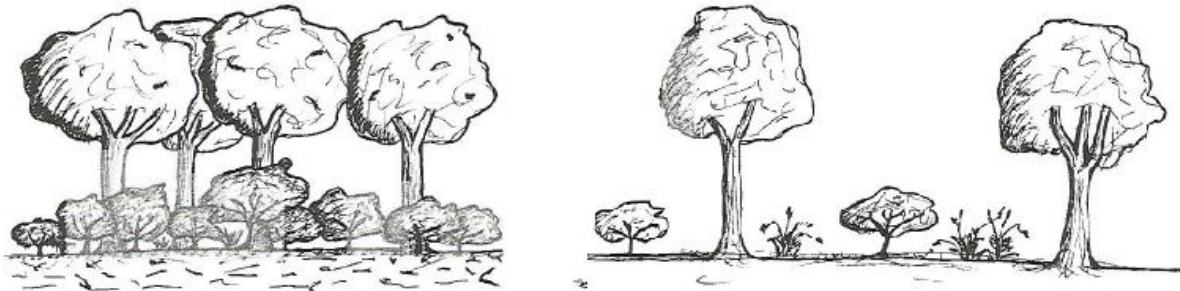

*Figure 2 Uniform horizontal continuity (left) and non-uniform horizontal continuity (right).*

Vertical continuity has higher probability to transform a surface fire into a crown fire. If the fuel is in stepwise form, there is big vertical continuity; otherwise, if the trees are well pruned and the soil is clean from shrubs or waste, there is no continuity (figure 3).

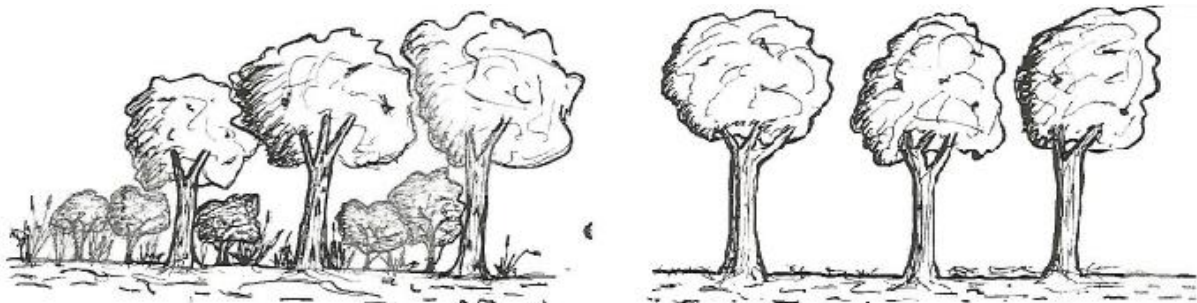

*Figure 3 Uniform vertical continuity (left) and non-uniform vertical continuity (right).*

## Wood density

Wood density affects the heat capacity, or in other words, the power of the wood to absorb or release heat without changing its temperature. Denser wood like oak, before igniting absorbs more heat than a lighter wood such as pine. Fuel as stumps or rotten branches and logs have low density and therefore, low heat capacity, which makes them easier to ignite with lower intensity heat source.

## Chemical substances

Some fuels contain certain volatile materials together with cellulose. These chemical substances, such as oils, wax and resin, make the fuel that contains them available to ignite under circumstances that do not allow ignition in fuel that do not possess them. These chemical substances can affect the intensity of the fire, difficult the extinction or increase the spreading speed, etc. The higher the amount of these substances the higher the intensity and spreading speed of the fire.

## Moisture content

This is by far the most important factor when evaluating forest fuels, influences the probability of ignition and the behaviour of the fire once ignited. Before burning, it is necessary to evaporate the excess of moisture contained in the fuel. Fuel moisture is defined as water content expressed in percentage of dry weight (Porrero, 2001).

$$\frac{\text{Moist weight} - \text{Dry weight}}{\text{Dry weight}} \times 100 = \text{Fuel moisture (\%)}$$

Live fuels such as shrubs, trees and green pasture have high moisture, in a way that they can act as fire retardants (moisture from live fuels can be up to 300%). Dead fuels are constantly exchanging moisture with the environment. This process depends of the relative moisture of the air in a way that they have always tendency to reach the moisture hygroscopic equilibrium, which is the maximum moisture that a fuel particle can reach in a set environment.

The speed in which this particle reaches the equilibrium moisture content comes determined by the delay time. Delay time is the time it takes a fuel body to gain or lose the 63% (2/3) of the difference between the actual moisture content, or initial, and its moisture equilibrium point (Porrero, 2001). This time depends mainly of size and thickness (surface area/volume ratio) of the particle. From experience is known that a leaf dries faster than a log, therefore, thinner fuel reach faster the equilibrium point with the environment than the thickest.

Table 2 Fuel classification by size and delay time

Size category (mm)	Delay time
Thin or light: <5	1 hour
Normal: 5-25	10 hours
Medium: 25-75	100 hours
Thick or heavy: >75	1000 hours

Thin fuel gain and lose moisture very easily, on the contrary, the thickest are slower in this matter. This explains why there can be a serious fire on a pasture, only few hours after it has rained. This is also the motive why at night, logs burn with high intensity while pasture is too wet with dew to burn.

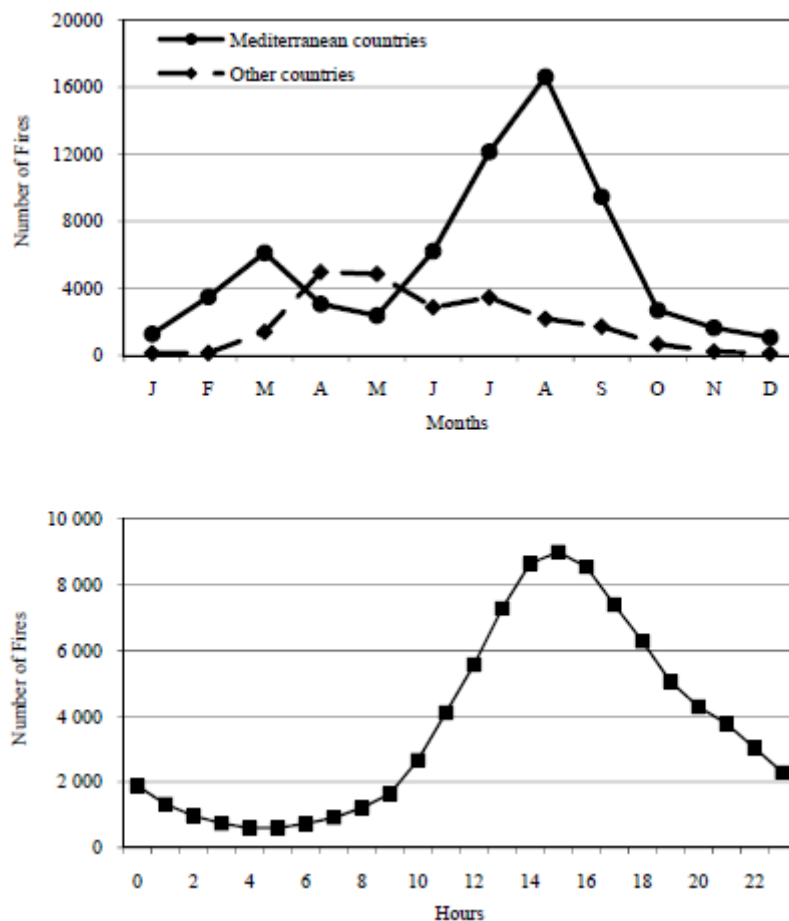

Figure 4 Average monthly (top) and hourly (bottom) distribution of wildfires in Europe. Data extracted from the fire database of European Forest Fire Information System (EFFIS) (Period 1998-2007; 21 countries).

Moisture content in fuel varies along the time of the day and from place to place but in general, diminishes during wildfires season in relation to days without rain. Dead fuel dries because of the high temperatures and low amount of precipitation. It has been estimated that when moisture content of dead fuel goes between 15 and 25% this fuel is available to burn (Porrero, 2001).

Live fuel also get dry, as summer advances, the soil starts to dry because of the lack of rain, water from the leaves of trees and shrubs evaporates and it doesn't get replaced because the soil has no resources. In flowering season, vegetables can have moisture over 300%, during the fire season it can decrease up to 80%. When the moisture lowers to 60%, the vegetation is ready to be burned in a big conflagration.

The factors that influence the most changes in moisture from fuel as seen in the manual from M.A. Porrero are:

- Fuel condition (alive or dead).
- Season of the year.
- Air temperature.
- Relative moisture.
- Days without rain.
- Insolation degree (has direct effect into relative moisture and temperature).
- Wind.
- Proximity to burning fuels.
- Exposition and slope (received radiation).

M. A. Porrero has devised a guide to estimate the moisture content of live fuel in his manual as it is represented in Table 3.

Table 3 Guide to estimate the moisture content of live fuel

Vegetation stage of development	Water content (%)
Tender foliage, annual plants at the start of their growth cycle	300
Maturing foliage, still in development, with full turgidity	200
Mature foliage, new growth complete and equal to old perennial foliage	100
Start of dormancy and change of colour, some leaves already fallen	50
Completely dry	<30, dead fuel

## Availability

In a wildfire, not all the plant material existent burns and be consumed, rarely the thickest fuels carbonize totally. Normally, this kind of fuel are simply scorched. This indicates that not all the fuel in the area was in condition to burn, or what is the same, available.

M. A. Porrero distinguished the fuel between:

- Total fuel: all plant matter found in the fire area, alive or dead.
- Available fuel: all matter in condition to burn and be consumed in the fire.
- Remaining fuel: the fraction of fuel that is not available to burn and stays after the fire.

Probably not burnt due to high moisture content (wet or alive), due to the size or due to being out of the flames reach.

Availability of fuel changes depending of the hour of the day, season, stratus, weather, fuel characteristics and intensity of the fire.

## Fuel combination

In nature, fuel is not present as units but aggrupation of different fuels with different characteristics. Therefore, to be able to predict the behaviour and find the origin of the fire, it is necessary to create models of behaviour. These models, developed by R. Rothermel in 1972, are fire-spreading models for surface fires and despite being developed in 1972, they are still widely used and effective combined with statistical software like R.



These models study the spreading of the fire in function of the fuel that burns, which is called Flammability. These structural fuel models are identifiable visually and can help us predicting the behaviour and spreading of the fire a priori. R. Rothermel considers that forest fuels can be combined in thirteen models distributed in four groups: pasture, scrubland, leaf litter under trees and thinning. Each model represents a structural type of vegetation independently of the species, which makes it suitable for almost all temperate forests.

## Models

To be able to identify to which model belongs the area of the fire it is necessary to analyse the following characteristics (R. Rothermel):

1- Potential fuel:

Pasture

Scrubland

Leaf litter under trees

Thinning

2- Fuel that will spread the fire:

In an open tree area where there is pasture, litter will be scarce. In this case, the fuel that will spread the fire will be the pasture. Because of this, we will have to select one of the models from pasture (1, 2, 3). In the same area, if the grass is sparse or is not present, the spreading agent will be litter and it should be selected a model from litter (8, 9) and like that with all of them.

3- General compaction and height of the fuel.

The mean height and spatial distribution of the fuel.

4- Existent fuel and its influence in the fire behaviour.

Green or dead.

Thin or thick

Healthy or decomposed

Existence of twigs, branches, with leaves or not, etc.

Following this guide, I will summarize the models in which R. Rothermel divided the aggrupation.

## Pasture group

### Model 1

- Fuel characteristics: Thin pasture, generally height inferior to the knee. Dry or almost all dead. Continuous pasture, with very little shrub or tree presence, covering less than a third of area. Annual prairies or meadows are typical examples.
- Spreading: Fire spreading due to herbaceous fuel, thin, dry or almost dry.
- Fire behaviour: Fast spreading of fire through the dry pasture and close materials. Fuel quantity (dry matter) = 1-2 t/ha.

### Model 2

- Fuel characteristics: Pastureland with presence of shrubs or dispersed trees that cover more than a third of the area without reaching two thirds. Fuel composed by dry pasture, litter and fallen branches from the shrubs.
- Spreading: Fire spreading through thin herbaceous fuel.
- Fire behaviour: Surface fire, litter and fallen branches from the shrub or trees contribute to increase the fire intensity. If there are disperse accumulations of fuel, these will cause higher intensities and release of cinders. Fuel quantity (dry matter) = 5-10 t/ha.

### Model 3

- Fuel characteristics: Pasture with thick structure, dense and high (close to 1 m) and it is difficult to walk across. A third or more has to be dry. Unharvested cornfields, natural high pastures and waterlogged grasslands are representative of this model.
- Spreading: The spreading element is the pasture, with high development speed under the influence of wind.
- Fire behaviour: The biggest intensity fires under the category of pasture; the wind causes the progress through the upper part of the grass, jumping even waterlogged areas.  
Fuel quantity (dry matter) = 4-6 t/ha.

## Scrubland group

### Model 4

- Fuel characteristics: Scrubland or young tree stand, very dense, up to two meters high, with horizontal and vertical continuity of the fuel. Besides of the flammable foliage, abundance of dead woody fuel (branches) over the live plants.
- Spreading: The fire spreads across the tops of the scrubs forming a continuous layer.
- Fire behaviour: These are fast fires with big flames. The presence of woody material contributes to rise the intensity of the fire. The moisture from live fuel has big importance in the behaviour of the fire. There can be a dense litter layer that could difficult the labour of extinction. Fuel quantity (dry matter) = 25-35 t/ha.

### Model 5

- Fuel characteristics: Dense scrubland but short, with height less than 0.6 meters with light litter loads under it. The scrubland is young, with few dead material and low volatile foliage. The surface is entirely covered by the scrubs.
- Spreading: The fire moves across the surface fuels composed by litter spread through the scrubland, pasture and other herbs from the understory.

- Fire behaviour: The intensity of fire is not high due to the light loads of fuel and the majority of it being live. Fuel quantity (dry matter) = 5-8 t/ha.

#### Model 6

- Fuel characteristics: Scrubland older than the previous one with height between 0.6 and 1.2 meters. Live fuels are scarcer and disperse. This model covers a wide range of scrubland conditions. Here can be included the dry thinning from broadleaves.
- Spreading: The fire spreads across the foliage of the scrubland, which is more flammable than in model 5.
- Fire behaviour: With slow winds, the fire will descend to the soil and spread through the litter layer. This composition requires faster winds (13 km/h at medium flame) to advance through the scrub layer. The expected spreading speed and linear fire intensity (length of the flames) is from moderate to high. Fuel quantity (dry matter) = 10-15 t/ha.

#### Model 7

- Fuel characteristics: Flammable scrubland from 0.6 to 1.2 meters, generally under tree cover.
- Spreading: The fire spreads through the soil surface and the scrubland layer with equal ease.
- Fire behaviour: The fire can develop with higher contents of moisture from the dead fuel than in other models, due to the high degree of flammability of the live fuel. Fuel quantity (dry matter) = 10-15 t/ha.

## Litter under trees group

### Model 8

- Fuel characteristics: Litter in dense coniferous or broadleaves forest. Litter forms a compact layer, composed by short needles (<5 cm), like in *Pinus sylvestris* stands, or by flat small leaves like *Fagus sylvatica*. The surface layer is composed by leaves and some small branches, with very little scrubs or herbaceous vegetation in the understory.
- Spreading: The surface layer of the compacted litter is the spreading agent.
- Fire behaviour: Surface fires, burn with short flame length. The sporadic accumulation of heavy fuel originate flares. Only under adverse atmospheric conditions (high temperatures, low relative moisture and strong winds), the fuel can turn dangerous. Fuel quantity (dry matter) = 10-12 t/ha.

### Model 9

- Fuel characteristics: Litter in dense coniferous or broadleaves forest. Difference from model 8 is that it forms a spongy layer with much more air inside. It is formed by longer pine needles, such as *Pinus pinaster* stands, or by big and curly leaves such as oak (*Quercus pyrenaica*, *Quercus robur*, etc.) or by chestnut leaves (*Castanea sp.*).
- Spreading: The fire spreads faster through the surface litter than in model 8, with a longer flame length.
- Fire behaviour: Strong winds generate faster spreading speeds than in the above mentioned. This is due the release of cinders that they produce. Concentrations of dead woody material cause the sporadic ignition of some treetops (crowning), creation of secondary outbreaks and crown fires. Fires from autumn in broadleaves forest are very representative of this model. Fuel quantity (dry matter) = 7-9 t/ha.

### Model 10

- Fuel characteristics: Surface layer of litter with big quantities of dead fuel, which include a high percentage of branches with 7.5 cm diameter or more, product of extreme factors or natural disaster (snow, wind, etc.). Thicker fuel are well distributed over the area and there can be some live fuel with total height lower than the knee level, even though some can be higher.
- Any kind of forest can be considered inside this model if there are lots of dead heavy fuel on the ground. For example, forests infected by diseases or insect pests, or with high quantity of trees fallen on the ground, old forest with woody material fallen, waste from old thinning or partial cutting.
- Spreading: Produced through the surface and ground fuel, which burn with higher intensity than in other forest models.
- Fire behaviour: The crown fire, secondary outbreaks and crowning of individual trees are more frequent in this model than in the previous. These fires pose more difficulties in their control labours. Fuel quantity (dry matter) = 30-35 t/ha.

## Thinning group

### Model 11

- Fuel characteristics: Light waste (diameter < 7.5 cm) recent (0 to 3 years) from silvicultural practices or exploitations, forming a low compacted layer of low height (30 cm). Live fuel, if present, play a key role. The waste come from thinning labours or partial clearings; clearcutting operations produce a lot more waste than the indicated previously. Material loads that are less than 7.5 cm in diameter are under 25 t/ha.
- Spreading: Produced through the waste, but it has to exist litter and thin materials that help conducting the fire.
- Fire behaviour: The fire will be very active in the thin material and waste (leaves, little branches and herb) mixed. The spacing of the fuel (of light load), the shadow of the

crowns or the age of the thin fuels contribute to limit the fire intensity. Fuel quantity (dry matter) = 25-30 t/ha.

#### Model 12

- Fuel characteristics: Thinning waste that covers totally the terrain (bigger load than in model 11). There is possibility to find some areas of the ground naked or lightly covered. The medium height of the waste is 0.6 meters and they are not excessively compacted. Half of the leaves can be attached to the branches (but not dry). Live fuel, if present, are not expected to influence the fire behaviour. The visual effect is that waste of less than 7.5 cm in diameter predominates. Total load is inferior to 80 t/ha. Coniferous stands with strong clearings, clearcutting and intense partial cuttings are represented in this model.
- Spreading: It is produced through the waste that conduct the fire rapidly and with high intensity, being able to generate cinders.
- Fire behaviour: When the fire starts, it spreads continuously until reaching a firewall barrier or a change in the fuel type. Fuel quantity (dry matter) = 50-80 t/ha.

#### Model 13

- Fuel characteristics: The waste form a continuous layer (load heavier than in model 12), not excessively compacted and with mean height of 1 meter. Half of the leaves are still attached to the branches and are green. Live fuel do not affect the fire behaviour. Fuel charge is dominated by material over 7.5 cm in diameter. Material under 7.5 cm in diameter represent 10% of the total load, that can exceed 450 t/ha. Clearcutting or partial cutting from mature and old stands can be included here.
- Spreading: The fire runs through the layer of waste. It spreads fast through the thin fuel and the speed slows down when the thick fuel start to burn.

- Fire behaviour: High intensity fires, in which the flames last long time and generate cinders of various sizes, contributing to the creation of secondary outbreaks when the atmospheric conditions are adverse. Fuel quantity (dry matter) = 100-450 t/ha.

It is important to make a good evaluation of the fire to classify into these models in order to make the fire management successfully. Knowing where and how the fire will spread will help the extinction and control labours to save time and react faster and in the places needed.

## Combustion

After reviewing the causes, and assessing models and behaviour of fire in forest areas, the next step is to understand the process of combustion, ignition and spreading of the fire. The conditions in which wood shows flame, heat transmission and phases of combustion.

Combustion is an exothermic chemical reaction that is self-powered in presence of fuel in all three phases, solid, liquid and gaseous (Byram, 1959). This oxidation process of a fuel done by the oxygen in the atmosphere is commonly associated with the emission of light. Normally, solid and liquid fuels vaporize before burning. Sometimes, solid matter can burn directly in the form of incandescence or embers. Combustion in gaseous phase generally produces visible flame (Porrero, 2001).

Vegetal fuel that reacts in this process is made mainly from cellulose, hemicellulose and lignin. When an external heat source is applied, with enough energy to reach ignition temperature and in presence of oxygen, the following reaction takes places (Byram, 1959):

Equation 1.

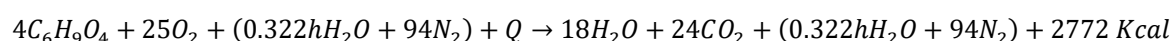

Where:

*h*: moisture content in percentage.

*Q*: Energy.



In this process is released an amount of energy equivalent to 2772 Kcal, which is 4855 Kcal/kg of woody material in a complete combustion. Fifteen percent of this amount is radiated to the outside, producing the heating of the air mass and fuel in the vicinity. The remaining is latent heat or smouldering heat, used by the material to self-power the reaction and increase the temperature of the combustion phases (Byram, 1959).

## Ignition

The phenomenon that starts the self-powered combustion is called ignition (Byram, 1959). It is produced when an external small flame, spark or glowing ember is introduced into the material, or also called triggered ignition. If the ignition is not caused by any external source, it is called auto-ignition. The minimum temperature needed by a substance to ignite represents its ignition temperature and generally is lower than the auto-ignition temperature (Babrauskas, 2001). Once ignited, the combustion will continue until the full consumption of the fuel or the oxidant, or until the flame will be extinguished by cooling or other causes. Generally, in the forest the fuel will have an ignition point between 275 and 360° C (Hernando et al., 2010).

## Combustion phases

In woody fuels, there are three main phases of combustion. They can overlap and exist simultaneously as the fire advances. These three phases are pre-heating, gas combustion and solid combustion (Byram, 1959).

Pre-heating: Taking a woody log in a typical situation, it will experiment an initial heating by radiation when a heat source is applied. As the surface temperature reaches 100°C (boiling point of water), the wood starts to release gases, mostly water vapour. This gases contain very little amount of fuel, but as temperature increases and overcomes the boiling point of water, the drying process advances into the core of the wood. (Porrero, 2001).

When the heating continues and the temperature gets close to 300°C, is when the changes in the wood start to be appreciated. The colour changes and visualization of pyrolysis takes places

due to the chemical decomposition of the matter. When wood pyrolyzes, it releases fuel gases and leaves a residual black coal, called charcoal ((Byram, 1959). Immediately after the active pyrolysis, the wood produces enough fuel gases to power a gaseous phase combustion, but before the combustion takes place, is necessary to have flame or a source of chemically active molecules in enough amounts to reach ignition. (Babrauskas, 2001).

Gas combustion: Once ignition is produced, a flame covers rapidly all pyrolyzed area and prevents its contact with oxygen meanwhile it heats the surface of the log and increases the speed of pyrolysis. The flames that are seen from a forest fire are product of the burning of distilled gases that have water vapour and carbon dioxide (CO<sub>2</sub>) as main products. If the combustion is not complete, some substances will condense and form the smoke that accompanies most fires (Byram, 1959).

Solid combustion: The layer of charcoal will increase in thickness as the combustion continues. That layer possess good insulating properties, limiting the heat flow penetrating to the inside of the wood, reducing the intensity of pyrolysis, until the gas combustion cannot be maintained. The oxygen from air that is in contact with the charcoal helps to maintain the glowing combustion when the heat loses radiated are not too high (Porrero, 2001).

*Table 4. Combustion process summary.*

Temperature (°C)	Process	Phase
< 100	Drying of the woody material, releasing water vapour until complete dehydration	Pre-heating
100-270	Distillation of the woody material, releasing of fuel gases. CO <sub>2</sub> emission	Gas combustion
270-350	Presence of CO. Start of charcoal. Energy release > 300 Kcal/Kg	
350-500	Combustion continues	Solid combustion
500-800	Exhausting of gases, slow combustion of charcoal	
800-1200	Complete combustion	

Before talking about heat transmission, it is important to note the amount of energy released by some of the most common European tree species listed in the table below and extracted from George Byram's work.

Table 5 Heat of combustion of some woods.

Substance	Heat of combustion for oven-dry material, Kcal/kg
Wood (oak)	4623
Wood (beech)	4776
Wood (pine)	5088
Wood (poplar)	4355
Pine sawdust	5196
Spruce sawdust	4697
Wood (shavings)	4585
Pecan shells	4944
Hemlock ark	4866
Pitch	8406

Table 6 Calorific power classification of Mediterranean and central European species

Calorific power (Kcal/kg)	
> 5000	
<i>Arbutus unedo</i>	<i>Eucalyptus globulus</i>
<i>Calluna vulgaris</i>	<i>Pinus halepensis</i>
<i>Erica arborea</i>	<i>Pinus pinaster</i>
<i>Erica australis</i>	<i>Rosmarinus officinalis</i>
<i>Erica multiflora</i>	
5000-4500	
<i>Cistus ladanifer</i>	<i>Quercus ilex</i>
<i>Juniperus communis</i>	<i>Quercus pyrenaica</i>
<i>Pinus pinea</i>	<i>Quercus suber</i>
<i>Pinus sylvestris</i>	
< 4500	
<i>Anthyllis cytisoides</i>	<i>Populus sp.</i>
<i>Atriplex halimus</i>	<i>Rubia peregrina</i>
<i>Buxus sempervirens.</i>	<i>Rubus sp.</i>
<i>Pteridium aquilinum</i>	<i>Salix sp.</i>

Table 6 is extracted from Hernando et al. laboratory document for the Spanish organization CIFOR-INIA. This species are mostly Mediterranean, although some are common in central Europe such as *Quercus pyrenaica*, *Pinus sylvestris* and *Populus sp.* The calorific power of

species found in south-west Europe are more flammable than species found in central Europe. It is important to note that this heat release is in standardized conditions and losses should be expected in natural conditions. As G. Byram notes in his work, around 440 and 667 Kcal/kg would be lost due to environment moisture.

## Heat transmission

Heat transmission characterises the ignition, combustion and extinction of most of the fires (Hernando et al., 2010). Heat mostly transfers in three forms, conduction, radiation and convection.

Conduction is produced when there is direct contact between two bodies with different temperatures. The amount of thermal energy transferred depends of the temperature and the conductivity of the contact area.

Radiation is the energy that moves through space or materials in the form of electromagnetic waves, light, radio waves or x rays. Radiation is very dangerous in wildfires because close surfaces (plant fuels) absorb much of the radiation incident on them and enter pre-heating. The energy advances in a straight line and goes freely through symmetric diatomic gases such as hydrogen, oxygen and nitrogen but can be absorbed by asymmetric gas molecules such as CO<sub>2</sub>, H<sub>2</sub>O, CO, and SO<sub>2</sub> and suspended particles such as smoke. (Hernando et al., 2010).

Convection is how heat is transmitted through liquid and fluid gases. Air is the major convection fluid in forest fires, transmitting heat vertically as the hot air ascends naturally. This convection is called natural convection meanwhile when the wind forces the movement of the hot air in a different direction this convection is called forced convection (Porrero, 2001).

## Spreading

To start a forest fire, it is necessary to have a number of circumstances to favour its start and afterwards spreading. Most authors coincide that the circumstances that origin fires are:

- Enough fuel, thin, live or dead with an adequate size and continuous distribution.
- Low moisture content fuel, that speeds up the spreading.
- Presence of an ignition source, that provides the necessary activation heat.

Depending of the fuel distribution the spreading will take on surface, underground or on the treetops. The size and development of the fire will be given by external factors, such as meteorology (wind, moisture, temperature) and topography (slope), which can altogether difficult the extinction labours (Hernando et al., 2010).

### Start of the fire

The start of the fire is determined by the flammability of the fuel, which is the time it takes the fuel to release flammable gases while under the influence of an external heat source. This flammability depends of the moisture content of the fuel and the point in which the fuel-released gases ignite with the heat source is called ignition temperature. This temperature oscillates between 250°C and 450° C, depending of the moisture. The following list has been developed by INIA institute to compare the flammability of Mediterranean species.

#### Very flammable species all year round

*Calluna vulgaris*  
*Erica arborea*  
*Erica australis*  
*Erica herbacea*  
*Erica scoparia*  
*Phillyrea angustifolia*  
*Pinus halepensis*  
*Quercus ilex*  
*Thymus vulgaris*

#### Very flammable species only in summer

*Anthyllis cytisoides*  
*Cistus ladaniferus*  
*Genista falcate*  
*Pinus pinaster*

*Quercus suber*  
*Rosmarinus officinalis*  
*Rubus idaeus*  
*Stipa tenacissima*  
*Ulex parviflorus*

Moderated or low flammability species

*Arbutus unedo*  
*Cistus albidus*  
*Cistus salvifolius*  
*Erica multiflora*  
*Juniperus oxycedrus*  
*Olea europaea*  
*Quercus coccifera*

## Fire spreading

A fire started in stable conditions (without wind) in a flat terrain and with continuous and uniform fuel, will have a round shape, because the heat will transmit equally to all points by the effect of radiation. A normal flame transmits by radiation in “v” shape.

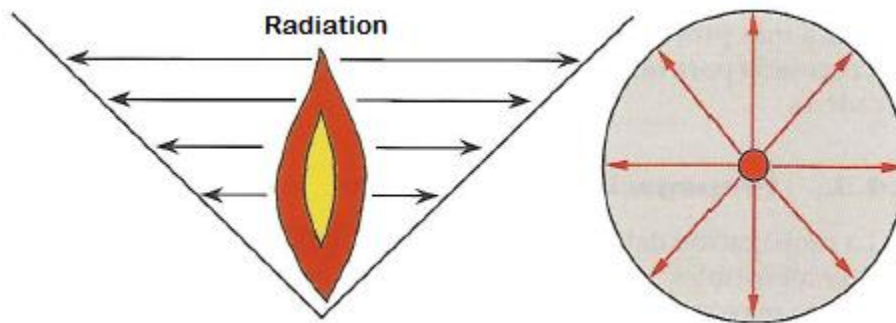
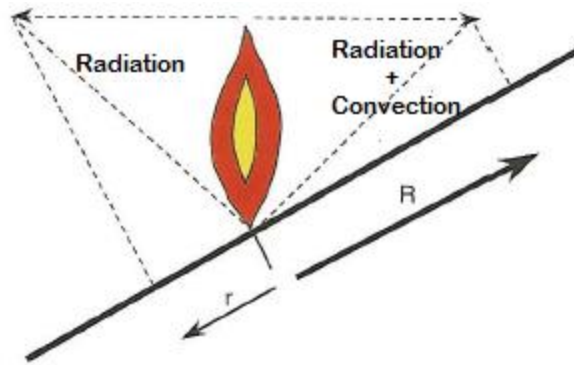

Figure 5 Heat distribution by radiation.

When there is wind, this produces an inclination of the flame that causes bigger amount of radiation to be directed towards the advancing direction and therefore, that the close fuels ignite earlier. As the size of the affected area increases, there can be distinguished a front and a rear, where the front generates larger energy because the heat emission is produced by radiation and convection (Porrero, 2001).



*Figure 6 Effect of slope in fire spreading*

The slope is another factor that affects the spreading. Due to the slope, the flame gets an effect of tilting, which increases the heat transmitted to the upper part of the slope rather than in the lower part (Blanco et al., 2008).

When the wind and slope work together, the heat at the front of the fire increases considerably, making the fuels that are in the direction of the wind and up the slope will reach the ignition temperature a lot faster. The area affected by a fire adopts geometric forms depending of the factors that intervene in its spreading. In a flat area, the shape will be round, when there exist factors such as slope or wind, the round shape transforms into an ellipse (Byram, 1959).

Another dangerous way of spreading fire is the emission of ignited particles. Secondary outbreaks are formed by particles (pieces of ignited fuel) that are transported by the wind to a certain distance. J. Blanco et al. define the particles into two categories short distance and long distance particles. The difference in distance is not clear in case of proper distance, it depends on the fact that the particles land on a pre-heated area that soon will be reached by the main front of the fire.

Short distance particles are produced by the fire front and are transported a short distance in front of it. When they land, they can produce or not the ignition of the fuel, and in case of ignition, the front advances to the new outbreak before it makes a new fire and advance independently.

Long distance particles are the ones transported far away from the fire, where they produce new outbreaks that develop and advance independently of the original fire. The particles are transported in two ways and it depends of their size. The small particles are elevated through a convection column where they are suspended by the wind until they fall. These particles come from the treetops and their small density makes them able to travel long distances, but in the most cases they will extinguish before reaching the ground. Big size particles can be elevated by a fire swirl and sent out of the fire area. The size of these particles can reach 7 cm in diameter and 1 meter long when the energy of the swirl is big. The particles are transported through the vortex of the swirl until this loses energy and they are deposited on the surface (Porrero, 2001).

So far, with the review of the main causes of forest fires and the way the fire behaves and interacts with the fuels is done. This review will help understand the how and where to act in order to prevent the fires or to act in the labours of extinction if produced.

## Type of forest

The type of forest will determine greatly the kind of fuel and the quantity that will be present. Different species have different flammability and therefore, some forest will have more risk to suffer a fire than others will. The climatic conditions will determine the moisture content of the fuel, environment and the species that will live and die in the area.

In the countries studied here that is Spain and the Czech Republic, differences exist in forest types, natural conditions and climate. This differentiation will be made from the MCPFE classification of forest diversity in Europe (AEMA, 2006).



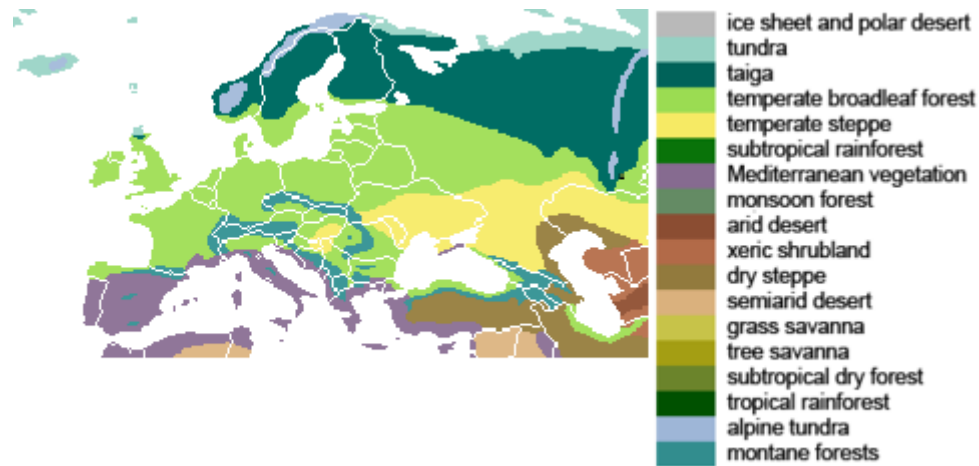

*Figure 7 Map of biomes in Europe.*

In the map of European biomes can be seen the major difference between both countries. Spain is located in the south-west of Europe, while the Czech Republic is located in the heart of Europe. This supposes a big difference in biome, as figure 6 shows, Spain has mostly Mediterranean vegetation with montane forest in the high mountains of the Pyrenees in the north and Sierra Nevada in the south, while in the centre is the mountain range of Madrid. Only the north-west of the country (Galicia and Asturias) has temperate broadleaf forest due to the wet weather made by the Atlantic currents. As opposed to this, the Czech Republic is covered in the north by a fringe from west to east of montane forest while the southern part of the country belongs to temperate broadleaf forest.

### Climatic conditions

To the biomes, it is indispensable to add information about climate. In the Köppen classification, Spain has a wider range of climatic conditions than the Czech Republic. Most of the Spanish territory is considered to have cold semi-arid climate (BSk), the south and west are considered warm Mediterranean climate (Csa) while most of the north is considered temperate oceanic climate (Cfb). Some of the North West and the centre of the Iberian Peninsula are considered temperate Mediterranean climate (Csb), with a small patch of

Mediterranean continental climate (Dsb). In the north, in a small part of the Pyrenees, we can see cool continental climate and tundra climate (Dfc and ET).

The Czech Republic is covered in most of the territory by temperate continental climate (Dfb) with a small patch on the south that belongs to temperate oceanic climate (Cfb) and in the North West border cool continental climate (Dfc).

Europe map of Köppen climate classification

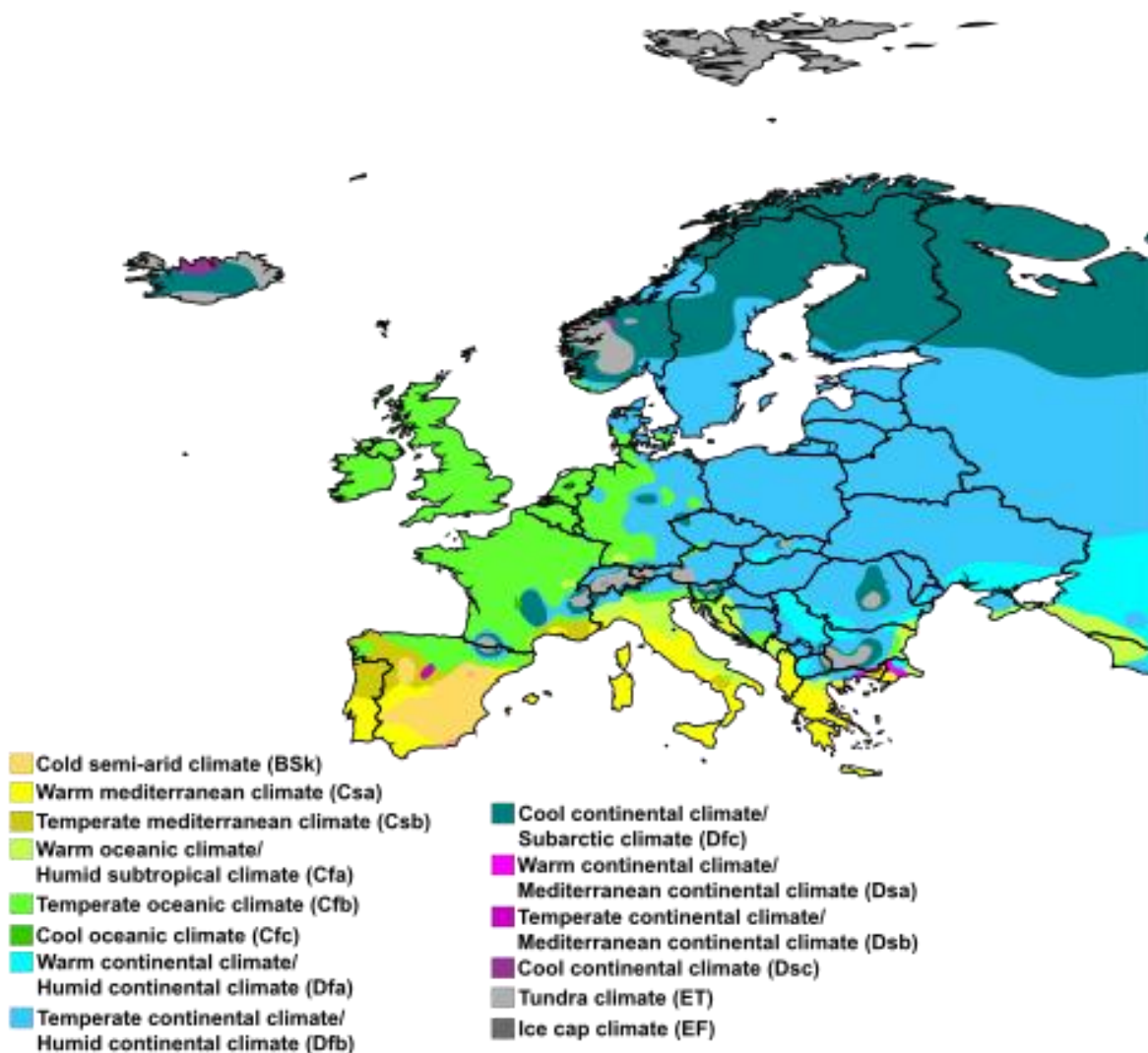

Figure 8 Köppen climate classification in Europe.

Therefore, the major differentiation will be between Mediterranean and continental climate. If we take the description made by the Köppen classification, the majority of the Spanish territory

is the Csa, Csb, Cfb and BSk. The Köppen classification is made taking various criteria, such as precipitation and mean temperature. The B category reflects the places where the precipitation is not equally distributed through the seasons, 70% or more falls summer half of the year or winter half of the year and the amount of precipitation is less than 20 times the average annual temperature plus 280. The symbol S means that the amount of precipitation is less than the upper limit but more than one-half of that amount. The k means that the average annual temperature is less than 18 °C (Britannica Editors, 2016). This category (BSk) translates into an area with low precipitations, ranging 350-700 mm annually and mean temperatures close to 18 °C. This means that the region is dry, warm and therefore the species that inhabit there will suffer drought periods.

The category C is mainly done with temperature, belonging to this category all areas with temperature of the warmest month greater or equal to 10 °C and the temperature of the coldest month less than 18 °C but greater than -3 °C. Inside this category, the second symbol refers to precipitation, and in this case, s means precipitation of the driest month of the summer half of the year less than 30 mm and less than one-third of the wettest month of the winter half. The symbol f means precipitation more evenly distributed throughout the year or criteria that does not satisfy the other symbols. As for the third symbol, a means temperature of the warmest month 22 °C or above and b means temperature of each of four warmest months 10 °C or above but warmest month less than 22 °C. With this, in Spain can be found Csa, Csb and Cfb, meaning that the weather is dry and warm but not as much as category B in case of Cs cases and in the case of Cf the periods of drought are shorter due to more evenly distributed precipitations (Britannica Editors, 2016).

In the case of the Czech Republic, Dfb, Dfc and Cfb are found. The Cfb category is the same as in the north of Spain, so we could find similarities in species and weather, with the slight difference of the influence of the ocean that makes the climate a wetter. Category D is for

cooler climates, when the temperature of the warmest month is greater than 10 °C and the temperature of the coldest month -3 °C or lower. The symbol f is the same as in category C so the precipitations are evenly distributed throughout the year. The third level symbol b is the same as in C, where the temperature of each of the four warmest months is 10 °C or above but the warmest month is less than 22 °C. The symbol c means that the temperature of one to three months is 10 °C or above but warmest month less than 22 °C. Therefore, we find in the Czech Republic colder and wetter climate than in Spain, with more evenly distributed rain and therefore less or none periods of heavy drought. The temperatures can reach negative degrees so the species have to be adapted to frosts (Britannica Editors, 2016).

### Species composition

Before talking about the actual species composition of the forest in Spain and the Czech Republic, it is necessary to note first the natural forest formations and the potential natural vegetation. Natural forest formations are those who exist in a place naturally without being introduced by man. Potential natural vegetation (PNV) is a concept referring to the vegetation that would be expected in an area given environmental factors without human intervention or hazard event (Chiarucci et al., 2010).

The natural formations in Spain are strongly marked by the dry climate, therefore most of the territory is occupied by Mediterranean sclerophyllous forest and scrub, with thermophilous mixed deciduous broad-leaved forest in the centre and some patches of xerophytic coniferous forest and scrub. Only in the north and North West, the wet and cool areas of Spain, the vegetation is mesophytic deciduous broadleaved and coniferous-broadleaved forest. Localizing in the map (figure 8) the Czech Republic, as typical continental climate the natural vegetation formations are like in the north of Spain, Mesophytic deciduous broadleaved and coniferous-broadleaved forests. The exceptions are thermophilous mixed deciduous broad-leaved forests

in very narrow patch in the North West and small mesophytic and hygromesophytic coniferous and broadleaved-coniferous forests (EEA, 2006).

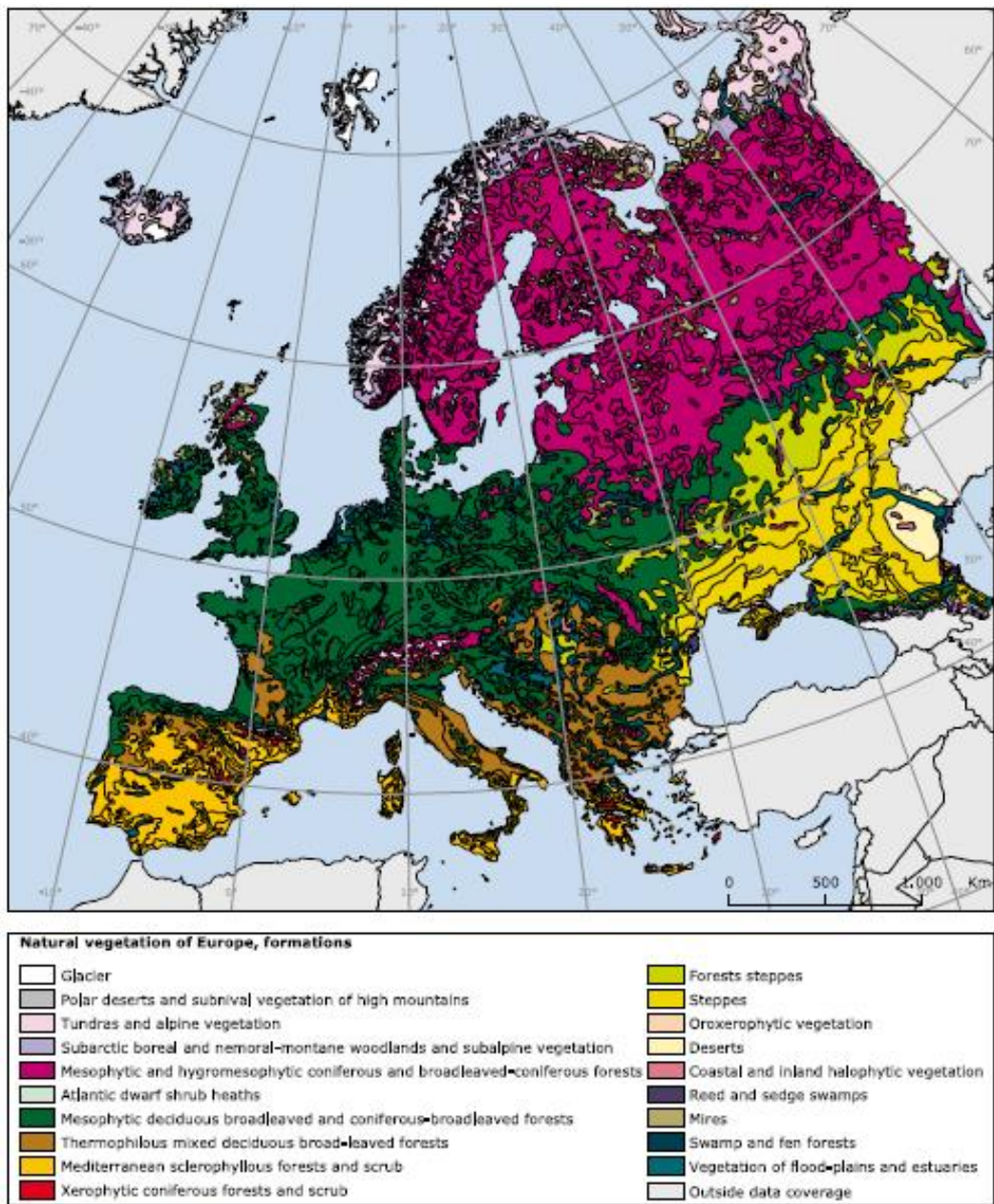

Source: Bohn et al., 2000.

Figure 9 Natural vegetation formations in Europe.

Between the classification of forest types in Europe and the classification of natural vegetation, exist some differences that need to be cross-linked in order to understand the potential natural vegetation of the areas. The EEA provides a table with this links in order to know which forest type equals to a natural vegetation type with the help of a map (table 7, figure 9)

Table 7 Cross-links of the category level with natural forest vegetation types in Europe.

European forest types – category level	Natural vegetation of Europe
1. Boreal forest	C2; D1; D2; D3; D4; D5; D6; D7; D10; D11
2. Hemiboreal forest and nemoral coniferous and mixed broadleaved-coniferous forest	D8; D11; D12
3. Alpine coniferous forest	C3; D9
4. Acidophilous oakwood and oak-birch forest	F1
5. Mesophytic deciduous forest	F2; F3; F4
6. Lowland to submountainous beech forest	F5a
7. Mountainous beech forest	F5b
8. Thermophilous deciduous forest	G1; G2; G3; G4; L1; L2
9. Broadleaved evergreen forest	J1; J2; J3; J4; J5; J6; J7; J8
10. Coniferous forests of the Mediterranean, Anatolian and Macaronesian regions	K1; K2; K3; K4
11. Mire and swamp forest	S3; T1; T2
12. Floodplain forest	U1; U2; U3; U4
13. Non-riverine alder, birch or aspen forest	-
14. Plantations and self-sown exotic forest	-

**Source:** After Bohn et al., 2000.

In figure 9, Spain has the labels of J1, J6, J8, J4, K4, K1 and C3, meanwhile the Czech Republic has the same pattern as Germany and Poland, where it is considered F5 and F3 and the pink patches belong to D9 category.

If we look into table 7, J1, J4, J6 and J8 belong to broadleaved evergreen forest, K1 and K4 to coniferous forest of the Mediterranean, Anatolian and Macaronesian regions and C3 to Alpine coniferous forest. The categories F5 and F3 belong to lowland to submountainous beech forest and mesophytic deciduous forest respectively, where it represents the dominant species of the region. The category D9 belongs to Alpine coniferous forest, representing the high elevation forest in the country.

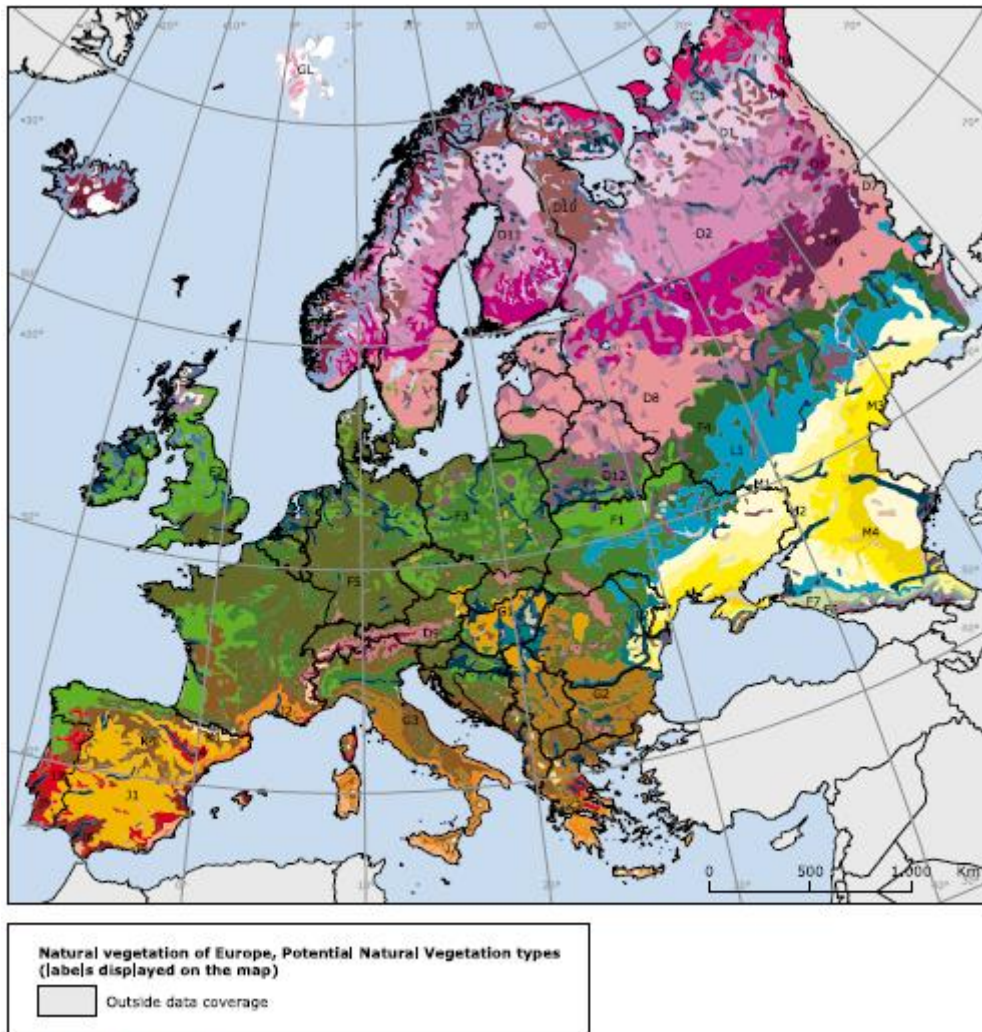

Source: Bohn et al., 2000.

Figure 10 Potential natural vegetation types of Europe.

In the European Forest types technical report from the European Environment Agency (EEA), a rough estimate of the relative frequency of the categories mentioned above has been done in relation of each country. The estimate is done in percentages and for Spain, with a number of ICP level I plots of 607, and the Czech Republic, with 140 ICP level I plots is distributed as:

Table 8 Rough estimate of relative frequency of ICP categories.

Country (n° plots ICP level I)	1	2	3	4	5	6	7	8	9	10	11	12	13	14	Total country (%)
Spain (607)	0	0	3	2	2	0	2	9	26	43	0	0	0	12	100
Czech Republic (140)	0	69	1	1	9	4	4	0	0	0	0	1	3	9	100

These categories, as seen in table 7, represent the major types of forest in Europe. The majority of Spanish forests belong to the categories ten (43%) and nine (26%), that are coniferous forests of the Mediterranean and broadleaved evergreen forests. The thermophilous deciduous forest (9%) and exotic plantations (12%) are also important. The categories of Alpine coniferous forest and acidophyllous oakwood forests (3% and 2% respectively) represent very little amount of the country forest area.

For the Czech Republic, the majority of the forest is labelled as hemiboreal forest and nemoral coniferous and mixed broadleaves-coniferous forest (69%). The second most common type of forest is mesophytic deciduous forest and exotic forest plantations (9%). Leaving the lowland and mountainous beech forests at 4% each. This amount contrasts with the natural vegetation where beech forest should be predominant and instead the boreal conifers (*Picea abies*) is predominant.

Table 9 Species composition in Spain.

Species	Proportion (%)
Quercus ilex	19.12
Pinus sylvestris	11.09
Pinus halepensis	9.87
Quercus pyrenaica	8.72
Pinus nigra	7.65
Pinus pinaster (Atl)	5.90
Quercus faginea	4.27
Fagus sylvatica	3.59
Eucaliptus sp.	3.47
Pinus pinaster (Med)	2.89
Quercus petraea	2.75
Castanea sativa	2.02
Pinus pinea	1.91
Pinus radiata	1.64
Juniperus sp.	1.62
Quercus suber	1.51
Pinus uncinata	1.09
Other sp.	10.90

Table 10 Species composition in Czech Republic

Species	Proportion (%)
Picea abies	54.1
Abies alba	0.9
Pinus sylvestris	16.8
Larix decidua	3.8
Other coniferous species	0.2
Quercus petraea	6.4
Fagus sylvatica	6.0
Betula sp.	2.9
Other broadleaved species	7.1



In these two tables, we can observe the species composition of the two countries studied. In Spain, the species composition fits the natural forest types, and the potential vegetation, even with the introduced species and the naturalised ones, (*Eucaliptus sp*, *Pinus halepensis*) fits the description of the map. For the Czech Republic, the species composition is distorted. The amount of broadleaves should be around 65% (40% for beech), the amount of spruce round 11% and the scots pine 3% (Postulka, 2008).

## Regeneration and response to fire

In the Mediterranean region, fire has been a constant since the late Quaternary, when they were very frequent. Because of this, many species have adapted and acquired mechanisms to persist and regenerate after recurrent fires (Pausas, et al., 2008). In the Mediterranean, the communities have been sorted according to fire regimes, differentiating biodiversity, which makes clear that fire is a natural occurrence. The problem lies in the fact that large fires like the ones that have been occurring lately are relatively new in recent history of the Mediterranean basin (Saura-Mas et al., 2010).

In broad-leaved scrublands with resprouting species, that are very common in the Mediterranean region, one of the most common ecosystems is the garrigue, dominated by *Quercus coccifera* (kermes oak) (Pausas et al., 2008). In a study made in France by L. Trabaud in 1991, *Quercus coccifera* scrublands were burned in different frequencies and in different seasons for nineteen years. In all cases, *Quercus coccifera* resprouted vigorously with no signs of degradation. In another study in Greece, Delitti et al, in 2005, found that despite the high recovery rate there was evidence of decreasing productivity if the fire frequency was higher (Pausas et al., 2008).

In scrublands dominated by non-resprouting species, the strategy to persist after fire is not with a high resprouting capability but with having a seed-bank that persists after fire, allowing post-

fire recruitment. Because of this, most of the species growing in fire prone ecosystems with non-resprouting strategy are seeder species and the germination of some of these species is stimulated by the heat of the fire or by other fire products such as charred wood or smoke (Pausas et al., 2008). In this case, soil losses are higher due to the plants dying in the fire, and therefore the root system recovery is slower. This ecosystem is more sensitive to post fire weather conditions due to the seed regeneration (Quintana et al. 2004).

Another kind of community found in the Mediterranean region are the broadleaved evergreen sclerophyllous woodlands. In this communities, where the most abundant are *Quercus ilex* (holm oak) and *Quercus suber* (cork oak) (Pausas, 1997). Coppicing has been used since ancient times in these regions because of the strong resprouting capacity of these species. In the case of *Q. ilex*, traditionally was used for firewood harvesting and charcoal production (Pausas et al., 2008). The strong resprouting capacity of *Q. ilex* made possible this harvesting without degrading the populations and only showing signs of not resprouting after fire in very old individuals of the *Q. ilex* subspecies *ballota* (Pausas, 1997). In the case of *Q. suber*, the protective insulating bark of this oak protects almost all of the epicormic buds of the tree, enabling the quick resprouting (Pausas, 1997). Furthermore, the species has lignotuber that permits basal resprouting when fire kills the main stem (Pausas, 2008).

The other characteristic communities of the Mediterranean region are pine woodlands. None of the Mediterranean pines, such as *Pinus halepensis* and *Pinus pinaster*, are able to resprout and post-fire regeneration relies on the canopy seed bank protected in the serotinous cones (Moreira et al., 2012). *Pinus halepensis* is the most abundant pine in the Mediterranean region, covering more than 2.5 million hectares (Pausas et al., 2008). The serotinous percentage of the cones varies widely with the fire regime, where in some cases has been found up to 80% serotiny in places with a lot of fire history (Goubitz et al., 2004).

Despite having post-fire resilience, the regeneration of these pines can fail if the intervals between fires is shorter than the time required to accumulate enough seed bank (Pausas et al., 2008). The interval considered to recover the canopy seed bank is about 10 to 20 years for *Pinus halepensis* but the increase in fire recurrence in the Mediterranean region is reducing the capacity of this pines to successfully regenerate after fire (Pausas et al., 2008).

Another pine common in the Mediterranean region but with unknown distribution, due to the selection for the use of its seeds, is the stone pine (*Pinus pinea*). This species do not possess serotinous cones but the high resistance to heat of its seeds and the thickness of its cones make the post fire regeneration possible (Escudero et al., 1999). This species has a thick bark and the effect of self-pruning leaves the lower part of the tree without branches, and it can survive fires with more than 80% of the crown volume scorched (Pausas et al., 2008).

For the central Europe forests, fire stopped having a significant role in the ecosystem dynamics at least during the last three thousand years. What had a major influence were the human-caused fires, like traditional methods of agriculture and pasture that were even praised until the middle of the twentieth century (Goldammer and Page, 2000).

With so little influence of the fire in the ecosystem, the species have evolved with no response to fire and the ecosystems have been altered mainly by man. Now, historically important landscapes used for grazing have to be maintained or else the natural course of the vegetation will eventually reach the climax and therefore the landscape will change (Lütgepol and Stubbe, 1997). Secondary succession is seen as negative from the nature conservation and biodiversity point of view, since that will make animals and plants adapted to the actual conditions disappear. (Goldammer and page, 2000).

Therefore, fire is considered as a substitute for natural disturbances in order to maintain the landscape. Prescribed burnings are the most used nowadays allowing the burning of excess

loads outside the dangerous season to reduce the risk and favour regeneration of primary succession (Moser et al., 2010). In addition, Moser et al. in their publication have found that after a fire, the pioneer species have more successful recruitment than original stand forming species, and that in extended periods of drought, which can occur after a fire, the vegetation can shift completely to drought-tolerant species or to an open space with no forest.

## Chapter III: Methodology

The nature of this thesis makes it hard to produce direct investigation, given the fact that forest fires are undesired in most cases. The research is made by using statistical data of occurrence of fires in the given countries, which is Spain and the Czech Republic. Historical data is the one that will represent the trend of the fires, causes and effects in the most effective way.

The data related to forest fires will be taken from documentation found in EFFIS, as well as from the manual written by M. A. Porrero for the Spanish part and, for the Czech part, from the 2014 yearbook of the Czech Republic fire and rescue service.

The fire situation of the two countries is completely different in the present day so a direct comparison cannot be done, instead, the fire situation will be analysed separately.

The fire management section will have as the main goal identifying the fire prevention, fire uses and policies of both countries, which are being currently implemented.

Climate change will be taken into account for the presentation of silvicultural measures, new approaches to fire prevention and protection.

For the effects of the fires and management in the Czech Republic will be reviewed J. Albers document, Ecological restoration in the Czech Republic document and E. Kula article on forest fire causes in the Czech Republic. The effects and fire management in Spain will be reviewed

from Pausas et al. article, the state of the forests and forest sector of Spain 2013 and the research report number 23, 2010 from the European Forest Institute.

## Chapter IV: Results

In this chapter will be given the fire statistics of both countries. The statistics will be made in tables regarding causes of the fires, number of fires and number of hectares burnt. This section will be divided in two big frames, statistics of forest fires and fire management. Both countries will be given separately and a brief summarization will take place in the end. After reviewing the statistics and fire management, the possibility of climate change will be evaluated and the effects that can have in the occurrence of forest fires. In the end of the chapter will be given technology innovation in the area of identification and prevention of wildfires as well as silvicultural practices that have been studied to reduce wildfires impact on the forest.

### Statistics of forest fires

In Europe, the burnt area in forest fires has been increasing during the last two decades. It is common to think that areas around the Mediterranean are the most affected ones and in that spite, two maps showing two different parameters will be evaluated: the burnt area and the annual number of fires.

Mediterranean countries are the most affected, only between Spain, Portugal, Italy and Greece the area burnt in 2010 amounted to 243.364 hectares, while Portugal was the most affected with 133.090 hectares (55% of all Mediterranean countries) (Montero and Serrada, 2013).

The most affected regions were, apart from Portugal, the north-west, west and east of Spain, south of Italy and Greece, for the period 1998-2007, as seen in figure 10.

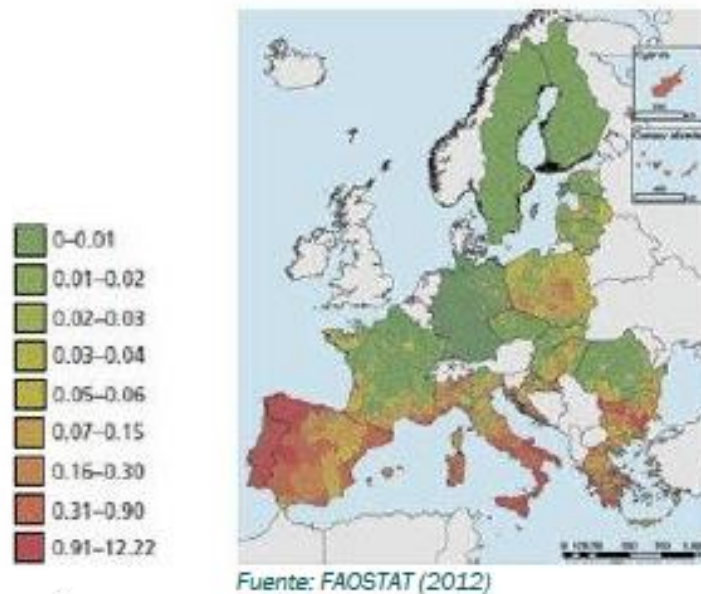

Figure 11 Annual burnt forest area (percentage over the total forest area). Mean values for the interval 1998-2007.

The other map is related with another interesting information, the annual number of forest fires. This indicator is not considered very relevant in studies but it is necessary to understand how critical the fires are in all Europe. In the Mediterranean, there is a correlation between the number of fires and the area burnt as we can see high values in both indicators. Figure 11 shows that the correlation between number of fires and area burnt is positive. In Spain, we can see that for this period, the majority of the fires are concentrated in the north-west (Galicia).

In countries like Poland, Sweden and south of Finland, the number of fires are intermediate and are comparable to those in the centre of Spain. This means that the number of fires is elevated but the area burnt is very small, which is due to the difference of weather. In countries of central and north Europe, this correlation is not necessarily positive because the fires are smaller in area than in the Mediterranean (Montero and Serrada, 2013).

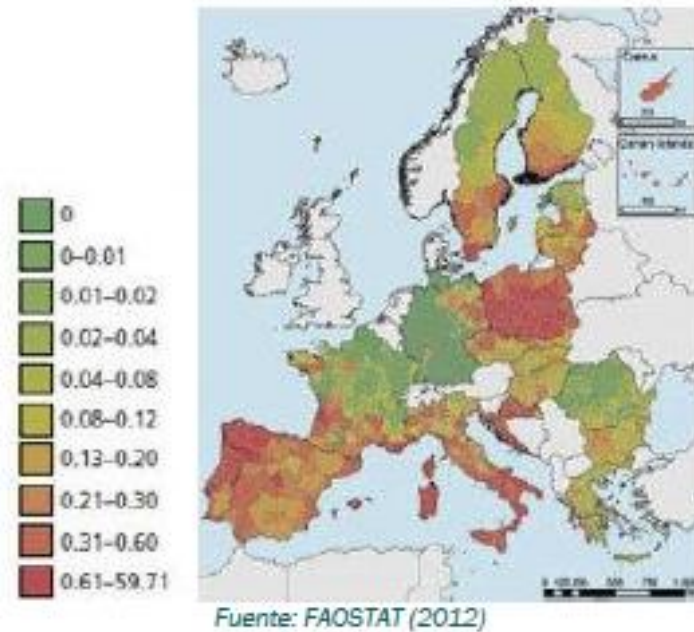

Figure 12 Number of fires by year and 10km2 in wildland. Mean values for the interval 1998-2007.

## Statistics in Spain

In Spain, fire has been used commonly as a territory managerial tool in many rural lands and as has been happening in many countries, the rural abandonment produced in the last decades has produced an evident change in the Spanish agroforestral landscape (Schmuck et al, 2014). The actual tendency in the Spanish mountains vegetation structure is towards becoming more and more dangerous. The Spanish forests accumulate thin biomass that in the past was used to cover heating necessities and cattle feeding. This biomass has bigger spatial continuity of forest fuel, where the previously sown fields now lay full of vegetation. This vegetation eventually will transform into forest and will have less fire threat but for this they need decades and the periodicity of the fire in Spain is at most five years for the catastrophic events. In the EGIF (General Statistics of Forest Fires in Spanish), they show that the catastrophic years are 1985, 1989, 1991, 1994, 2000, 2005 and 2012, and this can also be seen in the graphic below (figure 12).

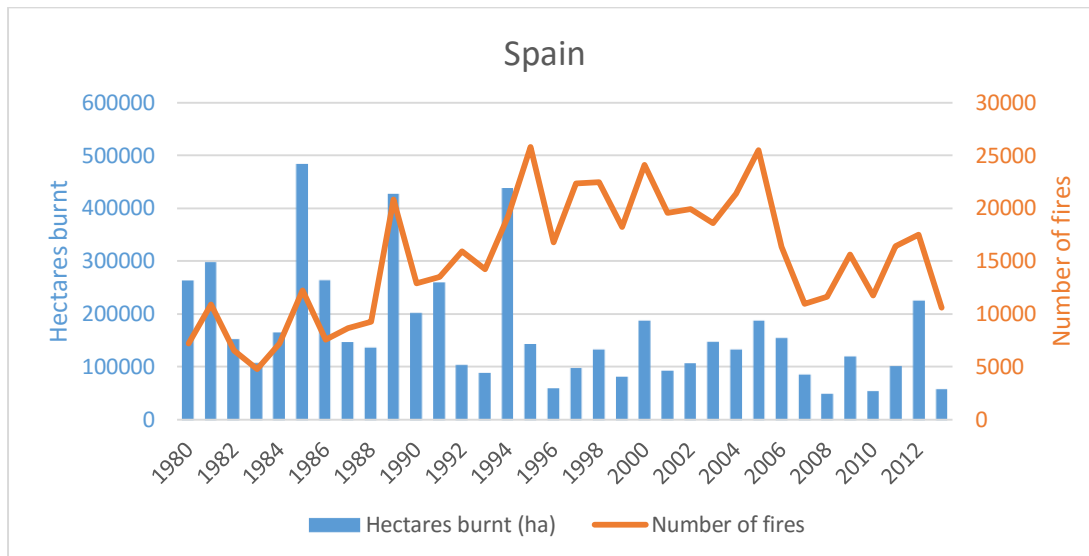

Figure 13 Overlapping burnt area with number of fires in Spain for the period 1980-2013. Source Schmuck et al. 2014.

From 1960 to the 1990 in Spain occurred a mean of 5,144 annual fires with a total forest area affected of 146,523 hectares (State of the forest 2013). From 1990 to 2010, the fires registered a maximum of 25,557 annual fires (year 1995) with a mean of 17,864 and the forest area affected for this period was 139,775 hectares annually. This exponential increase is due to the aforementioned, the rural abandonment. What shows a change is also from 1992, with 1994 as an exception, the number of fires continues more or less constant but the area burnt got to half of what it was years before with less number of fires. This is due to the conatus, which is any fire that affects less than a hectare, that number more than half of the total fires for this period with 10,694 out of 17,864 as an average.

Other kind of fires are the large wildfires. These fires are classified as the ones that affect more than 500 hectares (Firewise, 1998. Montero and Serrada, 2013). In this period, 679 large wildfires have been registered with a mean of 32 annually. The average area affected by such wildfires is 58,847 or 39% of the annual area affected by all forest fires in Spain.



Table 11 Evolution of n° of fires including large wildfires for the period 1990-2010 Source: MAGRAMA 2012.

years	Number of fires	Nº fires ≥500 ha.	Forest area (ha)	area affected by large wildfires
1990	12914	56	203641	66184
1991	13529	80	260303	138928
1992	15956	19	105278	30919
1993	14253	25	89331	43532
1994	19249	93	437603	335359
1995	25557	26	141082	31700
1996	16586	10	58919	6962
1997	22320	7	98503	5309
1998	22003	27	132892	41762
1999	17943	16	81681	17399
2000	23574	49	187567	63635
2001	19547	16	93298	20325
2002	19929	18	107464	16993
2003	18616	43	148172	76796
2004	21396	20	134193	56726
2005	25492	48	188697	84606
2006	16334	58	155345	72119
2007	10936	16	86122	52234
2008	11655	6	50322	5500
2009	15634	35	120094	56266
2010	11722	11	54770	12539
Mean	17864	32	139775	58847

Traditionally there is a difference in the regions of Spain regarding large wildfires. The northern regions, due to the climate and the structure of the forest, tend to suffer more number of forest fires but of smaller dimensions. In contrast, in the Mediterranean and the centre of the country, the fires are fewer but because of the dry conditions and the stacking of fuel, the fires tend to be of bigger dimensions.

Generally, Galicia, Castilla-León and Asturias are the three regions of Spain with bigger number of fires, but when we look at the number of hectares burnt, the ratio is smaller than in eastern regions. Taking year 2012 as an example, Galicia had 3,798 fires that burnt a total area of 15,365 hectares, Asturias had 2,220 fires with 13,308 hectares affected and Castilla-León (a drier and warmer region) 2,611 fires with a total of 43,523 hectares burnt. Then if we look at

Valencian Community, with only 502 fires 57,607 hectares were burnt (source MAGRAMA 2012).

Therefore, in figure 13 are best represented the ratios between number of fires and forest area burnt, where eastern regions with Mediterranean climate and dry conditions have a bigger ratio and regions from the north and north west with Atlantic and continental climate have lower ratios.

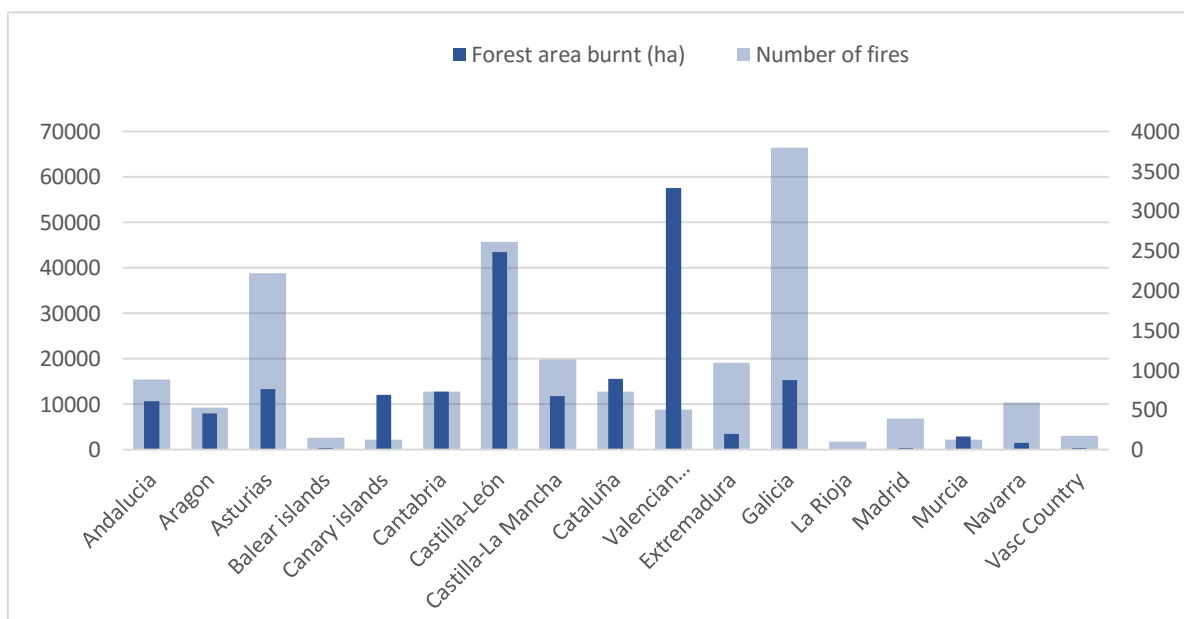

Figure 14 Wildfires distribution by Autonomic Community in 2012. Left axis represents area affected in hectares. Right axis represents the number of fires.

The main species affected by wildfires throughout the country are *Pinus halepensis* and *Pinus pinaster*. Both of them have serotinous cones and have a good seed regeneration. The main reason for this two species is, for *P. pinaster*, the fact that is the most productive species in the forestry industry in Spain, followed by *Eucalyptus sp.* as for *P. halepensis*, this species has been used in all the Mediterranean for reforestation purposes due to the adaptability and growth potential in areas affected by fires (Porrero, 2000).

Table 12 Main species affected by fires in the period 2001-2010 by Region.

A. Community	Species 1	Area (ha)	Species 2	Area (ha)
Andalucia	<i>Eucalyptus camaldulensis</i>	17652	<i>Pinus pinea</i>	10305
Aragon	<i>Pinus halepensis</i>	10985	<i>Pinus nigra</i>	4513
Asturias	<i>Eucallyptus globulus</i>	3007	<i>Castanea sativa</i>	2685
Canary Islands	<i>Pinus canariensis</i>	26028	<i>Myrica falla</i>	616
Cantabria	<i>Quercus pyrenaica</i>	1552	<i>Quercus robur</i>	843
Castilla-Leon	<i>Pinus pinaster</i>	11812	<i>Quercus pyrenaica</i>	10011
Castilla-La Mancha	<i>Pinus pinaster</i>	13369	<i>Pinus halepensis</i>	4920
Cataluña	<i>Pinus halepensis</i>	9916	<i>Quercus ilex</i>	2498
Valencian Community	<i>Pinus halepensis</i>	9171	<i>Pinus nigra</i>	553
Extremadura	<i>Pinus pinaster</i>	17350	<i>Quercus ilex</i>	8197
Galicia	<i>Pinus pinaster</i>	54108	<i>Eucalyptus globulus</i>	40096
Balearic Islands	<i>Pinus halepensis</i>	1043	<i>Olea europaea</i>	9
La Rioja	<i>Pinus halepensis</i>	49	<i>Quercus pyrenaica</i>	31
Madrid	<i>Pinus pinea</i>	1098	<i>Pinus halepensis</i>	440
Murcia	<i>Pinus halepensis</i>	837	<i>Pinus pinea</i>	13
Navarra	<i>Pinus halepensis</i>	481	<i>Quercus faginea</i>	414
Vasc Country	<i>Pinus radiata</i>	972	<i>Quercus faginea</i>	361

As for the causes of the forest fires in Spain, the main are lightning, negligence or accidents, deliberate ignition, unknown and reproduction of previous fires. For the period 1986 to 1997, M.A. Porrero did a classification of the causes, where it can be seen that the percentage of unknown causes descended from almost half of the causes (48.2%) to barely 17 percent. Fires started by lightning, and negligence have remained stable through this period of time, but deliberate ignitions have escalated from being a third of the causes (30.7%) to being 70 percent of them. This clear increase is proportional to the unknown causes descend, as technology and identification techniques improve, more causes are better classified.

Table 13 Causes of fires in Spain for the period 2001-2010. Source MAGRAMA 2012.

Causes	Number of fires		Area burnt	
	Number	(%)	Number	(%)
Lightning	7499	4.39	83315	7.32
Negligence and accidents	39825	23.31	263333	23.15
Deliberate	93489	54.73	676468	59.47
Unknown	26267	15.38	98174	8.63
Reproduction	3742	2.19	16276	1.43
Total	170822	100	1137566	100

For the period 2001-2010, in the state of the forests of Spain document (Montero and Serrada, 2013) have further classified the causes reaching the conclusion that 78 percent of the total fires are of human origin affecting the 82.6 percent of the total burnt area. The most common cause is the deliberate ignition with more than half of the total and 60 percent of the burnt area. Negligence and accidents are responsible of the 23.31 percent of the fires and 23.15 percent of the area burnt. Inside this category, the agricultural traditional burning to regenerate pasture are the most important ones, making up for 8.21 percent of the total fires and 5.17 percent of the total burnt area.

There are also differences between the regions concerning the causes, while in the north and north-west the deliberate ignitions have a high percentage, it gets down to a third of the total causes when going to the east or the centre of the country. In the Mediterranean area and the centre of Spain, almost half of the causes are negligence or accidents (46% and 43% respectively). The majority of the lightning produced fires are concentrated in the centre and the Mediterranean regions.

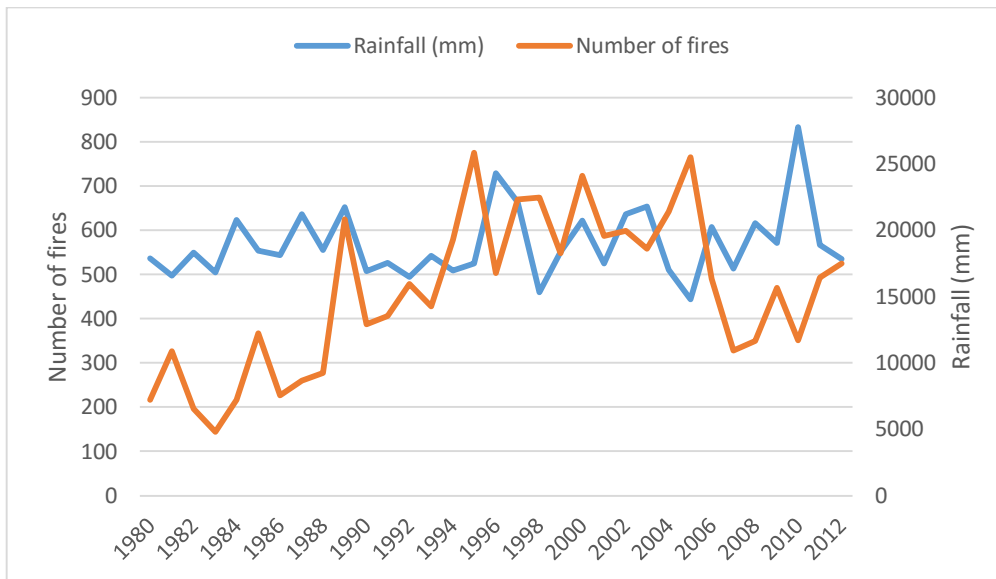

Figure 15 Rainfall against number of fires in Spain for the period 1980-2012. Source: Climatic Research Unit (CRU) of University of East Anglia (UEA).

Figure 15 represents the amount of annual rainfall opposed to the annual number of fires. This shows that the number of fires depend on the moisture. If the year is dry, the number of fires increases and if the year is moist the number of fires decrease proportionally. This is especially true in normal years, but when taking into account the transition period (1980-1994), the series become unstable due to the changes in use and accumulation of fuel.

### Statistics in Czech Republic

The Czech Republic, as a central Europe country, does not have a big history with forest fires. If the number of fires and the hectares burnt in Spain and in the Czech Republic were to be compared, this number is ten and one hundred times smaller respectively in the Czech Republic. Opposed to the situation of Spain, the difference in climates inside the Czech Republic is less intense and therefore, the figure 16 shows a more even ratio of fire per hectare throughout the series.

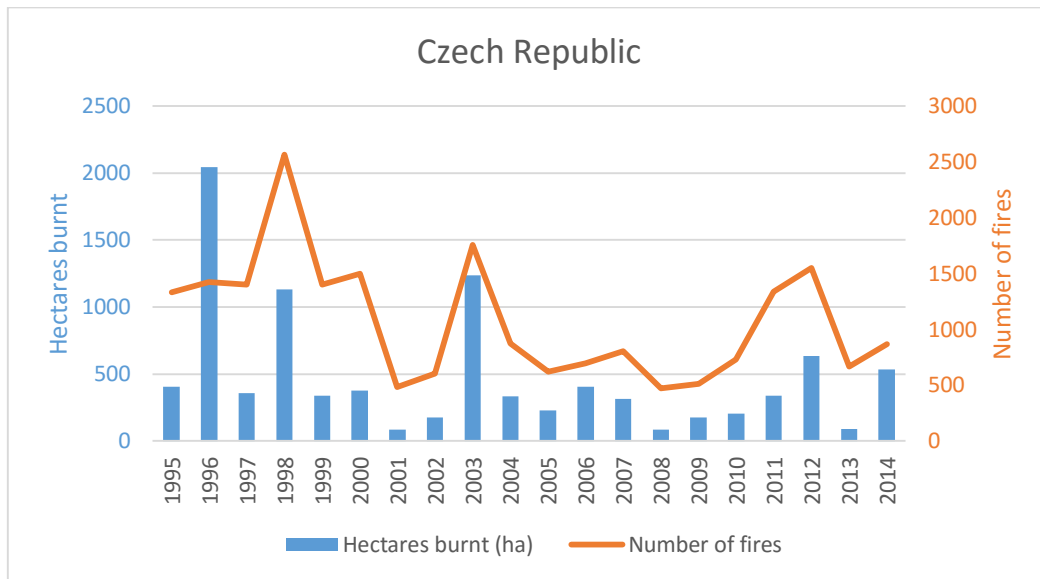

Figure 16 Overlapping burnt area with number of fires in the Czech Republic for the period 1995-2014. Source Schmuck et al. 2014. (Years 1995-2005). Statistical Yearbook 2014, Fire and Rescue service in the Czech Republic (years 2006-2014).

The increase in fires that took place in this period of time was due to low total precipitation where the year 2003 was very dry (507 mm against the normal 672 mm for the period 1961-1990), and the years 1995, 2001 and 2002 where classified as very rich. As for the temperature, it went over the normal for the period 1961-1990, which was 7.5 °C with the exception of 1996 that was affected by a decrease in temperatures in the months of January to March (Kula and Jankovská, 2013). With this data is clear that the climatic conditions affect mostly the area burnt, affecting the extinction labours.

Most of the fires were reported in the North-Bohemian and Central-Bohemian regions with 18.7 percent and 17.8 percent respectively, with the maximum total burnt area in the South-Moravian region with 20.8 percent and the West-Bohemian region 18.3 percent (Kula and Jankovská, 2013).

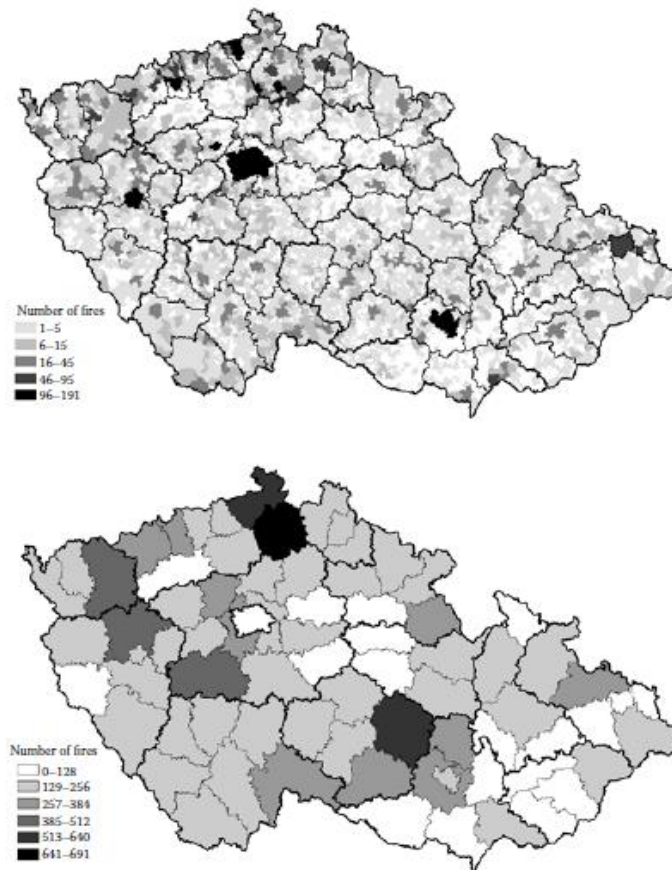

Figure 17 Number of fires by municipalities (up) and number of fires by districts (down) in Czech Republic, 1992-2004) Source Kula and Jankovská 2013.

As for the causes, for the period 1992-2004 were classified by E. Kula and Z. Jankovská, obtaining that fire raising (22.6%) with an area burnt of 22.1 percent was the most important, followed by smoking (22.4%) with an area burnt of 17.3 percent. The third one is management in the forest with 10.1 percent and 11.7 percent respectively that previously were placed inside the fire-raising category. A category not used in the Mediterranean area such as children under 15 years old was fourth with 4.6% and 3.1% respectively. Unexplained fires were counted for a total of 29.9 percent of the fire causes and 33.3% of the total burnt area. The significance of lightning fires is very low in central Europe. Deliberate ignition, in contrast with Spain, accounted only for 3.44 percent of the fires with an area burnt of 3.08 percent. This can point to differences in the culture, activities taking place in the forests and forest management. The need for grazing areas, traditional use of the fire and the attraction of incentives are stronger in Spain than in Czech Republic.

The fires in central Europe usually occur in sites dominated by pines like Scots pine (*Pinus sylvestris*) with dry conditions or coniferous dominated sites with mixture of Scots pine and Norway spruce (*Picea abies*) (Albers, 2012).

Table 14 Causes of forest fires and burnt area in the Czech Republic (1992-2004). Source Kula and Jankovská, 2013.

Causes	Forest fires		Burnt area	
	Number	(%)	Number	(%)
Unexplained	4778	29.89	2603.71	33.28
Heating devices and flue ways	9	0.06	0.60	0.01
Operation-technical defects	133	0.83	159.99	2.04
Combustible and explosive materials	2	0.01	0.31	0.00
Extraordinary events	230	1.44	113.50	1.45
Deliberate ignition (arson)	550	3.44	165.22	2.11
Children up to 15 years	731	4.57	240.67	3.08
Smoking	3585	22.43	1350.44	17.26
Fire raising	3611	22.59	1731.99	22.13
Management in forests	1615	10.1	917.69	11.73
Negligence of adults	288	1.8	151.84	1.94
Railway operation	166	1.04	311.94	3.99
Blasts and self-ignition	65	0.41	42.52	0.54
Lightning	222	1.39	34.40	0.44
Total	15985	100	7824.82	100

Figure 18 shows the number of fires opposed to rainfall. As it occurs in the Spanish counterpart, in the Czech Republic, the number of fires is also inversely proportional to the amount of rain. Therefore, the number of fires does not depend on the temperature as much as it depends on the moisture.



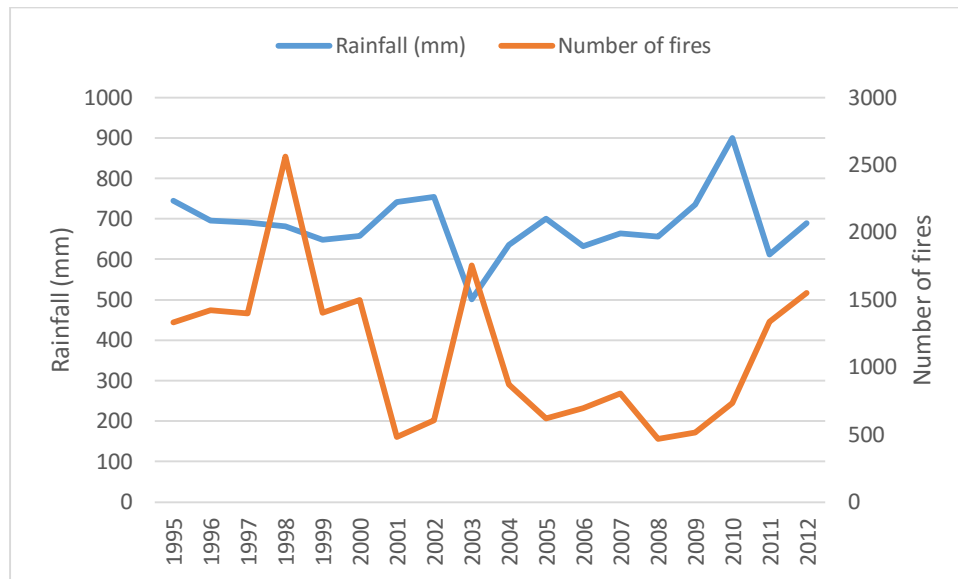

Figure 18 Rainfall against number of fires in the Czech Republic for the period 1995-2012. Source: Climatic Research Unit (CRU) of University of East Anglia (UEA).

## Fire management

Through the FAO database tool called FAOLEX, we find two types of legislation concerning forest fires. The first is legislation specific to forest fires and the second forestry-related legislation covering forest fires (FAO 2004). The legislation specific to forest fires will be covered individually in each country meanwhile the forestry-related legislation covering forest fires will be described shortly. This national legislation is common to the members of FAO and in 2004 FAO described it as it follows:

- General firefighting measures, making obligatory for the government to combat or help controlling forest fires without regard of ownership of the forest areas;
- Deriving upon individual persons the responsibility to report forest fires or situations of possible risk that may result from them. Some laws make it an offence to not report such facts;
- Creation of information exchange mechanisms and data on projected weather changes in order to facilitate the rapid response;
- Identification of special protection measures to protect the public and the environment;

- Compensation mechanisms for damage suffered by those involved in firefighting and incentives upon report of risk situations;
- Restoration of forest areas affected by fires.

## Fire management in Spain

Fire management in Spain is made in four categories, coordination of the institutions, prevention, security and extinction (MAGRAMA). The coordination of the institutions is made with sharing information. The National Coordination Centre of Information regarding Forest Fires (CCINIF) has three key roles:

- Elaboration of the national statistics of forest fires under supervision of MAGRAMA (Ministerial office of Agriculture, Food and Environment) with the data offered by the Autonomic Communities each year.
- Canalization and disposition of the information to the competent organisms in real time with:
  - Daily provisional report: real time updated information of the forest fires with media involved in action.
  - Daily definitive report: daily updated data from the action of the media the previous day.
  - Daily risk report: updated daily information with the risk of fire outbreak the next day.
  - Information of fire risk at European level (source EFFIS).
  - Provisional statistics of forest fires: weekly updated information for the risky season (01 July to 30 September) of the fire occurrences. Outside the risky season is updated monthly.

- MAGRAMA media: statistical information of media availability, operative terms and mobilization rules of these.
- Support and reinforcement to the Autonomic Communities through the State extinction media.

Prevention management is done with Preventive Work Brigades (PWB), Integral Prevention Teams (IPT) and prevention derived from FEADER programs. PWB perform preventive silvicultural work, consisting of the reduction and control of forest fuel, making the forest more resistant to the start and spread of the fire and facilitating suppression actions (Schmuck et al, 2012).

IPT is the result of the collaboration of MAGRAMA with the prevention program. These teams were created in 1998 to intervene directly in the territory affected by problems that led to fire. Their work consist in supporting the rural population in conducting prescribed burns and providing social awareness (Schmuck et al, 2012).

The prevention derived from FEADER programs involves preventive silviculture, modifying the structure and composition of the forest stands with a medium and long term, in order to difficult the fire spreading with actions such as conditioning and maintaining firewall strips, auxiliary strips, defence lines etc. The other major action that involves the FEADER programs is the creation and improvement of access roads to forest areas, water points, vigilance posts or tracks for the aerial media (MAGRAMA).

For the security management, two kinds of resources are spend. Human resources called Reinforcement Brigades against Forest Fire (RBFF), which are transported by helicopter anywhere in the country and are highly specialized teams and aerial means, where the hydroplanes are used to extinguish forest fires from the air.

The extinction labours are done via the same media used for protection plus the help of the firefighters and their trucks.

## Fire management in Czech Republic

The fire management in the Czech Republic is not as wide and specified as the Spanish one, given the fact that forest fires are not as big of an issue as they are in Spain. The management of fire events is done via the Fire Rescue Service of the Czech Republic (FRS) that is the main organisation fighting against all kinds of fires produced in the country, not only the ones produced in the forests.

Its organization is made by the General Directorate on top of the organization, followed by Regional Directorates of the FRS distributed through all the country. Under its wing, we find the Special Secondary School of Fire Protection and High Special School of Fire Protection located in Frýdek-Místek, where the training of the future firefighters will take place. On the lower level we find the Technical Institute of Fire Protection of Prague, under the Operational Management Division, The Population Protection Institute Lázně Bohodaneč under the Prevention and Civil Emergency Preparedness Division. Under the Division for Economy there is the Repair Plant and the Logistics Base in Olomouc, and under the Director office Division there is the Specialized educational establishments of fire protection Borovany, Brno, Frýdek-Místek and Chomutov. The lower level of the organization is made by the Emergency Units, which are the ones to be deployed when a fire takes place. The fire units are four:

- Regional FRS unit. Consists of professional firefighters of the Czech Fire Rescue Service, employed in fire stations around the country.
- Company FRS unit. Consists of company employees that perform firefighting as their job.

- Municipal unit of voluntary firefighters. Members of that unit do not perform firefighting as their profession.
- Company unit of voluntary firefighters. Company employees that do not perform firefighting as their regular job.

From the nearly 83,400 firefighters that work in fire units, approximately 9,000 are professional and 74,400 are voluntary (Fire Rescue Service of the Czech Republic).

The prevention is performed as a supervision by means of the General Directorate of Fire Rescue Service of Czech Republic:

- Inspections of the duties given by the fire protection regulations are implemented.
- Reviewing of spatial planning documentation, projects and designs for constructions, changes in constructions or in its use. The order of the necessary changes, safety works, special proceedings can be given as a solution to fires.
- Checking fire safety conditions in constructions based on reviewed designs and documentation given.
- Reviewing of fire safety products if it is not given by specific regulations and reviewing of functionality of systems for fire safety equipment.
- Approvals of fire risk evaluation of activities with high fire risk.
- Investigation of fire causes.
- Inspections of preparedness and readiness of fire units.
- Lying on provisions to remove inadequancies found by inspections.

For the prevention in the forests, the legislation in the section of forest fire control aim is to minimize risk of fire caused by human activities (more than 70% of the total causes). The forest act of the Czech Republic No. 289/1995 and the amends of the act 3 of November 3<sup>rd</sup> of 1995 specifies a restriction of the activities that produce the majority of the fires in the forests:

- Driving or parking motor vehicles.
- Riding bicycles and horses, skiing and sledging out of marked paths.
- Smoking, lighting or keeping in fires and camping at other than approved places.
- Throwing away burning or smouldering objects.
- Littering the forests.

It is also prohibited to light or keep in fires within 50 meters from the forest edge, as well as a safety distance between human activities and buildings from hay or straw.

The Fire Control Brigades (FCB) carry out the state fire inspection in the regional, territorial and district level. Fire wardens are State Administration placed personnel responsible for detecting and eliminating causes of fires in forest stands (Forest Act 1995).

## Silvicultural practices to reduce the impact of forest fires

Silvicultural practices to reduce the impact and severity of the forests take place in the wildland-urban interface and in the river courses. Urban-wildland interfaces can be from population area like a city or a town or agricultural lands to forest. These practices consist in fire barriers and firewall strips (Moya and Moya, 2012).

The fire barriers are normally made from tree species resistant to fire or with low ignition value. They consist in a barrier system of trees with clean soil of fuel and enough space between them to separate the flames but close enough to slow the wind and therefore the speed of the fire spreading. Firewall strips are made by spacing trees in a wide range to minimize the spreading of crown fire and maintaining the ground clean of fuel. The trees are optional and depend on the nature of the forest, the most successful firewall stripes are a bald discontinuity of the forest without trees.

In 2012, a CYPFIRE project proposed the use of Mediterranean cypress (*Cupressus sempervirens*) as a fire barrier species. The reason behind that is the study of flammability made by Gianni Della Rocca and Roberto Danti. In the study, they showed that cypress was the one that released the least amount of heat, the second greater value in ashes (the greater the amount, the less able to burn) and the content of silicon, which reduces the flammability of the gases, was the greatest of the specimens.

In the flammability index, Mediterranean cypress is found in the middle with an average 2.5 out of 5 (mean time in seconds and frequency of flammability in percentage). Mean ignition time of Mediterranean cypress was the highest of all the species and was the conifer with the highest value.

In the document, Della Rocca and Danti believe there are three factors that favour the combustion and spreading of the fire: the roughness of the bark, the presence of serotinous strobilus and the architecture of the crown and habitus.

Mediterranean cypress bark is thin and smooth; therefore, the trunk has less surface area exposed to the flames in comparison to the rough barks. In a front fire that passes rapidly through the vegetation, the cypress is less likely to catch fire than trees with rough bark like pines (Della Rocca and Danti, 2012).

The Mediterranean cypress possess a natural self-pruning ability, which breaks the vertical continuity of the fire naturally and makes less likely for the crown to suffer damages. Stands of Mediterranean cypress with no shrubs will be very difficult to be affected by crown fires. the crown is very dense, which in case of catching fire, will slow considerably the advance due to the reduced air circulation and the bigger moisture content.

The cones of *C. sempervirens* are serotinous, but as opposed to other conifers such as *P. halepensis* or *P. pinaster*, its cones do not shot from the flames to great distances (dispersion mechanism), they can stay closed on the tree for even several years).

Another great difference is the amount of litter produced by this species. Cypress litter is thinner, more compact and characterised by a reduced circulation of air, maintaining higher moisture than pine litter. The acidity of the litter makes impossible for other plants to germinate and the shading on the ground diminishes the amount of light that reaches the ground, making the understory naturally clean (Della Rocca and Danti, 2012).

Inside the forest stands, the main silvicultural activities that take places are selection of species, changing density and inter-tree distance, thinning and spacing, and site preparation (Forest for Tomorrow).

The selection of species can be made by changing the species composition to suit the fire regime of the region. In productive forest, this criterion has been used traditionally to obtain benefits. The selection of deciduous trees with good regeneration post fire and low flammability (Aspen, Poplar, Maple and Birch). Selecting species with higher moisture content (generally deciduous) reduces the intensity of the fire. A mixed stocking would allow more valuable assortment into the stand.

The density of trees and inter-tree distance influences the surface, ladder and crown fuels in the case of a fire. The wider the spacing of the trees the lower the continuity, however, too much spacing increases ground fuel and younger trees stablsh and grow, increasing vertical continuity. If the trees are too densely spaced, the competition can lead to dead trees and therefore an increase in vertical continuity but used correctly can add moisture and shade, reducing the ignition point of the dead fuel.



Thinning is another popular silvicultural practice. It is normally used as a stand management tool to influence which individuals are desired to grow for the productive aspect of the stand. Juvenile thinning reduces vertical continuity of the fuels and generally requires additional treatment to remove the waste. Commercial thinning provides chance to remove merchantable material and the opportunity to select species for the next rotations. Fire resistant species can be left to increase the proportion of these trees in the future. This thinning reduces the crown density and the ladder fuels can be removed if the thinning is from below (Forest for Tomorrow). If pruning is added, the height of the crown gained reduces the probabilities of suffering a crown fire.

The last one is site preparation. Site preparation can be done with prescribed fires or mechanical site preparation. The Integrated Fire Management (EFI, 2010), offers the integration of human caused fires into the management plan in order to reduce the fuel load. This is done before the fire season starts in order to reduce the likelihood of a fire occurring and in case it occurs, the amount of fuel available will be reduced. These fires are controlled (prescribed fires) and have to be done under strict safety measures.

Mechanical site preparation is often done with machinery and removing wood waste reducing ground fuels. Here exists a big difference between Mediterranean regions and central European regions. Nowadays exist this trend to leave the pruning/thinning residues on site to protect the soil and improve the level of humus and organic matter. In the Mediterranean, this practice cannot be put into practice due to the risk that it poses. Dead wood in the Mediterranean dries fast and can be ignited very easily ignited with the high temperatures of the dry season.

## New techniques to identify and prevent wildfires

The best way to avoid fire damages is with prevention and identification. After a successful fire management, the probabilities of fire occurrence are smaller but that does not

mean that they will disappear. The fire management in Spain and the Czech Republic is very complete and well planned (MAGRAMA, FRS). Therefore, the process that can be improved radically with the new technologies is prevention and identification. If we could identify starting fires right after they ignited or even before, the extinction labours would be much easier and the damages less important.

In the north of Spain, more accurate in Galicia and Asturias, two of the regions with most fires in the country, SISVIA “Vigilancia y Seguimiento Ambiental” (Environmental Vigilance and Monitoring), have developed an integrated forest detection system called Libelium (Solobera, 2010). The area that is covered by this system spans about 210 hectares, is capable of alert and deliver warning alarms. The system is comprised by three parts, the wireless sensor network, where the sensors are placed in the forest, the communication network, consisting of the wifi and gprs transmission network, and the reception centre, where the information is evaluated and transformed with satellite and teledetection system to mapping.

The sensors are capable of measuring temperature, relative moisture, carbon monoxide (CO) and carbon dioxide (CO<sub>2</sub>) every five minutes, allowing the reception centre to react very fast in case of a fire outbreak.



*Figure 19 Waspmote wireless sensor. Source Solobera, 2010.*

Remote sensing is being use all around the world. The system called FireWatch (IQ Wireless Gmbh) is one of the most used globally and uses tower based sensors for the early recognition of the fire. It can detect smoke clouds day and night, and the area supervised by each sensor can be more than seven thousand hectares. This system uses a spectroscope to detect smoke and the infrared technology is used to detect warmer objects than their surroundings. The system uses an optical sensor system that rotates 360° to cover a wide round span. This tower with the sensors is connected wireless to the office computer situated in the forest wardens' workplace. In Spain, there are three systems with one workplace covering 130,000 hectares in the region of Madrid (IQ wireless Gmbh).

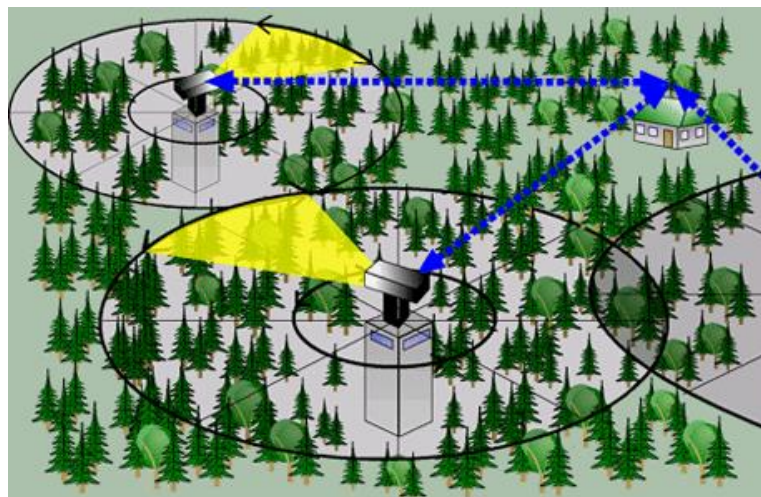

*Figure 20 FireWatch tower system representation of how it works.*

These systems are stationary and cover a certain area. The next step would be using moving sensors and that can be done now with the use of drones. Drones are unmanned vehicles that can travel to places too risky or costly for humans to be deployed. Aerial drones specifically are a good way to improve the remote sensing of fires.

A drone can be equipped with cameras and other sensors, allowing a real time monitoring of the forest and detect possible changes. In the Olympic National Park in the United States of

America, officials fighting a forest fire claim to have successfully deployed a drone with infrared video camera to steer water-dropping helicopters to their target (Gates, 2015).

Drones can be radio controlled from many kilometres away (ELIMOC E300 about 60 km, Sensefly eBee 16 km) depending of the size and purpose. The drones can be programmed with GPS to make patrols over certain areas and afterwards using a GIS software to make a mapping of the affected areas when a fire has started or even a hotspots map of the heat or smoke points and later be reported to the firefighting brigades (Dr Drones, 2014).

Drones are considerably cheaper to deploy than work force, therefore they can be deployed several days a week in the fire season equipped with infrared cameras, thermal cameras, GPS and wireless system to transmit the information in real time and directly to the station.



*Figure 21 Example of drone with infrared video camera (RPAS MCFLY-IR). Source Drone Technology.*

## Climate change

Climate change affects all regions around the world, polar ice melts, the sea is rising and in some regions, extreme events are becoming more and more common (European Commission). In the report “Climate change, impacts and vulnerability in Europe 2012” was described that the temperatures observed across Europe were higher and the precipitation in southern regions was decreasing meanwhile in the northern regions of Europe was increasing.

The consequences of the climate change are different for each European region. For the southern and central Europe more heat waves, forest fires and droughts have to be expected in the upcoming years. For the Mediterranean area, drier conditions making it more drought vulnerable and fire prone. For the northern Europe will mean wetter climate and more common winter floods.

Climate change will bring both positive and negative impacts in the forests structure, growth patterns, composition, productivity and functioning, depending on the location and type of forest (EEA, 2016). Soil degradation, prolonged droughts and fires are already an issue in the Mediterranean region and becoming more and more common in the central European region. Because of these factors, desertification risk has increased in the recent years (EEA, 2012).

Climate change will also bring changes to the way pests and diseases interact with the forests. Some species will move to habitats that have no records of them being present and some of them will become more aggressive. This will bring also the shifting in species, moving to latitudes outside their normal distribution and may become invasive species (EEA, 2016).

In the Mediterranean, the climate change would increase the barrenness of the region, changing the forest fires regime due to a bigger flammability of the vegetation and the extreme droughts periods would increase the risk of ignition and the amount of available fuel. The risk of fire would expand to other areas that historically were very little affected by wildfires and the nil adaptation of the vegetation to them would increase the risk of deforestation (Poyatos et al. 2013). The species composition would shift to scrublands and fire adapted species where originally high forest species were predominant.

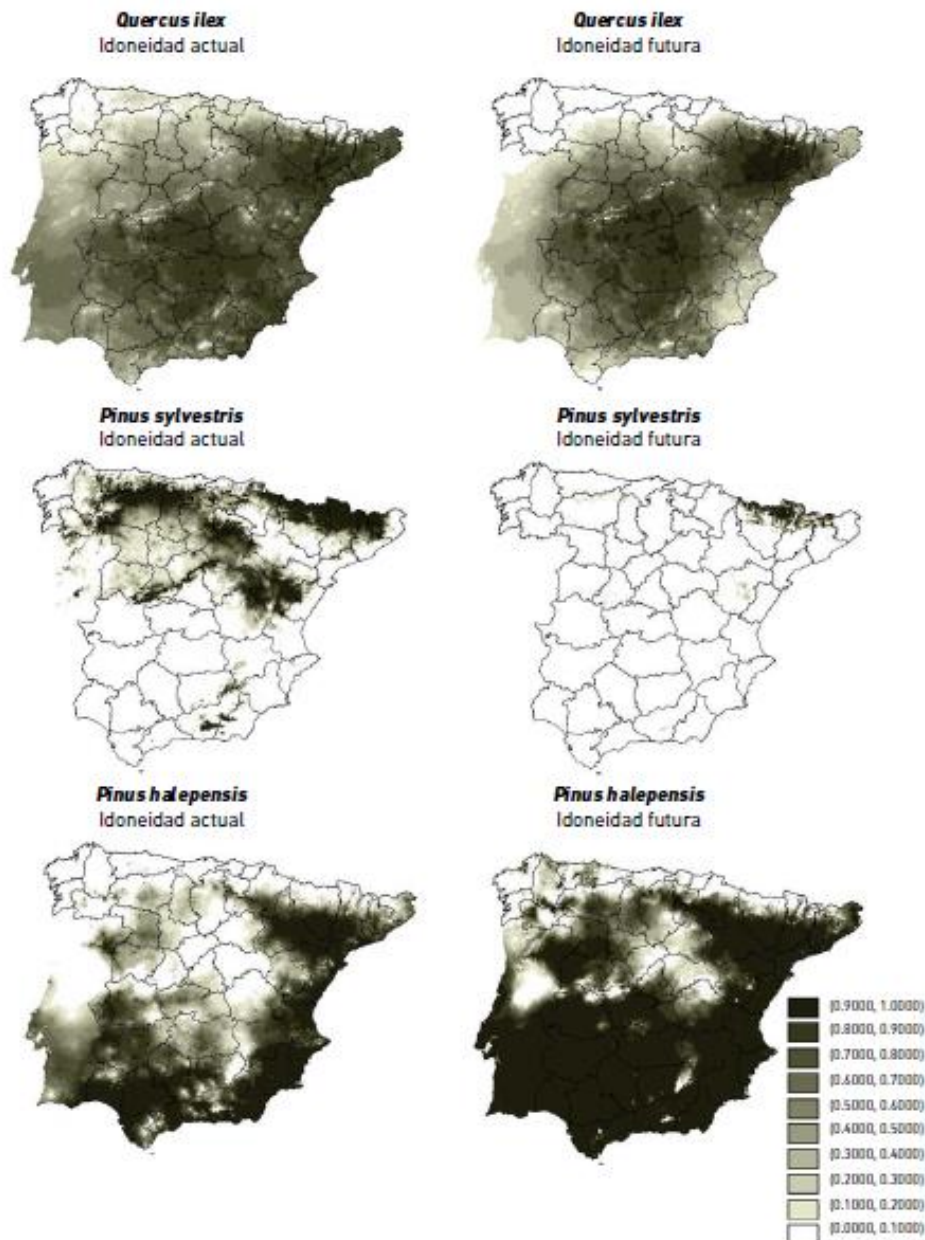

Figure 22 Actual (left) and future (right) (2050-2080) climatic adequacy of the three most abundant tree species in the Spanish forests.

This figure shows the changes in distribution and adequacy of the most common tree species of Spain in the scenario of climate change. For *Quercus ilex*, the distribution does not change much because this species is adapted to forest fires. *Pinus halepensis* would experience an increase in distribution due to the changing conditions of areas that now are not suited for it to grow and the opposite would happen with *Pinus sylvestris* that would recede to the higher mountains in the Pyrenees looking for suitable conditions to grow (Poyatos et al. 2013).

For the Czech Republic, being located in the central European region, the effects of climate change would follow the same pattern as the Mediterranean, drier periods, higher temperatures and less precipitation in summer and therefore, increasing the risk of fires (EEA, 2016). These changes would approach the Czech Republic to what Spain is nowadays, with the problems that would imply. These changes would disturb the actual distribution of the forests and the vegetation belts (Hlásny et al., 2011). The species would shift to higher altitudes, and the bigger change would be in the beech-dominated belt. The oak, better adapted to drier and warmer conditions would make the beech retreat to higher altitude areas. This would also favour the entrance of southern oak species such as *Quercus pubescens*, *Q. cerris* and *Q. frainetto* into the country due to the expansion of the northern distribution limit of these species (Hlásny et al., 2011). This does not mean the beech distribution would recede. In Spain have been found in replacements of beech by *Q. ilex* in the lower range, however in the upper range, beech have been successfully competing with established species and increasing the upper limit of the distribution (Peñuelas et al., 2007).

In higher belts, actual resident species would shift upwards and beech would advance, bringing also broadleaved hardwoods in the process. In the mountain belt, the highest belt would suffer in conditions of climate change due to its vulnerability (Hlásny et al., 2011). This would make Norway spruce retreat further north and to high altitude ranges or even if the temperature change is big enough, completely disappear from the country.

The future vegetation distribution of the Czech Republic, in the climate change scenario, would leave the country with the lower half broadleaved species with much more oak species, the upper half with beech and pine mixed forest and in the northern parts of the country and the highest belt Norway spruce and coniferous forest. This shift in species would make the country more prone to wildfires and with the increased temperatures and drought periods, the risky season would increase.

## Chapter V: Conclusion

Forest fires are a big concern in Spain, the increasing number of fires in the last decades have made the management very efficient but the size of the fires have complicated things as of late. The best direction for the fire management in Spain to take action would be in improving the identification technology through drones and similar advances. The derogation of the last forest law concerning forest fires “Ley de Montes 43/2003” and its article 50, where the administration changed the 30 years period in which the burnt land could not get requalified and change its use when the regional government sees it fit. This change increases the benefit of burning the forest and therefore increasing the arsons. In Asturias, in 2015, right before the elections occurred, 130 forest fires were reported. The speculation was that the owners caused the fires afraid of the new government changing the law and leaving them unable requalify their land. The climate change scenario should be taken more seriously and addressed as soon as possible to avoid deforestation, desertification and loss of soil, which are already important problems in Spain.

As for the Czech Republic, the fact that forest fires are not important now does not mean that they will not in the future. The shift in species and the devaluation of the forest would change drastically the forestry sector and measures to change products and benefits from forest should be addressed in the future. The increase of forest fires would be too demanding for the actual Fire Rescue Service and a new service in charge of the forest monitoring should be created, imitating the actual successful services of the Mediterranean countries. Silvicultural practices for the harvest of dead wood should be put to practice to reduce the fuel load in the Czech forests.



## References

- AEMA (2006). Tipología de bosques Europeos. OPOCE, Madrid, Spain.
- Albers, J. (2012). *Comparative Analysis of the Forest Fire Situation in Central-Eastern Europe* (Master of Science in European Forestry). University of Natural Resources and Life Sciences (BOKU) Vienna, Austria.
- Babrauskas, V. "Pyrophoric Carbon" and Long-term, Low-temperature Ignition of Wood. (2001) *Ignition Handbook* 51 (2), 12-14.
- Chiarucci, A; Araujo, M. B., Decocq, G., Beierkuhnlein, C. & Fernandez-Palacios, J.M. (2010). "FORUM The concept of potential natural vegetation: an epitaph?" *Journal of Vegetation Science*.
- Davis, K.P., Byram, G. M. (1959). *Forest Fire. Control and use*, Chapters 3 and 4 by George M. Byram. Pp. xiii. 584. McGraw-Hill Book Co.: New York.
- Delitti WBC, Ferran A, Vallejo R, Trabaud L (2005) Effects of fire recurrence in *Quercus coccifera* L. shrublands of the Valencia region (Spain): I. plant composition and productivity. *Plant Ecology* 177, 57–70. doi:10.1007/S11258-005-2140-Z
- EEA. (2006) *European Forest types. Categories and types for sustainable forest management reporting and policy*. Office for Official Publications of the European Communities. Luxemburg.
- EEA. (2013) *Climate change, impacts and vulnerability in Europe 2012, an indicator-based report*. Office for Official Publications of the European Communities. Luxemburg.
- EFFIS. (2012) *New fire causes classification scheme adopted for the European Fire Database*. European Commission.
- FAO (2005). *Legal Frameworks for Forest Fire Management: International Agreements and National Legislation. Follow-up Report to FAO/ITTO International Expert Meeting on Forest Fire Management, March 2001. Forest Protection Working Papers, Working Paper FFM/3/E. Forest Resources Development Service, Forest Resources Division. FAO, Rome (unpublished)*.
- FAO (2007). *Fire management- global assessment 2006*. FAO, Rome, Italy.

FAO (2015). Global Forest Resources Assessment 2015. Country Report Spain. FAO, Rome, Italy.

Fire Chief. (2014). 5 drone technologies for firefighting. Retrieved April 30, 2016, from <http://www.firechief.com/2014/03/20/5-drone-technologies-firefighting/>

Gates, D. (2015) Drone tracks fire hot spots in successful Olympic forest test. Retrieved April 30, 2016, from <http://www.seattletimes.com/business/boeing-aerospace/drone-tracks-fire-hotspots-in-successful-national-park-test/>

Goldammer, J.G., Page, H. (2000) Fire History of Central Europe: Implications for Prescribed Burning in Landscape Management and Nature Conservation. BALTEX FIRE 2000. Finland.

Goubitz S, Nathan R, Roitenberg R, Ne'eman G, Shmida A (2004). Canopy seed bank structure in relation to: fire, tree size and density. *Plant Ecology* 173: 191-201.

Hernando, C., Guijarro, M., Díez, C., San Martín, J. & Madrigal, J. (2010). *Laboratorio de Incendios Forestales CIFOR-INIA*. Presentation. Ministerio de Ciencia y Tecnología. Spain.

Hlásny, T., Holuša, J., Štěpánek, P., Turčáni, M., Polčák, N. (2011). Expected impacts of climate change on forests: Czech Republic as a case study. *Journal of Forest Science*, 57 (10): 422-431.

JRC. (2013) Forest Fires in Europe, Middle East and North Africa 2012. European Commission. Office for Official Publications of the European Communities. Luxemburg.

Kula, E., Jankovská, Z. (2013). Forest fires and their causes in the Czech Republic (1992-2004). *Journal of Forest Science*, 59, (2): 41-53.

Montero, G. Serrada, R. (2013) La situación de los bosques y el sector forestal en España. ISFE, Pontevedra, Spain.

Moser, B., Temperli, C., Schneiter, G., Wohlgemuth, T. (2010) Potential shift in tree species composition after interaction of fire and drought in the Central Alps. *European Journal of Forest Research*, 129, 4, Page 625-633.

F. Moreira et al. (eds.), *Post-Fire Management and Restoration of Southern European Forests, Managing Forest Ecosystems 24*, DOI 10.1007/978-94-007-2208-8\_5, © Springer Science+Business Media B.V. 2012.

Moya, B., Moya, J., (2012) *Las Barreras Cortafuegos de Ciprés Mediterráneo: el "Sistema Ciprés"*. IMELSA, Valencia, Spain.

Pausas, J. C., J. Llovet, A. Rodrigo, and R. Vallejo. 2008. Are wildfires a disaster in the Mediterranean basin? a review. *International Journal of Wildland Fire*, v. 17, no. 6, p. 713-723.

Pausas JG (1997) Resprouting of *Quercus suber* in NE Spain after fire. *Journal of Vegetation Science* 8, 703-706.

Porrero Rodríguez, M.A. (2001) *Incendios Forestales. I. Investigación de causas*. Ediciones Mundi-prensa. Madrid, Barcelona, México. Spain and México.

Postulka, Z. (2008) *Funding forest into the future? How the European Fund for Rural Development affects Europe's forests*. FERN, Czech Republic.

Quintana JR, Cruz A, Fernandez-Gonzalez F, Moreno JM (2004) Time of germination and establishment success after fire of three obligate seeders in a Mediterranean shrubland of central Spain. *Journal of Biogeography* 31, 241-249.

Rocca, G., Danti, R. (2012). *The Role of Cypress in Controlling Forest Fires*. IMELSA, Valencia, Spain.

Rothermel, Richard C. 1972. A mathematical model for predicting fire spread in wildland fuels. Res. Pap. INT-115. Ogden, UT: U.S. Department of Agriculture, Intermountain Forest and Range Experiment Station. 40 p.

Editors of *Encyclopædia Britannica*. (n.d.). Mediterranean climate. Retrieved April 30, 2016, from <http://www.britannica.com/science/Mediterranean-climate>.

Saura-Mas et al. (2010) Fuel loading and flammability in the mediterranean Basin woody species with different post-fire regenerative strategies. *International Journal of Wildland Fire* 19, 783-794.

J. S. Silva et al. Towards Integrated Fire Management- Outcomes of the European Project Fire Paradox. 2010. European Forest Institute. Joensuu, Finland.

USDI National Park Service. (2003) Fire Monitoring Handbook. Boise (ID): Fire Management Program Center, National Interagency Fire Center. 274p.

Vonásek, V., Lukeš, P. Statistical Yearbook 2014. Ministry of Interior, Fire & Rescue Service of the Czech Republic. Prague, Czech Republic.

Vykoukal, J. (2009). Fire Rescue Service of the Czech Republic. Prague, Czech Republic. MV-generální ředitelství HZS ČR.

Wooten, G. Fire and fuels management: Definitions, ambiguous terminology and references. 2006. Twisp, Washington.

Www2.gov.bc.ca. (2016). Forests for Tomorrow - Province of British Columbia. [Online] Available at: <http://www2.gov.bc.ca/gov/content/environment/natural-resource-stewardship/land-based-investment/forests-for-tomorrow> [Accessed 30 Apr. 2016].

## Annex

Number of fires and burnt area for the years 2010-2012 divided by Autonomic Communities.

Autonomic Communities	year	Number of fires	Forest area burnt	Autonomic Communities	year	Number of fires	Forest area burnt
Andalucia	2010	553	1493	Valencian Community	2010	328	5650
	2011	751	3053		2011	419	2436
	2012	888	10742		2012	502	57607
Aragon	2010	343	1144	Extremadura	2010	550	2245
	2011	442	900		2011	905	4453
	2012	527	8042		2012	1091	3525
Asturias	2010	1862	7996	Galicia	2010	3852	14807
	2011	1793	13992		2011	6342	42390
	2012	2220	13308		2012	3798	15365
Balear islands	2010	100	606	La Rioja	2010	114	282
	2011	158	2341		2011	82	63
	2012	149	431		2012	105	108
Canary islands	2010	111	199	Madrid	2010	179	101
	2011	99	59		2011	294	385
	2012	126	12135		2012	391	431
Cantabria	2010	764	7922	Murcia	2010	139	763
	2011	775	9670		2011	130	477
	2012	728	12728		2012	128	3008
Castilla-León	2010	1173	8901	Navarra	2010	598	652
	2011	2194	17621		2011	559	615
	2012	2611	43523		2012	598	1513
Castilla-La Mancha	2010	465	607	Vasc Country	2010	116	783
	2011	745	2181		2011	140	425
	2012	1134	11803		2012	176	347
Cataluña	2010	475	619	Spain	2010	11722	54770
	2011	586	1098		2011	16414	102161
	2012	730	15624		2012	15902	209885

Number of fires and area burnt for the period 1980-2013 in Spain.

Spain	Hectares burnt (ha)	Number of fires
1980	263017	7190
1981	298288	10878
1982	152903	6545
1983	108100	4791
1984	165119	7203
1985	484476	12238
1986	264887	7570
1987	146662	8679
1988	137734	9247
1989	426693	20811
1990	203032	12913
1991	260318	13531
1992	105277	15955
1993	89267	14254
1994	437635	19263
1995	143484	25827
1996	59814	16771
1997	98503	22320
1998	133643	22446
1999	82217	18237
2000	188586	24118
2001	93297	19547
2002	107464	19929
2003	148172	18616
2004	134193	21396
2005	188697	25492
2006	155345	16354
2007	86122	10936
2008	50322	11655
2009	120094	15643
2010	54770	11721
2011	102161	16414
2012	226125	17503
2013	58985	10626

Number of fires and hectares burnt for the period 1995-2014 in the Czech Republic. Source Kula and Jankovská 2013 period 1995-2004, FRS of the Czech Republic period 2005-2014.

Czech Republic	Hectares burnt (ha)	Number of fires
1995	403	1331
1996	2043	1421
1997	359	1398
1998	1132	2563
1999	336	1402
2000	375	1499
2001	87	483
2002	178	604
2003	1236	1754
2004	335	873
2005	227	619
2006	405	697
2007	316	805
2008	86	470
2009	178	514
2010	205	732
2011	337	1337
2012	634	1549
2013	92	666
2014	536	865