

**CZECH UNIVERSITY OF LIFE  
SCIENCES PRAGUE**

Faculty of Tropical AgriSciences



Czech University of Life Sciences Prague  
**Faculty of Tropical  
AgriSciences**

**Biomass and Bioenergy Potential  
of Agriculture Crop Residues in Indonesia**

Master's Thesis

Prague, 2022

**Supervisor:**  
Assoc. prof. Tatiana Ivanova

**Author:**  
Nur Farhana Abdul Hamid

## **Declaration**

I am hereby declaring that this Thesis entitled “BIOMASS AND BIOENERGY POTENTIAL OF AGRICULTURE CROP RESIDUES IN INDONESIA” is my own work and all the sources have been quoted and acknowledged by means of complete references.

Prague, 22.04.2022

-----  
Nur Farhana Abdul Hamid

# Copyright

All material contained within the thesis, including without limitation text, logos, icons, photographs, and all other artwork, is copyright material of Czech University of Life Sciences Prague unless otherwise stated. Use may be made of any material contained within the thesis for non-commercial purposes from the copyright holder. Commercial use of material may only be made with the express, prior, written permission of Czech University of Life Sciences Prague.

Copyright © Czech University of Life Sciences Prague

## **Acknowledgement**

Prima facie, I am grateful to God for the good physical, mental and emotional health as well as daily wellbeing that were vitally necessary to complete my research thesis with the title of “BIOMASS AND BIOENERGY POTENTIAL OF AGRICULTURE CROP RESIDUES IN INDONESIA”.

I would first like to express my most sincere gratitude to my thesis advisor doc. Ing. Bc. Tatiana Ivanova, Ph.D. at Czech University of Life Sciences Prague. The door to Dr Tatiana’s office was always accessible and she consistently allowed this thesis to be my own work but steered me in the right direction whenever she thought I needed it. Her professional guidance, best advice, continuous encouragement, immense knowledge, and valuable comments have tremendously helped me throughout writing of this thesis and through the whole Master study.

This research was partially supported and reinforced with the agricultural knowledge by during my summer internship Big Terra Alpha. My sincere thank you to Pavel Juruš, Paul Kucera, and Lukáš Tůma who provided insightful comments and excellent expertise that greatly assisted the research. I am also grateful to, prof. RNDr. Pavla Hejčmanová, Ph.D. from the Faculty of Forestry and Wood Sciences for sharing expertise, irreplaceable advice and valuable guidance extended to me in the analytical part of research methods.

I take this opportunity to express gratitude to the former Dean of the Faculty of Tropical AgriSciences, prof. Ing. Jan Banout, Ph.D., for providing me with all the necessary facilities for the research and as well as to all the Department faculty members for their endless help and support. I also place on record my sense of gratitude to PhD students, who directly or indirectly, have lent their precious hand in this bewildering venture.

Finally, it is my greatest privilege to express my deepest gratitude and appreciation to both of my parents, my siblings and relatives who have been very supportive with their concerns and blessings. Also, I am utterly grateful to my dearest friends for providing me with unfailing support and unceasing encouragement throughout my years of study and through the process of researching and writing this thesis. This accomplishment would not have been possible without them.

The research was supported by Internal Grant Agency (IGA) of the Faculty of Tropical AgriSciences, Czech University of Life Sciences Prague - grant number 20205012 and 20213108.

Thank you.

## Abstract

The growing population poses a serious challenge in Indonesia to produce sufficient energy, electricity, and power to supply the ever-increasing energy demand for continuing daily lives. The current situation related to energy supply and production of renewable energy in Indonesia was reviewed; it was found that the agriculture biomass residues from the production of staple food crops are favourable for the implementation of the technology for the additional bioenergy and power supply of both: urban and rural areas. This fact promotes the swift development of bioenergy generated by agricultural biomass residues on large and small-scale levels within Indonesia.

Biomass residues from agricultural crops is regarded as the most sustainable source of bioenergy production due to their low production cost and high quantities after harvesting period. Five main crops were chosen in this study based on their annual production and yield in the country: oil palms, sugarcane, paddy rice, maize, and coconut. Laboratory determinations of fuel-energy properties of tested materials showed that the best material is coconut shells characterized by the highest calorific value ( $\text{NCV}_d$  19.20  $\text{MJkg}^{-1}$ ) and very low ash content (1.18  $\text{wt}\%_d$ ). The second-best calorific value was measured in case of palm kernel ( $\text{NCV}_d$  18.21  $\text{MJkg}^{-1}$ ). Relatively low ash content for herbaceous biomass was found in maize stalks and cobs (3.12  $\text{wt}\%_d$  and 3.59  $\text{wt}\%_d$ ).

However, based on the calculations and laboratory measurements' results, the main findings in this study suggest that paddy rice straw, empty fruit bunches (EFB), and maize stover (stalks) has the higher estimated annual energy potential (473.12 TWh, 261.84 TWh and 164.60 TWh respectively). Despite coconut shells having the best characteristics of fuel-energy properties, the annual production was not enough for a competitive annual energy potential (30.51 TWh). Besides calorific value, the main driving factor in the total energy potential is biomass yield/abundant availability.

In addition, majority of the respondents collected through online questionnaire manifest high interest for the utilization and application of remaining crop parts (leaves, branches, stalks, straw etc.) into livestock feeds, biofertilizer and bioenergy production. The estimated total energy yield in this work can be beneficial for further studies to broaden the knowledge in this specific agriculture-based bioenergy industry, especially to understand cost efficiency and to set-up proper implementation of technologies.

Therefore, bioenergy diversifications should be encouraged. Simultaneously, biomass residues collection centres should be made available through provision of reasonable selling price and communicating added values in energy supply within Indonesia.

Keywords: bioenergy production, biomass residues, electricity, power, biofertilizer

# Table of contents

1	INTRODUCTION.....	1
1.1	Background of study .....	1
1.2	Motivations and problem statement.....	2
1.3	Research objectives.....	4
1.3.1	General objective .....	4
1.3.2	Specific objectives .....	4
1.4	Significance of the study.....	5
1.5	Scope of study.....	5
2	LITERATURE REVIEW.....	7
2.1	Bioenergy and agriculture.....	7
2.1.1	Types of biomasses .....	9
2.1.2	How is bioenergy produced?.....	10
2.1.3	Biomass conversion technologies .....	11
2.1.4	Production of biochar.....	18
2.1.5	Benefits of bioenergy .....	19
2.2	Energy demands and sustainable renewable energy in Indonesia .....	24
2.3	Role of agriculture in Indonesia.....	30
2.4	Relationship between biomass and agriculture in Indonesia .....	34
2.5	Energy policy and strategies on biomass production in Indonesia .....	35
3	RESEARCH METHODOLOGY .....	38
3.1	Time frame.....	38
3.2	Data and data sources .....	38
3.2.1	Primary data sources .....	38
3.2.2	Secondary data sources .....	39
3.3	Origin of materials and preparation of analysis samples.....	39



3.4	Determination of the biomass energy properties .....	42
3.4.1	Sieve analysis .....	42
3.4.2	Moisture content .....	43
3.4.3	Ash content .....	44
3.4.4	CHNSO content .....	45
3.4.5	Calorific value (CV).....	45
3.5	Calculation of the total energy yield.....	47
3.6	Questionnaire survey .....	47
4	RESULTS.....	48
4.1	Sieve analysis calculations and particle size distribution curve .....	48
4.1.1	Palm kernel shells (PKS) .....	48
4.1.2	Paddy rice husks.....	48
4.1.3	Maize stover (cobs).....	49
4.2	Evaluation of fuel-energy properties of tested biomass materials .....	50
4.3	Total energy yield .....	53
4.4	Questionnaire survey .....	55
5	DISCUSSION .....	60
5.1	Availability of agricultural crops and possibilities of energy use .....	61
5.1.1	Oil palm.....	61
5.1.2	Sugarcane .....	62
5.1.3	Paddy rice.....	64
5.1.4	Maize.....	66
5.1.5	Coconut .....	67
5.2	Estimation of fuel-energy properties and energy potential.....	69
5.3	Spatial distribution and seasonal availability of crop residues .....	73
5.4	Socioeconomic characteristics of the respondents.....	74

5.5	Consumer attitude and factors influencing bioenergy production.....	75
5.6	Limitations of the research.....	77
6	CONCLUSION.....	78
7	REFERENCES.....	79

## List of Figures

- Figure 1: Effect of COVID-19 on bioenergy (Kummamuru & Rakos, 2020)
- Figure 2: The substantial factors of bioenergy production from agriculture (Lopez Izquierdo, 2012)
- Figure 3: The general concept of a biorefinery (Lopez Izquierdo, 2012)
- Figure 4: Co-firing of coal and biomass fuel blends (Sami, et al., 2001)
- Figure 5: Components of a CHP unit (Hadley, et al., 2002)
- Figure 6: Tri-generation installation scheme (Sala Lizarraga & Picallo-Perez, 2020)
- Figure 7: Green gas plant in Kootstertille, Netherlands (KPP energy & waste solutions BV, 2022)
- Figure 8: Developing countries in Asia lead the progress in direct biogas use (International Energy Agency, 2020)
- Figure 9: The relationship between pyrolysis temperature and products for hemicellulose, cellulose, and lignin (Sekimoto, et al., 2018)
- Figure 10: Schematic representation of the laboratory gasification system (Vaskalis, et al., 2019)
- Figure 11: Surface image of the biochar (a) and the image of pores (b) in the biochar using the scanning electron microscopy (Joseph, et al., 2015)
- Figure 12: The carbon-neutral/negative agriculture for bioenergy production delivers several socio-economic and environmental benefits both to rural and urban areas (Honua Ola Bioenergy, 2022)
- Figure 13: Global renewable energy employment by technology, 2012-2019 (IRENA, 2021)
- Figure 14: Six component of the energy transition strategy (IRENA, 2021)
- Figure 15: Share of electricity generating capacity of non-renewable and renewable (IRENA, 2021)
- Figure 16: Renewable electricity used for heat is forecast to rise by more than 40% accounting for one-fifth of global renewable heat consumption by 2024 (International Energy Agency, 2021)
- Figure 17: Annual CO<sub>2</sub> emissions from fossil fuels by world regions (Ritchie & Roser, 2020)

Figure 18: Average share in six biggest provinces on rice production in Indonesia 2014 (Azwardi, et al., 2016)

Figure 19: Time of adoption of the future of farming technology (Word Government Summit, 2018)

Figure 20: Map of Indonesia divided into Provinces (Worldofmaps.net, 2022), with Lampung Province highlighted (circled in red)

Figure 21: Grinding processes of the tested material sample

Figure 22: The dry basis samples tested in the ash content test equipment, LAC

Figure 23: The experimental setup of the calorimeter for the CV determination

Figure 24: Plotted comparison of particle size distribution of the tested material samples via the sieve analysis

Figure 25: Profiles of survey respondents in Indonesia by gender on 2021's survey

Figure 26: Profiles of survey respondents in Indonesia by age on 2021's survey

Figure 27: Profiles of survey respondents in Indonesia by their education background on 2021's survey

Figure 28: Profiles of survey respondents in Indonesia by age on 2021's survey

Figure 29: Profiles of survey respondents in Indonesia by their household income contribution on 2021's survey

Figure 30: Respondents' farming activities background in term of the type of land rights, land use in hectare, type of agriculture products and monthly agriculture income

Figure 31: The percentage of respondents with their total estimated crop production in a month (kg per total land)

Figure 32: The perspectives of bioenergy and biofertilizer among the respondents toward potential applications from agricultural biomass residues for local farmers

Figure 33: World production of main primary crops by main producers in 2019 (FAO, 2021)

Figure 34: The production of oil palm in Indonesia from year 1960 to 2020 (FAOSTAT, 2022)

Figure 35: The production of sugarcane in Indonesia from year 1960 to 2020 (FAOSTAT, 2022)

Figure 36: The production of paddy rice in Indonesia from year 1960 to 2020 (FAOSTAT, 2022)

Figure 37: The production of maize in Indonesia from year 1960 to 2020 (FAOSTAT, 2022)

Figure 38: The production of coconuts in Indonesia from year 1960 to 2020 (FAOSTAT, 2022)

## List of Tables

- Table 1: Types and examples of biomass and biofuels (Johansson, et al., 2012)
- Table 2: The overall overview of energy sector in Indonesia from 2009-2020 (BP, 2021)
- Table 3: The most important agricultural plant in Indonesia in 2020 (FAOSTAT, 2022)
- Table 4: The details of the type of residual biomass from the top five chosen crops
- Table 5: Sieve analysis test calculations of tested sample, palm kernel shells (PKS)
- Table 6: Sieve analysis test calculations of tested sample, rice husk.
- Table 7: Sieve analysis test calculations of tested sample, maize stover (cobs).
- Table 8: Proximate and ultimate analysis of the tested material samples (as received)
- Table 9: Ultimate analysis of the tested material samples (dry basis)
- Table 10: GCV and NCV of the tested samples (as received and dry basis)
- Table 11: Total energy potential per year of the tested material samples in Indonesia
- Table 12: Composition of sugarcane bagasse and leaves as % of dry matter (Ferreira-Leitao, et al., 2010)

## **List of Abbreviations**

**ADB** Asian Development Bank

**ASEAN** Association of Southeast Asian Nations

**ASR** assessment, strategy, and road map

**CHP** combined heat and power

**CHNSO** carbon, hydrogen, nitrogen, sulphur, oxygen

**CO<sub>2</sub>** carbon dioxide

**COVID-19** coronavirus disease

**EFB** empty fruit bunches

**EU** European Union

**FAME** fatty acid methyl esters

**FAO** Food and Agriculture Organization of the United Nations

**FAOSTAT** Food and Agriculture Organization Corporate Statistical Database

**GDP** gross domestic product

**GHG** greenhouse gas/es

**IBI** The International Biochar Initiative

**IEA** International Energy Agency

**LNG** liquefied natural gas

**LPG** liquefied petroleum gas

**MSW** municipal solid waste

**OECD** Organisation for Economic Co-operation and Development

**OPEC** Organization of the Petroleum Exporting Countries

**RES** renewable energy sources

**UN** United Nations

**WBA** World Bioenergy Association

## **Units of measurement**

**°C** degree Celsius

**GWh** gigawatt-hour

**Gt** gigatonnes

**Ha** hectare

**Hg/Ha** hectogram per hectare

**km<sup>2</sup>** square kilometre

**kWh** kilowatt hour

**MW** megawatt

**PJ/year** petajoules per year

**TWh** terawatt-hour



# 1 INTRODUCTION

## 1.1 Background of study

The coronavirus outbreak has been causing widescale apprehension and economic adversity for businesses, consumers, and communities across the globe. The crisis raises a few unique challenges and is fast-moving with widespread effects. Most of the world were in lockdowns across countries in emerging and developing economies. When it comes to preparing for emergencies, most of the time power and utility companies have a sturdy proven track record in supply and demand readiness. Even the best thought-out and thoroughly tested business continuity plans should be seamlessly flexible to fully address the fast-moving and unknown variables of an outbreak like COVID-19 (PwC, 2020).

However, electricity demand around the world is ricocheting or even exceeding pre-pandemic levels half a year later with COVID-19 recent developments constantly triggering commotions to electricity systems therefore the situation remains unpredictable (International Energy Agency, 2021). Fossil fuel-based generation and its associated emissions are increasing along with forecasts on electricity demand, even though continuous add-ons of global renewable generation, capacity and supply were simultaneously developed (Stich, et al., 2017).

The power and utility industry as a sole responsible provider of crucial infrastructure ought to be strategized, equipped to respond and react appropriately to countless unanticipated threats, including health crises. Typical contingency plans enable operational effectiveness following events like cyber incidents, power outages, and natural disasters. Health emergencies develop distinguishing yet exclusive twists, comprising of possible travel restrictions, widespread quarantines, and workforce disruptions that might obscure earlier established continuity and contingency plans (Arun, et al., 2021).

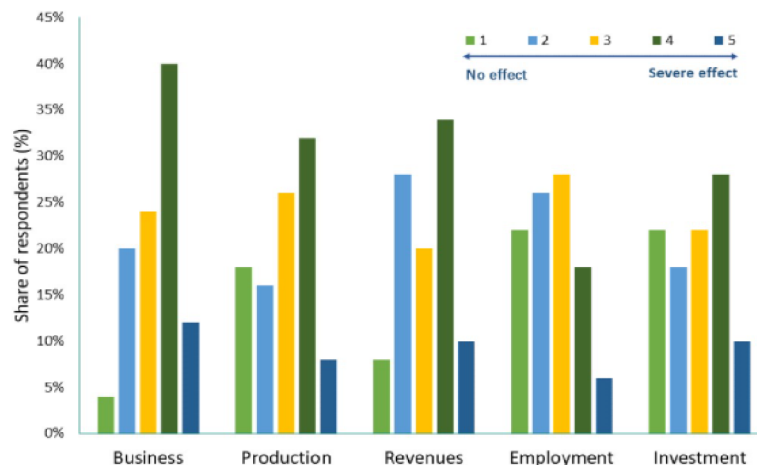

Figure 1: Effect of COVID-19 on bioenergy (Kummamuru & Rakos, 2020)

The generation and/or delivery of electricity, natural gas and water to customers must persist reliably and consistently despite the fact that a health emergency strictly limits the employees and contractors who are able to go to work (Krarti & Aldubyan, 2021). Regrettably, many electric and gas utility companies went bankrupt in recent months and were forced to close especially in the UK and most European countries. This phenomenon shows us that even countries with strong economies are still quite vulnerable to energy security issues during unprecedented COVID-19 outbreak (Norouzi, 2021). According to a survey done by World Bioenergy Association (WBA) in May 2020, when COVID-19 started to spread globally following Figure 1, the significant impact of the pandemic can be highly unfavourable on the global bioenergy sector especially in terms of production, profits/revenues, employment, and international investments (Kummamuru & Rakos, 2020).

## 1.2 Motivations and problem statement

Biomass is an attractive source of renewable energy, which could contribute markedly to battling the crisis of global warming. Biomass encompasses many different types of fuel; it can be a plant such as maize or switchgrass or the methane produced in a landfill, or the garbage discarded by households every day. Biomass fuels are an eminent subject of hot debate in industrial and scientific communities. Common problems of biomass produced energy are cost, transportation, seasonal restrictions, and lack of

efficiency from the fuels produced. Biomass may be the oldest from the renewable sources that can supply energy for our future generations, but it is also the least developed.

Biomass energy is in the current spotlight – but what are the most common complications linked with this kind of energy? This is potentially one of the best sources of renewable energy with close to a zero-carbon footprint. Deforesting to use wood for biomass fuel has damaged many third-world countries that lacked resources and education in forest conservation or renewal. Through deforestation, we are doubling the effects on the environment. There are nations where the forest has been clear-cut to burn wood for cooking and heat. This results in poor living conditions in a poverty-stricken country which is even worse once the trees are gone as land is open to flooding and erosion.

Another common problem is the cost as biomass is "mass". Producing and transporting biomass is expensive. Natural gas shrinks to a one sixth of its initial volume when it's cooled and transported. With biomass, the only reduction is compacting of garbage or waste. Transporting huge trees, factory wood waste and crops require a huge shipping industry. By putting more vehicles such as rail cars and semi-trucks in place, it increases the use of fuel and greenhouse gases.

Another problem with biofuels is that they are created using food crops. Instead of being exported to feed people, a field of e.g., maize will be harvested and sold to a huge corporation that produces biofuels. The price of maize has risen rapidly in the past ten years. More farms are abandoning other crops to grow maize as the market for maize is stable and prices are high. Thus, not only is less maize available for food but other grain harvests are also being reduced due to ethanol production. This has led to an ongoing argument that is referred to as the "food vs. fuel debate". The debate is now a global discussion as biofuels support a rather high style of living in the western world while the exported food may not be sufficient to feed populations in third world countries (Mahidin, et al., 2020).

Perhaps the biggest problem is the cost of building processing plants which must be designed to collect process and purify biofuel. Research in the future may offer answers to the problems of biomass fuel costs but currently biomass fuels are less economical than fossil fuels. Biofuels do not create the same amount of energy and do not burn as efficient as fossil fuels. In contrast, biomass fuels are renewable and fossil

fuels will ultimately be depleted. Ethanol production also depends on the seasons of farming, and this is one reason switchgrass is currently being researched to use for ethanol. Nowadays, the crops used are only harvested during one or two seasons of the year. Ethanol must be produced during those seasons and stored to provide fuel during crop off seasons.

### **1.3 Research objectives**

Research objectives are divided into general objective and specific objectives.

#### **1.3.1 General objective**

The main objective of the thesis was to investigate the energy potential as well as production quantities and fuel properties of the most abundant agricultural residues in Indonesia suitable for energy utilization (primarily as solid biofuels).

#### **1.3.2 Specific objectives**

Achieving of the main objective was supported and supplemented by specific objectives such as:

- 1) To identify five main crops grown in Indonesia suitable for energy utilization.
- 2) To determine and evaluate the main physical and chemical properties of selected residual biomass materials according to the standard laboratory testing methodology.
- 3) To calculate production of residual biomass as well as annual energy yield.
- 4) To discover the perception of local farmers toward potential bioenergy applications of agricultural biomass residues.
- 5) To determine the personal motivation factors that driven the uses of residual biomass among farmers such as biofertilizer, animal feedstocks and bioenergy production.

## **1.4 Significance of the study**

Integrated production, management, harvesting, and conversion of residual biomass to efficiently produce clean energy are fundamental to optimizing the balance of relationships among energy, economic growth and security, the environment, and national security. Previously, the role and potential for use of biomass energy has been poorly understood and the reality is the technology has not caught up to the potential. This research project discovers the potential of agroresidual biomass for energy use an example of Indonesia, thus, overall targeting to improve the importance of the potential applications of agricultural biomass residues in bioenergy production and possibly help in replacing a significant portion of fossil fuels. The findings of this study may contribute and provide a benefit for local farmers, scientists, government officials among other to make use of the residual biomass within the country. The top five crops proposed may be incorporated by industries in Indonesia, which can also indirectly be collected/harvested by the local farmers to sell. The selected crops with higher potential/yield will enable the local farmers to regain additional income sources quicker and get out poverty sooner.

## **1.5 Scope of study**

Scope of study is divided to theoretical and geographical parts. In theory, the basics of burning biomass are well known but the potential has yet to be developed. There are many opportunities to leverage agricultural resources on existing lands in Indonesia without interfering with production of food, feed, fibre, or forest products. Dedicated biomass energy crops and agricultural crop residues are abundant, diverse, and widely distributed across the country which are not fully utilized for clean and renewable energy resources. These potential biomass supplies can play a significant role in a national biofuels' commercialization strategy and as a mean of replacing the ongoing depleted traditional energy resources in the incoming years since the fossil fuels are consumed at such a high rate globally.

Geographically, Indonesia is the largest archipelago worldwide with the most populous country (237.4 million people); it has 1,811,569 km<sup>2</sup> land, 93,000 km<sup>2</sup> water, and an annual gross domestic product (GDP) of 1,105 billion dollars. Approximately 550,000 km<sup>2</sup> are highly fertile agricultural land consisted of 240,000 km<sup>2</sup> arable land and

200,000 km<sup>2</sup> under permanent crops: where about 1,290,000 km<sup>2</sup> are characterized as forest land (Asian Development Bank, 2020). Indonesia is blessed with an abundance of biomass, approximately 140 million tonnes of biomass per year. With a large forestry industry, it is one of the world's largest exporters of wood products, and a key palm oil producer and exporter of palm kernel shells to many countries for biomass feedstock use (Ministry of Agriculture Republic of Indonesia, 2019).

## 2 LITERATURE REVIEW

### 2.1 Bioenergy and agriculture

Energy from biomass plays a large and growing role in the global energy system. It can make significant contributions to reducing carbon emissions, especially from difficult-to-decarbonize sectors like aviation, heavy transport, and manufacturing. Biomass residues should never be used as energy sources if they are still useful either as animal feeds or fertilizers or chemicals or substitute materials (Stich, et al., 2017). It seems that energy should be the last priority when involving land use for agricultural productions.

Simple technologies for utilizing biomass as energy sources, especially thermal energy, have been continuously developed and implemented (Waqas & Biswajit, 2018). Those growing technologies to produce renewable fuels can be accredited from direct biomass combustion in stoves, pyrolysis, briquetting, gasification, oil extraction by pressing machine, to advanced hydrothermal treatment. Its outstanding sustainability and inconsequential environmental impacts have been proven by many scientists considering the biomass resources were from leftovers and wastes (Saptoadi, 2014).

There is an abundant supply of biomass. Nevertheless, the capitalized biomass ought to be non-edible or industrial residues. Most energy demand is typically dominated by fossil fuels where government policies are required for nationwide importations (Cheng, 2017). Sooner or later, energy demand can be mostly covered by renewable energy and the rest by fossil fuels if managed efficiently and effectively. There are various cordons for such goals which are exclusively due to fuel subsidies provided by the governments.

Assessment, strategy, and road maps (ASR) have been launched in some countries and considered mandatory until 2025 for bioenergy production and for biofuel usage (Kitt & Yates, 2020). Feed-in-Tariff for electricity derived from biomass and municipal solid waste (MSW) has been introduced as well across nationwide. Yet, most electricity generated are frequently off-grid and used internally for the production process by private companies. Blending of diesel fuel and fatty acid methyl esters (FAME) was introduced in 2006 and recently, it reached B-10 (Go, et al., 2019). Despite that, blending of gasoline

with bioethanol which is produced via fermentation processes is no longer marketed as its development during these years have been discouraged due to heavy competition from hydrocarbon fuels and adverse economic cycles which leads to uncompetitive prices (Humberto & Barragán-Ocaña, 2021).

During the production of bioenergy, biomass released carbon dioxide (CO<sub>2</sub>) from carbon that circulates in a loop in the atmosphere through the process of photosynthesis and decomposition. Hence, no additional CO<sub>2</sub> contributed from the production of bioenergy to the atmosphere (Waqas & Biswajit, 2018). The degree of greenhouse gases (GHG) emissions reduction differs extensively and depends mainly on numerous aspects including how biomass are produced and acquired, the biomass (feedstocks) used, and the type and effectiveness of the technology utilized to generate bioenergy. In the following, Figure 2 shows the overall characteristics of bioenergy production.

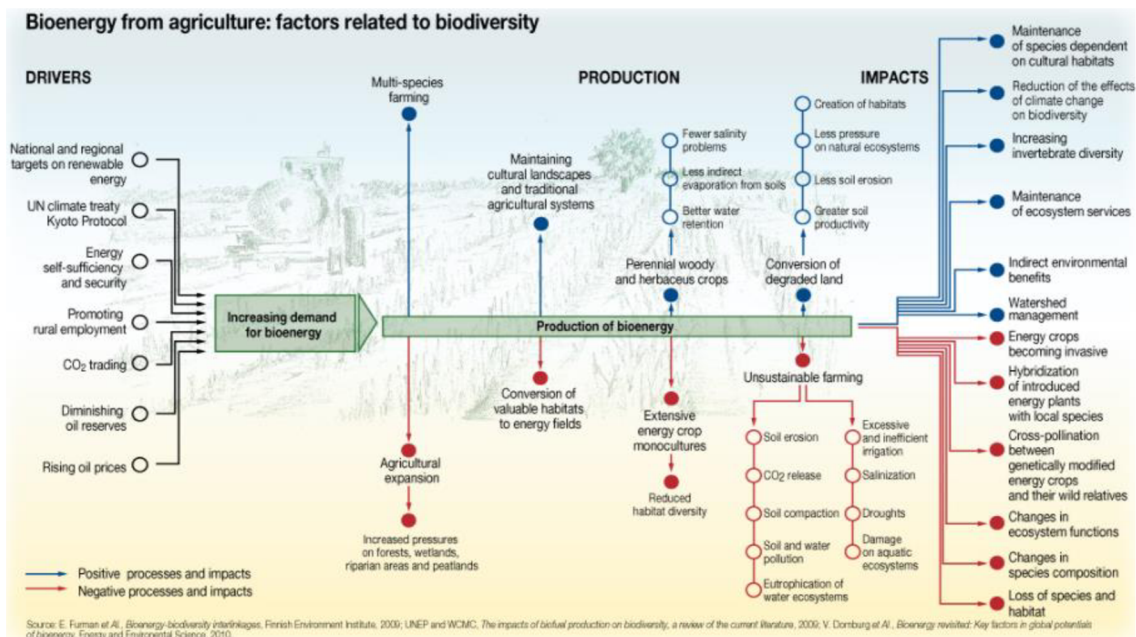

Figure 2: The substantial factors of bioenergy production from agriculture (Lopez Izquierdo, 2012)

The modern plants were commonly known where waste biomass is converted to heat or combined heat and power (CHP) is placed near to where the waste is generated where the GHG emissions reduction from bioenergy systems is at its greatest. Bioenergy's GHG reduction advantages are suppositionally larger than those of other renewables. For example, stubble can be harvested from cut stalks left in the field to be burnt and ignited in an emissions-controlled bioenergy plant. Henceforward, GHG emissions reductions



are completed twofold – through reduced burning once in the field and again through bioenergy production by fossil fuel substitution (Rauoof, et al., 2022).

Fossil fuels are a limited non-renewable resource, originally derived from organic matter and have been created over millions of years through biological and geological processes. Their usage essentially characterizes a one-way flow of GHGs from underneath the Earth's surface to the atmosphere (van Asselt, 2021). On the other hand, bioenergy generated from the organic matter called biomass or bioenergy feedstocks is the most widely used renewable energy in the world which provides around 10% of the world's primary energy resources: predominantly thermal energy for cooking and heating. Bioenergy can be traced back to energy from sunlight or produced via photosynthesis (Liu, et al., 2022). Additionally, it can be as simple as a log fire or as complex as an advanced second-generation liquid biofuel. The energy biomass generated can be converted into heat, electricity, or biofuels and biomass can typically be considered as a storage house of bioenergy and often to be nature's 'solar batteries' (Rauoof, et al., 2022).

### **2.1.1 Types of biomasses**

Biomass may be obtained from animal and plant wastes, agricultural crops, wood, algae, and organic residential/industrial waste in accordance with Table 1. The source of biomass is crucial for the technology that can be used to produce bioenergy which will eventually determine the type and amount of bioenergy that can be produced. For instance, agricultural crops such as canola and maize can be used to produce liquid biofuels such as biodiesel produced via transesterification and ethanol via fermentation respectively. Alternately, wet wastes like cow manure are perfectly suitable for biogas production through anaerobic digestion, which can be combusted to supply heat, electricity or upgraded into biomethane (Simangunsong, et al., 2017). Biomass production of densified solid biofuels via mechanical compression like pellets and briquettes can be made from energy crops, agricultural residues, untreated lumber, food waste, and industrial waste and co-products (Nishiguchi & Tabata, 2016).

Table 1: Types and examples of biomass and biofuels (Johansson, et al., 2012)

Woody biomass	Non-woody biomass	Processed Waste	Processed fuels
<ul style="list-style-type: none"> <li>• Trees</li> <li>• Shrubs and scrub</li> <li>• Bushes such as coffee and tea</li> <li>• Sweepings from forest floor</li> <li>• Bamboo</li> <li>• Palms</li> </ul>	<ul style="list-style-type: none"> <li>• Energy crops such as sugarcane</li> <li>• Cereal straw</li> <li>• Cotton, cassava, tobacco stems and roots</li> <li>• Grass</li> <li>• Bananas, plantains and the like</li> <li>• Soft stems such as pulses and potatoes</li> <li>• Swamp and water plants</li> </ul>	<ul style="list-style-type: none"> <li>• Cereal husks and cobs</li> <li>• Bagasse</li> <li>• Wastes from pineapple and other fruits</li> <li>• Nut shells, flesh and the like</li> <li>• Plant oil cake</li> <li>• Sawmill wastes</li> <li>• Industrial wood bark and logging wastes</li> <li>• Black liquor from pulp mills</li> <li>• Municipal Waste</li> </ul>	<ul style="list-style-type: none"> <li>• Charcoal from wood and residues</li> <li>• Briquette and densified biomass</li> <li>• Methanol and ethanol</li> <li>• Plant oils from palms, rape, sunflower and the like</li> <li>• Producer gas</li> <li>• Biogas</li> </ul>

### 2.1.2 How is bioenergy produced?

There are several methods to produce bioenergy. One of the methods is through selecting the finest technology and pathway for the type of bioenergy to be generated based on the sources of biomass material. Some procedures can be comparatively simple, like growing, harvesting, and burning wood for heat generation. Other complex methods including transport fuels produced from algae need a specific microalgae species in a controlled growing environment. The algae are then treated to separate the oils which are refined into biofuels (Srivastava, 2019).

A variation of conversion pathways to convert biomass into energy via a range of technologies can be applied in the form of electricity, heat, or transportation fuels for powering engines and turbines. Biomass conversion pathways either function alone or in a combination including biochemical, thermal, or mechanical from simple solid wood combustion heaters to boilers and biodigesters (Liu, et al., 2022).

Facilities that convert biomass into numerous fuel types and other bio-products are commonly known as biorefineries, such as conventional oil refineries. The biorefineries development can significantly provision efforts to intensify resource efficiency by maximizing the value of a biomass feedstock as displayed on Figure 3. Biorefineries can take benefits of the differences in biomass components and intermediate products by integrating biomass conversion processes and equipment to produce multiple products including fuels, power, and chemicals (Singh, et al., 2022).

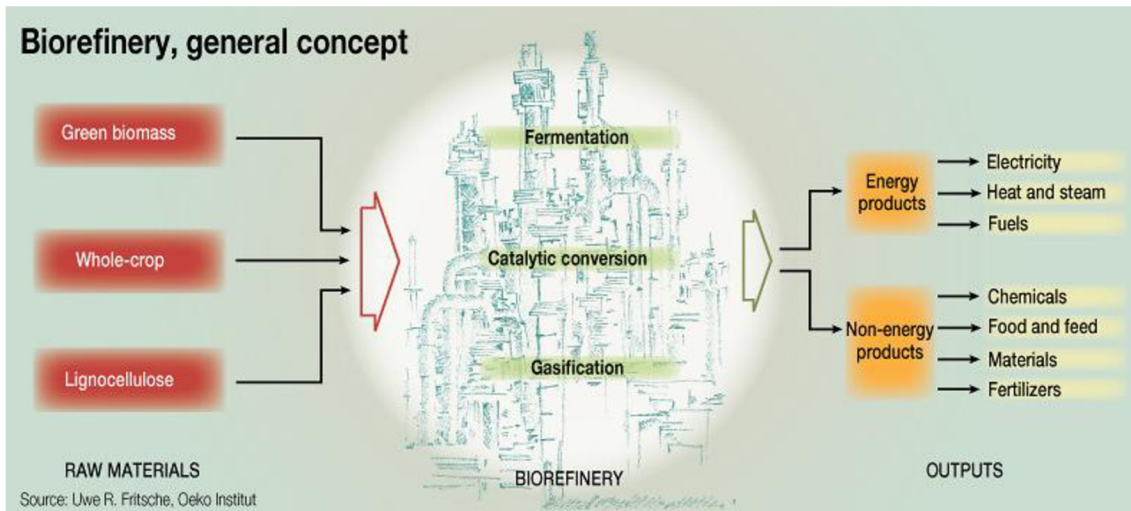

Figure 3: The general concept of a biorefinery (Lopez Izquierdo, 2012)

### 2.1.3 Biomass conversion technologies

There is an extensive variety of feedstocks, processes, and technologies that can be used for production of heat and/or electricity for extracting energy from biomass and converting it into stationary bioenergy being conventional combustion, anaerobic digestion, pyrolysis, and gasification are more commonly used (Darmawan & Aziz, 2022).

#### a) Conventional combustion

The simplest most widely used method of bioenergy technology for converting biomass to heat is direct combustion. The energy produced is often used to heat water, to produce electricity via a turbine or steam engine, for space heating or cooling, and for use in industrial processes. Combustion characteristically has an electrical efficiency of only 20-35%, but co-generation techniques can further increase energy efficiencies to over 85%. On a global scale, recent thermal systems are far more common than biomass cogeneration systems. The advanced thermal systems are much simpler and cheaper to install and run, which also operate at or above 85% efficiency which is comparatively similar to co-generation systems (Darmawan & Aziz, 2022).

The two main combustion technologies are fixed bed combustion and fluidized bed combustion. Overall, fluidized bed boilers produce lower emissions than fixed bed boilers. Fixed bed combustion involves burning materials on a fixed or moving grate with air passing through it. On the other hand, biomass is mixed with sand in fluidized bed

combustion which acts more like a fluid, burning more evenly and leading to increased efficiencies and higher moisture contents allowing a wider range of fuel types to be processed (Pio, et al., 2020).

Co-firing is where biomass fuels, such as biomass pellets, sawdust, or biogas are combined and burnt with another base fuel, such as liquefied petroleum gas (LPG) or coal. Most fuels are processed and compressed into pellets or briquettes which made them denser, more consistent in quality with a moisture content that allows easier handling, transporting, and storing in the later stage (YuanLv, et al., 2022). Henceforth, it can be a cost-effective way for fossil fuel power generators to reduce GHG emissions. Several fuels can be combusted with coal with minimal processing beyond chipping or shredding and drying following Figure 4.

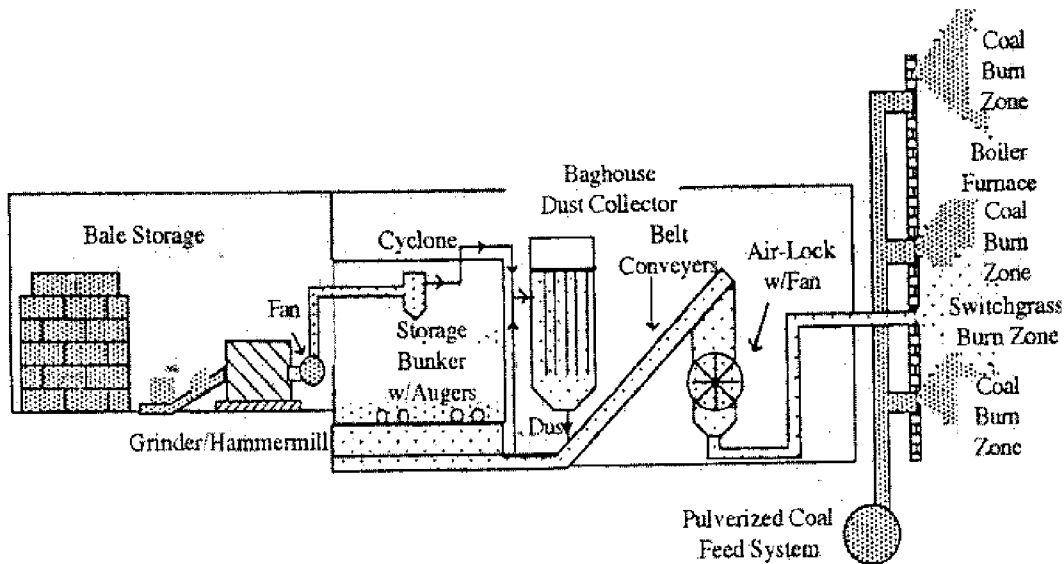

Figure 4: Co-firing of coal and biomass fuel blends

(Sami, et al., 2001)

Co-generation, also widely acknowledged as CHP is a well-known technology shown in Figure 5; it is also recognised globally as a way cleaner alternative to traditional centralised generation. This is more evidently demonstrated in the following Figure 4. It captures 'waste' heat from electricity generation commonly by conventional steam turbines via absorption chillers that has greater energy conversion efficiencies, which can then be used for space and water heating or cooling (Żołądek, et al., 2021). Co-generation is perfectly suited in conditions where electricity can be used on site and where heating or cooling necessities are continuous (Hyde, 2016).

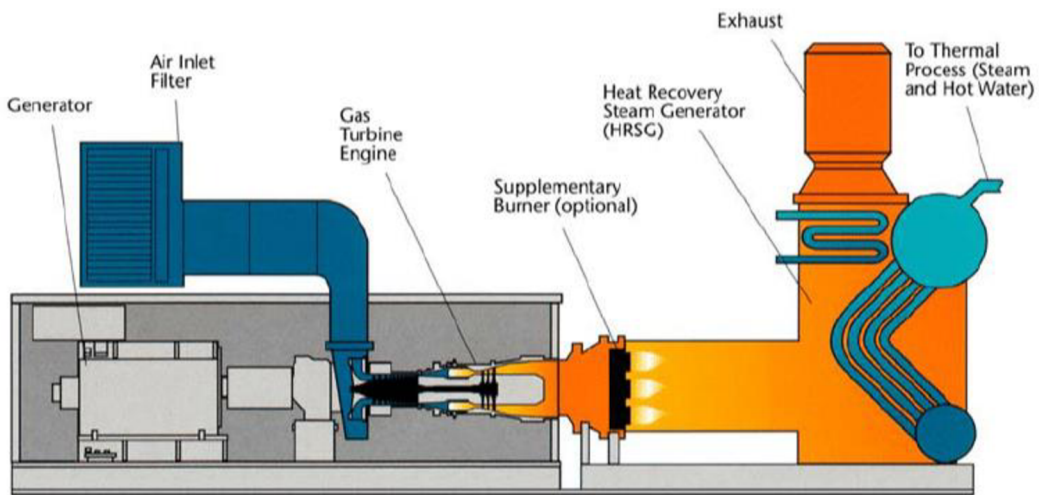

Figure 5: Components of a CHP unit (Hadley, et al., 2002)

Tri-generation (CCHP – Combined Cooling Heat and Power or CHRP – Combined Heating, Refrigeration and Power) following Figure 6, is a cutting-edge technology for the combined generation of three types of energy simultaneously (thermal energy, electric energy, and cooling energy) which cause overall efficiencies to go as high as 90% (Sonar, 2021). Moreover, Tri-generation technology has integrated with a thermally driven refrigeration system to provide cooling, heating, and electrical power. Waste heat can be used via absorption chilling refrigeration where heat drives a cooling system using a closed cycle of evaporating, dissolving, and separating out two liquids at different pressures.

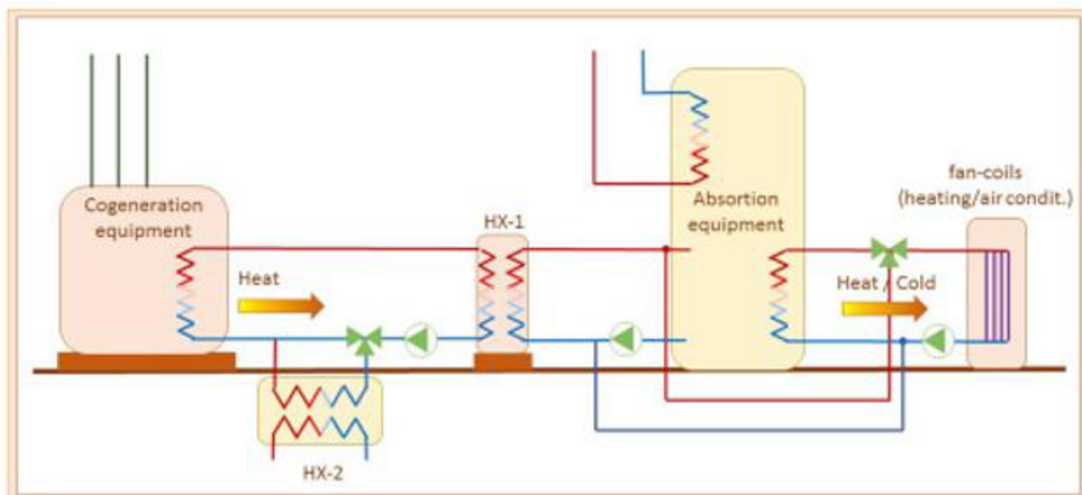

Figure 6: Tri-generation installation scheme (Sala Lizarraga & Picallo-Perez, 2020)

## b) Anaerobic digestion

Anaerobic digestion happens naturally in oxygen-free circumstances during the biological breakdown of biomass to produce a concoction of mostly methane and carbon dioxide, habitually known as biogas (Cheng, 2017). The breakdown process of biomasses in a closed systems anaerobic biodigesters has purposely promoting the controlled biogas production in oxygen starved peat swamps and in man-made environments, including landfills, purpose-built biodigesters, and effluent lagoons (Prananta & Kubiszewski, 2021) .

It is principally suitable for damp feedstocks that do not comprise of lignin. Wet agricultural residues, sewage, straw, effluents, and manure can be utilized as biomasses in anaerobic digestion (Erdiwansyah, et al., 2020). The so-called mixture of biogas can be very useful for generating heat and/or power in a gas turbine through a combustion or subsequently upgraded to natural gas standards and used in gas engine vehicles or exported to the gas grid for household distribution.

In Europe Union (EU) countries, biogas is primarily produced from anaerobic fermentation in anaerobic digesters using energy crops, manure, and agricultural waste with conservative estimates pointing to a tenfold increase in production by 2030 (Enerdata, 2020). The current state of biogas production is very diverse between different countries based on the source and production of biogas. Following Figure 7, Green Gas Plant in Kootstertille uses fermentation based on the Hogen technology to convert 75,000 tonnes of biomass into green gas yearly which will stipulate roughly 7,200 Dutch households with a sustainable alternative to natural gas.

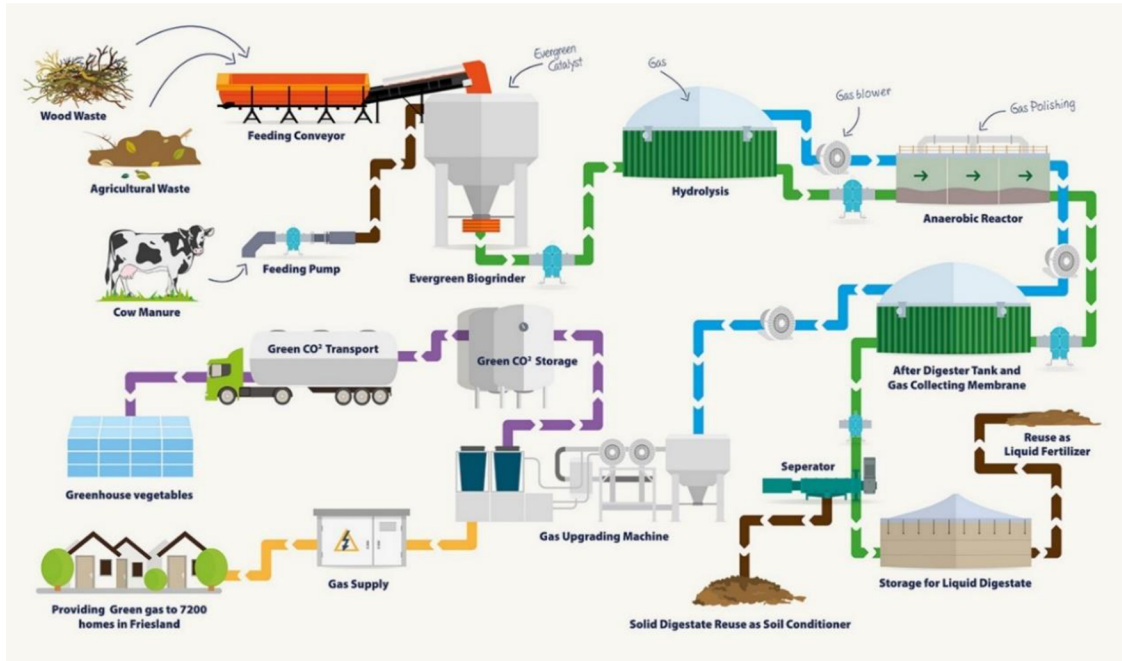
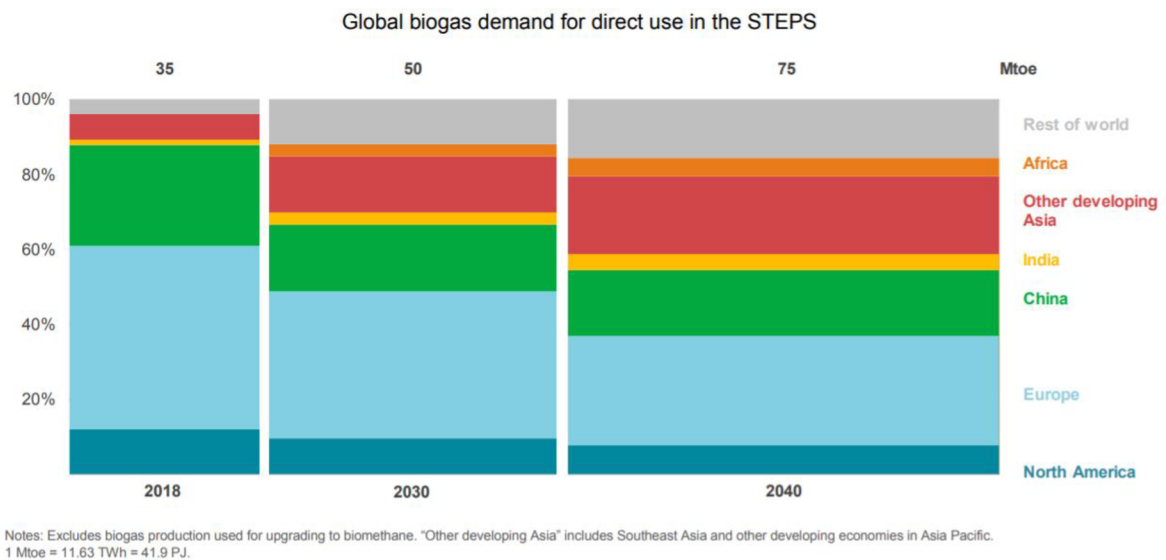

Figure 7: Green gas plant in Kootstertille, Netherlands (KPP energy & waste solutions BV, 2022)

A very simple design of biodigesters is regularly assembled and utilized in developing countries by households with growing demand in accordance with Figure 8. Biogases can be apprehended through collection conduits and burnt off in sewage treatment ponds and waste landfills which can then be used to generate bioenergy. Some various larger systems are used by food processors and farmers in developed countries (International Energy Agency, 2020). Production of heat and/or electricity from the biogases are captured by most of the larger sewage treatment plants and landfills which is used for on-site or frequently sold as 'green power' with a premium price (Enerdata, 2020). Nevertheless, the undigested sludge residue from biodigesters can produce more bioenergy through the process of dehydration and additional combustion or utilized as a compost or an organic fertilizer (Darmawan & Aziz, 2022).



*Figure 8: Developing countries in Asia lead the progress in direct biogas use  
(International Energy Agency, 2020)*

### c) Pyrolysis

Biomass pyrolysis is the fundamental chemical reaction that involves thermal decomposition of biomass combusted in the absence or with very limited of air or oxygen to produce solid, liquid and/or gaseous products at ratios dependent on the temperature and speed of the pyrolysis process, which can be effectively used to produce bioenergy (Mohan, et al., 2006). The products of biomass pyrolysis include biochar, bio-oil and gases including methane, hydrogen, carbon monoxide, and carbon dioxide. Pyrolysis will yield mostly gases with rapid heating rates at high temperatures, greater than 800°C while at a slow heating rate with low temperatures less than 450°C that results in solid product yield with biochar as the main product (Cheng, 2017). Figure 9 demonstrates the temperature range to form specific products described by chemical structures based on the individually coloured bars.



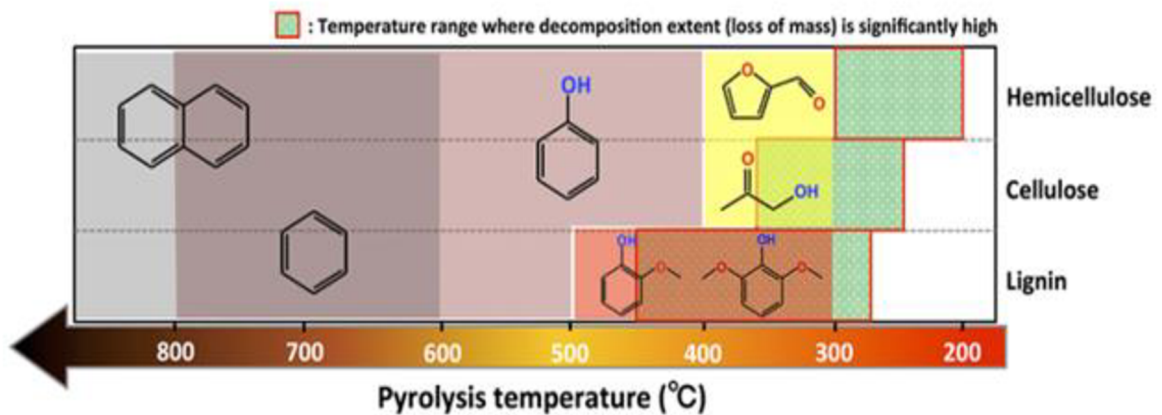

Figure 9: The relationship between pyrolysis temperature and products for hemicellulose, cellulose, and lignin (Sekimoto, et al., 2018)

#### d) Gasification

Gasification is a thermo-chemical process that involves heating solid biomass to temperatures of around 800-1,000°C in a gasifier with a restricted supply of oxygen, see Figure 10. Under these conditions, fuel is only partly burnt and is largely converted to 'syngas' which contains a mixture of gases, including carbon monoxide and hydrogen, that can be apprehended, cleaned, and ignited to generate heat and power with small amounts of char are produced. Syngas can be utilized unswervingly for heating applications to run gas turbines, gas engines, or combined cycle power systems (Brown, 2021). It can also be upgraded via a series of existing and emerging technologies for biofuel production. The need to remove tars and scrub gases can be an additional problem if the syngas ran through a gas engine to generate power (Cheng, 2017).

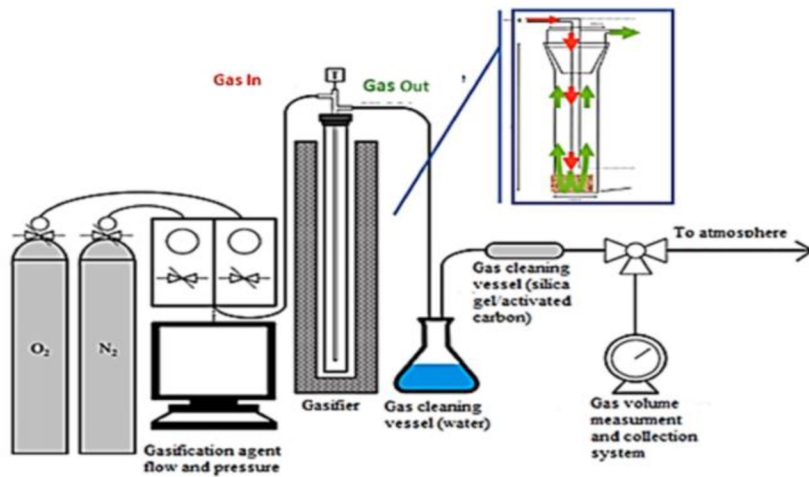
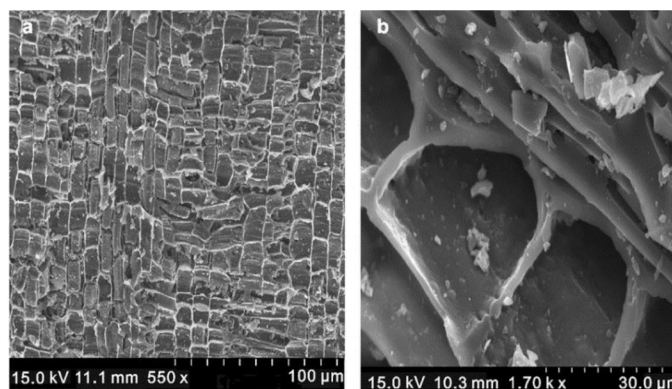

Figure 10: Schematic representation of the laboratory gasification system (Vaskalis, et al., 2019)

#### 2.1.4 Production of biochar

Biochar is a stable carbon rich product form of charcoal (see Figure 11) made from numerous procedures by combusting organic materials in negligible oxygen environments, known as gasification and pyrolysis and therefore have many varied structural and chemical properties. It is often a co-product of biofuel production, improving both economic viability of biomass-based renewable fuels and the GHG balance which may be utilized later to produce heat/power, or it might partake other marketable value as a carbon sequestration product and soil amendment (Seow, et al., 2022).

Biochar produced by gasification stereotypically yield only about 1% with syngas being the major end-product. Production of biochar through pyrolysis also yields bioenergy in the form of heat and bio-oil in varying amounts depending on the temperature and pyrolysis process used (Joseph, et al., 2015). Some of the basic biochar pyrolysers can release toxic gases and powerful GHG whilst modern well-designed pyrolysers can capture and convert hydrogen gases and methane to renewable energy and tackle these emissions (Owsianiak, et al., 2021).



*Figure 11: Surface image of the biochar (a) and the image of pores (b) in the biochar using the scanning electron microscopy (Joseph, et al., 2015)*

Biochar systems need to complete lifecycle analyses to determine their climate mitigation potential using internationally accepted protocols and comprehensive standards from International Biochar Initiative (IBI) for biochar characterization, production, and utilization. The rising fears around climate change topics have brought attention into biochar as open burning of agricultural residues increases the emission of a large amount of CO<sub>2</sub> (Xie, et al., 2022). Biochar acts as a stable carbon sink improving soils and when properly made, it can store CO<sub>2</sub> in the soil leading to reduction in GHGs emission and enhancement of soil fertility. Also, biochar has several other advantages including acting as a soil amendment to increase plant growth yield, increasing the available nutrients for plant growth, water retention and reducing the amount of fertilizer applied. Biochar can also reduce methane and nitrous oxide emissions from soil, thus further reducing GHGs emissions (Seow, et al., 2022).

### **2.1.5 Benefits of bioenergy**

Biomass is one of a selection of renewable energy sources (RES) that can contribute to tackling the international matters associated with population growth, energy security, global increase in per capita energy demand, and ultimately climate change. This is largely due to the utilization of biological organic resources and materials including algae, plants, marine life, micro-organisms, and fungi, for generating renewable energy, including biofuels (Muscat, et al., 2020). An increasing biomass production industry will also benefit boosting the economic growth and creating new jobs in a variety of sectors along the supply chain of biomass fuel globally following Figure 12 and 13.

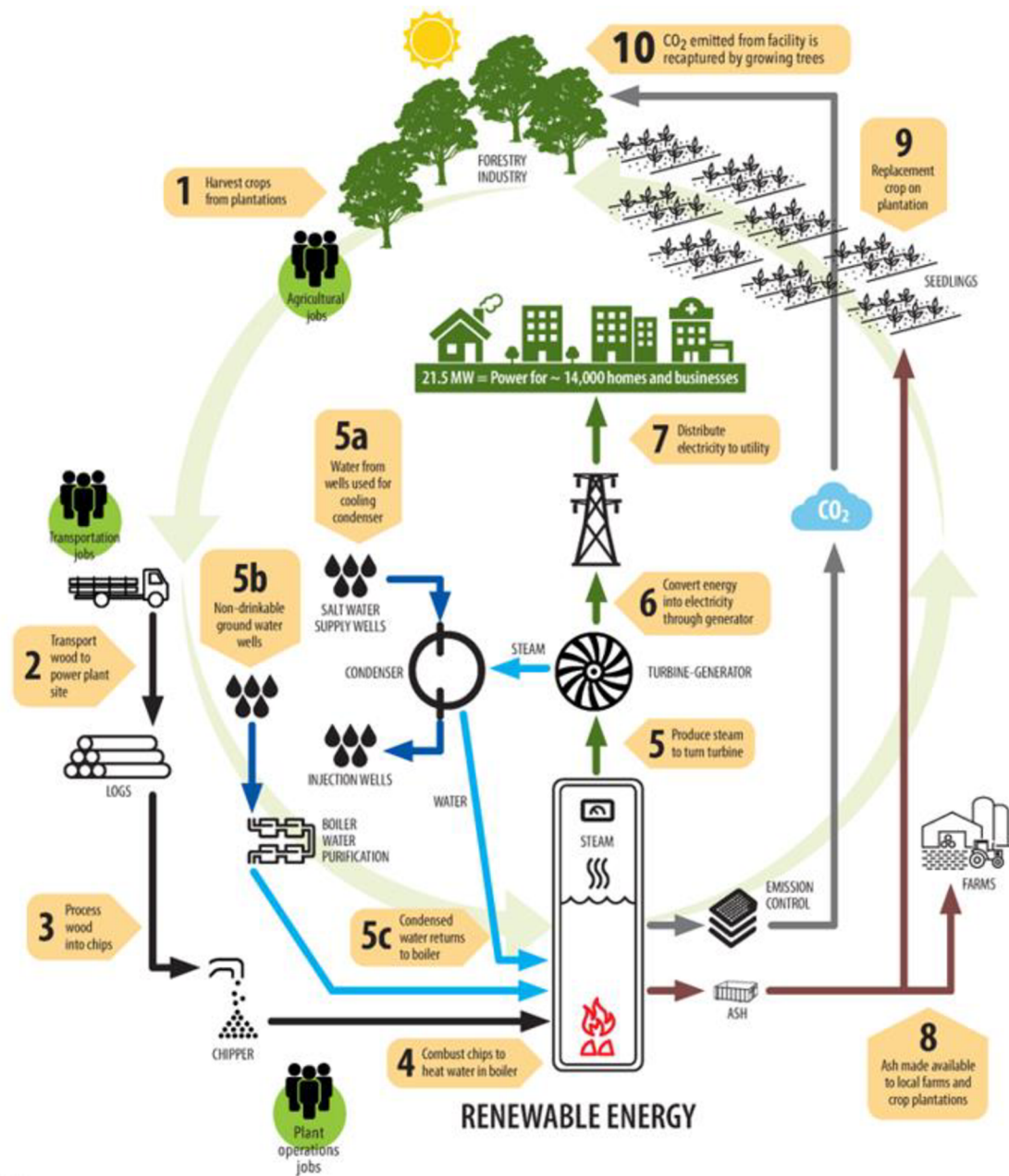
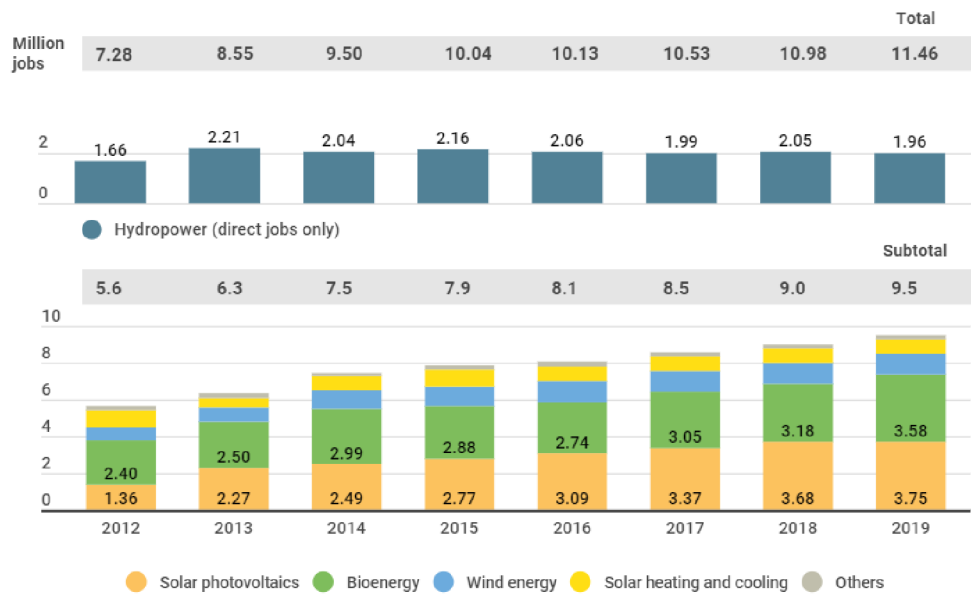

Figure 12: The carbon-neutral/negative agriculture for bioenergy production delivers several socio-economic and environmental benefits both to rural and urban areas (Honua Ola Bioenergy, 2022)



Source: IRENA, 2020a.

Figure 13: Global renewable energy employment by technology, 2012-2019 (IRENA, 2021)

On top of that, bioenergy can stipulate air quality benefits through six components of the energy transition strategy identified by IRENA in the energy sector (Figure 14) where biomass residues such as forest slash, stubble, or tree pruning, is collected, and combusted in an innovative emissions-controlled bioenergy plant (IRENA, 2021). Bioenergy production can bring a better resolution to prescribed open burning of biomass residues in the forests or fields by shifting to renewable energy and using less energy. Biomass removal and mechanical thinning can be performed in bioenergy as a system to lessen perilous levels of fuel and reduction of 12.5 gigatonnes (Gt) GHGs emissions annually, especially in the areas with high risks of prescribed burning (Johansson, et al., 2012). Petrochemicals and petroleum-based fuels are major groundwater and surface pollutants; these can be detrimental to the environment whilst biofuels such as bioethanol and biodiesel are biodegradable and less toxic (Heffron, et al., 2021).

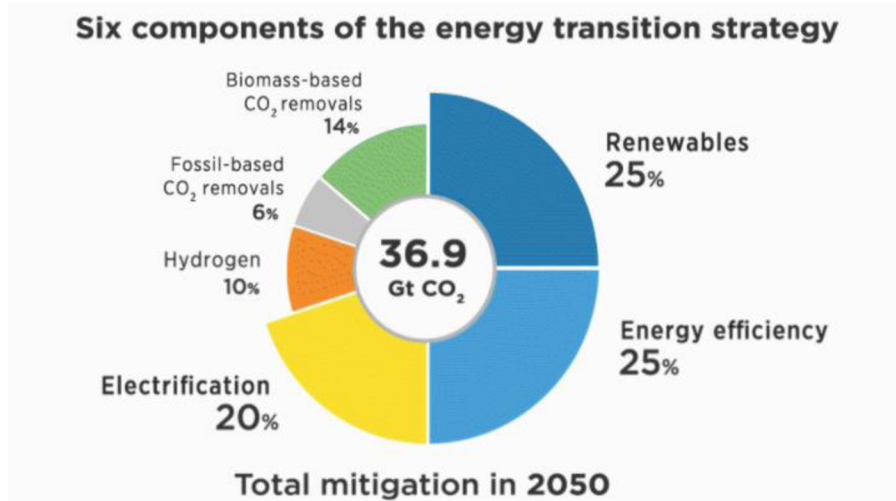
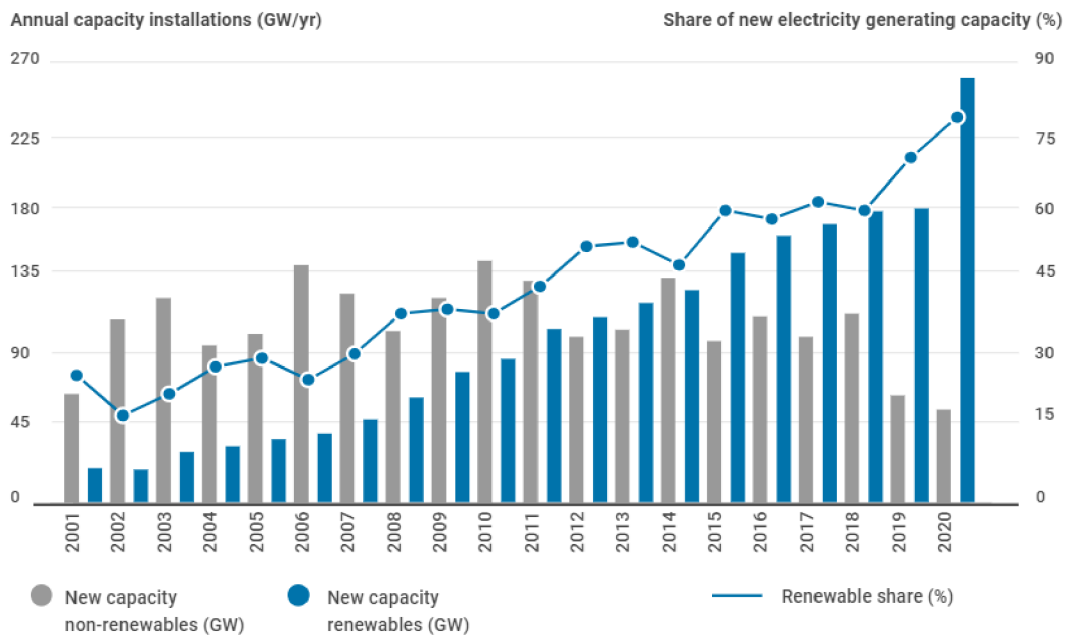

Figure 14: Six component of the energy transition strategy (IRENA, 2021)

Additionally, bioenergy benefits stimulating local economic employment and development by offering new, diversified, and decentralized profit streams from biomass and bioenergy production, commonly exceeding other forms of renewable energy. New and fresh employment openings result from growing and reaping biomass, handling, transport, and through procurement, operation, construction, and maintenance of bioenergy plants. This provides property-owners additional market selections for their conventional agricultural and tree crops and for their usage of waste streams including animal manures. It might also offer supplementary opportunities to cultivate and grow new crops, predominantly on low or marginal rainfall countryside. For instance, Juncea as a low rainfall break-crop for biodiesel (Johansson, et al., 2012).

The utilization of biomass can benefit shape pliability in agricultural and food-processing productions. Bioenergy brings an effective usage for their leftover streams that can aid them in diminishing their costs for energy utilization and possibly expand a new income stream of selling biomass-derived heat and/or distributing 'green' electricity to the grid. Using the accurate bioenergy technology in the precise condition can accomplish larger cost savings, exclusively in the remote zones from or near the end of the power grid, where electricity transmission losses and costs to upgrade the power supply are relatively high hence subjected to frequent 'brownouts' and/or 'blackouts' in daily routines (Rauoof, et al., 2022). Based on Figure 15 and 16, the annual capacity of renewables and global renewable heat consumption have been rising exponentially throughout years demonstrating how innovative technologies have been evolving using different sources.



Based on IRENA's renewable energy statistics.

Figure 15: Share of electricity generating capacity of non-renewable and renewable (IRENA, 2021)

Renewable heat consumption growth by technology

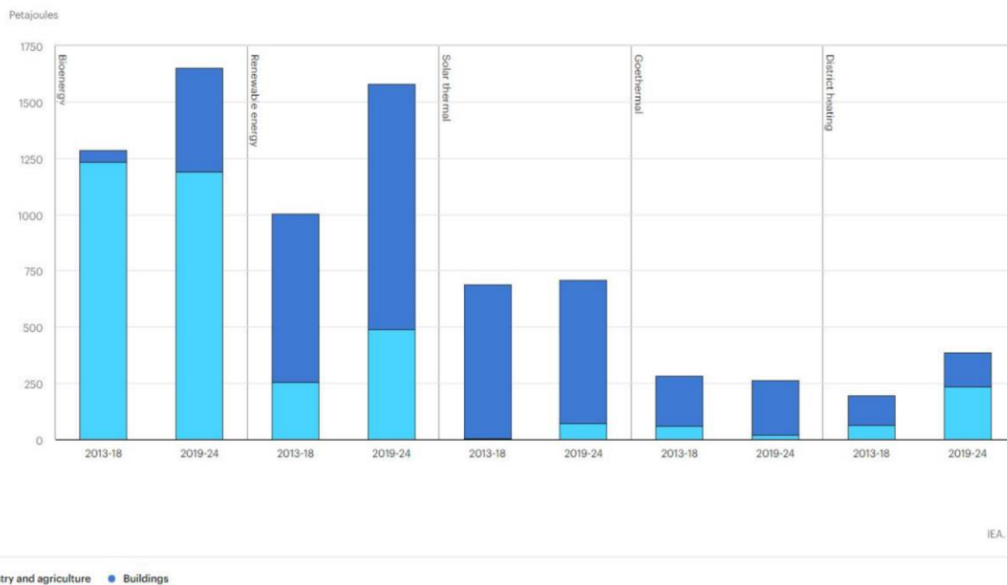

IEA. All Rights Reserved

Figure 16: Renewable electricity used for heat is forecast to rise by more than 40% accounting for one-fifth of global renewable heat consumption by 2024 (International Energy Agency, 2021)

Production of bioenergy using waste streams reduces contamination risks and protects the limitations of disposal in landfills. Rural and regional energy security and reliability can be improved by offering an uninterrupted, mandatory national energy source that can run continuously in tandem with the electricity market through better flexibility to increase production at short notice than large coal-fired plants. There is a rising series of demonstrated flexible technologies accessible for converting biomass into electricity, heat, and biofuels (Karti & Aldubyan, 2021). Bioenergy and biofuel production can be associated with the development of other biotechnologies and bioproducts. For instance, organic digestates can be utilized as a fertilizer or soil enhancer obtained from anaerobic digestion (Sonnino, 1994).

There is also demonstrated improved water quality where fuel reduction burning is replaced with biomass harvesting. Bioenergy crops can be cultivated as an added vegetation cover where trees can be harvested for their woody biomass on farms in arrangements that offer shade, salinity control, farm shelter, carbon sinks, and species biodiversity (Joseph, et al., 2015). Additionally, e.g., species such as Mallee eucalypts are extensively cultivated due to their capability to re-shoot (coppice), can be repetitively regrown and harvested to produce renewable energy and other on-farm advantages (Bush, et al., 2014). The COVID-19 pandemic has affected investment, prices, supply, demand, and other aspects of the energy sector. The short-term impact is about 25% reduction in petroleum consumption, and it is projected to decrease the competitiveness within energy carriers post-COVID hence allowing integration of the bioeconomy sector as part of broader recovery programmes (Norouzi, 2021).

## **2.2 Energy demands and sustainable renewable energy in Indonesia**

Energy demand in Indonesia is anticipated to increase in the foreseeable future; nonetheless, newly implemented national policies necessitate that Indonesia decreases its dependency on fossil fuel-based energy resources. Biomass from timber production and agricultural crop residues could be a realistic possibility including the primary energy equivalent of solar, tide, wind, hydro, geothermal, and wave sources attributable to their environmental and social benefits for energy production. The utilization of biomass residues in many nations as a substitute for fossil fuel-based energy has been motivated by many reasons including decreasing GHGs emissions, increasing energy security,



lowering fossil-fuel dependency, and embracing economic development (National Geographic, 2019).

Humans have depended profoundly on oils, coals, and other fossil fuels to power everything from factories to cars to light bulbs for the past 150 years. Fossil fuels are entrenched in almost the whole lot of things we do, and subsequently, the GHGs emissions from the fuel's combustion have extended factually to extreme levels (see Figure 17). The heat that would otherwise escape into space is now trapped by GHGs in the atmosphere, hence causing the average temperatures on the surface increasing, scientifically termed as 'global warming' (Ritchie & Roser, 2020). Renewable energy is every so often brought up as an innovative solution in any debate about climate change to eradicate the detrimental effects of increasing temperatures as renewable energy sources do not release CO<sub>2</sub>. To stabilize or even diminish CO<sub>2</sub> concentrations in the atmosphere, the world needs to reach net-zero emissions hence requires large and fast reductions in emissions (Liu, et al., 2022).

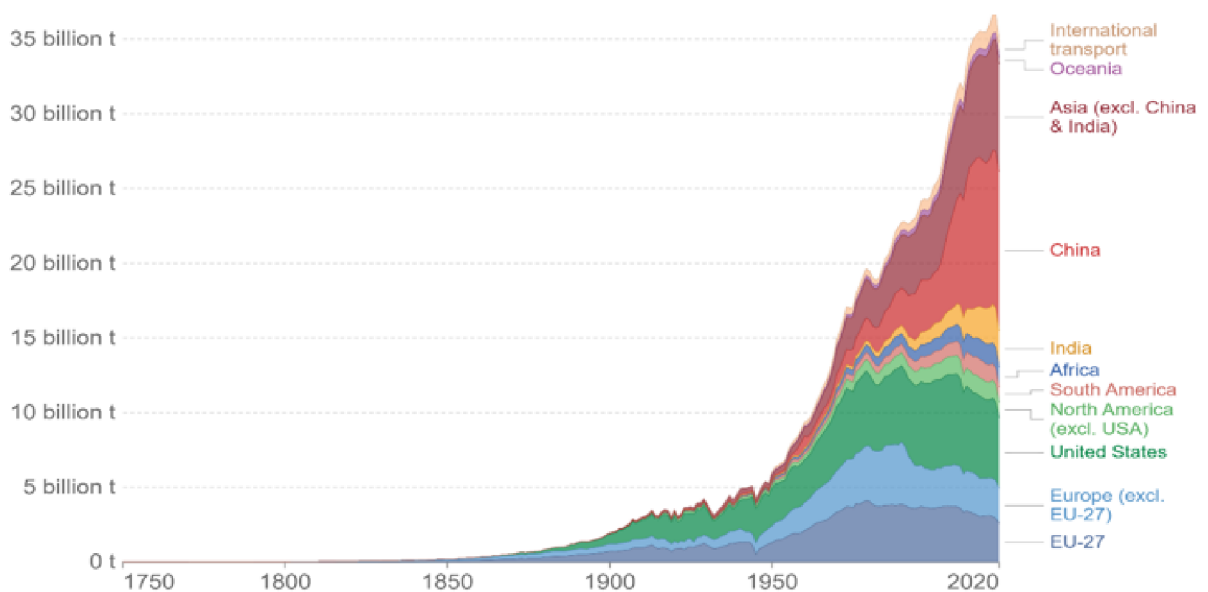

*Figure 17: Annual CO<sub>2</sub> emissions from fossil fuels by world regions (Ritchie & Roser, 2020)*

Heat, power, and/or electricity produced from renewable energy is expected to increase by one-fifth between 2019 and 2024. Buildings account for over half of growing worldwide renewable heat demand, followed by industry. China, India, the United States,

and the EU are held responsible for two-thirds of the worldwide upsurge over the forecast period in the consumption of renewable heat (Krarti & Aldubyan, 2021). The increasing consequences are principally from greater electrification of end uses and an over-increasing segment of renewables in electricity generation. More than two-thirds of modern bioenergy progress is estimated to arise in the industry sector. Nevertheless, renewables' segment of worldwide heat consumption is predicted to increase slightly by 2% in 2024. In general, the potential of renewable heating remains immensely underutilized, and disposition is not in accordance with the worldwide climate goals, necessitating bigger determination and sturdier policy sustenance (Kummamuru & Rakos, 2020).

Fossil fuels are fundamental to Indonesia's energy policy, and its important source of export revenues (Kitt & Yates, 2020). The on-going shale gas revolution and continuous rising environmental apprehensions in conjunction with strident drops in coal values challenge the sustainability of an energy strategy built based on almost wholly on fossil fuels (Go, et al., 2019). This perspective contests Indonesia's existing energy policy and recommends alternatives to use renewables and intensify its energy efficiency. Above all, its gas sector ought to be further established to lessen the gap until enough renewable energy represented. Yet, an unfair regulatory environment, insufficient investment, and the shortage of transport infrastructure are obstructing the renewable energy sector from accomplishing its whole potential. A concise strategy should be based on clarifying, streamlining, and publicizing simple regulations that address all energy-related activities will aid in bringing much needed investment. The continuous constraint of natural resource exploitation on the environment should be tackled by appropriately defining property rights, establishing clear regulations regarding forest lands, and executing a positive implicit carbon price (Dutu, 2016).

Akin to many nations, Indonesia has developed a growing consideration in producing energy from biomass and other renewable energy sources (see Table 2). In the previous few years, the Indonesian government has mandated new-fangled laws and policies to continuously support a renewable and bio-based economy through regulating the utilization of clean technologies using renewable energy sources in the energy sector for electricity generation, as well as founding the national strategies and instruments for financing the energy transition (FAO, 2021). The rising sector generates professions helps

lower energy bills, expands energy access in developing countries and makes electric grids more resilient. All these aspects have successfully aided in a renewable energy revitalization in current years, with solar and wind setting novel records for energy production.

Table 2: The overall overview of energy sector in Indonesia from 2009-2020 (BP, 2021)

Units in EJ unless otherwise stated	Level			Growth rate per annum				Share (%)		
	2009	2019	2020	(%)		(EJ)		2009	2019	2020
				2009-19	2020	2009-19	2020			
<b>Consumption</b>										
Primary energy	5.8	8.7	8.1	4.0	-6.7	0.3	-0.6	100	100	100
Oil	2.7	3.2	2.8	1.5	-12	0	-0.4	47	37	35
Natural gas	1.5	1.6	1.5	0.4	-5.7	0	-0.1	26	18	20
Coal	1.4	3.4	3.3	9.4	-4.9	0.2	-0.2	24	39	43
Nuclear	0	0	0	n/a	n/a	0	0	0	0	0
Hydro	0.1	0.1	0.2	3.2	17	0	0	1.8	1.7	2.3
Renewables	0.1	0.3	0.4	14	6.3	0	0	1.6	4.0	4.8
Wind	0	0	0	62	-2.6	0	0	0	0	0.1
Solar	0	0	0	87	770	0	0	0	0	0.1
Other renewables*	0.1	0.3	0.4	14	5.3	0	0	1.6	3.9	4.7
<b>Native units</b>										
Oil (Mb/d)	1.4	1.6	1.2	1.9	-24	0	-0.4			
Natural gas (bcm)	42	44	42	0.4	-5.7	0.2	-2.4			
<b>Electricity generation (TWh)</b>										
Total	157	279	275	5.9	-1.6	12	-3.7	100	100	100
Oil	20	11	6.8	-6.1	-36	-0.9	-3.8	13	3.8	2.5
Natural gas	50	62	51	2.2	-18	1.2	-11	32	22	19
Coal	66	174	181	10	3.4	11	6.4	42	63	66
Nuclear	0	0	0	n/a	n/a	0	0	0	0	0
Hydro	11	17	19	3.8	17	0.5	2.9	7.3	5.9	7.1
Renewables	9.3	15	17	4.8	13	0.6	1.9	6.0	5.3	6.1
<b>Production</b>										
Oil (Mb/d)	1.0	0.8	0.7	-2.4	-4.9	0	0			
Biofuels (Kboe/d)	2.8	124	126	46	2.1	12	2.6			
Natural gas (bcm)	78	68	63	-1.4	-6.8	-1.0	-4.4			
Coal	6.3	15	14	9.2	-9.0	0.9	-1.3			
<b>Carbon</b>										
CO <sub>2</sub> emissions (billion tonnes)	0.4	0.6	0.6	4.6	-7.4	0	0			
<b>Macro</b>										
Population (millions)	239	271	274	1.3	1.1	3.2	2.9			
GDP (USD billion – PPP, 2015)	1,902	3,228	3,161	5.4	-2.1	133	-67			

EJ = exajoules

\*includes biomass, geothermal and biofuels

There is a rising attention in consuming energy crops for liquid fuels, biofuel production as well as crop and forestry residues for heat and electricity generation in

Indonesia. Biofuels derived directly or indirectly from biomass include vegetal waste, animal materials or wastes, wood, ethanol, and sulphite lyes (Erdiwansyah, et al., 2020). Currently, however, the primary energy production in Indonesia is highly dependent on fossil fuels. On average, 137,775 Gigawatt hours (GWh) yearly have been produced from 1994 to 2019, of which 32% consisted of oil, 28% coal, 15% gas and 25% renewable sources, respectively (Enerdata, 2020).

Biomass comprises 13% of the total energy production in Indonesia in 2020. Firewood is still the foremost biomass energy sources supplying 29% the total energy consumption. Firewood is used in household cooking and heating in most of the rural areas with an estimated 40% of all households (24.5 million households) still rely heavily on fuelwood. It is expected that by 2030, the number of houses relying on fuelwood would drop to about 8 million mainly through the uptake of electricity and liquefied petroleum gas (LPG) for cooking and will be replaced by efficient cook stoves that would reduce half of firewood for cooking. Hence, the traditional biomass used for cooking will account for 20% of the total biomass used. It is also anticipated that biomass from various resources will be fully utilized for biofuel and bioenergy production (IRENA, 2017).

Assessment of the diverse biomass resources are required for deliberate development in biomass-based industries. Some studies have been done assessing the potential of biomass energy production in many methodologies bearing in mind three key groups: MSW, agrofuels (energy crops, agro-industrial residues, manure, and livestock residues) and fuelwood (from logging, forest plantations, managed forest, and forest industry residues) (Wu, et al., 2018). MSW encompasses wastes collected or generated by local authorities from the commercial, residential, and public service sectors in a central site for disposal to produce heat and/or power (Saptoadi, 2014).

A potential energy production from modern renewable energy biomass is projected to increase more than five-fold, up to nearly 2,200 petajoules per year (PJ/year), where 86.50 PJ/ year from MSW and 1,608 PJ/year come from fuelwood. Energy crops including palm oil, sugar cane, sorghum, maize, and *Jatropha* account for 25% of the total potential of agrofuels. Other assessments designate that the potential of biomass for energy production is around 1,105 PJ/year. Some other assessments show that agriculture

residues from wheat, maize, sorghum, and forestry residues have a hypothetical potential of generating 34 MW of electricity. The potential of biomass for energy production differs and varies based on the year, estimations, techniques, and procedures to conduct the experiments (Eduardo Molina-Guerrero, et al., 2020).

Most of the studies have been conducted in one specific year for the estimations; though, it is acknowledged that forest timber and agricultural crop production changes between years. About 70% of the cultivated area of agricultural crops in Indonesia relies deliberately on the rainy season and rainfall alone is just insufficient for a decent crop yield and production. Additionally, crop growth is also inadvertently affected by climate events such as drought, floods, and hail, causing adverse effects on the crop production and the cultivated area. Forest timber production is commonly affected by fire, the proportion of harvested and authorized volume and restricted accessibility to the harvesting areas during the raining season (Amador Honorato-Salazar & Sadhukhan, 2020).

It is also extensively documented that agricultural crop production is seasonal and relying profoundly on the crop's sowing period, which the harvesting time will then be an unpredictable stage along the year, thus prompting an irregular monthly accessibility of crop residues (Cheng, 2017). It is crucial to not only to estimate the spatial distribution and the total estimated amount of these residues appropriately in detailed areas but also to assess the seasonal and annual inconsistency of accessible biomass residues for better decision-making and premeditated preparation to build and develop biomass-based plants (Darmawan & Aziz, 2022).

There are several difficulties for progression of bioenergy programs where fossil fuels have been dominating in Indonesia since decades. Most Indonesians appreciate it greatly and are by now comfortable with all superior features of low-priced subsidized fossil fuels. Since all majority of the inhabitants still decisively consider that the country has plentiful quantities of fossil fuel resources, the government seems to have lacking courage and hesitant to declare an authoritative condition in the nationwide energy landscape (Norouzi, 2021). Some policies concerning fossil fuels are built and developed based more on political standpoints instead of economical or environmental standpoints. More than a few challenges might be shared with other Association of Southeast Asian Nations (ASEAN) countries, but some others happen predominantly in Indonesia.

## **2.3 Role of agriculture in Indonesia**

The role of agriculture has experienced a substantial progression in economic development as agriculture was often regarded as the unreceptive cohort in the development process in the past years. Nevertheless, it is now characteristically considered as a dynamic and co-equal segment with the industrial sector. The association between agriculture and poverty is inevitably important as improved social and economic wellbeing of a nation's inhabitants with sensible access to all necessities of life outlines the economic development (Stich, et al., 2017). Economic development becomes sustainable when the needs of the present generations are met interminably over a period of no less than two decades without bargaining the capability of upcoming generations to meet their social economic needs.

Since 1960, the development of agriculture and its contribution to the economic growth has been obvious, there are indispensable complications affected principally by the characteristics of Indonesian agriculture. It is correspondingly overwhelmingly noticeable that adversative environments and meagre enactment of economic policies were unfavourable to productivity intensification in the agriculture sector. Consequently, the progress of modernization of the sector has been very slow. Recently, Indonesia has managed to accomplish combining rapid reductions in rural poverty, high rates of growth, and a substantial structural transformation of its economy without a huge growth in urban manufacturing (Owsianiak, et al., 2021).

Indonesia can be characterized as an agricultural country, where the role played by agriculture to economic development in Indonesia is important in providing job opportunities for most of the labour force, producing foods for the nation, providing raw materials for the industrial sector, and strengthening food security and rural development. The Indonesian government jested a vital position in productivity growth and agricultural development including public investments in irrigation in combination with subsidies for improved seeds and fertilizer to produce an adequate food source for domestic needs with less labour. Thus, increasing agricultural productivity is a win-win strategy as it drops the food cost, increases labour to the non-farm sectors and intensifies farmer incomes hence plummeting poverty (Kookana, et al., 2020).

Indonesia is distinctively sanctified with a rich and diversified natural resources. The role of agriculture becomes more significant when Indonesia is in the middle of an economic crisis. 50% of the Indonesian population is still categorized as rural even though this has been deteriorating progressively over the years and therefore, the fundamental motivation as to why agriculture development in Indonesia cannot be disconnected from rural development is on a whole level (FAO, 2021). The advancement of the agriculture sector will bring a great influence on the wellbeing of the rural population as their welfare conditions will predominantly affect national development. In the following Table 4 Table 4 are the top ten important agricultural plants in Indonesia derived from official data and FAO data based on imputation methodology (FAOSTAT, 2022).

*Table 3: The most important agricultural plant in Indonesia in 2020 (FAOSTAT, 2022)*

Agricultural plants	Production (tonnes)	Area harvested (ha)	Yield (hg/ha)
Oil palm fruit	256,528,600	14,996,010	171,065
Paddy rice	91,100,220	10,657,275	51,279
Sugarcane	28,913,829	420,505	687,598
Maize	23,143,728	4,065,629	115,252
Cassava	18,302,000	701,615	260,855
Coconut	16,824,848	2,770,000	60,740
Bananas	8,182,756	158,147	517,415
Mangoes, Mangosteen, Guavas	3,617,271	275,913	131,102
Rubber	3,366,415	3,668,735	9,176
Chilies and peppers	2,772,594	314,772	88,083

Agriculture development in Indonesia is also interconnected to the determination to diminish poverty and reinforce food security. Most farmers in Indonesia own small pieces of agricultural lands where average land ownership is approximately 1 hectare, every so often deprived of assistance of top-quality fertilizer, good seed or current methods and advanced tools. The farmer with small land and/or landless farmers is susceptible to undergoing food insecurity and living below the poverty line because of

the small size of land ownership in rural areas. The income drops or the growing of food prices is enough to make farmers and their families facing a destitution to acquire access to enough food (Liu, et al., 2022).

The agriculture sector has maintained its position in the influence on Indonesia's economic growth as seen by its significant contribution to the national GDP. It has been well-known that the agricultural sector has made a substantial contribution to the national fiscus which was troubled by undependable precipitation patterns in the last season which hit some parts of the country. Thus, agricultural, and industrial developments are not substitutions but are complementary and mutually auxiliary with respect to both inputs and outputs (Kookana, et al., 2020). It is understood that improved agricultural production and yield incline to contribute considerably to a total economic development of the country making it coherent and fitting to put larger prominence on further development of the agricultural sector.

Rice remains to be Indonesia's most vital commodity which by far is the main staple food for a majority of the population in rural areas as it is the most important energy and protein source in Indonesian diets. Indonesia has the highest per capita rice consumption in the world, approximately 139 kilos per capita per year. The rice production in 2021 was estimated about 35.82 million metric tonnes (see Figure 18) and the forecast shows a slight increase to 36.73 million metric tonnes in 2030. Indonesia is one of the world's leading producers of rice. Yet, the country is still dependent on the rice imports from Vietnam and Thailand to secure the domestic rice supply (Azwardi, et al., 2016). There has been an intense debate concerning rice policy within Indonesia for the past couple of years. Food security seems to be the main topic of this debate, where food security implied on the rice self-sufficiency or an adequate domestic production of rice. The Indonesian government has positioned self-sufficiency programs for smallholding farmers through revitalization programs to promote higher production in certain agricultural products including rice, maize, soybeans, and sugar (Muscat, et al., 2020).



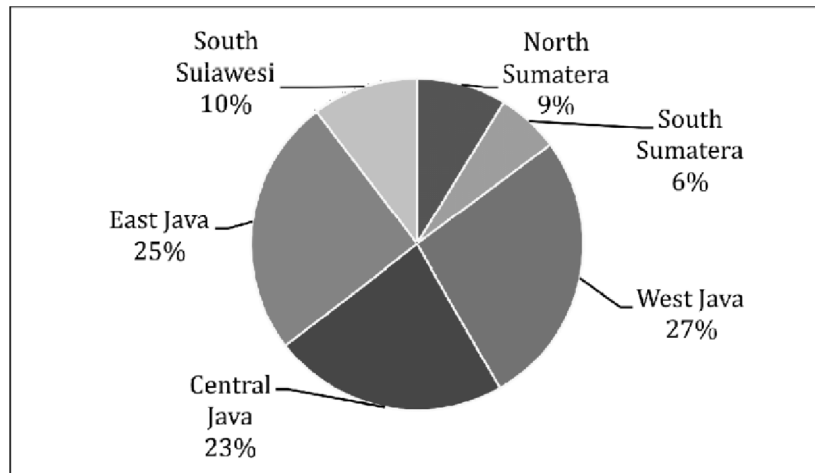

*Figure 18: Average share in six biggest provinces on rice production in Indonesia 2014 (Azwardi, et al., 2016)*

Agricultural land is categorized as the arable land areas under permanent crops or pastures. Presently, the agricultural sector of Indonesia comprises of three key types of farming: smallholder farming (mostly rice, vegetables, soybean, and maize), smallholder cash cropping, and about 1,800 large states owned and/or privately owned plantations. The latter two growing export crops (rubber and palm oil). Agriculture 4.0 was launched in February 2018 at the World Government Summit, in which technology will be crucial in the progression of precision farming. Smart Farming 4.0 introduced in Indonesia is a technology-based precision farming system and can be a brilliant solution for numerous complications in the Indonesian agricultural sector. The initiative released that the farmers would use the minimum amounts of water, fertilizers, and pesticides required to target very specific arid areas to grow crops whilst making use of clean and available resources (International Energy Agency, 2019).

Four key development challenges on agriculture in Indonesia have been clearly identified, which include food waste, climate change, demographics, and scarcity of natural resources. To tackle these forthcoming challenges, future agriculture will use sophisticated technologies such as robots, temperature and moisture sensors, aerial images, and GPS technology (see Figure 19) along with a collaborative effort by innovative agricultural technology companies, investors, and governments. These advanced devices, precision agriculture and robotic systems will allow farms to be more profitable, efficient, safe, and environmentally friendly (FAO, 2020).

MAP OF TECHNOLOGIES AND MATURITY

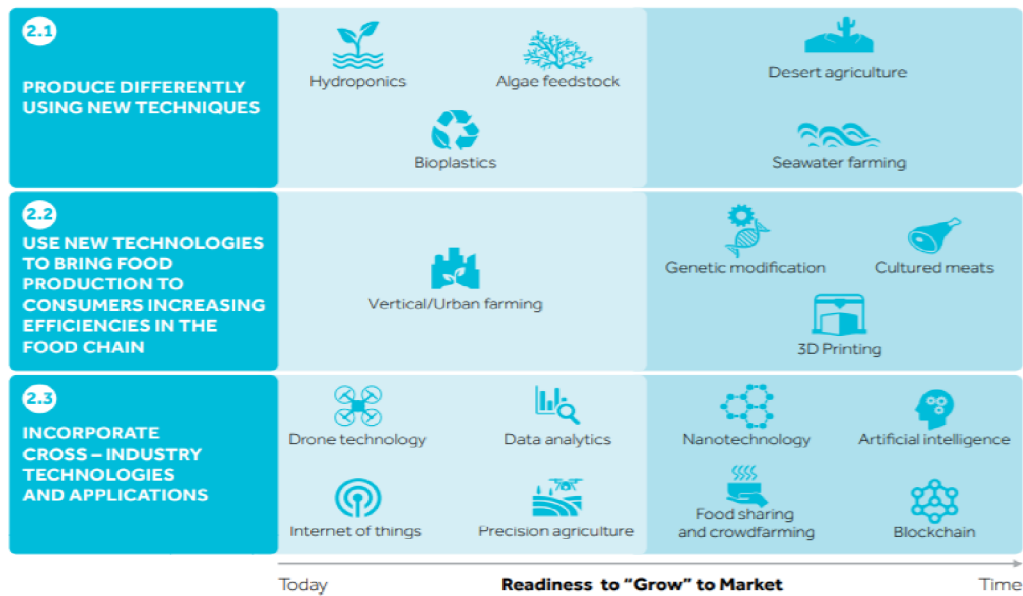

Figure 19: Time of adoption of the future of farming technology (Word Government Summit, 2018)

## 2.4 Relationship between biomass and agriculture in Indonesia

Biomass fuels show more potential as alternative resources of substituting the fossil fuels that are spent at such an extreme proportion globally than any other resources of generating energy thus far considered. Unlike fossil fuels, biomass is a very ample source that is entirely renewable. Biomass is fundamentally the surplus material produced by living and not long dead organisms. It can be in the form of fallen leaves, dead carcasses, dead wood, dung, trimmings from a landscaping task, and waste parts from animal processing plants that produce food (Hill, et al., 2006). Production of biomass can be a slow course as if one harvests a tree and uses it as fuel to create energy; that tree can take many years to replace. The agricultural biomass and its utilization for energy production purposes can contribute directly or indirectly to eradicate more than a few problems, such as the pollution caused by using fossil fuels, the dependency on import of energy products, the growing quantities of food losses and surpluses, and the land abandonment by farmers with the associated suburbanization (IRENA, 2020).

If farmers and ranchers were remunerated for these waste materials and taken to a nearby processing facility intended to produce biomass fuels from such raw materials, the energy industry would have a plentiful source of fuel that easily renewable and the

agriculture industry would commence to demonstrate a profit again. As of now, there is no incentive for agriculture workers in Indonesia to retrieve waste matter for any purpose other than as fertilizer for the next crop. If more work were done to improve the developments of converting raw biomass into usable fuels that produce a satisfactory amount of energy, the relationship between biomass and agriculture could be enhanced too, with both industries delivering each other in a reciprocally profitable cycle (Sonnino, 1994). More studies are still needed to be done and new innovations are to be established daily to extract as much energy as possible from material that would otherwise simply be wasted.

Public authorities at different levels can spur its production and usage through incentives of a different nature with regards to the indirect costs and giving a value to the advantages. From a long-term standpoint, high-tech invention can expand the cost efficacy of biomass production. Hence, an innovative rotation of plant domestication is required to develop new plant varieties, species, or genera producing higher biomass quantities than plants now grown for food production (Langer, et al., 2021). Agriculture, then again, produces huge quantities of unexploited biomass residues as sources of energy. Farmers grow crops to feed the entire world; some are used directly by individuals and the remaining leftover is utilized as fodder for livestock to fatten them up for butchery. Still, we do not use all the parts of the plants that are grown and are left as surplus. This untapped material is a form of raw biomass that could be treated to create fuel pellets for generating electricity in a power plant or firing a furnace (van Asselt, 2021). Some plants can be handled to produce a form of alcohol (bioethanol) as a clean burning substitute for petroleum; some manures from animal processing plants can be processed to extract methane gas (biogas) to create energy when burned to natural gas.

## **2.5 Energy policy and strategies on biomass production in Indonesia**

The production of agricultural waste can be used as biofuels to obtain power/energy has huge potential to supply energy needs. Although not entirely of local demand but a large part of it. The energy policy in Indonesia now is based on obtaining and exporting fossil fuels to foreign countries, making this practice the main source of export income at the national level. In contrast to the increasing environmental awareness, growing concerns about the ecological impact of these energy sources and the fall in the

price of coal in recent years, it is disputed whether grounding an entire energy policy wholly on fossil fuels is a sustainable idea. This approach challenges the energy policy presently advocated by the Indonesian government and proposes to try finding a different, desirably renewable, energy source (Prananta & Kubiszewski, 2021; Pramaita et al., 2020).

Another issue to be addressed primarily as a regulatory step in order to attain better control and regulation on the use of renewable energies has to do with the exploitation of natural resources, adequately defining property rights and establishing clear regulations regarding forest lands. The policies directly related to the regulation of energy approved by the Indonesian government since 2005 and valid for the next few years until 2025 are listed below:

*1. Electricity Law (Law no. 30/2010)*

- To encourage private limited corporations to partake in electricity supply.
- To give higher priority for the use of renewable energy and clean technology for electricity supply.
- To encourage more utilization of small-scale distributed power generation from renewable sources such as from biomass energy.

*2. Energy Law (Law no. 30/2007)*

- To regulate renewable energy development and energy efficiency policy, particularly by increasing the utilization of renewable energy and provide incentives for renewable energy developers for a certain period of time.

*3. Presidential Regulation no.5 on National Energy Policy, 2006*

- To set energy diversification targets for 2025, including 5% biofuel, and 5% geothermal and other renewables such as biomass.
- To set an energy conservation target of reducing energy intensity by 1% per year.

*4. Blueprint of National Energy Implementation Program 2005 – 2025 issued by Minister of Energy and Mineral Sources, 2005*

- To delineate measures for the enhancement of energy supply security.
- To provide development road maps for various sectors, covering renewable and non-renewable energy sectors.
- To design programs to phase out subsidies and improve energy efficiency.

The Indonesian government has issued a series of policies from the presidential levels, with the aim of encouraging, promoting, and accelerating the use of renewable energy, specifically the use of biomass in energy production. These policies and regulations address the problems faced by the entire supply, profits, project financing schemes, fiscal incentives, biofuel standard, among others. Institutions were also created to manage the direction of policies and regulations in the energy sector focused on renewable and clean energy (IRENA, 2017). All these actions have resulted in the operational growth of biomass as an energy resource in Indonesia. Although there are policies to encourage the development of renewable energies, Indonesia currently does not have a strategy or strong institution that is fully dedicated to the energy sector focused on biomass. The strategy currently being followed should be stringent to promote awareness of bioenergy applications among Indonesians and be responsible for capturing all the potential content of biomass residues, creating adequate processes, and giving boundless support to the producers of such wastes (Singh & Setiawan, 2013).

## **3 RESEARCH METHODOLOGY**

### **3.1 Time frame**

The research was carried out during the academic year 2020-2022. It comprised of the three-year full-time MSc studies at Czech University of Life Sciences Prague (CZU). The action research took place over a duration of one year with data collection of primary and secondary data following with laboratory works of the samples collected from the origin country of this research, Indonesia. However, some of the steps of this research have had to drastically change due to lockdowns and restrictions during COVID-19 pandemic which comprises of travelling to Indonesia for on-site sample/material collection and in-person interviews with the local farmers. Hence, the laboratory works were halted until June 2021 due to the logistic problems and in-person interviews were re-directed to online questionnaire distributed throughout friends from/in Indonesia and Facebook groups.

### **3.2 Data and data sources**

Two types of data sources were used in this research: primary and secondary data. Both primary and secondary data were treated equally as main sources of information to find out the most promising answer to respective objectives.

#### **3.2.1 Primary data sources**

Primary data were obtained via laboratory measurements of the main fuel-energy parameters of the studied materials which we brought from Indonesia. Primary data were also collected by formulating a questionnaire survey using Google Forms and distributing it to Indonesia farmers across different channels through mouth of words and social media groups. In essence, the questions were tailored to elicit the data and information that will help answer the specific purposes in this study.

### **3.2.2 Secondary data sources**

Secondary data sources were used in this research by means of reanalysing, reinterpreting, or reviewing the data focused on the chosen country, Indonesia. Most of the recent information was accessible from available Indonesian governmental reports, published and peer reviewed scientific papers, as well as overviews and data from IEA, IRENA, and FAO to formulate the general understanding of the present situation and possible energy applications. It revealed the potential gaps in available information and supported as input data with the outcomes of the laboratory work in calculating the energy potential altogether of the studied agricultural biomass residues.

### **3.3 Origin of materials and preparation of analysis samples**

Ten kinds of biomass residual materials from the five top crops in Indonesia were chosen based on the secondary data analysis from FAOSTAT data regarding the biomass availability/crops production, yield, and harvested areas in the county (namely oil palms, sugarcane, paddy rice, maize, and coconut). Different parts of residual biomass from these five crops were collected from different industries/markets/fields in Lampung Province, Indonesia around July 2021 and delivered to Prague, Czech Republic with the extensive support of Czech Embassy in Indonesia and the partnered universities located in Indonesia due to COVID-19 travel restrictions. The raw materials as received can be seen in Appendix 2. Figure 20 illustrated the Indonesia provinces on a map for better visualization. Description to the studied material (parts of crops, location of the collected samples, weight of collected presentative samples) is presented in Figure 20 and Table 4.



Figure 20: Map of Indonesia divided into Provinces (Worldofmaps.net, 2022), with Lampung Province highlighted (circled in red)

Table 4: The details of the type of residual biomass from the top five chosen crops

Type of residual biomass	Collection points of the samples	Total Mass (g) as delivered
Palm kernel shells (PKS)	Industry, Central Lampung District, Lampung Province	384.20
Oil palm empty fruit bunches (EFBs)	Palm oil industry (PT. Lambang Perkasa), Central Lampung District, Lampung province	519.79
Sugarcane bagasse	Industry (PT. Gunung Madu), Central Lampung District, Lampung Province	561.47
Sugarcane trash (leaves)	Industry (PT. Gunung Madu), Central Lampung District, Lampung Province	249.67
Paddy rice husks	Field, South Lampung, Lampung Province	224.63
Paddy rice straw	Field, South Lampung, Lampung Province	201.96
Coconut shell	Traditional market, Central Lampung District, Lampung Province	101.34
Maize stover (leaves)	Field, East Lampung District, Lampung Province	272.83
Maize stover (stalks)	Field, East Lampung District, Lampung Province	310.17
Maize stover (cobs)	Field, East Lampung District, Lampung Province	162.27

Oil palm industry produces a huge number of wastes and residues in the form of palm kernel shells (PKS), empty fruit bunch (EFBs), trunk of the plant, fibre, leaves and others. PKS are a fibrous material of the outer shell fractions left from nut removal after crushing in the Palm Oil mill. EFBs are abundantly available in a typical Palm Oil mills



as fibrous material of purely biological origin without any chemicals nor mineral additives and free from foreign elements such as gravel, nails, and wood residues. Empty fruit bunches can be conveniently collected and are available for exploitation in all Palm Oil mills (Mahidin, et al., 2020).

Sugarcane residues (bagasse and leaves/trash) are the key feedstock in Indonesia. Sugarcane bagasse is a by-product from the extraction of sugarcane juice in the sugarcane (Ferreira-Leitao, et al., 2010).

The rice husk, also called rice hull, is the agro-industrial leftover residue characterized as the outermost layer of the paddy grain or the coatings of seeds, or grains, of rice that is removed from the rice grains during the milling process. Rice straw is rice by-product cut at grain harvest or after, often ends up being piled or spread out in the field. Both rice husk and rice straw are indigestible fibrous plant material parts, attractive lignocellulosic materials for bioethanol production and these are the amplest renewable resources by the largest rice-producing countries (Azwardi, et al., 2016).

Coconut biomass is available in the form of coconut husk and coconut shells, agricultural wastes abundantly accessible throughout Indonesia.

Maize cobs are a by-product of the maize crop, consisting of the central core of an ear of maize (the maize "ear"). It's not edible when matured but can sometimes be consumed when they're still young enough to be tender. Milled cobs are used for livestock feeds and also for animal bedding, landfill, and fuel. The maize stalk and leaves are every so often left to become organic matter for the soil where it is crumpled into a mangled pile on the ground after harvesting processes (Ahmad, et al., 2022).

The scientific experiments/laboratory works took place in the Laboratory of biofuels of the Faculty of Tropical AgriSciences (FTA, CZU, Czech Republic) and the Laboratory of thermochemical properties of organic materials of the Faculty of Engineering (EF, CZU, Czech Republic). The tested samples were attained according to the standard sampling methodology BS EN ISO 18135:2017 (BSI Standards Publication: London, UK, 2017). The material samples were obtained from the raw materials without contamination from/with any additives or other materials following the standard methodology of BS EN ISO 14780:2017 (BSI Standards Publication: London, UK, 2017) for further laboratory testing. Laboratory Retsch Grindomix knife mill model GM100

(Retsch GmbH, Haan, Germany) was utilized for the final homogenization of the material samples to the particle size below 1 mm (see below Figure 21).



*Figure 21: Grinding processes of the tested material sample*

### **3.4 Determination of the biomass energy properties**

A detailed characterization of material samples was conducted according to the current European and International standards/International Organization for Standardization for solid biofuels.

#### **3.4.1 Sieve analysis**

Three tested material samples (palm kernel shells, rice husk and maize cobs) were further examined by size via sieve analysis to determine the particle size distribution of a given sample. The sieve analysis test was conducted by using sieve shaker (Retsch AS 200, Germany) comprising standard calibrated sieves with the diameter of 20 cm and different opening sizes.

For the determination PKS and maize cobs particle size distribution, the experiment used a test sieve shaker assembled by the sieves with the opening sizes of 10.00, 8.00, 6.70, 5.60, 4.50, 3.15, 1.50 mm (7 pcs) and the bottom collecting pan. For the measurement of rice husks, 7 sieves were used with smaller diameter due to extremely minute sizes of rice husk particles – 4.50, 3.15, 2.50, 1.50, 1.00, 0.50, 0.25 mm and the bottom collecting pan. During the sieve analysis, a representative weighed sample was poured into the top sieve with the largest screen opening size, and 10-minute sieve shaking time and amplitude 3.0 mm g<sup>-1</sup> were applied.

After the sieving process the material retained on each sieve was analysed using a digital laboratory scale KERN PEJ 2200 2M (Germany), weighing range 0 to 2,200 g, weighing accuracy +/- 0.01 g was used. The percentage of the tested material retained on any sieve was found by the equation below. Three repetitions with +/- 50 g were performed for each fraction (with sieving loss error approx. 0.3%) and the average value was considered as the final result. As for the data for three repetitions, see Appendix 4.

$$\% \text{ Retained} = \frac{W \text{ Sieve}}{W \text{ Total}} \times 100$$

where:

*W Sieve*—weight of the tested material retained on the sieve, g.

*W Total*— the total weight of the tested material, g.

### 3.4.2 Moisture content

The measurement of moisture content of the prepared tested samples was executed under the standard BS EN ISO 18134-3:2015. Tested samples were dried for about 3 hours duration in the drying oven Memmert 100–800 (Mettler GmbH, Schwabach, Germany) at the temperature of 105°C until a constant weight was achieved. For each of the tested samples, the process was repeated *n* times until the variance between procedure *n* and *n-1* stood equal or less than 0.2% absolute. The moisture content was calculated using the below equation and full tables of data entry for moisture content can be found in Appendix 5.

$$\text{Mar} = \frac{(m_2 - m_3)}{(m_2 - m_1)} \times 100$$

where:

*Mar*—moisture content as received, wet basis, %.

*m1*—mass of an empty dish and lid, g.

*m2*—mass of a dish and lid with a sample before drying, g.

*m3*—mass of a dish and lid with a sample after drying, g.

### 3.4.3 Ash content

Mass of inorganic residue remaining after tested sample heating was determined according to the standard BS EN ISO 18122:2015 under specific conditions. Approximately 1 gram of the previously dried tested sample at 105 °C, was positioned in a laboratory furnace LAC LH 06/13 (LAC, Rajhrad, Czech Republic) shown below in the Figure 22 and constantly heated in an ambient temperature to 250°C for 30 minutes and then continued at this temperature for another 60 minutes. Later, the temperature inside the furnace was steadily raised to 550°C over 30 minutes and kept at this level for a further 120 minutes.



Figure 22: The dry basis samples tested in the ash content test equipment, LAC

Ash content of each sample was determined as a mean of three repetitions to attain a repeatability precision. The calculation of the moisture content using the following equation and as for the complete data for calculations of ash content, see Appendix 6.

$$A = \frac{(m3 - m1)}{(m2 - m1)} \times 100$$

where:

- A*—ash content on a dry basis, %.  
*m1*—mass of an empty dish, g.  
*m2*—mass of dish with a sample, g.  
*m3*—mass of dish with ash, g.

#### 3.4.4 CHNSO content

Determination of Carbon (C), Hydrogen (H), Nitrogen (N), Sulphur (S), and Oxygen (O) content was performed using the standard BS EN ISO 16948:2015 and BS EN ISO 16994:2016 respectively via LECO CHNS628 (LECO Corporation, Saint Joseph, MI, USA). Calibration of the machine was commenced before three replicates of 0.1 gram of dried tested samples wrapped in aluminium foil placed into the equipment and combusted into simple compounds. The final compounds were analysed by the infrared detectors and thermal conductivity at temperature about 1,050°C with 100% oxygen. The automated results from the equipment were calculated by mass (%). Subsequently, the mass percentages of oxygen were calculated according to the following equations:

$$O(\%) = 100 - (C(\%) + H(\%) + N(\%) + S(\%) + Ash(\%))$$

- O (%)*—mass percentages of oxygen, %.  
*C (%)*— mass percentages of carbon, %.  
*H (%)*— mass percentages of hydrogen, %.  
*N (%)*— mass percentages of nitrogen, %.  
*S (%)*— mass percentages of sulphur, %.  
*Ash (%)*— mass percentages of ash content, %.

#### 3.4.5 Calorific value (CV)

The measurement of calorific value was conducted under the standard BS EN 14918:2009. Automatic calorimeter LAGET MS-10A (LAGET Ltd., Prague, Czech Republic) was used for the calorific value determination with about 1 gram of the representative biofuel sample positioned together with a combustion paper and an ignition wire, see Figure 23 below.



Figure 23: The experimental setup of the calorimeter for the CV determination

Gross calorific value (GCV) was calculated according to the following equations:

$$Q_{v,gr} = \frac{\varepsilon \times \theta - (m_{ign} \times Q_{ign} + m_{cb} \times Q_{cb})}{m_s} \times 100$$

where:

$Q_{v,gr}$ —gross calorific value of a biofuel sample,  $J \cdot g^{-1}$ .

$\varepsilon$ —heat capacity of a calorimeter,  $9,099 J/^\circ C$ .

$\theta$ —temperature rise,  $^\circ C$ .

$m_{ign}$ —mass of the ignition wire, g.

$Q_{ign}$ —calorific value of the ignition wire,  $6,000 J/g$ .

$m_{cb}$ —mass of a combustion paper, g.

$Q_{cb}$ —calorific value of a combustion paper,  $16,279 J/g$ .

$m_s$ —mass of a tested sample.

Subsequently, Net calorific value (NCV) was calculated using the below equation and converted into Megajoule per kilogram (MJ/kg) to keep consistency with the previous similar studies.

$$Q = Q_{v,gr} - 24.42 \times (M + 8.94 \times H)$$

where:

$Q$ —net calorific value,  $J \cdot g^{-1}$ .

$Q_{v,gr}$ —gross calorific value of a biofuel sample,  $J \cdot g^{-1}$ .

$\varepsilon$ —heat capacity of a calorimeter,  $9,099 J/^\circ C$ .

24.42—coefficient corresponding to 1% of the water from the sample at  $25^\circ C$ .

$M$ —moisture content in the sample, %.

8.94—coefficient for the conversion of hydrogen to the water.

$H$ —hydrogen content in the sample, %.

### 3.5 Calculation of the total energy yield

The calculation for the energy yield/potential of agricultural biomass residues was assessed ensuing the recommended equation designed by Akhmedov et al (Akhmedov, et al., 2019). The end results of calculated energy potential can be found in Appendix 3 and were then converted and expressed in another unit, TWh as 1 TWh is equal to 3,600 T.

$$Ep = (Tp * k) * Q$$

where:

*Ep*—annual energy potential of residual biomass, TJ.

*Tp*—total annual grain/crop production of country/region/province, t.

*k*—constant/share of residual biomass or residue ratio.

*Q*—net calorific value of residual biomass as received\*, TJ t<sup>-1</sup>.

### 3.6 Questionnaire survey

A questionnaire survey was formulated and finalized then translocated/proofread by a native Indonesia speaker in Prague, Czech Republic into Indonesian language to ensure the highest quality and consistency of the translocation. Recommendations from associated lecturers and PhD students were highly considered in this research before distributing them to the target audiences. The questionnaire consisted of 19 questions are separated into three main sections – confidentiality of the responses, knowledge/past experiences of the application of agricultural biomass residues and sociodemographic information.

Due to the travel movement restrictions regionally and globally, the questionnaire survey was created as an online survey via Google Forms, as attached in Appendix 1. The survey link was then shared with a brief introduction of the survey via Facebook's public groups (approximately 30 and more Facebook groups) consisted of agricultural farmers in Indonesia who represent the required characteristics for this research such as Petani Cabai Indonesia, Petani Melon Indonesia, Petani Kentang Indonesia, Petani Sawi Indonesia and many more. The online survey was conducted anonymously without taking details of the respondents including name and email. The collected data were then analyzed, visualized, and concluded as tables, graphs, and figures.

## 4 RESULTS

### 4.1 Sieve analysis calculations and particle size distribution curve

In sieve analysis, palm kernel shells, paddy rice husks and maize stover (cobs) were examined. Sieve analysis test was performed according to standard UNE-EN ISO 17827-1:2016, 2016 and the results are represented in table form.

#### 4.1.1 Palm kernel shells (PKS)

The weight values and the percentage weight values of PKS (as received) of obtained by sieving analysis are shown in Table 5. As it can be seen from the results, majority of the PKS are comprised of the particles with a size between 6.70 and 10.00 mm. The smallest amount of the material was captured by the sieve 1.5 mm and after this the amount of material on collecting pan was negligible.

*Table 5: Sieve analysis test calculations of tested sample, palm kernel shells (PKS)*

Sieve opening size [mm]	Average non-cumulative mass retained [g]	Average cumulative mass retained [g]	Mass retained [%]
10.00	18.13	18.13	34.96
8.00	13.68	31.81	61.35
6.70	12.34	44.15	85.15
5.60	4.71	48.86	94.23
4.50	2.30	51.16	98.67
3.15	0.55	51.71	99.74
1.50	0.11	51.82	99.95
Collecting Pan	0.02	51.85	100.00

#### 4.1.2 Paddy rice husks

The sieve opening size for paddy rice husks were used starting with 4.5 mm as the first sieve. Table 6 describes most of the paddy rice husks are comprised of the particles with a size between 1.5 and 2.5 mm.



*Table 6: Sieve analysis test calculations of tested sample, rice husk.*

Sieve opening size [mm]	Average non-cumulative mass retained [g]	Average cumulative mass retained [g]	Mass retained [%]
4.50	0.24	0.24	0.47
3.15	0.26	0.50	0.99
2.50	7.22	7.72	15.21
1.50	38.65	46.37	91.36
1.00	2.30	48.67	95.89
0.50	1.49	50.16	98.82
0.25	0.30	50.45	99.41
Collecting Pan	0.30	50.75	100.00

#### **4.1.3 Maize stover (cobs)**

Table 7 shows that majority of the maize stover consists of the particles with a size over 10 mm. Sieves 1.5, 3.15, and 4.5 mm including the bottom collecting pan did not catch any material.

*Table 7: Sieve analysis test calculations of tested sample, maize stover (cobs).*

Sieve opening size [mm]	Average non-cumulative mass retained [g]	Average cumulative mass retained [g]	Mass retained [%]
10.00	44.43	44.43	85.91
8.00	6.92	51.36	99.30
6.70	0.35	51.71	99.98
5.60	0.01	51.72	100.00
4.50	0.00	51.72	100.00
3.15	0.00	51.72	100.00
1.50	0.00	51.72	100.00
Collecting Pan	0.00	51.72	100.00

The following Figure 24 represents the comparison of the three different tested material samples used for the sieve analysis. In the below graph, PKS has a wide range of the particle size distribution. As for paddy rice husks and maize stover (cobs), the particle size distribution was dominated by one specific sieve opening size (1.5 and 10 mm respectively).

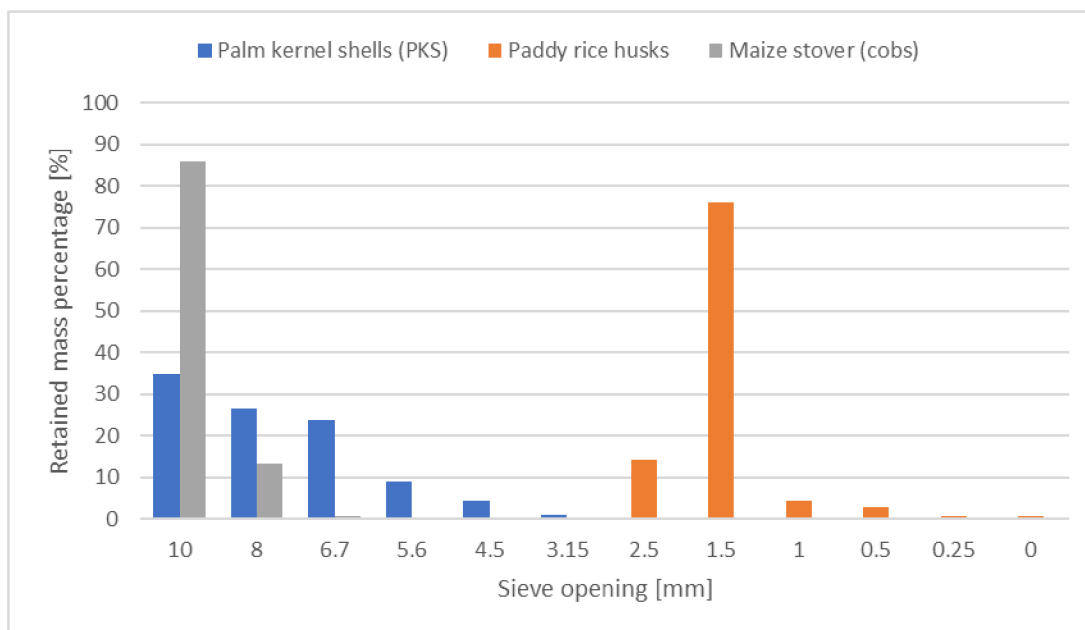

Figure 24: Plotted comparison of particle size distribution of the tested material samples via the sieve analysis

## 4.2 Evaluation of fuel-energy properties of tested biomass materials

From the Table 8, it can be summarized that the tested sugarcane bagasse had the highest moisture content, 9.86% whilst the paddy rice straw had the lowest moisture content, 6.53% among all the samples (as received). Sugarcane bagasse was grinded and dried to a 9.86% moisture content due to a very high 40.22% moisture content as received using BOSCH Coffee Grinder TSM6A013B (Robert Bosch GmbH, Gerlingen, Germany). Meanwhile, as Figure 9 shows, coconut shells have the lowest ash content, and followed by both maize stover stalks and cobs. The CHNSO content for both as received and dry basis of empty fruit bunches (EFB), sugarcane bagasse and sugarcane trash (leaves) were relatively similar to the previous studies (Rahim, et al., 2019), (Kumproa & Nuntiya, 2015), (Kasim, et al., 2016) and (Solangi, et al., 2018) respectively.

Table 8: Proximate and ultimate analysis of the tested material samples (as received)

Type of residual biomass	M <sub>ar</sub> [wt.% <sub>ar</sub> ]	C [wt.% <sub>ar</sub> ]	H [wt.% <sub>ar</sub> ]	N [wt.% <sub>ar</sub> ]	S [wt.% <sub>ar</sub> ]	O [wt.% <sub>ar</sub> ]
Palm kernel shells (PKS)	8.52	49.34	6.08	0.36	0.00	34.22
Empty fruit bunches (EFB)	8.74	41.04	6.19	1.14	0.05	34.62
Sugarcane bagasse*	9.86	43.44	6.17	0.33	0.00	37.28
Sugarcane trash (leaves)	9.57	42.93	6.30	0.62	0.13	36.02
Paddy rice husks	8.94	34.83	5.19	0.45	0.01	31.27
Paddy rice straw	6.53	34.46	5.34	1.13	0.06	30.20
Coconut shell	9.12	49.24	6.06	0.16	0.00	37.97
Maize stover (leaves)	8.69	42.23	6.11	2.67	0.21	30.67
Maize stover (stalks)	8.28	43.07	6.30	0.39	0.00	38.94
Maize stover (cobs)	8.67	44.59	6.19	0.88	0.04	38.63

Sugarcane bagasse\* was further grinded and dried to 9.86% moisture content using BOSCH Coffee Grinder TSM6A013B (Robert Bosch GmbH, Gerlingen, Germany) due to a very high moisture content, 40.22% (as received).

As received samples were then dried and tested for ultimate analysis in dry basis. Based on the results in Table 9, the carbon, nitrogen, sulphur and oxygen content of dried tested samples are relatively higher than the tested samples as received, in exception for hydrogen content.

Table 9: Ultimate analysis of the tested material samples (dry basis)

Type of residual biomass	A [wt.% <sub>d</sub> ]	C (wt.% <sub>d</sub> )	H (wt.% <sub>d</sub> )	N (wt.% <sub>d</sub> )	S (wt.% <sub>d</sub> )	O (wt.% <sub>d</sub> )
Palm kernel shells (PKS)	8.73	54.04	5.59	0.39	0.00	37.48
Empty fruit bunches (EFB)	8.29	45.29	5.67	1.26	0.05	38.21
Sugarcane bagasse	50.00	46.71	5.77	0.35	0.00	40.19
Sugarcane trash (leaves)	5.96	47.12	5.83	0.68	0.14	39.53
Paddy rice husks	21.28	38.10	4.62	0.49	0.01	34.21
Paddy rice straw	18.00	38.20	4.70	1.25	0.06	33.49
Coconut shell	1.18	52.86	5.68	0.17	0.00	40.76
Maize stover (leaves)	11.09	46.28	5.62	2.92	0.23	33.61
Maize stover (stalks)	3.12	47.89	5.75	0.44	0.00	43.30
Maize stover (cobs)	3.59	48.28	5.77	0.95	0.05	41.83

The values of NCV in dry basis are higher than the values of NCV in as received based on the Table 10 below. Taking into account the net calorific values (NCV) in dry basis, the best tested materials in this research are coconut shells, palm kernel shells and maize stover leaves ( $19.20 \text{ MJkg}^{-1}$ ,  $18.21 \text{ MJkg}^{-1}$  and  $17.06 \text{ MJkg}^{-1}$  respectively).

Table 10: GCV and NCV of the tested samples (as received and dry basis)

Type of residual biomass	GCV (MJkg <sup>-1</sup> <sub>ar</sub> )	GCV (MJkg <sup>-1</sup> <sub>d</sub> )	NCV (MJkg <sup>-1</sup> <sub>ar</sub> )	NCV (MJkg <sup>-1</sup> <sub>d</sub> )
Palm kernel shells (PKS)	18.65	19.43	17.11	18.21
Empty fruit bunches (EFB)	16.90	17.94	15.34	16.70
Sugarcane bagasse*	8.21	11.42	6.62	10.16
Sugarcane trash (leaves)	16.53	17.63	14.92	16.36
Paddy rice husks	14.14	15.41	12.79	14.40
Paddy rice straw	13.43	14.46	12.10	13.43
Coconut shell	18.66	20.44	17.11	19.20
Maize stover (leaves)	17.01	18.29	15.46	17.06
Maize stover (stalks)	16.69	17.46	15.11	16.20
Maize stover (cobs)	16.85	18.21	15.29	16.95

### 4.3 Total energy yield

The values of annual energy potential (TJ/TWh) in dry basis are higher than the values of annual energy potential in as received. In the following Table 11, it can be concluded that the paddy rice straw has the highest annual energy potential in dry basis (473.12 TWh), followed by the empty fruit bunches (261.84 TWh) and the maize stover stalks (164.40 TWh).

*Table 11: Total energy potential per year of the tested material samples in Indonesia*

Type of residual biomass	Annual Energy Potential (TJ <sub>ar</sub> )	Annual Energy Potential (TWh <sub>ar</sub> )	Annual Energy Potential (TJ <sub>d</sub> )	Annual Energy Potential (TWh <sub>d</sub> )
Palm kernel shells (PKS)	263,423	73.17	280,277	77.85
Empty fruit bunches (EFB)	865,462	240.41	942,607	261.84
Sugarcane bagasse*	63,186	17.55	96,945	26.93
Sugarcane trash (leaves)	99,227	27.56	108,778	30.22
Paddy rice husks	146,767	40.77	165,275	45.91
Paddy rice straw	1,534,713	426.31	1,703,235	473.12
Coconut shell	97,901	27.19	109,832	30.51
Maize stover (leaves)	71,578	19.88	78,981	21.94
Maize stover (stalks)	552,617	153.50	592,558	164.60
Maize stover (cobs)	95,525	26.53	105,919	29.42

#### 4.4 Questionnaire survey

The below figures are the results from the online questionnaire. All respondents participated the online survey willingly without compensation. Figure 25 shows that majority of the respondents were males.

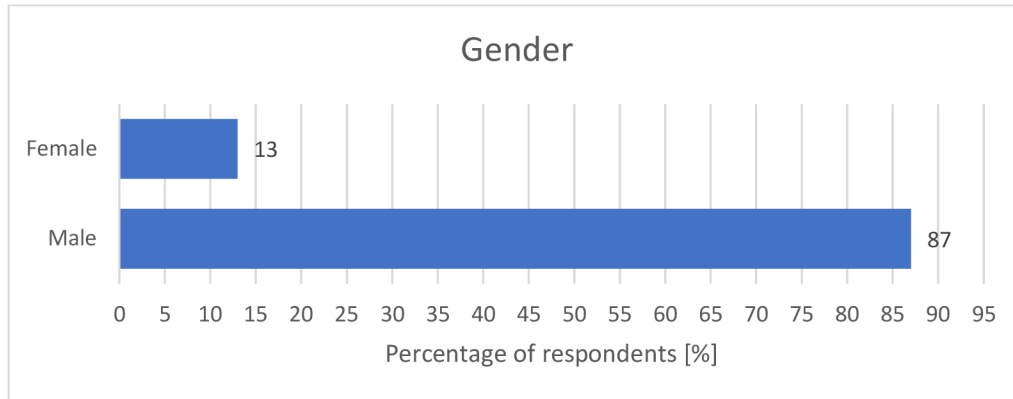

Figure 25: Profiles of survey respondents in Indonesia by gender on 2021's survey

Figure 26 shows the age groups of the respondents with a majority of them aged between 45 and 54 years old. In overall, half of the respondents are young aged below 44 years old.

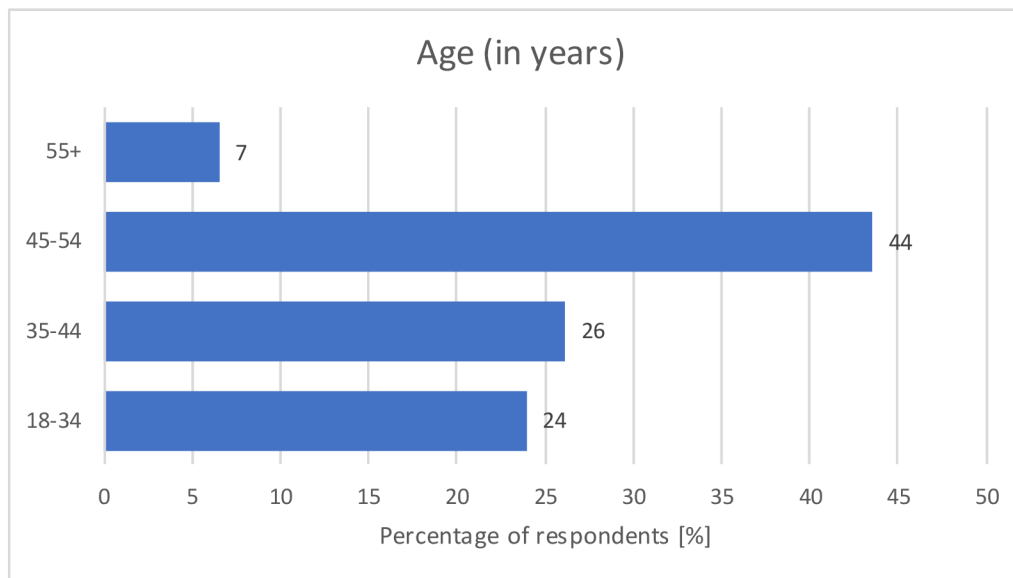
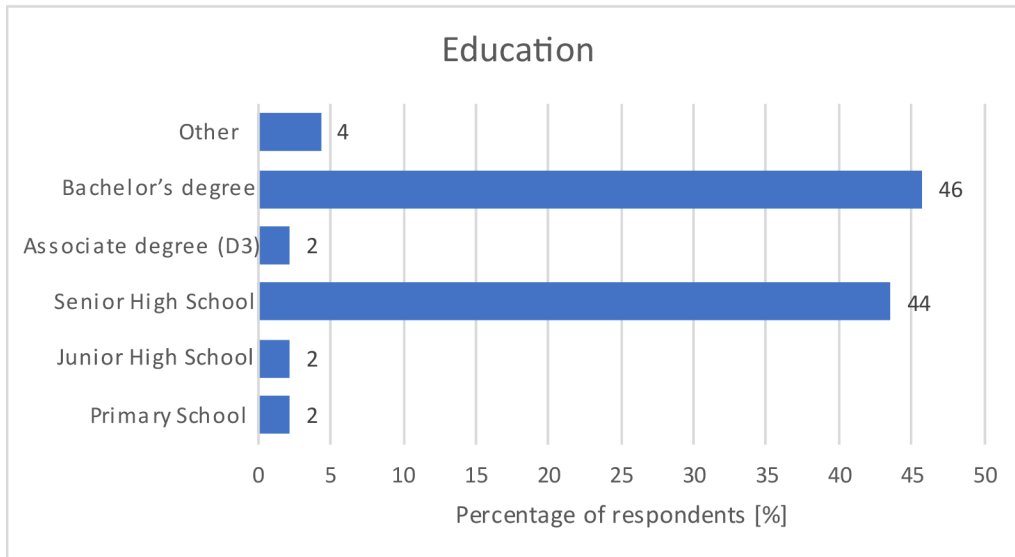

Figure 26: Profiles of survey respondents in Indonesia by age on 2021's survey

Figure 27 shows majority of the respondents are with a high-school educational background and some have pursued their education to a higher level by attending a college, a vocational school, or a university to obtain a bachelor's degree or as a postgraduate.



*Figure 27: Profiles of survey respondents in Indonesia by their education background on 2021's survey*

Figure 28 shows almost 50% of the respondents are from Java islands, followed by Sumatra islands with 24%. The rest of the respondents were from the Sulawesi, Lesser Sunda and other islands.

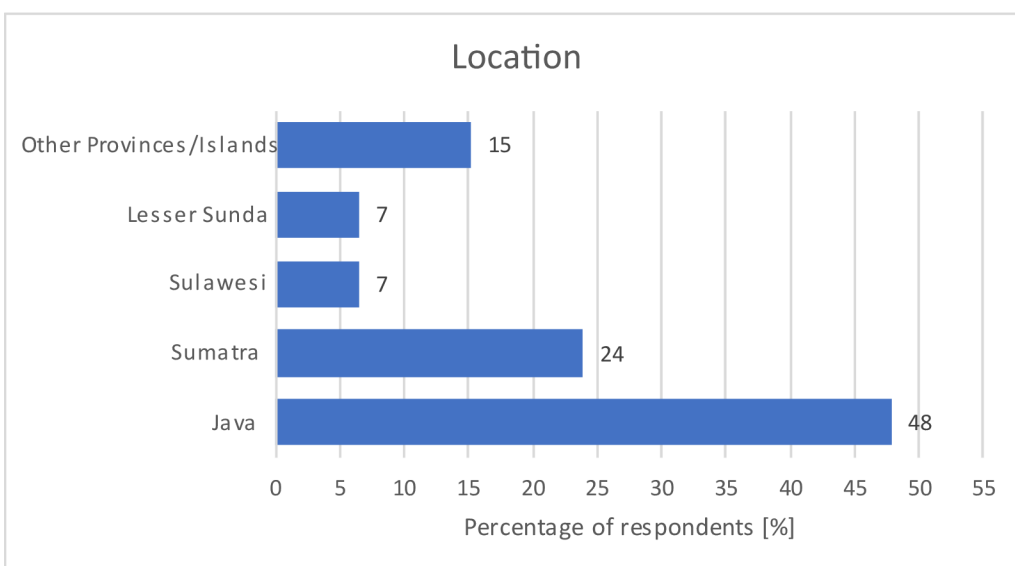

*Figure 28: Profiles of survey respondents in Indonesia by age on 2021's survey*



Majority of the respondents were responsible for more than half of their household's income. Figure 29 shows more than 83% of the respondents were a main contributor in their family.

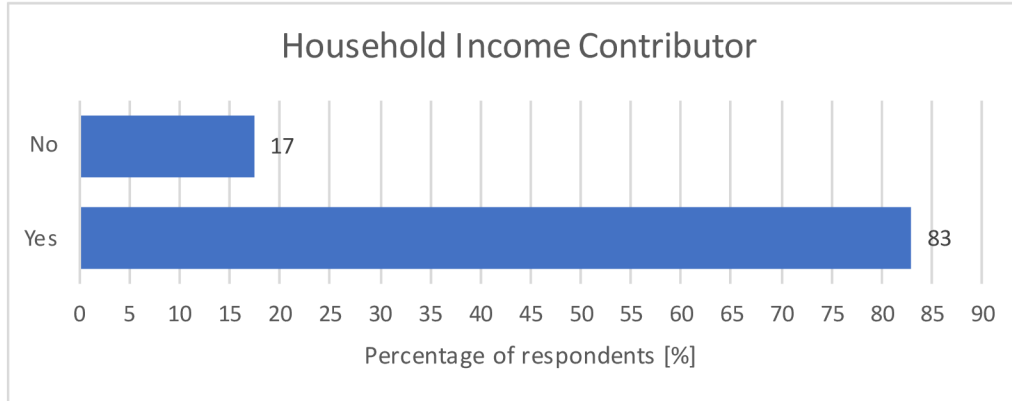

*Figure 29: Profiles of survey respondents in Indonesia by their household income contribution on 2021's survey*

In the following, Figure 30 shows the background of the respondent's farming and agricultural activities in regard to their land rights, land use, products, incomes, and types of the residues produced as well as residues' application. Based on the results of this study, 81% of the respondents are carrying out their farming activities in their own private lands. Over half of the respondents are having more than one hectare of land to farm. Additionally, almost 80% of the respondents are growing only crops in their lands with 24% of them uncertain about their farming incomes or revenues. In term of the agricultural residues produced in their farming activities, the top three biomass residues can be found from leaves, branches and stalks (26%, 19% and 18% respectively). A significant percentage of respondents (40%) are considering (or already) using these residues as an organic fertilizer whilst 38% of the rest of the respondents prefer to throw them away.

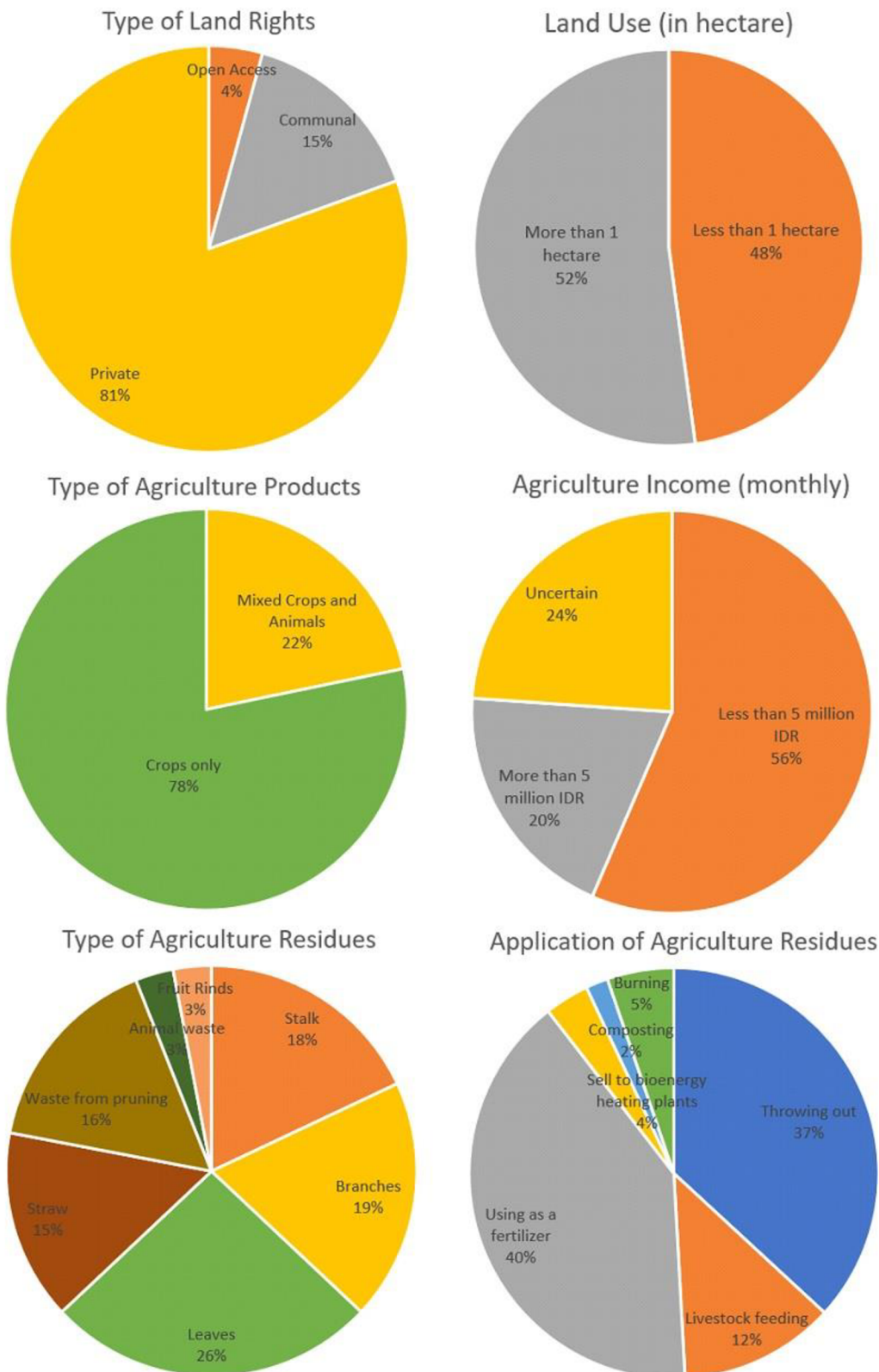

Figure 30: Respondents' farming activities background in term of the type of land rights, land use in hectare, type of agriculture products and monthly agriculture income

Figure 31 shows that almost 33% of the respondents in this research study estimated their monthly crop production to be within the range of 1,000-4,900 kg. Yet, about 13% of them were uncertain about their monthly production.

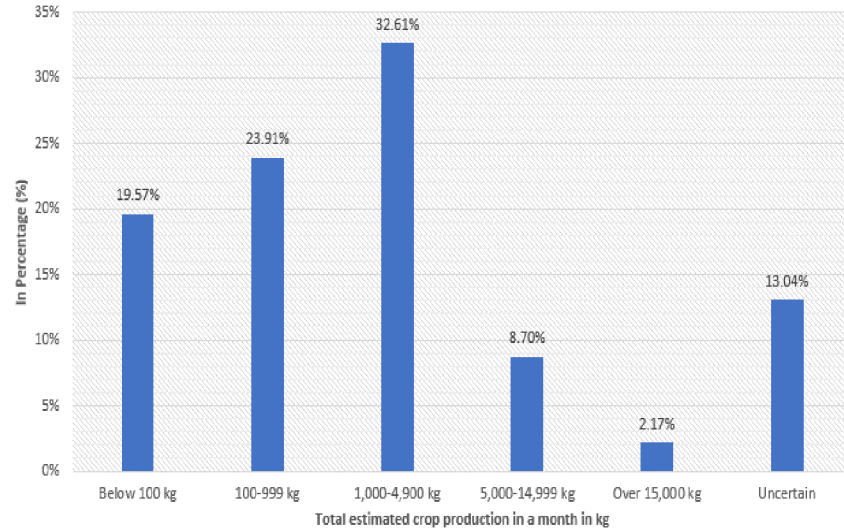

Figure 31: The percentage of respondents with their total estimated crop production in a month (kg per total land)

In the following Figure 32, the transformation of biomass residues into bioenergy and sustainable organic fertilizers (biofertilizer) were studied and 63% of the respondents do not have any knowledge about that. Despite that, a majority of the respondents agree with the positive impacts of residual waste for farmers, in general.

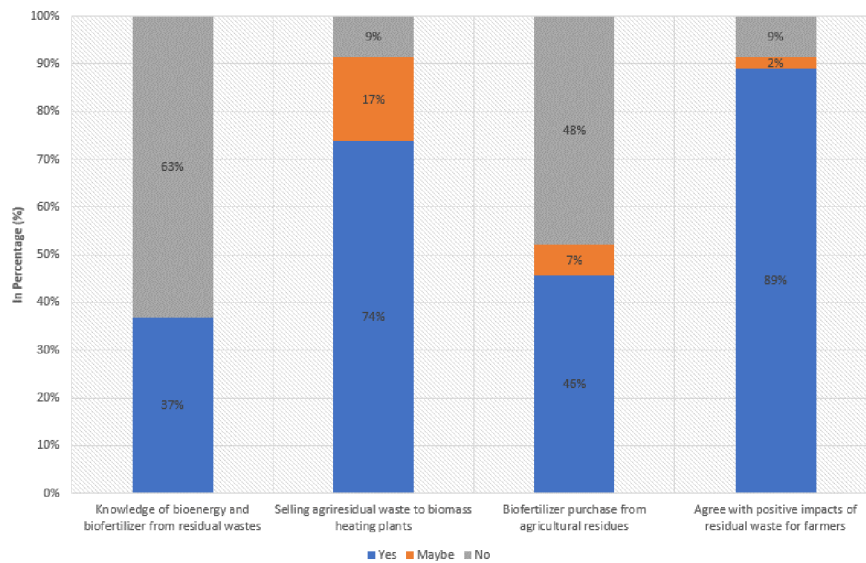

Figure 32: The perspectives of bioenergy and biofertilizer among the respondents toward potential applications from agricultural biomass residues for local farmers

## 5 DISCUSSION

In this research study, the results that were gathered, collated, and analysed, emphasised the significance of residual biomass in agriculture industry. Results were initially categorized into two basic themes: fuel-energy properties and energy potential of five chosen tested material samples. Additionally, the results from the online-distributed questionnaire survey were then tested and concluded to understand the socioeconomic characteristics and consumer perspectives among the respondents consisted of Indonesian local farmers towards agricultural biomass residues in the production and/or consumption of bioenergy and biofertilizer. This study facilitated the development of the key factors of questioning, investigating, and predicting the costs and benefits of biomass applications. Indonesia was the world's largest producer of oil palm fruit and third largest paddy rice producer in 2019 (60% and 10% of the total global production respectively) (FAO, 2021), see Figure 33 below.

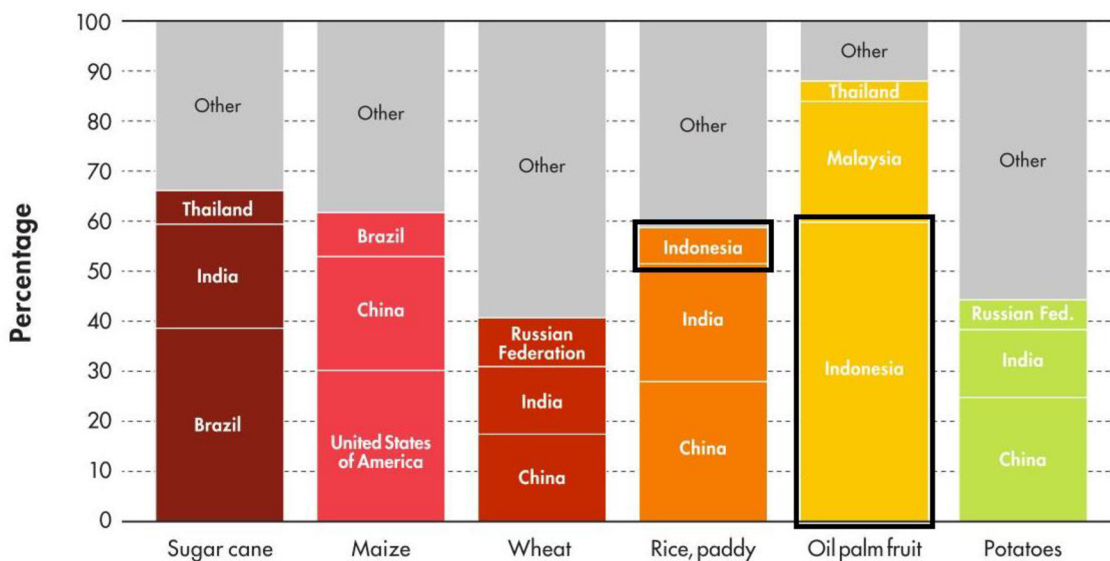

Figure 33: World production of main primary crops by main producers in 2019 (FAO, 2021)

As the global population is expected to raise to nearly 11.2 billion around 2100 according to the United Nations, the global renewable energy use needs to expand significantly including traditional biomass use (United Nations, 2022). Since Indonesia is dominating the world's production in oil palm fruit and is major producer in paddy rice, this study found that residual materials from these crops, empty fruit bunches from oil

palm and paddy rice husks, have the highest annual energy potential to supply energy nationally, when compared to other crops.

## **5.1 Availability of agricultural crops and possibilities of energy use**

### **5.1.1 Oil palm**

The main products on palm oil plantations and at local mills are crude palm oil (CPO) and kernel oil (KO) while the by-products including oil palm fronds (OPF), empty fruit bunches (EFB), palm kernel shells (PKS), palm oil mill effluents (POME), palm kernel cake (PKC), roots, trunks, fibre, and other by-products. Huge amounts of these biomass by-products produced in the palm oil production chain are scarcely utilized as added values to the production chain. The present palm oil production scheme is principally recognized as unsustainable due to the detrimental effects on current biodiversity including loss of virgin forests and greenhouse gas emissions associated with existing waste disposal methods (Abu Bakar, et al., 2017).

The utilization of by-products for bioenergy and green chemicals somewhat gives positive perceptions for creating a “certified” sustainable food oil production chain that fits perfectly in the bio-based economy development among the global citizens. Nevertheless, EFB and PKS are selected in this study to be analysed as they are both highly considered as high economic value by-products as raw materials for bioenergy production (e.g.: bio-pellets) and biofertilizers. Besides, Indonesia is the top producer of the oil palm fruits with over 250M tonnes in 2020; approximately 6% of palm kernel shells and 22% of empty fruit bunches can be generated from the palm oil production according to Moni, Sulaiman, & Baheta, 2018.

However, the utilization is not every so often considered as optimal as most of the industries in Indonesia are lacking the recent innovative technologies to process EFB. In fact, EFB is often stacked in empty landfills without any further treatments. Since PKS and oil palm fibres are comparatively very easy-to-handle with considerably high-quality fuels compared to EFB, it'd be more advantageous to make these by-products more accessible for off-site utilization which may bring more revenues as compared to on-site burning. On the other hand, EFB can be effectively utilized for on-site energy demand.

According to Figure 34, the production of oil palm in Indonesia has grown exponentially in the past few years where palm oil – a staple agricultural commodity found in roughly 50% of all packaged food products sold in the supermarkets. The country produces more than 30 million tonnes of palm oil per year generating 4.5% of its GDP and providing employment to approximately 3 million Indonesian people.

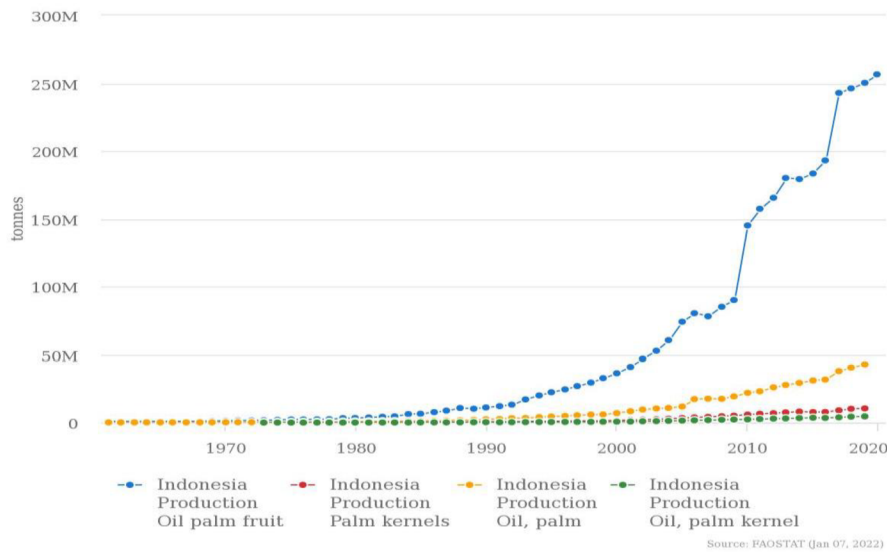

Figure 34: The production of oil palm in Indonesia from year 1960 to 2020 (FAOSTAT, 2022)

Global population growth and expansion of food processing industry have contributed to more than double of the global use of palm oil in food products, such as cooking oil and margarine. Hence, the edible oil prices continue to raise with seasonal high demand from major importing countries, and eventually driving food inflation to their highest level in 10 years globally. However, constrained supply with lower palm production by top producer Indonesia due to heavy summer rains, flooding, and ongoing labour shortages due to COVID-19 restrictions/protocols (Norouzi, 2021).

### 5.1.2 Sugarcane

At present, the sugar industry has utilized the sugarcane bagasse and trash (leaves) as biofuels to sustain most of their on-site activities. Sugarcane bagasse is a by-product of sugarcane which can only be found in this specific industry and is processed into sugarcane juice and/or crystal sugar. Sugarcane leaves dried during the harvest period are usually utilized as organic fertilizers in sugarcane plantations and/or biofuels, especially in bioethanol production. The composition of both sugarcane residues (bagasse

and leaves) is shown below in Table 12 considered as positively encouraging as some characteristics are very attractive, such as high availability, low cost, and hypothetically low occupational risk.

*Table 12: Composition of sugarcane bagasse and leaves as % of dry matter (Ferreira-Leitao, et al., 2010)*

Content	Bagasse (% of dry matter)	Leaves (% of dry matter)
Glucan	41.4	33.3
Xylan	22.5	18.1
Arabinana	1.3	3.1
Galactan	1.3	1.5
Mannan	3.4	1.5
Lignin	23.6	36.1
Total	93.5	93.6

There are eleven sugar refineries that can be found in Indonesia, tightly regulated, and controlled by Government of Indonesia (GOI). These refineries are processing raw sugar into refined sugar, with a total installed running capacity of about five million tonnes depending on the raw sugar import permits. The COVID-19 pandemic has now weakened the exchange rate of Indonesian rupiah (IDR) to Euro (€) and indirectly reduced consumption of the food and beverage industry which is negatively impacting the refinery running capacity (Pradana, et al., 2019). In addition, a prolonged dry season due to current global climate change with late onset of rainy season in Indonesia had stunted the growth of sugarcane may possibly lead to at least 10% decline in yield per hectare despite a continued area expansion outside of Java and increased productions (see Figure 35).

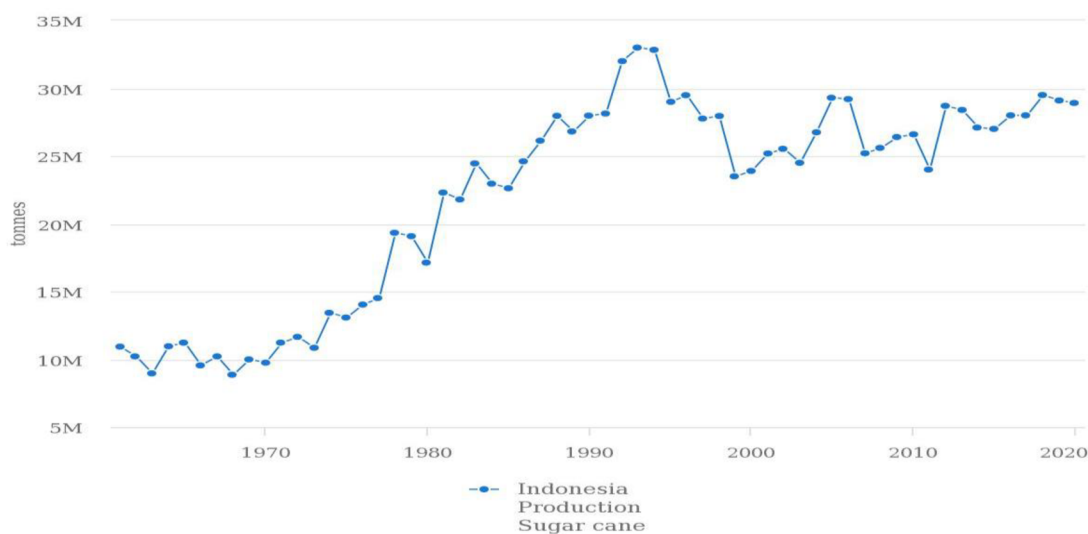
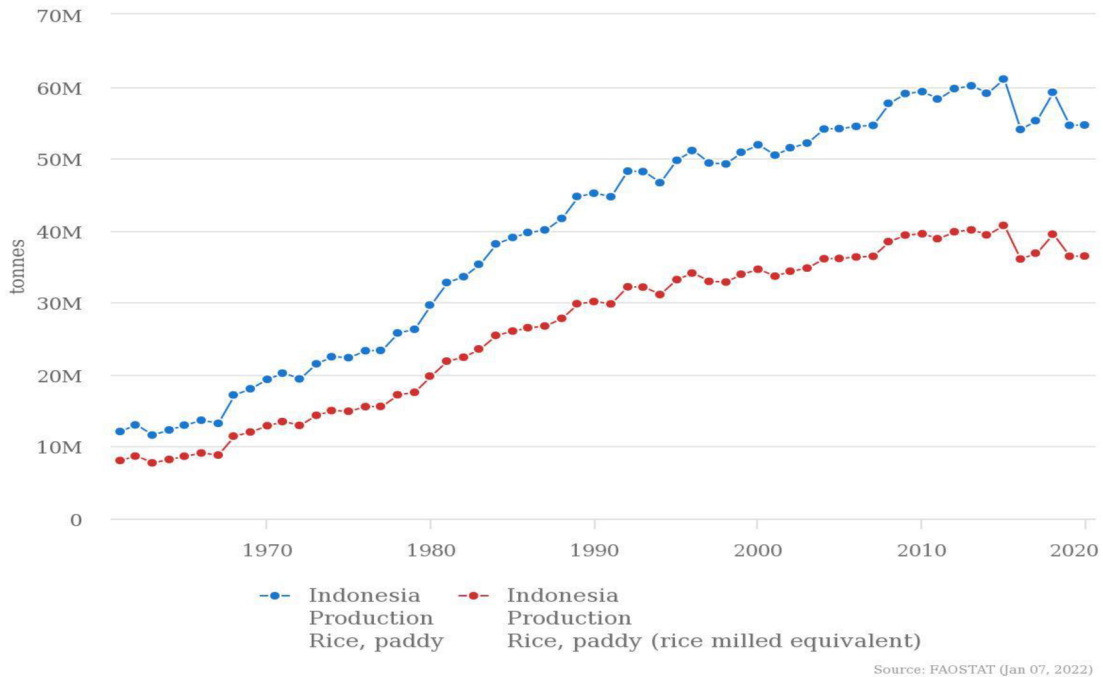

Figure 35: The production of sugarcane in Indonesia from year 1960 to 2020 (FAOSTAT, 2022)

### 5.1.3 Paddy rice

Rice is Indonesia’s most important staple food products; it is often eaten as the main ingredient and at least twice per day. Indonesia was one of the major producers of rice globally, with the annual production increasing over years following Figure 36. Its production produces enormous quantities non-food biomass, primarily in the form of husks and straw. According to Goswami, Mondal, & Mandi, the crop residue to crop ratio of the paddy rice is about 4:1 and considered the most residue-producing crop in Asia and Africa. Paddy rice husks have a substantially high economic value in Indonesia as most of the rice milling factories within rice industry will process it through grinding and subsequently sell it as animal feeds for poultry, cattle, and swine industries. Moreover, the rice husks can also be used as growing media for horticulture plants in which some farmers might process it into rice briquettes. Rice husks compositional analysis consists of 15–30% hemicellulose, 20–35% cellulose, and approximately 10% lignin while the rice straw consists of 20.91% hemicellulose, 39.04% cellulose, and 5.71% lignin (Benová, et al., 2021). The rice straw is typically left unattended in the fields after harvest stage and most of the farmers will burn it before sowing new crops the next season. Burning is often considered the low-cost solution way to dispose of the rice straw so that the fields can be made ready for seeding and the best alternative to tilling in the straw after rainy weather (Goodman, 2020).





*Figure 36: The production of paddy rice in Indonesia from year 1960 to 2020 (FAOSTAT, 2022)*

The rice prices are unfortunately climbing until February 2022, continuing a trend that started at the end of last year because of low harvests from November to December 2021. It's understandable that stable rice prices cannot be separated from the influence of sufficient and safe national rice stock conditions. Indonesian State Logistics Agency (BULOG) is expecting rice production to happen from February to March 2022 due to the resulting abundant water availability provided by sufficient rainfall from La Nina weather patterns for growing paddy rice, which would provide up to 4.14 million tonnes of rice for the agency to absorb, helping stabilize rice supplies and prices (Global Agricultural Monitoring, 2022). Hence, considering rice-rice system is contributing crop residue about 80% of its total production, approximately 16 million tonnes of paddy rice residues available in the field (Goswami, et al., 2020).

No substantial changes were reported in the highly reliant rice consumption in Indonesia, with only 0.62% reduction in per capita rice consumption per year as lower-middle income consumers continue to substitute rice-based dishes with instant noodles due to ease of preparation and affordability whilst middle and upper-middle income consumers continue diversifying their diets to include more western-style foods like bread and pasta. Hence, this reflecting a slower economy and decreased consumer purchasing power, because of the global COVID-19 pandemic (Nasir, et al., 2021).

#### 5.1.4 Maize

After paddy rice, maize is considered the second most important main staple food and cereal crop in Indonesia. Indonesia customarily experiences a dry season from April to October and rainy season from October to April annually. Although some areas might only have two planting seasons, most of the Indonesian regions typically offer three planting periods. The first maize season can take place from October to February (49%); the second from March to June (37%); and the third from July to September (14%). Sufficient water availability from adequate rainfall due to the La Nina weather pattern until the end of February 2022 resulted in some farmers on semi-technically irrigated area switching from maize to paddy rice during the third crop cycle of 2020/2021 (Global Agricultural Monitoring, 2022) .

The demand for maize, especially for animal feeds, is progressively increasing. Currently, Indonesia's feed mill sector consists of 110 feed mills located in 10 provinces, with 81 mills located on Java Islands. Feed mills are currently running at an average of 70% of total installed capacity of 29.6 MMT. The poultry industry accounting for 90% with aquaculture consumes about 6% and cattle and swine the remaining 4% of domestic animal feed supplies. Maize residues consisted of husks, straw, bran, cobs, skins, and trimmings, remain one of the best and cheapest methods for feeding livestock for many generations (Syahrudin, et al., 2020). Domestic demand for maize commodities in Indonesia continues surging due to insufficient maize production to meet the ever-increasing national consumption despite the high maize production in the last three decades following Figure 37.

The primary challenge is the characteristics of maize cultivation itself where most of the maize are planted seasonally depending on the farmer's preference determined by many factors and produced in small pieces of lands scattering across the country. Therefore, the impact of this condition is the scarcity of maize commodities, increase in maize prices, and a rapid increment in the net import of maize. Due to maize residue practice, crop, and livestock both were benefited through resources interdependences. GOI pressure to use local production has encouraged feed mills to use more local maize as the primary energy source in feeds as the prices of imported animal feed ingredients on the international market keep rising (Ngongo, et al., 2021).

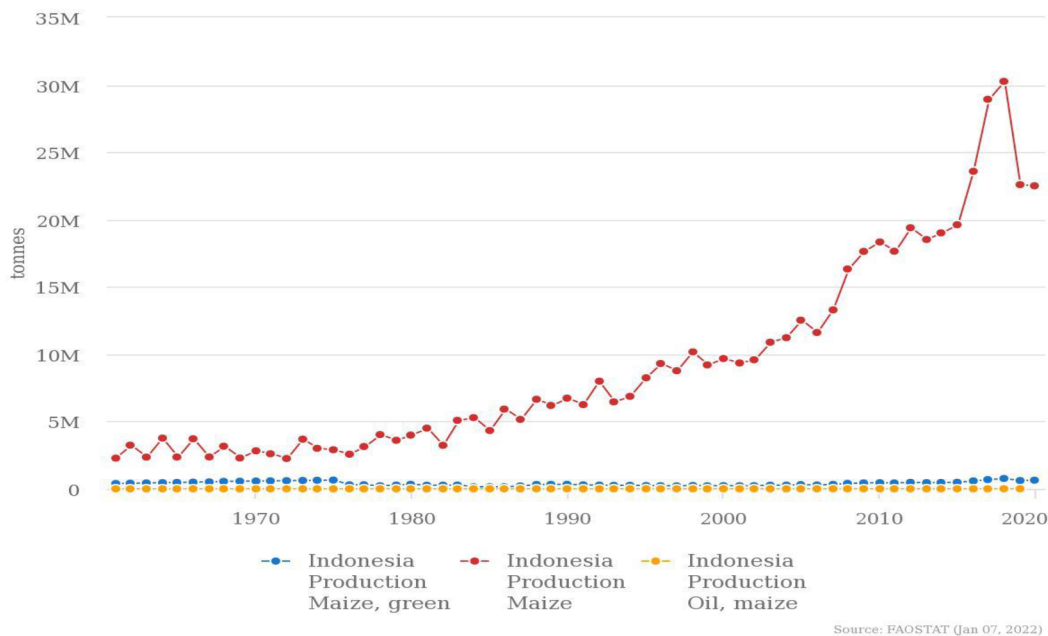

Figure 37: The production of maize in Indonesia from year 1960 to 2020 (FAOSTAT, 2022)

### 5.1.5 Coconut

Indonesia is the world's largest coconut-producing countries with approximately 16.82 million metric tonnes in 2020 (see Figure 38). Average annual coconut oil price forecasted to increase by 2.3% year-on-year globally following the fundamental trend relevant to all vegetable oils, limited supply from key exporters, and high freight rates and logistic costs. At present, the global market demand of coconut oil is fluctuating while demand for certain coconut products such as coconut water, milk and flour is growing rapidly. In 2020, Indonesia was one of the key exporters of coconut oil along with the Philippines, amounting to about 65% of worldwide exports. The cultivation of coconuts has been a vital source of income for small farmers in Indonesia (Ahmad, et al., 2022).

Coconut biomass residues comprised of coconut shell, leaves, frond, fibre, husk, coir, and husk. A study conducted by Obeng et al., 2020, emphasized that about 65% of the whole coconut fruit in the form of husks and shells are solid inedible wastes which can be transformed into a commodity of high economic value. It can be a potential bioenergy resource used as fuel to possibly replace wood and other traditional for cooking, small-scale electricity production and industrial heating. Coconut shells are also frequently used as craving craft materials within the handicraft industry to make biodegradable bowls, spoons, vases, lampshade, teapots, and wall displays; most coconut

sellers have contracts as coconut shell suppliers with the industry for extra incomes. There is also a high demand by the international markets for premium quality coconut shell charcoal briquettes from Indonesia for BBQ, shisha, and cooking (Yana, et al., 2022).

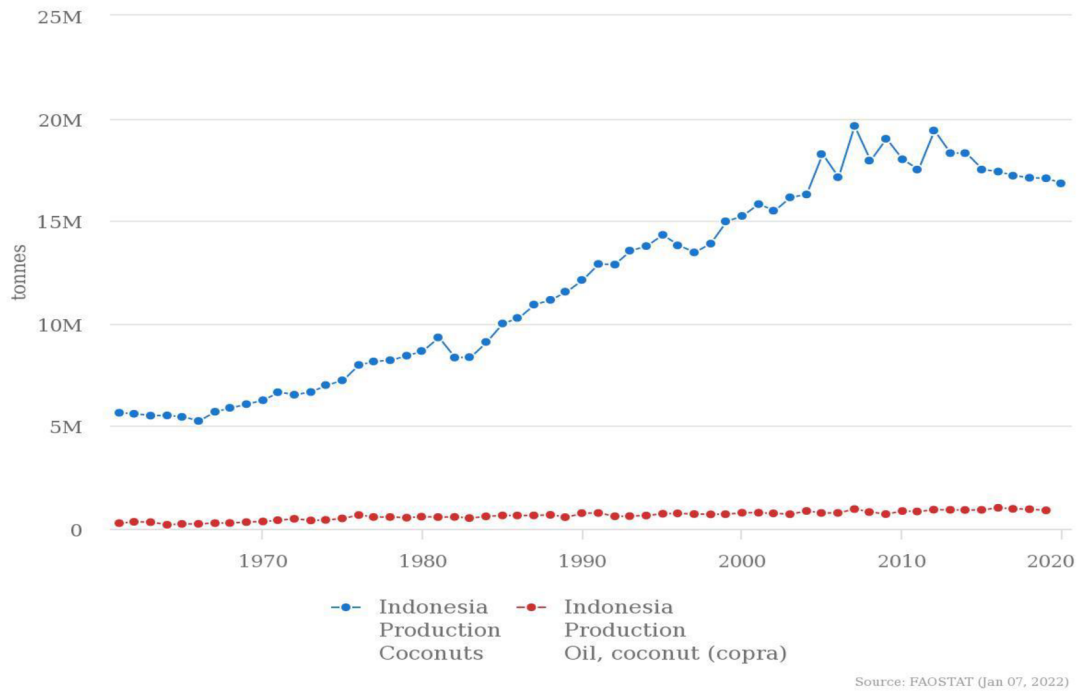

*Figure 38: The production of coconuts in Indonesia from year 1960 to 2020 (FAOSTAT, 2022)*

Crude coconut oil was discovered as one of the vegetable oils containing active ingredients beneficial for human health that dominated the world's food oil based on health issues used as industrial raw material for the food and pharmaceutical industry. Yet, the average national coconut productivity is still lower than the production potency of superior varieties. As the potential for crude coconut oil increases in Europe, Indonesia requires obtaining a fair policy that can benefit both coconut farmers and industries in trade flows to continue increase its export in the world market. The low income of coconut farmers and the coconut industry is likely caused by monoculture planting systems, price fluctuations, the low supply of industrial raw materials, inefficient supply chains, and limited product diversification. By distributing high-quality coconut seedlings and training smallholders in effective agricultural techniques will increase the yield, production, and incomes of farmers in the country (Ministry of Trade Indonesia, 2019).

## 5.2 Estimation of fuel-energy properties and energy potential

Table 9 shows that the properties of dried tested materials are comparable for herbaceous biomass. The three best materials characterised by low ash content with relatively considerable calorific values are coconut shells, maize stover (stalks and cobs), and sugarcane leaves. Coconut shells were surprisingly found to be lowest ash content in this research, 1.18 wt% with 19.2 MJkg<sup>-1</sup> NCV in dry basis. Maize stover (stalks and leaves) has the second lowest ash content, below 3.5 wt% for dry biomass with over 16.20 MJkg<sup>-1</sup> and 16.95 MJkg<sup>-1</sup> in net calorific values respectively. Sugarcane leaves in dry basis were found with 5.96 wt% ash content and 16.36 MJkg<sup>-1</sup> in net calorific values. However, Table 11 represents the estimated energy potential in TJ and TWh calculated based on available secondary data (i.e., data on annual crop production and residues ratio) and the results of the laboratory tests (net calorific value of residual biomass as received and dry basis). The highest energy potential in this research was from the paddy rice straw (473.12 TWh), followed by the empty fruit bunches (261.84 TWh) and the maize stover stalks (164.60 TWh).

Generation of solid waste from palm oil agroindustry production activities located all over Indonesia in about twenty provinces is widely abundant in the form of empty fruit bunch (EFB), palm kernel shell (PKS), palm kernel meal (PKM), and mesocarp fibre (MF). These solid wastes can be utilized as sources of alternative fuel, fertilizer, chemical compounds, and biomaterials to improve the added value of oil palm, minimize the waste, and make oil palm industry more sustainable. Empty fruit bunches are estimated to generate 261.84 TWh equivalent to 942,608 TJ as the second highest annual energy potential, after paddy rice straw. Abu Bakar et. al, 2017 confirmed higher ash content over 6 wt% in EFB (8.29 wt% in this study) contributed to the lower energy content of the residues. The higher ash content might be caused by soil and dirt contamination during handling of the raw materials (Abu Bakar, et al., 2017). On top of that, Onochie Uche et. al., 2015, reported that the moisture content for the palm kernel shell and empty fruit bunch are 6 wt% and 29 wt% respectively with the heating value of 23.60 MJkg<sup>-1</sup> and 17.85 MJkg<sup>-1</sup> in Nigeria.

Sugarcane produces two main types of residues: bagasse and trash (leaves). Sugarcane bagasse represents up to 30% of sugarcane weight and can be burned as raw

materials in energy production after juice extraction process. Sugarcane bagasse was found in this study to be the highest moisture content despite having to be dried before measurement, 40.22 wt% before drying and 9.86 wt% after drying/moisture reduction, affect its calorific value. The study of Anwar (2010), found similar moisture content of fresh wet sugarcane bagasse without drying at 40-50 wt% moisture content, can be improved with moisture reduction of the samples using microwave oven. When there is no specific processing after being acquired directly from the sugar mill, it is fed into the boiler which is affecting its calorific value to be very low. A much better energy source with high calorific value can be accomplished when sugarcane bagasse is dried and transformed into the form of briquettes. The torrefaction of bagasse can also be considered for the improvement of energy production characteristics (Anwar, 2010).

Sugarcane trash left on the field after harvesting estimated to be 14 tonnes per hectare, and it consists of green leaves, dry leaves, sheaths, tops, stalk fractions and physical mineral impurities. Appropriate handling at the beginning is always important and proper care of trash, raking and baling, leading to a better collection of waste with low amounts of soil contaminants. The most promising utilization of sugarcane trash is as a fuel for direct energy production or as a part of feedstock for second-generation biofuels. Based on the practical study of Jutakradsada et. al., 2016, the sugarcane leaves have a higher ash content than maize stover after drying in an oven to below 10 wt% moisture content (6.48 wt% and 1.77 wt% respectively). The heating value analysis in dry basis for sugarcane leaves was 14.47 MJkg<sup>-1</sup>. Therefore, Table 9 and Table 10 show that the results of sugarcane leaves are almost similar to the above-mentioned values of ash content and the characteristic calorific value for sugarcane leaves.

The paddy rice harvesting process generates two main types of the most untapped resource of residues: straw and husks. The residual biomasses are neglected as the high mineral content makes crop residues unsuitable as animal feeds. Yet, its potential as raw material with high lignocellulose content might be suitable for prospective energy sources. Compared to other studies, several authors have reported lower values of moisture content and ash content in both leftover paddy rice residues, rice husks and straw, e.g., Kaniapan et. al. (2022) declared that rice husks and straw have 4.07–9.50 wt% and 8.53–13.06 wt% respectively for moisture content and 16.30–17.36 wt% and 6.90–9.22 wt% for ash content. However, the calorific values are almost similar to this study despite different

compositions or characteristics, 14.61–15.44 MJkg<sup>-1</sup> for rice husks and 12.10–16.60 MJkg<sup>-1</sup> for rice straw. Some studies proved that rice straw and husks are rich in silica (15–20%) which could be utilized as a supplementary cementitious material (Kaniapan, et al., 2022).

The residues produced from post-harvest of rice production in the form of straw are range from 0.41 to 3.96 kg per kg of paddy rice harvested (Benová, et al., 2021). Rice straw as an energy feedstock has an advantage in produced volume, but the customary practice is open, uncontrolled, and indiscriminate burning in the fields as the straw collection is problematic when residues produced in a widely dispersive manner. This biomass material demands densification technology to ease transportation, storage and handling process, leading to denser solids (pellets, briquettes, or sticks) with tremendously higher energy intensity. A case study done by Yerizam et al. (2013) reported a higher moisture content of 11.58 wt% and ash content of 61.96 wt%, with lower calorific values of 6.39 MJkg<sup>-1</sup> for rice straw collected from Muara Telang Village, Banyuasin of South Sumatra than anticipated in this study.

Although rice straw is accessible in huge amount in Indonesia with higher annual energy potential following its production based on this study, the generation of the paddy rice straw biofuels is accompanied by two technical challenges: high energy consumption during the densification process and relatively low calorific value. It is critical to modify the recalcitrant nature of rice straw through enhancing the accessibility of cellulose, removing the lignin-carbohydrates complexes, and decreasing the crystallinity of cellulose with appropriate pre-treatment. In addition, rice husks are typically collected at the factory level, very dry and with very low moisture content, not requiring pre-processing and widely applied as bedding in the animal husbandry industry. Obtaining energy from rice husks in the field of bioenergy, is using thermochemical processes as direct combustion, pyrolysis, gasification, and liquefaction (Kaniapan, et al., 2022).

From the Table 9, it is obvious that the coconut shells can be characterised by far the best fuel-energy properties with low ash content (1.18 wt%) and higher net calorific value (19.20 MJkg<sup>-1</sup>) which are comparable to wood-based fuels in Indonesia such as meranti 19.6 MJkg<sup>-1</sup>, teakwood 20.2 MJkg<sup>-1</sup>, rubberwood 19.4 MJkg<sup>-1</sup> and sengon 17.8 MJkg<sup>-1</sup> based on the study done by Haryanto *et. al.* (2021). On top of that, the NCV of coconut shells from this study are also almost corresponding to the net calorific values of

the coniferous wood (19.20 MJkg<sup>-1</sup>) and broad-leaf wood (19.20 MJkg<sup>-1</sup>) originated in boreal forest located in Canada, Russia, Alaska, and northern Europe according to wood fuels handbook in 2015 written by Dr Nike Krajnc (Krajnc, 2015).

Moreover, the ash content of maize stover (cobs) stated by Wojcieszak *et al.* (2022), along with carbon (C), hydrogen and nitrogen (N) from selected maize cultivars from maize plantations located on a farm in Kiedrowo, Poland, differing in terms of their FAO variety earliness pattern were lower than the values in this study. The NCV determined were surprisingly closer and within this range with the present research, from 16.19 MJkg<sup>-1</sup> to 17.79 MJkg<sup>-1</sup>. The maize production in Indonesia is projected to generate at least 8 million tonnes of maize stover cobs from the average estimated production of maize of 12 million tonnes per year. Yet, the best parts of maize stover with a higher energy potential are the stalks (164.60 TWh) in this study compared to leaves and cobs (21.94 TWh and 29.42 TWh respectively).

A potential renewable bioenergy production is anticipated to continue increasing to approximately 2,200 PJ/year. According to Eduardo Molina-Guerrero, Sanchez, & Vázquez-Núñez (2020), the potential of biomass from agricultural residues for energy and power generation varies based on the year, estimations, techniques, and procedures of the experiments. Nonetheless, majority of the studies were conducted in one specific year for the estimations even though most of the agricultural crop production changes between years. About 70% of the agricultural crops grown in Indonesia depend on the rainy season and is sometimes inadequate for a decent crop production. Furthermore, unavoidable climate events such as drought, floods, and hail, causing adversative effects on the crop growth and conditions. (Amador Honorato-Salazar & Sadhukhan, 2020).

With regards to residues, there is still a significant lack of data and gap of information about the availability and produced quantities of biomass residues. It is also widely recognised that an irregular monthly accessibility of crop residues should be expected by all the farmers as the crop production is heavily depending on the crop's sowing period, which the harvesting time will then be an unpredictable stage along the year (Cheng, 2017). It is highly critical to evaluate the spatial distribution, potential in the postharvest losses. The total estimated amount of these biomass residues properly and assess the seasonal and annual inconsistency of accessible biomass residues for better



decision-making and premeditated preparation to build and develop biomass-based plants in designated areas (Darmawan & Aziz, 2022).

The average estimated annual household electric power consumption in Indonesia is around 4,000 kWh per capita annually, based on IEA Statistic (2022) – 1,084 kWh per capita annually, 73.1 million households, along with the assumption of 3.69 persons per household. According to the results of this study, the total energy potential of paddy rice straw is over 470 TWh, it indicates that the full capacity of residual could hypothetically cover the energy needs of over 110 million households annually. In addition, empty fruit bunches could potentially produce 261.84 TWh if proper procedures applied before and after palm oil processing, enough to supply energy to more than 64 million households per annual in Indonesia. The third highest annual energy potential was discovered in this study to be maize stover (stalks), 164.60 TWh which could possibly provide almost 41 million households with their energy needs annually.

### **5.3 Spatial distribution and seasonal availability of crop residues**

The tropical and wet climate of Indonesia is favourable to grow multiple crops in the same piece of land within the same year. Average temperature is around 26-28<sup>0</sup>C, with total annual rainfall ranging from 1,000 mm to more than 3,000 mm in some areas. In Java islands, the primary food crop is wet rice, and more than two-third of the island's land area is under cultivation. Nationally, Java islands remain the largest maize producing area, contributing 40% of national maize production, followed by Sulawesi (24%), Sumatera (24%), and Nusa Tenggara (10%) (Pramaita, et al., 2020).

Java islands has seen some new area expansion under land controlled by Perhutani (State-Owned land administered by the Ministry of Forestry and Environment), however these added areas have been more than offset by loss of land to development. Rapid infrastructure development on Java islands as well as competition with other food crops which provide higher margins, such as maize and paddy, are the main cause of the island's declining area. Area expansion in southern Sumatera, which accounts for 35% of harvested area, has also slowed due to land conversation to non-agricultural use. As a result, harvested area is estimated to continue declining to 411,000 hectares (Dutu, 2016).

Cropping systems are very diverse and include different ecosystems (upland, lowland, swamps, tidal), and water regimes (rainfed and irrigated). Irrigated systems are commonplace for flooded (lowland) rice systems. Cropping intensity (for annual crops) varies from 1 to 3 crops per year. An example for maize- and rice-based cropping systems in Indonesia is shown for Central Java and Yogyakarta. In this region, the rainy season continues until the end of March. The month of October often clashes with the onset of the rainy season for most areas. In order to manufacture coconut products of substantial value, establishment of seed farms, replanting of senile palms, managing pests and illnesses, synergy among industries, farmers, and governments as well as research on finding more innovative technologies and technology transfer to solve existing problems are crucial to ensure the lifespan of the coconut sector (Ngongo, et al., 2021).

#### **5.4 Socioeconomic characteristics of the respondents**

In this research, there was a total of 46 respondents partaking in this online questionnaire where most of the respondents are male. The total male respondents are 40 that equal to 87.0% while total female respondents are 6 that equal to 13.0%. Almost half (43.5%) of the respondents were from 45-54 years old and 91.3% of them has reported to having completed a high school diploma (Sekolah Menengah Atas). A high number of respondents (47.8%) were from Java Island, whereas the remaining of the respondents were coming from Sumatra Island, Lesser Sunda Island, Sulawesi Island, and other Islands (23.9%, 6.5%, 6.5% and 15.2% respectively). Detailed data on the characteristics of all participants such as gender, age, education, location, household income contribution, and family household size are presented in the following Figure 25 to Figure 29.

Meanwhile, 81% of the respondents were having private lands with 52% of them owning more than 1 hectare of lands following Figure 30. Only 22% of the respondents were carrying out mixed crop-livestock farming whilst 78% cultivating only crop in the lands. In a month, 56% of the respondents made less than 5 million IDR equivalent to 322.06 € from the farming activities whereas 24% respondents were uncertain about their monthly income in overall. In term of agricultural biomass residues for bioenergy production and organic fertilizer application, most of the respondents do not any basic knowledge of bioenergy nor organic fertilizer made from biomass residues as only 37% of them has a general idea of what these are.

In contrast, the types of agricultural residues produced by the respondents in their farming lands are consisting of leaves (26%), branches (19%), stalks (18%), waste from pruning (16%), straw (15%), fruit rinds (3%) and animal waste (3%). Regrettably, the types of the cultivated crops or animals were not noted nor collected in the questionnaire which could really be beneficial for this study. Consequently, 40% of the respondents were using the residual biomass from agricultural activities as organic fertilizers. This is highly due to the fact that returning crop residues to soil can enhance soil quality by improving soil physical properties through decreasing bulk density, increasing total porosity, and increasing soil moisture content.

Furthermore, 37% of the respondents threw the biomass residues away, 12% use them for livestock feeding, 5% considered field-burning, 4% wanted to sell them to bioenergy heating plants if given opportunity near their farms, and 2% decided to compost the residual biomass. On an interesting note, most respondents mentioned about receiving a price expectation 1,000-5,000 IDR per kilogram depending on the types of biomass residues if there will be designated biomass collection points built for this. GOI should implement comprehensive strategies with a strong institution that is fully dedicated to the renewable energy sector entirely focused on biomass residues to promote awareness of bioenergy applications among Indonesians. By doing so, giving boundless support to the producers of such wastes to capture all the potential content of biomass residues, creating adequate processes and encourage the development of renewable energies in Indonesia.

## **5.5 Consumer attitude and factors influencing bioenergy production**

The growing demand for individual and social needs have led to a constant growth of many industries, unswervingly driven by the habits of life and operating processes of companies and with it a growth in energy consumption altogether. Access to energy is essentially vital to almost every major challenge and opportunity that today's world faces including labour issues, social security, food production and distribution, climate change, and/or social awareness. Biomass has shown its excellent potential with nearly zero negative impacts for sustainability in most cases and plays a significant and growing role in the world energy system. It can make substantial contributions to reduce carbon emissions sent to the atmosphere practically in daily life. There is an ample supply of biomass globally that could be greatly used as a replacement for the primary energy

sources presently consumed. However, the exploited biomass residues must be inedible or industrial waste and government policies are required.

Due to high-efficiency energy production, the importance and enhancement of renewable energy utilization remains with a substantial role in the present modern technologies. The increased need for energy efficient products is also aimed at attaining sustainability goals. The utilization of renewable energy delivers many advantageous, including lessening the reliance on imported fossil fuels that are pricy and the reduction of global warming through the reduction in the GHG emission. For instance, the use of fossil fuels contributed to 89% of the global carbon emissions that contribute to global warming in 2018. Renewable energy is every so often referred to as “clean energy”, and it contributes to improved public health. The environmental pollution caused by the consumption of fossil fuels is linked to various health problems and complications, including cancer, breathing problems, and premature deaths from illnesses. On the other hand, renewable energies are harnessed from natural resources, including water, wind, and solar sources that cause limited environmental pollutions.

The consumer’s willingness to consume renewable energy is significant in the transition towards sustainable energy use. The enhanced effects of global warming, climate change, and pollution continue to affect the consumer’s understanding and consideration about the environment and their beliefs towards the consumption of renewable energies. There are various aspects that influence the consumer’s willingness to pay for renewable energies, including the age and education level of the consumers. (Asian Development Bank, 2020) reported that middle-aged individuals and highly educated people in Indonesia are more likely to adopt the use of renewable energies. Apart from the how willing consumers are, household income also affects their ability to adopt renewable energy. Only a small segment of individuals is willing to switch to renewable energy for the consumption of clean energy. An increase in the consumption of renewable energy has the ability of increasing investments in sustainable energy.

Success in renewable energy will require advanced science and technology development and execution; increased public-private partnerships; and more community enhanced consideration of energy, the environment, and the economy. In the future, energy demand will be managed efficiently and will be covered mainly with renewable energy and the rest with fossil fuels.

## **5.6 Limitations of the research**

A few limitations of the research could be emphasised. Firstly, this study was conducted in Czechia due to COVID-19 pandemic, where the possibility of travelling to Indonesia in person to interview local farmers, to assess the applications of potential residual biomass and to do the laboratory work in Indonesia after collection of the material samples was not feasible at all. Another limitation is that the sample size was relatively small, considering that it was collected via online survey focusing on the local farmers in Indonesia which then affecting the generalizability of overall results. It can be meaningful to collect a large and homogeneous sample data over time to provide a better understanding of the research study models across two or more time points which might improve its ability to be generalized correctly. Future studies should also be performed to understand the dynamics involving rural renewable energy users and factors that may affect their adoption of renewable energy.

This is a serious time for moving science and policy forward to expand biomass utilization for biobased products and bioenergy as part of the enhancement of renewable energy and biomass economy. Future research interest would be to determine the energy efficiency, material consumption, production costs, carbon taxes, life cycle assessment (LCA), total capital investment, and providing information on the improvement and operation of bioenergy production. Thus, contemporary biomass options from this study could be utilized as a biomass fuel substitute for a sustainable energy concession, which is a win–win solution for both the environment and global economic growth. All in all, Indonesia is very different from other countries, and therefore the applications of the findings to other regions should be approached with caution.

## 6 CONCLUSION

Indonesia is a developing country that has plentiful biomass energy potential from municipal waste and agricultural waste to meet the Indonesian target to renewable energy share of 23% by 2025 by enhancing of the utilization of these biomass resources. The most important crops in Indonesia are oil palms, paddy rice and sugarcane, with an annual GDP of more than 30 billion EUR. In recent years, the production of these valued crops has been rising, which was unquestionably linked to the increasing quantities of unused residues contributes poorly to the sustainable farming and environment in overall.

In this work, the primary aim was to test, investigate, and identify different parts of residual biomass of important crops in Indonesia (oil palms, paddy rice, maize, sugarcane, and coconuts) based on their compositions and characteristics for potential bioenergy production. By using the latest annual crop production in 2020, the results show that the top three best material samples with the higher annual potential energy yield are paddy rice straw (473.12 TWh), empty fruit bunches (261.84 TWh) and maize stover stalk (164.60 TWh). This amount constitutes a potential bioenergy resource that can be considered as an alternative to fossil fuels. If proper procedures and handling processes applied to these residual matters during and after postharvest, the full capacity of residual combined could theoretically cover the annual energy needs of the whole nation.

Besides, the social factors and attributes relevant to local farmers' acceptance of renewable energy production using agricultural residues were evaluated. Nevertheless, understanding ones' knowledge, behaviors and intentions was challenging task, and explaining human behavior in all its complexity is tremendously difficult. It was found that 74% of the respondents in this study are willing to sell their agricultural residues to biomass heating plants with a price expectation of at least 3,000 IDR (0,19 EUR) per kg. Hence, GOI should implement comprehensive strategies with a strong institution that is fully dedicated to the renewable energy sector wholly focused on biomass residues to promote awareness of bioenergy applications among Indonesians. Extensive research would be to investigate energy conversion efficiency, production costs, and the technical and economic potentials of using biomass for energy purposes.

## 7 REFERENCES

- Abu Bakar, N., Subramaniam, V., Loh, S., Astimar, A., & Lim. (2017). Quality compliance and environmental impact assessment of commercial empty fruit bunch (EFB) pellet fuel in Malaysia. *Journal of Oil Palm Research*, 570-578. doi:<https://doi.org/10.21894/jopr.2017.0002>
- Ahmad, R., Sulaiman, S., Yusup, S., Dol, S., Inayat, M., & Umar, H. (2022). Exploring the potential of coconut shell biomass for charcoal production. *Ain Shams Engineering Journal*, 13(1), 101499. doi:<https://doi.org/10.1016/j.asej.2021.05.013>
- Akhmedov, S., Ivanova, T., Abdulloeva, S., Muntean, A., & Krepl, V. (2019). Contribution to the Energy Situation in Tajikistan by Using Residual Apricot Branches after Pruning as an Alternative Fuel. *Energies*, 12(16), 3169. doi:<https://doi.org/10.3390/en12163169>
- Alhassan, E., Olaoye, J., Olayanju, T., & Okonkwo, C. (2019). An investigation into some crop residues generation from farming activities and inherent energy potentials in Kwara State, Nigeria. *IOP Conference Series Materials Science and Engineering*, 640, 1-11. doi:[10.1088/1757-899X/640/1/012093](https://doi.org/10.1088/1757-899X/640/1/012093)
- Amador Honorato-Salazar, J., & Sadhukhan, J. (2020). Annual biomass variation of agriculture crops and forestry residues, and seasonality of crop residues for energy production in Mexico. *Food and Bioproducts Processing*, 119, 1-19. doi:<https://doi.org/10.1016/j.fbp.2019.10.005>
- Anwar, S. (2010). Determination of moisture content of bagasse of jaggery unit using microwave oven. *Journal of Engineering Science and Technology*, 5(4), 472-478. Retrieved from [https://jestec.taylors.edu.my/Vol%205%20Issue%204%20December%2010/Vol\\_5\\_4\\_472\\_478\\_S.I.%20ANWAR.pdf](https://jestec.taylors.edu.my/Vol%205%20Issue%204%20December%2010/Vol_5_4_472_478_S.I.%20ANWAR.pdf)
- Arun, J., Kannappan Panchamoorthy, G., Sivaramakrishnan, R., Sundar Rajan, P., Malolan, R., & Pugazhendhi, A. (2021). Technical insights into the production of green fuel from CO<sub>2</sub> sequestered algal biomass: A conceptual review on green energy. *Science of The Total Environment*, 755(2), 142636. doi:<https://doi.org/10.1016/j.scitotenv.2020.142636>
- Asakereh, A., Omid, M., Alimardani, R., & Sarmadian, F. (2014). Spatial Analysis the Potential for Energy Generation from Crop Residues in Shodirwan, Iran. *International Journal of u- and e- Service, Science and Technology*, 7(1), 275-284. doi:[10.14257/ijunesst.2014.7.1.25](https://doi.org/10.14257/ijunesst.2014.7.1.25)
- Asian Development Bank. (2020). *Indonesia Energy Sector Assessment, Strategy, and Road Map*. Asian Development Bank. doi:<http://dx.doi.org/10.22617/TCS200429>
- Azwardi, A., Bashir, A., Adam, M., & Marwa, T. (2016). The effect of subsidy policy on food security of rice in Indonesia. *14*, 9009-9022.

- Benová, D., Mareš, K., Hutla, P., Ivanova, T., Banout, J., & Kolaríková, M. (2021). Energy Potential of Agri Residual Biomass in Southeast Asia with the Focus on Vietnam. *Agronomy*, 11(1). doi:<https://doi.org/10.3390/agronomy11010169>
- BP. (2021). *Statistical Review of World Energy: Indonesia's energy market in 2020*. BP plc. Retrieved February 22, 2022, from <https://www.bp.com/en/global/corporate/energy-economics/statistical-review-of-world-energy.html>
- Brown, R. (2021). The Role of Pyrolysis and Gasification in a Carbon Negative Economy. *Processes*, 9(5), 1-17. doi:<https://doi.org/10.3390/pr9050882>
- BSI Standards Publication: London, UK. (2017). BS EN ISO 14780:2017. *Solid Biofuels: Sample Preparation*, 1-32. BSI Standards Publication: London, UK.
- BSI Standards Publication: London, UK. (2017). BS EN ISO 18135:2017. *Solid Biofuels: Sampling*, 1-66. BSI Standards Publication: London, UK.
- Bush, D., Macdonell, P., & Doran, J. (2014). *Identifying mallee eucalypts for biomass production in seasonally dry tropic and sub-tropic climates*. Rural Industries research and Development Corporation. Retrieved May 15, 2021, from [https://www.researchgate.net/publication/264384248\\_Identifying\\_mallee\\_eucalypts\\_for\\_biomass\\_production\\_in\\_seasonally\\_dry\\_tropic\\_and\\_sub-tropic\\_climates](https://www.researchgate.net/publication/264384248_Identifying_mallee_eucalypts_for_biomass_production_in_seasonally_dry_tropic_and_sub-tropic_climates)
- Cheng, J. (2017). *Biomass to renewable energy processes* (2 ed.). CRC Press Taylor & Francis Group. Retrieved November 14, 2020
- Darmawan, A., & Aziz, M. (2022). Chapter 2 - Process and products of biomass conversion technology. *Innovative Energy Conversion from Biomass Waste*, 25-60. doi:<https://doi.org/10.1016/B978-0-323-85477-1.00004-X>
- de Gouvello, C., Dayo, F., & Thioye, M. (2008). *Low-carbon Energy Projects for Development in Sub-Saharan Africa*. The International Bank for Reconstruction and Development / The World Bank. Retrieved June 15, 2021, from [https://www.researchgate.net/publication/242664481\\_Low-carbon\\_Energy\\_Projects\\_for\\_Development\\_in\\_Sub-Saharan\\_Africa](https://www.researchgate.net/publication/242664481_Low-carbon_Energy_Projects_for_Development_in_Sub-Saharan_Africa)
- Dutu, R. (2016). Challenges and policies in Indonesia's energy sector. *Energy Policy*, 98, 513-519. doi:<https://doi.org/10.1016/j.enpol.2016.09.009>
- Eduardo Molina-Guerrero, C., Sanchez, A., & Vázquez-Núñez, E. (2020). Energy potential of agricultural residues generated in Mexico and their use for butanol and electricity production under a biorefinery configuration. *Environmental Science and Pollution Research*, 27(23). doi:10.1007/s11356-020-08430-y
- Elauria, J., Castro, M., Elauria, M., & Bhattacharya, S. (2005). Assessment of sustainable energy potential of non-plantation biomass resources in the Philippines. *Biomass and Bioenergy*, 29(3), 191-198. Retrieved from [https://www.researchgate.net/publication/223062794\\_Assessment\\_of\\_sustainable\\_energy\\_potential\\_of\\_non-plantation\\_biomass\\_resources\\_in\\_the\\_Philippines](https://www.researchgate.net/publication/223062794_Assessment_of_sustainable_energy_potential_of_non-plantation_biomass_resources_in_the_Philippines)



Enerdata. (2020). Indonesia Energy Information. Enerdata. Retrieved January 18, 2022, from <https://www.enerdata.net/estore/energy-market/indonesia/>

Erdiwansyah, M., Hamdani, M., Hisbullah, M., Mamat, R., & Susanto, H. (2020). Potential And Utilization Of Biomass For Heat. *International Journal of Scientific & Technology Research*, 9(10), 331-344. Retrieved October 10, 2021

FAO. (2020). *Agriculture 4.0 – Agricultural robotics and automated equipment for sustainable crop production*. FAO. Retrieved March 27, 2021, from <http://www.fao.org/3/cb2186en/CB2186EN.pdf>

FAO. (2021). *GIEWS Country Brief INDONESIA*. FAO UN. Retrieved 2021, from <https://www.fao.org/giews/countrybrief/country.jsp?code=IDN>

FAO. (2021). *World Food and Agriculture – Statistical Yearbook 2021*. Rome, Italy: FAO. doi: <https://doi.org/10.4060/cb4477en>

FAOSTAT. (2022). *Crops and livestock products*. Food and Agriculture Organization Corporate Statistical Database. Retrieved January 2, 2022, from <https://www.fao.org/faostat/en/?msckid=19e39498bc1411ecb12d686578fd2326#data/QCL>

Ferreira-Leitao, V., Cruz Perrone, C., Rodrigues, J., Machado Franke, A., Macrelli, S., & Zacchi, G. (2010). An approach to the utilisation of CO<sub>2</sub> as impregnating agent in steam pretreatment of sugar cane bagasse and leaves for ethanol production. *Biotechnology for Biofuels*, 3(7), 1-8. doi:10.1186/1754-6834-3-7

Global Agricultural Monitoring. (2022). *Crop monitor early warning*. Global Agricultural Monitoring. Retrieved April 1, 2022, from [https://reliefweb.int/sites/reliefweb.int/files/resources/EarlyWarning\\_CropMonitor\\_202202.pdf](https://reliefweb.int/sites/reliefweb.int/files/resources/EarlyWarning_CropMonitor_202202.pdf)

Go, A., Conag, A., Igdon, R., Toledo, A., & Malila, J. (2019). Potentials of agricultural and agro-industrial crop residues for the displacement of fossil fuels: A Philippine context. *Energy Strategy Reviews*, 23, 100-113. doi:<https://doi.org/10.1016/j.esr.2018.12.010>

Goodman, B. (2020). Utilization of waste straw and husks from rice production: A review. *Journal of Bioresources and Bioproducts*, 5(3), 143-162. doi:<https://doi.org/10.1016/j.jobab.2020.07.001>

Goswami, S., Mondal, R., & Mandi, S. (2020). Crop residue management options in rice-rice system: a review. *Archives of Agronomy and Soil Science*, 66(9), 1218-1234. doi:10.1080/03450340.2019.1661994

Hadley, S., Kline, K., Livengood, S., & Dyke, J. (2002). *Analysis of CHP Potential at Federal Sites*. US Department of Energy (US). doi:<https://doi.org/10.2172/814411>

- Haryanto, A., Hidayat, W., Hasanudin, U., Iryani, D., Kim, S., Lee, S., & Yoo, J. (2021). Valorization of Indonesian Wood Wastes through Pyrolysis: *14*(5), 1-25. doi:<https://doi.org/10.3390/en14051407>
- Heffron, R., Körner, M.-F., Sumarno, T., Wagner, J., Weibelzahl, M., & Fridgen, G. (2021). How different electricity pricing systems affect the energy trilemma: Assessing Indonesia's electricity market transition. *Energy Economics*, 105663. doi:<https://doi.org/10.1016/j.eneco.2021.105663>
- Hill, J., Nelson, E., Tilman, D., Polasky, S., & Tiffany, D. (2006). Environmental, economic, and energetic costs and benefits of biodiesel and ethanol biofuels. *103*(30), 11206-11210. doi:<https://doi.org/10.1073/pnas.0604600103>
- Honua Ola Bioenergy. (2022). Economic Benefits of Biomass Production. Honua Ola Bioenergy. Retrieved August 24, 2021, from <https://honuaolabioenergy.com/economic-benefits-of-biomass-production/>
- Humberto, M., & Barragán-Ocaña, A. (2021). The impact of market factors on the development of eco-friendly energy technologies: the case of bioethanol. *Clean Technologies and Environmental Policy*, 233. doi:<https://doi.org/10.1007/s10098-021-02225-6>
- Hyde, J. (2016). *Introduction to Cogeneration (CHP)*. ENER-G Combined Power. ENER-G. Retrieved January 8, 2022, from [https://www.slideshare.net/JohnHyde4/cpd-sample-slide-deck-rev10-23715?next\\_slideshow=69236646](https://www.slideshare.net/JohnHyde4/cpd-sample-slide-deck-rev10-23715?next_slideshow=69236646)
- International Energy Agency. (2019). *Renewables 2019: Analysis and forecast to 2024*. Renewable Energy Division. International Energy Agency. Retrieved February 3, 2022, from [https://iea.blob.core.windows.net/assets/a846e5cf-ca7d-4a1f-a81b-ba1499f2cc07/Renewables\\_2019.pdf](https://iea.blob.core.windows.net/assets/a846e5cf-ca7d-4a1f-a81b-ba1499f2cc07/Renewables_2019.pdf)
- International Energy Agency. (2020). *Outlook for biogas and biomethane: Prospects for organic growth*. International Energy Agency. Retrieved June 13, 2021, from [https://iea.blob.core.windows.net/assets/03aeb10c-c38c-4d10-bcec-de92e9ab815f/Outlook\\_for\\_biogas\\_and\\_biomethane.pdf](https://iea.blob.core.windows.net/assets/03aeb10c-c38c-4d10-bcec-de92e9ab815f/Outlook_for_biogas_and_biomethane.pdf)
- International Energy Agency. (2021). *Electricity Market Report – July 2021*. International Energy Agency. Retrieved 2022, from <https://iea.blob.core.windows.net/assets/01e1e998-8611-45d7-acab-5564bc22575a/ElectricityMarketReportJuly2021.pdf>
- IRENA. (2017). *Renewable Energy Prospects: Indonesia*. International Renewable Energy Agency. Retrieved April 4, 2021, from [https://www.irena.org/-/media/Files/IRENA/Agency/Publication/2017/Mar/IRENA\\_REmap\\_Indonesia\\_summary\\_2017.pdf?la=en&hash=F530E18BAFC979C8F1A0254AFA77C9EBC9A0EC44](https://www.irena.org/-/media/Files/IRENA/Agency/Publication/2017/Mar/IRENA_REmap_Indonesia_summary_2017.pdf?la=en&hash=F530E18BAFC979C8F1A0254AFA77C9EBC9A0EC44)
- IRENA. (2020). *The Post-COVID Recovery: An agenda for resilience, development and equality*. International Renewable Energy Agency. Retrieved March 3, 2021,

from [https://www.irena.org/-/media/Files/IRENA/Agency/Publication/2020/Jun/IRENA\\_Post-COVID\\_Recovery\\_2020.pdf](https://www.irena.org/-/media/Files/IRENA/Agency/Publication/2020/Jun/IRENA_Post-COVID_Recovery_2020.pdf)

IRENA. (2021). *World Energy Transitions Outlook*. International Renewable Energy Agency. Retrieved December 15, 2021, from <https://irena.org/publications/2021/Jun/World-Energy-Transitions-Outlook/DigitalReport#/>

Johansson, T., McCormick, K., & Neij, L. (2012). The Potentials of Renewable Energy. *Renewable Energy: A Global Review of Technologies, Policies and Markets*. doi:10.4324/9781849772341

Joseph, S., POW, D., Dawson, K., Mitchell, D., Rawal, A., Hook, J., . . . Rust, J. (2015). Feeding Biochar to Cows: An Innovative Solution for Improving Soil Fertility and Farm Productivity. *Pedosphere*, 25(5), 666-679. doi:10.1016/S1002-0160(15)30047-3

Jutakradsada, P., Sriprasoed, R., Patikarnmonthob, N., & Kamwilaisak, K. (2016). Comparison study of sugarcane leaves and corn stover as a. *Energy Procedia*, 100, 26-29. doi:10.1016/j.egypro.2016.10.142

Kaniapan, S., Pasupuleti, J., Patma Nesan, K., Abubackar, H., Umar, H., Oladosu, T., . . . Rene, E. (2022). A Review of the Sustainable Utilization of Rice Residues for Bioenergy Conversion Using Different Valorization, Techniques, Their Challenges, and Techno-Economic Assessment. *International Journal of Environmental Research and Public Health*, 19(6), 1-30. doi:<https://doi.org/10.3390/ijerph19063427>

Kasim, N., Ismail, K., Mohd Ishak, M., & Ahmad, R. (2016). Demineralization of oil palm empty fruit bunch (EFB) intended as a high quality bio-oil feedstock. *The Institution of Engineering and Technology*, 1-7. doi:10.1049/cp.2016.1364

Kitt, F., & Yates, K. (2020). *Indonesia Energy Sector Assessment, Strategy, and Road Map Update*. Asian Development Bank. doi:<https://dx.doi.org/10.22617/TCS200429>

Kookana, R., Drechsel, P., Jamwal, P., & Vanderzalm, J. (2020). Urbanisation and emerging economies: Issues and potential solutions for water and food security. *Science of the Total Environment*, 732, 139057. doi:<https://doi.org/10.1016/j.scitotenv.2020.139057>

KPP energy & waste solutions BV. (2022). Green Gas Plant in Kootstertille. Netherlands: KPP energy & waste solutions BV. Retrieved January 18, 2022, from <https://kpp-ews.com/projects/>

Krajnc, D. (2015). *Wood Fuels Handbook*. The Food and Agriculture Organization of the United Nations. Retrieved from <http://large.stanford.edu/courses/2017/ph240/timcheck1/docs/fao-krajnc-2015.pdf>

- Krarti, M., & Aldubyan, M. (2021). Review analysis of COVID-19 impact on electricity demand for residential buildings. *Renewable and Sustainable Energy Reviews*, 143, 110888. doi:<https://doi.org/10.1016/j.rser.2021.110888>
- Kumar, B., & Verma, P. (2021). Life Cycle Assessment: Blazing a Trail for Bioresources Management. *Energy Conversion and Management X*. doi:[10.1016/j.ecmx.2020.100063](https://doi.org/10.1016/j.ecmx.2020.100063)
- Kummamuru, B., & Rakos, C. (2020, July 28). COVID-19: Impacts and Future Outlook for Bioenergy Sector. World Bioenergy Association. Retrieved February 11, 2021, from <https://www.renewable-ei.org/en/activities/column/REupdate/20200728.php>
- Kumproa, K., & Nuntiya, A. (2015). Production of High Concentration Hydrogen Gas from Sugarcane Bagasse and Sugarcane Leaf by Mechanochemical Treatment Followed with Gasification Method. *Chiang Mai Journal of Science*, 42(2), 443-455. Retrieved from <https://www.thaiscience.info/journals/Article/CMJS/10972682.pdf>
- Langer, J., Quist, J., & Blok, K. (2021). Review of Renewable Energy Potentials in Indonesia and Their Contribution to a 100% Renewable Electricity System. *Energies*, 14(21), 7033. doi:<https://doi.org/10.3390/en14217033>
- Liu, T., Miao, P., YangShi, Tang, K., & Yap, P.-S. (2022). Recent advances, current issues and future prospects of bioenergy production: A review. *Science of The Total Environment*, 810, 152181. doi:<https://doi.org/10.1016/j.scitotenv.2021.152181>
- Lopez Izquierdo, N. (2012). *Biofuels Vital Graphics - Powering Green Economy*. GRID-Arendal (A UNEP Partner). Retrieved January 8, 2022, from <https://www.grida.no/resources/6231>
- Mahidin, Saifullah, Erdiwansyah, Hamdani, Hisbullah, A. Rinaldi, . . . Y. Bindar. (2020). Analysis of power from palm oil solid waste for biomass power plants: A case study in Aceh Province. *Chemosphere*, 253, 126714. doi:<https://doi.org/10.1016/j.chemosphere.2020.126714>
- Ministry of Agriculture Republic of Indonesia. (2019). *Statistik Pertanian 2019 (Agricultural Statistics)*. Center for Agricultural Data and Information System. Retrieved June 25, 2021, from <http://epublikasi.pertanian.go.id/arsip-perstatistikan/713-statistik-pertanian-2019>
- Ministry of Trade Indonesia. (2019). *Export News Indonesia: Indonesia various coconut products*. Ministry of Trade Indonesia. Retrieved March 22, 2021, from [http://djpen.kemendag.go.id/app\\_frontend/admin/docs/publication/1561519014552.pdf](http://djpen.kemendag.go.id/app_frontend/admin/docs/publication/1561519014552.pdf)
- Mohan, D., Pittman Jr, C., & Steele, P. (2006). Pyrolysis of Wood/Biomass for Bio-oil: A Critical Review. *Energy Fuels*, 20(3), 848-889. doi:<https://doi.org/10.1021/ef0502397>

Moni, M., Sulaiman, S., & Baheta, A. (2018). Downdraft Co-gasification of Oil Palm Frond with Other Oil Palm Residues: Effects of Blending Ratio. *MATEC Web of Conferences*, 225(06018), 1-9. doi:<https://doi.org/10.1051/mateccconf/201822506018>

Muscat, A., de Olde, E., de Boer, I., & Ripoll-Bosch, R. (2020). The battle for biomass: A systematic review of food-feed-fuel competition. *Global Food Security*, 25, 100330. doi:<https://doi.org/10.1016/j.gfs.2019.100330>

Nasir, M., Jamhari, & Mulyo, J. (2021). The implication of the Covid-19 pandemic on rice market performance in Java, Indonesia. *IOP Conference Series: Earth and Environmental Science*, 637(010249), 1-8.

National Geographic. (2019, January 30). Renewable energy, explained. National Geographic. Retrieved February 14, 2021, from <https://www.nationalgeographic.com/environment/article/renewable-energy>

Ngongo, V., Irawan, & Haryati, U. (2021). Conservation agriculture in semi-arid area of Indonesia: lesson learnt to increase maize production and farmers' awareness on environmental friendly land management. *IOP Conference Series: Earth and Environmental Science*, 640(012030), 1-10. doi:10.1088/1755-1315/648/1/012030

Nishiguchi, S., & Tabata, T. (2016). Assessment of social, economic, and environmental aspects of woody. *Renewable and Sustainable Energy Reviews*, 57, 1279-1286. doi:<https://doi.org/10.1016/j.rser.2015.12.213>

Norouzi, N. (2021). Post-COVID-19 and globalization of oil and natural gas trade: Challenges, opportunities, lessons, regulations, and strategies. *International Journal of Energy Research*, 1-19. doi:10.1002/er.6762

Obeng, G., Amoah, D., Opoku, R., Charles, K., Eunice Akyereko, A., & Mensah, E. (2020). Coconut Wastes as Bioresource for Sustainable Energy: Quantifying Wastes, Calorific Values and Emissions in Ghana. *Energies*, 13(9), 1-13. doi:<https://doi.org/10.3390/en13092178>

Onochie Uche, P., Itoje Harrison, J., Itabor, N., Akhator, P., & Ojariafe, G. (2015). Calorific Value of Palm Oil Residues for Energy Utilisation. *International Journal of Engineering Innovation & Research*, 4(4). Retrieved from [https://www.researchgate.net/publication/303685597\\_Calorific\\_Value\\_of\\_Palm\\_Oil\\_Residues\\_for\\_Energy\\_Utilisation](https://www.researchgate.net/publication/303685597_Calorific_Value_of_Palm_Oil_Residues_for_Energy_Utilisation)

Osei, I., Addo, A., & Kemausuor, F. (2021). Crop Residues Utilisation for Renewable Energy Generation in Ghana: Review of Feedstocks Assessment Approach, Conversion Technologies and Challenges. *Ghana Journal of Technology*, 5(1), 29-42. Retrieved from [https://www.researchgate.net/publication/351346360\\_Crop\\_Residues\\_Utilisation\\_for\\_Renewable\\_Energy\\_Generation\\_in\\_Ghana\\_Review\\_of\\_Feedstocks\\_Assessment\\_Approach\\_Conversion\\_Technologies\\_and\\_Challenges](https://www.researchgate.net/publication/351346360_Crop_Residues_Utilisation_for_Renewable_Energy_Generation_in_Ghana_Review_of_Feedstocks_Assessment_Approach_Conversion_Technologies_and_Challenges)

- Owsianiak, M., Lindhjem, H., Cornelissen, G., Hale, S., Sørmo, E., & Sparrevik, M. (2021). Environmental and economic impacts of biochar production and agricultural use in six developing and middle-income countries. *Science of The Total Environment*, 755(2), 142455.  
doi:<https://doi.org/10.1016/j.scitotenv.2020.142455>
- Pio, D., Tarelho, L., Nunes, T., Baptista, M., & Matos, M. (2020). Co-combustion of residual forest biomass and sludge in a pilot-scale bubbling fluidized bed. *Journal of Cleaner Production*, 249, 119309.  
doi:<https://doi.org/10.1016/j.jclepro.2019.119309>
- Pradana, Y., Daniyanto, Hartono, M., Prasakti, L., & Budiman, A. (2019). Effect of calcium and magnesium catalyst on pyrolysis kinetic of Indonesian sugarcane bagasse for biofuel production. *Energy Procedia*, 158, 431-439.  
doi:<https://doi.org/10.1016/j.egypro.2019.01.128>
- Pramaita, D., Kumara, I., & Ariastiana, W. (2020). A Review on Biomass For Electricity Generation In Indonesia. *Journal of Electrical, Electronics and Informatics*, 4(1).
- Prananta, W., & Kubiszewski, I. (2021). Assessment of Indonesia's Future Renewable Energy Plan: A Meta-Analysis of Biofuel Energy Return on Investment (EROI). (P. Desrochers, Ed.) *Energies*, 14(10), 2803.  
doi:<https://doi.org/10.3390/en14102803>
- PwC. (2020). *COVID-19: What it means for the power and utilities industry*. PwC. Retrieved 2022, from <https://www.pwc.com/us/en/industries/energy-utilities-mining/library/how-covid-19-is-impacting-power-and-utilities.html>
- Rahim, D., Yan, M., Pohan, R., & Susanto, H. (2019). Upgrading of Palm Oil Empty Fruit Bunches to Solid Fuel Using Torrefaction and Hydrothermal Treatment. *Advances in Engineering Research*, 202, 176-180. Retrieved 3 April, 2021, from <http://creativecommons.org/licenses/by-nc/4.0/>
- Rauoof, A., Wani, A., Mumtaz, S., Ahmad Padder, S., Husain Khan, A., Ibrahim Almohana, A., . . . Rehman Baba, T. (2022). Bioenergy: a foundation to environmental sustainability in a changing global climate scenario. *Journal of King Saud University - Science*, 34(1), 101734.  
doi:<https://doi.org/10.1016/j.jksus.2021.101734>
- Ritchie, H., & Roser, M. (2020, August). CO<sub>2</sub> and Greenhouse Gas Emissions. Our World in Data . Retrieved June 15, 2021, from <https://ourworldindata.org/co2-and-other-greenhouse-gas-emissions>
- Sala Lizarraga, J., & Picallo-Perez, A. (2020). Efficient buildings and the arguments for incorporating exergy. *Exergy Analysis and Thermoconomics of Buildings*, 3-66.  
doi:<https://doi.org/10.1016/B978-0-12-817611-5.00001-1>

- Sami, M., Annamalai, K., & Wooldridge, M. (2001). Co-firing of coal and biomass fuel blends. *Progress in Energy and Combustion Science*, 27, 171-214. doi:10.1016/S0360-1285(00)00020-4
- Saptoadi, H. (2014). The Future of Biomass Energy in Indonesia. Retrieved January 2, 2022, from [https://www.ic.kmitl.ac.th/rcenee2014/images/papers/The\\_Future\\_of\\_Biomass\\_Energy\\_in\\_Indonesia.pdf](https://www.ic.kmitl.ac.th/rcenee2014/images/papers/The_Future_of_Biomass_Energy_in_Indonesia.pdf)
- Seglah, P., Wang, Y., Wang, H., & Bi, Y. (2019). Estimation and Efficient Utilization of Straw Resources in Ghana. *Sustainability*, 11(15), 1-25. doi:10.3390/su11154172
- Sekimoto, K., Koss, A., Gilman, J., Selimovic, V., Coggon, M., Zarzana, K., . . . Lerner, B. (2018). High- and low-temperature pyrolysis profiles describe volatile organic compound emissions from western US wildfire fuels. *Atmospheric Chemistry and Physics*, 1-39. doi:10.5194/acp-2018-52
- Seow, Y., Tan, Y., Mubarak, N., Kansedo, J., Khalid, M., & Ibrahim, M. (2022). A review on biochar production from different biomass wastes by recent carbonization technologies and its sustainable applications. *Journal of Environmental Chemical Engineering*, 10(1), 107017. doi:<https://doi.org/10.1016/j.jece.2021.107017>
- Simangunsong, B., Sitanggang, V., Manurung, E., Rahmadi, A., Moore, G., Aye, L., & Tambunan, A. (2017). Potential forest biomass resource as feedstock for bioenergy and its economic value in Indonesia. *Forest Policy and Economics*, 81, 10-17. doi:<https://doi.org/10.1016/j.forpol.2017.03.022>
- Singh, N., Singhanian, R., Nigam, P., Puri, M., Dong, C.-D., & Patel, A. (2022). Global status of lignocellulosic biorefinery: Challenges and perspectives. *Bioresource Technology*, 344(Part B), 126415. doi:<https://doi.org/10.1016/j.biortech.2021.126415>
- Singh, R., & Setiawan, A. (2013). Biomass energy policies and strategies: Harvesting potential in India and Indonesia. *Renewable and Sustainable Energy Reviews*, 22(C), 332-345. Retrieved April 4, 2021, from <https://ideas.repec.org/a/eee/rensus/v22y2013icp332-345.html>
- Solangi, S., Jakhrani, A., Mukwana, K., Jatoi, A., & Luhur, M. (2018). Investigation of Quantity, Quality and Energy Content of Indigenous Sugarcane Trash in Naoshehro Feroze District, Sindh. *Engineering, Technology & Applied Science Research*, 8(6), 3609-3613.
- Sonar, D. (2021). Chapter 4 - Renewable energy based trigeneration systems - technologies, challenges and opportunities. *Renewable-Energy-Driven Future*, 125-168. doi:<https://doi.org/10.1016/B978-0-12-820539-6.00004-2>
- Sonnino, A. (1994). Agricultural biomass production is an energy option for the future. *Renewable Energy*, 5(5-8), 857-865. doi:[https://doi.org/10.1016/0960-1481\(94\)90105-8](https://doi.org/10.1016/0960-1481(94)90105-8)

- Srivastava, R. (2019). Bio-energy production by contribution of effective and suitable microbial system. *Materials Science for Energy Technologies*, 2(2), 308-318. doi:<https://doi.org/10.1016/j.mset.2018.12.007>
- Stich, J., Ramachandran, S., Hamacher, T., & Stimming, U. (2017). Techno-economic estimation of the power generation potential from biomass residues in Southeast Asia. *Energy*, 135, 930-942. doi:<https://doi.org/10.1016/j.energy.2017.06.162>
- Syahrudin, K., Azrai, M., Nur, A., Abid, M., & Wu, W. (2020). A review of maize production and breeding in Indonesia. *IOP Conference Series: Earth and Environmental Science*, 484(012040). doi:10.1088/1755-1315/484/1/012040
- United Nations. (2022). *World population projected to reach 9.8 billion in 2050, and 11.2 billion in 2100*. United Nations. Retrieved August 20, 2021, from <https://www.un.org/en/desa/world-population-projected-reach-98-billion-2050-and-112-billion-2100>
- van Asselt, H. (2021). Governing fossil fuel production in the age of climate disruption: Towards an international law of 'leaving it in the ground'. *Earth System Governance*, 9, 100118. doi:<https://doi.org/10.1016/j.esg.2021.100118>
- Vaskalis, I., Skoulou, V., Stavropoulos, G., & Zabaniotou, A. (2019). Towards Circular Economy Solutions for The Management of Rice Processing Residues to Bioenergy via Gasification. *Sustainability*, 11(6433), 21-42. doi:10.3390/su11226433
- Waqas, A., & Biswajit, S. (2018). Impact of carbon emissions in a sustainable supply chain management for a second generation biofuel. *Journal of Cleaner Production*, 186, 807-820. doi:<https://doi.org/10.1016/j.jclepro.2018.02.289>
- World Government Summit. (2018). *Agriculture 4.0: The Future of Farming Technology*. World Government Summit in collaboration with Oliver Wyman. Retrieved January 24, 2021, from <https://www.worldgovernmentsummit.org/api/publications/document?id=95df8ac4-e97c-6578-b2f8-ff0000a7ddb6>
- Worldofmaps.net. (2022). *Map of indonesia (provinces)*. (Virgil Interactive GmbH) Retrieved January 15, 2022, from Worldofmaps.net: <https://www.worldofmaps.net/en/asia/map-indonesia/map-provinces-indonesia.htm>
- Wu, Y., Zhao, F., Liu, S., Wang, L., Qiu, L., Alexandrov, G., & Jothiprakash, V. (2018). Bioenergy production and environmental impacts. *Geoscience Letters*, 5(14), 1-9. doi:<https://doi.org/10.1186/s40562-018-0114-y>
- Xie, Y., Wang, L., Li, H., Westholm, L., Carvalho, L., Thorin, E., & Skreiberg, Ø. (2022). A critical review on production, modification and utilization of biochar. *Journal of Analytical and Applied Pyrolysis*, 161, 105405. doi:<https://doi.org/10.1016/j.jaap.2021.105405>



Yana, S., Nizar, M., Irhamni, & Mulyati, D. (2022). Biomass waste as a renewable energy in developing bio-based economies in Indonesia: A review. *Renewable and Sustainable Energy Reviews*, 160(112268).  
doi:<https://doi.org/10.1016/j.rser.2022.112268>

YuanLv, LiangXu, YanqingNiu, Wang, G., YuLei, Huang, H., & Shi'enHui. (2022). Investigation on ash deposition formation during co-firing of coal with wheat straw. *Journal of the Energy Institute*, 100, 148-159.  
doi:<https://doi.org/10.1016/j.joei.2021.11.009>

Żołądek, M., Figaj, R., & Sornek, K. (2021). Energy analysis of a micro-scale biomass cogeneration system. *Energy Conversion and Management*, 236, 114079.  
doi:<https://doi.org/10.1016/j.enconman.2021.114079>

## **List of appendices**

Appendix 1: Online questionnaire Survey

Appendix 2: Raw material samples

Appendix 3: Calculations of total energy yield

Appendix 4: Calculations of sieve analysis test

Appendix 5: Calculations of total moisture content

Appendix 6: Calculations of total ash content

# Appendix 1: Online questionnaire Survey

## *Agriculture Residues in Indonesia*

### *Consent to Participate in a Research Study*

The purpose of this page is to provide you with the information that you need to consider in deciding whether to participate in this research study. The study is being conducted as part of my MSc Agri-food Systems and Rural Development degree at Czech University of Life Sciences in Prague.

### *Project Description*

This study seeks to understand and measure farmers' knowledge about the production and use of biomass to produce energy based on crop residues on local farms and their willingness to use such resource. This study will not cause any physical or mental harm; therefore, you will not experience any distress whilst participating in this study.

### *Confidentiality of the Data*

There is complete anonymity and confidentiality of the data, which will be kept safely electronically. Your details such as email address will be personally unidentifiable and only seen by the researchers when collecting the data, but this information will not be in the report and only the results will be kept after the study is completed.

### *Disclaimer*

You are not obliged to take part in this study and should not feel coerced. You are free to withdraw at any time. Should you choose to withdraw from the study you may do so without disadvantage to yourself and without any obligation to give a reason.

- I have read the information sheet relating to the above research study and have been given a copy to keep. The nature and purposes of the research have been explained to me, and I have had the opportunity to discuss the details and ask questions about this information. I understand what is being proposed and the procedures in which I will be involved have been explained to me.
- I understand that my involvement in this study, and particular data from this research, will remain strictly confidential. Only the researchers involved in the study will have access to identifying data. It has been explained to me what will happen once the research study has been completed.
- I hereby freely and fully consent to participate in the study which has been fully explained to me. Having given this consent I understand that I have the right to

withdraw from the study at any time without disadvantage to myself and without being obliged to give any reason. I also understand that should I withdraw; the researcher reserves the right to use my anonymous data in the write-up of the study and in any further analysis that may be conducted by the researcher.

If you have any questions or concerns about how the study has been conducted, please contact Dr Tatiana Ivanova ([ivanova@ftz.czu.cz](mailto:ivanova@ftz.czu.cz)). If you are happy to continue then please confirm that you consent to taking part in this study by ticking the box and click on "Next".

Thank you for taking part in this survey. Please complete the survey in one session.

This questionnaire is anonymous, and results will be used to Diploma Thesis data collection and writing at Czech University of Life Science, Faculty of Tropical AgriSciences, Kamýcká 129, 165 00 Prague, Czech Republic.

***Agricultural background, perception, and application of biomass residues.***

Q1. What type of agriculture products do you cultivate on your farm?

- Crops only
- Animals only
- Mixed crops and animals

Q2. How much kg of the crop production do you generate on average in a month?

Answer: \_\_\_\_\_

Q3. Please specify the total area (hectare) of the land used for your farming activities.

Answer: \_\_\_\_\_

Q4. Can you specify your current land tenure?

- Private
- Communal
- Open access
- State

Q5. Do you have paid helpers/workers working on the farm?

- Yes
- No

Q5a. If YES, how many do you currently employ?

Answer: \_\_\_\_\_

Q6. Please select the main purposes of the agriculture farming in your farm.

- Subsistence
- Trading
- Livestock Feeds
- Other

Q7. How much revenue (IDR) do you make on average in a month from the productions?

Answer: \_\_\_\_\_

Q8. What type of agriculture residues do you have/or you produce in your farm?

- Stalks
- Branches
- Leaves
- Straw
- Wastes from pruning
- Other

Q9. What do you normally do to with agriculture residues?

- Throwing out
- Livestock feeding
- Using as a fertilizer
- Sell to bioenergy plants
- Other

Q10. Are you aware of bioenergy and biofertilizer productions made from agricultural residues?

- Yes
- No

Q11. If there is a biomass heating plant buying agricultural residues from farms, will you consider selling the remaining residues?

- Yes
- No
- Maybe

Q11a. If YES, what will be the expectation of price per kilogram?

Answer: \_\_\_\_\_

Q12. Have you ever purchased organic (bio)fertilizer made from agricultural residues?

- Yes
- No
- Maybe

Q12a. If YES, please select the benefits of the biofertilizer made from agricultural residues based on your overall experiences.

- Help to make plant's nutrients more available
- More effectiveness compared to traditional fertilizers
- Reduce the need for traditional fertilizers
- Reduce the overall cost of the crop
- Environmentally friendly
- Other

Q12b. If YES, please select the disadvantages of the biofertilizer made from agricultural residues based on your overall experiences.

- Expensive
- Inefficient
- Complicated storage facility
- Short shelf-life
- Other

Q13. In general, do you agree with the positive impacts agricultural residues have on the farmers?

- Yes
- No
- Maybe

### ***Personal Background***

Q14. Are you...?

- Male
- Female

Q15. How old are you?

- 18 – 24
- 25 – 34
- 35 – 44
- 45 – 54
- 55 – 69
- 70+

Q16. What is the highest degree or level of school you have completed?

- Sekolah Dasa
- Sekolah Menengah Pertama (SMP)
- Sekolah Menengah Atas (SMA)
- Diploma Akademi (DIII)
- Sarjana (Universitas)
- None of these

Q17. Where are you from? Please write name of the city and provinces.

Answer: \_\_\_\_\_

Q18. How many members make up your home?

Answer: \_\_\_\_\_

Q19. Do you contribute at least half of the household income for your home?

- Yes
- No

## Appendix 2: Raw material samples





## Appendix 3: Calculations of total energy yield

Type of residual biomass	Crop to Residue ratio (k)	Production 2020 (t/year)	Net Calorific Value (TJt <sup>-1</sup> <sub>ar</sub> )	Annual Energy Potential (TJ <sub>ar</sub> )	Annual Energy Potential (TWh <sub>ar</sub> )	Net Calorific Value (TJt <sup>-1</sup> <sub>d</sub> )	Annual Energy Potential (TJ <sub>d</sub> )	Annual Energy Potential (TWh <sub>d</sub> )
Palm kernel shells (PKS)	0.06	256,528,600	0.0171	263,423	73.17	0.0182	280,277	77.85
Empty fruit bunches (EFB)	0.22	256,528,600	0.0153	865,462	240.41	0.0167	942,608	261.84
Sugarcane bagasse	0.33	28,913,829	0.0066	63,186	17.55	0.0102	96,945	26.93
Sugarcane trash (leaves)	0.23	28,913,829	0.0149	99,227	27.56	0.0164	108,778	30.22
Paddy rice husks	0.21	54,649,202	0.0128	146,767	40.77	0.0144	165,275	45.91
Paddy rice straw	2.32	54,649,202	0.0121	1,534,713	426.31	0.0134	1,703,235	473.12
Coconut shell	0.34	16,824,848	0.0171	97,901	27.19	0.0192	109,832	30.51
Maize stover (leaves)	0.20	23,143,728	0.0155	71,578	19.88	0.0171	78,981	21.94
Maize stover (stalks)	1.58	23,143,728	0.0151	552,617	153.50	0.0162	592,558	164.60
Maize stover (cobs)	0.27	23,143,728	0.0153	95,525	26.53	0.0170	105,919	29.42

1) The total production of five tested crops was extracted from (FAOSTAT, 2022) with the recent data available online.

2) Crop to residue ratio (k) of the tested materials was extracted from the previous publications and the values are calculated as an average value of the biomass residues (if applicable) where:

- k for palm kernel shells (PKS) is **0.06**, the value was obtained from the previous study (Moni, et al., 2018)
- k for empty fruit bunches (EFB) is **0.22**, the value was obtained from the previous study (Moni, et al., 2018)
- k for sugarcane bagasse is **0.33**, the value was obtained from the previous studies (Asakereh, et al., 2014); (Benová, et al., 2021)
- k for sugarcane trash (leaves) is **0.23**, the value was obtained from the previous studies (Asakereh, et al., 2014); (Kumar & Verma, 2021); (Benová, et al., 2021)
- k for paddy rice husks is **0.21**, the value was obtained from the previous studies (Asakereh, et al., 2014); (Osei, et al., 2021); (Benová, et al., 2021)
- k for paddy rice straw is **2.32**, the value was obtained from the previous studies (Asakereh, et al., 2014); (Osei, et al., 2021); (Benová, et al., 2021)
- k for coconut shell is **0.34**, the value was obtained from the previous studies (Elauria, et al., 2005); (de Gouvello, et al., 2008)
- k for maize stover (leaves) is **0.20**, the value was obtained from the previous studies (Seglah, et al., 2019)
- k for maize stover (stalks) is **1.50**, the value was obtained from the previous studies (Osei, et al., 2021); (Seglah, et al., 2019); (Alhassan, et al., 2019)
- k for maize stover (cobs) is **0.27**, the value was obtained from the previous studies (Osei, et al., 2021); (Seglah, et al., 2019); (Alhassan, et al., 2019)

## Appendix 4: Calculations of sieve analysis test

Sieve opening size	Repetition 1 [g]	Repetition 2 [g]	Repetition 3 [g]	Average of repetitions [g]	Standard deviation [g]
<b>Paddy rice husks</b>					
4.50 mm	0.57	0.15	0	0.24	0.30
3.15 mm	0.66	0.09	0.03	0.26	0.35
2.50 mm	20.57	0.55	0.54	7.22	11.56
1.50 mm	26.22	45.56	44.17	38.65	10.79
1.00 mm	1.55	2.33	3.01	2.30	0.73
0.50 mm	1.02	1.49	1.96	1.49	0.47
0.25 mm	0.17	0.3	0.42	0.30	0.13
Collecting pan	0.12	0.32	0.46	0.30	0.17
Total mass of all fractions	50.88	50.79	50.59	50.75	
<b>Palm kernel shells</b>					
10.00 mm	20.66	15.1	18.62	18.13	2.81
8.00 mm	13.21	16.11	11.73	13.68	2.23
6.70 mm	10.44	13.12	13.46	12.34	1.65
5.60 mm	4.4	5.13	4.59	4.71	0.38
4.50 mm	2.61	1.51	2.78	2.30	0.69
3.15 mm	0.49	0.22	0.95	0.55	0.37
1.50 mm	0	0.11	0.23	0.11	0.12
Collecting pan	0	0.01	0.06	0.02	0.03
Total mass of all fractions	51.81	51.31	52.42	51.85	
<b>Maize stover (cobs)</b>					
10.00 mm	42.06	42.49	48.75	44.43	3.74
8.00 mm	8.84	9.21	2.72	6.92	3.64
6.70 mm	0.32	0.33	0.41	0.35	0.05
5.60 mm	0	0.01	0.02	0.01	0.01
4.50 mm	0	0	0	0.00	0.00

3.15 mm	0	0	0	0.00	0.00
1.50 mm	0	0	0	0.00	0.00
Collecting pan	0	0	0	0.00	0.00
Total mass of all fractions	51.22	52.04	51.9	51.72	

## Appendix 5: Calculations of moisture content

Tested sample	Mass of an empty dish and lid [g]	Mass of a dish and lid with a sample before drying [g]	Mass of a dish and lid with a sample before drying [g]	Moisture content as received, wet basis [%]	Average moisture content [%]	Standard deviation of moisture content [%]
<b>Paddy rice straw</b>						
Repetition 1	27.7455	28.7616	28.6954	6.5151	6.53	0.04
Repetition 2	25.0864	26.1623	26.0916	6.5712		
Repetition 3	26.1033	27.4233	27.3376	6.4924		
<b>Sugarcane trash (leaves)</b>						
Repetition 1	24.7734	25.8824	25.7762	9.5762	9.57	0.03
Repetition 2	26.2629	27.2762	27.1789	9.6023		
Repetition 3	25.8074	26.82	26.7234	9.5398		
<b>Maize stover (stalks)</b>						
Repetition 1	27.7455	28.8274	28.7376	8.3002	8.28	0.02
Repetition 2	25.0872	26.4168	26.3067	8.2807		
Repetition 3	26.1035	27.5149	27.3982	8.2684		
<b>Maize stover (leaves)</b>						
Repetition 1	26.2083	27.8068	27.6683	8.6644	8.69	0.03
Repetition 2	26.4201	27.9299	27.799	8.6700		
Repetition 3	26.4125	27.9482	27.8142	8.7257		
<b>Empty fruit bunches (EFB)</b>						
Repetition 1	24.7735	25.7988	25.7087	8.7877	8.74	0.06
Repetition 2	26.2629	27.3113	27.2194	8.7657		
Repetition 3	25.8075	26.8144	26.7271	8.6702		
<b>Maize stover (cobs)</b>						
Repetition 1	27.7454	28.9876	28.8803	8.6379	8.67	0.04

Repetition 2	25.0866	26.2552	26.1533	8.7198		
Repetition 3	26.1034	27.4427	27.3268	8.6538		
<b>Sugarcane bagasse (as received)</b>						
Repetition 1	146.07	207.15	182.7	40.0294	40.22	1.14
Repetition 2	238.2	325.85	291.5	39.1899		
Repetition 3	166.93	222.63	199.55	41.4363		
<b>Palm kernel shells (PKS)</b>						
Repetition 1	27.7448	29.056	28.9433	8.5952	8.52	0.06
Repetition 2	25.0862	26.3827	26.2728	8.4767		
Repetition 3	26.1028	27.4954	27.377	8.5021		
<b>Coconut shells</b>						
Repetition 1	26.2075	27.2245	27.1314	9.1544	9.12	0.05
Repetition 2	26.4195	27.4699	27.3738	9.1489		
Repetition 3	26.4115	27.4547	27.3601	9.0683		
<b>Paddy rice husks</b>						
Repetition 1	24.7725	26.3235	26.18406	8.990329	8.94	0.04
Repetition 2	26.2621	27.7663	27.6323	8.908390		
Repetition 3	25.8064	27.0871	26.9727	8.932615		
<b>Sugarcane bagasse (grinded and dried)</b>						
Repetition 1	25.0861	26.7551	26.5889	9.958059	9.86	0.69
Repetition 2	26.103	27.7539	27.6032	9.128354		
Repetition 3	26.4113	27.7898	27.6451	10.49692		

## Appendix 6: Calculations of ash content

Tested sample	Repetition	Mass of empty dish [g]	Mass of dish with a sample [g]	Mass of dish with ash [g]	Ash content on a dry basis [%]	Average ash content [%]	Standard deviation of ash content [%]
Paddy rice husks	1	26.0829	27.4493	26.3726	21.2017	21.28	0.07
	2	17.7069	19.2257	18.0304	21.2997		
	3	18.0697	19.4723	18.3688	21.3247		
Palm kernel shells (PKS)	1	15.6349	16.704	15.7292	8.8205	8.73	0.09
	2	16.7525	17.7839	16.8425	8.7260		
	3	22.3539	23.6775	22.4684	8.6507		
Empty fruit bunches (EFB)	1	21.8871	22.9259	21.972	8.1729	8.29	0.17
	2	18.2389	19.3523	18.3303	8.2091		
	3	17.1092	18.2824	17.2087	8.4811		
Sugarcane bagasse	1	26.8714	27.9703	27.4667	54.1724	50.00	4.08
	2	24.6008	25.7691	25.1825	49.7903		
	3	18.6627	19.8492	19.2088	46.0261		
Sugarcane trash (leaves)	1	16.7141	17.8193	16.7797	5.9356	5.96	0.03
	2	26.4815	27.4889	26.5414	5.9460		
	3	20.8125	21.944	20.8803	5.9920		
Maize stover stalks	1	20.3095	21.4409	20.3448	3.1200	3.12	0.011
	2	21.5177	22.8264	21.5584	3.1100		
	3	18.4752	19.7575	18.5152	3.1194		
Maize stover leaves	1	25.7968	26.826	25.911	11.0960	11.09	0.04
	2	20.3532	21.402	20.4699	11.1270		
	3	21.6774	22.8702	21.8092	11.0496		

Maize stover cobs	1	16.1491	17.4716	16.197	3.6219	3.59	0.11
	2	25.3812	26.5445	25.424	3.6792		
	3	18.0822	19.3586	18.1265	3.4707		
Coconut shells	1	24.1792	25.4302	24.1938	1.1671	1.18	0.01
	2	20.223	21.3564	20.2364	1.1823		
	3	25.3685	26.7458	25.3851	1.2053		
Paddy rice straw	1	18.4889	19.6045	18.6803	17.15669	18.00	0.91
	2	24.8646	25.9795	25.0640	17.8850		
	3	25.0623	26.2585	25.2892	18.9684		