

**CZECH UNIVERSITY OF LIFE SCIENCES PRAGUE**



Department of Mechanical Engineering

**MASTER'S THESIS**

Michael Onwuka

**Drying kinetics of common agricultural products under different  
processing factors and methods**

**Supervisor**

doc. Ing. Abraham Kabutey, Ph.D.

2024

# **DIPLOMA THESIS ASSIGNMENT**

Michael Onwuka, B.E.

Technology and Environmental Engineering

Thesis title

**Drying kinetics of common agricultural products under different processing factors and methods**

---

## **Objectives of thesis**

- (i) To provide the experimental drying curves of the selected dried agricultural products at different processing factors and methods.
- (ii) To describe mathematically the drying curves of the selected dried agricultural products at different processing factors and methods by applying established theoretical models.
- (iii) To analyze the color parameters of the selected dried and fresh agricultural products at different processing factors and methods.
- (iv) To calculate the drying parameters of the selected dried (fresh) agricultural products at different processing factors and methods.
- (iv) To discuss considerably the advances in drying technologies of agricultural products.

## **Methodology**

Some fresh agricultural products/materials will be picked for the drying experiments. The experiment will be done at the Department of Mechanical Engineering, Faculty of Engineering, Czech University of Life Sciences Prague. The initial moisture content of the chosen agricultural products/materials will be determined using the hot air oven drying procedure. The drying equipment (hot air oven, infrared and/or vacuum) will be used for the drying experiments at different processing factors (drying temperature, drying time and thickness). The color measurements (total color difference, chroma difference, color index, browning index, whiteness index and hue angle) of the dried and fresh agricultural products will be evaluated using the RGB color analyzer (RGB-2000 Voltcraft). Among these drying parameters namely effective moisture diffusivity, activation energy, rehydration capacity, shrinkage, energy consumption, bulk density, projected area and surface area will be calculated. The data will be analyzed statistically using Statistica 13 software by employing appropriate statistical techniques. The recent drying technologies of the agricultural products/materials will be discussed broadly based on scientific literature.

Code for compiling the MSc. Thesis

1. Introduction

1.1 Research problem statement

## 1.2. Objectives

## 2. Literature review

### 2.1 Drying of agricultural crops

#### 2.1.1 Types of dryers

#### 2.1.2 Drying techniques

#### 2.1.3 Advances in drying technologies

### 2.2 Drying mechanisms

#### 2.2.1 Equilibrium moisture content

#### 2.2.2 Drying and dehydration

#### 2.2.3 Food drying curves

### 2.3 Thin layer mathematical models

#### 2.3.1 Statistical measures

#### 2.3.2 Factors affecting drying kinetics

### 2.4 Quality changes during drying

#### 2.4.1 Physical and chemical qualities

#### 2.4.2 Microbial and nutritional qualities

## 3. Results and Discussion

## 4. Conclusions

## 5. Recommendations

## 6. References

## 7. Appendixes

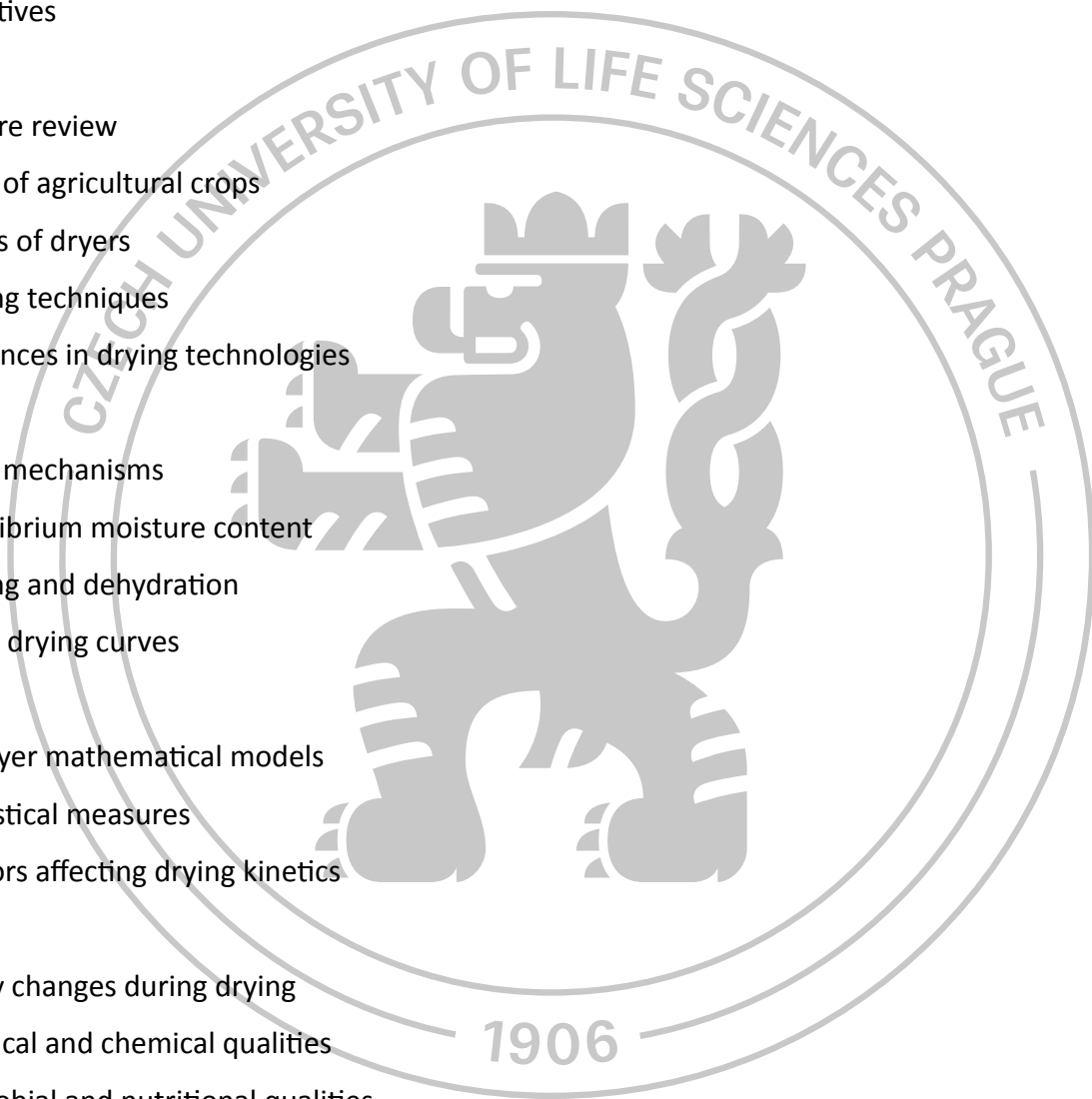

## The proposed extent of the thesis

60–70 pages

## Keywords

Agricultural products, drying behaviour, colour measurements, shrinkage, specific energy consumption

---

## Recommended information sources

- Aidani, E., Hadadkhodaparast, M. and Kashaninejad, M. 2016. Experimental and modeling investigation of mass transfer during combined infrared-vacuum drying of Hayward kiwifruits. *Food Science and Nutrition*, 597-601.
- Gunathilake, D.M.C.C., Senanayaka, D.P., Adiletta, G. and Senadeera, W. Chapter 14: Drying of agricultural crops – In: Chen, G. (Ed.). (2018). *Advances in Agricultural Machinery and Technologies* (1st ed.). CRC Press. <https://doi.org/10.1201/9781351132398>.
- Inyang, U.E., Oboh, I.O. and Etuk, B.R. 2018. Kinetic models for drying techniques – *Food Materials. Advances in Chemical Engineering and Science*, 8:27-48.
- Jafari, F., Movagharnejad, K. and Sadeghi, E. 2020. Infrared drying effects on the quality of eggplant slices and process optimization using response surface methodology. *Food Chemistry*, 333, 127423.
- Khaled et al. 2020. Application of computational intelligence in describing the drying kinetics of persimmon fruit (*Diospyros kaki*) during vacuum and hot air drying process. *Processes*, 5(544):1-21.
- Lamidi, R.O., Jiang, L., Pathare, P.B., Wang, Y.D. and Roskilly, A.P. 2019. Recent advances in sustainable drying of agricultural produce: A review. *Applied Energy*, 233-234, 367-385.
- Majdi, H., Esfahani, J.A. and Mohebbi, M. 2019. Optimization of convective drying by response surface methodology. *Computers and Electronics in Agriculture*, 156:574-584.
- Onwude, D.I., Hashim, N. and Chen, G. 2019. Recent advances of novel thermal combined hot air drying of agricultural crops. *Trends in Food Science and Technology*, 57:132-145.
- Selvi et al. 2020. The effect of infrared drying on color, projected area, drying time and total phenolic content of rose (*Rosa rugosa*) petals. *Plants*, 9(236):1-13.
- Sivakumar, R., Saravanan, R., Perumal, A.E. and Iniyar, S. 2016. Fluidized bed drying of some agro products – A review. *Renewable and Sustainable Energy Review*, 61:280-301.
- 

## Expected date of thesis defence

2023/2024 SS – FE

## The Diploma Thesis Supervisor

doc. Ing. Abraham Kabutey, Ph.D.

## Supervising department

Department of Mechanical Engineering

Electronic approval: 22. 2. 2023

**doc. Ing. Pavel Neuberger, Ph.D.**

Head of department

Electronic approval: 29. 3. 2023

**doc. Ing. Jiří Mašek, Ph.D.**

Dean

Prague on 31. 03. 2024



## **ABSTRACT**

This study investigated the effect of infrared (IR) drying on sliced Golden Delicious apples, focusing on drying kinetics, color changes, and quality parameters. The influence of drying temperature (40, 50, and 60°C) was evaluated. The research shows that drying rates increased significantly with higher temperatures, reflecting faster moisture removal. Three mathematical models were meticulously chosen and our result identified the logarithmic and Weibull distribution models as the most effective in representing the drying curves within the investigated temperature range. The Weibull model exhibited the most consistent performance across temperatures. The goodness-of-fit of each model was assessed using 4 major statistical measures: root mean square error (RMSE), chi-square ( $\chi^2$ ), coefficient of determination ( $R^2$ ), and modelling efficiency (EF). Lower RMSE and  $\chi^2$  values alongside higher  $R^2$  and EF values indicate a better fit between the model and the experimental data. Higher drying temperatures within the studied range (40-60°C) correlated with better color preservation, potentially due to advantages of IR drying technology. The ironing index (BI) and total color change ( $\Delta E$ ) increased with temperature, while the whiteness index (WI) decreased. Rehydration capacity, a measure of water uptake ability peaked at a moderate temperature (50°C), suggesting its importance for process optimization. Shrinkage values showed complex interactions with the drying temperature.

**KEYWORDS:** Golden Delicious apple, drying behaviour, colour measurements, shrinkage, mathematical models

## **DECLARATION**

I hereby declare that this Master's Thesis '**Drying kinetics of common agricultural products under different processing factors and methods**' is the result of my own work and that it has not been submitted to this University or any institution for a degree. All references, however, used in the development of the work have been dully acknowledged in the text and provided in the list of references.

In Prague

Date: 31.03.2024

Michael Onwuka

## **ACKNOWLEDGEMENT**

I extend my heartfelt gratitude to my supervisor, doc. Ing. Abraham Kabutey, Ph.D., for his invaluable insights and expert guidance, which significantly contributed to the successful completion of this thesis. I am also grateful to my family and friends for their support.



# TABLE OF CONTENTS

<b>DECLARATION .....</b>	<b>II</b>
<b>ACKNOWLEDGEMENT .....</b>	<b>III</b>
<b>TABLE OF CONTENTS .....</b>	<b>IV</b>
<b>LIST OF TABLES.....</b>	<b>VI</b>
<b>LIST OF FIGURES.....</b>	<b>VII</b>
<b>LIST OF APPENDIXES.....</b>	<b>VIII</b>
<b>1 INTRODUCTION .....</b>	<b>1</b>
1.1 RESEARCH PROBLEM STATEMENT.....	2
1.2 OBJECTIVES.....	3
<b>2 LITERATURE REVIEW .....</b>	<b>4</b>
2.1 DRYING OF AGRICULTURAL CROPS .....	4
2.1.1 <i>Types of dryers</i> .....	5
2.1.2 <i>Drying techniques</i> .....	9
2.1.3 <i>Advances in drying technologies</i> .....	10
2.2 DRYING MECHANISMS .....	11
2.2.1 <i>Phases of drying</i> .....	11
2.2.2 <i>Drying time</i> .....	12
2.2.3 <i>Equilibrium moisture content</i> .....	12
2.2.4 <i>Drying and dehydration</i> .....	13
2.2.5 <i>Food drying curves</i> .....	15
2.3 THIN LAYER MATHEMATICAL MODELS .....	18
2.3.1 <i>Statistical measures</i> .....	18
2.3.2 <i>Factors affecting drying kinetics</i> .....	19
2.4 QUALITY CHANGES DURING DRYING.....	19
2.4.1 <i>Physical qualities</i> .....	20
2.4.2 <i>Chemical qualities</i> .....	21
2.4.3 <i>Microbial and nutritional qualities</i> .....	23
<b>3 MATERIALS AND METHODS.....</b>	<b>25</b>
3.1 EXPERIMENTS UNDER UNIAXIAL COMPRESSION LOADING.....	25
3.2 SAMPLES .....	25
3.3 INFRARED DRYING.....	25
3.4 COLOUR MEASUREMENT.....	26
3.5 CALCULATED DRYING PARAMETERS.....	27
3.5.1 <i>Dry basis moisture content</i> .....	27
3.5.2 <i>Moisture ratio</i> .....	27

3.5.3	<i>Rehydration capacity</i> .....	28
3.5.4	<i>Shrinkage</i> .....	29
3.5.5	<i>Bulk density</i> .....	30
3.5.6	<i>Surface area</i> .....	30
3.5.7	<i>Graphs illustrations</i> .....	30
<b>4</b>	<b>RESULTS AND DISUSSION</b> .....	<b>31</b>
4.1	EXPERIMENTAL DRYING CURVES .....	31
4.2	EVALUATION OF COLOR PARAMETERS .....	34
4.3	CALCULATED PARAMETERS UNDER INFRARED DRYING .....	34
4.4	MODELS FITTING OF EXPERIMENTAL DRYING CURVES .....	35
<b>5</b>	<b>CONCLUSIONS</b> .....	<b>40</b>
<b>6</b>	<b>RECOMMENDATIONS</b> .....	<b>41</b>
<b>7</b>	<b>REFERENCES</b> .....	<b>42</b>
<b>8</b>	<b>APPENDIXES</b> .....	<b>51</b>

## LIST OF TABLES

Table 1. Overall mean measurements of sample dimensions. ....	33
Table 2. Overall mean measurements of initial mass, dried mass and rehydrated sample, <i>RC</i> (g). ....	34
Table 3. Calculated parameters of dried apple sample under infrared. ....	35
Table 4. Fitting models coefficients at 40,50 and 60 °C. ....	38
Table 5. Fitting models coefficients and their statistical parameters at 40,50 and 60 °C. ....	39

## LIST OF FIGURES

Figure 1. Diagram of direct and indirect heated air.....	6
Figure 2. Diagram of a typical Batch and Continuous Dryer. ....	7
Figure 3. Diagram of a Continuous Belt Dryer.....	7
Figure 4. Diagram of tunnel dryer. ....	8
Figure 5. A typical drying curve of agricultural products showing constant rate and falling rate periods (Onwude et al. 2016; Carrin and Crapiste, 2008). ....	17
Figure 6 Whole Golden delicious apples and a sliced sample in a petri dish. ....	25
Figure 7. Freshly sliced (a) and dried sample (b) representing all samples dried at each drying teperature. ....	26
Figure 8. Samples of sliced apple dried at drying teperatures of (a) 40 (b) 50 and (c) 60 °C. ....	26
Figure 9. Procedure for calculating the rehydration capacity of the dried apple sliced sample. ....	28
Figure 10. Rehydrated samples at drying temperatures (a) 40 °C (b) 50 °C and (c) 60 °C. ....	29
Figure 11. Drying curves of sliced apple samples at 40 °C for 12 hrs.....	31
Figure 12. Drying curves of sliced apple samples at 50 °C for 12 hrs.....	32
Figure 13. Drying curves of sliced apple samples at 50 °C for 12 hrs.....	32
Figure 14. Drying curves of sliced apple samples averaged at 40°C, 50°C and 60°C for 12 hrs. ....	33
Figure 15. Measured and fitted curves based on Weibull, logarithmic and page models at 40 °C. ....	36
Figure 16. Measured and fitted curves based on Weibull, logarithmic and page models at 50 °C. ....	37
Figure 17. Measured and fitted curves based on Weibull, logarithmic and page models at 60 °C. ....	37

## LIST OF APPENDIXES

Appendix 1. Experimental data of sliced golden delicious apple at 40 °C for samples 1 to 3. ....	51
Appendix 2. Experimental data of sliced golden delicious apple at 40 °C for samples 4 to 6. ....	52
Appendix 3. Experimental data of sliced golden delicious apple at 50 °C for samples 1 to 3. ....	52
Appendix 4. Experimental data of sliced golden delicious apple at 50 °C for samples 4 to 6. ....	53
Appendix 5. Experimental data of sliced golden delicious apple at 60 °C for samples 1 to 3. ....	53
Appendix 6. Experimental data of sliced golden delicious apple at 60 °C for samples 4 to 6. ....	54
Appendix 7. RGB data of sliced golden delicious apple for fresh samples before drying at 40 °C. ....	55
Appendix 8. RGB data of sliced golden delicious apple at 40 °C for dried samples. ....	56
Appendix 9. RGB data of sliced golden delicious apple for fresh samples before drying at 50 °C. ....	57
Appendix 10. RGB data of sliced golden delicious apple at 50 °C for dried samples. ....	58
Appendix 11. RGB data of sliced golden delicious apple for fresh samples before drying at 60 °C. ....	59
Appendix 12. RGB data of sliced golden delicious apple at 60 °C for dried samples. ....	60
Appendix 13. Lab data of sliced golden delicious apple at 40 °C. ....	61
Appendix 14. Lab data of sliced golden delicious apple at 50 °C. ....	62
Appendix 15. Lab data of sliced golden delicious apple at 60 °C. ....	63
Appendix 16. MA 50/1.R moisture analyzer showing some drying functions. ....	64
Appendix 17. MA 50/1.R moisture analyzer showing the main parts for the drying operation (Selvi et al., 2020). ....	64
Appendix 18. The drying process of a sliced apple using the moisture analyzer Radwag MA 50/1.R ....	65
Appendix 19. The drying process of a sliced apple using the moisture analyzer Radwag MA 50/1.R (a)Sample is added to the weighing pan and weighed. (b) Drying process begins. ....	66

# 1 INTRODUCTION

Drying is a popular post-harvest method used for preserving agricultural products. Drying is essential in prolonging Agricultural products' shelf life, preventing spoilage, and reducing their weight (moisture content) for more convenient transportation (Rodríguez et al. 2013). When agricultural products are dried, the heat and mass transfer involved in the process deactivate enzymatic reactions and reduce the moisture content within the product. Additionally, it helps in extracting bioactive compounds from the food products (Rasaq et al. 2019).

There are various methods of drying these agricultural products. They are hot-air drying (HAD), vacuum drying (VD), freeze-drying (FD), infrared Drying (IRD), and microwave drying (MWD). Among these methods, HAD and VD are the most widely and commercially used methods due to their ability to produce uniformly dried, non-toxic, and naturally safe products. In the case of VD, it employs low temperatures in the absence of oxygen to preserve foods sensitive to heat and prone to oxidation (Hashim et al. 2014). Failure to use the appropriate operating parameters for hot-air drying (HAD) and vacuum drying (VD) can negatively alter the essential qualities, such as the nutrition and phytochemical properties of the dried product. Therefore, it's crucial to determine the best operating parameters and drying conditions using appropriate drying models to achieve optimal results while keeping product costs low and yields high (Behroozi and Ghassemian 2013).

The primary factors influencing customers to either buy or not are the quality of color and the smell of the dried product (Díaz-Maroto et al. 2002). Dried products are primarily evaluated using the product's appearance and internal structural components. Factors like color, appearance, flavor, texture, active ingredients, and more are heavily considered to assess the overall drying quality (Lahsasni et al. 2004). These factors are linked to the drying operating parameters, drying methods, and the initial preparation of the product before drying.

It is also important to note that before large-scale production on a dryer is done, tests are first conducted with small amounts of the product slices in a compact cabinet dryer. This approach helps to reduce costs and save a significant amount of money (Baysal et al. 2002).

Large dryers will require larger quantities of raw materials, and they may generate a large amount of waste while determining the optimal drying conditions. When conducting drying experiments, one gains more insights from "failures" than "successes." While carrying out the drying experiment, there may be a need to test down to the limit of the drying process. This will help to identify the conditions where the final dried product does not meet the standard finished product specifications. Knowing the drying conditions that lead to test failures (poor product specifications) can establish the right operating strategy for the dryer which helps to avoid these undesirable conditions and stays within a safe range of drying conditions (Sammy and Digvir 2022).

### **1.1 Research problem statement**

Traditional drying methods require excessive time and energy, which often produce wrong finished products. It has been observed that the structural properties of such a finished product may be damaged, including discoloration, excessive shrinkage, nutrient loss, and severe deterioration of nutritional properties (Behroozi and Ghassemian 2013). Before modern drying techniques were invented, drying was a simple and natural process powered by the sun. Let's consider a fresh agricultural product like pepper, which is dried in the sun in most West African regions under ambient conditions, crushed into powdered form, and used as a meal spice. But the most common drawback of sun drying is when drying the fresh pepper; it is exposed to insect infestation, enzymatic reactions, loss in quality, microorganism growth, and mycotoxin production. The drawback has limited the efficiency and reliability of Sun drying, which is a traditional drying method (Onwude 2018). Also, sun drying does not dry products at regulated operating parameters, which might produce the wrong end-product after drying (uneven drying of moisture content). In other words, it restricts the optimization and production of desirable outcomes since the drying occurred without any conditions.

## 1.2 Objectives

The objectives of the Master's Thesis are to:

- i. provide the experimental drying curves of the selected dried agricultural products at different processing factors and methods.
- ii. describe mathematically the drying curves of the selected dried agricultural products at different processing factors and methods by applying established theoretical models.
- iii. analyze the color parameters of the selected dried and fresh agricultural products at different processing factors and methods.
- iv. calculate the drying parameters of the selected dried (fresh) agricultural products at different processing factors and methods.
- v. discuss considerably the advances in drying technologies of agricultural products.



## **2 LITERATURE REVIEW**

### **2.1 Drying of agricultural crops**

Crops are referred to as any cultivated plant grown for purposes like food, animal feed, medicine, bio-fuel, or other uses. Agricultural crops are generally categorized into grains, legumes, fruits, and vegetables (Balasubramanian 2014).

The history of farming can be traced back thousands of years, but today it has evolved under the influence of various cultures, climates, and technologies. In the modern world, industrial agriculture is characterized by large-scale monoculture farming, which has become the dominant method of farming (Tilman et al. 2002).

Durable crops, like grains and legumes, have lower water content, allowing them to be stored for extended periods compared to perishable crops like fruits and vegetables. However, durable crops must be adequately dried to a low moisture content to achieve a safe, long-term storage condition before they are sent to market. Hence, drying is a crucial operation in enhancing and prolonging the shelf life of durable crops (Donald 2007).

Also, some crops have specific growing seasons and are typically abundant during those times. However, when these crops are in peak season, their prices drop significantly, leading to substantial losses for farmers. The surplus supply in the market often results in spoilage, further compounding the issue. To address this problem, there's a need to preserve and store these crops for extended periods so they can be used during off-seasons. This preservation and storage approach can reduce significant crop wastage and ensure their availability during off-seasons at profitable prices (Sharshir et al. 2023).

Furthermore, since crops are only available during specific seasons, there have been efforts to extend their freshness by removing moisture through dehydration. Several drying methods have been employed for this purpose. However, these methods require advanced equipment and specialized training, making it challenging to adopt them at the field or rural level (Valarmathi et al. 2020). Various drying methods are available, with the most prevalent one involving the use of air. In this method, heat is applied through convection, removing moisture from the product as humidity. Instances where this method is practiced include sun drying.

Alternatively, there are methods like vacuum drying and fluidized bed drying. In these processes, agricultural products are placed in vacuum conditions, and water is utilized to evaporate and fluidize the product. These methods are more suitable for crops sensitive to heat. Drum drying represents another method of drying. It uses a heated surface to supply heat to the product. Spray drying involves atomizing liquid particles to extract moisture, as seen in the production of milk powders. Unique drying and curing methods are applied to preserve large onion crops. This emphasizes the importance of drying as a key preservation method for food crops. In this chapter, we delve into the theories behind drying agricultural crops, various methods, different types of dryers, and recent advancements in drying technology. (Sivakumar et al. 2016).

## **2.1.1 Types of dryers**

### **2.1.1.1 Direct and indirect heating**

One significant factor that sets various dryer types apart is how they deliver heat to the material that is being dried. Even freeze dryers incorporate some degree of heat in combination with a vacuum at low temperatures to remove moisture from products. The most common practice to provide heat to substances in a dryer is known as "direct" heating. In this method, the drying medium consists of preheated air that enters the drying chamber. This air can be heated by passing it through a burner, such as a natural gas burner, or by directing it to overheated metal surfaces where it absorbs heat and then conveys it to the material being dried (Bahaa 2023). However, there are situations where using hot air for direct drying may not be suitable. In such cases, the product can come into contact with heated surfaces, allowing heat to be transferred to the material in this form. The use of hot surfaces from the outside of a rotating metal drum while having stream circulating through them to dry the product is one method of indirect heating (Chanda et al. 2023).

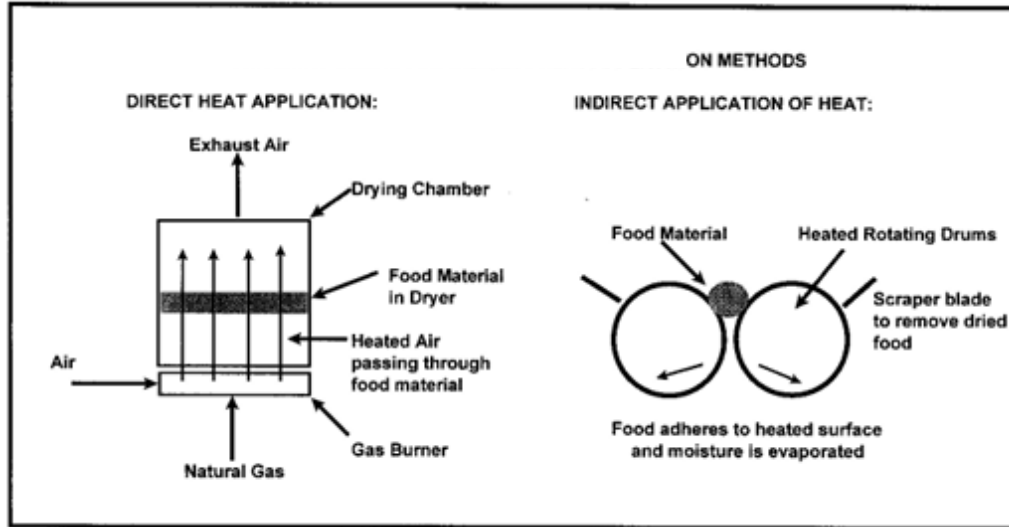

Figure 1. Diagram of direct and indirect heated air.

Source: (Donald and Mercer 2007).

### 2.1.1.2 Batch and continuous dryers

Another way to categorize dryers is by how they are used. Considering the scenario where materials are dried in small quantities, like in a laboratory or even in the kitchen. The materials are placed inside a bench-top dryer or in a kitchen oven. This initiates the drying process to eliminate moisture, and eventually, once the material reaches the desired level of dryness, the dried materials are retrieved. This approach is known as "batch drying" and the dryers used to carry out this process are called "batch dryers" because they are suitable for handling small batches of material (Becker and Isaacson 2009).

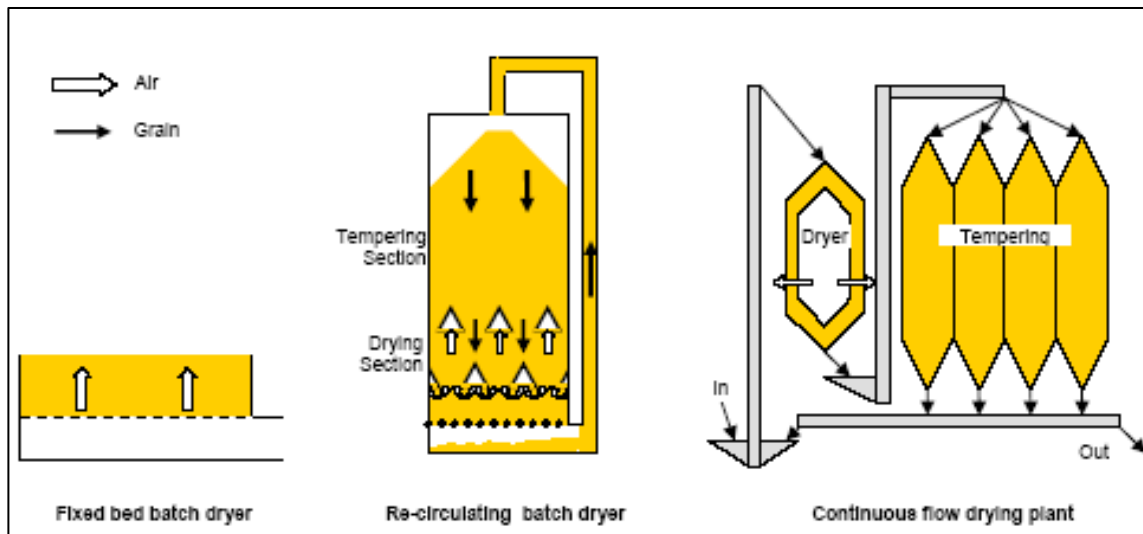

Figure 2. Diagram of a typical Batch and Continuous Dryer.

**Source:** (Donald and Mercer 2007).

However, for larger commercial scale drying, using a batch dryer is not practical or efficient. It is unrealistic, labor-intensive, and very slow to continually load small amount of material and remove them once they are dried. In cases where there is a large volume/quantity of material to dry over a long period, "continuous dryers" are best suitable for such process.

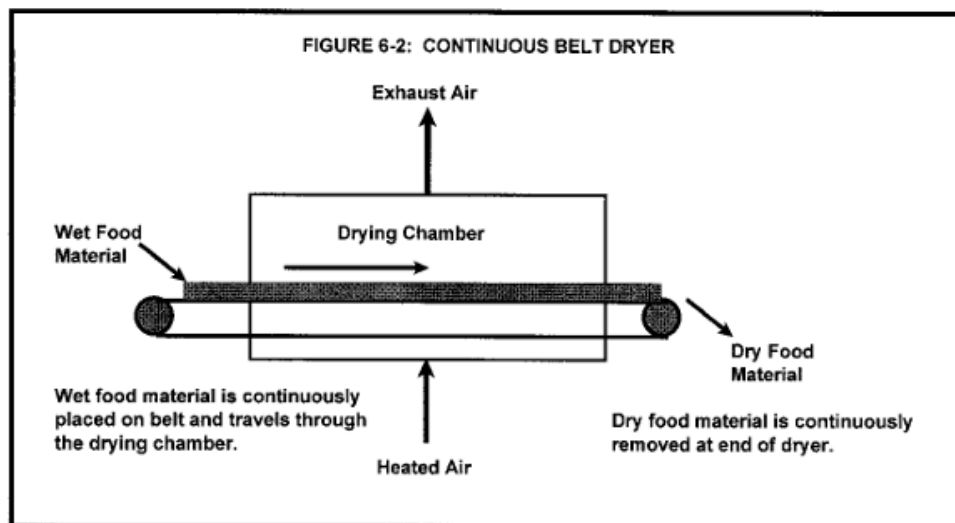

Figure 3. Diagram of a Continuous Belt Dryer

**Source:** (Donald and Mercer 2007).

### 2.1.1.3 Tunnel dryers

Tunnel dryers have some similarities to continuous through-circulation dryers. However, a notable difference lies in how the material is handled. Instead of being positioned on a moving conveyor belt, the material prepared for drying is arranged on trays or racks. These trays or racks are then placed on carts, which are pulled through the long tunnels where heated air is directed over the material (Gunathilake 2018). Figure 5 gives a clearer illustration of the dryer. The carts are often loaded manually into the trays or racks and are pushed at the "front end" of the dryer. They can either be attached to a chain that pulls them through the tunnel or an assembled object can grip the cartwheels to accomplish the same. The duration of the materials in the dryer is determined by the speed at which the carts are pulled inside the dryer. Once the carts get to the end of the dryer, they are pushed out and unloaded. The empty carts are subsequently returned to the beginning of the dryer to be reloaded and sent through again with a fresh batch of product containing high moisture content. It's worth noting that these dryers demand significantly more labor to operate compared to continuous belt dryers. Hence, they are no longer frequently in use again (Chou 1997).

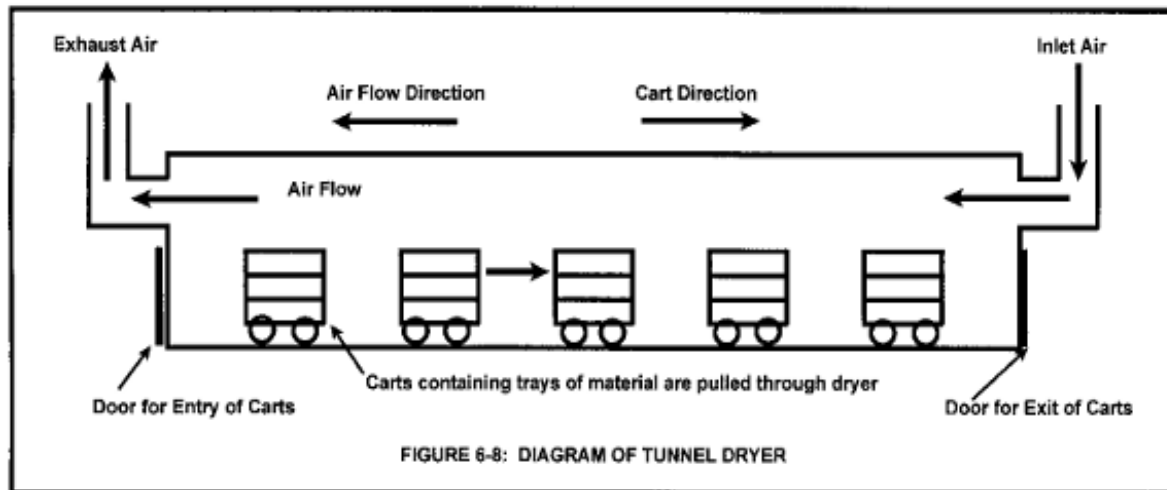

Figure 4. Diagram of tunnel dryer.  
**Source:** (Donald and Mercer 2007).

## **2.1.2 Drying techniques**

### **2.1.2.1 Hot air drying**

As of today, hot air drying is a commonly used drying technique. It is both simple and efficient for robust industrial food products. This drying is a very cost-effective solution for manufacturers who engage more in food drying. Nevertheless, this method has the potential to thoroughly dry up the outer layer of the product, resulting in cracks or uneven drying of the product. Its rate of drying heavily depends on the specific product and the permitted drying temperature (Sun et al. 2023).

### **2.1.2.2 Sun drying**

Sun drying, an age-old and cost-effective method, involves air drying through sunlight exposure. It is well used for the traditional drying of fruits and vegetables such as pepper, tomatoes, apricots, plantain peels, etc. in both undeveloped and some developed regions. One disadvantage of using this technique is that it does not retain all the product properties and vitamins. Other disadvantages include the need for significant drying space and time and limited process control for drying (Akpinar 2004).

### **2.1.2.3 Infrared drying**

Infrared drying operates by removing water or solvent through high-temperature exposure. It can be combined with hot air and is suitable for concentrated surface drying which includes roasting of the outer layer of the product. However, this method is less suitable for products that should not be subjected to elevated temperatures (Hany 2023).

### **2.1.2.4 Freeze drying**

The freeze-drying technique relies on transforming water into vapor at low temperature and pressure condition. This is a recommended technique of drying food that are sensitive to heat because it does not alter their physical properties like taste, color, texture, etc. However, freeze-drying is a time-consuming and costly process. Its operation are mostly in batch processes and under low pressure conditions (Krokida et al 1998).

### **2.1.2.5 Fluidized bed drying**

Fluidized bed drying involves mixing air and solid particles in a way that makes the result of the mixture to be a fluid-like property. It's primarily employed for drying seeds or granular materials, and the process of drying is swift (Hirakh 2020). However, the disadvantage of using the technique is that the high temperature used in this process can denature or damage the finished product.

### **2.1.2.6 Dielectric drying**

Microwave and radio frequency drying depends on dielectric technology. This technology functions by heating the entire product evenly at once. This technique is best suited for drying heat-sensitive products in the food, industrial, and medical sectors since it guarantees the preservation of organoleptic properties of the food (Wankhade et al. 2016).

## **2.1.3 Advances in drying technologies**

### **Radio frequency (RF) drying**

Radio frequency (RF) treatment, an emerging thermal technology in food processing, has been extensively investigated for various applications. Alongside optimizing RF processing conditions, the performance of equipment plays a crucial role in determining process efficiency and product quality. Despite the utilization of different types and scales of RF equipment, the increasing demand has underscored certain limitations in RF applications, particularly regarding heating uniformity, operational convenience, treatment efficiency, and product quality. Consequently, there is a growing focus on custom-designed or combined equipment tailored to specific application scenarios (Jilong Gao et al. 2003)

### **Solar photovoltaic (PV) drying**

Solar photovoltaic (PV) power, derived directly from solar energy, is recognized as a significant clean energy alternative to mitigate environmental issues associated with conventional energy sources. Hybrid dryers combining solar PV and solar thermal collectors with heat and electricity storage have been developed to address the limitations of standalone solar systems. However, despite the benefits, the costs of photovoltaic systems remain high compared to traditional power systems (Ceylan et al. 2016).

## **Air jet impingement drying**

The combination of air jet impingement with radio frequency and hot air drying has been explored as an effective drying method. In this technique, high-velocity air impacts the product surface, removing thermal boundary layers of moisture and enhancing heat transfer rates (Peng et al. 2019).

## **Electrohydrodynamic (EHD) drying**

Electrohydrodynamic (EHD) drying involves the removal of water from wet material exposed to a strong electric field, facilitated by the aerodynamic action of a corona wind. This wind originates from an electrically conducting pin or fine horizontal wire, with ions leaving the pin/wire and impinging on the material's surface (Kudra and Martynenko 2019).

## **2.2 Drying mechanisms**

When we blow hot air over moist food, it transfers heat to the surface, making the water evaporate due to its latent heat of vaporization. These water vapors then spread through a thin layer of air and are carried away by the moving air. This creates an environment where the lower water vapor pressure gradient is established from the moist interior part of the food to the dry air. This gradient or difference in vapor pressure is responsible for the driving force of water removal from the food (Jajas and Singh 2011). Some of the factors that enhances drying of food are: the movement of liquid due to capillary action, the spread of liquids due to differences in concentration, the diffusion of liquids, which get absorbed into layers on the surfaces of solid parts of the food and the diffusion of water vapor in air spaces within the food due to differences in vapor pressure (Vapor pressure gradient) (Srikiatden and Roberts 2007).

### **2.2.1 Phases of drying**

In hygroscopic food materials, there are several stages of falling drying rates. In the initial phase, moisture evaporates from a specific layer inside the food, and water diffuses through the dry food material to reach the drying air. This phase ends when the plane of evaporation reaches the center of the food and the water's partial pressure drops below the saturated water



vapor pressure. The second phase of falling drying rates occurs when the partial pressure of water drops below the saturated vapor pressure, and the drying process shifts to desorption. Among these phases in the food drying process, the falling rate period is the longest. Finally, the Equilibrium Moisture Content (EMC) is attained when dry regions are developed on the food's surface, reducing the area exposed to dry air, which, in turn, leads to a decrease in evaporation (Fellows 2009; Singh Et al. 2023).

### **2.2.2 Drying time**

Drying time represents the overall duration needed to remove moisture from food. Drying time and wet bulb depression are inversely related while drying rate correlates directly with the wet bulb depression (Silva et al 2018).

### **2.2.3 Equilibrium moisture content**

Water activity in food material refers to the humidity level (RH) of the air above the product when it is sealed in a container after equilibrium is attained. In this equilibrium state, the chemical potential energy of water in vapor form and within the product are the same. Since there's no net difference in this chemical potential energy it means that there is no net movement of water molecules at equilibrium. The water sorption isotherms of foods illustrate the moisture content (also known as equilibrium moisture content; EMC) and  $a_w$  or RH are related at equilibrium under constant temperatures and pressures. The EMC of food materials is vital in drying due to it correlates with storage, handling, and processing (Osman and Bozoglu 2016).

The condition of water within foods directly affects their quality and stability by influencing chemical and enzymatic reactions. Consequently, controlling and determining EMC and  $a_w$  have been a focal point of extensive research. Water activity is very important especially when studying processes like freezing, freeze concentration, evaporation, reverse osmosis, and drying. It also plays a role in determining the mechanical properties such as elasticity and rheological behavior in the product. Generally, when the temperature rises, the EMC decreases at a specific relative humidity. At these elevated temperatures, the energy levels

increase and less energy is needed for vaporization or desorption processes (Jixian and Gauri 2010).

#### **2.2.4 Drying and dehydration**

Drying is among the oldest techniques humans have used to preserve food. Humans have been preserving meat, fish, and various plants by letting them dry under the sun or in the naturally arid air of deserts and mountains since ancient times. This practice continues to play a crucial role in the day-to-day life of many rural communities (Bolin et al. 1982).

Dehydration is most times referred as one of the oldest unit operations applied in the food processing industry. Food dehydration is a process by which the moisture content of food is reduced to low levels, thus extending its shelf life. This is achieved by introducing one or more forms of energy into the food. However, it's important to note that this process doesn't involve removing moisture from food through mechanical pressing or concentrating liquid foods. Normally, heat is the primary energy source added to the food by passing hot air through the food. This heat does not only increase the temperature of the food material during drying but also reduces its moisture content (Araya-Farias 2009). During the food dehydration process, there is a simultaneous heat and mass transfer within the food and also within the medium used to convey energy to the food. In instances where alternative energy sources other than hot air are used to dehydrate food, it is required that another type of gas is used to transport the moisture away from the food

The four major technological aims of food dehydration are as follows:

- a. Preservation achieved by lowering water activity levels.
- b. Decrease in both weight and volume.
- c. The conversion of food into a more convenient form for storage, package, transportation, and use. For instance, converting liquids like milk, eggs, fruit and vegetable juices, or coffee extract into a dry powder that can be reconverted to its original state by adding water (instant products).
- d. Introducing a specific desirable feature to a food product, like adding different flavors, crispiness, chewiness, etc., to create a new type of food (e.g., the process of transforming grapes into raisins).

Regardless of the research and use of drying in industrial operations, our understanding of the complex processes involved in dehydration and rehydration remains incomprehensible. When it comes to food materials, modeling the drying processes is quite challenging. Presently, there has not been a fully satisfying model for predicting drying kinetics specifically when applicable to food. Nonetheless, in our exploration of drying, we will frequently refer to theoretical models. It's crucial to bear in mind that these models are merely close approximations so relying solely on them for process development or equipment design is not advisable. In "food drying engineering," practical knowledge and hands-on experimentation still play the leading role.

The major engineering and technological challenges in food dehydration are as follows:

- a. The kinetics of drying: Drying tends to be a relatively gradual process, except for some methods like spray drying. So, understanding the factors that control the rate at which drying occurs is crucial for designing and operating a drying system to produce optimal results.
- b. Product quality: The elimination of water is not the only result of most drying processes. During drying, various significant changes can take place in taste, flavor, appearance, texture, structure, and nutritional value, affecting the overall quality of the product. The magnitude of these changes largely depends on the conditions of the process or the operating conditions.
- c. Energy consumption: In most common drying processes, large amounts of energy are consumed. This is often at a relatively low level of efficiency. From an energy point of view, drying is an inefficient method of removing water when compared to other processes like evaporation or membrane separation.

The process of drying eliminates water through two simultaneous processes. Firstly, heat is applied to make the water in the food evaporate. Secondly, the formed water vapors are transported from the food. In essence, drying involves both the transfer of heat and the movement of moisture content (heat and mass transfer), occurring simultaneously. As we will explore in the following sections, the part of the drying process that limits the rate of drying (rate-limit mechanism) can either be surface evaporation or the internal movement of water, depending on the conditions involved (Donald 1943).

Depending on the mode of heat and mass transfer, industrial drying processes can be grouped into two categories: convective drying and conductive (boiling) drying. Based on the mode of heat and mass transfer, industrial drying can be categorized into two sections: Conductive (boiling) drying and convective drying.

*Conductive (boiling) drying:*

In this process, there is a contact between the moist food and a hot surface (or, in specific cases, with superheated steam). This high temperature causes the water in the food to essentially "boil off." In essence, boiling drying is very much like evaporating food material until it is completely dry. Vacuum drying, drum drying, and drying using superheated steam are all examples of this drying method (Zeki 2018).

*Convective drying:*

In this process, we use hot and dry air to provide the heat needed to evaporate the water vapor and transport the water vapor away from the food's surface. When the hot air is passed over the food, they mainly exchange heat and mass through convection, although conduction and radiation may take part to some extent during the process. This common method of drying is also called air drying, and it occurs relatively slowly. It is estimated that it takes two-thirds of the drying time just to eliminate one-third of the moisture content (Lima 2014).

### **2.2.5 Food drying curves**

Drying curves are graphs used for understanding the "kinetics" of how a specific product dry under particular conditions. This means that the drying curve (Figure 5) is a graph that helps to know how the material is being dried over time or how much moisture is contented in the product material over time under specific operating conditions. It can also be described as the rate of water removal over time. A highly moist product will dry differently than a material with less water. Drying curves interpret the transformation process during drying, leading to necessary adjustments to the drying process accordingly (Onwude et al. 2006).

Attached above is the drying curve, illustrating the drying rate and temperature changes over time. This curve is instrumental in identifying the dominant mechanism of product drying. Initially, the air temperature surpasses that of the product, leading to an increase in drying rate between points A and B as the product temperature rises until it reaches equilibrium (illustrated by the transition from line B to C). Agricultural and biological products typically

undergo a sequence of stages during drying under consistent conditions. This includes an initial phase of constant rate (B to C), akin to the evaporation of pure water, followed by one or more stages of decreasing rate where moisture movement is influenced by a combination of external and internal resistances or by either external or internal resistance to heat and mass transfer. The falling rate periods, during which fruit and vegetable drying primarily occurs, are mainly governed by diffusion mechanisms. Drying halts upon reaching a steady state equilibrium. During the constant rate phase, the product's physical structure, particularly its surface, is notably impacted, largely influenced by capillary and gravitational forces. Various factors such as temperature, airflow velocity, and relative humidity further affect the product during this phase. The first falling rate period (C to D) initiates when the product's surface appears dry, and its moisture content declines to a critical level. Subsequently, as drying progresses, a transition occurs from the first falling rate period to the second falling rate period (D to E).

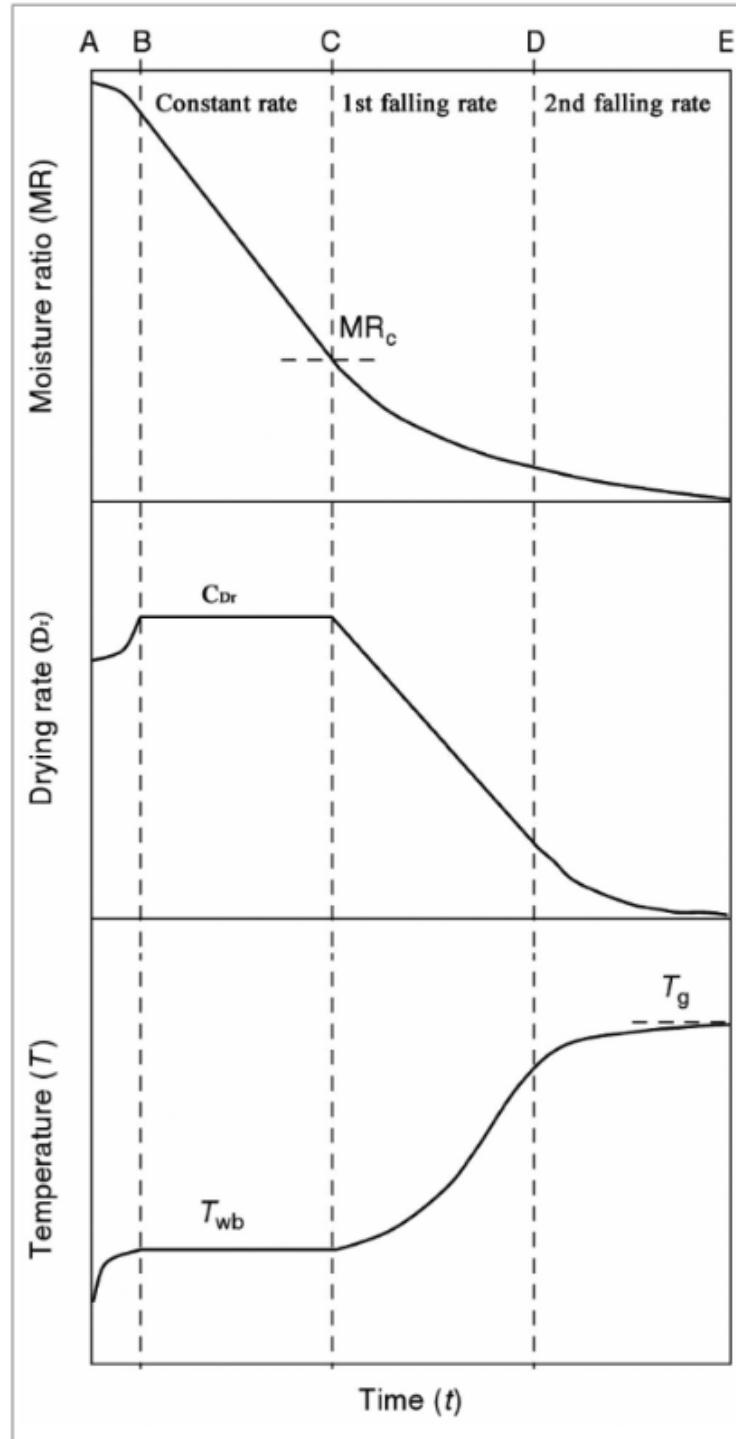

Figure 5. A typical drying curve of agricultural products showing constant rate and falling rate periods (Onwude et al. 2016; Carrin and Crapiste, 2008).

## 2.3 Thin layer mathematical models

### Thin-layer mathematical models

More than 20 thin-layer mathematical models have been reported in the literature for describing thin-layer agricultural products such as apples (Westerman et al. 1973; Yaldiz et al. 2001 and Babalis et al. 2006; Meisami-asl et al. 2009; Aidani et al. 2016; Onwude et al. 2016c; Karaaslan et al. 2017 and Bagheri and Dinani, 2019). Three models namely page (equation 1), logarithmic (equation 2) and Weibull distribution (equation 3) have been mentioned as suitable for describing the drying curves of thin-layer apples (Dajbych et al. 2023).

$$MR = \exp(-k \cdot t^n) \quad (1)$$

$$MR = a \cdot \exp(-k \cdot t) + c \quad (2)$$

$$MR = a - b \cdot \exp(-(k \cdot t^n)) \quad (3)$$

#### 2.3.1 Statistical measures

To obtain the quality of the fitted models, statistical measures namely root mean square error (RMSE) (equation 4), Reduced chi-square ( $\chi^2$ ) (equation 5), coefficient of determination ( $R^2$ ) (equation 6), and modelling efficiency (EF) (equation 7) were used. If the coefficient of determination is chosen as the statistical measure, the model with the highest  $R^2$  is used to determine the drying curves. According to Inyang (2018), a model is seen as the best fitness if it has a high  $R^2$  and obtain a low scores in other measures such as  $\chi^2$  and RMSE (Pandey and Diwan 2015).

$$RMSE = \left[ \sum_{i=1}^N \frac{1}{N} (MR_{exp,i} - MR_{pre,i}) \right]^{\frac{1}{2}} \quad (4)$$

$$\chi^2 = \sum_{i=1}^n \frac{(MR_{exp,i} - MR_{pre,i})^2}{N - n} \quad (5)$$

$$R^2 = 1 - \frac{(MR_{exp,ii} - MR_{pre,i})^2}{(MR_{exp,i} - MR_{pre,i})^2} \quad (6)$$

$$EF = \frac{\sum_{i=1}^n (MR_{i,exp} - MR_{i,expmean})^2 - \sum_{i=1}^n (MR_{i,pre} - MR_{i,exp})^2}{\sum_{i=1}^n (MR_{i,exp} - MR_{i,expmean})^2} \quad (7)$$

### 2.3.2 Factors affecting drying kinetics

Drying kinetics is an important piece in drying process, knowing the the principles and factors that influences the drying rate of agricultural products is essential for improving drying processes (John 2014).

#### 2.3.2.1 Temperature

Studies according to Raka and Tiri (2017), demonstrated that increasing the drying temperature accelerates the drying process. According to the study, when temperature is increased, the ability of air to abosorb moisture content from the agricultural product increases until equilibrium is attained.

#### 2.3.2.2 Mechanical properties

Wang and Zhang (2023) emphasized the significance of material properties, such as moisture diffusivity and porosity, in determining drying kinetics. These properties affect the rate at which moisture is transported within the material and subsequently removed during drying.

#### 2.3.2.3 Airflow and humidity

Malisa et al.(2020) emphasized through their research that the overall moisture transfer coefficient or in this case drying, increases with air velocity and relative humidity. Relative humidity influences drying directly by increasingthe force if moisture rate transfer.

### 2.4 Quality changes during drying

Drying brings about significant changes in the final quality of the product. Oftentimes, it serves as one of the final operations in food processing. Also, it significantly influences the overall quality of the end product (Mohammad 2021). Drying is used across different food



products, ranging from grains to fully processed goods, covering both raw materials and byproducts. Several processes are employed in drying, and these processes greatly depend on the type and quantity of the products to be dried, the amount of water to be removed, and the desired quality or function of the final dried product. Furthermore, drying leads to structures usually differing from those of the initial humid product. This can be a disadvantage, but it can also offer a new benefit, as for example the porous structure of mashed potato flakes, crispy granulates for breakfast cereals, instant dry milk powder, and so on. The drying process can, therefore, also be considered as a controlled texturing operation, a source of innovative and easy-to-use products (Babu 2018).

When we talk about the quality of foods, the primary concern is safety, followed by sensory and nutritional properties. However, there is often a distinct relation between the intensity of processing and its impact on safety including sensory or nutritional quality. Intensive processing tends to lead to greater nutritional loss and lower overall quality of the food. Still, it does enhance food safety. To achieve the optimal drying time and the appropriate level of intensity of processing, there must be a right balance in design to obtain the specific (desired) food properties. Regulating the properties mentioned depends on all the chemical and physical occurrences that take place during drying and storage period. Though these properties are quite complex in a way Mohammad (2020).

#### **2.4.1 Physical qualities**

##### **2.4.1.1 Cellular structure**

Natural solid foods with cellular structures contain moisture both between and within the cells. While the tissue is alive, moisture is retained within the cells by the cell walls and membranes, maintaining turgor pressure instead of experiencing leakage but once an animal or plant is dead, the cells become more permeable to moisture. An experiment was carried out on dead tissues and discovered that when blanched or cooked, the tissue will further increase its permeability to moisture. In general, cooked vegetables, meat, or fish will dry faster than when they are fresh, as long as the cooking process does not lead to excessive toughening or shrinking (Vindya 2024).

#### **2.4.1.2 Shrinkage**

Dead cells exhibit various degrees of elasticity. This phenomenon allows them to stretch or shrink under stress. If the stress becomes too intense, the cells may surpass their elastic limit. This may prevent them from regaining their original shape once the stress is removed (Sjöholm 1995).

#### **2.4.1.3 Case hardening**

Case hardening is a phenomenon that is common in food rich in concentrated dissolved sugars and other solutes during dehydration. It occurs in different ways as water is eliminated from the food materials during the drying. In cellular foods, some water is removed through molecular diffusion across cell walls and membranes. When the membranes are selective over solutes during the molecular diffusion, some dissolved solutes are left behind. Moreover, water within the food can be vaporized after being subjected to heat and it escapes with solute-free vapor molecules (Tushar 2015).

#### **2.4.1.4 Porosity**

Almost all drying methods are aimed at developing a more porous structure in food products to improve mass transfer (movement of water and other solutes) and accelerate the drying rate. Regardless, there are instances where an increase in mass transfer rate achieved through methods like puffing or structural opening, does not lead to a higher drying rate. The porous sponge-like structures serve as efficient insulators that impede the heat transfer rate into the food. The overall outcome depends on whether the alteration in porosity has a more significant effect on the heat and mass transfer rate in the particular food material and drying design (Karathanos 1996).

#### **2.4.2 Chemical qualities**

During the dehydration of food, many chemical alterations occur in addition to the previously discussed physical changes. These transformations play a crucial role in determining the ultimate (final) quality of both the dried products and their rehydrated forms to influence the color, taste, texture, viscosity, reconstitution speed, nutritional content, and storage durability of the final food product (Katharina 2012). While these changes often vary depending on the specific food product, there are a few fundamental types of changes that are observed in

almost all foods subjected to drying. The magnitude of these changes is contingent on the food's composition and the intensity of the drying process (Fabiano 2008).

#### **2.4.2.1 Browning reactions**

This reaction can occur through enzymatic oxidations of polyphenols and susceptible compounds if the oxidizing enzymes remain active. The drying temperatures of food are usually insufficient to deactivate these enzymes during the drying process due to the cooling effect of water evaporation. Consequently, it is a common practice to pasteurize or blanch foods using heat or chemicals before initiating the drying process (Bing 2023). Another prevalent form of browning is the caramelization of sugars and scorching of other materials, especially when heat is excessive. In the area of food dehydration, non-enzymatic or Maillard browning products play a significant role. This process involves a reaction between aldehydes and amino groups found in sugars and proteins. Similar to other chemical reactions, Maillard browning is accelerated by high temperatures and elevated concentrations of reactive groups in the presence of some water. Throughout the dehydration process, these reactive groups become concentrated. Maillard browning typically occurs most rapidly when the moisture content decreases to the range of about 20-15%. As the moisture content continues to decrease, the rate of Maillard browning diminishes. In dried products with less than 2% moisture, there is further change in color but this type of browning is hardly noticeable, even during extended storage. Due to this effect, drying systems or heating schedules are generally designed to expedite dehydration through the 20-15% moisture range, this will help minimize the time for Maillard browning under these optimal conditions (Staurt 1955)

#### **2.4.2.2 Loss in the ease of rehydration**

Dehydration commonly leads to a reduction in the rehydration efficiency. Physical shrinkage and distortion of cells and capillaries play a role in this, but a substantial portion arises from chemical or physicochemical alterations at the colloidal level (Bixiang 2023). The effects of heat and salt concentration during water removal can cause partial denaturation of proteins, hindering their ability to fully reabsorb and bind water. Additionally, modifications in starches and gums may make them become less hydrophilic in nature. Furthermore, sugars and salts percolate out of the damaged cells into the water used for reconstituting dehydrated foods, thus causing a loss of turgor. These chemical transformations, among others, contribute to the

reduction of water reabsorption by dried products, making it lower than the original water content and influencing the overall texture of the product (Zeki 2018).

### **2.4.3 Microbial and nutritional qualities**

Packaging, processing, and handling of food can all have an impact on its nutritional quality. Dried materials can lose their nutritional value in addition to undergoing physical and chemical changes. The main reasons for vitamin and other material losses during processing are their water solubility, enzymatic oxidation, sensitivity to heat and oxygen, and metal ion catalysis. Furthermore, during drying and storage, sugar-amine interactions, or the Maillard reaction, may take place, which could result in nutritional loss. Pretreatments, careful method selection, novel and inventive drying techniques, and drying environment optimization can all help to minimize food losses Guinière (2018).

#### **2.4.3.1.1 Changes in protein**

Drying process affects the biological value of proteins. Extended exposure to elevated temperatures may reduce the protein's nutritional value. Protein that has been treated at low temperatures may be more soluble than the original material (Reshan et al. 2022).

#### **2.4.3.1.2 Changes in lipid**

A key issue with dried foods is rancidity. At higher temperatures than at low dehydration temperatures, fat is more easily oxidized. Antioxidant-based fat protection is a useful control. Rancidity, the emergence of bad flavors, and the loss of pigments and fat-soluble vitamins in many foods-especially dry foods-are all caused by lipid oxidation (Velasco and others, 2010).

#### **2.4.3.1.3 Changes in vitamins**

Different vitamins are soluble in different amounts of water, and some become supersaturated and precipitate out of solution as drying goes on, such as riboflavin. Thus, losses are minimal. Others, like ascorbic acid, are soluble up until the food's moisture content drops extremely low and react with solutes more quickly as drying progresses. Additionally vulnerable to oxidation and heat is vitamin C. To prevent significant losses during storage, short drying times, low temperatures, and low moisture and oxygen levels are required. Although other water-soluble vitamins are more resistant to heat and oxidation, thiamin is nevertheless heat sensitive.

Moreover, losses during drying seldom surpass 5–10% (blanching losses excluded) (Khraisheh 2004).

### 3 MATERIALS AND METHODS

#### 3.1 Experiments under uniaxial compression loading

The experiments were conducted at the laboratory of the Department of Mechanical Engineering, Faculty of Engineering, Czech University of Life Sciences Prague.

#### 3.2 Samples

Samples of Golden delicious apples (Figure 6) were procured from Kaufland supermarket in Prague, Czech Republic. The samples were homogeneously selected. The samples were stored in a refrigerator at 5 °C.



Figure 6. Whole Golden delicious apples and a sliced sample in a petri dish.

#### 3.3 Infrared drying

The moisture analyzer Radwag MA 50/1.R (Warsaw, Poland) (Appendixes) was used for the drying experiments of the freshly sliced apple samples at drying temperatures of 40, 50 and 60 °C. The moisture analyzer is programmed to test samples' moisture content by heating via an infrared emitter, a halogen or a metal heater (Dajbych et al., 2023). For each whole apple, six slices were made using a slicer and dried at each drying temperature set at a fast mode from the four drying profiles (standard, mild, step and fast). The profiles variation ensure various dynamics of temperature increase. The experiments were dried for 12 h. The drying

data was stored automatically which was retrieved by means of USB port for further analysis. The freshly sliced and dried sample is shown in Figure 7. Samples dried at drying temperatures of 40, 50 and 60 °C are shown in Figure 8.

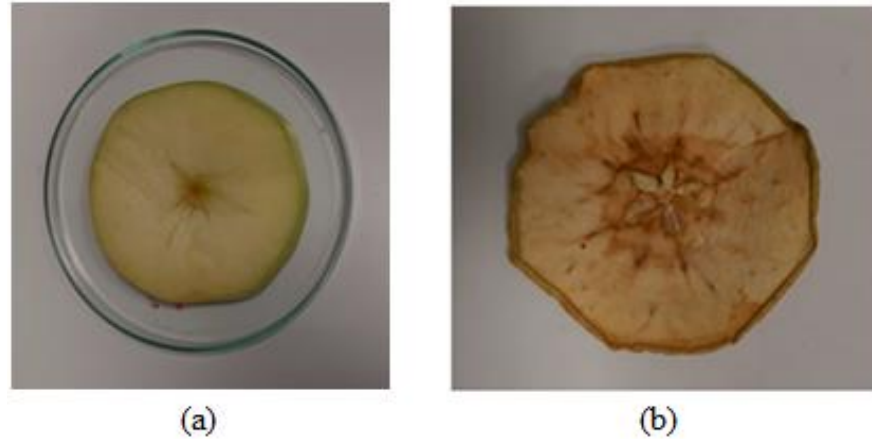

Figure 7. Freshly sliced (a) and dried sample (b) representing all samples dried at each drying temperature.

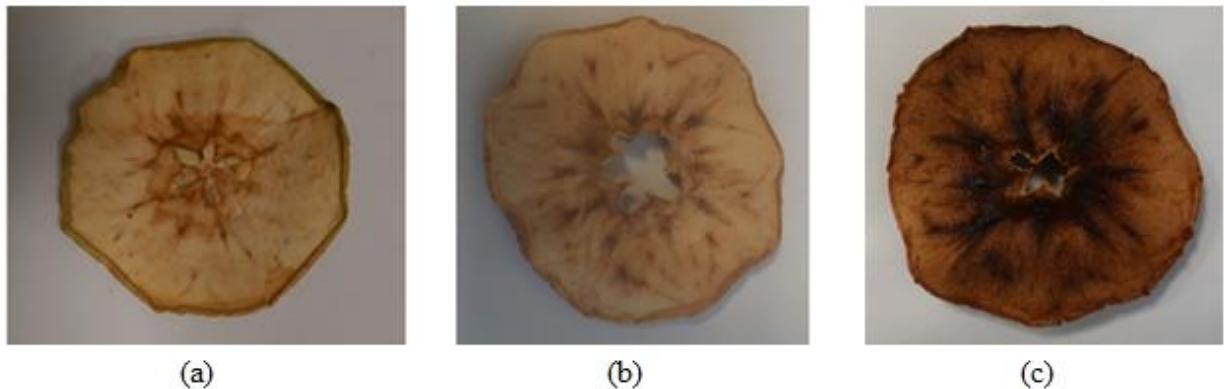

Figure 8. Samples of sliced apple dried at drying temperatures of (a) 40 (b) 50 and (c) 60 °C.

### 3.4 Colour measurement

The RGB (Red, Green and Blue) colour analyzer (RGB-2000 Voltcraft) (Appendix 2) was used for the samples (fresh and dried) colour measurement. The RGB values were converted to Lab values using an online converter. The total colour change ( $\Delta E$ ), whiteness index (WI) and browning index (BI) of the fresh and dried sliced apples under different drying temperatures were calculated using equations (8) to (10) as follows (Izli et al. 2022; Dajbych et al. 2023).

$$\Delta E = \sqrt{(L_o^* - L^*)^2 + (a_o^* - a^*)^2 + (b_o^* - b^*)^2} \quad (8)$$

$$WI = 100 - \sqrt{(100 - L^*)^2 + a^{*2} + b^{*2}} \quad (9)$$

$$BI = \frac{[100(x - 0.31)]}{0.17} \quad (10)$$

$$x = \frac{(a^* + 1.75 \cdot L^*)}{(5.645 \cdot L^* + a^* - 3.012 \cdot b^*)}$$

where  $L_o^*$ ,  $a_o^*$  and  $b_o^*$  represent the fresh samples whereas  $L^*$ ,  $a^*$  and  $b^*$  represent the dried samples. The  $L^*$  colour parameter range from 0 (blackness) to 100 (whiteness). The  $a^*$  parameter is from  $-a^*$  (greenness) to  $+a^*$  (redness) and the  $b^*$  parameter is  $-b^*$  (blueness) to  $+b^*$  (yellowness).

### 3.5 Calculated drying parameters

#### 3.5.1 Dry basis moisture content

The dry basis moisture content  $M_t$  was calculated using equation (11) as follows (Dajbych et al. 2023):

$$M_t = \frac{(W_1 - W_2)}{W_2} \quad (11)$$

where  $M_t$  is the dry basis moisture content of the sample at the moment of drying time t, (g/g);  $W_1$  is the total mass of sample (g) at the moment of drying time t and  $W_2$  is the mass of dry matter (g) (Hussain et al. 2021; Wang et al. 2021; Xie et al. 2022; Dajbych et al. 2023).

#### 3.5.2 Moisture ratio

The moisture ratio  $M_R$  was calculated using equation (12) (Xia et al. 2010; Xie et al. 2022; Dajbych et al. 2023) as follows:

$$M_R = \frac{M_t}{M_o} \quad (12)$$

where  $M_o$  is the initial dry-basis moisture content (g/g).



### 3.5.3 Rehydration capacity

The weighted dehydrated samples (for example, a sample in Figure 9a) were dipped into a beaker of hot water at 80 °C for 15 min (Figure 9b). The rehydrated samples were filtered over a mesh for 2 min (Figure 9c) and thereafter were blotted with an absorbent tissue (Figure 9d) and then weighted again (Figure 9e) (Cui et al. 2008; Bozkir and Ergun 2020; Nurkhoeriyati et al. 2021; Dajbych et al. 2023). The rehydration capacity,  $R_C$  (g/g) of the samples (Figure 9) was calculated using equation 13 as follows (Dajbych et al. 2023):

$$R_C = \frac{M_{rs}}{M_{ds}} \quad (13)$$

where  $M_{rs}$  is the mass of the rehydrated sample (g) and  $M_{ds}$  is the mass of the dried sample (g).

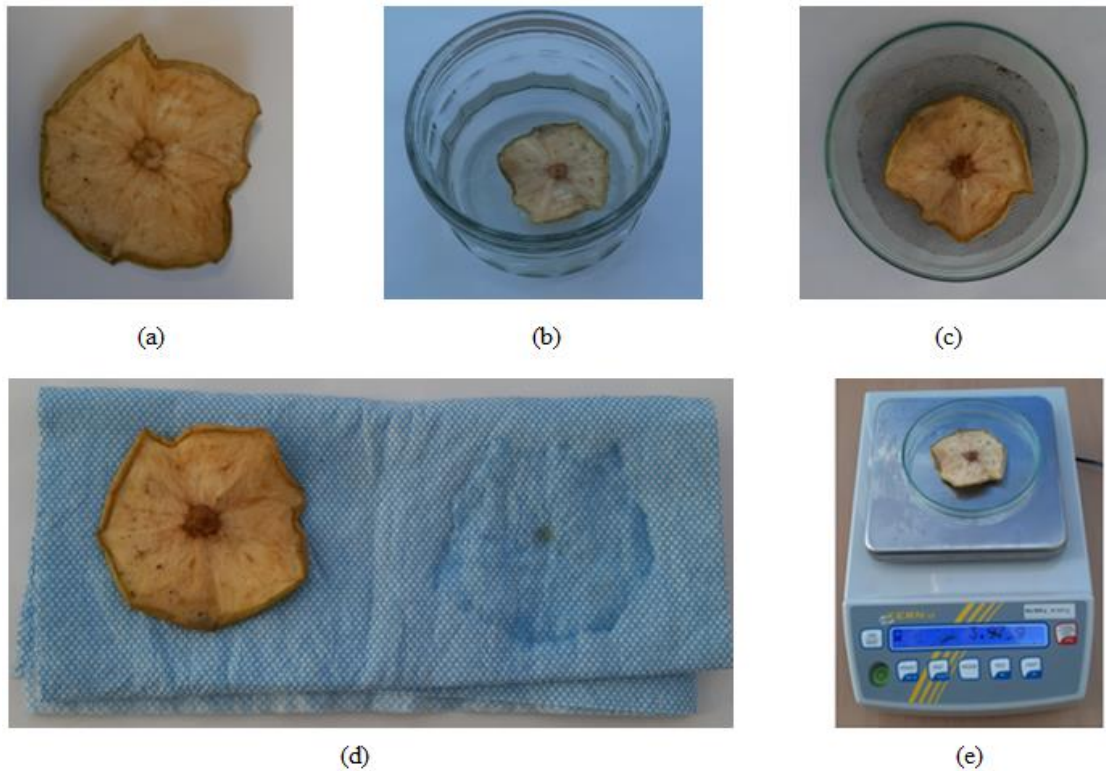

Figure 9. Procedure for calculating the rehydration capacity of the dried apple sliced sample.



(a)



(b)



(c)

Figure 10. Rehydrated samples at drying temperatures (a) 40 °C (b) 50 °C and (c) 60 °C.

### 3.5.4 Shrinkage

The shrinkage  $S_K$  (%) of the samples was calculated using equation 14 as follows Dajbych et al. 2023):

$$S_K = \left[ \left( \frac{V_o - V_f}{V_o} \right) \cdot 100 \right]$$

$$V_o = \pi \left( \frac{D_o}{2} \right)^2 \cdot t_o \quad (14)$$

$$V_f = \pi \left( \frac{D_f}{2} \right)^2 \cdot t_f$$

where  $V_O$  is the initial volume of the fresh sample (mL) and  $V_f$  is the final volume of the dried sample (mL),  $D_O$  and  $D_f$  and  $t_O$  and  $t_f$  are the initial and final diameters (mm) and thicknesses (mm) of the sample (Zhu et al. 2010; Majdi et al. 2019; Dajbych et al. 2023).

### 3.5.5 Bulk density

The bulk density  $\rho_d$  (g/mL) of the dried samples was calculated using equation (15) as follows (Dajbych et al. 2023):

$$\rho_d = \frac{M}{V_f} \quad (15)$$

where  $M$  is the mass of the dried sample (g) and  $V_f$  is the volume of the dried sample (mL) (Goula and Adamopoulos 2005; Bozkir and Ergun 2020; Hussain et al. 2021; Dajbych et al. 2023).

### 3.5.6 Surface area

The surface area  $A$  (mm<sup>2</sup>) of the fresh and dried sliced samples was calculated using Eq. 16 as follows (Dajbych et al. 2023):

$$A = 2\pi r(r + h) \quad (16)$$

where  $r$  is the radius (mm) and  $h$  is the thickness (mm) of the fresh and dried samples (Cetin and Saglam 2019; Hussain et al. 2021; Dajbych et al. 2023).

### 3.5.7 Graphs illustrations and models fitting

Graphical illustrations were done using STATISTICA 13 software (Statsoft 2013). The models fitting of the experimental drying curves and statistical measures were done using Python program.

## 4 RESULTS AND DISCUSSION

### 4.1 Experimental drying curves

Based on the drying curves obtained from our thin-layer apple experiments conducted using the infrared drying method, it is evident that drying temperature significantly impacts drying rates. Our study involved examining six different thin layers of apples of varying sizes, subjected to temperatures ranging from 40°C to 60°C, as depicted in Figures 11–14. The consistency in results across different temperatures indicates a decrease in sample mass after 12 hours of drying. However, a comparison of the three figures reveals that higher temperatures lead to shorter drying times for the apple samples. Notably, Figure 15 illustrates the average mass of sliced golden delicious apples at 40°C, 50°C, and 60°C, showing that the drying time is shortest at 60°C, followed by 50°C, with the longest drying time observed at 40°C. This finding aligns with the investigation by Ndukwu (2009).

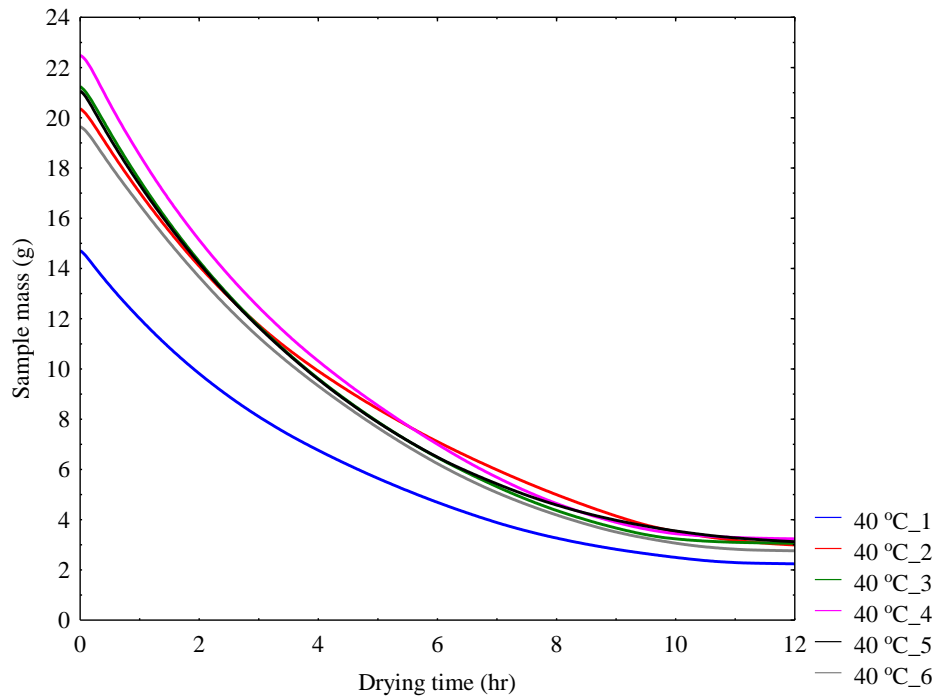

Figure 11. Drying curves of sliced apple samples at 40 °C for 12 hrs.

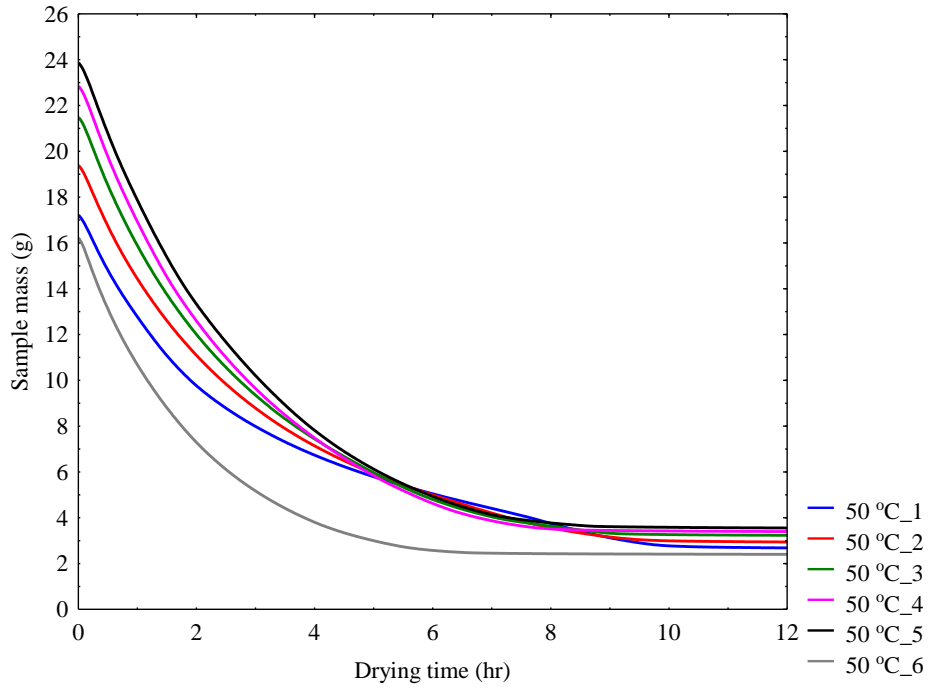

Figure 12. Drying curves of sliced apple samples at 50 °C for 12 hrs.

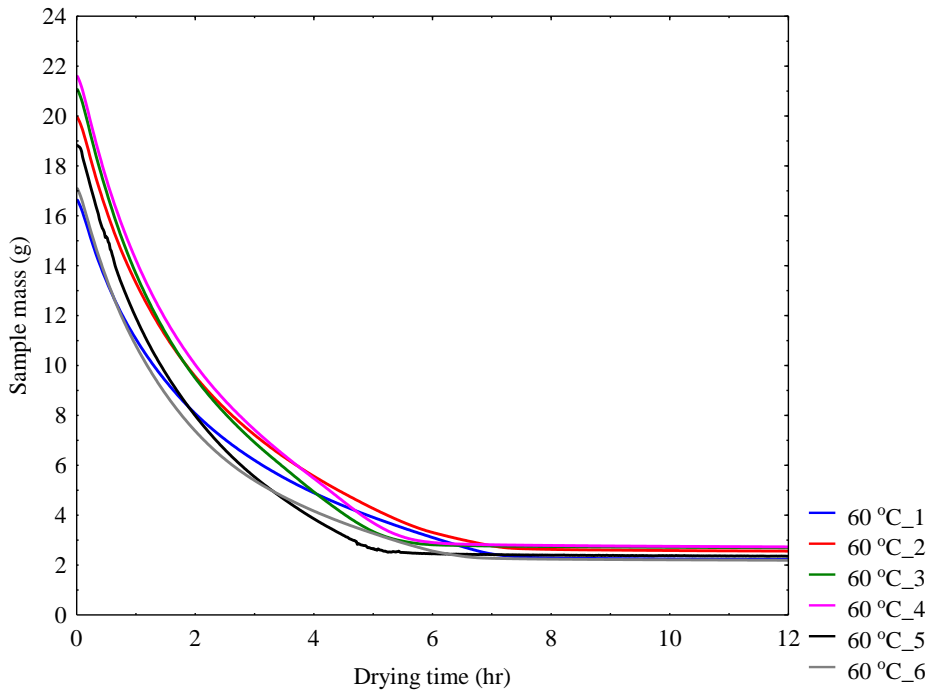

Figure 13. Drying curves of sliced apple samples at 60 °C for 12 hrs.

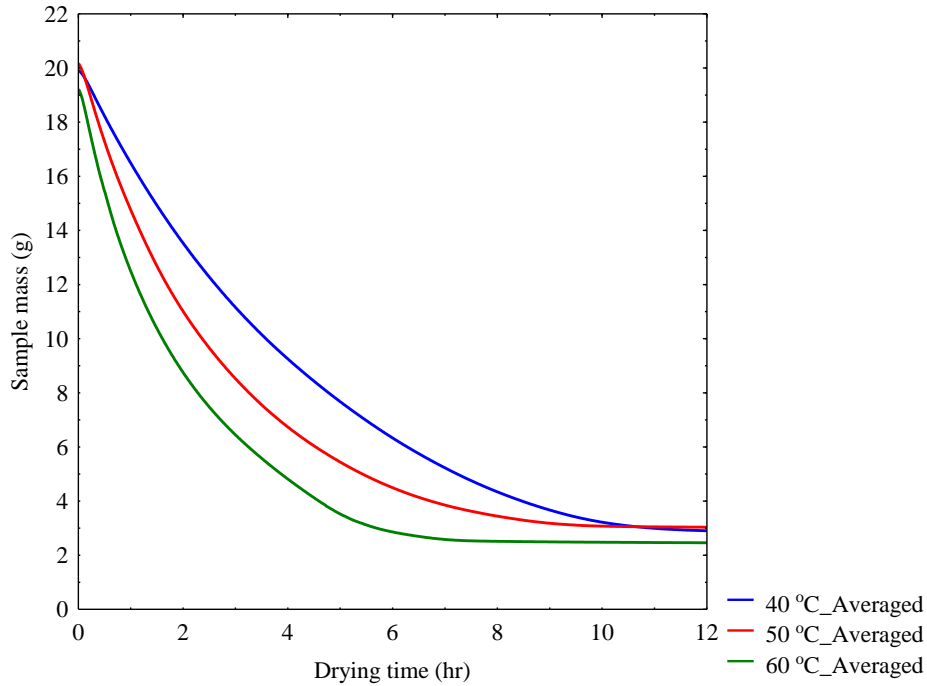

Figure 14. Drying curves of sliced apple samples averaged at 40°C, 50°C and 60°C for 12 hrs.

We utilized data from appendices 1-6 to calculate the overall mean values for sample diameter, thickness, initial mass, dried mass, and rehydrated mass at each drying temperature (40 °C, 50 °C, and 60 °C) shown in Tables 1 and 2. These tables reveal a consistent decrease in diameter, thickness, and mass of the samples with increasing drying temperature. This observation aligns with the findings of Raka and Tiri (2017) who reported that drying temperature has a significant impact on the drying rate of agricultural products

Table 1. Overall mean measurements of sample dimensions.

Measurements	40 °C		50 °C		60 °C	
	Fresh	Dried	Fresh	Dried	Fresh	Dried
Overall mean measurements of sample diameter (mm)	67.21	57.01	67.49	60.075	65.22	55.94
Overall mean measurements of sample thickness (mm)	8.01	5.76	7.95	6.03	7.94	6.45
Measurement of sample area (mm <sup>2</sup> )	8784.62	6137.53	8838.97	6806.12	8307.71	6048.63

Table 2. Overall mean measurements of initial mass, dried mass and rehydrated,  $R_C$  sample.

Measurements (g)	40 °C			50 °C			60 °C		
	Initial	Dried	$R_C$	Initial	Dried	$R_C$	Initial	Dried	$R_C$
	19.916	2.904	5.78	20.162	3.041	6.29	19.204	2.499	4.87

## 4.2 Evaluation of color parameters

Color, a critical factor influencing consumer preference, can be significantly altered during drying due to heat treatments. Non-enzymatic browning and pigment breakdown are common contributors to these changes (Jafari et al. 2020). This study explored the impact of drying temperature (40-60°C) on the color of apple slices dried using infrared (IR) drying. Lightness, greenness/redness, and blueness/yellowness values (denoted by L, a, and b\*) generally exhibited contrasting trends with increasing temperature. The browning index (BI), and total color change ( $\Delta E$ ) experienced an increase in value with higher drying temperature and the whiteness index (WI) decreased as the temperature increases. This aligns with some prior studies that reported increased browning at higher temperatures (Lechtanska et al. 2015; Izli et al. 2022).

## 4.3 Calculated parameters under infrared drying

Studies suggest that dried samples processed at higher temperatures develop a more porous structure compared to those dried at lower temperatures. This increased porosity is believed to be linked to the ease with which water can re-enter the dried product during rehydration. The rehydration ratio, which reflects the amount of water a dried sample can reabsorb, is often used as an indicator of structural damage during drying. A higher rehydration ratio generally implies a product with less structural damage and potentially better quality (Wang et al. 2018). And from our experiment, the rehydration capacity witnessed an increase from 40 °C to 50 °C, but experienced a decrease above 50 °C as seen in table 3, this is a similar result to experiment carried out by Aral and Basal (Aral, Basal 2016).

Shrinkage values for the dried apple slices under IR drying exhibited both increasing and decreasing trends across the drying temperatures (40-60°C) in table 3. It's important to note

that the impact of drying temperature on shrinkage can be complex and depends on several factors. Some studies suggest that slow drying at lower temperatures can lead to higher shrinkage due to internal stresses building up within the sample. Conversely, high drying temperatures might initially increase stresses but also promote faster drying, potentially limiting shrinkage through surface (Sturm et al. 2014). Further research is needed to fully understand the interplay between drying temperature and shrinkage.

The bulk density of dried apple slices under IR drying exhibited variations across the drying temperatures (40-60°C). A clear trend wasn't observed, the values generally fell within the range of 0.16 to 0.19.

Table 3. Calculated parameters of dried apple sample under infrared.

Temperatures (°C)	$R_C$	$S_K$	$V_O$ (ml)	$V_f$ (ml)	$\rho_d$ ( $\frac{g}{ml}$ )	$\Delta E$	$WI$	$BI$
40	1.99	48.19	28.40	17.71	0.20	24.63	27.57	142.97
50	2.07	39.91	28.42	17.08	0.18	40.32	18.24	189.79
60	1.98	40.22	26.52	15.85	0.16	53.32	8.63	200.61

Rehydration capacity ( $R_C$ ), shrinkage ( $S_K$ ), initial volume ( $V_O$ ), final Volume ( $V_f$ ), bulk density ( $\rho_d$ ), color change ( $\Delta E$ ),browning index ( $BI$ ),whiteness index ( $WI$ ).

The surface area of the apple slices were influenced by drying temperature (Aral, Basal 2016). When Fresh and dried sample were compared, there is a decrease in the area of the dried sliced apple compared to the fresh sliced apple. Table 3 shows us that the area of the sample decreases with increasing drying temperature.

#### 4.4 Models fitting of experimental drying curves

This study investigated the drying behavior of golden delicious apple slices under infrared drying method and at temperature of 40 °C,50 °C, and 60 °C. Three main mathematical models as discussed in our literature review were employed to analyze the drying curves and identify the most suitable model for describing the drying process (Figures 15-17). The analysis utilized the page, logarithmic, and Weibull distribution models to capture the drying curves of apple slices dried using infrared method at temperatures ranging from 40 to



60 °C. Among the evaluated models, the Weibull distribution emerged as the most appropriate for depicting the drying behavior of apple slices across different drying temperatures (as shown in Figure 15-17). The goodness-of-fit of each model was assessed using statistical parameters like root mean square error (RMSE), chi-square ( $\chi^2$ ), coefficient of determination ( $R^2$ ), and modelling efficiency (EF). Lower RMSE and  $\chi^2$  values alongside higher  $R^2$  and EF values indicate a better fit between the model and the experimental data.

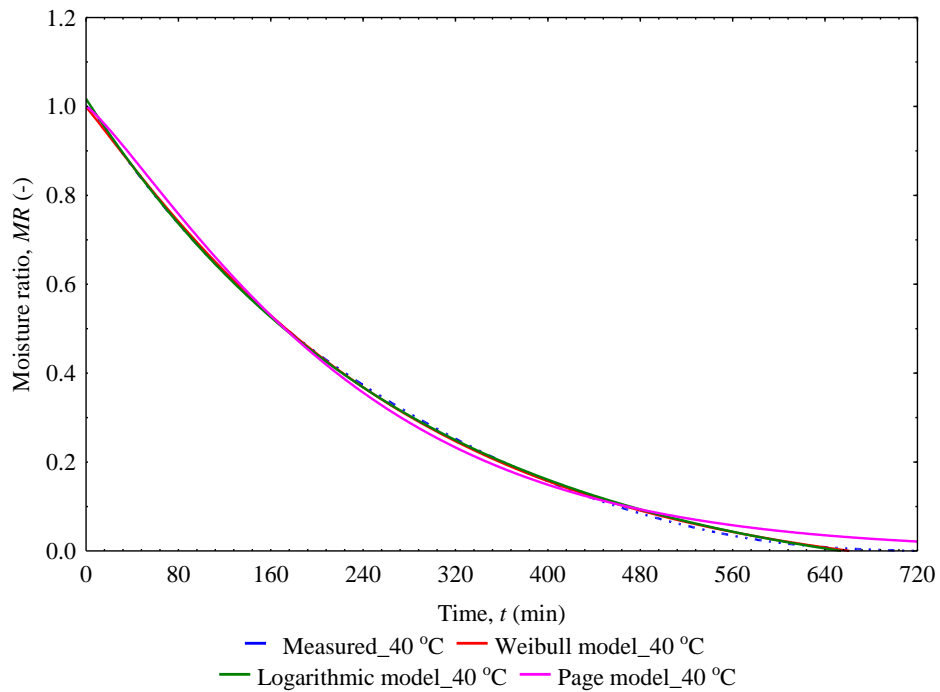

Figure 15. Measured and fitted curves based on Weibull, logarithmic and page models at 40 °C.

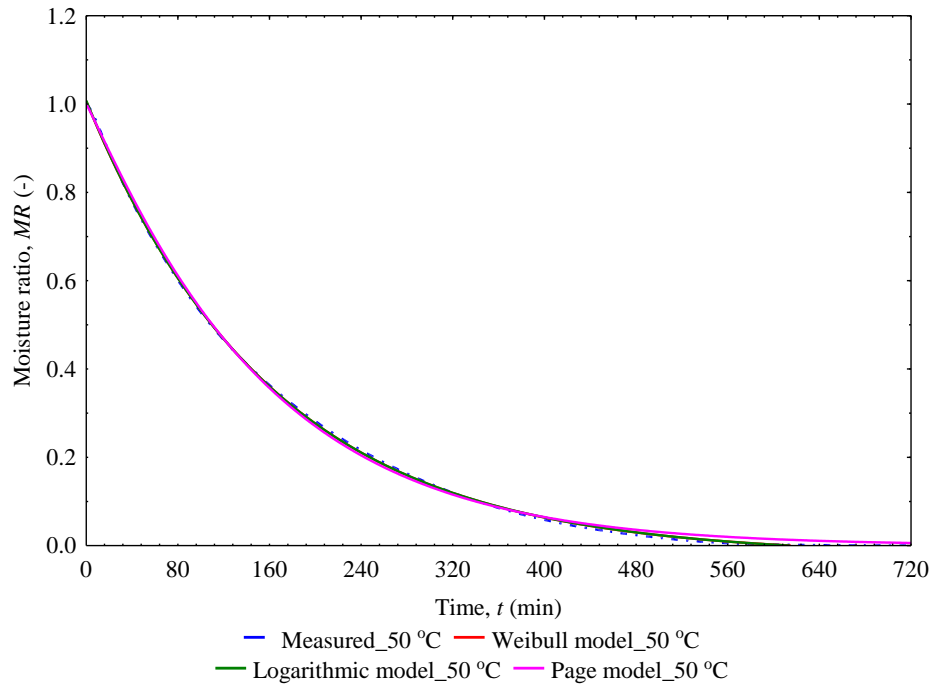

Figure 16. Measured and fitted curves based on Weibull, logarithmic and page models at 50 °C.

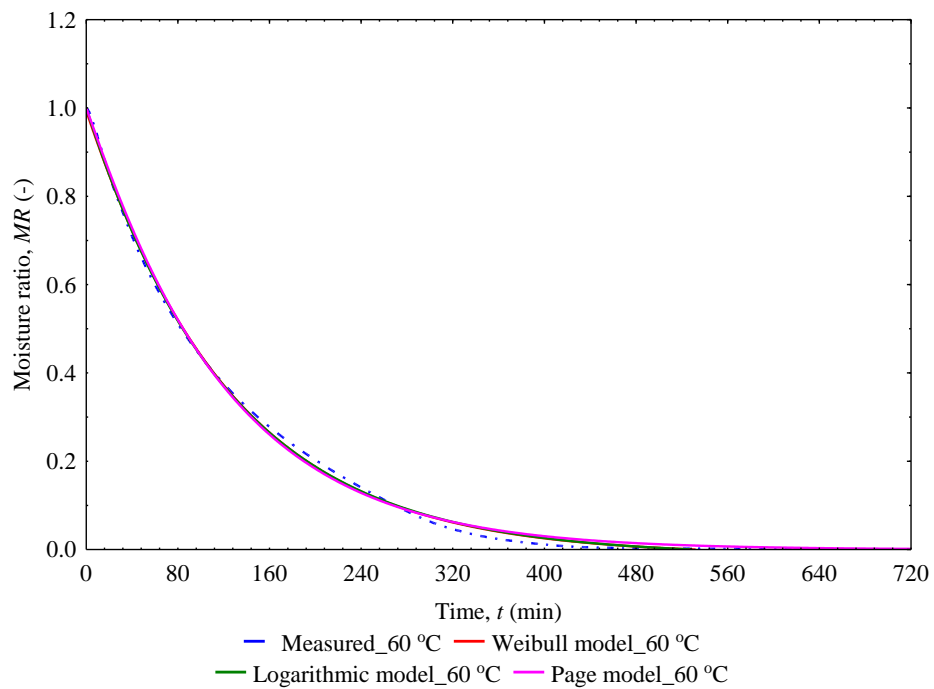

Figure 17. Measured and fitted curves based on Weibull, logarithmic and page models at 60 °C.

Table 4. Fitting models coefficients at 40,50 and 60 °C.

<b>Drying temperature 40 °C</b>					
<b>Weibull model</b>	Coefficients	<b>Logarithmic model</b>	Coefficients	<b>Page model</b>	Coefficients
<i>k</i>	0.002562	<i>k</i>	0.003587	<i>k</i>	0.001448
<i>a</i>	-0.08199	<i>a</i>	1.124787	<i>n</i>	1.198583
<i>b</i>	-1.08048	<i>c</i>	-0.10759		
<i>n</i>	1.064529				
<b>Drying temperature 50 °C</b>					
<i>k</i>	0.006033	<i>k</i>	0.006182	<i>k</i>	0.004593
<i>a</i>	-0.0224	<i>a</i>	1.03111	<i>n</i>	1.066618
<i>b</i>	-1.02865	<i>c</i>	-0.02307		
<i>n</i>	1.004619				
<b>Drying temperature 60 °C</b>					
<i>k</i>	0.00737	<i>k</i>	0.008074	<i>k</i>	0.006768
<i>a</i>	-0.01269	<i>a</i>	1.015001	<i>n</i>	1.042749
<i>b</i>	-1.00621	<i>c</i>	-0.01407		
<i>n</i>	1.017369				

*k*, *a*, *b*, *n* and *c* are the models constants.

Table 5. Fitting models coefficients and their statistical parameters at 40,50 and 60 °C.

	Statistical parameters			
<b>Models</b>	<b><i>RMSE</i></b>	<b><i>R</i><sup>2</sup></b>	<b><i>X</i><sup>2</sup></b>	<b><i>EF</i></b>
<b>Drying temperature 40 °C</b>				
Weibull	0.070053	0.999878	0.000034	1
Logarithmic	0.072082	0.999767	0.000046	1
Page	0.126264	0.999229	0.000317	0.999589
<b>Drying temperature 50 °C</b>				
Weibull	0.066291	0.999928	0.000024	1
Logarithmic	0.066153	0.999924	0.000024	1
Page	0.09385	0.999784	0.000092	0.999669
<b>Drying temperature 60 °C</b>				
Weibull	0.095758	0.999598	0.000108	1
Logarithmic	0.096093	0.999598	0.000109	1
Page	0.103272	0.999257	0.000157	0.999319

*RMSE*: Root mean square error; *R*<sup>2</sup>: Coefficient of determination; *X*<sup>2</sup>: Chi-square and *EF*: Model efficiency.

## 5 CONCLUSIONS

This study investigates the influence of infrared (IR) drying temperature (40, 50, and 60°C) on the drying behavior, color changes, and quality attributes of sliced Golden Delicious apples. Our analysis, employing three mathematical models detailed in equations (1) to (3), revealed that the logarithmic and Weibull distribution models best represent the drying curves within this temperature range. Notably, the Weibull distribution model exhibited the most consistent performance in describing drying processes across the investigated temperatures. The quality of the model fits was assessed using statistical measures like root mean square error (*RMSE*), chi-square ( $\chi^2$ ), coefficient of determination ( $R^2$ ), and modelling efficiency (*EF*). Lower *RMSE* and  $\chi^2$  values and higher  $R^2$  and *EF* values indicated a better fit between the model and the experimental data. Our findings revealed a trend of increasing browning index (*BI*) and total color change ( $\Delta E$ ) with higher drying temperatures. This corresponds with a decrease in whiteness index (*WI*) as temperature rises. These observations align with previous research that documented increased browning at higher drying temperatures.

The rehydration capacity, a measure of a dried product's ability to reabsorb water, exhibited an increase from 40 °C to 50 °C but decreased at 60°C. This suggests that a moderate drying temperature of 50 °C might be optimal for preserving rehydration characteristics. Shrinkage values exhibited both increasing and decreasing trends across drying temperatures, indicating the complex interplay between temperature and factors like internal stresses within the sample. The bulk density of dried apple slices also showed variations across temperatures, but a clear trend was not observed. This suggests that further research is needed to understand the combined effects of drying temperature, sample slice thickness, and other factors on bulk density. Finally, the surface area of the apple slices decreased with increasing drying temperature, as expected due to moisture loss and shrinkage. This study shows that there can be significant development of an efficient and high-quality dried apple products using IR drying technique by preserving the nutritional value, color, rehydration capacity, and overall sensory attributes which are crucial for consumers' acceptance.

## 6 RECOMMENDATIONS

Future research should:

- i. expand the drying temperature range to explore potential trade-offs between drying rate and color preservation.
- ii. investigate the effect of drying time on quality parameters, particularly at lower temperatures.
- iii. evaluate the impact of slice thickness on drying kinetics, rehydration capacity, and shrinkage.
- iv. include sensory evaluation components to assess consumer preferences for dried apple slices produced at different drying conditions.
- v. determine the effective moisture diffusivity, activation energy and energy consumption of the dried samples under the drying technique utilized. These parameters should require detailed theoretical analyses.
- vi. consider combined infrared and hot-air drying techniques for different apple varieties and other agricultural products.
- vii. subject the calculated drying parameters to a rigorous statistical evaluation to understand the statistical significance of the input operating factors on the output responses.

## 7 REFERENCES

1. Aidani, E., Hadadkhodaparast, M., Kashaninejad, M. (2016): Experimental and modeling investigation of mass transfer during combined infrared-vacuum drying of Hayward kiwifruits. *Food Science Nutrition*. 1–7.
2. Akpınar E. (2004): Experimental investigation of convective heat transfer coefficient of various agricultural products under open sun drying. *International Journal of Green Energy*, 1(4): 429-440.
3. Aral, S., Bese, A.W. Convective drying of hawthorn fruit (2016): Effect of experimental parameters on drying kinetics, color, shrinkage, and rehydration capacity. *Food Chemistry*, 210: 577–584.
4. Araya-Farias, Ratti M.C. (2009): *Dehydration of foods*. CRC Press, 1-36.
5. Ayhan Topuz., Dincer C. Kalkan T. A., Aygun S. A. (2023): Drying of tea, herbals, and spices. *Woodhead Publishin*, 543-586.
6. Babalis, S.T., Papanicolaou, E., Kyriakis, N., Belessiotis, V.G. (2006): Evaluation of thin layer drying models for describing drying kinetics of figs (*Ficus carica*). *Journal of Food Engineering*, 75: 205–214.
7. Bagheri, N., Dinani, S.T. (2019): Investigation of ultrasound-assisted convective drying process on quality characteristics and drying kinetics of zucchini slices. *Heat Mass Transf*, 55: 2123–2163.
8. Becker H., Isaacson R. (2009): Wheat drying in well-stirred-batch and continuous-moving-bed dryers. *The Canadian Journal of Chemical Engineering*, 48: 560-567.
9. Behrooz-Khazaei N., Tavakoli T., Ghassemian H., Khoshtaghaza M.H., Banakar A. (2013): Applied machine vision and artificial neural network for modeling and controlling of the grape drying process. *Computers and Electronics in Agriculture*, 98: 205-213.
10. Berk Z. (2018): Dehydration. In Z. Berk (Ed.), *Food Process Engineering and Technology (Third Edition)*. Academic Press, 513-566.
11. Bing Zhang., Hong Quan., Yixi Cai., Xinghao Han., Houyu Kang., Yazhou Lu., Hao Cheng., Nan Xiang., Xiaozhong Lan., Xinbo Guo. (2023): Comparative study of browning, phenolic profiles, antioxidant and antiproliferative activities

- in hot air and vacuum drying of lily (*Lilium lancifolium* Thunb.) bulbs. *LWT*, 184: 115015.
12. Bixiang Wang., Yuanlong Jia, Yue Li, Zhitong Wang, Liankui Wen, Yang He, Xiuying Xu. (2023): Dehydration–rehydration vegetables: Evaluation and future challenges. *Food Chemistry*, 20: 100935.
  13. Blahovec, J. *Agromaterials Study Guide*; Czech University of Life Sciences Prague: Prague, Czech Republic, 2008.
  14. Bozkir, H., Ergun, A. R. (2020): Effect of sonication and osmotic dehydration applications on the hot air drying kinetics and quality of persimmon. *LWT—Food Science and Technology*, 131: 109704.
  15. Carrin, M. E., Crapiste, G. H. (2008): Convective drying of foods. In: C. Ratti (Ed.): *Advances in food dehydration*. CRC Press, 123-152.
  16. Cetin N. Saglam C. Demir B. (2019): Effects of different drying conditions on physical changes of apple (*Malus communis* L.). *MKUJAS*, 24:71–77.
  17. Ceylan İ. Gürel A. E., Ergün A., Tabak A. (2016): Performance analysis of a concentrated photovoltaic and thermal system. *Solar Energy*, 129: 217–223.
  18. Chakespari, A. G., Rajabipour, A., Mobli, H. (2010): Strength behaviour study of apples. In: Shafi Abadi Golab KohanzL: under compression loading. *Modern Applied Science*, 4(7): 173-182.
  19. Chakespari, A.G., Rajabipour, A., Mobli, H. 2010. Strength behaviour study of apples (cv. Shafi Abadi & Golab Kohanz) under compression loading. *Modern Applied Science*, 4(7), 173-182.
  20. Chanda P. Podder B. Biswas A. Sengupta A. R. (2023): Advancements in solar assisted drying technologies. *Journal of Stored Products Research*, 104: 102190.
  21. Chanioti, S., Tzia, C. 2017. Optimization of ultrasound-assisted extraction of oil from olive pomace using response surface methodology: Oil recovery, unsaponifiable matter, total phenol content and antioxidant activity. *LWT – Food Science and Technology*, 79:178–189.
  22. Chanpet M., Rakmak N., Matan N., Siripatana C. (2020): Effect of air velocity, temperature, and relative humidity on drying kinetics of rubberwood. *Heliyon*, 6(10): e05151.



23. Chou S. K., Hawlader M., Chua K. J., Teo C. (1997): A methodology for tunnel dryer chamber design. *International Journal of Energy Research*, 21: 395-410.
24. Cui Z. W., Li C., Y. Song C. F., Song Y. (2008): Combined microwave vacuum and freeze drying of carrot and apple chips. *Dry. Technol*, 26: 1517–1523.
25. Dajbych, O., Kabutey, A., Mizera, Ā., Herák, D. (2023): Investigation of the Effects of Infrared and Hot Air Oven Drying Methods on Drying Behaviour and Colour Parameters of Red Delicious Apple Slices. *Processes* 2023, 11: 1–27.
26. Danlami, J.M., Arsad, A., Zaini, M.A.A. (2015): Characterization and process optimization of castor oil (*Ricinus communis* L.) extracted by the Soxhlet method using polar and non-polar solvents. *Journal of the Taiwan Institute of Chemical Engineers*, 47: 99-104.
27. Deli, S., Masturah, F.M., Aris, T.Y., Nadiah, W.W.A. (2011): The effects of physical parameters of the screw press oil expeller on oil yield from *Nigella sativa* L seeds. *International Food Research Journal*, 18(4):1367–1373.
28. Dengwen Lei., Yongkang Xie., Zehui Jia., Wenling Sun., Zekang Peng., Yanhong Liu. (2024): Dielectric properties of in-shell peanuts with radio frequency and microwave heating treatment and RF heating performance. *Postharvest Biology and Technology*, 211: 112800.
29. Díaz-Maroto M.C., Pérez-Coello M.S., Cabezudo M.D. (2002): Effect of drying method on the volatiles in bay leaf. *Journal of Agricultural and Food Chemistry*, 50(16): 4520-4524.
30. Erbay Z., Icier F. (2010): A Review of Thin Layer Drying of Foods: Theory, Modeling, and Experimental Results. *Critical Reviews in Food Science and Nutrition*, 50: 441-464.
31. Fabiano A.N. Fernandes Maria. Izabel Gallão. Sueli Rodrigues (2008): Effect of osmotic dehydration and ultrasound pre-treatment on cell structure: Melon dehydration. *LWT - Food Science and Technology*, 41(4): 604-610. Link

32. Gao J. Wu M. Du S. Zhang H. Wang S. Ling B. (2023): Recent advances in food processing by radio frequency heating techniques: A review of equipment aspects. *Journal of Food Engineering*, 357: 111609.
33. Goula A.M. Adamopoulos K.G. (2005): Spray drying of tomato pulp in dehumidified air: II. The effect on powder properties. *Journal of Food Engineering*, 66:L 35–42.
34. Guiné Raquel. (2018): The Drying of Foods and Its Effect on the Physical-Chemical, Sensorial and Nutritional Properties. *International Journal of Food Engineering*, 4(2): 93-100.
35. Gulati T. Datta A. K. (2015): Mechanistic understanding of case-hardening and texture development during drying of food materials. *Journal of Food Engineering*, 166: 119-138.
36. Gupta, R.K., Das, S.K. 2000. Fracture resistance of sunflower seed and kernel to compressive loading. *Journal of Food Engineering*, 46:1–8.
37. Hany S. El-Mesery. Kwami Ashiagbor. Zicheng Hu. W.G. Alshaer. (2023): A novel infrared drying technique for processing of apple slices: Drying characteristics and quality attributes. *Case Studies in Thermal Engineering*, 52: 103676.
38. Hashim N. Onwude D. Rahaman E. (2014): A preliminary study: kinetic model of drying process of pumpkins (*Cucurbita moschata*) in a convective hot air dryer. *Agriculture and Agricultural Science Procedia*, 2(2): 345–352.
39. Herak, D., Kabutey, A., Choteborsky, R., Petru, M., Sigalingging, R. 2015. Mathematical models describing the relaxation behaviour of *Jatropha curcas* L. bulk seeds under axial compression. *Biosystems Engineering*, 131:77–83.
40. Hernandez-Santos, B., Rodriguez-Miranda, J., Herman-Lara, E., Torruco-Uco, J.G., Carmona-Garcia, R., Juarez-Barrientos, J.M., Chavez-Zamudio, R., Martinez-Sanchez, C.E. 2016. Effect of oil extraction assisted by ultrasound on the physicochemical properties and fatty acid profile of pumpkin seed oil (*Cucurbita pepo*). *Ultrasonics Sonochemistry*, 31: 429–436.

41. Hirakh Jyoti Das., Pinakeswar Mahanta., Rituraj Saikia., Md Shoaib Aamir. (2020): Performance Evaluation of drying Characteristics in conical bubbling fluidized bed dryer. *Powder Technology*, 374: 534-543.
42. Hussain P.R., Wani I.A., Rather S.A., Suradkar P., Ayob O. (2021): Effect of post-processing radiation treatment on physico-chemical, microbiological and sensory quality of dried apple chips during storage. *Radiation Physics and Chemistry*, 182: 109367.
43. Izli, G., Yildiz, G., Berk, S.E. (2022): Quality retention in pumpkin powder dried by combined microwave-convective drying. *J. Food Science Technology*, 59: 1558–1569.
44. Jafari, F., Movagharnejad, K., Sadeghi, E. (2020): Infrared drying effects on the quality of eggplant slices and process optimization using response surface methodology. *Food Chemistry*, 333: 127423.
45. Jayas, D.S., Singh, C.B. (2011): Drying of Agricultural Products. In: J. Gliński J. Horabik J. Lipiec (Eds.): *Encyclopedia of Agrophysics*. Springer.
46. Jayawardena S. R., Morton J. D., Bekhit A. E. A., Bhat Z. F., Brennan C. S. (2022): Effect of drying temperature on nutritional, functional and pasting properties and storage stability of beef lung powder, a prospective protein ingredient for food supplements. *LWT*, 161: 113315
47. Joardder (Omar) U. H., Karim A., GHNIMI S. (2021): Retaining Quality When Drying Food: Challenges and Solutions. *Frontiers in Sustainable Food Systems*, 5.
48. Karaaslan, S., Ekinici, K., Akbolat, D. (2017): Drying characteristics of sultana grape fruit in microwave dryer. *Pol. Acad. Sci*, 2017: 1317–1327.
49. Karathanos V. T., Kanellopoulos N. K., Belessiotis V. G. (1996): Development of porous structure during air drying of agricultural plant products. *Journal of Food Engineering*, 29(2): 167-183.
50. Khraishah M. A. M., McMinn W. A. M., Magee T. R. A. (2004): Quality and structural changes in starchy foods during microwave and convective drying. *Food Research International*, 37(5): 497-503.

51. Krokida M. K., Karathanos V. T., Maroulis Z. B. (1998): Effect of freeze-drying conditions on shrinkage and porosity of dehydrated agricultural products. *Journal of Food Engineering*, 35(4): 369-380.
52. Kudra T., Martynenko A. (2019): Electrohydrodynamic drying: Theory and experimental validation. *Drying Technology*, 38(1): 1-8.
53. Lahsasni S., Kouhila M., Mahrouz M., Idlimam A. (2004): Thin layer convective solar drying and mathematical modeling of prickly pear peel (*Opuntia ficus indica*): *Energy*, 29(2): 211-224.
54. Lamidi R. O., Jiang L., Pathare P. B., Wang Y. D., Roskilly A. P. (2019): Recent advances in sustainable drying of agricultural produce: A review. *Applied Energy*, 233–234: 367-385.
55. Lechtanska, J.M., Szadzinska, J., Kowalski, S.J. (2015): Microwave and infrared-assisted convective drying of green pepper: Quality and energy considerations. *Chemical Engineering Process*, 98: 155–164
56. Lima A. G. B., Delgado J. M. P. Q., Oliveira V. A. B., Melo J. C. S. Joaquina e Silva, C. (2014): Porous Materials Drying Model Based on the Thermodynamics of Irreversible Processes: Background and Application. *Advanced Structured Materials*, 48: 1–23.
57. Majdi H., Esfahani J. A., Mohebbi M. (2019): Optimization of convective drying by response surface methodology. *Computers and Electronics in Agriculture*, 156: 574–584.
58. Meisami-asl, E., Rafiee, S., Keyhani, A., Tabatabaeefar, A. (2009): Mathematical modeling of moisture content of apple slices (Var. Golab) during drying. *Pak. J. Nutr.* 2009, 8(6), 80–809.
59. Mercer D. G. (2007): An intermediate course in food dehydration and drying. In: Mercer.D.G (Ed.): AN INTERMEDIATE COURSE IN FOOD DEHYDRATION AND DRYING. 3–18.
60. Mani P., Prasad T., Krishna J., Subramani S. (2020): Applications of thin layer modelling techniques and advances in drying of agricultural products. *AIP Conference Proceedings*, 2311: 090025.

61. Ndukwu, Macmanus. (2009). Effect of Drying Temperature and Drying Air Velocity on the Drying Rate and Drying Constant of Cocoa Bean. *Agricultural Engineering International : The CIGR e-journal*, Xi: 1.
62. Nurkhoeriyati T. Kulig B., Sturm B. (2021): The effect of pre-heating treatment and drying conditions on quality and energy consumption of hot air-dried celeriac slices: Optimization. *Foods*, 10: 1–19.
63. Onwude D. I., Hashim N., Janius R. B., Nawi N. M., Abdan K. (2016): Modeling the thin layer drying of fruits and vegetables: A review. *Comprehensive Reviews in Food Science and Food Safety*, 15: 299-618.
64. Onwude D. I., Hashim N., Abdan K. Janius R., Chen G. (2018): Modelling of coupled heat and mass transfer for combined infrared and hot-air drying of sweet potato. *Journal of Food Engineering*, 228: 12-24.
65. Onwude, D.I., Hashim, N., Janius, R.B., Nawi, N.M., Abdan, K. (2016c): Modeling the thin layer drying of fruits and vegetables: a review. *Compr. Rev. Food Sci. Food Saf*, 15, 599–618.
66. Peng J., Yin X., Jiao S., Wei K., Tu K., Pan L. (2019): Air jet impingement and hot air-assisted radio frequency hybrid drying of apple slices. *LWT—Food Science and Technology*, 116: 108517.
67. Putra R. N., Ajiwiguna T. A. (2017): Influence of air temperature and velocity for drying process. *Procedia Engineering*, 170: 516-519.
68. Rodríguez J., Clemente G., Sanjuan, N., Bon J. (2013): Modelling drying kinetics of thyme (*Thymus vulgaris* L.): Theoretical and empirical models, and neural networks. *Food Science and Technology International*, 20: 13–22.
69. Schössler K., Thomas T., Knorr D. (2012): Modification of cell structure and mass transfer in potato tissue by contact ultrasound. *Food Research International*, 49(1): 425-431.
70. Sharshir S. W., Joseph A., Peng G., Kandeal A., Abdullah A. S., Abdelaziz G., Edreis E. M. A., Yuan Z. (2023): Recent efforts in developing agricultural product drying processes using solar energy. *Solar Energy*, 137-154.

71. Sivakumar R., Saravanan R., Elaya Perumal A., Iniyar S. (2016): Fluidized bed drying of some agro products – A review. *Renewable and Sustainable Energy Reviews*, 61: 280-301.
72. Sjöholm I., Gekas V. (1995): Apple shrinkage upon drying. *Journal of Food Engineering*, 25(1): 123-130.
73. Srikiatden J., Roberts J. S. (2007): Moisture Transfer in Solid Food Materials: A Review of Mechanism, Models and Measurements. *International Journal of Food Properties*, 10: 739-777.
74. StatSoft Inc. (1995). *STATISTICA for Windows*. StatSoft Inc.: Tulsa, OK, USA, 2013.
75. Sturm, B., Vega, A.-M.N., Hofacker, W.C. (2014): Influence of process control strategies on drying kinetics, colour and shrinkage of air dried apples. *Appl. Therm. Engineering*, 62, 455–460.
76. Sun T., Wang J., Ling F., Zhu L. (2023): Hot-air drying of corn kernels: Drying kinetics and quality improvement. *Cereal Chemistry*, 100.
77. Sun Y., Zhang M., Mujumdar A. (2019): Berry Drying: Mechanism, Pretreatment, Drying Technology, Nutrient Preservation, and Mathematical Models. *Food Engineering Reviews*, 11.
78. Thuppahige V. T. W., Welsh Z. G., Joardder M., Karim A. (2024): Recent advances in determining the cellular-level property evolutions of plant-based food materials during drying. *Trends in Food Science Technology*, 143: 104291.
79. Valarmathi T. N., Mani P., Prasad T. Krishna J., Subramani S. (2020): Applications of thin layer modelling techniques and advances in drying of agricultural products. *AIP Conference Proceedings*, 2311: 090025.
80. Velasco, J., Dobarganes, C., Márquez-Ruiz, G. (2010): Oxidative rancidity in foods and food quality. In: L.H. Skibsted J. Risbo M.L. Andersen (Eds.): *Chemical Deterioration and Physical Instability of Food and Beverages*. 3-32.: Woodhead Publishing.
81. Wagner J. R., Mount E. M., Giles H. F. (2014): *Drying*. *Plastics Design Library*.

82. Wang H., Liu Z.L., Vidyarthi S. K., Wang Q.H., Gao L., Li B.R., Wei Q., Xiao H.W. (2021): Effects of different drying methods on drying kinetics, physicochemical properties, microstructure, and energy consumption of potato (*Solanum tuberosum* L.) cubes. *Dry. Technol*, 39: 418–431.
83. Wang, L., Xu, B., Wei, B., Zeng, R. (2018): Low frequency ultrasound pretreatment of carrot slices: Effect on the moisture migration and quality attributes by intermediate-wave infrared radiation drying. *Ultrason. Sonochem*, 40: 619–628
84. Westerman, P.W., White, G.M., Ross, I.J. (1973): Relative humidity effect on the high temperature drying of shelled corn. *Trans. ASABE*, 16: 1136–1139.
85. Xiao H. W., Pang C. L., Wang L., H. Bai J. W., Yang W. X., Gao Z. J. (2010): Drying kinetics and quality of Monukka Seedless grapes dried in an air-impingement jet dryer. *Biosyst. Eng*, 105: 233–240.
86. Yaldiz, O., Ertekin, C., Uzun, H.I. (2001): Mathematical modeling of thin layer solar drying of Sultana grapes. *Energy*, 26: 457–465.
87. Zhu Y., Pan Z., McHugh T. H., Barrett D. M. (2010): Processing and quality characteristics of apple slices processed under simultaneous infrared dry-blanching and dehydration with intermittent heating. *J. Food Eng.* 97: 8–16.

## 8 APPENDIXES

Appendix 1. Experimental data of sliced golden delicious apple at 40 °C for samples 1 to 3.

Samples measurements	40 °C Sample 1		40 °C Sample 2		40 °C Sample 3	
	Fresh	Dried	Fresh	Dried	Fresh	Dried
Diameter 1 (mm)	56.58	45.67	64.39	53.46	68.93	61.14
Diameter 2 (mm)	56.53	46.44	65.81	56.63	71.69	59.37
Mean	56.56	46.06	65.10	55.05	70.31	60.26
Thickness 1 (mm)	7.26	5.12	9.43	7.41	7.68	6.52
Thickness 2 (mm)	7.05	4.79	9.51	5.59	7.97	6.09
Thickness 3 (mm)	7.25	4.64	8.56	5.60	7.92	5.24
Mean	7.19	4.85	9.17	6.20	7.86	5.95
Mass of initial sample (g)	14.703		20.358		21.239	
Mass of dried sample (g)	2.244		2.994		3.06	
Mass of rehydrated sample (g)	3.97		6.02		5.95	



Appendix 2. Experimental data of sliced golden delicious apple at 40 °C for samples 4 to 6.

Samples measurements	40 °C Sample 4		40 °C Sample 5		40 °C Sample 6	
	Fresh	Dried	Fresh	Dried	Fresh	Dried
Diameter 1 (mm)	71.58	62.80	73.41	63.56	67.29	55.81
Diameter 2 (mm)	70.46	61.59	71.03	62.04	68.74	55.56
Mean	71.02	62.20	72.22	62.80	68.02	55.69
Thickness 1 (mm)	7.33	5.67	8.45	6.62	8.27	6.03
Thickness 2 (mm)	7.56	5.33	8.29	6.15	8.40	6.39
Thickness 3 (mm)	7.43	5.23	7.68	5.16	8.02	6.15
Mean	7.44	5.41	8.14	5.98	8.23	6.19
Mass of initial sample (g)	22.488		21.065		19.641	
Mass of dried sample (g)	3.239		3.124		2.763	
Mass of rehydrated sample (g)	7.52		5.90		5.31	

Appendix 3. Experimental data of sliced golden delicious apple at 50 °C for samples 1 to 3.

Samples measurements	50 °C Sample 1		50 °C Sample 2		50 °C Sample 3	
	Fresh	Dried	Fresh	Dried	Fresh	Dried
Diameter 1 (mm)	58.38	48.14	67.22	58.17	66.95	57.87
Diameter 2 (mm)	61.09	51.79	63.01	60.98	71.25	63.26
Mean	59.74	49.97	65.12	59.58	69.10	60.57
Thickness 1 (mm)	8.45	5.45	7.48	5.35	8.06	5.90
Thickness 2 (mm)	7.38	6.87	8.09	6.54	7.33	6.16
Thickness 3 (mm)	8.24	4.94	7.60	5.62	7.95	5.99
Mean	8.02	5.75	7.72	5.84	7.78	6.02
Mass of initial sample (g)	17.207		19.38		21.477	
Mass of dried sample (g)	2.683		2.943		3.232	
Mass rehydrated sample (g)	5.13		5.82		6.32	

Appendix 4. Experimental data of sliced golden delicious apple at 50 °C for samples 4 to 6.

Samples measurements	50 °C Sample 4		50 °C Sample 5		50 °C Sample 6	
	Fresh	Dried	Fresh	Dried	Fresh	Dried
Diameter 1 (mm)	73.99	66.65	67.53	64.51	64.92	62.44
Diameter 2 (mm)	77.50	62.34	70.14	62.52	67.84	62.18
Mean	75.75	64.50	68.84	63.52	66.38	62.31
Thickness 1 (mm)	7.93	5.91	8.22	7.01	7.61	5.47
Thickness 2 (mm)	7.80	6.21	8.40	6.11	7.49	5.39
Thickness 3 (mm)	7.69	7.11	8.73	6.24	8.58	6.19
Mean	7.81	6.41	8.45	6.45	7.89	5.68
Mass of initial sample (g)	22.836		23.859		16.21	
Mass of dried sample (g)	3.398		3.553		2.402	
Mass of rehydrated sample (g)	7.88		7.38		5.24	

Appendix 5. Experimental data of sliced golden delicious apple at 60 °C for samples 1 to 3.

Samples measurements	60 °C Sample 1		60 °C Sample 2		60 °C Sample 3	
	Fresh	Dried	Fresh	Dried	Fresh	Dried
Diameter 1 (mm)	56.21	48.70	61.41	54.22	64.38	57.33
Diameter 2 (mm)	59.22	51.31	65.26	58.00	73.45	61.46
Mean	57.72	50.01	63.34	56.11	68.92	59.40
Thickness 1 (mm)	7.84	6.65	8.27	6.21	7.99	6.94
Thickness 2 (mm)	8.11	5.68	7.77	5.71	8.03	6.76
Thickness 3 (mm)	8.31	6.11	8.20	6.61	8.27	6.54
Mean	8.09	6.15	8.08	6.18	8.10	6.75
Mass of initial sample (g)	16.645		19.965		21.083	
Mass of dried sample (g)	2.223		2.561		2.692	
Mass rehydrated sample (g)	3.89		4.96		5.55	

Appendix 6. Experimental data of sliced golden delicious apple at 60 °C for samples 4 to 6.

Samples measurements	60 °C Sample 4		60 °C Sample 5		60 °C Sample 6	
	Fresh	Dried	Fresh	Dried	Fresh	Dried
Diameter 1 (mm)	71.19	59.54	65.12	60.15	60.45	48.86
Diameter 2 (mm)	75.64	61.45	68.91	60.83	61.31	49.35
Mean	73.42	60.50	67.02	60.49	60.88	49.11
Thickness 1 (mm)	8.62	6.41	7.32	6.76	7.92	6.47
Thickness 2 (mm)	7.59	6.62	7.22	6.88	7.91	6.20
Thickness 3 (mm)	7.30	7.16	7.84	6.29	8.38	6.12
Mean	7.84	6.73	7.46	6.64	8.07	6.26
Mass of initial sample (g)	21.605		18.814		17.112	
Mass of dried sample (g)	2.73		2.355		2.195	
Mass of rehydrated sample (g)	5.36		5.23		4.22	

Appendix 7. RGB data of sliced golden delicious apple for fresh samples before drying at 40 °C.

Color measurements	Fresh samples					
	Sample 1	Sample 2	Sample 3	Sample 4	Sample 5	Sample 6
R	519	504	686	711	561	406
	569	595	743	740	438	383
	535	524	742	703	410	329
	-	490	741	752	442	330
	-	482	736	701	460	360
Mean	541	519	730	721	462	362
Overall Mean	556*					
G	438	408	603	634	471	350
	490	519	676	659	397	339
	455	432	673	624	323	289
	-	423	681	688	357	291
	-	504	662	623	369	306
Mean	461	457.2	659	645.6	383.4	315
Overall Mean	487*					
B	238	216	393	427	291	217
	290	316	489	459	222	225
	257	233	487	414	161	155
	-	228	503	478	192	161
	-	302	454	417	208	202
Mean	262	259	465	439	215	192
Overall Mean	305*					

R: Red; G: Green; B: Blue; \* Should be divided by 4 to be in the range between 0 and 255 to convert to Lab values.

Appendix 8. RGB data of sliced golden delicious apple at 40 °C for dried samples.

Color indicators	Dried samples					
	Sample 1	Sample 2	Sample 3	Sample 4	Sample 5	Sample 6
R	368	343	537	393	282	160
	288	390	504	395	203	110
	308	378	528	465	339	148
	-	402	579	419	229	191
	-	410	550	452	232	111
Mean	321	385	540	425	257	144
Overall Mean	345*					
G	262	240	397	291	209	109
	199	276	371	297	151	074
	216	271	383	391	265	105
	-	299	425	319	169	131
	-	282	382	320	164	087
Mean	226	274	392	324	192	101
Overall Mean	251*					
B	140	117	212	151	112	058
	097	141	199	163	081	041
	108	135	205	230	149	059
	-	161	228	172	089	059
	-	136	185	169	085	050
Mean	115	138	206	177	103	53
Overall Mean	132*					

R: Red; G: Green; B: Blue; \* Should be divided by 4 to be in the range between 0 and 255 to convert to Lab values.

Appendix 9. RGB data of sliced golden delicious apple for fresh samples before drying at °C.

Color measurements	Fresh samples					
	Sample 1	Sample 2	Sample 3	Sample 4	Sample 5	Sample 6
R	687	634	570	602	550	567
	520	655	614	763	500	472
	595	725	636	644	541	551
	531	667	516	760	529	590
	619	653	566	790	459	452
Mean	590	667	580	712	516	526
Overall Mean	599*					
G	617	577	503	547	495	516
	450	594	559	694	450	422
	526	611	585	590	484	500
	454	602	446	698	464	527
	541	583	516	730	403	408
Mean	518	593	522	652	459	475
Overall Mean	536*					
B	407	345	303	392	331	370
	271	373	364	485	301	276
	334	477	365	388	316	360
	267	384	261	508	310	360
	344	342	335	530	261	268
Mean	325	384	326	461	304	327
Overall Mean	354*					

R: Red; G: Green; B: Blue; \* Should be divided by 4 to be in the range between 0 and 255 to convert to Lab values.

Appendix 10. RGB data of sliced golden delicious apple at 50 °C for dried samples.

Color measurements	Dried samples					
	Sample 1	Sample 2	Sample 3	Sample 4	Sample 5	Sample 6
R	131	332	152	122	228	415
	140	300	168	236	219	369
	156	368	174	187	238	360
	141	347	242	261	202	423
	163	360	164	204	269	390
Mean	146	341	180	202	231	391
Overall Mean	249*					
G	079	207	096	087	134	302
	083	184	112	141	124	268
	095	240	121	119	136	240
	087	225	153	180	115	303
	099	234	108	143	160	261
Mean	89	218	118	134	134	275
Overall Mean	161*					
B	036	109	042	056	068	166
	039	099	052	074	066	146
	048	133	068	067	062	116
	045	123	064	095	051	165
	050	127	049	080	069	137
Mean	44	118	55	74	63	146
Overall Mean	83*					

R: Red; G: Green; B: Blue; \* Should be divided by 4 to be in the range between 0 and 255 to convert to Lab values.

Appendix 11. RGB data of sliced golden delicious apple for fresh samples before drying at 60 °C.

Color measurement	Fresh samples					
	Sample 1	Sample 2	Sample 3	Sample 4	Sample 5	Sample 6
R	578	617	537	779	511	601
	628	525	509	778	451	590
	606	583	609	787	628	611
	659	644	685	770	533	620
	662	548	647	741	637	519
Mean	627	583	597	771	552	588
Overall Mean	620*					
G	502	519	428	707	452	536
	555	439	402	698	385	534
	531	517	515	708	561	552
	593	538	595	692	469	570
	599	462	591	654	575	469
Mean	556	495	506	692	488	532
Overall Mean	545*					
B	291	290	271	509	301	384
	330	228	241	499	237	334
	293	279	311	500	404	357
	381	304	371	495	336	366
	400	251	381	447	438	282
Mean	339	270	315	490	343	345
Overall Mean	350*					

R: Red; G: Green; B: Blue; \* Should be divided by 4 to be in the range between 0 and 255 to convert to Lab values.



Appendix 12. RGB data of sliced golden delicious apple at 60 °C for dried samples.

Color measurements	Dried samples					
	Sample 1	Sample 2	Sample 3	Sample 4	Sample 5	Sample 6
R	141	126	139	118	134	104
	140	125	172	214	098	110
	155	154	169	147	086	171
	127	134	197	160	184	165
	133	114	141	176	123	116
Mean	139	131	164	163	125	133
Overall Mean	142*					
G	089	086	085	070	080	071
	088	082	102	126	064	062
	098	100	099	086	054	096
	078	089	116	092	111	094
	081	077	082	102	073	074
Mean	87	87	97	95	76	79
Overall Mean	87*					
B	051	049	056	046	050	053
	054	053	064	072	046	034
	058	058	061	057	043	057
	047	046	068	051	058	058
	047	048	051	055	042	052
Mean	51	51	60	56	48	51
Overall Mean	53*					

R: Red; G: Green; B: Blue; \* Should be divided by 4 to be in the range between 0 and 255 to convert to Lab values.

Appendix 13. Lab data of sliced golden delicious apple at 40 °C.

Color measurements	Fresh samples					
	Sample 1	Sample 2	Sample 3	Sample 4	Sample 5	Sample 6
$L_o^*$	49.26	48.46	68.21	66.76	41.76	34.04
Mean	51.42					
$a_o^*$	1.00	-0.77	-0.71	-0.48	2.23	0.11
Mean	0.23					
$b_o^*$	29.85	29.30	27.81	29.11	26.85	20.11
Mean	27.17					
Color measurements	Dried samples					
	Sample 1	Sample 2	Sample 3	Sample 4	Sample 5	Sample 6
$L^*$	25.92	31.51	44.42	36.24	21.13	9.79
Mean	28.17					
$a^*$	6.56	7.38	9.62	5.59	4.03	3.54
Mean	6.12					
$b^*$	21.23	24.81	31.68	25.56	16.79	9.27
Mean	21.56					

$L_o^*$ ,  $a_o^*$  and  $b_o^*$  represent the fresh samples whereas  $L^*$ ,  $a^*$  and  $b^*$  represent the dried samples. The  $L^*$  colour parameter range from 0 (blackness) to 100 (whiteness). The  $a^*$  parameter is from  $-128$  (greenness) to  $+128$  (redness) and the  $b^*$  parameter is  $-128$  (blueness) to  $+128$  (yellowness).

Appendix 14. Lab data of sliced golden delicious apple at 50 °C.

Color measurements	Fresh samples					
	Sample 1	Sample 2	Sample 3	Sample 4	Sample 5	Sample 6
$L_o^*$	54.92	61.86	54.93	67.21	48.82	50.34
Mean	56.35					
$a_o^*$	-0.20	-0.41	-1.95	-1.77	-0.55	-0.79
Mean	-0.95					
$b_o^*$	28.98	30.05	28.38	26.95	23.57	22.21
Mean	26.69					
Color measurements	Dried samples					
	Sample 1	Sample 2	Sample 3	Sample 4	Sample 5	Sample 6
$L^*$	8.92	26.03	12.72	14.93	15.91	31.78
Mean	18.38					
$a^*$	6.04	10.41	5.02	5.99	9.37	8.52
Mean	7.56					
$b^*$	8.95	20.92	13.03	13.24	16.49	24.03
Mean	16.11					

$L_o^*$ ,  $a_o^*$  and  $b_o^*$  represent the fresh samples whereas  $L^*$ ,  $a^*$  and  $b^*$  represent the dried samples. The  $L^*$  colour parameter range from 0 (blackness) to 100 (whiteness). The  $a^*$  parameter is from  $-128$  (greenness) to  $+128$  (redness) and the  $b^*$  parameter is  $-128$  (blueness) to  $+128$  (yellowness).

Appendix 15. Lab data of sliced golden delicious apple at 60 °C.

Color measurements	Fresh samples					
	Sample 1	Sample 2	Sample 3	Sample 4	Sample 5	Sample 6
$L^*_O$	58.31	52.89	54.17	71.32	51.83	55.74
Mean	57.38					
$a^*_O$	-0.90	0.99	1.71	-0.11	0.61	-1.75
Mean	0.09					
$b^*_O$	31.28	33.46	29.14	28.35	21.99	27.25
Mean	28.58					
Color measurements	Dried samples					
	Sample 1	Sample 2	Sample 3	Sample 4	Sample 5	Sample 6
$L^*$	8.66	8.36	10.25	10.23	7.08	7.70
Mean	8.71					
$a^*$	5.18	4.07	7.25	7.13	4.89	5.54
Mean	5.68					
$b^*$	7.62	7.16	9.01	9.50	5.72	6.21
Mean	7.54					

$L^*_O$ ,  $a^*_O$  and  $b^*_O$  represent the fresh samples whereas  $L^*$ ,  $a^*$  and  $b^*$  represent the dried samples. The  $L^*$  colour parameter range from 0 (blackness) to 100 (whiteness). The  $a^*$  parameter is from  $-128$  (greenness) to  $+128$  (redness) and the  $b^*$  parameter is  $-128$  (blueness) to  $+128$  (yellowness).



Appendix 16. MA 50/1.R moisture analyzer showing some drying functions.

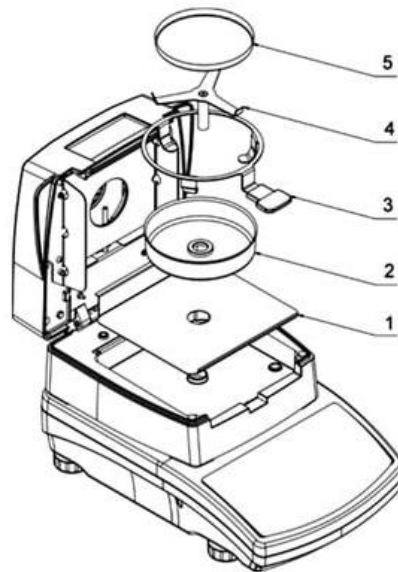

1. Drying chamber base insert
2. Drying pan shield
3. Drying pan handle
4. Cross-shaped holder
5. Disposable pan

Appendix 17. MA 50/1.R moisture analyzer showing the main parts for the drying operation (Selvi et al., 2020)

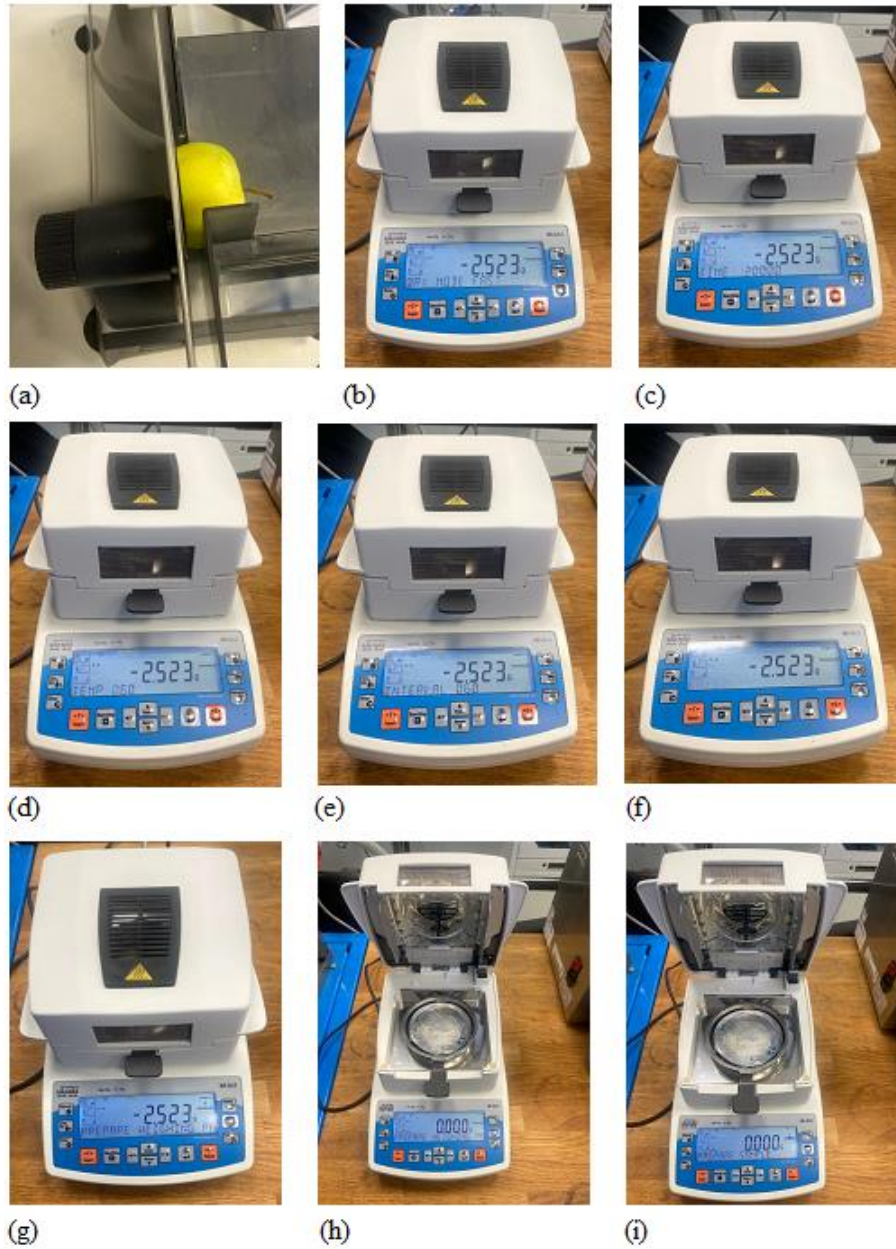

Appendix 18. The drying process of a sliced apple using the moisture analyzer Radwag MA 50/1.R (a) Cut the apples into thin layers (b) Set the mode of the infrared dryer; in this case “fast”(c) Set the time for the drying process (d) Set the temperature (e) Set the interval (f) Save (g) Prepare the weighing pan (h) Tare the device and (i) Prepare sample.



(a)



(b)

Appendix 19. The drying process of a sliced apple using the moisture analyzer Radwag MA 50/1.R (a) Sample is added to the weighing pan and weighed. (b) Drying process begins.