



# BRNO UNIVERSITY OF TECHNOLOGY

VYSOKÉ UČENÍ TECHNICKÉ V BRNĚ

## FACULTY OF ELECTRICAL ENGINEERING AND COMMUNICATION

FAKULTA ELEKTROTECHNIKY  
A KOMUNIKAČNÍCH TECHNOLOGIÍ

## DEPARTMENT OF RADIO ELECTRONICS

ÚSTAV RADIOELEKTRONIKY

## LABORATORY WORKPLACE FOR MEASURING PERFORMANCES OF DVB-T2/T2-LITE

MĚŘENÍ A ANALÝZA TV SIGNÁLU V SYSTÉMU DVB-T2

### BACHELOR'S THESIS

BAKALÁŘSKÁ PRÁCE

### AUTHOR

AUTOR PRÁCE

Kristina Youssefová

### SUPERVISOR

VEDOUCÍ PRÁCE

doc. Ing. Ladislav Polák, Ph.D.

BRNO 2019

# Bakalářská práce

bakalářský studijní obor **Elektronika a sdělovací technika**  
Ústav radioelektroniky

**Studentka:** Kristina Youssefová

**ID:** 205961

**Ročník:** 3

**Akademický rok:** 2018/19

## NÁZEV TÉMATU:

### Měření a analýza TV signálu v systému DVB-T2

#### POKYNY PRO VYPRACOVÁNÍ:

V teoretické části práce prostudujte vlastnosti vysílacího a přijímacího řetězce standardu DVB-T2 pro zemské digitální vysílání druhé generace a způsob měření a vyhodnocení jeho parametrů. Zaměřte se taky na popis kvadraturního modulátoru. Na základě získaných teoretických znalostí a předpokladů navrhnete a realizujete kompletní laboratorní pracoviště pro měření vysílání a příjem TV signálu DVB-T2.

V experimentální části práce provedte měření a analýzu příjmu TV signálu DVB-T2. Při měření uvažujte různé přenosové scénáře a systémové parametry DVB-T2 (např. rotovaná konstelace) a případné nedokonalosti kvadraturního modulátoru (např. amplitudové nevyvážení, fázová chyba). Výsledky laboratorních měření v rámci možností porovnejte s teoretickými předpoklady. Navrhnete laboratorní úlohu pro měření různých přenosových scénářů DVB-T2 a připravte vzorové vypracování navržené úlohy.

#### DOPORUČENÁ LITERATURA:

[1] FISCHER, Walter. Digital Video and Audio Broadcasting Technology: A Practical Engineering Guide. 3rd ed. Berlin: Springer, 2010. ISBN 978-3-642-11611-7.

[2] POLAK, Ladislav, Tomas KRATOCHVIL. Influence of IQ-errors on DVB-T2 performance and its suppression by different methods. In: 12th International Conference BMSB. IEEE, 2017, 2017, s. 1-5. ISBN: 978-1-5090-4-37-0.

**Termín zadání:** 4.2.2019

**Termín odevzdání:** 23.5.2019

**Vedoucí práce:** doc. Ing. Ladislav Polák, Ph.D.

**Konzultant:**

**prof. Ing. Tomáš Kratochvíl, Ph.D.**  
*předseda oborové rady*

#### UPOZORNĚNÍ:

Autor bakalářské práce nesmí při vytváření bakalářské práce porušit autorská práva třetích osob, zejména nesmí zasahovat nedovoleným způsobem do cizích autorských práv osobnostních a musí si být plně vědom následků porušení ustanovení § 11 a následujících autorského zákona č. 121/2000 Sb., včetně možných trestněprávních důsledků vyplývajících z ustanovení části druhé, hlavy VI. díl 4 Trestního zákoníku č.40/2009 Sb.

## **Abstrakt**

Tato práce se zaměřuje na zkoumání vlastností standardu pro digitální televizní vysílání přes pozemní vysílače (DVB-T2). Dělí na tři hlavní části. V první části je prozkoumán řetězec signálového zpracování DVB-T2. Ohled je rovněž brán na možný nepoměr I/Q v modulátoru OFDM. V druhé části je navrhnuté laboratorní měřicí pracoviště pro měření vlastností systému DVB-T2. Ve třetí části je ověřena správnost navrhnutého postupu pomocí rozsáhlých experimentálních měření. Součástí této práce byl návrh laboratorní úlohy, která se zabývá měřením různých přenosových scénářů DVB-T2.

## **Klíčová slova**

DVB-T2, SISO, C/N, BER, MER, I/Q nevyvážení, kanálové modely, RF měření.

## **Abstract**

This work focuses on the exploring of the properties of the second generation terrestrial digital video broadcasting standard (DVB-T2). This work can be divided onto three main parts. In the first part, the signal processing chain in the standard DVB-T2 is studied. Possible I/Q-Imbalances in DVB-T2 OFDM modulator are also taken into account. In the second one, a laboratory measurement workplace is proposed to measure the performance of DVB-T2 system. In the third one, the correctness of the proposed concept is verified by extensive experimental measurements. This work also proposes a laboratory work to measure different DVB-T2 transmission scenarios.

## **Keywords**

DVB-T2, SISO, C/N, BER, MER, I/Q errors, channel models, RF measurement.

### **Bibliografická citace:**

YOUSSEFOVÁ, Kristina. *Měření a analýza TV signálu v systému DVB-T2*. Brno, 2019.. Bakalářská práce. Vysoké učení technické v Brně, Fakulta elektrotechniky a komunikačních technologií, Ústav radioelektroniky. Vedoucí práce Ladislav Polák.

## **Prohlášení**

*„Prohlašuji, že svou bakalářskou práci na téma Měření a analýza TV signálu v systému DVB-T2 jsem vypracoval samostatně pod vedením vedoucí/ho bakalářské práce a s použitím odborné literatury a dalších informačních zdrojů, které jsou všechny citovány v práci a uvedeny v seznamu literatury na konci práce.*

*Jako autor uvedené bakalářské práce dále prohlašuji, že v souvislosti s vytvořením této bakalářské práce jsem neporušil autorská práva třetích osob, zejména jsem nezasáhl nedovoleným způsobem do cizích autorských práv osobnostních a jsem si plně vědom následků porušení ustanovení § 11 a následujících autorského zákona č. 121/2000 Sb., včetně možných trestněprávních důsledků vyplývajících z ustanovení části druhé, hlavy VI. díl 4 Trestního zákoníku č. 40/2009 Sb.*

V Brně dne: **23. května 2019**

.....  
podpis autora

## **Poděkování**

*Děkuji vedoucímu bakalářské práce Ing. Ladislavu Polákovi za účinnou metodickou, pedagogickou a odbornou pomoc a další cenné rady při zpracování mé bakalářské práce.*

V Brně dne: **23. května 2019**

.....  
podpis autora

# Content

1.	Introduction.....	14
2.	Standard DVB-T2 .....	15
2.1	Input processing .....	15
2.1.1	Mode adaptation module .....	16
2.1.2	Stream adaption .....	16
2.2	BICM Module.....	17
2.2.1	FEC encoding .....	18
2.2.2	Bit interleaving.....	18
2.2.3	Bit to cell word de-multiplexer .....	20
2.2.4	Cell word mapping into I/Q constellations.....	20
2.2.5	Constellation Rotation and Cyclic Q- Delay .....	21
2.2.6	Cell interleaving.....	22
2.2.7	Time interleaving .....	23
2.3	Frame structure .....	24
2.3.1	Frequency interleaver .....	26
2.4	OFDM generation .....	26
2.4.1	Pilot insertion.....	26
2.4.1.1	Scattered pilots.....	27
2.4.1.2	Continual Pilots.....	28
2.4.1.3	Edge pilots .....	28
2.4.2	Peak to Average Power Ratio reduction.....	28
2.4.3	Guard interval insertion.....	29
3.	The Modulator in DVB-T2.....	30
3.1	I/Q Errors of the Modulator in DVB-T2 .....	30
3.1.1	Amplitude Imbalance (AI).....	31
3.1.2	Phase imbalance (PI).....	31
4.	Transmission channel models used for DVB-T2.....	33
4.1	Gaussian Channel.....	33
4.2	Ricean Channel .....	33
4.3	Rayleigh Channel .....	34

5.	LABORATORY WORKPLACE TO MEASURE THE RECEIVED DVB-T2 SIGNAL .....	35
5.1	The proposed scheme .....	35
5.2	DVB-T2 parameters .....	36
5.2.1	Bit Error Ratio (BER)before and after LDPC .....	36
5.2.2	Modulation Error Ratio (MER) .....	37
5.2.3	Carrier to Noise ratio(C/N).....	37
5.2.4	The minimum required power for demodulating DVB-T2 signals .....	37
5.2.5	The number of decoding iterations .....	37
6.	Measurement procedure .....	38
6.1	Scenario1:Multi frequency network (MFN) rooftop reception .....	38
6.1.1	Measurement results for scenario 1.....	38
6.1.1.1	BER Parameter Measurement.....	38
6.1.1.2	MER Parameter Measurement.....	39
6.1.1.3	The Number of Iterations Parameter Measurement.....	42
6.1.1.4	Scenario 1 – Objective versus Subjective Results .....	42
6.2	Scenario 2: Single frequency network(SFN) rooftop reception .....	46
6.2.1	Measurement results for scenario 2.....	46
6.2.1.1	BER Parameter Measurement.....	46
6.2.1.2	MER Parameter Measurement.....	47
6.2.1.3	The Number of Iterations Parameter Measurement.....	50
6.2.1.4	Scenario 2- Objective versus Subjective Results.....	50
6.3	Scenario 3: Portable reception .....	54
6.3.1	Measurement results for scenario 3.....	54
6.3.1.1	BER Parameter Measurement.....	54
6.3.1.2	MER Parameter Measurement.....	55
6.3.1.3	The Number of Iterations Parameter Measurement.....	58
6.3.1.4	Scenario 3 – Objective versus Subjective Results .....	58
7.	Conclusion .....	62



## List of Abbreviations

AI	Amplitude Imbalance
AWGN	Additive white Gaussian Noise
BBFRA	Base Band Frame
BCH	Bose–Chaudhuri–Hocquenghem
BER	Bit Error Rate
BICM	Bit-interleaved coding and modulation
CBR	Constant Bit Rate
CRC-8	Cyclic Redundancy Check codes
DNP	Deleted Non-Packets
DVB-T2	Digital Video Broadcasting - Second Generation Terrestrial
FEC	Forward Error Correction
FEF	Future Extension Frame
FFT	Fast Fourier Transform
GFPS	Generic Packetized Stream
GS	Generic Stream
IF	Interleaving Frame
ISI	Inter Symbol Interference
ISSY	Input Stream Synchronization
LDPC	Low-Density Parity-Check
MER	Modulation Error Ratio
MISO	Multiple Input Single Output
SISO	Single Input Single Output
PAPR	Peak-to-Average Power Ratio
OFDM	Orthogonal Frequency Division Multiplexing
PI	Phase Imbalance
PLP	Physical Layer Pipe
PRBS	Pseudo Random Binary Sequence
PSK	Phase-shift keying
QAM	Quadrature amplitude modulation.
TI	Time Interleaving
TS	Transport Stream

## List of Figures

Figure.2-1:Simplified block diagram of the DVB-T2 system[2] .....	15
Figure.2-2:Input processing module(based on [2]) .....	16
Figure.2-3:BB frame format[2] .....	17
Figure.2-4:PRBS generator [2] .....	17
Figure.2-5:Bit Interleaved Coding and Modulation (BICM) ( based on [2]) .....	17
Figure.2-6: FEC Frame format [2] .....	18
Figure.2-7:Bit Interleaving [2] .....	19
Figure. 2-8:De-multiplexing of bits into sub-streams (based on [2]).....	20
Figure.2-9 : Mapping cells into constellation diagrams: (a) 16QAM, (b) QPSK [2]	21
Figure.2-10 :Rotated Q-delayed constellation diagram – 16QAM [3].....	21
Figure. 2-11:Cell interleaving[3].....	22
Figure.2-12 : 1 IF =1 TI-block , 1 IF=1 T2-frame (based on [2]).....	23
Figure.2-13: 1 IF=1 TI-block , 1 IF= several T2-frames (based on [2]) .....	23
Figure.2-14: 1 IF = many TI-blocks , 1 IF = 1 T2-frame(based on[2]).....	24
Figure.2-15 :Time interleaving[2] .....	24
Figure.2-16:Super frame and T2-frame and symbols( based on [2]) .....	25
Figure.2-17:OFDM generation (based on[2]) .....	26
Figure.2-18: Scattered pilot pattern PP2(SISO) [4] .....	28
Figure.2-19 :Constellation Extension method [3] .....	29
Figure.2-20: inserting the guard interval .....	29
Figure.3. 1:The DVB-T2 modulator[5] .....	30
Figure.3. 2:The DVB-T2 modulator with I/Q errors[5] .....	31
Figure.3. 3: 16-QAM constellation diagrams : (a) AI=0%,PI=0° (b) AI=10%,PI=0°(c) AI=0%,PI=10° .....	32
Figure .4-1 : Gaussian channel .....	33
Figure.4-2 :Ricean channel .....	34
Figure.4-3 :Rayleigh channel .....	34
Figure.5-1:The supposed block diagram for measuring DVB-T2 signal .....	35

Figure.6-1:BER before LDPC decoding vs. C/N in AWGN channel (Scenario 1) ..	40
Figure.6-2:BER before LDPC decoding vs. C/N in RC20 channel (Scenario 1) .....	40
Figure.6-3:BER before LDPC decoding vs. C/N in RL20 channel (Scenario 1) .....	40
Figure.6-4:MER vs. C/N in AWGN channel (scenario 1).....	41
Figure.6-5:MER vs. C/N in RC20 channel (scenario 1).....	41
Figure.6-6:MER vs. C/N in RL20 channel (scenario 1).....	41
Figure.6-7:LDPC iterations vs. C/N (Scenario 1) .....	42
Figure.6-8:Snapshots of the 256-QAM constellation diagrams in AWGN channel (a) AI=0% and PI=0°, (b) AI=5% and PI=5°. In RC20 channel (c) AI=0% and PI=0° (d) AI=5% and PI=5°. In RL20 channel (e) AI=0% and PI=0° (f) AI=5% and PI=5° ..	44
Figure.6-9: Snapshots of the 256-QAM spectrum diagrams in AWGN channel (a) AI=0% and PI=0° (b) AI=5% and PI=5°. In RC20 channel : (c) AI=0% and PI=0° (d) AI=5% and PI=5°. In RL20 channel : (e) AI=0% and PI=0° (f) AI=5% and PI=5°, All spectrum diagrams were captured at C/N=30 dB, Frequency =689 MHz. ....	45
Figure.6-10:BER before LDPC decoding vs. C/N in AWGN channel(scenario2) ..	48
Figure.6-11:BER before LDPC decoding vs. C/N in RC20 channel (scenario2) ...	48
Figure.6-12:BER before LDPC decoding vs C/N in RL20 channel (Scenario2)....	48
Figure.6-13:MER vs. C/N in the AWGN channel (Scenario2) .....	49
Figure.6-14:MER vs. C/N in RC20 channel (Scenario2) .....	49
Figure.6-15:MER vs. C/N in RL20 channel (Scenario2) .....	49
Figure.6-16:LDPC iterations vs C/N (scenario2).....	50
Figure.6-17: Snapshots of the 16-QAM constellation diagrams in AWGN channel (a) AI=0% and PI=0°, (b) AI=5% and PI=5°. In RC20 channel (c) AI=0% and PI=0° (d) AI=10% and PI=10°. In RL20 channel (e) AI=0% and PI=0° (f) AI=10% and PI=10° (scenario2).....	53
Figure.6-18:BER before LDPC decoding vs C/N in AWGN channel (Scenario3) ..	56
Figure.6-19:BER before LDPC decoding vs C/N in RC20 channel(Scenario 3) ....	56
Figure.6-20:BER before LDPC decoding vs. C/N in RL20 channel(Scenario 3)....	56
Figure.6-21: MER vs C/N in AWGN channel (scenario3).....	57
Figure.6-22: MER vs C/N in RC20 channel (Scenario3) .....	57
Figure.6-23: MER vs C/N in RL20 channel (Scenario3) .....	57
Figure.6-24:LDPC iterations vs. C/N (scenario3).....	58

Figure.6-25: Snapshots of the 16QAM constellation diagrams in AWGN channel (a) AI=0% and PI=0° (b) AI=10% and PI=10° . In RC20 channel (c) AI=0% and PI=0° (d) AI=10% and PI=10°. In RL20 channel (e) AI=0% and PI=0° (f) AI=10% and PI=10° (scenario3).....61

## List of Tables

Tab.2-1:The values of $Q_{ldpc}$ depending on the code rates[2] .....	19
Tab.2-2:Bit Interleaver structure[2].....	19
Tab.2-3:Number of sub-streams in de-multiplexer[2].....	20
Tab.2-4:The Rotation angle for each modulation type[3] .....	22
Tab.2-5:Maximum number of COFDM symbols per T2 frame [2] .....	25
Tab.2-6:Presence of the various types of pilots in each type of symbol[2].....	27
Tab.2-7: Scattered pilot pattern to be used for each allowed combination of FFT size and guard interval in SISO mode[2].....	27
Tab.6-1:System Parameters of DVB-T2 for Scenario 1 [4].....	38
Tab. 6-2:QEF table(scenario1).....	43
Tab.6-3: System Parameters of DVB-T2 for scenario2 [4] .....	46
Tab. 6-4:QEF table (scenario2).....	51
Tab. 6-5:QEF table when using 64-QAM (scenario2) .....	52
Tab.6-6:System Parameters of DVB-T2 for scenario3 [4].....	54
Tab.6-7:QEF table (scenario3).....	59
Tab.6-8:QEF table for CR =3/4(scenario3) .....	60

# 1. INTRODUCTION

The second generation terrestrial DVB standard (DVB-T2), as the successor of DVB-T, was firstly published in 2008. Nowadays, it is the world's most advanced digital terrestrial TV system. Compared to DVB-T, it is more flexible and provides higher quality and advanced signal processing chains and additional system parameters make it more efficient (at least 50%) [1].

This work focuses on the exploring of the properties of DVB-T2 standard. This standard uses advanced algorithms to provide the best service. For instance, the High Efficiency Video Coding (HEVC) is used to improve the quality. It also uses advanced methods to protect the DVB-T2 signal against high noise levels and interferences. The new error protection techniques allow the usage of such high modulation schemes (256-QAM). This and the improved protection technique greatly improve the DVB-T2 capacity [1].

This thesis is divided into seven chapters. The basic signal processing chain in the DVB-T2 is briefly described in section 2. Section 3 studies the possible imperfections of a quadrature modulator. Section 4 deals with the presentation of the fading channel models that will be used in this work to emulate transmission conditions for DVB-T2 broadcasting. A laboratory measurement workplace proposed to measure the performance of DVB-T2 is presented in section 5. This section also includes a brief description of the measured parameters used to evaluate the performance of DVB-T2. Outputs from measurements and their discussion are presented in section 6. Finally, this thesis is concluded by section 7.

## 2. STANDARD DVB-T2

DVB-T2 is the second generation of the television standard DVB-T. The transition from DVB-T to DVB-T2 gives a lot of benefits where, it becomes possible to transmit a larger number of programs in the same radio frequency (RF) spectrum that has used in DVB-T. Compared to DVB-T, The net data rate is increased about 30% and about 50% [2]. DVB-T2 is also very flexible system where; it provides additional options for modulation type, code rate, guard interval and pilot signals. DVB-T2 uses an additional modulation mode: 256-QAM which helps to increases the DVB-T2 capacity. This standard uses very efficient methods to protect the signal against interferences, low density parity check (LDPC) and Bose Chaudhuri Hocquengham (BCH) are used to protect the DVB-T2 signal against errors. In this thesis the DVB-T2 system will be studied in greater detail.

The module of DVB-T2 is shown in Figure.2-1. The input pre-processor, which is not a part of T2-system, makes it possible to transmit many services at the same time by grouping them into many Physical Layer Pipes (PLPs). The T2 system is split into many parts: Input processing, Bit-Interleaved Coding and Modulation, Frame structure and OFDM symbol generation modules.

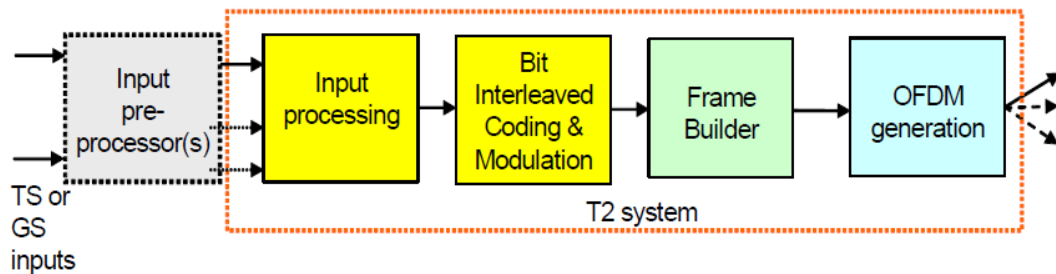

**Figure.2-1: Simplified block diagram of the DVB-T2 system[2]**

### 2.1 Input processing

This module is divided into two parts (see Figure.2-2). The first one is called the mode adaption module. It slices the input data stream into data fields. These fields are called baseband frames (BBFRAMEs). After that the baseband headers are inserted in front of the BBFRAME. The second one is called the stream adaption module. In this part, we adjust the baseband frame and scramble it.

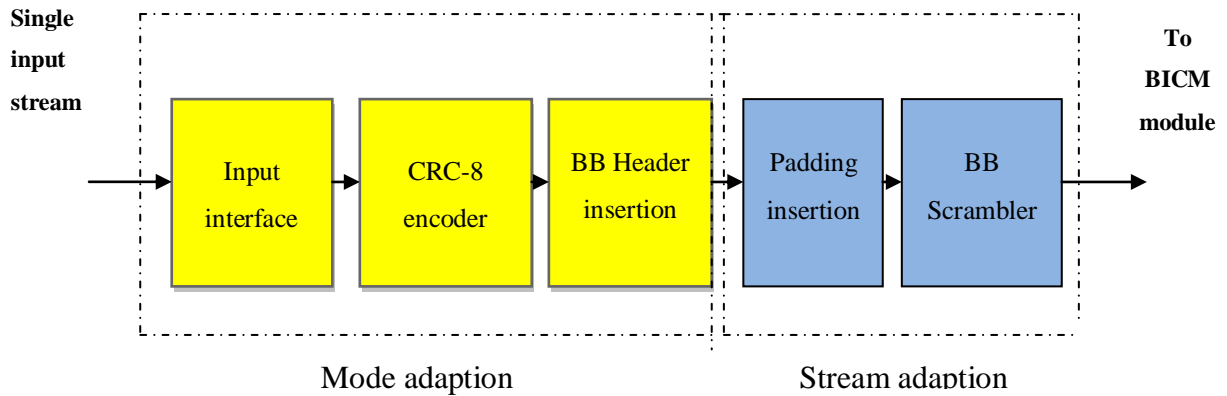

**Figure.2-2:Input processing module(based on [2])**

### 2.1.1 Mode adaptation module

The input to the mode adaption module consists of one PLP, which contains the input data stream: MPEG-2 Transport Stream (TS) or Generic Stream (GS). This module begins with the input interface, which forms the BBFRAME data. After that, the Input Stream Synchronization (ISSY) field is inserted in order to maintain Constant Bit Rate (CBR). The Null Packet Deletion is used to maintain Constant bit rate (CBR). These packets shouldn't be transmitted because they are non-data bits necessary for transmission. For this reason, they are removed and the number of removed Null packets is placed in Deleted Non-Packets (DNP) counter. So that, the receiver will be able to re-insert null packets at the appropriate place. Cyclic Redundancy Check codes (CRC-8) encoding is used to allow the receiver to detect the transmission errors in the stream. The mode adaptation module ends with inserting the baseband header (BBHEADER) at the start of each data BBFRAME. This header gives information about the data field. For instance: The data format (Generic Packetized Stream (GFPS), Transport Stream (TS)), if we used MISO or SISO mode, etc [2].

### 2.1.2 Stream adaption

Stream adaption module consists of - Padding process followed by BB scrambling. Padding is used when the length of the data is in addition to the length of the BBHEADER does not achieve the required length of BBFRAME ( $k_{bch}$  bits) (see Figure.2-3) where,  $k_{bch}$ , is the number of bits protected by the low density parity check (LDPC) and Bose Chaudhuri Hocquengham (BCH) codes and its value depends on the selectable LDPC rate. BB scrambling provides error protection where, a Pseudo



Random Binary Sequence (PRBS) scramble completely the BBFRAME [2]. The output of this block will be a random BBFRAME (see Figure.2-4).

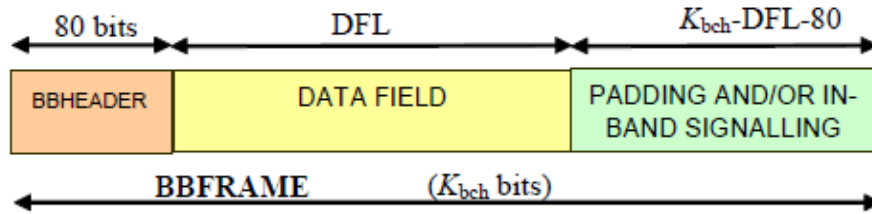

Figure.2-3:BB frame format[2]

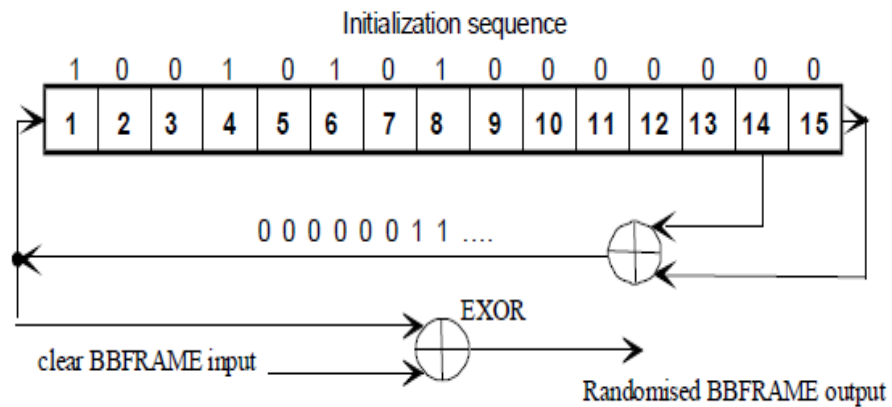

Figure.2-4:PRBS generator [2]

## 2.2 BICM Module

Bit-interleaved coding and modulation (BICM) module of DVB-T2 is shown in Figure.2-5

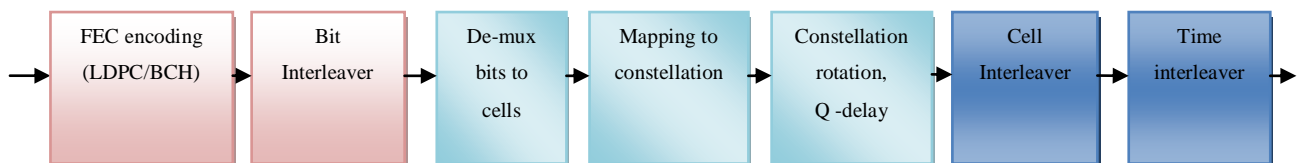

Figure.2-5:Bit Interleaved Coding and Modulation (BICM) ( based on [2])

## 2.2.1 FEC encoding

The random BBFRAME is supplied to the Forward Error Correction (FEC) block. This block consists of: outer coding (BCH) followed by Inner Coding (LDPC) and bit interleaving. FEC encoding protects the stream from errors that can be caused by noisy communication channel. The parity bits BCH are first added to BBFRAME. After that, the parity bits LDPC is added in the LDPC encoder (see Figure.2-6) where, its length depends on the selectable code rate. The code rates for frames with length ( $N_{ldpc} = 64800$  bits) are:  $1/2, 3/5, 2/3, 3/4, 4/5, 5/6$  whereas, the code rates for frames with length ( $N_{ldpc} = 16200$ ) are:  $1/4, 1/3, 2/5, 1/2, 3/5, 2/3, 3/4, 4/5, 5/6$  [3]. The minimum code rate provides maximum error protection and minimum data rate while the maximum code rate provides minimum protection and maximum data rate [3].

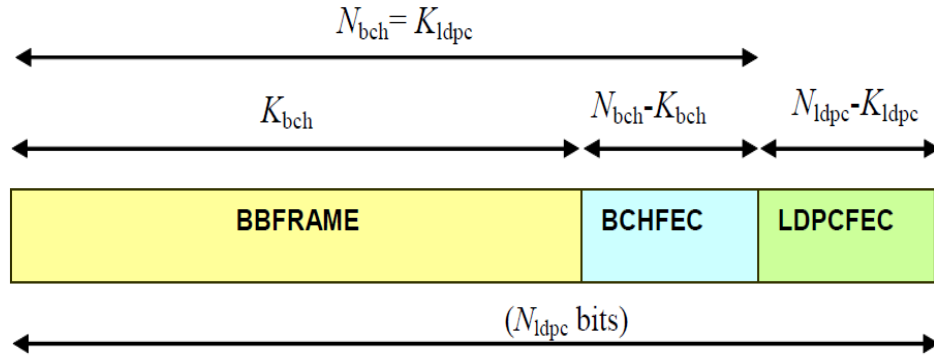

Figure.2-6: FEC Frame format [2]

## 2.2.2 Bit interleaving

A bit interleaving is applied on the FEC block. It makes the output of LDPC encoder more robust to group errors (burst errors). This type of interleaving consists of parity interleaving followed by column twist interleaving. In Parity interleaving, the parity bits of FEC block are interleaved by this equation [3]:

$$u_{k_{ldpc}} + 360t + s = \lambda_{k_{ldpc}} + Q_{ldpc}s + t \quad (2.1)$$

where,  $\lambda$  is the output of the LDPC encoder,  $u$  is the output of parity interleaving  $Q_{ldpc}$  is a parameter that depends on a selectable code rate for LDPC encoder (see Tab.2-1).

**Tab.2-1: The values of  $Q_{ldpc}$  depending on the code rates[2]**

LDPC code	Normal frame	Short frame
	$Q_{ldpc}$	$Q_{ldpc}$
1/4	-	36
1/2	90	25
3/5	72	18
3/5	60	15
3/5	45	12
4/5	36	10
5/6	30	8

In the column twist interleaving process, the parity interleaver output is written into the columns and read into rows (see Figure.2-7). The start position of each column when writing is specified by twist parameter ( $t_c$ ) [2]. The column twist interleaving parameters depend on the selectable modulation (see Tab.2-2).

**Tab.2-2: Bit Interleaver structure[2]**

Modulation	Rows $N_r$		Columns $N_c$
	$N_{ldpc}=64800$	$N_{ldpc}=16200$	
16-QAM	2025	2025	8
64-QAM	5400	1350	12
256-QAM	4050	—	16
	—	2025	8

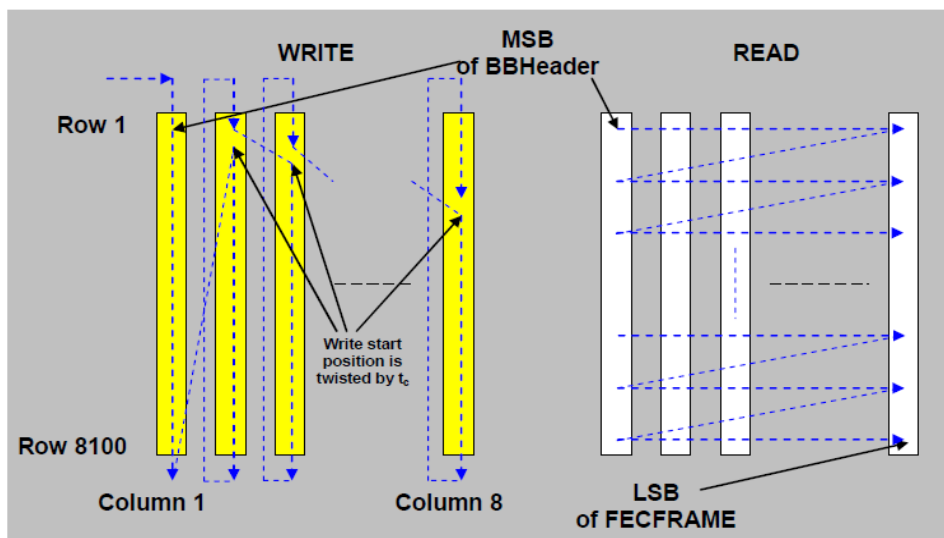

**Figure.2-7: Bit Interleaving [2]**

### 2.2.3 Bit to cell word de-multiplexer

The output bit stream from the bit interleaver is de-multiplexed into  $N$  sub-streams (see Figure.2-8). The purpose of this process is to obtain parallel cell words where each sub-stream forms one cell. The number of sub-streams depends on frame length and on the selectable modulation type (see Tab.2-3).

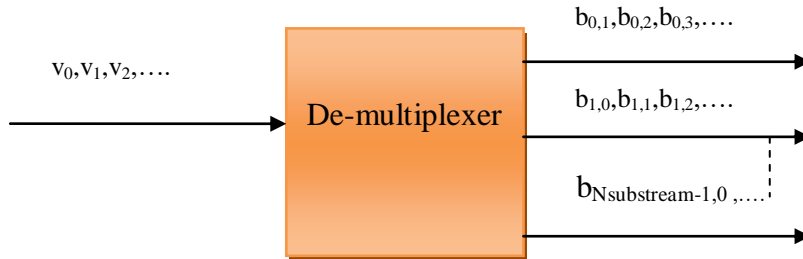

**Figure. 2-8:De-multiplexing of bits into sub-streams (based on [2])**

**Tab.2-3:Number of sub-streams in de-multiplexer[2]**

Modulation	$N_{LDPC}$	Number of sub- streams ( $N_{substreams}$ )
QPSK	All	2
16-QAM	All	8
64-QAM	All	12
256-QAM	64800	16
	16200	8

### 2.2.4 Cell word mapping into I/Q constellations

Each cell word from the de-multiplexer is mapped onto constellation points (OFDM cells). After that the Gray mapping code is applied to achieve that order where every two adjacent points in constellation diagram differ from each other by one bit (see Figure.2-9).

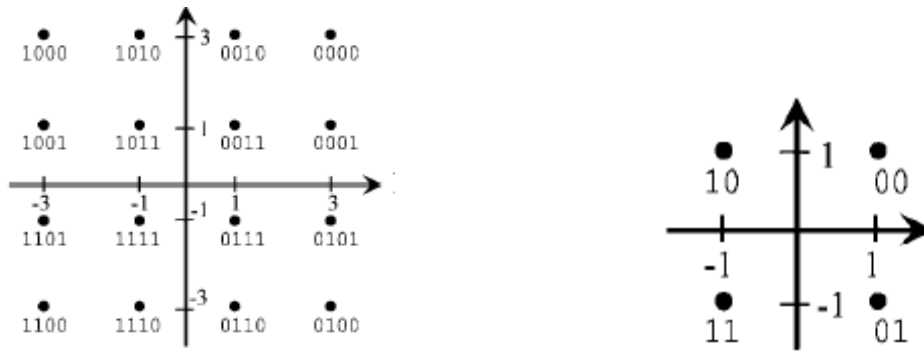

Figure.2-9 : Mapping cells into constellation diagrams: (a) 16QAM, (b) QPSK [2]

### 2.2.5 Constellation Rotation and Cyclic Q- Delay

As previously mentioned, the data is protected against errors by LDPC and BCH coding then bit and cell interleaved. The constellation rotation is used in order to improve the DVB-T2 performance when broadcasting over fading channels. This technique increases the system robustness against errors. The rotation angle  $\Phi$  depends on the modulation type (see Tab.2-4). When the constellation points are rotated, each point will have its own I and Q components. Thus each component, I or Q has enough information to know which was the transmitted OFDM cell .So that, If the channel destroys one of the components, the other component can be used to recover the information [4]. The cyclic Q delay is used to enable the I and Q components to transmit separately on different carries and at different times.

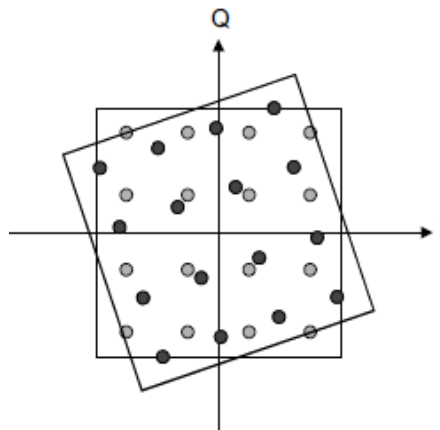

Figure.2-10 :Rotated Q-delayed constellation diagram – 16QAM [3]

**Tab.2-4:The Rotation angle for each modulation type[3]**

Modulation	QPSK	16-QAM	64-QAM	256-QAM
$\Phi(\text{degrees})$	29.0	16.8	8.6	$\text{atan}(1/16)$

## 2.2.6 Cell interleaving

This interleaving distributes the coming FEC data block randomly by using pseudo random function (see Figure.2-11). The input of cell interleaving shall be the output of the Constellation Rotation and Cyclic Q Delay while the output shall be a vector defined by [3]:

$$d_{r,l(q)} = g_{r,q} \quad (2.2)$$

where,  $r$  is the index of FEC block,  $q = 0, 1, \dots, N_{\text{cells}}-1$ ,  $L_r(q)$  is a permutation function applied to FEC codeword  $r$  of the time interleaving (TI) block and it is different for each FEC codeword of one TI Block,  $g$  is the input of the cell interleaving.

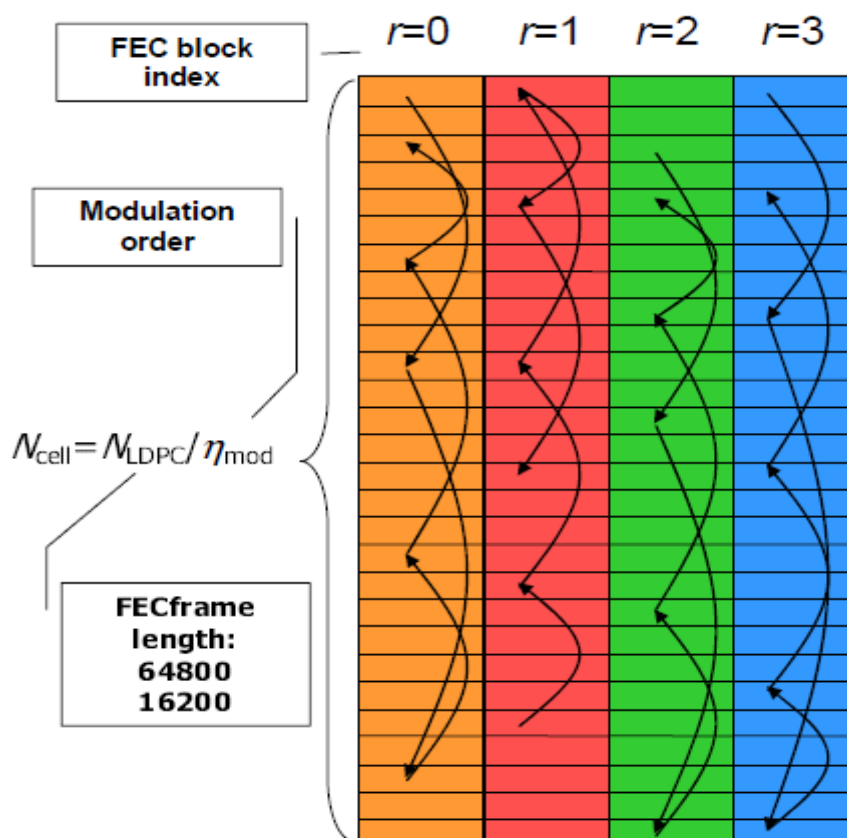

**Figure. 2-11:Cell interleaving[3]**

## 2.2.7 Time interleaving

The time interleaving helps to ensure that the I and Q values are transmitted in a separated way in time. Thus after cell interleaving, the FEC blocks are grouped into Interleaving Frames (IF). Due to fact that only one interleaving frame can be transmitted in each T2 frame, it is necessary to partition the interleaving frames into several Time Interleaving (TI) blocks in order to fit the TI memory [3]. Then the TI frames can be mapped into one T2 frame or into several T2 frames.

We distinguish three cases of time interleaving process:

- Each IF contains one TI-block and it is mapped into one T2 frame (see Figure.2-12).
- Each IF contains one TI-block and it is mapped into several T2 frame( see Figure.2-13)
- Each IF contains several TI-blocks and it is mapped into one T2 frame(see Figure.2-14)

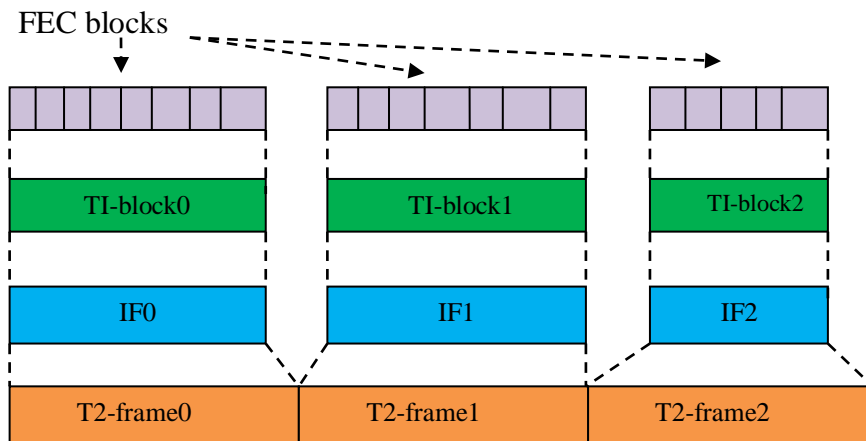

Figure.2-12 : 1 IF =1 TI-block , 1 IF=1 T2-frame (based on [2])

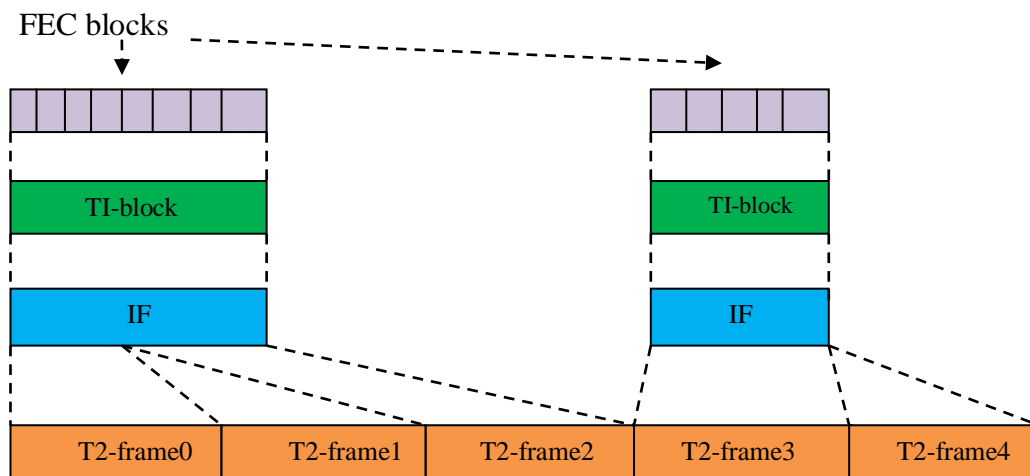
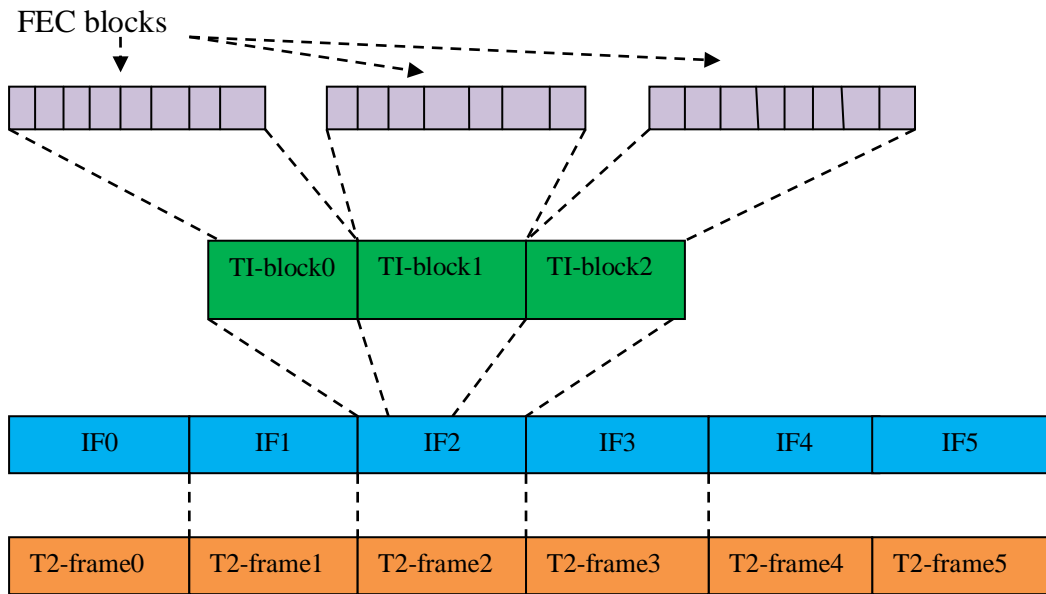
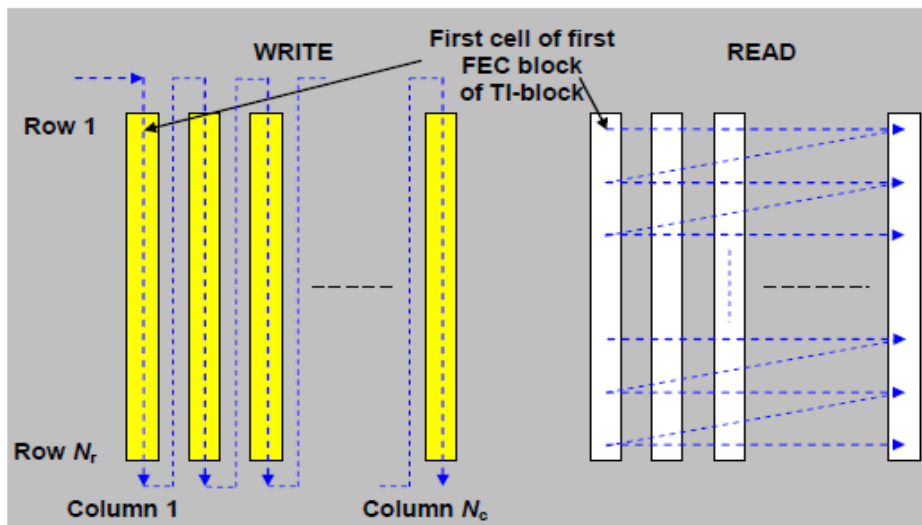

Figure.2-13: 1 IF=1 TI-block , 1 IF= several T2-frames (based on [2])



**Figure.2-14: 1 IF = many TI-blocks , 1 IF = 1 T2-frame(based on[2])**

The principle of Time interleaving is similar to the bit interleaving process (see Figure.2-15).



**Figure.2-15 :Time interleaving[2]**

### 2.3 Frame structure

The DVB-T2 frame (see Figure.2-16) consists of super frames. These super frames consist of many T2-frames and may also contain optional Future Extension Frame (FEF) parts. The maximum length of one super frame when the FEF part is not used is about 63.57 s. In this case, the super frame contains 255 T2-frames. The length varies if the FEF part is used where it equals to 127.5s [3]. The T2-frames are divided into



COFDM symbols: the P1 symbol, the P2 symbols and many data symbols. The Maximum number of COFDM symbols per one T2-frame is given in Tab.2-5. The P1 symbol carries the P1 signalling (7 bits) which indicates the transmission type and the transmission parameters, for instance, the FFT size and MISO/SISO use. The P2 symbol carries the L1-pre signalling and the L1- post signalling. They are modulated and error-protected. The L1- pre signalling has fixed parameters: The modulation type is BPSK and the used LDPC code rate is equal to 1/2. L1 pre-signalling gives information like: the guard interval fraction that used for the current super frame and the number of T2-frames in the super Frame. The L1- post signalling can use many types of modulation: BPSK which use LDPC code rate =1/2 or 1/4 and QPSK, 16 QAM, 64 QAM modulation which use LDPC code rate = 1/2 [2]. The L1-post signalling consists of: configurable and dynamic fields. These fields give the receiver necessary information to decode correctly the PLP. For instance, the payload type (TS or GES) and the modulation used by the associated PLP (QPSK, 16 QAM, 64 QAM, 256 QAM).

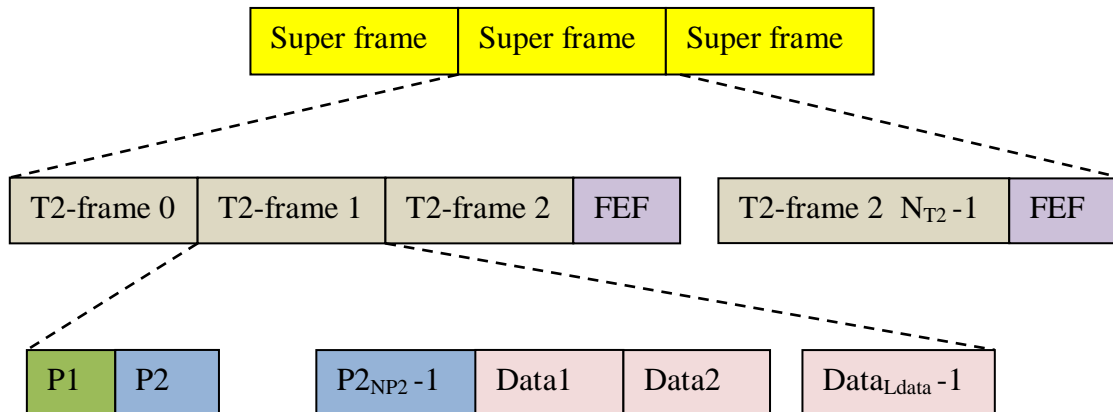

Figure.2-16:Super frame and T2-frame and symbols( based on [2])

Tab.2-5:Maximum number of COFDM symbols per T2 frame [2]

FFT size	Tu(ms)	Guard interval						
		1/128	1/32	1/16	19/256	1/8	19/128	1/4
32k	3.584	68	66	64	62	60	NA	NA
16k	1.792	138	135	131	129	123	121	111
8k	0.896	276	270	262	259	247	242	223
4k	0.448	NA	540	524	NA	459	NA	446
2k	0.224	NA	1081	1049	NA	991	NA	892
1k	0.112	NA	NA	2098	NA	1982	NA	1784

### 2.3.1 Frequency interleaver

It distributes the data cells from the frame builder randomly in the various DVB-T2 OFDM cells and then mapped them onto the available data carriers in each symbol. This process is occurred by using permutation functions which base on pseudo-random address generator. These functions are different for each FFT mode. The interleaving vector for the FFT mode 32K is defined by [3]:

$$\begin{aligned} a_{m,l,H(p)} &= x_{m,l,p} && \text{for even symbols} \\ a_{m,l,p} &= x_{m,l,H(p)} && \text{for odd symbols} \end{aligned} \quad (2.3)$$

For other modes: 1K, 2K, 4K, 8K, 16K:

$$\begin{aligned} a_{m,l,p} &= x_{m,l,H0(p)} && \text{for even symbols} \\ a_{m,l,p} &= x_{m,l,H1(p)} && \text{for odd symbols} \end{aligned} \quad (2.4)$$

where,  $m$  is index T2 frame,  $l$  is index OFDM symbol,  $p$  is the data carries in the OFDM symbol ( $p=0, \dots, N_{\text{data}}-1$ ),  $H(p)$  is the permutation function.

### 2.4 OFDM generation

Orthogonal Frequency Division Multiplex (OFDM) generation module is shown in Figure.2-17

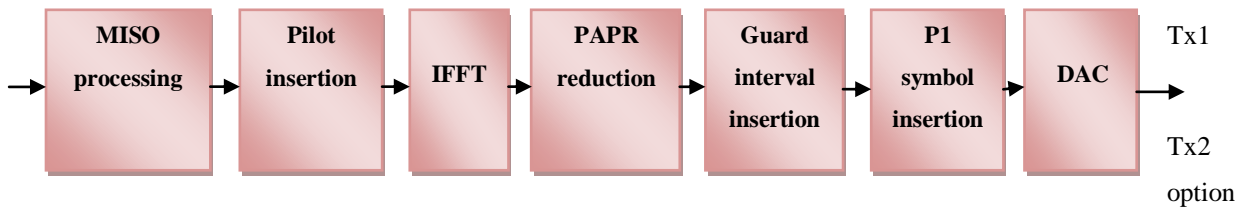

Figure.2-17:OFDM generation (based on[2])

#### 2.4.1 Pilot insertion

Pilots are carries which do not contain data information. They serve for transmission. For example, Channel estimation, channel correction and the Signalling of the transmission parameters [4]. There are different types of pilots: scattered, continual,

edge, P2 or frame-closing pilot. Each symbol can use a specific type of pilots (see Tab.2-6).

**Tab.2-6: Presence of the various types of pilots in each type of symbol[2]**

Symbol	Pilot Type				
	Scattered	Continual	Edge	P2	Frame Closing
<b>P1</b>					
<b>P2</b>				×	
<b>Normal</b>	×	×	×		
<b>Fram closing</b>			×		×

#### 2.4.1.1 Scattered pilots

Scattered pilots are used in the receiver to estimate the quality of the channel for every OFDM cell and that helps to compensate the distortions caused by the transmission channel in order to improve the received signal. DVB-T2 is very flexible. It uses eight pilot patterns (PP), PP1 to PP8. Each pilot pattern repeats in a different frequency. For instance, PP2 is repeated every second OFDM symbol [4]( see Figure.2-19). Only a subset of pilot patterns can be used for every FFT size and Guard Interval combination (see Tab.2-7).

**Tab.2-7: Scattered pilot pattern to be used for each allowed combination of FFT size and guard interval in SISO mode[2]**

FFT size	Guard interval						
	1/128	1/32	1/16	19/256	1/8	19/128	1/4
32K	PP7	PP4 PP6	PP2 PP8 PP4	PP2 PP8 PP4	PP2 PP8	PP2 PP8	Not Allowed
16K	PP7	PP7 PP4 PP6	PP2 PP8 PP4 PP5	PP2 PP8 PP4 PP5	PP2 PP3 PP8	PP2 PP3 PP8	PP1 PP8
8K	PP7	PP7 PP4	PP8 PP4 PP5	PP8 PP4 PP5	PP2 PP3 PP8	PP2 PP3 PP8	PP1 PP8
4K,2K	Not Allowed	PP7 PP4	PP4 PP5	Not Allowed	PP2 PP3	Not Allowed	PP1
1K	Not Allowed	Not Allowed	PP4 PP5	Not Allowed	PP2 PP3	Not Allowed	PP1

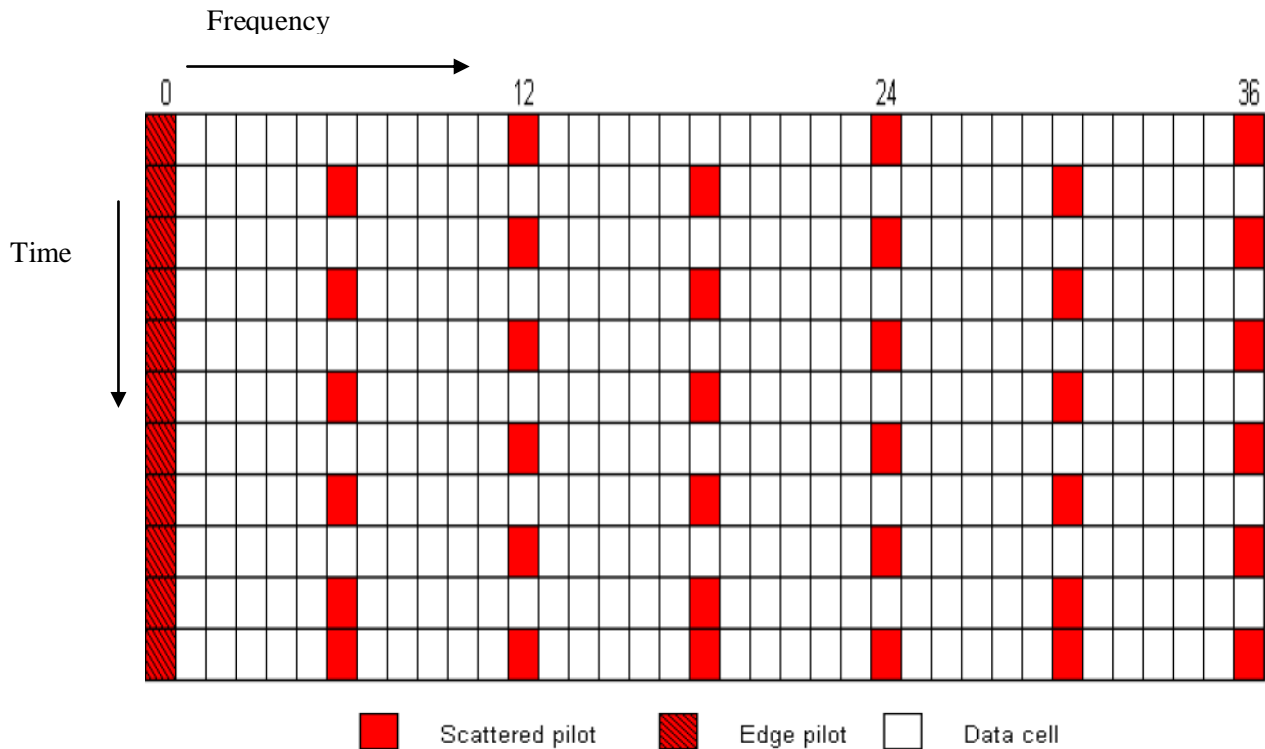

**Figure.2-18: Scattered pilot pattern PP2(SISO) [4]**

#### 2.4.1.2 Continual Pilots

Continual pilots are used for frequency and time synchronization. They are inserted in every symbol of the OFDM frame except the P1 and P2 symbols [2].

#### 2.4.1.3 Edge pilots

Edge pilots are used for estimating the frequency characteristics of the transmission channel. They are inserted at the beginning and the end of OFDM symbol [3].

### 2.4.2 Peak to Average Power Ratio reduction

High Peak to Average Power Ratio(PAPR) leads to large degradation on the DVB-T2 performance. For this reason, many methods have been used to reduce the PAPR effect. For instance, Active Constellation Extension (ACE) and Tone Reservation (TR). The ACE method increases the amplitude of the constellation points which affect

Negatively to the peak, by shifting them further out(see Figure.2-19). The Tone Reservation method uses a specific carries to reduce the PAPR [4].

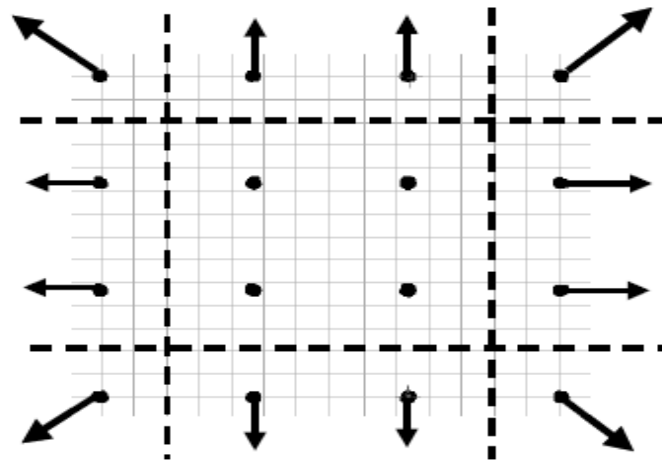

Figure.2-19 :Constellation Extension method [3]

### 2.4.3 Guard interval insertion

The DVB-T2 signal arrives at the receiver from several different paths and at different times. That is lead to Inter Symbol Interference (ISI). To avoid this phenomenon, the Guard Interval (GI) is inserted at the beginning of OFDM symbol and The last part of this symbol will be copied to the GI (see Figure.2-19).

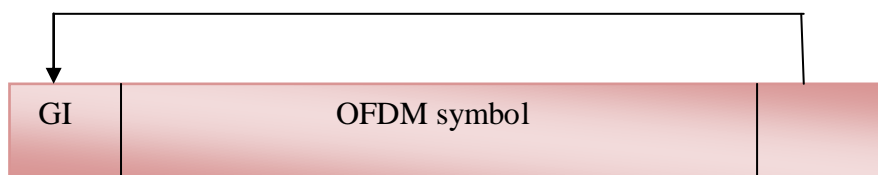

Figure.2-20: inserting the guard interval

### 3. THE MODULATOR IN DVB-T2

The COFDM modulator consists of IFFT module which transforms the COFDM symbol from frequency domain to time domain. After the transition to the time domain all real time domain signal ( $re(t)$ ) will be grouped in the I branch and all imaginary time domain signal ( $im(t)$ ) will be grouped in the Q branch where, the amplitudes of the I and Q branches are equal. The I/Q mixer makes the phase angle between the I and Q branches equal to 90 degrees (see Figure.3-1).

The model of the modulator can be expressed by this equation [5]:

$$y_{IQ} = x_i \cos(2\pi f_c t) - x_q \sin(2\pi f_c t) \quad (3.5)$$

where,  $x_i$  and  $x_q$  are the the I and Q components of the data respectively,  $f_c$  is the carrier frequency.

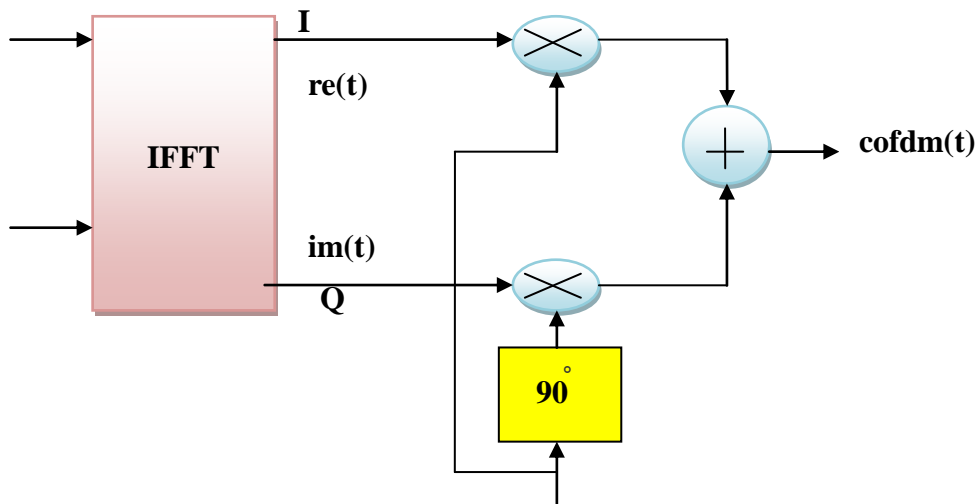

Figure.3. 1: The DVB-T2 modulator[5]

#### 3.1 I/Q Errors of the Modulator in DVB-T2

There are two types of I/Q errors which can occur in DVB-T2 modulator: amplitude imbalance-AI and phase imbalance-PI (see Figure.3.2).

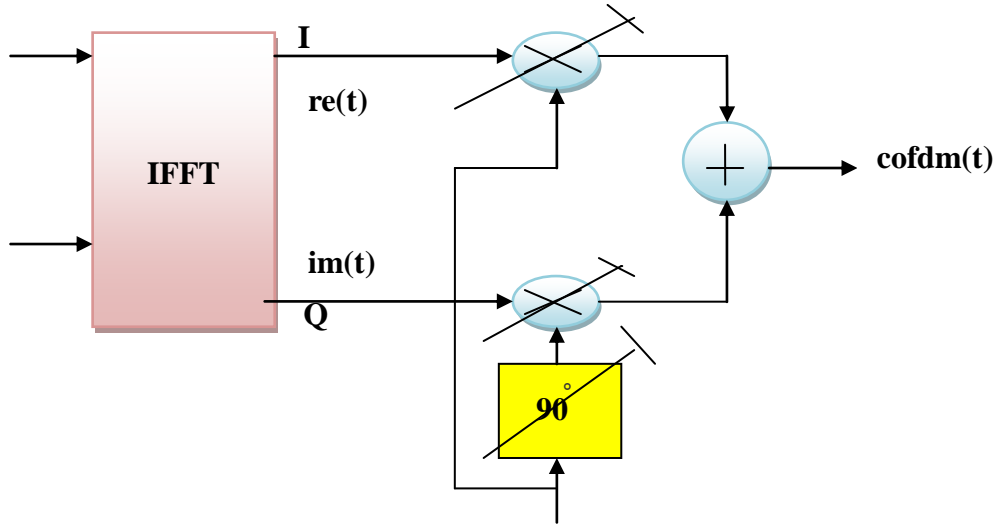

Figure.3. 2:The DVB-T2 modulator with I/Q errors[5]

### 3.1.1 Amplitude Imbalance (AI)

If the amplitudes of I and Q branches are different, then a AI occurs. (see Figure.3.3). The transmitted signal in the presence of AI error can be expressed by this equation [5]:

$$y = (1 + \alpha)x_i \cos(2\pi f_c t) - (1 - \alpha)x_q \sin(2\pi f_c t) \quad (3.6)$$

where,  $\alpha$  represents the amplitude difference between the I and Q branches.

### 3.1.2 Phase imbalance (PI)

If the phase difference between the I and Q branches is not equal to 90 degrees. then a PI occurs. The transmitted signal in the presence of PI error can be expressed by this equation [5]:

$$y = x_i \cos(2\pi f_c t) - x_q \sin(2\pi f_c t + \varphi) \quad (3.7)$$

where,  $\varphi = \theta(\frac{\pi}{180})$  represents the phase difference between the I and Q branches and It is given in units of radian.

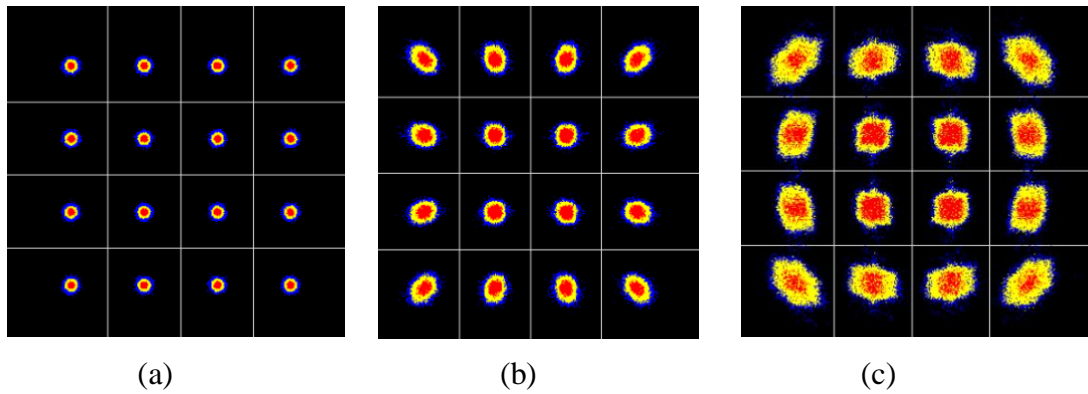

**Figure.3. 3: 16-QAM constellation diagrams : (a) AI=0%,PI=0° (b) AI=10%,PI=0°(c) AI=0%,PI=10°**



## 4. TRANSMISSION CHANNEL MODELS USED FOR DVB-T2

Many available channel models are used to describe the simulation of transmitting TV signals between TX and RX in different transmission conditions. Each model has its own characteristics. For instance, the number of paths, attenuation, etc. Three models are used in this work. Gaussian channel, Ricean channel and Rayleigh channel.

### 4.1 Gaussian Channel

In this type of channel, only the Additive white Gaussian noise (AWGN) is added to the signal. DVB-T2 has the best performance in the Gaussian channel. This is caused by a fact that in this channel model only a direct path between the TX and RX is considered (see Figure.4-1).

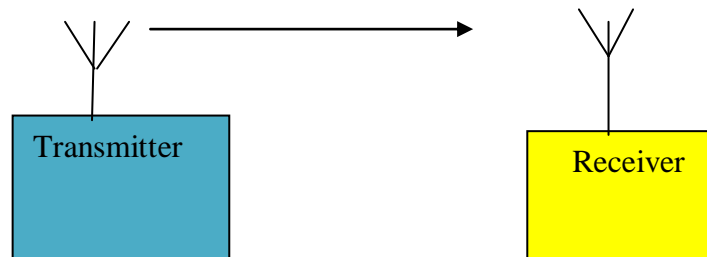

Figure .4-1 : Gaussian channel

### 4.2 Ricean Channel

This channel consists of direct signal with many reflected signals (see Figure.4-2). The model of this channel is given by this equation [4]:

$$y(t) = \frac{(\rho_0 \cdot x(t) + \sum_{i=1}^N \rho_i e^{-j\theta_i} x(t-\tau_i))}{\sqrt{\sum_{i=1}^N \rho_i^2}} \quad (4.9)$$

where,  $x(t)$  is input signal,  $y(t)$  is output signal,  $\rho_0$  and  $\rho_i$  are the attenuations of the direct path and the reflected paths respectively,  $\theta_i$  is the phase delay,  $\tau$  is the delay of the reflected paths,  $N$  is the number of echo paths.

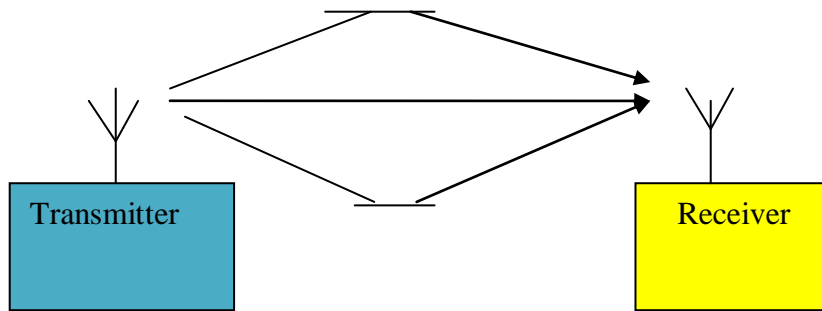

**Figure.4-2 :Ricean channel**

### 4.3 Rayleigh Channel

In this type of channel, there isn't direct visibility between the transmitter and the receiver. This channel provides the worst condition for reception( only reflected signals are available) (see Figure.4-3) .

The model of this channel is given by this equation [4]:

$$y(t) = k \sum_{i=1}^N \rho_i e^{-j\theta_i} x(t - \tau_i) \quad (4.10)$$

where,  $k = \frac{1}{\sqrt{\sum_{i=1}^N \rho_i^2}}$

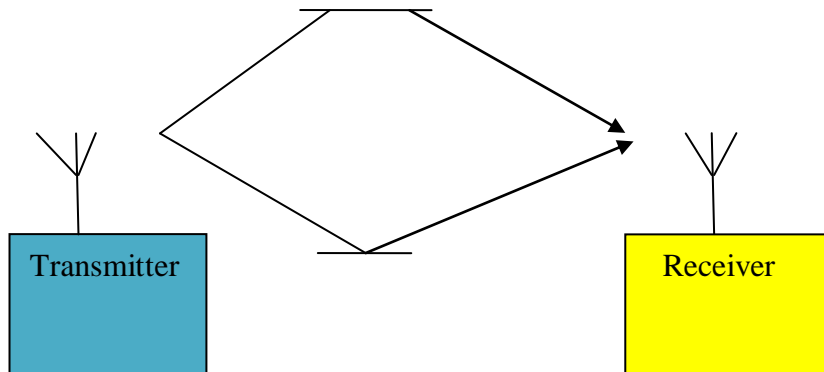

**Figure.4-3 :Rayleigh channel**

## 5. LABORATORY WORKPLACE TO MEASURE THE RECEIVED DVB-T2 SIGNAL

In this chapter, a laboratory measurement workplace is proposed to measure the performance of DVB-T2 system. It also gives a brief description about DVB-T2 system parameters: Bit Error Ratio (BER), Modulation Error ratio (MER), number of iterations.

### 5.1 The proposed scheme

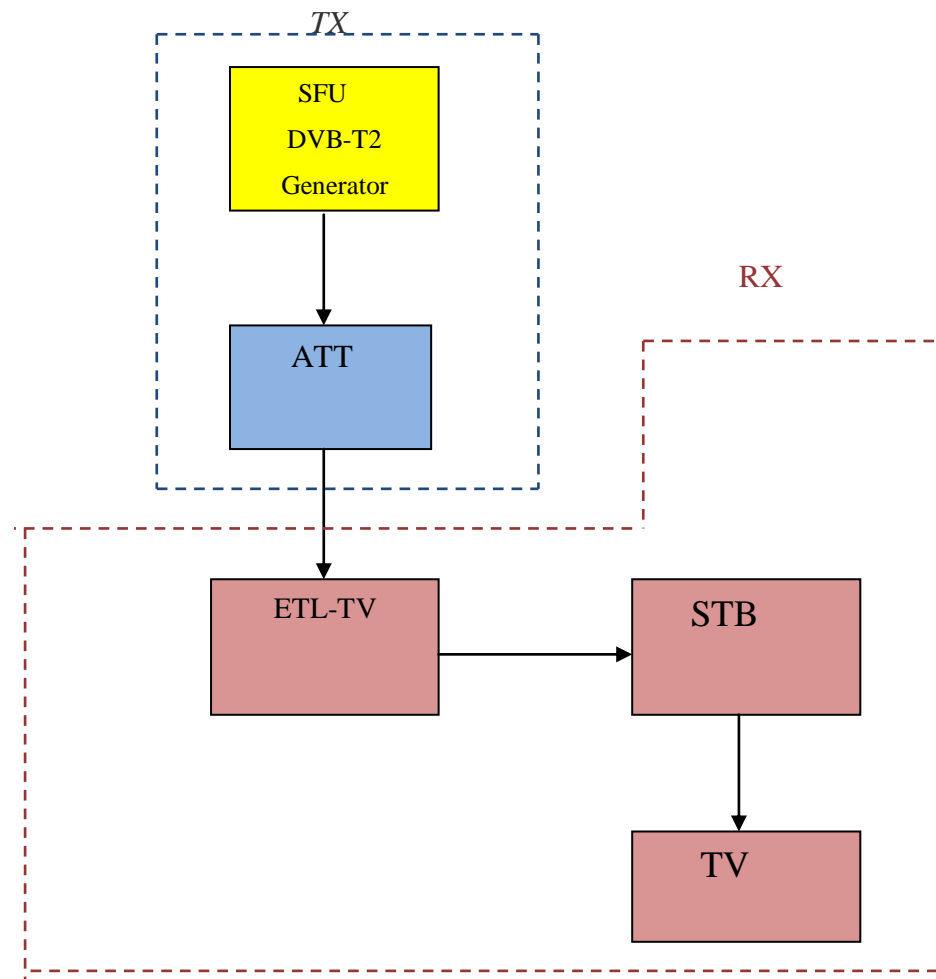

Figure.5-1: The supposed block diagram for measuring DVB-T2 signal

This diagram represents the basic laboratory workplace of the proposed concept. It consists of:

- Rohde & Schwarz (R&S) SFU generator: It can generate a complete DVB-T2 RF signal. The DVB-T2 signal is generated according to the selected system parameters. It includes the ability to emulate various I / Q-errors in the OFDM modulator (Amplitude Imbalance-AI and Phase Imbalance-PI). It also contains a functional block to use different fading channel models to emulate various conditions available in the transmission environment.
- Attenuator (ATT): the level of the generated DVB-T2 signal can be reduced By the ATT. In this work, the attenuator is set on 0 dB.
- Rohde & Schwarz(R&S) ETL-TV analyzer: This measurement device allows to measure the most important objective parameters, for instance, bit error ratio (BER) before and after LDPC decoding and modulation error ratio (MER).
- Set Top Box (STB) and TV: The STB is used to decode the received DVB-T2 signal and then show it on the TV. Such a concept allows to evaluate the quality of the TV signal subjectively.

## 5.2 DVB-T2 parameters

### 5.2.1 Bit Error Ratio (BER)before and after LDPC

Bit Error Ratio (BER) is the ratio between the number of incorrect bits transmitted to the total number of bits for a specified time interval. This parameter is used to evaluate the DVB-T2performance. When the DVB-T2 signal is broadcasted, there is a possibility of errors to occur because of many factors. For instance, noise and fading. These errors can be suppressed by LDPC decoding algorithm. The Quasi Error Free (QEF) reception is the minimum required carrier-to-noise ratio to receive DVB-T2 signal correctly. In DVB-T2, the QEF reception is identified by determining the corresponding C/N ratio of BER after LDPC decoding equal or less than  $1 \times 10^{-7}$  [4]. This value depends on the selectable channel.

## **5.2.2 Modulation Error Ratio (MER)**

Modulation Error Ratio (MER) is a measure of the sum of all interference effects occurring at the transmission-link. These interferences deviate actual constellation points from their ideal locations (the center of the decision errors). Thus the error vector is formed between the ideal constellation point and the point received by the receiver. The MER parameter is given in units of dB [3].

## **5.2.3 Carrier to Noise ratio(C/N)**

The carrier to noise ratio (C/N) expresses the robustness of the DVB-T2 system depending on the selectable channel mode [4]. This ratio determines the required ratio between the carrier and noise levels so that if the signal is broadcasted through the fading channels, the receiver will be able to decode it. C/N is given in units of dB.

## **5.2.4 The minimum required power for demodulating DVB-T2 signals**

In this work, we consider that the minimum required power for demodulating DVB-T2 signal is equal to -60 dBm to avoid damage of measuring devices and to get true measured values [4].

## **5.2.5 The number of decoding iterations**

The performance of LDPC decoder can be improved by increasing the number of decoding processes. Due to this algorithm, the QEF reception can be achieved at lower C/N ratios. However, a higher number of decoding iterations leads to unwanted decoding latency [7].

## 6. MEASUREMENT PROCEDURE

It was used MER and BER parameter and the number of LDPC iterations to analyze the DVB-T2 system performance for different I/Q errors (PI=0° and AI=0%, PI=0° and AI=5%, PI=5° and AI=0%, PI=5° and AI=5%, PI=0° and AI=10%, PI=10° and AI=0%, PI=10° and AI=10%). These parameters were measured according to three different propagation scenarios. Three channel models were used, Gaussian channel, Ricean channel and Rayleigh channel.

### 6.1 Scenario1:Multi frequency network (MFN) rooftop reception

This transmission scenario has proposed to increase the data rate and at the same time maintain the same coverage that was achieved by the DVB-T system. So that, the DVB-T2 uses the same infrastructure that was used in DVB-T to maintain the same coverage and for delivering high-bit-rate, the 32K FFT mode and the 256-QAM modulation type are used [4]. This scenario is applied in Multi frequency network (MFN) .The parameters that were set in the SFU generator are presented in Table.6-1.

**Tab.6-1: System Parameters of DVB-T2 for Scenario 1 [4]**

<b>Bandwidth</b>	8 MHz
<b>FFT size</b>	32K
<b>Scattered pilot pattern</b>	PP2
<b>Guard interval</b>	1/8
<b>Modulation</b>	256-QAM (non-rotated)
<b>Code rate</b>	2/3
<b>Frequency</b>	689MHz
<b>Carrier mode</b>	extended

#### 6.1.1 Measurement results for scenario 1

##### 6.1.1.1 BER Parameter Measurement

BER was measured before LDPC decoding according to the I/Q errors and depending on the C/ N ratio. Results from the experimental measurements are shown in Figure.6-1, Figure.6-2, Figure.6-3. From the obtained results it can be seen that the small values of the I/Q errors have significant effect on the DVB-T2 performance where, the PI error effect on the performance is more noticeable than the AI error effect. The DVB-T2 parameters can not be measured by the analyzer for I/Q errors  $PI=10^\circ$ ,  $AI=0\%$  and  $PI=10^\circ$ ,  $AI=10\%$  due to the used 256 QAM modulation mode. This type of modulation has low robustness against errors. The BER curves in RC20 channel differ only slightly from the curves, obtained in AWGN channel because of the existence of the direct path. The highest DVB-T2 performance degradation was observed in RL20 channel (only reflected signals are available). For achieving  $BER = 6.2 \cdot 10^{-2}$ , in case of  $AI=5^\circ$ ,  $PI=5\%$  it is needed  $C/N=40$  dB for RL20 channel whereas, 22 dB for AWGN channel.

### 6.1.1.2 MER Parameter Measurement

Results from the experimental measurements are shown in Figure.6-4, Figure.6-5, Figure.6-6. The explanation of the curves is similar to the explanation that was introduced in the BER paragraph. Visible differences in achieved MER can be seen at higher C/N values. It can be seen that in the case of  $AI=0\%$ ,  $PI=0^\circ$ , the MER values at  $C/N=40$  dB are equal to 34.8 dB for AWGN channel and 33.8 dB for RC20 channel and 29.1dB for RL20 channel whereas in case of  $AI=10\%$ ,  $PI=0^\circ$ , the MER values at  $C/N=40$  dB are equal to 23.2 dB for AWGN channel and 23.3 dB for RC20 channel and 17.9 dB for RL20 channel.

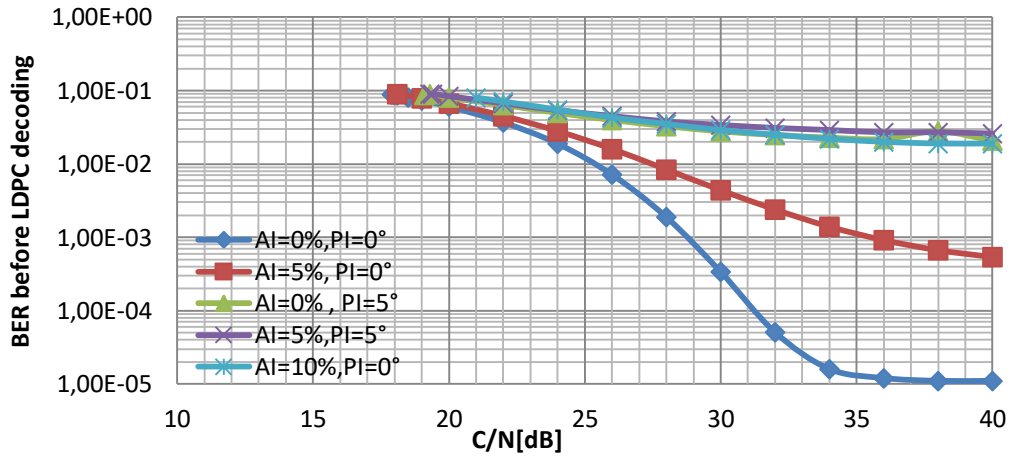

Figure.6-1:BER before LDPC decoding vs. C/N in AWGN channel (Scenario 1)

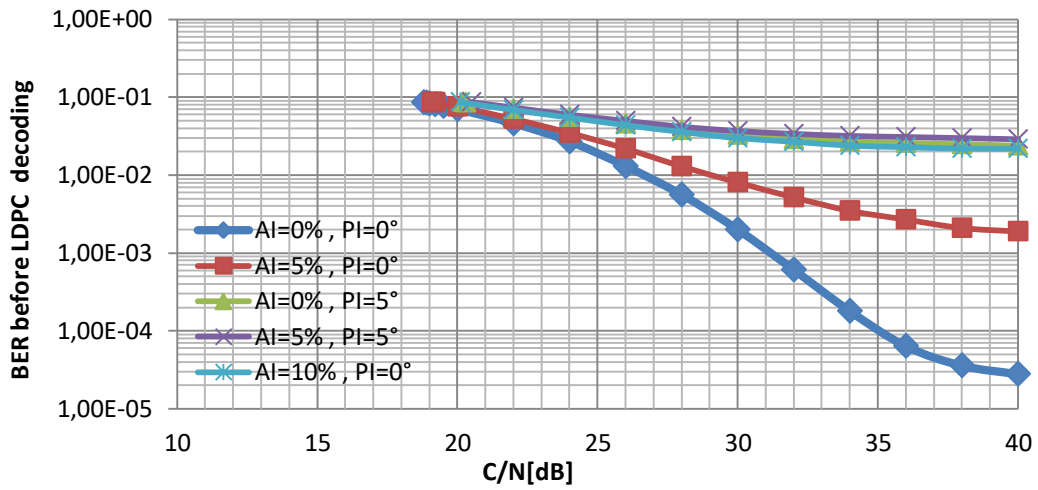

Figure.6-2:BER before LDPC decoding vs. C/N in RC20 channel (Scenario 1)

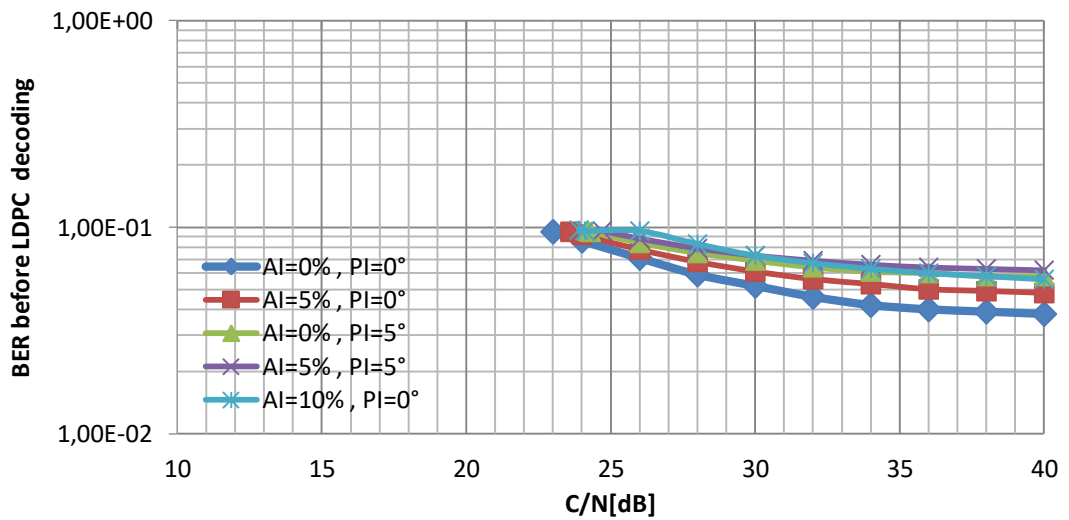

Figure.6-3:BER before LDPC decoding vs. C/N in RL20 channel (Scenario 1)



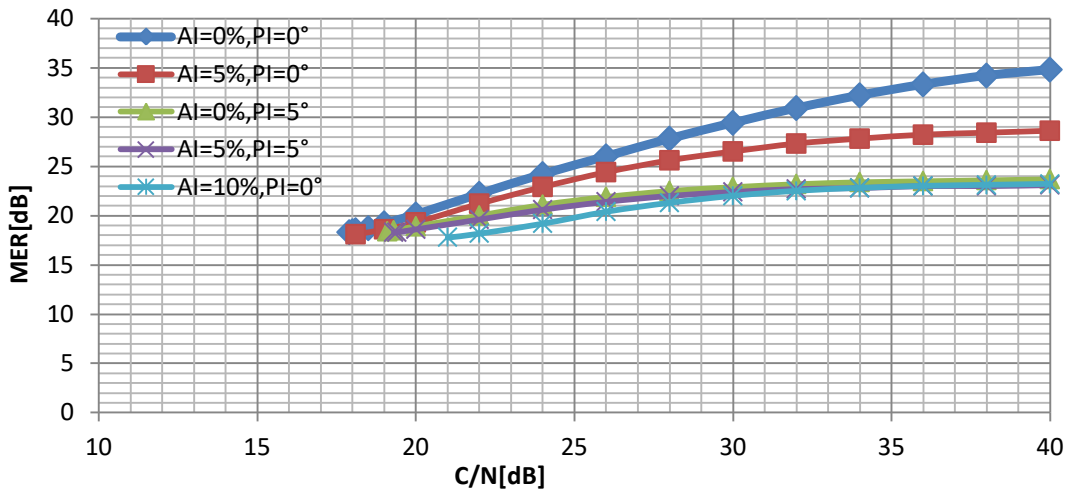

Figure.6-4:MER vs. C/N in AWGN channel (scenario 1)

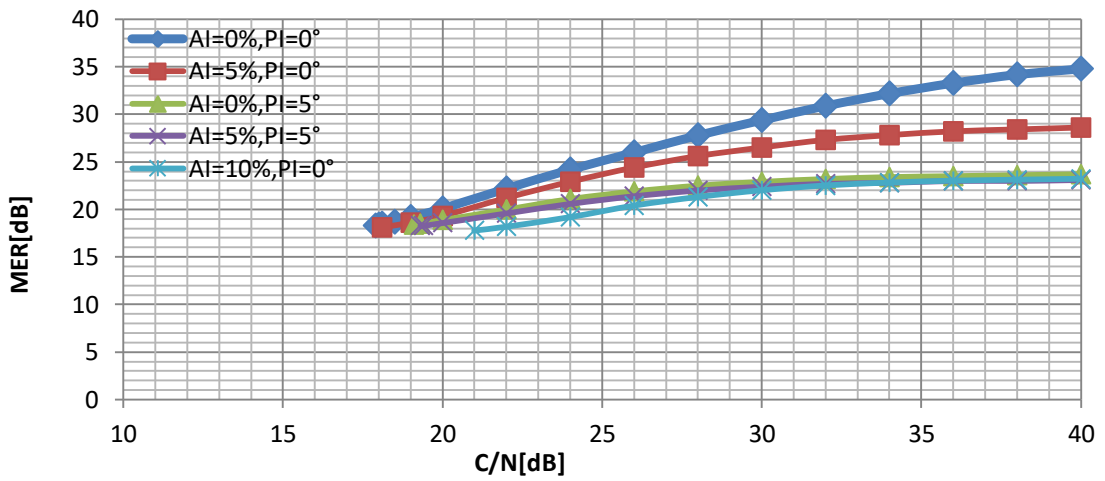

Figure.6-5:MER vs. C/N in RC20 channel (scenario 1)

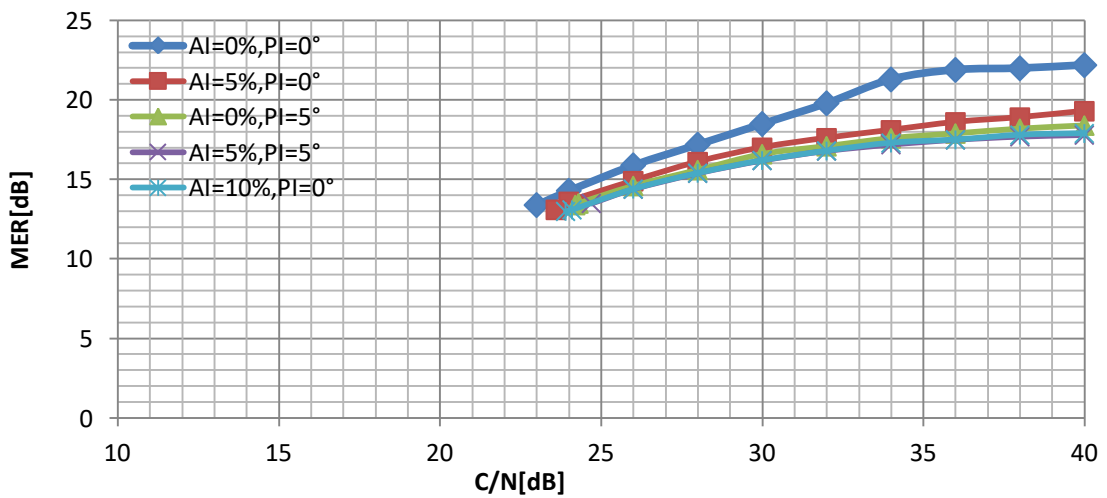

Figure.6-6:MER vs. C/N in RL20 channel (scenario 1)

### 6.1.1.3 The Number of Iterations Parameter Measurement

Results from the experimental measurements are shown in Figure.6-7. As we know that the RL20 channel has higher BER values than the AWGN and the RC20 channel. This is the reason of that the number of iterations is greater. It can be seen from the measurements that higher DVB-T2 performance degradation was observed in the case of  $PI=5^\circ$ ,  $AI=5\%$ .

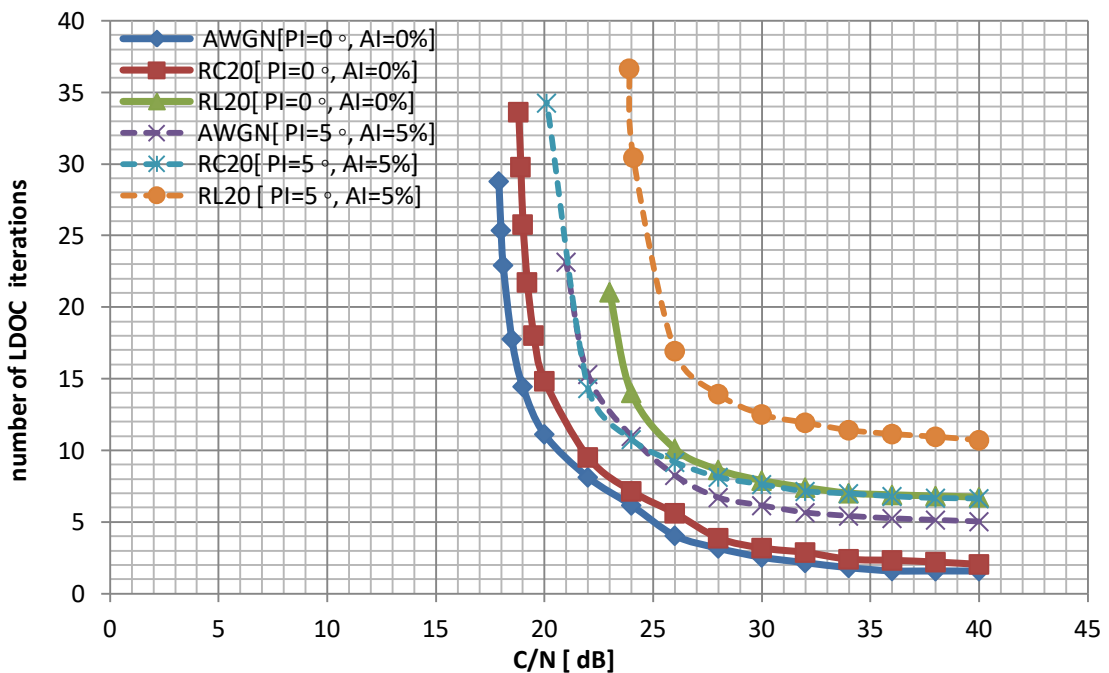

Figure.6-7:LDPC iterations vs. C/N (Scenario 1)

### 6.1.1.4 Scenario 1 – Objective versus Subjective Results

BER parameter was also measured after LDPC decoding. From the measurements it became possible to determine the minimum C/N ratio for QEF. The minimum C/N ratio for QEF reception was measured on the ETL-TV analyzer and monitored by THOMSON-THT712 STB then they were compared. As we said previously, the analyzer can not decode the signal for  $I/Q$  errors  $PI=10^\circ$ ,  $AI=0\%$  and  $PI=10^\circ$ ,  $AI=10\%$  but the STB can do. The reason is that the STB has a better sensitivity and use different algorithms to process the DVB-T2 signal. However, the required C/N for QEF reception on STB is still high.

**Tab. 6-2:QEF table(scenario1)**

<b>I/Q-imbalance</b>	<b>Channel mode</b>	<b>C/N measured by ETL analyzer [dB]</b>	<b>C/N Monitored by THOMSON- STB [dB]</b>
<b>AI=0 % , PI=0°</b>	<b>AWGN</b>	17.9	17.6
	<b>RC20</b>	18.8	18.2
	<b>RL20</b>	23	20.6
<b>AI=5 % , PI=0°</b>	<b>AWGN</b>	18.1	17.9
	<b>RC20</b>	19.1	18.6
	<b>RL20</b>	23.6	20.8
<b>AI=0 % , PI=5°</b>	<b>AWGN</b>	19.1	18.2
	<b>RC20</b>	20.2	18.9
	<b>RL20</b>	24.2	21.7
<b>AI=5 % , PI=5°</b>	<b>AWGN</b>	19.3	18.4
	<b>RC20</b>	20.5	19.1
	<b>RL20</b>	24.7	21.8
<b>AI=10 % , PI=0°</b>	<b>AWGN</b>	21	18.3
	<b>RC20</b>	20.1	18.9
	<b>RL20</b>	24.8	21.5
<b>AI=0 % , PI=10°</b>	<b>AWGN</b>	-	24
	<b>RC20</b>	-	24.9
	<b>RL20</b>	-	30
<b>AI=10 % , PI=10°</b>	<b>AWGN</b>	-	40
	<b>RC20</b>	-	40
	<b>RL20</b>	-	40

The snapshots of the 256-QAM constellation diagrams and RF spectrum for I/Q errors AI=0 % , PI=0° and AI=5% , PI=5°, obtained at C/N=30 dB, are shown in Figure.6-8, Figure.6-9.

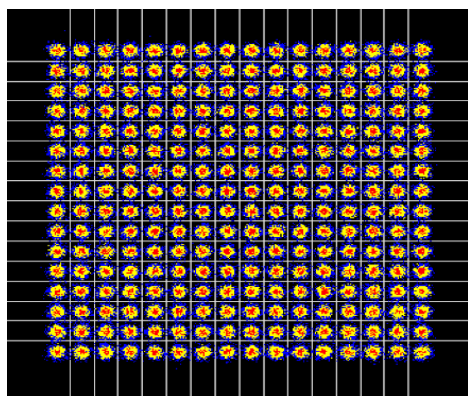

(a)MER=29.4 dB

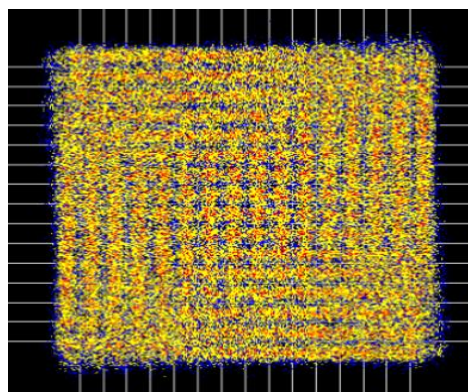

(b)MER=22.4 dB

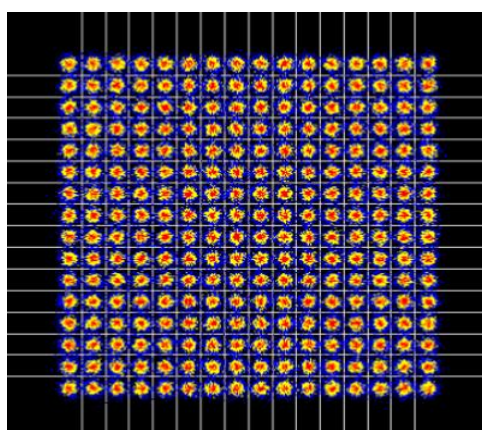

(c )MER=28.7 dB

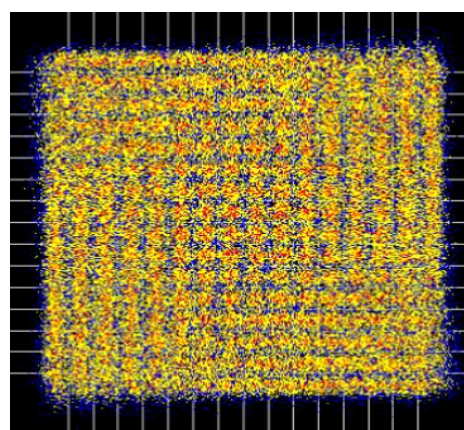

(d)MER=22.3 dB

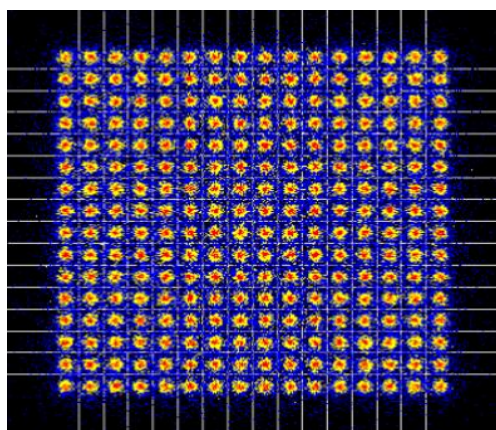

(e) MER= 18.5 dB

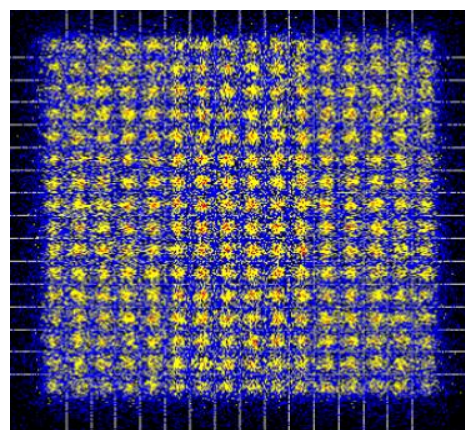

(f)MER=16.2 dB

**Figure.6-8: Snapshots of the 256-QAM constellation diagrams in AWGN channel (a) AI=0% and PI=0°, (b) AI=5% and PI=5°. In RC20 channel (c) AI=0% and PI=0° (d) AI=5% and PI=5°. In RL20 channel (e) AI=0% and PI=0° (f) AI=5% and PI=5°.**

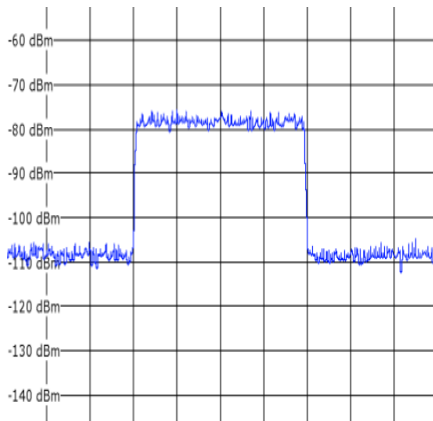

(a)

RBW= 100 KHz, VBW= 1MHz,  
Span=20.0 MHz

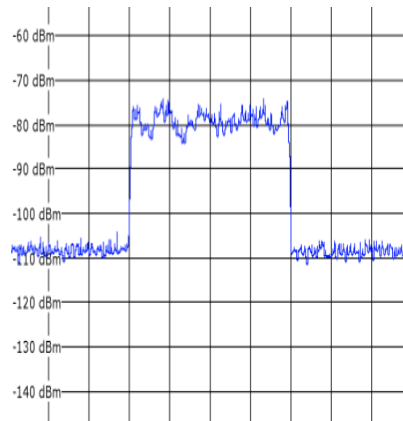

(c)

RBW= 100 KHz,VBW= 1MHz,  
Span=20.0 MHz

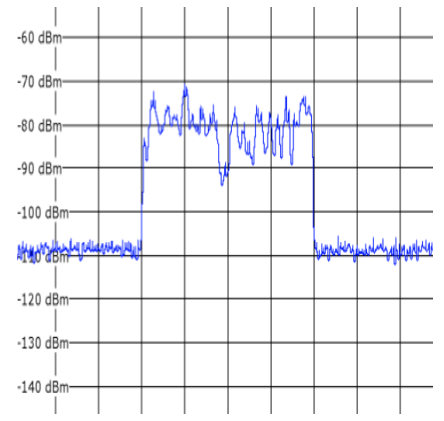

(e)

RBW= 100 KHz,VBW= 1MHz,  
Span=20.0 MHz

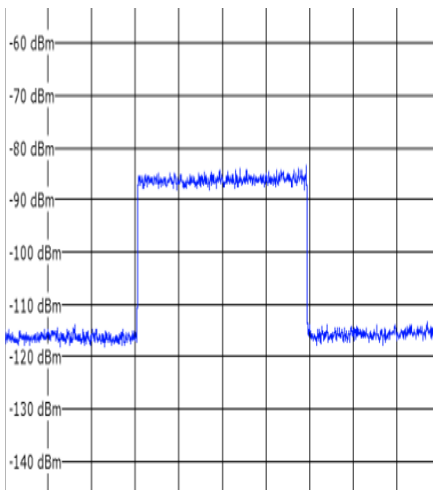

(b)

RBW= 10 KHz,VBW= 30KHz,  
Span=20.0 MHz

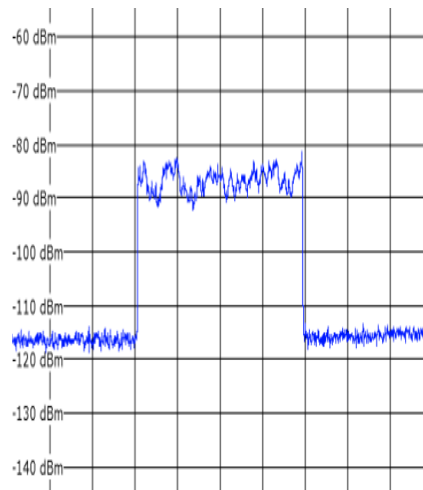

(d)

RBW= 10 KHz,VBW= 30KHz,  
Span=20.0 MHz

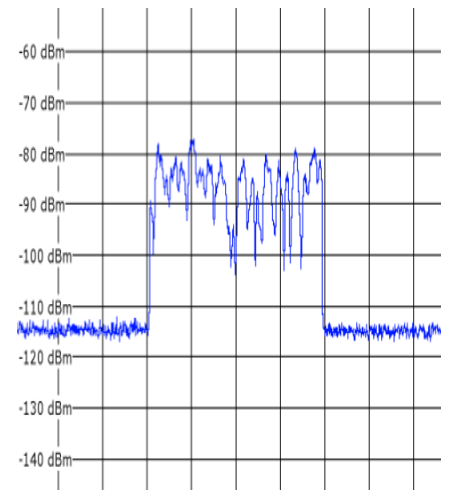

(f)

RBW= 10 KHz,VBW= 30KHz,  
Span=20.0 MHz

**Figure.6-9: Snapshots of the 256-QAM spectrum diagrams in AWGN channel (a) AI=0%andPI=0° (b) AI=5%andPI=5°. In RC20 channel :( c) AI=0% and PI=0° (d) AI=5% and PI=5°. In RL20 channel :( e) AI=0% and PI=0° (f) AI=5% and PI=5°, All spectrum diagrams were captured at C/N=30 dB, Frequency =689 MHz.**

## 6.2 Scenario 2: Single frequency network(SFN) rooftop reception

The purpose of this scenario is to maximize the coverage in Single frequency network (SFN). In this case, it is necessary to use robust DVB-T2 parameters. Compared to scenario1, the modulation type 16QAM is used because it is more robust than 256-QAM. It also uses robust code rate (2/3) and the 32K FFT is used in order to increase the capacity [4]. The parameters that were set in the SFU generator are given in Tab.6-3.

**Tab.6-3: System Parameters of DVB-T2 for scenario2 [4]**

<b>Bandwidth</b>	8 MHz
<b>FFT size</b>	32K
<b>Scattered pilot pattern</b>	PP2
<b>Guard interval</b>	1/8
<b>Modulation</b>	16-QAM (non-rotated)
<b>Code rate</b>	2/3
<b>Frequency</b>	689MHz
<b>Carrier mode</b>	extended

### 6.2.1 Measurement results for scenario 2

#### 6.2.1.1 BER Parameter Measurement

BER was measured before LDPC decoding according to the I/Q errors and depending on the C/ N ratio. Results from the experimental measurements are shown in Figure.6-10, Figure.6-11, Figure.6-12. The best curve is obtained when the PI=0°, AI=0% (ideal case). From obtained results it can be seen that the PI error effect is higher than the AI error effect. The performance of DVB-T2 system is not significantly affected when the values of AI and PI are small due to system robust. The degradation of the performance start to be noticeable at PI=10° and AI=0 %. The worst case is occurred when PI=10° and AI=10% where, the BER vs. C/N ratio is increased significantly in comparison with the other considered cases. The BER curves in RC20 channel differ only slightly from the curves, obtained in AWGN channel because of the existence of the direct path. The highest DVB-T2 performance degradation was observed in RL20 channel (only reflected signals are available). It can be seen that in the case of AI=0%, PI=0°, the BER values at C/N=40 dB are equal to  $5.6 \times 10^{-8}$  for AWGN channel and  $4.6 \times 10^{-6}$  for RC20 channel and  $1.7 \times 10^{-3}$  for RL20 channel whereas, in case of AI=10%, PI=10°, the BER values at C/N=40 dB are equal to

$4.3 \times 10^{-4}$  for AWGN channel and  $2 \times 10^{-3}$  for RC20 channel and  $3.7 \times 10^{-2}$  for RL20 channel. Compared to the previous scenario, the DVB-T2 performance is more robust

### 6.2.1.2 MER Parameter Measurement

Results from the experimental measurements are shown in Figure.6-13, Figure.6-14, Figure.6-15. The explanation of the curves is similar to the explanation that was introduced in the BER paragraph. As we know, when reducing the C/N ratio, the measured MER parameter is deteriorated. The highest DVB-T2 performance degradation was observed in RL20 channel (due to echo paths). Visible differences in achieved MER from the point of IQ-errors can be seen at higher C/N values. It can be seen that in the case of AI=0%, PI=0°, The MER values at C/N=40 dB are equal to 34.5 dB for AWGN channel and 33.5 dB for RC20 channel and 25.1 dB for RL20 channel whereas in case of AI=10%, PI=10°, the MER values at C/N=40 dB are equal to 16.7 dB for AWGN channel and 16.3 dB for RC20 channel and 13.5 dB for RL20 channel. The difference between the considered cases appears slightly at lower C/N ratios where, in the case of AI=0%, PI=0°, the MER values at C/N= 14 dB are equal to 14.3 dB for AWGN channel and 13.6 dB for RC20 channel and 9.5 dB for RL20 channel whereas in case of AI=10%, PI=10°, the MER values at C/N=40 dB are equal to 12.3 dB for AWGN channel and 11.7 dB for RC20 channel and 7.5 dB for RL20 channel.



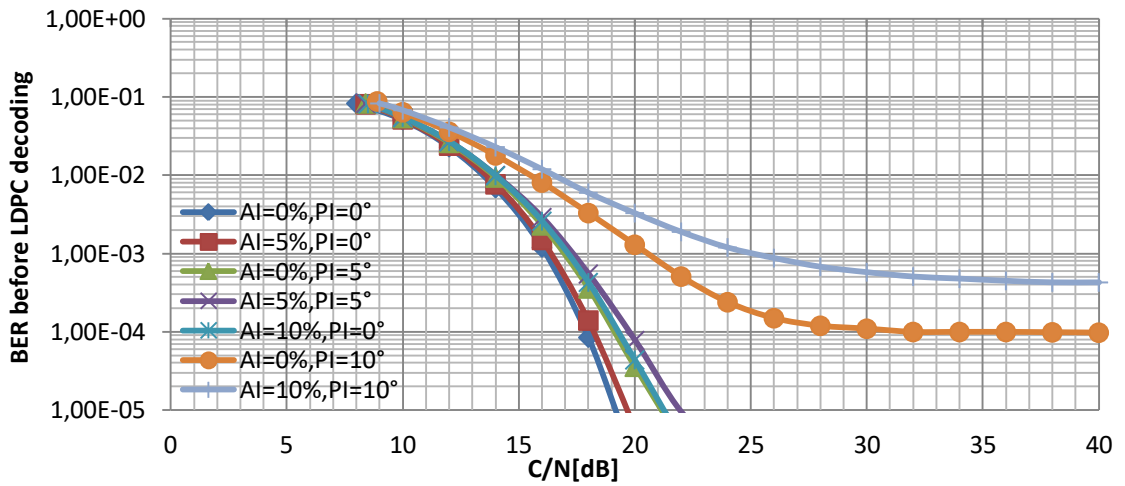

Figure.6-10:BER before LDPC decoding vs. C/N in AWGN channel(scenario2)

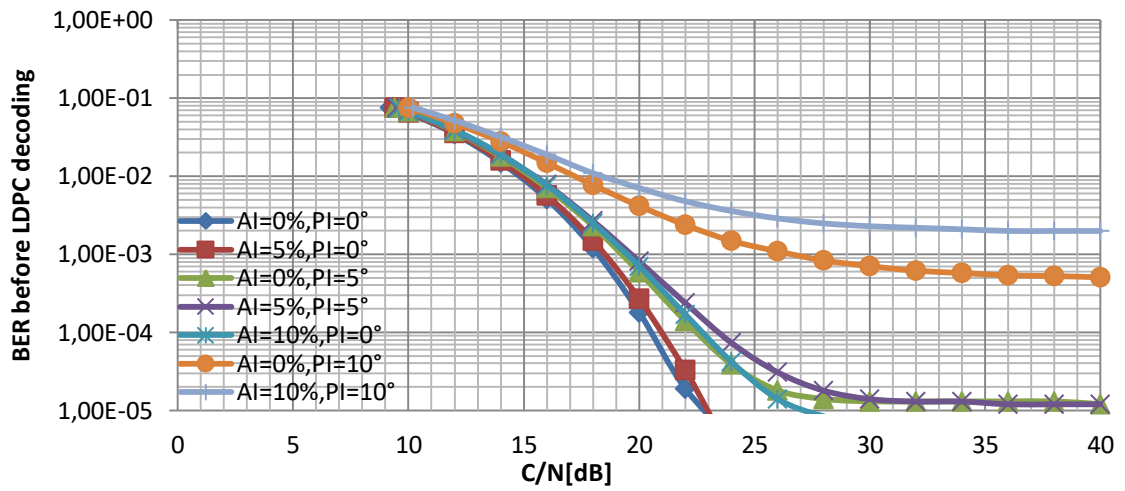

Figure.6-11:BER before LDPC decoding vs. C/N in RC20 channel (scenario2)

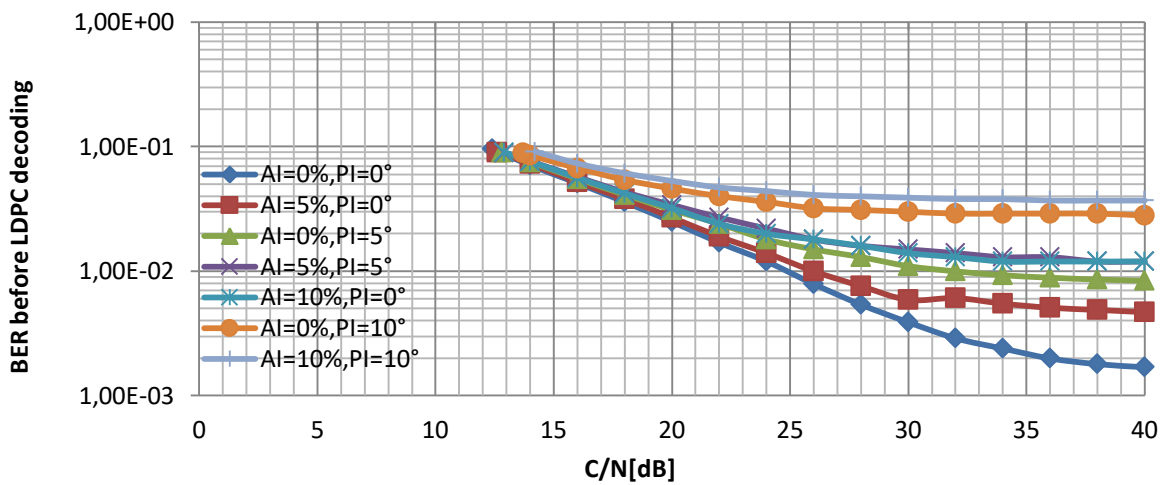

Figure.6-12:BER before LDPC decoding vs C/N in RL20 channel (Scenario2)



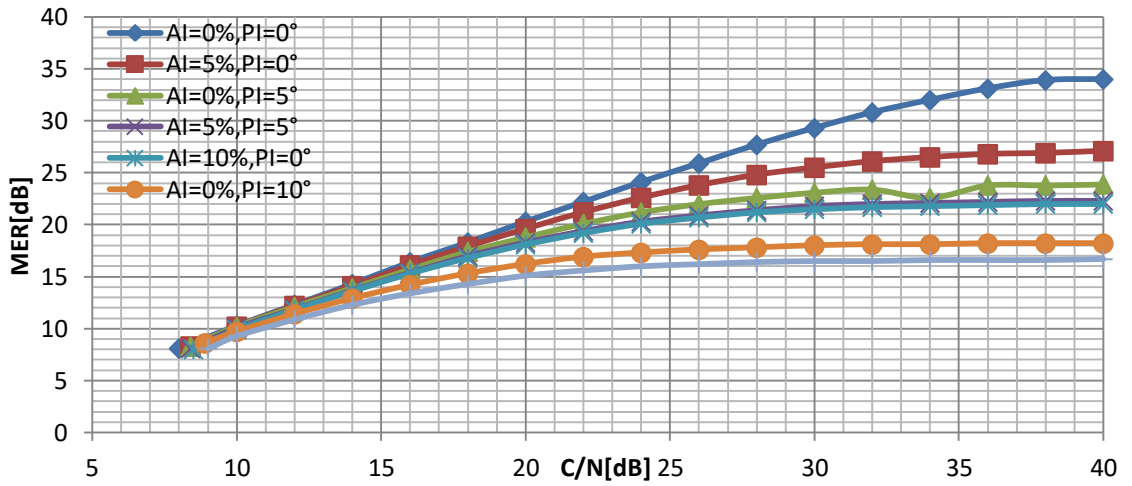

Figure.6-13:MER vs. C/N in the AWGN channel (Scenario2)

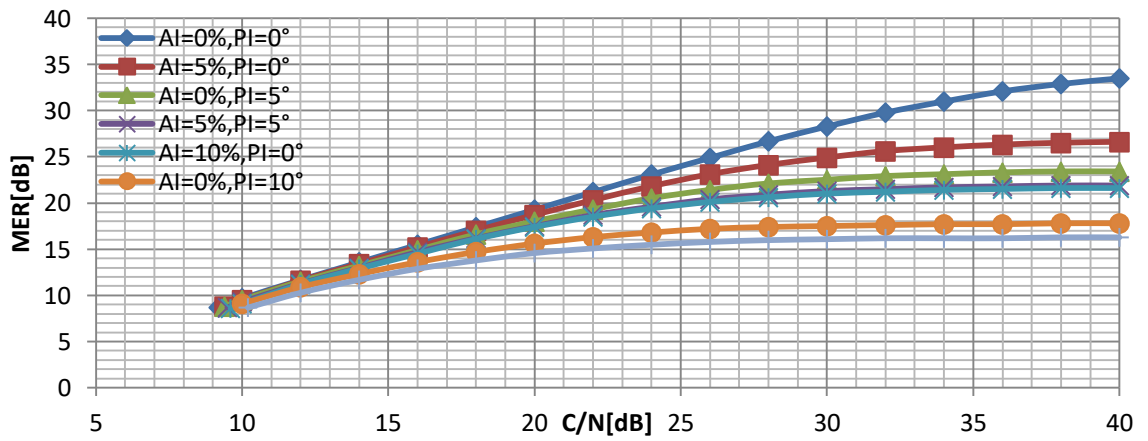

Figure.6-14:MER vs. C/N in RC20 channel (Scenario2)

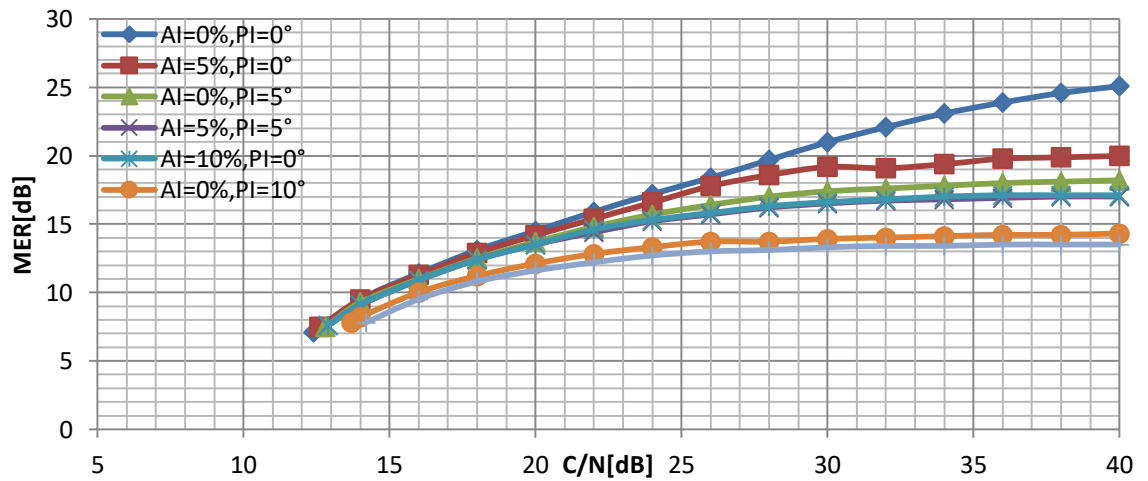

Figure.6-15:MER vs. C/N in RL20 channel (Scenario2)

### 6.2.1.3 The Number of Iterations Parameter Measurement

Results from the experimental measurements are shown in Figure.6-16. These graphs explain the difference between the DVB-T2 performance at  $PI=0^\circ$ ,  $AI=0\%$  and at  $PI=10^\circ$ ,  $AI=10\%$ . We noticed that the number of iterations keeps on holding constant values at C/N ratios (from 40 dB to 25 dB). After that, they start to increase in order to improve the DVB-T2 performance. As we know that the RL20 channel has higher BER values than the AWGN and the RC20 channel modes. This is the reason of that why the number of iterations in RL20 channel is higher. From obtained results it is clearly shown that the performance is worse at  $AI=10\%$  and  $PI=10^\circ$ . It can be seen that in the case of  $AI=0\%$ ,  $PI=0^\circ$  (no I/Q errors), the LDPC iterations at  $C/N=40$  dB are equal to 1 for AWGN channel and 1 for RC20 channel and 5.67 for RL20 channel whereas in case of  $AI=10\%$ ,  $PI=10^\circ$ , The LDPC iterations at  $C/N=40$  dB are equal to 2.41 for AWGN channel and 3.48 for RC20 channel and 9.16 for RL20 channel.

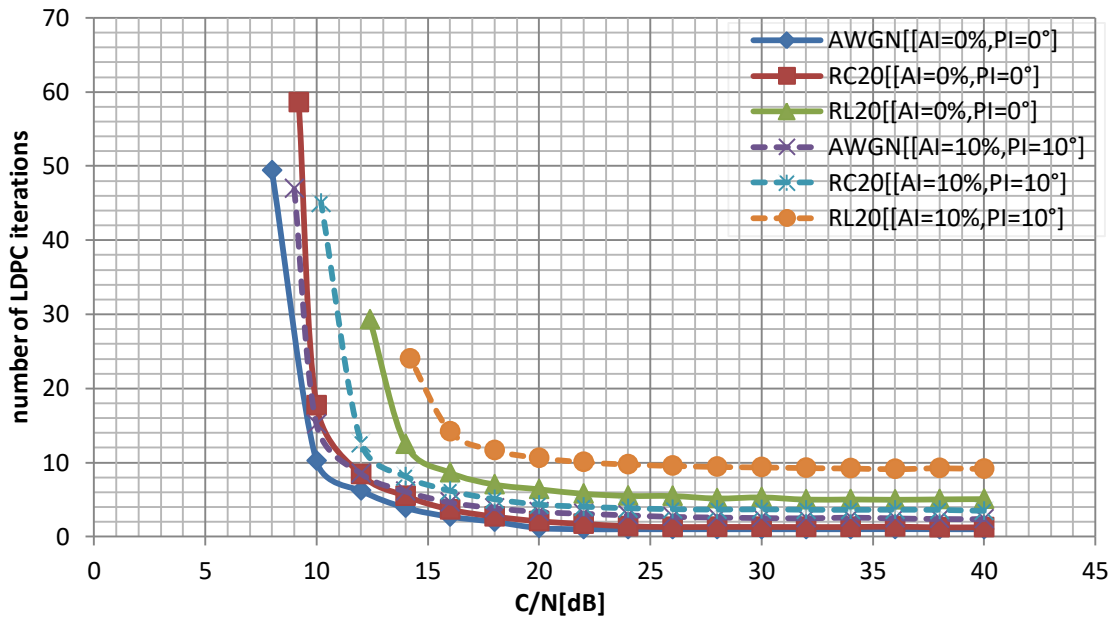

Figure.6-16:LDPC iterations vs C/N (scenario2)

### 6.2.1.4 Scenario 2- Objective versus Subjective Results

BER parameter was also measured after LDPC decoding. From the measurements it became possible to determine the minimum C/N ratio for QEF. The minimum C/N ratio for QEF reception was measured on the ETL-TV analyzer and monitored by THOMSON-THT712 STB then they were compared. As we noticed that the STB can decode the received signal at lower C/N ratios than the analyzer. Compared to the scenario1, the required C/N ratio to achieve QEF reception is lower due to the system robustness.

**Tab. 6-4:QEF table (scenario2)**

<b>IQ-imbalance</b>	<b>Channel mode</b>	<b>C/N Measured by ETL analyzer [dB]</b>	<b>C/N Monitored by THOMSON- STB [dB]</b>
<b>AI=0 % , PI=0°</b>	<b>AWGN</b>	8	8.2
	<b>RC20</b>	9.2	8.8
	<b>RL20</b>	12.4	10.8
<b>AI=5 % , PI=0°</b>	<b>AWGN</b>	8.4	8.2
	<b>RC20</b>	9.6	8.8
	<b>RL20</b>	12.6	10.9
<b>AI=0 % , PI=5°</b>	<b>AWGN</b>	8.5	8.3
	<b>RC20</b>	9.7	8.8
	<b>RL20</b>	12.8	11
<b>AI=5 % , PI=5°</b>	<b>AWGN</b>	8.6	8.2
	<b>RC20</b>	9.8	8.8
	<b>RL20</b>	12.9	11
<b>AI=10 % , PI=0°</b>	<b>AWGN</b>	8.7	8.2
	<b>RC20</b>	9.9	8.8
	<b>RL20</b>	13	11
<b>AI=0 % , PI=10°</b>	<b>AWGN</b>	9	8.2
	<b>RC20</b>	10.2	9
	<b>RL20</b>	13.7	11.7
<b>AI= 10% , PI=10°</b>	<b>AWGN</b>	9.2	8.5
	<b>RC20</b>	10.4	9.2
	<b>RL20</b>	14.6	11.6

If we change the modulation parameter (see Table.6-3 ) to 64-QAM, the required C/N to achieve QEF value will be increased (see Table.6-5) because higher state modulation offers more capacity but on the other hand they are less robust against errors.

**Tab. 6-5:QEF table when using 64-QAM (scenario2)**

<b>IQ-imbalance</b>	<b>Channel mode</b>	<b>C/N measured by ETL analyzer [dB]</b>	<b>C/N monitored by THOMSON- STB [dB]</b>
<b>AI=0 % , PI=0°</b>	<b>AWGN</b>	13.1	12.9
	<b>RC20</b>	14.2	13.5
	<b>RL20</b>	16.8	15.6
<b>AI=5 % , PI=0°</b>	<b>AWGN</b>	13.4	13
	<b>RC20</b>	14.4	13.7
	<b>RL20</b>	17.3	15.8
<b>AI=0 % , PI=5°</b>	<b>AWGN</b>	13.6	13.1
	<b>RC20</b>	14.6	13.8
	<b>RL20</b>	17.6	16
<b>AI=5 % , PI=5°</b>	<b>AWGN</b>	13.8	13.3
	<b>RC20</b>	14.8	14
	<b>RL20</b>	18.2	16.4
<b>AI=10 % , PI=0°</b>	<b>AWGN</b>	13.7	13.3
	<b>RC20</b>	14.8	14
	<b>RL20</b>	18.1	16.3
<b>AI=0 % , PI=10°</b>	<b>AWGN</b>	15	14
	<b>RC20</b>	16.3	14.7
	<b>RL20</b>	21.7	17.9
<b>AI= 10% , PI=10°</b>	<b>AWGN</b>	16.1	14.7
	<b>RC20</b>	17.4	15.4
	<b>RL20</b>	28	23

The snapshots of the 16-QAM constellation diagrams and RF spectrum for I/Q errors AI=0 % , PI=0° and AI=10%, PI=10°, obtained at C/N=30 dB, are shown in Figure.6-17.

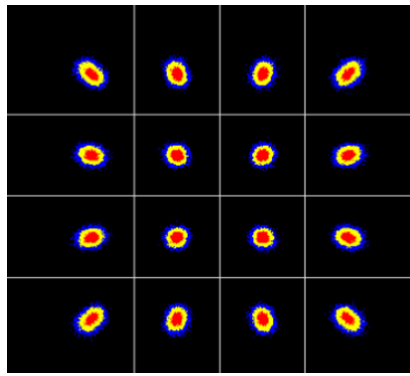

(a)MER=29.3dB

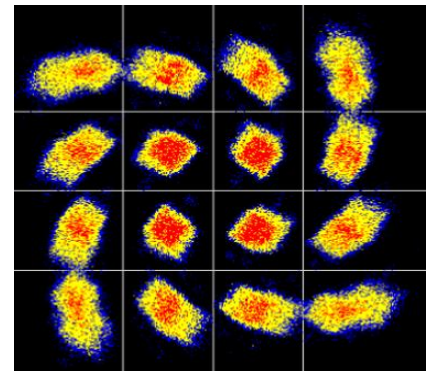

(b)MER=16.5 dB

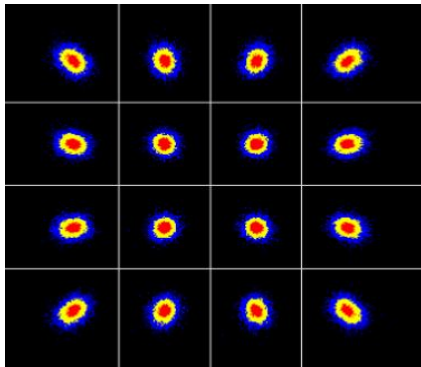

(c)MER=28.3 dB

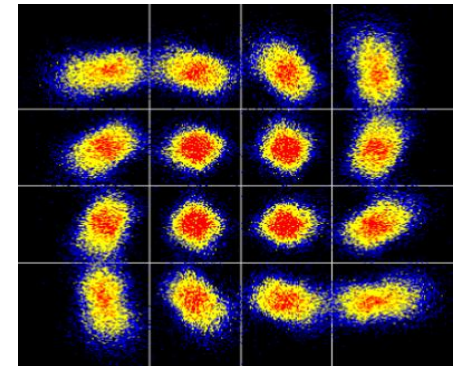

(d)MER=16.1 dB

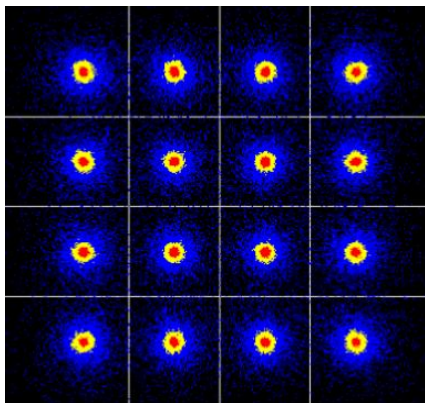

(e)MER=21dB

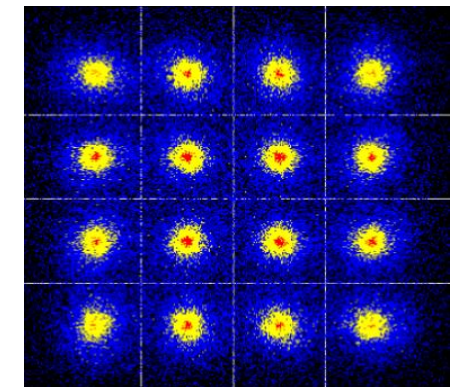

(f)MER=13.5dB

**Figure.6-17: Snapshots of the 16-QAM constellation diagrams in AWGN channel (a) AI=0% and PI=0°, (b) AI=5% and PI=5°. In RC20 channel (c) AI=0% and PI=0° (d) AI=10% and PI=10°. In RL20 channel (e) AI=0%and PI=0° (f) AI=10% and PI=10° (scenario2)**

### 6.3 Scenario 3: Portable reception

This scenario is used for portable reception because of its high robust parameters (see Table.6-6). For portable reception, a lower FFT size such as 16K is used, the PP3 is used because of the channel characteristic which, don't change that fast so it can be better to use less pilot signals [4]. The modulation 16-QAM is used because of its robust against errors. It is also uses high robust code rate (1/2) which is more robust against errors than (2/3) code rate which was used in the previous scenario. The resulting data rate according to this scenario is equal to 22.7 Mb/s [4].

**Tab.6-6: System Parameters of DVB-T2 for scenario3 [4]**

<b>Bandwidth</b>	8MHz
<b>FFT size</b>	16K
<b>Scattered pilot pattern</b>	PP3
<b>Guard interval</b>	1/8
<b>Modulation</b>	16-QAM (non-rotated)
<b>Code rate</b>	1/2
<b>Frequency</b>	689MHz
<b>Carrier mode</b>	extended

#### 6.3.1 Measurement results for scenario 3

##### 6.3.1.1 BER Parameter Measurement

BER was measured before LDPC decoding according to the I/Q errors and depending on the C/ N ratio. Results from the experimental measurements are shown in Figure.6-18, Figure.6-19, Figure.6-20. The best curve is obtained when the PI=0° and AI=0% (ideal case). From obtained results it can be seen that the PI error effect on performance is higher than the AI error effect. The performance of DVB-T2 system is not significantly affected when the values of AI and PI are small. The degradation of the performance start to be noticeable at PI=10° and AI=0%. The worst case is occurred when PI=10° and AI=10% where, the BER vs. C/N ratio is increased significantly in comparison with the other considered cases. The BER curves in RC20 channel differ only slightly from the curves, obtained in AWGN channel because of the existence of the direct path. The Highest DVB-T2 performance degradation was observed in RL20 channel (only reflected signals are available). It can be seen that in the case of AI=0%, PI=0°, The BER values at C/N=40 dB are equal to 0 for AWGN channel and 0 for RC20 channel and  $1.6 \times 10^{-3}$  for RL20 channel whereas in case of AI=10%, PI=10°, the BER values at C/N=40 dB are equal to  $1.3 \times 10^{-4}$  for AWGN channel and  $5.5 \times$

$10^{-4}$  for RC20 channel and  $3.4 \times 10^{-2}$  for RL20 channel. How it can be seen from these graphs, for achieving the same BER that have been obtained in the scenario2 a lower C/N ratio is required due to the high system robustness.

### 6.3.1.2 MER Parameter Measurement

Results from the experimental measurements are shown in Figure.6-21, Figure.6-22, Figure.6-23. The explanation of the curves is similar to the explanation that was introduced in the BER. The highest DVB-T2 performance degradation was observed in RL20 channel (due to echo paths). Visible differences in achieved MER from the point of I/Q-errors can be seen at higher C/N values (from 25 dB to 40 dB). It can be seen that in the case of AI=0%, PI=0°. The MER values at C/N=40 dB are equal to 34.8 dB for AWGN channel and 33.8 dB for RC20 channel and 25.5 dB for RL20 channel whereas in case of AI=10%, PI=10°, the MER values at C/N=40 dB are equal to 18.1 dB for AWGN channel and 17.7 dB for RC20 channel and 13.5 dB for RL20 channel. The difference between the considered cases appears slightly at lower C/N ratios. For instance, in the case of AI=0%, PI=0°, the MER values at C/N= 14 dB are equal to 14.4 dB for AWGN channel and 13.6 dB for RC20 channel and 10 dB for RL20 channel whereas in case of AI=10%, PI=10°, the MER values are equal to 12.8 dB for AWGN channel and 12.2 dB for RC20 channel and 8 dB for RL20 channel. Compared with the measured values in Scenario 2, the DVB-T2 performance is better.

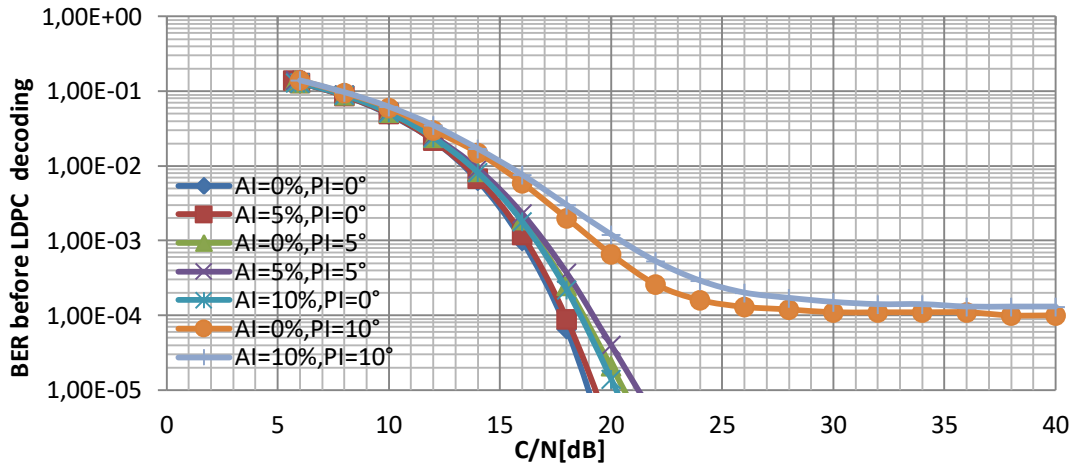

Figure.6-18:BER before LDPC decoding vs C/N in AWGN channel (Scenario3)

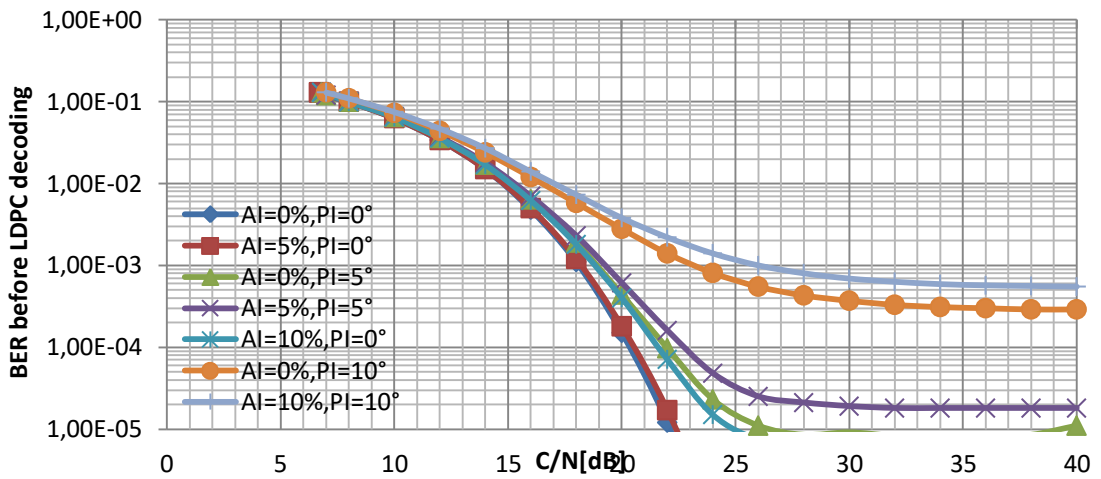

Figure.6-19:BER before LDPC decoding vs C/N in RC20 channel(Scenario 3)

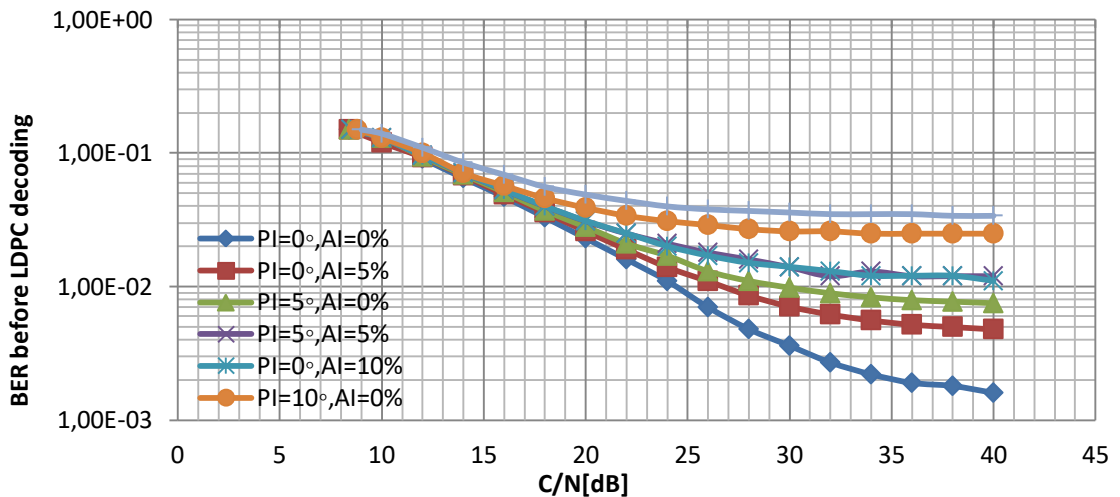

Figure.6-20:BER before LDPC decoding vs. C/N in RL20 channel(Scenario 3)



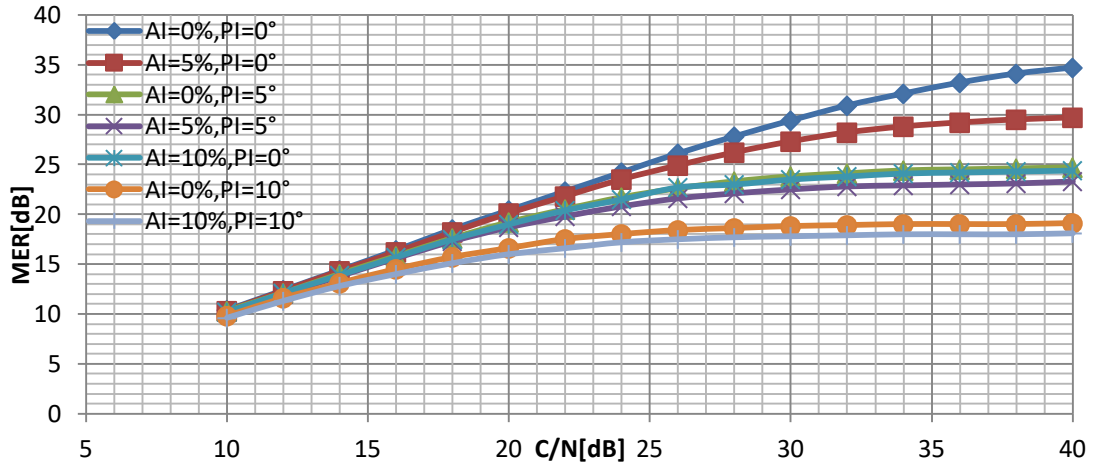

Figure.6-21: MER vs C/N in AWGN channel (scenario3)

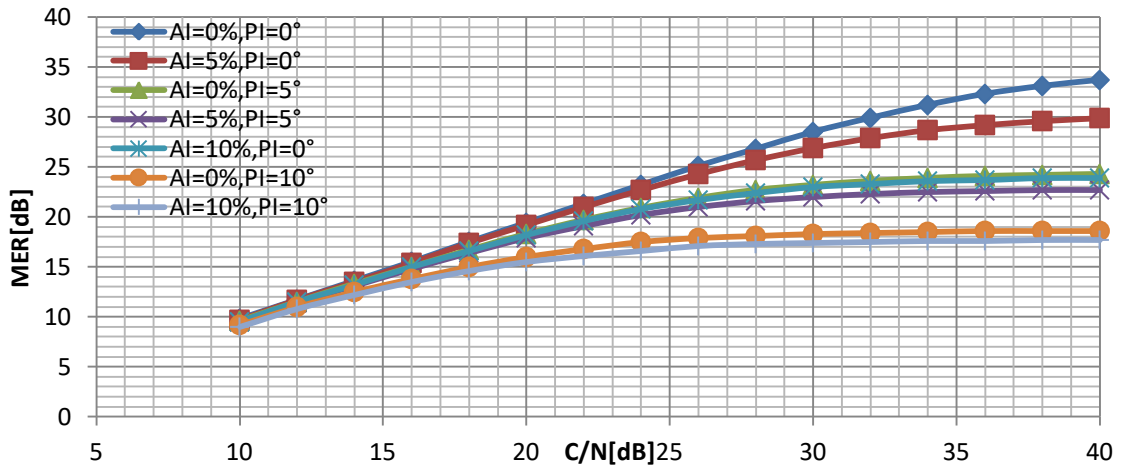

Figure.6-22: MER vs C/N in RC20 channel (Scenario3)

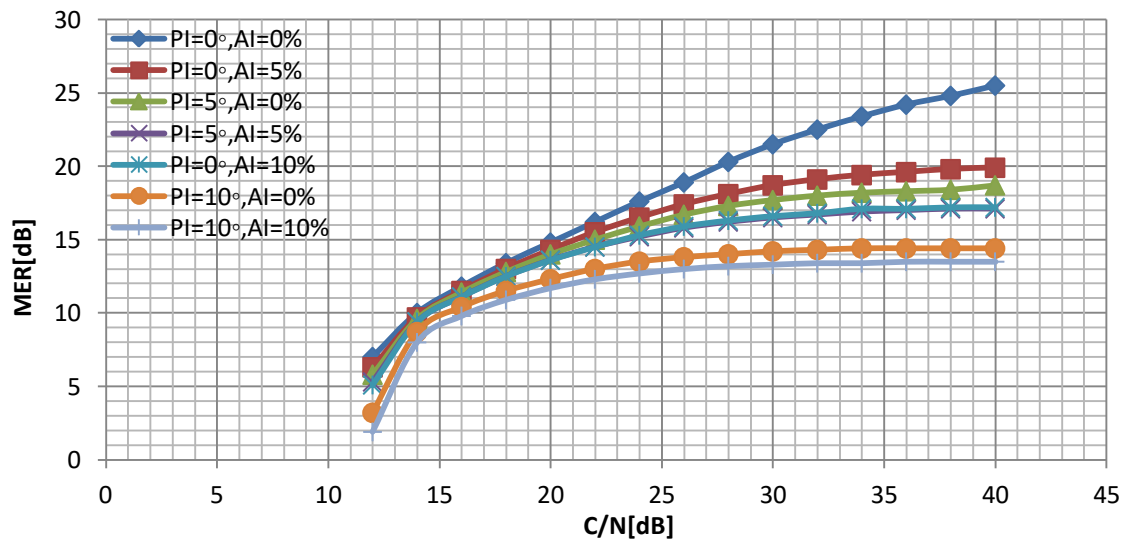

Figure.6-23: MER vs C/N in RL20 channel (Scenario3)

### 6.3.1.3 The Number of Iterations Parameter Measurement

Results from the experimental measurements are shown in Figure.6-24. These graphs explain the difference between the DVB-T2 performance at  $PI=0^\circ$ ,  $AI=0\%$  and at  $PI=10^\circ$ ,  $AI=10\%$  where, it is clearly shown that the performance is worse at  $AI=10\%$  and  $PI=10^\circ$ . It can be seen that in the case of  $AI=0\%$ ,  $PI=0^\circ$  (no I/Q errors), the LDPC iterations at  $C/N=40$  dB are equal to 1 for AWGN channel and 1 for RC20 channel and 5.67 for RL20 channel whereas in case of  $AI=10\%$ ,  $PI=10^\circ$ , The LDPC iterations at  $C/N=40$  dB are equal to 2.34 for AWGN channel and 4.14 for RC20 channel and 10.48 for RL20 channel. The number of iterations keeps constant at  $C/N$  (from 40 dB to 20 dB) then start to rise rapidly in order to improve the FEC frame. Compared with the scenario2, LDPC iterations in scenario 2 is greater, which means that the decoder needs to correct more errors. So that, DVB-T2 signal in portable reception is more robust against errors.

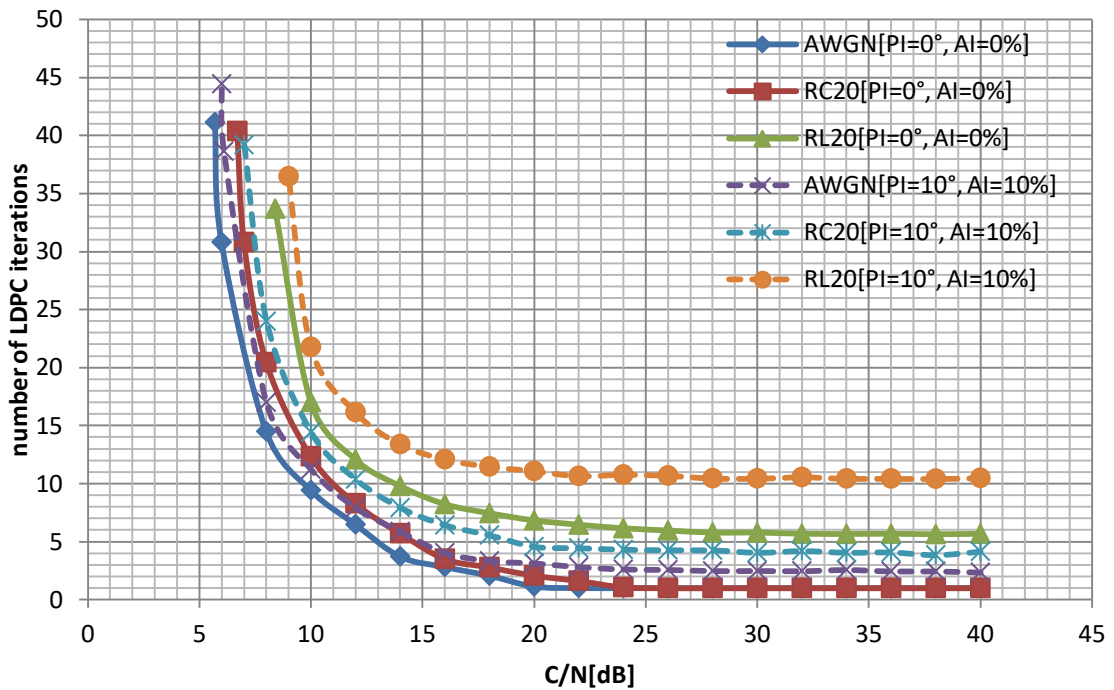

Figure.6-24:LDPC iterations vs. C/N (scenario3)

### 6.3.1.4 Scenario 3 – Objective versus Subjective Results

BER parameter was also measured after LDPC decoding . From the measurements it became possible to determine the minimum C/N ratio for QEF. The minimum C/N ratio for QEF reception was measured on the ETL-TV analyzer and monitored by THOMSON- THT712 STB then they were compared. Compared to scenario2, the

required C/N ratio to achieve QEF reception is lower due to high system's robust against errors.

**Tab.6-7:QEF table (scenario3)**

<b>IQ-imbalance</b>	<b>Channel mode</b>	<b>C/N measured by ETL analyzer [dB]</b>	<b>C/N monitored by THOMSON- STB [dB]</b>
<b>AI=0 % , PI=0°</b>	<b>AWGN</b>	6	5.4
	<b>RC20</b>	6.8	5.9
	<b>RL20</b>	8.6	7.7
<b>AI=5 % , PI=0°</b>	<b>AWGN</b>	5.8	5.5
	<b>RC20</b>	6.8	6
	<b>RL20</b>	8.6	7.7
<b>AI=0 % , PI=5°</b>	<b>AWGN</b>	6	5.5
	<b>RC20</b>	6.9	6.1
	<b>RL20</b>	8.6	7.7
<b>AI=5 % , PI=5°</b>	<b>AWGN</b>	5.9	5.5
	<b>RC20</b>	6.9	6
	<b>RL20</b>	8.6	7.7
<b>AI=10 % , PI=0°</b>	<b>AWGN</b>	5.9	5.5
	<b>RC20</b>	6.9	6.1
	<b>RL20</b>	8.7	7.7
<b>AI=0 % , PI=10°</b>	<b>AWGN</b>	6.1	5.6
	<b>RC20</b>	7.1	6.2
	<b>RL20</b>	8.9	7.9
<b>AI= 10% , PI=10°</b>	<b>AWGN</b>	6.1	5.7
	<b>RC20</b>	7	6.3
	<b>RL20</b>	9.1	8

If we change the code rate parameter (see Table.6-6) to 4/3, the required C/N ratio for QEF reception will increase (see Table.6-8). Although increasing the code rate value is an advantage. But on the other hand, it decreases the signal robust against errors

**Tab.6-8:QEF table for CR =3/4(scenario3)**

<b>IQ-imbalance</b>	<b>Channel mode</b>	<b>C/N measured by ETL analyzer [dB]</b>	<b>C/N monitored by THOMSON- STB [dB]</b>
<b>AI=0 % , PI=0°</b>	<b>AWGN</b>	9.4	9.3
	<b>RC20</b>	10.5	10
	<b>RL20</b>	13.8	12.5
<b>AI=5 % , PI=0°</b>	<b>AWGN</b>	9.5	9.3
	<b>RC20</b>	10.6	10
	<b>RL20</b>	14.1	12.6
<b>AI=0 % , PI=5°</b>	<b>AWGN</b>	9.5	9.4
	<b>RC20</b>	10.7	10.2
	<b>RL20</b>	14.3	12.8
<b>AI=5 % , PI=5°</b>	<b>AWGN</b>	9.6	9.5
	<b>RC20</b>	10.8	10.2
	<b>RL20</b>	14.5	12.8
<b>AI=10 % , PI=0°</b>	<b>AWGN</b>	9.6	9.5
	<b>RC20</b>	10.7	10.3
	<b>RL20</b>	14.5	12.8
<b>AI=0 % , PI=10°</b>	<b>AWGN</b>	10	9.8
	<b>RC20</b>	11.2	10.5
	<b>RL20</b>	15.7	13.3
<b>AI= 10% , PI=10°</b>	<b>AWGN</b>	10.3	9.9
	<b>RC20</b>	11.5	10.7
	<b>RL20</b>	16.5	13.7

We noticed from the measurements that, the required C/N ratio for QEF reception when using code rate =1/2 is better where, in the case of AI= 10% , PI=10°, the required ratios are lower and they are equal to 6.1 dB for AWGN channel and 7 dB for RC20 and 9.1 dB for RL20.

After the set of the parameters according to the Table.6-6, snapshots of the 16QAM constellation diagrams for IQ imbalances AI=0%, PI=0° and AI=10%, PI=10°, obtained at C/N=30 dB, are shown in Figure.6-25.

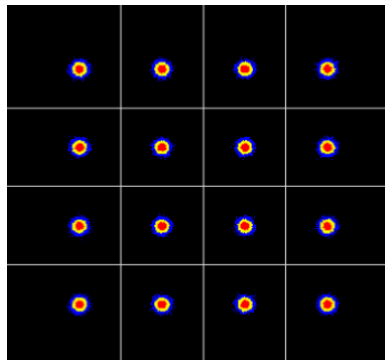

(a)MER=29.4 dB

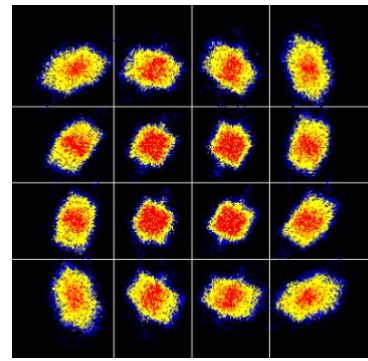

(b)MER=17.8 dB

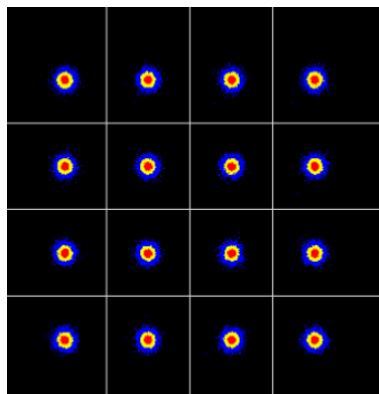

(c)MER=28.5 dB

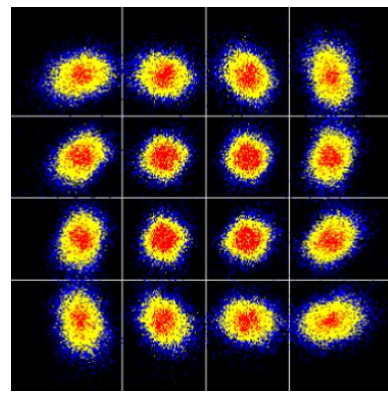

(d)MER=17.4 dB

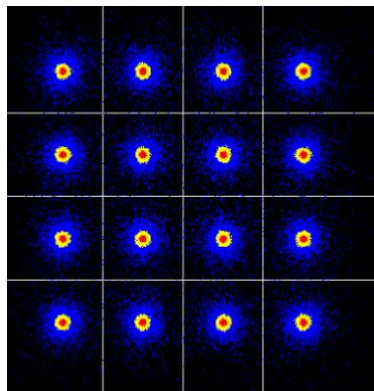

(e)MER=21.5 dB

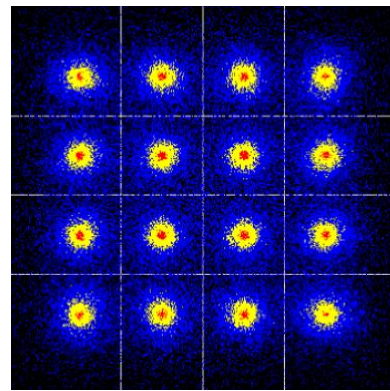

(f)MER=13.8 dB

**Figure.6-25: Snapshots of the 16QAM constellation diagrams in AWGN channel (a) AI=0%andPI=0° (b) AI=10%andPI=10° . In RC20 channel (c) AI=0%andPI=0° (d) AI=10%andPI=10°. In RL20 channel (e) AI=0%andPI=0° (f) AI=10%andPI=10° (scenario3)**

## 7. CONCLUSION

This work studied the basic signal processing chain in the DVB-T2. It also studied the possible I/Q errors in DVB-T2 OFDM modulator (amplitude imbalance-AI, phase imbalance-PI). Three fading channel models were studied: Gaussian channel, Rayleigh channel and Ricean channel. This work also proposed a laboratory measurement workplace to measure the performance of DVB-T2 and included a brief description of the measurement parameters. The measured parameters were MER, The number of iterations, BER before LDPC, BER after LDPC, according to different I/Q errors and different propagation scenarios. After that, the correctness of the proposed concept is verified by many graphs: MER versus C/N, number of iterations versus C/N, BER before LDPC decoding versus C/N. We noticed that the DVB-T2 has the best performance in the Gaussian channel. It is caused by a fact that in this channel model only a direct path between the TX and RX is considered. The QEF conditions in this channel are the best. In the case of RC20 channel model, the direct path between TX and RX is supplemented by multipath propagation. The results show that the penalty for C/N in this channel, compared with Gaussian, is not notable. This phenomenon is caused by the availability of the direct path. Finally, the results were obtained for the RL20 channel. The obtained results confirmed that this channel model represents the worst channel conditions for the broadcasting (only echo paths are available). In this channel the QEF is higher than the QEF in AWGN channel of about 3 dB. The performance of DVB-T2 is also highly depending on the selectable I/Q errors in DVB-T2 OFDM modulator. We noticed that the PI error Affects on the DVB-T2 performance more than the AI error where, the highest performance degradation was obtained at AI=10% and PI=10° for scenario 2 and scenario 3 and at AI=5% and PI=5° for scenario 1. The minimum C/N for QEF reception was measured by ETL-TV analyzer and monitored by THOMSON- THT712 STB where, we noticed that the required C/N ratio for QEF reception for scenario 5 is the best duo to high system's robust against errors. This work also gave Snapshots of the constellation diagrams and RF spectrum for the received signal. It also proposed a laboratory task to measure different DVB-T2 transmission scenarios and prepared a sample workout for the proposed task (see appendixes).

# Literature

- [1] Roland Beutler, The Digital Dividend of Terrestrial Broadcasting, Springer New York Dordrecht Heidelberg London 2012, ISBN 978-1-4614-1568-8.
- [2] ETSI EN 300 755 V1.4.1 (2015-07). Digital Video Broadcasting (DVB); Frame structure channel coding and modulation for a second generation digital terrestrial television broadcasting system DVB-T2. 2009.
- [3] Digital Video and Audio Broadcasting Technology A Practical Engineering Guide Third Edition. Springer Heidelberg Dordrecht London New York. ISBN 978-3-642-11611-7.
- [4] Rep. ITU-R BT.2254-2. Frequency and network planning aspects of DVB-T2. Report ITU-R BT.2254-2 (11/2014).
- [5] L.Polak, T.Kratochvil, "Influence of IQ-Errors on DVB-T2 Performance and its Suppression by Different Methods", Proc. of Int. Symp. BMSB, pp. 1-5, 2017.
- [6] ETSI TS 102 831 V1.2.1 (2012-08 Digital Video Broadcasting (DVB); Implementation guidelines for a second generation digital terrestrial television broadcasting system (DVB-T2).
- [7] ETSI EN 300 744 V1.6.1 (2009-01). Digital Video Broadcasting (DVB); Framing structure, channel coding and modulation for digital terrestrial television. 2009.
- [8] Ladislav Polak, Ondrej Kaller, Lukas Klozar, Martin Slanina, Jiri Sebesta, Tomas Kratochvil, Coexistence Between DVB-T/T2 and LTE Standards in Common Frequency Bands, Volu. 88, Pages 669-684, Issue 3, June 2016.
- [9] Frequency and Network Planning Aspects of DVB-T2 ,EBU – TECH 3348 (Geneva May 2011).
- [10] Rotated Constellations for DVB-T2 Electronic Engineering Department, University of Seville Escuela Superior de Ingenieros. Avda. Descubrimientos s/n. 41092. Sevilla, Spain.

- [11] COLLINS, G. W. Fundamentals of Digital Television Transmission New Jersey: John Wiley & Sons, Inc., 2001. 267 s. ISBN 0-471-39199-9
- [12] HANUS, S Základy televizní techniky Elektronické skriptum. Brno: FEKT VUT v Brně, 2008.
- [13] The DVB-T2 Reference Streams , DVB-T2 Verification & Validation Working Group, Version: 1.1 (11th August, 2011)
- [14] Efficient iterative receiver for bit-Interleaved Coded Modulation according to the DVB-T2 standard, Institut Telecom, Telecom Bretagne, CNRS Lab-STICC UMR 3192 Technopôle Brest Iroise, CS 83818 29238 Brest Université Européenne de Bretagne, France [firstname.lastname@telecom-bretagne.eu](mailto:firstname.lastname@telecom-bretagne.eu).
- [15] Field Trials Based Planning Parameters for DVB-T2 Indoor Reception, Cristina Regueiro, Member, IEEE, Unai Gil, Member, IEEE, Manuel Velez, Member, IEEE, Iñaki Eizmendi, Member, IEEE, Pablo Angueira, Senior Member, IEEE
- [16] ANALYSIS OF PILOT PATTERNS AND CHANNEL ESTIMATION FOR DVB-T2, Beijing University of Posts and Telecommunications, Beijing, China [fuli0602@bupt.cn](mailto:fuli0602@bupt.cn), [slsun@bupt.edu.cn](mailto:slsun@bupt.edu.cn), [jxiaojun@bupt.edu.cn](mailto:jxiaojun@bupt.edu.cn), [huanghai@bupt.edu.cn](mailto:huanghai@bupt.edu.cn).



## List of Appendix

Appendix1-The proposal of Laboratory Task.....	66
Appendix2- The elaboration of laboraory task .....	74

## **Appendix1-The proposal of Laboratory Task**

Laboratory task

## **The measurement of DVB-T2 system performance**

**The purpose of the task is to learn how to measure the basic features of a DVB-T2 system using objective parameters and test the STB for different values of I/Q modulator imperfection.**

### **Theoretical introduction**

The second generation terrestrial DVB standard (DVB-T2), as the successor of DVB-T is the world's most advanced digital terrestrial TV system. Compared with DVB-T, the DVB-T2 standard offers a bigger choice of the OFDM parameters and modulation schemes. Combining various modulation schemes with FFT sizes and guard intervals allows construction SFN networks designed for different applications: from low bit-rate but robust mobile reception to the high bit-rate fixed reception for domestic and professional use [4].

The DVB-T2 uses coded orthogonal multiplexing (COFDM) for transmission because of its high resistant to multiple signal propagation. The COFDM modulator consists of IFFT module which transforms the COFDM symbol from frequency domain to time domain. After the transition to the time domain all real time signals  $re(t)$  will be grouped in the I branch and all imaginary time signals  $im(t)$  will be grouped in the Q branch where, the amplitudes of the I and Q branches are equal and the phase angle between the I and Q branches is equal to 90 degrees (see Figure.1).

The model of modulator can be expressed by this equation:

$$y_{IQ} = x_i \cos(2\pi f_c t) - x_q \sin(2\pi f_c t) \quad (1)$$

where,  $x_i$  and  $x_q$  are the I and Q components of the data respectively,  $f_c$  is the carrier frequency.

In this task we will study the effect of the quadrature modulator imperfections (Amplitude Imbalance-AI and Phase Imbalance-PI) on DVB-T2 performance according to two scenarios (see Table.1). There are two types of I/Q errors which can occur in DVB-T2 modulator, amplitude imbalance-AI and phase imbalance-PI.

The AI error can be occurred when the amplitudes of the I and Q signals are not equal (see Figure.2). The transmitted signal in the presence of AI error can be expressed by this equation:

$$y = (1 + \alpha)x_i \cos(2\pi f_c t) - (1 - \alpha)x_q \sin(2\pi f_c t) \quad (1)$$

where,  $\alpha$  represents the amplitude difference between the I and Q branches.

The PI error can be occurred when the phase between the I and Q signals is different than 90 degree (see Figure.2). The transmitted signal in the presence of PI error can be expressed by this equation :

$$y = x_i \cos(2\pi f_c t) - x_q \sin(2\pi f_c t + \varphi) \quad (2)$$

where,  $\varphi = \theta(\frac{\pi}{180})$  represents the phase difference between the I and Q branches and It is given in units of radian.

The objective parameters of DVB-T2 system are: Modulation Error Ratio (MER) and Bit Error Ratio (BER). MER is a measure of the sum of all interference effects occurring at the transmission-link. It is given in dB. BER is the ratio between the number of incorrect bits transmitted to the total number of bits for a specified time interval. This parameter is used to evaluate the DVB-T2 performance. The Quasi Error Free (QEF) reception is the minimum required carrier-to-noise ratio to receive DVB-T2 signal correctly. In DVB-T2, the QEF reception is identified by determining the corresponding C/N ratio of BER after LDPC decoding equal or less than  $1 \times 10^{-7}$ . This value depends on the selectable channel. The subjective parameters in DVB-T2 are: signal strength and quality. The quality is related to the ratio between DVB-T2 signal power and the noise power (C/N).

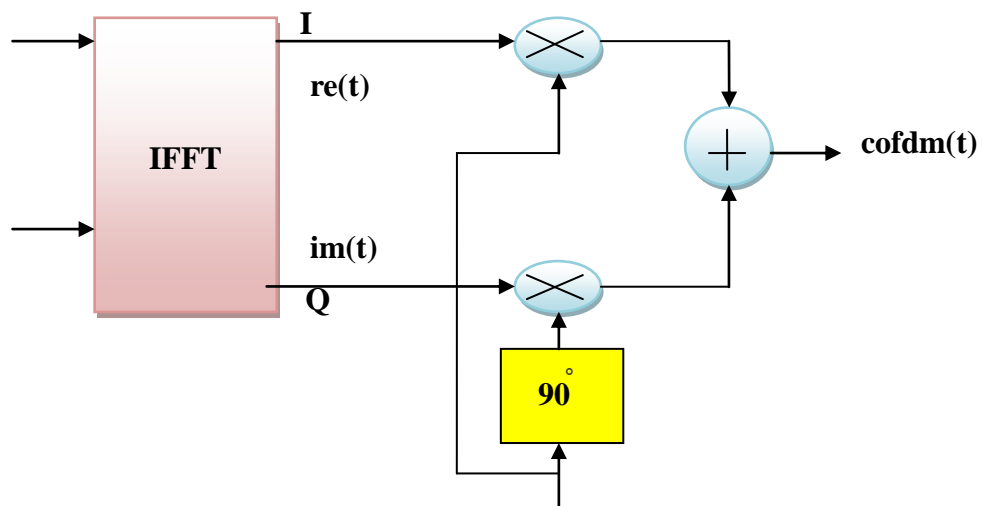

**Figure.1: The DVB-T2 modulator[3]**

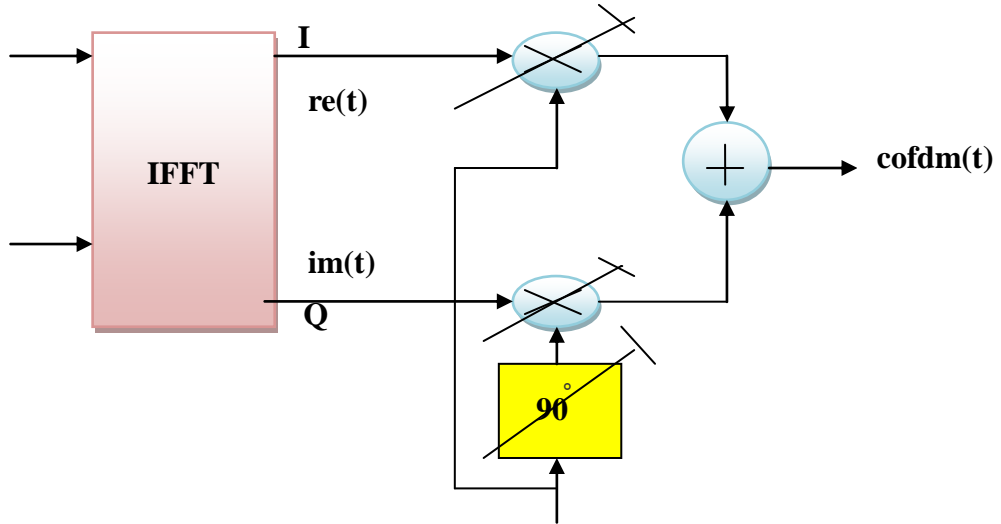

Figure.2: The DVB-T2 modulator with I/Q error

Table.1: System Parameters for transmitted DVB-T2

	Scenario 1 (Fixed rooftop reception)	Scenario2 (Portable reception)
<b>Bandwidth</b>	8 MHz	8MHz
<b>FFT size</b>	32K	16K
<b>Scattered pilot pattern</b>	PP2	PP3
<b>Guard interval</b>	1/8	1/8
<b>Modulation</b>	256-QAM	16-QAM
<b>Code rate</b>	2/3	1/2
<b>Frequency</b>	689MHz	689MHz
<b>Carrier mode</b>	extended	extended
<b>Channel mode</b>	AWGN,RL20	AWGN,RL20

## Tasks and Measurement procedure

1. Familiarize yourself with the operation of measuring devices Rohde & Schwarz (R&S) ETL-TV analyzer and THOMSON- THT712 Set Top Box (STB). Instructions for devices are a part of laboratory workplace.
2. Set the R&S SFE generator to the required parameters for DVB-T2 signal according to the scenario 1 (see table.1). Study the influence of the I/Q errors on the DVB-T2 signal by using these values for AI and PI imbalances(AI=0% and PI=0°(no I/Q error), AI=5% and PI=0°, AI=0% and PI=5°, AI=5% and PI=5°).

The procedure will be as follows:

- Open the menu and Press the **SETUP** Button » **FAVORITIES** » **FREQUENCY** » **TX:FREQUENCY: FREQUENCY** ( set 689 MHz) » **TX:LEVEL: LEVEL** (set - 60 dBm).
  - From menu Press the **DIGITALTV**» **BICM**»**MODULATION** (set the modulation) »**CODE RATE** (set the code rate).
  - **DIGITALTV**»**FRAMING+OFDM**»**GUARD INTERVAL**(set the guard interval)» **PILOTPATTERN** (set the pilot pattern) » **FFT SIZE** (set the FFT size).
  - **DIGITALTV**»**IMPAREMENTS**»**MODULATOR IMPAREMENTS** (set ON) » **QUARATURE ERROR** (set the PI error value) » **AMLITUDEIMBALANCE**(set the AI error value)
  - AWGN channel [ **NOISE** » **NOISE** » **AWGN** » **C/N** (set the C/N to 40 dB and gradually decrease the value by 2).
  - RL20 channel [ **FADING** » **PROFILE** » **STANDARD** (choose DVB) » **PARAMETER SET** (select RL20 ANX B) » **SPEED**( put speed fields on zero value ) » **FADING** (set ON)
  - select RF on.
3. Measure the MER and BER before LDPC decoding by using the R&S ETL-TV analyzer according to each value of I/Q imbalances. Then process these measurements in the form of a graph as a function of a C/N variable.

The procedure will be as follows:

- Set the **Frequency** to the 689 MHz.
- Press the **MEAS** button» **OVERVIEW** .

4. Set the ETL analyzer to display RF signal spectrum and the constellation diagram for I/Q imbalances (AI=0% and PI=0°, AI=5% and PI=5°).

The procedure to display the spectrum:

- Press the **MEAS** button» **Spectrum** button

The procedure to display the constellation diagram:

- Press the **MEAS** button» **Modulation Analysis** »**Const Diagram**.

5. Turn the STB on the working frequency to enable it to decode The DVB-T2 signal then determine the required C/N for QEF reception on STB. Compare this value with the required C/N for QEF reception on the analyzer according to the I/Q imbalances ( AI=0% and PI=0° , AI=5% and PI=5° ).

The procedure will be as following :

- **Menu** » **Installation** » **Terrestrial Search** (set OK) » **Search Mode** (set Manual) » **Frequency** (689 MHz) » **Search**» **Save**.

6. Set the R&S SFE generator to the required parameters for transmitted DVB-T2 signal according to the scenario 5 (see table.1). Then follow the same procedure as in point.2 and point.3 and point.4 and point.5.

## Measurement notes

During the measurement you should pay attention to adjust the TX:LEVEL vlaue to the – 60 dBm to avoid damage of devices and to get true measured values. You should also pay attention when you choose the RL20 ANX B channel .The speed fields must contain zero values .

## Used measuring devices

<b>STB</b>	digital terrestrial reciver DVB-T2 THOMSON- THT712
<b>TV</b>	TV reciver
<b>ETL</b>	Analyzer R&S ETL-K202 TV
<b>SFU</b>	laboratory transmitter DVB-T/T2 R&S SFU Broadcast Test System
<b>ATT</b>	ATTENUATOR 75BR- 014.



**Laboratory workplace for measuring DVB-T2 performances influenced by IQ-imbalances.**

## **Conclusion**

It is necessary to comment in detail on each measurement point. Justify and compare the graphs with each other.

## **Check Questions**

1. What is the difference between the amplitude imbalance and the phase imbalance?
2. What kind of I/Q imbalance has higher influence on the DVB-T2 performance: amplitude or phase?
3. What is the meaning of QEF and how can be measured?

## **Literature**

[1] Digital Video and Audio Broadcasting Technology A Practical Engineering



Guide Third Edition. Springer Heidelberg Dordrecht London New York.. ISBN 978-3-642-11611-7.

- [2] Rep. ITU-R BT.2254-2 . Frequency and network planning aspects of DVB-T2 .Report ITU-R BT.2254-2 (11/2014).
- [3] ETSI TS 102 831 V1.2.1 (2012-08 Digital Video Broadcasting (DVB); Implementation guidelines for a second generation digital terrestrial television broadcasting system (DVB-T2).
- [4] Frequency and Network Planning Aspects of DVB-T2, EBU – TECH 3348

## **Appendix2- The elaboration of laboraory task**

1. In the first point, we familiarize ourselves with the operation of measuring devices .
2. In this point, we have set the generator according to the instructions for scenario 1.
3. We have measured the MER and BER before LDPC decoding for I/Q errors (PI=0° and AI=0%, PI=0° and AI=5%, PI=5° and AI=0%, PI=5° and AI=5%). The DVB-T2 parameters couldnt be measured by the analyzer for I/Q errors PI=10°, AI=0% and PI=10°, AI=10% due to the use of 256-QAM modulation type. This type of modulation has low robustness against errors.

We have constructed the following graphs:

- The BER parameter

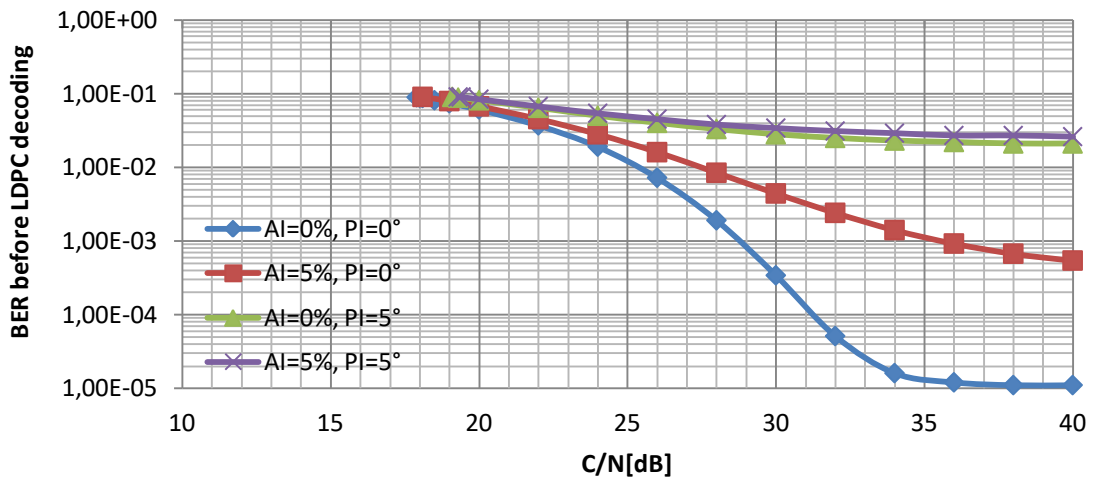

Figure.1: BER before LDPC decoding vs. C/N in AWGN channel(scenario1)

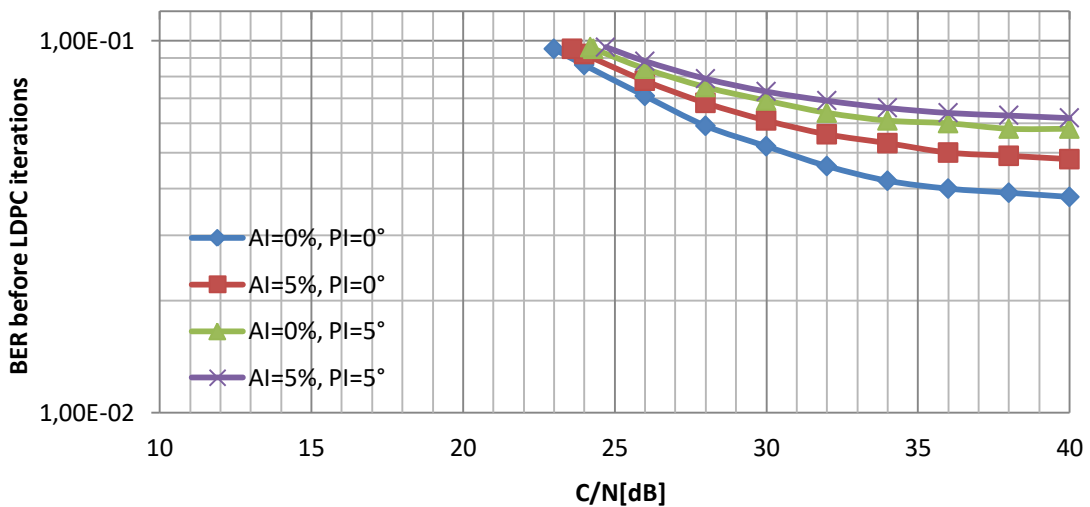
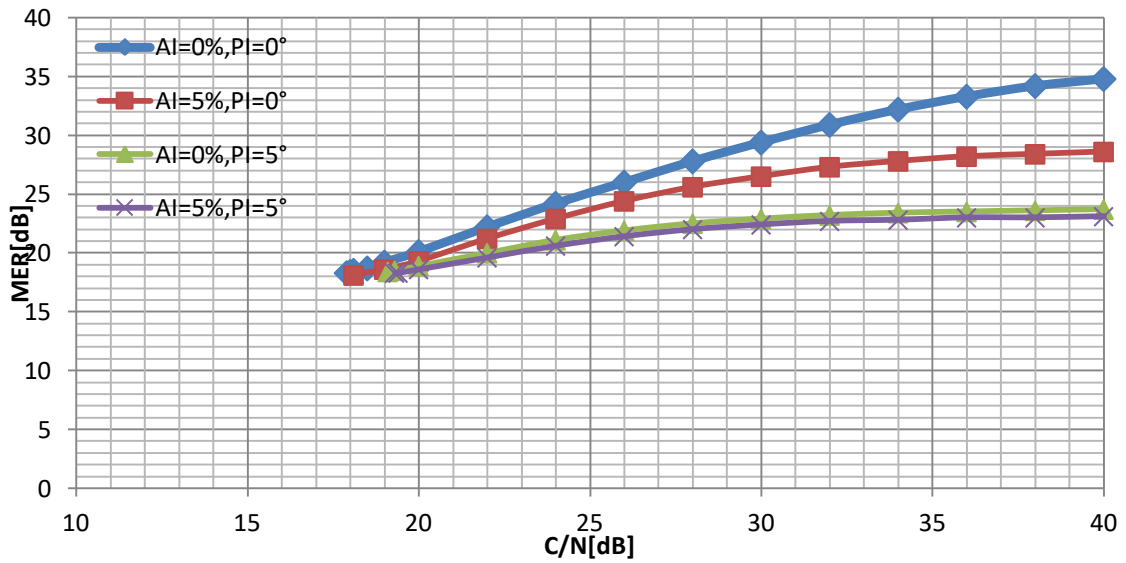
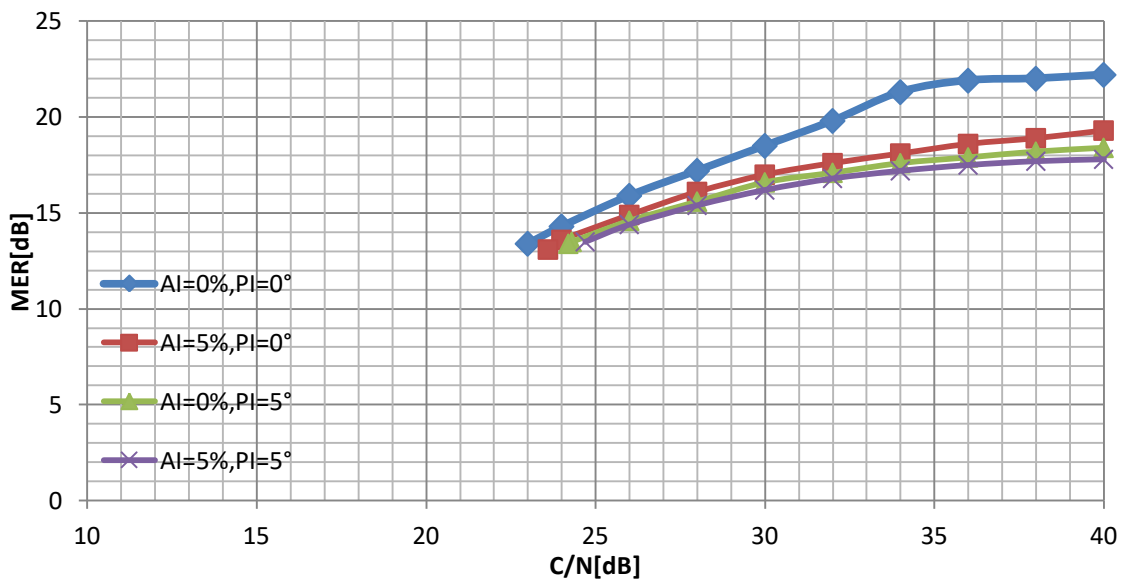

Figure.2: BER before LDPC decoding vs C/N in RL20 channel (scenario1)

- The MER parameter

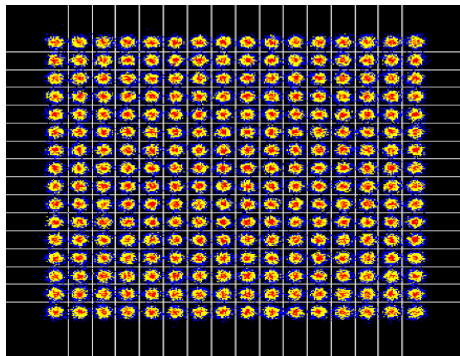

**Figure.3: MER vs C/N in the AWGN channel (scenario 1)**

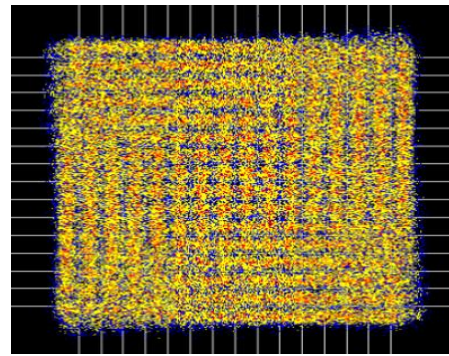

**Figure.4: MER vs C/N when in the RL20 channel (scenario 1)**

The constellation diagram and the RF spectrum are shown in Figure.5, Figure.6, Figure.7.



(a) MER=29.4 dB



(b) MER= 22.4dB

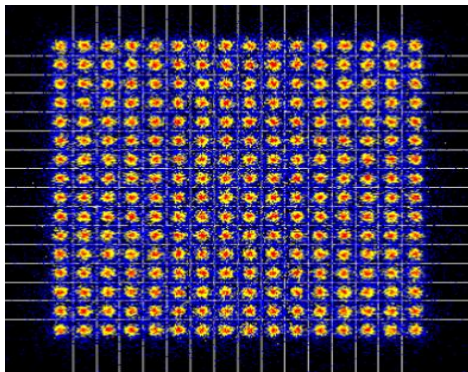

(c) MER= 25.1dB

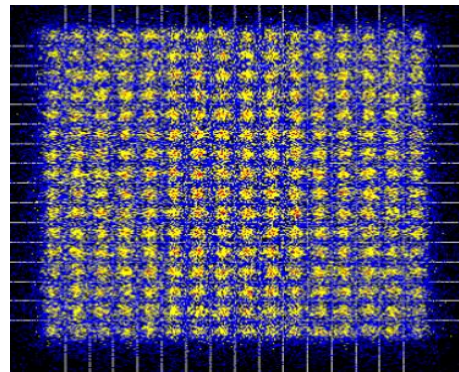

(d) MER=16.3 dB

**Figure.5: Snapshots of the 256-QAM constellation diagrams in AWGN channel (a) AI=0%andPI=0° (b) AI=5%andPI=5°. In RL20 channel (e) AI=0%andPI=0° (f) AI=5%andPI=5°.**

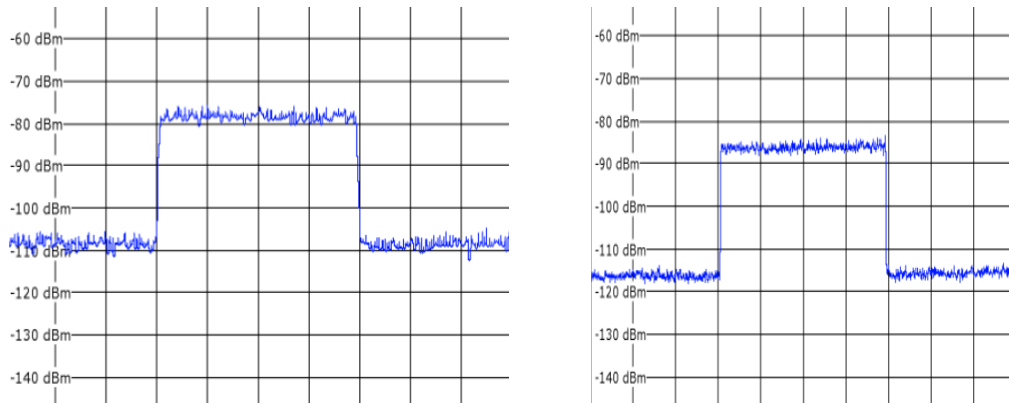

**Figure.6: Snapshots of the 256-QAM spectrum diagrams in AWGN channel (a) AI=0%andPI=0° (b) AI=5%andPI=5°, All spectrum diagrams were captured at C/N=30 dB, Frequency =689 MHz, Span=20.0 Mhz, RBW= 100 KHz,VBW= 1MHZ**

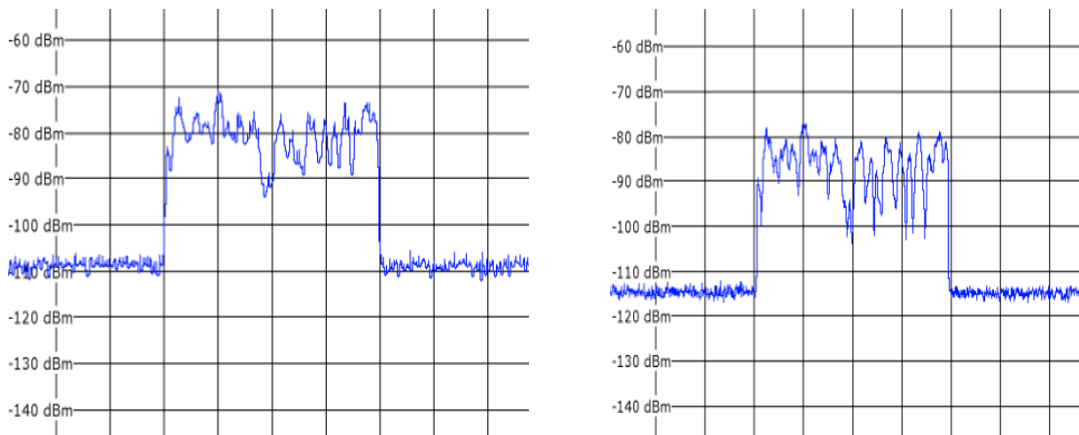

**Figure.7: Snapshots of the 256-QAM spectrum diagrams in RL20 channel (a) AI=0%andPI=0° (b) AI=5%andPI=5°, All spectrum diagrams were captured at C/N=30 dB, Frequency =689 MHz, Span=20.0 Mhz, RBW= 100 KHz,VBW= 1MHZ**

4.

**Table.1: QEF table (scenario1)**

I/Q imbalances	Channel mode	C/N Measured by ETL analyzer [dB]	C/N monitored by THOMSON STB [dB]
AI=0%andPI=0°	AWGN	17.9	17.6
	RL20	23	20.6
AI=5%andPI=5°	AWGN	19.3	18.4
	RL20	24.7	21.8

5. In this point, we have set the generator according to the instructions for scenario 2.

- BER parameter

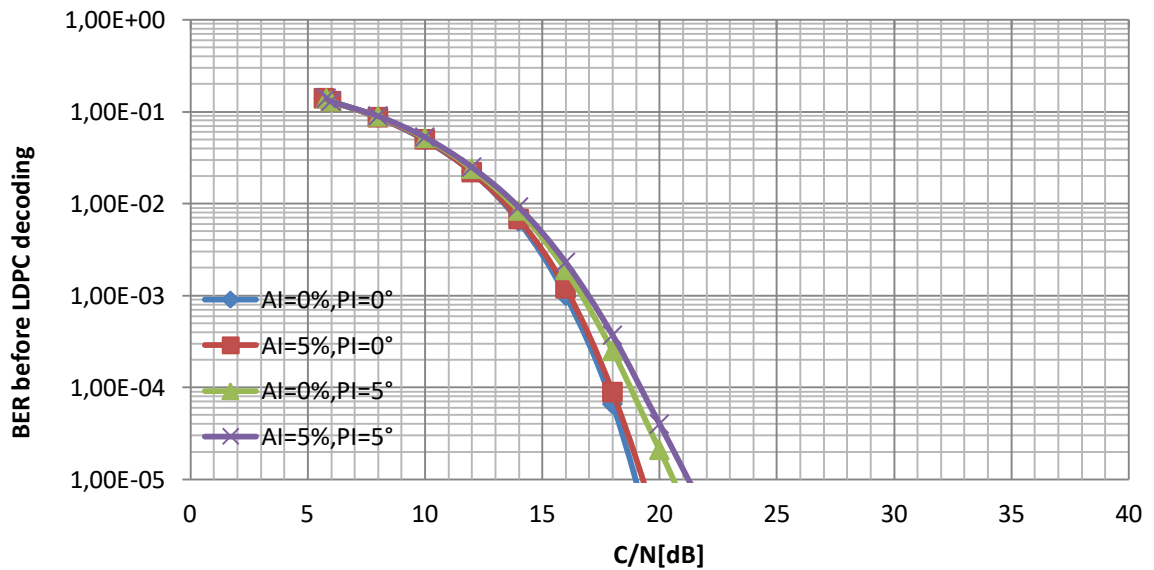

**Figure.8: BER before LDPC decoding vs. C/N in the AWGN channel (scenario 2)**

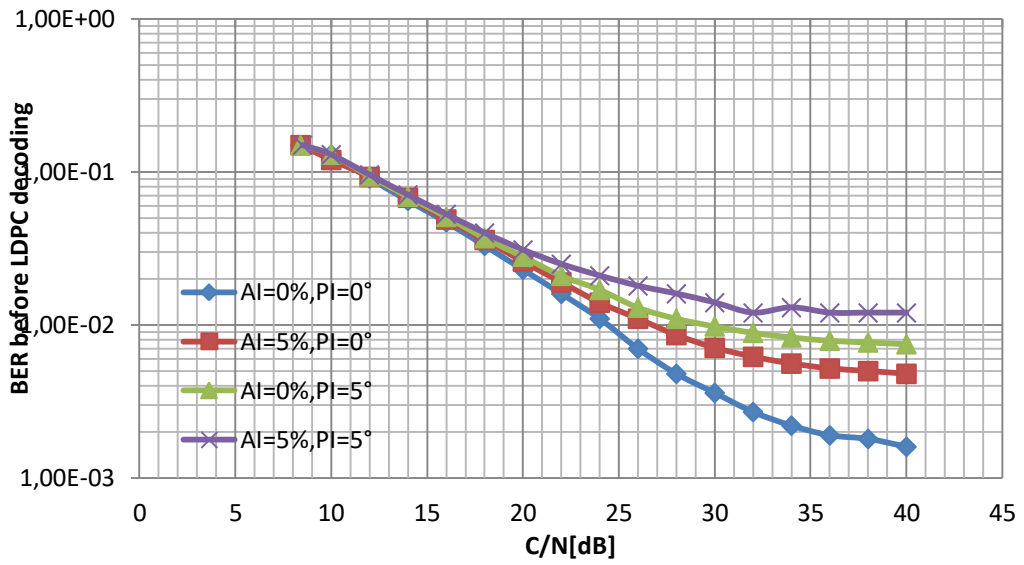

Figure.9: BER before LDPC decoding vs C/N in the RL20 channel (scenario 2)

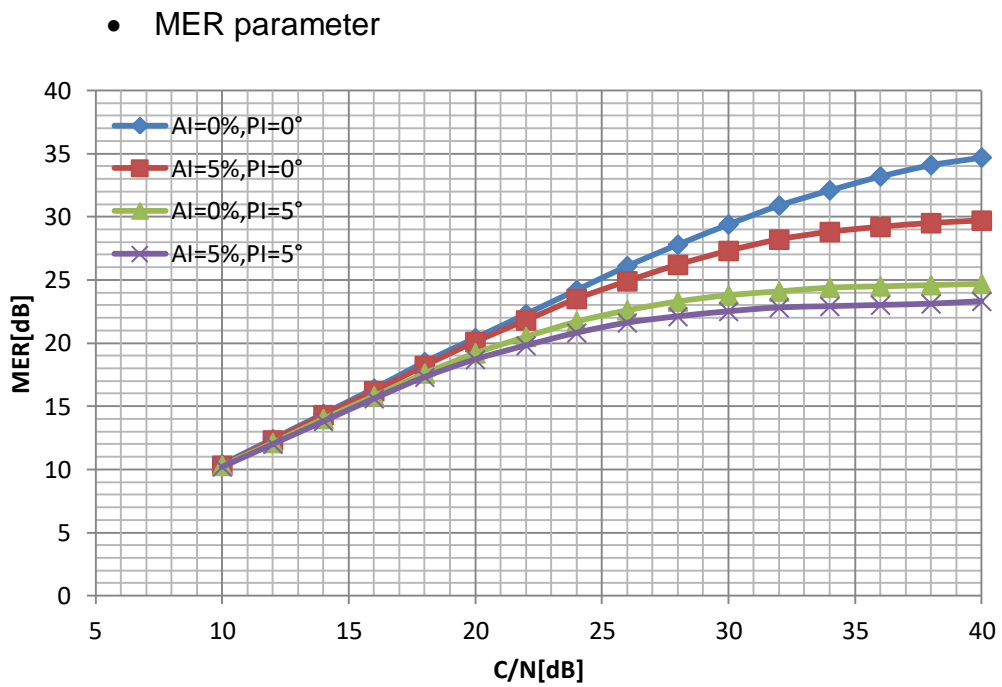

Figure.10: MER vs C/N in the AWGN channel (scenario2)



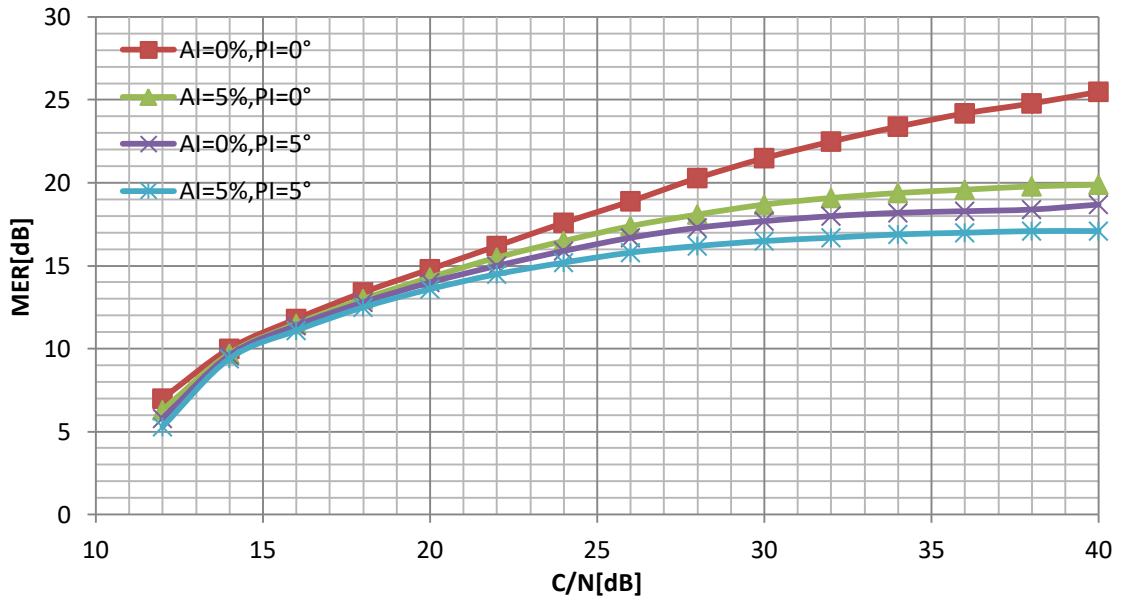
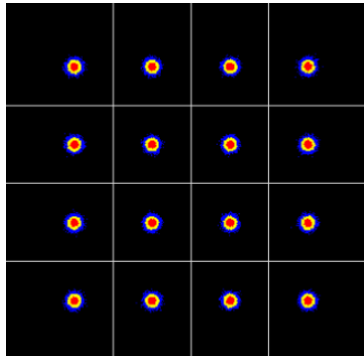

Figure.11: MER vs C/N in the RL20 channel (scenario2)

Table.2: QEF table (scenario2)

I/Q imbalances	Channel mode	C/N Measured by ETL analyzer [dB]	C/N monitored by THOMSON STB [dB]
AI=0%andPI=0°	AWGN	5.7	5.4
	RL20	8.4	7.9
AI=5%andPI=5°	AWGN	5.8	5.5
	RL20	8.5	7.7



(a) MER=29.4dB

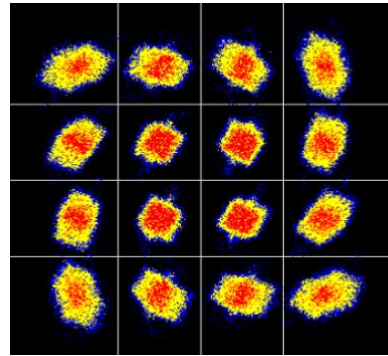

(b) MER=17.8dB

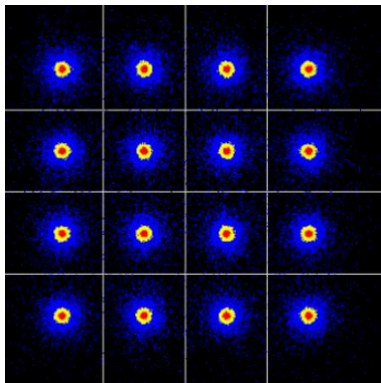

(e) MER=21.5dB

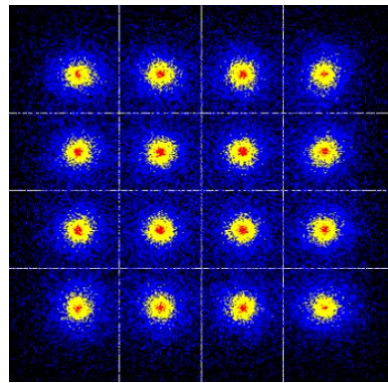

(f) MER=13.3 dB

**Figure.12: Snapshots of the 16QAM constellation diagrams in AWGN channel (a) AI=0%andPI=0°, (b) AI=10%andPI=10°, In RL20 channel (e) AI=0%andPI=0°, (f) AI=10%andPI=10°.**

## CONCLUSION

In this task we measured the DVB-T2 parameters and studied the effect of the quadrature modulator imperfections (AI and PI) on DVB-T2 system. At first, we measured the MER and BER before LDPC decoding for many values of I/Q imbalances then we processed these measured values in graphs. We noticed from graphs that the PI error has the highest effect on DVB-T2 performance whereas the AI error has a light effect. From measurement, it can be seen that portable reception is more robust than fixed reception due to its high robust parameters. We also take a snapshots of the constellation diagrams and we noticed that the constellation diagram gets worse when the I/Q error is occurred. We also determined the minimum C/N ration for QEF on analyzer and monitored it by STB .We noticed that the STB can decode the received signal at lower C/N ratios than the analyzer. The reason is that the STB has high sensitivity and uses different algorithms than the algorithms used in the analyzer.