

Czech University of Life Sciences Prague

Faculty of Economics and Management

Department of System Engineering



Master's Thesis

Project of establishing sales department in IT company

Bc. Nikola Šafránek

© 2023 CZU Prague

CZECH UNIVERSITY OF LIFE SCIENCES PRAGUE

Faculty of Economics and Management

DIPLOMA THESIS ASSIGNMENT

Bc. Nikola Šafránek

Informatics

Thesis title

Project of establishing sales department in IT company

Objectives of thesis

The objective of this thesis is to design a project plan for the establishment of a new sales department within a medium-sized IT company, as well as to design the processes that are critical for the smooth integration and full support of the department within the existing operational procedures.

The objective consists of the following points:

1. Conducting an in-depth evaluation of current company processes.
2. Developing a sales process that aligns with the company's needs.
3. Creating an achievable business model for the establishment of the new sales department.
4. Composing a realistic forecast for a high-impact lead-generation strategy strived at international expansion.
5. Specifying the responsibilities of the sales department and its personnel.
6. Assessing the implementation and proposing recommendations for future actions.

Methodology

The methodology for this thesis will involve analytical work to consider the company's existing processes. The outcome of the analysis, which will be created using the Lean Canvas approach, will serve as the proposition of a business model for the department. This business model will use the key components of the sales department's strategy, including the value proposition, target customer segments, and revenue streams. The methodology will also incorporate the principles of design thinking, which will declare the process of creating a new business process that aligns with the company's needs and objectives.

The proposed extent of the thesis

60-80 pages

Keywords

business model, design thinking, process management

Recommended information sources

Interviewing Users: How to Uncover Compelling Insights

Real-Life BPMN: Using BPMN 2.0 to Analyze, Improve, and Automate Processes in Your Company

The Design Thinking Playbook: Mindful Digital Transformation of Teams, Products, Services, Businesses and Ecosystems (Design Thinking Series)

The Lean Startup: How Constant Innovation Creates Radically Successful Businesses

Expected date of thesis defence

2022/23 SS – FEM

The Diploma Thesis Supervisor

Ing. Petra Pavlíčková, Ph.D.

Supervising department

Department of Systems Engineering

Electronic approval: 13. 3. 2023

doc. Ing. Tomáš Šubrt, Ph.D.

Head of department

Electronic approval: 14. 3. 2023

doc. Ing. Tomáš Šubrt, Ph.D.

Dean

Prague on 27. 03. 2023

Declaration

I declare that I have worked on my master's thesis titled "Project of establishing sales department in IT company" by myself and I have used only the sources mentioned at the end of the thesis. As the author of the master's thesis, I declare that the thesis does not break any copyrights.

In Prague on 30.11.2023

Nikola Šafránek

Acknowledgement

I would like to express my gratitude to Ing. Petra Pavlíčková, Ph.D. for guiding me throughout the development of this thesis, and for providing invaluable suggestions and feedback. Additionally, I would like to thank colleagues from Applifting for allowing me to gain insights from the company. I am grateful to Mindolé Clark, M.A. for kindly proofreading my thesis. Lastly, I extend my gratitude to my fiancée Merve for her unwavering support during my studies.

Abstract

We live in an era that demands fast-paced changes. IT companies grow uncontrollably, meanwhile, processes can be neglected. One of these processes is the sales process, which is critical for most businesses. Commonly, the most successful salesperson is the founder. As the company increases the number of its employees and the founder focuses on strategic management, sales may decline. Therefore, it is crucial to hire specialized salespeople, experts who can help the owner gradually replace many of their sales competencies. If the company has more than 100 employees, the new department must be fitted wisely into the gear of other departments. Emphasis is placed on hiring the right people and creating a good training environment. In this thesis, I focus on the creation of the sales department as a project that can be easily replicated and can inspire other entrepreneurs to establish or improve their existing sales department or sales process.

Keywords: Business model, design thinking, process management, sales, sales department, IT company, startup, scaleup, lead generation

Projekt vytvoření obchodního oddělení v IT společnosti

Abstrakt

Žijeme v rychlé době, která si žádá rychlých změn. Protože mnoho moderních společností z IT světa nekontrolovatelně roste, mnoho procesů může být zanedbáno. Jedním z nich je i proces obchodní, který je pro většinu firem kritický. Běžně se stává, že nejúspěšnějším obchodníkem je majitel firmy. Jak firma navyšuje počet zaměstnanců a majitel se věnuje strategickému řízení, obchod upadá. Proto je nutné najmout specializované obchodníky, odborníky, kteří jsou schopni majiteli pomoci anebo jej v této kompetenci postupně nahradit. Pokud má firma přes sto zaměstnanců, nové oddělení se musí chytře nastavit tak, aby zapadlo do soukolí všech ostatních oddělení. Důraz je kladen na najmutí správných lidí a vytvoření dobrého tréninkového prostředí. V této diplomové práci se proto věnuji právě vytvoření obchodního oddělení jako projektu, který lze snadno replikovat a může inspirovat další podnikatele k založení nebo vylepšení jejich stávajícího obchodního oddělení a procesu.

Klíčová slova: Obchodní model, design thinking, procesní management, obchod, sales, obchodní oddělení, IT firma, startup, scaleup, akvizice zákazníků.

Table of content

1 Introduction	10
2 Objectives and Methodology	11
2.1 Objectives.....	11
2.2 Methodology	12
3 Literature Review.....	14
3.1 What is Business Model?	14
3.2 What is Design Thinking?.....	16
3.2.1 Design Thinking in Interviews.....	22
3.3 What is Lean Canvas?	24
3.3.1 Architecture of Lean Canvas:	25
3.4 Business Process Modelling Notations (BPMN)	28
3.5 Gantt Chart	30
3.6 What the Marketing & Sales and Finance Team Does?.....	32
3.6.1 Financial planning and analysis	34
3.7 ICF Business Process and IT Controls	37
4 Practical Part	40
4.1 About the Company.....	40
4.1.1 What is the IT Company Applifting?.....	40
4.1.2 Current Organizational Structure	41
4.1.3 Inquiries from the CEO, Vratislav Kalenda.....	44
4.1.4 Why to build a new sales department in Applifting?	45
4.1.5 Current Status of Sales, Problems and Risks	46
4.1.6 What Value New Business Department Should Bring?.....	49
4.2 Business Model and Lean Canvas.....	50
4.2.1 New Business Model	51
4.2.2 Lean Canvas.....	60
4.2.3 Why Lean Canvas is Better for Our Use Case?	67
4.3 Interviews	67
4.3.1 Why Interview is Necessary?.....	68
4.3.2 How Design Thinking Was Applied in Interview Questions?.....	69
Question 1: Explain to me, what Applifting is doing?	70
Question 2: What is your role here?	71
Question 3: What competency do you dislike?	71
Question 4: What is the competitive advantage of Applifting?.....	72
Question 5: Where is the room for Improvement for Applifting?.....	72
Question 6: What is the biggest internal pain?	72

Question 7: What Clients Should We Work for?	73
Question 8: What is the advantage of your position in sales process?	73
Question 9: Share the biggest disadvantage of your position in sales process.....	74
Question 10: How can a Business Developer help you?	74
Question 11: How can a BD ruin something what you like?	74
Question 12: How do we maintain existing clients?	75
Question 13: What are we doing wrong in maintenance of clients?	75
Conducted Interview into Pre-Sell Phase	76
4.4 BPMN of New Model	76
4.5 Roadmap of New Model	80
4.6 Costs	82
4.6.1 Table For Costs and Elaboration	82
4.7 Job Descriptions	84
4.7.1 Sales Manager Position Summary	84
4.7.2 MKT Manager Position Summary	85
4.7.3 Sales Representatives Position Summary	86
4.7.4 IT/ICF Audit Person Position Summary	87
4.7.5 Financial Planning and Analysis Person Position Summary:	89
4.8 Source of Revenues	90
4.9 Forecasting	92
4.9.1 Forecast Based on Costs Analysis	92
4.9.2 Forecasting Based on ROI	93
5 Conclusion.....	95
6 References	96
7 Pictures, Tables, Graphs, Charts and Abbreviations	99
7.1 List of pictures	99
7.2 List of tables	106
7.3 List of Graphs and Charts	108
7.4 List of abbreviations.....	112
Appendix.....	113

1 Introduction

I believe that the software development company Applifting has a lot to achieve in the world. Applifting has a lot of paying customers and has a great name in the Czech Republic. The work they do is very valuable for their customers, not only providing coding and other quality services, but also validating the ideas of their customers.

This company appeals to me since I am currently studying IT and I grew up working in the IT business. At the same time, it is very important to note the importance of sales in Applifting to develop a better sales process for the company. Assigning a financial value to the product you want to sell and sell it to the buyer who gives that value.

However, making sales may not always be easy in today's competitive world. For this, it is necessary to learn and apply effective sales techniques and establish a business providing team. The goals of sales management can be divided into short and long-term goals. While businesses aim to gain and maintain their share of the market in the short term, make profits with their sales and gain new customers.

Gaining loyal customers in the long term and improving products and services with technological developments and customer feedback are among the long-term goals. Sales managers must have knowledge of the business they work for, its functions, products, services, and technology. Sales representatives must communicate well with existing and prospective customers and have persuasive skills. No matter how skilled the sales team is or how hard they work, nothing will change without a plan for successful sales process, company adding unnecessary stress to its existence in market.

Company Applifting didn't have a sales team and in this thesis is described why, and how it can be done.

2 Objectives and Methodology

2.1 Objectives

One of the objectives of the thesis will be to conduct an analysis of the current sales practices and processes employed by Applifting. This analysis aims to identify any gaps, inefficiencies, or areas for improvement within the existing sales practices. Understanding the strengths and weaknesses of the current sales approach will help in designing an effective sales department.

At the same time, to develop a project plan for the establishment of a new sales department within Applifting, this project plan will outline the necessary steps and actions required to set up the new sales department. It will include aspects such as resource allocation, budgeting, timeline management, and coordination with other departments within the organization.

Identifying the critical processes that need to be integrated within the new sales department will be one of the most crucial objectives of this thesis as well. This objective focuses on aligning the new sales department with the existing operational procedures of Application. By identifying the essential processes and workflows, we will ensure a smooth coordination and transition between the new sales department and other department. These objectives aim to guide the research and analysis which is required to design a project plan and processes for the establishment of a new sales department within Applifting, as well as provide recommendations for its efficient functioning.

Another important objective of the thesis will be composing a forecast for a high-impact lead-generation strategy strived at international expansion. This will ensure and help the company to predict the future of the organization with new sales team and processes. Various methods will be mentioned in the methodology part which will explain the ways that this thesis reaches to this aim.

Finally, proposing recommendations for enhancing the efficiency and effectiveness of the new sales department will be the last objective of the thesis and will involve suggesting improvements and recommendations to optimize the performance of the new sales department.

2.2 Methodology

One of the main methodologies for this thesis will involve analytical work to consider the company's existing processes. We will investigate and describe current sales processes of Applifting and try to anticipate the potential issues and gaps by developing a new business model based on design thinking.

As design thinking helps from various perspectives, it will have a crucial support in the other methodologies that will be used in the thesis which stands for helping us our aim on developing new sales process. Based on design thinking approach we will start to design our ideal business model using Lean Canvas. This will ensure the clarity of the model that we would like to build by using the key components of the sales department's strategy, including the value proposition, target customer segments, and revenue streams.

Followingly, we will utilize Business Process Modelling Notations as a basis to describe the process that thesis aims to implement. Introducing the Marketing & Sales team will also be one of the methods. We will show the importance of Marketing teams and their contribution to sales processes that we want to build. In order to compose a realistic forecast, we will need the expertise of another team which is Financial Planning and Analysis.

We will also establish our team of Financial Planning and Analysis, assign the necessary responsibilities and KPIs to ensure clarity in our forecast. Simultaneously within the finance department we will establish a data-based team which will ensure the proposition of continuous future development plans.

However, for the first we will make the analysis of our new sales process to define the very first recommendations for the company. Placing the ICF business process controls, defining the personnel, and assigning responsible people per each of the

controls that will be executed on a regular basis in the company will play a vital role to make the process more stable and reliable. Apart from ICF business controls, it is also very important to note the necessity of establishing IT audit/controls which will also follow the similar steps in developing the structure as business controls from tech perspectives. These controls will also have huge impact on tracking whether company processes run smoothly and according to compliant guidelines which are set up by the leadership and industry ethical norms or not.

By implementing all the above methodologies which are linked to various objectives of the thesis, we will not ensure the development of the new sales process within the company but also will deliver the definition of each business units' individual goals, mission, vision, and capabilities. Reaching to their milestones, analysing the process retrospectively and preventing the future gaps or mistakes prospectively.

3 Literature Review

Throughout the entire literature review we will go through all the theories of the tools to build the new process. We will cover the explanation of the tools and terms that will be used. Later, we will discuss the current situation about the company and give insights about it.

3.1 What is Business Model?

The business model is the conceptual definition of entrepreneurial activity. It explains how an organization creates, delivers, and captures value. The process of creating and changing business models is also called business model innovation and is part of strategic management. In theory and practice, the term business model is used to represent the fundamental aspects of an organization or Business, including its purpose, business process, target customers, offerings, strategies, infrastructure, organizational structures, sourcing, business practices and operational processes and policies, including its culture. Used for a wide range of informal and formal definitions. Simply put, a business model is the approach you take to make money. We can also say that it is how you provide value to your customers through a product or service for a certain cost.

The business model is a fundamental and indispensable element for any new venture because it helps you understand your value in the long run. We can also call this the income model you follow more. Take a company like Facebook, for example. When they first started, the platform was completely free, and once their audience grew large enough, they started making money through advertising. This was just one of the models they could choose from. They could also choose to charge a monthly subscription fee or sell products and services. The business model you adopt for your business often depends on your market and what your audience is willing to pay for. Don't think that you must continue with the business model you adopted when you first started, until the end. If we look at Amazon for example, today Amazon AWS (Amazon Web Services) is one of Amazon's largest revenue providers, providing scalable cloud infrastructure solutions. However, when it was first established, it served a completely different purpose. In the 1950s came new business models of

McDonald's restaurants and Toyota. In the 1960s, the innovators were Wal-Mart and hypermarkets. The 1970s saw new business models from FedEx and Toys "R" Us. Business models of Blockbuster, The Home Depot, Intel, and Dell in the 1980s; In the 1990s, Southwest Airlines, Netflix, eBay, Amazon.com and Starbucks business models arrived (Osterwalder, A, 2014).

Below picture describes how traditional business model tables look like.



Picture 1, Strategy Innovation Institute, 2023, Business Model Innovation Tools, [Infogrphics]. Si2blue.com

At the end of any model, once the vision of the model is clear it is also important to continue with the calculation of ROI of the model to define the expected returns. Return on investment (ROI) is a simple measurement that can provide information about your potential profit on a particular investment. Calculating the ROI of each of your marketing campaigns helps you refine your strategy and make informed and profitable decisions every time (Corporate Finance Institute, 2023).

Return on investment is one of the most clear and effective methods of evaluating the efficiency and profitability of an investment you have made. Investors can also use ROI to compare assets and determine exactly where they are playing their cards right. ROI is easy to calculate, and the sheer amount of information investors and businesses can collect is the main reason why ROI is highly relied upon. ROI calculations come with many advantage (Corporate Finance Institute, 2023).

However, it also has some limitations that you should be aware of. For example, when calculating a return on investment, you only consider the return and cost of the investment, not the holding period (Corporate Finance Institute, 2023).

How is the traditional business model eventually disrupted? Let's continue with next chapter.

3.2 What is Design Thinking?

Design thinking is all about finding solutions that respond to human needs and user feedback. The driving force of innovation is people, not technology. Therefore, an important part of the process is stepping into the user's shoes and truly empathizing with your target audience. The goal of design thinking is to pool diverse perspectives and ideas. At this point, design thinking encourages collaboration between heterogeneous and multidisciplinary teams that do not typically work together (Plattner, H, 2011).

Design thinking is a solution-based framework, so the focus is on finding as many ideas and potential solutions as possible. Ideation is both a fundamental design thinking principle and a step in the design thinking process. The ideation step is a judgment-free zone where participants are encouraged to focus on the quantity rather than the quality of ideas. Experimentation and iteration aren't just about coming up with ideas. It's also about turning them into prototypes, testing them, and making changes based on user feedback (Plattner, H, 2011).

Design thinking is an iterative approach, so you need to be prepared to repeat certain steps in the process as you uncover flaws and shortcomings in early versions of your proposed solution. Design thinking is a highly hands-on approach to problem solving that favours action over discussion. Instead of making assumptions about what your users want, design thinking encourages you to go out there and communicate with them face-to-face. Instead of talking about potential solutions, you can turn them into concrete prototypes and test them in the real world. Today even those who produce works in the fields of literature, art, music, science, engineering and all great innovative idea explorers in the business world apply the Design Thinking method. Some of the world's leading brands such as Apple or Google adopt the design thinking approach. (Plattner, H, 2011).

Design thinking is an iterative and non-linear process and mainly consisting of five steps:

- Try to empathize. everyone wants to be understood.
- Identify the core problem.
- Generate ideas about. It's time to set sail for innovative thoughts.
- Just like building a sandcastle, create a prototype.
- Test the results and use them to redefine one or more problems Test the users and use them to redefine one or more problems Test the results and use them to redefine one or more problems.

(Plattner, H, 2011)

The design thinking process has both a scientific and an artistic side, as the goal of this process is to ask you to understand your limiting thought patterns and, furthermore, challenge them and ultimately find innovative solutions to the problems your users face.

Taking the above into consideration we can describe the stages of design thinking as follows.

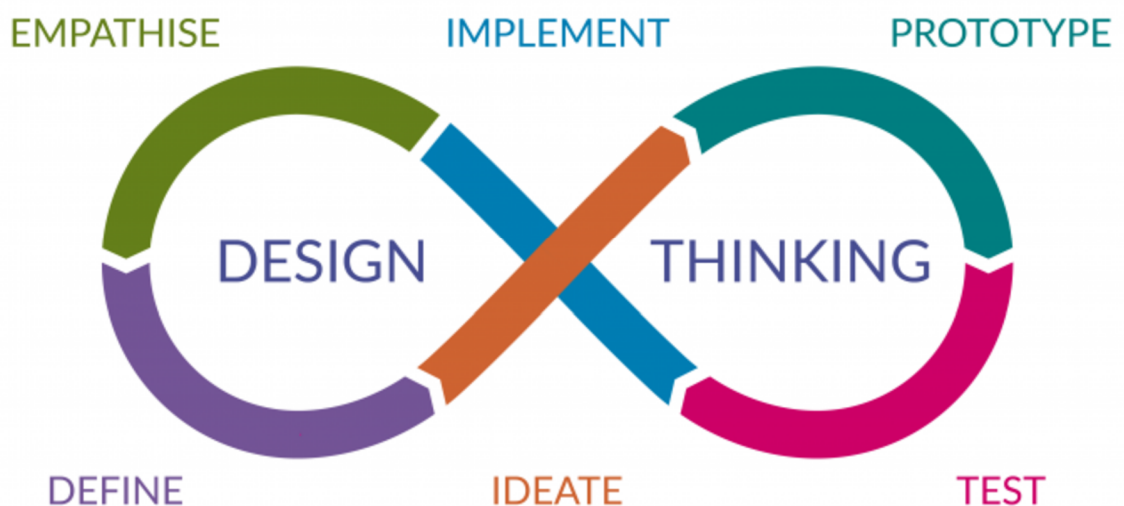

Picture 2, 2023, Design Thinking [Infographics], system-concepts.com

Stage 1 – Empathise

The first of the design-oriented thinking stages is the empathy stage. In fact, the order of these stages in design-oriented thinking may vary depending on the project, but to develop an idea, it is often necessary to first establish empathy (Plattner, H, 2011).

The empathy phase is the step where the problems that users encounter or may encounter regarding the product are taken into consideration. Thanks to the empathy step, the person who will develop the product puts himself in the user's shoes and thinks about what problems he will experience when using that product (Plattner, H, 2011).

When a person thinks this way, he or she clarifies the problem and can therefore come up with a better design. (Plattner, H, 2011)

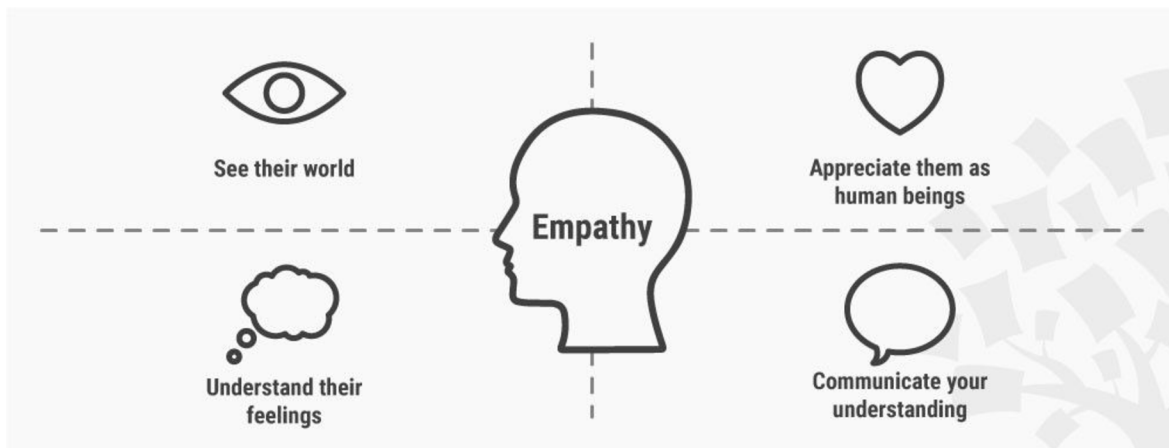

Picture 3 Mortensen Hvas, 2020 Stage 1 Design Thinking [Infographic]. Interaction-design.org

Stage 2 – Define

The interpretation (definition) phase is the second of the design thinking stages. The interpretation (definition) stage is the step in which these problems are identified after the problems with the product are identified through empathy. In the interpretation phase, the problem is clearly determined, and in determining what the problem is, observation-based data obtained in the empathy phase is used. In this way, it becomes easier to make the product functional. (Plattner, H, 2011)

DEFINE

How to consolidate insights and outline user problems:



Picture 4 2023, Design Thinking: Define[Infographics], system-concepts.com

Stage 3 – Ideate

The idea generation phase is the third among the design-oriented thinking stages. The idea generation phase is a step where, after the problem is identified, what needs to be done to solve the problem is considered. Creative thinking techniques can be used during the idea generation phase. For example, by using the 6 thinking hats method during the idea generation phase, the problem can be addressed from different perspectives and innovative solutions can be developed. (Plattner, H, 2011)

IDEATE

How to brainstorm creative, human-centred ideas:

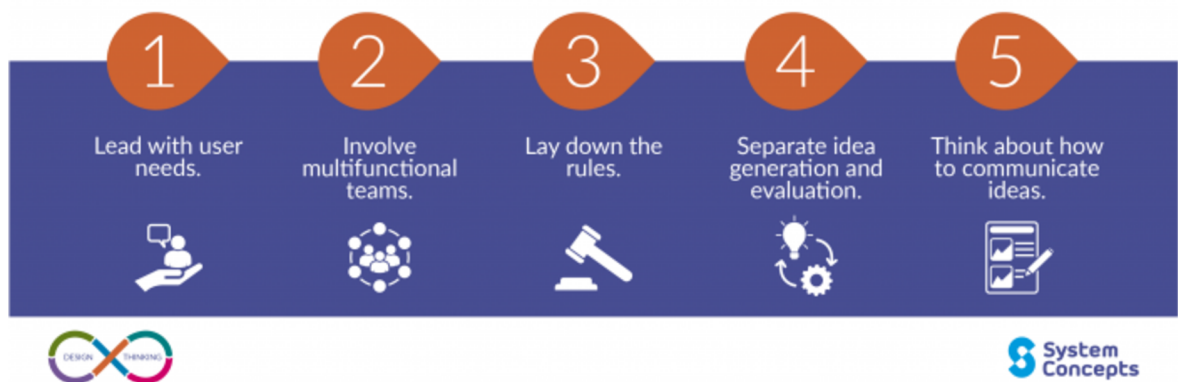

Picture 5 2023, Design Thinking: Ideate[Infographics], system-concepts.com

Stage 4 – Prototyping

The prototyping phase is the modelling of the product after presenting solution suggestions for the problem. A draft is created through 3D visualization to understand how the solution proposals produced during the prototyping phase will appear on the product. Applications such as Tinkercad, AutoCAD, 3ds Max, Blender can be used to make 3D modelling during the prototyping stage. The prototyping phase is important to determine whether the solution suggestions will work. The stages applied in design-oriented thinking should not be handled separately. For example, during the prototyping stage, one can go back to the empathy stage and evaluate the product draft. Thus, a more effective product is produced. (Plattner, H, 2011)

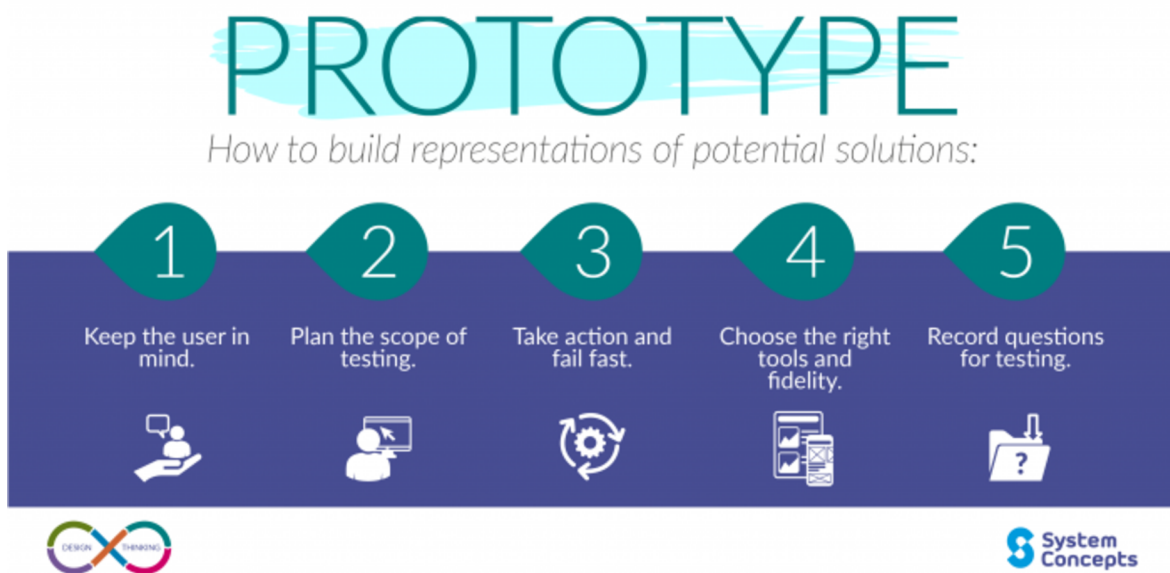

Picture 6, 2023, Design Thinking: Prototype[Infographics], system-concepts.com

Stage 5 – Testing

The testing stage involves "evaluating the prototypes with real users to gather feedback and insights" (Plattner H, 2011, p. 112). The testing (evaluation) phase is applied to see whether the created product prototype is suitable for the user experience and how fit the product is for the purpose. Analyses made during the testing (evaluation) phase are important for the development of the product. If problems with the product or product prototype are detected during the testing, that is, evaluation phase, other stages should be

returned to solve them, new ideas should be generated, and prototyping should be done again. (Plattner, H, 2011)



Picture 7, 2023, Design Thinking: Test [Infographics], system-concepts.com

Stage 6 – Implementation

In the 6th Stage of the design thinking model, test findings are evaluated by the team. During testing, you reiterate your solution proposal based on negative and positive feedback. This phase is the final phase of the model, but in an iterative process such as design thinking, the results produced are often used to redefine one or more problems. Designers may then choose to return to earlier stages in the process to make further changes and improvements to rule out alternative solutions. (Plattner, H, 2011)



Picture 8, 2023, Design Thinking: Implement [Infographics], system-concepts.com

3.2.1 Design Thinking in Interviews

By integrating design thinking into interviews, both the interviewer and interviewee can gain a deeper understanding of the role, challenges, and expectations, as well as assess the company's problems, creativity, and ability to empathize with the end-users (Brown, T, 2008).

Design thinking in interviews refers to the application of design thinking principles and methodologies during the interview process. It involves using a human-centered approach to gain insights, generate ideas, and solve problems. Design thinking in interviews can help both the interviewer and the interviewee to better understand the needs, expectations, and challenges of a particular role or organization (Brown, T, 2008).

To conclude our understand on design thinking we can state that it refers to more than a process. It opens up a whole new way for you to think, even leading you to discover new pathways along the way and offers a range of methods to help you implement this new mindset. So, you take a step on this new path, armed with a deep interest in understanding the people for whom you design products and services. That is, you empathize with the users you want to reach. Design Thinking allows you to question the problem, assumptions, and conclusions. You gain strength from design thinking through sketches, prototypes, tests, and testing of new concepts and ideas, especially when dealing with poorly defined or unknown problems. It's based on an iterative process where you try to deeply understand your users, challenge assumptions, redefine problems, create a prototype and innovative solutions that you can test, and allows you to work dynamically through questioning and gaining knowledge throughout the process to develop and initiate innovative ideas, thereby solving the problem. You can run these five thinking steps in parallel, repeat them, and return to the previous stage at any point in the process, which allows you to re-define and navigate to alternative strategies and solutions that you may not immediately recognize with your initial level of understanding (Brown, T, 2008).

Design thinking is often referred to as “thinking outside the box” because designers, just like artists do, try to develop new ways of thinking that do not fit into known problem-solving methods. Design thinking helps you think outside the box or the memorized. You may develop new ways of thinking that do not fit into known problem-solving methods. To

improve products, services, and processes, you can analyse how users interact with products and thus gain a deeper understanding of them. To improve products, services, and processes, you can analyse how users interact with products and thus get the chance to understand them more deeply. To improve products, services, and processes, you can analyse how users interact with products and thus gain a deeper understanding of them. Daring to think outside the box makes it possible to re-examine your previous assumptions and prove whether they are valid or not. When you question and investigate the conditions of a problem, the process of generating solutions leads you to generate ideas that reflect the real constraints and aspects of that problem (Brown, T, 2008).

As you can see, design thinking gives you a kind of tool to think outside the box and dig a little deeper into problem solving. This means you can do the right kind of research, create prototypes, and test your products and services to uncover new ways to meet your users' needs (Brown, T, 2008).

3.3 What is Lean Canvas?

Start-ups and sometimes even big corporates tend to start part of their business under conditions of extreme uncertainty. This naturally triggers their ability to think agilely and make quick decisions. These practical approaches and the constraints they have created the need to create a simpler but visible business plan at once, instead of long and costly business plans (Daniel, P, 2023).

According to Vanzadt Paul, “The Lean Canvas is defined as an adaptation of the traditional business model canvas that is optimized to consolidate a plan focused on maximizing user value. By deconstructing traditional business plans into their most important assumptions & values, the Lean Canvas takes a direct approach to diagram a business idea.” (Vanzadt, P, 2023)

In fact, these needs emerged years ago. In 1913, Henry Ford switched to the "Lean Manufacturing" system to increase mass production. This system was generally based on clearly understanding the customer's expectations, achieving operational excellence, and always aiming for better. Following Ford, Eiji Toyoda took this systematic one step further in the 1950s and contributed to its current form. Toyota, which has built its production system on the philosophy of continuous development with Eiji, has adopted the principle of identifying its customers, diagramming the production and sales processes, cutting down all unnecessary expenses and finding ways to continuously grow (Daniel, P, 2023).

In this context, if we need to define Lean, it would be correct to say, it is an approach that eliminates unnecessary resource consumption in production and other processes by always aiming for better with the philosophy of continuous development and analysis of customer needs (Daniel, P, 2023).

There are following advantages of Lean Canvas:

- Focuses your business objective on your potential customers.
- Simple to apply and understand.
- It is very easy to create plans for multiple business models.
- A simple one-page document that is more readable and less boring for investors.

- Easier to update regularly.
(Daniel, P, 2023)

3.3.1 Architecture of Lean Canvas:

To give knowledge on lean canvas we can look at the below empty table which is the typical canvas table to work on:









Problem 	Solution 	Unique Value Proposition 	Unfair Advantage 	Customer Segments 
	Key Metrics 		Channels 	
Cost Structure 			Revenue Streams 	

Table 1, Business Model Analyst, 2023, [Infographics]. Businessmodelanalyst.com

Problem

One of the first segments in the Lean Canvas is the Problem segment. This section requires a clear description of the problem that the business aims to solve, along with a brief explanation of the problem's impact on potential customers. By identifying and understanding the problem, entrepreneurs can devise innovative solutions that address the specific needs of their target market (Blank, 2013).

Solution

The Solution segment of the Lean Canvas requires entrepreneurs to propose their unique solutions to the identified problems. This section should include a brief description of the product or service that the business offers and how it directly addresses the needs of the

target market. This segment helps entrepreneurs develop a clear value proposition and sets the stage for competitive advantage (Maurya, 2012).

Unique Value Proposition

The Unique Value Proposition segment highlights the competitive advantage of the business. It describes the unique features, benefits, or advantages that differentiate the business from its competitors. This segment is crucial for attracting customers and establishing a strong market position (Blank, 2013).

Key Metrics

Key Metrics, another segment in the Lean Canvas, focuses on the key performance indicators (KPIs) that the business uses to measure its progress and success. By identifying and tracking these metrics, entrepreneurs can effectively evaluate the viability of their business model and make data-driven decisions (Maurya, 2012).

Customer Segments

The Customer Segments segment helps entrepreneurs identify the specific target market and customer segments that their business aims to serve. This segment requires a clear understanding of the characteristics, preferences, and needs of the target customers. By defining the customer segments, businesses can tailor their marketing, sales, and product development strategies accordingly (Blank, 2013).

Channels

Channels, another important segment, outlines the various marketing and distribution channels through which the business reaches its customers. This segment identifies the mediums, platforms, or methods used to deliver the product or service to the target market. By selecting the most appropriate channels, entrepreneurs can maximize their reach and effectively engage with their customers (Maurya, 2012).

Cost Structure

The Cost Structure segment focuses on the various costs associated with operating the business. This includes costs related to production, marketing, sales, distribution, and overhead expenses. By understanding the cost structure, entrepreneurs can optimize their

resources, minimize expenses, and ensure the financial sustainability of the business (Blank, 2013).

Revenue Streams

The Revenue Streams segment is essential for understanding the sources of revenue for the business. This section requires entrepreneurs to identify and outline the specific revenue streams, such as product sales, subscription fees, licensing, or advertising revenue. By analysing the revenue streams, businesses can prioritize their efforts and allocate resources to maximize profitability (Maurya, 2012).

Unfair Advantage

The Unfair Advantage segment of the Lean Canvas highlights the unique strengths or advantages that the business possesses over its competitors. These advantages can include expertise, intellectual property, strategic partnerships, or access to key resources. By leveraging these unfair advantages, businesses can establish a sustainable competitive edge (Blank, 2013).

To conclude, every Start-up that can make quick decisions and devotes its talents to acting can choose the lean canvas. The flexibility of the bare canvas model allows for updates based on customer feedback in the future. This is a very important factor in order not to be left behind in the ever-changing market and Start-up environment and to ensure the success of the business plan. You can think of the simple canvas as a summary of your business idea that needs to be constantly updated (Blank, 2013).

By constantly keeping it up to date with company's research, analysis, and ideas, it enables them to take quick action in case of any crisis and to see the issues that can think and that should not be missed, in a single file. That's why it's so important to keep it up to date and fill it with as much accurate information as possible (Maurya, A, 2020).

3.4 Business Process Modelling Notations (BPMN)

BPMN enables us to capture and document an organization's business processes in a clear and consistent manner, enabling the process owner and stakeholders to be involved in the process. In this way, the team can respond more effectively to any issue identified in the processes. BPMN provides notations that can be easily understood by both technical and non-technical stakeholders (Freund, J, 2014).

Benefits of BPMN:

- It is an industry standard developed by OMG (Object Management Group), a non-profit organization.
- It provides businesses with the ability to define and understand their procedures through business process diagrams.
- It provides a standard notation that is easily understood by all business stakeholders.
- It closes the communication gap that often occurs between the business process application in use and business process designs (process models).
- It is powerful yet easy enough to describe the potential complexities of a business process.
- Since it is supported and developed by an impartial organization, it also has extensive tool support.

(Freund, J, 2014)

Core Set of BPMN Elements

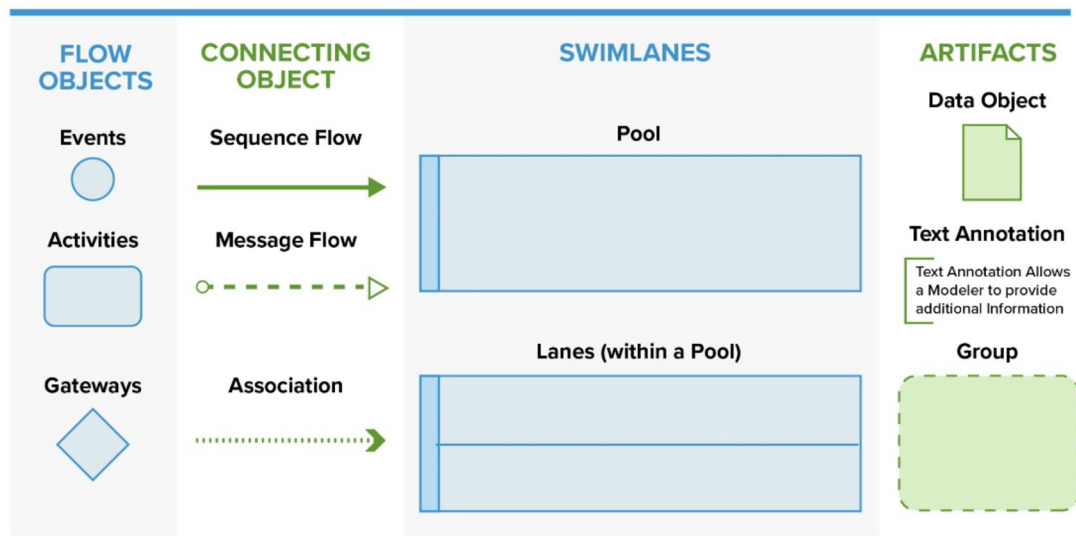

Picture 9, McKendrick, E (2023). What is BPMN 2.0 Standard? [Infographics]. Processmaker.com

Thanks to BPMN, businesses and institutions could understand their internal and external processes through these diagrams. The relationships between visual symbols and the progression of processes occur thanks to certain rules (Freund, J, 2014).

Moreover, thanks to graphical process modelling, exchanges between business units and corporate performance and efficiency can be observed. Thanks to this, the organization can recognize itself, simulate and/or change new processes before implementing them. BPMN has reached its current version, BPMN 2.0.2, under the leadership of OMG (Object Management Group), but BPMN 1.2 version is widely used. OMG is a non-profit Group and Consortium that manages and publishes these studies (Freund, J, 2014).

3.5 Gantt Chart

The Gantt update was not invented by a visionary whose last name is Gantt. The first professional to come up with this concept was Karol Adamiecki, a Polish engineer. He worked as a senior manager in a steel mill and was looking for advanced tools to find out the distribution of throughput (Tim, L, 2018).

Henry Gantt, a US project management, and engineer was inspired by Adamiecki's correlations and came up with their details. It was he who spread innovation among Western companies from different sectors. At the beginning of the 20th century, Gantt updates were drawn by hand. It required an inordinate amount of time and effort to replace or update it. With the digitalization of threads, children did not become obsolete, they precisely gained wider recognition. A Gantt update is a chart created along two axes: the Extreme one shows time performance and the vertical one shows actions to be performed. Its specific activity is indicated by a bar. You can determine the start date and deadline of your task by evaluating it according to the assurance in the guide. You can mark operations that must occur without interruption as "high nuclear" and operations that can be rescheduled as "high non-nuclear." (Lock, D, 2019).

This approach allows women to avoid problems and quickly identify more that can be taken out of business. Tasks may overlap. You can link them together and group them. The chart allows each program to see how long it took for a particular task, which worker's electricity, and the total total. The supervisor can increase the breadth of the work team's work capabilities by working on and editing several pieces at the same time. If some errors require joint efforts of the entire team, they can be arranged in this diagram. The Gantt update method also has its version. First, when users have too many activities and add-ons, it becomes cluttered. If you are using it to tackle a complex project, you should prepare it in two versions: detailed and clear. Secondly, Gantt is not very helpful in polishing update processes and their resource allocations. You will have to estimate for yourself how much time the size task will change - but how many specialists will need to develop it. For this reason, managers often resort to PERT records or other additional tools (Lock, D, 2019).

According to Forbes, “Gantt charts make it easy for project managers to identify the critical path to project completion and ensure that there is no delay in those tasks.” (Bottorff, C, 2022).

If a manager is hesitating whether to include this method in their workflow, they should verify whether their project meets the following criteria:

- Task deadlines
 - Requires collaboration of multiple experts and departments
 - Let professionals work on several tasks simultaneously.
 - Requires tasks to be done in a specific order.
 - Let people estimate the duration of each task.
 - Allow customers, stakeholders and other third parties to track progress.
- (Mind Tools, 2023)

If at least one of these criteria is met, an organization will benefit from the Gantt approach. A simple chart can be created in Excel to reduce expenses. However, dedicated Gantt chart software allows its users to compile reports, attach files and documents to tasks, facilitate communication between staff, customers, and stakeholders, etc. It offers a much wider range of functions such as. Additionally, custom software may have a more visually appealing design and user-friendly interface which will be choice of ours in this thesis (Mind Tools, 2023).

3.6 What the Marketing & Sales and Finance Team Does?

Marketing, both with sales, is a mutually beneficial and complex discipline. Creating a strategy will make this difficult process easier and ensure your mental comfort throughout the year. Because most of the things to be done, goals and risks will already be clear. Once you define your marketing strategy, it will guide not only you but also your team in setting goals, finding brand voice/tone, targeting demographics, analysing competitors. Let's look at how to plan and execute your marketing strategy, from USP (Unique Selling Proposition) to KPIs and SEO studies (Kotler, P, 2017).

First, keep in mind that if you make a marketing strategy and leave it somewhere in the middle of your hard drive, you will never achieve success. You should review your marketing strategy and plan every time you plan a campaign, every time you launch a new product, before and after working with an influencer, and every time you consider attending an event (Kotler, P, 2017).

This is your long-term game plan, so start with the following questions:

- How will we reach people?
- How will we turn these people into customers?
- How will we create your marketing plans?

We will continue with these questions:

- What is our value proposition?
- What is our competitive advantage in the market?
- What are demographics of target audience?
- What are key marketing messages?
- What is our brand's tone of voice?

Your marketing strategy will centre where you create your marketing plans now and in the future. Before starting everything, “How to create a Persona?” & “How to create a customer journey map?” Reading their articles is of critical importance to better understand your target audience and create a correct strategy. Thus, based on real data, you can analyse your target audience's behaviours, pain points, goals, etc. you will be able to

define. These articles will teach you how to speak the language of your consumers/customers and present your products/services.



semrush.com

SEMRUSH

Picture 10, Lyons, K (2023). The Ultimate Guide To Content Marketing Strategy [Infographics]. semrush.com

Before we start, I should say that marketing strategy and marketing plan are separate things, which can create confusion. One of the biggest advantages of talent marketing is that the team can work with a single priority backlog, which keeps the team focused and productive. However, middle managers are used to being the ones who assign work to their employees, which is one of the most difficult changes for your manager to make (Kotler, P, 2017).

The best way to navigate this is to educate him about agile ways of working. Rather than saying, "You can't assign us to work anymore," which can come off as rude and uncalled for, a better approach is to explain the benefits of agility and how backlogs help the team be more focused and productive. If this alone doesn't work, ask him if you can try it for a

week. Ask for a week where the team only works off the backlog and explain that you'll share the results of the experiment to see how much work gets done compared to how you work now. Unless there are stifles of other ideas, when a team can decide to work from the backlog, there is almost always a significant gain in how much work the team accomplishes (Kotler, P, 2017).

Pure productivity should never be the end goal in agile marketing (it should be about your customers), but metrics middle managers are useful and can help your team with agile practices. Agile marketing requires trusting the team doing the work and minimizing the overhead that slows them down. In agile marketing, the role of the manager becomes one of a leader who helps develop skills, create the right environment for the team to succeed and empower people. What do you do if you're on a team and your manager is still micromanaging? (Kotler, P, 2017)

First, you need to trust this manager, which may take time, but remember that every small change is a change in the right direction. To build trust, the team needs to be very transparent. Have a virtual dashboard that your manager can see in real time every day. Invite him to your stand-up meetings, but as an observer so he can see that the team can solve its own problems. Also, work on your relationship with this person and find out what he is afraid of, what he will trust in the team and work on small wins. Instead of asking for full trust all at once, see if there is a small project or task that the team can work on their own. If this small, non-risky item is done to his satisfaction, it will eventually lead to greater opportunities for team strengthening (Kotler, P, 2017).

3.6.1 Financial planning and analysis

The financial planning and analysis (FP&A) department is positioned under finance on the organizational chart in almost all large companies. People working in this department are in close contact with senior management and have key information about the company's progress. Financial planning and analysis team members think strategically, analyse data, and communicate with people at the company's management. (Cokins, G, 2009).

People working in this department, also known as the budget and reporting department, are tasked with bringing transparency to the company's financial situation and projecting critical decisions regarding the company's growth. Let's examine together the key responsibilities of people working in this department, known as financial planning and analysis or budgeting and reporting. (Cokins, G, 2009).

The main responsibilities of finance team are to prepare and maintain financial statements of the company from perspective of performance management, define the financial health of the company and develop an investment plan to contribute the ROI of the company from investment portfolios (Cokins, G, 2009).

The executive board, consisting of directors or deputy general managers, usually meets over the results every month to talk about the course of the company. The financial planning and analysis department, also known as budget and reporting, prepares the relevant presentations to be used in these meetings. The process of preparing this presentation, which highlights the company's performance, begins with the call of the top management. It then continues with determining the responsibilities of the relevant pages under the leadership of finance (Cokins, G, 2009).

Generally, executive board presentations consist of the following content:

- Things to highlight at the end of the period (if there are important achievements, losses)
- Technological updates (improvements in products, if any)
- Developments in sales and marketing (sales performance, loyalty rates, average basket sizes if any)
- Financial situation (end-of-period financial data, budget-actual comparative analysis)
- Other analyses requested by the executive board.

(Cokins, G, 2009)

The financial planning process is an important opportunity to work closely with senior management and understand the financial and operational performance of the company.

Ever-changing Roles for FP&A

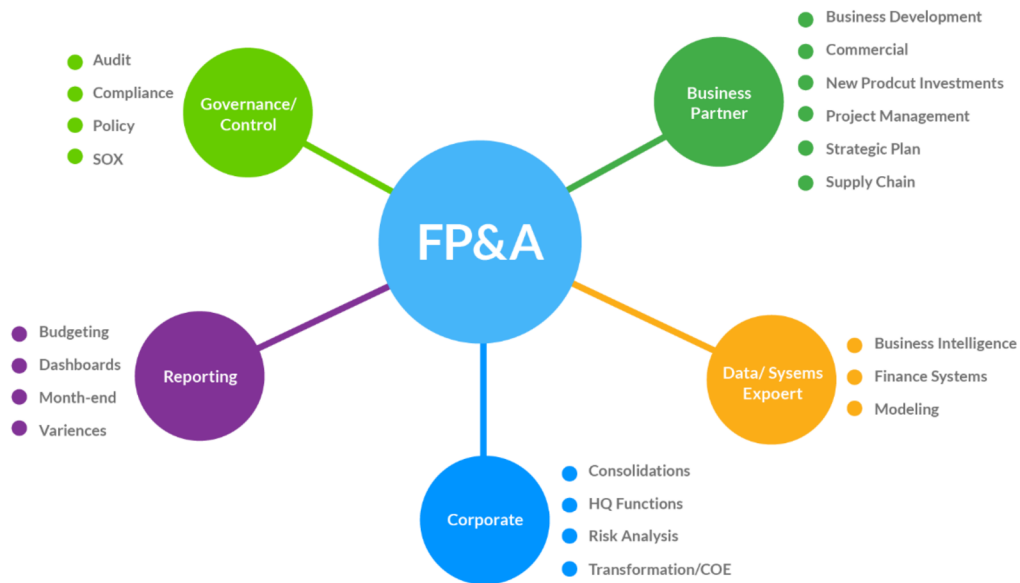

Picture 11, Rost, M (2023). Evolution of Financial Planning And Analysis [Infographics]. Workiva.com

Preparing monthly report packages is another activity that this team does. Keeping daily journal records is one of the most important duties of the accounting department. After each month's closing, financial planning and analysis department employees examine the daily book totals (trial balance) and investigate whether there are any unusual records. If there are incorrect records, the accounting department asks the records to be corrected. In this context, Finance acts as a financial controller and is responsible for keeping financial data accurate (Cokins, G, 2009).

After income and expenses are transferred to the correct cost centres, it extracts the financial data from the system and prepares basic financial statements (Income statement, Balance Sheet, Cash flow). These reports provide senior management with the competence to make operational decisions and provide information about the financial situation of the company. The accounting department also prepares basic financial statements during provisional tax periods. We can break down and analyse the data with the preparations of the financial planning and analysis department. Also as predicted by Mckinsey, "Based on our observations, next-level finance teams are more likely than peer organizations to synthesize financial and nonfinancial data to create a consistent fact base that can help inform critical business decisions and improve organizational performance." (Eklund, S,

2023). Also taking this into consideration the team is going to be the crucial team in building our new sales model.

3.7 ICF Business Process and IT Controls

The ICF audit will begin with a meeting between auditors and company management. During this meeting, auditors will discuss the scope, length, purpose, and expected results of the review process. Public companies have some assistance in selecting an auditor for the ICF audit process. However, the accounting firm performing the audit must be registered with the government or accounting oversight bodies. This ensures to the public that the inspectors performing the field work and inspection have the adequate education and training necessary to conduct the inspection (Tech Target, 2023).

ICF auditors also need to be separate from the company's regular auditors. If the same auditors perform both audits, this may be a conflict of interest. A ICF audit tests for variance and misinformation in a company's financial information, the strength of internal controls, and governance within the accounting department. When testing for variables and errors, auditors review documents prepared by the company. Auditors can recalculate the financial ledger and compare preparation instructions to standard accounting principles. Although some variance is typically acceptable, variances or errors greater than 5% are generally viewed as significant. Content on different topics can also be ordered. Internal control reviews test which employee is responsible for specific activities, how many similar tasks a person completes, which manager supervises various employees, has access to accounting software, and which defaults exist to find errors in the accounting software (Tech Target, 2023).

An ICF audit will focus heavily on internal controls, as these are procedures specifically designed to limit errors and prohibit fraudulent activity regarding the company's financial information. An ICF audit generally does not provide a company's management with the corrective measures necessary to resolve accounting problems (Tech Target, 2023).

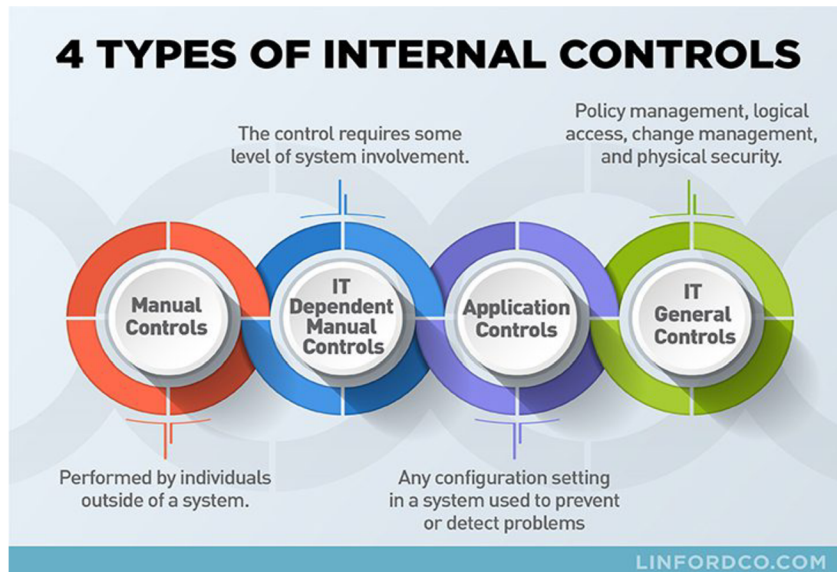

Picture 12, Finney, J (2022). What Are Internal Controls [Infographics]. Linfordco.com

Although some guidance is certainly needed, because ICF auditors fall into advisory services, they will quickly blur their independence by offering too many corrective suggestions. Under ICF laws, auditors cannot provide consulting services to audit clients because this would result in more than one accounting service being provided by an accounting firm. The content agency also serves on similar and different topics. Failure of a ICF audit will often result in a required remediation audit. Most auditors will score the audit on a 100-point scale, and with anything below 70 points, a repeat audit is scheduled. A remedial audit tests areas where the company failed during the initial audit and ensures that the company's corrections are effective and continue permanently to protect the company's information (Tech Target, 2023).

Today, many companies are investing heavily in cloud technology. New technologies may lead to some digital risks such as data breaches. The field of technology risk management has become increasingly important because such events can be detrimental to companies. Many companies need IT Audit to minimize these risks and ensure that information-related processes are working properly. The word IT Audit, created by the abbreviation of the words Information Technology Audit. It also appears to be used as IT control. The answer to the question of what IT Audit is can be given as the examination and evaluation of an organization's information technology infrastructure, policies and operations (Tech Target, 2023).

IT Audit is a new business area that is gaining more importance with the rise of cloud technology. Information technology audits. It determines whether corporate assets are protected, data integrity is ensured, and whether it is compatible with the general objectives of the business. An IT Audit examines not only physical security controls but also general business and financial controls involving information technology systems. The answer to the question of what IT Audit does is that it ensures that controls are established properly and effectively. However, it determines a line of action in the event of an unexpected event that would threaten the image and reputation of the examined business, even if sufficient security and compliance are ensured (Tech Target, 2023)

Some of the duties and responsibilities included in the IT Audit job description are:

- To evaluate on-site the systems and processes that secure company data.
- To identify risks to a company's information assets and help find methods to minimize these risks.
- Ensuring that information management processes comply with specific laws, policies, and standards.
- To identify inefficiencies in the systems used in the field of information technology and related management.
- Creating audit test plans.
- Determining the audit scope and objectives.
- To ensure coordination of audit activities.
- To comply with the audit standards set by the company.
- Developing detailed audit reports.
- Identifying best practices to meet audit requirements.
- Keeping information technology reports constantly updated.
- Designing audit findings and recommendations that can make the system more efficient.
- Ensuring that approved recommendations are correctly implemented by all employees.

(Tech Target, 2023)

4 Practical Part

The practical part will cover the implementation of all the tools and methods described in the theoretical part. We will start with the interviews and move to business model and continue with lean canvas. We will also show the new sales process with Business Processing and Modelling Notations, create the Gantt chart for project phases and sum it up with costs and forecast. During the theoretical part, various concepts, models, or approaches were introduced and analysed to provide a foundation of knowledge. However, understanding these concepts alone is not sufficient to drive real results. The implementation chapter aims to demonstrate how these theoretical ideas can be translated into actionable steps and strategies to solve practical problems or achieve specific objectives.

4.1 About the Company



Picture 13, Applifting logo (2023). Applifting.io

In this section of the thesis, we will elaborate more about our chosen company for the investigation of this thesis, and we will explain the status of the company. We will go through the processes, the mission and vision also we will describe why the company needs the new sales team. The section will also cover on how the selected way of building the new team will contribute to the company.

4.1.1 What is the IT Company Applifting?

Applifting is an international IT company of software engineers. It is focused on multiple services. One of the most interesting services that they provide is product discovery progress, which covers transforming the idea of the clients into a reality. The ideas of the

clients are refined through validation and designed through solution architecture. Next, there is implementation and testing. What makes this service is so interesting and so valuable is that it helps the founders to understand if the idea is valid. This means that if someone has an idea about a mobile app that they would like to create, Applifting is able to check if the idea is viable. A different board is able to succeed. An important part of this process is that the idea of the founder is clearly validated through the target group. The target group is a sample group of people who will be more likely to use the app.

Applifting is able to conduct research and understand if the idea is valid. And if the idea is valid, designers from Applifting create wire frames, then test those frames again, and from this, the design itself emerges. When the design is ready, it is transferred to the software engineering department where software engineers begin to develop the app. Software engineers can develop the mobile apps for iOS or for android. Sometimes, apps are also developed for a website.

Until now it seems a debtors this company is usual so first year and the note different from others. It is entirely untrue. Applifting is focused specifically on Fintech and MedTech target groups. Applifting has gained a lot of skills through working for large companies, such as Rasta group, and has deepened their understanding of fintech knowledge. But this is not only the difference.

4.1.2 Current Organizational Structure

Below is the current organizational chart of Applifting. As it can be seen the current structure of the organisation is very simple with no true organizational structure, and it lets us to understand the responsibilities of each guru on projects and other departments. Also, the CEO is responsible for the firm and is frequently referred to as a guru. The COO oversees operations.

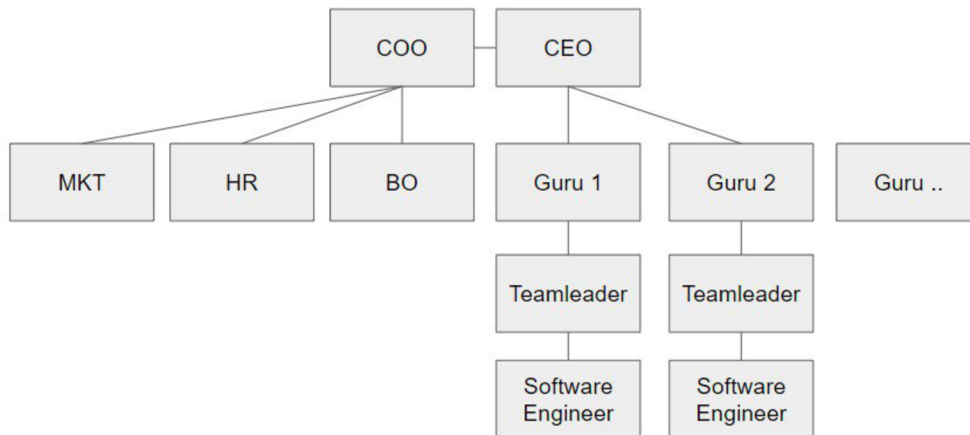

Chart 1, Organization structure of Applifting (2023). Author's work.

The owners of Applifting created Applifting as a teal organization.

This means that it is a 'freedom' company. The company culture is so different from other companies that it might be seen as unique or even surrealistic to describe it. There is no management structure. Teams are assigned to leaders, but these leaders are not the bosses of the people inside of the company. The company is led by the employees themselves. It may sound a little bit socialistic, but I am not here to change how this structure should be perceived, but to understand if there is a possibility for Applifting to grow within the global competition. The company is officially led by a council of elders, which is an institute to create a c-level employees. This council of elders is composed of six people who are elected through voting.

The processes in Applifting is currently led by system engineers with exceptional communication skills who are leading the sales as well. These people are not directly handling proper sales, but they are using their own network to create sales opportunities too. They are also active in networking events and within the events that Applifting creates. This means that there is no direct lead of sales or marketing specialists with qualified leads within the organization. We should not consider these people as a proper sales team. They are more like independent wolfs. If we are investigating the details of the company, we can see that the deals are made through word of mouth and individual

connections. Mini deals are also generated through referrals. A reference in this case means that many clients join because of a recommendation from Applifting's current or past clients.



Picture 14, Jablotron logo (2023). Jablotron.com



Picture 15, Erste Group logo (2023). ErsteGroup.com

Bank iD

Picture 16, BankID logo. BankID.cz

Currently, Applifting is working for many large companies. Some examples include Jablotron, Erste group, and BankID. All these companies have smaller deals which supply Applifting with a continuous revenue stream. For eight years, Applifting was working in this way without issues. But it all changed when COVID-19 struck. At that time a huge company, Česká Spořitelna, informed Applifting that they are not able to predict what will happen next and that because of COVID-19, they immediately need to end cooperation. As a result, twenty skilled software engineers were immediately transferred to the bench. Many of whom had mortgages. The C-level of Applifting had to determine the factors which led to this situation, and how to prevent it from recurring. They decided to create a sales team which would be properly focused on generating and closing new deals. The sales team should also allow a significant touch for the allocations and allocation planning over the software engineers. It should also increase the average rate which is currently generated from customers (Applifting, 2023).

4.1.3 Inquiries from the CEO, Vratislav Kalenda

In this section we will point the inquiries of CEO of Applifting based on the conducted interview with him.

Summary of Interview with Vratislav Kalenda:

Applifting focuses on creating and scaling digital products for clients, acting as partners throughout the process. The CEO, known as a guru, handles lead generation and qualification. He enjoys translating services into business values and collaborating with skilled individuals. Chasing clients and inconsistent lead generation are disliked, along with challenges in project execution. Applifting excels in bridging the gap between startups and enterprises, prioritizing partnerships, and avoiding vendor lock-in. They aim to improve sales effectiveness and target clients with higher budgets.

Internal challenges include limited middle management and resource allocation. The CEO's involvement in multiple aspects of the sales process creates pressure. Business developers play a role in lead generation and client engagement, with a focus on maintaining genuine partnerships. Maintaining existing clients is a priority, with an emphasis on support and delivering on promises. Consistent communication and strategic synchronization with clients need improvement. Expansion to Western markets raises concerns about meeting higher standards and building high-performing teams.

In conclusion, the CEO's insights from the interview shed light on the current state of Applifting and the challenges they face in building a new sales model. Based on the conducted interview with Vratislav Kalenda below are the list of inquiries we which we will also use as a basis in our business model creation.

List of inquiries:

- What strategies can improve lead generation and qualification processes, addressing concerns about chasing clients and inconsistent lead quality?
- How can the sales team better position Applifting's services to demonstrate ROI, cost savings, and de-risking?

- What steps can enhance Applifting's market positioning, brand awareness, and targeted business development activities?
- How can the new sales model provide better support to address contract finishing, proposal completion, and project execution?
- What measures can foster a growth-oriented company culture and address the lack of middle management?
- How can the new sales model improve communication with existing clients, strategic synchronization, and periodic check-ins?
- What strategies can address risks and challenges associated with expansion to Western markets and bridging the gap between client expectations and available resources?
- How can the new sales model create a collaborative and customer-centric sales environment?

4.1.4 Why to build a new sales department in Applifting?

There are multiple factors needed to be understood for the C-level of Applifting and their founders to create a new sales department.

First and foremost, it is necessary to have better planning over current deals and deals which are still in the pipeline. It also helps to better allocate software engineers and other resources into new deals. It prevents losing money and the profit on allocated people. There are multiple factors which influence the quality over the deal. The deal can be created and divided into three major parts which can classify the quality over the deal. The quality of the deal can be divided into quality of the customer and the rates which Applifting can charge. The project itself must be ethical and must help people in some way or lend itself to creating a better world. This might sound sentimental but is an important point for Applifting. This can include projects from a medical perspective or financial perspective. Both areas are very familiar to Applifting.

Next, it is important to focus on markets outside of the Czech Republic. Applifting would like to work for the markets where they can charge better rates and yield higher profits and

higher margins on the work. It is basically the vested market based on the old fashion division between the world before and after Iron Curtain.

The sales process itself is also very tightly connected with a better marketing strategy. A new strategy can be generated by the marketing department itself and can be immediately processed by sales department. This means that the marketing strategy is immediately validated, and it helps people from marketing to improve their campaigns to have the best results.

The creation of a sales department also means better control over all sales processes, which is necessary to help streamline the process, to be as effective as possible. Because effectiveness saves a lot of money. Effectiveness is very important because the typical sales cycle or sales window in an IT software development agency might take between three to six months in smaller deals, and up to one year in larger deals. It is not uncommon that cooperation with a larger corporation lasts two years.

4.1.5 Current Status of Sales, Problems and Risks

Currently in Applifting, there are two roles which are focused on generating new business. The main part of the business is done by the owner. Other business is brought by the kind of people who can communicate about and discuss technical knowledge. These people are called gurus in Applifting, and they are responsible for bringing new deals to the company as well as for finding technical solutions and leading projects. Gurus became technical partners for the clients, and thanks to their expertise, Applifting was easily able to grow from 30 to 150 people within six years.

Gurus generate leads from multiple channels. Each channel has its own advantages and disadvantages, and each group is better in different types of business generation. The development is decided by the gurus. The process is not set in stone, and every guru can approach his own lead generation by himself. In the next section, I will provide a few examples of how gurus currently approach new leads, which are crucial to the acquisition of new business.

The main source of leads for a guru is their own network. In their contacts from the previous companies where they have worked or which they owned, it is crucial to have a significant number of contacts, from whom they can arrange a call to have a coffee, business lunch, or business dinner, to understand if there is a possibility to form some new business for Applifting.

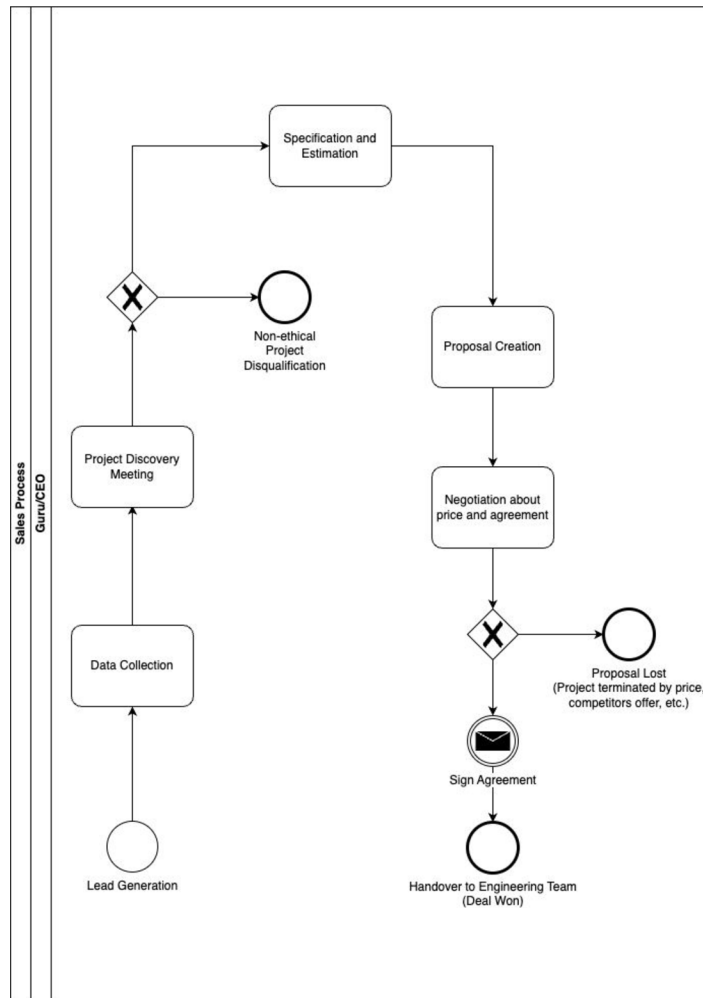

Chart 2, The current sales process in Applifting (2023). Author's work.

A guru's own network is a very valuable asset, and the same is true for any person who would like to become an entrepreneur. A network is so crucial that people without one have a very low chance to succeed in the business world. This is why Applifting's gurus are so valuable, and why their own network is considered as a very valuable asset when hiring. A problem that eventually occurs is at the time, usually within few years, when a guru has completely exhausted his own network, and can no longer use this channel. This channel

requires long term nurturing and continual growth of the network, so that the process of finding new business can be repeated within a few years.

Based on the various types of lead generations mentioned above, Applifting is attaining a low number of high-quality leads, which can be easily transferred into new deals. This might be not a problem in this timetable, but when any new action is needed, the current generation of gurus are not flexible enough to generate more and more new leads. Gurus who have brought new business are also responsible for leading it. It means that they have less and less time for regeneration and the regeneration of the company is slowly decreasing. In the long run, this process is difficult for the company, and can lead to a lack of leads when they are necessary.

At the same time, a guru who is creating a new deal or nurturing a current lead is doing so according to very high standards. A guru usually understands the technical solution in very deep detail and is expected to communicate with the client with a given level of expertise. This expertise and understanding of a client's needs can be easily transferred from the guru to the team, which is then able to deliver the solution that the clients need. For example, this solution might be a complex application for a pharmaceutical or medical company. Where the owner of the company is a businessman with contacts in healthcare but has a very low amount of technical IT knowledge, a guru can easily speak with the owner of this healthcare company by using more typical business language. This is a very significant advantage of all gurus.

Unfortunately, when gurus are focusing on leading their own projects, they lack the necessary time that it takes to nurture their network, i.e., attending networking events and other paths of generating new leads. There are multiple factors that need to be considered when using gurus as salespeople. The main point is that, from their own perspective, gurus are not salespeople, but rather IT consultants with a broad understanding of technology and business. This means that these individuals have competitive salaries. So, what are the problems that arise when they conduct business?

- Lack of new business opportunities when their own network is exhausted.
- Expensive maintenance of current client projects.

- Expensive lead qualification.
- Lack of time for sales while managing projects.
- Each guru has their own process for dealing with new leads.

The company is facing a very interesting dilemma that arises when a guru is successful. A successful guru is typically leading multiple projects. He is receiving rewards and commissions from this project which basically stop him from pursuing further lead generations. At the same time, some gurus are not as interested in leading or running the actual projects, and instead are more likely to be focused on the lead generation itself. This creates a tension between the guru and the team leader, because while one guru may be keen to cooperate with their team leader daily, another guru may not be as involved in running the project, and all the weight and pressure is on the team leader's back. The ultimate problem of why I was working on creating a new sales department as the subject of this diploma thesis occurred because of the COVID-19 pandemic.

In March of 2020, Applifting had approximately 130 employees, and most of them were split between only a few clients. When COVID struck, Applifting's largest client, a Czech bank, informed Applifting that they would need to pause all their current projects. This led to the near disastrous result of placing 20 software engineers on the bench, and Applifting had to cover all their salaries without invoicing the client. This caused a significant problem with the cash flow, which Applifting was not able to solve immediately, even though there were already a few gurus to take care of the business. At that time, the owners understood that it is essential to have a new sales department which would be fully focused on generating new leads and transferring leads into new deals. These deals must be both interesting and composed of good people on the client's side, to significantly increase the financial well-being of Applifting.

4.1.6 What Value New Business Department Should Bring?

The result of the research should be a suggestion on the improvement of the current situation in Applifting where the gurus are acting in partial roles as salespeople, project managers, solution architects, and technical advisors. There should be a new team of dedicated people, whose responsibility it will be to bring in new deals only. At the same time, some of the gurus should have the opportunity to follow up on the same process as

before, so that the transition that occurs as a result of the research and the application of the current project should be so delicate that the gurus can keep their salaries, rewards, and commissions, while simultaneously allowing the new sales team to bring in new deals and leads for the company.

It is assumed that the result will be that the salespeople should bring in exceptionally interesting deals, which even the current gurus would not be able to find through their own lead generation strategies and channels.

I have also recognized some flaws in the current process of creating new deals, in nurturing them, in creating slack channels, and then allowing the teams to be led by gurus. These flaws should also be investigated, analysed, and with the suggestion of the new solution, improved with a goal to enhance the process as much as possible. The impact of the research and the project of the creation of a sales department in an IT company should the enhance the current sales process, while providing a better division of work between guru's salespeople, improving the cash flow of Applifting and increase the company's overall profit.

4.2 Business Model and Lean Canvas

In this part we will focus on the new business model, lean canvas which we are planning to build based on the interview with CEO. We will give details about each and single note that have been created in the charts and graphs.

The reason why we are using both models is to explore the capabilities of both models and choose the best fir for our use case.

Later on, the other chapter we will reason our choice of method as this chapter serves as a bridge between theory and practice, highlighting how the proposed methodologies, frameworks, or strategies can be implemented in real-world scenarios.

4.2.1 New Business Model

A business model serves as the blueprint for how a company creates, delivers, and captures value. It outlines the key components and strategies that define how a business operates and generates revenue. A well-designed business model aligns the organization's resources, activities, and customer relationships to drive sustainable growth and profitability. A business model encompasses various elements, including the value proposition, target customer segments, channels for delivering products or services, revenue streams, cost structure, and key resources and activities. These components work together to create a clear understanding of the company's value proposition, competitive advantage, and the way it interacts with customers and stakeholders.

First, we start with the new business model. To start to explain the business model we had to create the model and focus on its key characteristics such as Key Partners, Key Activities, Value Propositions and etc.

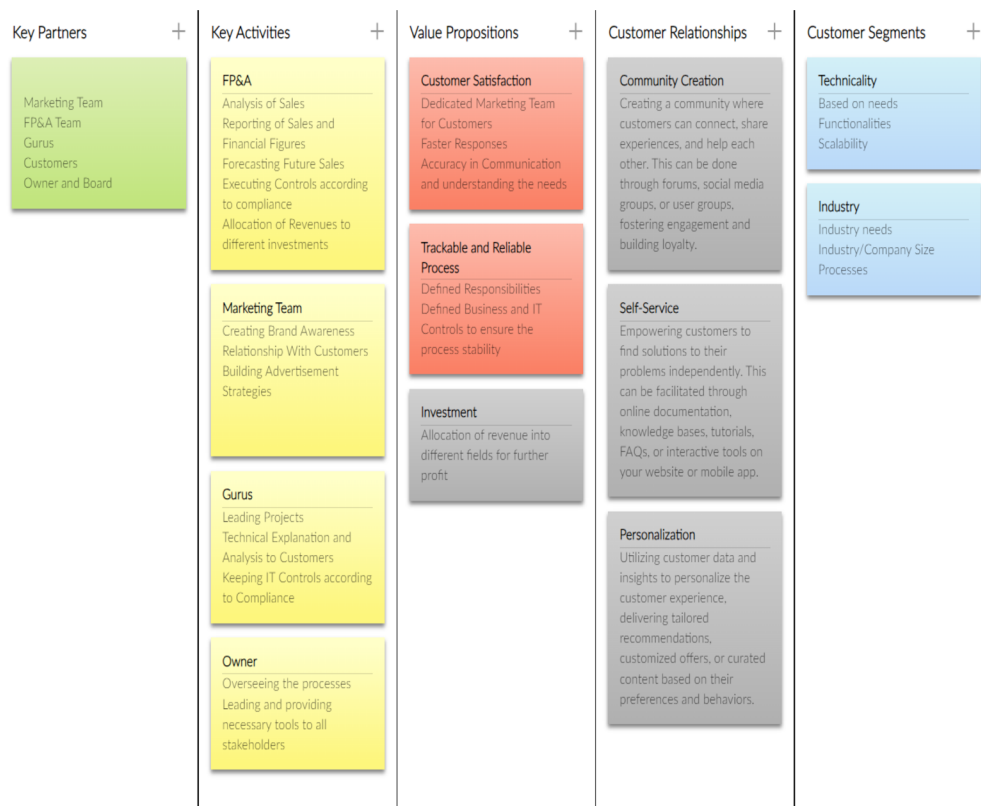

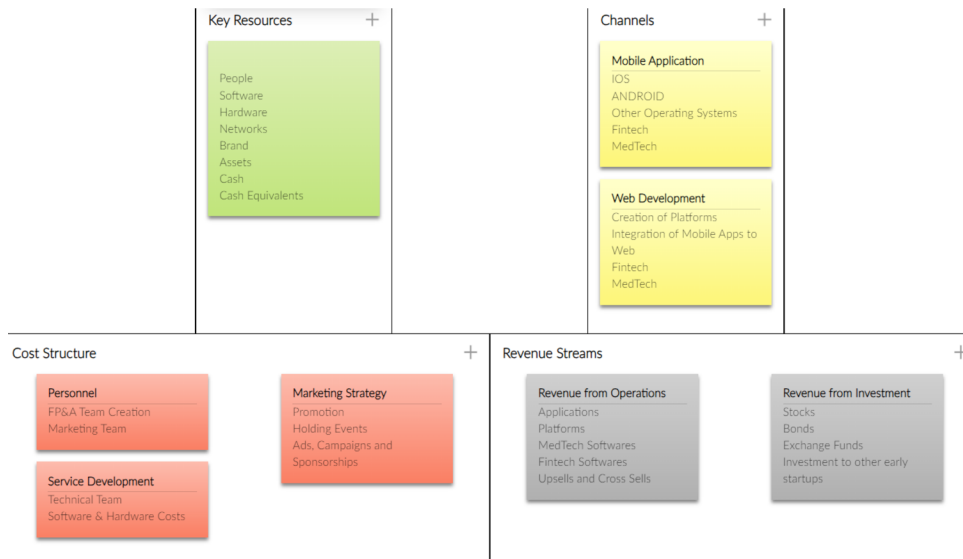

Picture 16, Business model (2023). Author's work.

Key Partners

As it can be seen in the above created model, the first key element in our business model to explain is the key partners. Taking into consideration that we are creating a dedicated marketing team and finance team, we are adding these teams to our key partners in this business model. Gurus, customers and leadership will also stay the key partners as previously were for the company with their differences in responsibilities and tasks.

Key Activities

The next important element is the key activities that are being executed by the assigned teams. Marketing team will be dedicated to creating brand awareness, relationship with customers and creating the marketing strategy for the future of the company. There will be certain pragmatic plans in terms of the freedom of marketing as it is very dynamic field. The marketing department must be performing certain control activities which will be created based on ICF/IT controls. Apart from compliant execution of those controls, the department should have freedom and work-life balance for being able to create and involve new customers.

When it comes to the activities by finance team, it is really crucial to have the appropriate management of the financial assets and resources in the company. This way company can detect and deduct the unnecessary costs, allocate resources accordingly and invest what is

left. Finance team, must be strictly compliant to the controls as it is very important to be organized in expenditure and allocation of assets in the company. There will be specific forecasting season when the people need to spend time on analysing the past data and forecasting future. Also the team will be responsible for preparing reports according to reporting standards to keep the correct track. Once the profit of the company is declared there will be another task for the team to define how to allocate internal and external investments for the future.

Gurus, owner and leadership will hold the key activities in a reduced way. They will ensure the smooth transfer of the existing relationships to customers over their network. Also they will still be responsible in governance of the project, providing technical support and educating the team according their expertise. This way, the network by Gurus will not be missed and also the impact may result based on their absence will be minimized.

Value Proposition

It is also very important to explain and derive the value propositions from the above business model which was developed.

As we have a dedicated marketing team to support the customers and relationships there will be stable and uninterrupted communication flow between company and customers. This will ensure the customer loyalty and keeping the brand awareness active all the time. Furthermore, the support of created ICF/IT controls will create a trackable and reliable process environment. It will be possible to check the results retrospectively and even create some prospective remediations based on the control testings every quarter/year end. Clear responsibilities by teams will also prevent any misalignment in work and ensure the highest quality of job to customers and also to people inside of the company. Last but not least, existence of finance team will give the power of analyzing the data, forecasting future and also help company to create profits with management of financial assets. The team will make propositions such as external investments to double and triple the company's existing net worth for the future. Consequently the profit will not be just from operations but also from investments.

Customer Relationships

Customer relationships of the new business model will be based on community creation, self-service and personalization. What is meant by community creation is to be able to create connection between clients, development team and customer service under marketing team. This way the company cannot only collect reviews but also evaluate the existing products fast and respond quicker. Another competitive advantage in customer relationships would be the self-service. The whole end to end process from receiving the order to created apps will be maximizing the focus on transparency that the customers can comfortably raise their requests and update or modify their products. Also, the personalization of the requests and products will be handled by both gurus and marketing team depending on the stage of the project. Team will use the customer data and insights to personalize the customer experience, delivering tailored recommendations, customized offers, or curated content based on their preferences and their preferences.

Customer Segments

Next, we will focus on customer segments which is another key part of the new business model that we desire to implement. The segments of customers will vary based on industry or technicality. By industry we mean the variety of needs based on different spheres. Taking into consideration that company currently have very strong expertise in Med Tech and FinTech both medical and financial sector companies can potentiall benefit from the services and products of Applifting. Also different industries can provide their technical requirements which can be easily adopted and developed by the developers in the company.

Key Resources

Another part in our business model is the key resources. Key resources are actual aspects that drives success in the company and overall in our business model too. People are a crucial resource in any organization. They include employees at all levels, from frontline staff to managers and executives. People bring their skills, knowledge, experience, and expertise to perform various tasks, contribute to innovation, and drive the success of the business. The right people in the right roles help with day-to-day operations, customer service, product development, marketing, and overall business growth. The main resource is the people where we include the new established finance team including marketing and

financeteam, Gurus and others. The expertise of the teams play crucial role in our business model.

Software resources encompass the computer programs, applications, or digital tools that are essential for business operations. This can include productivity software (e.g., office suites, project management tools), specialized software (e.g., accounting software, design software), or custom software solutions developed specifically for your business. Software resources facilitate data management, process automation, collaboration, analysis, and decision-making.

Hardware resources include the physical equipment, devices, or machinery required for business operations. This include computers, servers, networking equipment, manufacturing equipment, point-of-sale systems, or specialized tools relevant to your industry. Hardware resources enable production, storage, data processing, communication, and other essential functions necessary for delivering products or services to customers.

Networks refer to the partnerships and relationships your business has established with other organizations, suppliers, distributors, or industry associations. These networks provide access to resources, expertise, markets, and potential customers. Building strong relationships and networks increases opportunities for collaboration, investment, knowledge exchange, and market expansion. It can also help in sourcing raw materials, reducing supply chain risks, or reaching new customer segments.

The brand represents the intangible asset that encompasses your company's identity, reputation, and perception in the market. It includes the brand name, logo, visual identity, values, and the emotional connection customers have with your business. Building a strong brand enhances customer recognition, loyalty, and trust. It differentiates your business from competitors, attracts new customers, and retains existing ones. A robust brand also increases the perceived value of your products or services and provides a competitive advantage.

Assets include any physical or intangible resources owned by the business that have economic value. Physical assets can include property, real estate, manufacturing facilities,

vehicles, or inventory. Intangible assets can include patents, trademarks, copyrights, intellectual property, customer data, or proprietary technology. Assets provide value, generate revenue, or support business operations. Managing and leveraging assets effectively can enhance competitiveness, protect innovations, and create barriers to entry for competitors.

Cash and cash equivalents represent the liquid financial resources available to your business. They include cash on hand, funds in bank accounts, short-term investments, or other highly liquid assets that can be readily converted into cash. Cash and cash equivalents are essential for day-to-day operations, meeting financial obligations (e.g., payroll, bills), funding growth initiatives, investing in new opportunities, or managing unexpected expenses. Adequate cash flow management ensures business continuity and provides financial stability.

These key resources collectively contribute to the capabilities and value creation of your business. They support the execution of key activities, delivery of value to customers, and overall business success. By identifying, acquiring, and leveraging these resources effectively, you can enhance operational efficiency, maintain competitive advantage, and achieve your business objectives.

Channels

Each of the channels which is another important part of our business model offers unique opportunities and challenges, and the suitability of each channel will depend on your business model, target market, and specific industry. Understanding the characteristics, user base, and market dynamics of each channel will help you determine the most effective ways to reach and engage with your target audience. It's important to thoroughly research each channel, including platform policies, user demographics, and competition, to make informed decisions and develop effective strategies for your business.

iOS refers to Apple's operating system for mobile devices, such as iPhones and iPads. Building a channel on iOS involves developing and distributing your product or service through the Apple App Store. This channel allows you to reach a large user base of Apple device users and leverage the App Store's credibility and visibility.

Android is Google's operating system for mobile devices. Creating a channel on Android involves developing and distributing your product or service through the Google Play Store. Android has a significant market share worldwide, offering a broad reach to potential customers who use Android smartphones and tablets.

Apart from iOS and Android, there are other operating systems that your business can consider. These may include platforms such as Windows Mobile, Blackberry OS, or emerging operating systems specific to certain regions or devices. Assessing the market share and demand for these operating systems will help determine if they are viable channels for your business.

Fintech refers to technology-driven financial services. Building a channel in the fintech industry involves utilizing digital platforms or mobile apps to deliver financial products and services. This channel can encompass various financial services such as online banking, mobile payments, peer-to-peer lending, robo-advisory, or cryptocurrency platforms. Fintech channels leverage technology to provide efficient, convenient, and innovative financial solutions to customers.

MedTech, short for Medical Technology, focuses on the development and use of technology in healthcare. Building a channel in the MedTech industry involves developing and distributing medical devices, telemedicine solutions, healthcare software, or health monitoring applications. This channel enables you to reach healthcare providers, patients, and other stakeholders to improve healthcare delivery, diagnostics, patient care, and overall health outcomes.

Creation of platforms involves designing and developing web platforms that serve as the digital presence for your business. It includes creating websites or web applications that showcase your products, services, and brand. These platforms may include features such as interactive user interfaces, e-commerce capabilities, content management systems, or customer portals.

With the increasing use of mobile devices, integrating mobile apps with web platforms is an important aspect of web development. This allows users to easily access the services or

features provided by your mobile app through a web interface. Integration can include functionalities such as user account synchronization, data sharing, or cross-platform compatibility.

Within the web development channel, focusing on fintech involves developing web-based financial technology solutions. This can include online payment gateways, peer-to-peer lending platforms, crowdfunding platforms, or online investment portals. Fintech solutions leveraging web development help facilitate seamless and secure financial transactions, improve accessibility to financial services, and enhance user experience in the financial domain.

Similarly, within web development, MedTech focuses on creating web-based solutions for the healthcare industry. This can include telemedicine platforms, patient portals, electronic health record systems, or health monitoring applications accessible through web interfaces. MedTech web development enables healthcare providers to improve patient care, streamline administrative processes, enhance data security, and enable remote healthcare services.

By emphasizing web development in your channel strategy, you can leverage the power of the internet to reach a broader audience, provide efficient and convenient services, and enhance customer engagement. It allows you to create dynamic, scalable, and interactive platforms that align with the growing digital trends and meet the specific needs of your target market.

Cost Structure

Personnel costs refer to the expenses associated with your workforce. This includes salaries, wages, benefits, training, and any other costs related to hiring and retaining employees. Personnel costs are essential for carrying out day-to-day operations, managing customer relationships, developing and delivering services, and executing your marketing strategy. Managing personnel costs effectively involves optimizing staffing levels, ensuring competitive compensation, and investing in employee development to maximize productivity and maintain a skilled workforce.

Service development costs pertain to the expenses incurred in creating, improving, and maintaining your products or services. This includes research and development (R&D) expenses, prototyping, testing, design, and implementation costs. Service development costs can also include licensing fees for intellectual property, software or technology investments, or costs associated with outsourcing development tasks, if applicable. These costs are crucial for continuous innovation, enhancing the quality of your offerings, and staying competitive in the market.

Marketing strategy costs encompass the expenses incurred in promoting your products or services and reaching your target audience. This includes advertising campaigns, digital marketing efforts, content creation, branding activities, market research, public relations, and any other marketing initiatives. Marketing strategy costs are vital for creating awareness, attracting new customers, retaining existing customers, and building a positive brand image. Effective management of marketing costs involves allocating resources to the most effective channels, measuring the return on investment (ROI) of marketing efforts, and continually refining your marketing strategy based on market feedback and performance metrics.

Revenue Streams

Revenue from operations refers to the income generated through the primary activities of your business. It includes revenue earned from selling products, providing services, or offering subscriptions. This can involve one-time sales, recurring revenue models, licensing fees, service fees, or any other transactions related to your core business operations. Revenue from operations is the primary source of income that sustains your business and covers expenses, such as cost of goods sold, personnel costs, and overhead expenses.

Revenue from investment refers to income generated by investing surplus funds or assets. This can include interest income, dividends from stocks or mutual funds, rental income from real estate properties, or capital gains from selling investments. Revenue from investment allows your business to earn passive income and achieve additional financial returns beyond its core operations. It can be used to supplement revenue from operations, diversify income streams, and generate long-term wealth or financial stability.

4.2.2 Lean Canvas

After developing the business model, it is important to gain a deeper understanding of the problems faced by the target market and the solutions our business model offers. To facilitate this process, we use the Lean Canvas methodology. The Lean Canvas provides a concise framework to identify, analyse, and find the key aspects of our business model.

As we have similarly described the parts of business model, we will below explain in detail only the parts of Lean Canvas which differs from the Business model previously.

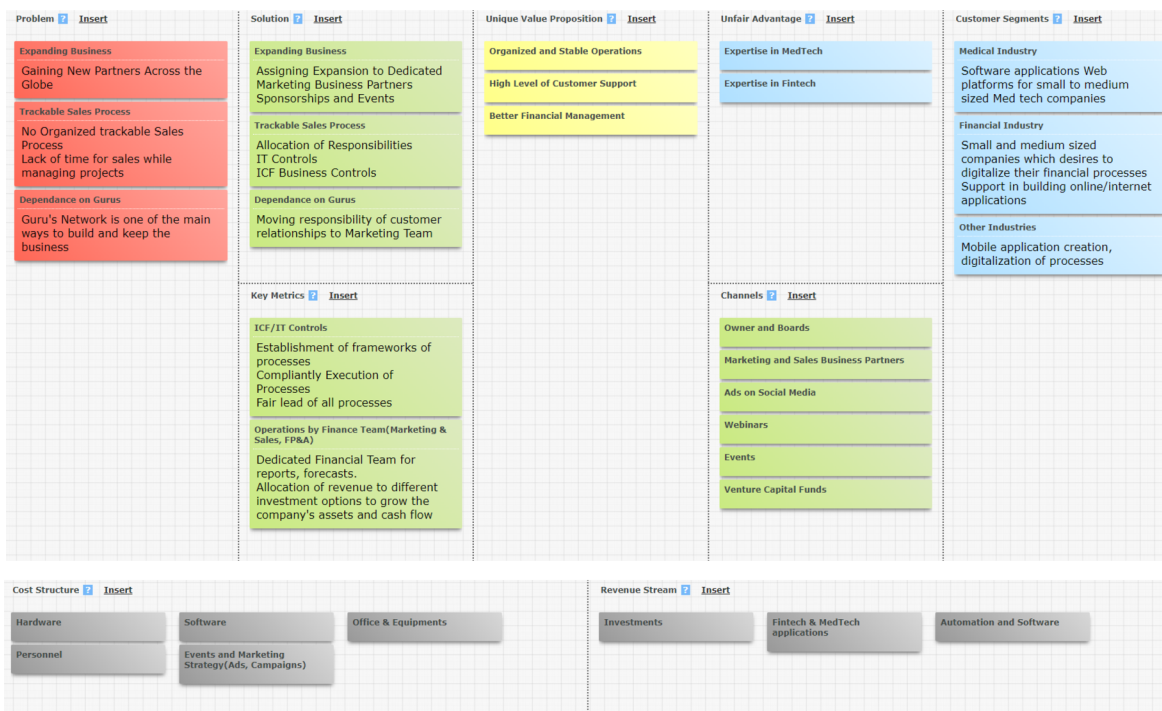

Picture 17, Lean Canvas (2023), Author's work.

Problem

It is crucial to identify and document the problems faced by the company. By acknowledging these challenges, we can proactively address them and work towards finding effective solutions. The company currently encounters issues primarily in three different areas, which require our attention and strategic focus.

The first area refers to business expansion. The company faces difficulties in expanding its presence and securing new partnerships across the globe. This challenge could risk the

company's growth potential and limit access to new markets. It is essential to devise strategies to overcome these barriers, establish fruitful partnerships, and capitalize on opportunities for international expansion.

The second area of concern revolves around the internal processes within the company. The lack of organization and structure in the sales process make comprehensive tracking of sales activities difficult, making it complex to analyze historical data and accurately forecast future sales. This challenge puts obstacle to our ability to make informed business decisions and develop effective strategies for growth. Streamlining and optimizing the sales process is important to enhance efficiency, enable data-driven decision-making, and drive future sales growth. Furthermore, the ambiguity surrounding team responsibilities within the company is another pressing issue. It becomes crucial to clarify and define roles, ensuring that every team member understands their responsibilities and is aligned with the company's objectives. Making clear lines of accountability and promoting effective cross-functional collaboration can improve overall operational efficiency and drive a great teamwork.

Networking represents a critical issue for the company as well. The heavy reliance on company gurus for networking opportunities risks the company's ability to establish strong and diverse customer relationships. This dependence limits our ability to expand our customer base and reach new markets efficiently. It is essential to develop a robust networking strategy that diversifies our connections and enables us to build stronger relationships with a broader range of customers, facilitating the company's growth and market expansion.

Solution

Expanding business: We will assign the task of expanding our business to dedicated marketing business partners who will be responsible for finding new customers, developing relationships, and closing deals. We will also sponsor events that are relevant to our target market and showcase our products and services.

Trackable sales process: We will create a clear and consistent sales process that defines the roles and responsibilities of each team member, the steps and stages of the sales cycle, and

the expected outcomes and metrics. We will use IT controls to monitor and manage the sales activities and data, and ICF business controls to ensure compliance and quality.

Dependence on gurus: We will reduce our reliance on a few skilled business people who have the most knowledge and experience in selling our products and services. We will transfer the responsibility of maintaining customer relationships to the marketing team, who will provide ongoing support and communication. We will also train and coach our sales staff to improve their skills and confidence.

Key Metrics

The first point is about ICF/IT Controls, which are the frameworks of processes that ensure the quality and compliance of the IT services and products. These frameworks include the standards, policies, procedures, and guidelines that govern the IT activities and operations.

By establishing these frameworks, the sales department can demonstrate the reliability and security of the IT solutions they offer to the customers. Moreover, by executing these processes compliantly, the sales department can avoid any legal or regulatory issues that might affect the reputation and performance of the company. Finally, by leading these processes fairly, the sales department can foster a culture of trust and collaboration among the IT staff and stakeholders.

The second point is about Operations by finance team (Marketing & Sales, FP&A), which are the financial activities and functions that support the sales department. These activities include the preparation and analysis of reports and forecasts that show the sales performance and trends.

These reports and forecasts help the sales department to plan and adjust their strategies and goals accordingly. Additionally, these activities include the allocation of revenue to different investment options that can grow the company's assets and cash flow. These options can be related to the development and improvement of the IT products and services, the expansion and diversification of the customer base, or the acquisition and retention of the talent and resources.

By having a dedicated financial team for these activities, the sales department can optimize their budget and resources and increase their profitability and efficiency.

Unique value proposition

Organized and stable operations means that the sales department will have a clear structure and process for managing the sales cycle, from lead generation to closing deals. The sales department will also have a reliable and consistent performance, meeting the targets and expectations of the company and the customers. This will create a competitive advantage for the IT company, as it will be able to deliver high-quality products and services in a timely and efficient manner.

High level of customer support means that the sales department will have a strong focus on building and maintaining relationships with the customers, providing them with the best possible solutions and assistance. The sales department will also have a feedback system to collect and analyze the customer needs and satisfaction, and use it to improve the products and services. This will create a loyal and satisfied customer base for the IT company, as it will be able to meet and exceed the customer demands and preferences.

Better financial management means that the sales department will have a sound and transparent budget and accounting system, tracking and reporting the sales revenue and expenses. The sales department will also have a strategic and realistic sales forecast and plan, setting and achieving the sales goals and objectives. This will create a profitable and sustainable business for the IT company, as it will be able to optimize the sales resources and maximize the sales results.

Unfair Advantage

Expertise in medtech and expertise in fintech are two areas that require specialized knowledge and skills, and not many IT companies can offer them. By having expertise in these fields, we can provide better solutions and services to our customers, and differentiate us from our competitors.

Medtech is the use of technology to improve the quality and efficiency of healthcare. It involves developing software, devices, and systems that can diagnose, treat, or prevent

diseases. Fintech is the use of technology to improve the delivery and accessibility of financial services. It involves creating software, platforms, and applications that can facilitate payments, transfers, lending, investing, or insurance. Both medtech and fintech are growing and lucrative markets, and they have high demand for IT solutions that can meet their needs and challenges.

Channels

We want to build a sales department in an IT company that can effectively reach out to potential customers and generate revenue. To do this, we need to identify the best channels to communicate our value proposition and showcase our products or services. We have chosen the following channels for this purpose:

Owner and Boards: We will leverage the network and influence of the owner and the board members of the company to connect with high-profile clients and investors. This will help us build trust and credibility in the market and secure funding for our growth.

Marketing and Sales business partners: We will partner with other marketing and sales agencies or consultants that have expertise and experience in the IT sector. They will help us create and execute effective campaigns and strategies to attract and convert leads into customers.

Ads on Social media: We will use social media platforms such as Facebook, Twitter, LinkedIn, and Instagram to promote our brand and products or services. We will create engaging and relevant content that showcases our value proposition and benefits. We will also target specific audiences based on their interests, demographics, and behaviors.

Webinars: We will host online events where we will share our knowledge and insights on the latest trends and challenges in the IT industry. We will also demonstrate how our products or services can solve the problems and needs of our potential customers. We will invite experts and influencers to join us and add value to our webinars.

Hosting events: A way to showcase our products and services to potential customers and partners. We can demonstrate how our solutions can solve their problems and add value to

their businesses. Hosting events also helps us to build relationships and trust with our target audience, as well as to generate leads and referrals. By hosting events, we can increase our brand awareness and reputation in the market.

Venture capital funds: Source of funding and support for our IT company. We can pitch our business idea and vision to investors who are interested in the IT sector and have the resources and expertise to help us grow. Venture capital funds can provide us with capital, mentorship, network, and access to new markets and opportunities. By partnering with venture capital funds, we can accelerate our growth and scale our business to the next level.

Customer segments

Medical industry: We offer software applications that can help medical professionals and patients with various tasks, such as scheduling appointments, managing records, monitoring health conditions, and accessing information. We believe that the medical industry is a potential market for us because it is constantly evolving and requires innovative solutions to improve efficiency and quality of care.

Financial industry: We target small and medium-sized companies that need software applications to handle their financial operations, such as accounting, invoicing, payroll, and reporting. We think that the financial industry is a lucrative market for us because it has a high demand for reliable and secure software solutions that can help them save time and money.

Other industries: We also cater to other industries that need software applications for various purposes, such as mobile apps, digitalization, e-commerce, and education. We think that these industries are diverse and dynamic markets for us because they have different needs and preferences that we can satisfy with our customized and flexible software solutions.

Cost Structure

Hardware: This includes the computers, laptops, phones, and other devices that we use to communicate with our customers and sell our products or services. Hardware costs can vary depending on the quality and quantity of the devices we need.

Software: This includes the applications, programs, and platforms that we use to manage our sales processes, such as CRM, email marketing, analytics, etc. Software costs can depend on the type and number of licenses we need to purchase or subscribe to.

Office and equipment: This includes the rent, utilities, furniture, and supplies that we need to maintain a physical or virtual office space for our sales team. Office and equipment costs can differ based on the location, size, and design of our office.

Personnel: This includes the salaries, commissions, bonuses, benefits, and training costs that we pay to our sales staff. Personnel costs can change based on the number, qualification, and performance of our salespeople.

Events and marketing strategy: This includes the costs of organizing, attending, or sponsoring events, such as trade shows, conferences, webinars, etc., where we can showcase our products or services and generate leads. It also includes the costs of creating and executing marketing campaigns, such as ads, social media, content, etc., where we can promote our brand and attract customers. Events and marketing strategy costs can fluctuate based on the frequency, scale, and effectiveness of our activities.

Revenue streams

Fintech and MedTech apps: Creation of apps that solve real-world problems in the financial and medical domains. These apps must be designed to be user-friendly, secure, and reliable. Apps can have paid downloads, subscriptions, or freemium models. Revenue from in-app purchases, advertisements, or commissions. These apps has to be done for the customers as well as internal projects.

Automation and software: We should provide automation and software solutions for businesses and organizations that need to optimize their workflows, reduce costs, and increase efficiency. We should offer customized software development, cloud computing,

data analytics, and artificial intelligence services. Charge our clients based on the scope, complexity, and duration of the projects.

4.2.3 Why Lean Canvas is Better for Our Use Case?

Taking into consideration that the Lean Canvas offers several advantages over business models.

- Provides simplicity and clarity by condensing all essential elements onto a single page, making the business model easy to understand.
- Focuses on identifying customer problems and proposing value-adding solutions, enabling effective product or service design.
- Aligns with lean startup methodology, encouraging an iterative and agile approach with continuous improvement, hypothesis testing, and learning from customer feedback. The visual representation of Lean Canvas facilitates quick visualization and analysis, allowing for the identification of connections, dependencies, and gaps in various aspects of the business model.
- Offers flexibility and adaptability, as it allows for easy modification and adaptation as the business evolves, supporting a growth mindset and facilitating pivots or changes in direction. Furthermore, the concise nature of Lean Canvas promotes effective communication and collaboration, enabling sharing and discussion of business ideas within teams and with stakeholders.
- Encourages early validation of assumptions through experimentation and customer feedback, reducing risks and increasing the chances of success.

4.3 Interviews

For conducting the in-depth evaluation of Lean Canvas, I used qualitative methods.

Through user interviews which are based on design thinking, I was able to deeply talk with multiple employees of Applifting, focusing on individuals who are the most important in the sales processes itself and have the highest impact on continued revenues. Are you used for this research the information from the book Interviewing Users: How to Uncover

Compelling Insights which helped me to understand what question I should be asking and why.

4.3.1 Why Interview is Necessary?

To confirm how the gurus are currently struggling, and in which fields, and where they can see the room for improvement. I will use the information from this confirm analysis in order to create a better understanding of the future role of salespeople.

Based on the research and Lean Canvas, I will also be able to see where the problems are which need to be solved to have a higher percentage of success within the competition. The research will be also investigated whether there are other major issues in Applifting which might be solved by the creation of a new strategy and implementing the project of a sales department.

I interviewed multiple people from Applifting in multiple positions.

I interviewed:

- Tomáš Landovský because he is the team lead of the backend department.
- Vrátilav Kalenda and Filip Kirschner, who are both gurus and owners of Applifting.
- Prokop Simek, who is currently the team leader of the subsidiary of Applifting.
- Radek Forgač, who is the team lead of the cloud engineering department.
- Dominik Snopek, who is a member of the council of elders
- Martin Srb, who is a guru.
- Jan Hauser, who is a guru and a CEO of the UK Applifting branch.
- Nikolay Barbariskiy who is the team lead of enterprise in Applifting.
- Jan Minárik, who is a guru.
- Jakub Marcin, who is a leader of the marketing department.
- Tereza Kvasnicová, who is a council member and part of the back office.

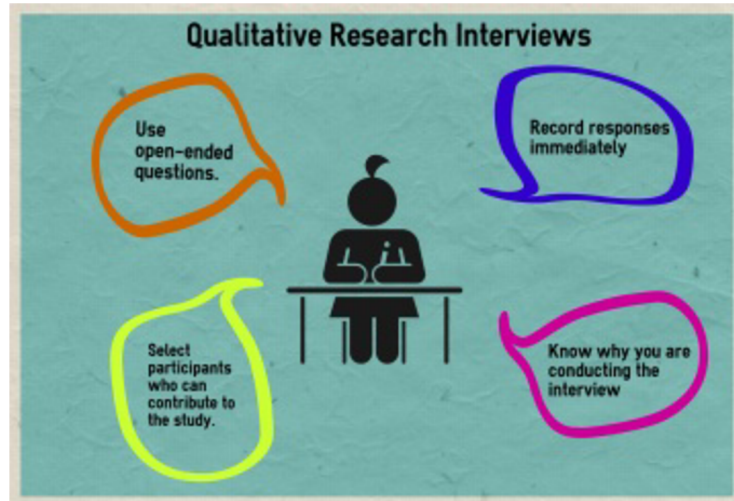

Picture 18, Sarah K, *What are the most important things to remember in conducting interviews?* [Infogrphics]. Chemmomak.wordpress.com

4.3.2 How Design Thinking Was Applied in Interview Questions?

"Qualitative research methods, such as user interviews, are invaluable for uncovering insights about users' behaviors, needs, and motivations. By talking to your users, you can gain a deep understanding of their experiences, pain points, and desires. When conducting user interviews based on design thinking, it's important to ask open-ended questions that allow users to express their thoughts and feelings freely.

By avoiding leading questions and listening actively to what users are saying, you can uncover insights that you might not have discovered through other research methods. Furthermore, the questions that are in the interviews are designed to create empathy with the people. Also it was very important to focus on needs and pain points for application of design thinking into interviews.

Additionally, it's crucial to focus on the right users - those who are most important in the sales process and have the highest impact on continued revenues. By doing so, you can ensure that you're getting insights that are relevant and actionable for your research goals."(PORTIGAL, S, 2013). All interviews were conducted one on one and all the interviewed members of Applifting gave me their permission to discuss their answers in this diploma thesis research. I will be not going into the answers individually for each person, but I will collect information based on the question asked.

I will be searching for the similarities in their answers, which I assume are the main points which need to be solved to have a successful sales department in Applifting.

Question 1: Explain to me, what Applifting is doing?

The reasoning behind this question is straightforward. I need to understand how each of the interviewee's techniques promote Applifting, so I know that this should be their perception of how the marketing department creates the company's image. I will use this information to understand the key sales points which have been used to sell Applifting's services.

Usually, Applifting claims to provide a digital product which can scale to make the success of the partner. One of Applifting's advantages is its claim of being a reliable partner and cannot work with companies which already have a software product which they can scale and boost.

Some other people basically say that Applifting is a software studio with seven years of experience, focusing on enterprise and startups. Although they are talking about digital innovation for enterprises, which I didn't understand so well. In here it might be a problem in explanation which can be widely used for people who don't exactly know what digital innovation is. Usually, people are talking about the main verticals they are focusing on. The first vertical is already mentioned in the digital product creation and is an understanding and scaling of a product for less money and the reduced risk of having no vendor-locking agreements. This service is focused on the founders or startups in phase zero.

I also understand that digital innovation means helping to innovate the rigid, old, dinosaur systems in huge enterprise companies and corporations. It can be beneficial when a corporation would like to innovate their internal systems. This was also described as creating microservices from monoliths. Monoliths here means is the large, old system created with old technology. Microservice means that a part of the monolithic system is extracted and recreated into a new technology.

The key take away here is that Applifting solves two main problems which helps startup founders build their software, usually a mobile app focusing on big corporations.

Question 2: What is your role here?

By this question, I would like to understand what each person's role is in Applifting, and if there are some differences between gurus, team leads, council members, and owners. People usually say that gurus are focused on searching for new leads, qualifying them, making stakeholders happy, and sometimes inviting other gurus to meetings, but in general I understood that sales is not their primary focus.

From what I was talking with them asking them these questions I understood that even though they should do sales, they are focused on multiple things, such as leading internal projects, working on the infrastructure, being a patron, offering technology, being a developer, taking care about how the company works, or leading the team.

From the research, I can easily understand that the role of guru and teammate each has its own focus. Team leaders are focused on leading their team. Gurus are focused on multiple projects lead the generation some of them more technical stuff architecture some of them coding some of them business and team leadership as well. It has a good visualization that gurus are what they are described to be. It means technical people with technical background and at the same time in majority of cases focused on the business.

Question 3: What competency do you dislike?

This is the question I was most interested in. From this, I would like to understand where new salespeople can help gurus, so that this competency can be implemented into job descriptions, and understand where to improve the sales process itself, in order to be as effective as possible.

I understand that some gurus do not like chasing clients. The process of lead generation is inconsistent. Disqualification can occur when a potential client with a large budget has a specific idea to build with a specific text spec, which applifting does not have. Some gurus don't like cold calling, opening doors, conferences, pushing people, blog posting, code lead again, with some marketing funnel. Some of our gurus don't like maintaining client relationships or being engaged in the day-to-day leading of the projects.

From what I understood from the research, most gurus don't like the first phase of the business, which means lead generation. They would be much happier if they could solve different types of problems for the clients who are eager to buy our services.

Question 4: What is the competitive advantage of Applifting?

To understand where Applifting has its strength I am asking this question.

The answers usually focused on being fair to clients, being able to decline business, caring about results, customer well-being, solving technical issues, strong technical background, creative mode, validated technological edge, and knowledge sharing. All these keywords were mentioned multiple times by gurus. I understood from this that the focus on customer happiness and customer success in Applifting is very strong. This means that lead generation should also focus on the success of the customers and finding solutions to their problems. This might increase the conversion rate of the new leaves coming into Applifting.

Question 5: Where is the room for Improvement for Applifting?

To understand the weaknesses of Applifting, I asked this question.

The answers were a better positioning over other software development agencies, lack of defined sales process and pre-sale process which needs to be newly shaped. The business is unpredictable, implying that sometimes they need to close the deal for every price otherwise hourly rate is too high for customers. A few gurus also mentioned that they are lacking personal contacts, and that Applifting is bad in lead generation.

Question 6: What is the biggest internal pain?

By asking this question I wanted to understand the major problems which need to be solved immediately.

The major complaint was that Applifting is not able to manage the size of the company because of a lack of middle management and a smaller leadership pool. This is something which can be only worsened by creating a new sales team, but it is also something which

the owners can fix. It cannot be fixed by the creation of a sales department. Some gurus have a problem with the utilization of people. There is also a problem with the lead funnel, as mentioned above, and with the sales process itself.

Another issue may be that knowledge between gurus is not exchanged. This means that some of the gurus need to reinvent the wheel, for example in the already mentioned difficulty of lead generation.

Some gurus mentioned that they want to pay more to their employees and want to be able to hire more senior people.

Question 7: What Clients Should We Work for?

From what I understand, there isn't a specific business vertical to pursue right now. However, those who were discussing the B2B segment see opportunities in helping startups with product development and assisting corporates with the transition from old to new technology. A better lead generation strategy needs to be created.

From my observation, it seems that Applifting is skilled in the Fintech industry.

Question 8: What is the advantage of your position in sales process?

By asking this question I wanted to understand how gurus are so successful in closing deals. Most mentioned that they can give advice for free.

They understand the whole technological stack, they understand the whole process behind the software development, they can work with customers on a business level as well as an engineering level, they have big technical overhead. By answering all these questions, I became convinced that gurus are material from CTOs. Where CTOs are very good vocally and have experience in technology.

Question 9: Share the biggest disadvantage of your position in sales process.

The main disadvantages mentioned are difficulty in finishing contracts, mental pain, too much pressure about the sales since they are not technically salespeople. Some mentioned that they felt unsocial, that they are too technical and clever to work with businesspeople, and that they attend many meetings which result in the understanding that there is really no point in cooperating with certain potential customers.

This clearly tells us that gurus are constructed of a unique material and need to be handled with maximum care and time optimization. Gurus should not go to pre-discovery meetings to understand if the client is classifiable for Applifting or not. These people need a prepared deal with a defined structure and list of problems. They will be happy to solve it with clients who have already signed an agreement. I can imagine that these people will be advisers in the process, and their knowledge can be crucial for winning the proposal.

Question 10: How can a Business Developer help you?

By this question, I am directly asking where they want to be helped from a sales team. They would like to have pre-qualified leads. They would like to be only a part of the sales process, in an area where they can help. They want businesspeople to open the door and prepare the leads. Most gurus said that generating leads means a lot of hard work and time. They would also expect that the salespeople could attend networking sessions which were they unable to attend from time to time. They would like to be involved in strategic decisions, but they would also like to spend time solving crucial technical problems, or to lend their expertise. They do not want to classify leads and open the doors.

Question 11: How can a BD ruin something what you like?

I am asking this question to understand potential fears regarding the new salespeople. This question should give us a recommendation as to what we should teach salespeople for them to be successful and for the sales team to be impactful and meaningful.

This information will be taken into consideration while hiring salespeople. Salespeople should not promise something which they cannot deliver. They don't understand customers' problems. They don't know about technical solutions, and they could harm

Applifting's reputation. Sometimes, they might set expectations that are harder to solve, or misinterpret expectations from the company. Some of them might go for closing a deal even when the deal might be unethical. Gurus are also afraid that salespeople could harm values by giving a wrong presentation or by promising a deadline which is not possible to deliver.

All of this information is critical to understand in order to create a proper job description and profile of the future salespeople. The new sales team will need to be trained very well in order to avoid these mistakes, which are the biggest fears of current gurus.

Question 12: How do we maintain existing clients?

With this question, I am trying to understand what the training plan of new salespeople should look like, and what values we should focus on in this project.

The gurus told me that they are happy about being fair to the clients and utilizing an honest policy. Gurus care about their client's success, and they are happy to meet them every month. If they have new problems, they are happy to solve it for them. In their meetings, clients explain their problems, and gurus find solutions. Taking care of the customers is key for the happiness of gurus in their work.

Question 13: What are we doing wrong in maintenance of clients?

I asked this question to understand if there is some room for improvement in the current means of maintaining existing client relationships. I found answers such as, Applifting is not consistent, some periodicity should be added into relationships, that Applifting doesn't have strategical synchronization meetings with clients, and they are not preparing customers before offboarding. Sometimes it might be a bit chaotic that there is no smooth continuous process of nurturing the client. Some of the gurus said that they are putting so much effort into maintaining their relationships, which is probably detracting time for lead generation.

Conducted Interview into Pre-Sell Phase

In this part of the interview, I was able to understand how gurus work; where they are looking for new leads and businesses, and what are the specifics in a software agency business. It is divided between multiple channels, such as social networks such as LinkedIn, personal contacts, personal referrals, specifics on new business offers, and in the end, what are the key factors of making a deal, and how long does it take.

Most gurus agree that networking events are very important. These events might introduce you to a lot of new people and new connections that you can easily follow up. Most gurus also say that LinkedIn is a very important part of the lead generation strategy and presale phase itself.

When they talk about specifics, they mostly dislike like the perception that Applifting is a Body Shop. A Body Shop means that Applifting can only sell the developers to the companies like loops here and there, with no added value. This is something which is not perceived well in the eyes of gurus because as we have understood previously, they would always like to help clients. All their offers involve trying to create some special, interesting understanding of the customer's needs.

When I ask gurus about the time frame of making a new deal, the answers ranged from about a month, but that many new deals came from referrals. Unfortunately, I understand that the strategy behind generation is very individual, but networking can lead to reinventing the wheel for gurus. It is also important to mention that everyone interviewed had slightly different opinions about the strategies, and each group is a little bit different.

4.4 BPMN of New Model

Based on the sales process, Lean Canvas and interviews outlined above, for better understanding and visualization, I created a BPMN diagram. This diagram pictures the process from lead generation by the marketing department, through nurturing of clients by the business development team, data collection and specification creation by the product department. Proposals and negotiations are again handled by the business team, and if successful, the sales process is completed, and the data is handed over to the engineering

department. As you can see, most of the business development responsibilities are taken care of by the sales department, with support from the marketing department in lead generation and the product department for detailed specification of the project. Nevertheless, salespeople have to understand the scope of the project created by product managers in order to have a good overview of the project size and to prepare for the pitch to the client.

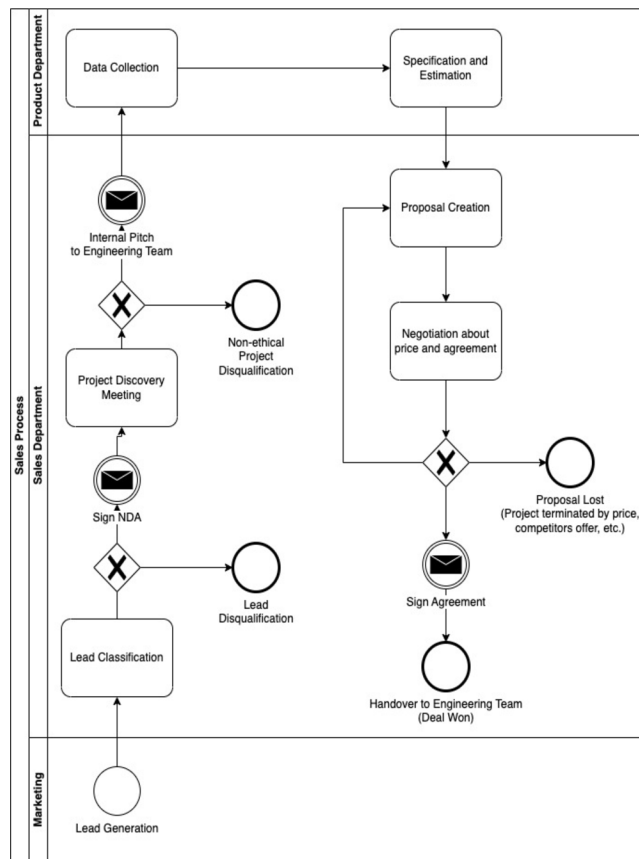

Graph 1, New sales process (2023), Author's work.

Similarly, below is the BPMN diagram of the new model within all the teams that we would like to establish. This diagram illustrates the entire process that starts with a request

from leadership, driven by the identified business needs. Each step in the diagram represents an activity that contributes to the implementation of the new sales model.

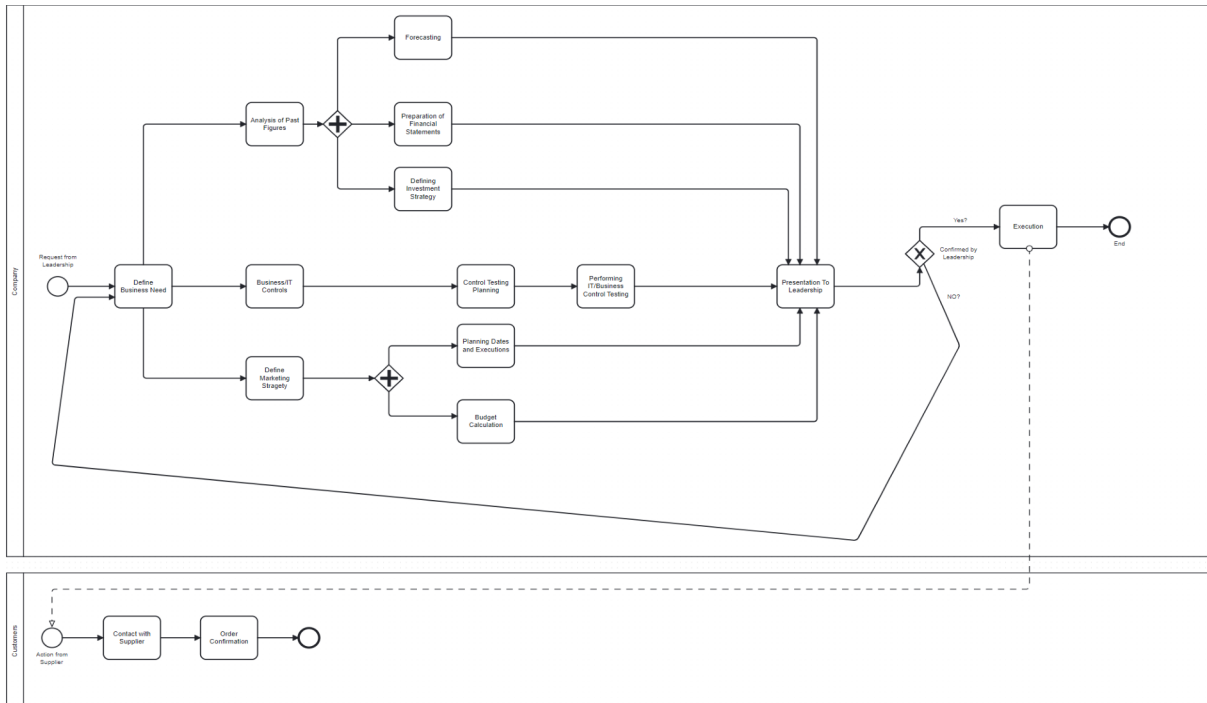

Graph 2, Implementation of the new sales department into the company (2023), Author's work.

The Finance team plays a crucial role in this process, with three distinct processes: FP&A, Marketing, and ICF/IT Controls. Each of these processes begins by defining the specific business need it addresses, providing a comprehensive view from different perspectives. The ICF/IT Controls process, for instance, involves a meticulous approach to control activity testing. This starts with planning the testing, followed by the execution of the tests. Once completed, the results of the testing are presented to the leadership team, providing insights into the stability and effectiveness of the overall process. This step allows the leadership team to make informed decisions and take necessary actions to ensure regulatory compliance and efficient IT controls.

The finance team's process is centred around analysing past financial figures to gain insights into the organization's financial performance. This analysis serves as the foundation for three simultaneous activities that are vital for efficient operation. The team engages in forecasting, preparing financial statements, and defining investment strategies for the future. All of these activities are then presented to leadership for further approval or rejection, ensuring alignment with the organization's overall goals. This step enables the

leadership team to make informed financial decisions, allocate resources effectively, and drive the organization's financial success.

The Marketing team's process begins with the strategic definition of the marketing approach. Subsequently, the team plans the timing of advertisements, events, and other marketing actions, while also calculating the associated costs. This strategic planning ensures that marketing efforts are executed in a coordinated and cost-effective manner. Once all strategies and cost calculations are defined, the Marketing team presents them to the leadership team for approval. This step ensures that the marketing strategy aligns with the overall business objectives and receives the necessary support and resources for successful execution. Based on the approved strategies, the Marketing team proceeds with the implementation of the planned actions. These actions play a pivotal role in establishing effective communication and connection between customers and the company. Through targeted advertisements, engaging events, and other marketing activities, the team aims to create a strong brand presence, attract new customers, and nurture existing customer relationships. This connection cultivates trust, brand loyalty, and contributes to the overall success of the sales model.

It's important to note that the approval from leadership is a significant milestone in this process. If the strategies are approved, execution of the planned actions can proceed. However, if not approved, the entire process must be revisited, and a new plan must be created to address any concerns or modifications requested by the leadership team. This iterative approach ensures that the sales model is tailored to the organization's evolving needs and responds effectively to market dynamics.

The BPMN diagram visually depicts the flow and interdependencies of the various activities within the new sales model. This comprehensive approach ensures that each step is carefully considered, aligned with business needs, presented to leadership for review, and executed accordingly. By following this structured process, the organization can establish an efficient and effective sales model that facilitates positive customer interactions, drives revenue growth, and sustains long-term success in the market.

4.5 Roadmap of New Model

In this phase of the thesis, we will provide a comprehensive and detailed overview of the process involved in settling the new business model. The aim is to prepare for the implementation of the model by setting respective target dates before the end of the year 2023, thus enabling us to go live with the new business model in 2024. It is important to highlight that the timeline and approach presented here are specifically set for the thesis. Nonetheless, the company can adopt a similar process at any given time in the future, ensuring its readiness to capitalize on emerging opportunities and meet market needs. The flexible and adaptable nature of this approach positions the company for continued success and growth.

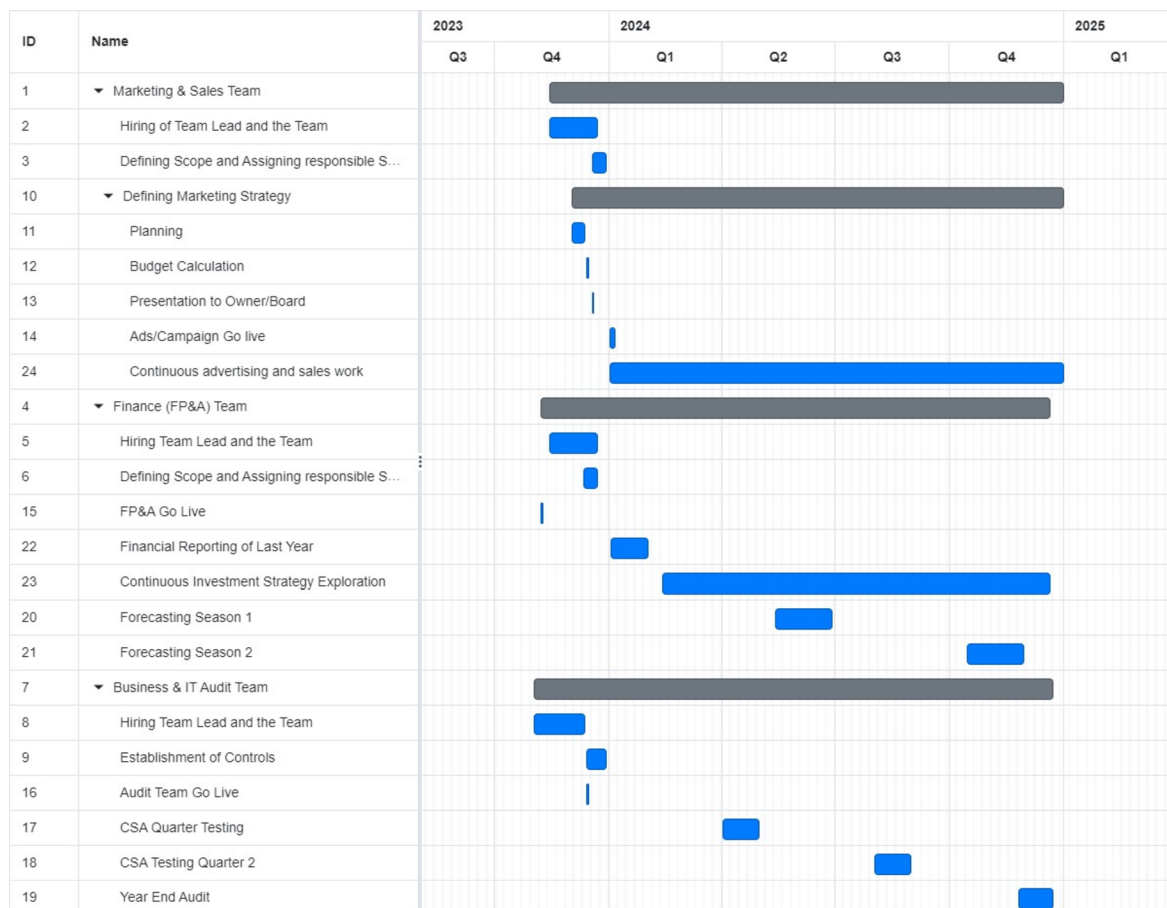

Chart 3, Roadmap (2023), Author's work.

To initiate this transformation, our primary focus will be on hiring a dedicated team of Business and IT audit specialists. This initial step is important as it enables us to define and

implement the necessary activities within the Internal Control Framework before the Marketing and Finance teams become fully operational. Accordingly, the hiring process for the team lead and two specialists will be initiated in November. By ensuring the inclusion of these skilled professionals, we can establish the foundation for the upcoming control activities. The hiring process is expected to be completed by the end of November, allowing the team to commence work promptly.

Subsequently, in December, the newly formed Business and IT audit team will begin building the control activities required for the successful implementation of the new business model. This proactive approach guarantees that the control framework will be in place and fully operational by the time the Marketing and Finance teams are settled and ready to execute their respective roles.

ID	Name	Start Date	End Date
7	Business & IT Audit Team	November 2023, 1st Week	December 2024, last week
8	Hiring Team Lead and the Team	November 2023, 1st Week	December 2023, 1st week
9	Establishment of Controls	December 2023, 1st Week	December 2023, 2nd week
16	Audit Team Go Live	December 2023, 1st Week	December 2023, 1st Week
17	CSA Quarter Testing	April 2024, 1st Week	April 2024, Last Week
18	CSA Testing Quarter 2	August 2024, 1st Week	August 2024, Last Week
19	Year End Audit	November 2024, Last Week	December 2024, Last Week

Table 2, Business & IT Audit team activity (2023), Author's work.

Concurrently, in order to ensure the smooth integration of the Finance team into the new business model, we will initiate the hiring process for the Finance team lead and two specialists in November as well. By December, once the team lead is hired, they will assume responsibility for defining the scope and clarifying the responsibilities of the Finance team. This step will ensure that the team is well-prepared to perform its activities as of January 2024, aligning with the planned timeline for implementing the new business model.

ID	Name	Start Date	End Date
4	Finance (FP&A) Team	November 2023, 1st Week	December 2024, last week
5	Hiring Team Lead and the Team	November 2023, 1st Week	December 2023, 1st week
6	Defining Scope and Assigning responsible SOX Controls	December 2023, 1st Week	December 2023, 2nd week
15	FP&A Go Live	December 2023, 1st Week	December 2023, 1st Week
22	Financial Reporting of Last Year	January 2024, 1st Week	February 2024, 1st week
23	Continuous Investment Strategy Exploration	February 2024, 2nd Week	December 2024, 3rd Week
20	Forecasting Season 1	May 2024, 2nd Week	June 2024, Last week
21	Forecasting Season 2	October 2024, 2nd Week	November 2024, Last week

Table 3, Finance team activity (2023), Author's work.

Like the Finance team, the Marketing team will also follow a parallel hiring process. By November, we will begin the process of hiring the Marketing team lead and two specialists, essential to driving the success of the marketing initiatives within the new

business model. Once the team lead is in place, the scope of work and responsibilities will be precisely defined for effective collaboration and smooth integration of the process. Throughout December, the Marketing team will focus on planning, calculating budgets, and preparing presentations, ensuring that the marketing strategy is well-structured and ready for execution by January 2024.

ID	Name	Start Date	End Date
1	Marketing & Sales Team	November 2023, 2nd Week	December 2024, last week
2	Hiring of Team Lead and the Team	November 2023, 2nd Week	December 2023, last week
3	Defining Scope and Assigning responsible SOX Controls	December 2023, 2nd Week	December 2023, last week
10	Defining Marketing Strategy	December 2023, 1st Week	December 2024, last week
11	Planning	December 2023, 1st Week	December 2023, 3rd Week
12	Budget Calculation	December 2023, 2nd Week	December 2023, 3rd Week
13	Presentation to Owner/Board	December 2023, 3rd Week	December 2023, 3rd Week
14	Ads/Campaign Go live	January 2024, 1st Week	January 2024, 2nd Week
24	Continuous advertising and sales work	January 2024, 1st Week	December 2024, last week

Table 4, Marketing & Sales team activity (2023), Author's work.

4.6 Costs

To drive business growth and ensure operational effectiveness, the allocation of resources is necessary across various areas within the company that we have described so far.

4.6.1 Table For Costs and Elaboration

This includes investments in the Marketing & Sales Team, Finance Team, and IT/ICF Audit Controls. These teams and activities play a crucial role in driving sales and marketing efforts, financial planning, and analysis, and ensuring IT control and compliance. By allocating resources to these teams and activities, we can strengthen the company's marketing and sales efforts, enhance financial planning and analysis capabilities, and maintain effective IT and internal control systems. These investments contribute to the overall success of the business by driving revenue growth and providing valuable financial insights. Taking this into consideration we will not only build the costs table for the business model described based on the reference to Gantt Chart and Lean Canvas, but we will also calculate the return on investment for the first year in order to understand the expected growth within the company.

The costs related to the Marketing & Sales Team includes salaries, benefits, recruitment, training, office space, advertising, marketing campaigns, events, and other accrual

expenses. These allocations are very important for developing effective marketing strategies, customer engagement, and achieving sales targets.

Similarly, the Finance Team contains costs related to salaries, recruitment, training, office space, and other expenses. This investment ensures accurate financial analysis, forecasting, and budgeting, thereby supporting informed decision-making and financial stability.

The IT/ICF Audit Controls involve costs related to salaries, compliance, audit tools, office space, and equipment. These allocations are essential for maintaining high level architecture of internal controls frameworks, ensuring IT compliance, protecting the integrity and security of the company.

Finally, to assess the feasibility and effectiveness of the investment, the total initial investment (first-year costs) needs to be considered. The previously calculated costs amount to €871,000, including various expenses such as salaries, recruitment, training, office space, equipment, marketing, and audit controls. The below table was created with assistance of generative AI and modified according to the needs for our use-case.

Marketing & Sales Team:		Amounts
Salaries and Benefits for Marketing Manager		€ 60,000.00
Salaries and Benefits for Sales Manager		€ 70,000.00
Salaries and Benefits for 2 Marketing Analysts		€ 100,000.00
Salaries and Benefits for 2 Sales Representatives		€ 100,000.00
Recruitment Costs		€ 5,000.00
Onboarding and Training Costs		€ 10,000.00
Office Space and Equipment Costs		€ 15,000.00
Advertising Costs		€ 30,000.00
Marketing Campaign Costs		€ 28,000.00
Events and Trade Shows Costs: €25,000		€ 25,000.00
Miscellaneous Marketing Expenses		€ 10,000.00
Total Marketing & Sales Team Costs		€ 453,000.00
FP&A Team:		Amounts
Salaries and Benefits for Finance Manager		€ 80,000.00
Salaries and Benefits for 1 Financial Analyst		€ 50,000.00
Recruitment Costs		€ 8,000.00
Training and Development Costs		€ 12,000.00
Office Space and Equipment Costs		€ 20,000.00
Total FP&A Team Costs		€ 170,000.00
IT/ICF Audit Controls:		Amounts
- Salary and Benefits for IT Audit Manager: €90,000 per year		€ 90,000.00
- Salary and Benefits for 2 IT Audit Analysts: €100,000 per year		€ 100,000.00
- ICF Compliance Costs (software and consulting): €30,000		€ 30,000.00
- IT Audit Tools and Resources: €10,000		€ 10,000.00
- Office Space and Equipment Costs: €18,000 per year		€ 18,000.00
Total IT/ICF Audit Controls Costs		€ 248,000.00
Total Initial Investment (First Year Costs)		€ 871,000.00

Table 5, Costs (2023), Author's work.

4.7 Job Descriptions

Based on the gannt chart and the costs, we will describe the job profiles too. Below are individual descriptions of each job profile which is very crucial for the stability and success of our new sales model. Taking into consideration that the entire model is designed based on the colloboration of various teams, the below jobs candidates play a vital role in driving the business and must be carefully chosen during the actual hiring process.

4.7.1 Sales Manager Position Summary

The Sales Manager is responsible for leading and managing a team of sales professionals to achieve sales targets and drive revenue growth. They play a critical role in developing and implementing sales strategies, identifying new business opportunities, and building strong customer relationships. The Sales Manager reports to the Director of Sales or a similar executive position.

Responsibilities:

- Develop and execute sales strategies to achieve company sales targets and revenue goals.
- Set sales targets for the sales team and provide guidance and support to help them reach their goals.
- Identify new business opportunities and potential customers, and develop strategies to capture market share.
- Manage the sales pipeline and ensure timely follow-up on leads and opportunities.
- Build and maintain strong relationships with key customers through regular communication and meetings.
- Monitor market trends, competitor activities, and customer needs to identify potential business risks and opportunities.
- Provide sales forecasting and budgeting reports to senior management.
- Train and mentor the sales team to enhance their skills and capabilities.
- Collaborate with marketing and product teams to develop effective sales and marketing materials.

- Stay updated on industry trends, new products, and technologies to provide valuable insights to the sales team.

Requirements

- Bachelor's degree in business, marketing, or a related field. MBA preferred.
- Proven track record of success in sales, preferably in a leadership role.
- Strong knowledge of sales techniques, strategies, and methodologies.
- Excellent communication and interpersonal skills.
- Ability to build and maintain relationships with customers at all levels.
- Analytical and strategic thinking abilities.
- Goal-oriented and results-driven mindset.
- Proficiency in CRM software and other sales tools.

4.7.2 MKT Manager Position Summary

The Marketing (MKT) Manager is responsible for developing and executing marketing strategies to promote a company's products or services, drive customer engagement, and generate revenue. They work closely with cross-functional teams, including sales, product, and creative teams, to ensure marketing initiatives align with business objectives. The MKT Manager reports to the Director of Marketing or a similar executive position.

Responsibilities

- Develop and implement marketing strategies and campaigns to drive brand awareness, customer acquisition, and retention.
- Conduct market research to identify customer needs, market trends, and competitor activities.
- Plan and execute multi-channel marketing campaigns, including digital marketing, social media, email marketing, and traditional advertising.

- Collaborate with product teams to define and communicate product positioning and messaging.
- Create and manage marketing budgets and analyze the effectiveness of marketing campaigns.
- Measure and analyze key performance indicators (KPIs) to assess the success of marketing initiatives.
- Develop and maintain strong relationships with key stakeholders, including customers, partners, and industry influencers.
- Stay updated on industry trends and best practices in marketing.
- Manage and mentor a team of marketing professionals.
- Collaborate with sales teams to ensure marketing initiatives support sales goals.

Requirements

- Bachelor's degree in marketing, business, or a related field. MBA preferred.
- Proven experience in marketing, preferably in a managerial role.
- Strong knowledge of marketing principles, strategies, and tactics.
- Experience in developing and executing multi-channel marketing campaigns.
- Excellent communication and interpersonal skills.
- Analytical and data-driven mindset.
- Proficiency in marketing automation tools and CRM software.
- Creativity and ability to think outside the box.

4.7.3 Sales Representatives Position Summary

Sales Representatives, also known as sales executives or account managers, are responsible for selling a company's products or services to customers. They play a crucial role in generating revenue, building customer relationships, and achieving sales targets. Sales Representatives report to the Sales Manager or a similar supervisor.

Responsibilities

- Identify and pursue new sales opportunities through prospecting, cold calling, and networking.
- Build and maintain strong relationships with existing customers to ensure customer satisfaction and repeat business.
- Present and demonstrate company products or services to potential customers.
- Understand customer needs and provide appropriate product solutions and recommendations.
- Negotiate and close sales deals, including pricing and contract terms.
- Collaborate with internal teams, such as sales support, marketing, and product development, to meet customer requirements.
- Prepare sales reports and forecasts for management review.
- Stay updated on industry trends, competitor activities, and product knowledge.
- Attend industry events and conferences to expand networks and generate leads.
- Provide exceptional customer service and support post-sales.

Requirements

- High school diploma or equivalent. Bachelor's degree in business or a related field preferred.
- Proven experience in sales, preferably in a B2B environment.
- Strong communication and interpersonal skills.
- Persuasive and confident in presenting and negotiating.
- Self-motivated and results-driven mindset.
- Ability to work independently and in a team.
- Proficiency in CRM software and other sales tools.
- Willingness to travel, if required.

4.7.4 IT/ICF Audit Person Position Summary

The IT/ICF Audit Person is responsible for assessing and evaluating an organization's information technology (IT) systems and internal controls framework (ICF) to ensure compliance, data integrity, and risk mitigation. They conduct audits and reviews to identify

weaknesses, recommend improvements, and provide assurance on the effectiveness of IT and ICF systems. The IT/ICF Audit Person typically reports to the Internal Audit Manager or a similar position.

Responsibilities

- Plan, execute, and manage IT and ICF audits based on established standards and guidelines.
- Assess IT systems, networks, applications, and infrastructure to identify vulnerabilities, risks, and compliance gaps.
- Review and evaluate IT and ICF controls, policies, procedures, and documentation for effectiveness and adherence to regulatory requirements.
- Perform data analysis and testing to validate the accuracy, completeness, and integrity of information processed through IT systems.
- Identify control deficiencies, weaknesses, and areas for improvement, and provide recommendations to mitigate risks.
- Prepare audit reports summarizing findings, recommendations, and action plans for management review.
- Collaborate with IT teams and stakeholders to ensure audit observations are addressed and remediated in a timely manner.
- Stay updated on industry best practices, emerging technologies, and regulatory changes related to IT and ICF.
- Assist in the development and implementation of IT and ICF policies, procedures, and controls.
- Support external auditors and regulatory compliance audits as needed.

Requirements

- Bachelor's degree in information systems, computer science, accounting, or a related field. Professional certifications such as CISA (Certified Information Systems Auditor) and CIA (Certified Internal Auditor) are preferred.
- Strong knowledge of IT and ICF audit methodologies, standards, and frameworks.
- Experience in conducting IT and ICF audits, preferably in a corporate or public accounting environment.

- Familiarity with IT general controls, application controls, and IT security.
- Analytical and critical thinking skills.
- Excellent communication and report writing skills.
- Ability to work independently and in a team.
- Proficiency in audit software and data analysis tools.

4.7.5 Financial Planning and Analysis Person Position Summary:

The FP&A Person, or Financial Planning and Analysis Person, plays a crucial role in the Finance team of an organization. They are responsible for supporting financial planning, budgeting, forecasting, and analysis activities to drive business performance and assist in decision-making processes. The FP&A Person typically reports to the FP&A Manager or a similar position.

Responsibilities

- Collaborate with cross-functional teams to develop and maintain financial models, budgets, and forecasts.
- Analyze and interpret financial data to identify trends, risks, and opportunities for performance improvement.
- Prepare and present financial reports, including monthly, quarterly, and annual financial statements and variance analysis.
- Conduct profitability analysis and provide insights on cost drivers, pricing strategies, and revenue streams.
- Assist in the development and evaluation of business cases for new initiatives, investments, and strategic projects.
- Support the annual budgeting and planning process, including revenue projections, expense allocation, and target setting.
- Monitor and track key financial performance metrics and key performance indicators (KPIs) to assess business performance.
- Conduct financial analysis to evaluate the financial impact of potential business decisions and provide recommendations.

- Collaborate with accounting and finance teams to ensure accurate and timely financial reporting and adherence to accounting principles.
- Stay updated on industry trends, economic factors, and regulatory changes that may impact financial planning and analysis activities.

Requirements

- Bachelor's degree in finance, accounting, or a related field. A master's degree or professional certifications (e.g., CFA, CPA) may be preferred.
- Proven experience in financial planning and analysis, financial modeling, or related roles.
- Strong understanding of financial principles, accounting practices, and financial statement analysis.
- Proficiency in financial modeling techniques, data analysis, and financial forecasting tools.
- Advanced Excel skills and experience with financial software and ERP systems.
- Analytical and critical thinking abilities with attention to detail.
- Excellent communication and presentation skills, with the ability to effectively communicate complex financial information to non-financial stakeholders.
- Ability to work independently and collaborate in a team-oriented environment.
- Strong organizational and time-management skills to meet deadlines in a fast-paced environment.
- Business acumen and the ability to understand the broader business context and implications of financial analysis.

4.8 Source of Revenues

The below table provides a breakdown of the different sources of income for Applifting, along with the corresponding amounts. These sources of income play a vital role in generating revenue for the company. The first source of income is Social Media Ads, which is expected to generate €50,000. This refers to the income generated through

advertisements placed on various social media platforms, such as Facebook, Instagram, Twitter, and LinkedIn. These ads help in reaching a wider audience and promoting the company's products or services.

The second source of income listed in the table is TV Ads. However, no specific amount is provided for this source, indicating that the company may not be investing in TV ads as a source of income. The third source, Radio and Podcast Informative Ads, also has no specified amount. This suggests that there is no specific income assigned for this type of advertising. The fourth source is Sponsorships to events. This refers to the income obtained through sponsoring various events, such as conferences, workshops, or industry exhibitions. By sponsoring such events, Applifting can gain exposure and attract potential customers. The fifth source of income is from Live Representation of Applifting in Community Events. This refers to the income generated when Applifting participates in community events, such as trade shows or local gatherings. By actively engaging with the community, the company can build brand awareness and attract new customers.

The table also includes Revenue from existing customers, which is expected to be €200,000. This represents the income generated from the company's existing customers who continue to avail their services or products. It indicates the loyalty and satisfaction of these customers, contributing to a steady stream of revenue.

Revenue from brand new projects from customers is listed as €400,000. This signifies the income generated from new projects or contracts initiated by customers who have not previously engaged with Applifting. It demonstrates the company's ability to attract new clients and expand its market reach. The table also includes Revenue from customers involved in live events, expected to be €100,000. This represents the income generated from customers who have interacted with Applifting during live events. It indicates the effectiveness of engaging with customers in person and converting leads into actual sales.

Another source of income listed in the table is Investments of existing cash reserves, which is expected to generate €270,000. This pertains to the income generated from investing the company's existing cash reserves in various ventures or investment opportunities. By making smart investment decisions, the company can generate additional income.

Finally, the table provides the Total Expected Revenues, which is calculated to be €1,020,000. This column represents the sum total of all the expected revenues from the different sources mentioned above. It provides an overview of the projected income for a given period.

Source of Income	Amount
Social Media Ads	
TV Ads	
Radio and Podcast Informative Ads	€ 50,000
Sponsorships to events	
Live Representation of Applifting in Community Events	
Revenue from existing customers	€ 200,000
Revenue from brand new projects from customers	€ 400,000
Revenue from customers involved from live events	€ 100,000
Investments of existing cash reserves	€ 270,000
Total Expected Revenues	€ 1,020,000

Table 6, Revenue streams (2023), Author's work.

4.9 Forecasting

In this section, we will shift our focus to the numerical analysis and forecasting of sales, as well as the structure of processes for the future. By examining the numbers, we can gain valuable insights into the potential outcomes and trends that may shape the business moving forward.

4.9.1 Forecast Based on Costs Analysis

Based on the cost analysis, it is evident that the new sales model may implement more structured allocation of costs. Each team and department have their own designated budget, which provides a clear vision of the financial resources required for the entire year. This allocation allows for better planning and ensures that each team has the necessary funds to execute their tasks and responsibilities effectively. Furthermore, the implementation of increased financial controls within the new sales model serves to minimize any potential extra costs that may arise during projects. By closely monitoring and regulating expenses, organizations can identify and address any deviations from the allocated budget promptly. This proactive approach helps in preventing unnecessary financial burdens and ensures that projects are executed within the defined cost parameters.

The benefits of this cost analysis and forecasting approach will include:

- Financial planning: The structured cost allocation provides a clear roadmap for financial resources throughout the year, allowing for better planning and resource allocation.
- Improved cost management: The implementation of increased financial controls minimizes unexpected costs, ensuring projects stay within the defined budget.
- Proactive financial monitoring: By closely monitoring expenses, any deviations from the allocated budget can be identified and addressed promptly, preventing unnecessary financial burdens.

4.9.2 Forecasting Based on ROI

Based on the return on investment (ROI) analysis, it is evident that the implementation of the new business model will yield a profit of 17.1% within the first year. This indicates that the changes made to the sales model have a positive financial impact on the company.

However, it is important to consider that the subsequent years will provide even more structure and a better understanding of the company's financial landscape.

As the company becomes more organized and gains a deeper understanding of its financial structure, it can make more informed investment decisions. This increased level of organization allows for improved budget allocation, appropriate resource allocation, and better cost management. Having a clearer picture of the financial aspects, the company will identify and prioritize investment opportunities that offer higher potential returns. The key point to note is that as the company continues to enhance its organizational structure and financial understanding, the expected return on investment is likely to increase consistently in the upcoming years. With a more structured and informed approach to investment, the company can leverage opportunities that align with its strategic goals and maximize ROI. It is important for the company to maintain a focus on continually improving its financial management practices, refining its investment strategies, and staying updated with market trends. By doing so, the company can ensure sustained growth and profitability in the long run.

Updated Expected Benefits:	Amounts
Increased Sales and Revenue	€ 950,000.00
Cost Savings due to Improved Financial Controls	€ 70,000.00
Total Expected Benefits: €1,020,000	€ 1,020,000.00
Total Initial Investment (First Year Costs)	€ 871,000.00
Recalculated ROI:	Calculation
ROI = (Total Expected Benefits - Total Initial Investment) / Total Initial Investment	
ROI	0.171067738

Table 7, Forecast with ROI (2023), Author's work.

If we want to summarise the benefits of this ROI analysis and forecasting approach would include:

- Increased profitability: The projected ROI of 17.1% in the first year demonstrates the positive financial impact resulting from the new sales model.
- Better investment decision-making: With a clearer understanding of the financial landscape, the company can prioritize investment opportunities that offer higher potential returns.
- Improved financial management: By refining investment strategies, staying updated with market trends, and continually improving financial practices, the company ensures sustained growth and profitability in the long run.

5 Conclusion

In conclusion, the methods discussed and applied to Applifting have the potential to have a significant positive impact on the company's culture and financial strength. These methods can help the company achieve its expansion goals in the global market while maintaining a happy and compliant workforce.

The emphasis on constant trackability, financial investments, and the application of scientific methods can propel the company towards becoming a multinational organization that serves as an inspiration to others. By implementing the discussed scientific methods across various projects within the company, Applifting can generate significant return values, not only from a financial perspective but also in terms of building stable relationships with customers.

Allowing each onboarded team to contribute innovative ideas and encouraging them to voice their opinions will enable the organization to stay competitive within the industry and potentially surpass its competitors.

It is important to appreciate the business model that has been created using design thinking, applied with a lean canvas, executed with Gantt chart, and accomplished with trust in employees. This combination of approaches has not only laid a strong foundation for the company but also positioned it for future success. Applifting's commitment to embracing these methodologies and fostering a culture of innovation and trust is commendable.

By continuing to invest in these practices and nurturing a dynamic and supportive work environment, the company can navigate the challenges of the industry, achieve sustainable growth, and maintain its position as a leader in the market.

6 References

- Daniel, P. (2023). *Toyota Business Model*. *Business Model Analyst*. Retrieved from <https://businessmodelanalyst.com/toyota-business-model/>
- Osterwalder, A., Pigneur, Y., Bernarda, G., & Smith, A. (2014). *Value Proposition Design: How to Create Products and Services Customers Want*. Wiley.
- Plattner, H., Meinel, C., & Leifer, L. (Eds.). (2011) *Design Thinking: Understand – Improve – Apply*. Springer.
- Knapp, J., Zeratsky, J., & Kowitz, B. (2016). *Sprint: How to Solve Big Problems and Test New Ideas in Just Five Days*. Simon & Schuster
- Brown, T. (2008). *Design Thinking*. *Harvard Business Review*. Retrieved from <https://hbr.org/2008/06/design-thinking>
- Freund, J., & Rücker, B. (2014). *Real-Life BPMN: Using BPMN 2.0 to Analyze, Improve, and Automate Processes in Your Company*. Packt Publishing.
- Portugal, S. (2013). *Interviewing Users: How to Uncover Compelling Insights*. Rosenfeld Media.
- Maurya, A. (2012). *Running Lean: Iterate from Plan A to a Plan That Works*. O'Reilly Media, Inc.
- Maurya, A. (2020). *Lean Canvas*. Retrieved from <https://leanstack.com/lean-canvas/>
- Lock, D. (2019). *Project Management: Ninth Edition*. Gower Publishing, Ltd.
- Mind Tools. (2023.). *Gantt Charts: Planning and Scheduling Team Projects*. Retrieved from https://www.mindtools.com/pages/article/newPPM_03.htm

CFI. (2023.). *What is Return on Investment (ROI)?* Retrieved from <https://corporatefinanceinstitute.com/resources/knowledge/finance/return-on-investment-roi-formula/>

Cokins, G. (2009). *Performance Management: Integrating Strategy Execution, Methodologies, Risk, and Analytics*. John Wiley & Sons.

Freund, J., & Rücker, B. (2014). *Real-Life BPMN: Using BPMN 2.0 to Analyze, Improve, and Automate Processes in Your Company*. Packt Publishing.

Kotler, P., Keller, K. L., & Sivaramakrishnan, S. (2017). *Marketing management*. Pearson.

TechTarget. (2023.). *IT Controls*. Retrieved from <https://searchcio.techtarget.com/definition/IT-controls>

Applifting. (2023). *About Us*. Retrieved from <https://applifting.io/about-us>

PORTIGAL, S. *Interviewing Users: How to Uncover Compelling Insights*. 2013.

Blank, S. (2013). *Why the Lean Startup Changes Everything*. *Harvard Business Review*, 91(5).

Maurya, A. (2012). *Running Lean: Iterate from Plan A to a Plan That Works*. O'Reilly Media.

Kelly, L. (2023). *The Ultimate Guide to Content Marketing Strategy*. <https://www.semrush.com/blog/content-marketing-strategy-guide/>

Finney, J (2022). *What Are Internal Controls* <https://linfordco.com/blog/types-of-controls/>

Design Thinking: An Introduction (2022)

<https://www.system-concepts.com/insights/design-thinking-introduction/>

McKendrick, E (2023). What is BPMN 2.0 Standard

<https://www.processmaker.com/blog/what-is-the-bpmn-2-0-standard/#>

Rost, M (2023). Evolution of Financial Planning And Analysis

<https://www.workiva.com/blog/evolution-financial-planning-and-analysis-fpa>

7 Pictures, Tables, Graphs, Charts and Abbreviations

7.1 List of pictures

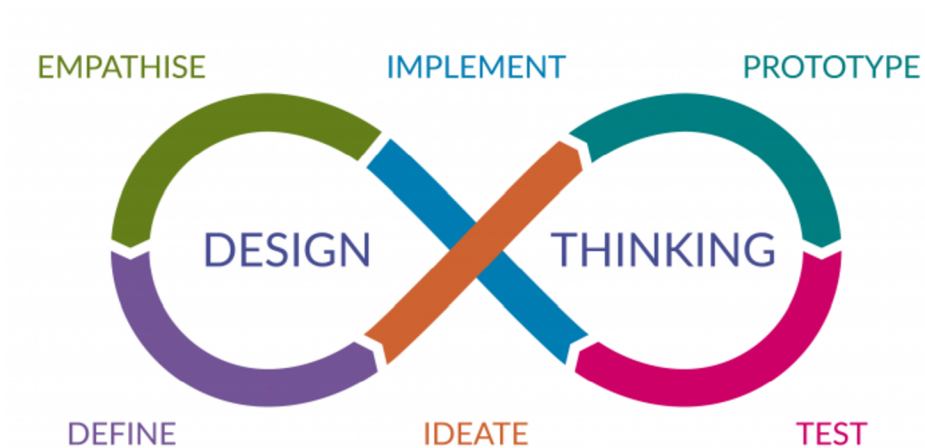

Core Set of BPMN Elements

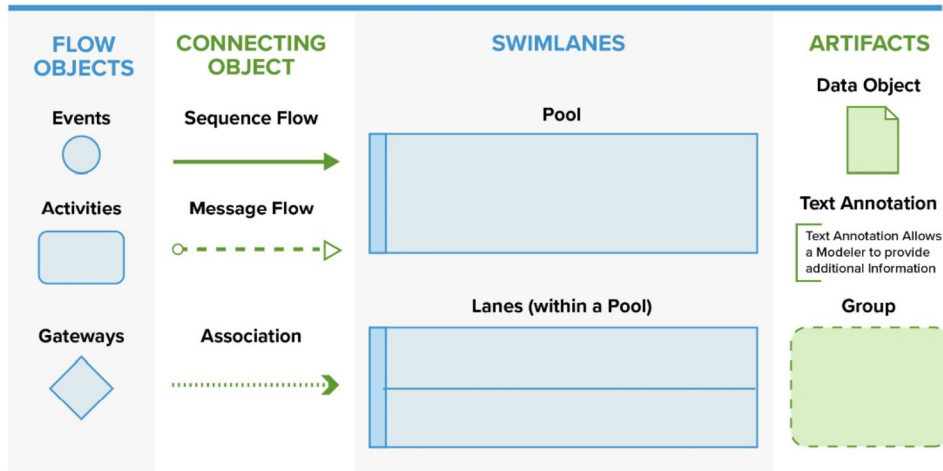

4 TYPES OF INTERNAL CONTROLS

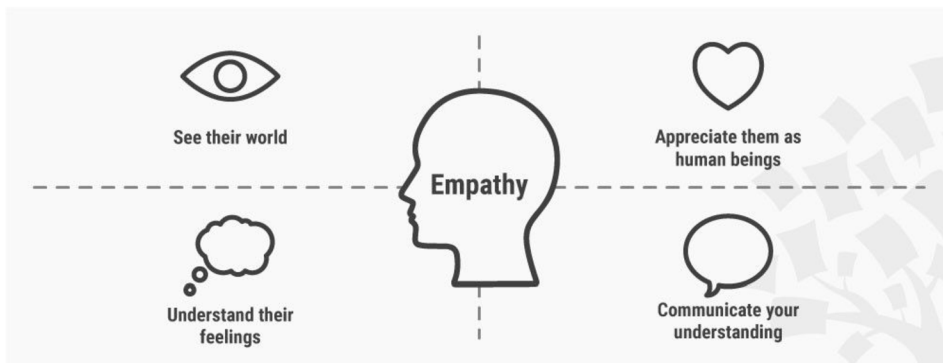
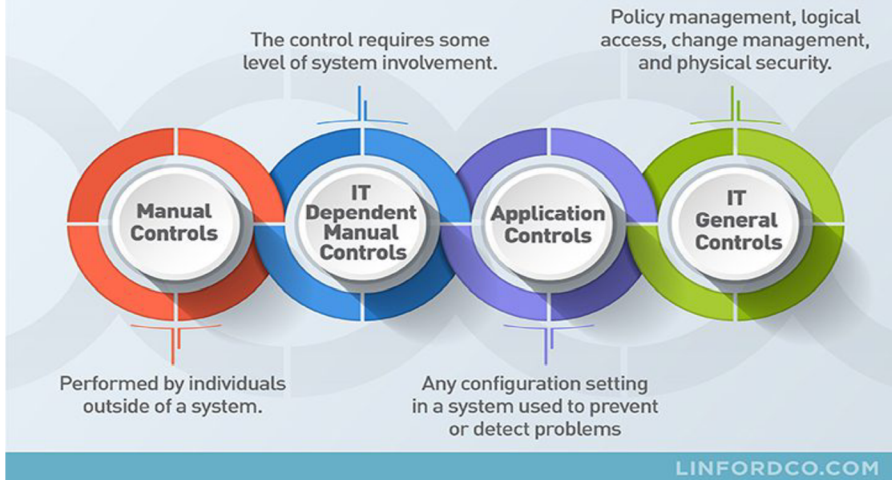

DEFINE

How to consolidate insights and outline user problems:



IDEATE

How to brainstorm creative, human-centred ideas:



PROTOTYPE

How to build representations of potential solutions:



TEST

How to gather feedback from real or target users:

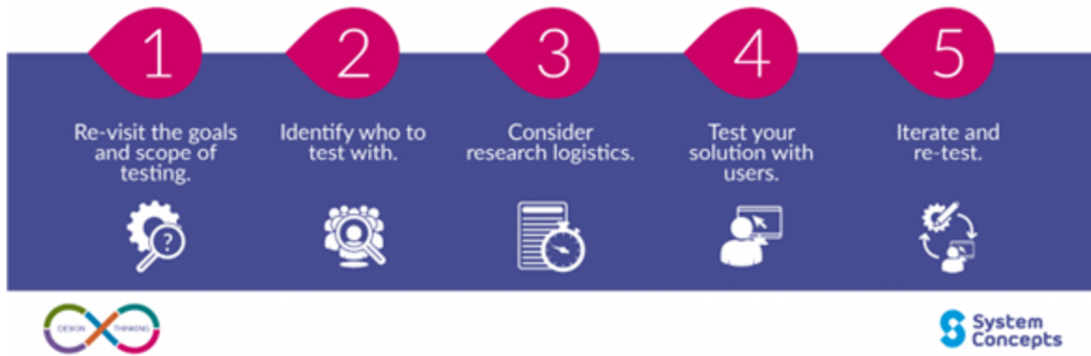

IMPLEMENT

How to develop and launch an optimised user experience:

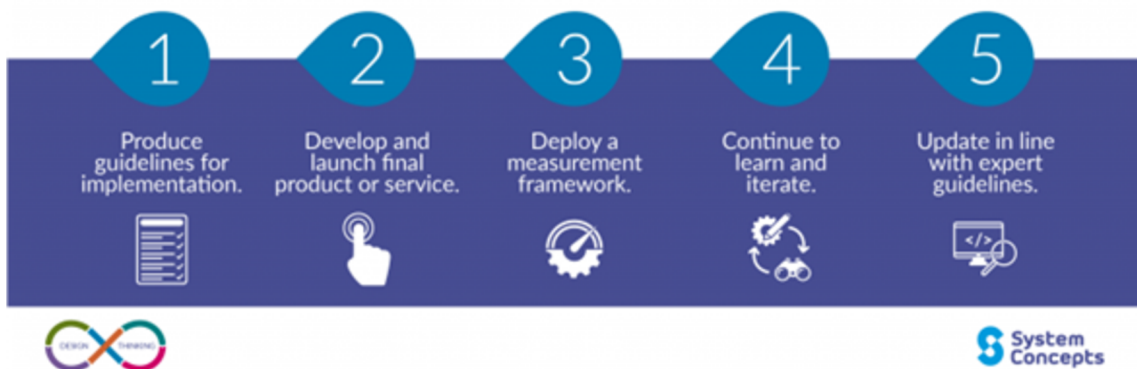



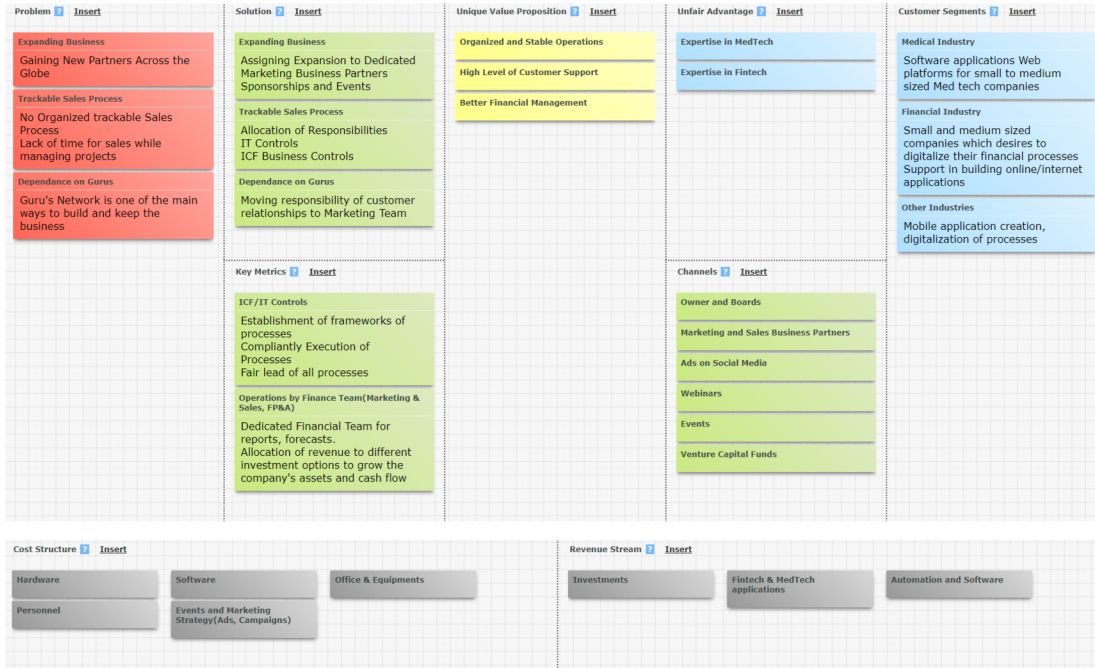











Bank iD

7.2 List of tables

Problem 	Solution 	Unique Value Proposition 	Unfair Advantage 	Customer Segments 
	Key Metrics 		Channels 	
Cost Structure 		Revenue Streams 		

ID	Name	Start Date	End Date
7	Business & IT Audit Team	November 2023, 1st Week	December 2024, last week
8	Hiring Team Lead and the Team	November 2023, 1st Week	December 2023, 1st week
9	Establishment of Controls	December 2023, 1st Week	December 2023, 2nd week
16	Audit Team Go Live	December 2023, 1st Week	December 2023, 1st Week
17	CSA Quarter Testing	April 2024, 1st Week	April 2024, Last Week
18	CSA Testing Quarter 2	August 2024, 1st Week	August 2024, Last Week
19	Year End Audit	November 2024, Last Week	December 2024, Last Week

ID	Name	Start Date	End Date
4	Finance (FP&A) Team	November 2023, 1st Week	December 2024, last week
5	Hiring Team Lead and the Team	November 2023, 1st Week	December 2023, 1st week
6	Defining Scope and Assigning responsible SOX Controls	December 2023, 1st Week	December 2023, 2nd week
15	FP&A Go Live	December 2023, 1st Week	December 2023, 1st week
22	Financial Reporting of Last Year	January 2024, 1st Week	February 2024, 1st week
23	Continuous Investment Strategy Exploration	February 2024, 2nd Week	December 2024, 3rd Week
20	Forecasting Season 1	May 2024, 2nd Week	June 2024, Last week
21	Forecasting Season 2	October 2024, 2nd Week	November 2024, Last week

ID	Name	Start Date	End Date
1	Marketing & Sales Team	November 2023, 2nd Week	December 2024, last week
2	Hiring of Team Lead and the Team	November 2023, 2nd Week	December 2023, last week
3	Defining Scope and Assigning responsible SOX Controls	December 2023, 2nd Week	December 2023, last week
10	Defining Marketing Strategy	December 2023, 1st Week	December 2024, last week
11	Planning	December 2023, 1st Week	December 2023, 3rd Week
12	Budget Calculation	December 2023, 2nd Week	December 2023, 3rd Week
13	Presentation to Owner/Board	December 2023, 3rd Week	December 2023, 3rd Week
14	Ads/Campaign Go live	January 2024, 1st Week	January 2024, 2nd Week
24	Continuous advertising and sales work	January 2024, 1st Week	December 2024, last week

Marketing & Sales Team:		Amounts
Salaries and Benefits for Marketing Manager		€ 60,000.00
Salaries and Benefits for Sales Manager		€ 70,000.00
Salaries and Benefits for 2 Marketing Analysts		€ 100,000.00
Salaries and Benefits for 2 Sales Representatives		€ 100,000.00
Recruitment Costs		€ 5,000.00
Onboarding and Training Costs		€ 10,000.00
Office Space and Equipment Costs		€ 15,000.00
Advertising Costs		€ 30,000.00
Marketing Campaign Costs		€ 28,000.00
Events and Trade Shows Costs: €25,000		€ 25,000.00
Miscellaneous Marketing Expenses		€ 10,000.00
Total Marketing & Sales Team Costs		€ 453,000.00
FP&A Team:		Amounts
Salaries and Benefits for Finance Manager		€ 80,000.00
Salaries and Benefits for 1 Financial Analyst		€ 50,000.00
Recruitment Costs		€ 8,000.00
Training and Development Costs		€ 12,000.00
Office Space and Equipment Costs		€ 20,000.00
Total FP&A Team Costs		€ 170,000.00
IT/ICF Audit Controls:		Amounts
- Salary and Benefits for IT Audit Manager: €90,000 per year		€ 90,000.00
- Salary and Benefits for 2 IT Audit Analysts: €100,000 per year		€ 100,000.00
- ICF Compliance Costs (software and consulting): €30,000		€ 30,000.00
- IT Audit Tools and Resources: €10,000		€ 10,000.00
- Office Space and Equipment Costs: €18,000 per year		€ 18,000.00
Total IT/ICF Audit Controls Costs		€ 248,000.00
Total Initial Investment (First Year Costs)		€ 871,000.00

Source of Income	Amount
Social Media Ads	
TV Ads	
Radio and Podcast Informative Ads	€ 50,000
Sponsorships to events	
Live Representation of Applifting in Community Events	
Revenue from existing customers	€ 200,000
Revenue from brand new projects from customers	€ 400,000
Revenue from customers involved from live events	€ 100,000
Investments of existing cash reserves	€ 270,000
Total Expected Revenues	€ 1,020,000

Updated Expected Benefits:	Amounts
Increased Sales and Revenue	€ 950,000.00
Cost Savings due to Improved Financial Controls	€ 70,000.00
Total Expected Benefits: €1,020,000	€ 1,020,000.00
Total Initial Investment (First Year Costs)	€ 871,000.00
Recalculated ROI:	Calculation
ROI = (Total Expected Benefits - Total Initial Investment) / Total Initial Investment	
ROI	0.171067738

7.3 List of Graphs and Charts

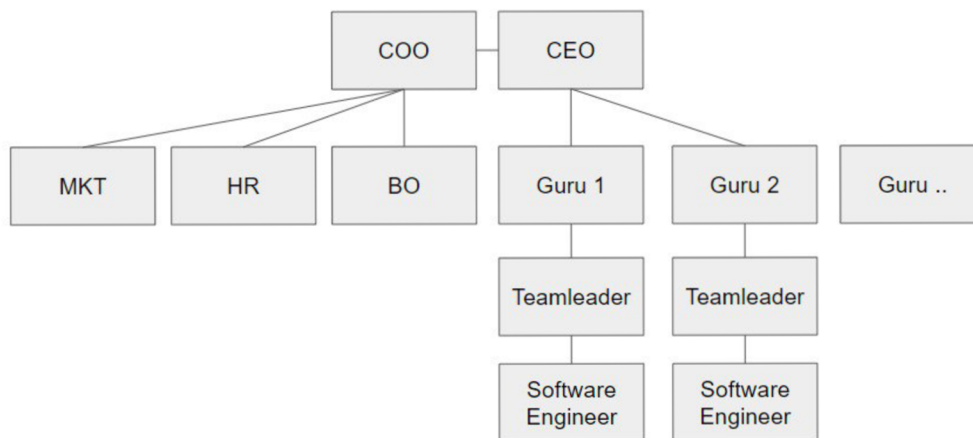

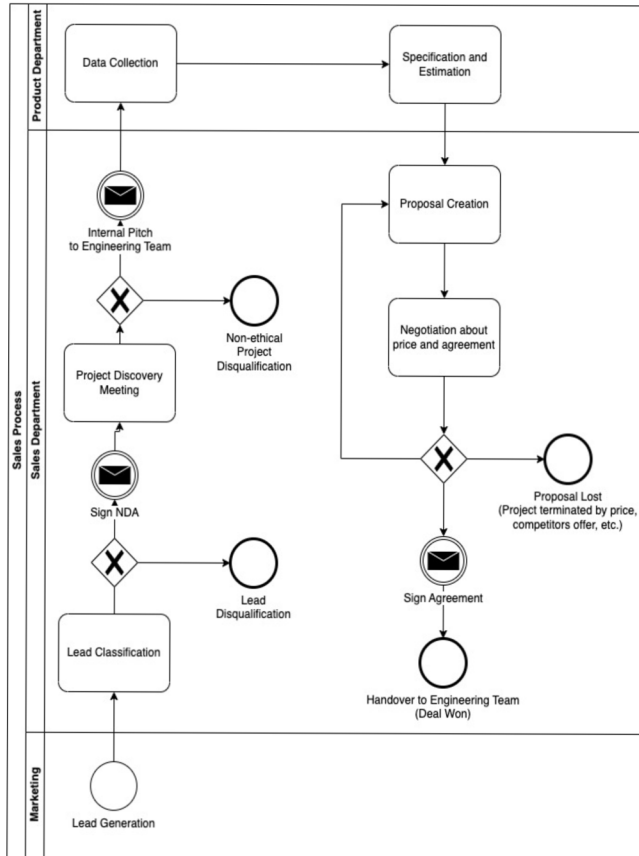

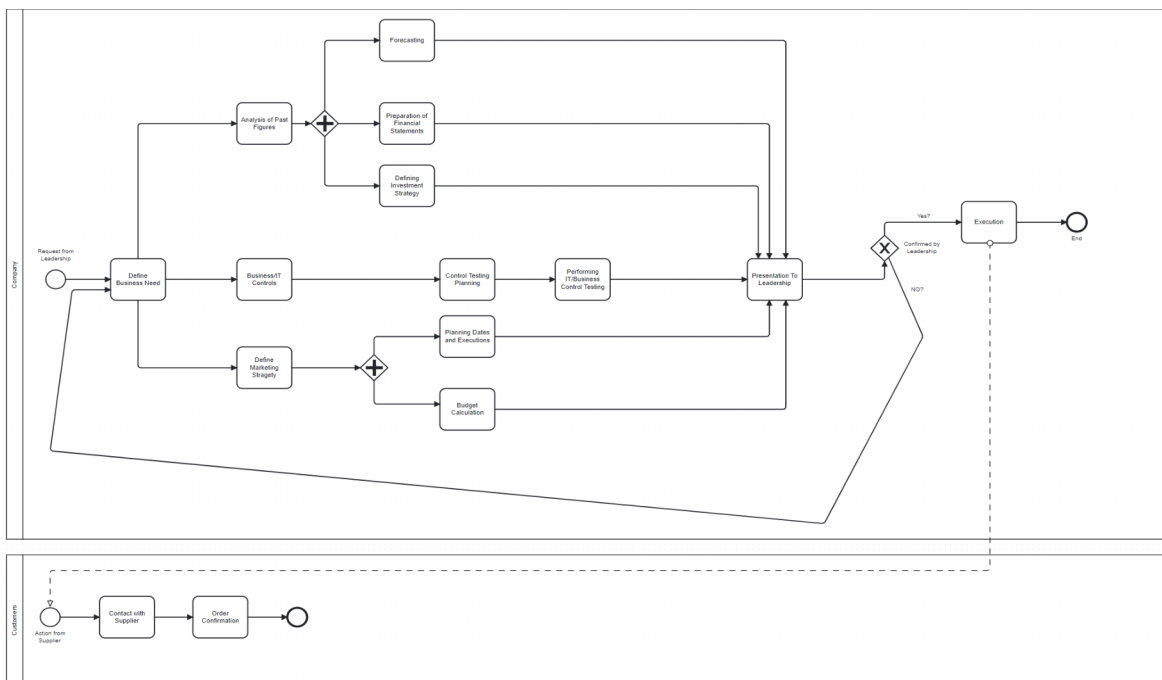
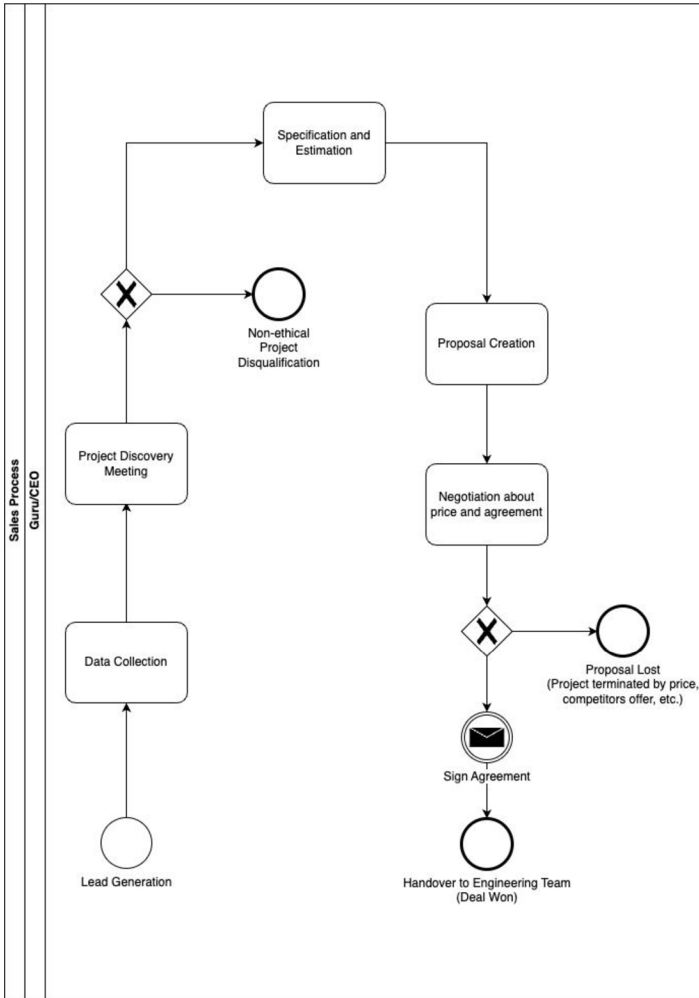

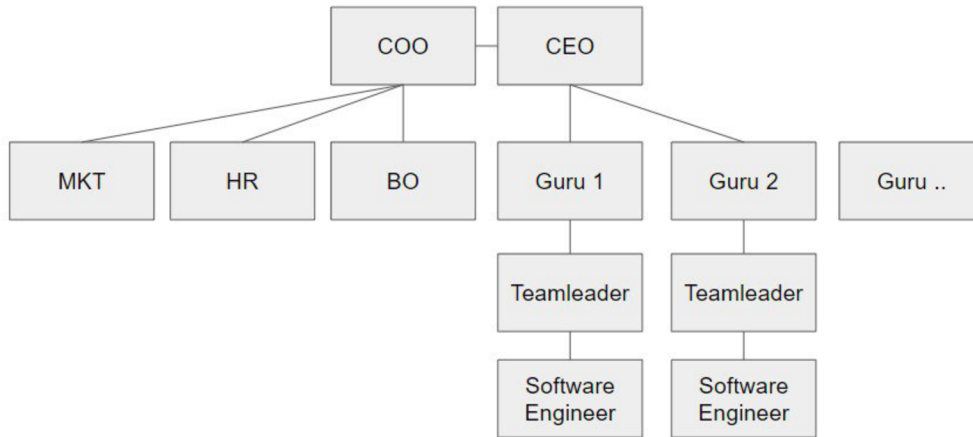

ID	Name	2023		2024				2025
		Q3	Q4	Q1	Q2	Q3	Q4	Q1
1	Marketing & Sales Team							
2	Hiring of Team Lead and the Team							
3	Defining Scope and Assigning responsible S...							
10	Defining Marketing Strategy							
11	Planning							
12	Budget Calculation							
13	Presentation to Owner/Board							
14	Ads/Campaign Go live							
24	Continuous advertising and sales work							
4	Finance (FP&A) Team							
5	Hiring Team Lead and the Team							
6	Defining Scope and Assigning responsible S...							
15	FP&A Go Live							
22	Financial Reporting of Last Year							
23	Continuous Investment Strategy Exploration							
20	Forecasting Season 1							
21	Forecasting Season 2							
7	Business & IT Audit Team							
8	Hiring Team Lead and the Team							
9	Establishment of Controls							
16	Audit Team Go Live							
17	CSA Quarter Testing							
18	CSA Testing Quarter 2							
19	Year End Audit							

7.4 List of abbreviations

ICF – Internal Control Framework

FP&A – Financial Planning and Analysis

BPMN – Business Process Modelling Notations

IT – Information Technology

Appendix

