

FACULTY OF ENVIRONMENT

Department of Ecology

Field of study: Environmental engineering

CZECH UNIVERSITY OF LIFE SCIENCES PRAGUE



**Evaluation of the long-term performance of
constructed wetlands Spálené Poříčí and Velká
Jesenice**

Bachelor thesis

Thesis supervisor: Ing. Tereza Hnátková, Ph.D.

Author: Michaela Porážíková

Prague, 2022

CZECH UNIVERSITY OF LIFE SCIENCES PRAGUE

Faculty of Environmental Sciences

BACHELOR THESIS ASSIGNMENT

Michaela Porazíková

Environmental Engineering

Thesis title

Evaluation of the long-term performance of constructed wetlands Spálené Poříčí and Velká Jesenice

Objectives of thesis

1. Describe the principle of wastewater treatment in constructed wetlands.
2. Describe constructed wetlands Spálené Poříčí and Velká Jesenice.
3. Evaluate the cleaning efficiency of the monitored constructed wetlands.
4. Evaluate the performance of monitored constructed wetlands.

Methodology

In the first part of the work is made a brief overview of wastewater, types of constructed wetlands, their parts and substances treated at constructed wetland based on literature sources.

The next part describes the constructed wetlands Spálené Poříčí and Velká Jesenice over the years based on project documentation.

In the third part, the efficiency of the constructed wetlands in different phases of operation is evaluated and the efficiency is compared with the efficiency before intensification. Available materials from the relevant authorities are used for the evaluation.

The proposed extent of the thesis

40 stran

Keywords

constructed wetland, reconstruction, maintenance, treatment efficiency, nutrients

Recommended information sources

- ABIDI, S., KALLALI, H., JEDIDI, N., BOUZAÏANE, O., HASSEN, A., 2009: Comparative pilot study of the performances of two constructed wetland wastewater treatment hybrid systems. *Desalination* 246, 370–377
- BAHLO K. E., WACH F. G., 1990: Purification of Domestic Sewage With and without faeces by Vertical Intermittent Filtration in Reed and Rush Beds. *Constructed Wetlands in Water Pollution Control (Adv. Wat. Pollut. Control no. 11)* Pergamon Press, Oxford, pp. 215- 221
- BRIX H., 2003: Plants used in constructed wetlands and their functions. Department of Plant Ecology, Institute of Biological Sciences, University of Aarhus, Denmark, 30 s.
- HABERL R., 2003: Constructed Wetlands for the Treatment of Organic Pollutants. *JSS – J Soils & Sediments* 3 (2) 109 – 124.
- HUDCOVÁ T., VYMAZAL J., DUNAJSKÝ M. K. 2013: Reconstruction of a constructed wetland with horizontal subsurface flow after 18 years of operation., *Water Science & Technology* 68(5):1195-202. 8 s
- MELIÁN J. A. H., RODRÍGUEZ A. J. M., ARAÑA J., DÍAZ O. G., MAY, E. et al., 1990: Chemical and microbiological processes in gravel-bed hydroponic (GBH) systems for sewage treatment. In *Sborník konf. Constructed Wetlands in Water Pollution Control*, Cooper,
- ŠÁLEK J., TLAPÁK V., 2006: Přírodní způsoby čištění znečištěných povrchových a odpadních vod, ČKAIT, Praha. 283 s. ISBN 80-86769-74-7
- ŠEREŠ, Michal, Petra INNEMANOVÁ, Tereza HNÁTKOVÁ, Miloš ROZKOŠNÝ, Alexandros STEFANAKIS, Jaroslav SEMERÁD a Tomáš CAJTHAML. Evaluation of Hybrid Constructed Wetland Performance and Reuse of Treated Wastewater in Agricultural Irrigation. *Water* [online]. 2021, 13(9) [cit. 2022-02-18]. ISSN 2073-4441. Dostupné z: doi:10.3390/w13091165
-

Expected date of thesis defence

2021/22 SS – FES

The Bachelor Thesis Supervisor

Ing. Tereza Hnátková, Ph.D.

Supervising department

Department of Applied Ecology

Electronic approval: 21. 2. 2022

prof. Ing. Jan Vymazal, CSc.

Head of department

Electronic approval: 22. 2. 2022

prof. RNDr. Vladimír Bejček, CSc.

Dean

Prague on 30. 03. 2022

DECLARATION

I declare that I am a bachelor on the topic: Evaluation of the long-term performance of constructed wetlands Spálené Poříčí and Velká Jesenice, prepared independently and I quoted all information resources that I used in the work and which I also listed at the end of the work in the list of used information sources.

I am aware that Act No. 121/2000 fully applies to my bachelor's thesis Coll., On copyright, on rights related to copyright and on the amendment of certain laws, as amended, in particular the provisions of Section 35, Paragraph 3 of this Act, i.e., on the use of this Act works.

I am aware that by submitting my bachelor's thesis, I agree with its publication pursuant to Act No. 111/1998 Coll., on Higher Education Institutions and on Amendments to Other Acts, as amended later regulations, regardless of the outcome of its defence. By signing, I also declare that the electronic version of the work is identical to the printed version and that the data presented in the work was handled in connection with the GDPR.

.....

Michaela Porážíková

In Prague 29.3.2022

ACKNOWLEDGMENT

I would like to thank all those who helped me in the elaboration of the bachelor's thesis, in particular I would like to thank my supervisor: Ing. Tereza Hnátková, Ph.D., for valuable advice, comments and methodical guidance of the bachelor's thesis. I would also like to thank Mr. Ing. Petr Pelikán, Ing. Jaroslav Slavík and Ing. Petr Jeništa for expert consultations and provided data.”

ABSTRACT

Constructed wetlands for wastewater treatment are extensive treatment systems based on the processes which occur in natural wetlands. Due to high treatment efficiency and low operation and maintenance costs constructed wetlands have become an attractive treatment technology.

The aim of the bachelor thesis is to evaluate the long-term efficiency of wastewater treatment of constructed wetlands Spálené Poříčí and Velká Jesenice in regard to its expansion through years and intensification. Wastewater samples taken by authorized person during operation were evaluated on the basis of parameters for assessing wastewater quality.

The work is focused on the average annual inflow and outflow evaluation of biochemical oxygen demand (BOD₅), chemical oxygen demand (COD_{Cr}), total suspended solids (TSS), phosphorus (P) and ammonia (N-NH₄⁺) during the period 1992-2021 for constructed wetland Spálené poříčí and 2000-2021 for constructed wetland Velká Jesenice.

Measured data were processed in Microsoft Office Excel 2016. The results were compared with the valid legislation of the Czech Republic and Water Authority limits given for constructed wetlands in Spálené Poříčí and Velká Jesenice. Both constructed wetlands performance met required limits through whole operation. Outflow concentrations showed minimal effectiveness in removing ammonia nitrogen until intensification.

KEYWORD: constructed wetland, treatment efficiency, reconstruction, maintenance, nutrients

ABSTRAKT

Kořenové čistírny odpadních vod jsou rozsáhlé systémy založené na procesech, které se vyskytují v přírodních mokřadech. Díky vysoké účinnosti čištění a nízkým nákladům na provoz a údržbu se vybudované mokřady staly atraktivní technologií.

Cílem bakalářské práce je zhodnotit dlouhodobou účinnost čištění odpadních vod vybudovaných mokřadů Spálené Poříčí a Velké Jesenice s ohledem na její rozšiřování v průběhu let a intenzifikaci. Vzorky odpadních vod odebrané oprávněnou osobou během provozu byly vyhodnoceny na základě parametrů pro posuzování jakosti odpadních vod.

Práce je zaměřena na vyhodnocení ročních koncentrací na přítoku a odtoku biochemické spotřeby kyslíku (BSK_5), chemické spotřeby kyslíku ($CHSK_{Cr}$), celkových nerozpuštěných látek (NL), fosforu (P) a amoniaku ($N-NH_4^+$) v období 1992-2021 pro kořenovou čistírnu odpadních vod Spálené poříčí a 2000-2021 pro kořenovou čistírnu odpadních vod Velká Jesenice.

Naměřená data byla zpracována v aplikaci Microsoft Office Excel 2016. Výsledky byly porovnány s platnou legislativou ČR a limity Vodoprávních úřadů stanovenými pro kořenovou čistírnu odpadních vod ve Spáleném Poříčí a Velké Jesenici. Obě kořenové čistírny odpadních vod splňovaly požadované limity po celou dobu provozu. Koncentrace odtoku vykazovaly minimální účinnost při odstraňování amonného dusíku až do intenzifikace.

KLÍČOVÁ SLOVA: kořenová čistírna odpadních vod, účinnost úpravy, rekonstrukce, údržba, živiny

CONTENTS

| | |
|---|----|
| INTRODUCTION | 1 |
| AIMS OF THE WORK | 2 |
| 3. Wastewater..... | 3 |
| 3.1 Rainwater | 4 |
| 3.2 Municipal wastewater | 4 |
| 3.3 Industrial wastewater | 4 |
| 3.4 Wastewater containing particularly dangerous substances | 5 |
| 3.5 Amount of wastewater | 6 |
| 3.5.1 Flow calculation..... | 6 |
| 4. Wetlands | 8 |
| 5. CHARACTERISTICS OF CONSTRUCTED WETLAND | 10 |
| 5.1 Types of constructed wetland | 11 |
| 5.1.1 Constructed wetland with floating plants..... | 11 |
| 5.1.2 Constructed wetland with submerged plants..... | 12 |
| 5.1.3 Constructed wetland with emergent plants | 13 |
| 5.1.4. Constructed wetland with subsurface flow | 13 |
| 5.1.5. Constructed wetland with surface flow | 13 |
| 5.1.6. Horizontal flow constructed wetland | 13 |
| 5.1.7. Vertical flow | 14 |
| 6. Division of parts of CW..... | 15 |
| 6.1 Pre-cleaning | 15 |
| 6.1.1 Sedimentation tanks | 16 |
| 6.2 Filter bed..... | 17 |
| 6.2.1 Filter bed area | 18 |
| 7. Vegetation..... | 18 |
| 8. Substances eliminated in constructed wetland..... | 20 |
| 8.1 Removal of organic substances..... | 20 |
| 8.2 Removal of total suspended solids (TSS) | 21 |
| 8.3 Phosphor (P) removal | 21 |
| 8.4 Nitrogen removal | 23 |
| 8.5 Removal of microbial contamination..... | 24 |
| 8.6 Heavy metals..... | 25 |
| 9. Investment and operating costs..... | 26 |

| | |
|--|----|
| 10. Evaluation of selected constructed wetlands | 27 |
| 10.1 Methodology | 27 |
| 10.2 Spálené Poříčí | 28 |
| 10.2.1 General characteristics | 28 |
| 10.2.2 Constructed wetland Spálené Poříčí..... | 28 |
| 10.2.3 Investment and operating costs | 33 |
| 10.3 Velká Jesenice..... | 34 |
| 10.3.1 Constructed wetland Velká Jesenice..... | 34 |
| 10.3.2 Investment and operating costs | 38 |
| 10.4 Limits for waste water discharge | 39 |
| 10.4.1 Limits according to water authorities | 40 |
| 10.5 Wastewater samples..... | 42 |
| 11. RESULTS | 43 |
| 11.1 Biochemical oxygen demand - BOD ₅ | 43 |
| 11.2 Chemical oxygen demand - COD _{Cr} | 46 |
| 11.3 Total suspended solids- TSS | 49 |
| 11.4 Ammonia - N-NH ₄ ⁺ | 52 |
| 11.5 Phosphorus - P | 55 |
| 11.6 Removal efficiency of CW Spálené Poříčí and CW Velká Jesenice with other hybrid constructed wetlands | 58 |
| 12. DISCUSSION | 60 |
| 13. CONCLUSION | 64 |
| 14. CITATIONS | 66 |
| 15. List of figures..... | 78 |
| 17. List of tables..... | 80 |
| Annex list..... | 82 |

INTRODUCTION

Conventional wastewater treatment plants are predominantly used for wastewater treatment in the Czech Republic. Effects of these treatment plants are very good, but they are accompanied by high operating costs. Many smaller municipalities and towns cannot always afford such costs. A suitable alternative for the settlement is constructed wetlands for their effects the removal of organic and undissolved substances, complying with water management requirements and lower operating costs.

Most commonly used constructed wetlands for domestic wastewater treatment are constructed wetland with horizontal sub-surface flow, which does not due to limited oxygen transfer capacity provide nitrification and vertical sub-surface flow, which on the other side provide nitrification are unable of denitrification. According to *Vymazal (2004)* constructed wetlands are very efficient at breaking down even low levels of biological pollution, their efficiency in removing nitrogen and phosphorus is low due to them not being constructed for their removal.

In early 1960s first hybrid constructed wetland was introduced in Germany by *Seidel (1965)* design consisted of two stages of several parallel vertical flow beds usually planted with *Phragmites australis* followed by 2-3 horizontal beds in series containing numerous plant species, such as *Carex*, *Iris*, *Typha* or *Sparganium* this combined system showed higher nitrogen removal.

These systems were according to *Vamazal (2007)* designed to treat domestic, or municipal wastewater with required nitrified effluents. In 1980s several hybrid systems of Seidel's type were built in France. During 1990s and early 2000s those VF- HF systems were built in many European countries. Followed by study in late 1990s introduced by *Johansen et Brix (1996)*. Since then, more studies with different configuration were presented. Such as constructed wetland in Poland designed for 750 EO with use of HF- HF-VF-HF planted with *Phragmites australis* (Obarska- Pempkowiak 1999).

The ever-increasing requirements for the quality of wastewater discharges force the development of new technologies to achieve optimal efficiency of wastewater treatment, to meet the conditions of the given locality, environmental requirements and the prospective nature of wastewater sources. The bachelor thesis deals with the evaluation of the long-term operation of two constructed wetlands in the Czech Republic, namely in Spálené Poříčí and Velká Jesenice.

AIMS OF THE WORK

1. Describe the principle of wastewater treatment in constructed wetlands.
2. Describe constructed wetlands Spálené Poříčí and Velká Jesenice.
3. Evaluate the cleaning efficiency of the monitored constructed wetlands.
4. Evaluate the performance of monitored constructed wetlands.

In the first part of the work is made a brief overview of wastewater, types of constructed wetlands, their parts and substances treated at constructed wetland based on literature sources.

The next part describes the constructed wetlands Spálené Poříčí and Velká Jesenice over the years based on project documentation.

In the third part, the efficiency of the constructed wetlands in different phases of operation is evaluated and the efficiency is compared with the efficiency before intensification. Available materials from the relevant authorities are used for the evaluation.

3. Wastewater

Water, as a necessary human need, is used not only to hydrate the body, but also for ordinary work in everyday life in larger quantities than can be consumed. This part of used water drains away, wastewater. According to *Act No. 544/2020 Coll. on Waters and on the Amendment of Certain Acts (Water Act)*, wastewaters are waters which have changed their quality after their use (any change from the original state see *Annex 1*) and are thus dangerous for the deterioration of the quality of surface water and groundwater.

According to *Act No. 544/2020 Coll.* wastewater can be from residential, agricultural, medical facilities, as well as seepage water from landfills. The individual degrees of pollution *Table 1* depend mainly on the type of settlement, industry and incoming waters (ballast and rainwater) that dilute the wastewater

The separation of wastewater according to *Act No. 544/2020 Coll.*, depends primarily on the source producing the wastewater and the composition of the external pollutants. Wastewater can thus be divided into several types, which are then treated according to applicable legislation (Sojka 2004).

| | |
|---------------------------|---|
| I- very clean water | suitable for water supply purposes, food industry, swimming pool, salmon fish farming, has great landscape value |
| II- pure water | suitable for water supply purposes, fish farming, water sports, industrial supply |
| III- polluted water | only for the supply of industry, if there is no more suitable source, then it also serves for water supply purposes |
| IV- very polluted water | usually only for limited purposes |
| V- heavily polluted water | unsuitable for any purpose |

Table 1: Water quality (Sojka 2004).

| Substances | g on 1 EO |
|------------------------|-----------|
| Total suspended solids | 55 |
| BOD ₅ | 60 |
| COD _{cr} | 120 |
| Total nitrogen | 11 |
| Total phosphorus | 2,5 |

Table 2: Average daily concentrations of pollutants in wastewater on 1EO (Junga et. al. 2015).

3.1 Rainwater

Water of various states, which does not touch any part of the Earth's surface or buildings located on it. The purity of such water according to *Act No. 554/2020 Coll.* depends on the quality of the air in the area of occurrence, where it can be affected by transport fumes or industrial flue gases.

After contact with the surface, rainwater become surface water, which is then based on place of impact led to the sewerage network. Such raw water is often used in family houses or gardens as commercial water for watering. If infiltration is not possible, it is necessary to build at least a retention object with a regulated outflow (*Vykydal 2017*).

3.2 Municipal wastewater

Or sewage water, forms the largest volume of discharged wastewater in the urban populated area. Such water includes water already used for everyday use (cesspool), washing objects (rinsing water). Unlike rainwater, this water cannot be used in its raw state. It is so polluted that it must be drained directly into the sewer so that it does not cause damage to the environment. Average values of BOD₅ are 200–300 mg l⁻¹ and for COD_{Cr} it is 300-500 mg l⁻¹ (*Graczyk 2009, IKS R CIPR ICBR © 2022*).

| Municipal wastewater parameters | |
|---------------------------------|---------------------------------|
| Strength | BOD ₅ concentrations |
| Strong | 1 000 mg l ⁻¹ |
| Medium | 500 mg l ⁻¹ |
| Weak | 250 mg l ⁻¹ |

Table 3: General wastewater classification according to BOD₅ content (*Pereira et al. 2014*).

3.3 Industrial wastewater

In the narrower sense, industrial wastewater is generated directly during production in an industrial zone. Its composition depends on the type of industry and the technologies used in it *Table 4*. When dealing with this type of wastewater, it is necessary to perform a wastewater analysis and determine contained substances.

These can be flammable substances or substances with a high content of organic material. Only after measurement and then permission from the administrator by the operating rules of the sewerage system can the industrial water be diluted by sewage, rainwater and drained into the sewerage system (VA TECH).

| Wastewater type | Average pH range | Suspended solids (mg l ⁻¹) | BOD ₅ (mg l ⁻¹) | COD (mg l ⁻¹) | TKN (mg NI ⁻¹) | Total P (mg l ⁻¹) | Salt (g l ⁻¹) |
|--------------------------|------------------|--|--|---------------------------|----------------------------|-------------------------------|---------------------------|
| Brewery | 3.3–7.6 | 500–3 000 | 1 400–2 000 | 815–12 500 | 14–171 | 16–124 | |
| Dairy milk-cheese plants | 5.2–11.3 | 350–1 082 | 709–10 000 | 189–20 000 | 14–450 | 37–78 | 0.5 |
| Dairy parlour | 2–11 | 100–300 | 166–477 | 470–820 | 25–45 | 17–21 | 0.05–0.7 |
| Dying | 8.2–12 | 56–70 | 140–840 | 70–3 200 | 27–42 | 5–7 | |
| Food pickling | 2.6–3 | 40–110 | 7 000–8 000 | 20 000–22 000 | 4–6 | 22–25 | 30–150 |
| Metal working fluids | 9 | | 1 500–11 400 | 5 300–40 000 | 160–440 | 28–77 | |
| Pulp and paper | 6.6–10 | 21–1 120 | 77–1 150 | 100–3 500 | 1–3 | 1–3 | ~0.05 |
| Tannery | 8–11 | 2 070–4 320 | 1 000–7 200 | 3 500–13 500 | 250–1 000 | 4–107 | 6–40 |
| Textile mills | 4.5–10.1 | 20–210 | 700–1 650 | 1 900–100 000 | 14–72 | 1–18 | 0.5–0.9 |
| Winery | 3.9–5.5 | 170–1 400 | 210–8 000 | 320–27 200 | 21–64 | 16–66 | 0.1–1 |
| Municipal | 6–8 | 100–350 | 110–400 | 250–1 000 | 20–85 | 4–15 | <0.5 |

Table 4: Industrial wastewater characteristics (Bielefeldt 2009).

3.4 Wastewater containing particularly dangerous substances

If particularly dangerous substances are recorded during the analysis, it must be permitted from the water authority to discharge this wastewater into the sewer. According to *Act No. 544/2020 Coll.*, On Waters and on the Amendment of Certain Acts (Water Act) § 16, this permit is obtained if the industry in question establishes a control point or if equipment with sufficient efficiency pursuant is installed.

| Pollution source size (EO) | COD _{Cr} (mg/l) | | BOD ₅ (mg/l) | | TSS (mg/l) | | N-NH ₄ ⁺ (mg/l) | | N _{inorg} (mg/l) | | P _{total} (mg/l) | |
|----------------------------|--------------------------|-----|-------------------------|----|------------|----|---------------------------------------|----|---------------------------|----|---------------------------|---|
| | p | m | p | m | p | m | p | m | p | m | p | m |
| <500 | 150 | 220 | 40 | 80 | 50 | 80 | / | / | / | / | / | / |
| 501- 2 000 | 125 | 180 | 30 | 60 | 35 | 70 | / | / | / | / | / | / |
| 2 001- 10 000 | 120 | 170 | 25 | 50 | 30 | 60 | 15 | 30 | / | / | / | / |
| 10 001- 100 000 | 90 | 130 | 20 | 40 | 25 | 50 | / | / | 15 | 2 | 2 | 6 |
| > 100 000 | 75 | 125 | 15 | 30 | 20 | 40 | / | / | 30 | 20 | 1 | 3 |

Table 5: Indicators for sewage and urban waters (Hlavínek et al. 2003).

3.5 Amount of wastewater

The amount of wastewater discharged is variable and greatly affected by the level of equipment of the municipality. From the industrial zone, infrastructure, services, households and all operating appliances used for human comfort. The specific amount is given in the amount produced 1EO per day. Volume of water discharged is proportional to the variability of the period depending on the life rhythm of the city. For the Czech Republic this value is around 100 liters per person per day (RD Rýmařov, © 2022).

To quantify this variability, the coefficients of daily k_{dn} non-uniformity and hourly k_h non-uniformity are introduced over a period of time. The most well-known are the minimum and maximum flow in a given period of time, depending on the size of the source of pollution. The value of the coefficient is of a statistical nature and should be assessed in this way (Sojka 2004).

Wastewater fluctuations are characterized by nocturnal minimum and maximum flow in the morning and evening. The design must take into account the development in the municipality associated with the production of wastewater (Sojka 2004).

| Specific wastewater production | |
|---|----------------------|
| Office, trade | 1 EO (2-3 employees) |
| Place in the garden | 1 EO (10 places) |
| Camping (2 people) | 1 EO |
| Apartment area < 50 m ² | 2 EO |
| Apartment area (50- 75 m ²) | 3 EO |
| Apartment area (75 m ²) | 4 EO |
| Accommodation facility (1 bed) | 1- 3 EO |
| Hospitality (1 x day operation) | 1 EO (3 places) |
| Hospitality (2- 3 x day operation) | 1 EO (1 place) |
| Hospitality (4- 6 x day operation) | 2 EO (1 place) |

Table 6: Specific wastewater production according to ČSN 75 6402

3.5.1 Flow calculation

Calculation of the amount of sewage flowing into the constructed wetland is performed according to the guideline values ČSN 75 6402 and ČSN 75 6401 from the use of specific wastewater production, most often given in m³/day or l / s.

| Daily unevenness factor for wastewater treatment plants | |
|---|------|
| < 1 000 EO | 1,5 |
| 1 000-5 000 EO | 1,4 |
| 5 000- 20 000 EO | 1,35 |
| > 20 000 | 1,25 |

Table 7: Coefficient of daily unevenness for wastewater treatment plants determined according to the set standard (ČSN 75 6402).

Calculation of the average daily inflow (1):

$$Q_{24, m} = EO * q_{spec} \text{ (m}^3\text{/day)} \quad (1)$$

EO – equivalent population

q – specific consumption of 1 person per day

The average daily inflow (I) is obtained by the product of the equivalent population and the specific water consumption.

Calculation of maximum rainless inflow per day Q_d v $\text{m}^3\text{/day}$ (2) is obtained by the sum of ballast water Q_{BAL} with the average daily inflow of wastewater of the population multiplied by the coefficient of daily inequality and the coefficient of multiplied wastewater from industry.

$$Q_d = Q_{24, m} * k_d + Q_{24, p} * k_{d, p} + Q_{BAL} \text{ (m}^3\text{/day)} \quad (2)$$

K_d – the coefficient of daily inequality is equal to 1.5 according to the standard in *Table 3*

$K_{d, p}$ – coefficient of daily inequality multiplied by daily inflow of industrial wastewater equal to 1 according to the standard

Q_{BAL} – ballast water ($\text{m}^3\text{/day}$)

The maximum rainless hourly inflow Q_h (3) is calculated according to the formula (ČSN 75 6401, ČSN 75 6402).

$$Q_h = (Q_{24, m} * k_d * k_h + Q_{24, m} * k_{d, p} + Q_{BAL}) / 24 \text{ (m}^3\text{/hour)} \quad (3)$$

K_h – coefficient of maximum hourly inequality

The calculation for the daily balance (4) is expressed as:

$$S = Q + R + I - O - ET \quad (4)$$

S = net change in storage

Q = surface flow, including wastewater or stormwater inflow

R = contribution from rainfall

I = net infiltration (infiltration less exfiltration)

O = surface outflow

ET = loss due to evapotranspiration

The formula can be used to calculate daily, monthly to yearly intervals. If it is expected during the season, it is essential to obtain monthly data for evaluation. For detailed data, it is necessary to collect data for comparison in the pilot test of the constructed wetland and in full operation (EPA.gov. 1993).

4. Wetlands

Wetlands are specific biotopes characterized by constant supply of water or presence of a high level of underground allowing at least seasonal growth of wetland plants (Vymazal 1995)

By definition of *Cowardin et al. (1979)* Drained hydric soils incapable to support hydrophytes due to change in water regime are not considered wetlands, but still function as indication of suitable areas for potential restoration and as record of historical wetlands. These habitats are located on the border of aquatic and terrestrial environment. Due to the fluidity of the transition, boundary of wetland is not fixed. Smith 1980 defined wetlands as a halfway world exhibiting the characteristics of both.

According to *Kouřil (2006)*, wetlands occupy about 6% of Earth's surface. Beside Antarctica, wetlands occur on all continents and in all climatic zones. Presence of water is the main factor influencing nature of substrate and thus influencing nature of substrate and thus type of animal and plant communities in wetland. Wetlands may be fed by runoff, groundwater or by precipitation and thus water chemistry ranges from very acidic to very alkaline (*Cowardin et al. 1979*)

Individual elements occurring in the environment are characteristic by different migratory ability, depending on values of pH. This value expresses electron content. With large amount the environment becomes more reducing and conversely in absence of electrons oxidative, which is often

simultaneously acidic. The pH value indicates content of protons the environment becomes acidic. Otherwise with a lack of protons environment is alkaline. Soil flooding causes a decrease in pH for alkaline soils and an increase in pH for acidic soils. In flooded soils pH thus moves in area of neutral values (Drever 1988).

Diversity of wetlands is also in their total area. They can spread over a few hectares (sometimes m²), but can reach up to several km². Thus, can be divided into marshes, sedge meadows, wet prairie, fens, seeps, bogs, mangroves, swamps, rice fields and many other (Cowardin et al. 1979).

Definition of wetlands is a constant subject of debate and opinion. Since the definition of wetlands is perceived differently by ecologists, geologists, economics, hydrologist, biologist depending on goals and interests of end user (Mitsch et Goselink 2000).

Wetlands provide many functions. Among the most important ones can be mentioned hydrological functions (flood protection, water reservoir in landscape, source of drinking water), biochemical (fixation of CO₂ and its deposition in sediments, nutrient cycle and transportation, sediment retention and nutrient deposition), ecological (high biodiversity, food source, refuge of many rare and protected organisms). Other include climate regulation and aesthetic character (JUST T. et al. 2004; Powers et al. 2011).

Cleaning capacity of wetlands has been used for several decades. According to *Vymazal (2004)* it has been known for over 100 years. *Šálek (1995)* states, that over 30 years Institute of Water management has been dealing with natural methods of wastewater treatment.

Initially rather than controlled treatment it was an uncontrolled wastewater discharge, resulting in damage and even destruction of many rare ecosystems. This, is how wetlands were damaged until sixties of 20th century. Owing to study of wetlands in last few decades, it has become clear, what indispensable importance they have and what functions they perform. Due to Ramsar Convention, their importance and value increased after 1971. States which signed Ramsar Convention are committed to the rational use and protection of wetlands (Matthews 1993).

5. CHARACTERISTICS OF CONSTRUCTED WETLAND

The constructed wetland (later refer as CW) works on the principle of mechanical - biological filtration with maximum flow into the allocated chambers and given area of vegetation to remove excess nutrients from the wastewater. It is a man-made artificial wetland ecosystem. This complex is a combination of biotic components (animals, plants, microorganisms) with abiotic components, which by their action improve the quality of water, which is essential for the ecological value of the landscape (Gelt 1997).

It becomes a suitable alternative in the case of smaller municipalities up to 2000 EO, where the construction of conventional wastewater treatment plants (later referred as WWTP) is a very expensive matter. The advantage of CW over WWTPs is the ability to treat highly diluted wastewater with a low concentration of BOD₅, which at a concentration lower than 50-80 mg / l becomes problematic for conventional WWTPs (Kočková et al. 1994).

The principle of treatment is the drainage of wastewater into the building, where most of the waste is mechanically separated. The wastewater further flows freely horizontally and vertically, trapping dirt particles by natural sedimentation. These impurities are further broken down by microorganisms (especially bacteria) into simple elements by the decomposition of nitrogenous substances, which serve to nourish the vegetation. This process helps to balance the oxygen, supplying the necessary oxygen to the root zone of the vegetation and removing mineralized nutrients from the wastewater (EPA.gov. 1993).

One of the disadvantages of CW is the area needed for its implementation. A larger area of land is required to locate the CW, but land with a soil area unsuitable for other purposes can also be used. It can also be used in biologically valuable areas as a more aesthetic alternative to wastewater treatment (EPA.gov. 1993, Vymazal 2004, Junga et. al. 2015).

| Advantages: | Disadvantages: |
|--|---|
| Year-round operation | Area consumption |
| Their appearance fits well into the landscape, or they can also fulfill an ornamental function | A white coating of elemental sulfur may appear on the effluent during anaerobic decomposition in the filter beds. |
| require minimal maintenance - low maintenance costs | Vegetation is prone to toxic pollution |
| able to clean waste materials with a low concentration of organic substances | The need to protect against raids from plants that could damage the insulation layer |
| less prone to defects | They are not suitable for removing phosphorus and ammonia |
| deal well with the quality and quantity of wastewater | They require a minimum supply of water for their function, vegetation cannot withstand complete moisture loss |
| They do not bother the surroundings with noise | |
| Its construction creates a new habitat for organisms | |

Table 8: Advantages and disadvantages of constructed wetland (ČVUT 2012).

5.1 Types of constructed wetland

According to *Brix (2003)* artificial wetlands can be divided into several categories according to the way the wastewater flows and the type of vegetation. According to the direction of wastewater flow, artificial wetlands can be divided into two basic groups:

- CW with vertical flow
- CW with horizontal flow

In accordance with the vegetation that is used, CW can be divided into three basic groups:

- CW with floating plants
- CW with submerged plants
- CW with emerged plants

5.1.1 Constructed wetland with floating plants

This type of CW is not widely represented and can rarely be found in subtropical and tropical areas. The area of these CWs can exceed several hectares, where the plants are free on the water surface. They are most often built to a depth of 3 m. *Tanner et Headly (2011)* reported maximum root system depth ranging 57- 87 cm. According to *Vymazal (1995)* plants from the family (*Lemnaceae*) and water hyacinth (*Eichomia crassippes*) are most often used for this method of cleaning.

While ducklings are abundantly geographically widespread and are able to withstand even lower temperatures, they are limited by their root system. However, it forms a very thick, continuous coating on the surface, which prevents algae from producing photosynthesis and serves as a good base for bacteria (Hlavínek 2000).

Water hyacinth is the most productive to use, but the problem is frequent growth and clogging of drains and canals. Limiting factor for this plant is the temperature, which already limits the plant's growth even at 10 ° C. It is therefore able to operate year-round only in subtropical and tropical areas (Vymazal 2004).



Figure 1: floating plants (GRANIA ©2021).

5.1.2 Constructed wetland with submerged plants

This type is based on the principle of ponds. Used mainly for final cleaning. Submerged plants are able to assimilate the necessary nutrients mainly by their root system. During their growth, they remove dissolved inorganic carbon from the environment, causing an increase in oxygen concentration. Such an environment is good for phosphorus precipitation and ammonia volatilization. The condition for the use of submerged plants is well-oxygenated water (Vymazal 1995).

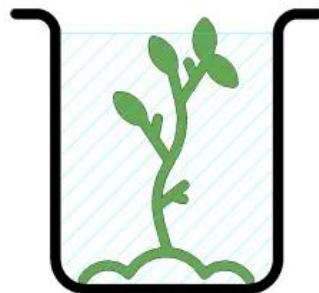

Figure 2: submerged plants (GRANIA ©2021)

5.1.3 Constructed wetland with emergent plants

Emergent plants are planted with their part in the substrate or filter material with a larger part of the plant protruding above the surface of the filter bed or the surface of the water surface. This is the most widespread group of CW, which is further divided into two groups depending on the wastewater flow (GRANIA ©2021).

- CW with surface flow
- CW with subsurface flow

5.1.4. Constructed wetland with subsurface flow

It is the most widespread wetland type CW in the world. The water here flows only through the surface of the filter surface area, which allows the growth of emergent vegetation (Hudcová et al. 2013).

5.1.5. Constructed wetland with surface flow

The wastewater here flows horizontally over the surface of a low-permeable substrate. The planted wetland plants ensure the growth of microorganisms needed for the decomposition of the material on their submerged parts (Greiner et Jong 1984, Němcová et al. 1994).

In appearance, this type of CW resembles natural wetlands. *Scirpus Spp.* and *Typha Spp.* are most often used for this type. They are mostly used in North America under the name FWS (free water system) or (surface flow) SF. This type is not common in Europe (Brix 1987, Kouřil 2006).

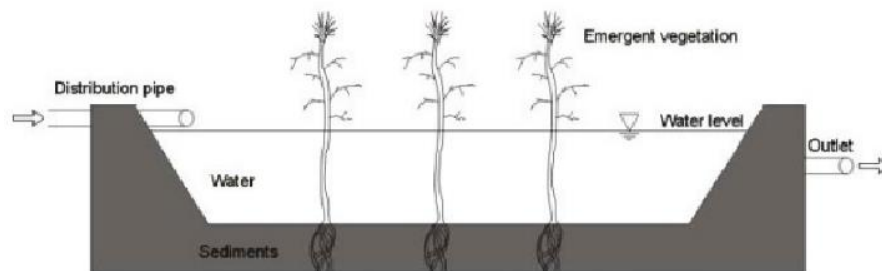

Figure 3: CW diagram with surface flow (Langergraber et Haberl 2004).

5.1.6. Horizontal flow constructed wetland

This is the most common type of CW in the world. Wastewater first undergoes mechanical pre-treatment, where most of the waste is removed. Pre-treatment prevents possible blockage by accumulated waste. After mechanical pre-treatment, the waste water passes horizontally through the filter bed and forms a continuous level, flowing from one side of the filter bed to the other. This is where microbial processes take place (GRANIA ©2021).

In the root zone at the surface of the filter bed, an aerobic environment is formed and BOD₅, undissolved substances and pathogens decompose. Due to the predominant anaerobic environment, it is not suitable for the reduction of ammoniacal nitrogen. The control shaft at the end of the treatment plant regulates the level using a device located in it (GRANIA ©2021).

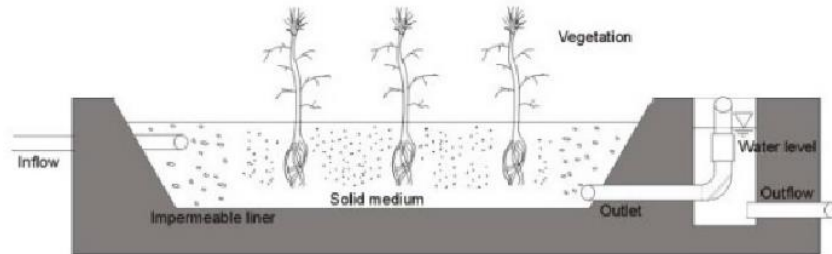

Figure 4: CW diagram with horizontal flow (Langergraber et Haberl 2004).

The disadvantage of this type is the high pollution load on small parts at the entrance to the filter bed, which can cause clogging. Another problem is maintaining a uniform distribution of water flow. If this did not happen, the currents would start to shorten and drain out of the filter bed quickly. This type of CW can be used for less polluted wastewater, or as part of another type of CW with more efficient treatment (SSWM ©2020).

5.1.7. Vertical flow

The main difference between a vertical flow system and a horizontal one is in the direction of the continuous flow of wastewater. The dosing of wastewater takes place by supplying wastewater to the shaft, which, after its sufficient accumulation, drains the wastewater and discharges it to the entire surface of the filter bed. Here, the wastewater flows from the entire surface of the filter bed into the lower layers, from where it is subsequently drained through the drainage pipe.

In appearance, the vertical CW is similar to the horizontal one. However, the difference is the supply of oxygen to the filter bed associated with the outflow of wastewater, in contrast to horizontal treatment, where the water remains (Šálek 2006, Raphael et al. 2019).

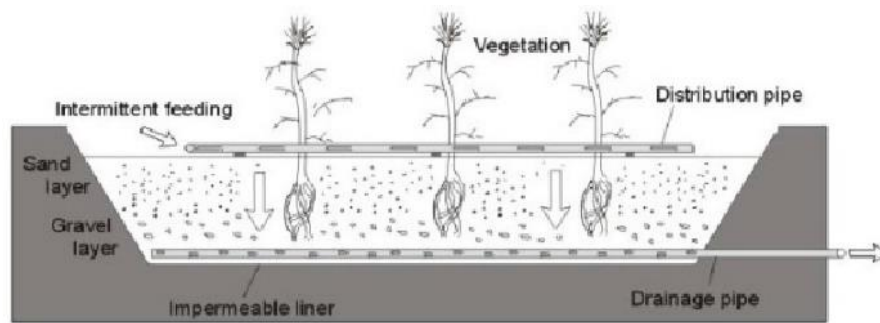

Figure 5: CW diagram with vertical flow (Langergraber et Haberl 2004).

Even dosing can be ensured by a pump or by means of special devices in the form of float outlets or siphons. The number of doses during the day varies between 4-12, which ensures time for water to drain through the drainage pipe and air to pass between the new dose of wastewater. This makes this type of CW more efficient for cleaning BOD₅ and ammoniacal nitrogen, but it is not able to reduce the overall nitrogen (GRANIA ©2021, Šálek 2006).

6. Division of parts of CW

A typical arrangement of the CW is the supply of waste water to the mechanical pre-treatment chamber, where most of the contamination is removed to prevent clogging of the inlet to the filter bed in the next phase of waste water treatment. From there, the waste water is led over the entire area of the filter bed, where the final purification and subsequent discharge of water free of waste substances takes place (EPA.gov. 1993).

6.1 Pre-cleaning

The capacity of the mechanical pre-treatment stage depends on the number of connected inhabitants. According to the origin, composition and amount of wastewater, the degree of treatment is arranged. For small treatment plants up to 50 EO, it is possible to use a settling tank or septic tank (GRANIA ©2021).

In large municipalities, where the value is up to 3000 EO, a complete mechanism consisting of sieves, sand trap, grease trap and primary settling tank is already necessary. The supply to these chambers can be influenced by a relief chamber, which regulates the supply of waste water and thus prevents possible clogging of the mechanism. These chambers can be several in a row even after mechanical pre-cleaning and each amount of water can be gradually regulated (Vymazal 2011).

| | |
|---------------------|---|
| Sieve | They consist of obliquely mounted bars at an inclination (45-60°) with gaps up to 4 cm wide. The wiping of trapped dirt depends on the type and can be mechanical or manual. Serves to capture coarse parts of impurities from wastewater (kitchen waste, paper, packaging waste, wood rags, etc.). |
| Sand traps | Horizontal, vertical or combination of both can be used. Based on principle of sedimentation of sandy particles, while reducing the flow rate of wastewater. |
| Grease traps | Possible to include for wastewater treatment containing higher concentrations of fats or petroleum substances. Submerged walls with possible aeration are most often used. |

Table 9: Components of pre- cleaning process (JAMProjekt 2018).

6.1.1 Sedimentation tanks

The most commonly used so-called slot tanks. Designed with horizontal, vertical and radial flow. In the lower part of the tank is a digestion space for the collection of settled sludge, which must be disposed of after a certain time. It is possible to take it for disposal, or according to Vymazal (1995) to drain it in the reed fields in the CW complex.

For the first time, this method of sludge disposal was used in Denmark. Waste water is freed of coarse impurities by these processes and fed to the central part of the CW, where it is evenly distributed over the entire area of the filter bed. For small sources of contamination, it can be replaced by a multi-chamber septic tank using submerged walls

between the chambers. The septic tank must be cleared after reaching 1/3 of the useful height, leaving a 15 cm layer of digested sludge for vaccination. According to ČSN 75 6402 retention time in a biological septic tank is 3-5 days (Kočková et al. 1994).

The design of the septic tank (5) based on the ČSN 75 6402 standard states that the number of chambers is three. The volume calculation is performed as follows.

$$V = a * n * q * t \quad (5)$$

V- effective septic tank volume (m³)

a- coefficient expressing sludge space (given by norm, usually a value of 1.5)

n- number of connected inhabitants

q- specific water demand (m³/day* inhab.)

t- mean residence time (day) (by norm 3-5 days)

| Size of biological septic tank according to ČSN 75 6402 | | | |
|---|--------------------|--------------------|-------------------|
| Number of connected inhabitants | 1 | 1 | 1 |
| Sludge space coefficient | 1,5 | 1,5 | 1,5 |
| Specific average daily water consumption | 0,15 | 0,15 | 0,15 |
| Dwell time in days | 3 | 4 | 5 |
| Total effective septic tank volume | 0,7 m ³ | 0,9 m ³ | 1,1m ³ |

Table 10: Size of biological septic tank according to ČSN 75 6402.

6.2 Filter bed

It is a waterproofed natural reservoir containing aggregates of various fractions and thicknesses forming a permeable surface planted with wetland vegetation. The bottom of the CW is lined with a special insulating foil made of synthetic rubber or polyester protected on both sides by geotextiles. Washed stones with a thickness of about 80 cm are laid on the insulating layer, which is piled with smaller aggregates (gravel, gravel sand) up to the sand with the root zone of the wetland vegetation (Chen Y. et al. 2013, Fahim et al. 2019).

The substances are decomposed under aerobic and anaerobic conditions by the action of microorganisms in a flooded area. During operation, a constant water level is maintained 10-15 cm below the surface of the filter bed. The level is regulated in the drain shaft, which prevents freezing at low temperatures (in winter) (Chen et al. 2013, Fahim et al. 2019).

There are several variants of the filter bed. It can be only one area, but it is limited by flexibility at higher wastewater flows. Another variant includes the use of two surfaces built in parallel, in which the wastewater is guided evenly on both parts. If necessary, only one part can be used. Another variant is a filter bed connected in series, combining several cleaning mechanisms. If they are used in this way, it is necessary to supply wastewater to each of them separately by means of a pipe network placed below the level of the filter bed or above it. The pipe is made of plastic with large holes to prevent clogging (Norvee 2005, Anonymous 1 2016).

6.2.1 Filter bed area

The area of the filter field is designed with a slight slope of the bottom for the correct value of the hydraulic gradient. *Simeral (1998)* state that the ideal bottom slope should not exceed 0,5%. Current wastewater treatment plants have an average bottom slope of less than 1% compared to the 8% slope proposed in the 1980s (*Vymazal 1995*).

This area calculation (6) is focused on the removal of insoluble substances and BOD₅ contained in water.

$$A_h = Q_d * (\ln C_o - \ln C_t) / K_{BSK} \quad (6)$$

A_h – Area of filter fields (m²)

Q_d – average daily inflow of wastewater (m³/day)

C_o – BOD₅ concentration in the inflow (mg/l)

C_t – required concentration of BOD₅ in the effluent (mg/l)

K_{BSK} – speed constant (m/ day)

$$A_h = Q_d * \ln ((C_t - C^*) / (C_o - C^*)) / K_{BSK} \quad (7)$$

In the 1990s, this equation was modified using the C^* concentration (7). This is a representation of BOD₅ created by the decomposition of substances in CW (e.g., decomposition of plant biomass) (*Vymazal 2016*).

7. Vegetation

Mechanism by which plant populations boost treatment efficiency in constructed wetland is not yet completely understood. However, types of plants, their level of tolerance to nutrient load, number, growth, season of their germination, density, spacing of the plants, harvesting, performance of attached microbial populations, oxygen supply to roots affect the performance.

Plant populations in constructed wetland require many macronutrients and micronutrients in proper proportions for healthy growth. According to *U.S. EPA (2000)* nitrogen and phosphorus are key nutrients in life cycle of wetland plants. However, concentration of inorganic substances in wastewater effluent importantly nitrogen and phosphorus altogether with loading rate to constructed wetland vary depending on wastewater quality, season and treatment facilities (*Kadlec et Knight 1996; Tchobanoglous et al. 2003; Batty et Younger 2004; Poach et al. 2004*).

Nutrient changes could influence plant growth, where according to *Poorter et Nagel (2000)* in low nutrient environment growth rate of plants is slower in comparison to high nutrient supply, but at the same time increase their biomass allocation to roots and reduce nutrient concentrations in biomass (*Aerts et Chapin 2000*).

The presence of vegetation is important for providing two basic functions. The first is to create an aerobic environment between the roots by supplying a sufficient amount of oxygen and thus allowing aerobic decomposition of organic matter by microorganisms. The second function is to maintain good hydraulic conductivity caused by the formation of pores after dead rhizomes.

Other advantages include thermal insulation of the filter bed surface, which allows operation even in the cold season, provide a good basis for bacterial growth and at the same time eliminate alkaloids with bactericidal effects. Last but not least, their appearance ensures the aesthetic value of CW (*Bahlo et. al. 1990, Haberl 2003*).

When choosing a suitable flora, there should be perennial plants with high biomass bioproduction. In another case, ornamental species may be chosen to increase the aesthetic value. Freshly planted plants must first be flooded with clean water and then gradually concentrated more with wastewater. This will help them better adapt to the future burden. Those can be planted throughout the growing season, with the most suitable months from the end of August to the end of September, in the case of pre-grown plants. In the case of plants grown last season, it is more appropriate to plant in the spring. According to European directives, a density of 4 plants per 1 m² is proposed for reeds (*Vymazal 1995, Brix et al. 2003*).

| Overview of plants used in constructed wetland | |
|---|--|
| common reed (<i>Phragmites australis</i>) | Length up to 3.5-4 meters, high root density section in 30-60 cm below surface. Maximum root depth up to 70 cm. Plays certain role in phosphorous and nitrogen removal (<i>Le. 2006</i>) |
| broad-leaved cattail (<i>Typha latifolia</i>) | Length up to 1-2,5m, spread from lowlands to the mountains, plays certain role in removing faecal coliform (<i>Ciria 2005</i>) |
| narrow-leaved cattail (<i>Typha angustifolia</i>) | Length up to 40-80cm, tolerates severe degradation of wetlands. Efficient in removing textile dye and total dissolve solids (<i>Nilratnisakorn 2009</i>) |
| reed rattlesnake (<i>Phalaris arudinacea</i>) | Length up to 20-30 cm, forms clonal colonies, root system produces extensive rhizomes |
| water beetle (<i>Glyceria maxima</i>) | Length up to 80-200cm. Grows on nutrient-rich substrates, able to stabilize shores. Plays role in nitrogen removal (<i>Oostrom A. 1995</i>) |
| deciduous bulrush (<i>Juncus effusus</i>) | Length up to 30-150cm. Grows in floodplain swamps, wet meadows, wetlands, banks of stagnant and flowing waters. |
| yellow iris (<i>Iris pseudacorus</i>) | Length up to 50-150cm. Occurs in rivers, swamps, borders of ponds, ditches. |

Table 11: Overview of plants used in constructed wetland (*Cibulka 2007, Krása 2008*)

8. Substances eliminated in constructed wetland

8.1 Removal of organic substances

Their removal can be considered very effective. The process of sedimentation, filtration and, above all, microbial decomposition acting in the filter bed contributes to their disposal. However, the efficiency of organic treatment is not dependent on the concentration of incoming wastewater, nor the time of year. In the filter bed, organic matter decomposes under aerobic conditions created by wetland flora near their root system. The rest of the filter bed forms an anaerobic to anoxic environment. According to *Langergraber (2001)* main mechanism of removal are volatilization, photochemical oxidation, sorption, aerobic and anaerobic respiration, sedimentation and degradation by fermentation (Haberl R. 2003).

- **Biochemical oxygen demand (BOD₅)**

Defined as the mass concentration of dissolved oxygen consumed by the biochemical oxidation of organic substances. The designation BOD₅ is due to 5 days incubation period (Pytl 2004, Pitter 2009).

Used according to *ČSN 75 6401* to determine the number of equivalent inhabitants (EO). 1 EO is expressed as the production of 60g BOD₅ / day divisible into 30g undissolved substances and 30g dissolved. Undissolved substances can be separated by filtration or sedimentation and dissolved substances can be removed with the help of microorganisms and biochemical processes.

Average BOD₅ values of sewage waters according to *Groda et al. (2007)* are in range of 150 up to 400 mg/l, values outside this range can be considered anomalous. BOD₅, enters wastewater together with sewage discharged from individual households.

- **Chemical oxygen demand (COD_{Cr})**

Content level of substances capable of chemical oxidation. Result is given in the amount of oxygen which is equivalent to the consumption of the oxidizing agent used. It is given in mg / l. In wastewater, a BOD₅ / COD_{Cr} ratio in the range of 0.3-0.8 can be considered. Higher ratio value indicates a higher content of readily degradable organic substances. According to *Groda et al. (2007)* average COD_{Cr} values of sewage waters are in range of 300 up to 800 mg/l. Values outside of this range can be considered anomalous (Saeed T. 2012).

Potassium dichromate is most commonly used as the oxidizing agent. The ratio of COD_{Cr} with BOD_5 expresses the degree of biological decomposition of organic substances. According to *Groda et al. (2007)* low ratio of $\text{COD}_{\text{Cr}}/\text{BOD}_5$ (< 2) presence easily degradable substances, otherwise high values show presence of substances difficult to decompose. This ratio cannot be generally expressed because it is for every wastewater different (*Pitter 2009, Sojka 2004*).

According to *ČSN 75 6401* Specific production is given as 120g COD_{Cr} per day per one inhabitant. About half of this are undissolved substances.

8.2 Removal of total suspended solids (TSS)

These substances, like organic substances, are effectively removed in the first part of the filter bed by filtration and sedimentation. Those are either inorganic substances or of organic origin of larger dimensions. Incomplete pre-cleaning can clog the bed and thus the surface drain. This problem does not affect the function of the CW, but there may be hygiene problems associated with odour or the accumulation of mosquitoes (*Malý et Malá 2006*).

8.3 Phosphor (P) removal

Removal of phosphorus is very important, with increased concentration in watercourses, water survival and subsequent multiplication of cyanobacteria and algae can occur. Over time, they begin to form floors and, as they grow, consume oxygen in the water. Eutrophication escalates to the point of creating a green mass. The lower floors lose contact with light and, when oxygen is depleted, cause the lower parts to die. This process continues with the constant formation of ammonia in an anaerobic environment until the water becomes uninhabitable for organisms (*Smith et al. 1999*).

Constructed wetland is limited in phosphorus removal potential due to its capacity. Removal is highly dependent on nature of materials used for its construction and biofilm. Biofilm growth attached to media reduce interaction between material and wastewater. To overcome those limits, several alternatives have been suggested and tested such as chemical precipitation of P at pre-treatment stage, P removal in separate filter unit by granular medium with high phosphorus binding capacity and constructing whole system with chemically enriched media.

Materials used for P removal must simultaneously have good hydraulic characteristics altogether with sustained and consistent elimination of phosphorus from wastewaters. Determination of these inherent properties typically includes chemical and physical features characterisation. Once chosen material is then tested. Those generally includes evaluation of P-

biding capacity through sorption equilibrium isotherms experiment, P-saturation by constantly feeding wastewater/ P- spiked water through construction of, columns” and retention tested by balance between inlet and outlet P- concentration (Arias et al. 2001; Drizo et al. 2002; Del Bubba et al. 2003).

According to ČSN 75 6402 the daily production of phosphorus per 1 EO is 2.5 g The source of phosphorus can be divided into anthropogenic (household cleaners, fertilizers) and natural (leaching of minerals from soils). Phosphorus occurring as a phosphate in inorganic and organic compounds is thus removed mainly by physico-chemical processes, adsorption and precipitation in a filter bed with calcium, iron and aluminium ions present. The material in the filter field (gravel, crushed aggregate) has a very limited sorption capacity. Improvement of sorption capacity can be achieved by using natural materials such as apatite, zeolite, calcite, or blast furnace slag can also be used. Phosphorus adsorption depends on several factors: pH, the surface of the filter material used and the hydraulic conductivity (Vymazal 2004, Malý et Malá, 2006, AYZ et al. 2012).

Sedimentation occurs, when phosphorus bounded to particles/ aggregates enters constructed wetland. When water velocity is reduced, phosphorus particle can settle on bottom. Chemical removal of phosphorus is caused by sorption and precipitation. Incoming phosphorus can be absorbed on sediment/ soil particles containing Al^+ , Ca^+ and Fe^+ compounds. In acidic soils, phosphate is adsorbed on hydrous oxides of aluminium and iron. Phosphorus may precipitate as Al^+ and Fe^+ phosphates. With pH greater than 8.0, phosphorus is precipitated as Mg^+P or Ca^+P (Richardson 1999).

Removal of phosphorus by plant uptake is not directly proportional to the growth rate of plants, as most of the stored phosphorus during decomposition is returned to the water. In the soil, phosphorus is very strongly bound and is not so amenable to biological processes (Reddy et al. 1999).

According to *Gardavská (2013)* removal of phosphorus by adsorption is dependent on the time when at the beginning of the cleaning process the removal rate is one hundred percent, but after filling the sorption sites, the removal rate decreases rapidly. It is even possible to observe the release of sorbed phosphorus at low concentrations of water on the tributary.

8.4 Nitrogen removal

Another very problematic is removal of nitrogen from wastewater. Its important sources include sewage and agricultural land. According to *Vymazal (2016)*, the removal itself does not exceed 50% and the elimination of ammoniacal nitrogen is most often between 20-40%. From a hygienic point of view, ammoniacal nitrogen is an important indicator of biological water pollution (*Pitter 2009*).

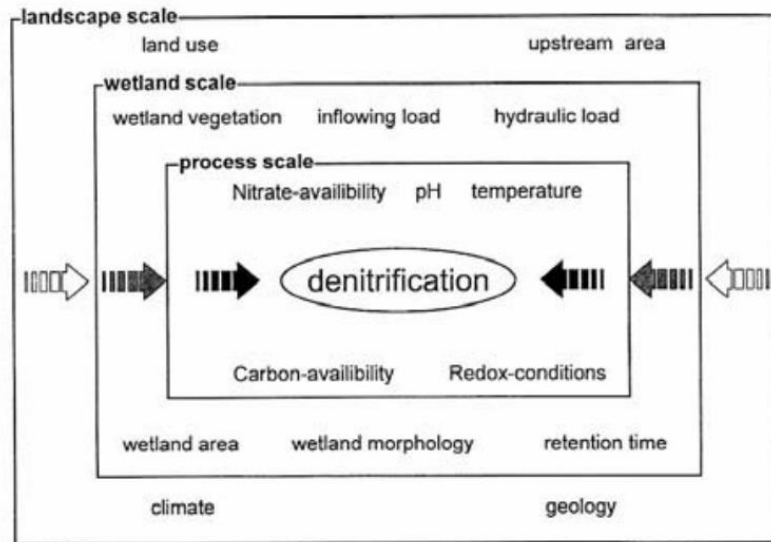

Figure 6: factors affecting denitrification on different scales (Trepel 2002).

As can be seen in *Figure 5* rates of nitrification and denitrification are affected by several factors. According to *Reddy et Patrick (1984)* nitrifying bacteria require oxygen, ammonium, inorganic carbon source and favour pH in range (7.5-8) soil with optimal temperature 30-40°C. In denitrification process, organic material commonly serves as an electron donor, while nitrate is used as electron acceptor. Denitrification favour anoxic conditions, bioavailable organic carbon, high nitrate availability, pH 6-8.5 and high temperature optimally 60-75 °C. According to *Knowles (1982)* denitrifying bacteria are mostly heterotrophs and some autotrophs using CO₂, H₂ and reduced sulphur compounds (*Knowles 1982, Proser 1989*).

Reason for not too high nitrogen removal is the lack of oxygen in the filter bed. Nitrogen is decomposed in aerobic environment of the root system of wetland plants into ammoniacal nitrogen, which is converted into a gaseous form (denitrification) in the anoxic parts of the filter bed, which is released into the atmosphere. Elimination can be affected by the combination of a filter bed with upstream CWs with vertical flow, where intensive nitrification occurs due to sufficient oxygen (*Kriška et Němcová 2015, Malý et Malá 2006*).

In sewage, nitrogen is found in organic and ammoniacal form. The number of ammonifying bacteria in the root fields is up to 6 orders of magnitude larger than the nitrifying bacteria, which can cause an increase in the concentration of ammonia in effluent from CW. According to *Andersson et al. (2005)* A lower nitrogen removal has been observed in constructed wetlands receiving municipal water, due to receiving large quantity of ammonium nitrogen in comparison to those receiving nitrogen in nitrate form i. e. runoff agriculture water. Nitrogen removal is mainly regulated by denitrification rate (May 1990, ex Ekologgruppen 2001).

Different internal flow patterns may cause shortcuts in system resulting in higher water velocities, shorter nitrogen residence times and less efficient constructed wetland area, which affects contact between bacteria, nutrients and consequently nitrate removal efficiency. According to *Braskerud (2001)* these can depend on vegetation, or according to *Persson (1999)* on morphology. Negative high flow shown to have large impact on average annual nitrogen removal of constructed wetland basin, hence high flow effects should be avoided to achieve high nitrogen removal (Spieles et Mitsch 2000).

According to *Vymazal (2016)*, decomposition can also be negatively affected, at lower temperatures, when removal efficiency decreases. Decomposition depends on ambient temperature. *ČSN 75 6402* states the value of 11 g of nitrogen per day per 1 EO.

8.5 Removal of microbial contamination

Wastewater consist of five main categories of pathogens. Viruses, fungi, helminthes, enteric bacteria and protozoa. Measured organisms are usually expressed as faecal coliforms (FC) and total coliforms (TC). Both groups indicating both animal and human contamination (Sharma et al. 2003).

Due to high amount, of bacteria species, it is common practice to quantify specific indicator bacteria group. According to *Eiler et al. (2004)* up to 50 bacterial species can be found in single millimetre of water.

This specific indicator should be easy to measure and identify through reliable method to provide correlation with the total number of pathogen population, but none of them can be characterised as perfect indicator (Stefanakis et al. 2016).

The common indicator for faecal contamination is *Escherichia coli* (*E. coli*), with typical concentration between $10^6 - 10^9$ CFU/100 ml (Asano et al. 2007).

Measurement of total coliform group represents general identification of other bacteria form *Enterobacteeilerriaceae* family, but does not provide specific indication for human pollution (Ashbolt et al. 2001).

Most common genera of TC group are *Citrobacteria*, *Klebsiella*, *Enterobacter* and *Escherichia coli*, which makes up to 20-30% of TC group in raw domestic wastewater (Dufour et al. 2003).

Faecal streptococci (FS) are used as second indicator group, but are limited due to temperature variations and reproduce very little compared to FC. FS are used as indicator of fresh pollution, due to their shorter lifespan in comparison to FC (Ashbolt et al. 2001).

This group includes *Streptococcus bovis*, *S. faecalis*, *S. avium* and *S. equinus* with Enterococci subgroup (*E. faecium*, *E. avium*, *E. durans*, *E. gallinarum* and *E. faecalis*). These are often used as virus indicator in biosolid material (Payment 2002).

Removal is usually applied through combination of physico-biological-chemical processes. Physical being through filtration and sedimentation. Most common biological removal is natural death, which is higher in water, then in the sedimentation. Furthermore, combined with predation, antibiosis and biolytic processes. Chemical removal is happening through oxidation, adsorption into biofilm, exposure to plant biocides and UV radiation from sunlight (Stefanakis et al. 2016).

8.6 Heavy metals

To a greater extent, heavy metals are contained in wastewater from small settlements. Purified by many mechanisms including sedimentation, adsorption, chemical precipitation, microbial activity and biomass capture. Complex metal compounds with organic ligands are considered an important factor in eliminating metal toxicity. Compared to organic pollution, it is impossible to remove heavy metals by the biological process itself (Kadlec et Knight 1996).

Metal removal is affected by individual metals, but mostly the purification rate reaches 80%. Of which only about 10% is captured in biomass. Study showed dependence of adsorption efficiency on the use of plant species. When cattail (*Typha domingensis*) proved unsuitable for its low cumulative ability (Maine et al. 2007).

In an aerobic environment, presence of iron is important for sorption. Under these conditions, oxidation and formation of precipitates of iron oxyhydroxides occur, which in this process help simultaneous precipitation of other metals by trapping them. In an anaerobic environment, dissolved iron reacts with hydrogen sulphide formed during reduction of sulphates under strongly reducing filter bed conditions. Formed sulphates are stored, but hydrogen sulphide gas may escape into air. This process is accompanied by an unpleasant odour (Hammer et Bastian 1989, Vymazal 2004).

9. Investment and operating costs

During initial construction of constructed wetlands in Czech Republic, size of investment costs were 2x to 5x lower than amount of investment for construction of conventional wastewater treatment plants. At present however investment costs were approximately at the same level around 4.000- 25.000 CZK per connected inhabitant. Many factors determine size of investment costs per 1EO. Those include sustainability of the site for construction, subsoil characteristics, availability of sustainable materials, number of connected inhabitants etc. Price of the filter bed was approximately 60%, where pre- treatment usually represented 25% and e.g., distribution and collection systems, shafts and fencing represented about 15% of the total amount.

Within cost of filter bed is cost of filtration material and its transport on site, representing 40%, 10% on sealing foil, 5% for wetland vegetation and 5% for earthworks. Individual costs can vary considerably according to local conditions (Vymazal et Kröpfelová, 2006).

Operating costs include sludge transportation, wage costs for worker in charge of control and maintenance of constructed wetland, working/ protective equipment for worker and water analyses. According to *Kočková et al. (1994)* operating costs at constructed wetland reach up to only 15- 30% of wastewater treatment plants operating costs. According to *Beneš (2009)* based on data from 28 constructed wetlands average annual operating costs on 1 EO per year came up to around 385 CZK.

10. Evaluation of selected constructed wetlands

10.1 Methodology

Following part of bachelor thesis deals with evaluation of long- term efficiency of two constructed wetlands in Czech Republic. Both constructed wetlands were selected due to them being in operation over 20 years and have undergone intensification. Constructed wetlands selected for evaluation of long- term operation in municipalities Spálené Poříčí and Velká Jesenice falls within category of 500- 2 000 EO. To evaluate operation, data from inflow and outflow of constructed wetlands were obtained on basis of which its efficiency was calculated.

Both constructed wetlands have a long- term results of BOD₅, COD_{Cr}, TSS, N-NH₄ and P concentrations. Data of monthly concentrations of constructed wetland Spálené Poříčí were provided by Ing. Petr Pelikán for period 1992- 2017, for period 2018- 2020 by Ing. Miroslav Slavík, viz *Annex no. 3*, with reports see *Annex no. 4*, *Annex no. 5*, *Annex no. 6* and for year 2021 by Ing. Tereza Hnátková, Ph.D. Together with project documentations concerning changes done to constructed wetland Spálené Poříčí and investment costs provided by Ing. Miroslav Slavík for changes done in period 1992- 2018 and documentation of intensification process carried out in 2019 by Ing. Tereza Hnátková, Ph.D. together with maximum limits for nutrient content in treated discharged waters set by water authority Blovice provided by environmental department Blovice. Operating costs were available online on website of municipality Spálené Poříčí

Constructed wetland Velká Jesenice has a long- term sampling results of individual pollutants concentration. Monthly data of concentrations were provided by Ing. Petr Jeništa for period 2000- 2021 with project documentations concerning changes done to constructed wetland with investment costs and maximum limits for nutrient content in treated discharged waters. Operating costs were available online on website of municipality Velká Jesenice.

Each constructed wetland has very different parameters and is designed for a different number of EO. Due to this it is not possible to compare those constructed wetlands with each other. Aim of bachelor thesis is only to evaluate the effectiveness of long- term operated constructed wetlands with regard to limits set by *Government Regulation No. 401/ 2015 Coll.* and relevant water authorities. Evaluation of constructed wetlands effectiveness was based on average annual concentrations of individual pollutants. All data was processed in MS Excel.

10.2 Spálené Poříčí

10.2.1 General characteristics

Municipality Spálené Poříčí is located in south- eastern part of Pilsen region in western Bohemia, 23 km south of Pilsen. Spálené Poříčí is located in Brdy highlands, through area flows river Bradava, which serves as recipient (outlet of treated wastewater from constructed wetland to the watercourse Bradava- ČHP 1-10-05-050-0-00. Territory belongs to Vltava River basin. Spálené Poříčí is located at an altitude of 417 m above sea level with total cadastral area 54.52 km². Municipality has unified sewerage system (Křest'ánek 1984, EDPP.CZ © 2010 – 2021).

10.2.2 Constructed wetland Spálené Poříčí

CW is completely located in the cadastral territory of the town of Spálené Poříčí. These are lands with parcel number 2700, st.714 and partly after intensification also land with parcel number 2636, see *Annex 2*. It is situated in the floodplain of the Bradava river at a distance of up to 700 m from the housing development. Owner of the constructed wetland and at the same time the operator of the CW, water supply, sewerage and technical services is the municipality Spálené Poříčí (*Vavříčka 1998, JAMlprojekt 2018*).

CW in Spálené Poříčí was put into operation on November 1, 1992. With its current capacity, it won first place among CW in the Czech Republic. When founded, it was dimensioned for 500 EO. It was a CW with a horizontal flow, divided into 4 fields of 25 x 25 m with a total area of 2500 m².

During 2001, CW was expanded by two parallel filters. Thus, the CW was expanded by an area of 2700 m² with an added cleaning capacity of 500 EO. It functioned in this way until 2018, when its intensification began.

Existing CW see *Figure 7*, is connected to public unified sewerage system for the entire period of its operation.



Figure 7: Satellite image of constructed wetland Spálené Poříčí (URL 1).

10.2.2.1 1st phase

CW was designed for 500 EO with a total area of 2500m² see Figure 8. It was a CW with a horizontal flow of mechanically treated wastewater guided by a permeable substrate. Divided into 4 root fields, each with an area of 625 m² (25 x 25 m). The slope was 1: 1 with a 1% slope. Insulation against seepage into the subsoil was solved with PVC 803 foil on both sides protected by NETEX geotextile deposited on a layer of dust material.

Filter bed was made of coarse concrete sand with a coefficient of hydraulic conductivity of 10⁻³ m.s⁻¹ with a total thickness of 600-800 m.

Mechanical pre-treatment consisted of hand-wiped screens and a vortex separator (sand trap) followed by a slotted tank. Fields were planted alternately with *Baldingera arundinacea* and *Phragmites australis*. *Baldingera arundinacea* was chosen for its compact root system and tolerability of water level fluctuations. *Phragmites australis* was chosen for rapid growth and a deep root system reaching up to 800 mm. Wastewater level was kept below the surface of the filter bed, controlled by discharge elements.

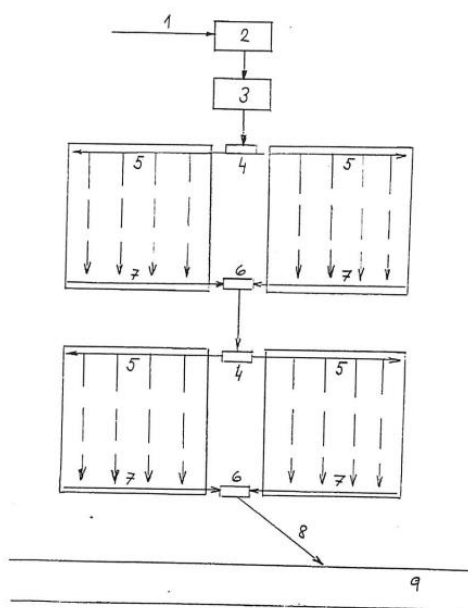

Figure 8: Scheme of CW in Spálené Poříčí (not in scale). 1- inflow, 2- rough pre-cleaning, 3- slit tank, 4- distribution shafts, 5- distribution drainage, 6- collection shafts, 7-collection drainage, 8-drain, 9- Bradava (Vavříčka 1998).

In first year of operation, around 350 inhabitants were connected to constructed wetland, from the second year of operation this number increased to 500 inhabitants. Samples were taken once a month. According to Vavříčka et Vavříčková (2000) as of March 2000, about 600 EOs were connected to constructed wetland (Vavříčka 1998, Vavříčka et Vavříčková 2000).

| | Designed parameters (600 EO) | Actual parameters (500 EO) |
|---|------------------------------|----------------------------|
| Q_{\max} (l.s ⁻¹) | 2 | 2,36 |
| Q_{mod} (l.s ⁻¹) | 1,04 | 2,06 |
| Q_{year} (m ³ .year ⁻¹) | 32 850 | 64 900 |
| BOD ₅ (kg.year ⁻¹) | 854,1 | 230 |
| TSS (kg.year ⁻¹) | 1478,2 | 583 |
| BOD ₅ (kg.d ⁻¹) | 2,33 | 0,63 |
| TSS (kg.d ⁻¹) | 4 | 1,6 |

Table 12: Comparison of design parameters (600 EO) and actual parameters (500 EO) at CW Spálené Poříčí (Vavříčka 1998).

Results in Table 12 show a stable exceeding of permitted amount of discharged wastewater caused by a uniform sewerage loaded by ballast water. This situation was not taken into account during calculation in proposal. Highest value of the inflow for 1997 was measured in January - 6324 m³ (Vavříčka 1998).

10.2.2.2 2nd phase

During 2001, CW was expanded by a separate mechanical-biological part. This increased its capacity by 500 EO. It was put into full operation in 2002, when, according to the evaluation of the test operation, approximately 1000 EO would be connected to CW. In 2015, according to Water supply and sewerage development plan approximately 1508 EO was to be connected (Jindřich et Čermáková 2002).

In the original design, the CW was conceived as a two-stage. First stage was to be formed by a slotted tank from which wastewater would flow to the second stage formed by six parallelly connected fields. Each of the fields was alternately planted with *Phragmites australis* and *Baldingera arundinacea* set in a bed of crushed aggregate. Most of the proposal was implemented with the exception of fields, where it was agreed to implement four (JAMIprojekt 2012).

Rain separators were built on inflow from main sewer collector to the CW in order to prevent CW storm water. Behind the third rain separator, medium-sized screens with a horizontal sand trap and a vertical sand trap were installed. Treated water was then led through drainage gutter along a trap made of reinforced concrete to individual slotted tanks measured 7 x 4.9 m and 3.5 x 5.45 m (JAMIprojekt 2018).

From slotted tanks, wastewater was led to distribution shaft, which served for distribution of wastewater to individual activation tanks. Those consisted of a reinforced concrete base slab with a concrete thickness of C20 / 25 150 mm, on which a curly mesh reinforcement 8/100/100 mm was placed at the upper edge of the slab. In addition, shaft contained ferrous sulphate

dispensers intended for phosphorus removal. The CHLOROZ-EXTRA 50 device was chosen, but according to *Jindřich et Čermáková (2002)* it proved to be unreliable.

Biological treatment took place in the first phase by two parallelly connected horizontal subsurface flow filters with an area of 2500 m². In second phase, this process was repeated again in remaining two horizontal subsurface flow filters, which were identical to the filters from the first phase. The total area of all four fields was 5000 m². Original measuring shaft was cancelled and replaced by a concrete shaft, where the drain was captured in outlet object with the measurement of the flow of treated wastewater by Parshal trough (*HYDROEKO 2001*).

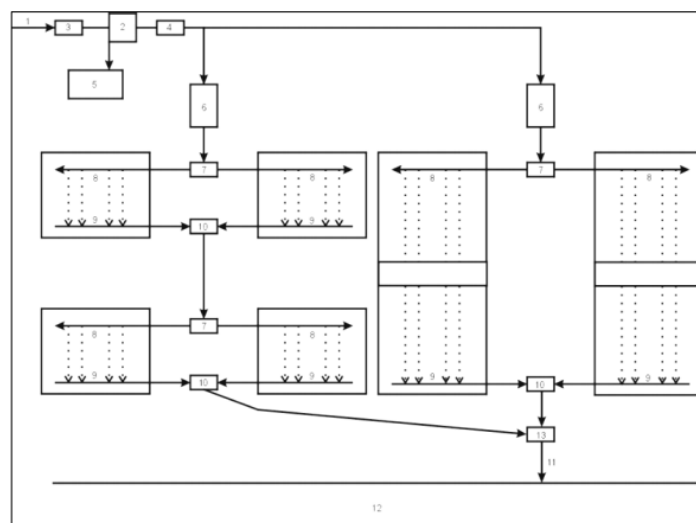

Figure 9: Scheme of CW in Spálené Poříčí, 2nd stage, old part on the left, new on the right): 1) wastewater inflow, 2) rough pre-treatment with relief of rainwater made from old parts of CW, 3) screens with phosphorus removal equipment, 4) vertical and horizontal sand trap, 5) polder, 6) slotted tank, 7) distribution shafts, 8) distribution drainage, 9) collecting drainage, 10) collecting shafts, 11) drain, 12) rivulet Bradava 13) control shaft (Chladová 2017 ex. Anonymous2.).

10.2.2.3 3rd phase

The expected start of 2018 and the completion of construction took place in 2019.

Intensification of constructed wetland was used for the treatment of sewage and individual wastewater led to it from existing unified sewerage system. CW was newly dimensioned for 1750 EO.

Mechanical pre-treatment consists of new relief chambers OK1 and OK2 with modification of sieves and sand trap. Inlet is led to the modified tank of the biological septic tank 1 and through the newly created relief chamber into biological septic tank 2. New activation part of the CW, a sludge sump and a new service house were built. From the activation part, water is

led to newly modified vertical filter i.e. vertical subsurface flow pulse sprinkled filter (VKF) with additional recirculation. Constructed wetland also includes a newly built electrical connection to supply the activation part of conventional plant and VKF's recirculation drive, see in *Figure 10* from which it is led into measuring shaft and then straight into Bradava (*JAMiprojekt 2018, Toman- Elektro 2018*).

Sedimentation sump connected to outlet from the light water inlets OK1 and OK2. After passing through the sedimentation tank, wastewater is divided according to intensity of rainwater. It is thus distributed evenly into parallel horizontal subsurface flow filters (HKF) 1a, 1b, 2a, 2b. From the HKF 1a and 1b filters, purified water is further led to the outlet via HKF 1c. From HKF 2a and 2b water continues straight to outlet. Inflow, from relief chamber OK3 is led through filter HKF 1b into recipient Bradava.

Retention tank, which was previously used to relieve inflow of wastewater led onto CW, was backfilled and closed, including inflow and outflow on it. Whole area is newly fenced and additionally marked with the tables "Risk workplace" and "Unauthorized entry prohibited." Entrance area to the complex was paved (*Toman- Elektro 2018, IPR AQUA 2017*).

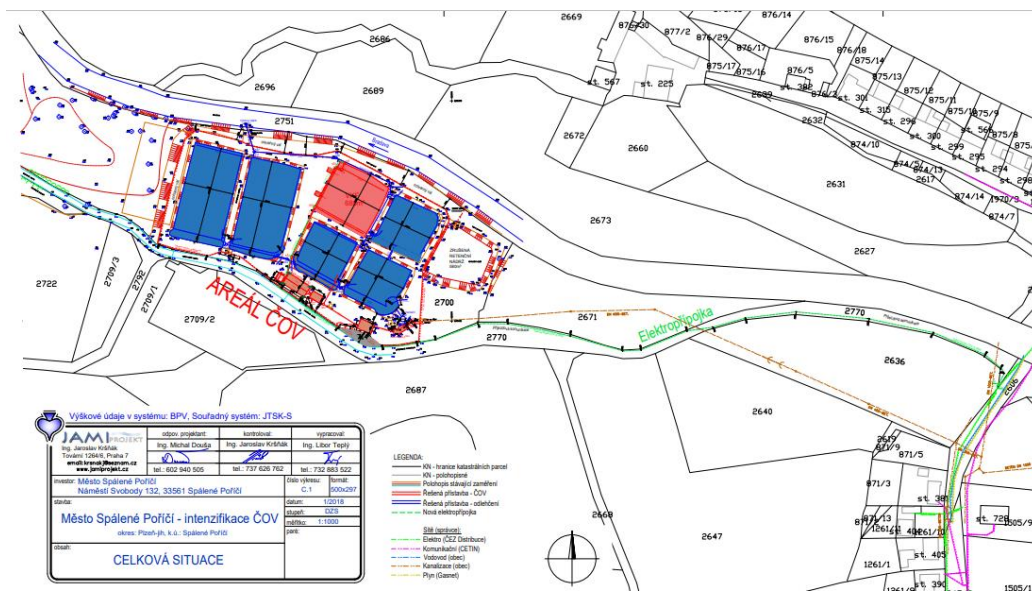

Figure 10: CW intensification - overall situation (JAMiprojekt 2018).

Electrical connection

Complied with the requirements of ČSN 73 6005 incl. Amendments No. 1 to 4 (Spatial arrangement of technical equipment networks) and ČSN 83 9061 (Technology of vegetation modifications in the landscape. Protection of trees, stands and vegetation areas during construction works). Earthworks were carried out exclusively by hand in the vicinity of existing underground networks.

Voltage system 3, PEN, N, PE, ~ 50 Hz, 3x400 / 230 V / TN-C-S guided by an AYKY-J 4Bx50 cable was placed in a groove at a depth of 0.6 m. Cables were placed in a KOPOFLEX Ø63mm protector. An FeZn Ø10mm earthing switch was installed along the entire length for earthing all cabinets and switchboards. Electrical connection was thus protected during normal operation. In the event of a fault, system will automatically disconnect from the power supply (*Toman- Elektro 2018, EXTEC 2018*).

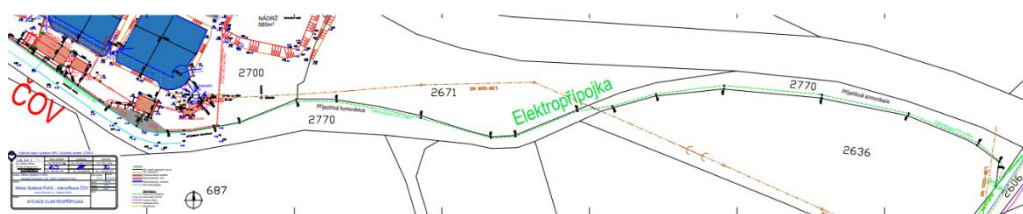

Figure 11: marked electrical connection line in the CW complex (*JAMiprojekt 2018*).

10.2.3 Investment and operating costs

Construction costs in first stage for the construction of CW Spálené Poříčí amounted to CZK 2,200,000. Operating costs include overall maintenance of constructed wetland, cleaning of above-ground biomass, removal of generated waste, see *Table 13*. Among other things, these costs include the performance of analyse of wastewater treatment.

Costs for expansion of original parts amounted to 5,500,000 CZK. In 2010, the operating costs were around 240,000 CZK / year. Compared to a conventional WWTP with the same output, the operation would cost around 1,500,000 CZK / year. (*Veřejná správa online © 2021*)

Intensification of CW in the third stage amounted to 11,211.38 CZK. Operating costs for wastewater treatment for the town of Spálené Poříčí in 2019 associated with the intensification and operation of CW cost 15,610.00 CZK / year. In 2021 electric consumption was around 200,000 CZK / year. Operating costs for wastewater treatment and fees for the discharge of waste water into surface waters amounted to 311,000 CZK / year.

| object | operating instructions | work description | terms |
|---------------------------|---|---|--|
| field-constructed wetland | vegetation | Weaving of stands (removal of grasses and weeds), Checking the level in the tanks (drying of the ends of the reed leaves signals a low level) | according to need |
| | grasslands of slopes and areas around constructed wetland | Mowing and removal of cutgrass by incineration | according to need |
| outlet object | control of constructed wetland outlet | Checking the masonry and cleanliness of the outlet pipe | Once a month and always after large waters |

Table 13: Operating rules of object procurement. The generated waste is disposed of according to valid legislation (HYDROEKO 2001).

10.3 Velká Jesenice

Municipality Velká Jesenice is located in district Náchod of region Hradec Králové northwest about 30 km from statutory city Hradec Králové and falls under the municipality with extended competence Náchod. Total cadastral area of Velká Jesenice is 14.72 Km² at an altitude of 286 m above sea level (Matouš 2013).

10.3.1 Constructed wetland Velká Jesenice

CW Velká Jesenice is completely located in town Velká Jesenice, situated in the floodplain of the Rozkoš river. Owner of constructed wetland is Velká Jesenice. Operator of CW and at the same time sewerage, water supply and technical services of town is Velkojesenická s. r. o. (Matouš 2013, CHMI 2019).

Existing constructed wetland see *Figure 13* has been in operation since 1996. Design counted with capacity of horizontal system around 630EO with an area of 3x 1050 m². Constructed wetland was planned as mechanical stage of pre-treatment consisting of coarse sieves, sand trap, relief chamber and slotted settling tank. Main stage of cleaning was to consist of three parallel connected vegetation filters with a total area of 3 150 m². Sludge management was to be solved by one sludge field with a total area of 620 m².

From original plan beside mechanical pre- treatment, only two fields with an area of $2 \times 1\,050\text{ m}^2$ with capacity of about 420 EO and only half of the proposed size of sludge field were implemented. Treated wastewater was drained from CW into recipient Rozkoš. Constructed wetland was connected to half of municipality by unified sewerage. In 2012 the second half of the municipality was annexed. During this period separation of septic tanks from sewers took place at individual pollution producers. Due to those new limits for discharged pollution were implemented altogether with need to remove ammonia pollution from wastewater (Matouš 2013, Jeništa, 2018).

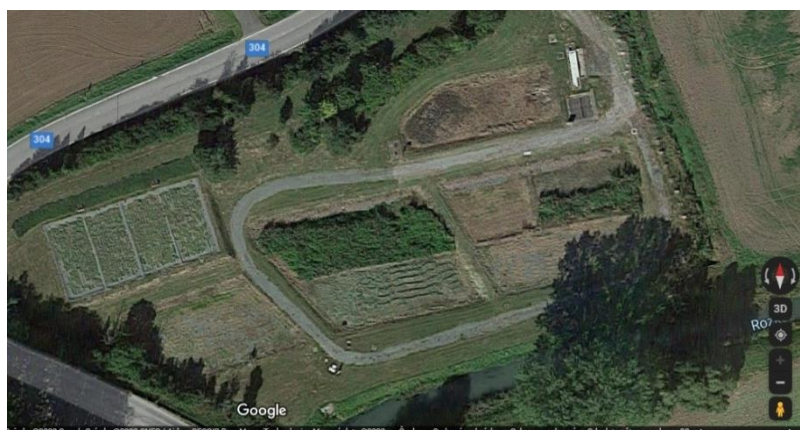

Figure 13: Satellite image of constructed wetland Velká Jesenice (URL 2).

10.3.1.1 1st phase

Constructed wetland Velká Jesenice was built during 1995 and approved after trial operation in 1998.

In the original design from 1994 CW was supposed to be consisted of three- fields with areas of $1\,070\text{ m}^2$, $1\,040\text{ m}^2$ and $1\,025\text{ m}^2$. Fields were to be operated as separate units. Bypass solution would thus allow CW to operate in continuous or discontinuous mode. In continuous mode, there would be a parallel distribution of wastewater into horizontal subsurface filter beds. In discontinuous mode, cyclic filling and emptying of the fields would occur. Sludge management was to be solved by one sludge field with a total area of 620 m^2 .

From the original design, only two parallel horizontal subsurface beds with an area of $2 \times 1\,050\text{ m}^2$ for a capacity of about 420 EO were implemented. Filter beds were filled with duckweed in fraction (4-16 mm). Tank seal was made of IZOFOL protected by layers of fine sand and IZOCHRAN. Fields were planted alternately with *Baldingera arundinacea* and *Phragmites australis*.

The mechanical pre-treatment consisted of hand-wiped screens and a vortex separator (sand trap) followed by a slotted tank. For short- term storage of screenings made of racks and sand deposited in sand trap a concrete platform was built next to the sand trap. Safety overflow of the slotted tank was inserted into the CW bypass.

CW was supplemented by a vegetation sludge field, see *Figure 14*. Of the original design, only half of the proposed size was realized. Anaerobically distributed sludge as needed (approximately 1x in 3-4 months) was pumped from the slotted tank by a portable electric pump into the sludge field. The sludge was intergrown with *Phragmites australis* and over the years changed into high-quality humus, that could be used in agriculture.

Safety bypass was formed from stoneware DN 300 coming out of the shutdown shaft and ending into the recipient. Distribution and manifolds that distribute the wastewater and filter fields were made of PVC. Drain was led through the Parshall trough to recipient Rozkoš (Holý 1994, JAMIprojekt 2013).

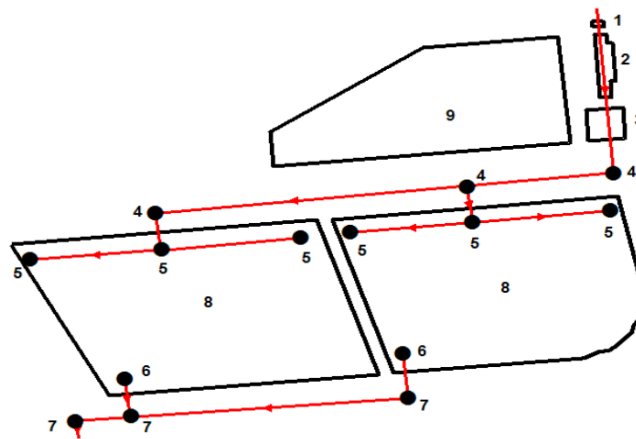

Figure.14: Simple scheme of constructed wetland Velká Jesenice): 1-rack, 2- sand trap, 3-slotted tank, 4-distribution shaft, 5-inlet shaft, 6-collecting shaft, 7-inspection and control shaft, 8-filter bed, 9-sludge field (Matouš 2013).

10.3.1.2 2nd phase

In 2015 reconstruction and intensification of constructed wetland was carried out. Construction was designed for capacity about 670 EO with degradation of ammonia nitrogen and phosphorus see *Figure 15*.

To the original CW was added a rain relief chamber by means of a trough flow regulator, which significantly reduced overload of slotted tank and sand trap. Mechanical pre-treatment itself was supplemented with adding a floating sorbents of petroleum substances, some light oils and burrows into the slotted tank.

Inlet zones of both horizontal subsurface filters were replaced within 5 m and filter charge was removed in a width of about 2 m in the centre of the filters to enlarge sorption capacity. Those zones were then supplemented with new river aggregates of fractions 64/ 128 and 32/ 64. In addition, DN 100 manifold was added. Into centre of the existing horizontal subsurface filter beds were newly planted *Phragmites australis* 4 pcs/ m². On the outlet of those filter beds were newly added pumping wells with equipment consisting of two pumps with float regulation, which can be moved according to current use of filter.

Four vertical subsurface flow filters (4 m x 10 m x 17.5 m) have been added with the possibility of connecting temporary additional aeration to ensure necessary nitrification in the event of a long-term high concentration of N-NH₄⁺. Additional horizontal subsurface low filter was added after vertical subsurface flow filter to ensure additional nutrient removal. Outflow and connections from constructed wetland into recipient Rozkoš were preserved (JAMIprojekt 2013).

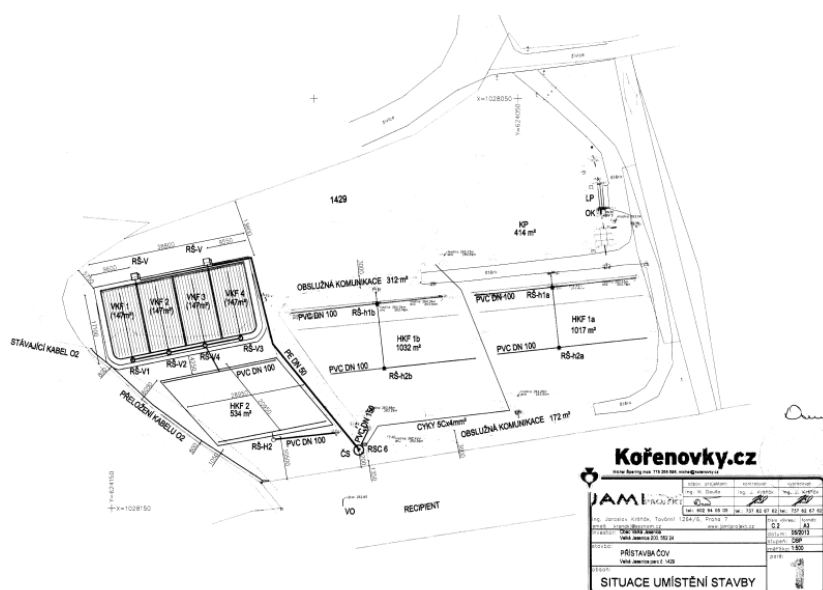

Figure 15: CW intensification - overall situation (JAMIprojekt 2013).

10.3.2 Investment and operating costs

Construction cost in 1995 of constructed wetland Velká Jesenice amounted to 6,750,000 CZK. Costs incurred for intensification come to 5,697,984 CZK. Construction itself, including VAT in 2015 cost 5,141,730.26 CZK.

Operating cost for 2015 amounted to 138,159 CZK. Operating cost consisted of energy consumption, wages and personnel costs, analyses and constructed wetland maintenance such as grate cleaning (1-3 days interval), „small maintenance” consisting of grate and sand trap cleaning + alternating fields and inspection every 2 weeks, „big maintenance” consisting of sludge pumping and, „small maintenance” once a month and mowing/biomass removal 2x year. In 2021 operating cost amounted to 206,000 CZK (JAMIProjekt 2018, Jeništa 2018).

10.4 Limits for waste water discharge

For the discharge of wastewater into the recipient a permit from the Water Authority of the Czech Republic is strictly required. Indicators for the discharge of wastewater into the recipient are set by *Government Decree No. 401/2015 Coll* listed in *Table 14*. According to *Vaculíková et Zápecová (2009)* The quality of discharged wastewater is given by two values, which is from tkzv. Emission and limit. The emission value is the value of waste water pollution at the entrance to the constructed wetland and the limit value, which is the value of the of waste water pollution leaving from constructed wetland into receiving water.

EO category represents population equivalent with a production of 60g BOD₅ per day. For category below 2 000 EO, it is possible to calculate balance in indicator BOD₅/ kg for calendar year on the inflow to constructed wetland

p- permissible concentration value for the analysis of mixed samples (for N_{inorg} and P_{total} mean values)

m- maximum permissible concentration value for the analysis of simple samples

| Pollution source size (EO) | COD _{Cr} | | BOD ₅ | | TSS | | N-NH ₄ ⁺ | | N _{inorg} | | P _{total} | |
|----------------------------|-------------------|-----|------------------|----|-----|----|--------------------------------|----|--------------------|----|--------------------|---|
| | p | m | p | m | p | m | p | m | p | m | p | m |
| <500 | 150 | 220 | 40 | 80 | 50 | 80 | / | / | / | / | / | / |
| 501- 2 000 | 125 | 180 | 30 | 60 | 35 | 70 | / | / | / | / | / | / |
| 2 001- 1 000 | 120 | 170 | 25 | 50 | 30 | 60 | 15 | 30 | / | / | / | / |
| 10 001- 100 000 | 90 | 130 | 20 | 40 | 25 | 50 | / | / | 15 | 2 | 2 | 6 |
| >100 000 | 75 | 125 | 15 | 30 | 20 | 40 | / | / | 30 | 20 | 1 | 3 |

Table 14: Limits of discharged wastewater (mg / l) according to *Government Decree No. 401/2015 Coll*.

| Pollution source size (EO) | COD _{CR} | BOD ₅ | N-NH ₄ ⁺ | N _{celk} | P _{celk} |
|----------------------------|-------------------|------------------|--------------------------------|-------------------|-------------------|
| <500 | 70 | 80 | - | - | - |
| 501- 2 000 | 70 | 80 | 50 | - | - |
| 2 001- 10 000 | 75 | 85 | 60 | - | 70 |
| 10 001- 100 000 | 75 | 85 | - | 70 | 80 |
| >100 000 | 75 | 85 | - | 70 | 80 |

Table 15: Emission standards- permissible minimum cleaning efficiency in percentage (minimal percentage of removal efficiency) according to *Government Decree No. 401/2015 Coll*.

10.4.1 Limits according to water authorities

For municipality Spálené Poříčí, relevant water authority is a municipal authority of the environmental department Blovice. For municipality Velká Jesenice, relevant water authority is municipal authority of the environmental department Náchod. Municipal authorities Blovice and Náchod determine the permissible amount of pollution discharged wastewater in accordance with government regulation altogether with regard to the opinion of the stream administrator and river basin manager. Set limits are given in *Table 16, 17, 18.* for CW Spálené Poříčí and in *Table 19, 20, 21, 22.* for CW Velká Jesenice.

10.4.1.1 Limits set by the water authority Blovice

| | BOD ₅ (mg/l) | COD _{cr} (mg/l) | TSS (mg/l) | N-NH ₄ ⁺ (mg/l) |
|---------|----------------------------|-----------------------------|---------------|--|
| average | 25 | 70 | 20 | 20 |
| maximum | 30 | 120 | 30 | 30 |

Table 16: Limits set for permissible amount of pollution in discharged wastewater for CW in Spálená Poříčí according to water authority for period 1992- 2019.

| | Average (mg/l) | Maximum (mg/l) | t/year |
|-------------------------------------|-------------------|-------------------|--------|
| BOD₅ | 25 | 30 | 2,6 |
| COD_{cr} | 70 | 120 | 7,3 |
| TSS | 20 | 30 | 2,1 |
| N-NH₄⁺ | 20 | 40 | 2,1 |
| P_{total} | monitored | | |

Table 17: Limits set for permissible amount of pollution in discharged wastewater for CW in Spálená Poříčí according to water authority for period in trial operation in 2020.

| | Average (mg/l) | Maximum (mg/l) | Kg/year |
|-------------------------------------|-------------------|-------------------|----------|
| BOD₅ | 10 | 30 | 702,6 |
| COD_{cr} | 40 | 140 | 2.810,50 |
| TSS | 10 | 30 | 702,6 |
| N-NH₄⁺ | 10 | 20 | 702,6 |
| P_{total} | 1 | 5 | 70,3 |

Table 18: Actual limits set for permissible amount of pollution in discharged wastewater for CW in Spálená Poříčí according to water authority since 2021.

10.4.1.2 Limits set by water authority Náchod

| | Emission limit (mg/l) | t/year |
|-------------------------------------|------------------------------|---------------|
| BOD₅ | 25 | 0,75 |
| COD_{cr} | 120 | 3,7 |
| TSS | 33,3 | 1,04 |
| N-NH₄⁺ | 40 | 1,175 |

Table 19: Limits set for permissible amount of pollution in discharged wastewater for CW in Velká Jesenice according to water authority for period 2000- 2005.

| | Average (mg/l) | Maximum (mg/l) | t/year |
|-------------------------|-----------------------|-----------------------|---------------|
| BOD₅ | 15 | 30 | 0,3 |
| COD_{cr} | 60 | 100 | 1,6 |
| TSS | 15 | 30 | 0,5 |

Table 20: Limits set for permissible amount of pollution in discharged wastewater for CW in Velká Jesenice according to water authority for period 2005- 2014.

| | Average (mg/l) | Maximum (mg/l) | t/year |
|-------------------------------------|-----------------------|-----------------------|---------------|
| BOD₅ | 250 | 360 | 7,4 |
| COD_{cr} | 6 | 120 | 1,7 |
| TSS | 80 | 140 | 2,4 |
| N-NH₄⁺ | 50 | 100 | 1,5 |

Table 21: Limits set for permissible amount of pollution in discharged wastewater for CW in Velká Jesenice according to water authority for period of trial operation in 2015.

| | Average (mg/l) | Maximum (mg/l) | t/year |
|-------------------------------------|-----------------------|-----------------------|---------------|
| BOD₅ | 125 | 180 | 5,06 |
| COD_{cr} | 30 | 60 | 1,2 |
| TSS | 40 | 70 | 1,62 |
| N-NH₄⁺ | 20 | 40 | 1,175 |

Table 22: Actual limits set for permissible amount of pollution in discharged wastewater for CW in Velká Jesenice according to water authority since 2016.

10.5 Wastewater samples

For CW Velká Jesenice sampling and processing is carried out by an accredited laboratory AGROS CS a.s. For this bachelor thesis results of analyses were provided by mayor of Velká Jesenice Ing. Petr Jeništa. These results of wastewater analyses are for period 2000- 2021.

For CW Spálené Poříčí sampling and processing is carried out by an accredited laboratory DEKONTA a.s. For this thesis results of analyses were provided by Ing. Petr Pelikán 1992- 2017, Ing. Jaroslav Slavík 2018- 2020 and for year 2021 by Ing. Tereza Hnátková Ph.D.

Sampling is carried out by an authorised person from DEKONTA a.s in an overflow into a control shaft from a free beam of overflowing water (i.e., mixed two- hour samples poured from eight equal volume parts taken at intervals of 15 minutes). Frequency of sampling is set by water authority as 12x year, see *Table 23*.

From *Table 14* can be seen that for constructed wetlands in category up to 2 000 EO, to which CW Spálené Poříčí and Velká Jesenice belongs, *NV č.401/2015 Sb* monitoring of N_{total} , P_{total} and TOC is not mandatory. However, water authorities Náchod and Blovice decided to monitor P_{total} in addition to the monitored indicators according to the *NV č.401/2015 Sb*.

At constructed wetland Velká Jesenice, samples of wastewater are regularly taken by authorised person from DEKONTA a.s 1 time per month at the outlet and 1 time in 3 months samples are taken at inflow and in the filter bed. *Table 24* shows that according to the number of samples taken, it is a category of 8- 16 samples.

| Velikost zdroje znečištění (EO) ¹⁾ | Typ vzorku ²⁾ | BSK ₅ | CHSK _{Cr} | NL | N-NH ₄ ⁺ | N _{celk} | P _{celk} | TOC |
|---|--------------------------|------------------|--------------------|----|--------------------------------|-------------------|-------------------|-----|
| < 500 ⁴⁾ | A ³⁾ | 4 | 4 | 4 | - | - | - | - |
| 500 – 2 000 | A ³⁾ | 12 | 12 | 12 | 12 | - | - | - |
| 2 001 – 10 000 | B ³⁾ | 12 | 12 | 12 | 12 | 12 | 12 | - |
| 10 001 – 100 000 | C | 26 | 26 | 26 | 26 | 26 | 26 | - |
| > 100 000 | C | 52 | 52 | 52 | 52 | 52 | 52 | 52 |

Table 23: Minimum annual frequency of sampling discharged wastewater (*NV č.401/2015 Sb.*).

| Celkový počet vzorků | Přípustný počet nevyhovujících vzorků |
|----------------------|---------------------------------------|
| 4 – 7 | 1 |
| 8 – 16 | 2 |
| 17 – 28 | 3 |
| 29 – 40 | 4 |
| 41 – 53 | 5 |
| 54 – 67 | 6 |
| 68 – 81 | 7 |

Table 24: Permissible number of samples exceeding the specified emission limits depending on total number of samples (*NV č.401/2015 Sb.*).

11. RESULTS

11.1 Biochemical oxygen demand - BOD₅

The average annual concentration of BOD₅ measured at inflow and outflow with annual removal efficiency over the years at CW Spálené Poříčí and Velká Jesenice are shown in *Table 25*.

KČOV Spálené Poříčí

For whole period 1992-2021 concentration of BOD₅ in the inflow ranges from 8.2 - 174.5 mg / l with an average annual concentration of 69.2 mg / l. The outflow in the effluent ranges from 3-13.9 mg / l with an average annual concentration of 82.9 mg / l.

The average annual cleaning efficiency of BOD₅ through whole period of its operation ranges from 48,8% to 96,1% with 82,9% of average for period 1992-2021. After intensification average annual removal efficiency for period 2020- 2021 reached 90.3% see *Figure 18, Annex no. 3*.

As can be seen in *Figure 16* The maximum set value of 30 mg / l by the water authority was not exceeded during the entire period of operation.

Constructed wetland Velká Jesenice

For biochemical oxygen demand municipality Náchod set the current limits for BOD₅. Of 180 mg/l as maximum value. Concentration of BOD₅ varies in wide range. At inflow the annual concentration in monitored period ranges from 33 to 1 030.3 mg/l with an average annual concentration for period 2000- 2021 of 220.6 mg/l and at outflow from 5 to 24.5 mg/l with an average annual concentration for the entire reporting period of 12.6 mg/l. *Figure 17* shows that maximum limit set by water authority was not exceeded in period 2000- 2021. Efficiency of constructed wetland Velká Jesenice for BOD₅ removal is 60.3 %- 98.6% see in *Figure 18*. Average efficiency in removing BOD₅ for reporting period is 89.7%. After intensification average annual removal efficiency for period 2015-2021 reached 96.3%.

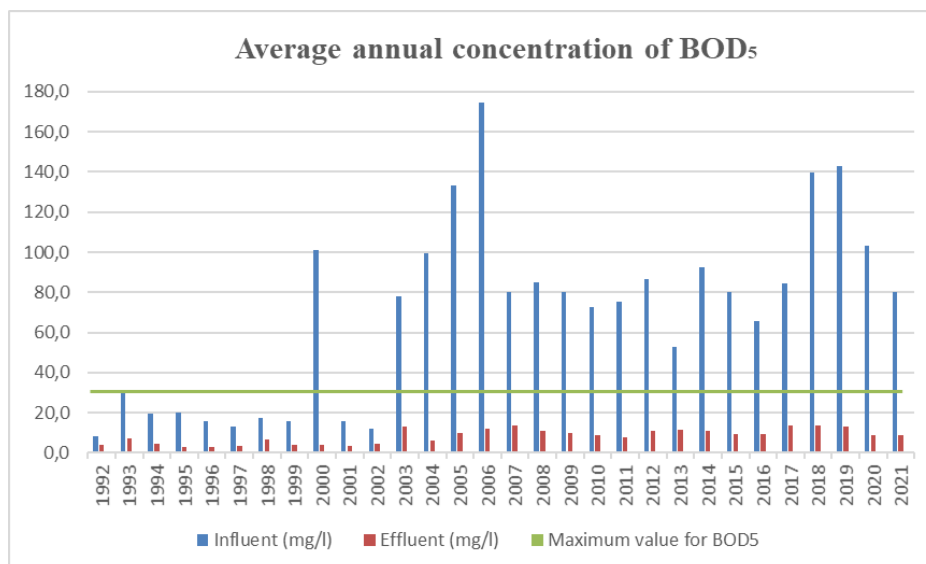

Figure 16: Average annual concentration of BOD₅ (mg/l) at CW Spálené Poříčí 1992-2021 with maximum limit of 30 mg/l BOD₅ set by water authority for CW Spálené Poříčí (Hnátková 2022, Pelikán 2022, Slavík 2022).

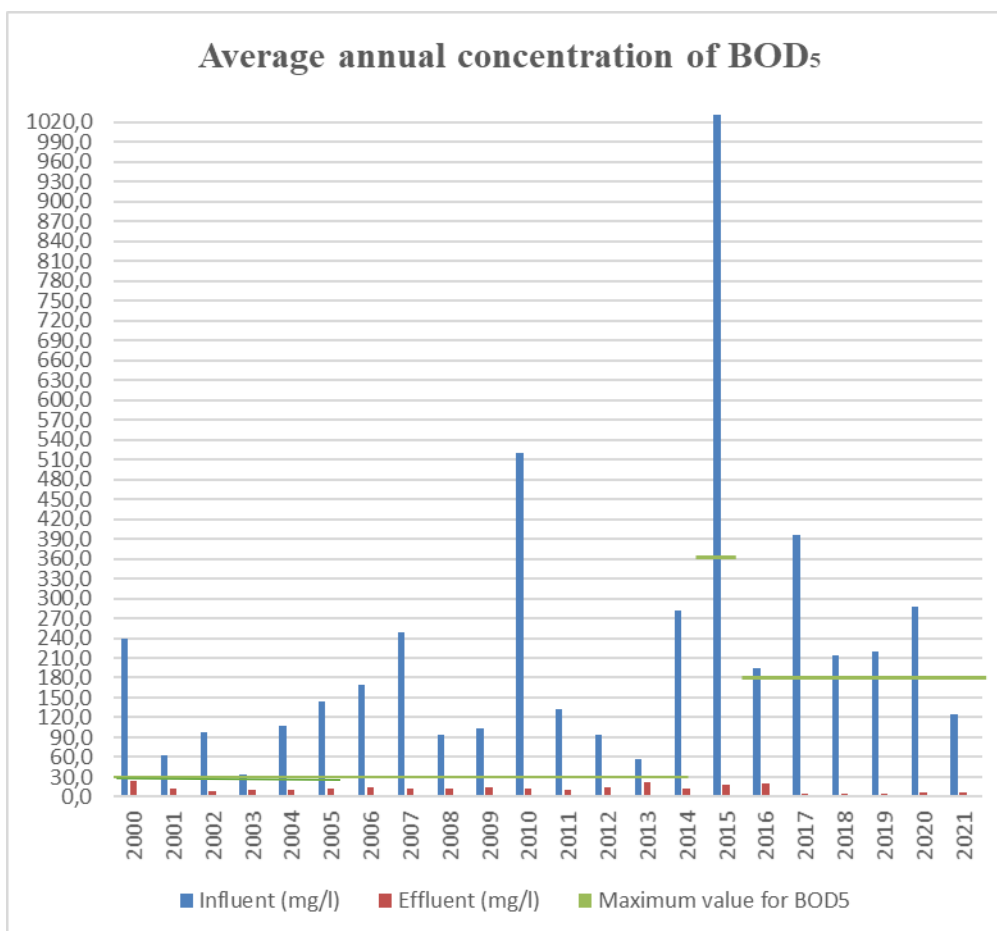

Figure 17: Average annual concentration of BOD₅ (mg/l) at CW Velká Jesenice 2000-2021 in comparison with maximal limits set by water authority through years 2000- 2021 (Jeništa 2022).

| | Spálené Poříčí | | | Velká Jesenice | | |
|----------------|--------------------|--------------------|----------------------------|--------------------|--------------------|----------------------------|
| | Influent (mg/l) | Effluent (mg/l) | Removal efficiency % | Influent (mg/l) | Effluent (mg/l) | Removal efficiency % |
| 1992 | 8,2 | 4,2 | 48,8 | | | |
| 1993 | 30,2 | 7,3 | 75,8 | | | |
| 1994 | 19,6 | 4,4 | 77,6 | | | |
| 1995 | 20,0 | 3,1 | 84,5 | | | |
| 1996 | 15,8 | 3,0 | 81,0 | | | |
| 1997 | 13,1 | 3,6 | 72,5 | | | |
| 1998 | 17,6 | 6,8 | 61,4 | | | |
| 1999 | 15,9 | 3,9 | 75,5 | | | |
| 2000 | 101,0 | 3,9 | 96,1 | 239,0 | 24,5 | 89,7 |
| 2001 | 15,8 | 3,7 | 76,6 | 63,0 | 13,0 | 79,4 |
| 2002 | 12,0 | 4,3 | 64,2 | 98,0 | 8,0 | 91,8 |
| 2003 | 77,8 | 13,1 | 83,2 | 33,0 | 10,0 | 69,7 |
| 2004 | 99,4 | 6,3 | 93,7 | 108,0 | 11,0 | 89,8 |
| 2005 | 133,5 | 9,9 | 92,6 | 145,0 | 13,0 | 91,0 |
| 2006 | 174,5 | 11,8 | 93,2 | 170,0 | 15,0 | 91,2 |
| 2007 | 80,2 | 13,6 | 83,0 | 248,5 | 13,0 | 94,8 |
| 2008 | 85,1 | 11,0 | 87,0 | 94,3 | 13,0 | 86,2 |
| 2009 | 80,2 | 9,7 | 87,9 | 104,0 | 15,0 | 85,6 |
| 2010 | 72,4 | 8,7 | 88,0 | 519,0 | 13,0 | 97,5 |
| 2011 | 75,3 | 7,8 | 89,6 | 132,5 | 11,0 | 91,7 |
| 2012 | 86,4 | 10,9 | 87,4 | 93,5 | 14,0 | 85,1 |
| 2013 | 52,6 | 11,5 | 78,1 | 58,0 | 23,0 | 60,3 |
| 2014 | 92,3 | 10,8 | 88,3 | 282,0 | 13,0 | 95,4 |
| 2015 | 80,4 | 9,2 | 88,6 | 1030,3 | 18,8 | 98,2 |
| 2016 | 65,7 | 9,3 | 85,8 | 193,8 | 20,5 | 89,4 |
| 2017 | 84,3 | 13,6 | 83,9 | 396,0 | 5,5 | 98,6 |
| 2018 | 139,9 | 13,9 | 90,1 | 213,0 | 5,0 | 97,7 |
| 2019 | 142,9 | 13,2 | 90,8 | 220,0 | 5,0 | 97,7 |
| 2020 | 103,3 | 9,0 | 91,3 | 288,0 | 7,0 | 97,6 |
| 2021 | 80,1 | 8,6 | 89,3 | 124,0 | 6,0 | 95,2 |
| average | 69,2 | 8,3 | 82,9 | 220,6 | 12,6 | 89,7 |
| min. | 8,2 | 3,0 | 48,8 | 33,0 | 5,0 | 60,3 |
| max. | 174,5 | 13,9 | 96,1 | 1030,3 | 24,5 | 98,6 |

Table 25: Average annual concentration of BOD₅ at influent and effluent with average annual removal efficiency through years 1992-2021 (Hnátková 2022, Jeništa 2022, Pelikán 2022, Slavík 2022).

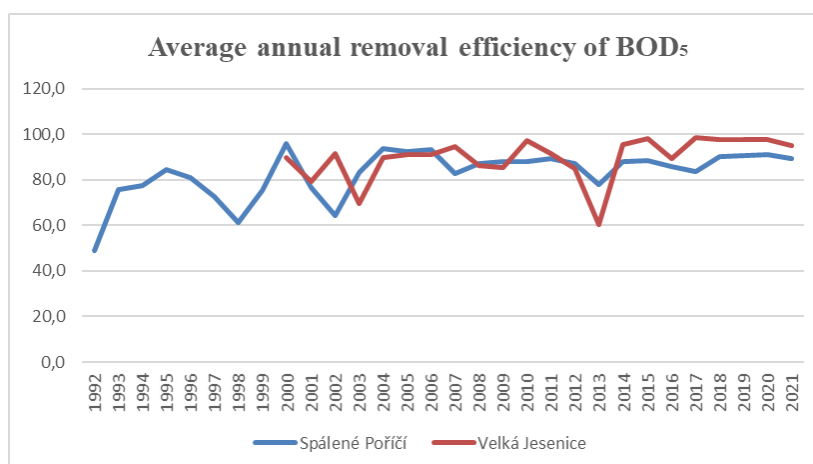

Figure 18: Average efficiency of BOD₅ removal at CW Spálené Poříčí and CW Velká Jesenice 1992-2021 expressed in % (Hnátková 2022, Jeništa 2022, Pelikán 2022, Slavík 2022).

11.2 Chemical oxygen demand - COD_{Cr}

The average annual concentration of COD_{Cr} measured at inflow and outflow with annual removal efficiency over the years at CW Spálené Poříčí and Velká Jesenice are shown in *Table 26*.

Spálené Poříčí

Data used for this graph are from the years 1993-2021. As can be seen, the data from 1992, 1996, 1997 could not be evaluated. In these years, COD_{Cr} was not determined, only COD_{Mn}.

This method, due to its lower values, cannot be comparable to the dichromate method. The set maximum limit for the output concentration of COD_{Cr} was not exceeded during the entire CW operation.

Concentration of COD_{Cr} in the inflow ranges from 47 – 302.8 mg / l with an average annual concentration of 146.8 mg / l. The outflow in the effluent ranges from 19-68.4 mg / l with an average annual concentration of 40.7 mg / l. The maximum value of 125 mg / l given for period 1992-2020 and new maximum value 140 mg/l set by the water authority for CW Spálené Poříčí since 2021 was not exceeded for the entire period of operation see *Figure 19*.

Average annual COD_{Cr} cleaning efficiency of constructed wetland ranges from 46,2% to 90,6% with average annual removal efficiency for period 1992-2021 being 68.1%. After intensification the average annual removal efficiency for period 2020- 2021 reached 83.5% see in *Figure 21*.

Velká Jesenice

The maximum value for concentration of discharged controlled substances according to water authority for CW Velká Jesenice for period 2000- 2014 was 125 mg/l of COD_{Cr}. This value was since 2015 lowered to 60 mg/l. As can be seen in *Figure 20* average annual concentration of COD_{Cr} at influent vary from 84.0 mg/l to 2,198.3 mg/l with an average 454.5 mg/l. The average annual concentration at effluent ranges from 18.4 to 110 mg/l with average annual concentration in period 2000-2021 being 51.4 mg/l.

The average annual COD_{Cr} removal efficiency as can be seen in *Figure 21* is varying 35.5-97.4%. The average annual removal efficiency of CW Velká Jesenice for whole period of operation 2000-2021 is 80.4%. After intensification the average annual removal efficiency for period 2015- 2021 reached 92.8%.

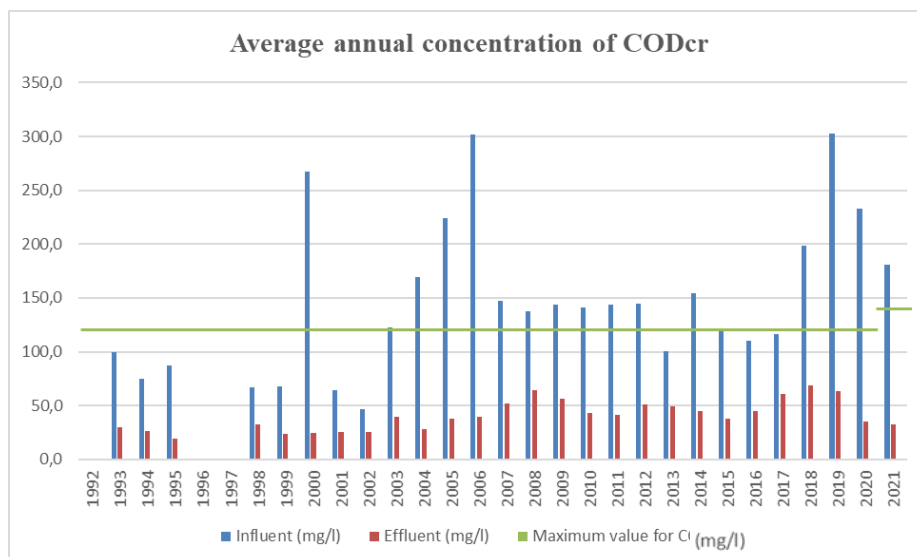

Figure 19: Average annual concentration of COD_{Cr} (mg/l) at CW Spálené Poříčí 2000-2021 in comparison with maximal limits set by water authority through years 2000- 2021 (Hnátková 2022, Pelikán 2022, Slavík 2022).

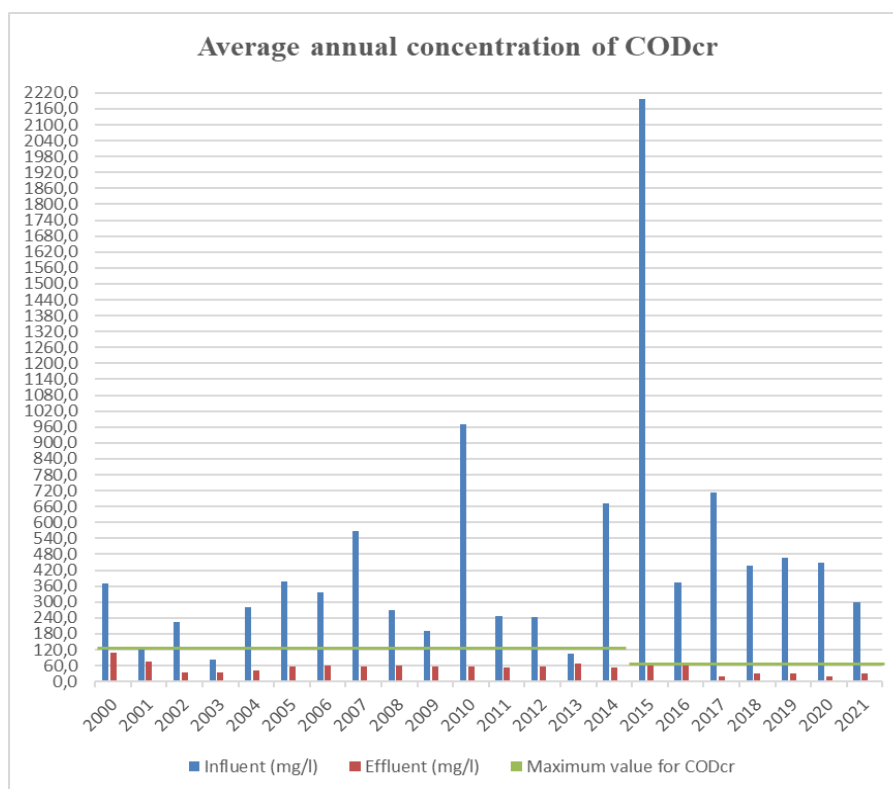

Figure 20: Average annual concentration of COD_{Cr} (mg/l) at CW Velká Jesenice 2000-2021 in comparison with maximal limits set by water authority through years 2000- 2021 (Jeništa 2022).

| | Spálené Poříčí | | | Velká Jesenice | | |
|----------------|--------------------|--------------------|----------------------------|--------------------|--------------------|----------------------------|
| | Influent (mg/l) | Effluent (mg/l) | Removal efficiency % | Influent (mg/l) | Effluent (mg/l) | Removal efficiency % |
| 1992 | | | | | | |
| 1993 | 99,2 | 29,6 | 70,2 | | | |
| 1994 | 75,0 | 26,0 | 65,3 | | | |
| 1995 | 87,0 | 19,0 | 78,2 | | | |
| 1996 | | | | | | |
| 1997 | | | | | | |
| 1998 | 67,0 | 32,9 | 50,9 | | | |
| 1999 | 68,0 | 23,8 | 65,0 | | | |
| 2000 | 267,0 | 25,0 | 90,6 | 369,0 | 110,0 | 70,2 |
| 2001 | 64,0 | 25,8 | 59,7 | 126,0 | 75,0 | 40,5 |
| 2002 | 47,0 | 25,3 | 46,2 | 224,0 | 36,0 | 83,9 |
| 2003 | 122,2 | 39,5 | 67,7 | 84,0 | 36,0 | 57,1 |
| 2004 | 169,5 | 28,2 | 83,4 | 281,0 | 41,0 | 85,4 |
| 2005 | 224,3 | 38,2 | 83,0 | 378,0 | 55,0 | 85,4 |
| 2006 | 302,0 | 39,5 | 86,9 | 337,0 | 59,0 | 82,5 |
| 2007 | 147,0 | 51,5 | 65,0 | 566,0 | 57,0 | 89,9 |
| 2008 | 138,0 | 64,2 | 53,5 | 268,0 | 59,0 | 78,0 |
| 2009 | 144,0 | 56,7 | 60,6 | 190,0 | 58,0 | 69,5 |
| 2010 | 141,0 | 43,2 | 69,4 | 969,8 | 57,0 | 94,1 |
| 2011 | 143,3 | 41,6 | 71,0 | 247,3 | 52,0 | 79,0 |
| 2012 | 144,4 | 50,7 | 64,9 | 242,3 | 58,0 | 76,1 |
| 2013 | 100,5 | 48,9 | 51,3 | 107,0 | 69,0 | 35,5 |
| 2014 | 154,3 | 44,8 | 71,0 | 673,0 | 53,0 | 92,1 |
| 2015 | 119,0 | 38,1 | 68,0 | 2198,3 | 64,5 | 97,1 |
| 2016 | 110,3 | 45,1 | 59,1 | 374,5 | 66,8 | 82,2 |
| 2017 | 116,1 | 60,8 | 47,6 | 714,0 | 18,4 | 97,4 |
| 2018 | 198,3 | 68,4 | 65,5 | 438,0 | 29,0 | 93,4 |
| 2019 | 302,8 | 63,5 | 79,0 | 466,0 | 29,0 | 93,8 |
| 2020 | 232,8 | 34,8 | 85,1 | 448,0 | 19,0 | 95,8 |
| 2021 | 180,5 | 32,9 | 81,8 | 298,0 | 29,0 | 90,2 |
| average | 146,8 | 40,7 | 68,1 | 454,5 | 51,4 | 80,4 |
| min. | 47,0 | 19,0 | 46,2 | 84,0 | 18,4 | 35,5 |
| max. | 302,8 | 68,4 | 90,6 | 2198,3 | 110,0 | 97,4 |

Table 26: Average annual concentration of COD_{Cr} at influent and effluent with average annual removal efficiency through years 1992-2021 (Hnátková 2022, Jeništa 2022, Pelikán 2022, Slavík 2022).

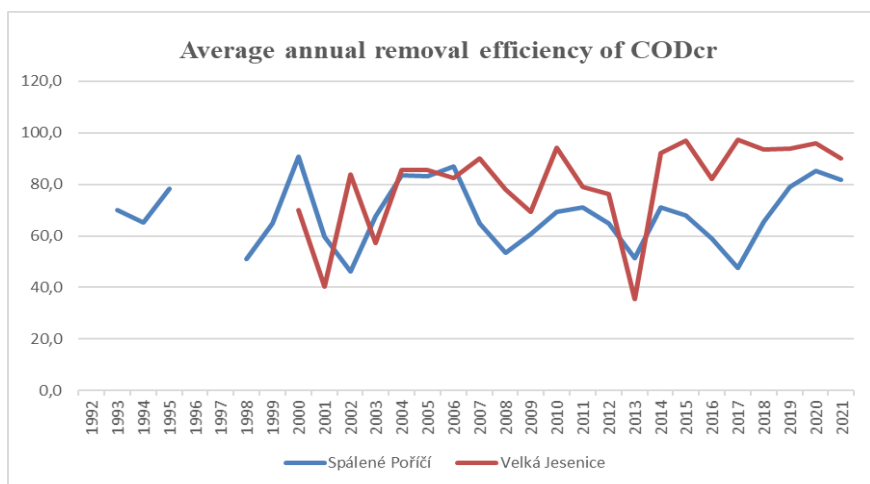

Figure 21: Average efficiency of COD_{Cr} removal at CW Spálené Poříčí and CW Velká Jesenice 1992-2021 expressed in % (Hnátková 2022, Jeništa 2022, Pelikán 2022, Slavík 2022).

11.3 Total suspended solids- TSS

The average annual concentration of TSS measured at inflow and outflow with annual removal efficiency over the years at CW Spálené Poříčí and Velká Jesenice are shown in *Table 27*.

Spálené Poříčí

The concentration of TSS in the inflow ranges from 7.8 - 312 mg / l with an average annual concentration of 57.9 mg / l. The concentration in the effluent ranges from 2.5 to 15.8 mg / l with an average annual concentration of 6.5 mg / l. The maximum value of 30 mg / l set by the water authority was not exceeded during the entire period of operation as can be seen in *Figure 22*.

Largest increase in the concentration of undissolved substances during the measurement was recorded in 2000. Reason was the number of connections of new inhabitants to CW. During this year, use of CW increased to 600 EO. The values of the TSS concentration in the effluent decrease.

During the observed period, the average cleaning efficiency of TSS of constructed wetland vary from 33.1% to 95.4%. The average annual removal efficiency for period 1992-2021 is 81.5% viz. *Figure 24*. After intensification the average annual removal efficiency for period 2020- 2021 reached 79.5% see in *Figure 24*.

Velká Jesenice

Value for maximal limit set by water authority for CW Velká Jesenice for period 2000-2005 was 33.3 mg/l. Since then, the maximal limit decreased to 30 mg/l of TSS. This value was increased in 2015 up to 140 mg/l and then since 2016 decreased to 70 mg/l. As can be seen in *Figure 23* average annual concentration of TSS at influent vary from 23 mg/l to 908.5 mg/l with an average 196.8 mg/l. The average annual concentration at effluent ranges from 10.9 to 33 mg/l with average annual concentration in period 2000-2021 being 17 mg/l.

The average annual TSS removal efficiency as can be seen in *Figure 24* is varying 39.1-97.1%. The average annual removal efficiency of CW Velká Jesenice for whole period of operation 2000-2021 is 83.6%. After intensification the average annual removal efficiency for period 2015- 2021 reached 94.3%.

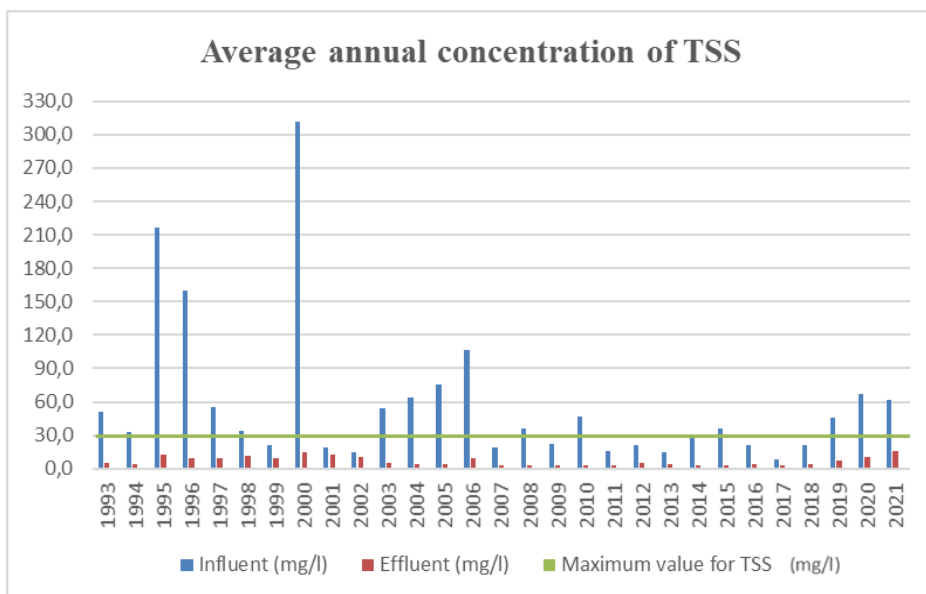

Figure 22: Average annual concentration of suspended solids – TSS at CW Spálené Poříčí 1992-2021 with maximal value for TSS set by water authority (Hnátková 2022, Pelikán 2022, Slavík 2022).

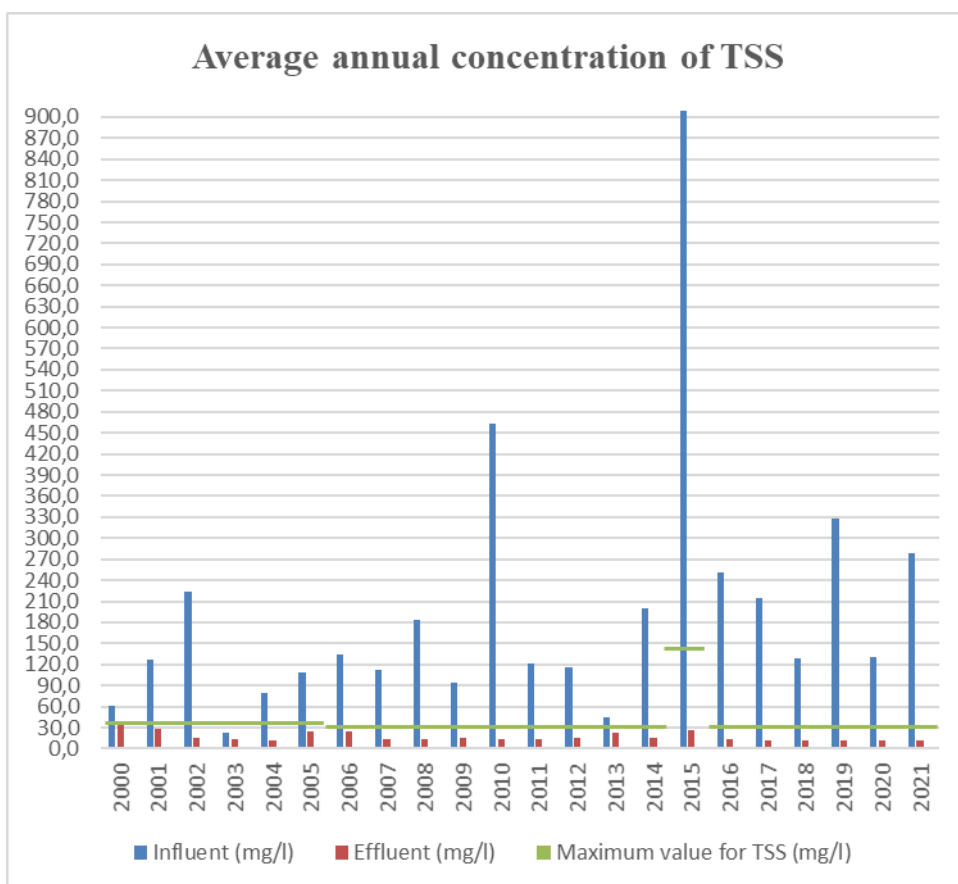

Figure 23: Average annual concentration of total suspended solids-TSS (mg/l) at CW Velká Jesenice 2000-2021 in comparison with maximal limits set by water authority through years 2000- 2021 (Jeništa 2022).

| | Spálené Poříčí | | | Velká Jesenice | | |
|----------------|--------------------|--------------------|----------------------------|--------------------|--------------------|----------------------------|
| | Influent (mg/l) | Effluent (mg/l) | Removal efficiency % | Influent (mg/l) | Effluent (mg/l) | Removal efficiency % |
| 1993 | 51,3 | 5,5 | 89,3 | | | |
| 1994 | 33,3 | 4,3 | 87,1 | | | |
| 1995 | 216,0 | 12,2 | 94,4 | | | |
| 1996 | 160,0 | 8,9 | 94,4 | | | |
| 1997 | 55,0 | 9,0 | 83,6 | | | |
| 1998 | 33,4 | 11,4 | 65,9 | | | |
| 1999 | 21,5 | 8,8 | 59,1 | | | |
| 2000 | 312,0 | 14,3 | 95,4 | 61,0 | 33,0 | 45,9 |
| 2001 | 19,3 | 12,0 | 37,8 | 126,0 | 28,0 | 77,8 |
| 2002 | 14,8 | 9,9 | 33,1 | 224,0 | 16,0 | 92,9 |
| 2003 | 54,5 | 5,0 | 90,8 | 23,0 | 14,0 | 39,1 |
| 2004 | 63,4 | 4,0 | 93,7 | 79,0 | 12,0 | 84,8 |
| 2005 | 75,7 | 3,6 | 95,2 | 108,0 | 24,0 | 77,8 |
| 2006 | 106,3 | 8,8 | 91,7 | 134,0 | 25,0 | 81,3 |
| 2007 | 18,6 | 2,8 | 84,9 | 112,0 | 13,0 | 88,4 |
| 2008 | 36,5 | 2,5 | 93,2 | 183,0 | 14,0 | 92,3 |
| 2009 | 22,3 | 2,7 | 87,9 | 94,0 | 15,0 | 84,0 |
| 2010 | 46,5 | 2,8 | 94,0 | 463,0 | 14,0 | 97,0 |
| 2011 | 16,2 | 2,6 | 84,0 | 121,5 | 14,0 | 88,5 |
| 2012 | 20,8 | 5,0 | 76,0 | 116,0 | 15,0 | 87,1 |
| 2013 | 14,3 | 3,6 | 74,8 | 45,0 | 23,0 | 48,9 |
| 2014 | 28,2 | 2,8 | 90,1 | 200,0 | 15,0 | 92,5 |
| 2015 | 35,8 | 2,8 | 92,2 | 908,5 | 26,3 | 97,1 |
| 2016 | 21,1 | 3,8 | 82,0 | 251,0 | 14,3 | 94,3 |
| 2017 | 7,8 | 2,5 | 67,9 | 214,5 | 10,9 | 94,9 |
| 2018 | 21,3 | 3,8 | 82,2 | 128,0 | 12,0 | 90,6 |
| 2019 | 46,1 | 7,6 | 83,5 | 328,0 | 12,0 | 96,3 |
| 2020 | 66,8 | 10,2 | 84,7 | 131,0 | 12,0 | 90,8 |
| 2021 | 61,2 | 15,8 | 74,2 | 279,0 | 11,0 | 96,0 |
| average | 57,9 | 6,5 | 81,5 | 196,8 | 17,0 | 83,6 |
| min. | 7,8 | 2,5 | 33,1 | 23,0 | 10,9 | 39,1 |
| max. | 312,0 | 15,8 | 95,4 | 908,5 | 33,0 | 97,1 |

Table 27: Average annual concentration of TSS at influent and effluent with average annual removal efficiency through years 1992-2021 (Hnátková 2022, Jeništa 2022 Pelikán 2022, Slavík 2022).

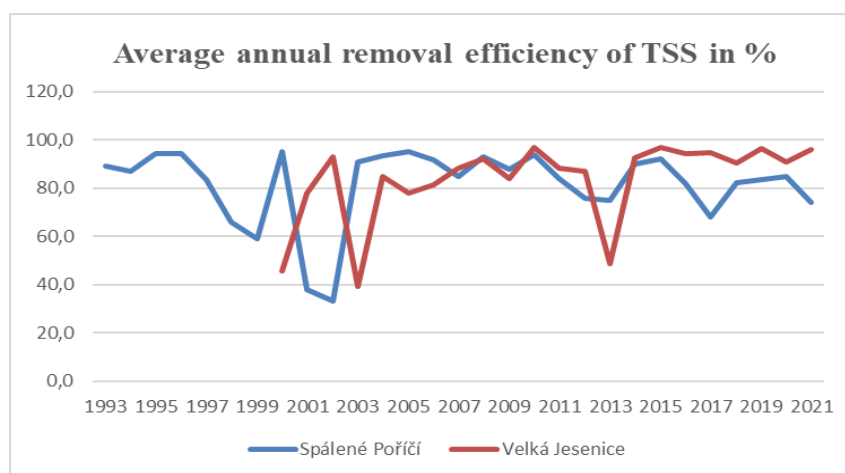

Figure 24: Average annual efficiency of suspended solids – TSS removal at CW Spálené Poříčí and CW Velká Jesenice in the years 1992-2021 expressed in % (Hnátková 2022, Jeništa 2022 Pelikán 2022, Slavík 2022).

11.4 Ammonia - N-NH₄⁺

The average annual concentration of N-NH₄⁺ measured at inflow and outflow with annual removal efficiency over the years at CW Spálené Poříčí and Velká Jesenice are shown in *Table 28*.

Removal efficiency of N-NH₄⁺ is dependable on the sufficient supply of oxygen. Due to the previous construction of the, it was not possible to sufficiently remove ammoniacal nitrogen.

Spálené Poříčí

Despite the low cleaning efficiency, the set maximum limits by water authority viz. *Figure 25*, 30 mg/l for period 2000-2019. This value was later increased up to 40 mg/l for year 2020 and following year 2021 lowered to 20 mg/l. N-NH₄⁺ concentrations at CW effluent were never exceeded. As can also be seen, after intensification in period 2020- 2021, CW was able to purify ammoniacal nitrogen with an average efficiency of 66.1%.

Concentration of N-NH₄⁺ in the inflow ranges from mg / l, with an average annual concentration of mg / l. Concentration in the effluent ranges from mg / l with an average annual concentration of mg / l.

For the observed period 1992-2020, the average annual removal efficiency of N-NH₄⁺ of constructed wetland Spálené Poříčí varied from -48.7 to 69.9. with an average of 19.5% see in *Figure 27*.

Velká Jesenice

The maximum value for concentration of discharged controlled substances according to water authority for CW Velká Jesenice for period 2000- 2014 was 40 mg/l of N-NH₄⁺. This value was increased in 2015 up to 100 mg/l and the in following year lowered back to 40 mg/l. In years 2004, 2006, 2007, 2008, 2009 and 2014 as can be seen in *Figure 26* maximum limit was breached. This may be due to filter bed being significantly anaerobic and thus the ammonification process predominates over nitrification/denitrification.

As can be seen in *Figure 26* average annual concentration of N-NH₄⁺ at influent vary from 17 mg/l to 149 mg/l with an average 54.3 mg/l. The average annual concentration at effluent ranges from 1 to 67.7 mg/l with average annual concentration in period 2000-2021 being 28.9 mg/l.

As can also be seen, after intensification in period 2015- 2021, CW was able to purify ammoniacal nitrogen with an average efficiency of 77%.

The average annual N-NH₄⁺ removal efficiency as can be seen in *Figure 27* is varying -67.8- 98.4%. The average annual removal efficiency of CW Velká Jesenice for whole period of operation 2000-2021 is 26.7%.

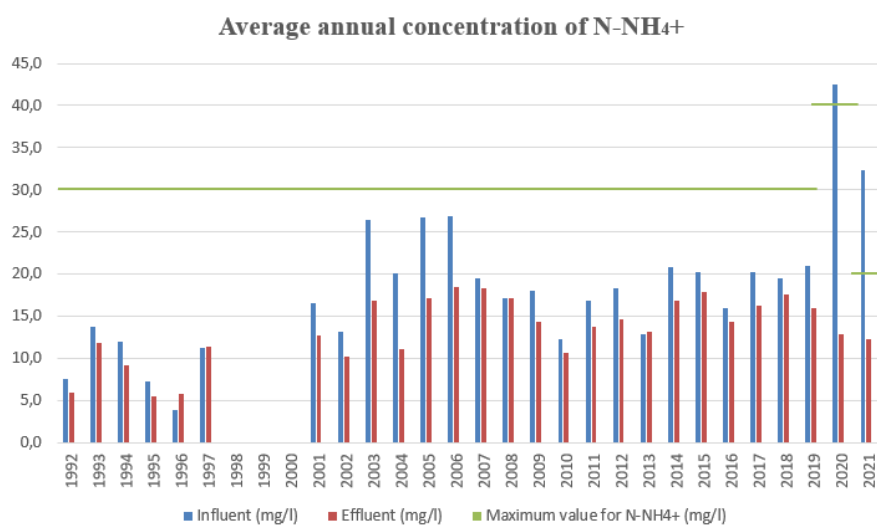

Figure 25: Average annual concentration of $N-NH_4^+$ (mg/l) at CW Spálené Poříčí 2000-2021 in comparison with maximal limits set by water authority through years 2000- 2021 (Hnátková 2022, Pelikán 2022, Slavík 2022).

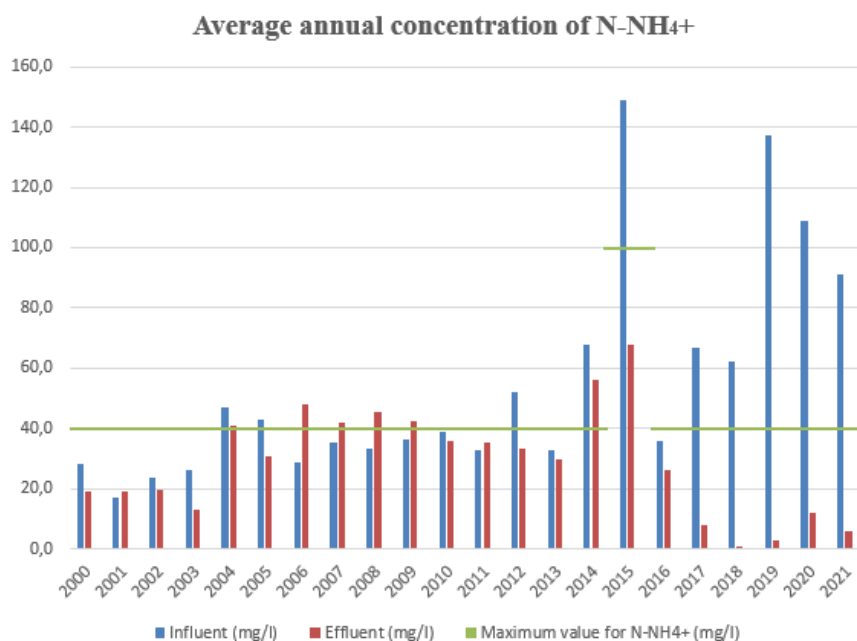

Figure 26: Average annual concentration of $N-NH_4^+$ (mg/l) at CW Velká Jesenice 2000-2021 in comparison with maximal limits set by water authority through years 2000- 2021 (Jeništa 2022).

| | Spálené Poříčí | | | Velká Jesenice | | |
|----------------|-----------------|-----------------|----------------------|-----------------|-----------------|----------------------|
| | Influent (mg/l) | Effluent (mg/l) | Removal efficiency % | Influent (mg/l) | Effluent (mg/l) | Removal efficiency % |
| 1992 | 7,6 | 5,9 | 22,4 | | | |
| 1993 | 13,7 | 11,9 | 13,1 | | | |
| 1994 | 12,0 | 9,2 | 23,3 | | | |
| 1995 | 7,3 | 5,5 | 24,7 | | | |
| 1996 | 3,9 | 5,8 | -48,7 | | | |
| 1997 | 11,2 | 11,4 | -1,8 | | | |
| 1998 | | | | | | |
| 1999 | | | | | | |
| 2000 | | | | 28,1 | 19,3 | 31,3 |
| 2001 | 16,5 | 12,7 | 23,0 | 17,0 | 19,2 | -12,9 |
| 2002 | 13,2 | 10,2 | 22,7 | 23,6 | 19,6 | 16,9 |
| 2003 | 26,4 | 16,8 | 36,4 | 26,3 | 12,9 | 51,0 |
| 2004 | 20,1 | 11,1 | 44,8 | 47,0 | 41,0 | 12,8 |
| 2005 | 26,7 | 17,1 | 36,0 | 43,0 | 31,0 | 27,9 |
| 2006 | 26,8 | 18,5 | 31,0 | 28,6 | 48,0 | -67,8 |
| 2007 | 19,5 | 18,3 | 6,2 | 35,4 | 41,8 | -18,1 |
| 2008 | 17,1 | 17,1 | 0,0 | 33,3 | 45,7 | -37,2 |
| 2009 | 18,0 | 14,4 | 20,0 | 36,5 | 42,6 | -16,7 |
| 2010 | 12,2 | 10,7 | 12,3 | 38,9 | 35,7 | 8,7 |
| 2011 | 16,8 | 13,7 | 18,5 | 32,7 | 35,1 | -7,3 |
| 2012 | 18,3 | 14,7 | 19,7 | 51,9 | 33,1 | 36,2 |
| 2013 | 12,8 | 13,2 | -3,1 | 33,0 | 30,0 | 6,1 |
| 2014 | 20,8 | 16,9 | 18,8 | 68,0 | 56,0 | 17,6 |
| 2015 | 20,2 | 17,9 | 11,4 | 149,0 | 67,7 | 45,7 |
| 2016 | 15,9 | 14,4 | 9,4 | 35,8 | 26,0 | 27,4 |
| 2017 | 20,3 | 16,3 | 19,7 | 67,0 | 8,0 | 87,3 |
| 2018 | 19,5 | 17,6 | 9,7 | 62,0 | 1,0 | 98,4 |
| 2019 | 21,0 | 16,0 | 23,8 | 137,0 | 3,0 | 97,8 |
| 2020 | 42,5 | 12,8 | 69,9 | 109,0 | 12,0 | 89,0 |
| 2021 | 32,3 | 12,2 | 62,2 | 91,0 | 6,0 | 93,4 |
| average | 18,2 | 13,4 | 19,5 | 54,3 | 28,9 | 26,7 |
| min. | 3,9 | 5,5 | -48,7 | 17,0 | 1,0 | -67,8 |
| max. | 42,5 | 18,5 | 69,9 | 149,0 | 67,7 | 98,4 |

Table 28: Average annual concentration of $N-NH_4^+$ at influent and effluent with average annual removal efficiency through years 1992-2021 (Hnátková 2022, Jeništa 2022, Pelikán 2022, Slavík 2022).

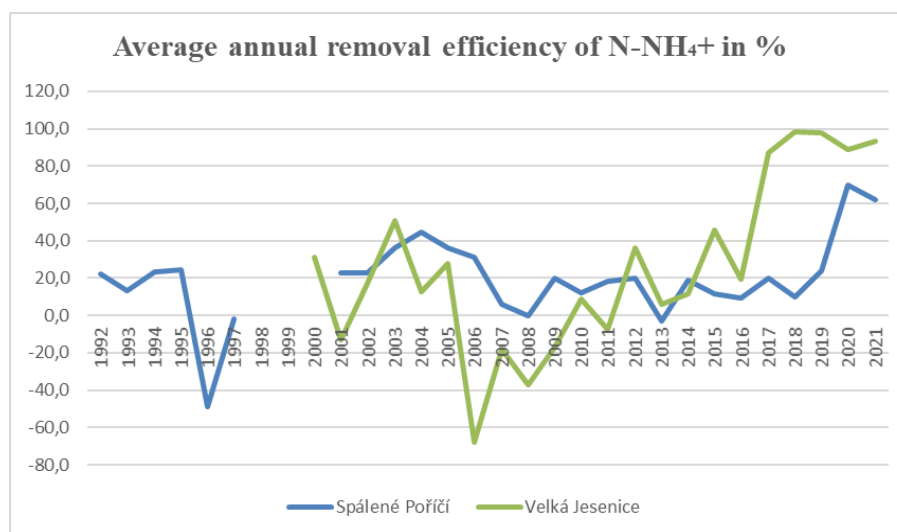

Figure 27: Average annual removal efficiency of $N-NH_4^+$ at CW Spálené Poříčí and CW Velká Jesenice 1992-2021 expressed in %. (Hnátková 2022, Jeništa 2022, Pelikán 2022, Slavík 2022).

11.5 Phosphorus - P

The average annual concentration of P measured at inflow and outflow with annual removal efficiency over the years at CW Spálené Poříčí and average annual concentration of P measured at outflow with annual removal efficiency through period 2012- 2021 at CW Velká Jesenice are shown in *Table 29*.

The government regulation does not set any outflow limits for constructed wetlands up to 2000 EO, however some constructed wetlands provide data on phosphorus concentrations at outflow, or even inflow. After intensification of CW Spálené Poříčí in 2021 water authority Blovice set maximum limit for 5 mg/l of P_{total} at effluent.

Spálené Poříčí

For the observed period 1992-2021, the concentration of P in the inflow ranges from 1.4 - 4.8 mg / l with an average annual concentration of 2.7 mg / l.

The concentration at effluent ranges from 1.2 to 3.27 mg / l with an average annual concentration of 2.2 mg / l. From the observed period, the average efficiency of phosphorus removal of constructed wetland is 13.8%. As can be seen in *Figure 28* low phosphorus removal efficiency is due to the low phosphorus content at inflow.

The results for the years 2020-2021 were performed on the CW after its intensification. They point to the effective phosphorus removal from wastewater. The average annual removal efficiency in this period reached 49.5% as can be seen in *Figure 30*.

Velká Jesenice

As can be seen in *Figure 29* average annual concentration at effluent ranges from 1.5 mg/l to 7 mg/l with average annual concentration in period 2012-2021 being 4.4 mg/l.

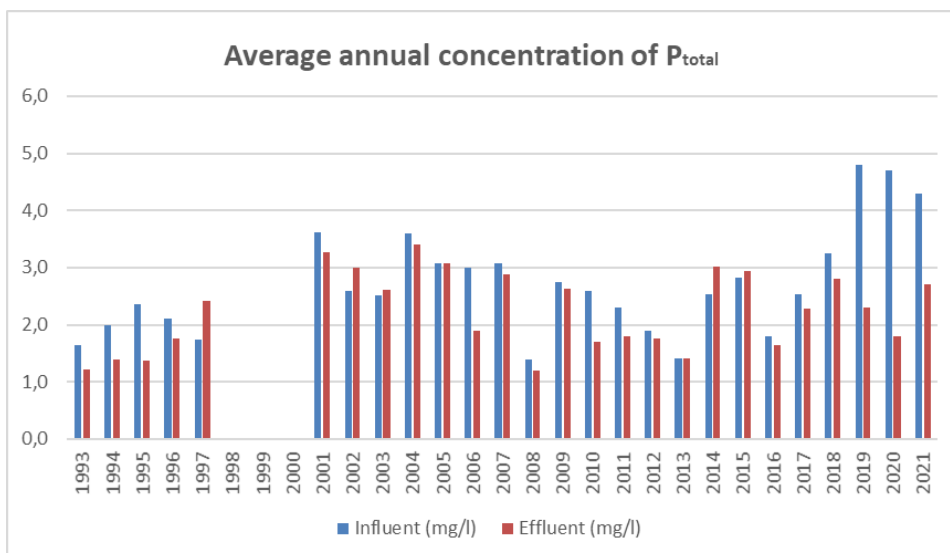

Figure 28: Average annual phosphorus concentration at CW Spálené Poříčí 1992-2021 (Hnátková 2022, Pelikán 2022, Slavík 2022).

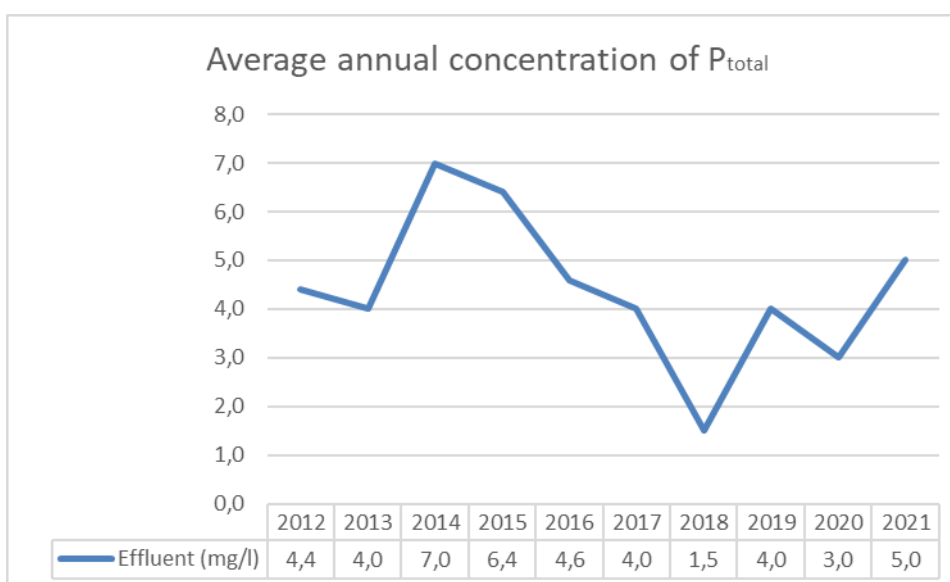

Figure 29: Average annual phosphorus concentration at CW Velká Jesenice 2012-2021 (Jeništa 2022).

| | Spálené Poříčí | | | Velká Jesenice | | |
|----------------|--------------------|--------------------|----------------------------|--------------------|--------------------|----------------------------|
| | Influent (mg/l) | Effluent (mg/l) | Removal efficiency % | Influent (mg/l) | Effluent (mg/l) | Removal efficiency % |
| 1993 | 1,6 | 1,2 | 26,2 | | | |
| 1994 | 2,0 | 1,4 | 30,5 | | | |
| 1995 | 2,4 | 1,4 | 41,5 | | | |
| 1996 | 2,1 | 1,8 | 16,2 | | | |
| 1997 | 1,7 | 2,4 | -39,1 | | | |
| 1998 | | | | | | |
| 1999 | | | | | | |
| 2000 | | | | | | |
| 2001 | 3,6 | 3,3 | 9,7 | | | |
| 2002 | 2,6 | 3,0 | -15,4 | | | |
| 2003 | 2,5 | 2,6 | -3,9 | | | |
| 2004 | 3,6 | 3,4 | 5,6 | | | |
| 2005 | 3,1 | 3,1 | 0,4 | | | |
| 2006 | 3,0 | 1,9 | 36,7 | | | |
| 2007 | 3,1 | 2,9 | 6,3 | | | |
| 2008 | 1,4 | 1,2 | 14,3 | | | |
| 2009 | 2,7 | 2,6 | 3,6 | | | |
| 2010 | 2,6 | 1,7 | 34,6 | | | |
| 2011 | 2,3 | 1,8 | 21,7 | | | |
| 2012 | 1,9 | 1,8 | 7,4 | | 4,4 | |
| 2013 | 1,4 | 1,4 | 0,0 | | 4,0 | |
| 2014 | 2,5 | 3,0 | -18,9 | | 7,0 | |
| 2015 | 2,8 | 2,9 | -3,5 | | 6,4 | |
| 2016 | 1,8 | 1,6 | 8,9 | | 4,6 | |
| 2017 | 2,5 | 2,3 | 10,2 | | 4,0 | |
| 2018 | 3,3 | 2,8 | 13,8 | | 1,5 | |
| 2019 | 4,8 | 2,3 | 52,1 | | 4,0 | |
| 2020 | 4,7 | 1,8 | 61,7 | | 3,0 | |
| 2021 | 4,3 | 2,7 | 37,2 | | 5,0 | |
| average | 2,7 | 2,2 | 13,8 | | 4,4 | |
| min. | 1,4 | 1,2 | -39,1 | | 1,5 | |
| max. | 4,8 | 3,4 | 61,7 | | 7,0 | |

Table 29: Average annual concentration of P_{total} at influent and effluent with average annual removal efficiency through years 1992-2021 (Hnátková 2022, Jeništa 2022, Pelikán 2022, Slavík 2022).

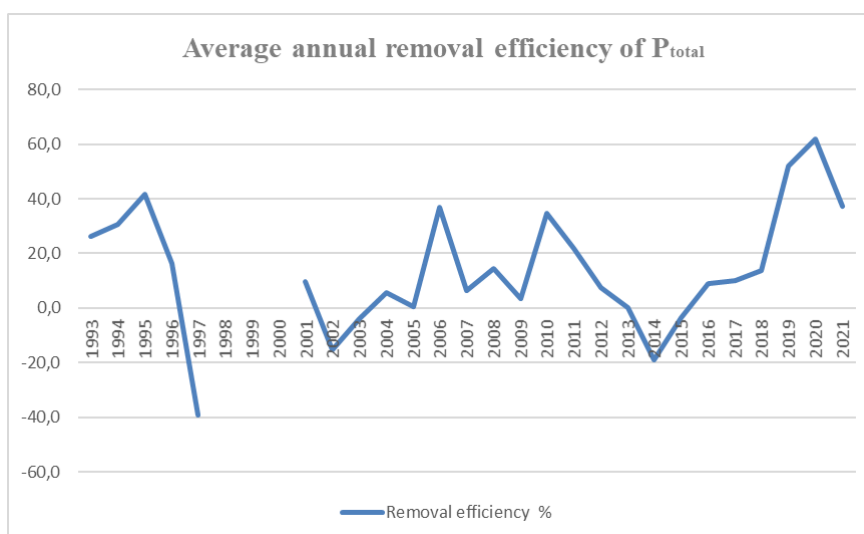

Figure 30: Average annual efficiency of phosphorus removal at CW Spálené Poříčí 1993-2021 (Hnátková 2022, Pelikán 2022, Slavík 2022).

11.6 Removal efficiency of CW Spálené Poříčí and CW Velká Jesenice with other hybrid constructed wetlands

| Arrangement of CW | Locality | EO | BOD ₅ | COD _{cr} | TSS | N-NH ₄ ⁺ | P _{total} | Vegetation | Citation |
|-------------------|--------------------------------|------|------------------|-------------------|------|--------------------------------|--------------------|--|----------------------------|
| VF-HF | Estonia, Paistu | 64 | 91 | / | 78 | 77 | 89 | <i>Phragmites australis</i> | (Öövel M. 2007) |
| VF-HF | Turisia, El Menzah | NA | 85 | 75 | 80 | 70 | / | <i>Phragmites australis</i> , <i>Typha sp.</i> | (Abidi et al. 2009) |
| VF-HF | Spain, Gran Canaria | NA | 86 | 80 | 96 | 88 | 24 | <i>Phragmites australis</i> , <i>Scirpus sp.</i> | Melián H. et al. 2010) |
| HF-VF | Italy, Florence | 140 | 95 | 94 | 84 | 86 | 94 | <i>Phragmites australis</i> | (Masi F. 2007) |
| HF-HF | New Zealand, Hamilton | NA | 98 | / | 96 | 61 | 62 | <i>Baumea articulata</i> , <i>Schoenoplectus tabernaemontani</i> | (Tanner C. C. 2012) |
| VF-HF-VF | Turkey, Gebze | NA | / | / | / | 91 | / | <i>O. Iris sp.</i> , <i>Phragmites sp.</i> | (Tuncsiper B. 2009) |
| HF-HF-VF | New Zealand, Hamilton | NA | 98 | / | 95 | 99 | 45 | <i>Baumea articulata</i> , <i>Baumea articulata</i> , <i>Carex virgata</i> | (Tanner C. C. 2012) |
| HF-VF-HF | Poland, Wilkino | NA | 96.1 | 93.9 | 93.8 | / | / | <i>Phragmites australis</i> | (Tuszyńska A. et al. 2008) |
| HF-VF-HF | Poland, Wieszyno | NA | 86 | 84.5 | 92.2 | / | / | <i>Phragmites australis</i> | (Tuszyńska A. et al. 2007) |
| HF-VF-HF | Czech republic, Velká Jesenice | 670 | 96 | 93 | 94 | 77 | / | <i>Phragmites australis</i> , <i>Phalaris arudinacea</i> | |
| HF-VF-HF | Czech republic, Spálené Poříčí | 1750 | 90 | 84 | 80 | 66 | 50 | <i>Phragmites australis</i> , <i>Phalaris arudinacea</i> | |

Table 30: Average removal efficiencies of combined constructed wetlands (in %). NA- not available (data is not mentioned in the study) data for CW Spálené Poříčí provided by (Hnátková 2022, Slavík 2022) data for CW Velká Jesenice provided by (Jeništa 2022).

According to arrangement of filter beds in constructed wetlands shown in *Table 30*. Average annual removal of Constructed wetland Spálené Poříčí are not high. Even so average annual removal efficiency of total phosphorus reaches up to 50%, but still exceeds that of constructed wetland in Hamilton by 5%.

Constructed wetland Velká Jesenice on the other hand is doing really well. In comparison to others HF-VF-HF systems, constructed wetland Velká Jesenice has best results in TSS removal efficiency of 94%.

Average annual removal efficiency after intensification of CW Spálené Poříčí for period 2020-2021 and CW Velká Jesenice after intensification for period 2015- 2021 is shown with the removal efficiency of 9 foreign CWs with different number of filter fields in series connected. Due to differences such as length of operation, frequency of sampling methods and order of connected filters the comparison is only indicative.

Some studies of constructed wetlands *Abdi et al. (2009)* and *Melián et al. (2010)* are pilot constructed wetlands and in other studies, choice of

filter bed material is not mentioned. Constructed wetlands also differ in chosen vegetation, moreover the individual constructed wetlands are located in various climate zones, which according to *Tunsciper (2009)* influence processes of constructed wetland by their specific weather, i. e. change in degree of evaporation.

12. DISCUSSION

Constructed wetlands are an alternative method of wastewater treatment. Its use is especially suitable in municipalities where it is not possible to connect to public sewerage.

The average efficiency of CW Spálené Poříčí was 82.9% for BOD₅ between 1992 and 2021. According to *Vymazal (2016)*, the national average cleaning efficiency of 84.8%. It can be stated that CW Spálené Poříčí is in the effectiveness of removing BOD₅ below the national average. If we were to divide the time into sections 1992-2019, when it was constructed wetland with horizontal subsurface flowing filters, and for the period 2020-2021, when it was already a hybrid constructed wetland. The average efficiency for the period 1992-2019 would be 82.3%. And for the period 2020-2021 reached 90.3%.

Compared to the national average, the average removal efficiency of BOD₅ CW Velká Jesenice for the period 2000-2021 reaches 89.7% above the national average. When divided into the period before the intensification of 2000-2014 and after the intensification of 2015-2021. The average cleaning efficiency of BOD₅ would be 86.6% for the period 2000-2014. As a hybrid CW Velká Jesenice for the period 2015-2021 reaches 96.3%

Reason for the difference in the efficiency of the two constructed wetlands is the different values recorded on the inflow from unified sewerage. The average value of BOD₅ on the tributary of the CW Spálené Poříčí for the monitored period 1992-2021 is in low values i.e., 69.2 mg/l. On the other hand, the average BOD₅ values in CW Velká Jesenice were on a tributary with an average value of 220.6 mg/l. On the drain, however, the values of both constructed wetlands were close. CW Spálené Poříčí 8.3 mg/l and for CW Velká Jesenice 12.6 mg/l. Average BOD₅ contained in sewerage according to *Groda et al. (2007)* is from 150 to 400 mg/l, any value out of mentioned range can be considered anomalous. Due to these results can be stated, that both constructed wetlands are capable of BOD₅ removal below maximal limits stated by respective water authorities.

The efficiency of COD_{Cr} removal is usually lower than BOD₅ due to chemically difficult to degrade compounds. According to *Groda et al. (2007)* average values in sewage are in the range of 300-800 mg/l, values outside this area can be considered anomalous. Average values on the tributary of 146.8 mg/l and on the outflow of 40.7 mg/l in the CW Spálené Poříčí compared to the average values on the tributary of 454.5 mg/l and the outflow of 51.4 mg/l in the CW Velká Jesenice, it can be stated that compared to the average values of CW Velká Jesenice, average values of the CW Spálené Poříčí on the tributary are significantly lower.

The average efficiency of COD_{Cr} removal on CW Spálené Poříčí for the period 1992-2021 reaches 68.1% compared to the national average of

75.4% according to *Vymazal (2016)*, the average cleaning efficiency is again below the national average. However, if we were to divide the whole period into the period 1992-2019 and 2020-2021, for the period 1992-2019 CW Spálené Poříčí achieved an average cleaning efficiency of 66.9% and 83.5% for the period 2020-2021.

Compared to the national average, the average cleaning efficiency of COD_{Cr} CW Velká Jesenice for the period 2000-2021 with 80.4% is again above the national average. When divided into the period before the intensification of 2000-2014 and after the intensification of 2015-2021. The average COD_{Cr} cleaning efficiency would be 74.6% for the period 2000-2014. As a hybrid CW Velká Jesenice for the period 2015-2021 reaches 92.8%.

According to *Seo et al. (2008)* the main processes involved in the removal of TSS are sedimentation and filtration, most of the suspended solids are retained already behind the entrance to the filter bed. According to *Sayadi et al. (2012)* study hybrid constructed wetlands were effective in suspend solids removal.

The average cleaning efficiency of suspended solids was 81.5% for the period 1992-2021 in constructed wetland Spálené Poříčí and 83.6% for the period 2000-2021 in constructed wetland Velká Jesenice. Compared to the national average of 82.1% according to *Vymazal (2016)*, CW Velká Jesenice was again above the national average compared to CW Spálené Poříčí, slightly below it.

For period 2020-2021 average annual removal efficiency of constructed wetland Spálené Poříčí amounted to 79.5%. CW Velká Jesenice in years 2015-2021 reached 94.3%. If divided into period 1992- 2019, when it was constructed wetland with horizontally subsurface flowed filters, average annual removal efficiency of CW Spálené Poříčí 81.6% and in CW Velká Jesenice 75.6%.

This difference in the efficiency of both constructed wetlands is due to the difference in the number of suspended solids on the inflow, while in the CW Spálené Poříčí the average values were 57.9 mg/l inflow and 6.5 mg/l on the outflow. On the tributary of CW Velká Jesenice the average values were 196.8 mg/l and on the outflow 17 mg/l. According to *Groda et al. (2007)* the average concentration of TSS in sewage reaches 370 mg/l. The reason for the lower values may be due to the dilution of wastewater by rainwater on the inflow through a uniform sewer.

According to *Šereš et al. (2021)* N-NH₄⁺ removal is one of most important advantages of hybrid systems. In years 2020- 2021 average annual removal reached 66.1%, while for CW Velká Jesenice in period 2015-2021 average annual removal of N-NH₄⁺ reaches 77%. Results are significantly lower in comparison to of 91% N-NH₄⁺ removal in study of HSSF-VSSF-HSSF system done by *Obarska-Pempkowiak et Gajevska (2003)*. Those results remain however significantly higher, than those obtained on traditional

horizontal sub-surface flow constructed wetland Spálené Poříčí in 1992- 2019 – 15.7% and 3.2% for constructed wetland Velká Jesenice in 2000- 2014. Removal of NH_4^+ was according to *Chen et al. (2022)* mainly affected by the temperature of the wastewater and the amount of dissolved oxygen needed for nitrification. Its increase can be influenced by adding an aeration

Compared to the national average of removal of N-NH_4^+ 30.4%, according to *Vymazal (2016)*, as can be seen both monitored constructed wetland Spálené Poříčí for the period 1992-2021 was 19.5% and constructed wetland Velká Jesenice 2000-2021 was 26.7%, they are below the national average. It can therefore be stated that after intensification, the constructed wetlands of Spálená Poříčí and Velká Jesenice were able to effectively remove ammonia pollution.

Constructed wetland Spálené Poříčí combine activation part of WWTP with vertical pulse sprayed filter with recirculation. Activation part of WWTP was added into constructed wetland Spálené Poříčí due to its previous construction, which did not reach sufficient aerobic processes and it was not possible to replenish it naturally. According to *Bilgin et al. (2014)* study suggested this as a possible alternative for pharmaceutical residues treatment.

Phosphorus is degraded from wastewater mainly by sorption of phosphates onto the substrate of the vegetation field. However, the sorption capacity is limited and after some time it is necessary to replace the filter cartridge. The efficiency of phosphorus removal from wastewater could only be assessed for constructed wetland Spálené Poříčí, only effluent concentrations were available for constructed wetland Velká Jesenice.

Average efficiency of phosphorus removal in constructed wetland Spálené Poříčí for the period 1992-2021 was 13.8%. Average phosphorus value 2.7 mg/l on inflow with an average value of 2.2 mg/l in outflow. For the period 1992-2019, this figure reached 10.8% compared to the period after intensification 2020-2021 when average efficiency reached 49.5%. The average phosphorus concentration at the CW Velká Jesenice using slag as final treatment, effluent was 4.4 mg/l.

According to *Józwiakowski et al. (2018)* study the efficiency of phosphorus removal can be influenced by a combination of different fields. Study showed 10 different hybrid constructed wetlands in Poland capable of around 89% average phosphorus removal with concentrations on inlet between 8.2-39.8 mg/l and 0.1- 11.3 mg/l. With data from period 2020-2021, constructed wetland Spálené Poříčí average phosphorus removal was 49.5% with phosphorus concentration of inlet 4.3- 4.7 mg/l and of 1,8- 2.7 mg/l in effluent.

During expansion of CW Spálené Poříčí in 2001, phosphorus precipitation was included in the comb shaft, but *Chladová (2017)* stated in her work that it was missing in the pre-treatment. For this reason, it is not

possible to define an exact period for evaluating the effectiveness of this type of phosphorus removal from wastewater.

Removal of N-NH₄⁺ can be increased by using a material with a high sorption capacity, such as dolomite. An alternative material could be biochar. According to study by *Ji et al. (2020)* benefits of granular biochar with sufficient mechanical strength used in lab- scale constructed wetlands with different systems showed that if incorporated into gravel based constructed wetland increased P removal in N₂O flux reduction and was able to adsorb N₂O for subsequent biotic consumption and showed efficient nutrient removal.

13. CONCLUSION

By comparing the above-mentioned constructed wetlands Spálené Poříčí and Velká Jesenice, it was found that the treatment effects of both constructed wetlands were very acceptable and meet the legislative requirements. During the test operations, there were no major problems and both of them can be stated as functional.

In both constructed wetlands treated wastewaters were diluted with rainwater. Especially in the constructed wetland Spálené Poříčí those concentrations were much lower than the national average. Even then average annual removal efficiency for constructed wetland Spálené Poříčí 1992- 2021 was BOD₅ 82. 9%, COD_{Cr}68.1%, TSS 81.5%, N-NH₄⁺ 19.5%, P_{total} 13.8%. For period 1992- 2019 as constructed wetland with horizontal subsurface flow has been BOD₅ 82. 3%, COD_{Cr} 66.9%, TSS 81.6%, N-NH₄⁺ 15.7%, P_{total} 10.8% and as hybrid constructed wetland with activation part of WWTP and vertical pulse sprayed filter for period 2020-2021 was BOD₅ 90. 3%, COD_{Cr} 83.5%, TSS 79.5%, N-NH₄⁺ 66.1%, P_{total} 49.5%.

Average annual removal efficiency for constructed wetland Velká Jesenice 2000- 2021 was BOD₅ 89. 7%, COD_{Cr} 80.4%, TSS 83.6%, N-NH₄⁺ 26.7%. For period 2000- 2014 as constructed wetland with horizontal subsurface flow has been BOD₅ 86. 6%, COD_{Cr} 74.6%, TSS 75.6%, N-NH₄⁺ 3.2% and as hybrid constructed wetland 2015-2021 was BOD₅ 96. 3%, COD_{Cr} 92.8%, TSS 94.3%, N-NH₄⁺ 77%.

Results in years 2004, 2006, 2007, 2008, 2009, 2014 for N-NH₄⁺ concentrations on effluent of constructed wetland Velká Jesenice did not meet the concentration limits given by the water authorities as constructed wetland Velká Jesenice was dimensioned as horizontal subsurface flow constructed wetland. Constructed wetland Spálené Poříčí meet the concentration limits given by the water authorities. Both constructed wetlands comply with legislation according to Government Decree No. 401/2015 Coll.

In terms of financial costs, it is evident that the total investment costs of the two constructed wetlands were different. However, this difference depends on the technological demands of constructed wetlands. In simple constructed wetlands with a horizontally subsurface flow filter, technologies are replaced by natural processes. Constructed wetland Spálené Poříčí after intensification electrical connection was brought to supply the activation part of the conventional treatment plant and supported by a pulse-sprinkled vertical filter and constructed wetland Velká Jesenice, which was equipped with pumping wells with two pumps and the possibility of connecting additional aeration.

Previous configuration of constructed wetland Spálené Poříčí with horizontal subsurface flow filter did not reach sufficient aerobic processes, together with limited area for constructed wetland, the intensification was

solved differently than in constructed Velká Jesenice and it was thus proceeded to add the activation part of the conventional treatment plant into constructed wetland Spálené Poříčí. Introduction of this technology turned out to be a financially cheaper option than building a conventional wastewater treatment plant. Which represents the use of a suitable combination of filter fields and technology for nutrient removal supported by results.

However, due to sampling at the inflow and outflow from the constructed wetland, only the efficiency of the entire constructed wetland was obtained and it was not possible to determine the exact amount of the impact of the activation part of the conventional treatment plant in such a system on the resulting removal efficiency. In order to verify function of activating part of conventional plant in combination with vertical pulse sprayed filter in constructed wetland Spálené Poříčí samples should be taken in more parts, then on inlet and effluent, as such assessment does not take into consideration more complex systems. To verify function of activating part of conventional plant with vertical pulse sprayed filter it would be desirable to take samples on inlet, entrance to vertical pulse sprayed filter and on effluent.

14. CITATIONS

ABIDI, S., KALLALI, H., JEDIDI, N., BOUZAIANE, O., HASSEN, A., 2009: Comparative pilot study of the performances of two constructed wetland wastewater treatment hybrid systems. *Desalination* 246, 370–377(online) [cit. 2021.03.22], available from <<https://doi.org/10.1016/j.desal.2008.03.061>>

ACT NO. 544/2020 COLL., Act amending Act No. 254/2001 Coll., on Water and on The Amendment of Certain Acts (Water Act), as amended, and other related acts

AERTS R., CHAPIN F. S., 2000: The mineral nutrition of wild plants revisited: a reevaluation of processes and patterns. *Advances in Ecological Research*, 30, 1-67.

ANDERSSON J.L., BASTVIKEN S.K., TONDERSKI K.S., 2005: Free water surface wetlands for wastewater treatment in Sweden- nitrogen and phosphorus removal. *Wat. Sci. Tech.* 51:39-46

ANONYMOUS 1, 2016: Hybridní kořenové čistírny odpadních vod. (online) [cit. 2021.03.22], available from <https://www.dekonta.cz/files/uploads/Hybridni_korenove_cistirny_o>

ARIAS C.A., DEL BUBBA M., BRIX H., 2001: Phosphorus removal by sands for use as media in subsurface flow constructed reed beds. *Water Research*, 35, 1159-1168.

ASANO T., BURTIN FL., LEVERENZ HL., TSUCHIHASHI R., TCHOBANOGLOUS G., 2007: *Water reuse: issues, technologies, and applications*. MacGraw-Hill, New York. ISBN: 9780071459273

ASHBOT N.J., GRABOW W. O. K., SNOZZI M., 2001: Indicators of microbial water quality. In: Fewtrell L., Bartram J. (eds) *Water quality: guidelines, standards and health*. IWA Publishing, World Health Organization, London (online) [cit. 2021.03.22], available from

AYAZ S. C., AKTAS O., FINDIK N., AKCA L., 2012b.: Phosphorus removal and effect of adsorbent type in a constructed wetland system. *Desalination and water treatment* 37, 152-159. (online) [cit. 2021.03.22], available from

BAHLO K. E., WACH F. G., 1990: Purification of Domestic Sewage With and without faeces by Vertical Intermittent Filtration in Reed and Rush Beds. *Constructed Wetlands in Water Pollution Control* (Adv. Wat. Pollut. Control no. 11) Pergamon Press, Oxford, pp. 215- 221

BATTY L.C., YOUNGER P.L., 2004: Growth of *Phragmites australis* (Cav.) Trin ex. Steudel in mine water treatment wetlands: effects of metal and nutrient uptake. *Environmental Pollution*, 132, 85-93.

BENEŠ, J., 2009: Kořenové čistírny odpadních vod. Evidence a hodnocení existujících KČOV v ČR. MTP ČR, v tisku.

BIELEFELDT A. R., 2009: Water Treatment, Industrial. Academic press. Encyclopedia of Microbiology (Third edition). pp. 569-586 (online) [cit. 2021.03.22], available from <<https://www.sciencedirect.com/science/article/pii/B97801237394450>>

BILGIN M., SIMSEK I., TULUN S., 2014: Treatment of domestic wastewater using a lab-scale activated sludge/vertical flow subsurface constructed wetlands by using *Cyperus alternifolius*. Ecological engineering, volume 70. pp. 362-365 (online) [cit. 2021.03.22], available from <<https://www.sciencedirect.com/science/article/pii/S0925857414002857?via%3Dihub>>

BRASKERUD B.C., 2001: The influence of vegetation on sedimentation and resuspension of soil particles in small constructed wetlands. J. Environ. Qual. 4

BRIX H., 1987: Treatment of Wastewater in the Rhizosphere of Wetland Plants – The Root Zone Method, Wat. Sci. Tech. Vol 19, Rio, pp. 107-118. (online) [cit. 2021.03.22], available from <https://www.researchgate.net/profile/Hans-Brix/publication/230563359_Treatment_of_Wastewater_in_the_Rhiz>

BRIX H., 2003: Plants used in constructed wetlands and their functions. Department of Plant Ecology, Institute of Biological Sciences, University of Aarhus, Denmark, 30 s. (online) [cit. 2021.03.22], available from <https://www.researchgate.net/publication/230563384_Plants_used_in_constructed_wetlands_and_their_functions>

CIBULKA A., 2007: JUNCUS EFFUSUS L. – sítina rozkladitá / sitina rozložitá (online) [cit. 2021.03.22], available from <<https://botany.cz/cs/juncus-effusus/>>

COWARDIN, L. M. et al., 1979: Classification of Wetlands and Deepwater Habitas of the United States. U. S. Fisch and Wildlife Service Publ. FWS/OBS79/31, Washington, D. C

ČSN 75 6401: Čistírny odpadních vod pro ekvivalentní počet obyvatel (EO) více než 500. Český normalizační institut, Praha, 2014. 40s.

ČSN 75 6402: Čistírny odpadních vod do 500 ekvivalentních obyvatel. Úřad pro technickou normalizaci, metrologii a státní zkušebnictví, Praha, 2017. 32 s.

ČSN 73 6005 Prostorové uspořádání vedení technického vybavení Úřad pro technickou normalizaci, metrologii a státní zkušebnictví, Praha, 2020.36s

ČSN 83 9061 Technologie vegetačních úprav v krajině - Ochrana stromů, porostů a vegetačních ploch při stavebních pracích Úřad pro technickou normalizaci, metrologii a státní zkušebnictví, Praha, 2006. 8s

ČVUT, POLLERT J., 2012: 10- Stabilizační nádrže. Biologické čištění odpadních vod 5s. (online) [cit. 2021.03.22], available from <http://kzei.fsv.cvut.cz/pdf/COV_pr_10.pdf>

DEL BUBBA M., ARIAS C.A., BRIX H., 2003: Phosphorus absorption maximum of sands for use as media in subsurface flow constructed reed beds as measured by the Langmuir isotherm. *Water Research* 37, 3390–3400.

DREVER J.I., 1988: *The Geochemistry of Natural Waters*. 2nd Edition, Prentice-Hall, Englewood Cliffs, 437 p

DRIZO A., COMEAU Y., FORGET C., CHAPUIS R.P., 2002: Phosphorus saturation potential: a parameter for estimating the longevity of constructed wetland systems. *Environ. Sci. Technol.*, 36 , pp. 4642-4648

DUFOUR A., SNOZZI M., KOSTER W., BARTRAM J., RONCHI E., FEWTRELL L., 2003: *Assessing microbial safety of drinking water: improving approaches and methods*. WHO drinking water quality series, OECD—WHO, Paris, France. IWA Publishing, London (online) [cit. 2021.03.22], available from <https://www.who.int/water_sanitation_health/publications/9241546301/en/>

EDPP.CZ© 2010 – 2021: Spálené Poříčí, povodňový plán města. Charakteristika zájmového území (online) [cit. 2021.03.22], available from <https://www.edpp.cz/spo_charakteristika-zajmoveho-uzemi/>

EILER A., BERTILSSON S., 2004: Composition of freshwater bacterial communities associated with cyanobacterial blooms in four Swedish lakes. *Environ Microbiol* 6:1228–1243 (online) [cit. 2021.03.22], available from <<https://pubmed.ncbi.nlm.nih.gov/15560821/>>

EPA.GOV., 1993: *A Handbook Of Constructed Wetlands A Guide To Creating Wetlands For: Agricultural Wastewater Domestic Wastewater Coal Mine Drainage Stormwater in the Mid-Atlantic Region Volume1*. U.S. Government Printing Office, Washington DC. pp.53. ISBN 0-16- 052999-9

EXTEC S.R.O., 2018: Město Spálené Poříčí- intenzifikace ČOV Elektro, k.ú.: Spálené Poříčí, okres: Plzeň-jih. 76s. "nepublikováno". Dep.: městský úřad Blovice

FAHIM R., LU X., JILANI G., HUSSAIN J., HUSSAIN I., 2019: Comparison of floating-bed wetland and gravel filter amended with limestone and sawdust for sewage treatment. *Environmental Science and Pollution Research* (2019) 26:20400–20410. (online) [cit. 2021.03.22], available from <<https://link.springer.com/article/10.1007%2Fs11356-019-05325-5>>

GARDAVSKÁ A., 2013: *Modelování čištění komunálních odpadních vod*, Masarykova univerzita Institut biostatistiky a analýz LF a PřF MU Centrum

pro výzkum toxických látek v prostředí, Brno 77s. (diplomová práce). „nepublikováno“. Dep. SIC MU v Brně

GELT J. 1997, Constructed Wetlands: Using human integrity, Natural Processes to Treat Water, Build habitat, Arroyo, March, Vol. 9, No. 4 (online) [cit. 2021.03.22], available from <<https://wrrc.arizona.edu/publications/arroyo-newsletter/constructed-wetlands-using-human-ingenuity-natural-processes-treat-wa>>.

GRACZYK T. K., CHALEW T. E., MASCHINSKI Y., LUCY F. E., 2009: Wastewater Treatment (not infectious hazards) . Academic press. Encyclopedia of Microbiology (Third edition), pp. 562-568 (online) [cit. 2021.03.22], available from <<https://www.sciencedirect.com/science/article/pii/B97801237394450>>

GRANIA©: Kořenové čistírny a voda a krajina. (online) [cit. 2021.03.22], available from <<http://grania.cz/>>

GREINER, R. W. A DE JONG, J., 1984: The use of marsh plants for the treatment of wastewater in areas designated for recreation and tourism. Rijksdienst voor de Ijsselmeerpolders, Flavobericht nr. 225, 1. (online) [cit. 2021.03.22], available from <https://puc.overheid.nl/rijkswaterstaat/doc/PUC_85115_31/>

GRODA, B., VÍTĚZ, T., MACHALA, M., FOLLER, J., SURÝNEK, D., MUSIL, J., 2007: Čištění odpadních vod jako nástroj k ochraně životního prostředí v zemědělské praxi a na venkově. Brno, s. 57

HABERL R., 2003: Constructed Wetlands for the Treatment of Organic Pollutants. JSS – J Soils & Sediments 3 (2) 109 – 124. (online) [cit. 2021.03.22], available from <<https://citeseerx.ist.psu.edu/viewdoc/download?doi=10.1.1.464>>

HAMMER D.A., AND BASTIAN R.K., 1989: Wetland Ecosystem Natural Water Purifiers. In Constructed Wetlands for Wastewater Purifiers. In: Hammer, D.A., Ed., Constructed Wetlands for Waste Water Treatment: Municipal, Industrial and Agriculture, Proceedings, First International Conference of Constructed Wetlands for Waste Water Treatment, Chattanooga, 13-17 June 1988, 508-514.

HLAVÍNEK P.2000: Možnosti čištění odpadních vod z malých sídel a obcí, sborník přednášek Luhačovice, NOEL, 73 s.

HLAVÍNEK P., MIČÍN J., PRAX P., 2003: Stokování a čištění odpadních vod. Brno: Akademické nakladatelství CERM, 2003. ISBN 8021425350

HNÁTKOVÁ T., 2022: unpublished results 2021

HOLÝ V., 1994: Projektová dokumentace, Novostavba KČOV. k.ú.: Velká Jesenice, okres:Náchod

HUDCOVÁ T., VYMAZAL J., DUNAJSKÝ M. K. 2013: Reconstruction of a constructed wetland with horizontal subsurface flow after 18 years of operation., *Water Science & Technology* 68(5):1195-202. 8 s. (online) [cit. 2021.03.22], available from <https://www.researchgate.net/publication/256611635_Reconstru>

HYDROEKO, 2001: Provozní a manipulační řád. Kořenová čistírna odpadních vod Spálené Poříčí, městský úřad Spálené Poříčí, okres: Plzeň-jih. 8s. "nepublikováno". Dep.: městský úřad Blovice

HYDROEKO, 2001: Rozšíření KČOV Spálené Poříčí- úprava. Technická zpráva, „městský úřad Spálené Poříčí, okres: Plzeň-jih. 6s. "nepublikováno". Dep.: městský úřad Blovice

CHEN Y., CHENG J., NIU S., KIM Y., 2013: Evaluation of the different filter media in vertical flow stormwater wetland. *Desalin Water Treat* 51:4097–4106. (online) [cit. 2021.03.22], available from<<https://doi.org/10.1080/19443994.2013.781106>>

CHEN X., ZHONG F., CHEN Y., WU J., CHENG S., 2022: The Interaction Effects of Aeration and Plant on the Purification Performance of Horizontal Subsurface Flow Constructed Wetland. *Int. J. Environ. Res. Public Health* 10p. (online) [cit. 2021.03.22], available from<<https://doi.org/10.3390/ijerph19031583>>

CHLADOVÁ B., 2017: Vyhodnocení dlouhodobého provozu kořenové čistírny ve Spáleném Poříčí Česká zemědělská univerzita, Fakulta 62 životního prostředí, Praha. 71 s. (bakalářská práce). „nepublikováno“. Dep. SIC ČZU v Praze

CHMI., 2019: Hydrologický seznam podrobného členění povodí vodních toků ČR. 59-137. (online) [cit. 2021.03.22], available from <http://voda.chmi.cz/opv/doc/hydrologicky_seznam_povodi.pdf>

IKSR CIPR ICBR © 2022 – International Commission for the Protection of the Rhine- Municipal wastewater- (online) [cit. 2021.03.22], available from <<https://www.iksr.org/en/topics/pollution/wastewater/municipal-wastewater>>

IPR AQUA, S.R.O., 2017: Projektová dokumentace pro stavební povolení. Intenzifikace čistírny odpadních vod pro město Spálené Poříčí (přístavba a stavební úprava), s.r.o., k.ú.: Spálené Poříčí, okres: Plzeň-jih. 9s. "nepublikováno". Dep.: městský úřad Blovice

JAMIPROJEKT, 2012: Studie intenzifikace kořenové čistírny odpadních vod v obci Spálené Poříčí., k.ú.: Spálené Poříčí, okres: Plzeň-jih. 7p. "nepublikováno". Dep.: městský úřad Blovice

JAMIPROJEKT, 2013: Studie intenzifikace KČOV Obce Velká Jesenice. . k.ú.: Velká Jesenice, okres:Náchod 8p "nepublikováno". Dep.: městský úřad Náchod

JAMIPROJEKT, 2018: Město Spálené Poříčí - Intenzifikace Čistírny Odpadních Vod (Přístavba a stavební úprava). k.ú.: Spálené Poříčí, okres: Plzeň-jih. 28p. "nepublikováno". Dep.: městský úřad Blovice

JENIŠTA, P., 2019. Kořenová čistírna odpadních vod Velká Jesenice. (online) [cit. 2022.03.29], available from <<https://drive.google.com/file/d/1TjCrI8vvGGKNOJfmGPM5zo20saqbFOp/view>>

JENIŠTA P., 2022: unpublished results 2000- 2021

JI B., CHEN J., MEI J., CHANG J., LI X., JIA W., QU Y., 2020: Roles of biochar media and oxygen supply strategies in treatment performance, greenhouse gas emissions, and bacterial community features of subsurface-flow constructed wetlands, *Bioresource Technology*, 302 , p. 122890 (online) [cit. 2022.03.29], available from <<https://doi.org/10.1016/j.biortech.2020.122890>>

JINDŘICH J., ČERMÁKOVÁ, 2002: Vyhodnocení zkušebního provozu a návrh limitů pro trvalý provoz. Vodohospodářský servis s. r. o, město Spálené Poříčí, 10s. "nepublikováno". Dep.: městský úřad Blovice

JOHANSEN N.H., BRIX H., 1996: Design criteria for a two-stage constructed wetland. *Proceedings of the 5th International Conference on Wetland Systems for Water Pollution Control*, Universität für Bodenkultur Wien, Vienna, Austria. Pp. IX3.1-IX3.8

JOZWIAKOWSKI K., BUGAJSKI P., MUCHA Z., KUREK K., FÁTIMA NUNES CARVALHO M., ALMEIDA A.A., SIWIEC T., BOROWSKI G., CZEKALA W., DACH J., GAHEWSKA M., 2018: Reliability and efficiency of pollution removal during long-term operation of a one-stage constructed wetland system with horizontal flow. *Sep. Purif. Technol.*, 187 , pp. 60-66

JUNGA, Petr, VÍTĚZ T., VÍTĚZOVÁ M., GERŠL M. 2015: Technika pro zpracování odpadů II. Brno,. 78 s. (online) [cit. 2021.03.22], available from <https://web2.mendelu.cz/af_291_projekty/files/23/23-technika_pro_zpracovani_odpadu_2_junga_a.pdf>

JUST, T., FUCHS, P., PÍSAŘOVÁ, M., 2004: Odpadní vody v malých obcích, II. upravené vydání, Ústav pro ekopolitiku, o. p. s., Praha

KADLEC R. H., KNIGHT R. L., 1996: *Treatment Wetlands*. Lewis Publishers, Boca Raton, 893 p

KNOWLES R., 1982: Denitrification. *Microbiological reviews* 46p. 43-70

KOČKOVÁ A KOL., 1994: Vegetační kořenové čistírny odpadních vod. Česká zemědělská tiskárna, Praha, 67 s. ISBN 80-7084-104-4

KOUŘIL, M., 2006: Kořenové čistírny, Alternativní způsob nakládání s odpadními vodami. DAPHNE ČR, České Budějovice, 24. ISBN 80- 86778-22-3.

KRÁSA P., 2008: *TYPHA ANGUSTIFOLIA L.* – orobinec úzkolistý / páłka úzkolistá (online) [cit. 2021.03.22], available from <<https://botany.cz/cs/typha-angustifolia/>>

KRIŠKA M., NĚMCOVÁ M., 2015: Kořenové čistírny odpadních vod – Metodická příručka pro povolování, návrh, realizaci a provoz, Vysoké učení technické v Brně. 45 s. (online) [cit. 2021.03.22], available from <http://uvhk.fce.vutbr.cz/sites/default/files/kzp/pdf/korenove_cistirny>

KŘEŠŤÁNEK J., 1984: Zeměpisný lexikon ČSR. Vodní toky a nádrže. ed. Vlček V. Academia, Praha, 316 s., 66–67

LANGERGRABER G., 2001: Development of a simulation tool for subsurface flow constructed wetlands. Wiener Mitteilungen 169, Vienna, Austria, 207, ISBN 3-85234-060-8.

LANGERGRABER G., HABERL R., 2004: Application of Constructed Wetland Technology in EcoSan Systems. In: Proceedings of the 4th IWA World Water Congress, 19-24 September 2004, Marrakech, Morocco, (CD-ROM, paper no. 116541).

NĚMCOVÁ, M. et al., 1994: Bilance sledování funkce vegetační čistírny realizované v rámci úpravy odkaliště Germignies v Lallaing v severní Francii. In Sborník konf. Kořenové čistírny a další vegetační systémy zlepšující kvalitu vody, Čížková, H., Flek, S. a Husák, Š., Eds., BÚ AV ČR a ENVI, Třeboň, 81.

MAINE M. A., SUNE N., HADAD H., SÁNCHEZ G., BONETTO C., 2007 : Removal efficiency of constructed wetland for wastewater treatment according to vegetation dominance, *Chemosphere* 68, 1105-1113 (online) [cit.

MASI F., MARTINUZZI N., 2007. Constructed wetlands for the Mediterranean countries: hybrid systems for water reuse and sustainable sanitation. *Desalination* 215, 44–55. (online) [cit. 2021.03.22], available from <<https://www.sciencedirect.com/science/article/pii/S0011916407>>

MELIÁN J. A. H., RODRÍGUEZ A. J. M., ARAÑA J., DÍAZ O. G., HENRÍQUEZ J. J. G., 2010: Hybrid constructed wetlands for wastewater treatment and reuse in the Canary Islands. *Ecological Engineering* 36, 891–899 (online) [cit. 2021.03.22], available from <<https://doi.org/10.1016/j.ecoleng.2010.03.009>>

MALÝ, J., MALÁ J., 2006: ed. *Chemie a technologie vody*. 2., dopl. vyd., ARDEC, Brno. ISBN: 80-86020-50-9

MATOUŠ A. 2013: Vyhodnocení dlouhodobého provozu kořenové čistírny Velká Jesenice u Náchoda. Fakulta životního prostředí - Česká zemědělská univerzita v Praze. Praha. (diplomová práce). „nepublikováno“. Dep. SIC ČZU v Praze

MITSCH W.J., GOSSELINK J.G., 2000: Wetlands. 3rd edition. New York: John Wiley & Sons

EKOLOGGRUPPEN 2001: Dammar som reningsverk. Landskrona

MAY, E. et al., 1990: Chemical and microbiological processes in gravel-bed hydroponic (GBH) systems for sewage treatment. In Sborník konf. Constructed Wetlands in Water Pollution Control, Cooper, P. F. a Findlater, B. C., Eds., Pergamon Press, Oxford, 33

NAŘÍZENÍ VLÁDY Č. 401/2015 Sb. o ukazatelích a hodnotách přípustného znečištění povrchových vod a odpadních vod, náležitostech povolení k vypouštění odpadních vod do vod povrchových a do kanalizací a o citlivých oblastech

NORVEE A., POLDVERE E., MANDER U., 2005: The effect of a vertical flow filter bed on a hybrid constructed wetland system. *Water Science & Technology* Vol 51 No 9 pp 137- 144 (online) [cit. 2021.03.22], available from https://www.researchgate.net/publication/7703821_The_effect_of_a

OBARSKA-PEMPKOWIAK H., 1999: Nutrient cycling and retention in constructed wetland systems in Darzłubie near Puck Bay Southern Baltic Sea. Leiden: Backhuys Publishers.

Obarska-Pempkowiak H, Gajewska M. 2003. The dynamics of processes responsible for transformation of nitrogen compounds in hybrid wetland systems in a temperate climate. In: *Wetlands: Nutrients, Metals, and Mass Cycling* (Vymasal J, ed). 129-142, Backhuys, Leiden, Netherlands

ÖÖVEL M., TOOMING A., MAURING T., MANDER Ü., 2007: Schoolhouse wastewater purification in a LWA-filled hybrid constructed wetland in Estonia. *Ecological engineering* 29, 17–26. (online) [cit. 2021.03.22], available from https://www.researchgate.net/publication/222821878_Schoolho

PAYMENT P., GODFREE A., SARTORY D., 2002: Clostridium. In: Bitton G (ed) *Encyclopedia of environmental microbiology*. Wiley Interscience, New York, pp 861–871

PELIKÁN P., 2022: unpublished results 1992- 2017

PEREIRE L. S., DUARTE E., FRAGOSO R., 2014: Water Use: Recycling and Desalination for Agriculture. Ed. Neal K. Van Alfen. *Encyclopedia of Agriculture and Food Systems* pp. 407-424 (online) [cit. 2021.03.22], available from <https://doi.org/10.1016/B978-0-444-52512-3.00084-X>

PERSSON J., 1999: Hydraulic efficiency in pond design. Phd-thesis. Department of hydraulics. Chalmers university of technology, Göteborg

PITTER P., 2009: Hydrochemie. 4., aktualiz., VŠCHT Praha, Praha. 568 s. ISBN: 978-80-7080-701-9

POACH M.E., HUNT P.G., REDDY G.B., STONE K.C., JOHNSON M.H., GRUBBS A., 2004: Swine wastewater treatment by marsh-pond marsh constructed wetlands under varying nitrogen loads. *Ecological Engineering*, 23, 165-175.

POORTER H., NAGEL O. 2000: The role of biomass allocation in the growth response of plants to different levels of light, CO₂, nutrients and water: a quantitative review. *Australian Journal of Plant Physiology*, 27, 595-607.

POWERS, R.P., HAY, G.J., CHEN, G., 2011: How wetland type and area differ through scale: A GEOBIA case study in Alberta's Boreal Plains. *Remove setting of environment Vol.:* 117 pp. 135-145.

PROSSER J.I., 1989: Autotrophic nitrification in bacteria. *Adv. microb. physiol.* 30:125-179

PYTL V., 2004: Příručka pro provozovatele čistírny odpadních vod. Medim, Líbeznice u Prahy. ISBN 80-239-2528-8.

RAPHAEL O. D., OJO S.I.A., OGEDENGBE K., EGHOBAMIEN C., MORAKINYO A. O., 2019: Comparison of the performance of horizontal and vertical flow constructed wetland planted with *Rhynchospora corymbosa*. *International Journal of Phytoremediation*. ISSN: 1522-6514 (Print) 1549-7879 (Online)

MATTHEWS G.V.T., 1993: The Ramsar Convention on Wetlands: its history and development. Gland, Switzerland, Ramsar Convention Bureau.

RD RÝMAŘOV, © 2022: Kolik spotřebujeme vody a jak si Česká republika stojí se spotřebou ve světě? (online) [cit. 2021.03.22], available from <<https://www.rdrymarov.cz/novinka-kolik-spotrebujeme-vody-a-jak-si-ceska-republika-stoji-se-spotrebou-ve-svete>>

RICHARDSON C.J., 1999: The role of wetlands in storage, release, and cycling of phosphorus on the landscape: A 25-year retrospective. In Reddy KR, O'Connor GA & Schelske CL (eds.) *Phosphorus biogeochemistry in subtropical ecosystems*. CRC Press LLC, Boca Raton, Florida, US.

REDDY K.R., PATRICK W.H., 1984: Nitrogen transformation and loss in flooded soils and sediments. *CRC Critical Reviews in Environmental Control* 13(4): 273–309.

REDDY K.R., KADLEC R.H., FLAIG E., GALE P.M., 1999: Phosphorus retention in streams and wetlands: A review. *Critical Reviews in Environmental Science and Technology* 29: 83-146.

SAEED T., Guangzhi S., 2012: A review on nitrogen and organics removal mechanisms in subsurface flow constructed wetlands: Dependency on environmental parameters, operating conditions and supporting media. *Journal of Environmental Management*. 112, 429- 448. ISSN 0301-4797. (online) [cit.30 3 2022]. Available from < 10.1016/j.jenvman.2012.08.011 >

SAYADI H.M., KARGAR R., DOOSTI R.M., SALEHI H., 2012: *Hybrid constructed wetlands for wastewater treatment: A worldwide review*. (online) [cit.30 3 2022]. Available from <https://www.researchgate.net/publication/312751744_Hybrid_constructed_wetlands_for_wastewater_treatment_A_worldwide_review>

SEIDEL K., 1965: Neue Wege zur Grundwasseranreicherung in Krefeld. *Hydrobotanische Reinigungsmethode, GWF Wasser/Abwasser* 30 vol. II , pp. 831-833

SEO D.C., HWANG S., KIM H., ET A.L., 2008: Evaluation of 2- and 3-stage combinations of vertical and horizontal flow constructed wetlands for treating greenhouse wastewater. *Ecological engineering*, 32: 121-132

SHARMA S., SACHDEVA P., VIRDI J. S., 2003: Emerging water-borne pathogens. *Appl. Microbiol. Biotechnol* 61:424–428 (online) [cit. 2021.03.22], available from <<https://link.springer.com/article/10.1007/s00253-003-1302-y>>

SIMERAL D. D., 1998: Using constructed Wetlands for Removing Contaminants from Livestock Wastewater, Ohio State University Fact Sheet, A-5-98

SLAVÍK M., 2022: unpublished results 2018- 2020

SMITH V. H., TILMAN G. D., NEKOLA J. C., 1999: Impacts of excess nutrient inputs on freshwater, marine, and terrestrial ecosystems: *Environmental Pollution [Environ. Pollut.]*, vol. 100, no. 1-3, pp. 179- 196

SPIELES D. J., MITSCH W. J., 2000: The effects of season and hydrologic and chemical loading on nitrate retention in constructed wetlands: a comparison of low- and high-nutrient riverine systems. *Ecological Engineering*, 14(1-2), 77-91.

SOJKA J., 2004. *Malé čistírny odpadních vod*. Grada Publishing a. s., Praha, 96 s.

SSWM,. © 2020: Horizontal Subsurface Flow Constructed Wetland (online) [cit. 2021.03.22], available from <<https://sswm.info/taxonomy/term/3933/horizontal-subsurface-flow-constructed-wetland>>

STEFANAKIS A. I., AKRATOS CH. S., 2016: Removal of Pathogenic Bacteria in Constructed Wetlands: Mechanisms and Efficiency. *Phytoremediation – Management of Environmental Contaminants Volume 4*.

A.A. Ansari, S.S. Gill, R. Gill, G. Lanza, L. Newman, Springer International Publishing pp. 327-346 DOI 10.1007/978-3-319-41811-7_17

ŠÁLEK, J., 1995: Přírodní způsoby čištění odpadních vod. Vysoké učení technické, Brno

ŠÁLEK J., TLAPÁK V., 2006: Přírodní způsoby čištění znečištěných povrchových a odpadních vod, ČKAIT, Praha. 283 s. ISBN 80-86769-74-7

ŠEREŠ M., INNEMANOVÁ P., HNÁTKOVÁ T., ROZKOŠNÝ M., STEFANAKIS A., SEMERÁD J., CAJTHAML T., 2021: Evaluation of Hybrid Constructed Wetland Performance and Reuse of Treated Wastewater in Agricultural Irrigation. *Water* **13**(9), 1165. ISSN 2073-4441. (online) [cit. 2022.03.28], available from <doi:10.3390/w13091165>

TANNER C. C., T.R. HEADLEY, 2011: Components of floating emergent macrophyte treatment wetlands influencing removal of stormwater pollutants, *Ecol. Eng.* **37**, 474–486.

TANNER C.C., SUKIAS, J.P.S., HEADLEY T.R., YATES C.R., STOTT R., 2012 :Constructed wetlands and denitrifying bioreactors for on-site and decentralised wastewater treatment: Comparison of five alternative configurations. *Ecological Engineering* **42**, 112–123 (online) [cit. 2021.03.22], available from <https://www.sciencedirect.com/science/article/pii/S09258574120004>

TCHOBANOGLIOUS G., BURTON F.L., STENSEL H.D., 2003: Wastewater engineering: treatment and reuse. 4th ed. McGraw-Hill, Boston.

TOMAN- ELEKTRO, 2018: Elektropřípojka ČOV, k.ú.: Spálené Poříčí, okres: Plzeň-jih. 5s. "nepublikováno". Dep.: městský úřad Blovice

TREPEL M., PALMERI L., 2002: Quantifying nitrogen retention in surface flow wetlands for environmental planning at the landscape-scale. *Ecol. Eng.* **19**:127-140

TUNCSIPER, B., 2009. Nitrogen removal in a combined vertical and horizontal subsurface-flow constructed wetland system. *Desalination* **247**, 466–475 (online) [cit. 2021.03.22], available from <https://www.sciencedirect.com/science/article/pii/S0011916409>

TUSZYŃSKA A., OBARSKA-PEMPKOWIAK H., 2007: Influence of COD-fractions on removal effectiveness and accumulation of organic matter in constructed wetlands. *Ecohydrology & Hydrobiology* Vol. 7, No 3-4, 311-319

TUSZYŃSKA A, OBARSKA-PEMPKOWIAK H., 2008. Dependence between quality and removal effectiveness of organic matter in hybrid constructed wetlands. *Bioresource Technology*, **99**: 6010-6016

U.S. EPA, 2000: Constructed wetlands treatment of municipal wastewater. Manual. EPA 625/R-99/010, U.S. Environmental Protection Agency, Cincinnati.

VA TECH WABAG Brno spol. s r.o. ©: Odpadní voda průmyslová | Technologie. Wabag Brno. dodavatel technologie pro úpravu vody- (online) [cit. 2021.03.22], available from <<https://www.wabag.cz/technologie/odpadni-voda-prumyslova>>

VACULÍKOVÁ V., ZÁPECOVÁ D., 2009: Možnosti a strategie odkanalizování obcí Zlínského kraje do 2000 EO. Praktická příručka pro obce zlínského kraje. Spolek pro obnovu venkova a Zlínský kraj, Zlín.

VAVŘIČKA V., 1998: Vyhodnocení zkušebního provozu KČOV Spálené Poříčí. Plzeň, 30146, U lomu 5. Spálené Poříčí, okr. Plzeň- jih., 9s."nepublikováno". Dep.: městský úřad Blovice

VAVŘIČKA V., VAVŘIČKOVÁ L., 2000: A. Souhrnná technická zpráva pro stavební řízení. Plzeň, 30146, U lomu 5. Spálené Poříčí, okr. Plzeň- jih. 13s."nepublikováno". Dep.: městský úřad Blovice

VEŘEJNÁ SPRÁVA ONLINE., © 2021 : Kořenové čistírny odpadních vod- ekonomika výstavby a provozu. Triada, spol. s r. o., Praha, spolupráce: (online) [cit. 2021.03.22], available from <<http://www.dvs.cz/clanek.asp?id=6447408>>

VYKYDAL M., 2017: Dešťové kanalizace předmět (ne)odborného (ne)zájmu (online) [cit. 2021.03.22], available from <<https://vodnihospodarstvi.cz/destove-kanalizace/>>

VYMAZAL J., 1995, Čištění odpadních vod v kořenových čistírnách, ENVI s.r.o., Třeboň. 147 s.

VYMAZAL J., 2004: Kořenové čistírny odpadních vod. ENKI o.p.s., Třeboň. 14 p.

VYMAZAL J., 2007: Removal of nutrients in various types of constructed wetlands, *Science of the Total Environment*, vol. 380, no. 1–3, pp. 48–65

Vymazal J., 2011: Constructed Wetlands for Wastewater Treatment: Five Decades of Experience. *Environ. Sci. Technol.* 45p. 61–69.

VYMAZAL J., 2016: Kořenové čistírny odpadních vod – Využití ve světě, České republice a Plzeňském kraji, Krajský úřad Plzeňského kraje, odbor životního prostředí, Plzeň. 66 s.

VYMAZAL J., KRÖPFELOVÁ L., 2008: Wastewater Treatment in Constructed Wetlands with Horizontal Sub-Surface Flow, Springer, Dordrecht, Nizozemí, pp. 1-576.

15. List of figures

Figure 1: floating plants (GRANIA ©2021).

Figure 2: submerged plants (GRANIA ©2021).

Figure 3: CW diagram with surface flow (Langergraber et Haberl 2004).

Figure 4: CW diagram with horizontal flow (Langergraber et Haberl 2004).

Figure 5: CW diagram with vertical flow (Langergraber et Haberl 2004).

Figure 6: factors affecting denitrification on different scales (Trepel 2002).

Figure 8: Scheme of CW in Spálené Poříčí (not in scale). 1- inflow, 2- rough pre-cleaning, 3- slit tank, 4- distribution shafts, 5- distribution drainage, 6- collection shafts, 7-collection drainage, 8-drain, 9- Bradava (Vavříčka 1998).

Figure 9: Scheme of CW in Spálené Poříčí, 2nd stage, old part on the left, new on the right): 1) wastewater inflow, 2) rough pre-treatment with relief of rainwater made from old parts of CW, 3) screens with phosphorus removal equipment, 4) vertical and horizontal sand trap, 5) polder, 6) slotted tank, 7) distribution shafts, 8) distribution drainage, 9) collecting drainage, 10) collecting shafts, 11) drain, 12) rivulet Bradava 13) control shaft (Chladová 2017 ex. Otava 2002).

Figure 10: CW intensification - overall situation (JAMlprojekt 2018).

Figure 11: marked electrical connection line in the CW complex (JAMlprojekt 2018).

Figure.14: Simple scheme of constructed wetland Velká Jesenice): 1-rack, 2-sand trap, 3-slotted tank, 4-distribution shaft, 5-inlet shaft, 6-collecting shaft, 7-inspection and control shaft, 8-filter bed, 9-sludge field (Matouš 2013).

Figure 15: CW intensification - overall situation (JAMlprojekt 2013).

Figure 16: Average annual concentration of BOD₅ (mg/l) at CW Spálené Poříčí 1992-2021 with maximum limit of 30 mg/l BOD₅ set by water authority for CW Spálené Poříčí..

Figure 17: Average annual concentration of BOD₅ (mg/l) at CW Velká Jesenice 2000-2021 in comparison with maximal limits set by water authority through years 2000- 2021.

Figure 18: Average efficiency of BOD₅ removal at CW Spálené Poříčí and CW Velká Jesenice 1992-2021 expressed in % (Hnátková 2022, , Pelikán 2022, Slavík 2022).

Figure 19: Average annual concentration of COD_{Cr} (mg/l) at CW Spálené Poříčí 2000-2021 in comparison with maximal limits set by water authority through years 2000- 2021 (Hnátková 2022, , Pelikán 2022, Slavík 2022).

Figure 20: Average annual concentration of COD_{Cr} (mg/l) at CW Velká Jesenice 2000-2021 in comparison with maximal limits set by water authority through years 2000- 2021 (Jeništa 2022).

Figure 21: Average efficiency of COD_{Cr} removal at CW Spálené Poříčí and CW Velká Jesenice 1992-2021 expressed in % (Hnátková 2022, , Pelikán 2022, Slavík 2022).

Figure 22: Average annual concentration of suspended solids – TSS at CW Spálené Poříčí 1992-2021 with maximal value for TSS set by water authority (Jeništa 2022).

Figure 23: Average annual concentration of total suspended solids-TSS (mg/l) at CW Velká Jesenice 2000-2021 in comparison with maximal limits set by water authority through years 2000- 2021 (Hnátková 2022, , Pelikán 2022, Slavík 2022).

Figure 24: Average annual efficiency of suspended solids – TSS removal at CW Spálené Poříčí and CW Velká Jesenice in the years 1992-2021 expressed in % (Jeništa 2022).

Figure 25: Average annual concentration of $N-NH_4^+$ (mg/l) at CW Spálené Poříčí 2000-2021 in comparison with maximal limits set by water authority through years 2000- 2021 (Hnátková 2022, , Pelikán 2022, Slavík 2022).

Figure 26: Average annual concentration of $N-NH_4^+$ (mg/l) at CW Velká Jesenice 2000-2021 in comparison with maximal limits set by water authority through years 2000- 2021 (Jeništa 2022).

Figure 27: Average annual removal efficiency of $N-NH_4^+$ at CW Spálené Poříčí and CW Velká Jesenice 1992-2021 expressed in % (Hnátková 2022, , Pelikán 2022, Slavík 2022).

Figure 28: Average annual phosphorus concentration at CW Spálené Poříčí 1992-2021 (Hnátková 2022, , Pelikán 2022, Slavík 2022).

Figure 29: Average annual phosphorus concentration at CW Velká Jesenice 2012-2021 (Jeništa 2022).

Figure 30: Average efficiency of phosphorus purification at CW Spálené Poříčí 1993-2021. (Hnátková 2022, , Pelikán 2022, Slavík 2022).

URL 1:
<<https://www.google.cz/maps/place/K%C4%8COV/@49.6142392,13.5894135,174m/data=!3m1!1e3!4m5!3m4!1s0x470ae1957a023533:0xbdb50a8b65c40111!8m2!3d49.6093617!4d13.6045147!5m1!1e1>>

URL 2:
<<https://www.google.cz/maps/place/Velkojesenick%C3%A1+s.r.o./@50.3546646,16.0447111,213m/data=!3m1!1e3!4m5!3m4!1s0x470e7c87cc19a597:0x60ae342a735b1823!8m2!3d50.3628894!4d16.0334747!5m1!1e1>>

17. List of tables

Table 1: *Water quality (Sojka 2004).*

Table 2: *Average daily concentrations of pollutants in wastewater on IEO (Junga et. al. 2015).*

Table 3: *General wastewater classification according to BOD₅ content (Pereira et al. 2014).*

Table 4: *Industrial wastewater characteristics (Bielefeldt 2009).*

Table 5: *Indicators for sewage and urban waters (Hlavínek et al. 2003).*

Table 6: *Specific wastewater production according to ČSN 75 6402*

Table 7: *Coefficient of daily unevenness for wastewater treatment plants determined according to the set standard (ČSN 75 6402).*

Table 8: *Advantages and disadvantages of constructed wetland (ČVUT 2012).*

Table 9: *Components of pre- cleaning process (JAMIprojekt 2018).*

Table 10: *Size of biological septic tank according to ČSN 75 6402.*

Table 11: *Overview of plants used in constructed wetland (Cibulka 2007, Krása 2008).*

Table 12: *Comparison of design parameters (600 EO) and actual parameters (500 EO) at CW Spálené Poříčí (Vavříčka 1998).*

Table 13: *Operating rules of object procurement. The generated waste is disposed of according to valid legislation (HYDROEKO 2001).*

Table 14: *Limits of discharged wastewater (mg / l) according to Government Decree No. 401/2015 Coll.*

Table 15: *Emission standards- permissible minimum cleaning efficiency in percentage (minimal percentage of removal efficiency) according to Government Decree No. 401/2015 Coll.*

Table 16: *Limits set for permissible amount of pollution in discharged wastewater for CW in Spálená Poříčí according to water authority for period 1992- 2019.*

Table 17: *Limits set for permissible amount of pollution in discharged wastewater for CW in Spálená Poříčí according to water authority for period in trial operation in 2020.*

Table 18: Actual limits set for permissible amount of pollution in discharged wastewater for CW in Spálená Poříčí according to water authority since 2021.

Table 19: Limits set for permissible amount of pollution in discharged wastewater for CW in Velká Jesenice according to water authority for period 2000- 2005.

Table 20: Limits set for permissible amount of pollution in discharged wastewater for CW in Velká Jesenice according to water authority for period 2005- 2014.

Table 21: Limits set for permissible amount of pollution in discharged wastewater for CW in Velká Jesenice according to water authority for period of trial operation in 2015.

Table 22: Actual limits set for permissible amount of pollution in discharged wastewater for CW in Velká Jesenice according to water authority since 2016.

Table 23: Minimum annual frequency of sampling discharged wastewater (NV č.401/2015 Sb.).

Table 24: Permissible number of samples exceeding the specified emission limits depending on total number of samples (NV č.401/2015 Sb.).

Table 25: Average annual concentration of BOD₅ at influent and effluent with average annual removal efficiency through years 1992-2021 (Hnátková 2022, Jeništa 2022, Pelikán 2022, Slavík 2022).

Table 26: Average annual concentration of COD_{Cr} at influent and effluent with average annual removal efficiency through years 1992-2021 (Hnátková 2022, Jeništa 2022, Pelikán 2022, Slavík 2022).

Table 27: Average annual concentration of TSS at influent and effluent with average annual removal efficiency through years 1992-2021 (Hnátková 2022, Jeništa 2022, Pelikán 2022, Slavík 2022).

Table 28: Average annual concentration of N-NH₄⁺ at influent and effluent with average annual removal efficiency through years 1992-2021 (Hnátková 2022, Jeništa 2022, Pelikán 2022, Slavík 2022).

Table 29: Average annual concentration of P_{total} at influent and effluent with average annual removal efficiency through years 1992-2021 (Hnátková 2022, Pelikán 2022, Slavík 2022).

Table 30: Average removal efficiencies of combined constructed wetlands (in %). NA- not available (data is not mentioned in the study) (Hnátková 2022, Jeništa 2022).

Annex list

Annex no. 1: DOE Water Quality Index Classification <
<https://www.researchgate.net/profile/Nassereldeen-Kabbashi/publication/338699433/figure/tbl1/AS:882033777704961@1587304648695/DOE-Water-Quality-Index-Classification.png>>

Annex no. 2: Types and parcel numbers of the parcels concerned (Vavříčka 1998)

Annex no. 3: Analysis of constructed wetland Spálené Poříčí- 2020 (Slavík 2022).

Annex no. 4: Proper reporting of discharged water- page 1-4. (SLAVÍK 2022).

Annex no. 5: Proper reporting of discharged water- page 2-4. (SLAVÍK 2022).

Annex no. 6: Proper reporting of discharged water- page 3-4. (SLAVÍK 2022).

Annex no. 1: DOE Water Quality Index Classification (URL 3)

| Parameters | Unit | Classes | | | | |
|---|------|---------|-------------|-------------|-------------|--------|
| | | I | II | III | IV | V |
| Ammoniacal Nitrogen | mg/l | <0.1 | 0.1 – 0.3 | 0.3 – 0.9 | 0.9 – 2.7 | > 2.7 |
| Biochemical Oxygen Demand (BOD ₅) | mg/l | < 1 | 1 – 3 | 3 – 6 | 6 – 12 | > 12 |
| Chemical Oxygen Demand (COD) | mg/l | < 10 | 10 – 25 | 25 – 50 | 50 – 100 | > 100 |
| Dissolved Oxygen | mg/l | > 7 | 5 – 7 | 3 – 5 | 1 – 3 | < 1 |
| pH | mg/l | > 7 | 6 – 7 | 5 – 6 | < 5 | > 5 |
| Total Suspended Solids (TSS) | mg/l | < 25 | 25 – 50 | 50 – 150 | 150 – 300 | > 300 |
| Water Quality Index (WQI) | mg/l | > 92.7 | 76.5 – 92.7 | 51.9 – 76.5 | 31.0 – 51.9 | < 31.0 |

Annex no. 2: Types and parcel numbers of the parcels concerned (Vavříčka 1998)

1.4. Druhy a parcelní čísla dotčených pozemků:

| Číslo parcely | Druh pozemku | Výměra m ² | Vlastník |
|---------------|--------------|--------------------------|---------------------|
| 974/3 ✓ | vodní pl. | 1154 | Obec Spálené Poříčí |
| 974/4 | Vodní pl. | 1380 | Obec Spálené Poříčí |
| 974/5 ✓ | Vodní pl. | 435 | Obec Spálené Poříčí |
| 1043/5 | Ost. plochy | 933 | Obec Spálené Poříčí |
| 1043/6 | Ost.plochy | 216 | Obec Spálené Poříčí |
| 934/4 | Ost.plochy | 73 | Obec Spálené Poříčí |
| 934/5 | Ost.plochy | 147 | Obec Spálené Poříčí |
| 934/6 | Ost.plochy | 258 | Obec Spálené Poříčí |
| 934/7 | Ost.plochy | 423 | Obec Spálené Poříčí |
| 1964/9 | Ost.plochy | 74 | Obec Spálené Poříčí |
| 1964/11 | Ost.plochy | 414 | Obec Spálené Poříčí |

Annex no. 3: Analysis of constructed wetland Spálené Poříčí- 2020 (Slavík 2022).

| ANALYSIS OF CONSTRUCTED WETLAND SPÁLENÉ POŘÍČÍ - 2020 | | | | | | | | | | | |
|--|--------|------------------|--------------|-------------------|--------------|-----------|--------------|-------------------|--------------|-------------------|--------------|
| | | BOD ₅ | efficiency % | COD _{Cr} | efficiency % | NL 105 °C | efficiency % | N-NH ₄ | efficiency % | total phosphorus. | efficiency % |
| January | inflow | 247 | 97,3 | 643 | | 285 | | 42,6 | 56,81 | 5,37 | 29,61 |
| | outlet | 6,66 | | <12 | | <2 | | 18,4 | | 3,78 | |
| February | inflow | 9,57 | 55,59 | 91,2 | 70,18 | 36,6 | 72,95 | 23,8 | 65,04 | 2,77 | 31,77 |
| | outlet | 4,25 | | 27,2 | | 9,9 | | 8,32 | | 1,89 | |
| March | inflow | 87 | 90,74 | 127 | 59,06 | 29 | | 27,5 | 93,35 | 3,03 | 48,51 |
| | outlet | 8,06 | | 52 | | <2 | | 1,83 | | 1,56 | |
| April | inflow | 203 | 85,71 | 214 | 77,57 | 53,7 | 43,39 | 53,8 | 70,82 | 6,3 | 64,76 |
| | outlet | 29 | | 48 | | 30,4 | | 15,7 | | 2,22 | |
| May | inflow | 96,1 | 97,53 | 301 | 84,32 | 52,6 | | 58,2 | 79,73 | 6,4 | 74,84 |
| | outlet | 2,37 | | 47,2 | | <2 | | 11,8 | | 1,61 | |
| June | inflow | 27,4 | 85,55 | 130 | 69,23 | 33,1 | 71,91 | 44 | 55,23 | 4,44 | 59,68 |
| | outlet | 3,96 | | 40 | | 9,3 | | 19,7 | | 1,79 | |
| July | inflow | 113 | | 256 | 79,06 | 47,3 | 61,1 | 41,1 | 58,88 | 4,44 | 64,86 |
| | outlet | <1 | | 53,6 | | 18,4 | | 16,9 | | 1,56 | |
| August | inflow | 71,7 | 91,56 | 139 | 86,19 | 69,3 | 79,94 | 49,1 | 70,06 | 6,13 | 75,04 |
| | outlet | 6,05 | | 19,2 | | 13,9 | | 14,7 | | 1,53 | |
| September | inflow | 96,4 | 93,64 | 218 | 94,5 | 60,9 | 68,8 | 40 | 71,5 | 5,17 | 70,41 |
| | outlet | 6,13 | | 12 | | 19 | | 11,4 | | 1,53 | |
| October | inflow | 108 | 90 | 157 | 76,05 | 22,9 | 69,65 | 48,3 | 61,49 | 4,91 | 79,02 |
| | outlet | 10,8 | | 37,6 | | 6,95 | | 18,6 | | 1,03 | |
| November | inflow | 43 | 56,05 | 117 | 80,17 | 25,8 | 74,61 | 28 | 92 | 1,92 | 77,55 |
| | outlet | 18,9 | | 23,2 | | 6,55 | | 2,24 | | 0,431 | |
| December | inflow | 137 | 91,97 | 400 | 88,6 | 85,7 | 98,25 | 54,1 | 74,68 | 5,57 | 52,42 |
| | outlet | 11 | | 45,6 | | 1,5 | | 13,7 | | 2,65 | |
| drain diameter [mg.l-1] | | 9,74 | 90,57 | 36,87 | 84,16 | 12,88 | 80,73 | 12,77 | 69,98 | 1,8 | 61,7 |
| average inflow [mg.l-1] | | 103,26 | | 232,77 | | 66,83 | | 42,54 | | 4,7 | |

Annex no. 4: Proper reporting of discharged water- page 1-4. (SLAVÍK 2022).

Řádné hlášení Doplněné hlášení

Rok **2 0 1 9** Název vypouštění: **Město Spálené Poříčí KČOV**
Vypouštěné vody Zdroj vypouštění: **ŠN + kořenová ČOV**
 Druh ekonomické činnosti: **841 100 84.11 Všeobecné činnosti veřejné správy**

Ověřovatel - správce povodí: **Povodí Vltavy, státní podnik**

Trvalý pobyt - sídlo povinného subjektu: IČO **0 0 2 5 7 2 4 9**
 Trvalý pobyt - sídlo provozovatele: IČO **0 0 2 5 7 2 4 9**

Název: **Město Spálené Poříčí** Typ subjektu: **Město Spálené Poříčí**
 Sídlo subjektu: **Náměstí Svobody 132, 335 61 Spálené Poříčí** Sídlo subjektu: **Náměstí Svobody 132, 33561 Spálené Poříčí**

| | | | | | |
|----------|--|---|-------------------------------|--------------------------------|-----------------------------|
| 1 | Identifikační číslo vypouštění vody (číslo VHB) | 140601 | | | |
| 2 | S-JTSK souřadnice | JTSK Y | 809 473 | JTSK X | 1 086 587 |
| 3 | Číslo hydrologického pořadí | 1-10-05-0500-0-00 | | | |
| 4 | Název vodního toku | Bradava | IDVT | 10100322 | |
| 5 | Říční kilometr | 7,23 | | | |
| 6 | Běh | <input checked="" type="radio"/> levý | <input type="radio"/> střed | <input type="radio"/> pravý | <input type="radio"/> oba |
| 7 | Kraj / Okres / Obec / Katastrální území | Plzeňský kraj | Plzeň-jih | | |
| | | Spálené Poříčí | Spálené Poříčí | | |
| 8 | Způsob stanovení množství vypouštěných vod | <input checked="" type="radio"/> měření | <input type="radio"/> výpočet | <input type="radio"/> odvození | <input type="radio"/> odhad |
| 9 | Způsob stanovení hodnot jakosti vypouštěných vod | <input checked="" type="radio"/> měření | <input type="radio"/> výpočet | <input type="radio"/> odvození | <input type="radio"/> odhad |
| 9a | Způsob stanovení hodnot jakosti produkovaných vod | <input checked="" type="radio"/> měření | <input type="radio"/> výpočet | <input type="radio"/> odvození | <input type="radio"/> odhad |
| 10 | Typ rozboru / Počet rozborů | P | S2 | 12 | S8 |
| | | | S24 | S24p | Jiný |
| 11 | Čistírna odpadních vod | Ano Biologické čištění odpadních vod Ne | | | |
| | Mechanické čištění odpadních vod | Ano Chemické čištění odpadních vod | | | |
| 12 | Ostatní druhy čištění odpadních vod uveďte do poznámky | | | | |
| 13 | Rozhodnutí o povolení k vypouštění vod vydal: MEÚ Blovice dne: 30.1.2018 pod č.j.: MUBlov 18013/17/ZP/Čer. platnost doc: 31.12.2020 v množství: 4,12 průměr l/s v jakosti: CHSK _{Cr} hodnota "p" *m" 6,18 max. l/s BSK ₅ hodnota "p" *m" 70 120 mg/l tis. m ³ / měs mg/l 7,3 t / rok 130 tis. m ³ / rok t / rok | | | | |
| 14 | Žádáme o přiložení platného rozhodnutí k vypouštění vod | Ne | | | |
| Příloha: | Přidat přílohu Odebrat přílohu | | | | |
| 15 | Žádáme o přiložení kopie mapy se zakreslením místa vypouštění | Ne | | | |
| Příloha: | Přidat přílohu Odebrat přílohu | | | | |

Součet velikostí přiložených příloh nesmí přesáhnout 10MB.

| | | | | | |
|---------------------------|---|-----------|---------------|-------------------|------------------------------|
| Jméno: | Jaroslav | Příjmení: | Slavík | Kontaktní adresa: | Město Spálené Poříčí |
| Tel.: | + 4 2 0 3 7 1 5 9 4 6 3 6 | | | Název: | Město Spálené Poříčí |
| Mobil: | + 4 2 0 | | | Ulice: | Náměstí Svobody |
| Fax: | + 4 2 0 | | | Číslo popisné: | 132 Číslo orientační: |
| E-mail: | jaroslav.slavik@spaleneporici.cz | | | Obec: | Spálené Poříčí |
| Datum vyhotovení hlášení: | 24.1.2020 | | | PSC: | 3 3 5 6 1 |

Annex no. 5: Proper reporting of discharged water- page 2-4. (SLAVÍK 2022).

Identifikační číslo vypouštění vody (číslo VHB) 1 4 0 6 0 1

Vložit z Excelu

VYPOUŠTĚNÉ MNOŽSTVÍ VOD (v tis. m³ /měs. - zaokrouheno na tři desetinná místa)

| rok | I | II | III | IV | V | VI | VII | VIII | IX | X | XI | XII | Celkem |
|-----------------------|-------|-------|-------|-------|-------|-------|-------|-------|-------|-------|-------|-------|--------|
| 16 2019 | 9,891 | 8,458 | 7,647 | 6,817 | 7,447 | 7,698 | 7,422 | 9,286 | 7,142 | 6,937 | 5,503 | 7,677 | 91,925 |
| 17 výhled na rok 2020 | 10 | 9 | 7,8 | 7 | 7,5 | 7,8 | 7,6 | 10 | 7,5 | 7,2 | 6 | 8 | 95,4 |
| 18 výhled na rok 2024 | 10,2 | 10 | 8 | 8 | 7,8 | 8 | 8 | 11 | 8 | 8 | 7 | 8,2 | 102,2 |

Vložit z Excelu

POČET HODIN VYPOUŠTĚNÍ (zaokrouheno na celé hodiny)

| rok | I | II | III | IV | V | VI | VII | VIII | IX | X | XI | XII | Celkem |
|---------|-----|-----|-----|-----|-----|-----|-----|------|-----|-----|-----|-----|--------|
| 19 2019 | 744 | 672 | 744 | 720 | 744 | 720 | 744 | 744 | 720 | 744 | 720 | 744 | 8 760 |

Vložit z Excelu

VYPOUŠTĚNÁ A PRODUKOVANÉ ZNEČIŠTĚNÍ (zaokrouheno na tři desetinná místa)

| Číslo | Ukazatel | Jednotka | Popis | Zob. 20a Ypouštěné, průměr za kalendářní rok (rok 2019) | Zob. Produkováné, průměr za kalendářní rok (rok 2019) | Zob. 23 Ypouštěné t/rok dle vzorce *) (rok 2019) | Zob. 24 Produkováné t/rok dle vzorce *) (rok 2019) |
|-------|----------|----------|--|---|---|--|--|
| U1 | BSK5 | mg/l | BSK5 (s potlačenou nitrifikací) | 13,167 | 142,917 | 1,21 | 13,138 |
| U2 | CHSK Cr | mg/l | chemická spotřeba kyslíku dichromanem | 63,5 | 203,833 | 5,837 | 18,737 |
| U3 | NL | mg/l | nerozpuštěné látky susené při 105 st.C. (NL-105, NL-suš) | 7,583 | 46,083 | 0,697 | 4,236 |
| U4 | RAS | mg/l | rozpuštěné anorganické soli zthvané při 550 st.C | 16,017 | 21,025 | 1,472 | 1,933 |
| U5 | N-NH4 | mg/l | amoniakální dusík | | | | |
| U6 | N anorg. | mg/l | anorganický dusík (výpočtem) | | | | |
| U7 | P celk. | mg/l | celkový fosfor | 2,33 | 4,838 | 0,214 | 0,445 |

přidat nový ukazatel zobrazit sloupce s výhledem znečištění

*) Ypouštěné resp. produkováné znečištění v t/rok. dle vzorce (prům. mg/l x tis. m³/rok) / 1000

Napětí zby provoz

Rozpočítat hodnoty

- V případě, že v ovládacím roce pro daný ukazatel:
- nebylo provedeno deskupná koncentrace - nepřijímá hodnotu jako „0,000“ a podle nechte prázdné
 - byla vyjádřena hodnota průměrného koncentrace až na 4. desetinná místa a číslo - ohlášeno hodnotou 0,0000 jako < 0,0000 - skutečné vyjádření hodnoty průměrné roční koncentrace ukazatele uvedte ob. rozdílně na konci hlášení;
 - všechny naměřené hodnoty koncentrací byly pod mezí stanovenou zvláštní metodou (na všech protokolech s výsledky rozbory jsou uvedena čísla se značkou < před číselm) - ohlášete hodnotu průměrné roční koncentrace ukazatele jako „< xxx“, kde „xxx“ je hodnota meze stanovenosti (číslo se značkou <) ukazatele dle protokolu s výsledky rozbory;
 - některé z naměřených hodnot koncentrací byly pod mezí stanovenou zvláštní metodou (na některém z protokolů s výsledky rozbory jsou uvedena čísla se značkou < před číselm) - ohlášete hodnotu průměrné roční koncentrace ukazatele (j. sxx,2, kde „sxx“ je hodnota meze stanovenosti (číslo se značkou <) ukazatele dle protokolu s výsledky rozbory a výsledek tohoto výpočtu ohlášete.

Integrovaný systém plnění ohlašovací povinnosti

Strana 4 z 28 4

2019.1.20200116.170950

Annex no. 6: Proper reporting of discharged water- page 3-4. (SLAVÍK 2022).



Identifikační číslo vypouštění vody (číslo VVB) 1 4 0 6 0 1

| | | | | | | | |
|---|--------------------------------------|---------------------------------------|----------------------------|---------------------------------|------------|------------|--------|
| 25 | Počet skutečně připojených obyvatel: | 1 420 | Typ kanalizace: | jednotná | | | |
| DRUH VYPOUSTĚNÝCH VOD (v tís. m ³ z celkového množství) | | | | | | | |
| | chladičí vody z průtočného chlazení | chladičí vody z cirkulačního chlazení | průmysl bez chladičích vod | kanalizace pro veřejnou potřebu | dílní vody | ostatní | celkem |
| 26 | | | | 91,925 | | | 91,925 |
| PŮVOD VYPOUSTĚNÝCH VOD (v tís. m ³ z celkového množství) | | | | | | | |
| | povrchová voda | podzemní voda | veřejný vodovod | minerální voda | dílní voda | jiný původ | celkem |
| 27 | 10 | 15 | 59 | | | 7,925 | 91,925 |

Poznámka:



Ostatní přílohy

Přidat přílohu

Součet velikostí příložených příloh nesmí přesáhnout 10MB.