

**CZECH UNIVERSITY OF LIFE SCIENCES PRAGUE**

**FACULTY OF ENGINEERING**



---

**Department:** Vehicles and Ground Transport

**Academic Year:** 2010/2011

## **SETTING M.Sc. THESIS**

**For Mr. Nguyen Huynh Truong Gia, Bsc**

**Course: Technology and Environmental Engineering**

This thesis is required by the Head of Department as laid down in the rules of the  
Master studies at CULS

### **Thesis Title**

**THE IRRIGATION PROJECT TO SELECTED FARM**

*Case Study in Rambutan Farm at Binh Phuoc Province,*

*Vietnam*

Czech University of Life Sciences Prague

Faculty of Engineering

Department of Vehicles and Ground Transport

Academic year 2009/2010

# **DIPLOMA THESIS ASSIGNMENT**

**Gia Nguyen Huynh Truong**

specialization of the study: Technology and Environmental Engineering

In accordance with the Study and Examination Regulations of the Czech University of Life Sciences Prague, Article 17, the Head of the Department assigns the following diploma thesis to

Thesis title: **The irrigation project for selected farm**

## **The structure of the diploma thesis:**

1. Introduction
2. Literature overview
3. Objectives of thesis and methodology
4. Description of farm's conditions
5. Proposal of irrigation plan and design.
6. Conclusions
7. Bibliography
8. Supplements

The proposed extent of the thesis: 40 - 60 pages

**Bibliography:**

Y.P.Rao – S.R. Bhakar: Irrigation technology Theory & Practise,2008, ISBN:81-8321-116-X

<http://www.fao.org/documents/> (14.1.2009)

Crop evapotranspiration - Guidelines for computing crop water requirements, FAO Irrigation and Drainage Papers - 56 (1998)

<http://www.fao.org/docrep/X0490E/x0490e00.htm#Contents> (14.1.2009)

Irrigation Water Management: Irrigation Water Needs (1986)

<http://www.fao.org/docrep/s2022e/s2022e00.htm#Contents> (16.1.2009)

Crop Water Requirements and Irrigation Scheduling (2002)

<ftp://ftp.fao.org/docrep/fao/010/ai593e/ai593e00.pdf> (16.1.2009)

The Diploma Thesis Supervisor: **Ing. Miroslav Růžička, CSc.**

Term assignment of the diploma thesis: November 2009

Deadline of the diploma thesis submission: April 2011



Head of the Department





Dean

Prague 30th November 2009

## ABSTRACT

Nowadays development of small scale farms in Vietnam dramatically increases. Consequently irrigation requirements laid down on quantity and quality of pumping or pressurized systems are raised quickly as well. However Vietnamese farmers are very familiar with surface irrigation methods, their knowledge and experience is not sufficient in pressurized irrigation up to now. It could cause wastes in water resources, energy wastes and the crop yield decrease.

The master thesis introduces progressive steps in selecting and designing a micro-sprinkler irrigation system in a rambutan farm which is located at Hon Quang, Long Binh, Binh Phuoc province, the Vietnam Republic. The proposed irrigation system was designed and derived from results of CROPWAT software which is suggested by FAO to calculate evapotranspiration. The meteorology data were collected in nation meteorological and hydrological stations which are located in Dong Xoai, Binh Phuoc province. Analysis of soil and water were carried out at Research Center for Environmental Technology and Natural Resource Management of Nong Lam University, Ho Chi Minh City.

Thesis proposes and designs irrigation system with these parameters: supplying 5 (mm/day) water for nearly 6 hectares orchard with 1500 rambutan trees, system with a centrifugal BMHM 4/15 with 18(kW) motor and a fixed PVC pipe mesh with  $\varnothing 90$  main line pipes. At each rambutan tree, there are three micro-sprinkler emitters which can supply maximum 66 liters of water per hours. It was set to operate in 8 hours per day. It needs 2 hours for manual control with twelve on/off valves. The whole system is protected from overload pressure and backflow by two devices; PGA -200 and PRS – Dial. A basket filter and a 75 mesh cartridge filter are assembled at inlet and outlet pipe to avoid sand and mosses in surface water resources which can cause dusty in pipe line.

In term of economy, the initial cost for the system could be 13,190,039 (VND) or 10,992 (Kč) per year per hectare. Operation cost, including electric power and labour cost could be count for approximately 8,140,000 (VND) or nearly 7008 (Kč) per hectare per year.

## DECLARATION

I, hereby, declare that this thesis is my own work and effort and that it has not been submitted anywhere for any award. Where other sources of information have been used, they have been acknowledged.



.....  
Nguyen Huynh Truong Gia

Prague, 9<sup>th</sup> April, 2011

## ACKNOWLEDGEMENTS

This thesis was written to graduate for the Master of Science (MSc) Technology and Environmental Engineering from the Czech University of Life Sciences (CULS), Prague.

This piece of work would not have been accomplished without supports of EURASIA Program that gave me a scholarship to come to Czech Republic for studying. With my whole heart, I would like to thank to people who have an idea to organize as well as carry out the program, especially my scholarship coordinators, Ms Petra Chaloupková, and her assistants; Ms Ingrid Melnikovová, Ms Jana Zámečnicková, Ms. Olga Sklenièková and also Mr. Nguyen Huu Dung. They all have willingly helped whenever I face difficulties. With all my respect, I hope that the wonderful program would last for years to support more and more young people in developing countries to have a chance to follow a post graduation education abroad.

I offer my sincerest gratitude to my supervisor, Mr. Miroslav Růžicka, who supported me throughout my thesis with his patience and knowledge. I attribute the level of my Masters degree to his encouragement and effort and without his instruction; this thesis would not have been completed.

Thanks also go to Mr. Tran Minh Triet, (Director of Quoc Minh Company) who welcomed me to conduct the experiment in his farm. I also thank to employees who also willingly helped me with necessary information needed for this compilation.

To Mr. Kumhala Frantisek (Vice Dean), Mr. Kic Pavel, Mrs. Marie Malounova (International Relations Officer), and all staffs in Technical Faculty, thank you for your support and suggestion.

To Mr. Nguyen Hay, Mr. Nguyen Van Ngai, and all my colleagues in Nong Lam University, thank you for your suggestions and your help to me in scientific field.

To my parents, my parents in law, my sisters, my brother; thank you for supporting me not just financial, but morally and spiritually throughout my life. To Ms Trinh Thanh Huong and Mr. Trinh Hong Anh; thank you for your supports when I was in Hanoi.

I thank full to my wife, Ms. Trinh Thuc Hien who always encourages me to overcome difficulties. Thank you so much.

To my friends to mention a few; Baffour Kwasi Asare, Kabutey Abraham, Vanaphone Putthana, Nguyen Thi Nga, Nguyen Thi Thanh Phuong and Nguyen Ngoc Duc; thanks for being there for me when I need you.

Finally, to everybody that has been a part of my life but I failed to mention, thank you very much. There won't be enough space if I will mention you all.

<b>LIST OF FIGURES</b> -----	<b>2</b>
<b>LIST OF TABLES</b> -----	<b>3</b>
<b>LIST OF SYMBOLS</b> -----	<b>4</b>
<b>I INTRODUCTION</b> -----	<b>5</b>
<b>II LITERATURE OVERVIEW</b> -----	<b>7</b>
II.1 IRRIGATION-----	7
II.1.1 Surface irrigation-----	7
II.1.2 Sub - irrigation-----	9
II.1.3 Pressurized irrigation-----	11
II.1.4 Water plant requirements-----	13
II.1.5 Irrigation planning-----	16
II.1.6 Irrigation method selection-----	18
II.2 IRRIGATION DEVELOPMENT IN VIETNAM-----	20
II.3 RAMBUTAN TREE-----	23
II.3.1 Historical background and origin-----	23
II.3.2 Region-----	23
II.3.3 Botany-----	24
II.3.4 Uses-----	25
<b>III OBJECTIVE OF THESIS AND METHODOLOGY</b> -----	<b>26</b>
III.1 OBJECTIVE OF THESIS-----	26
III.2 METHODOLOGY-----	26
<b>IV DESCRIPTION OF FARM'S CONDITION</b> -----	<b>28</b>
IV.1 BINH PHUOC PROVINCE OVERVIEW-----	28
IV.1.1 Natural conditions-----	28
IV.1.2 Land and water resources-----	28
IV.2 GENERAL DESCRIPTION OF FARM-----	31
IV.2.1 Position-----	32
IV.2.2 Irrigation facilities-----	32
IV.2.3 Power resource-----	32
IV.2.4 Production-----	33
IV.2.5 Status of farm's irrigation system-----	33
IV.2.6 Farm (local) climate conditions-----	34
IV.2.7 Water and soil conditions-----	36
<b>V PROPOSAL OF IRRIGATION PLAN AND DESIGN</b> -----	<b>38</b>
V.1 IRRIGATION METHODS-----	38
V.2 IRRIGATION APPLY-----	40
V.3 ECONOMIC COMPARISON-----	53
V.3.1 Capital cost-----	53
V.3.2 Operating cost-----	55
V.3.3 Comparison-----	55
<b>VI CONCLUSION</b> -----	<b>57</b>
<b>VII BIBLIOGRAPHY</b> -----	<b>59</b>
<b>VIII SUPPLEMENT</b> -----	<b>61</b>

## List of figures

Figure 1: The factors could effected to efficiency of surface irrigation application .....	9
Figure 2: A scheme of natural sub –irrigation .....	10
Figure 3: A scheme of a basic pressurized system .....	13
Figure 4: Reference evapotranspiration, $ET_o$ and crop evapotranspiration $ET_c$ .....	15
Figure 5: Irrigation application efficiency $E_a$ .....	17
Figure 6 : Number of pumps in selected Asian countries, 1979 – 1999.....	22
Figure 7: Four year old rambutan in the farm. ....	25
Figure 8: Official map of Binh Phuoc province .....	31
Figure 9: A farm’s micro- sprinkler .....	32
Figure 10: Rambutan crop pattern according crop factors $K_c$ .....	34
Figure 11: Soil classification triangle .....	36
Figure 12: Irrigation requirement for rambutan at selected farm in 2007 -2009.....	38
Figure 13: The map of position of sector and scheme of previous irrigation pipe system.....	41
Figure 14: The irrigated areas of existing system and proposal system.....	42
Figure 15: Emitter position and irrigated area in rambutan tree canopy area .....	43
Figure 16: Percentage of irrigated area in tree canopy .....	44
Figure 17: Total head loss at selected point in 4 sectors .....	47
Figure 18: Picture of PGA valve and PRS-Dial .....	48
Figure 19: Example for differential pressure of mesh filter cartridges .....	48
Figure 20: Total head curve of selected pump .....	51
Figure 21: Assembling dimension of pump .....	52
Figure 22: Dimension at inlet and outlet of pump.....	52
Figure 23: Proposed prime method for irrigation system.....	53
Figure 24: Irrigation scheduling graph in year 2007 .....	62
Figure 25: Irrigation scheduling graph in year 2008 .....	63
Figure 26: Irrigation scheduling graph in year 2009 .....	65
Figure 27: Farm water analysis report – Nong Lam University, Vietnam – 4 <sup>th</sup> March 2010 ..	66
Figure 28: Farm soil analysis report – Nong Lam University, Vietnam – 4 <sup>th</sup> March 2010.....	67
Figure 29: Position of emitters at rambutan tree of exited irrigation system in farm.....	68
Figure 30: In front of rambutan sector of selected farm.....	68
Figure 31: The underground PVC pipe mesh of exited irrigation system.....	69
Figure 32: Lake provides water for irrigation system .....	69



## List of tables

Table 1: Factors effect to the irrigation method selection .....	19
Table 2: Growth in irrigation in South East Asian from 1961 to 1990 .....	21
Table 3: Monthly mean air temperature in year of Binh Phuoc province .....	29
Table 4: Monthly rainfall in year of Binh Phuoc province .....	30
Table 5: Suggested crop irrigation in Sumatra and Malaysia.....	33
Table 6: Climate data at Binh Phuoc Province in 2007 (from Dong Xoai station).....	34
Table 7: Climate data at Binh Phuoc Province in 2008 (from Dong Xoai station).....	35
Table 8: Climate data at Binh Phuoc Province in 2009 (from Dong Xoai station).....	35
Table 9: Available water capacities of soil.....	37
Table 10: Analysis result of farm's irrigated water quality .....	37
Table 11: Average canopy diameter of farm's rambutan tree .....	39
Table 12: Results of calculating capacity of each sector .....	39
Table 13: Technical parameter of chosen emitter .....	43
Table 14: Calculation of head loss of longest distance point in sector B.....	46
Table 15: Technical parameter of selected pumps .....	51
Table 16: Total equipment cost of proposal system .....	54
Table 17: Irrigation investment costs in regions in year 2000 .....	56
Table 18: Monthly $ET_o$ result in year 2007 .....	61
Table 19: The scheme supply for rambutan tree in year 2007 .....	62
Table 20: Monthly $ET_o$ result in year 2008 .....	63
Table 21: The scheme supply for rambutan tree in year 2008 .....	63
Table 22: Monthly $ET_o$ result in year 2009 .....	64
Table 23: The scheme supply for rambutan tree in year 2009 .....	64

## List of symbols

A	Average canopy area of tree
D	Mean of root depth
d	Diameter of cross section of pipe
$d_i$	Net depth irrigation
$d_g$	Gross irrigation dose
$ET_o$	Reference evapotranspiration
$ET_c$	Crop evapotranspiration
$E_a$	Application efficiency of system
$E_{ff}$	Effective precipitation
$IR_n$	Net irrigation requirement
$G_e$	Ground water contribution
$H_g$	Geodetic head
$H_z$	Total pressure loss in mesh pipe
h	Total head loss of pipe system
$LR_{mm}$	Leaching requirement
l	Length of pipes
p	Soil moisture depletion
Q	Flow rate through pipe
$K_c$	Crop factor
Ti	irrigation interval
t	Operation time of system per day
S	Cross section of pipe
$S_a$	Soil water available or total available moisture
v	Velocity of water movement in the pipes
$\lambda$	Darcy –Weisbach friction coefficient
$\zeta$	Fitting loss coefficient
$W_b$	Water stored in soil

# I INTRODUCTION

Water is the essential condition of development of every human society and for an existence of majority of ecosystems. The increase of human population and development demands requires new allocations of ground and surface water used for the domestic, agricultural and industrial purposes. The pressure on water resources and their utilization rapidly rises. The more worldwide growing population and rising demand, the more serious potential conflict among water consumers linked with water resources can occur. Moreover water is one of the most important elements for growing plants. Nowadays agriculture accounts for 70% of all water use globally, up to 95% in several developing countries such as Vietnam (*FISCHER et al., 2007*). Water is necessary for photosynthesis processes, for the transfer of nutrition substances and it regulates temperature of plants by transpiration. Every specific plant has its own specific water requirements depending on life cycle, soils, local and climatic conditions etc. Surplus or lack of water supply prevents to adequate plant development. The increase of water use productivity holds the key to future water scarcity challenges.

Vietnam is one of the developing countries in area of Southeast Asia. It has plentiful of water resources ranging from many river systems to high yearly precipitation. In general it provides great advantages in agricultural and industrial developments in Vietnam. Surface water resource accounts for about 2% total flow of rivers in the world, in compare with only 1.35% world's territory. Average precipitation is around 1800 mm per year, with a minimum of 650 mm in Phan Rang, and a maximum of 4760 mm in Bac Quang (*Nguyen Thuong Bang, 2006*). Nevertheless the water resources are not distributed equally throughout country by time and space. While in Red and Mekong Delta, rainfall is often very high, from 3000 (mm) – 4000(mm), droughts occur frequently in Middle of Vietnam, such as Binh Thuan, Ninh Thuan provinces. Moreover Vietnam population will increases dramatically within the few decades and mismanagement of water resources can contribute to deprivation of pure water in near future. Climate changes influence the water demand in agriculture in the whole world as well. According to the climate change A2 scenario, in 2080, an increase about 20% was estimated in global irrigation water needs. Two-third of increase, 75% -80% in developing countries, results from an increase in daily water requirements (*FISCHER et al., 2007*).

Agriculture is an important part of Vietnamese economy with approximately 80% of the employed population located in rural areas (*FAO, 2001*). Therefore, irrigation and drainage are studied and applied frequently, especially the flood irrigation. Most of irrigation methods are applied in rice production but few in fruit tree or industrial tree production. Moreover, agricultural sector is mostly created around small-scale family farms with average square less than 1 hectare (ha) (*HARRIS, 2006*). There are few researches on irrigation for farms which have area more than 10 ha. Most of irrigation applications depend on owners' experiences. This situation could lead to losses in surface or ground water utilization. Applications of improved irrigation methods should be applied to such farms are expanding quickly as a result of the increasing demand on minimizing the effects of irrigation improving utilization of water, increasing and expanding production yields and ranges.

## **II LITERATURE OVERVIEW**

### ***II.1 Irrigation***

Plant needs adequate water supply for good yield. Water was supplied to plant by rainfall, surface water or ground water. However, these natural sources could not satisfy agricultural demands, because of not only changing climate all the time but also intensification and diversification themselves. Application of effective irrigation methods to distributing water is sole key to improve utilization of water resources avoid uncontrolled withdrawal, saving energy, and ensuring good harvests as well. Moreover, large distribution irrigation systems could play an essential role in water distribution which could allow water resource management avoiding uncontrolled withdrawals from the sources such as rivers, springs or ground water. Irrigation in a field is concerned with transferring water from a conveyance system of pipes or channels into the soil within usable range of growing plant root systems at specific times. Irrigation run water over the surface so that it infiltrates in to the soil, pass water into the soil at specific depth until capillary force raises it to root zone or cause water to fall to the ground in such a way that it could not destroy either crop or soil. Base on the principles, there are three main categories of practical irrigation named as surface irrigation, sub-irrigation, and overhead irrigation (*Bruce Withers – 1988*). However, irrigation systems could be also divided in two basic types: open canal systems and pressured systems (*FAO – 2007*). Their selection depends on soil gradient at the site, crops features, the available water sources and the degree of control required over water flow. A success of an irrigation project could be decided on proper functioning of its water transport and distribution system. While its operations conditional upon good organization, effectiveness essentially depends on a good plan, design and construction of system from the sources of water supply to each tree in the farm (*FAO -1975*).

#### **II.1.1 Surface irrigation**

Surface irrigation is method in which water is applied to surface field by gravitation force. It could be an open canal systems, since it refers to method of water application where a body of water, of some depth, is applied to one end of a bay or furrows. Those furrows are constructed with a slight slope so that water is driven down in sheet or a stream and in controlling of its movements. People have been driven water on the land by surface irrigation for many thousands of years. However, either to reduce wasting water and labour

requirements or hazards of waterlogging and salinity, the scientific approach of recent years has selected and developed surface irrigation techniques which are the most effective (*Bruce Withers – 1988*). A number of different versions of surface irrigation are practiced now. While furrow irrigation is employed for irrigation of rows crops such as groundnut or sugarcane crops, border irrigation and basin irrigation are preferred for field crops, like paddy rice crop.

Basin irrigation is most common in utilizing surface irrigation, especially for term of small field (*www.fao.org*). A field, encompassed by dyke, supplied an undirected flow of water and level in all direction, is named a basin. Basin irrigation could be served easier than others because their level allow water supply from anywhere along the basin perimeter. Application of automatic control is easy as well. On the contrary, basin irrigation has a number of limitations. First of all, it could not be utilised to crops that cannot stand inundation. Precision land levelling is the most important factors which affected to efficiencies and uniformities. Moreover, from mechanization point of view, because the basin is surrounded by dyke, precision equipment cannot work effectively. Last but not lease, the dyke have to be well maintained frequently to prevent from breaching that created by animals and insects.

Border irrigation could view as an expanding of basin irrigation to slopping, long rectangular or contoured field shapes, with free draining conditions at the lower end (*www.fao.org*). In this type, the precision level of soil surface is also essential but levelling operation could be better through applying farm machinery.

In furrow irrigation systems, crops are planted in raised beds, enabling water to flow down along furrows. One direct flow of water could be driven to head of furrows from open channel through siphons, from a low pressure gated pipe or from fluming. Successful furrow irrigation means that water could spread not only laterally into the beds but also downward into the root zone. Therefore, hydraulic conductivity of soil defines furrow spacing and crop row spacing as well (*Neil Southorn – 1997*). Others soil characteristics such as infiltration rate, slope determine length of furrows. Furrow irrigation method could avoid disadvantages of previous methods (*www.fao.org*). Furrows provide better on-farm water management under many surfaces irrigation. More types of topography could apply it. It is very difficult, however, to say that furrow irrigation gives higher application efficiencies than basin and border irrigation do. Furthermore, it could make several disadvantages to the field. These may include: the increasing concentration of salinity between furrows, the adding expense and time for furrow construction, increasing run-off or

erosion along furrows. Finally, with furrow irrigation system, automatic control seems to be impossible, particularly with balance flow rate between furrows (*www.fao.org*).

Neil Southorn (1997) agreed that there are a number factors influence the amount of water entered to the profile under surface irrigation and the uniformity of that application. Large efforts are needed to make accurate survey soil characteristics and reconstruct the topsoil until the required gradient, smooth surfaces are achieved. Although all design requirements are adapted, water application efficiency and potentially the yield could not be controlled. During water transported in opened channel, it has been infiltrating, while water might not reached to bottom of furrow. Besides, it is difficult to reach crop requirements, since water could waste through percolating to water table or evaporation process.

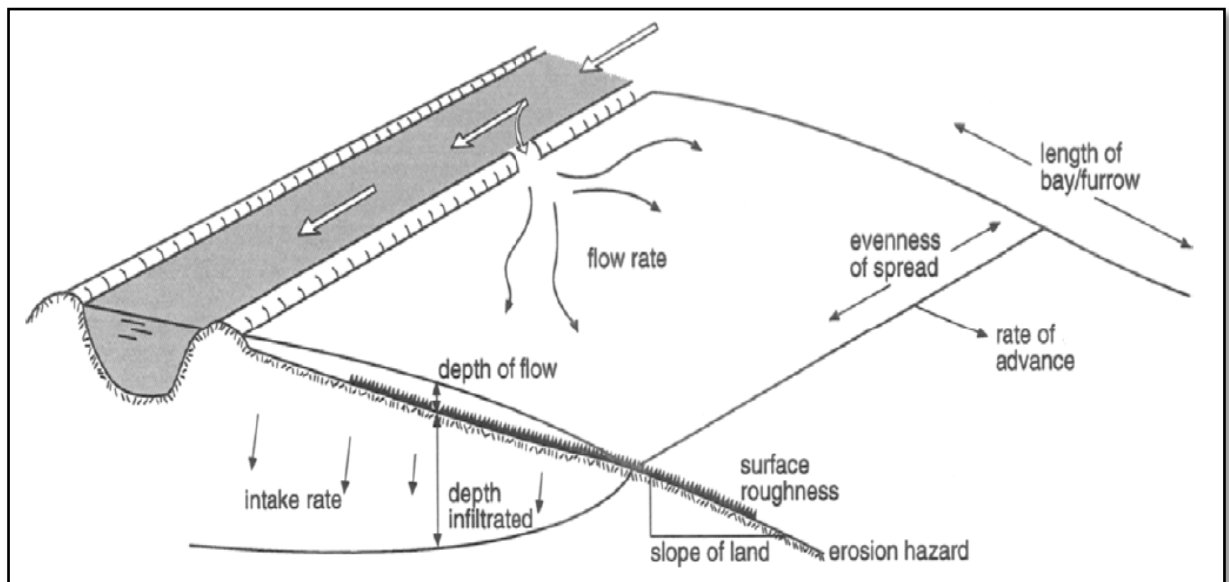
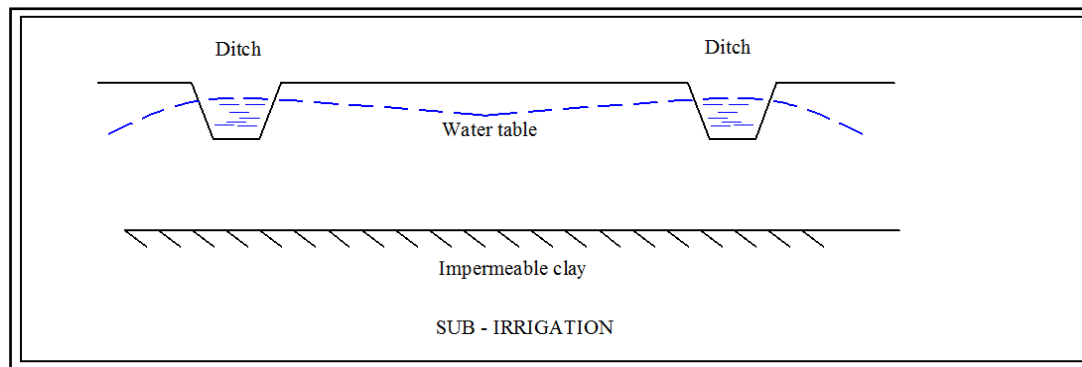

**Figure 1: The factors could effected to efficiency of surface irrigation application**

*Source: Neil Southorn – 1997*

### **II.1.2 Sub - irrigation**

With advantages of avoidance of the evaporative losses of open water or wet soil surface, sub-irrigation has an attractive proposition to the irrigator if he can devise the means of execution. Moreover, sub-irrigation eliminates impedances caused to cultivation by pipes and ditches.



**Figure 2: A scheme of natural sub –irrigation**

*Source: Neil Southorn – 1997*

As Bruce Withers et al (1988), natural sub-irrigation is so called because the conditions which make it possible are geological and topographical. These are near-level terrain, and a deep topsoil of very high lateral permeability underlay at 2 (m) to 7 (m) depth by an impermeable stratum. If the area with this soil profile is sufficiently expansive, it creates a convenient underground reservoir that could be refilled by spreader ditches and wells. The water table at irrigated area is monitored frequently. If drawdown occurs by comprising consumptive use by vegetation and net seepage outflow, losses are replaced by supply.

In the process of supply to the plant, all water movement is upwards from the water table. Consequently, unwanted salts could move upward within the soil. This could be more affective where have the harmful salts close to or on the soil surface such as in arid climates. Should this be the case, heavy applications of water to the surface could provide periodic leaching to the soil. Drainage for removal of salts by leaching must included. This could be a disadvantage of sub-irrigation (*Bruce Withers – 1988*).

Man-made sub-irrigation involves the use of a buried perforated pipes system through which water is passed at pressure to percolate into the soil. This method will only function effectively if the soil has high horizontal and low vertical permeability. System of this type requires pipes at spacing as low as 450 (mm) and depths in region of 500 (mm). They are complicate and expensive installation. Moreover, this system is able to damage by deep cultivation such as disc ploughs. In operation, a certain pressure could be maintained in operation by pumping or potential energy from an elevated storage (*Bruce Withers – 1988*).



### **II.1.3 Pressurized irrigation**

Pressurized irrigation system mentions to systems in which flow water is sprayed to crops from water sources through pipes line to emitters under pressure created main pumps. Pressure systems consist mainly fixed or flexible pipes which were connected the entire emitters to sources by the most economic ways (*Nicola Lamaddalena -2000*).The sources could be pumping station on a river, a lake, a canal or a well where can provide water with acceptable quality. Pressurized irrigation system could divides into two main categories; sprinkler and drip (trickle) system (*Neil Southorn – 1997*). Both of them are classified to many kinds by their emitter types, lateral features, drop sizes and operating principles.

In comparison with surface irrigation, pressurized irrigation does not depend on topographic restrictions. Because there are no losses through evaporation, operating efficiencies of systems are better than surface system as well. It leads to a large quantity water can be saved or the operating cost may be decreased. Though the pressure system could be more technical but automation could be applied more easily than others. Consequently, need of labours might be decreased with self-propeller machines which more easily managed than a channel systems. Another advantage of this system could be preventing cell liquid freezing because of continuous application of water to the plant surface. Furthermore, chemical substances, for example pesticide and fertilizer, could be easily added and sprayed to trees with irrigated water. However, pressurize irrigation system could bring to irrigators some trouble when operating and maintaining systems. First of all, in some case, especially spray irrigation, uniformity and efficiency could be reduced because of wind. Moreover, the design capacity of system sets a limit for application rate and irrigation schedule, pressurize system seems to difficultly copy with extreme condition of water demand Finally, equipments such as pump, pipe lines and emitters require a frequently maintaining schedule for good services (*Neil Southorn – 1997*).

Although there are several disadvantages, as Glenn J Hoffman et, al (2006), pressure irrigation system have revolutionized the development of irrigated agriculture, because of the raising on the demand for higher irrigation efficiency, improved utilization of water and intensification and diversification of production. FAO (2000) indicated that pressure piped irrigation techniques are replacing successfully the traditional open canal surface methods at farm level from their experience which they gained at many countries in arid and semi-arid zones. The pressurized irrigation system could bring to operator many benefits through reducing water losses which could be estimates at up to 40 percent in traditional system. In the pipe, water cannot be losses by seepage, phreatophytes and

leakage in gates, spillways, etc. The irrigation efficiency of pressurized system can be ranges from 75 – 95 percent (%) under good design and operating. In open canals, this figure could reach a maximum of 60 percent. According to yield, because of high efficiency during application, crop yield could increase 10 – 45 percent (*FAO - 2000*). There is a big surprise to know that the open canal irrigation require higher skilled labour than those in pressurized irrigation. The need of man – hours in open canal system could be four to ten times higher than those in pipe irrigation. Open canal also needs expensive operations to maintenance system, while no maintenance or continuous repair of constructions is required in pressurize system. The complete piped system requires a yearly maintenance costing about 5 percent of the initial investment (*FAO - 2000*).

It could divide pressurized systems into two categories; high and low pressure irrigation system. Both of them are constructed by a main pump which drives water from sources to through mainline, lateral to emitters. Water could be purified by filter or mixed with chemical substances such as fertilizer or pesticide before sprayed. The operating discharge and pressure in system could be controlled by a water meter and pressure gauge, placed after main pump. The first means sprinkler irrigation, sometime called overhead irrigation. They could be tow line systems, hand move laterals, side roll systems, side move with trailer line and center pivots. The mechanical pressure regulator is used to maintain the design operation pressure of at sprinkler, which may range from 200– 400 (kPa) for the different type of sprinkler systems. In this system, water is forced out of single or dual nozzles, breaking up into droplets as it leaves the nozzle and supplied over head crops (*Neil Southorn – 1997*). The latter mentioned trickle irrigation and micro sprinkler system. To apply frequently water in field for long period of time with a small discharge, people have utilized drip (trickle) irrigation. By this type, water is slowly supplied as discrete or drops, tiny stream or miniature spray by emitters on, above or beneath the soil by surface trickle, subsurface trickle, bubbler, spray and pulse systems. As surface irrigation, water in trickle irrigation system flows from the emissions point through the soil by capillarity and gravity to crop root zone. Most of agricultural trickle irrigation was designed with operating pressure range from 27 – 207 (kPa) (*F.S Nakayama et, al – 1986*).

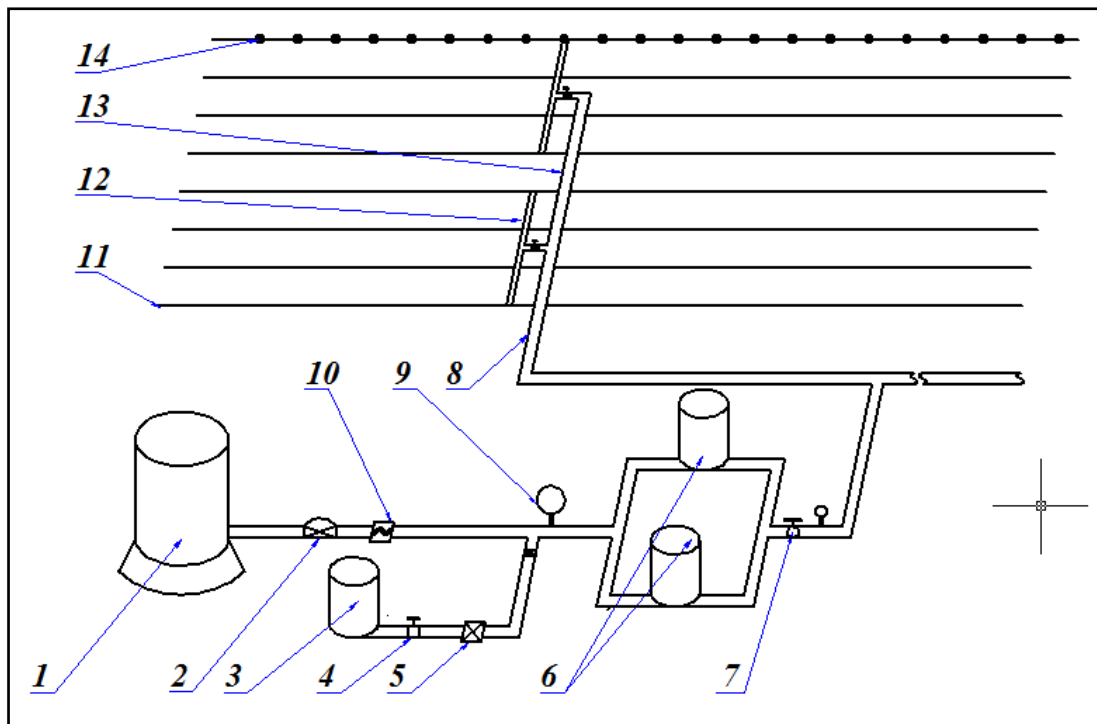

- |                           |                        |
|---------------------------|------------------------|
| 1. Main pump              | 8. Main line           |
| 2. Back flow preventer    | 9. Pressure gauge      |
| 3. Chemical tank          | 10. Water meter        |
| 4. Control valve          | 11. Lateral            |
| 5. Chemical injector pump | 12. Manifold or header |
| 6. Filters                | 13. Sub- main line     |
| 7. Pressure regulator     | 14. Emitters           |

**Figure 3: A scheme of a basic pressurized system**

*Source: F.S Nakayama et, al – 1986*

#### **II.1.4 Water plant requirements**

Water plant requirement or crop water requirement encompasses the total amount of water use in evapotranspiration of specific plant (FAO -2002). It refers to amount of water used by crop for cells construction and transpiration. Evapotranspiration, abbreviated ET, from vegetation is primary water requirements in agricultural crops. It is losses of water through two processes, evaporation and transpiration. In evaporation, water in soil or wet plant surface is converted from liquid or solid form into vapour. On another hand, transpiration is process in which water, contained in plant tissues, vaporizes into the atmosphere through small openings in the plant leaf, called stomata (FAO -2002 and Glenn J Hoffman et.al -2006).

Climatological factors such as radiation, temperature, air humidity and wind speed affect to both processes. Although these processes occur often at the same time, they have difference factors that influence to their values. While soil surface, the ratio of shading of the crop canopy and water available content at the evaporating surface are the other factors that affect the evaporation process, soil water content, water permeability and root depth also determine the transpiration rate (*FAO – 2002*). The evapotranspiration of reference surface not short of water is reference evapotranspiration, abbreviated  $ET_o$ . The quantification of ET and  $ET_o$  as well are necessary for design and sizing of irrigation system components for operating irrigation and water resource system for conducting water because and for conducting hydrologic analysis (*Glenn J Hoffman et.al -2006*).

There are two methods to estimate  $ET_o$  which are introduced by FAO, called FAO Penman – Monteith method and pan method. The FAO Penman – Monteith methods requires the meteorological data figures. These figures are applied in the Penman – Monteith equations which were invented by Penman in 1948. The latter is practical method in which the loss of water in standard pans are collected in the field where collecting  $ET_o$ . The pan can be a cylinder pan with 120.7(cm) in diameter and 30 (cm) in height or a square pan with 90x90 (cm) dimension (*FAO -2002*).

Crop evapotranspiration,  $ET_c$ , is more important for designer because it is connected directly to crop growth stages.  $ET_c$  could be found via  $ET_o$  which is estimated by historical or present weather data and coefficient, called crop factor  $K_c$ .  $K_c$  or  $ET_c$  are influenced by crop growth stages, amount and frequently conditions and crop management (*Glenn J Hoffman et.al -2006*). Richard Allen et.al (*FAO - 56*) agreed that differences crops have difference  $K_c$ . The changing characteristics of plants over growing seasons, soil evaporation and climate may affect to the coefficient  $K_c$ . The equation and picture below could explain clearly relationship between  $ET_o$ ,  $ET_c$  and  $K_c$ .

$$ET_c = ET_o * K_c \text{ [mm/day]} \qquad \text{Equation 1}$$

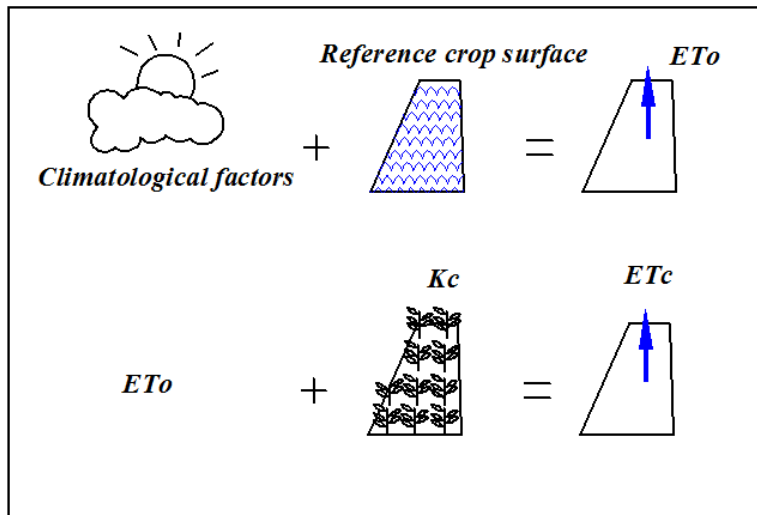

**Figure 4: Reference evapotranspiration,  $ET_0$  and crop evapotranspiration  $ET_c$**

*Source: FAO – 2002*

It is necessary to distinguish between crop water requirement and irrigation requirement, abbreviated IR. Crop water requirement is amount of water which crop need and can be provided from many sources such as precipitation, snow, fog, water storage in soil, or irrigation. It is equals to  $ET_c$  (FAO -2002). On the other hand, irrigation water requirement is water supplied through irrigation system to ensure that crops received enough their water requirement in each growing period. If crop receive some of its water from other sources, IR could be considerably less than crop water requirement.

Irrigation water requirement is one of the most essential parameters for planning, design and operation irrigation systems. It helps to determined capacity of irrigation systems, the need of storage reservoirs as well. Incorrect estimation of the IR could lead to only serious failure in the irrigation system performance but also the waste of water resources. It may cause waterlogging, salinity or leaching of nutrients from the soil. Finally, it could lead to waste energy in irrigation operation and developing operating cost.

Net irrigation requirement,  $IR_n$ , is depth of irrigation water, exclusive of precipitation, soil water storage or supplied water from water table, which is required to meet crop water requirement. It does not include the losses that may occur during process of irrigation.

FAO (2002) suggest equation for  $IR_n$  from field balance:

$$IR_n = ET_c - (E_{ff} + G_e + W_b) + LR_{mm} \quad \text{Equation 2}$$

In which,

$E_{ff}$  is effective dependable precipitation, only a part of water from rain, snow or fog which crops could consumptive. It is not total annual precipitation because of losses through

soil infiltration, surface run – off or evaporation. To estimate  $P_e$ , FAO suggest using USDA method in which root zone depth and soil storage capacity play important roles for computing  $P_e$ .

$G_e$  and  $W_b$  are ground water contribution from water table, water stored in soil at the beginning of each period. However, in some areas which have very small rainfall or very deep water table, they could be considered negligible (FAO - 2002).

$LR_{mm}$ , leaching requirement, mentions to amount of water used to avoid high salinity concentration at root zone by leaching. FAO (2000) recommended that an excess amount of water, 10-15 percent, is applied during the irrigation where necessary for leaching purposes.

### II.1.5 Irrigation planning

Irrigation planning or irrigation schedule is one of the most important factors that influence the agronomic and economic viability of farms. Moreover, it is not influence only water savings but also improving crop yields. Irrigation schedule concerns to two primary decisions figures: when to irrigation (timing) and how much water to supply (amount). They could be an irrigation interval of frequency,  $T_i$  and depth of water applied per irrigation,  $d_i$ . They are depended on monitors of: the soil water status and the crop water requirements (FAO -2000).

The first, crop water requirement or water plant requirement, is mentioned in previous part. The latter includes number of features of soil which performance soil – water relationship such as saturation capacity, soil available water, available moisture water and infiltration rate (FAO – 2000).

According to FAO - 2000, irrigation interval  $T_i$ , is the number of days between two different irrigations. It could be computed by equation:

$$T_i = \frac{d_i}{ET_c} \quad \text{Equation 3}$$

Where:

$d_i$ : Net depth irrigation application [mm]

$ET_c$ : Crop water requirement [mm]

Net depth irrigation shows the quantity of water in each irrigation interval that could be supplied. To find this figure, FAO – 2000, recommended the equation:

$$d_i = (S_a \times p) \times D \quad \text{Equation 4}$$

In which:

$S_a$ : Soil water available or total available moisture [mm/m]

$p$ : soil moisture depletion

$D$ : Mean of root depth [m]

The fraction of moisture in the soil, which given by ( $S_a \times p$ ), shows amounts of 20 - 70 percent of total soil water available. This could be easily absorbed by the crop (without any stress that effects to crop yields). Soil moisture depletion is called fraction of water effect by Glenn J Hoffman et.al (2006). The  $p$  value depends on the crop, the root depth, the climatic conditions and the irrigation techniques. FAO -2000 suggested that  $p$  could be:

- 0.2 – 0.3 for shallow rooted seasonal crops
- 0.4 – 0.6 for deep rooted field crops and mature trees.

Although net depth irrigation shows the amount of water contained in root zone, consider losses occurs during irrigation procedure such as evaporation, seepage and deep percolation, etc. Hence, irrigation application efficiency,  $E_a$  (%), is given to adjust amount of irrigated water. This value differs according to irrigation method. With given of  $E_a$ , the gross depth of irrigation application or gross irrigation dose ( $d_g$ ) is calculated as follows:

$$d_g = d \times E_a \quad \text{Equation 5}$$

The figure below (Figure 5) shows the value of irrigation application efficiency belong to irrigation systems.

Systems/ Methods	Irrigation application efficiency, $E_a$ (%)
Earth canal network surface methods	40-50
Lined canal network surface methods	50-60
Pressure piped network surface methods	65-75
Hose irrigation systems	70-80
Low-medium pressure sprinkler systems	75
Micro sprinklers, micro-jets, mini sprinklers	75-85
Drip irrigation	80-90

**Figure 5: Irrigation application efficiency  $E_a$**

*Source: FAO - 2000*

According to the salinity level in the roof zone, an amount of water, called leaching requirement, LR, could be added to excess water for leaching purpose. This amount of water is recommended from 10 to 15 percent (%) of excess gross depth irrigation water.

The second important figure is amount of water which is supplied by irrigation system, capacity system or total discharge, Q (liters per second, l/s). F.S Nakayama (1986) suggested that

$$Q = \frac{(2.77) \times IR_n \times A}{t \times E_a} \quad \text{Equation 6}$$

In which;

IR <sub>n</sub> : irrigation requirement	[mm/day]
A: Average canopy area of tree	[ha]
t: Operation time of system per day	[h]
E <sub>a</sub> : application efficiency of system	(fraction)

### II.1.6 Irrigation method selection

All methods irrigations have advantages and disadvantages. To choose an irrigation method, the designer must know the advantages and disadvantages of the various methods. The suitability of the various irrigation methods, i.e. surface, sprinkler or trickle irrigation depends mainly on the following factors:

- Natural conditions
- Previous experience with irrigation
- Type of crop
- Required labour inputs
- Type of technology
- Costs and benefits.

First of all, the natural conditions such as soil type, slope, climate, water quality and availability, have influence on the choice of an irrigation method. Soil type is the first reason which should be considered. For example, because sandy soils have a low storage capacity and high infiltration, sprinkler or drip irrigation are more suitable than surface irrigation. On the other hand, clay soils with low infiltration rates are respected to surface irrigation. In case that there are several type of soil in one irrigation scheme, sprinkler or trickle irrigation are recommended because of their easily variable water distributing characteristics ([www.fao.org](http://www.fao.org)).

The second factor affecting to irrigation method selection is type of crop. Generally, pressurized systems are often utilized for high values cash crops, such as vegetable and fruit trees, because of their high capital cost. Drip irrigation is suited to driving water to plants or trees or row crops such as sugarcane.

In general, pressurized irrigation, of course, is technically more complicated selection. The purchase of equipment requires high initial cost and they may depend on unstable imported products. The maintenance cost and operation cost are high as well,



because these methods require higher level of ‘know-how’ labours ([www.fao.org](http://www.fao.org)). In contrast, surface irrigation requires more labors input than others. Moreover, previous experience with irrigation also helps people in choosing an irrigation method. It is easier to improve the traditional irrigation method than represent a totally new method. A table 1 below represents factors which are concerned when people are going to establish an irrigation system.

TYPE OF SYSTEM		MAX		Water application rate (mm/h)		Shape of field	Chemical application	Orchards and Vineyards	Labor required (min/1000m <sup>2</sup> )	Approximately cost (\$/1000 m <sup>2</sup> )
		SLOPE		Min	Max					
		Non sodded crops	Sod crops							
SURFACE IRRIGATION	Basin, level borders	Less than 1% slope		2.54	50.8	Any shape	No	Yes	2 - 8	0.6-1
	Graded borders	Greater than 0.1% slope		2.54	50.8	Any shape	No	Yes	2 - 8	0.6-1
	Corrugations	4%	8%	2.54	50.8	Any shape	No	Yes	6 - 18	0.2 - 0.6
	Furrows	3%	NA	2.54	76.2	Rows should be equal in length	No	Yes	6 - 18	0.6-2
	Controlled Flooding	0.1%	NA	7.62	50.8	Rectangular	No	Yes	3-15	0.6-2
TRICKLE IRRIGATION	Surface trickle	No Limit		Any		Any shape	Yes	Yes	0.9	NA
	Subsurface trickle	5%		38.1			Yes	No		
	Micro spray	No Limit		Any			No	Yes		
SPRINKLER IRRIGATION	Linear move	20%		5.08	50.8	Circular	Yes	NA	0.75-2.25	NA
	Center pivo	20%		2.54	38.1	Square or rectangular				
	Fixed set	No Limit		1.27	50.8	Any shape				
	Side rolls	10%		2.54	50.8	Rectangular				
	Hand move	20%		2.54	50.8					
	Big gun	5%		6.35	25.4	Any shape				
	Traveling			6.35	25.4					
								30-75		
								15-45		
								7.5-22.5		
								1.5-75		

**Table 1: Factors effect to the irrigation method selection**

Source: [www.nm.nrcs.usda.gov](http://www.nm.nrcs.usda.gov)

Additionally, in term of choosing an irrigation method, FAO suggest that surface irrigation is by far the most widespread irrigation method, because it seems cheaper and less requirements than pressurized methods (*www.fao.org*). Trickle irrigations are suited all terrains and most agricultural crops and soils including steep or rocky ground that is unsuitable for other forms of irrigation. Addition, it is suggested to regions that have storage of water in lower part of soil profile. They are easily automated, good control over timing and water application, less water required. Chemicals and fertilizer could be efficiently applied. Runoff and deep percolation can be avoided as well.

## ***II.2 Irrigation development in Vietnam***

Vietnam has abundant rainfall that averages around 1,800 mm per year. The annual distribution is highly uneven because the country locates in a tropical monsoonal region. However, 80–85% of the total rainfall occurs in the rainy season. Consequently, irrigation systems play an important role in managing water resources for agricultural production. Vietnam has around 3.5 million ha of irrigated agriculture (*David N. Harris, et.al -2006*). Irrigation systems are based mainly nearby the major river basins and are managed by government institutions. The systems draw water from the river basins to agricultural farms which average area are less than 1 hectare, in the dry season. In some cases, they are also used for water drainage to manage the flooding that can occur during the peak of the wet season.

According to Randolph Barker and François Molle (2004), as many Asian and Southeast Asian countries, Vietnam irrigation developed through three periods:

- The Colonial Era, from 1850 to 1945
- The Cold War Era, from 1946 to 1989
- The New Era of Globalization, 1990 onward.

In the first period, Vietnam was occupied by French. Although, they improved their colonies to get benefits for themselves, they, somehow, helped to developing colonies' facilities as well. They improved flood control in Red River delta and applied new mechanical technology to dredge river bed in Mekong delta. This allowed the expansion of canals for irrigation in middle 19th century. Consequence, paddy field area increased dramatically from 350,000 ha in 1868 to 2,443,000 ha in 1930. (*François Molle -2004*)

The second period was counted from the end of World War II to the fall of Berlin wall. At that time, while others were in reconstruction from the war, Vietnam was still in

civil war. Most of infrastructures, including irrigation systems, were destroyed because of out of using. However, after 1975, under sponsors from Soviet Union, the Vietnamese government tried their best to build most of national irrigation construction such as Dau Tieng reservoir, Cu Chi gravity irrigation system which irrigates for 170,000 hectares and drainages for 14,500 hectares agricultural land in the South and two pump based irrigation systems, La Khe and Dan Hoai scheme which can supply 8.650 and 6520 hectare crops land, respectively, in the North (*David N. Harris, et.al -2006*).

From 1990 onward, Vietnamese economy has growth rapidly. Vietnam became the second largest rice exporting country. Under these expansion and intensification, most systems could not apply enough irrigated water, especially at Mekong delta. Hence, the private small systems, based on surface water and ground water, have been developed considerably. In the Mekong delta, pumps that use motors and propellers from small boats are common, while in the Red river delta, larger-scale collective pumps are used. Pumps are using to abstract water directly from nearby rivers or ponds, independently of functioning irrigation system (*François Molle -2004*). A table and a graph below (table 2 and figure 6) show this trend in this period.

Country	Irrigated area 1998 (thousand ha)	Increase in total irrigated area 1962 - 1998 (thousand ha)	Irrigated area in 1998 as a % of that in 1962	Average annual growth 1962 -1998(%)	Irrigated area as a % of harvested area, 1998
Thailand	4,836	3,131	284	5.1	30
Indonesia	4,815	915	123	0.7	16
Vietnam	2,767	1,767	277	4.9	25
Myanmar	1,663	1,042	268	4.7	15
Cambodia	270	206	422	8.9	12
Laos	167	154	1,285	34.8	19
South East Asia	16,424	8,191	199	2.8	18

**Table 2: Growth in irrigation in South East Asian from 1961 to 1990**

*Source: François Molle -2004*

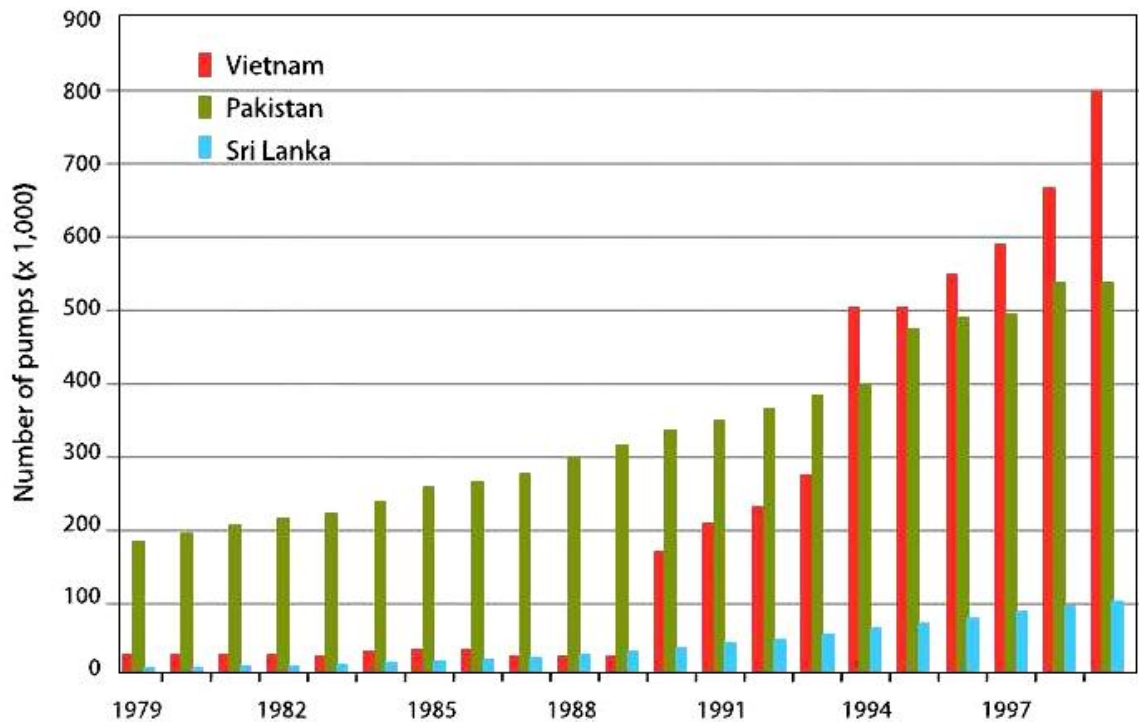

**Figure 6 : Number of pumps in selected Asian countries, 1979 – 1999**

*Source: François Molle -2004*

It can be seen that the utilization of pumps in private sector in Vietnam has a rapid increase since 1989. The number of used pumps jumped from around 10,000 in 1989 to nearly 200,000 in 1990. The second jump was happened in 1994, when amount of used pumps rose approximately doubly in only a year, from over 250,000 units to over a half of million units. It had kept continuous increasing sharply until 1999 and got points 800,000 units.

According to structure of irrigation services in Vietnam, David N. Harris, et.al (2006) reported that bulk water companies, operated by provincial government, have generally organized irrigation services. All these companies are controlled by center government through the Ministry of Agriculture and Rural Development. They are responsible for operation and management for main water supply canal system, while local irrigation services are managed by water management groups whom voted by commune farmers. These groups are responsible control supplying water to farmers, maintaining the infrastructure connected to main canal and collecting fees for irrigation and drainage services. These fees are determined by the provincial government and based on the season average crops yields.

## ***II.3 Rambutan tree***

Although rambutan tree have been cultivated for long time in many countries in South East Asia and Australia, it seem still unusual to European people. Meanwhile, litchi and longan, which are in same family with rambutan, seem be more familiar.

### ***II.3.1 Historical background and origin***

Rambutan (*Nephelium lappaceum* L.) is native to Malaysia and Indonesia (Diczbalis -2002). It belongs to the family Sapindaceae together with other well-known fruits from South-East Asia like litchi, longan and pulasan (Jürgen Pohlan, et al – 2008). Rambutan tree may be 10(m) in height and 14 (m) in width. It is, sometimes, referred to as the soapberry family, probably due to fact that *Sapindus saponaria* L. fruits can be used for making a type of soap (*FAO - 1994*).

The commonly used name of “rambutan” is derived from the Malay word “rambut”, which means “hair” and is in general used in Malaysia, Indonesia and The Philippines. In the Philippines, local names such as “usan” or ‘usau” or “usare” are used. In Thailand, Rambutan is call “ngo” or “phruan”, and In Vietnam; it is called by “chôm chôm”. In EU, other names used are: “rambutao” (Spanish), “litchi chevelu” (French) and “ramboetan” (Dutch) (*FAO- 1994*).

*Nephelium* species are found growing in a semi-wild state in many Asian tropical countries, appearing in the lower or middle storey in various types of primary and secondary forest, ranging from relatively dry areas to swamp conditions (*FAO - 1994*).

### ***II.3.2 Region***

Rambutan is indigenous to the Malay Archipelago. It has been widely cultivated throughout the region in Thailand, South Vietnam, Indonesia, the Philippines, India and Sri Lanka. It have been planted in many others regions which are located from 20°N to 20°S (*FAO – 1994*).The tropical climate of these countries is characterized by high and evenly distributed rainfall, high humidity, low evaporation rates and average minimum temperatures above 20°C. Rambutan thrives well under these conditions and produces good quality fruits. A warm climate is ideal for its growth and high yield. It is suitable for most types of soil, except waterlogged and peat areas. Because rambutan requires a lot of moisture, it is not suitable on hilly terrain or highland and does not perform well on sandy areas as well (*Jürgen Pohlan, et al – 2008, Diczbalis -2002*). Diczbalis (2002) reports that rambutan was first introduced into Australia in 1930’ and commercially planted in 1970’.

### II.3.3 Botany

In book Rambutan cultivation of FAO, botanical characteristics have been researched in detail in many literatures such as Van Welzen et al (1988). The main characteristics mentioned below are just a summary which can be following:

- Tree size and form

As many reports, there are two method to cultivate rambutan, seedling and cloning. By seedling, rambutan tree could grow from 12-20 (m) high with a canopy width of around two-thirds of the height. Another type, clonal trees, may be smaller, with 4-12 (m) high. The truck diameter could be from 40-60 (*FAO -1994*). In normal conditions, trees are well branched with pruning adding to branching complexity. The tree bark may be smooth or rough, depending on types.

- Root system

Many reports, including Y Diczbalis (1996), root system of rambutan is very near soil surface, despite the main taproot could extend to several meters (*FAO-1994*). About 80% root system of mature tree is in the top 15 (cm) layers of soil, although the main root could reach several meters in depth. Most root of rambutan tree is found in distance of 50 (cm) around the truck in horizontal direction (*Y Diczbalis- 1996*).

- Flower and fruit

The hermaphrodite flowers can either function female or male. The flowers are small, generally less than 6 mm in diameter. Rambutan fruits need 3 to 6 months to mature, depending on cultivar conditions. Mature fruits are 25 to 45 g in weight and ovoid to globose in shape. In most cases, 5 to 20 fruits occur on a panicle. The outer skin (pericarp) is 2-4 mm thick and covered in long soft spines (spinsters). In tropical areas, usual duration from flowering to fruit maturity takes 3-4 months (*Y Diczbalis – 2002*).



**Figure 7: Four year old rambutan in the farm.**

#### **II.3.4 Uses**

The trees are cultivated for their very popular fruit. The juicy sarcotesta around the seed is eaten. The sweet-tasting fruits are consumed fresh; the more sour ones are eaten stewed. The sarcotesta can be canned for use in jam, but losses much of its flavor.

Medicinal uses: the fruit is said to be astringent, stomachic and the roots used in decoctions for treating fever; the bark as an astringent for the tongue; the leaves are used in poultices for headache. The fruit wall contains a toxic saponin; cases of poisoning are known; however in Java it is dried and used as medicine.

Other less important uses: the kernel can be used for the production of rambutan tallow, a solid fat similar to cacao butter, which could be edible and also used soaps and candles. The seed itself is edible (after roasting) but the bitter and narcotic. The wood is suitable for the general construction. The tree is very ornamental when it fruits. (*E.W.M Verheij and R.E Cornolel – 1983*).

## III OBJECTIVE OF THESIS AND METHODOLOGY

### *III.1 Objective of thesis*

A trend, in which urban people invest in a small scale farm in suburban or rural areas, is developing quickly in Vietnam. These new farmers always want to apply modern cultivation methods to their orchards where they can plant high profit crops such as rambutan, durian or mangos. Irrigation is the first operating which they want to apply the newest method first. Unfortunately, since farmers in Vietnam have been only well-prepared for paddy cultivation through long history paddy cultivation, they do not have enough experience in irrigation for such kind of those crops. It could lead to that they tried to apply traditional paddy irrigation methods to their farms. Subsequence, it could bring problems to not only the farm but also natural sources, particularly water sources. Therefore, irrigation system designs based on each specific crop (rambutan) and local natural conditions of the farms are very necessary.

According to this need, this thesis aims to design an irrigation system for small scale farm in Binh Phuoc province, basing on, of course, rambutan characteristics, local conditions, and farmers' investment and farm's irrigation system. The result of this thesis could give a proposal to previous irrigation system so that it could be increased operation efficient, reduced operating cost as well.

### *III.2 Methodology*

A successful irrigation system should meet the optimization of investment and running costs (FAO 59– 2000). These objectives require designer should follow the main critical a number of parameters, called environmental parameters and decision parameters. The first depend on local natural conditions, so that they cannot be modified and must to be collected as data for design area. Designer could decide on the latter.

The most important environmental and decision parameters were listed in FAO 59 (2000). They are:

#### *Environmental parameters*

- Climate conditions
- Pedologic conditions
- Agricultural structure and land tenure
- Socio- economic conditions of farmers

#### *Decision parameters*

- Cropping pattern
- Satisfaction of crop water requirements (partially or fully)
- On-farm irrigation method



- Type and position of the water resource
- Structure of systems ( density and discharge of hydrants)
- Delivery schedule

To find these parameters, both primary and secondary data were collected.

According to primary data;

- To determine average canopy and height of crop, canopy and height of rambutan trees in farm were measured.
- Sample of water source was also taken and analyzed at research center of environmental technology and natural resource management of Nong Lam University to determine water quality.
- To find the soil water available, two samples of soil, collected at 0.5 meter under surface, were sending to analysis center of Nong Lam University and Technical University at Ho Chi Minh City. Base on soil particles, this figure could be estimated.
- A map (1: 5000 in scale) of farm was also used for setting up irrigation system.

In accordance with secondary data, all climate parameters in three years, from 2007 - 2009, such as average rainfall, temperature, humidity, sunny hours per day and wind speed were collected from Binh Phuoc's Statistic Office 2008 year book and Vietnam Southern Regional Hydro meteorological Center reports.

The characteristics of rambutan crops figures like crop factor  $K_c$ , average root zone depth, were found on FAO article and rambutan research reports.

In relation to FAO's recommendations, computer programme, called CROPWAT 8.0, is used to calculate crop water requirement and irrigation schedule. They were accounted with three difference input data from three year, 2007-2009. Average results will be used to design constructs of system. Moreover, most of decisions of design are based on FAO recommendations about irrigation problem and local farmers' experiences.

## **IV DESCRIPTION OF FARM'S CONDITION**

### ***IV.1 Binh Phuoc province overview***

Binh Phuoc is located the western part of Southeast of Vietnam. Because it has many advantages such as water, soil resources to developing agriculture, Binh Phuoc became one of the most important centres of Vietnam in industrial plant such as rubber tree, cassava and cashew tree. Nearly 50 percentages of employees is in agricultural field, about 25, 618 over total 52,082 people. Main goods for exportation are rubber, cashew nut and pepper. Total exported amounts in 2008 are 92,933 ton 12,202 ton and 1,441 ton, respectively. (*Binh Phuoc Statistical book - 2008*)

#### **IV.1.1 Natural conditions**

- Geographical location

Binh Phuoc is surrounded by Lam Dong and Dong Nai provinces on the east, Tay Ninh Province and Cambodia on the west, Binh Duong province on the south, Dalak and Cambodia on the north. The total area is 6,873.41 (km<sup>2</sup>)

- Topographical features

The area of Binh Phuoc is a plateau in the north and northeast. Binh Phuoc's territory, which is slowly lower to the west and South West, is mountainous and hilly.

- Climate

Binh Phuoc is located on in a specific region with tropical and cross-equatorial monsoon climate. There are two distinct seasons: the rainy season and dry season. The average temperature is high and stable from 25.8°C to 26.2°C. The annual precipitation is approximately 2000 – 2800 (mm) (*www.binhphuoc.gov.vn*).

#### **IV.1.2 Land and water resources**

- Land resource

Binh Phuoc is one of the provinces which possess soils of good quality in comparison with the whole of Vietnam. It is very important to the development of agriculture in the province. With a total natural area of 6855.99 kilometres square, Binh Phuoc province has seven main groups composed of 13 kinds of soils. Good quality soils such as black, bazan and alluvia soils account for 61.13 percentage of the total natural area, soils of average quality account for 36.90 percentages. According to classification of soil resources, there are 420,213 hectares of fertile soil, accounting for 61.17 percentages (%) of natural land area; 252,066 hectares of soil which has the average quality, accounting for

36.78 percentages (%) and only 7,884 hectares of nutrient-poor soil, accounting for 1.15 percentages of land area ([www.binhphuoc.gov.vn](http://www.binhphuoc.gov.vn)).

- Water resource

There exist relatively plentiful systems of rivers with density from 0.7 - 0.8 (km/km<sup>2</sup>), including the Saigon River, Song Be - Dong Nai River, Mang River and many large springs. There are also a number of lakes and dams such as Suoi Lam Lake, Suoi Cam Lake, Thac Mo hydroelectric dam, Sork Phú Miêng hydroelectric dam. Moreover, underground water is playing an important role in Binh Phuoc province, as well. Water sources, in the southwest province, are quite rich and can be exploited for the socioeconomic development. Bazal water floor may distribute more than 4000 kilometres square. Its flow is relatively quite enough from 0.5 to 16 liters per second.

However, due to the significantly changes in the infiltration, the rate of exploitation by drilling is not very high. Pleistocene water floor having great reserves with good quality water is distributed in Binh Long district and at the south of Dong Phu district. Pliocene reservoir with the flow of 5-15 (l/s) provides good quality water. There is also Mezozol water floor, distributing in low hills (altitude 100-250m) ([www.binhphuoc.gov.vn](http://www.binhphuoc.gov.vn)).

<b>MONTHLY MEAN AIR TEMPERATURE IN YEAR – AT DONG PHU STATION °C</b>					
<b>Month</b>	<b>2000</b>	<b>2005</b>	<b>2006</b>	<b>2007</b>	<b>2008</b>
January	25.9	25.2	25.9	25.8	26.7
February	26.2	27.0	27.7	27.0	26.4
March	27.1	27.9	27.8	27.9	27.0
April	27.7	29.3	28.0	28.8	28.3
May	27.0	28.7	27.8	28.4	26.9
June	26.7	27.6	27.4	27.2	27.3
July	26.0	26.2	26.7	26.5	26.8
August	26.1	26.8	26.0	26.3	26.4
September	25.9	26.2	25.7	26.0	26.0
October	25.7	26.7	26.4	26.4	26.6
November	25.6	27.0	26.8	26.8	25.4
December	25.4	24.9	25.8	26.2	25.6
<b>Average</b>	26.3	27.0	26.8	26.9	26.6

**Table 3: Monthly mean air temperature in year of Binh Phuoc province**

*Source: Binh Phuoc's Statistic Office-2008)*

---

**MONTHLY RAINFALL IN YEAR – AT DONG PHU STATION (mm)**

---

<i>Month</i>	<i>2000</i>	<i>2005</i>	<i>2006</i>	<i>2007</i>	<i>2008</i>
January	12.4	0.0	3.8	2.3	0.3
February	10.6	0.0	5.3	1.8	58.4
March	91.8	44.5	256.0	108.2	99.1
April	149.8	35.7	247.0	131.9	149
May	361.6	301.0	243.0	272.6	342.3
June	304.7	509.1	189.0	309.4	156.2
July	374.0	300.5	152.0	274.2	240.6
August	393.3	304.5	145.0	264.8	393.4
September	408.2	521.8	143.0	392.3	607.8
October	448.2	353.2	202.0	268.4	292.7
November	160.2	260.7	246.0	199.2	280.1
December	105.1	217.3	218.0	145.1	77.2
<b>Sum</b>	<b>2819.9</b>	<b>2848.3</b>	<b>2050.1</b>	<b>2370.2</b>	<b>2697.1</b>

---

**Table 4: Monthly rainfall in year of Binh Phuoc province**

*Source: Binh Phuoc's Statistic Office-2008)*

According to two tables 3 and 4 above, rainy season in Binh Phuoc province often begins in May and ends in November. The total yearly precipitation in Binh Phuoc province is often higher 2500(mm), except two years 2006 and 2007 with only 2050.1 (mm) and 2370.2 (mm), respectively. The average monthly rainfall could reach around 400 – 450 millimeters, especially in September 2005 and 2008; it was 521.8 (mm) and 607.8 (mm), respectively. On the other hand, in drying season, there is not total rain in some month, such as January, February 2005 or very few in January 2008, 0.3 millimeters. Year 2005 is quite particular with the highest average temperature and highest total rainfall as well. One of the most important is that the average temperatures in rainy months are usually higher than those in drying months, although it was rain frequently.



Figure 8: Official map of Binh Phuoc province

Source: [www.binhphuoc.gov.vn](http://www.binhphuoc.gov.vn)

### IV.2 General description of Farm

Depending on farmer's demands and economic ability, a farm was selected. It was established three years ago and located on reclaimed area of Binh Phuoc province. At beginning, it was designed to breed cow for milk, wild pig for meat and plant several types of fruit trees such as grape fruit, mango, rambutan, and durian tree. However, by many factors, most of them can not improve, except only rambutan and few grape fruits trees.

#### **IV.2.1 Position**

Selected farm is located in Hon Quan- Binh Long, Binh Phuoc province. The position of farm, determined by GPS device, is 11°32'57''N – 11°32'42''N and 106°33'32''E to 106°32'50''E. Farm area is about 20 hectares. The farm is surrounded by other rubber farms and a manmade lake in the western part of the farm.

#### **IV.2.2 Irrigation facilities**

Rambutan trees are irrigated by a sprinkler irrigation system. This system irrigates to 1800 rambutan trees. All tubes are placed under a surface of ground in depth 0.5(m). The system is proposed in “Herringbone form” with a diameter 90 (mm) of main tube and branch tubes with diameter 42 (mm). The system is controlled manually by on/off valves. Each valve controls applying water for 30 -70 trees, depends on seasons and trees. At each tree, there are four micro-sprinklers with 1 (mm) in diameter hole.

When a 1.12 (kW) centrifugal pump works, it supplies water from lake to only two branches tube. It means that about 60-140 trees are irrigated. In another way, with five pumps, about 0.1 hectare is irrigated in 1 hour. A working day, from 6h00 to 18h00, it supplies 6 hectares. Therefore, in 3 days, nearly 20 hectares are fully irrigated. Unfortunately, the voltage of power is not enough to open 5 pumps at same time, especially in evening. Hence, system usually operates only in 12 hours per day in drought period.



**Figure 9: A farm's micro- sprinkler**

#### **IV.2.3 Power resource**

The main power used in this farm is national electricity systems. They are 220V or 3x380V, 50Hz system. They cost nearly 1400 VND (Vietnamese currency), about 1.2 Kč



(Czech Republic currency) per kWh (VNexpress, 14th September, 2010). Besides, a 5Hp diesel engine also used to supply power for operating pump when main power is taken off. In comparison with other farms in area, this farm was equipped rather well, although this is not enough. The price of diesel oil is 14,750 VND per litter, about 15 Kč per litter (Vietnam National Petroleum Corporation, 26<sup>th</sup> September, 2010).

#### IV.2.4 Production

Main product of farm is rambutan fruit. It is RongRieng rambutan type, from Thailand. On the farm, there are about 1500 rambutan trees and approximately 300 grapefruit trees. Rambutan fruit is often harvested from April to May yearly. Because the rambutan trees are young and they are grown up, each tree provides only average 45(kg) of yield. Price of rambutan fruit depends much on yield, climate and season. For example, in year 2009, it cost 25,000VND, about 25 Kč per kg, but in 2010, it did only 7,000VND, about 7 Kč per kg. The earlier is harvest of rambutan fruit, the higher price is.

#### IV.2.5 Status of farm's irrigation system

Farm irrigation is applying every 2-3 days during period of drought, except during flower initiation period. It depends on experience and observation. Each tree receives approximately 300 liters of water in each three days. As many reports about rambutan cultivation, this quality of water is not enough. It should be applied more water and suitable in each growing seasons of rambutan. For example, it is data for rambutan irrigation in Sumatra and Malaysia, in 1992 – 1996

PERIOD	CROP FACTOR	# mm per day	litres/ tree /day	litres / tree / week
End wet to flowering	0.6 -0.8	4.2-5.6	100-134	700-940
Flowering to early fruit fill	1.0	7.0	168	1,176
Early fruit fill to harvest	1.2	8.4	200	1,400
Harvest to end of wet	1.0	7.0	168	1,176

# Based on: Tree Size - Canopy cover 25 m<sup>2</sup>, Evaporation = 7.0 mm/day

**Table 5: Suggested crop irrigation in Sumatra and Malaysia**

Source: Y Diczbalis, 1992 – 1996.

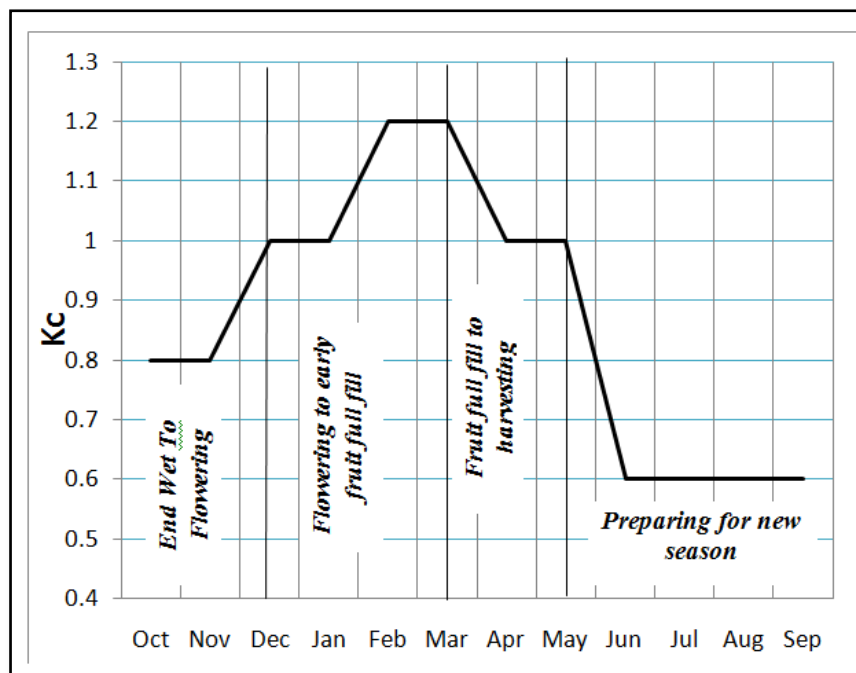

**Figure 10: Rambutan crop pattern according crop factors Kc**

In real observation of farm host, phenomenon of water shortages often occurs in his farm every season. It is showed by average size of rambutan fruit. It may influence quality and, of course, price of fruit, as well. However, because of status of electricity power and labours, system could not increase working time per day.

#### **IV.2.6 Farm (local) climate conditions**

Farm is located in Binh Phuoc so that all climate data was collected from Dong Xoai weather station (it is about 100 kilometres away as the crow flies) in 3 years, 2007 to 2009, and was described in yearly order tables below:

Monthly	Temperature (°C)	Humidity (%)	Sunny hours (h)	Rainfall (mm)	Wind speed (m/s)
1	25.8	70.7	10.60	<b>2.3</b>	0.85
2	27.0	68.0	10.10	<b>1.8</b>	0.74
3	27.9	68.7	7.60	108.2	0.87
4	28.8	73.3	9.10	131.9	0.78
5	28.4	81.7	7.98	272.6	0.70
6	27.2	85.0	9.45	309.4	0.75
7	26.5	86.7	7.98	274.2	0.81
8	26.3	87.7	12.41	264.8	0.80
9	26.0	86.3	10.20	392.3	0.82
10	26.4	85.0	12.00	268.4	0.51
11	26.8	80.7	8.04	199.2	0.75
12	26.2	75.3	5.91	145.1	0.70
<b>Average</b>	<b>26.9</b>	<b>79.1</b>	<b>9.3</b>	<b>197.5</b>	<b>0.76</b>

**Table 6: Climate data at Binh Phuoc Province in 2007 (from Dong Xoai station)**



Monthly	Temperature (°C)	Humidity (%)	Sunny hours (h)	Rainfall (mm)	Wind speed (m/s)
1	26.2	72.0	9.3	<b>0.3</b>	1.01
2	26.4	67.0	9.1	<b>58.4</b>	0.51
3	27	73.0	11.0	<b>99.1</b>	0.81
4	28.2	78.0	10.5	149	0.56
5	26.9	85.0	7.6	342.3	0.65
6	27.3	85.0	8.8	156.2	0.70
7	26.8	84.0	7.8	240.6	1.06
8	24.4	86.0	7.5	393.4	0.86
9	25.9	89.0	5.4	607.8	0.84
10	26.6	86.0	8.6	292.7	0.53
11	25.8	85.0	7.4	280.1	0.84
12	25.6	78.0	8.3	77.2	0.62
<b>Average</b>	<b>26.4</b>	<b>80.7</b>	<b>8.4</b>	<b>224.8</b>	<b>0.75</b>

**Table 7: Climate data at Binh Phuoc Province in 2008 (from Dong Xoai station)**

Monthly	Temperature (°C)	Humidity (%)	Sunny hours (h)	Rainfall (mm)	Wind speed (m/s)
1	24.4	71	8.0	3.8	1.0
2	26.2	80	10.1	15.2	0.5
3	27.8	76	8.5	119.9	0.8
4	27.7	82	9.8	142.7	0.6
5	27.2	84	6.8	304.1	0.6
6	27.3	85	13.6	293.7	0.7
7	26.4	87	5.3	268.3	1.1
8	27.5	84	7.0	300.2	0.9
9	26.0	90	7.2	414.6	0.8
10	26.3	87	6.4	312.9	0.5
11	26.8	77	7.5	229.2	0.8
12	26.2	73	8.9	152.5	0.6
<b>Average</b>	<b>26.7</b>	<b>81.3</b>	<b>8.3</b>	<b>213.1</b>	<b>0.7</b>

**Table 8: Climate data at Binh Phuoc Province in 2009 (from Dong Xoai station)**

According to the table 6, 7 and 8, the comparison between three years shows that year 2007 was the hottest and driest with 26.9 (° C) average temperatures and 197.5(mm) rainfall in this period. On the other hand, year 2008 had lowest average temperature with 26.4 (° C) and highest rainfall with 224.8 (mm). More detail, it can be seen that farm's climate is tropical climate with high humidity, over 80% and high temperature, nearly 27 (°C). The

precipitation in this area is quite high with around 200 mm per month. However, the monthly precipitation was various in all three years. For example, in January and February of all, while there was very low rainfall (under 20 mm), rainfall in September was nearly 400 (mm), especially 600 (mm) in 2008 year. In the dry months, without irrigation, crops could not give good yield, even they cannot survive.

#### IV.2.7 Water and soil conditions

##### IV.2.7.1 Farm's soil

Type of soil in this farm has same quality with most of soil types in others area in Binh Phuoc province. It is a black soil and percentage of soil particles are 79.6 percentage Sand, 6.1percentage Clay and 14.3 percentage Silt (Limon) (Report on analysis result from Research center of Environmental Technology and Natural Resource Management of Nong Lam University, 4th March 2010). According to soil classification triangle, this soil is loamy sand. Basing on an article of British Columbia (2002), water storage capacity of loamy sand soil could be 100 (mm/m).

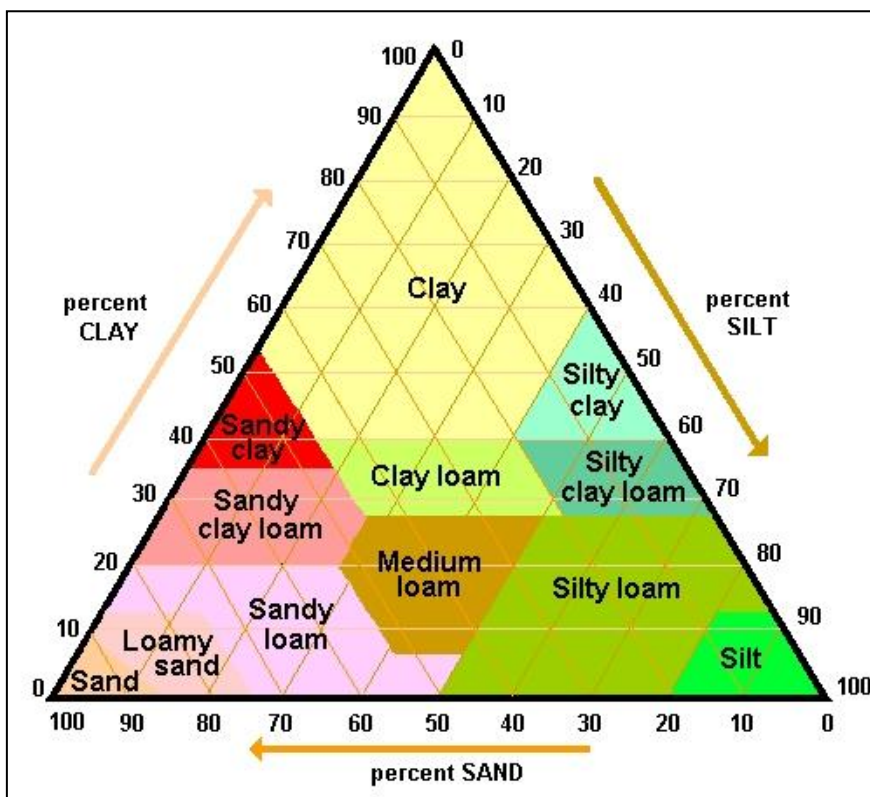

Figure 11: Soil classification triangle

Source: [www.dirtguytopsoil.com/soiltypes.htm](http://www.dirtguytopsoil.com/soiltypes.htm) -7<sup>th</sup>, Feb, 2011

A Guide to Available Water Storage Capacities of Soils			
Textural Class	Available Water Storage Capacity (AWSC)		
	(in. water / in. soil)	(in. water / ft. soil)	(mm water / m soil)
Clay	0.21	2.5	200
Clay Loam	0.21	2.5	200
Silt loam	0.21	2.5	208
Clay loam	0.20	2.4	200
Loam	0.18	2.1	175
Fine sandy loam	0.14	1.7	142
Sandy loam	0.12	1.5	125
Loamy sand	0.10	1.2	100
Sand	0.08	1.0	83

**Table 9: Available water capacities of soil**

*Source: Ministry of Agriculture, Food and Fisheries - February 2002*

#### IV.2.7.2 Water sources

There are two main water sources used to irrigation. The first source is a man-made lake with surface area about 20 hectares (ha) and 10 meters (m) in average depth. The second source is a drilled well with 50 meters (m) in depth. Water is supplied from lake to irrigation system by pump system with five 2.23 kW centrifugal pumps. When power is taken off, a diesel pump may be replaced. With water from the well, a 1.5 kW submersible pump directs water to irrigation system.

According quality, water source of the lake is good enough for irrigation but not for directly drinking. The table 10 below shows five figures about water in the lake. Water sample was collected at the lake in 22<sup>nd</sup> February 2010.

No	Target analysis	Water sample (Content)	Method
1	pH Water acidity	6.41	TCVN 6492 – 2000
2	DO Dissolved oxygen (mg/L)	4.39	TCVN 5499 – 1995
3	SAR Sodium adsorption ratio	0.56	
4	TDS Total dissolved solid (mg/L)	5	TCVN 6625 – 2000
5	Cl <sup>-</sup> Ion Cl <sup>-</sup> concentration (mg/L)	4.7	TCVN 6194 – 1996

**Table 10: Analysis result of farm's irrigated water quality**

*Source: Research centre of Environmental Technology and Natural Resource Management*

*(TCVN: Vietnamese national standards)*

## V PROPOSAL OF IRRIGATION PLAN AND DESIGN

### V.1 Irrigation methods

Selecting irrigation method depends on many factors such as botany features of rambutan, climate conditions and crop water requirement. Plant's irrigation requirement is one of the most important factors to make a choice of the most suitable irrigation method. System flow rate (l/s) takes into account and compute with the irrigation requirement and that is the reason of importance of this quantity.

By using CROPWAT 8.0, suggested by FAO, the secondary data such as average monthly temperature ( $^{\circ}\text{C}$ ), humidity (%), average sunny hours per day (h), average monthly rainfall (mm), average monthly wind speed (m/s) was used to find  $\text{ET}_o$ ,  $\text{ET}_c$ ,  $\text{E}_{ff}$ , irrigation requirement  $\text{IR}_n$ . The graph and table (see Figure 12.) below show irrigation requirement results by applying climate data in 2007-2009 in the selected farm.

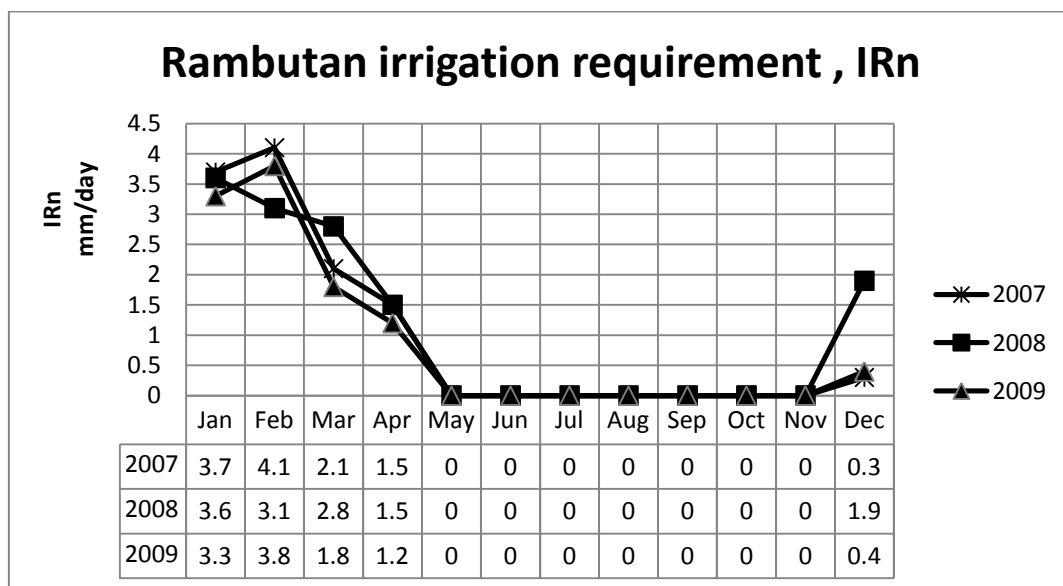

**Figure 12: Irrigation requirement for rambutan at selected farm in 2007 -2009**

It can be seen that, the  $\text{IR}_n$  was highest in February 2007, 4.1 (mm/day). The results are quite suitable to reality situation of the farm. However, chosen  $\text{IR}_n$  is 5 (mm/day) to ensure that amount of irrigated water could be suitable for year which may have higher temperature caused by climate change.

Farm can use electric power in 10 hours per day. Total operation time is 8 hours and 2 more hours needed for system control operations. The table (table 11) below shows average canopy of rambutan which was computed by a result of measurement in the farm in February 2010. There are four sectors, simply marked by A, B, C and D, already determined

by the farm owner for previous irrigation. In each sector, rambutan trees were measured to get data of their diameters at random. The average result is used to calculate Q (l/s), total system discharge or system capacity.

Average canopy diameter of rambutan in sector				
	Number of tree	Biggest diameter (cm)	Smallest diameter (cm)	Average diameter (cm)
Sector A	15	642	375	479.1
Sector B	8	610	419	467.2
Sector C	17	660	430	475.6
Sector D	6	600	387	448.3
<b>Average</b>				<b>467.55</b>

**Table 11: Average canopy diameter of farm's rambutan tree**

Although both drip irrigation system and micro-sprinkler system seem suitable to rambutan trees in the farm, micro-sprinkler method is proposed according to existed fixed pipe system. The total discharge was computed following equation 6.

$$Q = \frac{(2,77) * IR_n * A}{t * E_a}$$

In which A is total area of total amount of irrigated trees in hectares (ha). A table 12 below shows the result of calculation.

System capacity - Q (l/s) base on each region A, B, C, D							
		Unit	A	B	C	D	
Number of trees	N	tree	380	372	374	370	
Average diameter of canopy area d	d	m	5	5	5	5	Fixed figures
Irrigated area = N x Pi x d <sup>2</sup> / 4 x 10 <sup>4</sup>	A	ha	0.75	0.73	0.73	0.73	
Irrigation requirement each tree IR <sub>n</sub>	IR <sub>n</sub>	mm.day <sup>-1</sup>	5	5	5	5	
Net irrigation operation time t <sub>i</sub>	t	h.day <sup>-1</sup>	2	2	2	2	
Irrigation efficiency E <sub>a</sub>	E <sub>a</sub>		0.75	0.75	0.75	0.75	
		l.s <sup>-1</sup>	6.89	6.74	6.78	6.71	<b>7</b>
System capacity	Q	m <sup>3</sup> .h <sup>-1</sup>	<b>24.80</b>	<b>24.28</b>	<b>24.41</b>	<b>24.15</b>	<b>25</b>
Flow rare for each tree q=Q/N	q	l.h <sup>-1</sup>	<b>65.2666</b>	<b>65.27</b>	<b>65.27</b>	<b>65.27</b>	<b>66.0</b>

**Table 12: Results of calculating capacity of each sector**

In the table 12, the net irrigation operation time  $t_i$  is 2 hours per day for each sector. Each sector could be irrigated in 2 hours and there is a half of hour, farm's workers can manually control valves in order switch irrigation to another sector. Hence, total operation time of system is 10 hours. This period can be expanded because of worker's mistakes in control operation or problems in system's equipments.

The canopy tree was chosen 5 (m) to ensure that water can be supply enough when plants grow. The highest discharge of system is found at sector A with 6.89 or 7 ( $\text{l.s}^{-1}$ ). Therefore, amount of water, which could be supplied to each tree, is 66 liters per hour (l/h) or 132 liters per day (l/day). In comparison to the experiment of Y Diczbalis (1992 – 1996), this figure could be satisfied.

## ***V.2 Irrigation apply***

The next part represents application of proposed system. It includes proposed mesh pipe scheme and calculation of total pressure head and system capacity. Last but not least, an economical comparison between proposed system cost and FAO recommendation system cost is shown in this part as well.

### **V.2.1.1 Proposal pipe system**

As a target of the project, proposing a new irrigation system based on the previous one, designed irrigation system depends on the underground fixed system and the arrangement of rambutan tree in farm. The total irrigated area is nearly 6 hectares (ha) with 1,500 rambutan trees. The figure 13 shows the position of the pipe system and rambutan trees. The trees were plant into four sectors and in spacing of 6 x 6 (m). The sectors are separated by paths every 12 meters (m). These paths are used for transport within the farm. Under the middle of the main path, there is a main pipe with diameter 90 (mm). Sub-main line is diameter 42 (mm) and it is connected with mainline through reducing tee fitting. There is ball valve at the beginning of sub main line that is used to switch off flow in this sub main line. The laterals with diameter 21 (mm), are assembled along the tree rows with distance 2 (m). The water is driven to emitter through three emitter lines with diameter 16 (mm) for each tree. All of these pipes are made of PVC material. The proposed system is nearly similar in comparison with the previous pipe system. There are few changes here. More sub-main lines will be added in each sector not only to balance this total flow for each sector but also to decrease a discharge in each sub-main line. In detail, at sector A, one sub-main line will be assembled to provide for furthest area. It means that there are 4 sub-main

lines in this sector. At sector C and D, one sub-main line also will be assembled. The pipes are fitted so that the flow in the sector is relatively balance. In figure 14, added sub-main lines are showed. It also can be seen the irrigated areas of each sub-main line. In compare with the previous one, distances from farthest point are shorter than these in the old structure. In figure 14, two differences of previous and proposed irrigation systems can be seen. In existing case, system seems to be simpler with only nine irrigated areas, in compare with twelve areas in proposal one. Nevertheless, friction head loss in first system is higher because the discharge and distance from pump to the farthest emitter is larger. The sub-main lines represented by dotted line are added pipes into new system. They are PVC pipe and diameter 42 (mm). The figure 14 also represents directions of water flows in laterals by directions of arrows.

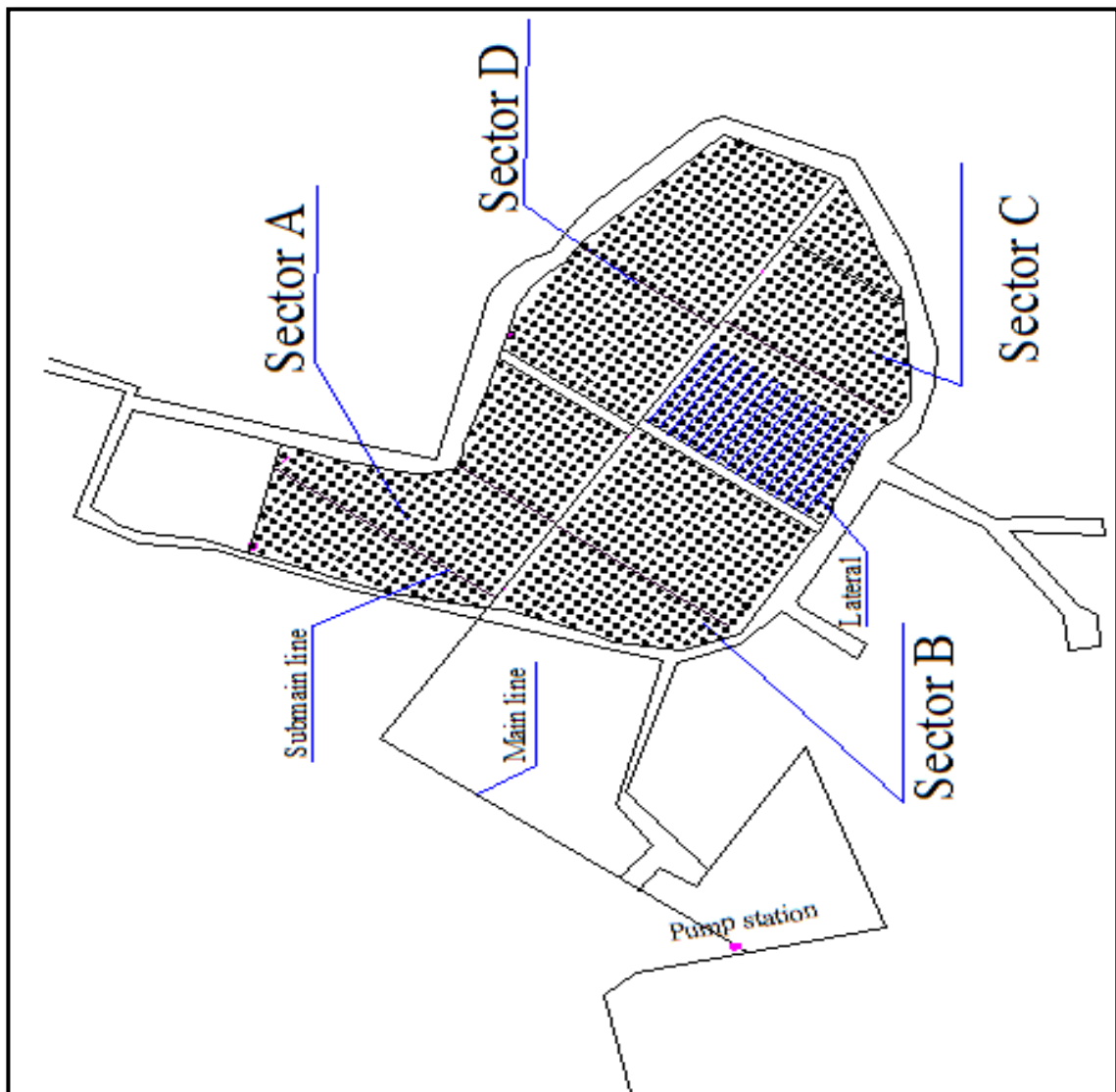

**Figure 13: The map of position of sector and scheme of previous irrigation pipe system**

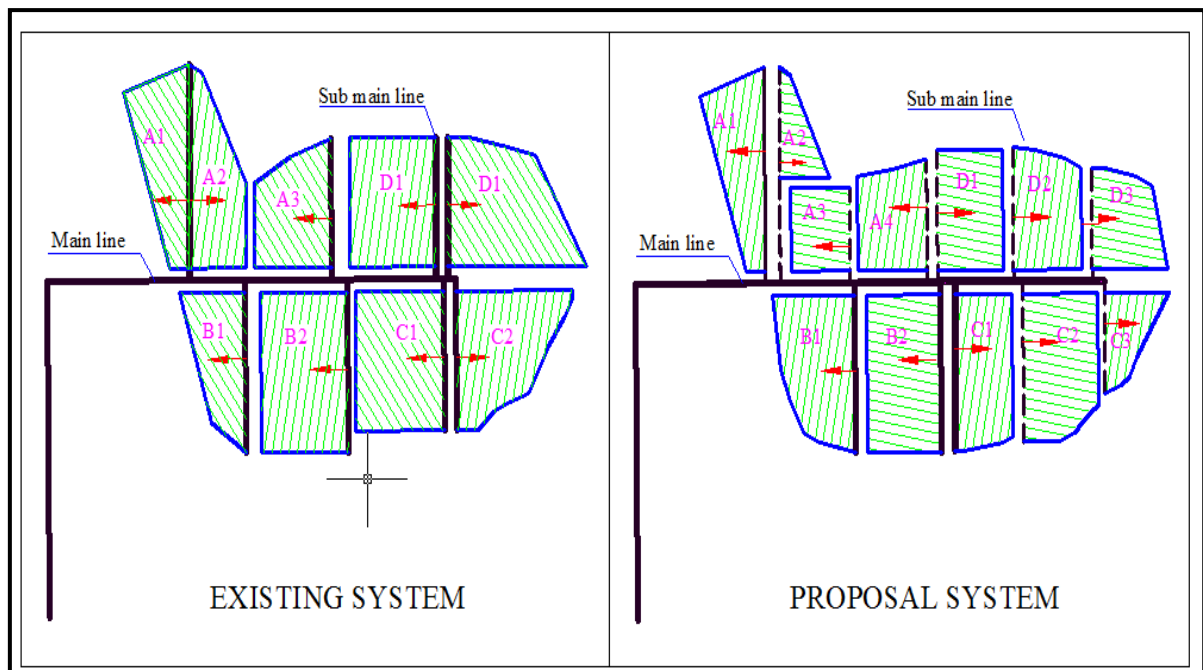

*Figure 14: The irrigated areas of existing system and proposal system.*

### V.2.1.2 System pressure loss

There are two parameters which are important to set a irrigation system. They are total discharge and total head loss. Total discharge is calculated by sum of discharge requirements of all emitters. Total discharger of proposal system is computed in previous part. In this part, total head loss is going to calculated basing on the system pipe and information from emitter producers as well.

Total head loss is sum of losses from pipe system, losses from emitter, and geometric losses. It can be measured in unit of pressures such as Pascal (Pa, kPa etc.) or metres. In this case, head loss units are determined in meter (m). In the farm's case, the average different elevation between water resource and irrigated areas is 3 meters. It can be converted to 3 meter of water (mH<sub>2</sub>O or m).

Loss of emitter is provided by the producer. Each type of emitter has its own loss depending on water flow and pressure. Choice of emitter depends on water requirement of each tree, the operation time of system, and distance from emitter position to the tree. In above part, the discharge requirement of rambutan tree is 66 (l/h). From the point of view of irrigation uniformity, the project proposed 3 emitters for each trees. It means that every chosen emitter should have 22 (l/h) required flow rate. RainBird Company catalogue of,



emitters was used to select the proper one, there is QN 05 type A and it is used in suggested irrigation system.

Irrigated areas		A	B	C	D	Total	
Number of trees		380	372	374	370	1496	
Number of emitter		1140	1116	1122	1110	4488	
QN-05 type A		Pressure (mH <sub>2</sub> O)	Flow rate (l/h)	Pressure loss (mH <sub>2</sub> O)	Radius (m)	Diameter of nozzle (mm)	Number of emitter per tree
		17.5	22	0.1	1.7	0.76	3

**Table 13: Technical parameter of chosen emitter**

Source: RainBird Company, 2011

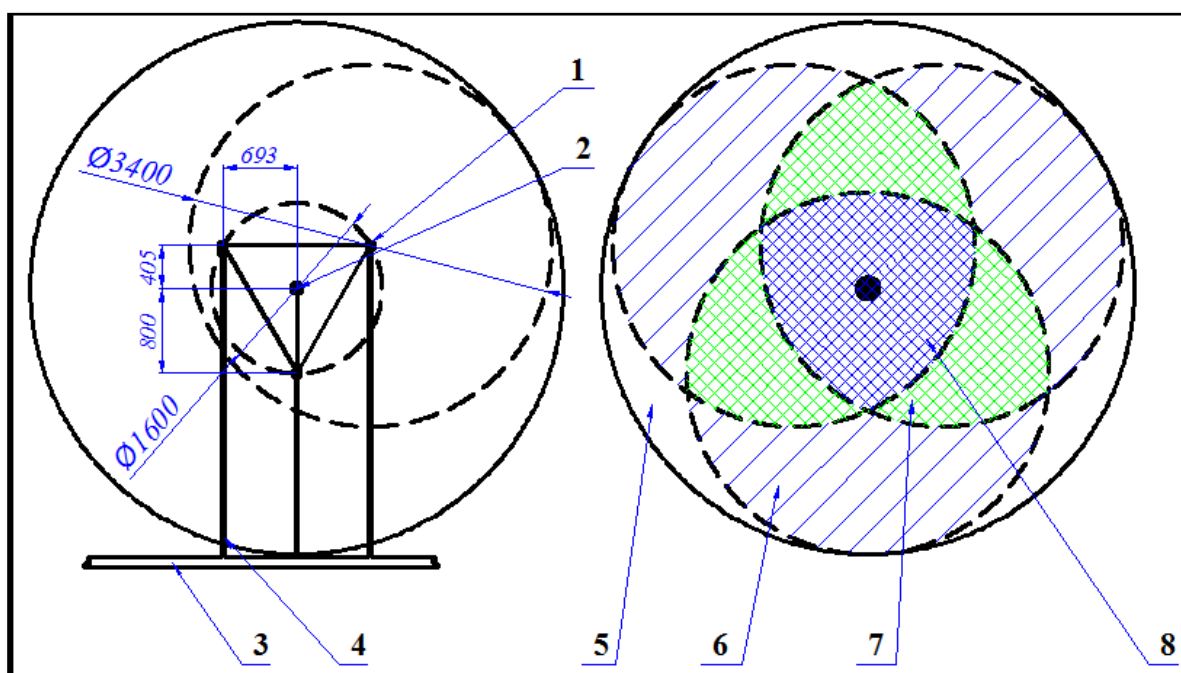

- |                 |                          |
|-----------------|--------------------------|
| 1. Emitter      | 5. None irrigated area   |
| 2. Truck        | 6. Single irrigated area |
| 3. Lateral      | 7. Double irrigated area |
| 4. Emitter line | 8. Triple irrigated area |

**Figure 15: Emitter position and irrigated area in rambutan tree canopy area**

The emitters will be assembled according to figure 15. This figure also represents areas which emitters couldn't irrigate. These areas account for 13% of canopy area. On the other hand, triple irrigated counts for 15% of tree canopy. Double area is the most important area

because it affect directly on root zoon. It may counts for 22 (%) of canopy area. It should be noted that these results basing on the optimal situation in which there is not any effect from natural environment. However, these results could help designers in selecting nozzles and assembling method.

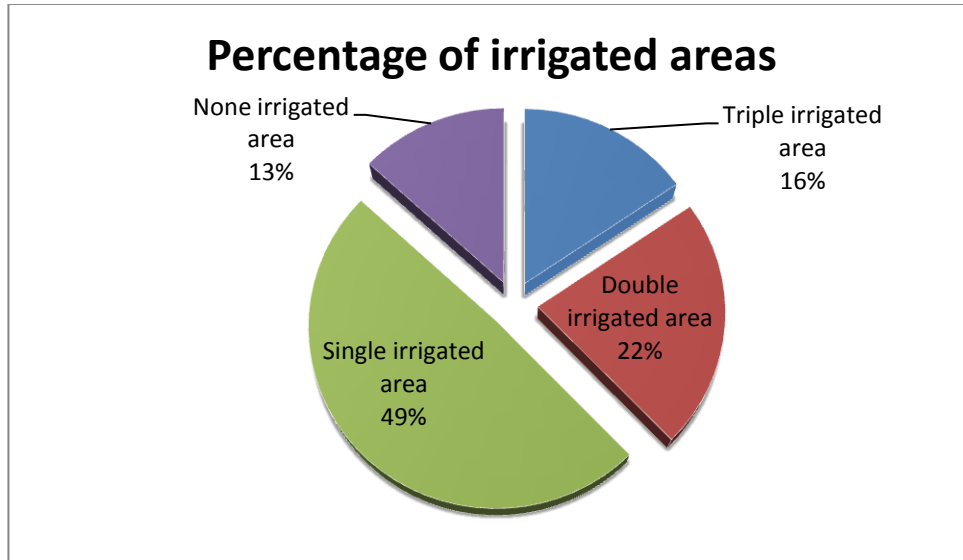

**Figure 16: Percentage of irrigated area in tree canopy**  
*(Note: The average diameter of canopy is 5 meters)*

When water moves through a pipe, it loses pressure due to friction loss. The amount of friction loss depends on the roughness of pipe or type of pipe, velocity of moving water, the water flow rate through cross section of pipe and the length of pipe. All of these parameters could be computer by formulas such as William- Hazen formula, Darcy – Weisbach formula. While Darcy –Weisbach formula is often used with SI system, otherwise, William- Hazen formula is often used with English unit system (*F.S Nakayama and D.A Bucks – 1986*).

$$h = \frac{v^2}{2.g} \left( \frac{\lambda.l}{d} + \sum \zeta \right) \quad \text{Equation 7}$$

Where:

- h: the total head loss of pipe system [m]
- v: velocity of water movement in the pipes [m.s<sup>-1</sup>]
- l: length of pipes [m]
- d: diameter of cross section of pipe [m]
- g: gravitational acceleration [m.s<sup>2</sup>]
- λ: Darcy –Weisbach friction coefficient
- ζ: Fitting loss coefficient

In equation 7, it can be seen that there are two type of head loss. First, related to  $\lambda$  roughness coefficient, is friction loss created by the roughness inside the pipe. It can be called major loss. It could be calculated by equation

$$h = \frac{v^2}{2.g} \cdot \frac{\lambda.l}{d} \quad \text{Equation 8}$$

If calculating of pipe system with many different type of pipe, velocity and flow rate, major head loss could be a sum of these losses. To calculate roughness coefficient,  $\lambda$  the formula of Swamee – Jain can be used. It is:

$$\lambda = \frac{0,25}{\left( \lg \left( \frac{K}{3,7.D} + \frac{5,57}{Re^{0,9}} \right) \right)^2} \quad \text{Equation 9}$$

Where:

K: roughness values of pipe (supplied by producer)

D: inside diameter of pipe [m]

Re: Reynolds number

Following some instructions, PVC pipe has roughness values K, from 0.0011 to 0.0015. In this project, K is chosen 0.0015 because of pipes are old and surface water can cause some dusty inside the pipes ([www.engineeringtoolbox.com](http://www.engineeringtoolbox.com)).

$$Re = \frac{\rho.v.l}{\mu} \quad \text{Equation 10}$$

In which:

$\rho$ : Density of water [kg.m<sup>-3</sup>]

v: velocity of water movement [m.s<sup>-1</sup>]

$\mu$  : Dynamic viscosity of water [kg. m<sup>-1</sup>.s<sup>-1</sup>]

To calculate head loss of the system, several points of pipe system which have largest distances are selected in four sectors. In this project, in each irrigated sector a point is picked up to calculate total head loss. The biggest head loss point is chosen for choosing system pump. The table (table 14) below represents calculating of head loss in sector B, highest head loss in all 4 sectors. Minor loss, related to  $\zeta$  fitting coefficient, is friction loss created by local fittings such as elbows, tees or connections. This loss could be calculated by 15 percent (%) of the major loss in case that the length of pipes is large.

Next figure (Figure 17) shows result of calculating loss pressure in four sectors, including loss of suction pipe, pressure loss of filter, check backflow valve and water meter. Because the pressure loss at sector B is highest, it will be used to choosing a system pump

<b>Cross section</b>	<b>Diame ter pipe</b>	<b>Hydraulic radius</b>	<b>Type of pipe</b>	<b>No of emitter</b>	<b>Length</b>	<b>Flow rate</b>	<b>Reynold number</b>	<b>Darcy coefficient</b>	<b>Velocity</b>	<b>Head loss</b>
S (m <sup>2</sup> )	D (mm)	R (m)		N <sub>o</sub>	L (m)	Q (l/h)	Re	λ	v (m/s)	H <sub>w</sub> (m)
0.0056	90	0.0211	B1	1095	390	2500 0	80385.95	0.05	1.25	17.11 4
0.0056	90	0.0211	B2	540	59	1279 0	41125.45	0.05	0.64	0.678
0.0011	42	0.0095	B21	540	4	1279 0	91125.35	0.06	3.13	3.389
0.0011	42	0.0095	B22	510	6	1122 0	79939.52	0.06	2.75	3.912
0.0011	42	0.0095	B23	480	6	1056 0	75237.19	0.06	2.59	3.466
0.0011	42	0.0095	B24	450	6	9900	70534.87	0.06	2.43	3.046
0.0011	42	0.0095	B25	420	6	9240	65832.54	0.06	2.26	2.654
0.0011	42	0.0095	B26	390	6	8580	61130.22	0.06	2.10	2.288
0.0011	42	0.0095	B27	360	6	7920	56427.89	0.06	1.94	1.950
0.0011	42	0.0095	B28	330	6	7260	51725.57	0.06	1.78	1.638
0.0011	42	0.0095	B29	300	6	6600	47023.24	0.06	1.62	1.354
0.0011	42	0.0095	B210	270	6	5940	42320.92	0.06	1.46	1.097
0.0011	42	0.0095	B211	240	6	5280	37618.60	0.06	1.29	0.867
0.0011	42	0.0095	B212	210	6	4620	32916.27	0.06	1.13	0.664
0.0011	42	0.0095	B213	180	6	3960	28213.95	0.06	0.97	0.488
0.0011	42	0.0095	B214	150	6	3300	23511.62	0.06	0.81	0.339
0.0011	42	0.0095	B215	120	6	2640	18809.30	0.06	0.65	0.217
0.0011	42	0.0095	B216	90	6	1980	14106.97	0.06	0.49	0.122
0.0011	42	0.0095	B217	60	6	1320	9404.65	0.06	0.32	0.054
0.0011	42	0.0095	B218	30	6	660	4702.32	0.06	0.16	0.014
0.0002	21	0.0045	B2181	30	2	660	10038.67	0.09	0.74	0.289
0.0002	21	0.0045	B2182	27	6	594	9034.80	0.09	0.66	0.702
0.0002	21	0.0045	B2183	24	6	528	8030.94	0.09	0.59	0.555
0.0002	21	0.0045	B2184	21	6	462	7027.07	0.09	0.52	0.425
0.0002	21	0.0045	B2185	18	6	396	6023.20	0.09	0.44	0.312
0.0002	21	0.0045	B2186	15	6	330	5019.34	0.09	0.37	0.217
0.0002	21	0.0045	B2187	12	6	264	4015.47	0.09	0.29	0.139
0.0002	21	0.0045	B2188	9	6	198	3011.60	0.09	0.22	0.078
0.0002	21	0.0045	B2189	6	6	132	2007.73	0.09	0.15	0.035
0.0002	21	0.0045	B21810	3	6	66	1003.87	0.09	0.07	0.009
0.0002	16	0.0035	B218101	1	2	22	425.45	0.11	0.04	0.001
<b>Friction losses</b>										<b>48.11</b>

**Table 14: Calculation of head loss of longest distance point in sector B**

<b>Results of total head loss at 4 sectors [m]</b>				
Sector	A	B	C	D
Friction losses	34.01	48.11	37.29	31.86
Local head loss (equal 15% with length head loss)	5.1	7.22	5.59	4.78
Loss by emitter and fitting pipe	0.1	0.1	0.1	0.1
Emitter requirement pressure	17.5	17.5	17.5	17.5
Average elevation head	3	3	3	3
Head loss by fertilizer	0	0	0	0
Head loss by filter	0.1	0.1	0.1	0.1
Loss PGA Valves	3.4	3.4	3.4	3.4
Loss water meter	2	2	2	2
Suction head loss	0.175	0.175	0.175	0.175
Double backflow prevented valve	34	34	34	34
<b>Total pressure loss <math>H_z</math></b>	99.38	<b>115.60</b>	103.16	96.92

**Figure 17: Total head loss at selected point in 4 sectors**

Pressure losses of equipment which need for stable operation of system such as filter, check back flow valve and water meter are also added in total pressure loss of system. Their values are provided by the suppliers and varieties depending technical parameter of irrigation system.

Water meter is used to measure flow rate of system. It is often assembled in outlet pipe. Distance between pump and water meter should be bigger than 15 times diameter of pipe. In this project, water meter is chosen with  $\varnothing 90$  mm inlet and outlet. Range flow rate of water is 22-27 ( $\text{m}^3 \cdot \text{h}^{-1}$ ). Following leaflet of ISTECH Company, the head loss of water meter is 2 meters ( $\text{mH}_2\text{O}$ ).

To control flow rate and pressure of system, a PGA valve of RainBird Company is suggested to apply for irrigation system. This valve can prevent contamination of water resource. The head loss of valve for  $\varnothing 90$  (mm) pipe and 25 ( $\text{m}^3 \cdot \text{h}^{-1}$ ) is 3.4 ( $\text{mH}_2\text{O}$ ). It should be added PRS-Dial to for pressure regulating operation.

Double backflow prevent valve is used in order to stop return flow in pipe which can cause damage in pump and other equipment. It is often assembled in main line after all equipments. For all cases, the safety head loss of backflow prevent valve is chosen 34 (m) ([www.irrigationtutorials.com](http://www.irrigationtutorials.com)).

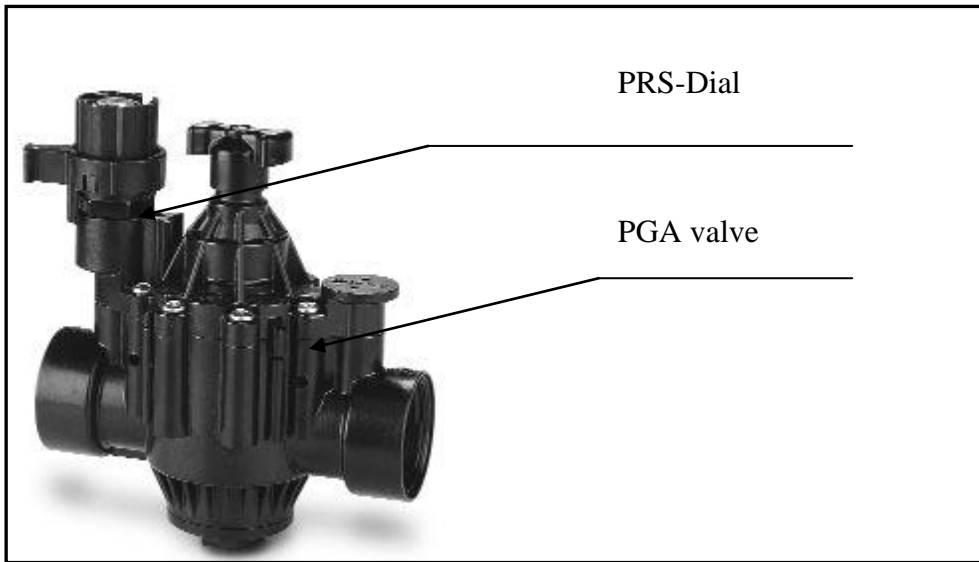

**Figure 18: Picture of PGA valve and PRS-Dial**

*Source: RainBird Company catalogue - 2010*

There are two filters which are proposed for the system. The first is basket screen which is assembled at inlet of suction pipe. It is used to prevent large particles in water resources (lake). It is made by 304-stainless steel to prevent corrosion. The later is 75 mesh filter to prevent small particles which have bigger 75 micrometer dimension such as sand or mosses ([www.irrigationtutorials.com](http://www.irrigationtutorials.com)). The losses of mesh filter cartridges by the graph in figure 19 below.

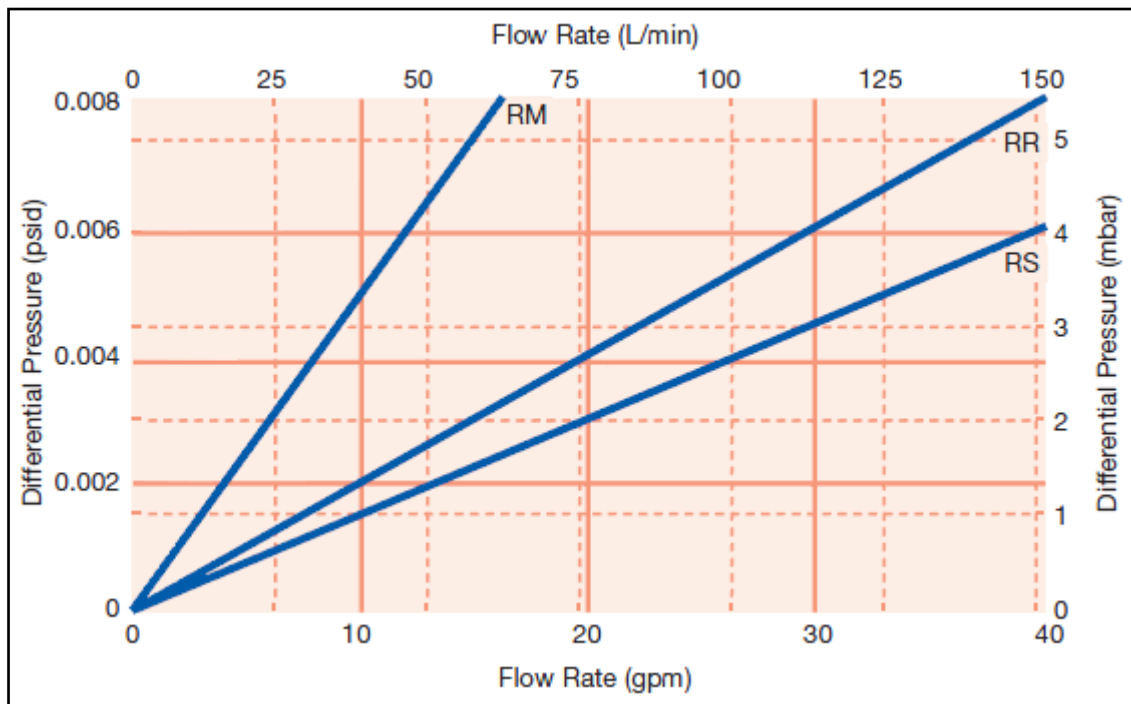

**Figure 19: Example for differential pressure of mesh filter cartridges**

*Source: PALL COOPERATION-2010*

It can be seen in the graph that the differential pressure mesh filter is small. Therefore, in proposal system, it can be calculated with 0.1 (m) pressure loss.

### V.2.1.3 Selecting pump

To selecting a pump, two parameters, total head loss and total discharge of system, are using. Head value and capacity of pump should be around the value of total head loss and total discharge of proposed system. When designers need to determine the working modes as well as characteristics of the pump, conditions and specific requirements of the farm as well as features mesh tube should be considered. The total head,  $H$  (m) of pump in a irrigation system with  $Q$  (l/s) capacity could be introduced by the formula:

$$H = H_g + H_z \quad \text{Equation 11}$$

Where:

$H_g$ : Geodetic head [m]

$H_z$ : Total pressure loss in mesh pipe [m]

Geodetic head,  $H_g$ , is different elevation between suction inlet and outlet pipe of the pump. Under real conditions of the farm, the pump station locates very near the water resources. Therefore,  $H_g$  may not count on the head of the pump. On the other hand, total pressure loss in proposed pipe system was calculated in upper part. It includes all head losses by friction in pipe and local head losses which are caused by system equipments. The total of head losses in the pipe system depends on pipe diameter, pipe length and flow rate through the pipe. It can indicate that relationship by the following expression:

$$H(Q) = H_t + K \cdot Q^2 \quad \text{Equation 12}$$

Where:

$H_t$  is total loss including friction and local losses of the pipes and equipments after the main line. It calculated in meter (mH<sub>2</sub>O)

$K$  is pressure loss coefficient. It can be determined by on the Darcy –Weisbach equation:

$$h = \frac{v^2}{2 \cdot g} \cdot \left( \frac{\lambda \cdot l}{d} + \sum \zeta \right) \quad \text{Equation 13}$$

Local losses can count by 15 percent (%) of friction loss. Hence, equation 13 can be rewritten as

$$h = 1,15 \cdot \frac{Q^2}{2 \cdot S^2 \cdot g} \left( \frac{\lambda \cdot l}{d} \right) \quad \text{Equation 14}$$

In which:

**S**: Cross section of pipe [m<sup>2</sup>]

**Q**: Flow rate through pipe [m<sup>3</sup>·h<sup>-1</sup>]

**l**: Length of pipe [m]

**d**: Diameter of pipe [m]

**λ**: Roughness coefficient

It can be seen that all these figures are constant when the pipe was chosen. Therefore, pressure loss coefficient is:

$$K = 1,15 \cdot \frac{\lambda \cdot l}{2 \cdot g \cdot d \cdot S^2} \quad \text{Equation 15}$$

A very important feature of centrifugal pump is the interdependence of its capacity and pressure head. Another word, H<sub>p</sub> is a function of flow rate Q<sub>p</sub>, H<sub>p</sub>=f(Q). The producer often gives the H<sub>p</sub> function or its curve. Practical capacity value of the pump is determined by combination of two curves, H (Q) and H<sub>p</sub> (Q).

After replacing the values of H<sub>t</sub> and K, the function is of pressure loss in mainline of proposed system and pump is expressed:

$$H = f(Q) = 98,49 + 130,63 \cdot Q^2 \quad \text{Equation 16}$$

Where:

**Q**: Flow rate through the pipe [l·s<sup>-1</sup>].

According to the flow rate and total head loss of system, several pumps from different suppliers are picked to select the most suitable one. The graph below shows the curves of them and the operating points.

In figure 20 below, it can be seen in the graph, there are only two curves of pump 1 and pump 2 meet the total head loss curve of pipe system at point which have 7,2 Q (l/s), and 117 H (m).

Pump No.1 is supplied by Sigma Company, named 50-CVX-160-10-4°-LC-000-9, a Czech company. Pump No.2 is supplied by FORAS – Italy, named BMHB 4/15. The table 15 below shows technical parameters of these two pumps.



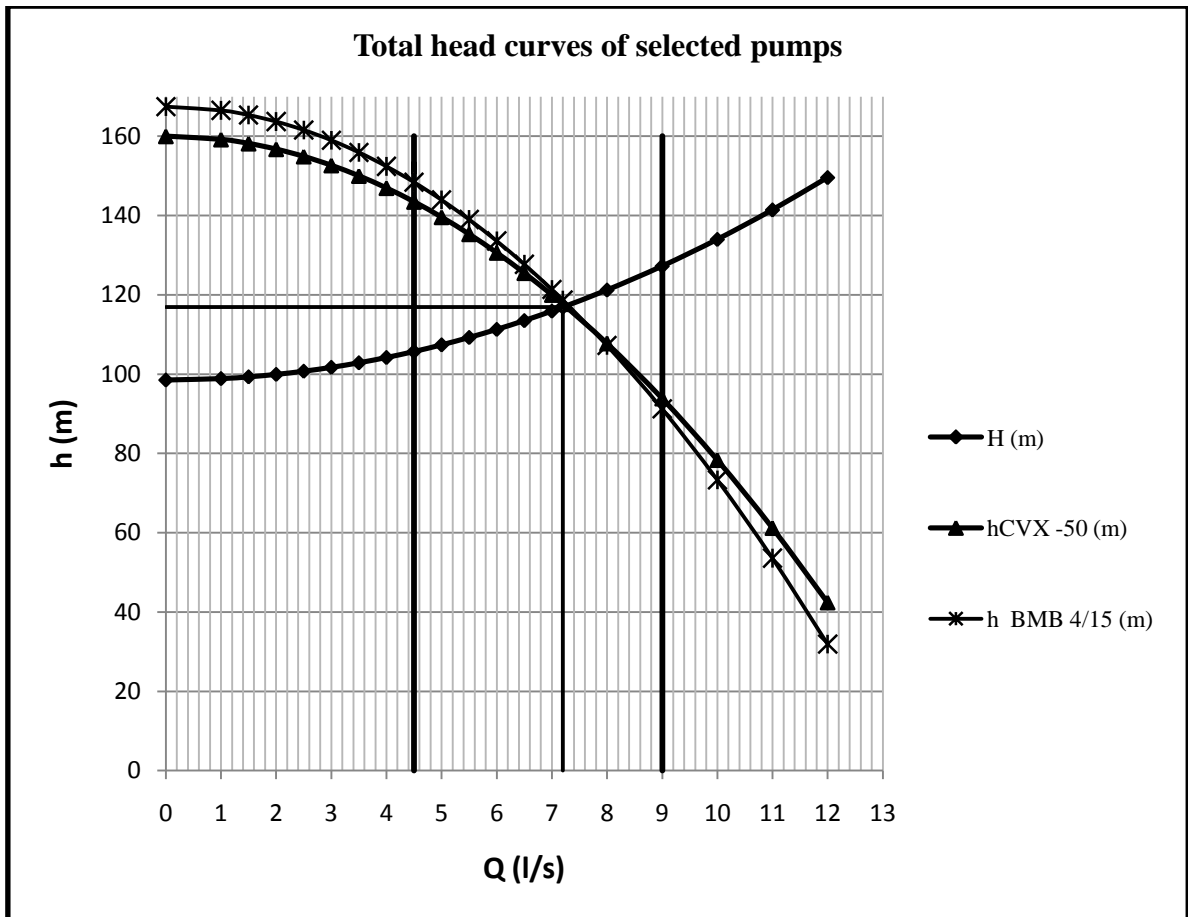
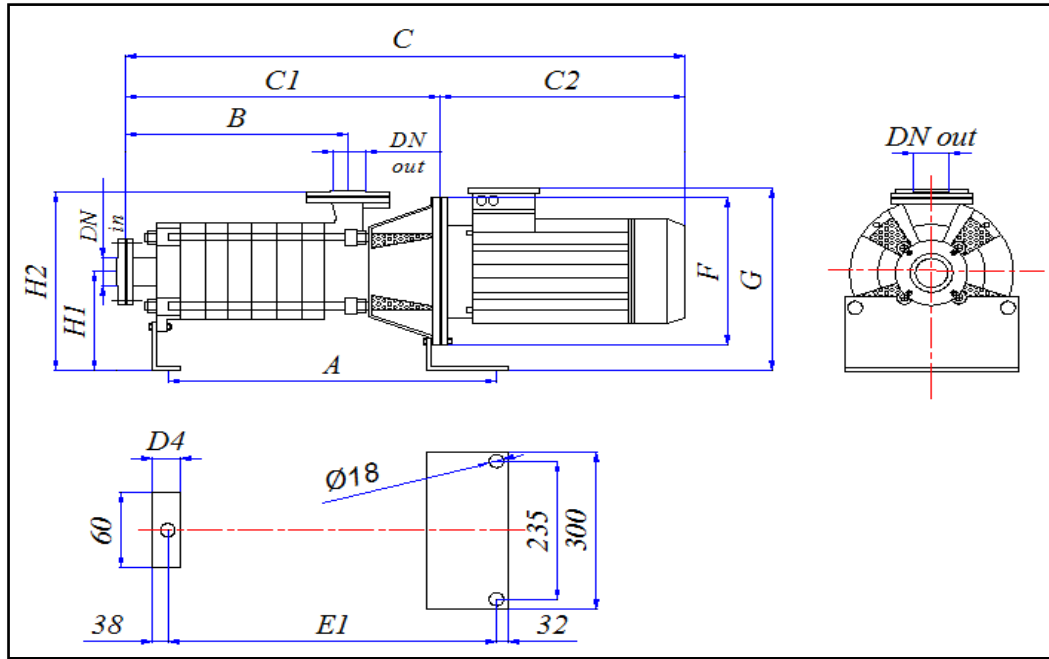

Figure 20: Total head curve of selected pumps and head loss curve

Parameter		CVX 50 -160	BMHB 4/15
Flow capacity	[l/s]	7	6.67
Total head	[m]	123.8	125.6
Number of stages		4	4
Efficiency	[%]	60	---
Speed	[RPM]	2950	2950
Max temperature	[°C]	160	110
Power absorbed by pump	[kW]	14.2	14
Necessary driver output	[kW]	16.3	15
Power output of motor	[kW]	18.5	16.4
Voltage	[Volt]	3x400/Y	3x400/Y
Protection level for motor		IP54	IP44
Insulation class		F	F
Weight (including motor)	[kg]	220	193

Table 15: Technical parameter of selected pumps

Both pumps are not major differences in terms of technique. However, because of advantages of supply and price, BMHB 4/15 pump is selected for the irrigation system. Assembling dimensions of this pump is shown in figure 21 and 22 below which are provided by manufacturer.



*Assembling dimension of BMHM 4/15 pump*

									[mm]
A	B	C	C1	C2	F	G	H1	H2	
655	308	1065	567	498	350	480	245	420	
D1	D2	D3	D4	E	E1	I	L	M	
300	150	60	70	325	571	140	500	500	

*Figure 21: Assembling dimension of pump*

*Source: BM catalogue-2011*

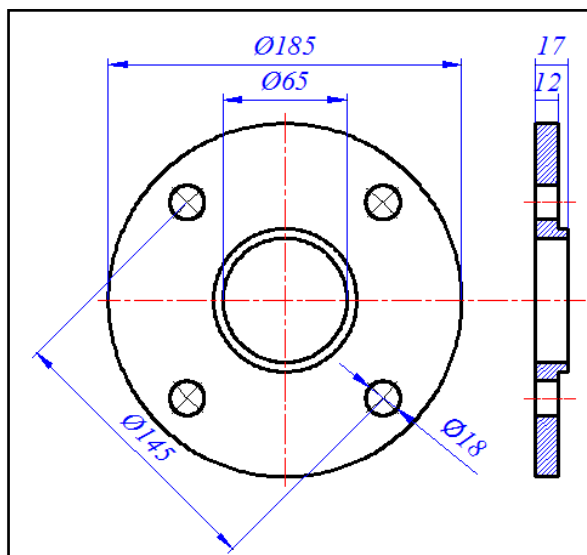
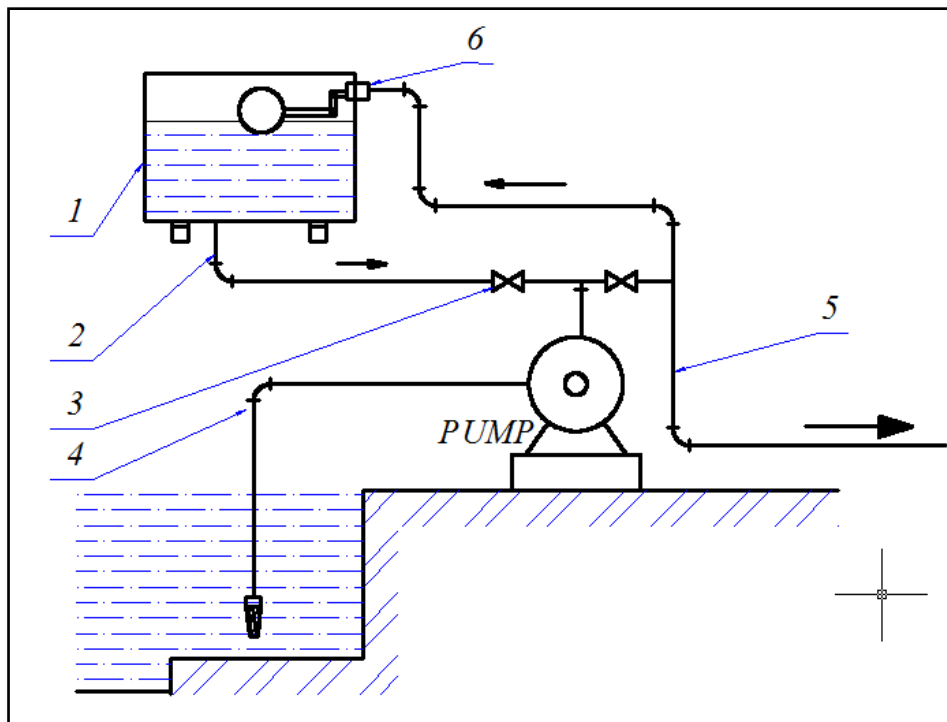

*Figure 22: Dimension at inlet and outlet of pump*

### V.2.1.4 Priming pump

All centrifugal pumps must have a "wet inlet", that is, there must be water in both the intake pipe and the casing when the pump is started. They must be "primed" by adding water to the intake pipe and case before every first use. To prime a centrifugal pump, people simply fill the intake pipe with water and then quickly turn on the pump.

In practice, several methods to prime a pump such as using another small pump, using pressure air pump, using a supply tank, could be used. According to the conditions of farm, a water tank with non-return valve may suitable for priming pump. The scheme of this method is presented in following figure 23.



- |                        |                         |                        |
|------------------------|-------------------------|------------------------|
| 1. Intake pipe of pump | 3. Water tank for prime | 5. Outlet pipe of pump |
| 2. Non return valve    | 4. Priming pipe         | 6. Float valve         |

**Figure 23: Proposed prime method for irrigation system**

*Source: Nguyen Van Bay - 1999*

## V.3 Economic comparison

In this part, with proposal system, the project tries to figure out cost of system. It includes capital cost and operation cost. Then, it will be compare with the average cost of irrigation systems which are suggested by FAO.

### V.3.1 Capital cost

Capital costs are costs incurred on the purchase of construction and equipments to be used in the production. In the irrigation case, capital cost including all purchase of pipe,

fittings, valves, pump and labours used for constructions. In the farms case, capital cost is not including water fees because of Vietnamese government support for agricultural field.

To calculate the capital cost of proposal irrigation system, all costs of equipment are collected from cost lists of manufacturers in year 2011. Most of them are Vietnamese producer, others come from Czech Republic.

Following table 16 shows all equipments that are necessary for proposal irrigation system, their costs and manufacturers as well.

	<i>Items</i>	<i>Code</i>	<i>Unit</i>	<i>Quantity</i>	<i>Price in VND</i>	<i>Cost in VND</i>	<i>Cost in Kč</i>	<i>Supplier</i>	
1	Main line	PVC φ90	M	574	60,390	34,663,860	28,886.55		
2	Sub-main line	PVC φ42	M	1129	15,730	17,759,170	14,799.31		
3	Lateral	PVC φ21	M	8009	8,360	66,955,240	55,796.03		
4	Emitter line	PVC φ16	M	13464	6,370	85,765,680	71,471.40		
5	Elbow φ90-45°	C90 45°	units	4	11,600	46,400	38.67		
6	Elbow φ16-90° (for rise)	C16 90°	units	4488	1,500	6,732,000	5,610.00	<i>Binh Minh. Co</i>	
7	Reducing elbow φ90/42 (for rise)	C 90/42	units	1	11,300	11,300	9.42		
8	Reducing Tee 90/42	T 90/42	units	11	15,200	167,200	139.33		
9	Reducing Tee 42/21	T 42/21	units	139	6,400	889,600	741.33		
10	Reducing Tee 21/16	T 21/16	units	4488	2,600	11,668,800	9,724.00		
11	Connector (inlet and outlet pump)	---	units	2	200,000	400,000	333.33		
12	Ball valve φ42	Vφ42	units	12	52,000	624,000	520.00		
13	Water meter	---	units	1	500,000	500,000	417		
12	Solvent cement	---	kg	3	96,470	289,410	241.18		
13	Emitter	QN -05 A	bags	180	44400	7,992,000	6,660.00		<i>RainBird Co</i>
14	Basket filter	---	units	1	150,000	150,000	125.00		
15	PGA -200	PGA-200	units	1	3,320,400	3,320,400	2,767.00		
16	PRS - Dial	PRS-D	units	1	2,046,000	2,046,000	1,705.00		
18	Pump	BMHM 4/15	unit	1	64,920,460	64,920,460	54,100.38	<i>Hai Thu Co</i>	
<b>Total</b>						<b>304,901,520</b>	<b>254,085</b>		

**Table 16: Total equipment cost of proposal system**

Note: Exchange rate is 1CZK = 1200 VND (Coilmill.com date, 10<sup>th</sup> March 2011)

The labors costs for constructions can be counted for 5% of total equipments cost. Therefore, the capital cost is 320,146,596 (VND) or 266,789 (Kč). The expected life period of proposal system could be 10 years. Hence, capital cost per year is 32,014,660 (VND). In addition, with the average interest bank rate is about 14 percent (%) per year (*Vietcombank, 11<sup>th</sup> March, 2011*), the inventory cost per year of proposal irrigation can be added with amount of opportunity cost 44,820,525(VND) per year. Then, the capital cost should be 76,835,183 (VND) or almost 64,030 (Kč). Amount of maintenance cost is counted for 3 percent (%) of annual initial cost. Hence, total capital cost, including maintenance cost, is 79,140,238 (VND). According to the 6 hectares (ha) irrigated area, average capital cost for proposal irrigation system per hectare per year is 13,190,039 (VND) or 10,992 (Kč).

### **V.3.2 Operating cost**

Operating cost could be calculated by cost of electric power and labours cost for controlling system. For controlling, proposal system needs only a worker who will switch on/off the valves to irrigate the sectors. In Vietnam, this worker could be pay average 1,500,000 (VND) per month or 10,500,000 (VND) per year (7 months irrigation).

According to the price of electric power in Vietnam, farmer has to pay 1,400 (VND) or 1.2 (Kč) per kWh. The irrigation system operates 8 hours a day and 7 months a year. The input power of electric motor is 16.3 (kW). Therefore, the total input power of irrigation system per month is  $A = 8 \times 30 \times 16.3 = 3,921$ (kWh per month). Hence, the cost of power is 5,476,800 (VND) per month or 38,337,600 (VND) per year.

The total operating cost to irrigate 1500 rambutan trees in a year is 48,837,600 (VND) or 40,698 (Kč) per year. The operating cost is 8,139,600 (VND) per hectare per year.

Finally, including initial cost and operating cost, in the first ten years after applied proposed irrigation system, the irrigated cost per hectare per year which farmers could pay, is 21,329,640 (VND) or approximately 17,775 (Kč).

### **V.3.3 Comparison**

In their website, FAO publics their data base on investment cost which they collected from many irrigation projects in regions on over the world. The costs are presented in US dollar (US\$) and converted to year 2000 price. According to sprinkler irrigations, the project just uses information in this database to examine the proposed irrigation system cost.

<i>Region</i>	<i>Country</i>	<i>Project name</i>	<i>On-farm irrigation technology</i>	<i>Year of project</i>	<i>Investment cost (in year 2000 US\$)</i>	<i>Project size (hectares)</i>	<i>Investment cost per hectare (in year 2000 US\$)</i>
SA	India	Haryana irrigation 2 project	Sprinkler	1992	212,991,030	174,600	1,220
LAC	Colombia	Small-scale irrigation project	Sprinkler	1989	90,451	75	1,206
LAC	Colombia	Abrego district schemes	Sprinkler	1986	1,285,763	1,400	918
LAC	Colombia	Coello district schemes	Sprinkler	1986	55,334,256	30,000	1,844
NENA	Morocco	Doukkala scheme	Sprinkler	1993	50,776,160	61,000	832
NENA	Egypt	El Manaifa scheme	Localized	1994	26 862 526	17,498	1,535
NENA	Egypt	El Wasat scheme	Localized	1994	46 238 473	31,259	1,479
NENA	Egypt	Mahmoudia scheme	Localized	1994	78 816 645	55,169	1,429
<b>Project</b>	<b>Vietnam</b>	<b>Hon Quang – Binh Phuoc</b>	<b>Micro – sprinkler</b>	<b>2009</b>	<b>5,574</b>	<b>6</b>	<b>929</b>

**Table 17: Irrigation investment costs in regions in year 2000**

Source: <http://www.fao.org/nr/water/aquastat/investment/index.stm>

- Abbreviates: Eastern Asia (EA); Southern Asia (SA); sub-Saharan Africa (SSA); Near East & North Africa (NENA); Latin America and the Caribbean (LAC).
- Localized dedicated drip, trickle, bubble and micro-sprinkler irrigation.
- Exchange rate: 1US\$ = 14,200VND (year 2000)  
([en.wikipedia.org/wiki/Tables\\_of\\_historical\\_exchange\\_rates\\_to\\_the\\_USD](http://en.wikipedia.org/wiki/Tables_of_historical_exchange_rates_to_the_USD)).

In the upper part, the initial cost of proposed irrigation system was counted 13,190,039 (VND) per hectares per year. It is about 929 (US\$) in year 2000. In comparison with small scale project in the table, the proposed cost is slightly higher. However, in considering to the project size, the proposed cost is acceptable. It can be seen that the bigger irrigated areas are, the lower initial costs are. Although, proposed system is supplying for 6 hectares (ha) only, its cost is approximately equal those of larger scale projects. There are two main reasons which may cause this low cost. First of all, the equipments of proposed system are selected from domestic manufacturer. Hence, the equipments price is low. Another reason, Vietnamese labours cost is quite lower than that in others. It might cause low construction cost which was counted only 3 percent (%) in the proposed project. Moreover, the designing costs does not include in initial cost.

## VI CONCLUSION

Number of agricultural projects has, nowadays, tendency to increase namely they are projects on less than 10 hectares (ha) area. Small farm scale irrigation, particularly pressurized irrigation, in Vietnamese agriculture becomes a necessary condition of beneficial production. Hence, proposed diploma thesis tries to introduce the processes from the system selection to the design of irrigation system for a small scale farm located in Vietnam. The proposed irrigation system of rambutan farm is based on already existing system. The proposed irrigation was designed with both primary and secondary data which were collected in the farm and from other various sources. Meteorological data of Dong Xoai national station were collected to compute crop water requirement,  $ET_c$ , by using CROPWAT 8.0 software. This system covers requirement of  $25 \text{ (m}^3\cdot\text{h}^{-1}\text{)}$  water flow and 120 (mH<sub>2</sub>O) total head. Since the emitters were assembled equilateral triangle, the uniform distribution of irrigated water is controlled by triangle assembling emitters under each tree. The external and internal factors which can cause destruction of system are prevented by equipments such as cartridge filter, pressure regulator and backflow prevent valve.

Although it is only proposal, the system could be successful because of its advantaged. Changes of water distributing to sectors, proposed irrigation system is able to decrease head loss in mesh pipe. Project provides a constant control and operating with use of equipments such as emitters, filter, prevent backflow valve, pressure regulator and pump. All these system elements were chosen and are supplied by reputable manufacturer. Moreover, operation costs of system were assessed and they are acceptable to the farmer, according to the average price of rambutan fruit.

The solution of proposed irrigation system, of course, could not avoid some little discrepancies. First of all, system design was based prevalingly on secondary data that were collected in national stations. Therefore, the results crop evapotranspiration,  $ET_o$ , might be less precise in comparison with local climatic data. Moreover, there is not any posted research article about crop coefficient,  $K_c$ , of rambutan which is cultivated in Vietnam. Furthermore, because of unpredictable climate changes, the irrigation system still has inevitable errors compared to actual, although the collected meteorology data are updated as soon as possible. This disadvantage could be avoided if pan evapotranspiration,  $ET_{pan}$ , were collected. This figure could be collected by applying practical method in which the loss of water in standard pan are counted in the field. The pan can be a circle pan with 120,7cm in diameter or a square pan with 90x90 cm dimension. However, this method is successful

unless it is done in dry season where it is not rain at all. Another recommendation for further researches in irrigation project is figure out coefficient crop,  $K_c$ , of Vietnamese rambutan. Although this research could take much effort, its results could be applied not only in irrigation field but also in others.

According to the technical view, it can be seen that water distributing devices (in each sector) require worker who has to open or turn off three valves in every half of hour, although this operation can be substituted by automatic control valves. Nevertheless, whether concerning to farm economy and level of workers' abilities, manual control method seems more suitable under local conditions. In addition, further researches should calculate and select a diesel motor with a transmission. It could be necessary to replace the electric motor in case that electric power is cut by accidents.



## VII BIBLIOGRAPHY

1. A Phocaidés: Handbook on pressurized irrigation techniques – FAO Consultation – Rome 2007. P 1-151.
2. Andreas P. Savva and Karen Frenken: Crop water requirements and Irrigation scheduling - FAO - Harare - 2002.
3. Bruce Withers, Stanley Vipond: Irrigation: design and practice – 1988. p 1-50
4. David N. Harris & Associates: Water management in public irrigation schemes in Vietnam - November 2006. p1-16
5. Dick Gordon: Irrigation hydraulics – 2004. p5-25
6. E.W.M Verheij and R.E Cornolel: Edible fruits and nuts – 1983Sigma pump catalogue -2011.
7. Example of the use of CROPWAT 8.0 – FAO – 2008.
8. F.S Nakayama and D.A Bucks: Trickle irrigation for crop production – 1986.
9. Glenn J Hoffman, Robert G.Evans , Farm irrigation systems – 2nd Editions – 2006. p557 -627
10. Gunther Fischer, Francesco N. Tubiello, Harrij van Velthuizen, and David A. Wiberg : Climates change impacts on irrigation water requirements: Effects of mitigation, 1990 – 2080 — December 2007, P 1-10.
11. GMP brochure – 2011.
12. Irrigation in Asia in figures – Food and agriculture organization of United Nation – 1999. p 219-226RainBird products’ catalogue -2011.
13. I. Broner: Irrigation scheduling: Water balance approach – No 4.707.
14. Janine Nyvall: Soil Water Storage Capacity and Available Soil Moisture - British Columbia, Ministry of Agriculture, Food and Fisheries - February 2002.
15. Neil Southorn: Farm irrigation: Planning and Management – 1997. p 31-69
16. Nicola Lamaddalena: Performance analysis of on-demand pressurized irrigation systems – FAO – 2000. p 1-13
17. Nguyen Van Toan: Project report: Surface water – Consultant– 2008. P 1- 45
18. Nguyen Van Bay: Pumps and pump stations in agriculture — Agricultural Publisher – 1999. P
19. Nguyen Thuong Bang and Nguyen Anh Tuan: Designing irrigation and drainage network – Construction Publisher.

20. Randolph Barker and François Molle: Report: Evolution of Irrigation in South and Southeast Asia – 2004. P 9-26
21. Rainbird Co – Landscape irrigation design manual - 2010
22. Rambutan cultivation – FAO plant production and protection Paper 121 – Rome 1994.
23. Report on analysis result from Research center of Environmental Technology and Natural Resource Management of Nong Lam University, 4th March 2010.
24. Richard G. Allen: FAO – Irrigation and drainage paper – Rome – 1975
25. Y Diczbalis, P Watson and P Albano: Root distribution of Rambutan (*Nephelium Lappaceum*) Trees Growing in Wet-Dry tropics of Northern Territory – 1992 -1996. P91-94
26. Yan Diczbalis: Rambutan Improving yield and Quality, a report for rural industries research and development corporation — November 2002.

#### Internet

1. Integrated cropping systems and water management handbooks - [www.nm.nrcs.usda.gov](http://www.nm.nrcs.usda.gov). Available access from <http://www.nm.nrcs.usda.gov/technical/handbooks/iwm/nmiwm.html>
2. Irrigation water management – [www.fao.org](http://www.fao.org). Available access from <http://www.fao.org/docrep/s8684e/s8684e08.htm> and <http://www.fao.org/nr/water/aquastat/investment/index.stm>
3. Guidelines for designing and evaluating surface irrigation systems – [www.fao.org](http://www.fao.org). Available access from <http://www.fao.org/documents/en>
4. <http://www.doylepump.com.au/>
5. <http://www.engineeringtoolbox.com/>
6. <http://www.irrigationtutorials.com>.

## VIII SUPPLEMENT

### VIII.1 *The results of CROPWAT application*

These tables and figures below are the results of using software CROPWAT 8.0. The meteorology data, which was collected in three years 2007 – 2009, are applied in software with FAO suggested method. They are present separately following the year which data was picked up.

#### VIII.1.1 *In the year 2007*

MONTHLY ETO PENMAN-MONTEITH DATA						
(File: C:\ProgramData\CROPWAT\data\climate\Binh Long - 2007- final.PEM)						
Country: Viet Nam - 2007			Station: Hon Quan- Long Binh			
Altitude: 127 m.			Latitude: 11.30 °N		Longitude: 106.30 °E	
Month	Avg Temp °C	Humidity %	Wind km/day	Sun hours	Rad MJ/m <sup>2</sup> /day	ET <sub>o</sub> mm/day
January	25.8	70	73	10.6	22.4	4.18
February	27.0	68	64	10.1	23.2	4.52
March	27.9	69	75	7.6	20.8	4.41
April	28.8	73	67	9.1	23.6	4.98
May	28.4	82	61	8.0	21.5	4.56
June	27.2	85	65	9.4	23.2	4.70
July	26.5	87	70	8.0	21.2	4.25
August	26.3	88	69	12.4	28.3	5.40
September	26.0	86	71	10.2	24.8	4.75
October	26.4	85	44	12.0	26.3	4.96
November	26.8	81	65	8.0	19.1	3.75
December	26.2	75	61	5.9	15.5	3.15
Average	26.9	79	65	9.3	22.5	4.47

**Table 18: Monthly ET<sub>o</sub> result in year 2007**

SCHEME SUPPLY												
ET <sub>o</sub> station: Hon Quan- Long Binh						Cropping pattern: Hon Quan - 2007						
Rain station: Dong Xoai -2007												
	Jan	Feb	Mar	Apr	May	Jun	Jul	Aug	Sep	Oct	Nov	Dec
Precipitation deficit												
1. Rambutan	114.1	113.5	64.0	45.6	0.0	0.0	0.0	0.0	0.0	0.0	0.0	10.4
Net scheme irr.req.												
in mm/day	3.7	4.1	2.1	1.5	0.0	0.0	0.0	0.0	0.0	0.0	0.0	0.3
in mm/month	114.1	113.5	64.0	45.6	0.0	0.0	0.0	0.0	0.0	0.0	0.0	10.4
in l/s/h	0.43	0.47	0.24	0.18	0.00	0.00	0.00	0.00	0.00	0.00	0.00	0.04
Irrigated area												
(% of total area)	100.0	100.0	100.0	100.0	0.0	0.0	0.0	0.0	0.0	0.0	0.0	100.0
Irr.req. for actual area												
(l/s/h)	0.43	0.47	0.24	0.18	0.00	0.00	0.00	0.00	0.00	0.00	0.00	0.04

**Table 19: The scheme supply for rambutan tree in year 2007**

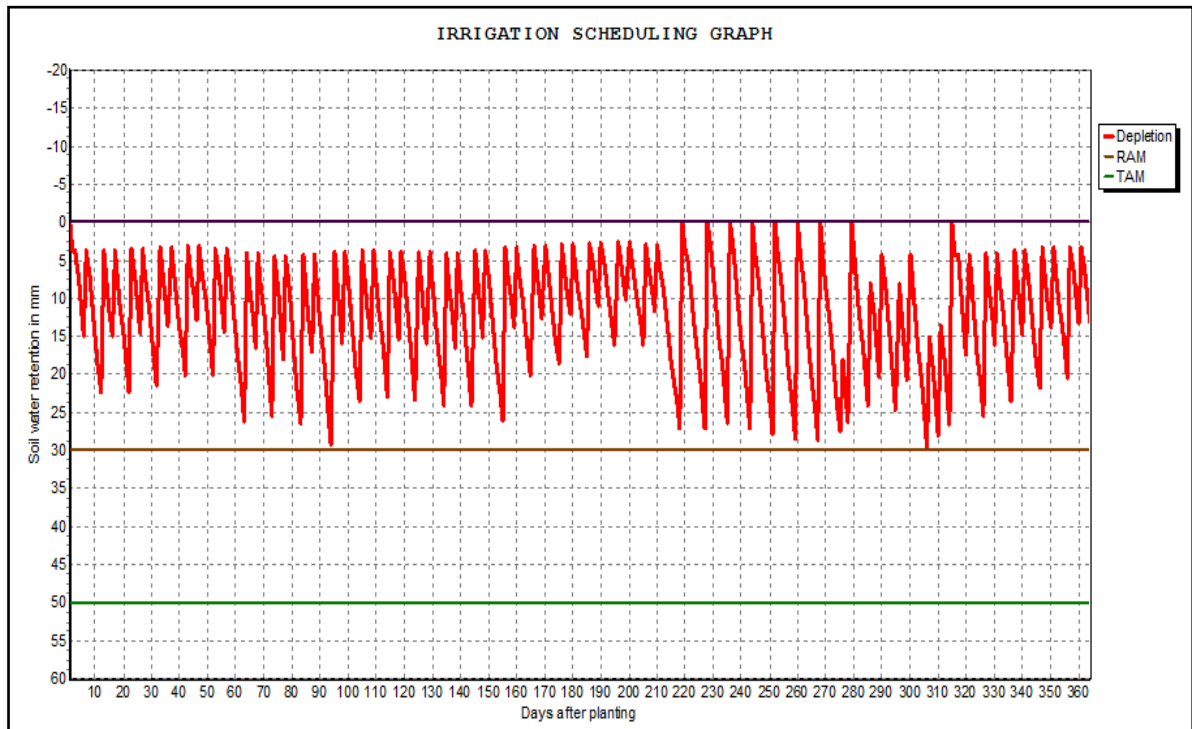

**Figure 24: Irrigation scheduling graph in year 2007**

### VIII.1.2 In the year 2008

**MONTHLY ETO PENMAN-MONTEITH DATA**  
(File: C:\ProgramData\CROPWAT\data\climate\Binh Long - 2008 final.PEM)

Country: Viet Nam - 2008                      Station: Hon Quan-Long Binh  
Altitude: 127 m.                                  Latitude: 11.32 °N                      Longitude: 106.30 °E

Month	Avg Temp °C	Humidity %	Wind km/day	Sun hours	Rad MJ/m <sup>2</sup> /day	ETo mm/day
January	26.2	72	78	9.3	20.6	3.98
February	26.4	67	86	9.1	21.8	4.38
March	27.0	73	63	11.0	26.0	5.07
April	28.2	78	86	10.5	25.7	5.31
May	26.9	85	66	7.6	20.9	4.26
June	27.3	85	64	8.8	22.3	4.52
July	26.8	84	67	7.8	21.0	4.30
August	24.4	86	65	7.5	20.8	3.97
September	25.9	89	70	5.4	17.5	3.46
October	26.6	86	45	8.6	21.3	4.16
November	25.8	85	53	7.4	18.2	3.50
December	25.6	78	54	8.3	18.7	3.50
Average	26.4	81	66	8.4	21.2	4.20

**Table 20: Monthly  $ET_o$  result in year 2008**

SCHEME SUPPLY												
ETo station: Hon Quan-Long Binh						Cropping pattern: Hon Quan -2008						
Rain station: Dong xoai - 2008												
	Jan	Feb	Mar	Apr	May	Jun	Jul	Aug	Sep	Oct	Nov	Dec
Precipitation deficit												
1. Rambutan	110.6	86.9	86.4	43.7	0.0	14.0	0.0	0.0	0.0	0.0	0.0	58.0
Net scheme irr.req.												
in mm/day	3.6	3.1	2.8	1.5	0.0	0.5	0.0	0.0	0.0	0.0	0.0	1.9
in mm/month	110.6	86.9	86.4	43.7	0.0	14.0	0.0	0.0	0.0	0.0	0.0	58.0
in l/s/h	0.41	0.36	0.32	0.17	0.00	0.05	0.00	0.00	0.00	0.00	0.00	0.22
Irrigated area (% of total area)	100.0	100.0	100.0	100.0	0.0	100.0	0.0	0.0	0.0	0.0	0.0	100.0
Irr.req. for actual area (l/s/h)	0.41	0.36	0.32	0.17	0.00	0.05	0.00	0.00	0.00	0.00	0.00	0.22

**Table 21: The scheme supply for rambutan tree in year 2008**

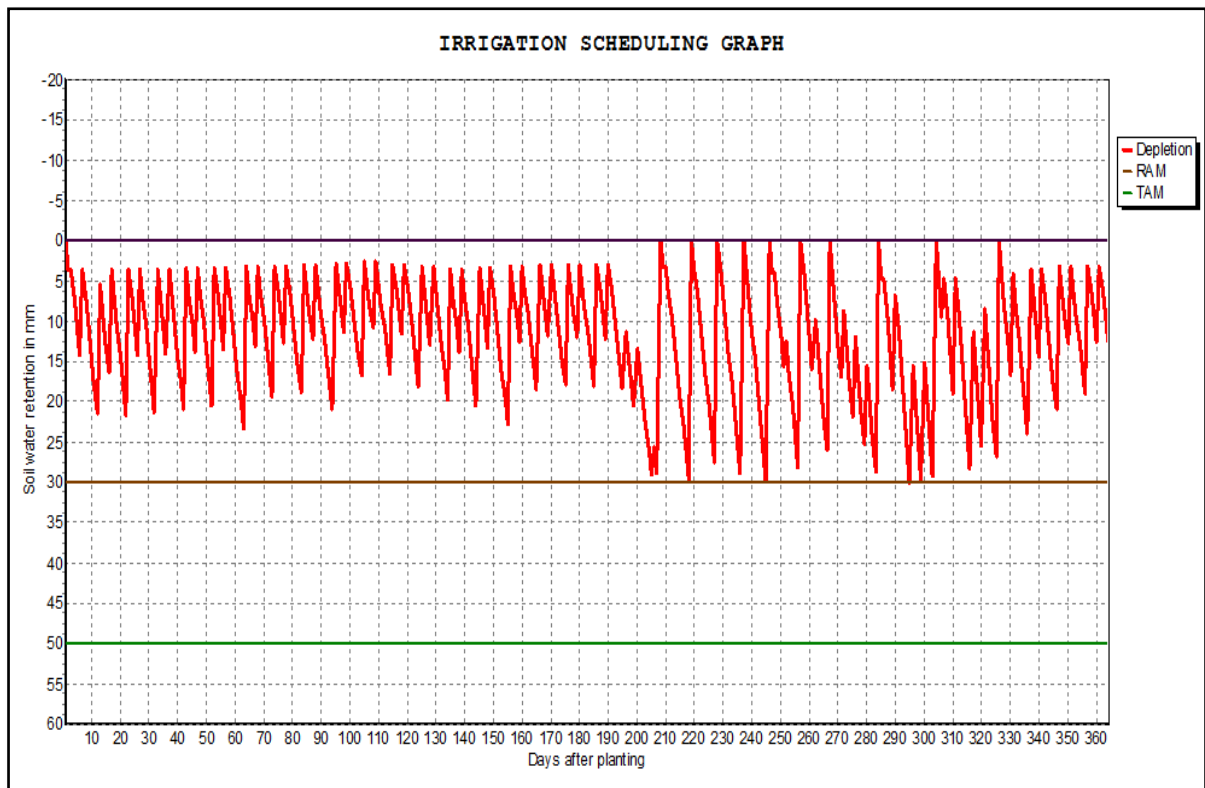

**Figure 25: Irrigation scheduling graph in year 2008**

### VIII.1.3 In the year 2009

MONTHLY ETO PENMAN-MONTEITH DATA						
(File: C:\ProgramData\CROPWAT\data\climate\Binh Long thu nghiem 2 - so trung binh 2009.PEM)						
Country: Vietnam -2009			Station: Hon Quan-Long Binh			
Altitude: 127 m.			Latitude: 11.32 °N		Longitude: 106.30 °E	
Month	Avg Temp °C	Humidity %	Wind km/day	Sun hours	Rad MJ/m <sup>2</sup> /day	ETo mm/day
January	24.4	71	86	8.0	18.8	3.61
February	26.2	80	43	10.1	23.2	4.33
March	27.8	76	69	8.5	22.2	4.56
April	27.7	82	52	9.7	24.5	4.98
May	27.2	84	52	6.8	19.7	4.07
June	27.3	85	61	10.3	24.5	4.92
July	26.4	87	95	5.3	17.2	3.55
August	27.5	84	78	7.0	20.1	4.18
September	26.0	90	69	7.2	20.2	3.98
October	26.3	87	43	6.4	18.1	3.57
November	26.8	77	69	7.5	18.4	3.68
December	26.2	73	52	8.9	19.5	3.73
Average	26.6	81	64	8.0	20.5	4.10

**Table 22: Monthly ET<sub>o</sub> result in year 2009**

SCHEME SUPPLY													
ETo station: Hon Quan-Long Binh							Cropping pattern: Hon Quan - 2009						
Rain station: Dong xoai - 2009													
	Jan	Feb	Mar	Apr	May	Jun	Jul	Aug	Sep	Oct	Nov	Dec	
Precipitation deficit													
1. Rambutan	102.3	107.6	56.4	37.2	0.0	0.0	0.0	0.0	0.0	0.0	0.0	12.5	
Net scheme irr.req.													
in mm/day	3.3	3.8	1.8	1.2	0.0	0.0	0.0	0.0	0.0	0.0	0.0	0.4	
in mm/month	102.3	107.6	56.4	37.2	0.0	0.0	0.0	0.0	0.0	0.0	0.0	12.5	
in l/s/h	0.38	0.44	0.21	0.14	0.00	0.00	0.00	0.00	0.00	0.00	0.00	0.05	
Irrigated area	100.0	100.0	100.0	100.0	0.0	0.0	0.0	0.0	0.0	0.0	0.0	100.0	
(% of total area)													
Irr.req. for actual area	0.38	0.44	0.21	0.14	0.00	0.00	0.00	0.00	0.00	0.00	0.00	0.05	
(l/s/h)													

**Table 23: The scheme supply for rambutan tree in year 2009**

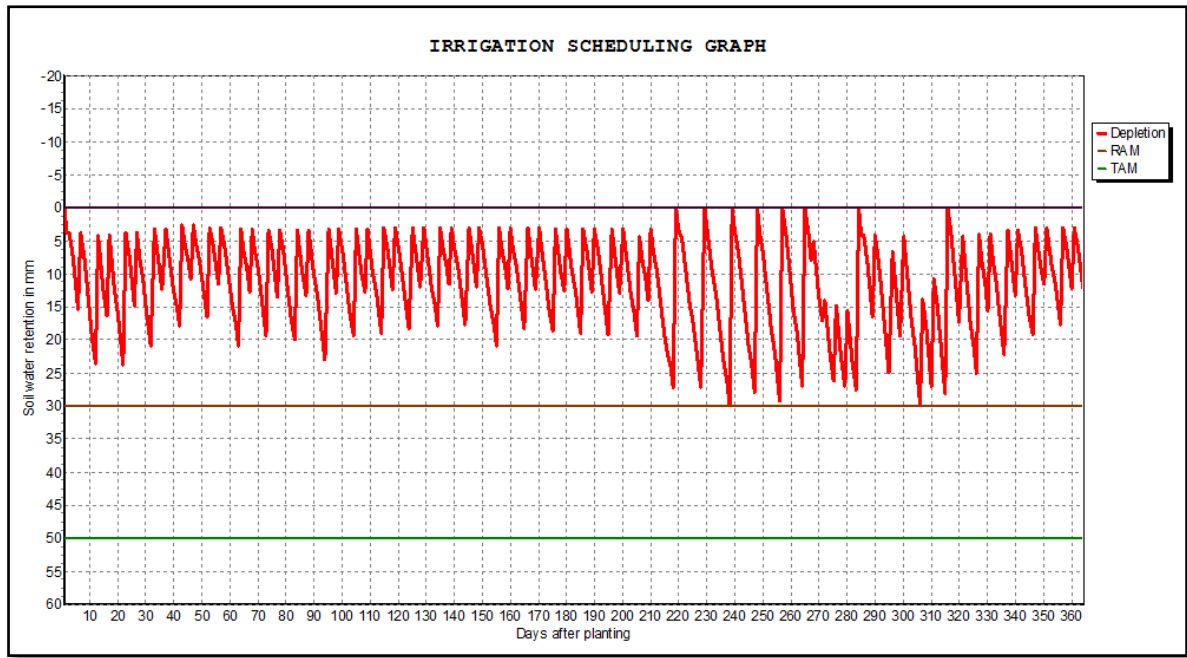

*Figure 26: Irrigation scheduling graph in year 2009*

## VIII.2 Water and soil analysis

The soil and water samples were collected at the selected farm. They were analysis by Research Center for Environmental Technology and Natural Resource Management of Nong Lam University, Ho Chi Minh City, Vietnam. The results are accepted by Vietnamese standard system – TCVN.



Trường Đại học Nông Lâm – Tp. Hồ Chí Minh  
**Trung Tâm Công Nghệ Và Quản Lý Môi Trường & Tài Nguyên (Cetnarm)**  
*Research Center for Environmental Technology and Natural Resource Management*  
 Website: [www.hcmuaf.edu.vn](http://www.hcmuaf.edu.vn) Email: [ttng@hcmuaf.edu.vn](mailto:ttng@hcmuaf.edu.vn) – [cetnarm@sphoo.com](mailto:cetnarm@sphoo.com)  
 Tel: 08 7.24.26.25 (6 lines) Fax: 08 8.96.33.48

---

No: 042b/AW – 22/02/2010

### REPORT ON ANALYTICAL RESULTS

Customer: **Nguyen Huynh Truong Gia**  
 Address: **Nong Lam University**  
 Sample name: **Water** Quantity: **01**  
 Received date: **22/02/2010** Date of result delivery: **4/3/2010**

Sample storage time: 07 days after the result delivery  
 BEYOND THE SAMPLE STORAGE TIME, THE CENTER DOES NOT HAVE RESPONSIBILITY ABOUT  
 COMPLAINING OF CUSTOMER

### RESULT OF ANALYSIS

No	Analyze	Soil Sample	Method
1	pH	6,41	TCVN 6492-2000
2	DO (mg/L)	4,39	TCVN 5499-1995
3	SAR	0,56	
4	TDS (mg/L)	5	TCVN 6625-2000
5	Cl (mg/L)	4,7	TCVN 6194-1996

Supervisor



Eng. NGUYEN CONG MANH

HoChiMinh City, March 4<sup>th</sup>, 2010



Director  
 MSc. NGUYEN CUU TUE

Figure 27: Farm water analysis report – Nong Lam University, Vietnam – 4<sup>th</sup> March 2010





Trường Đại học Nông Lâm – Tp. Hồ Chí Minh  
**Trung Tâm Công Nghệ Và Quản Lý Môi Trường & Tài Nguyên (Cetnarm)**  
*Research Center for Environmental Technology and Natural Resource Management*  
Website: [www.hcmuaf.edu.vn](http://www.hcmuaf.edu.vn) Email: [trmt@hcmuaf.edu.vn](mailto:trmt@hcmuaf.edu.vn) – [cetnarm@yahoo.com](mailto:cetnarm@yahoo.com)  
Tel: 08 7.24.26.25 (6 lines) Fax: 08 8.96.33.48

No: 042a/AS – 22/02/2010

### REPORT ON ANALYTICAL RESULTS

Customer: **Nguyen Huynh Truong Gia**  
Address: Nong Lam University  
Sample name: Soil Quantity: 01  
Received date: 22/02/2010 Date of result delivery: 4/3/2010

Sample storage time: 07 days after the result delivery  
BEYOND THE SAMPLE STORAGE TIME, THE CENTER DOES NOT HAVE RESPONSIBILITY ABOUT  
COMPLAINING OF CUSTOMER

### RESULT OF ANALYSIS

No	Analyze	Soil Sample	Method
1	Moiture (%)	1	TCVN 6647-2000
2	Soil partical	Sand (%)	79,6
		Clay (%)	6,1
		Limon (%)	14,3

Supervisor  
  
Eng. NGUYEN CONG MANH

HoChiMinh City, March 4<sup>th</sup>, 2010  
Director  
  
MsC. NGUYEN CUU TUE

Figure 28: Farm soil analysis report – Nong Lam University, Vietnam – 4<sup>th</sup> March 2010

### **VIII.3      *Pictures relating to the project***

The pictures were taken at the selected farm in dry seasons, February 2010.



***Figure 29: Position of emitters at rambutan tree of exited irrigation system in farm***



***Figure 30: In front of rambutan sector of selected farm***





*Figure 31: The underground PVC pipe mesh of exited irrigation system*



*Figure 32: Lake provides water for irrigation system*