



BRNO UNIVERSITY OF TECHNOLOGY

VYSOKÉ UČENÍ TECHNICKÉ V BRNĚ

FACULTY OF BUSINESS AND MANAGEMENT

FAKULTA PODNIKATELSKÁ

INSTITUTE OF MANAGEMENT

ÚSTAV MANAGEMENTU

APPLICATION OF PROJECT MANAGEMENT TOOLS AND METHODOLOGY IN DISPLAY & INFOTAINMENT SECTOR

APLIKACE NÁSTROJŮ A METODOLOGIE PROJEKTOVÉHO ŘÍZENÍ V SEKTORU DISPLAY &
INFOTAINMENT

MASTER'S THESIS

DIPLOMOVÁ PRÁCE

AUTHOR

AUTOR PRÁCE

Bc. Victoria Harea

SUPERVISOR

VEDOUCÍ PRÁCE

Ing. Lenka Širáňová, Ph.D.

BRNO 2023

Assignment Master's Thesis

Department: Institute of Management
Student: **Bc. Victoria Harea**
Supervisor: **Ing. Lenka Širáňová, Ph.D.**
Academic year: 2022/23
Study programme: International Business and Management

Garantka studijního programu Vám v souladu se zákonem č. 111/1998 Sb., o vysokých školách ve znění pozdějších předpisů a se Studijním a zkušebním řádem VUT v Brně zadává Master's Thesis s názvem:

Application of Project Management Tools and Methodology in Display & Infotainment Sector

Characteristics of thesis dilemmas:

Introduction
Goals of thesis and methods
A theoretical review of a problem
Analysis of the contemporary situation
Proposal of solution
Conclusion
References

Objectives which should be achieve:

The objective of thesis is application of project management tools and methods used for design and production of a display unit for an indoor, smart-home system built around the available technologies and know-how in the SemsoTec Czech company.

Basic sources of information:

BECK, Kent. Test-driven development: by example. Boston: Addison-Wesley, 2003. ISBN 0321146530.

BERKUN, Scott. Making Things Happen: Mastering Project Management. O'Reilly Media, Inc., 2008. ISBN: 978-0-596-51771-7.

COHN, Mike. User Stories Applied for Agile Software Development. Boston: Addison-Wesley Professional, 2009. ISBN 0-321-20568-5.

PORTNY, Jonathan, PORTNY, Stanley. Project Management For Dummies, 6th ed. John Wiley & Sons, Inc., Hoboken, New Jersey, 2022. ISBN: 978-1-119-86981-8.

SCHWABER, Ken, SUTHERLAND Jeff. The Scrum Guide [Online]. 2023 [cit. 2023-02-12]. Retrieved from: <https://scrumguides.org/>.

Deadline for submission Master's Thesis is given by the Schedule of the Academic year 2022/23

In Brno dated 5.2.2023

L. S.

doc. PhDr. Iveta Šimberová, Ph.D.
Branch supervisor

doc. Ing. Vojtěch Bartoš, Ph.D.
Dean

Abstrakt

Diplomová práce je věnována využití a implementaci příslušných nástrojů projektového řízení v rámci projektu založeného na návrhu a výrobě zobrazovací jednotky pro vnitřní systém inteligentní domácnosti. Práce se skládá ze tří hlavních částí. Teoretická část představuje ucelený popis nástrojů projektového řízení a metod použitých při jejich implementaci. Analytická část je zaměřena na zpracování primárních (rozhovor) a sekundárních dat (interní dokumenty a finanční výkazy) poskytnutých firmou, které usnadňují vyhodnocení současného stavu firmy. Návrhová část má za cíl vypracovat plán projektového řízení na základě zjištění analytické části.

Klíčová slova

Projektový management, časový plán projektu, SWOT, analýza rizik, PERT, GANTT diagram

Abstract

The diploma thesis is focused on the utilization and implementation of relevant project management tools within a project based on the design and production of a display unit for an indoor, smart-home system. The thesis consists of three main parts. The theoretical part represents a comprehensive description of project management tools and the methods used for implementation. The analytical part is focused on processing the primary (interview) and secondary data (internal documents and financial statements) provided by the firm that facilitates the company's current state evaluation. The design part is intended to develop a project management plan based on the findings of the analytical part.

Keywords

Project management, project timeline, SWOT, risk analysis, PERT, GANTT chart

Bibliographic citation

HAREA, Victoria. *Application of Project Management Tools and Methodology in Display & Infotainment Sector* [online]. Brno, 2023 [cit. 2023-05-06]. Available at: <https://www.vut.cz/studenti/zav-prace/detail/152570> Master's Thesis. Brno University of Technology, Fakulta podnikatelská, Ústav managementu. Supervisor Ing. Lenka Širáňová, Ph.D.

Affidavit

I declare that the present master project is an original work that I have written myself. I declare that the citations of the sources used are complete, that I have not infringed upon any copyright (pursuant to Act. no 121/2000 Coll.).

Brno dated 7th May 2023

Bc. Victoria Harea

author's signature

Acknowledgement

I would like to express my recognition to Ing. Lenka Širáňová, Ph.D. for her guidance that helped me into accomplishment of this work. Also, I would like to thank the company SemsoTec Czech s. r. o. for providing me with all the necessary documentation and information on the case. And my parents without whom I wouldn't be the person I am today.

CONTENT

INTRODUCTION.....	10
THE OBJECTIVE OF WORK, METHODS AND PROCEDURES FOR PROCESSING.....	11
1 THEORETICAL BACKGROUND OF THE THESIS.....	12
1.1 BASIC TERMS IN PROJECT MANAGEMENT PLANNING.....	12
1.2 PROJECT MANAGEMENT	13
1.2.1 Initiation phase	13
1.2.2 Planning phase.....	13
1.2.3 Execution phase.....	13
1.2.4 Monitoring and control phase	14
1.2.5 Closure phase	14
1.3 PROJECT MANAGER	14
1.3.1 Organizational structure	15
1.3.2 Stakeholders in project management.....	16
1.4 PROJECT LIFECYCLE	17
1.4.1 Pre-project phase	17
1.4.2 Project phase	17
1.4.3 After-project phase	18
1.5 DEFINITION OF PROJECT'S GOAL	19
1.5.1 Triple constraint in project management.....	19
1.5.2 SMART goal.....	20
1.6 LOGICAL FRAMEWORK	21
1.7 WBS IN PROJECT MANAGEMENT.....	22
1.8 PROJECT MANAGEMENT METHODS AND TOOLS.....	23
1.8.1 PERT	25
1.8.2 CPM	26
1.8.3 Gantt chart	27
1.9 RISK MANAGEMENT	29
1.9.1 Risk management in project management	29
1.9.2 FMEA.....	30
1.10 COMPANY'S INTERNAL AND EXTERNAL ENVIRONMENT ANALYSES	31
1.10.1 SLEPT analysis	31

1.10.2	PORTER analysis	32
1.10.3	7S analysis.....	34
1.10.4	SWOT analysis.....	35
2	ANALYSIS OF THE CURRENT STATE OF AFFAIRS	37
2.1	COMPANY INTRODUCTION	37
2.2	COMPANY’S HIERARCHY	39
2.2.1	V Project.....	40
2.3	SLEPT ANALYSIS	42
2.3.1	Social factor.....	42
2.3.2	Political-legislative factors	44
2.3.3	Economical factor	45
2.3.4	Technological factor	49
2.4	PORTER ANALYSIS.....	50
2.5	MCKINSEY 7S ANALYSIS	52
2.5.1	Strategy	52
2.5.2	Structure	52
2.5.3	Systems.....	53
2.5.4	Skills.....	53
2.5.5	Staff	53
2.5.6	Style.....	53
2.5.7	Shared values.....	54
2.6	SWOT ANALYSIS	55
2.6.1	Strengths.....	55
2.6.2	Weaknesses.....	55
2.6.3	Opportunities	55
2.6.4	Threats	56
3	PROPOSED SOLUTIONS AND BENEFITS OF THE PROPOSED SOLUTIONS	58
3.1	PROJECT MANAGEMENT & CONTROL.....	58
3.1.1	Project objective.....	58
3.1.2	Initial project charter	58
3.2	PROJECT IDENTIFICATION DOCUMENT	60
3.3	LOGICAL FRAMEWORK	61
3.4	WORK BREAKDOWN STRUCTURE.....	64

3.5	PROJECT TEAM	66
3.6	RACI MATRIX	67
3.7	RISK ANALYSIS	69
3.7.1	Risk Assessment	71
3.7.2	Risk Reduction	74
3.8	TIME ANALYSIS	78
3.8.1	Project timeline	78
3.9	GANTT CHART	81
3.9.1	Project implementation costs	82
	BENEFITS OF SOLUTION PROPOSALS	84
	CONCLUSION	85
	LIST OF REFERENCES	86
	LIST OF ABBREVIATIONS	93
	LIST OF FIGURES	94
	LIST OF TABLES	95
	LIST OF ANNEXES	96

INTRODUCTION

Nowadays, terms such as project management are increasingly becoming more and more popular and crucial among companies regardless of their size or business area. Project management is a standard to be followed for the proper operation of any business. The appropriate plan definition and implementation including adequate execution, and continuous rigorous control - represent the main pillars of project management.

The basic prerequisite for project management is not just a smooth process but also the efficient use of resources. Due to project management tools and their correct use, the process can be efficiently planned, controlled, and optimized in order to achieve project goals. Therefore, appropriately chosen management tools will not only save time but also costs and company's human resources.

SemsoTec Czech s.r.o. is a company under the SemsoTec Group umbrella operating in the Czech Republic officially since 2018. Due to the global pandemic caused by COVID-19, SemsoTec Czech started its operations in 2020. SemsoTec Group's companies cover the entire value chain for infotainment displays and control units, from prototype to series production. Until now, SemsoTec Czech s.r.o. was mainly processing projects outsourced by its mother company – SemsoTec GmbH. The “V Project” is, therefore, one of the first independent projects to be entirely realized and produced by SemsoTec Czech s.r.o. This big responsibility involves minutious planning and control. Therefore, adequate project management and expertise is required but also a reasonable plan of implementation is needed.

The objective of work, methods and procedures for processing

The aim of the work, based on the analyses carried out is the application of project management tools and methods used for design and production of a display unit for an indoor, smart-home system built around the available technologies and know-how in the SemsoTec Czech company.

The strategic analysis and the deep understanding of company's current status serves as a start point for the planning of the project implementation. Therefore, it is crucial to evaluate the company's strengths and weaknesses as well as opportunities and threats in the sector in which it operates. This assessment served as a base to propose strategic project implementation plan.

The thesis is conventionally divided into three main parts. The theoretical part is dedicated to the introduction to the project management tools and methodologies used for the project implementation.

The analytical part is focused on processing primary and secondary data collected from the company. The internal and external analyses supported the evaluation of the current status of SemsoTec Czech s.r.o. For this purpose, analyses such as SLEPT, McKinsey 7S model and Porter's competitive forces model were considered. Further, the output of these analyses was processed and used to create a SWOT analysis. In addition, secondary research data such as internal documents and financial statement provided by the company were used.

The last part of the thesis is dedicated to the design of a project plan for the "V Project", taking into consideration possible risks and their minimization. This part was compiled based on project management methods such as the logical framework, involving the creation of the project identification sheet and the WBS method to develop a detailed overview of the activities. The RACI matrix was created to assign each activity to responsible persons who will be accountable for their implementation. The risk analysis was created using the scoring method, defining threats, scenarios and suggestions for action, in order to reduce the values of individual risks. The PERT method was involved to build the timetable. Accordingly, the creation of CPM supported the identification of the minimum time needed for the implementation of the project. The project timeline was represented using the GANTT chart.

The overall initial costs of the company associated with the "V Project" are stated as a reflection of the company's initial investments. The last chapter of the thesis focuses on highlighting the project implementation milestones and the benefits it could bring.

1 THEORETICAL BACKGROUND OF THE THESIS

1.1 Basic terms in project management planning

The basic term definitions associated with planning in project management are:

- Scope – represents the detailed description of the project and its deliverables, containing what is included and excluded from the project. Setting the scope well in advance helps the team members with time management (Team Asana, 2022).
- Schedule – is the timeline for the project, including start and end dates for each task and the overall project.
- Budget – stands for the estimated cost of the project, including resources, materials, and labor, as well as any contingencies or unforeseen expenses.
- Risk – refers to the probability of potential problems that could arise during the project and the likelihood of their occurrence. Risk management involves identifying, assessing, and mitigating these risks (Eby K., 2017).
- Resources – includes people, equipment, and materials needed to complete the project.
- Communication - effective communication is essential for a successful project. A communication plan outlines how information will be shared among project stakeholders.
- Stakeholders – are individuals or organizations with an interest in the project and are directly impacted by the project. It is important to identify stakeholders and understand their needs and expectations (Team Asana, 2022).
- Milestones – are key points in the project where progress is measured and evaluated. Milestones are typically used to mark the completion of major project phases.
- Constraints – encounter limitations that may impact the project's schedule, budget, or scope. Examples include resource availability, legal requirements, and project dependencies.
- Change Management – is the process of managing changes to the project scope, schedule, or budget. Change requests are evaluated, and approved changes are integrated into the project plan (Team Asana, 2022).

1.2 Project management

Project management is the process of planning, organizing, and controlling resources to achieve specific goals within a defined timeframe. The main objective of project management is to complete a project successfully while meeting the required constraints in matter of scope, quality, time, and cost. In fact, project management is a critical process that ensures the successful delivery of projects, regardless of their size or complexity. Project management involves a wide range of activities, including project initiation, planning, execution, monitoring, and closure (Bridges J, 2023).

1.2.1 Initiation phase

The first step in project management is project initiation, where the project objectives, scope, and stakeholders are identified. This phase also involves defining the project's feasibility and the potential risks and benefits. The project charter is a key output from the initiation phase.

Project charter is a short document highlighting the goals and financial resources required before planning begins. It helps the participants and stakeholders understand matters such as: who will participate on the project, what are its risks associated, and how the participants will communicate (Gillis A.S., 2023).

1.2.2 Planning phase

After the initiation phase, the project moves into its planning phase where the project manager creates a project plan displaying the project's scope, objectives, timelines, and resources required. The communication channels are also crucial for effective communication during the project's life cycle. The project plan also states the responsibilities of the team members and the project's stakeholders. In this phase, the project manager additionally develops a detailed project schedule, budget plan, and risk management plan (Aziz E., 2015).

1.2.3 Execution phase

The execution or also known as the implementation phase is where the project plan is put into action. The project manager ensures that the team goes according to the project plan and that the project is progressing on set schedule. The project manager also manages the project's dedicated resources, such as: human resources, equipment, and other materials, to ensure that the project is completed on time and within set budget.

1.2.4 Monitoring and control phase

According to Donato H., the monitoring and control phase involves monitoring progress on the project and identifying any deviations from the set project plan. The best way to evaluate the performance is through various metrics. The project manager conducts meetings on a regular set basis with the project team to ensure that everyone is aware of the project's current state and it's progress, and that any issues are addressed, before it's too late. During this phase, the project manager also assesses the project's risks and takes steps to mitigate them.

In this phase it is also the correct time to communicate any additional required resources to the relevant stakeholders. These requests for additional resources need support of relevant data and reasoning (Donato H., 2022).

1.2.5 Closure phase

The final phase within project management is project closure. This phase's main objective is delivering the final result to the stakeholders, ensuring that all contractual obligations have been met, and communicating the project's overall success. The deliverables are reviewed and compared to see if they have the intended quality (Eby K., 2021).

Meeting minutes are written down to remind us what was discussed and agreed. The project manager also conducts a post-project review to identify any lessons learned that can be applied to future projects.

1.3 Project manager

A project manager is responsible for planning and overseeing a project from its inception to completion. Their main role is to plan, execute, and monitor projects, ensuring that they are completed on time, within budget, and to the satisfaction of stakeholders (Rittenberg J., Bottorff C., 2022).

According to Kashyap S., some key responsibilities of a project manager include:

- Defining project objectives, scope, and requirements;
- Breaking down the tasks into smaller subtasks;
- Developing a schedule for deliverables;
- Developing a detailed project plan, including timelines, resources, and budgets;
- Assigning tasks and responsibilities to project team members;

- Monitoring project progress and making adjustments as necessary;
- Managing project risks and issues, and developing contingency plans;
- Communicating project status to stakeholders and addressing any concerns or questions they may have;
- Ensuring project deliverables meet quality standards and are completed on time and within budget.

Project managers are involved in a large variety of industries. These professionals are operating in domains such as construction, engineering, software development, marketing, etc. To prove their competitiveness, project managers need to pass certifications such as Project Management Professional (PMP) or Agile Certified Practitioner (ACP) to demonstrate their expertise in project management methodologies (Kashyap S., 2022).

1.3.1 Organizational structure

Organizational structure is a pillar of project management. It defines the organization hierarchy, member roles, and responsibilities of individuals within a team. The project management team formation can vary depending on the project type, the size of the team, and the goals of the project.

1.3.1.1 Functional Organizational Structure

In a functional organizational structure, the team members are chosen and distributed in teams based on their areas of expertise or function. Accordingly, each team member is assigned to a functional department or task, and the project manager serves mediator between the team and the organization. This functional organizational structure is suitable for projects that require specialized skills and expertise. Therefore, the team members can work on multiple projects simultaneously (Usmani F., 2022).

1.3.1.2 Matrix Organizational Structure

A matrix organizational structure combines two or more types of organizational structure and two managers: the functional manager and the project manager. This structure enables a faster pace, based on a higher human resources usage, but it can also lead to conflicts between team members caused by lack of clarity regarding roles distribution (Westland J., 2022).

1.3.1.3 Project-Based Organizational Structure

Within a project-based organizational structure, the project manager has complete authority over the project team members. The team members are assigned to work on the project full-time until its completion, and they report directly to the project manager. According to Nasrudin A., this structural approach is suitable for large companies with short-duration projects (Nasrudin A., 2022).

1.3.1.4 Team-Based Organizational Structure

The team-based organizational structure is represented by the project team members organization into a team to work together to complete the project. This structure emphasizes collaboration and teamwork. The team members are responsible for their own decisions and outcomes. This structure is suitable for projects that require innovation, creativity, and flexibility (Westland J., 2022).

1.3.2 Stakeholders in project management

Managing stakeholders in project management is a critical aspect of ensuring the successful completion of any project. Stakeholders are individuals or groups interested in the project's outcome, and they can be internal or external to the organization. Effective stakeholder management involves identifying, analyzing, and engaging with stakeholders throughout the project's lifecycle (Lockhart L., 2023).

According to Vega K., stakeholders can be project sponsors, customers, team members, suppliers, government agencies, CEO, etc. Each stakeholder has unique needs, expectations, and priorities that must be taken into account during the project's planning and execution phases. Failure to manage stakeholders effectively can result in delays, cost overruns, and ultimately project failure (Vega K., 2023).

Effective stakeholder management can also bring many benefits to a project. Engaging with stakeholders early in the project is crucial. In such a way, project managers can gain valuable insights into the project's goals, requirements, and risks. This, in turn, can help them to develop an exact project plan that is more likely to succeed. Additionally, engaging stakeholders throughout the project can help to build trust, enhance communication, and increase stakeholder satisfaction. This can lead to improved project outcomes, increased stakeholder support, and develop a long-lasting business partnership.

1.4 Project lifecycle

The project lifecycle refers to the various stages or phases that a project goes through from its initiation to its closure. It provides a structured framework for managing and executing a project. The three main phases of a typical project lifecycle are:

1.4.1 Pre-project phase

The pre-project phase occurs before the project officially begins and involves activities aimed at identifying and evaluating the feasibility of the project. According to Miller D., key tasks and processes in this phase include:

- **Idea Generation:** This is the initial stage where project ideas are generated. It may involve brainstorming sessions, market research, or identifying a specific business need.
- **Feasibility Study:** A feasibility study is conducted to assess the viability and potential success of the project. It involves analyzing factors such as technical, economic, legal, and operational aspects to determine if the project is feasible.
- **Project Initiation:** Once the project is deemed feasible, it moves into the initiation phase. This involves defining the project's objectives, scope, deliverables, and stakeholders. A project charter or similar document may be created to outline these details.
- **Stakeholder Analysis:** Identifying and analyzing stakeholders who may be impacted by the project is crucial. This helps in understanding their expectations, requirements, and potential influence on the project's outcome.
- **Resource Planning:** The pre-project phase also involves identifying and securing the necessary resources, such as human resources, budget, equipment, and technology, required for the project's execution. (Miller D., 2023)

1.4.2 Project phase

The project phase is the main execution phase where the project's objectives are achieved. It encompasses the actual implementation, monitoring, and control of project activities. According to Miller D., key activities in this phase include:

- **Project Planning:** Detailed planning is done to define project tasks, establish timelines, allocate resources, and create a project schedule. This involves breaking down the project into smaller manageable tasks, creating work breakdown structures, and determining dependencies.

- **Execution:** This phase involves carrying out the planned activities, coordinating teams, and managing resources to achieve project objectives. Project managers monitor progress, resolve issues, and ensure tasks are completed according to the schedule.
- **Monitoring and Control:** Throughout the project phase, monitoring and control mechanisms are put in place to track progress, measure performance against set targets, and make adjustments as necessary. This includes regular status updates, progress reports, and quality assurance processes.
- **Risk Management:** Identifying, assessing, and mitigating risks is an ongoing process during the project phase. Risk management activities involve proactive planning, implementing risk mitigation strategies, and addressing unforeseen issues or changes.
- **Communication and Stakeholder Management:** Effective communication with stakeholders is essential to keep them informed about the project's progress, address concerns, and manage expectations. Regular communication channels and feedback mechanisms are established. (Miller D., 2023)

1.4.3 After-project phase

The after-project phase occurs after the project's objectives have been achieved or the project has been terminated. This phase involves activities aimed at concluding the project and evaluating its overall success. According to Miller D., key tasks in this phase include:

- **Project Deliverable Completion:** All project deliverables are finalized, reviewed, and accepted by the stakeholders. This includes documentation, reports, prototypes, or any other tangible outcomes defined in the project scope.
- **Project Evaluation:** A comprehensive evaluation of the project's performance and outcomes is conducted. This involves assessing whether the project achieved its objectives, met stakeholder expectations, stayed within budget and schedule, and delivered the desired quality.
- **Lessons Learned:** Identifying lessons learned from the project is crucial for future improvements. Project teams document successes, challenges, and best practices to enhance future project management processes and avoid repeating mistakes.
- **Project Closure:** The project is formally closed, and all administrative and financial activities associated with the project are finalized. This includes releasing project resources, archiving project documentation, and conducting closure meetings with. (Miller D., 2023)

1.5 Definition of project's goal

According to Investopedia, the goal of a project in project management is to achieve a specific objective or set of objectives within a defined timeframe and budget, while meeting certain quality standards. This can involve delivering a new product, service, or process, improving an existing one, or achieving a particular outcome or result (Investopedia, 2023).

Project goals involve the completion of specific tasks or milestones, such as: creating a project plan, developing project deliverables, conducting project reviews, and implementing project changes. The ultimate aim is to ensure that the project meets the needs and expectations of stakeholders.

1.5.1 Triple constraint in project management

The triple constraint is a concept that is often used in project management to describe the interdependent relationship between three critical factors: time, cost, and scope. These three factors directly impact the success of the project (Westland J., 2022).

This principle guides project managers in the decision-making, planning and implementation of projects together with ongoing control. Thus, once the scope of a project increases, more time and resources may be needed, which associates with an increase in the project cost.

- The first element of the triple constraint is time, accounting the duration of the project, including start and end dates and milestones to be achieved. Delays in one activity can have an impact on the entire project, which may influence the deadlines and final cost.
- The second element of the triple constraint is cost. Cost refers to the financial resources needed to successfully complete the project. It includes the cost of raw materials, labor, equipment and other costs. Cost overruns can have serious consequences for a project, including delayed completion, reduced quality or even cancellation of the project.
- The third element of the triple constraint is scope. Scope refers to the work that needs to be done to achieve the project objectives. Managing volume is necessary to ensure that the project meets the needs and expectations of stakeholders. Changes in scope can have a direct impact on the other two dimensions which is the project time and costs.

The project manager task is to develop a project plan that takes into account the correlation between these three factors and create a realistic timeline, budget and scope for the project.

Effective management of the triple constraint is critical to project success and requires careful planning, monitoring and control throughout the project life cycle (Bratta A., 2006).

1.5.2 SMART goal

SMART is an acronym that stands for Specific, Measurable, Achievable, Relevant, and Time-bound. A SMART goal is a well-defined objective that adheres to these criteria. This approach is a widely accepted and effective way to set goals in personal and professional life. SMART goals help individuals and organizations measure their progress and be accountable for their success (Herrity J., 2022).

The first component of a SMART goal is Specific. It means that the goal should be precisely defined and focused on a particular area. According to Leonard K. and Watts R. a specific goal could be sales number or launching a product. A specific goal should answer the five "W" questions: Who, What, Where, When, and Why. For instance, a goal to "improve customer satisfaction" is too general, whereas a goal to "increase customer satisfaction by 10% in the next six months by enhancing customer service training" is specific. The more precise the goal, the easier it is to understand and achieve (Leonard K. and Watts R., 2022).

The second component is Measurable. It means that the goal should be quantifiable so that progress can be monitored and evaluated. A measurable goal has a defined metric or standard that can be used to measure progress. For example, a goal to "increase sales" is vague and difficult to measure. On the other hand, a goal to "increase sales by 20% in the next quarter" is measurable. The goal setter should define the measurement criteria, such as the number of units sold, revenue generated, or customer satisfaction ratings.

The third component is Achievable. It means that the goal should be realistic and attainable given the available resources and constraints. A goal that is too ambitious or impossible to achieve can demotivate individuals or teams. Conversely, a goal that is too easy or insignificant can fail to inspire or challenge them. An achievable goal should stretch the limits of what is currently possible but should not be unrealistic or unattainable. For example, a goal to "increase revenue by 100% in the next month" is unrealistic and unachievable, while a goal to "increase revenue by 10% in the next quarter" is achievable.

The fourth component is Relevant. It means that the goal should be aligned with the broader objectives and purpose of the individual or organization. A relevant goal should contribute to the overall mission, vision, and values. It should address the critical needs, challenges, or

opportunities that the individual or organization faces. For a goal to "grow business revenues" it is relevant to look for new acquisition methods of new customers. On the other hand, changing packaging will not be relevant for the company in that situation (Gregory A., 2022).

The fifth component is Time-bound. It means that the goal should have a defined timeframe or deadline for completion. A time-bound goal creates a sense of urgency, accountability, and motivation. It also allows individuals or teams to track progress and adjust their strategies accordingly. For example, a goal to "launch a new product by the end of September" is time-bound, while a goal to "launch a new product eventually" is not (Woolf M., 2022)

Each component plays a critical role in setting goals that are clear, measurable, attainable, relevant, and time-bound. SMART goals help individuals and organizations focus on specific objectives and achieve them in a timely and efficient manner.

1.6 Logical framework

The Logical Framework is a project management tool that provides a systematic approach to project planning and management. It is a planning tool that helps project managers in defining the project objectives, outcomes, and activities in a logical and structured manner. It is also known as the Logframe and is widely used in the development sector, particularly in international development projects.

The Logical Framework consists of four linked components, namely the Goal, Purpose, Outputs, and Activities, as mentioned by Collins K.B. These components are linked in a hierarchical manner, with the Goal at the top, followed by the Purpose, Outputs, and Activities. The Goal represents the ultimate outcome or impact that the project seeks to achieve. The Purpose are the specific and measurable results that the project aims to accomplish. The Outputs are the tangible products or services that the project will produce. Lastly, the Activities are the specific tasks or actions that will be undertaken to achieve the project outputs (Collins K.B., 2021).

The Logical Framework is usually presented in a table format, with the four components listed in columns and the various elements listed in rows. The table provides a clear and concise overview of the project, which can be easily understood by stakeholders and project team members.

We use the Logical Framework to help us ensure that the project goals and purpose are SMART (Specific, Measurable, Achievable, Relevant, and Time-bound). This means that the goals and

purpose are clearly defined and measurable, which enables project managers to track progress and make adjustments as necessary.

Another useful benefit of the Logical Framework is that it helps to identify potential risks and assumptions that could impact the project. By identifying these risks and assumptions, project managers can mitigate potential issues before they occur (Candiliari F., 2019).

The Logical Framework is also useful for project monitoring and evaluation. By comparing the actual outputs and outcomes of the project with the planned outputs and outcomes, project managers can identify areas of success and areas where improvements can be made.

By using the Logical Framework, project managers can ensure that their projects are on track and achieving the desired outcomes, however the data must be in real-time.

1.7 WBS in Project management

The Work Breakdown Structure (WBS) method is a tool used in project management to break down a project into smaller, more manageable components. According to Organ C. and Bottorff C., this method is used to help project managers and teams better understand the scope of the project, develop a plan for completing the work, and identify the necessary resources and timelines required to complete each component, per (Organ C. and Bottorff C., 2022).

This method dives deep into the project's hierarchical structure of smaller, more manageable components. According to Sienkiewicz A., two types of WBS can be distinguished, the deliverable-based WBS and phase-based WBS. The first step in establishing a WBS is to identify the major deliverables of the project. These deliverables could include the final product, reports, or other outcomes that are expected at the completion of the project (Sienkiewicz A., 2022).

Once the main deliverables are identified, the project team can start to break them down into smaller, more manageable packages. This process continues until all components are small enough to be assigned to one person or group.

WBS method brings numerous benefits. First, it helps clarify the scope of the project and identifies all the necessary components needed to complete it. It helps ensure that nothing is overlooked and that all necessary work is identified.

Secondly, the WBS method helps to identify the necessary resources needed to complete each component of the project. This includes determining the necessary personnel, equipment, and materials needed to complete each component.

In addition, the WBS method helps identify any potential bottlenecks or problems that may happen during the project. In such a way, it becomes easier to identify any potential bottlenecks and develop strategies to overcome them when a project may fall.

Finally, the WBS method provides a clear and concise framework for communication between the project team and stakeholders.

1.8 Project management methods and tools

Project management methods and tools are essential for planning, organizing, and managing projects efficiently. Some of the commonly used methods and tools in project management are:

- **Gantt charts:** are known as a popular project management tool that provides a visual depiction of a project's tasks, dependencies, and timelines. They are useful for planning and tracking project progress (Grant M., 2022).
- **Critical Path Method (CPM)** is a cornerstone of project management. This technique is used to identify the critical path, which is the sequence of tasks that determine the shortest amount of time required to complete a project. It is useful for analyzing and optimizing project schedules and tracking project progress (Cohen E., 2022).
- **Program Evaluation Review Technique (PERT):** PERT is a project management diagram which defines all activities within a project. This visualization consists of numbered nodes with their vectors, used to represent all the tasks that are to be completed (Chai W., Brush K., 2021).
- **Waterfall Methodology:** Waterfall is a linear and sequential approach to project management that consists of five phases. Requirements, Design, Implementation, Verification, and Maintenance. This methodology is best suited for projects where we clearly define the end result, such as when developing software (Hoory L., Bottorff C., 2022).
- **Spiral Model:** The Spiral Model is a software development process model based on the idea of continuously refining and improving a project as it progresses through each stage of development. It serves the purpose of providing support for handling risk. The

process begins with planning and risk analysis, continues with the development and testing of the product in cycles (Pal S.K., 2023).

- **V-pattern Model:** V-pattern in project management is a model for software development projects that can help to ensure the final product meets the client's expectations and is delivered on time and within budget, as it has very specific deliverables and review process (Kumar D., 2023).
- **Agile Methodology:** Agile is an iterative and incremental approach to project management that emphasizes flexibility, collaboration, and customer satisfaction. This is achieved through constant communication with the team and the client (Santo D.E., 2022).
- **Kanban:** According to Paterson K., Kanban originates from Japanese, meaning “visual card”. It is an Agile framework composed of boards, lists and cards. This method emphasizes visualizing work, limiting work in progress, and optimizing flow. It is useful for managing and improving workflow and increasing productivity (Paterson K., 2022).
- **Scrum Framework:** Scrum is an Agile framework that emphasizes teamwork and self-organization. In scrum, the team has its focus on evolution of learning and adapting through a project’s life-cycle. The final product is delivered in small sizes, rather than at once (Singh V., 2021).

These are some of the commonly used project management methods and tools. Project managers can choose the method and tool that best suits them, based on their requirements and goals.

In the design part, methodologies such as PERT, CPM and the Gantt chart were used. Therefore, the following literature is focused on describing specifically these project management tools.

1.8.1 PERT

Program Evaluation Review Technique (PERT) is a project management planning tool used to calculate the amount of time it will take to realistically finish a project.

The technique involves breaking down a project into smaller tasks and identifying the dependencies and relationships between those tasks. Each task is assigned a duration and an optimistic, pessimistic, and most likely estimate of how long it will take to complete. Using this information, an estimate of the project's timeline is calculated, which takes into account the uncertainty and risk associated with completing each task.

PERT allows us to plan and manage projects more effectively and efficiently, while taking into account the uncertainty and risk associated with complex projects.

We consider three estimates for each task: optimistic (o), pessimistic (p) and most likely (M).

Using these estimates, PERT calculates the Expected time (TE) for each task using the formula:

$$TE = (O + 4M + P) / 6$$

Moreover, PERT calculates the Variance (V) for each task using the formula:

$$V = ((P - O) / 6)^2$$

Source: Bell M., 2021

These expected times and variances are later used to determine the critical path and project timeline using a probabilistic approach. It accounts for the uncertainty in task durations and provides a range of possible project durations, which helps project managers better understand the potential risks and uncertainties associated with the project timeline.

PERT also allows project managers to identify tasks with the highest impact on the project timeline, known as the critical path, which represents the longest path of dependent tasks that determines the project's overall duration. This helps in identifying tasks that are most critical to the project's timeline and focusing efforts on managing those tasks effectively.

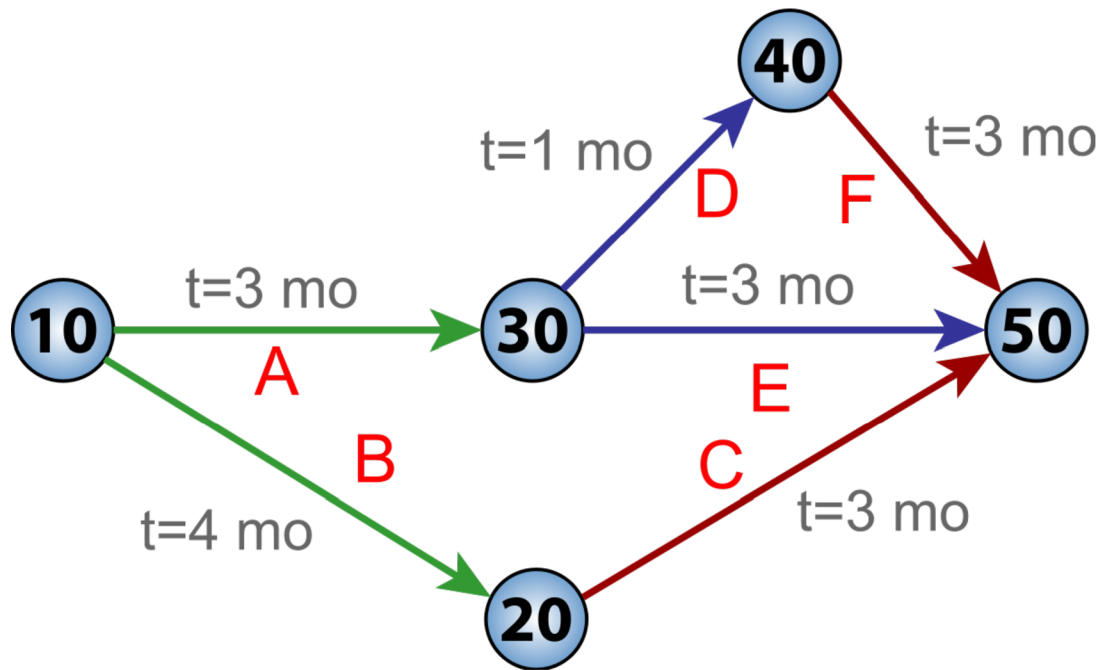

Fig. 1: PERT network chart (Source: Wikipedia, 2023)

1.8.2 CPM

CPM abbreviation stands for "Critical Path Method". It is a project management technique used to identify sequence of activities that must be completed on time in order for the project to be completed on schedule (Cohen E., 2022).

This method is used to analyze and optimize project planning, allocate resources, and track project progress. The steps in CPM involve dividing a project into individual tasks/packages, determining the dependencies between these tasks, and calculating the earliest and latest possible start and finish times for each task.

The technique also involves creating a network diagram that represents project tasks as nodes and their dependencies as vectors. Each task has a path, and the network diagram helps identify that path. The critical path has zero delay, which means that any additional delay along the critical path will have a direct impact on the project timeline.

By identifying the critical path, project managers can distribute their efforts on ensuring which tasks on that path are completed on time to keep the overall project on track.

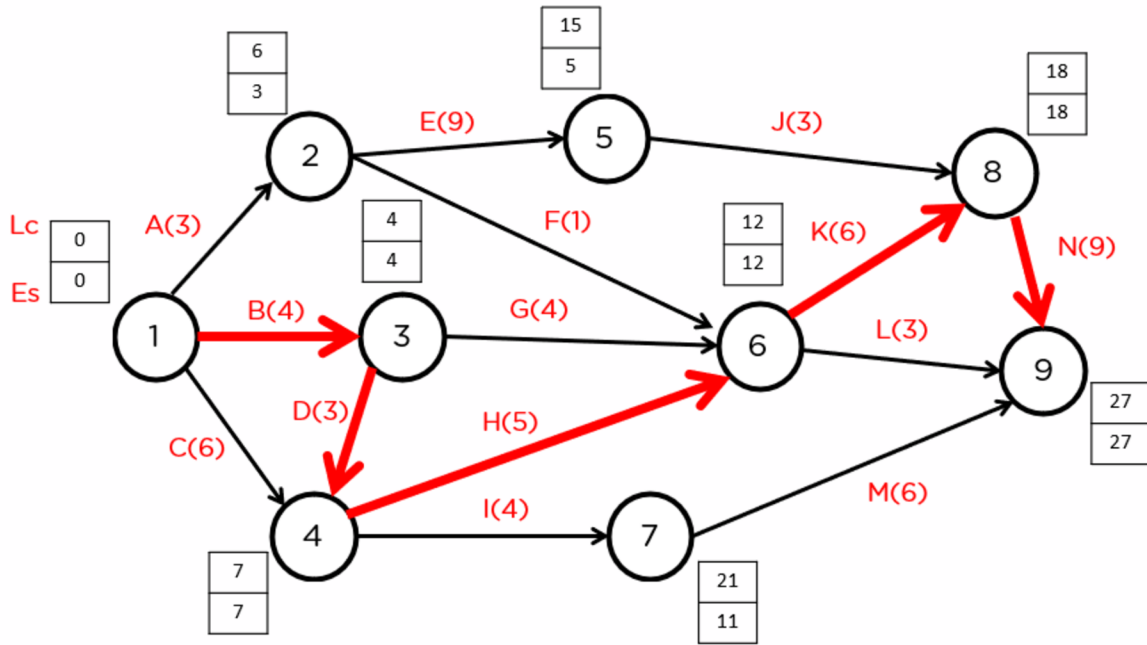

Fig. 2: Critical Path Identification (Source: Simplilearn Solutions, 2023)

1.8.3 Gantt chart

The Gantt diagram is a visual tool used in project management to represent the timeline of tasks and activities, as well as their dependencies and progress (Grant M., 2022).

This diagram consists of a horizontal axis - which represents the timeline of the project, and a vertical axis - on which the tasks or types of activities that must be performed are listed. Each task is represented by a horizontal bar that covers the period of the task on the timeline.

Gantt charts give a clear overview on the progress of the project, as well as any potential problems or delays that may occur. By identifying these problems at an early stage, the project managers can solve them and maintain the project at the proper level. In such a way, the GANTT chart allows project managers to easily determine critical paths, dependencies and milestones and can be used to track the progress of the project schedule. Moreover, the Gantt chart has the advantages of being user friendly, which is a great benefit when working in a large team (Grant M., 2022).

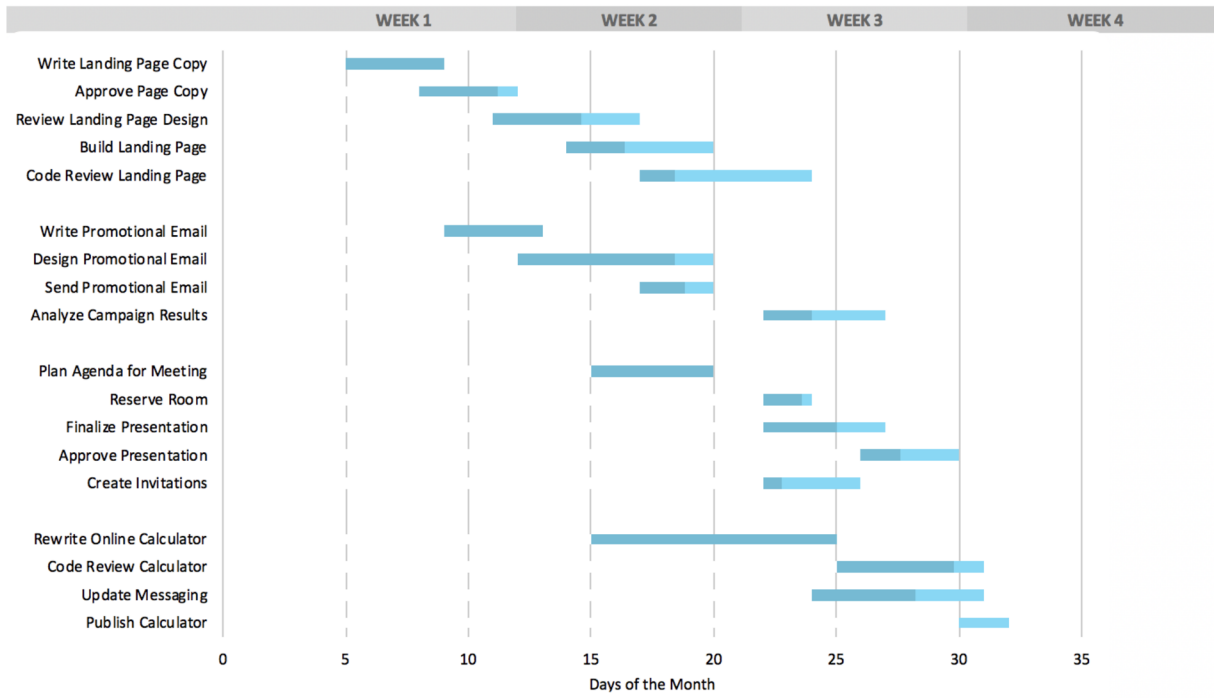

Fig. 3: GANTT chart (Source: TeamGantt, 2022)

1.9 Risk management

According to Biswas P., One of the most widely used risk management methods is the ISO 31000:2018 standard. This framework provides a comprehensive approach to risk management, including the identification, assessment, treatment, and monitoring of risks. It is based on the principle of continuous improvement and focuses on aligning risk management with an organization's objectives and values. The ISO 31000 standard is flexible and can be applied to a wide range of projects and industries (Biswas P., 2022).

Another popular risk management method is the COSO Enterprise Risk Management (ERM) framework. Per Hayes A., this framework takes a holistic approach to risk management, focusing on the identification, assessment, and management of risks across an organization. The COSO ERM framework includes eight components: internal environment, objective setting, event identification, risk assessment, risk response, control activities, information and communication, and monitoring (Hayes A., 2022).

The PMI Risk Management framework is also commonly used in project management. It includes five processes: risk management planning, risk identification, qualitative risk analysis, quantitative risk analysis, and risk response planning.

1.9.1 Risk management in project management

Risk management is a critical component of project management that helps project managers to identify, assess, and mitigate potential risks that can affect project objectives. Managing risks in project management involves a systematic process of identifying, analyzing, and mitigating potential risks to ensure the successful completion of a project (Ray S., 2021).

The Importance of Risk Management is because it helps project managers to identify potential risks that can impact project objectives, and develop a plan to minimize those risks. Risks can arise from various sources and if they are not identified and mitigated, they can result in project delays, cost overruns, and ultimately stakeholder dissatisfaction. Therefore, managing risks is crucial to ensure the success of a project and to minimize the impact of any risks that may arise.

The Process of managing risks involves a systematic process of identifying, analyzing, and mitigating. There are several steps we can take, according to Ray S.:

- **Risk Identification:** Identifying potential risks that can impact the project. This can be done by reviewing project documentation, brainstorming sessions, and input from stakeholders.
- **Risk Analysis:** Analyzing the identified risks to determine their likelihood and impact on the project. This can be done by assigning a probability and impact score.
- **Risk Evaluation:** Evaluating the identified risks to determine their level of potential threat, and prioritize them based on the magnitude of impact on the project.
- **Risk Mitigation:** Developing a plan to reduce the identified risks. This can include developing forecast plans, assigning responsibilities, and developing a risk management plan.
- **Risk Monitoring:** Monitoring the identified risks to ensure that the risk management plan is effective.

Following the best practices for risk management, project managers can minimize the impact of potential risks and ensure that project objectives are met. Effective risk management requires collaboration between all stakeholders, continuous risk monitoring and a willingness to adapt to changing circumstances.

1.9.2 FMEA

FMEA is acronym for a Failure Modes and Effects Analysis. It is a structured approach to identifying and analyzing potential failures in a process or product. It involves breaking down the system or process into its individual components, and gaining knowledge about each component to identify potential failure points in it. Once the potential failure modes have been identified, they are ranked according to their severity, occurrence probability, and detectability (Gillis A.S. and Schuchart W., 2022).

FMEA is typically used in engineering, manufacturing, or healthcare, but it can be applied to any system or process where failure can have serious consequences. For example, FMEA is often used in the automotive industry to identify potential failures in a vehicle's components (Armenta A., 2021).

One of the main useful benefit is that it allows organizations to identify potential risks before they occur. This can help organizations to take proactive measures to prevent failures. Additionally, FMEA helps organizations to prioritize risks based on their severity and likelihood

of occurrence, allowing organizations to allocate resources to address the most critical risks first.

1.10 Company’s Internal and External Environment Analyses

1.10.1 SLEPT analysis

SLEPT is an acronym for the social, legal, economic, political and technological factors that can impact a company's operations. It is a modified concept of the PEST Analysis that was developed by the Harvard professor Francis Aguilar in 1967. The essential criteria of the SLEPT analysis are presented in Table 1.

Table 1: Sample of criteria for SLEPT analysis (Source: Adapted from Hawks D., 2018)

Environmental forces	Criteria sample
Social factor	Demographics, lifestyle changes, and cultural trends that can influence consumer behavior
Legal factor	Laws and regulations that affect a company's operations, such as tax laws, labor laws, and environmental regulations
Economic factor	Economic growth, inflation, interest rates and consumption habits
Political factor	Government policies, political stability and international relations
Technological factor	Technological advances, innovation and automation

SLEPT analysis focuses at general view of factors that might influence a decision, a market, or a potential new business. SWOT Analysis explores these factors at a business, product-line or product level.

1.10.2 PORTER analysis

Porter's Five Forces Analysis is a framework developed to assess the competitiveness of an industry and the profitability of its firms. The model analyzes five competitive forces that determine the attractiveness of a particular market or industry. These forces are: threat of new entrants, bargaining power of suppliers, bargaining power of buyers, threat of substitutes and the competitive rivalry (Investopedia, 2023).

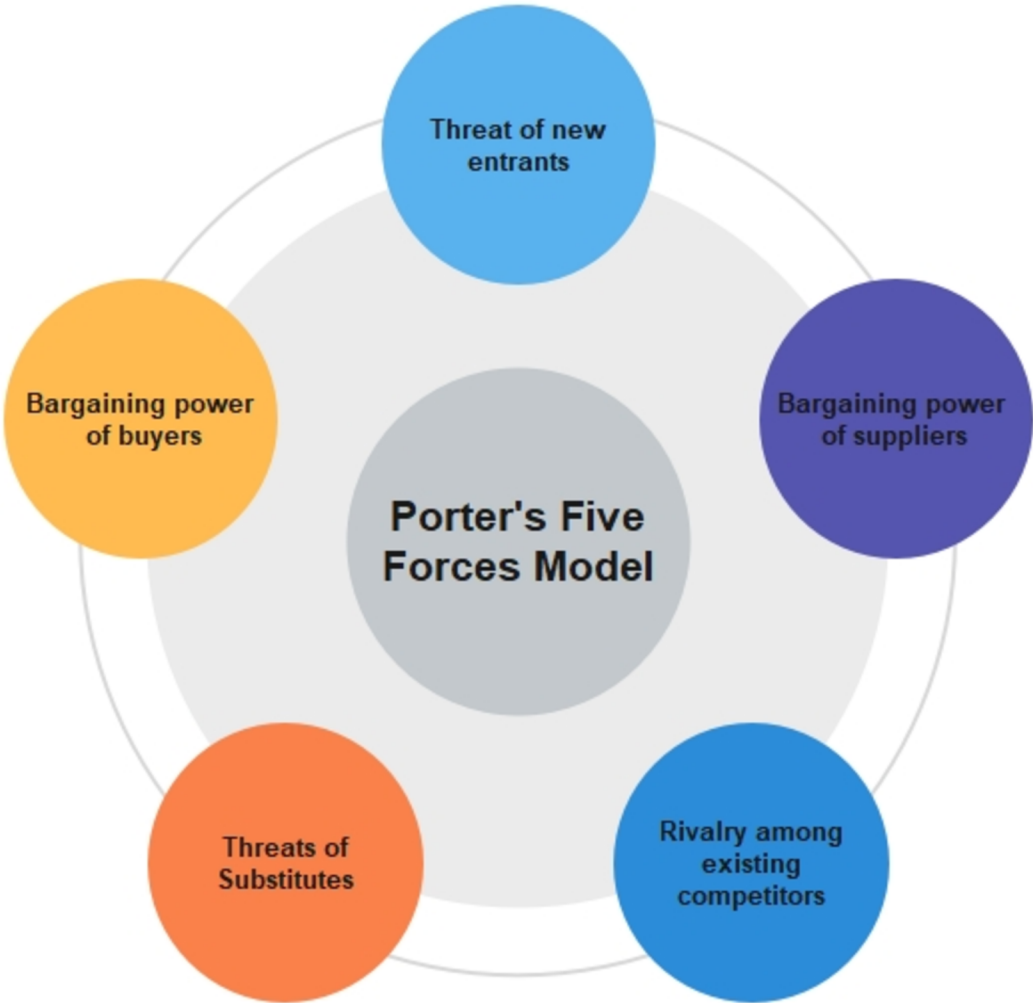

Fig. 4: Porter's Five Forces Model (Source: EdrawMind, 2023)

- The threat of new entrants determines how easy or difficult it is for new firms to enter a market and compete with existing firms. In industries with high barriers to entry, new entrants face significant challenges that must be considered. Conversely, in industries with low barriers to entry, new entrants can easily establish themselves, leading to high levels of competition.
- The bargaining power of suppliers refers to the power of suppliers to dictate prices and terms to their customers. When suppliers have a high demand, they can charge higher prices, thereby reducing the profitability of firms in the industry.
- The bargaining power of buyers convey the power of customers to dictate prices and terms to their suppliers. When buyers have a high degree of bargaining power, they can demand lower prices, thereby reducing the profitability of firms.
- The threat of substitutes refers to the availability of alternative products or services that can meet the same needs. When substitutes are available, firms in the industry face intense competition, leading to lower prices and reduced profitability.
- The intensity of competitive rivalry refers to the level of competition among existing firms in the industry. When the intensity of rivalry is high, firms must compete aggressively to maintain or increase their market share, leading to lower prices and reduced profitability (Investopedia, 2023).

By considering each of the five forces, firms can better understand the nature of competition in their industry and develop strategies to compete effectively.

1.10.3 7S analysis

The 7s analysis is a strategic management tool used to assess an organization's effectiveness and overall performance. Developed by McKinsey & Company, the 7S model focuses on seven key elements that must be aligned and integrated to achieve success. These seven elements include strategy, structure, systems, style, staff, skills, and shared values (Investopedia, 2023).

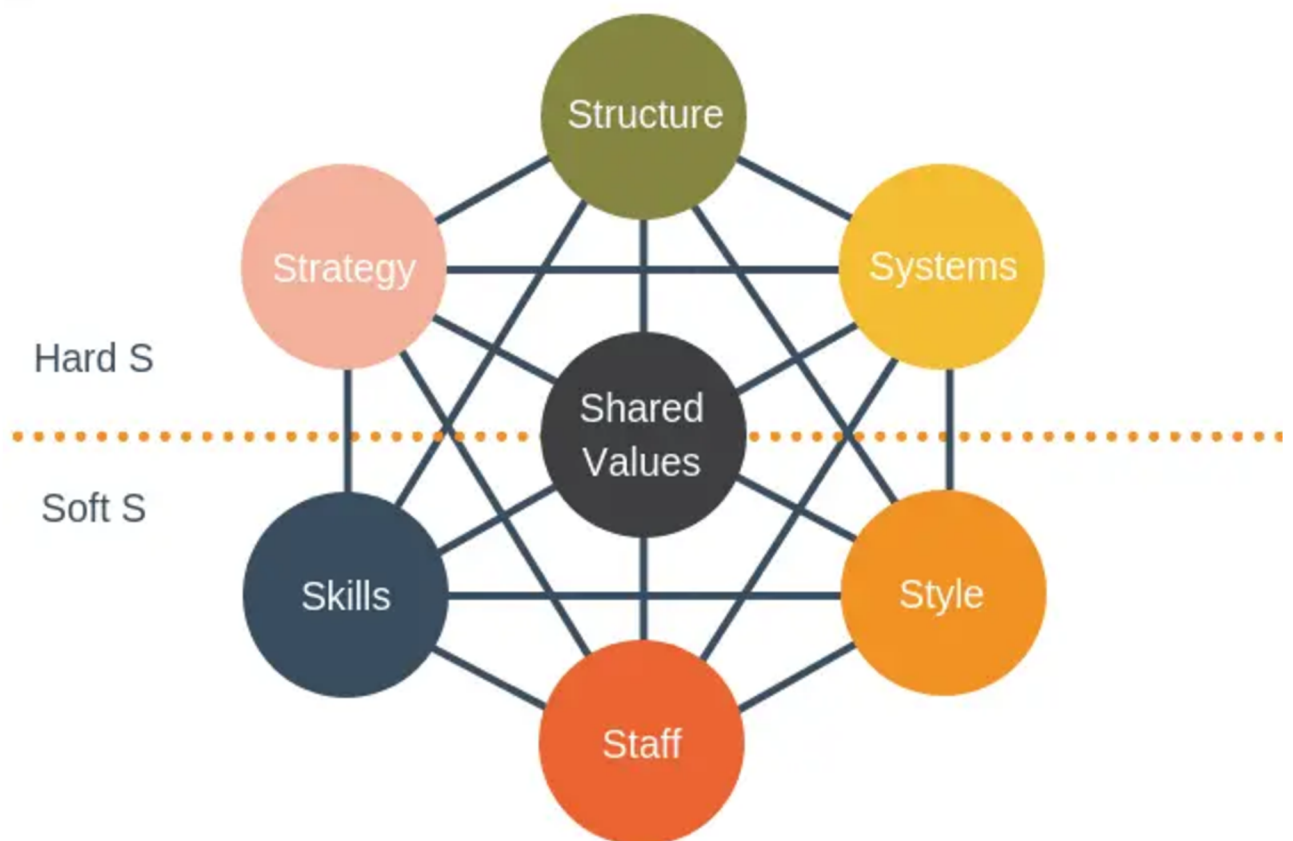

Fig. 5: McKinsey 7S (Source: CFI Team, 2023)

- Strategy - overall plan for achieving its goals and objectives. This includes identifying the company's target market, defining its competitive advantage, and determining its core values. A strong strategy is essential for the long-term success of any organization.
- Structure - organization's formal hierarchy, reporting lines, and how tasks are delegated. A company's structure should be designed to support its strategy and enable efficient decision-making.

- Systems - including the company's policies, procedures, and processes. These systems should support the organization's goals and be aligned with its strategy.
- Style – refers to the leadership style of the organization's senior management team. The style should be consistent with the company's culture and values.
- Staff - includes the company's employees and their skills and experience. Staff should be aligned with the company's strategy, and their skills should match the needs of the organization.
- Skills - encompass the skills and expertise needed by the organization to achieve its objectives. This includes both technical and managerial skills.
- Shared values - the core beliefs and values that guide the organization's behavior and decision-making. Shared values are important because they create a sense of identity and purpose, which can motivate employees and drive success (Investopedia, 2023).

The 7s model is effective because it recognizes that these elements are interconnected and interdependent. In such a way, the company can understand that its structure must be designed to support its strategy, and its systems must be aligned with its culture and values. Similarly, the skills and expertise needed by the organization must be consistent with its strategy, and its leadership style should be in line with its culture and values.

1.10.4 SWOT analysis

The SWOT analysis is a strategic tool used to assess the strengths, weaknesses, opportunities and threats of the company. This technique is used for understanding the internal and external status of the company identifying areas for improvement and formulating effective strategies (Investopedia, 2023).

- Strengths: Strengths refer to the internal factors that contribute to success. These can be tangible assets such as financial resources, intellectual property or skilled labour, or intangible factors such as brand reputation, customer loyalty or organisational culture. Strengths give an organisation a competitive advantage and help it achieve its goals.
- Weaknesses: Weaknesses refer to internal factors that hinder an organisation's success. These could be deficiencies in infrastructure, poor management practices or lack of resources. Weaknesses put an organisation at a disadvantage and make it vulnerable to external threats.
- Opportunities: Opportunities refer to external factors that an organization can use to its advantage. These could be emerging markets, technological advances or changes in

consumer behaviour. Opportunities give an organisation a chance to grow and expand its operations.

- Threats: Threats refer to external factors that could have a negative impact on an organisation's performance. These could be changes in the regulatory environment, economic downturns or increased competition. Threats can pose a significant risk to an organisation's success.

2 ANALYSIS OF THE CURRENT STATE OF AFFAIRS

This chapter is dedicated to the description of the company's current state focusing on the company's introduction, hierarchy, and ongoing projects with emphasis on the "V Project". This part will be endorsed with specific analyses to develop the case and conclude the company's current state that will serve as a base for the design part of the thesis.

2.1 Company introduction

SemsoTec is a German based company performing its operations in three branches. Two branches are based in Germany (Garching and Cham) and one in the Czech Republic (Brno).

Subject of business: SemsoTec Group's companies cover the entire value chain for infotainment displays and control units, from prototype to series production.

SemsoTec concentrates their expertise on innovative technologies, which are individually customized and delivered to the customer, specifically tailored to their wishes and requirements.

In the Display & Infotainment sector, SemsoTec offers specific know-how, electronic design and development services specializing in the physical characteristics of LCD TFT displays, as well as state-of-the-art technologies such as touch, handwriting recognition, foil lamination and optical bonding. These technologies are key factors for obtaining high levels of performance in demanding areas such as applications that can be read even in strong sunlight. They are specialists in high-quality displays with embedded software and hardware solutions for automotive and industrial applications. (SemsoTec Group, 2022)

Among other things, the company focuses on display-based system solutions with their respective HMI operating concepts, whereby quality and safety as well as innovative technology are of utmost importance to SemsoTec.

To also document SemsoTec's compliance officially with the highest standards, the company certified themselves as ISO 9001:2015 compliant by DEKRA.

Using their successful IATF 16949:2016 certification, the company meets the high requirements for product and process quality as well as the quality management system. (SemsoTec Group, 2022)

Size of the company:

German branches

- Garching (Small enterprise) – 38 employees (13 employees in production, 25 employees in the main office)
- Cham – currently in the stage of development, expected to start operating in the last quarter of 2023

Czech Republic branch

- Brno (Small enterprise) – 13 employees (2 employees in production, 11 employees in the main office)

Period of operation:

German branches

- Garching – since 2009
- Cham – expected to start operating in the last quarter of 2023

Czech Republic branch

- Brno – since 2018

Headquarters: Munich, Germany**Departments:** Automotive, Industrial, MedTech, Aerospace**Technical focus:**

- Human Machine Interface solutions
- State-of-the-art display and touch technology
- Efficient development of control devices
- Customized integration of software, electronics, and mechanics
- Vehicle lightweight design, structures, and vehicle dynamics

SemsoTec is executing its projects in Germany and the Czech Republic. The German branch is focusing on projects such as: Abbott, CAN-FD, EnbW, Heidelberger, SPV cutting (component production for 3 different DE projects), Schneider. These are some of the projects outsourced

to the Czech branch (such as SPV cutting). On the other hand, SemsoTec Czech s.r.o. is responsible for its own projects such as it is the “V Project“ - a project to be soon started in Brno and the subject of this project management thesis.

2.2 Company’s hierarchy

SemsoTec Czech s.r.o. is a small-sized company that currently has 15 full-time employees and two part-time workers. The company is under the SemsoTec Group umbrella. Therefore, the highest level of company’s management hierarchy – responsible for strategic and financial decisions is in Germany – Jochen Semmelbauer (CEO, CFO) (see Appendix 1).

The General Manager of SemsoTec Czech is Hans Versteegh. Besides this position, he oversees the department of Sales – having under supervision the Project Manager and Account Manager, and is overall accountable for all the other departments of the company (Production, Finance, Human Resource, etc.).

The Facility Manager position in the company is represented by Václav Kejmar. The Production Manager is Robert Hoffmann – who is accountable for supervising the three operators, Warehouse & Logistics specialist, and Quality Assurance Engineer. The Quality Management System is ensured by Dana Švejdová. Silvie Chylová is responsible for the Finance, Human Resource and General Affairs department of the company – having under its supervision the Senior Accountant, Payroll & VAT Specialist (external employee), Junior Administrative Support and the Administrative Support for Purchasing Specialist.

Overall, the hierarchical structure is meant to ensure the company’s efficient organizational distribution that will lead to the successful goals’ accomplishment by implying continuous planning, reporting, evaluation and feedback.

2.2.1 V Project

SemsoTec's "V Project" is a smart-home system for a large international company. The core idea of the SemsoTec Czech project is the design and production of an indoor display unit - smart-home system built around the available technologies and know-how in SemsoTec Czech.

SemsoTec Czech specializes in the following areas:

- Glass cutting and processing, including black decoration ink printing;
- Optical film cutting, processing and lamination under clean-room conditions;
- OCA bonding of several parts of optical stacks;

Based on the aforementioned specializations, SemsoTec looked into options to use these core capabilities in the field of EV charging-stations. While reaching the potential targeted customers, one of them came to the realization that SemsoTec could assist and would be more suitable in manufacturing another component – which is the main unit (control panel) of a smart-home system.

Initially, the customer had some general design ideas from their previous experience of developing their own electronics and software platform, including the driving-board. However, they struggled with display specifications and sourcing including the final integration matters. Shortly after, SemsoTec developed a solution and the decision was made for SemsoTec Czech to propose a final display design, including cover glass, display and touch module, optical integration and optical optimisation in terms of reflections and performance.

At that point, SemsoTec competed against two global competitors - one from China and the other one from Europe. Fast-forward, SemsoTec proved to be able to deliver the most attractive cost/benefit solution, with a high degree of design customization and a technically well-performing optical stack, leading to the official announcement that the customer's intention is to go ahead with SemsoTec to produce these displays.

The final product SemsoTec Czech will deliver consists of the following:

- Sourcing of the display and touch modules.
- Sourcing of mother-glass sheets and customized production of final cover glasses, including decorative ink printing to a specific design.

- Sourcing of optical films and their integration into the stack (in and around the device's camera holes) for optimal visual design and optical performance.
- Complete integration of all parts (including the electronics unit as provided by the customer) into a single product through optical bonding.

The initial budget estimations indicate the unit sales price of approximately 100 €/piece and the yearly quantity of 1000 pcs for the year 2023, that will increase to as much as 10 000 – 25 000 pcs/year from 2024. The project is estimated to last 5-10 years from 2023.

More detailed information about the “V Project” was gathered using the qualitative research method of data collection – namely interview with the project manager and sales representative Miroslav Valderrama. The interview (see Appendix 2) serves as a basis for the analytical part of the thesis.

2.3 SLEPT Analysis

SLEPT analysis is a framework used to analyze and assess the organization's business environment. It consists of 5 parts and focuses on describing the external factors that affects the firm. The term represents an abbreviation that stands for defining the Social, Legal, Economic, Political and Technological forces.

2.3.1 Social factor

Social factors are closely linked to the development of the population, its demographic structure, education level, income structure and also the migration rate and people's lifestyle and preferences. An important social factor that can influence SemsoTec Czech s.r.o, is the level of education of the population and their lifestyle that is influenced by other factors to be described later in this analysis. According to the Census from 2021, the tendency of people graduating from universities (tertiary education) is continuously growing over time from 12,5% in 2011 to 17,6% in 2021 (Czech Statistical Office, 2021). This growing trend does not only represent an opportunity for the entire society but it will also ensure that SemsoTec Czech s.r.o. will be able to hire speciality professionals.

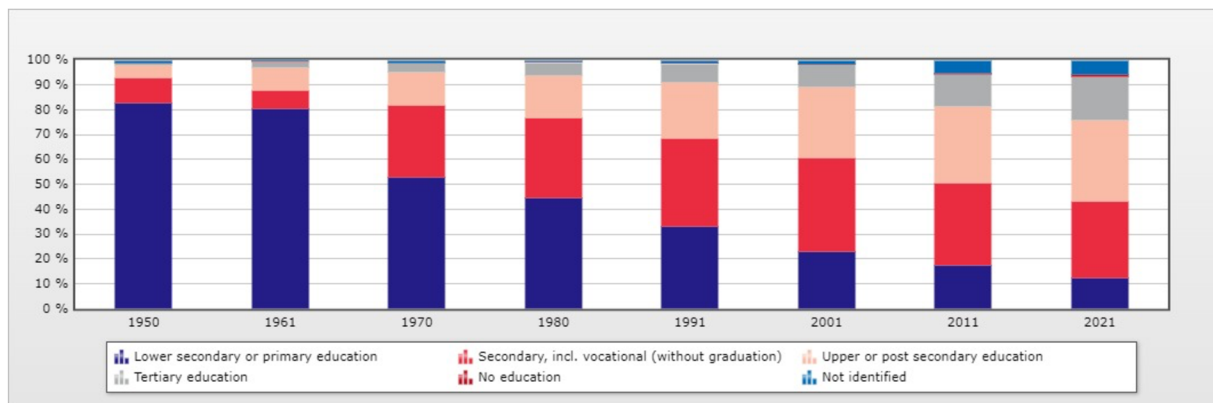

Fig. 6: Population aged 15 and over by highest educational attainment (Source: Czech Statistical Office, 2021)

The Czech Republic's solid automotive-related academic and institutional base, as part of the country's traditionally strong technical education system encountering for one of the highest numbers of graduates in engineering, manufacturing and construction worldwide (16.2 % of total university degrees) which again represents a valuable benefit for SemsoTec in matter of hiring suitable professionals.

The survey from June 2022 provided by the Ministry of Labour and Social Affairs of the Czech Republic reported that the Czech Republic has accepted 390 000 refugees from Ukraine making it the third most common European Union (EU) destination, and the country with the highest number of Ukrainian refugees per 100 000 inhabitants (European Commission, 2022).

The survey finds that among refugee newcomers to the Czech Republic from Ukraine, 44% are women and 36% are children. In terms of age, three-quarters of adult refugees from Ukraine are under 45 years old, with 28% of these being under 30 years old (European Commission, 2022). This means that newcomer refugees from Ukraine are bringing considerable workforce development potential to the Czech market but also an increased potential for SemsoTec to hire skilled employees for the production. On the other hand, by having access to such a large amount of manpower and foreign professionals, it might become challenging for the native population to find a reasonable work position with a competent salary remuneration.

The post-Covid socio-economic situation together with the currently ongoing global political status caused by the war from Ukraine influenced the consumer's purchasing power. Since SemsoTec operates in the display and infotainment sector producing final products for the automotive sector, it is worth considering the consumer attitude and purchasing power.

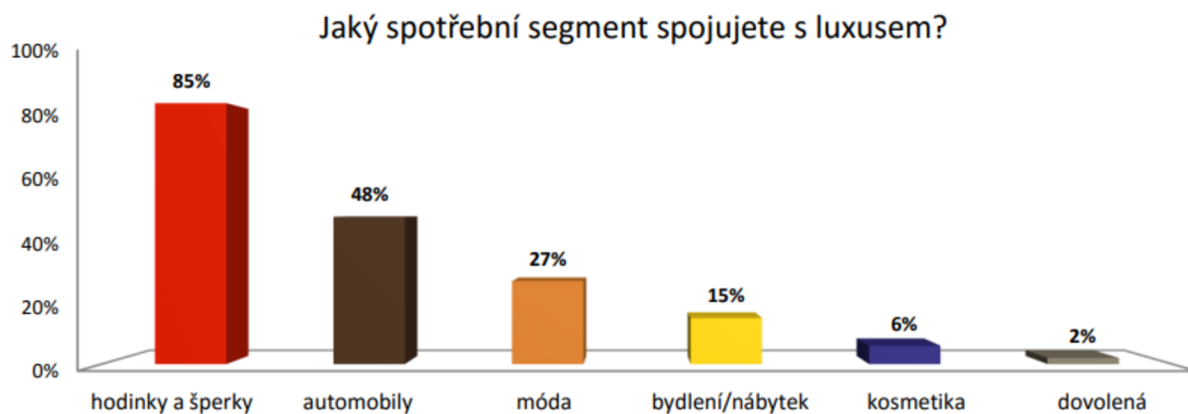

Fig. 7: Czech Republic ranking of items perceived as luxury (Source: Ogilvy & Mather, 2016)

Considering the research from 2016 of Ogilvy & Mather case study, Czech respondents placed the automobiles on the second place in the ranking of items perceived as luxury (on an overall of 48%). Considering the tremendous shift of economic indices towards the negative extreme, the automotive industry might be endangered in the context of purchasing power (see chapter 2.3.3.).

2.3.2 Political-legislative factors

The stability of the political situation in the country is one of the most important factors for the company, as the conditions for doing business in a particular state depend on it. The political situation in the Czech Republic is stable.

Overall, the business environment in the Czech Republic is stable and the Czech Republic is ranked on the 27th position in the ranking of countries where it is easiest to do business (The World Bank, 2022).

Another opportunity for SemsoTec Czech s.r.o. represents Czech Republic's membership in the European Union which enables the free movement of people, goods and capital. This is a very favourable factor for the company's cooperation with its mother company based in Germany but also in matter of finding clients that are based in European Union. Thus the company can trade freely with its customers.

Concerning legal factors, the company is influenced by the legislation in force in the Czech Republic. From 1 January 2023, according to Government Decree No. 487/2020 Coll., the minimum wage in the Czech Republic increased by 1 100 CZK amounting to 17 300 CZK/month. In such a way, the minimum hourly wage increased from 96.40 CZK to 103.80 CZK. The average monthly wage will increase from 38 911CZK to 40 324 CZK in 2023 (Ministry of Labour and Social Affairs, 2023).

Another important factor is the obligation to pay income tax. According to the law 586/1992 Coll., the corporate income tax rate is 19%. However, this is historically the lowest rate in history, which is certainly a positive phenomenon for SemsoTec Czech s.r.o. (Czech Statistical Office, 2023).

As for the future, Czech Republic initiated five domains of Structural Reform Priorities:

- Labour market: Make the labour market more fluid and inclusive;
- R&D and digitalisation: Enhance R&D investment and improve business environment;
- Environmental policy: Pursue greener growth;
- Labour market: Reform the pension system and promote longer working lives;
- Public sector efficiency: Improve public sector efficiency by consolidating local government services (Organisation for Economic Co-operation and Development, 2023);

The European New Green Deal that goes under the environmental policy focuses on reaching no net emissions of greenhouse gases by 2050 (European Commission, 2023). This represents a golden middle that could bring a wave of new customers and big projects for SemsoTec Czech s.r.o. in terms of display production for electro vehicles/charging stations and other infotainment solutions for indoor systems.

2.3.3 Economical factor

Economic factors are based on the economic situation of the Czech Republic, which depends on macroeconomic indicators. One of them is GDP development, which reflects the economic growth of the Czech Republic. According to the data from the World Bank (see table 2) the 2021 GDP of the Czech Republic was worth 281.78 billion USD. This value representing 0.13% of the world economy (Trading Economics, 2022).

Table 2: Czech Republic's Gross Domestic Product (2016-2021) (Source: Trading Economics, 2022)

Year	2016	2017	2018	2019	2020	2021
Value in USD	196.27	218.63	249	252.55	245.97	281.78

The GDP gap recorded in 2020 was caused by the COVID-19 crisis, that managed to recover one year later. Despite the war in Ukraine that experts consider a huge threat that might cause a global crisis, the estimated GDP for the years 2022 and 2023 are predicted to keep their growing tendency.

Other important macroeconomic indicators are the inflation rate (see fig. 3) and the unemployment rate, as the values of these indicators can affect the purchasing power. According to the statistical data from Statista the average inflation rate during the period of COVID-19 pandemic grew from 2,85% in 2019 to 3.84% in 2021. According to the forecasts of the of the Ministry of Finance in 2021, the inflation rate was supposed to fall to 1.9%, which would mean that the economy of the country would recover and be line with the Czech National Bank (Ministry of Finance of the Czech Republic, 2021).

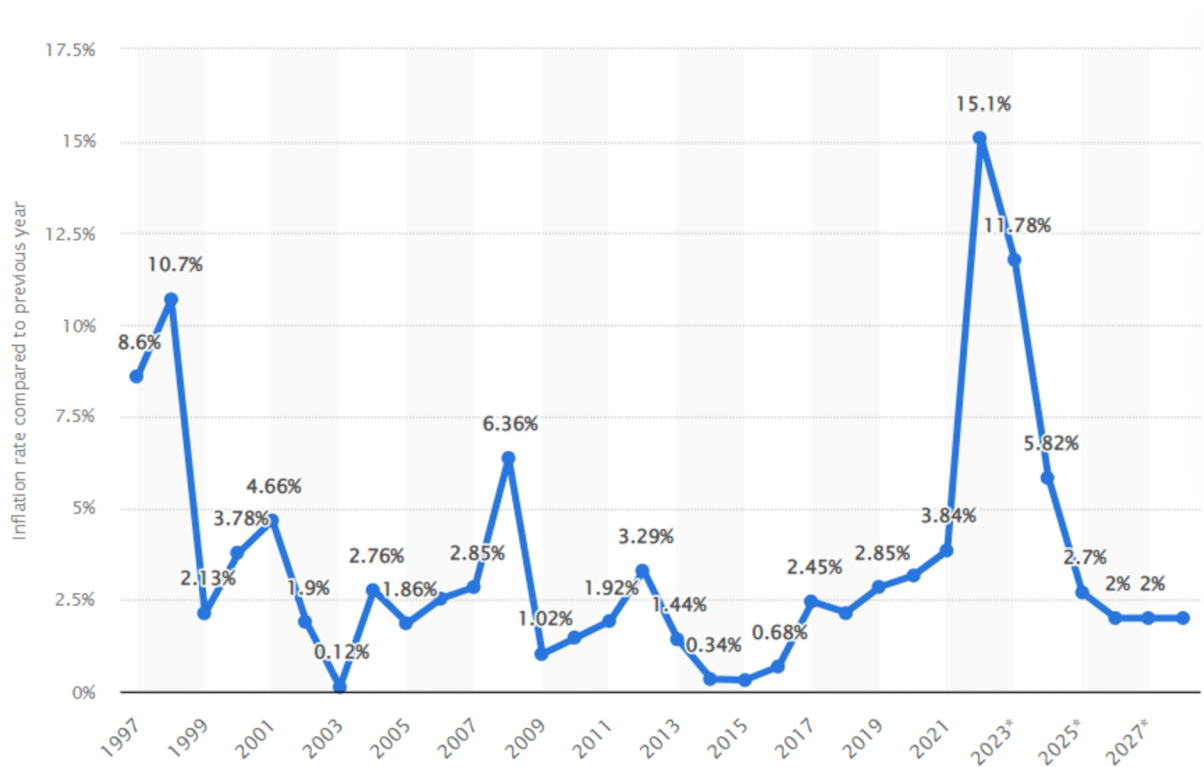

Fig. 8: Czech Republic – Inflation rate (Source: Statista, 2023)

However, due to the unexpected external factor such as the war from Ukraine that started in 2022 and the not yet recovered post-pandemic economy, the inflation rate raised recording a peak of 15,1% that year. One of the biggest challenges in this period were not only the growing prices of the commodities, but also the mortgages that were constantly growing from 5.7% to 8.5% (including minor fluctuations) since February 2022 (beginning of the Ukrainian war) till January 2023.

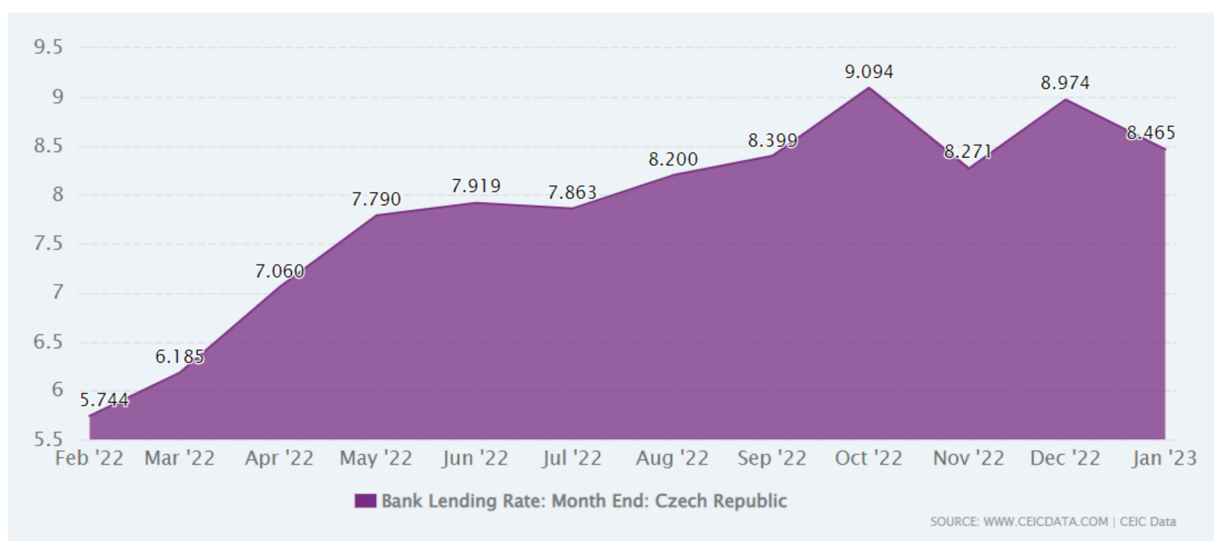

Fig. 9: Czech Republic Bank Lending Rate (Source: CEIC, 2023)

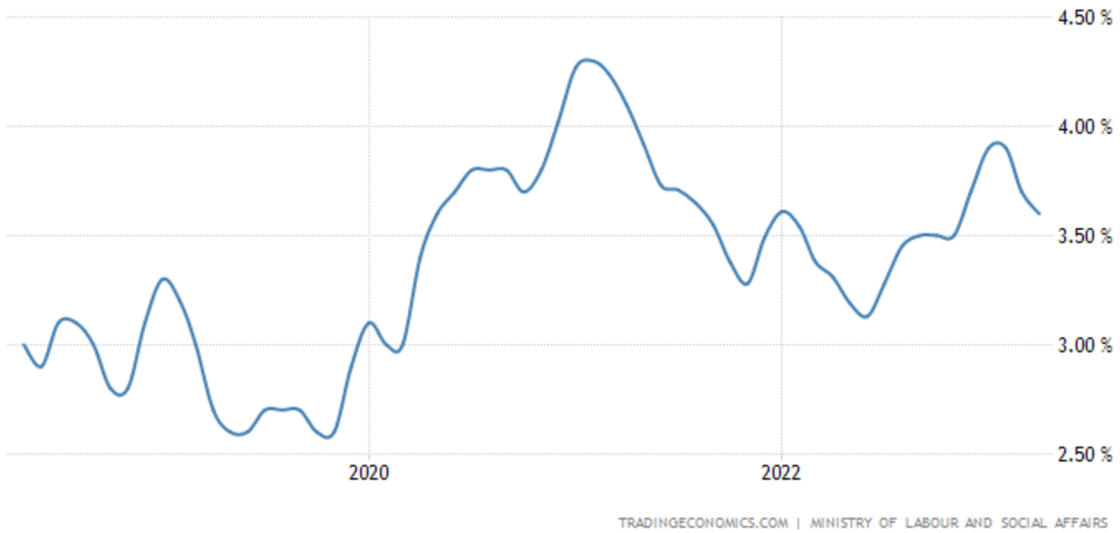

Fig. 10: Czech Republic unemployment rate (Source: Trading Economics, 2023)

The unemployment rate reached a peak of 4.3% during the period 2020-2022 (see fig. 5). The unemployment rate edged down to 3.6% in April 2023 – being in line with the market expectations. However, higher unemployment rates present some opportunities for businesses as it means a higher supply of labour on the market (Trading Economics, 2023).

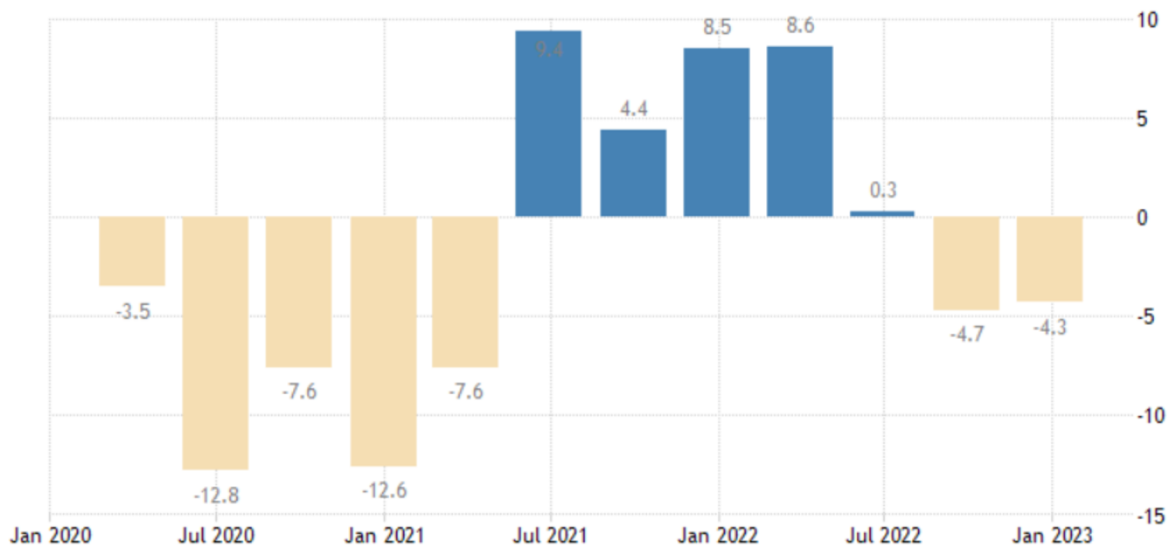

Fig. 11: Czech Republic household final consumption expenditures (Source: Trading Economics, 2023)

Household consumption is an important economic factor. According to Eurostat, the final consumption expenditure of households was -4.30% in December 2022. This index managed to recover after the pandemic – reaching a maximum of 8.5% in January 2022 (see fig. 6). However, the household consumption expenditures index was negatively affected by the Ukrainian war (Trading Economics, 2023). In other words, this would mean that the consumer's preferences and priorities shifted towards the tactic of spending less money. Referring to the social factor described in this chapter (namely to the graph reflecting what people from the Czech Republic perceive as luxury items) the negative index of the household consumption would highlight the idea of the automotive industry endangeredness – meaning that the customers would be much more reserved in spending large amount of capital in uncertain periods of time. Under such circumstances, SemsoTec's threat would be the low production demand due to automotive industry stagnation caused by the external economic, social and political factors.

2.3.4 Technological factor

The most significant advantage of the Brno region is the concentration of small and medium-sized businesses with their own commercial and technology-oriented research and development (R&D) sites, opening many opportunities for cooperation. Additionally, the knowledge intensity in the Brno region takes a leading position across the nation and is comparable to some of the most advanced EU regions (The Recursive, 2022).

According to Forbes, the backbone of Czech industry is the production of electrical, electronic and optical devices, as well as cars, transport vehicles and machinery. The growing demand for technological innovativeness represents a great opportunity for SemsoTec Czech. According to Forbes, the lockdown during COVID-19 pandemic proved that consumers will always choose convenience over money. That same period has speed up the dynamic of the businesses based on the consumer's behavior (Forbes, 2020). Based on this characteristic, SemsoTec has the unique opportunity to enrich its portfolio by producing devices for diverse purposes (e.g. displays for: power charging stations, terminals, self-service payment machines, smart-home systems, etc.). The product diversification will not only bring more clients/projects but will also ensure the company's operational sustainability and autonomy. To keep the business viable and offer competitive services to its customers, SemsoTec will need to invest into its R&D in order to grow and establish a sustainable business on the Czech market. This would comprehend continuous investment in acquiring the necessary machinery, that will enable the company to process more projects simultaneously and become independent in matter of profit generation.

2.4 PORTER analysis

Porter's analysis, also known as Porter's Five Forces analysis, is a framework for analyzing the competitive forces that affect an industry.

The five forces in Porter's analysis are:

1. Threat of new entrants: This refers to the likelihood of new competitors entering the industry and increasing competition. The Czech Republic is placed on the 27th place in the Ease of Doing Business ranking (The Enterprise World, 2023). The display and infotainment sector on the territory of the Czech Republic is currently overtaken by a large-sized company called Continental Engineering Services Ltd. that is a highly competitive company that have already established long-lasting relationships with their clients. This leads to the conclusion of relatively low threat of new entrants in this industry. In addition, this sector requires high initial investments and professionals with experience and specific skills-set that might be challenging to find.
2. Power of suppliers: This refers to the ability of suppliers to influence the price and quality of inputs, such as raw materials or labor. In the specific case of SemsoTec, the project manager of the “V-Project” shares the idea that it is especially challenging to find suppliers of glass for the production of displays. Not only that the number of suppliers is limited but also the specific requirements from the customers might be hard to fulfil considering the format of the glass or optical films, its design, density, etc. In case of SemsoTec, the company is importing the main components for the production from China and Japan, including the auxiliary materials from the Czech Republic (see Annex 2).
3. Power of customers: This refers to the ability of buyers to influence the price and quality of products or services. As previously mentioned, there are not too many companies operating in this sector. The interview (see Annex 2) highlights the idea that SemsoTec acknowledges four main competitors – two from China and other two from Europe. Therefore, the customers do now have a wide range of choice – which becomes a benefit for the company to provide added value to its products by offering the option of customization and assure its competitiveness on the market. The price creation of the products is based on the complexity of the project but also its size (referring to the economies of scale) – the more pieces to produce – the lower the price.

4. Threat of substitutes: This refers to the likelihood of customers switching to alternative products or services. SemsoTec has a big advantage to be under the umbrella of SemsoTec group and its mother company SemsoTec GmbH which enables the option to outsource some projects (that requires additional manpower or sophisticated machinery). In such a way, the range of flexibility and adaptability offered by SemsoTec will ensure that once the customer gets in touch with this company, the request will be realized in Brno or Garching. Therefore, considering the low level of competition and the added value of SemsoTec, there is a relatively low level regarding the threat of substitutes.
5. Intensity of competitive rivalry: This refers to the level of competition among existing firms in the industry. The industry does not comprehend too many companies operating in this sector. Overall, besides SemsoTec, there are two companies from China (that might be challenging to deliver in matter of time and the associated costs of delivery to Europe) and other two companies from Europe. Altogether, the current market share enables SemsoTec to become a competitive player on the European market in the sector of display and infotainment. Considering its direct competitor - Continental Engineering Services Ltd. which is a huge player on the Czech market, some of their projects might not be profitable, therefore, SemsoTec might consider this company being a potential partner that could cooperate in outsourcing and realization of some smaller projects.

2.5 McKinsey 7S Analysis

McKinsey 7S analysis is a tool used by companies to evaluate their current status and implement change regarding their Strategy, Structure, Systems, Style, Staff, Skills and Shared Values.

2.5.1 Strategy

SemsoTec's strategy is focused on developing innovative and customized displays for the Automotive, Industrial, MedTech, Aerospace sectors that would go hand in hand with customer's needs. The company follows the current trends and takes into consideration clients requests by continuously studying the market and acquiring the necessary machinery, components that would deliver a high-quality product. Additionally, the company is focused on building long-lasting relationships with the clients by initiating long-term projects (e.g. "V-Project" is estimated to last 5-10 years) with continuous focus on implementing new trends and requests from the customer.

2.5.2 Structure

SemsoTec follows a hierarchical organizational structure. The main financial and organizational decisions are made by the CEO from Germany. The general manager of SemsoTec Czech follows the dispositions of the CEO and its task is to control the proper operations of the Brno branch. The advantages of this type of organizational structure includes:

- Clearly defined task division;
- Increased level of department loyalty to achieve the organization's goals;
- Authority delegation – each department leader has a clearly defined task to direct and control;

Disadvantages include:

- Slower decision-making process due to high number of people involved in the chain of authority;
- Poor communication – a major cause of slow decision-making process;
- Limited collaboration and innovation potential due to the lack of shared experience among departments;

2.5.3 Systems

For accomplishing the organizational goal, the company uses MsTeams as an internal mean of communication among departments and employees in the company. As an external official mean of communication with suppliers or customers, the SemoTec uses emails or phone calls. After setting up the order and receiving all the necessary details, the company uses ABRA as a software system to track all the entries and business processes.

2.5.4 Skills

SemsoTec is a company embracing both young and middle-aged employees with expertise for specifically high-ranked positions. Yet, the company put high emphasis on the opportunity to learn and grow within the company. Therefore, the young professionals are trained in multiple areas and are encouraged to switch positions in order to extend their knowledge and discover the department that suits them best. The employees are also encouraged to attend diverse exhibitions in their field to determine the current trends and future valuable propositions on the market.

2.5.5 Staff

SemsoTec started its activity during the pandemic and gathered most part of its staff from other two companies that quitted their activity in Brno. Since then, the collective slightly changed – four people left the company. Yet, by the end of 2022, the CEO stated the disposal that SemsoTec will not hire new professionals in the near future. The company currently employs 15 full-time employees. However, the company is actively finding solutions to distribute the work load and the retention of the employees by offering the option of Home Office and numerous organizational benefits. It is also not excluded the option to enable the hiring process again in the near future when the Czech branch will receive more projects.

2.5.6 Style

SemsoTec follows the consultative management style – that is characterized by a high level of engagement towards the team from the manager's side. The general manager of SemsoTec Czech is constantly considering the feedback from the department leaders but also from the other employees to find out the possible gaps within the organization and come up with feasible solutions. The general manager is highly involved in the daily operations of the company which allows the employees to share their experience and address the arised issues.

2.5.7 Shared values

SemsoTec Czech bases its shared values on building strong and long-lasting relationships with its customers, partners, suppliers and employees. The company is striving to build a powerful company culture based on employee engagement and their retainment in the company. The general manager makes sure to have its team members on the same page and base the company's values on transparency, collaboration and clarity of the mission, vision and goals. The employees are encouraged to share any idea or suggestion that might increase the company's efficiency and lead to the accomplishment of the organization's goal. The relationship with clients, partners and suppliers are based on similar pillars of trust and transparency and cooperation. Therefore, SemsoTec makes sure that the partners and suppliers understand their impact and importance in the operational process chain of manufacturing displays and that meeting deadlines for order delivery to the client is a top-tier priority for SemsoTec. Considering the relationship with clients, SemsoTec ensures a high-quality product that will be delivered in time under the initially-signed terms and conditions.

2.6 SWOT analysis

SemsoTec's SWOT analysis is designed to assess the company's internal and external status. The purpose of this analysis is to describe the company's internal strengths and weaknesses, as well as identifying the external opportunities and threats in respect to their current status that can help to further develop a proposal for further project management implementation.

2.6.1 Strengths

SemsoTec offers a large spectrum of display solutions for the Automotive, Industrial, MedTech and Aerospace sectors – which represents the company's first strength. In addition to that, SemsoTec's flexibility and adaptability enables the option of display customization that represents an added value in order to meet customer's requirements. At the same time, the staff of the company is composed mainly out of young and middle-aged specialists which makes it be a dynamic environment where employees can learn and grow within the company.

2.6.2 Weaknesses

One of the major weaknesses of SemsoTec are the employees leaving the company and accordingly, the company not hiring new employees due to financial difficulties faced during the past four quarters and the general decision of the CEO. The limited number of machinery and force power represents another impediment that does not allow the company to undertake bigger projects and also the costly machinery that is not available for the Brno branch at the moment is a weakness that SemsoTec Czech currently faces.

2.6.3 Opportunities

Some opportunities to be considered would be low competition on the Czech market. Considering the only one biggest competitor based in the same region – Continental Ltd., another opportunity would be to transform this competition into a valuable partnership by presenting them the idea of outsourcing some smaller projects to SemsoTec. This idea could serve as a base to find new projects that would generate more profit. As being an organization that operates under a German-based mother company, SemsoTec Czech has a great opportunity to undertake some delegated tasks or projects until the its first autonomous projects. On the other hand, the investment into R&D and the acquisition of the necessary machinery would serve as an added value for the company in terms of following the current trends and fulfilment

of clients' necessities that will later on enable SemsoTec to focus on building long-lasting relationships with its customers, partners and suppliers.

2.6.4 Threats

The currently rapid-changing environment, defines one of the biggest threats being the global economic crisis that can decrease the demand or completely stop the production. Overall, the Political and Economic downturns and the changes in regulations are on the top of the list of threats that will require the company to be flexible in order to overcome the difficulties and ensure its position on the market. The increasing energy and commodity prices and the high risks associated with the delivery of components from China and Japan in matter of time and additional costs that are leading to the increase of the product price represent another imminent threat for the company. On the other hand, SemsoTec might not have another option due to the challenge to find suppliers for specific components needed for the production and of course the threat of other competitors appearing on the market must be definitely considered for staying competitive on the market.

Table 3: SemsoTec SWOT analysis (Source: Own processing)

Strengths	Weaknesses
<ul style="list-style-type: none"> • Display customization (flexibility & adaptability) • Display solutions for the Automotive, Industrial, MedTech, Aerospace sectors • Young and middle-aged specialists in the company • Employees can learn and grow within the company 	<ul style="list-style-type: none"> • Employees leaving the company • Company not hiring new employees • Limited number of machinery & force power • High initial investment in machinery
Opportunities	Threats
<ul style="list-style-type: none"> • Low competition • Operating under a German-based mother company – enabling task/project outsourcing • Find new customers/new projects to generate more profit • Investment into R&D • Acquire necessary machinery • Transform the competitor operating in the same field into partner • Focus on building long-lasting relationships with clients, partners, suppliers 	<ul style="list-style-type: none"> • Global economic crisis that can decrease the demand and stop the production • Changing regulatory environment • Political & Economic downturns • Emerging competitors • Increasing energy & commodity prices – increasing price/unit • Challenge to find suppliers for specific display components • High risk associated with the delivery of components from China & Japan (time, additional costs)

The analysis of the company's internal and external status, helped to identify and assess SemsoTec's strengths, weaknesses, opportunities and threats. Based on the elaborated SWOT analysis the design part will further develop and conclude a reasonable action plan that encounter the internal and external factors that might affect or, contrarily, support the effective management of the project.

3 PROPOSED SOLUTIONS AND BENEFITS OF THE PROPOSED SOLUTIONS

The design part of the thesis is devoted to the creation of a plan for the management of a project realized by the company SemsoTec Czech s.r.o. The following chapters are intended for defining the project goal and creating a logical framework and project identification document. This chapter includes a time analysis of the project and a risk analysis. The proposal part is divided into two main parts. The first part focuses on the identification of all activities using the WBS and establishing a responsibility matrix for the project “V Project“. The second part is dedicated to the presentation of ideas and control tactics that will ensure the well organized implementation of the “V Project“ based on the previous experience of SemsoTec Group.

3.1 Project management & control

3.1.1 Project objective

According to the interview with the project leader (see Appendix 2) and the associated information offered by the general manager of the company the purpose of the project is to meet the expectations of the stakeholders. “V Project” is one of the first big and autonomous projects for the Czech SemsoTec branch. Based on the overall experience of SemsoTec Group, and the aforementioned SWOT analysis there are several ideas that might minimize the risks and increase the company’s profit.

3.1.2 Initial project charter

The following table in this chapter is dedicated to the Initial Project Charter. The tables conclude basic information concerning the planned project - incorporating data such as a brief project description, the project benefits and planned start date, as well as information on the business case and the goals to be achieved in the process of the project implementation.

Table 4: Initial Project Charter (Source: Own processing)

Project Charter			
Project name	“V Project“	Date of project start	3 July 2023
Project customer	Company XX	Project manager	Hans Versteegh
Project description	Customization & production of a display unit for an indoor, smart-home system.		
Project benefits	Maximize the profit of the company by performing a reliable project plan that would focus on the risk reduction for the “V Project“ and the generation of profit.		
Business case	SemsoTec Czech s.r.o. initiates its first independent project apart from its mother company – SemsoTec GmbH. The project is going to start on the 3rd of July 2023. The first lot to be produced by the end of 2023 consists of 1000 pcs. The efforts of 8 members will be involved in the planning, controlling and manufacturing of the display units for this project. SemsoTec Czech can start its operational activity on this project by performing its first steps into considering the risk reduction for the upcoming project called “V-project“. As a result, the company will generate more profit and extend its portfolio that will enable the company’s expansion in matter of staff, brand recognition and service range.		
SMART goal	Based on the experience of the SemsoTec mother company – the goal is to create and implement a project management plan of actions that will consider the eventual risks in order to minimize them and by that maximize the profit.		

3.2 Project identification document

The following table is meant to represent the Identification Document, which contains basic information concerning the planned project. It contains more detailed information regarding the project and incorporates the main milestones that are crucial for its implementation.

Table 5: Project identification document (Source: Own processing)

Identification document	
Project name	V Project
Project description	Customization & production of a display unit for an indoor, smart-home system
Planned start date	03.07.2023
Planned completion date	15.12.2023
Project leader	Hans Versteegh
Project team members (Name/Surname)	Function
Hans Versteegh	Project Leader
Miroslav Valderrama	Project Manager/Sales
Robert Hoffmann	Production Manager
Daniel Boor	Logistics/Purchasing/Planning
Dana Švejdová	Quality Engineer
Operator 1; 2; 3	Production Operators
Milestone name	Milestone start date
Project Launch	03.07.2023
Project Planning	01.09.2023
Realisation – Contract Stage	13.10.2023
Realisation – Preparation Stage	03.11.2023
Realisation – Production Schedule	24.11.2023
Completion of The Project	08.12.2023
Project Finish (estimated)	15.12.2023

3.3 Logical framework

The table below is dedicated to the logical framework for the implementation of the project steps. This framework contains information about the project's purpose and objective, as well as the deliverables and the main activities of the project that need to be fulfilled in order to achieve the intended objective.

Table 6: Logical framework (Source: Own processing)

Logical framework matrix					
Project name:	V Project	Elaboration:	Victoria Harea	Date:	07.05.2023
	Description	OVI	Verification method	Requirements	
Intent	Keep the project running for 5-10 years	25 000 pieces or more per year	Invoice, accounting		
Goal	Create and implement a project management plan that will assess the eventual risks in order to minimize them and by that maximize the profit	Meeting the deadline	Project documentation	Goal → Intent	
		Meeting the budget	Invoice, accounting	Suitably assembled project team	
				Successful implementation	
				Low error rate	
Project outputs	1. Set up the project team	1.1. Setting up project team; roles assigned	Project documentation	Project output → Goal	
		1.2. Budget is 100 000€	Invoice, accounting	Detailed design specifications	
	2. Project planning	2.1. Documentation for product design	Record of analysis	Modern equipment and tools	
		2.2. Documentation	Record of analysis	Adequate training and support for production staff	

		for terms and conditions		
				Detailed production plan and schedule
	3. Realization – Contract stage	3.1. Contract with client	Contract	Skilled and experienced engineers and technicians
	4. Realization - preparation	4.1. Prototypes manifest (couldn't read it on the paper)	Project documentation	
		4.2. Prototypes testing	Employee report	
		4.3. Standard operation procedure	Project documentation	
	5. Realization – Production schedule	5.1. Production plan	Project documentation	
		5.2. Production supervision and control	Employee report	
		5.3. Analysis production after training	Record of analysis	
	6. Completion of the project	6.1. Compliance with the set costs 100 000€	Invoice, accounting	
		6.2. User reviews in relation to the new system	Questionnaire	
		Time frame	Resources	
Key activities	1.1. Team formation	1.1. 5 days	1.1. 2,5 MD	Key activities → Project outputs
	1.2. Roles distribution	1.2. 3 days	1.2. 1 MD	Skilled personnel to design and build the prototypes

	1.3. Kick-off meeting	1.3. 1 day	1.3. 4 MH	Clear criteria for evaluating the performance and functionality of the prototypes
	1.4. Defining goals	1.4. 15 days	1.4. 5 MD	Knowledge of production processes and techniques
	1.5. Defining budget	1.5. 20 days	1.5. 8 MD	Clear understanding of production processes and workflows
	1.6. Defining timeframe	1.6. 20 days	1.6. 4 MD	Sufficient time allocated for employee training
	2.1. Analysis of the production process	2.1. 30 days	2.1. 10 MD	Regular monitoring of production progress against the production plan and schedule
	2.2. Product design	2.2. 30 days	2.2. 20 MD	
	3.1. Draft contract	3.1. 10 days	3.1. 3 MD	
	3.2. Contract approval and signature	3.2. 5 days	3.2. 4 MH	
	4.1. Prototypes manufacturing	4.1. 10 days	4.1. 5 MD	
	4.2. Product testing	4.2. 10 days	4.2. 5 MD	
	4.3. Standard operation procedure	4.3. 15 days	4.3. 10 MD	
	5.1. Analysing production after training	5.1. 10 days	5.1. 5 MD	
	6.1. Calculation of costs	6.1. 5 days	6.1. 3 MD	

3.4 Work Breakdown Structure

The following chapter is devoted to the assessment of the WBS for the identification of all activities, that must be carried out in order to achieve the stated objective such as the successful implementation of the “V Project“. The WBS, as a hierarchical structure of work, is carried out based on the aforementioned logical framework, namely outputs and related key activities.

Table 7: Work Breakdown Structure (Source: Own processing)

Activity	Description
0	Manufacture of new and complex type of displays for “V Project“
1	PROJECT LAUNCH
1.1.	Set up project team
1.1. 1	Team formation
1.1.2.	Roles distribution
1.2.	Kick-off meeting
1.3.	Terms & Conditions definition
1.3.1.	Defining goals
1.3.2.	Defining budget
1.3.3.	Defining time frame
2	PROJECT PLANNING
2.1.	Product analysis & design
2.1.1.	Analysis of production/assembly process
2.1.2.	Product design
2.2.	Analysis of specific terms & conditions
3	REALISATION – CONTRACT STAGE
3.1.	Contract with client
3.1.1.	Draft contract
3.1.2.	Contract approval & signature
4	REALISATION – PREPARATION STAGE
4.1.	Prototypes manufacturing
4.2.	Prototypes testing
4.3.	Standard Operation Procedures (SOPs)
4.3.1.	Training employees
4.3.2.	Product manual elaboration
5	REALISATION – PRODUCTION SCHEDULE
5.1.	Production plan
5.2.	Production supervision & control
5.3.	Analyzing production after training
6	COMPLETION OF THE PROJECT
6.1.	Costs evaluation
6.2.	Assessment & feedback

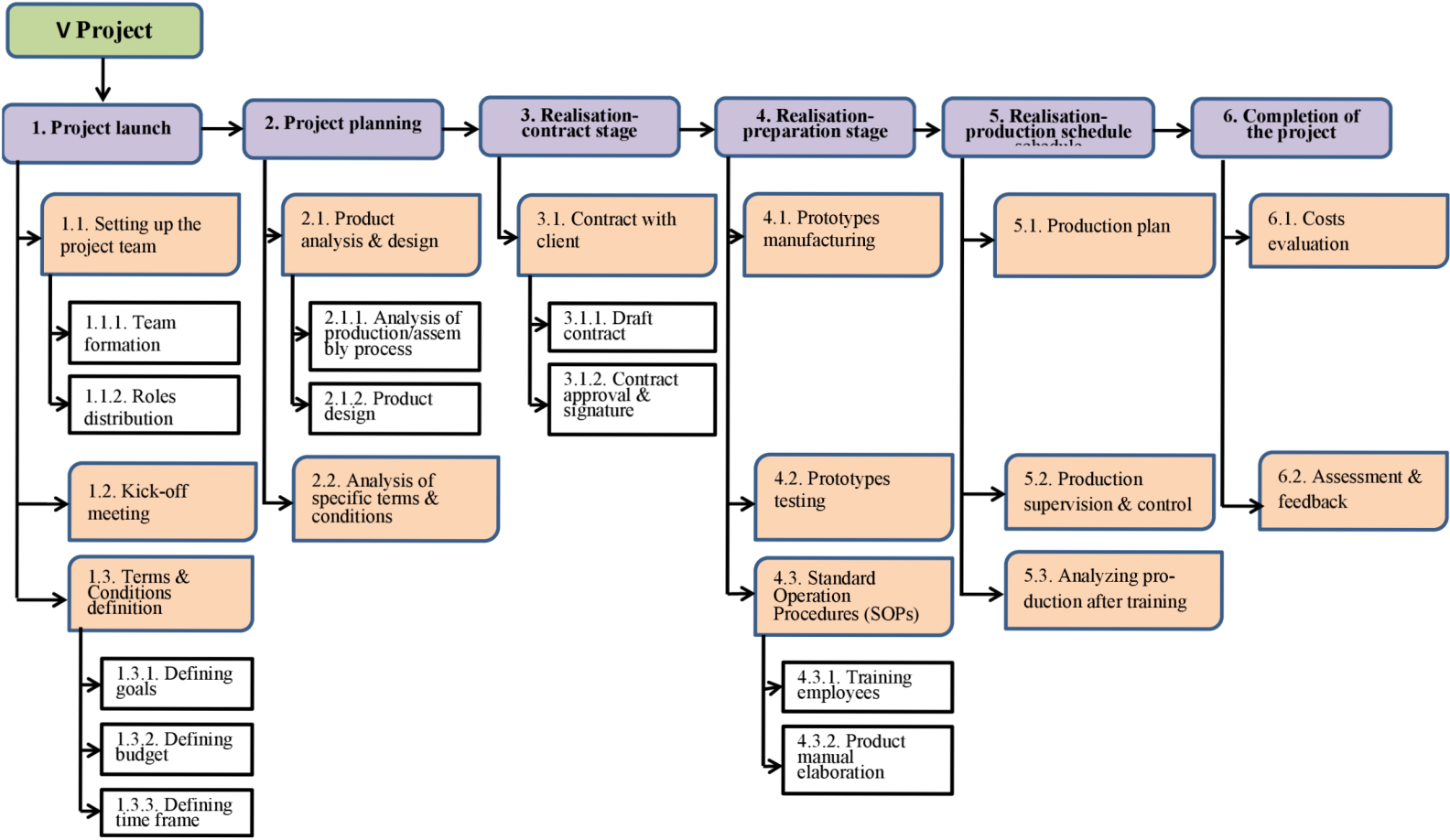

Fig. 12: Work Breakdown Structure (Source: Own processing)

3.5 Project team

The project team was established to implement the project, in this case the implementation of a project management plan and control in the company. This team will be responsible for the individual activities of the project.

The team members and their functions are as follows:

- Project Leader - responsible for achieving the stated project objective. This person is responsible for assigning tasks to individual team members and the deliverables.
- Project Manager/Sales – focused on being in touch with the customer and negotiate the project terms and conditions.
- Production Manager – responsible for the labour resources allocation and the distribution of manpower among projects, ensuring the projects' efficiency.
- Logistics/Purchasing/Planning specialist – handles the warehouse stock, ensuring the material availability and fulfilment of the supplies when needed.
- Quality Engineer – accountable for controlling and meeting the quality standards, inspecting materials, developing quality control systems and ensuring the high-quality of the items to be delivered to the customers.

3.6 RACI matrix

No responsibility matrix has been applied in the company so far, which may have resulted in some activities not being properly addressed or even were not given attention, which could have led to errors.

The RACI matrix serves as a tool to identify the responsibilities of people in the relationship to individual project activities. The basic roles of this matrix are defined as follows in the following table.

Table 8: RACI Matrix criteria (Source: Own processing)

Responsibility	Description
R (Responsible)	responsible for the implementation of the task
A (Accountable)	responsible for the outcome of the task
C (Consulted)	responsible for providing consultation
I (Informed)	informed about the outcome or progress of the task

The following table presents the responsibility matrix for the implementation of “V Project“

Table 9: RACI Matrix (Source: Own processing)

Activity	Project Leader	Project Manager/ Sales	Production Manager	Logistics/ Purchasing/ Planning	Quality Engineer
Setting up project team	R	A	I	I	I
Team formation	A	R	C	I	I
Roles distribution	A	R	C	I	I
Kick-off meeting	R	A	I	I	I
Terms & Conditions definition	A	R	C	C	C
Defining goals	A	R	I	I	I
Defining budget	C	A	I	R	I
Defining time frame	C	A	I	R	I
Project planning	A	R	C	C	I
Product analysis & design	I	A	C	I	R
Analysis of production/assembly process	I	A	C	I	R
Product design	A	R	C	I	I
Analysis of specific terms & conditions	A	R	C	C	C
Contract with client	R	A	I	I	I
Draft contract	A	R	I	I	I
Contract approval & signature	R	A	I	I	I
Prototypes manufacturing	I	C	R	I	A
Prototypes testing	I	I	R	I	A
Standard Operation Procedures (SOPs)	A	R	C	I	I
Training employees	A	R	I	I	I
Product manual elaboration	A	R	I	I	I
Production plan	A	R	C	I	I
Production supervision & control	I	A	R	I	I
Analyzing production after training	I	A	R	I	I
Completion of the project	A	R	I	I	I
Costs evaluation	R	A	I	C	I
Assessment & feedback	R	A	C	C	C

3.7 Risk analysis

This chapter is devoted to the identification of risks that may occur during the project and thus jeopardise the project. The identification of risks, their assessment and proposal for action will be developed on the basis of the scoring method.

The identification of risks and opportunities is essential for the project. Risk analysis is used to reduce the negative risks by means of setting up corrective measures. These measures will be then presented in this chapter.

Table 10: Risk analysis - description (Source: Own processing)

Risk	Risk description	Interpretation
R1	Global crisis	The global crisis influences buyers purchasing power and priorities. In such a way, this external factor can not only negatively influence the demand for SemsoTec's products but also lead to the company's bankruptcy.
R2	Low product demand	Low product demand due to Political (wars) and Economical (crisis) factors might negatively affect the company and result in company's insolvency.
R3	Not enough qualified team members	A poorly selected, unreliable team will cause poorly done work, corrections will be needed and this will prolong operations.
R4	High ratio of bad parts produced	Poor preparation and training of the staff will lead to increased production of bad parts, that will generate increased additional costs and project delays.
R5	Incapability to find necessary components for production	The limited number of suppliers might cause a deficit in matter of components that can eventually limit, delay or stop the production of some projects.
R6	Emerging competitors	The emerging competitors copying the products or delivering a better product represent an unstoppable threat.
R7	High rate of display returns	Errors and poor production result will lead to

		High rate of display returns that ultimately increase costs through additional training and remaking the displays.
R8	Contracts with unreliable suppliers	The selection of unsuitable suppliers might lead to customer dissatisfaction, delays in the delivery and eventual additional costs.
R9	Poor training/Personnel not able handle project's complexity	Ignorance of the team during the training phase will result in job performance inefficiency, errors and financial losses.
R10	Insufficient budget due to inflation (growing prices)	Costs exceeding plan due to the economic situation instability or the implementation of expensive solutions will increase costs and result in possible project delay.
R11	Incapability to fulfill customer's requirements	Inappropriately drafted project plan (time, budget and schedule) will lead to project delays, cost increases or failure to achieve the objective/customer's requirements.
R12	Failure to comply with contractual Terms & Conditions	If the project/product is planned/designed or set up incorrectly, it might lead to client's dissatisfaction and breach of contract terms and conditions.
R13	Poor quality design of the project/product	Poor project/product realisation meeting the quality standard will lead to high ration of returns and will result in additional costs and delays.
R14	Ignorance of adjustments based on feedback	Ignorance of adjustments based on feedback will lead to the delivery of a faulty display units, which will result in failure to meet the project's objective and its delay, possibly resulting in increased costs for correction or penalties.
R15	Debts & Bankruptcy	All the risks summed up into a pessimistic scenario might result into company debts and an imminent bankruptcy.

3.7.1 Risk Assessment

Risk assessment by FMEA (Failure Mode and Effect Analysis) method. We assign value to each risk in matter of probability and its impact.

The probability will be rated from 0 to 1 where:

- 0 – impossible;
- 0.25 – relatively impossible;
- 0.5 – occasionally possible;
- 0.75 – reasonably possible;
- 1 – highest possibility.

Accordingly, its impact on the implementation will be rated on a scale from 1 to 5 where:

- 1 – no impact;
- 2 - minor impact;
- 3 – average impact;
- 4 – critical impact;
- 5 – catastrophic impact.

The risk assessment was based on the scales defined above. The calculation of the risk priority number (RPN) is used for evaluation which is obtained by multiplying the probability and impact results. The maximum obtained RPN result can be 5 – in case of highest probability and catastrophic impact on the implementation. The following table shows the probability rating of the risks analysed, including their impact and the resulting value of the risks.

Table 11: Risk analysis – assessment (Source: Own processing)

Risk	Risk description	Probability	Impact	RPN
R1	Global crisis	0.75	5	3.75
R2	Low product demand	0.75	5	3.75
R3	Not enough qualified team members	0.25	3	0.75
R4	High ratio of bad parts produced	0.75	4	3
R5	Incapability to find necessary components for production	0.5	4	2
R6	Emerging competitors	0.5	2	1
R7	High rate of display returns	0.75	4	3
R8	Contracts with unreliable suppliers	0.5	4	2
R9	Poor training/Personnel not able to handle project's complexity	0.25	4	1
R10	Insufficient budget due to inflation (growing prices)	0.25	4	1
R11	Incapability to fulfill customer's requirements	0.25	5	1.25
R12	Failure to comply with contractual Terms & Conditions	0.5	4	2
R13	Poor quality design of the project/product	0.5	5	2.5
R14	Ignorance of adjustments based on feedback	0.25	4	1
R15	Debts & Bankruptcy	0.25	5	1.25

The below presented risk map shows the distribution of risks in accordance to their probability reported to their impact values.

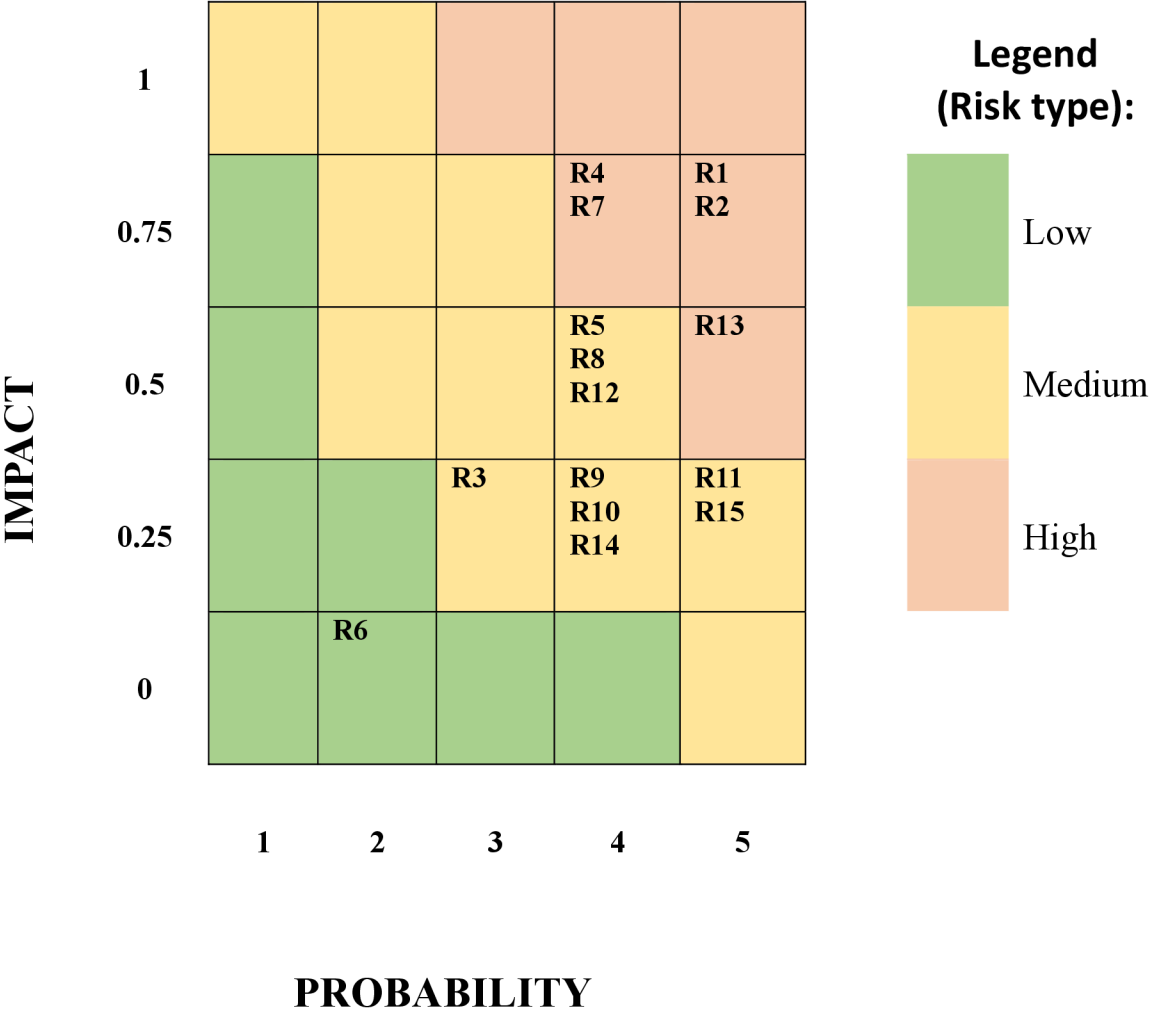

Fig. 13: Risk map (Source: Own processing)

As we can see, R6 is the only risk situated in the low risk category. Further risks R3, R8, R9, R10, R11, R14 and R15 are situated in the medium risk category (with fluctuating probability rate). R1, R2, R4, R7 and R13 are the most endangered risks displayed in the high risk category. The next chapter focuses on proposing measured lowering the risk probability.

3.7.2 Risk Reduction

This chapter focuses on proposing measures for the identified risks following proposed measures for risk reduction. The probability value will be adjusted based on the proposed measures, whereas the impact factor will remain untouched. Based on the new findings, the RPN is calculated again, this time considering the proposed measures.

Table 12: Risk analysis – risk reduction (Source: Own processing)

Risk	Risk description	Proposed measure	Probability	Impact	RPN
R1	Global crisis	Elaborating up-to-date reports regarding company's current state and perform the necessary organizational adjustments	0.5	5	2.5
R2	Low product demand	Contact other companies that might need a solution designed by SemsoTec. Develop the database of clients. Negotiate mutually beneficial contractual terms and conditions.	0.25	5	1.25
R3	Not enough qualified team members	Enhanced & ongoing training sessions	0	3	0
R4	High ratio of bad parts produced	Increased & active production supervision	0.25	4	1
R5	Incapability to find necessary components for production	Negotiation of alternatives with the customer	0.25	4	1

R6	Emerging competitors	Continuous market research to study the competitor's portfolio and action strategy	0.25	2	0.5
R7	High rate of display returns	Assessment of production and product adjustments	0.25	4	1
R8	Contracts with unreliable suppliers	Revise the terms and conditions with specific penalties applied in case of contract breach. If possible, change of suppliers	0.25	4	1
R9	Poor training/Personnel not able to handle project's complexity	Additional materials (manuals) and minutious monitoring of the production technique	0.25	4	1
R10	Insufficient budget due to inflation (growing prices)	Recalculate the resource allocations and adjust the margin and the unit price.	0.25	4	1
R11	Incapability to fulfill customer's requirements	Immediate adjustments of the production plan. Kepping the customer informed and updated	0	5	0
R12	Failure to comply with contractual Terms & Conditions	Analysis of the initial contract. Appeal to legally available emergency regulations if applicable.	0.25	4	1

		Availability of financial reserve			
R13	Poor quality design of the project/product	Monitoring the production and spotting the possible weaknesses of the project. Active involvement of the quality department and testers	0.25	5	1.25
R14	Ignorance of adjustments based on feedback	Warnings and penalties for the ignorant employees	0.25	4	1
R15	Debts & Bankruptcy	Active cooperation among departments. Meetings, reports and financial preliminary organizational conclusions	0.25	5	1.25

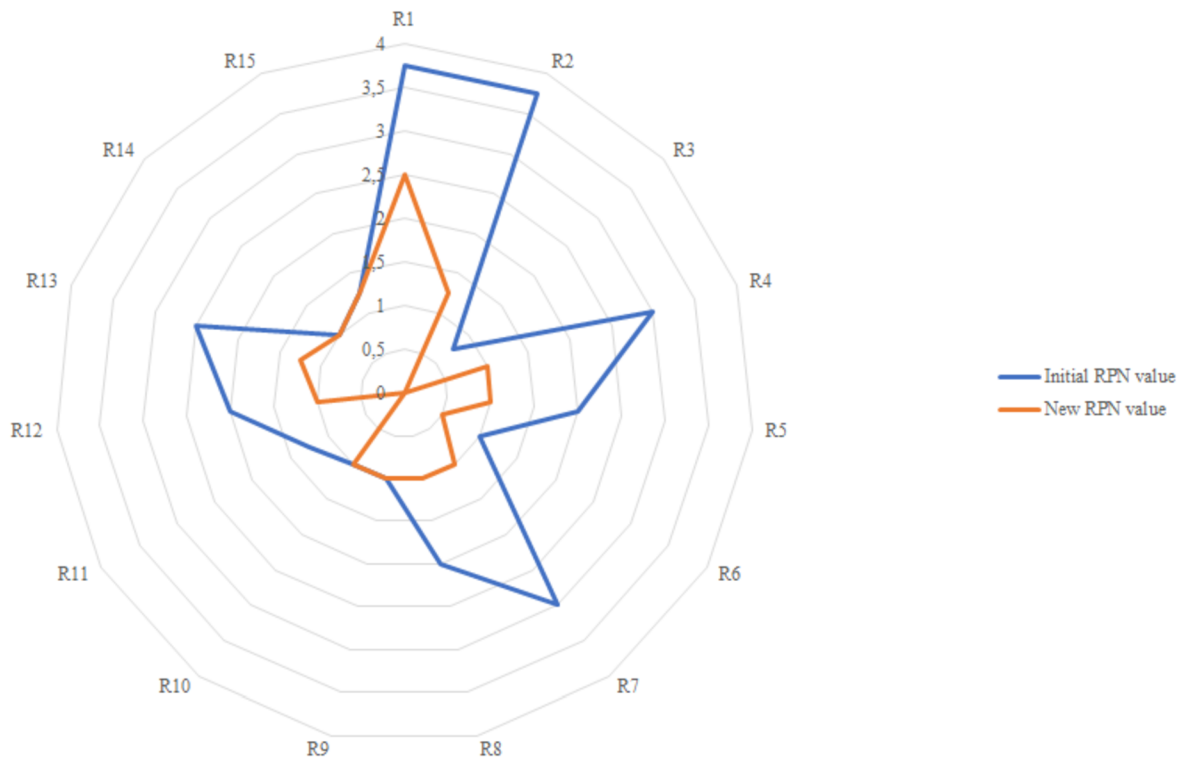

Fig. 14: Spider web graph (Source: Own processing)

The spider web graph represents the reduced value of risks by implementation of the measures proposed as corrective actions. However, it is necessary and crucial to continuously monitor the risks during the project and if new ones are found immediately include them in the analysis.

3.8 Time analysis

This chapter focuses on the project timeline. The individual project activities were taken from the WBS analysis. The expected duration of these activities was then determined individual activities, based on the PERT method.

3.8.1 Project timeline

The following chapter contains the project timetable. The management of "V Project" involves a series of activities. The analysis of these actions and their sequential arrangement, as well as the determination of the proposed duration required for completing each of these tasks, will be performed using Project Evaluation and Review Technique (PERT). Statistical observations from previous SemsoTec projects (if any) were used as input data. Missing data were modeled based on personal observations. All the input data was conventionally divided in:

Optimistic Time Estimate (t_o): is the least possible time within which a particular activity can be completed.

Most Likely Time Estimate (t_m): is estimating the most appropriate time for completion of any activity.

Pessimistic Time Estimate (t_p): is the highest possible time estimation for carrying out a particular activity.

Based on that, the next parameters were calculated:

Estimated Duration which is the duration which is supposedly required to accomplish a specific task. It is calculated through the following formula:

$$t_e = \frac{t_o + (4 \times t_m) + t_p}{6}$$

Variance which is the level of instability of the time required to carry an activity:

$$\sigma^2 = \left(\frac{t_p - t_o}{t_m} \right)^2, \text{ (see table 14),}$$

The critical path was determined according to the results from PERT Chart, shown in fig. 15. The expected project completion is 115 days. Another powerful attribute of PERT, is the possibility to find the probability of project delay by involving calculated variance.

Table 13: Project timeline (Source: Own processing)

Activity	Activity Description	Immediate Predecessor	t _o	t _m	t _p	t _e	Variance σ^2
A	Team formation		4	4,5	6	4,7	0,19
B	Roles distribution	A	2	2,5	3	2,5	0,16
C	Kick-off meeting	B	0,2	0,5	1	0,5	2,56
D	Defining goals	C	10	15	18	14,7	0,28
E	Defining budget	C	7	20	30	19,5	1,32
F	Defining time frame	D	10	20	25	19,2	0,56
G	Analysis of production/assembly process	D	20	30	58	33	1,6
H	Product design	E	18	30	40	29,7	0,54
I	Analysis of specific terms & conditions	F	10	15	22	15,3	0,64
J	Draft contract	H, G, I	5	12	15	11,3	0,69
K	Contract approval & signature	J	4	4,5	5	4,5	0,05
L	Prototypes manufacturing	K	10	10,5	12	10,7	0,04
M	Prototypes testing	L	4	4,5	5	4,5	0,05
N	Training employees	K	10	10,5	13	10,8	0,08
O	Product manual elaboration	N	10	15	21	15,2	0,54
P	Production plan	M	4	4,5	6	4,7	0,19
Q	Production supervision & control	P	4	4,5	7	4,8	0,44
R	Analyzing production after training	Q	10	10,5	14	11	0,15
S	Costs evaluation	R, O	3	4,5	5	4,3	0,19
T	Assessment & feedback	S	1	1,5	3	1,7	1,78

The table above contains the calculated mean durations, variances and standard deviations. The mean durations are used as input data for the Gantt chart. An important part of the time analysis is to find the critical path of the project. This is the longest project duration with zero time margin. The activities that lie on this path are referred to as being critical, and should they be delayed, they would result in an extension of the overall project duration. It is therefore essential that these activities are properly controlled. The following table shows the individual time characteristics and time margins, that were obtained using the PERT method.

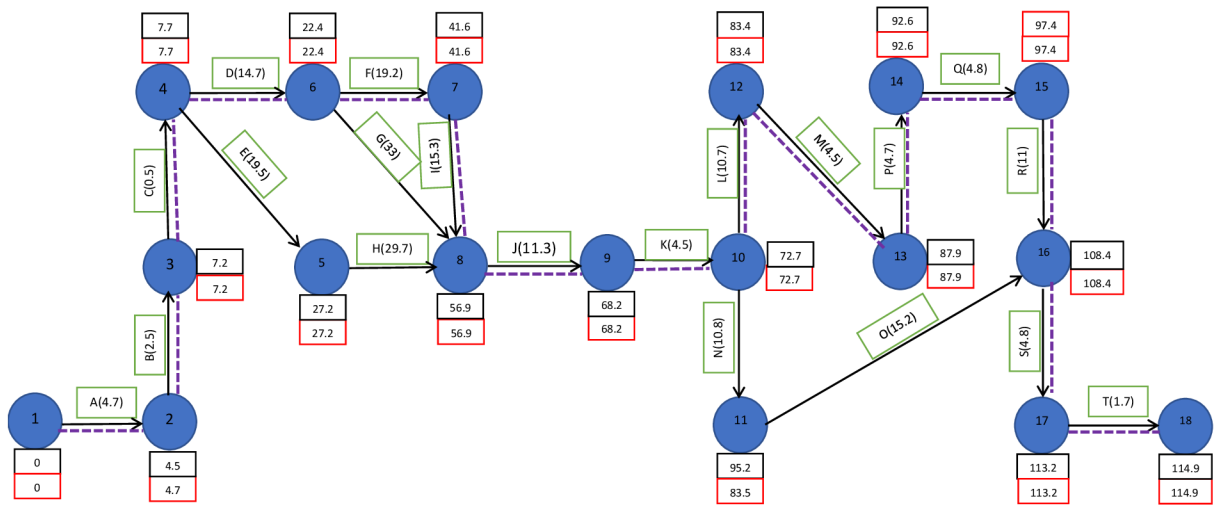

Fig. 15: Project critical path (Source: Own processing)

Earliest Start Time:

$$ES_j = \max_i (ES_i + D_{ij}), \text{ where}$$

ES_j is the Earliest Start Time of Ending Node;

ES_i is the Earliest Start Time of Starting Node and;

D_{ij} is the Estimated Duration of Concerned Activity.

\max_i -if ending node consists of more than one starting nodes, the highest ES_j is considered.

Latest Completion Time:

$$LC_i = \min_j (LC_j - D_{ij}), \text{ where}$$

LC_i is the Latest Completion Time of Starting Node;

LC_j is the Latest Completion Time of Ending Node and;

D_{ij} is the Estimated Duration of Concerned Activity.

\min_j -if two or more ending nodes for a particular starting node, the least LC_i value is considered.

- Critical Path
- Activity with estimated duration
- Latest Completion Time
- Earliest Start Time
- Events

The planned start of the project is set for the date of 03.07.2023 and the completion date is expected to be 15.12.2023. The planned duration of the project is 5 months and 12 days. After deduction of weekends and public holidays, the project is expected to last 120 days. One working day represents 8 hours, where the working hours are set from 8:00 to 17:00, with a one-hour lunch break from 12:00 to 13:00.

According to the above figure, it can be seen that the project can be completed in 115 days.

3.9 GANTT chart

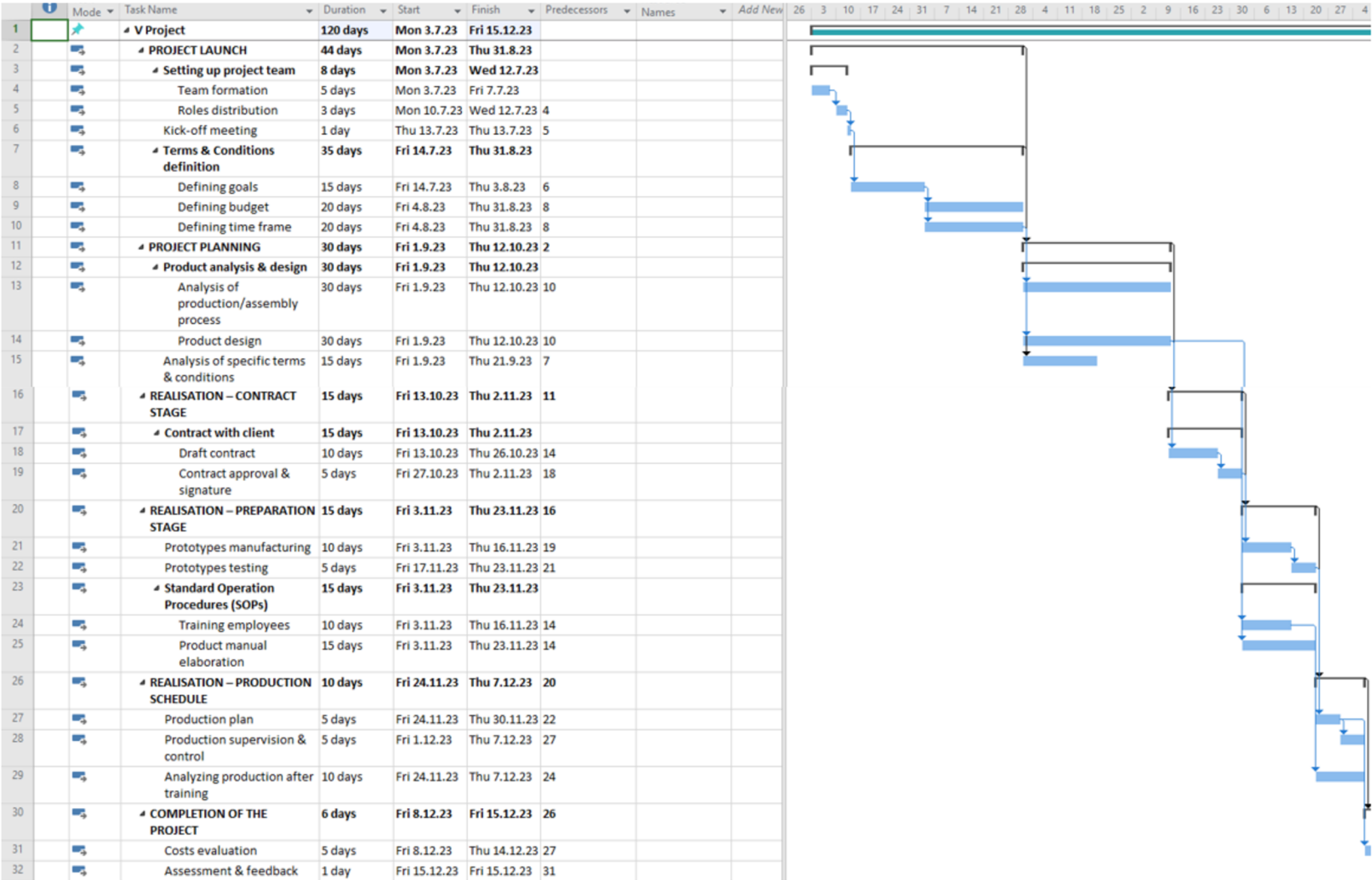

Fig. 16: Gantt chart (Source: Own processing)

3.9.1 Project implementation costs

This section is dedicated to the costs related to the whole project. The list of costs reflects associated expenses of the company for the planning/implementation of the first steps into starting to produce the first lot of 1000 pcs. Of displays for “V-Project“ estimated for the end of year 2023. The total associated expenses are counted as price associated to the activity multiplied by the amount of hours/repeatability/units needed for the period of 120 days which is the estimated time frame for the project implementation.

Table 14: Project implementation costs (Source: Own processing)

Activity description	Periodicity (days/units)	Cost
Employee training	10 days * 8h/day = 84h	Included in employee wages
Creation of manuals	15 days * 8h/day = 120h	Included in employee wages
Product design	30 days * 8h/day = 240h	Included in employee wages
Travel to different city to negotiate contract terms & sign contract	Max. 5 times (days)	4000 CZK * 5 times = 20 000 CZK (maximum cost for 5 business travel days to the V-Project customer) *4000 CZK/person/day
Production equipment	3+2 units (for the production operators + production supervisor & quality tester)	400 CZK * 5 pcs. = 2000 CZK (cost for the equipment supplies)
Raw materials for the creation of display samples	30 displays to be produced as samples	1000 CZK * 30 pcs. = 30 000 CZK (total cost for the 30 display samples)
Creation of samples	10 days * 8h/day=84h	Included in employee wages
Product testing	5 days * 8h/day=36h	Included in employee wages
Logistics for sample/product delivery	Max. 3 times (suppler DPD/PPL package size L)	159 CZK * 3 = 477 CZK
Employee wages	Calculated as average cost per day/employee (8 employees involved in the project)	252CZK/h * 8h = 2016 CZK (daily/employee) 2016 CZK * 8 employees = 16 128 CZK (daily/team) 16 128 CZK * 120 days = 1 935 360 CZK (total cost)

Table 15 represents the “V-Project“ list of activities and the associated costs. All the expenses except the employee wages are costs that will can be covered only if the contract is signed with the customer. Otherwise, these expenses will be recorded as cash outflow and go under the debit side of SemsoTec’s balance of payments. The total costs for the initial phase of display samples production and the negotiation with client reflects a maximum fixed sum of 52 477 CZK (excluding employee salaries). The 120 days running-project employee wages record a sum of 1 935 360 CZK. The total cost of the project implementation is estimated at 1 987 837 CZK.

Benefits of Solution Proposals

This chapter is dedicated to the evaluation of the benefits of the project aim, the purpose of which is the fulfillment of the defined goals and objectives of the utilization and implementation of relevant project management tools related to the design and production of a display unit under the name of “V Project“.

The project proposal is the basis for the creation of a plan for the management of a project realized by the company SemsoTec Czech s.r.o. The project proposal can be perceived as a comprehensive plan for the implementation phase project. This plan contains all important information such as project milestones, risk analysis, logical framework, time and financial analysis.

Although the successful completion of this project represents a benefit itself, there are additional benefits have been brought up within the design part of this thesis by taking into consideration the impediments that might occur within the project implementation. If taken into account in advance, the project implementation will be realized smoother and by that, preventing errors and money waste. These milestones are:

- Appropriate team formation and roles distribution;
- Clear goal and time frame definition;
- Minutious analysis of the production process and production supervision;
- Personnel training and manual elaboration;
- Costs evaluation;
- Assessment of the overall performance and continuous feedback;

The benefits of these milestones tracking are:

- Minimization of the production of the bad parts;
- Assessment of this project’s costs and profitability;
- Internal evaluation of the employees performance;
- Risk minimisation by ongoing planning;
- Customer satisfaction and portfolio diversification;

CONCLUSION

Project management nowadays is an integral part of business operations. The correct interpretation and realisation of customers' needs must be planned and controlled accordingly. Therefore, project management is crucial for the project's successful fulfilment. To make the project implementation successful – project management methods are used in practice.

The goal of the thesis was to use relevant project management tools for the elaboration of a project management plan related to the design and production of a display unit for an indoor, smart-home system.

The thesis is divided into three main parts. The theoretical part is dedicated to the introduction to the project management tools and methodologies used for the project implementation.

The analytical part is focused on processing primary and secondary data collected from the company. The primary data collection involved the interview method that was performed with the project leader. The internal and external analyses supported the evaluation of the current status of SemsoTec Czech s.r.o. For this purpose, analyses such as SLEPT, McKinsey 7S model and Porter's competitive forces model were considered. The output of these analyses was processed and used to create a SWOT analysis. In addition, secondary research data such as internal documents and financial statement provided by the company were used.

The last part of the thesis is dedicated to the design of a project plan for the “V Project“, taking into consideration possible risks and their minimization. This part was compiled based on project management methods. The logical framework, the development of a project identification sheet and the WBS method to develop a detailed overview of the activities. Within the RACI matrix, each activity was assigned responsible persons who will be accountable for their implementation. An important part of the project is the risk analysis, which was created using the scoring method, defining threats, scenarios and suggestions for action, in order to reduce the values of individual risks. The PERT method was used to build the timetable. The creation of CPM supported the identification of the minimum time needed for the implementation of the project. The project timeline was represented using the GANTT chart.

The overall initial costs of the company associated with the “V Project“ amounted in 1 987 837 CZK. The last chapter of the thesis focuses on highlighting the project implementation milestones and the benefits it could bring.

LIST OF REFERENCES

ARMENTA A. *Failure Mode and Effects Analysis (FMEA) Steps and Applications in Industrial Automation* [online]. ©2023 [cit. 2023-04-29]. Available at: <https://control.com/technical-articles/failure-mode-and-effects-analysis-fmea-steps-and-applications-in-industrial-automation/#:~:text=Transportation%20and%20logistics%20is%20another,benefit%20from%20the%20FMEA%20method.>

Arun R.. *Everything You Need To Know About CPM: The Critical Path Method With Examples* [online]. ©2023 [cit. 2023-05-02]. Available at: <https://www.simplilearn.com/tutorials/project-management-tutorial/critical-path-method>

AZIZ E. E. *Project Closing: the small process group with big impact* [online]. Project Management Institute, Inc., ©2023 [cit. 2023-04-12]. Available at: <https://www.pmi.org/learning/library/importance-of-closing-process-group-9949>

BOČKOVÁ K., LAJČIN D. *RIPRAN – one of the best project risk analysis methodologies* [online]. ©2023 [cit. 2023-04-29]. Available at: <https://journals.agh.edu.pl/manage/article/view/3240/2212>

BRATTA A. *The triple constraint* [online]. ©2006 [cit. 2023-04-17]. Available at: <https://www.pmi.org/learning/library/triple-constraint-erroneous-useless-value-8024>

BELL M. *A Three-Point Estimating Technique: PERT* [online]. ©2023 [cit. 2023-04-26]. Available at: <https://projectmanagementacademy.net/resources/blog/a-three-point-estimating-technique-pert/>

BISWAS P. *ISO 31000:2018 Risk Management Guidelines* [online]. ©2023 [cit. 2023-04-26]. Available at: <https://preteshbiswas.com/2022/06/27/iso-310002018-risk-management-guidelines/>

BRIDGES J. *What Is The Project Life Cycle?* [online]. ProjectManager.com, Inc., ©2023 [cit. 2023-04-12]. Available at: <https://www.projectmanager.com/blog/what-is-the-project-management-life-cycle>

CANDILIARI F. *Logical Frameworks, Information Management Systems and ActivityInfo* [online]. ©2023 [cit. 2023-04-21]. Available at: <https://www.activityinfo.org/blog/posts/2019-01-14-logframe-and-information-systems.html>

CFI Team. *McKinsey 7S Model* [online]. CFI Education Inc., ©2015-2023 [cit. 2023-05-12]. Available at: <https://corporatefinanceinstitute.com/resources/management/mckinsey-7s-model/>

EdrawMind. *Porter's Five Forces Analysis Definition and Examples* [online]. Edrawsoft, ©2023 [cit. 2023-05-12]. Available at: <https://www.edrawmind.com/article/porters-five-forces-analysis-definition-and-examples.html>

CEIC. *Czech Republic Bank Lending Rate* [online]. CEIC Data, ©2021 [cit. 2023-04-28]. Available at: <https://www.ceicdata.com/en/indicator/czech-republic/bank-lending-rate#:~:text=Czech%20Republic%20Bank%20Lending%20Rate%201%20Czech%20Republic,to%20Jan%202023%2C%20with%20229%20observations.%20Dal%C5%A1%C3%AD%200polo%C5%BEky>

CHAI W., BRUSH K. *PERT chart* [online]. ©2023 [cit. 2023-04-21]. Available at: <https://www.techtarget.com/searchsoftwarequality/definition/PERT-chart>

COHEN E. *How to Use Critical Path Method for Complete Beginners (with Examples)* [online]. Creative Manager Inc., ©2023 [cit. 2023-04-21]. Available at: <https://www.workamajig.com/blog/critical-path-method>

COLLINS K.B. *What is a LogFrame?* [online]. American University, ©2023 [cit. 2023-04-17]. Available at: <https://programs.online.american.edu/online-graduate-certificates/project-monitoring/resources/what-is-a-logframe>

CONRAD E. AND FELDMAN J. *Spiral Model* [online]. Elsevier B.V. , ©2023 [cit. 2023-04-26]. Available at: <https://www.sciencedirect.com/topics/computer-science/spiral-model>

Czech Statistical Office. *Census 2021 (Education)* [online]. CZSO, ©2023 [cit. 2023-05-04]. Available at: <https://www.czso.cz/csu/scitani2021/education>

DONATO H. *5 Phases of Project Management Life Cycle You Need to Know* [online]. TechnologyAdvice, ©2023 [cit. 2023-04-12]. Available at: <https://project-management.com/project-management-phases/>

EBY K. *How to Get Project Closure Right and Build Happy Teams and Clients in the Process* [online]. Smartsheet Inc., ©2023 [cit. 2023-04-17]. Available at: <https://www.smartsheet.com/content/project-closure#:~:text=Closure%20with%20Smartsheet,What%20Is%20Project%20Closure%3F,deliverables%20with%20the%20project's%20client.>

EBY K. *The Complete Glossary of Project Management Terminology* [online]. Smartsheet Inc., ©2023 [cit. 2023-04-12]. Available at: <https://www.smartsheet.com/complete-glossary-project-management-terminology>

European Commission. *A European Green Deal* [online]. European Commission, ©2023 [cit. 2023-05-01]. Available at: https://commission.europa.eu/strategy-and-policy/priorities-2019-2024/european-green-deal_en

European Commission. *The situation of refugees from Ukraine* [online]. European Commission, ©2023 [cit. 2023-05-01]. Available at: https://ec.europa.eu/migrant-integration/library-document/situation-refugees-ukraine_en

Forbes. *Why Convenience Is Essential* [online]. FORBES, ©2023 [cit. 2023-03-27]. Available at: <https://www.forbes.com/sites/stephanieburns/2020/09/24/why-convenience-is-essential/>

GILLIS A.S. AND SCHUCHART W. *FMEA (Failure Mode and Effects Analysis)* [online]. TechTarget, ©2007-2023 [cit. 2023-04-29]. Available at: <https://www.techtarget.com/searchcio/definition/FMEA-failure-mode-and-effective-analysis>

GILLIS A.S. *Project charter* [online]. TechTarget, ©2007-2023 [cit. 2023-04-12]. Available at: <https://www.techtarget.com/searchcio/definition/project-charter>

GRANT M. *Gantt Charting: Definition, Benefits, and How They're Used* [online]. Dotdash Meredith, ©2023 [cit. 2023-04-21]. Available at: <https://www.investopedia.com/terms/g/gantt-chart.asp>

GREGORY A. *SMART Goal Examples* [online]. Dotdash Meredith, ©2023 [cit. 2023-04-17]. Available at: <https://www.thebalancemoney.com/smart-goal-examples-2951827>

HAWKS, Douglas. *SLEPT Analysis: Example, Overview. In: Study.com* [online]. 20.10.2018 [cit. 2023-04-15]. Available on: <https://study.com/academy/lesson/slept-analysis-example-lesson-quiz.html>

HAYES A. *What Is Enterprise Risk Management (ERM)?* [online]. Dotdash Meredith, ©2023 [cit. 2023-04-26]. Available at: <https://www.investopedia.com/terms/e/enterprise-risk-management.asp>

HERRITY J. *Guide on How To Write SMART Goals (With Examples)* [online]. Indeed, ©2023 [cit. 2023-04-17]. Available at: <https://www.indeed.com/career-advice/career-development/how-to-write-smart-goals>

HOORY L., BOTTORFF C. *What Is Waterfall Methodology? Here's How It Can Help Your Project Management Strategy* [online]. Forbes Media LLC., ©2023 [cit. 2023-04-21]. Available at: <https://www.forbes.com/advisor/business/what-is-waterfall-methodology/>

Investopedia. *Project Management: What It Is, 3 Types, and Examples* [online]. Dotdash Meredith, ©2023 [cit. 2023-04-29]. Available at: <https://www.investopedia.com/terms/p/project-management.asp>

KASHYAP S. *13 Key Project Manager Roles And Responsibilities* [online]. ProofHub, ©2023 [cit. 2023-04-12]. Available at: <https://www.proofhub.com/articles/project-manager-roles-responsibilities>

KUMAR D. *Software Engineering SDLC V-Model* [online]. ©2023 [cit. 2023-04-26]. Available at: <https://www.geeksforgeeks.org/software-engineering-sdlc-v-model/>

LEONARD K. AND WATTS R. *The Ultimate Guide To S.M.A.R.T. Goals* [online]. Forbes Media LLC., ©2023 [cit. 2023-04-17]. Available at: <https://www.forbes.com/advisor/business/smart-goals/>

LOCKHART L. *11 Strategies for Effective Stakeholder Management* [online]. Float, ©2023 [cit. 2023-04-15]. Available at: <https://www.float.com/resources/stakeholder-management/>

MILLER D. *Project Life Cycle: What Is It, Its Phases & Why It's Important* [online]. © 2023 [cit. 2023-05-05]. Available at: <https://www.proprofsproject.com/blog/project-life-cycle-and-its-phases/>

Ministry of Labour and Social Affairs. *Přehled o vývoji částek minimální mzdy* [online]. Ministerstvo práce a sociálních věcí, © 2023 [cit. 2023-04-23]. Available at: <https://www.mpsv.cz/prehled-o-vyvoji-castek-minimalni-mzdy>

NASRUDIN A. *Project-Based Organizational Structure: Strengths and Weaknesses* [online]. ©2023 [cit. 2023-04-15]. Available at: <https://penpoin.com/project-based-organizational-structure/>

OGILVY & MATHER. *A jak si děláte radost vy? Luxusní značky v roce 2016* [online]. 2016, p.8 [cit. 2023-04-17]. Available at: https://mediagurucdneu.azureedge.net/wp-content/uploads/2016/08/Studie_OgilvyMather_Luxusni-znacky-2016.pdf

ORGAN C. AND BOTTORFF C. *Work Breakdown Structure (WBS) in Project Management* [online]. Forbes Media LLC., ©2023 [cit. 2023-04-29]. Available at: <https://www.forbes.com/advisor/business/what-is-work-breakdown-structure/>

Organisation for Economic Co-operation and Development. *Czech Republic Economic Snapshot* [online]. OECD, ©2023 [cit. 2023-04-23]. Available at: <https://www.oecd.org/economy/czech-republic-economic-snapshot/>

PAL S.K. *Software Engineering Spiral Model* [online]. ©2023 [cit. 2023-04-26]. Available at: <https://www.geeksforgeeks.org/software-engineering-spiral-model/>

PATERSON K. *Kanban 101: The ultimate guide to using Kanban* [online]. Zapier Inc., ©2023 [cit. 2023-04-26]. Available at: <https://zapier.com/blog/kanban-board/>

RAY S. *The Risk Management Process in Project Management* [online]. ProjectManager.com, Inc., ©2023 [cit. 2023-04-26]. Available at: <https://www.projectmanager.com/blog/risk-management-process-steps>

RITTENBERG J, BOTTORFF C. *What Is A Project Manager, And What Do They Do?* [online]. Forbes Media LLC., ©2023 [cit. 2023-04-12]. Available at: <https://www.forbes.com/advisor/business/software/what-is-a-project-manager/>

ROLLINGS M. *The 72 Best Project Management Software To Work Faster In 2023* [online]. HIVE® INC., ©2023 [cit. 2023-04-26]. Available at: <https://hive.com/blog/project-management-software/>

SANTO D.E. *Top 5 main Agile methodologies: advantages and disadvantages* [online]. ©2023 [cit. 2023-04-26]. Available at: <https://www.xpand-it.com/blog/top-5-agile-methodologies/>

SemsoTec Group. *Official webpage service section* [online]. Semsotec.de ©2023 [cit. 2023-03-10]. Available at: <https://semsotec.de/en/>

SIENKIEWICZ A. *Work breakdown structure (WBS) in project management* [online]. Appfire, ©2023 [cit. 2023-04-29]. Available at: <https://bigpicture.one/create-work-breakdown-structure-project-management/>

SINGH V. *Scrum Framework* [online]. ToolsQA.com, ©2013-2023 [cit. 2023-04-26]. Available at: <https://www.toolsqa.com/agile/scrum-framework/>

Statista. *Inflation rate in Czech Republic* [online]. Statista, ©2023 [cit. 2023-04-12]. Available at: <https://www.statista.com/statistics/369876/inflation-rate-in-czech-republic/>

Team Asana. *39 project management terms to know* [online]. Asana, Inc., ©2023 [cit. 2023-04-12]. Available at: <https://asana.com/resources/project-management-terms>

Team Gantt. *How to Create a Simple Gantt Chart in Excel: The Best Free Templates* [online]. ©2023 [cit. 2023-04-15]. Available at: <https://www.teamgantt.com/free-gantt-chart-excel-template>

The Enterprise World. *Business in the Czech Republic* [online]. The Enterprise World, ©2023 [cit. 2023-03-26]. Available at: <https://theenterpriseworld.com/business-in-the-czech-republic/#:~:text=The%20ease%20of%20doing%20business%20ranks%20the%20Czech,business%2C%20register%20property%2C%20and%20acquire%20a%20bank%20loan>

Trading Economics. *Czech Republic GDP* [online]. TRADING ECONOMICS, ©2023 [cit. 2023-05-01]. Available at: <https://tradingeconomics.com/czech-republic/gdp>

Trading Economics. *Czech Republic Unemployment Rate* [online]. TRADING ECONOMICS, ©2023 [cit. 2023-05-01]. Available at: <https://tradingeconomics.com/czech-republic/unemployment-rate#:~:text=Czech%20Republic%20Unemployment%20Rate%20The%20Czech%20unemployment%20rate,and%20compared%20to%20market%20estimates%20of%203.8%20percent>

Trading Economics. *Household final consumption expenditures* [online]. TRADING ECONOMICS, ©2023 [cit. 2023-05-01]. Available at: <https://tradingeconomics.com/czech-republic/household-final-consumption-expenditures-final-consumption-expenditure-of-households-eurostat-data.html>

The Recursive. *Why Brno Innovation Hub Is the Silicon Valley of the Czech Republic* [online]. Recursive Media JSC, ©2020-2022 [cit. 2023-04-29]. Available at: <https://therecursive.com/brno-innovation-hub/>

USMANI F. *What is a Functional Organizational Structure?* [online]. PM Study Circle, ©2023 [cit. 2023-04-12]. Available at: <https://pmstudycircle.com/what-is-a-functional-organization-structure/>

VEGA K. *What Is Stakeholder Management? Ultimate Guide + Examples* [online]. The Digital Project Manager, ©2023 [cit. 2023-04-15]. Available at:

<https://thedigitalprojectmanager.com/projects/stakeholder-management/stakeholder-management/>

WESTLAND J. *Matrix Organizational Structure – A Quick Guide* [online]. ProjectManager.com, Inc., ©2023 [cit. 2023-04-15]. Available at: <https://www.projectmanager.com/blog/matrix-organizational-structure-quick-guide>

WESTLAND J. *The Triple Constraint in Project Management: Time, Scope & Cost* [online]. ProjectManager.com, Inc., ©2023 [cit. 2023-04-15]. Available at: <https://www.projectmanager.com/blog/triple-constraint-project-management-time-scope-cost>

Wikipedia. *Program evaluation and review technique* [online]. ©2023 [cit. 2023-05-03]. Available at: https://en.wikipedia.org/wiki/Program_evaluation_and_review_technique

WOOLL M. *10 SMART goal examples for your whole life* [online]. BetterUp , ©2023 [cit. 2023-04-17]. Available at: <https://www.betterup.com/blog/smart-goals-examples>

LIST OF ABBREVIATIONS

ACP - Agile Certified Practitioner

CEO – Chief Executive Officer

CFO – Chief Financial Officer

CPM – Critical Path Method

EV – Electric Vehicles

FMEA - Failure Modes and Effects Analysis

GDP – Gross Domestic Product

HMI – Human Machine Interface

ISO – International Organization for Standardization

PERT - Program Evaluation Review Technique

PMP - Project Management Professional

R&D – Research and Development

VAT – Value Added Tax

WBS - Work Breakdown Structure

Pcs. – pieces

€ - euro sign

% - percentage

LIST OF FIGURES

Fig. 1: Pert network chart 26

Fig. 2: Critical path identification 27

Fig. 3: Gantt chart 28

Fig. 4: Porter’s five forces model 32

Fig. 5: Mckinsey 7s 34

Fig. 6: Population aged 15 and over by highest educational attainment 42

Fig. 7: Czech republic ranking of items perceived as luxury 43

Fig. 8: Czech republic – inflation rate 46

Fig. 9: Czech republic bank lending rate 47

Fig. 10: Czech republic unemployment rate 47

Fig. 11: Czech republic household final consumption expenditures 47

Fig. 12: Work breakdown structure 65

Fig. 13: Risk map 73

Fig. 14: Spider web graph 77

Fig. 15: Project critical path 80

Fig. 16: Gantt chart 81

LIST OF TABLES

Table 1: Sample of criteria for slept analysis 31

Table 2: Czech republic’s gross domestic product (2016-2021) 45

Table 3: Semsotec SWOT analysis 57

Table 4: Initial project charter 59

Table 5: Project identification document 60

Table 6: Logical framework 61

Table 7: Work breakdown structure 64

Table 8: RACI matrix criteria 67

Table 9: RACI matrix 68

Table 10: Risk analysis - description 69

Table 11: Risk analysis – assessment 72

Table 12: Risk analysis – risk reduction 74

Table 13: Project timeline 79

Table 14: Project implementation costs 82

LIST OF ANNEXES

Annex 1: Semsotec hierarchy..... 97

Annex 2: Interview with semsotec’s project manager of the V project 98

ANNEX 1: SemsoTec Hierarchy

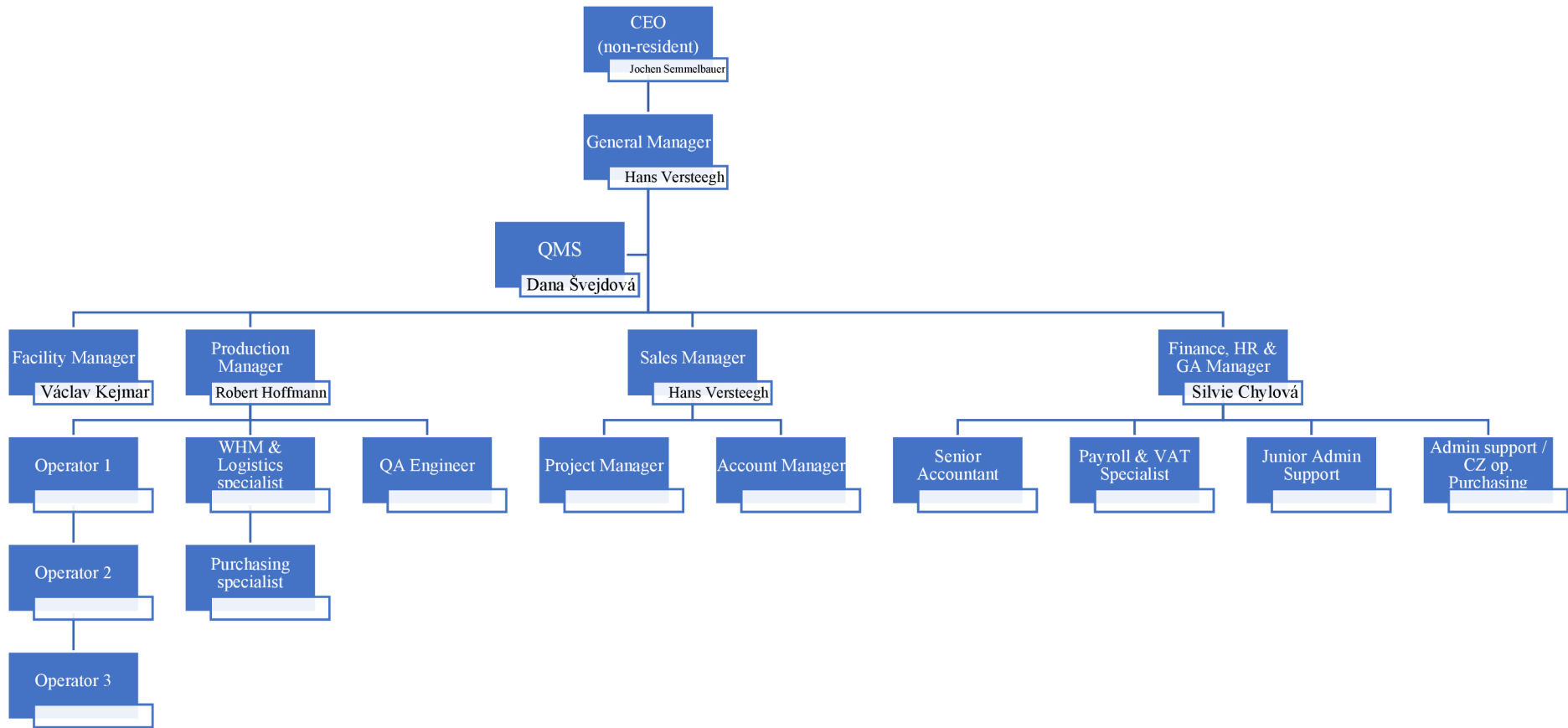

ANNEX 2: Interview with SemsoTec's Project Manager of the V Project

1. What are the impediments (external/internal factors) that could stop this project from going smoothly?

Obstacles grow over time. Some of them arise at the very beginning of a project when you need to establish, among other things, the personal relationships with all the people involved i.e. directors, production managers, and engineers. It's enough to make one of them unsatisfied on a personal level, and the whole project can go down the drain. This is because such projects are long-term programs, and the personal level is very important.

After the personal level is "tested", sometimes very thoroughly, and the client chooses you as one of the possible suppliers or manufacturers, the next phase begins. The phase, where the design and technical proposal is mainly considered. Coming up with your own design greatly increases the probability of success.

In our case, it was the first frameless glass overlay with router-edged and subsequently polished margins, with rounded corners.

Eventually, we came up with a faceted design that was changed from 4 to 8 facets. Finding the right glass supplier was much more difficult than we first thought. In the beginning, the biggest problem was the price. It was too expensive for mass production. The facets were mostly handmade and the production cost was too high. Once the basic design was developed and we found the right supplier, work on the product went in the right direction. It went from being a simple display through which the entire smart home could be controlled by an interior design accessory, looking as a luxurious piece of furniture.

However, there was a new requirement: when turned off, there should be no visible difference between the printed frame and the display. The sensor and the camera for communication had to be located in the notches of the printed frame.

This requirement was solved by using a special anti-reflective film that blocks 99.9% of reflected light. This made the holes in the frame perfectly hidden. However, the sensors could still function behind the anti-reflective film. Thus, the camera and other sensors work, creating a unique solution. Indeed the display is now completely black when off. A piece of beautiful black glass on the wall.

What could stop the project? First, if the LCD panel and its In-cell sensor could not work with the 3.0-mm cover glass, the optical optimization would not function properly. Second, if this special glass could be problematic for mass production. And finally, if the glass cover had a tolerance greater than the standard 0.2 mm, it would have created a problem in the optical bonding of the display.

There were still a few details to be resolved.

2. Could you describe the costs and revenue structure and the profit margin?

The initial budget estimations indicate the unit sales price of approximately 100 €/piece and the yearly quantity of 1000 pcs for the year 2023, that will increase to as much as 10 000 – 25 000 pcs/year from 2024. The project is estimated to last 5-10 years from 2023.

3. What is the demand for this product?

MOQ and SOP are being determined at the moment.

4. Who are the main competitors? (China, Europe)

There are two main competitors from China and Europe. The closest one (at least from the geographical point of view) could be considered Continental.

5. What are your production estimations and for what price?

We are able to produce and deliver the required number of pieces according to their current requirements. Preliminary estimates are 2023 MOQ: 1000pcs, 2024 MOQ: 5000pcs, 2025 and other years MOQ around 20,000 - 30,000pcs. But as I said previously, this is being defined at the moment. Also there are many factors influencing the price.

6. How often will the production cycle happen (within a year)?

Not too often with consideration of the size of the Czech market and German/European market. There could be at most several similar systems in development or in the process of development at this time. I believe there are not more than 10.

It should be also noted, that the central display, through which the smart home is controlled, is only one part of the whole system. A number of other devices and sensors are connected to it. The software is as much a crucial part as any part of the hardware, even more important. It usually takes several years to develop such software, and hundreds of thousands, if not millions of euro spent on its development. Next step is the testing, after which if everything works as it

should, you will need to find customers. There will not be many companies with such capital (both financial and intellectual) in the EU who could afford to develop such a complicated system.

7. Who are the people involved in this project and what are their responsibilities?

Currently, I am the project manager, I found the company on the internet, contact them, did the technical purpose, quotation, design, cut-outs dimming, solved production-related problems, negotiated a deal with a Chinese LCD manufacturer. I am currently arranging a contract and constantly looking for other possible uses for this display.

Other people involved:

- Business development Manager
- Product manager
- Quality Assurance engineer
- Project manager with production involvement

8. What is the vision and mission of this project?

Perspective of this project is to sell the smart home system globally. Ideally 25 ths. pieces or more per year. There are some possibilities to have multiple size versions of 10.1" or even 15.6" display. Of course in the same faceted cover glass design.

9. Where are the materials imported from?

From our side, materials and components are:

- 7,0" LCD one is imported from China, along motherboards and other auxiliary electronics,
- Cover glass is Czech crafted glass, alongside plastic frame and housing,
- Bonding material and optical films are from Japan.

10. When will be the project launched (estimation)?

Project will be launched:

- Pre-series test production for testing and verification of basic product features will be within 2 months. 6/2023. In limited volume approx. 50 pieces.

- The first mass production will be in September-October 2023 of about 1000 pieces. This should be the final product for presentations, building installations and verification of correct functionality. Also intended for first sales.
- Then 2024 aprox. other 5000 pieces, 2025 aprox. 10000 pieces 2026, 2027, 2028 ... around 25000 pieces. These numbers are rough estimates after discussions with client.