

**Czech University of Life Sciences Prague**

**Faculty of Economics and Management**

**Department of Business Administration**



**Master Thesis**

**Influence of Creativity and Innovation on the  
Entrepreneurial Performance of a Public Electricity  
Company**

**Famous Oghomwen IGBINOVIA**

© 2016 CULS Prague

## DIPLOMA THESIS ASSIGNMENT

Famous Oghomwen Igbinovia

Business Administration

Thesis title

**Influence of Creativity and Innovation on the Entrepreneurial Performance of a Public Electricity Company**

---

### Objectives of thesis

The main objective of this study is to enhance Innovation and Entrepreneurship in the Electric Power Industry. The specific objectives under this objective will be:

1. To determine the effect of high quality electricity product on the profitability of a public Electricity Transmission Company.
2. To determine the effect of introduction of new technology on the profitability of a public Electricity Transmission Company.
3. To determine the effect of improved product development on the sales turnover of a public Electricity Transmission Company.

### Methodology

In the work both quantitative and qualitative research methods will be used to address the research objectives. Multiple methods will allow the different research objectives and questions to be fully explored. Data from researches will be used to build the whole picture of innovation and entrepreneurship in the electric power industry. Based on the data collected, comparative analysis will be made, in order to shed a light for the research objective

A quantitative technique in designing of the questionnaire was chosen in order to intelligently capture the variables that can actually determine the dependent and independent constructs of this research. Data is collected nationwide from staffers of the transmission company of Nigeria. There was no restriction on the position nor educational status of respondents in the company. Thereafter, the data collected was analyzed.

## The proposed extent of the thesis

70-80 pages

## Keywords

Innovator, Innovation, Entrepreneur, Entrepreneurship, Electric power industry, Innovative Technologies.

---

## Recommended information sources

HUQ, M. – CLUNIES-ROSS, A. – FORSYTH, D. *Development economics*. London: McGraw-Hill, 2009. ISBN 978-0-07711453-4.

NORDHAUS, W D. – SAMUELSON, P A. *Microeconomics*. New York: McGraw-Hill, 1992. ISBN 0-07-054890-0.

SAWYER, W C. – SPRINKLE, R L. *International economics*. London: Pearson Prentice Hall, 2009. ISBN 978-0132089975.

SEN, A. *Development as freedom*. Oxford: Oxford University Press, 1999. ISBN 0-19-289330-0.

WICKHAM, P A. *Strategic entrepreneurship*. Harlow: Prentice Hall, 2004. ISBN 0-273-68226-1.

---

## Expected date of thesis defence

2015/16 SS – FEM

## The Diploma Thesis Supervisor

PhDr. Oldřich Ludwig Dittrich, MPH, Ph.D.

## Supervising department

Department of Economic Theories

Electronic approval: 29. 10. 2015

**doc. Ing. Josef Brčák, CSc.**

Head of department

Electronic approval: 11. 11. 2015

**Ing. Martin Pelikán, Ph.D.**

Dean

Prague on 12. 04. 2016

## **Declaration**

I declare that I have worked on my master thesis titled "Influence of Creativity and Innovation on the Entrepreneurial Performance of a Public Electricity Company" by myself and I have used only the sources mentioned at the end of the thesis. As the author of the master thesis, I declare that the thesis does not break copyrights of any third person.

In Prague on 31<sup>st</sup> March, 2016

---

Igbinovia, Famous Oghomwen

## **Acknowledgement**

I give glory to the Almighty God the creator of this wonderful world who continuously gave me renewed strength, knowledge and inspiration to attain my goal and without all would have been meaningless.

This work would not have been possible without motivation and assistance from many people. I do like to take the chance to convey my gratitude to all of them.

I also want to seize the chance to say a big thank you to my very wonderful family. My Love, Anthonia Osahenrhunmwun Igbino. My father, Robert Omoruyi Igbino, and my mother Anna Uwumwose Igbino (nee Omoruyi), who are both sleeping in the lord. And my siblings, without them I do not know what I would have been. You all have been wonderful. God bless you real good. Amen.

I am very grateful to my supervisor, PhDr. Oldřich Ludwig Dittrich, Ph.D., for his support and patience. He has not only inspired my work, but has given valuable guidance concerning research methods and academic-skill development.

I would like to emphasize the assistance from the respondents that were involved in the answering of the questionnaire. The research data provided by them made this thesis achievable. Thanks also go to staffers of the International Relations Office, Faculty of Economics and Management, Czech University of Life Sciences, most especially, PhDr. Vlastimil Černý, CSc., MA. My deep appreciation goes to Prof. Ing. Josef Tlustý, CSc of Czech Technical University, for his immense moral and academic support. Finally, thank you to Czech University of Life Sciences, for providing excellent study environment, and equipment.

# Vliv tvořivosti a inovací na ekonomické výsledky státní elektrárenské společnosti

## Souhrn

Tato výzkumná studie zkoumala vliv tvořivosti a inovace na ekonomické výsledky státní elektrárenské distribuční společnosti formou případové studie nigerijské elektrárenské distribuční společnosti. Cílem výzkumu bylo zkoumat vliv tvořivosti a inovace na ekonomické výsledky státní elektrárenské společnosti. Pro výzkum byla využita primární a sekundární data. Primární data byla shromážděna dotazníkovým šetřením. Dotazník byl zaslán 400 zaměstnancům nigerijské elektrárenské distribuční společnosti. Získané údaje byly statisticky analyzovány. Při analýze shromážděných údajů bylo zjištěno, že tvořivost a inovace v oblasti kvality výrobků, nových technologií a vývoje nových produktů významně ovlivňují ekonomické výsledky státní elektrárenské distribuční společnosti. Studie doporučuje, aby se státní elektrárenské distribuční společnosti za účelem zvýšení výkonnosti zaměřily na zlepšení kvality jejich produkce, čehož se dá dosáhnout zaváděním nových technologií.

**Klíčová slova:** tvořivost, elektrárénká distribuční společnost, ekonomické výsledky, inovace, vývoj nových produktů, nové technologie, kvalita výrobků, Nigérie.

# **Influence of Creativity and Innovation on the Entrepreneurial Performance of a Public Electricity Company**

## **Summary**

This research study examined the Influence of Creativity and Innovation on the Entrepreneurial Performance of a Public Electricity Company: A Case Study of the Transmission Company of Nigeria. The objective of the research was to examine the Influence of Creativity and Innovation on the Entrepreneurial Performance of a Public Electricity Company. Both primary and secondary data were used for the data gathered. The survey research method was used through the distribution of four hundred (400) questionnaires to Staffers of the Transmission Company of Nigeria. Thereafter, data gotten were statistically analysed. In analysis of the data gathered, it was found that creativity and innovation through product quality, new technology, and new product development significantly affect the performance of a public electricity transmission company. The study recommends that to enhance performance and sustainability public electricity transmission companies should engage more on technology in improving the quality of its electricity product.

**Keywords:** Creativity, Electricity Transmission Company, Entrepreneurial Performance, Innovation, New Product Development, New Technology, Product Quality, Public Electricity Transmission Company, Product Innovation, Process Innovation, Technology Innovation, Transmission Company of Nigeria, Nigeria.

# Table of Content

<b>Chapter 1. Introduction</b>	<b>10</b>
1.1 Background to the Study	10
1.2 Statement of the Research Problem	11
<b>Chapter 2. Objectives and Methodology</b>	<b>16</b>
2.1 Objectives	16
2.2 Research Questions	16
2.3 Significance of the Study	16
2.4 Methodology	17
2.4.1 Research Methods	17
2.4.2 Research Design	18
2.4.3 Population of study	19
2.4.4 Sample Size Determination	19
2.4.5 Sampling Techniques and Procedures	19
2.4.6 Source of Data	19
2.4.7 Research Instruments	20
2.4.8 Validity of the Research Instrument	20
2.4.9 Reliability of the Research Instrument	21
2.4.10 Method of Data Analysis	21
2.5 Scope of Study	22
2.6 Limitation of the Study	22
2.7 Definitions of Terms	22
<b>Chapter 3. Literature Review</b>	<b>24</b>
3.1 Conceptual Framework	24
3.1.1 Concept of Electricity Transmission	24
3.1.2 Importance of Transmission of Electricity	27
3.1.3 Challenges of Electricity Transmission in Nigeria	28
3.1.4 Creativity	30
3.1.5 Enhancing Creativity in Companies	30
3.1.6 Innovation	31
3.1.7 Classification of Innovation	32
3.1.8 Managing Creativity and Innovation	33



3.1.9 The Need for Creativity and Innovation in Electricity Transmission	
Companies	34
3.2 Theoretical Framework	35
3.2.1 Disruptive Innovation Theory	35
3.3 Empirical Framework	38
3.3.1 Creativity, Innovation and Companies Performance	38
3.3.2 Product Quality and Companies Performance	39
3.3.3 Technology and Electricity Companies Performance	40
<b>Chapter 4. Practical Part</b>	<b>41</b>
4.1 Data Presentation, Analysis and Interpretation	41
4.2 Data Presentation	41
4.3 Analysis of Data	41
<b>Chapter 5. Results and Discussion</b>	<b>72</b>
5.1 Product Quality	72
5.2 New Technology	74
5.3 Improved Product Development	75
5.4 Business Performance	77
<b>Chapter 6. Conclusion, Suggestion and Recommendations</b>	<b>79</b>
6.1 Conclusion	79
6.2 Suggestion for Further Studies	79
6.3 Recommendations	79
<b>References</b>	<b>81</b>
<b>Appendix 1</b>	<b>92</b>
<b>Appendix 2</b>	<b>93</b>
<b>Appendix 3</b>	<b>94</b>
<b>List of Figures</b>	<b>96</b>
<b>List of tables</b>	<b>98</b>

# **Chapter 1. Introduction**

## **1.1 Background to the Study**

Nigeria has tremendous energy resources in the form of abundant gas, water and mineral resources. Yet, it is highly energy deficient (Tallapragada PVSN, 2009). The country is rated first among Oil Producing countries in Africa with an average of 2.5 million barrel per day, and with highest natural gas reserve in Africa of 176 trillion cubic feet of natural gas. It also has extensive coal resource with inferred reserves estimate ranging from 1.5 billion metric tonnes to 2.75 billion metric tonnes (Centre for People and Environment (CPE) and Tryby Energy n.d; Minerals and Environmental Corporation, 2009) and renewable resources such as water, wind and sun energy from which appreciable electricity can be generated. With the abundance of energy resources, Nigeria need not import energy to achieve a sustainable generating capacity suffices the targeted economic growth. Nigeria had been able to trace the collapse of her industrial sector, small and medium scale businesses and economic downturn to the inadequate and erratic state of the country's electricity market – several commitments by different government of Nigeria, both financial and human capital, has been thrown behind the power sector in Nigeria with its attendance still continuous with target set (Famous O. Igbinovia, 2014). Three facts define the scope of the investment problem and enormity of the policy challenges associated with the electricity crisis in the country: the current low level of electricity and energy consumption per capita by global development standards; the dismal state of socio-economic conditions; and low human development indicators. This lack of strategic planning led the nation to the present dearth in electricity that now become difficult to surmount. The need for total deregulation of the sector, may be the way forward. Privatization of power generation, transmission and supply in Nigeria will boost competition for efficiency as it does in developed countries (Iwayemi A, 2008; Elusakin J, 2013)

Thus, given the present state of the economy of Nigeria there is the need for the promotion and encouragement of entrepreneurial activities as regards electricity transmission, which will assist in growing and increasing the national income of the country. the focus of this study is on the electricity transmission company. Electric power transmission is the process by which electricity is transported over long distances to consumers. Electricity transmission is an insurance policy embedded within the energy system. A robust transmission system allows the lowest cost generation at that point to serve customers. As a result, transmission system

helps to insulate electricity consumers from the effects of natural gas price spikes, low hydroelectric years and catastrophic events. New transmission lines can make local power markets more competitive, especially in transmission constrained areas, which have only limited ability to import power since the transmission system feeding into the constrained area is congested or already is at or close to its capacity. Transmission is necessary to deliver electricity to consumers; it represents approximately 10 percent of a customer's total electric bill (World Nuclear Association, 2015; J. C. Molburg, J. A. Kavicky, K. C. Picel 2007; Matthew H. Brown, Richard P. Sedano 2004).

Creativity is the ability to realize creative product. It is a piece of work which is to a significant extent new, original, and unique, it also shows a high degree of success in a specialised field. Innovation brings a new perceived benefit or value to a customer, employee, or shareholder. The new perceived benefit ranges from minimal to massive and may be functional, psychological, emotional, or financial. (Osaenwe Timothy Adegboyega 2012; Kuczarski, T.D., Middlebrooks, A., & Swaddling, J. 2000).

To innovate is to introduce something new, that is an idea, method or device. It is a combination of processes: generating new ideas and implementation. Thus creativity and innovation brings into the business place new ideas and ways of doing things which in the long run leads to efficiency and effectiveness in production process or service rendering as the case may be and in most cases the development of new products as well as the packaging and rebranding of old products. Creativity and innovation in the transmission of electricity in Nigeria can help to solve the challenges of constant outage of electricity in the country. This research focus is to examine the Influence of Creativity and Innovation on the Entrepreneurial Performance of a Public Electricity Company. Innovations Across the Electricity Grid is full of ideas that are working for utilities and their technology partners as they design and build the grid that will provide essential service for the future, such as the evolving platform grid, which is hope to be the foundation for integrating new supply and demand resources, for customer-facing solutions, and for optimizing the energy value chain from end-to-end (Osaenwe Timothy Adegboyega 2012; The Edison Foundation 2014).

## **1.2 Statement of the Research Problem**

The deterioration of Nigeria's electricity power generation, distribution and supply has attracted much national and international criticism. The resulting negative economic and social impact has prompted various government initiatives and legislation aimed at

restructuring and reviving this strategic sector, The policy sets out the government's objectives for the sector, including divestiture by the government of its interests in state-owned entities within the sector and the promotion of competition through the full liberalization of the electricity market. The act seeks to enshrine these objectives and provide a framework for their implementation. The road map indicates the government's intention to divest from the Power Holding Company of Nigeria (PHCN) successor companies, other than the Transmission Company of Nigeria (TCN), operates as a transmission and systems operations company and is responsible for the transmission of electricity in the country; Electricity transmission in Nigeria is a natural monopoly for the state. (Folake Elias Adebawale, Sally Udoma, Chukwuka Eze, and Aniekan George Ikott 2013; Bloomberg Business n.d),

System Operation (SO) being a semi-autonomous sector under the Transmission Company of Nigeria is responsible for operating the transmission system in a safe and reliable manner. The TCN network spreads to all parts of the country and across the border to several neighboring countries, and Nigeria is a net exporter of power. The transmission system in Nigeria comprises 330 kV and 132 kV circuits and substations as shown in figure no. 1.0. The thermal generation is located in the south of the country, generally near to the sources of gas, while the hydro generation is located further north at Jebba, Kainji and Shiroro. Distribution is split into 11 zones and the distribution networks comprise 33 kV, 11 kV and low voltage circuits. System nominal frequency in the country is 50 Hz (Nigeria Electricity System Operator n.d).

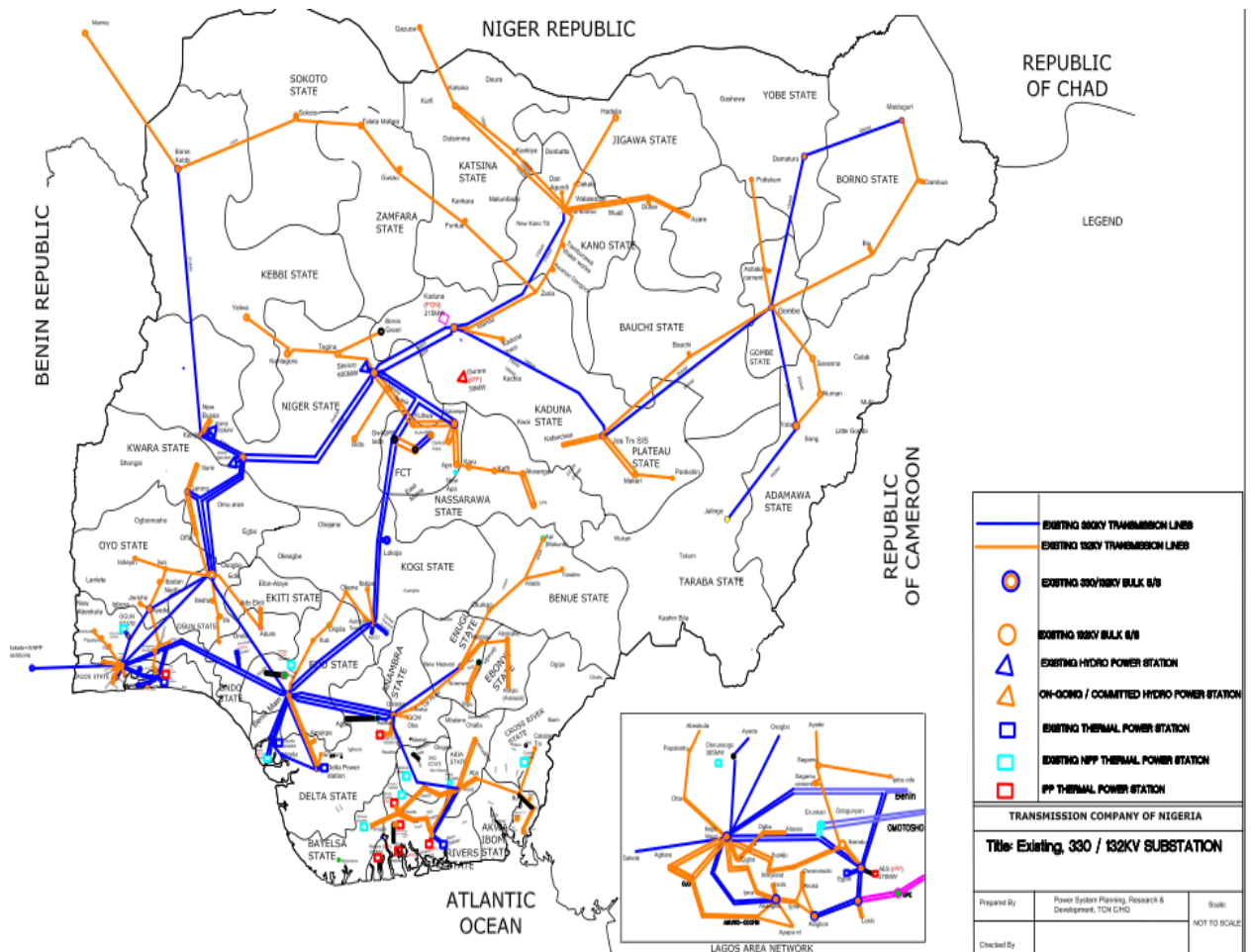

**Figure 1.0: Nigeria Electricity Transmission Grid Network**

Source: (Nigeria Electricity System Operator n.d)

The transmission network in Nigeria is characterized by several outages leading to disruption in the lives of the citizenry. The level of disruption is a function of the dependency of people on electricity, which can be very high for a developed country and not as much as developing countries. In Nigeria, the available energy generated is not enough to meet the demands of the users leading to constant load shedding and blackouts. Outages can be planned or forced. The National Control Centre (NCC), a unit of the Power Holding Company of Nigeria (PHCN), stipulated in its operational procedure that power stations and transmission stations are required to forward their planned outages schedules to NCC. This enables the NCC to plan a master programme of planned outages properly co-ordinated to ensure maintenance of Grid integrity after a thorough study and analysis of the various outages. Forced outages can be associated with aging equipment/defects, lightning, wind, birds/animals, vandalization, accidents and poor job execution by contractors. However, forced outages can be minimized

if the system is properly designed and maintained but this will not completely eliminate interruptions (Onohaebi, O.S., 2009;. Anil, P., H. Mark and T.R. Gaunt, 2007; PHCN, 2006).

Currently, the Transmission Company of Nigeria projected to have the capacity to deliver about 12,500 MW, has the capacity of delivering 4800 MW of electricity. Nigeria has a generating capacity of 5,228 MW but with peak production of 4500 MW against a peak demand forecast of 10,200MW. Implying that if the generation sector is to run at full production, the transmission grid will not have the capacity to handle the produced power reliably (Nigeria Compass 2013). This goes a long way to tell that the 330 KV transmission system is not running effectively as expected. As demand for power increases, more generating units are installed in Nigeria with no corresponding increase in transmission capacity. This makes the transmission lines run at their maximum power capacity which is very dangerous as there is too much power in the system at any moment. This power will be shifted to any available portion of the transmission system in case of any contingency thereby overloading the available portion. Figure no. 1.1, vividly shows the one-line diagram of the Nigeria 330-KV transmission grid (Chibuzo Nnonyele and Theophilus Chukwudolue Madueme (2013).

Despite the numerous studies that exist on the Nigerian Transmission Grid Network, there are still many evident cases of failure on the network. This shows that a gap still exist in literature on the effective execution of the Nigerian Transmission Network for greater impact to the economy. Hence this study examined the Influence of Creativity and Innovation on the Entrepreneurial Performance of the Transmission Company of Nigeria.

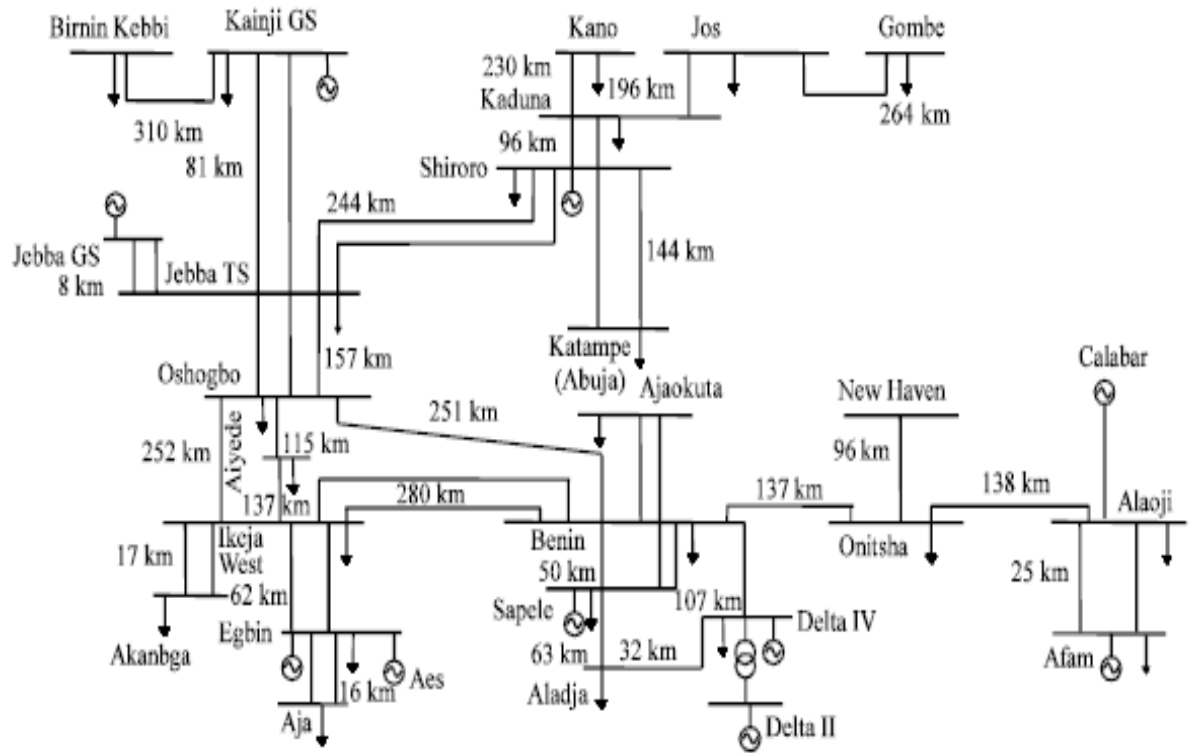

**Figure 1.1: One-line Diagram of the Nigeria 330-KV Transmission Grid**

Source: (Chibuzo Nnonyelu and Theophilus Chukwudolue Madueme, 2013)

## **Chapter 2. Objectives and Methodology**

### **2.1 Objectives**

The general objective of this study is to analyze the Influence of Creativity and Innovation on the Entrepreneurial Performance of a Public Electricity Company. The specific objectives of this study are as follow:

- i. To determine the effect of high quality electricity product on the profitability of a public Electricity Transmission Company.
- ii. To determine the effect of introduction of new technology on the profitability of a public Transmission Company.
- iii. To determine the effect of improved product development on the sales turnover of a public Electricity Transmission Company

### **2.2 Research Questions**

To achieve the above mentioned objectives, the following questions were addressed

- i. To what extent does the quality of product/services affect the profitability of a public Electricity Transmission Company?
- ii. How does the introduction of new technology affect the productivity of a public Electricity Transmission Company?
- iii. To what extent does new product development affect the sales turnover of a public Electricity Transmission Company?

### **2.3 Significance of the Study**

Electricity transmission companies that engage in creative and innovative behavior that characterized a company's level entrepreneurship are major contributors to the economic development and growth in world economies. Thus, the findings of this study is relevant to the Nigerian economy as the continuous growth and improvement of the electricity transmission firm as well as its sustenance lead to a robust economy especially in this time of economic crisis.

This study is also significant in helping the entrepreneurial development of the transmission company of Nigeria to engage in creative and innovative processes to ensure the sustainability



of the industry. Evaluation of the performance of transmission company's is a topic that has attracted the interests of several researchers but it is still at its nascent stage in Nigeria. Hence, this study added to knowledge in this area and is a base for further research and academic criticisms.

## **2.4 Methodology**

In order to correctly capture the influence of creativity and innovation on entrepreneurial performance of the Transmission Company of Nigeria, both primary and secondary data were used. The quality of electricity product and technology were used to determine creativity, and improved electricity product development was used to determine innovation. Profitability, productivity and electricity transmission sales turnover were used to determine the entrepreneurial performance of the Transmission Company of Nigeria (TCN). The Primary data were gotten through the administration of questionnaires while the secondary sources used included information on the activities of the company gotten from, abstracts, dissertations, journals, magazines, newspapers, periodicals, textbooks, and so on.

A quantitative technique in designing of the questionnaire was chosen in order to intelligently capture the variables that can actually determine the dependent and independent constructs of this research. Data is collected nationwide from staffers of the transmission company of Nigeria. There was no restriction on the position nor educational status of respondents in the company. Thereafter, the data collected was analyzed.

### **2.4.1 Research Methods**

Research is the process of getting reliable answers to significant questions using a systematic procedure of gathering, analyzing and interpreting evidence. Its end product is knowledge. Research is a structured enquiry that utilizes satisfactory scientific methodology to resolve problems and create new knowledge that is normally relevant. Scientific methods or techniques consist of systematic observation, classification and interpretation of data. There are three main types of research methods. These are survey research, experiment/ observation and ipso facto Research. Other research methods or techniques include case study, action research, grounded theory, ethnography, and archival research. The survey research method is the research in which questionnaires are used to collect the opinion of people. It is mostly used for exploratory and descriptive research. Case studies may be described as the thorough study of a particular case where the purpose of that research is partly to capture a larger group of case studies, such as a population. Case study research may incorporate several cases, that

is, multiple case studies. The survey research method was used in this study with the aid of questionnaires for data collection on the opinions of respondents who are all staffers of the transmission company of Nigeria (Dawson, Catherine, 2002; Kothari, C.R.,1985; Kumar, Ranjit, 2005; Osaenwe Timothy Adegboyega 2012).

### **2.4.2 Research Design**

This is a detailed outline of how an investigation will take place. It typically include how data is to be collected, what instruments will be employed, how the instruments will be used and the intended means for analyzing data collected. Research design is the science and art of planning the procedures for conducting studies so as to get the most valid findings. It is the conceptual structure within which research will be conducted. Research design is the plan, structure and strategy of research investigation conceived so as to obtain answers to research questions and control identified variables. Research can be classified based on the purpose, process, logic and outcome. The purpose focuses on the reason for conducting the research. The process concerns the technique in which data is collected and analysed both in a quantitative and qualitative research, logic explains the drift from general to specific i.e. deductive or inductive research or vice versa and the outcome illuminates whether the researcher is trying to solve a particular problem or make a general contribution to knowledge. The procedure used in selecting research design in this study was synthesizing several design alternatives which emphasize different design objectives, to characterize the alternatives in terms of precision, cost, and operational problems, and to achieve a consensus on the best overall design (Business Dictionary n.d; Vogt, W.P. 1993; Kerlinger F.N. 1983; Collis, J. and Hussey, R. 2003)..

This study however adopted the survey research design. The survey research design method was used in this study, by collecting data through questionnaire from population of interest. It involved using a self-designed questionnaire in collecting data from the respondents. This data collection method collects the opinion, views and perspective of respondents regarding the issue of research interest. It allows collection of data which is analyzed quantitatively. This is chosen in order to make reference to phenomena as they exist in real life and it is relatively economical in terms of time and resources. This is because of the large sample size of the study and the sample size comes from a wide geographical area.

### **2.4.3 Population of study**

Population is a set of objects or observations about which conclusions will be drawn. Because the Transmission Company of Nigeria is still under Government monopoly, the population of this study was the entire staff of the transmission company of Nigeria

### **2.4.4 Sample Size Determination**

This study considered all staffers of the transmission company of Nigeria. Four hundred (400) questionnaires were administered to staffers of the company. Out of the four hundred (400) questionnaires that were distributed to respondents, three hundred and sixty-eight (368) were found valid. Further details are given in the section for data presentation, analysis and interpretation. There was no restriction to the level of education or position of respondents. In order to effectively measure creativity and innovation in the electricity transmission companys performance, this study focused on every staff of the company irrespective of the years they have been employed with the company.

### **2.4.5 Sampling Techniques and Procedures**

Sampling techniques can be either probability sampling techniques or non-probability sampling techniques. In the case of probability sampling techniques, each element has a known probability of being covered in the sample but the non-probability sampling techniques do not allow researchers to determine the probability. Probability sampling techniques include simple random sampling, systematic sampling, stratified sampling, cluster/area sampling while non-probability sampling techniques include convenience sampling, judgmental sampling and quota sampling techniques. However this study utilized the convenience sampling technique in selecting the sample size of the study based on convenience and easy accessibility to the respondents.

### **2.4.6 Source of Data**

There are basically two ways of sourcing data. These are primary and secondary sources.

- **Primary Source of Data**

These are first hand information that was refined for the purpose of this research. This study made use of the questionnaire as a major source of primary data. This is also known as internal source of data.

- **Secondary Source of Data**

This refers to information already in existence, having been collected originally for some other purposes. These sources form the bedrock of information used for this thesis. This includes the reviewing of articles that have to do with creativity, innovation and the performance of a public electricity transmission company in current journal, textbooks, Newspapers, internet and so on.

#### **2.4.7 Research Instruments**

Research instruments are those tools which are being used to collect data for the purpose of testing hypothesis and answering research questions. To enable the collection of data and analysis, the researcher needs various types of instrument specifically designed for various purpose. The selection of research instruments depended on such factors as the nature of the study. The research instrument for this study was the questionnaire. Questionnaire is an instrument containing some questions and/or statements, some with suggested alternative answers for which respondents are expected to provide answers to the questions or confirm the statements (David Wilkinson and Peter Birmingham 2003; Osaenwe Timothy Adegboyega 2012). The questionnaire that was used in the study was divided into sections. Section A; contained information about the respondents that is their gender, marital status, educational qualification, years of working experience etc. Section B; contained items on innovation and creativity as it relates to performance of a public transmission company. With regards to the scoring of responses, the first section of the questionnaire did not attach any score to it, since the information gotten from that section were the demographic data of the respondents. The second section that is “B” was ranged from 5-1 point scale in the following pattern. Strongly agree: 5 Agree: 4 Undecided: 3 Disagree: 2 Strongly Disagree: 1.

#### **2.4.8 Validity of the Research Instrument**

A number of concepts are involved in a discussion of validity. Different types of validity have been identified. These include; the predictive validity which is the ability of an instrument to predict some future events, the concurrent validity which is usually measured by the calculation of a correlation coefficient between the distribution of test scores and some concurrently existing criterion measure, the content validity which is essentially determined by the process through which the items were selected, the construct validity whereby a researcher devises an instrument in terms of how much the results obtained fit the theoretical

formulations that constitute its development, the face validity which is concerned with the extent to which the researcher believes the instrument is appropriate, and the pilot study which is a small study designed to test logistics and gather information prior to a larger study, in order to improve the latter's quality and efficiency.

A pilot study can reveal deficiencies in the design of a proposed study or procedure and these can then be addressed before time and resources are expended on large scale studies. The research made use of the pilot study to test the validity of the research instrument used in the research. Participants of the pilot study were contacted by the researcher face to face explaining the research objective and asked them to participate.

#### **2.4.9 Reliability of the Research Instrument**

Reliability test measures the extent to which the research instrument consistently measures what it intends to measure. There are several methods for measuring the reliability of the research instruments. Cronbach's Alpha method is commonly used for measuring questionnaires reliability. The range of the coefficient values from 0 to 1. A research instrument with high reliability would tend toward 1, while an instrument of low or no reliability would have a score close to or at 0

#### **2.4.10 Method of Data Analysis**

For analyzing the data collected from the employees of the Transmission Company of Nigeria, literatures were searched in order to find similarities and differences in already existing models and theories and examples of creative and innovative activities already implemented in companies. Grounded theory methodology was used for analyzing the data collected, this method is appropriate for this analysis since it is concern with data collection and analysis, which are closely related to one another. Several tools are used to investigate research question, but for the purpose of this research survey theoretical sampling and constant comparison tools were used. Inferential statistics was then used to reach conclusions and make generalizations about the characteristics of populations based on data collected from the sample. Descriptive statistics was used to analyze the demographic data (Bryman, A. and Bell, E. 2003; Toma Martinkute and Kian Skandarioon 2013; Osaenwe Timothy Adegboyega 2012).

## 2.5 Scope of Study

This study examined the influence of creativity and innovation on the entrepreneurial performance of the transmission company of Nigeria. Transmission Company of Nigeria PLC operates as a transmission and systems operations company. The Transmission Company of Nigeria is solely responsible for the transmission of electricity in Nigeria; which is a natural monopoly for the state. To effectively measure creativity, innovation, and entrepreneurial performance of a public transmission company, this study considered the transmission company of Nigeria.

## 2.6 Limitation of the Study

In the course of carrying out the study, some constraints were encountered as outlined below. These include:

- i. Financial constraints
- ii. Limited time available for the research work.
- iii. Reluctance of respondents to answer questions.

## 2.7 Definitions of Terms

**Creativity:** means the production of novel and beneficial ideas in any domain. Creativity refers to the generation of novel, beneficial idea, and employees' ability to create new practical ideas. It is usually referred to as the start point of innovation.

**Entrepreneurial Performance:** this study defines sustainability as the continual existence of a firm as a result of its productivity, profitability, sales turnover, increased consumer base etc.

**Innovation:** is the successful implementation of novel ideas within a company. Innovation can be viewed as a novel idea that has been implemented and generally accepted which makes a company unique or produce a unique product or services.

**New product development:** is the terminology used to describe the complete process of bringing a new product to the market.

**New technology:** is defined as the machine as well as information used in production which makes production process easier or uncomplicated.

**Process Innovation:** deals with the introduction of new processes for making or delivering goods and services.

**Productivity:** This is a measure of the efficiency of production. Productivity is a ratio of production output (finished product) to what is required or essential to produce it (raw materials). The measure of productivity is defined as a total output per one unit of a total input.

**Product Quality:** Product quality is defined as a product that is made through innovation to efficiently or competently meet the needs of consumers.

**Product Innovation:** is the introduction of a new product or an important qualitative change in an existing product.

**Profitability:** This is the capability of a business to make profit from the sales of its product or the rendering of a service over time.

**Sales turnover:** is the amount of times an electricity product of a firm is sold in a period of time

**Technological Innovation:** encompasses the introduction of production techniques used to design, make, package, and deliver goods and services in the economy.

## **Chapter 3. Literature Review**

The electricity sector in Nigeria has been constrained by many factors, among which are generation deficit, weak transmission and distribution infrastructure, poor utility performance, and a long period of investment and maintenance neglect. The performance of the sector is much below international best practice. The Electricity Sector Reform Act in the country was enacted in March 2005 with the fundamental objective of ensuring that Nigeria has an electricity-supply industry that can meet the needs of its citizens. This has led to the restructuring, unbundling and privatization of the national electricity utility. A regulatory agency has also been put in place with overall oversight functions in the sector. Nigeria is blessed with an array of conventional energy-resources, prominent among which are crude oil, tar sands, natural gas and coal. In addition, there are substantive potentials for renewable energy-resources such as hydro, solar, wind, biomass, wave and tidal, and some geothermal. Despite these resources, the country is still unable to generate enough electricity to meet its demand. As at present, the name-plate capacity for electricity generation in Nigeria is about 6500 MW. Of this, only 3959 MW is available, due to the ageing of power plants, poor maintenance and paucity of funds. Because of the poor infrastructure, load shedding and frequent power-outages are common occurrences, and the average per capita electricity annual consumption is as low as 99 kWh per person. Evidence of the impact of the poor quality, unreliability and limited availability of power supplies on Nigeria's economic development are its debilitating effects on the industrial sector. Poor power-supply is probably the most important constraint on industrial production in the country. Many manufacturers now rely on self-generated electricity for their entire production process. Also, as a result of the inadequate power supply and poor infrastructure, less than 45% of the Nigerian population has access to electric power (National Electric Power Authority 2004; International Energy Agency 2005; The World Bank 2002; F.I. Ibitoye, A. Adenikinju 2006).

### **3.1 Conceptual Framework**

#### **3.1.1 Concept of Electricity Transmission**

Electric-power transmission is the bulk transfer of energy, from generating power plants to electrical substations located near demand centers. Transmission lines, when interconnected with each other, become transmission networks. The combined transmission and distribution



network is known as the power grid (KuNal MeHta, 2014). Electrical power transmission is the process by which electricity is transported over long distances to consumers. Load center is the place where maximum power is consumed. Hence there must be some means by which the generated power must be transmitted to the load center. Electrical transmission system is the means of transmitting power from generating station to different load centers. It is the process by which large amounts of electricity produced at power plants is transported over long distances for eventual use by consumers. Electricity is sent from power plants to the transmission grid, a vast network of electric power lines and associated facilities. Due to the large amount of power involved, and the properties of electricity, transmission normally takes place at high voltage (69 kV or above). Electricity is usually shipped to a substation near a populated area. At the substation, the high voltage electricity is converted to lower voltages suitable for consumer use, and then shipped to end users through relatively low-voltage electric-power distribution lines. (electrical4u.com n.d; Solar Energy Development Programmatic EIS Information Center n.d). Figure no. 3.0 below is an illustration of the structure of the transmission and distribution grid network.

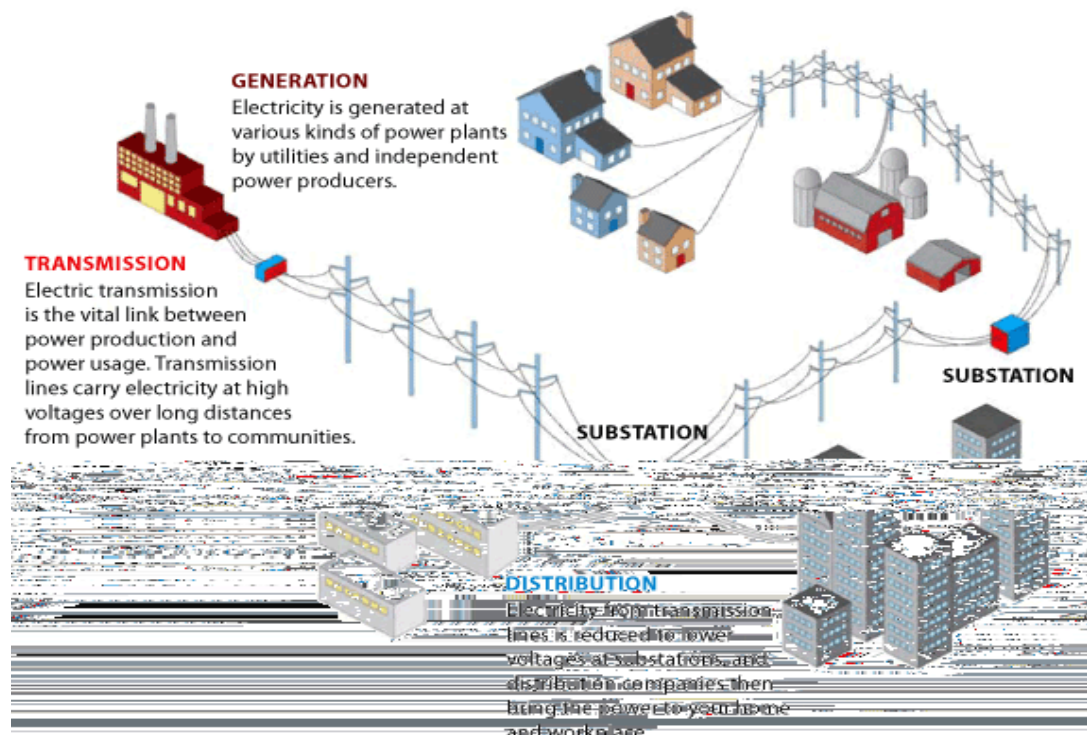

**Figure 3.0: Transmission and Distribution Grid Structure within the Power Industry**

Source: (Ali Arif Merchant and Michael F. Thompson 2010)

In the 1880s, electric lighting systems were some of the first applications of electricity to modern life. In those early electric-power systems like that of Thomas Edison's Pearl Street Station in Manhattan, which energized America's first power grid, electric power stations only served customers in a small network that covered only a few city blocks. One of the biggest differences between the small electricity grid at Pearl Street and the electricity we use today is that Edison used direct current (DC), while today's grids use alternating current (AC). Early power grids were small by today's standards, this is partly due to the physics of direct current networks. DC networks had to operate at low voltages in order to be safe, the downside being that transmitting low-voltage power is inefficient. Much of the power is lost in the form of heat, and the power simply cannot be transmitted very far. Hence, Edison's Pearl Street Station had no transmission component. Copper wires buried underground carried power only a short distance from the station to the electric lamps of Edison's customers. Pearl Street electricity technology was a huge leap forward to the beginning of modernity in the electricity industry, but grids powered by direct current only worked in densely populated areas like lower Manhattan. It was nearly impossible for anyone to implement on a wider scale. Electricity transmission is one of the pillars of advanced, industrialized economies. A typical electricity transmission line is shown in figure no. 3.1 (IER 2014; Matthew H. Brown, and Richard P. Sedano 2004; EESI n.d).



**Figure 3.1: Electricity Transmission Line**

Source: (EESI n.d)

The Transmission Company of Nigeria (TCN) is currently being managed by a Management Contractor, Manitoba Hydro International, a Canadian international company. Manitoba is responsible for revamping TCN to achieve technical and financial adequacy in addition to providing stable transmission of power without system failure. Currently, the transmission capacity of the Nigerian Electricity Transmission system is made up of about 5,523.8 km of 330 KV lines and 6,801.49 km of 132 KV lines. The TCN is made up of two major departments: System Operator and Market Operator. The Market Operations (MO) is a department under TCN charged with the responsibility of administering the wholesale electricity market, promoting efficiency and where possible, competition. The system operator is focused on system planning, administration and grid discipline (Nigeria Electricity System Operator n.d; Adewale Ajayi, Chibuzor Anyanечи, Segun Sowande, Marie-Therese Phido 2013).

### **3.1.2 Importance of Transmission of Electricity**

Electric-power is very indispensable for the fast development of the society. When electric-power is produced, it needs to be transmitted to the required places. Therefore, the power transmission is developed for efficient power transmission with less power loss during the process of transmission. Electric-power transmission is considered to be very important to the development of national economy and people's life. Industrial production greatly relies on electric-power. The whole world's demand for electricity continues to increase, and power transmission system is being continuously expanded and upgraded to meet the requirements of the world's growing population and economy. Power transmission system is widely used in factories, villages, schools, construction sites, etc. which requires large amount of consistent power. Electrical power transmission allow electric-power to be safe and efficient for people to use in life and industrial production. The transmission of power has made life simple and easy. Strong power transmission system can ensure reliable electric service and regional electricity markets. Adequate transmission has important implications for competition in deregulated electricity generation markets. The combination of inelastic demand and lack of storage means these markets are susceptible to the exercise of market power. Because it increases the number of relevant competitors, adequate transmission is necessary for competitive generation markets to function well. Having adequate transmission helps electricity markets to run more efficiently and reliably (SAC 2012; Borenstein, Severin,

James Bushnell, and Steven Stoft 2000; Wolak, Frank 2012; Ryan, Nicholas 2013; Lucas W. Davis, Catherine Hausman 2014),

### **3.1.3 Challenges of Electricity Transmission in Nigeria**

The transmission system in Nigeria does not cover every part of the country. It currently has the capacity to transmit a maximum of about 4,000 MW and it is technically weak thus very sensitive to major disturbances. To enhance transmission of electricity supply to the Nigerian Populace, several challenges need to be properly addressed. The major challenges identified are (A. S. Sambo, B. Garba, I. H. Zarma and M. M. Gaji 2010; Claudius A. Awosope 2014; Odion Omonfoman 2016; Akin Iwayemi 2008; Victor Okolobah, Zuhaimy Ismail 2013; Onohaebi, O.S., 2009; Felix Anyanrouh 2013):

- a. Funding challenges as a result of electricity transmission being funded solely by the Federal government whose resource allocation cannot sufficiently meet all the requirements, it also experiences absence of long term “patient” capital (equity/debt) to fund capital investment, high cost of borrowing, etc; All these results in weak financial and economic health of the state-owned Transmission Company of Nigeria.
- b. The electricity transmission grid in Nigeria is yet to cover many parts of the country
- c. It’s current maximum electricity wheeling capacity in Nigeria is 4,000 MW which is awfully below the required national needs;
- d. Some sections of the Nigeria electricity transmission grid is out-dated with inadequate redundancies as opposed to the required mesh arrangement;
- e. The Federal government of Nigeria lack the required fund to regular expand, update, modernize and maintain the network;
- f. The electricity industry in Nigeria experiences regular vandalisation of transmission lines by unscrupulous individuals for selfish gains, associated with low level of surveillance and security on all electrical infrastructure;
- g. The technologies used in the Nigeria transmission grid generally deliver very poor voltage stability and profiles;
- viii. There is a high prevalence of inadequate working tools and vehicles for operating and maintaining the transmission grid network in the country;
- h. There is a serious lack of required modern technologies for communication and monitoring of Nigeria’s transmission grid network;

- i. The transformers deployed for transmission of electricity in Nigeria are overloaded in most service areas;
- j. There is in-adequate spare-parts for urgent maintenance work on the Nigeria transmission grid when needed;
- k. There is poor technical staff recruitment, capacity building and training programme for employees of the transmission company of Nigeria.
- l. Many TCN transformers experiences insulation deterioration or collapse due to lightning strikes;
- m. The Nigerian transmission network usually experiences damage due to natural effects such as bird perching on the lines, felling of trees on the line or even other natural disasters like wind storm, etc.
- n. TCN grid network normally encounters fault generated due to sudden switching or other disturbance in the system.
- o. TCN encounters network infrastructure challenges as a result of overloaded transformers and feeders, obsolete equipment, limited network, lack of automation, and so on;
- q. Operational challenges faced by TCN includes, long feeders, quality of workforce, large operational areas, etc which makes the challenges more complicated;
- r. Ageing and poorly maintained transmission infrastructure facilities failures in the country;
- s. Weak institutional framework and governance failures in the country;
- t. There is no data for correct estimation of the customers to plan for in the country. Hence, uneven allocation and distribution of available resources like transmission transformers;
- u. The Nigeria National Grid control ties the whole country strongly as a single control area. This Control center is so far from some of the generating stations and this tend to inhibit effective communication in times of crisis on the transmission line.
- v. The transmission lines in the country are so long that before voltage gets to its destination it would have dropped considerably and so the supply in these areas are not adequate.
- w. Corruption in the line of execution of transmission projects in the country; Contracting for power transmission purchase agreements with state entity including payments for power transmission projects can attract corrupt practices.
- x. Poor management of public finance for transmission projects, there are frequent attempts to explore vulnerabilities on both the expenditure and revenue sides of public finance. Due to the

intricacies involved, budget management is frequently afflicted with inefficiencies and corruption.

### **3.1.4 Creativity**

Creativity is the act of turning new and imaginative ideas into reality. Creativity is characterized by the ability to perceive the world in new ways, to find hidden patterns, to make connections between seemingly unrelated phenomena, and to generate solutions. Creativity involves two processes: thinking, then producing. If one have ideas, but do not act on them, one is imaginative but not creative. It is a mental characteristic that allows a person to think outside of the box, which results in innovative or different approaches to a particular task (Linda Naiman n.d; Business Dictionary n.d)

Creativity is the construction of ideas or products which are new and potentially useful. These ideas can be internally or externally located, although the entrepreneur will tend to search and identify potential solutions shaped in part by internal competencies, creativity is the production of novel and useful ideas in any domain. Creativity entails that a product or an idea must be different from what has been done before but the product or idea cannot be merely different for difference sake, it must also be appropriate to the goal at hand, correct, valuable, or expressive of meaning. Creativity is basically a term that implies the process of developing original, novel, and appropriate response to problems. Creativity allows an organization to take advantage of opportunities which develop as a result of changing environmental conditions. Creativity plays an important role in new product development and creativity consist three techniques: brainstorming, visual confrontation, morphological techniques (Fillis, I. and Rentschler, R. 2010; Amabile, T. M. 1996; Halim, M. A. S and Mat, A. C. 2010; Phong-Inwong, P., and Ussahawanitchakit, P. 2011).

### **3.1.5 Enhancing Creativity in Companies**

The need for companies to be more competitive has sparked the interest of researchers and practitioners to better understand creativity in establishments. In today's competitive business environment, global competition forces organizations to perpetually seek ways of improving their products/services. Firms increasingly aspire to become more creative and capitalize on the benefits of creativity, and perceive the development of conditions that encourage creativity within their working environment as a long-term process rather than a quick fix to their current problems. While the capability of a company to become more creative must start

at the level of the individual, individual creativity in itself is not enough. A vital, often ignored component of creativity is the creativity that occurs at the organizational level. (Constantine Andriopoulos 2001), there are five major organizational dimensions under which sit characteristics and behavior that enhance or inhibit creativity in a work environment. These dimensions are organizational climate, organizational culture, organizational structure and systems, leadership style and resources and skills. Although the dimensions organizational climate, organizational culture, organizational structure and systems, leadership and resources and skills are explored individually it is important to acknowledge that the dimensions are somewhat overlapping and the boundaries between them are blurred. It is the sum of the whole rather than the individual parts that enhance creativity in companies. Organizational creativity is linked to a risky balance of complexity, compromise and choice, thus creative firms needs to be flexible while controlling risk, but at the same time provide the freedom to search for the new through learning and experimentation, an environment that is conducive to creativity is critical and is linked to the culture, the climate, and the physical aspects of the environment. In companies, creativity is facilitated when individuals are given maximum discretion in how they organize their work, when self-efficacy is strong, and when information is of high quality. Individual and organizational creative development is supported by structures and processes that ensure permeable boundaries, value increasing complexity, and provide safe psychological spaces (Shad S Morris and Scott A Snell (2011).

### **3.1.6 Innovation**

This is the process of translating an idea or invention into a good or service that creates value or for which customers will pay. For an idea to be called innovation, it must be replicable at an economical cost and must satisfy a specific need. Innovation entails intentional application of information, imagination and initiative in deriving greater or different values from resources, and consists of all processes by which new ideas are generated and converted into beneficial products. In business, innovation usually results when ideas are applied by organizations to further satisfy the needs and expectations of their customers (Business Dictionary n.d).

Innovation is any good service or idea that is perceived by someone as new. It is the initiation of new things, ideas, or ways of doing things/something, which is yet to be carried out by anyone or that is distinctive. Innovation is the successful implementation of a creation and

foster growth, profits and success. Many companies today because of the competitive nature of the market are innovative bringing about new ideas and modifying existing ones into their offerings. Some products catch on immediately, whereas others take a longer time to gain acceptance. Features peculiar to innovation are relative advantage which is the degree to which innovation appears superior to existing product, compatibility which is the degree to which innovation can go with the existing product of an organization, complexity which defines the degree to which an innovation is relatively difficult to understand, divisibility which defines the degree to which an innovation can be tried on a limited basis, and communicability which is the degree to which the beneficial results of usage are observable or describable to others. Products and services in the market place must have gone through new product development process or program as a result of the fact that organizations need to grow their revenue, market share and build their sales level by developing new products and expanding into new markets. To achieve this aim, companies have to put product and process innovation in all they do in order to be competitive in the industry (Kotler, P., Bowen, J.T. & Makens, J.C. 2006; Aliu, A. 2011; Henrik Berglund 2007).

### **3.1.7 Classification of Innovation**

Innovation can be classified as product and process innovation. Product innovation applies to new or improved product, equipment or service that is successful on the market. While process innovation implies the choosing of a new or improved manufacturing or distribution process, or a new method of social service. This does not mean that the two types of innovations are mutually exclusive. Process innovation may lead on to product innovation and product innovation may also influence innovation in processes. A third category of innovation is organizational change within a firm or company. Hence, further to product and process innovation, there is organizational innovation. Organizational innovation can lead to more successful utilization of human resources, which is crucial to the successful exploitation of ideas. Hence, innovations can occur in three broad dimensions, that is product, process and organizational. Creativity is occasionally used to mean innovation. This study does not in whatever way view creativity as innovation; rather it sees creativity as a start or beginning point for innovation. Creativity by individuals and teams is a beginning point for innovation. Therefore, creativity is a necessary condition to activate innovation, though it is not a sufficient condition for innovation to be activated. Innovation is the successful implementation of creative ideas within a company. Successful innovation can stem from



creative ideas that originate within an organization but it also depends on ideas that originate from elsewhere, take for instance technology transfer (Amabile, T. M. 1996).

### **3.1.8 Managing Creativity and Innovation**

Environmental hostility in Nigeria challenges companies to greater innovativeness and aggressiveness. This is hinge on the nature and type of environmental hostility. A hostile organisation business environment, which is within the control of an organisation, such as competition from other firms, scarcity of market information, and low demand for a company's services, can encourage pro-activity, aggressiveness and innovativeness. But a hostile environment outside the control of an organisation is indeed an actual or potential inhibitor of the success of a company (Agboli, M., and Ukaegbu C. C. 2006).

There are a number of challenges affecting innovation process these occur from the idea generation stage to the commercialization of the idea. A few of these challenges will be considered in this study. Including of these challenges is creativity. Large companies lack the motivational ability of small companies to encourage or motivate innovative people who have new, creative and break-through ideas. Few years after start up, A number of companies begin to feel comfortable with where they are and stop thinking about creativity. Nevertheless, some organizations depend upon historical experience to help them solve any issues confronting them and thereafter come out with solutions. Creativity in new product development can be addressed by different methods, such as technology driven product development or in most cases organizations have been successful by means of in-depth comprehension of customer's needs. The level of precedence given to innovation process in a company affects the implementation of innovate idea in such an organisation and plays a part in its achievement. Several companies list innovation as part of its goals but do not outline the necessary steps to put it into action. Also, risk aversion is the most common obstacle to innovation. Most organisations tell employees that they simply will not allow failure. The obstacle of balancing the need for success with the need to accept risk can be challenging. Innovation is risky since innovative actions intended for the future always confront uncertainty (Marnix Assink, 2006; Mahesh C and Neelankavil P. James, 2008; Kuczmarski, T.D., Middlebrooks, A., & Swaddling, J. 2000; Knight, F.H., 1971).

Innovation can create human resource risk. There is an ever-present risk of losing key workers in an establishment especially technically skilled personnel; this is so since certain projects maybe neglected to assist companies in reaching their innovative goals. There is the risk of

senior employees retiring with essential skills due to the pressure of training and learning new customs at a later stage in their career path than they had expected. Due to the fact that managers cannot predict precisely the outcome and reactions of the market, it results to uncertainty. Uncertainty makes it hard to get long-term internal support and resources. A framework has been developed by Pearson that is used for analyzing and understanding uncertainty in the process of innovation. The framework is developed as a result of research in technological innovations. It deals with uncertainty about ends and uncertainty about means. Pearson's Uncertainty Map is shown in figure no. 3.2 (Henrik Berglund 2007; Marnix, A. 2006; Trott, P. 2013; Henry, J. and Walker, D. 1991).

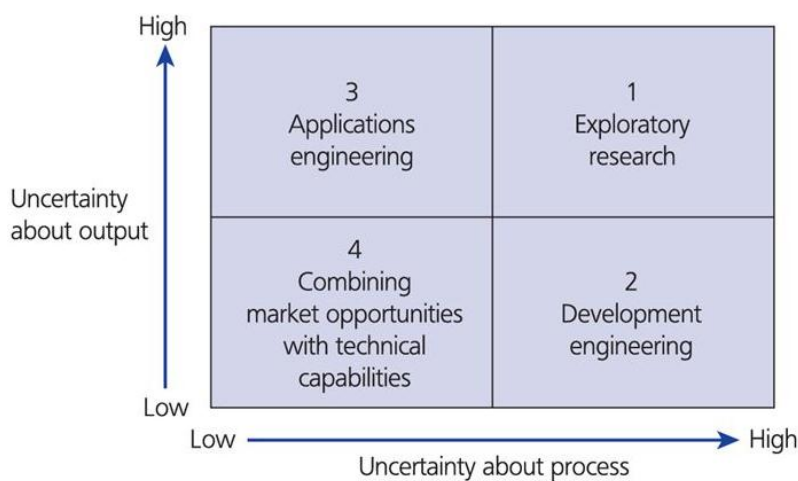

Figure 3.2: Pearson's Uncertainty Map

Source: (Trott, P. 2013)

### 3.1.9 The Need for Creativity and Innovation in Electricity Transmission Companies

The context for creativity and innovation in electricity networks is very different from that in competitive markets, where attention is mostly focused on innovation for sustainability. Electricity product is generally considered to be natural monopolies, networks are either state owned and operated or are heavily regulated. The balance of risk and reward for regulated companies is determined nearly absolutely by the nature of the regulatory regime, and these companies react to such regime by preference than to market opportunities. Electricity companies have historically been seen as risk averse and lacking the skills, capacity and

incentives for innovation (A. Smith, J.-P. Voß, J. Grin, 2010; Matthew Lockwood, 2016). As more and more of transmission networks are being established, the electric-power grid has to deal with different generating sources to ensure adequate supply of electricity product to end users, and competition become stiff in the electricity market. In other for transmission companies to achieve new gains and meet their needs and requirements, there is need for continuous search for the development of electricity product and services through innovation and creativity. Creativity and innovation will play a very significant role in helping transmission companies achieve core competence and competitive advantage in a deregulated energy economy by improving the quality of electricity product, improving the production process etc. Competitive advantage is a company's ability to perform in one or more ways that its competitors will not and cannot match. And this can be accomplished by means of creativity and innovation. At this present times, companies ought to compete to keep or gain market share. Innovation is deemed to be the key that will bring about competitive advantage in the industry (Kotler, N. G., Kotler, P., and Kotler, W. I. 2008; Stalk, G. 2006; Epetimehin, F.M. 2011).

Innovation is related with competitive advantage in both growing and mature markets. Innovation, unlike most other business organization customs can change the competitive balance in mature markets. The concept and practice of innovation is closely connected with economic gain and competitive advantage. Economic development is based on five types of economic innovations, these are: set up or discovery of a new product, a new manufacturing process, a new market, source or new organization. The chances of a small company to survive and to be successful are becoming ever more dependent on innovation. Product innovation is significant to maintain a sufficient market share, but also important is process innovation which will enable companies to produce below price level, and social innovation which is necessary to maintain a flexible and durable organization. (Brown, R. 1992; Letenyei, L., 2001; Henrik Berglund 2007).

## **3.2 Theoretical Framework**

### **3.2.1 Disruptive Innovation Theory**

This theory describes the phenomenon by which an innovation changes an existing market or sector by initiating simplicity, convenience, accessibility, and affordability where complication and high cost are the status quo. Originally, a disruptive innovation is used in a

niche market that may seem unattractive or inconsequential to industry incumbents, but in the long run the new product or idea totally redefines the industry. Disruption is a positive force, and disruptive innovations are not breakthrough technologies that make good products better or superior; by preference they are innovations that make products and services more accessible and affordable, thereby making them obtainable to a much larger population. Disruptive innovations do not try to bring better products to habitual consumers in existing markets. Preferably, they disrupt and redefine that trajectory by launching products and services that are not as good as presently obtainable products. But disruptive technologies provide additional benefits usually, they are simpler, more convenient, and less expensive products that appeal to new or less-demanding consumers

A disruptive innovation provides for a whole new population of customers access to a product or service that was historically only reachable to customers with a lot of money or skill. At any time a truly disruptive product or service takes root in simple applications at the bottom of a market it can progress persistently up market, ultimately dislodging established competitors. The disruptive innovation model is shown in figure no. 3.3. (Clayton M. Christensen, Michael E. Raynor and Rory McDonald 2015; Clayton Christensen institute n.d; The Economist 2015; Clayton M. Christensen n.d; INNOSIGHT n.d).

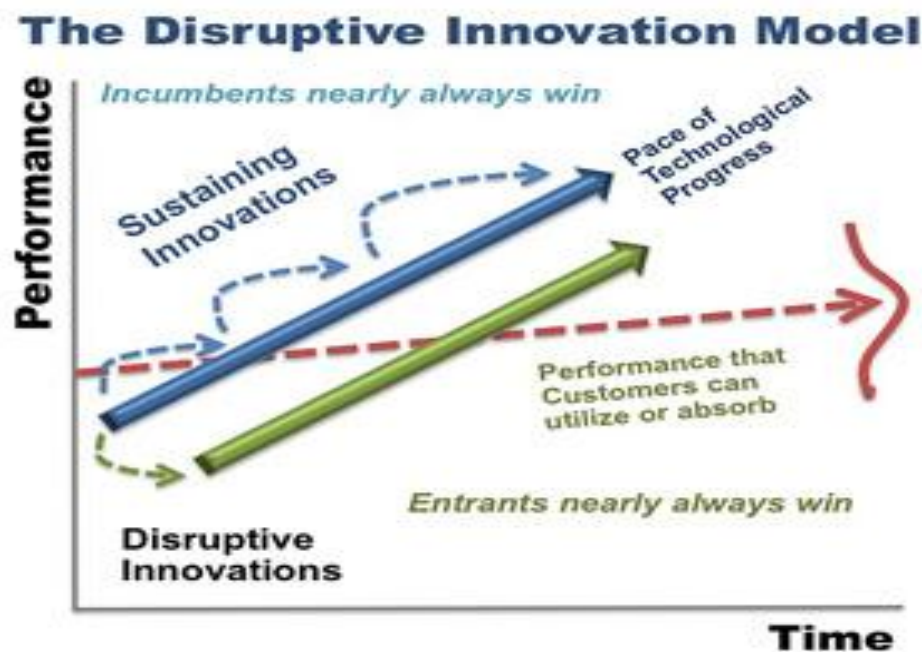

**Figure 3.3: The Disruptive Innovation Model**

Source: (INNOSIGHT n.d),

There are three strategies for bringing or introducing a product to a market. The first strategy is to look at sustaining-innovation strategy whereby a better product is brought into an established market. The second strategy is the low-end disruption strategy, where over served consumers are now served with a lower cost business model. The third is the new-market disruption, which brings the market to a different path by creating a new-market disruption and compete against non-consumption. The various disruption strategies are shown in figure no. 3.4. Since companies tend to innovate faster than their consumers' lives change, nearly all companies after a period of time end up producing products or services that are too good, too expensive, and too inconvenient for many consumers. By engaging in only sustaining innovations that maintain what has historically assisted them succeed, companies unintentionally open the door to disruptive innovations. (Raymond Seah, 2006; Clayton M. Christensen, Michael E. Raynor and Rory McDonald 2015; Clayton Christensen institute n.d).

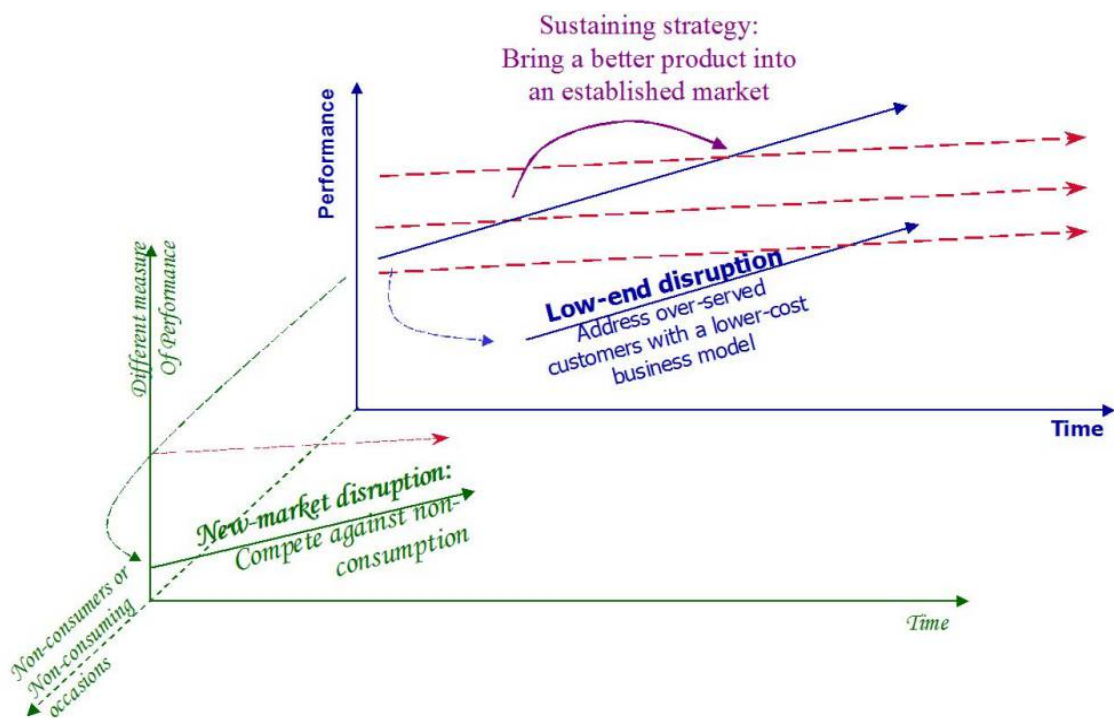

**Figure 3.4: New-Market and Low-End Disruption Strategies**

Source: (Clayton M. Christensen n.d).

### **3.3 Empirical Framework**

#### **3.3.1 Creativity, Innovation and Companies Performance**

Creativity and innovation are essential for company performance and competitive advantage. Nearly every company comes up with a good idea once in a while; or else most companies would not at all get started in the first place. The most prosperous companies make innovation a core management process. No single innovation tool or procedure will deliver consistent, profitable breakthroughs, and neither will a hodgepodge of misaligned or badly combined practices. It takes a systematic method to build a systemic capability. Success comes from focusing the company on goals, sticking to solid practices in driving in the direction of those goals and making decisions quickly and effectively. An organization hoping to enhance its innovation capacity have to assess where it is strong or weak. It can then launch targeted investments to build up its skills and develop the essential capabilities (Gary Hamel and Nancy Tennant 2015; Eric Almquist, Mitchell Leiman, Darrell Rigby and Alex Roth 2013).

Creative refers to the profitable opportunities seized by innovators, which ultimately benefit not just them but the whole society. While destruction refers to the process whereby an innovator takes away customers. Creative destruction is the outcome of the process of innovation by competing companies interacting in a given marketplace. It is a perceptive appreciation of the tension between the benefits from innovation and the costs to other firms that are standing still in terms of product design and technology. Innovation of any kind fosters the growth of small companies. However, only process innovation stimulates productivity. In a medium size companies, innovation is not very important for success. Innovation often goes along with low profits either as a reason for innovation or as a price of innovative investments. Only Research and Development (R&D) innovation in medium sized companies fosters profits. Creativity fosters product and possibly process innovation and increase of productivity only in older companies. So, the role of creativity in innovation and its success increases during a company's life cycle, possibly to compensate for increasing bureaucracy and stagnation. Research and development innovation is stimulated by flexibility and only in small companies by a mix of flexibility and control, while creativity and innovation only share risk-taking with regards to personality background. It is known that innovation has to deal with one's personal background such as level of education, self-confidence, future orientation and leadership affinity. While creativity is attributed to acceptance of challenges and entrepreneurship. Small and medium enterprises (SMEs) or

companies are normally required to attain dynamic success targets by improvement of their processes, products and services. One way of achieving this could be through quality initiatives and innovation in processes, products and services. A knowledge based economy requires the use of innovation measures in addition to quality initiatives for achieving competitiveness (Schumpeter, J. 1942; Litz, R. A. and Kleysen, R. F. 2001; Wu, J., Kuo, H., et al 2008; Heunks F. J, 1998; Hanif, A., and Manarvi, I. A. 2009).

### **3.3.2 Product Quality and Companies Performance**

Product quality and company's performance are of major interest to stake holders in an establishment. Product quality dimensions can be explained conceptually and empirically by the intrinsic and extrinsic value consumers are expecting to get from them. Research have shown that these values can be seen as antecedents to organizations internal and external performance. A company's external and internal performance can be improved not only by focusing on product quality as a holistic entity but rather by examining and emphasizing certain elements of product quality. Take for instance, companies that are more interested in sales volume and profitability than in the stability and loyalty of its workforce can emphasize those elements of the product that consumers can easily evaluate before purchase. This could be the case in industries where products are at parity and the cost of hiring, training, retaining or firing labor is minimal as it is the case in part-time labor. Alternatively, if companies are more interested in employee satisfaction and tenure more than sales volume and profitability they can emphasize those elements of the product that consumers can evaluate only after purchase. And this could be the case in monopolies, utilities, and highly technical and clearly differentiated products. However, if companies are concerned about both external and internal performance then they should concentrate on all product quality dimensions. Critical dimensions of product quality as a framework for strategic analysis include the following:-- Performance: this is the primary operating characteristics of the product;--Features: these are special supplements to the primary operating characteristics of the product;--Conformance: this is the degree to which the product's design and operating characteristics meet predetermined standards;--Aesthetics: this shows how the product looks, feels, sounds, smells, or tastes;--Durability: this has to do with the amount of usage the product offers before it must be replaced;--Serviceability: imply the speed, courtesy, and competence of service people and the speed and ease of repair of the product;--Reliability: is the probability of the product failure within a specified time frame;--Perceived quality: this is the quality as seen by the

consumer inferred from the marketer's reputation and image. This could be the case were the business is a market leader with a highly differentiated product selling at premium and it is not difficult to communicate value to consumers. This signifies the importance of certain elements of product quality in achieving certain levels of company's performance (Garvin, D., 1984; Mahmood M. Hajjat, and Fatimah Hajjat 2014; Petr Suchánek, Jiří Richter, Maria Králová 2015).

### **3.3.3 Technology and Electricity Companies Performance**

Technological innovation can assist a company to build competitive advantage through making more competitive products and services and more successful processes, or creating totally new business. Technological ability allows a company to add value to products and processes, and its impact on innovation successfulness is great. A company also needs technological management ability to manage its technology resources successfully and competently. A company's technology choice has no direct influence on innovation successfulness but technology choice has a notable positive effect on technological ability and technology management ability, which, in turn, have a remarkable positive effect on innovation successfulness; innovation successfulness has a notable positive effect on organizational performance. Research has shown that there exist a positive relation connecting technology innovation and company's performance (S. Hao and B. Yu 2011; Li, Lam, and Fag 2000).

It is believed that measuring the performance of a company can help to identify its weaknesses, and clarify its objectives and strategies, and improve management processes. While many theories on performance measurement and performance management have been developed mainly for large organizations over time, these tools are difficult to adapt for electricity transmission companies. The current development of various types of technologies in the electricity transmission industry, from recent achievements in both academic research community and industrial sectors is a positive one for the industry. A comprehensive analysis carried out based on relevant technical and economic data, on electricity transmission technologies and its application potentials has shown a synthesis of the state-of-the-art in important electricity transmission technologies, which can be used for supporting further research and development in this area and for assessing electricity transmission technologies for deployment (Donglin Wu 2009;. Xing Luo, Jihong Wang, Mark Dooner, Jonathan Clarke 2015).



## Chapter 4. Practical Part

### 4.1 Data Presentation, Analysis and Interpretation

The presentation, analysis and interpretation of the data collected during the course of this research survey is dedicated to this section. It concentrates on the investigation of the data collected from respondents. The bio-data of the respondents were analysed, thereafter the most important essence of the research survey questions which has to do with the various dimensions considered was dealt with.

### 4.2 Data Presentation

This research was conducted to find the influence of creativity and innovation on the entrepreneurial performance of a public electricity transmission company. Four hundred (400) questionnaires were administered out of which three hundred and sixty eight (368) were returned.

### 4.3 Analysis of Data

#### Gender of the Respondents:

Table 4.1 and figure no. 4.1 below revealed the gender distribution of the respondents. From the table it is seen that 87.5% of the respondents were male while 12.5% were female. This insinuate that the respondents were made up of more men than women.

	Frequency	Percentage	Valid Percentage	Cumulative Percentage
Valid Male	322	87.5	87.5	87.5
Female	46	12.5	12.5	100.0
Total	368	100.0	100.0	

**Table 4.1: Gender of the Respondents**

Source: Authors Field Survey 2016

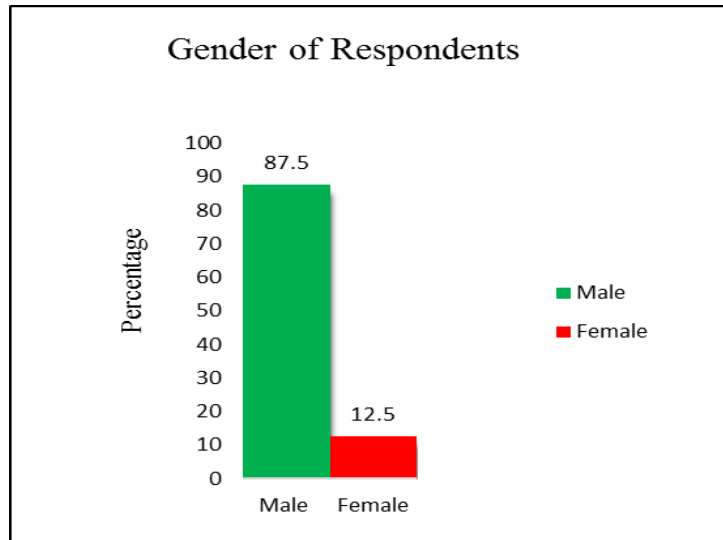

**Figure 4.1: Gender of the Respondents**

Source: Authors Field Survey 2016

### **Marital Status of Respondents**

Table 4.2 and figure no. 4.2 below presents the marital status of the respondents. It is seen from the table that 39.9% of the respondents were single, 60.1% were married, and none of the respondents chose the “others” choice which symbolizes divorced, separated, or widowed.

		Frequency	Percentage	Valid Percentage	Cumulative Percentage
Valid	Single	147	39.9	39.9	39.9
	Married	221	60.1	60.1	100.0
	Total	368	100.0	100.0	

**Table 4.2: Marital Status of Respondents**

Source: Authors Field Survey 2016

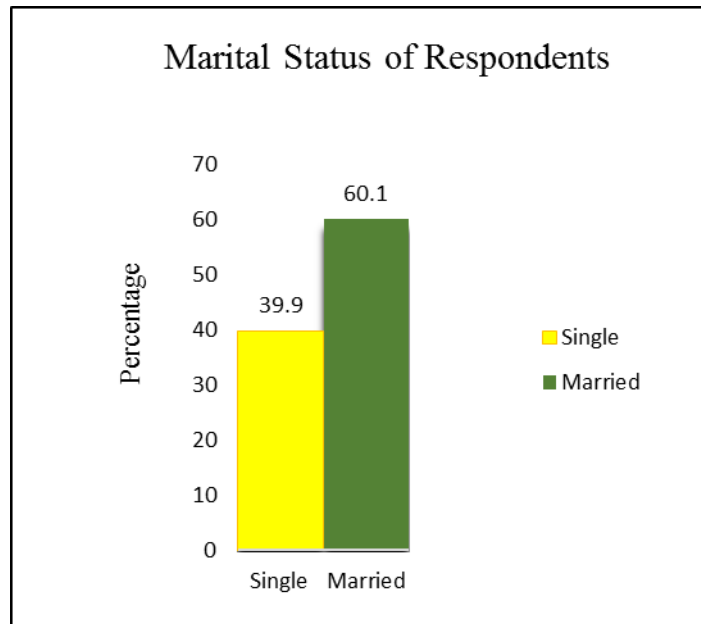

**Figure 4.2: Marital Status of Respondents**

Source: Authors Field Survey 2016

**Work experience of respondents:**

Table 4.3 and figure no. 4.3 below presents the work experience of the respondents. The table reveals that 39.9% of the respondents had work experience of between 1-5 years, 12.5% of the respondents had work experience of between 6-10 years, 15.0% of the respondents had work experience of between 11-15 years, and 32.6% of the respondents had work experience of above 15 years.

	Frequency	Percentage	Valid Percentage	Cumulative Percentage
Valid 1-5 yrs	147	39.9	39.9	39.9
6-10 yrs	46	12.5	12.5	52.4
11-15 yrs	55	15.0	15.0	67.4
Over 15 yrs	120	32.6	32.6	100.0
Total	368	100.0	100.0	

**Table 4.3: Work experience of respondents**

Source: Authors Field Survey 2016

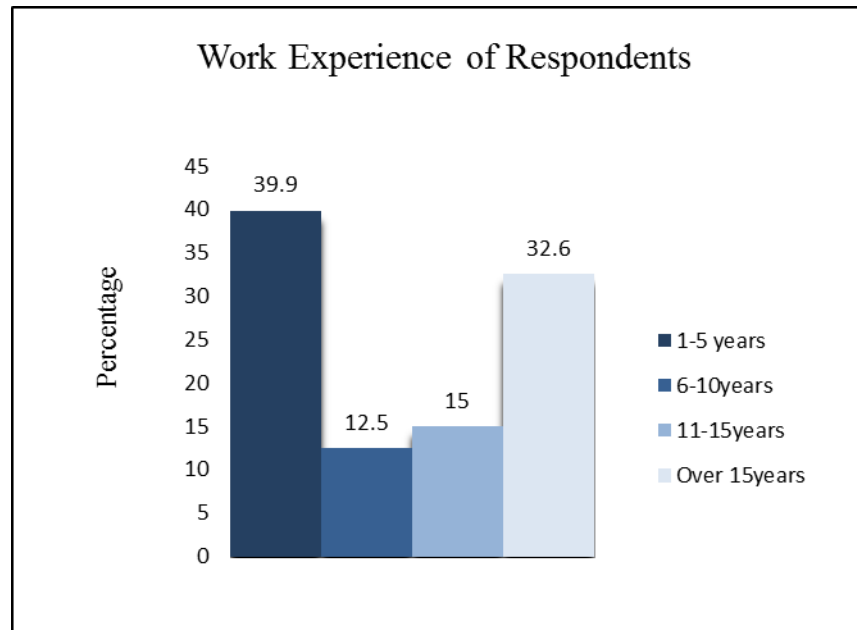

**Figure 4.3: Work experience of respondents**

Source: Authors Field Survey 2016

**Educational qualification of respondents:**

Table 4.4 and figure no. 4.4 below vividly shows the educational qualification of the respondents. From the table, it indicates that 22.6% of the respondents had Senior Secondary School Certificate (SSCE), 57.6% of the respondents were either Bachelor of Science (BSc) or Higher National Diploma (HND) degree holders, 17.4% had a Master's degree or an MBA (Master of Business Administration), and 2.4% had other forms of educational qualification.

	Frequency	Percentage	Valid Percentage	Cumulative Percentage
Valid SSCE	83	22.6	22.6	22.6
HND/BSC	212	57.6	57.6	80.2
MSc/MBA	64	17.4	17.4	97.6
Others	09	2.4	2.4	100.0
Total	368	100.0	100.0	

**Table 4.4: Educational qualification of respondents**

Source: Authors Field Survey 2016

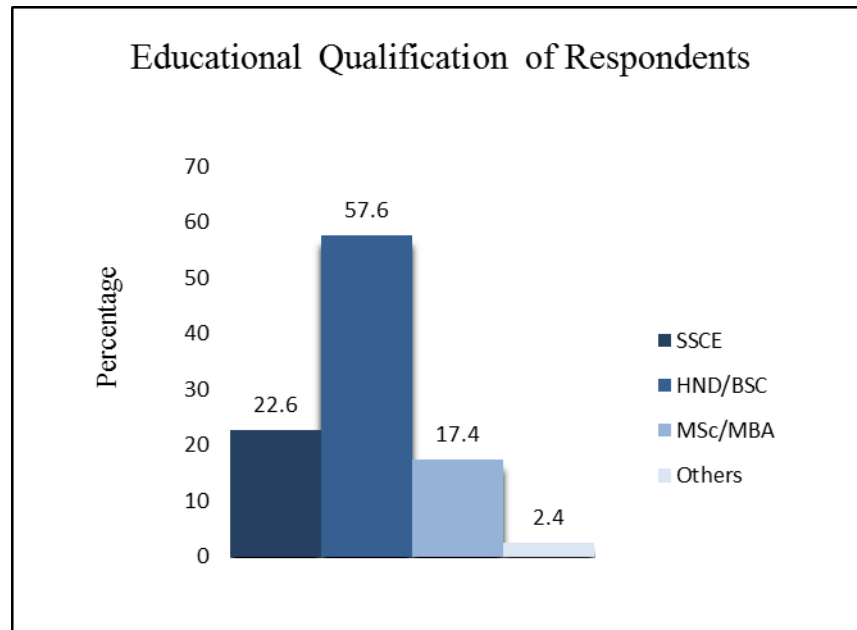

**Figure 4.4: Educational qualification of respondents**

Source: Authors Field Survey 2016

**Management category of respondent:**

Table 4.5 and figure no. 4.5 below shows the management category of the respondents. It is observed in the table that 25.0% of the respondents were in the lower level of the management category, 67.4% were at the middle level and the remaining 7.6% were among the top level managers

	Frequency	Percentage	Valid Percentage	Cumulative Percentage
Valid Lower level	92	25.0	25.0	25.0
Middle level	248	67.4	67.4	92.4
Top level	28	7.6	7.6	100.0
Total	368	100.0	100.0	

**Table 4.5: Management category of respondent**

Source: Authors Field Survey 2016

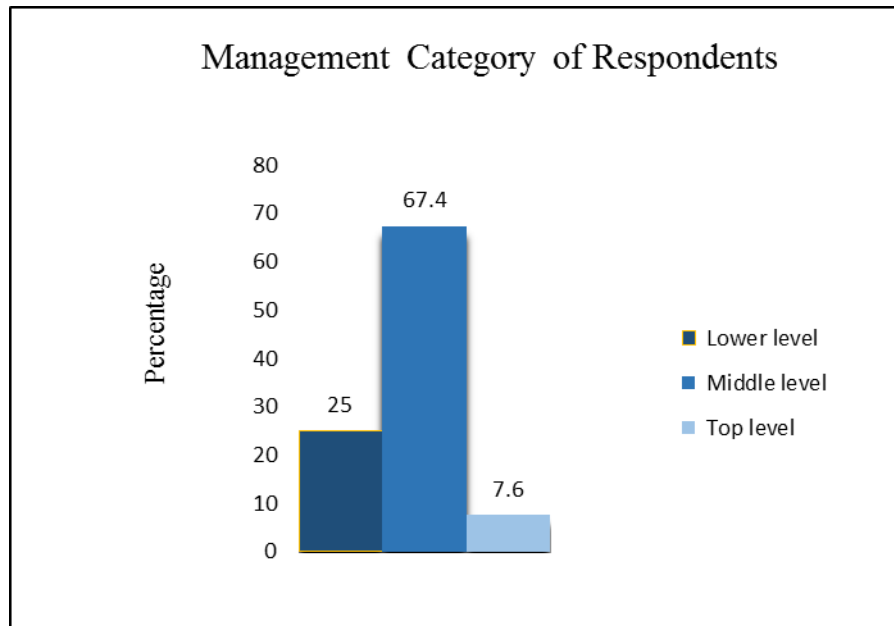

**Figure 4.5: Management category of respondent**

Source: Authors Field Survey 2016

**The quality of our company’s electricity product has made it more acceptable in the electricity market:**

Table 4.6 and figure no. 4.6 below shows that 7.6% of the respondents strongly disagreed that the quality of the company’s electricity product has made the company more acceptable in the market, 22.6% disagreed, 10.0% were undecided, 42.4% agreed, and 17.4% of the respondents strongly agreed to the proclamation.

:

	Frequency	Percentage	Valid Percentage	Cumulative Percentage
Valid Strongly Disagree	28	7.6	7.6	7.6
Disagree	83	22.6	22.6	30.2
Undecided	37	10.0	10.0	40.2
Agree	156	42.4	42.4	82.6
Strongly Agree	64	17.4	17.4	100.0
Total	368	100.0	100.0	

**Table 4.6: The quality of our company’s electricity product has made it more acceptable in the electricity market**

Source: Authors Field Survey 2016

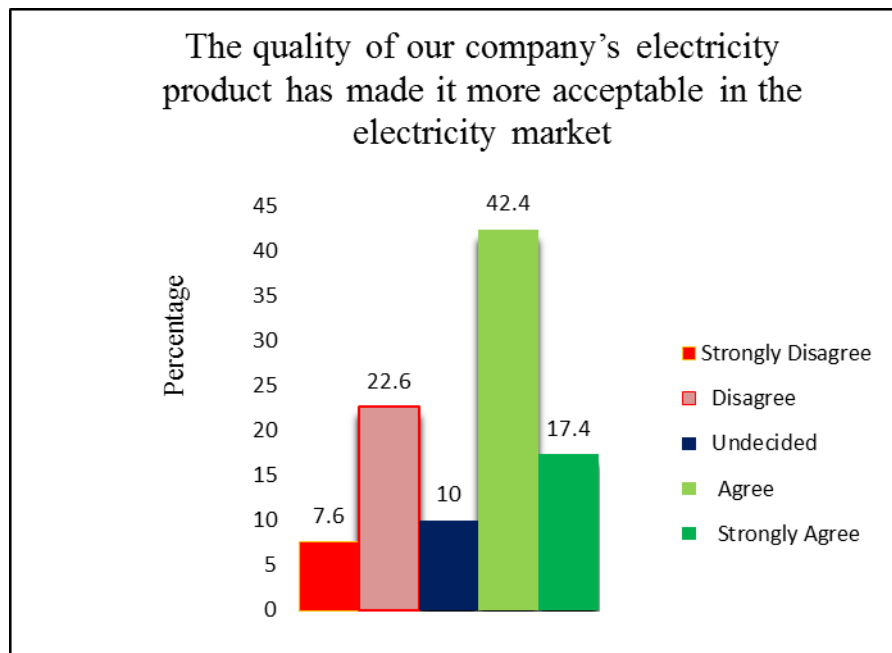

**Figure 4.6: The quality of our company's electricity product has made it more acceptable in the electricity market**

Source: Authors Field Survey 2016

**The goodwill of our company has improved as a result of quality electricity product delivered to customers:**

From table 4.7 and figure no. 4.7, it is seen that 7.6% of the respondents strongly disagreed that the goodwill of the company has improved as a result of the quality of electricity product delivered to customers, 29.9% disagreed, 10.0% were undecided, while 47.6% agreed and 4.9% strongly agreed to the affirmation.

	Frequency	Percentage	Valid Percentage	Cumulative Percentage
Valid Strongly Disagree	28	7.6	7.6	7.6
Disagree	110	29.9	29.9	37.5
Undecided	37	10.0	10.0	47.5
Agree	175	47.6	47.6	95.1
Strongly Agree	18	4.9	4.9	100.0
Total	368	100.0	100.0	

**Table 4.7: The goodwill of our company has improved as a result of quality electricity product delivered to customers**

Source: Authors Field Survey 2016

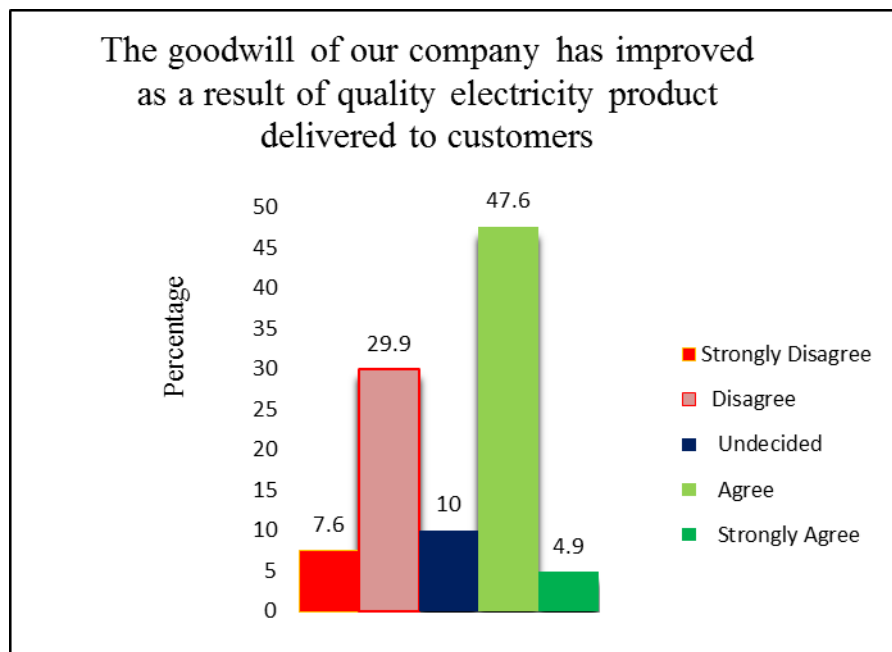

**Figure 4.7: The goodwill of our company has improved as a result of quality electricity product delivered to customers**

Source: Authors Field Survey 2016

**Our company engage in activities that lead to the creation of quality electricity product:** Table 4.8 and figure no. 4.8 below shows that 10.1% of the respondents strongly disagreed on whether the company engages in activities that led to the creation of quality electricity product, 14.9% disagreed, 17.3% were undecided, while 47.6% agreed to the assertion and 10.1% strongly agreed to the assertion. This shows that most of the respondents agreed that the company engage in activities that lead to creation of quality electricity product



		Frequency	Percentage	Valid Percentage	Cumulative Percentage
Valid	Strongly Disagree	37	10.1	10.1	10.1
	Disagree	55	14.9	14.9	25.0
	Undecided	64	17.3	17.3	42.3
	Agree	175	47.6	47.6	89.9
	Strongly Agree	37	10.1	10.1	100.0
	Total	368	100.0	100.0	

**Table 4.8: Our company engage in activities that lead to the creation of quality electricity product**

Source: Authors Field Survey 2016

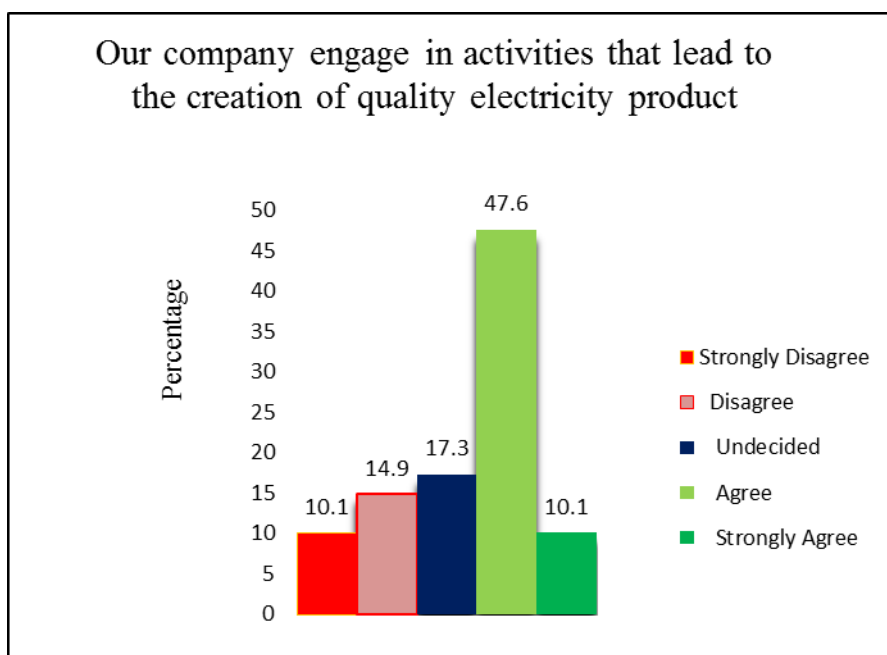

**Figure 4.8: Our company engage in activities that lead to the creation of quality electricity product**

Source: Authors Field Survey 2016

**Our company’s electricity quality control process has been of great advantage:**

Table 4.9 and figure no. 4.9 below reveals that 2.4% of the respondents strongly disagreed that the quality control process had been of benefit to the company, 20.1% disagreed, 15.0% of the respondents were undecided on the affirmation, 37.5% agreed, and 25.0% strongly agreed on the assertion.

		Frequency	Percentage	Valid Percentage	Cumulative Percentage
Valid	Strongly Disagree	09	2.4	2.4	2.4
	Disagree	74	20.1	20.1	22.5
	Undecided	55	15.0	15.0	37.5
	Agree	138	37.5	37.5	75.0
	Strongly Agree	92	25.0	25.0	100.0
	Total	368	100.0	100.0	

**Table 4.9: Our company’s electricity quality control process has been of great advantage**

Source: Authors Field Survey 2016

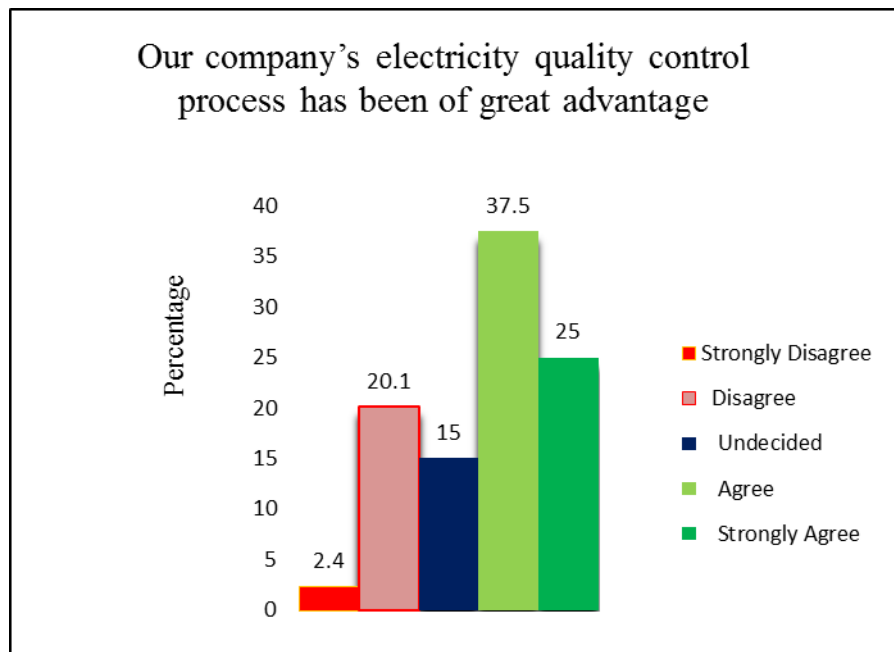

**Table 4.9: Our company’s electricity quality control process has been of great advantage**

Source: Authors Field Survey 2016

**The quality of our company’s electricity product has enhanced the pricing of electricity:**

From table 4.10 and figure no. 4.10, it is seen that 4.9% of the respondents strongly disagreed that the quality of the company’s electricity product has enhanced the pricing of electricity in the country, 35.1% disagreed, 25.0% were undecided, 25.0% agreed, and 10.0% of the respondents strongly agreed to the proclamation.

		Frequency	Percentage	Valid Percentage	Cumulative Percentage
Valid	Strongly Disagree	18	4.9	4.9	4.9
	Disagree	129	35.1	35.1	40.0
	Undecided	92	25.0	25.0	65.0
	Agree	92	25.0	25.0	90.0
	Strongly Agree	37	10.0	10.0	100.0
Total		368	100.0	100.0	

**Table 4.10: The quality of our company’s electricity product has enhanced the pricing of electricity**

Source: Authors Field Survey 2016

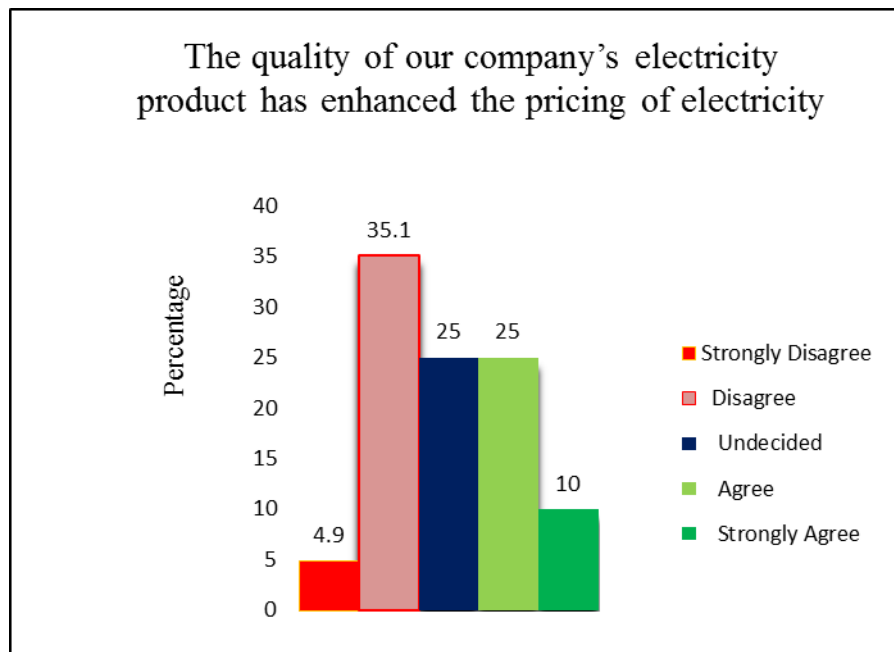

**Table 4.10: The quality of our company’s electricity product has enhanced the pricing of electricity**

Source: Authors Field Survey 2016

**Our company engage new technology in the design of electricity transmission lines:**

Table 4.11 and figure no. 4.11 below shows that 4.9% of the respondents strongly disagreed that the company engaged new technology in designing its electricity transmission lines, 12.5% of the respondents disagreed, 20.1% were undecided on the assertion, 57.6% agreed while another 4.9% strongly agreed on the assertion.

	Frequency	Percentage	Valid Percentage	Cumulative Percentage
Valid Strongly Disagree	18	4.9	4.9	4.9
Disagree	46	12.5	12.5	17.4
Undecided	74	20.1	20.1	37.5
Agree	212	57.6	57.6	95.1
Strongly Agree	18	4.9	4.9	100.0
Total	368	100.0	100.0	

**Table 4.11: Our company engage new technology in the design of electricity transmission lines**

Source: Authors Field Survey 2016

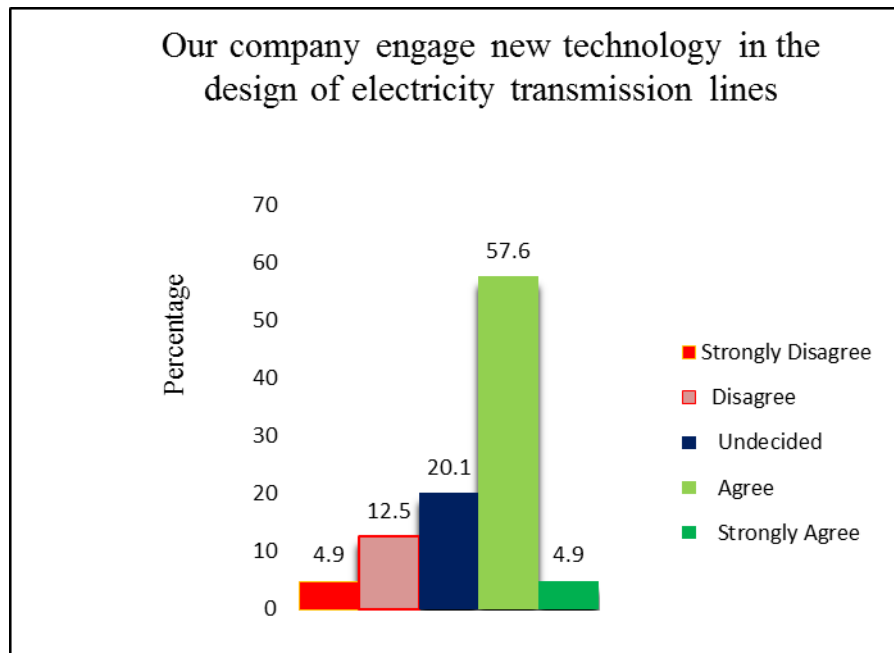

**Figure 4.11: Our company engage new technology in the design of electricity transmission lines**

Source: Authors Field Survey 2016

**Our company uses new technology in the transmission of electricity product:**

It can be seen in table 4.12 and figure no. 4.12 below that 2.4% of the respondents strongly disagreed that the company used new technology in the transmission of electricity product, 27.4% of the respondents were disagreed on the statement, 12.6% were undecided, 55.2% of the respondents agreed, and 2.4% of the respondents strongly agreed that the company used new technology in the transmission of electricity product.

	Frequency	Percentage	Valid Percentage	Cumulative Percentage
Valid Strongly Disagree	09	2.4	2.4	2.4
Disagree	101	27.4	27.4	29.8
Undecided	46	12.6	12.6	42.4
Agree	203	55.2	55.2	97.6
Strongly Agree	09	2.4	2.4	100.0
Total	368	100.0	100.0	

**Table 4.12: Our company uses new technology in the transmission of electricity product**

Source: Authors Field Survey 2016

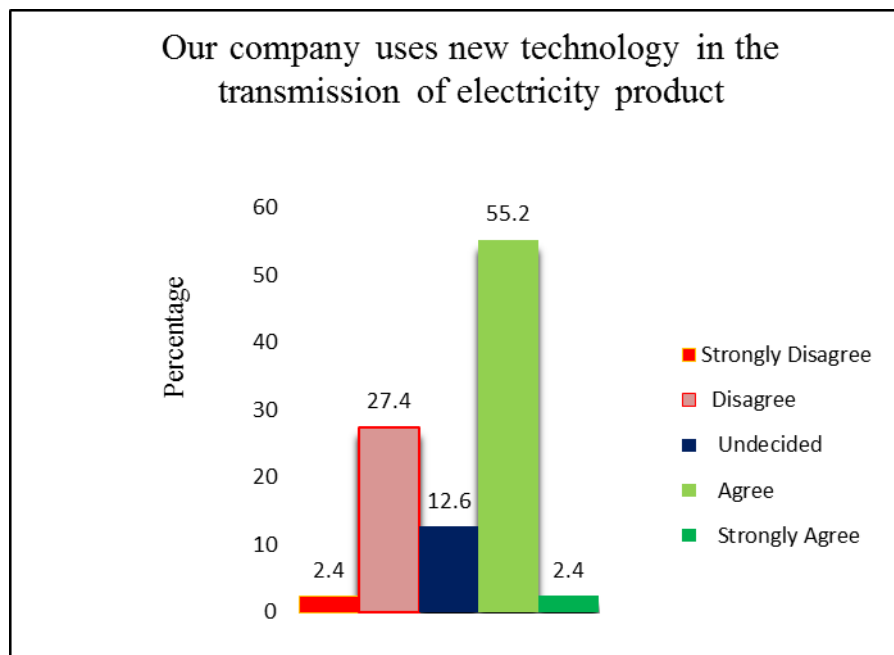

**Figure 4.12: Our company uses new technology in the transmission of electricity product**

Source: Authors Field Survey 2016

**Our company engage the use of new technology in the efficient utilization of power lines for the transmission of electricity product:**

Table 4.13 and figure no. 4.13 below reveals that 2.4% of the respondents strongly disagree that the company engaged the use of new technology in the efficient utilisation of power lines for the transmission of electricity product, 35.0% disagreed, 17.4% of the respondents were undecided, 40.0% of the respondents agreed, and 5.2% of respondents strongly agreed that the company used new technology in the efficient utilisation of power lines for the transmission of electricity product.

	Frequency	Percentage	Valid Percentage	Cumulative Percentage
Valid Strongly Disagree	09	2.4	2.4	2.4
Disagree	129	35.0	35.0	37.4
Undecided	64	17.4	17.4	54.8
Agree	147	40.0	40.0	94.8
Strongly Agree	19	5.2	5.2	100.0
Total	368	100.0	100.0	

**Table 4.13: Our company engage the use of new technology in the efficient utilization of power lines for the transmission of electricity product**

Source: Field Survey 2016

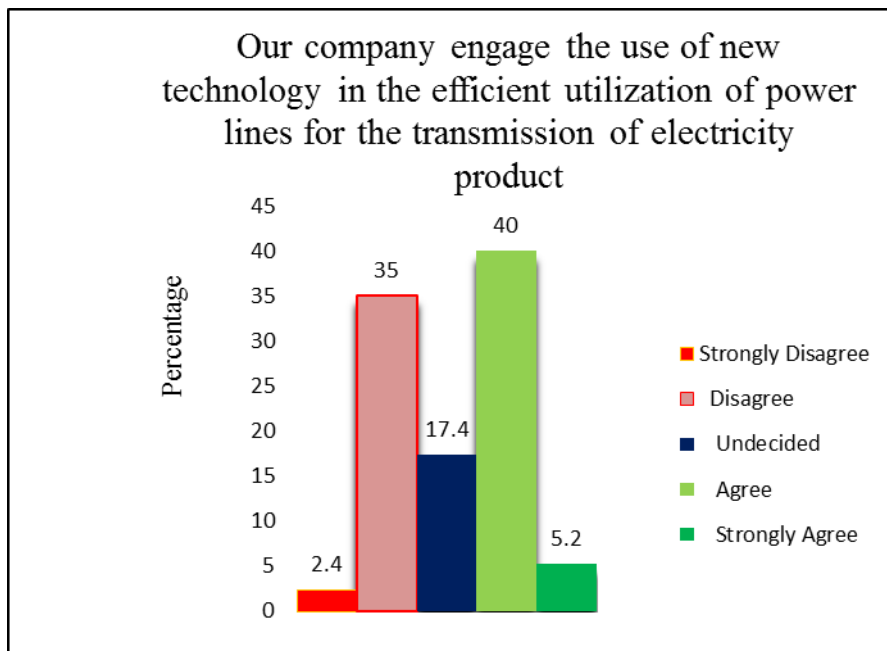

**Figure 4.13: Our company engage the use of new technology in the efficient utilization of power lines for the transmission of electricity product**

Source: Field Survey 2016

**New technology has made the transmission process of electricity in our company easier:**

Table 4.14 and figure no. 4.14 below shows that 4.9% of the respondents strongly disagreed that new technology had made the transmission process of electricity in the company easier, 29.9% disagreed, 12.5% of the respondents were undecided on the affirmation, another 45.1% of the respondents agreed, and 7.6% strongly agreed that new technology had made the transmission process of electricity in the company easier.

	Frequency	Percentage	Valid Percentage	Cumulative Percentage
Valid Strongly Disagree	18	4.9	4.9	4.9
Disagree	110	29.9	29.9	34.8
Undecided	46	12.5	12.5	47.3
Agree	166	45.1	45.1	92.4
Strongly Agree	28	7.6	7.6	100.0
Total	368	100.0	100.0	

**Table 4.14: New technology has made the transmission process of electricity in our company easier**

Source: Authors Field Survey 2016

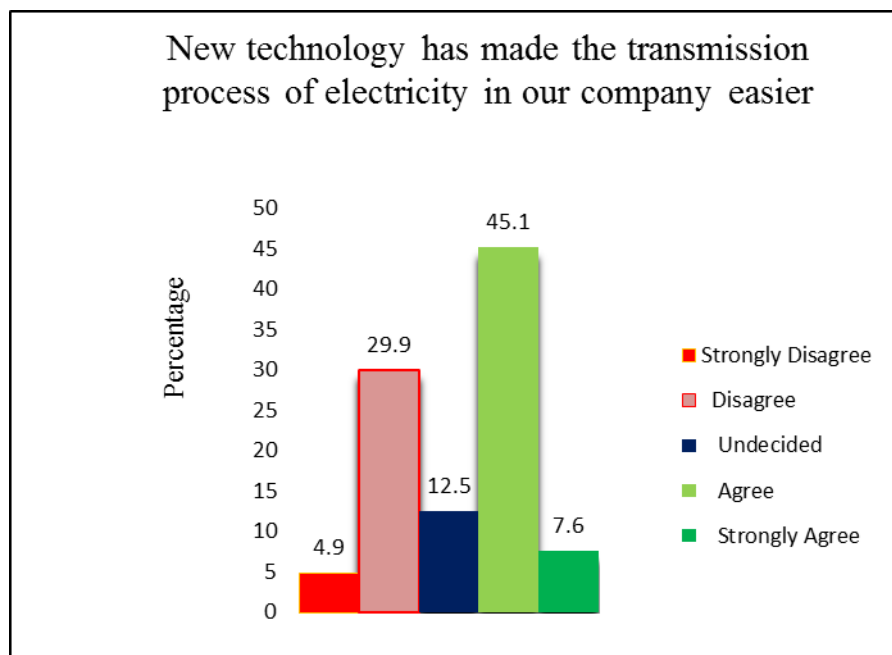

**Figure 4.14: New technology has made the transmission process of electricity in our company easier**

Source: Authors Field Survey 2016

**New technology in our company’s electricity transmission process has cut down cost of electricity transmission:**

From table 4.15 and figure no. 4.15 below, it is seen that 12.5% of the respondents strongly disagreed that new technology in the company’s electricity transmission process has cut down cost of electricity transmission, 29.9% of the respondents disagreed, 25.0% of the respondents were undecided on the statement, another 25.0% agreed, and 7.6% of the respondents strongly agreed on the proclamation.

	Frequency	Percentage	Valid Percentage	Cumulative Percentage
Valid Strongly Disagree	46	12.5	12.5	12.5
Disagree	110	29.9	29.9	42.4
Undecided	92	25.0	25.0	67.4
Agree	92	25.0	25.0	92.4
Strongly Agree	28	7.6	7.6	100.0
Total	368	100.0	100.0	

**Table 4.15: New technology in our company’s electricity transmission process has cut down cost of electricity transmission**

Source: Authors Field Survey 2016

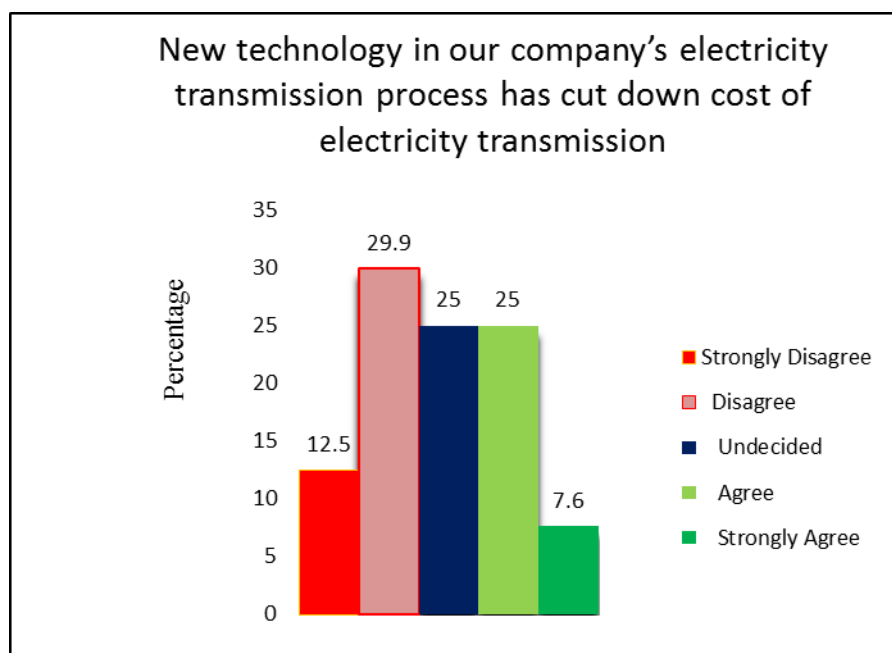

**Figure 4.15: New technology in our company’s electricity transmission process has cut down cost of electricity transmission**

Source: Authors Field Survey 2016



**Improved electricity product development has led to the creation of quality electricity product in our company:**

The data vividly shown in table 4.16 and figure no. 4.16 below reveals that 7.6% of the respondents strongly disagreed that Improved electricity product development has led to the creation of quality electricity product in the company, 25.0% disagreed, 19.8% were undecided on the assertion, 37.5% of the respondents agreed to the assertion, and 10.1% of the respondents strongly agreed to the assertion.

	Frequency	Percentage	Valid Percentage	Cumulative Percentage
Valid Strongly Disagree	28	7.6	7.6	7.6
Disagree	92	25.0	25.0	32.6
Undecided	73	19.8	19.8	52.4
Agree	138	37.5	37.5	89.9
Strongly Agree	37	10.1	10.1	100.0
Total	368	100.0	100.0	

**Table 4.16: Improved electricity product development has led to the creation of quality electricity product in our company**

Source: Authors Field Survey 2016

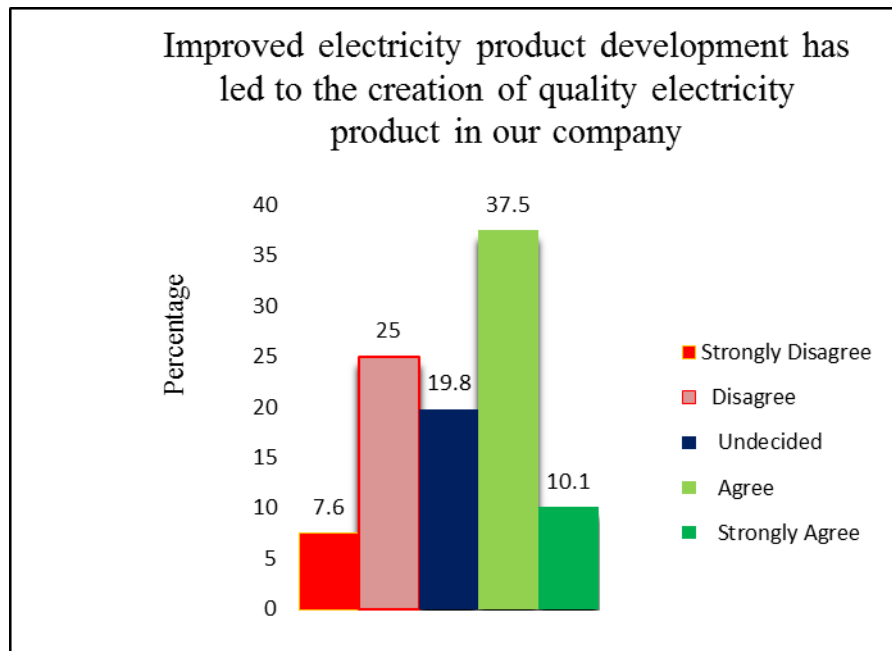

**Figure 4.16: Improved electricity product development has led to the creation of quality electricity product in our company**

Source: Authors Field Survey 2016

**Improved electricity product development has led to the upgrade of our company’s existing electrical power transmission lines to better satisfy our consumers:**

As depicted in table 4.17 and figure no. 4.17 below 2.4% of the respondents strongly disagreed that Improved electricity product development has led to the upgrade of the company’s existing electrical power transmission lines to better satisfy its consumers, 17.4% disagreed, 15.0% of the respondents were undecided, 50.0% of the respondents agreed, and 15.2% of the respondents strongly agreed to the affirmation.

	Frequency	Percentage	Valid Percentage	Cumulative Percentage
Valid Strongly Disagree	09	2.4	2.4	2.4
Disagree	64	17.4	17.4	19.8
Undecided	55	15.0	15.0	34.8
Agree	184	50.0	50.0	84.8
Strongly Agree	56	15.2	15.2	100.0
Total	368	100.0	100.0	

**Table 4.17: Improved electricity product development has led to the upgrade of our company’s existing electrical power transmission lines to better satisfy our consumers**

Source: Authors Field Survey 2016

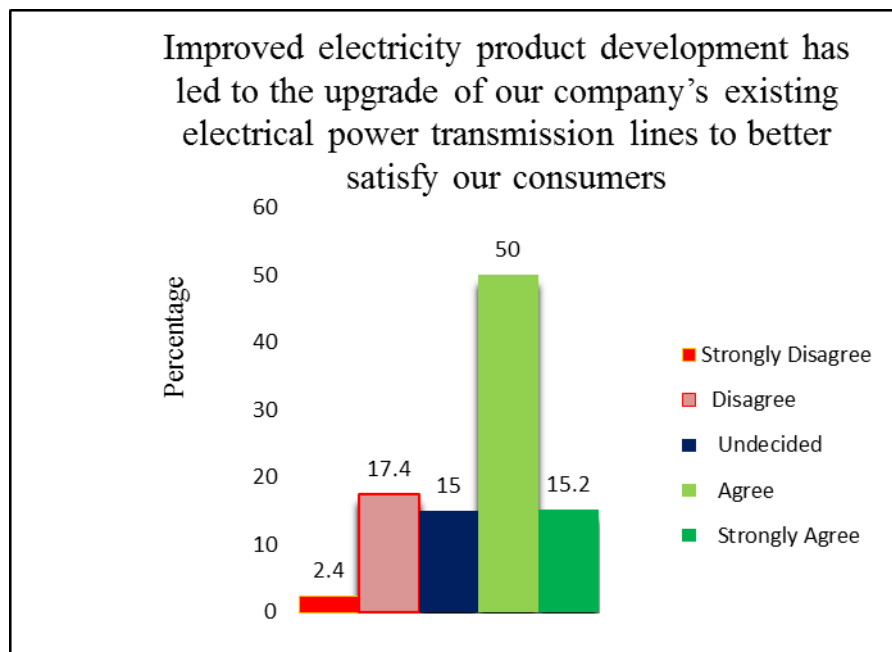

**Figure 4.17: Improved electricity product development has led to the upgrade of our company’s existing electrical power transmission lines to better satisfy our consumers**

Source: Authors Field Survey 2016

**The quality of electricity delivered to consumers has been improved by new electricity product development in our company:**

It is seen in table 4.18 and figure no. 4.18 below that 5.0% of respondent strongly disagreed and 27.4% of the respondent disagreed that The quality of electricity delivered to consumers has been improved by new electricity product development in the company. 20.1% of the respondents were undecided on the affirmation. 39.9% of the respondents agreed and 7.6% of the respondents strongly agreed to the assertion.

	Frequency	Percentage	Valid Percentage	Cumulative Percentage
Valid Strongly Disagree	18	5.0	5.0	5.0
Disagree	101	27.4	27.4	32.4
Undecided	74	20.1	20.1	52.5
Agree	147	39.9	39.9	92.4
Strongly Agree	28	7.6	7.6	100.0
Total	368	100.0	100.0	

**Table 4.18: The quality of electricity delivered to consumers has been improved by new electricity product development in our company**

Source: Authors Field Survey 2016

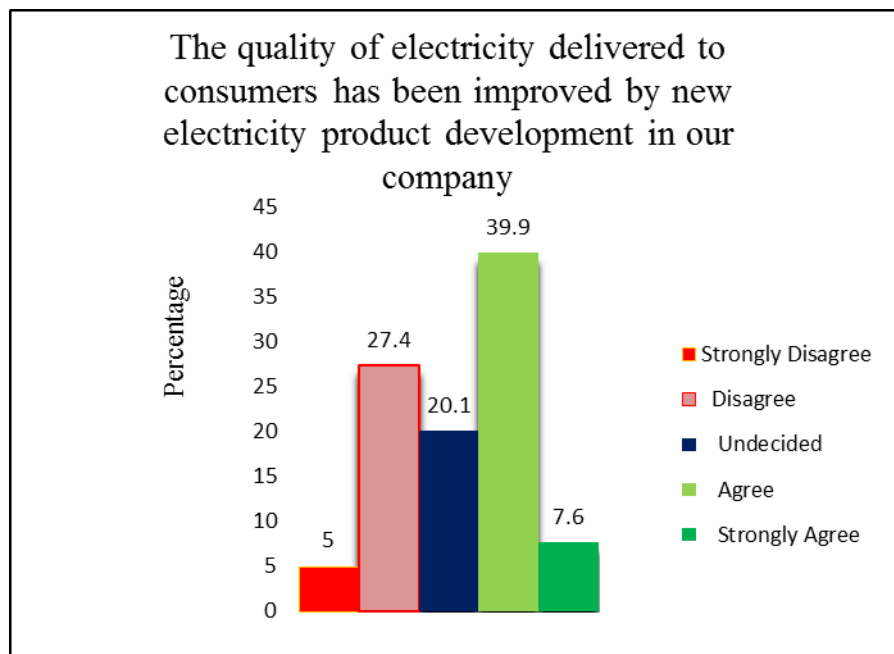

**Figure 4.18: The quality of electricity delivered to consumers has been improved by new electricity product development in our company**

Source: Authors Field Survey 2016

**Improved electricity product development has made our company to gain continuous relevance in the electricity transmission industry:**

Table 4.19 and figure no. 4.19 shows that 2.4% of the respondents strongly disagreed that improved electricity product development had made the company to gain continuous relevance in the electricity transmission industry, 17.7% of the respondents disagreed, 10.1% were undecided on the proclamation, 54.9% agreed and 14.9% strongly agreed that Improved electricity product development has made the company to gain continuous relevance in the electricity transmission industry.

	Frequency	Percentage	Valid Percentage	Cumulative Percentage
Valid Strongly Disagree	09	2.4	2.4	2.4
Disagree	65	17.7	17.7	20.1
Undecided	37	10.1	10.1	30.2
Agree	202	54.9	54.9	85.1
Strongly Agree	55	14.9	14.9	100.0
Total	368	100.0	100.0	

**Table 4.19: Improved electricity product development has made our company to gain continuous relevance in the electricity transmission industry**

Source: Authors Field Survey 2016

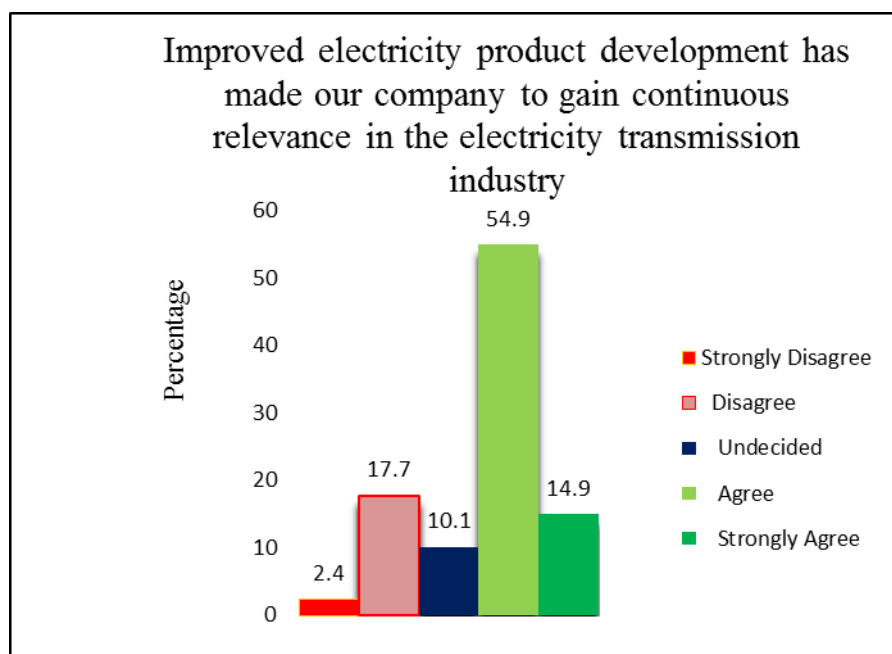

**Figure 4.19: Improved electricity product development has made our company to gain continuous relevance in the electricity transmission industry**

Source: Authors Field Survey 2016

**Our company’s electricity product quality delivered to customers has become more acceptable**

Table 4.20 and figure no. 4.20 reveals that 12.5% of the respondents strongly disagreed that the company’s electricity product quality delivered to customers has become more acceptable, 20.1% disagreed, 15.0% were undecided, 44.8% of the respondents agreed, and 7.6% of the respondents strongly agreed on the proclamation.

	Frequency	Percentage	Valid Percentage	Cumulative Percentage
Valid Strongly Disagree	46	12.5	12.5	12.5
Disagree	74	20.1	20.1	32.6
Undecided	55	15.0	15.0	47.6
Agree	165	44.8	44.8	92.4
Strongly Agree	28	7.6	7.6	100.0
Total	368	100.0	100.0	

**Table 4.20: Our company’s electricity product quality delivered to customers has become more acceptable**

Source: Authors Field Survey 2016

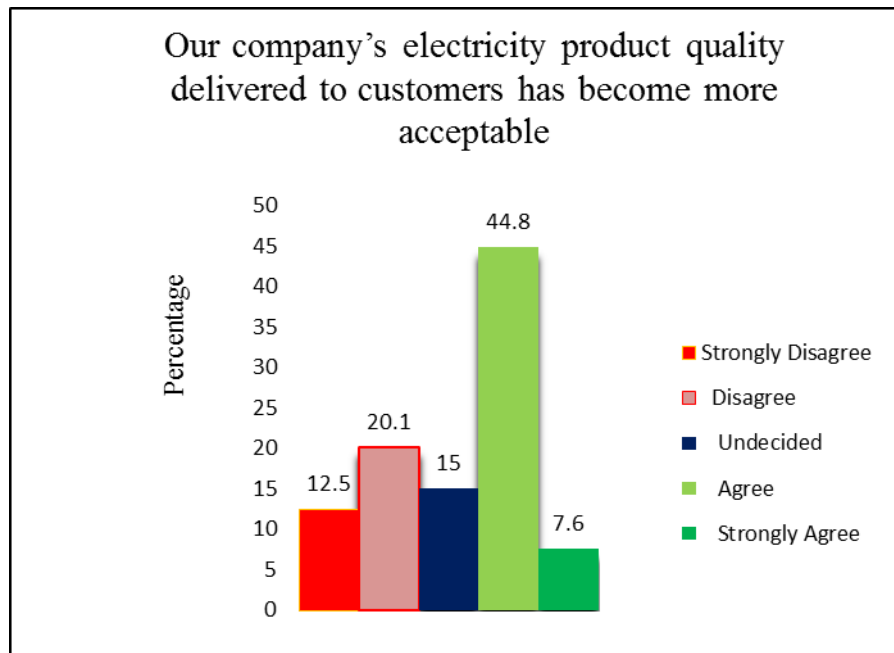

**Figure 4.20: Our company’s electricity product quality delivered to customers has become more acceptable**

Source: Authors Field Survey 2016

**The quality of our company’s electricity product has resulted to consumer satisfaction and an increase in their number:**

Table 4.21 and figure no. 4.21 below reveals that 10.0% of the respondents strongly disagreed that the quality of the company’s electricity product has resulted to consumers satisfaction and increase in their numbers, 42.4% disagreed, 17.4% of the respondents is undecided, 22.6% agreed and 7.6% of the respondents strongly agreed on the assertion.

	Frequency	Percentage	Valid Percentage	Cumulative Percentage
Valid Strongly Disagree	37	10.0	10.0	10.0
Disagree	156	42.4	42.4	52.4
Undecided	64	17.4	17.4	69.8
Agree	83	22.6	22.6	92.4
Strongly Agree	28	7.6	7.6	100.0
Total	368	100.0	100.0	

**Table 4.21: The quality of our company’s electricity product has resulted to consumer satisfaction and an increase in their number**

Source: Authors Field Survey 2016

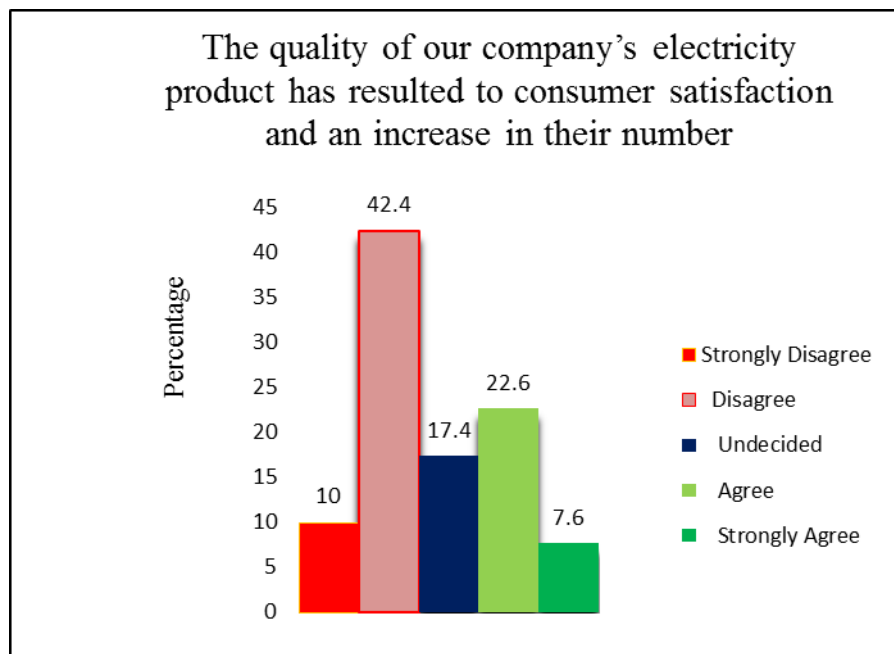

**Figure 4.21: The quality of our company’s electricity product has resulted to consumer satisfaction and an increase in their number**

Source: Authors Field Survey 2016

**The quality of our company’s electricity product has led to an increase in revenue inflow:**

Table 4.22 and figure no. 4.22 shows that 2.4% of the respondents strongly disagreed that the quality of the company’s electricity product has led to an increase in revenue inflow, 29.9% disagreed, 17.7% were undecided, 35.0% of the respondents agreed, and 15.0% of the respondents strongly agreed on the affirmation.

		Frequency	Percentage	Valid Percentage	Cumulative Percentage
Valid	Strongly Disagree	09	2.4	2.4	2.4
	Disagree	110	29.9	29.9	32.3
	Undecided	65	17.7	17.7	50.0
	Agree	129	35.0	35.0	85.0
	Strongly Agree	55	15.0	15.0	100.0
	Total	368	100.0	100.0	

**Table 4.22: The quality of our company’s electricity product has led to an increase in revenue inflow**

Source: Authors Field Survey 2016

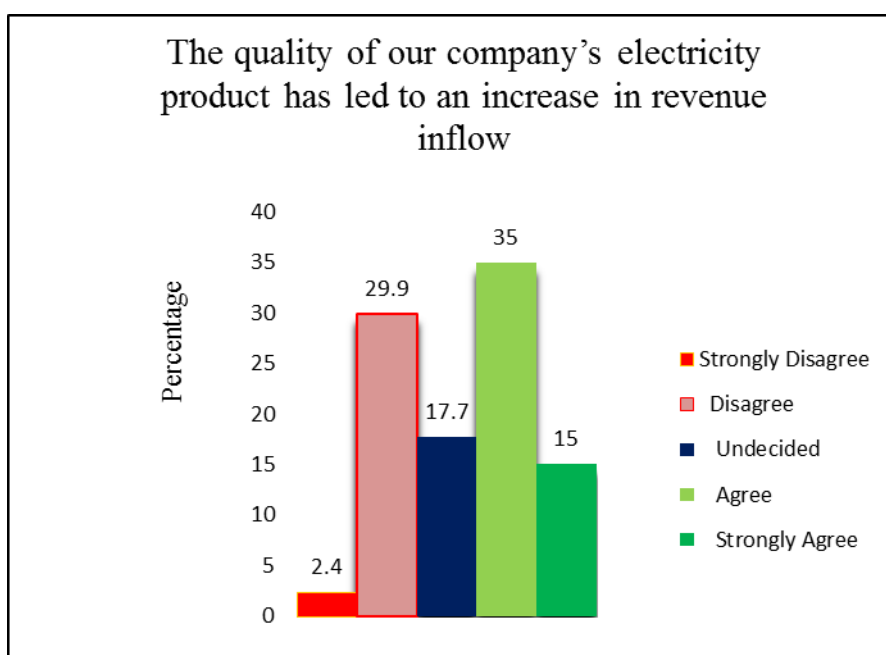

**Figure 4.22: The quality of our company’s electricity product has led to an increase in revenue inflow**

Source: Authors Field Survey 2016

**The quality of our company’s electricity product has evidently influenced the level of profitability:**

Table 4.23 and figure no. 4.23 below shows that 32.6% of the respondents disagreed, 17.4% were undecided, 37.5% agreed and the remaining 12.5% of the respondents strongly agreed that the quality of the company’s electricity product has evidently influenced the level of profitability.

	Frequency	Percentage	Valid Percentage	Cumulative Percentage
Valid Disagree	120	32.6	32.6	32.6
Undecided	64	17.4	17.4	50.0
Agree	138	37.5	37.5	87.5
Strongly Agree	46	12.5	12.5	100.0
Total	368	100.0	100.0	

**Table 4.23: The quality of our company’s electricity product has evidently influenced the level of profitability**

Source: Authors Field Survey 2016

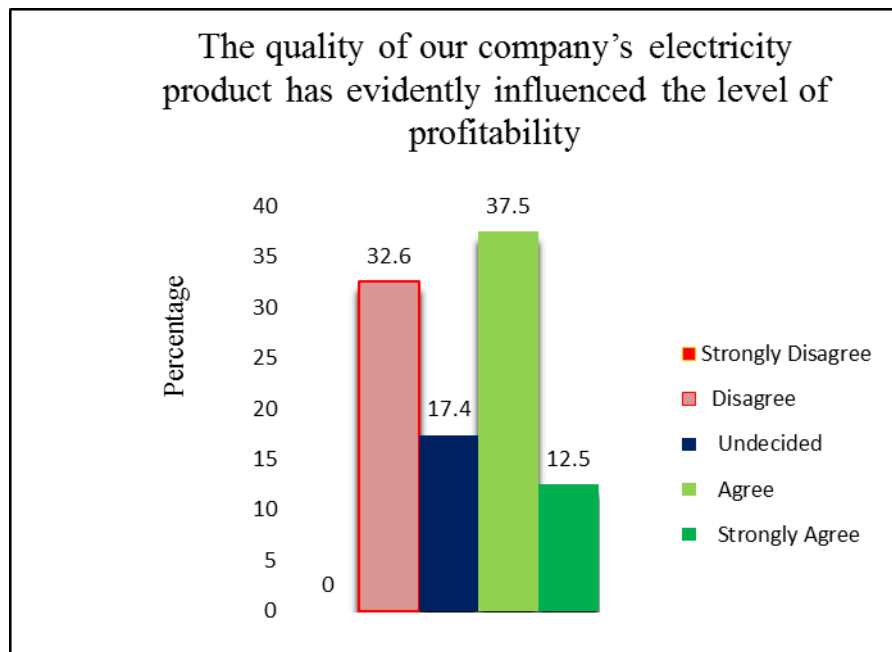

**Figure 4.23: The quality of our company’s electricity product has evidently influenced the level of profitability**

Source: Authors Field Survey 2016



**Our continued existence as electricity transmission company can be greatly linked to the quality of electricity product delivered to customers:**

Table 4.24 and figure no. 4.24 shows that 4.9% of the respondents strongly disagreed that the continued existence of the electricity transmission company can be greatly linked to the quality of electricity product delivered to customers, 32.6% disagreed, another 4.9% of the respondents were undecided on the affirmation, 42.7% agreed, and 14.9% strongly agreed with the proclamation.

	Frequency	Percentage	Valid Percentage	Cumulative Percentage
Valid Strongly Disagree	18	4.9	4.9	4.9
Disagree	120	32.6	32.6	37.5
Undecided	18	4.9	4.9	42.4
Agree	157	42.7	42.7	85.1
Strongly Agree	55	14.9	14.9	100.0
Total	368	100.0	100.0	

**Table 4.24: Our continued existence as electricity transmission company can be greatly linked to the quality of electricity product delivered to customers**

Source: Authors Field Survey 2016

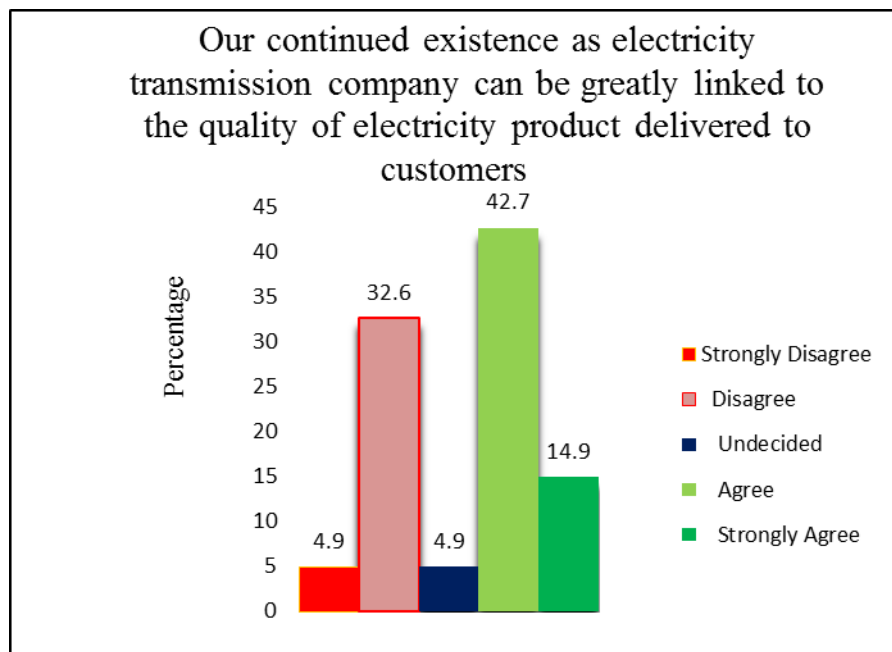

**Figure 4.24: Our continued existence as electricity transmission company can be greatly linked to the quality of electricity product delivered to customers**

Source: Authors Field Survey 2016

**The use of new technology has led our company to design transmission power lines and create electricity product that gives our company competitive advantage:**

Table 4.25 and figure no. 4.25 shows that 7.6% of the respondents strongly disagreed that the use of new technology has led the company to design transmission power lines and create electricity product that gives the company competitive advantage, 22.6% disagreed, 14.9% were undecided, 50.0% of the respondents agreed and the remaining 4.9% of the respondents strongly agreed to the assertion.

	Frequency	Percentage	Valid Percentage	Cumulative Percentage
Valid Strongly Disagree	28	7.6	7.6	7.6
Disagree	83	22.6	22.6	30.2
Undecided	55	14.9	14.9	45.1
Agree	184	50.0	50.0	95.1
Strongly Agree	18	4.9	4.9	100.0
Total	368	100.0	100.0	

**Table 4.25: The use of new technology has led our company to design transmission power lines and create electricity product that gives our company competitive advantage**

Source: Authors Field Survey 2016

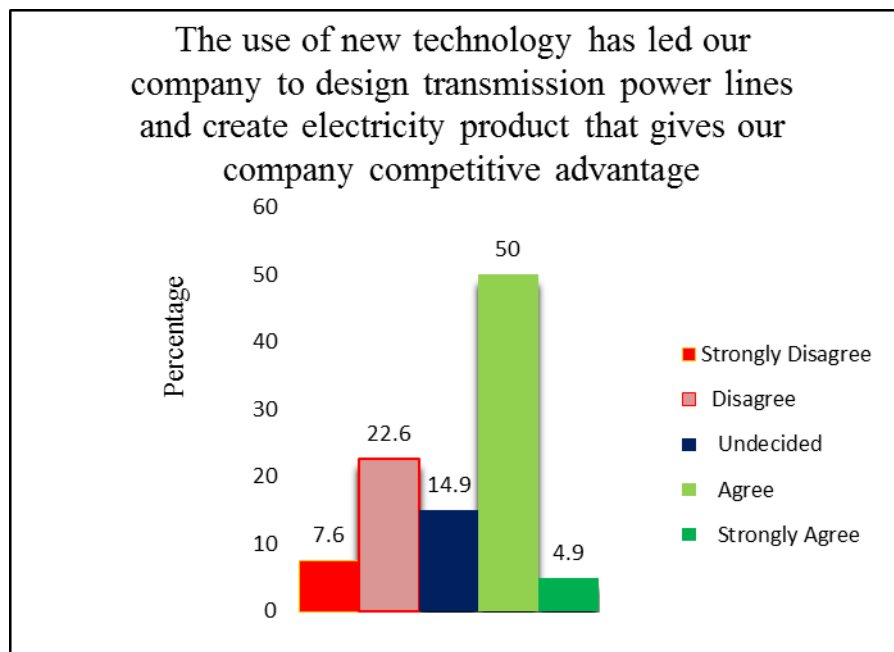

**Figure 4.25: The use of new technology has led our company to design transmission power lines and create electricity product that gives our company competitive advantage**

Source: Authors Field Survey 2016

**The new technology acquired for electricity transmission has greatly increased our company's level of productivity:**

Table 4.26 and figure no. 4.26 below shows that 14.9% of the respondents disagreed that the new technology acquired for electricity transmission has greatly increased the company's level of productivity, 12.5% were undecided, 67.4% of the respondents agreed, and the remaining 5.2% of the respondents strongly agreed to the affirmation.

		Frequency	Percentage	Valid Percentage	Cumulative Percentage
Valid	Disagree	55	14.9	14.9	14.9
	Undecided	46	12.5	12.5	27.4
	Agree	248	67.4	67.4	94.8
	Strongly Agree	19	5.2	5.2	100.0
	Total	368	100.0	100.0	

**Table 4.26: The new technology acquired for electricity transmission has greatly increased our company's level of productivity**

Source: Authors Field Survey 2016

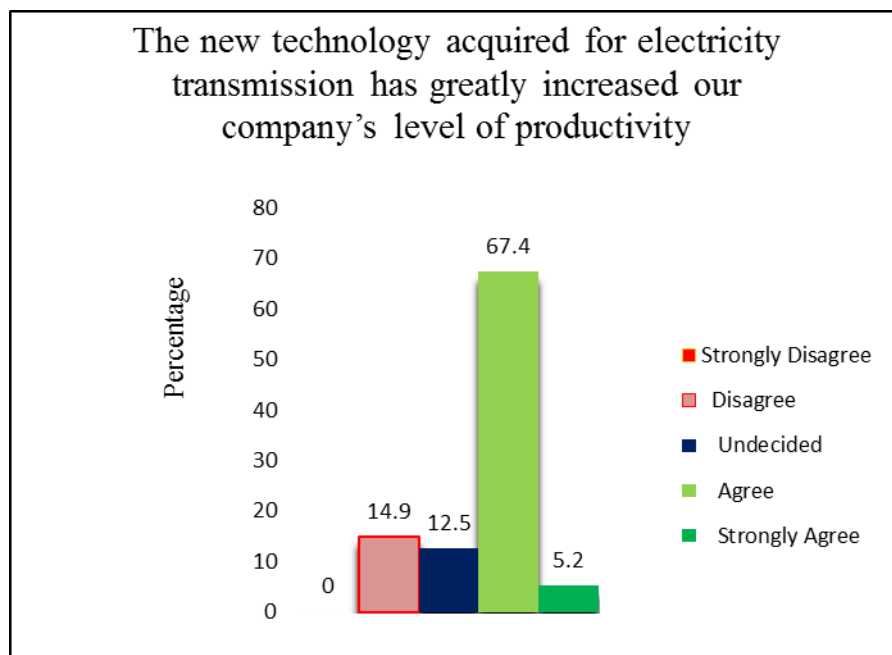

**Figure 4.26: The new technology acquired for electricity transmission has greatly increased our company's level of productivity**

Source: Authors Field Survey 2016

**The revenue of our company has increased as a result of the new technology employed in the transmission of electricity product:**

Table 4.27 and figure no. 4.27 below shows that 7.3% of the respondents strongly disagreed that the revenue of the company has increased as a result of the new technology employed in the transmission of electricity product, 20.1% disagreed, 17.4% of the respondents were undecided on the proclamation, 45.1% of the respondents agreed, and the remaining 10.1% of the respondents strongly agreed to the proclamation.

	Frequency	Percentage	Valid Percentage	Cumulative Percentage
Valid Strongly Disagree	27	7.3	7.3	7.3
Disagree	74	20.1	20.1	27.4
Undecided	64	17.4	17.4	44.8
Agree	166	45.1	45.1	89.9
Strongly Agree	37	10.1	10.1	100.0
Total	368	100.0	100.0	

**Table 4.27: The revenue of our company has increased as a result of the new technology employed in the transmission of electricity product**

Source: Authors Field Survey 2016

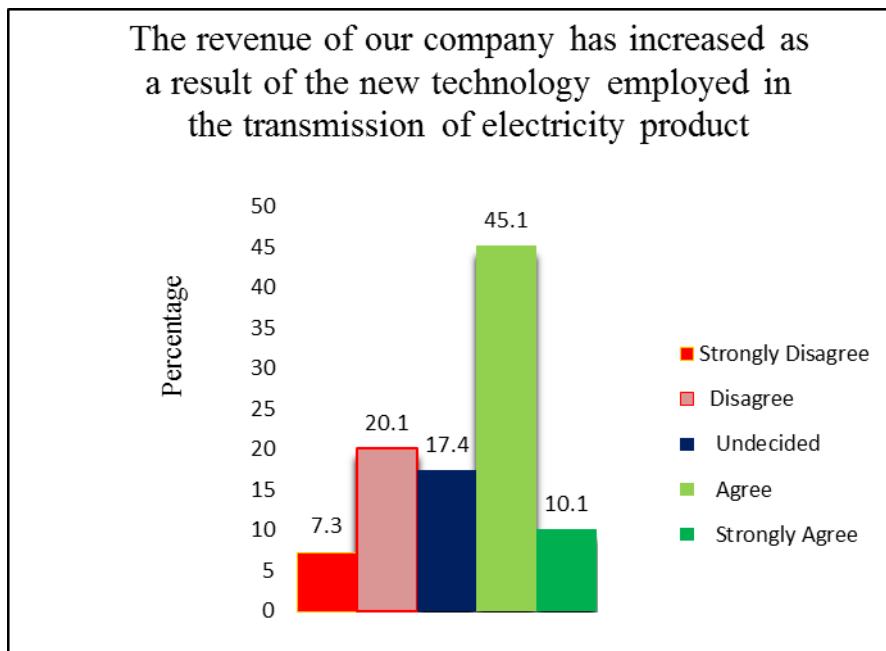

**Figure 4.27: The revenue of our company has increased as a result of the new technology employed in the transmission of electricity product**

Source: Authors Field Survey 2016

**The new technology adopted for electricity transmission has ensured our company's continued existence:**

Table 4.28 and figure no. 4.28 below shows that 14.9% of the respondents disagree that the new technology adopted for electricity transmission has ensured the company's continued existence, 17.7% were undecided, 52.4% agreed to the assertion, while the remaining 15.0% of the respondents strongly agreed.

		Frequency	Percentage	Valid Percentage	Cumulative Percentage
Valid	Disagree	55	14.9	14.9	14.9
	Undecided	65	17.7	17.7	32.6
	Agree	193	52.4	52.4	85.0
	Strongly Agree	55	15.0	15.0	100.0
	Total	368	100.0	100.0	

**Table 4.28: The new technology adopted for electricity transmission has ensured our company's continued existence**

Source: Authors Field Survey 2016

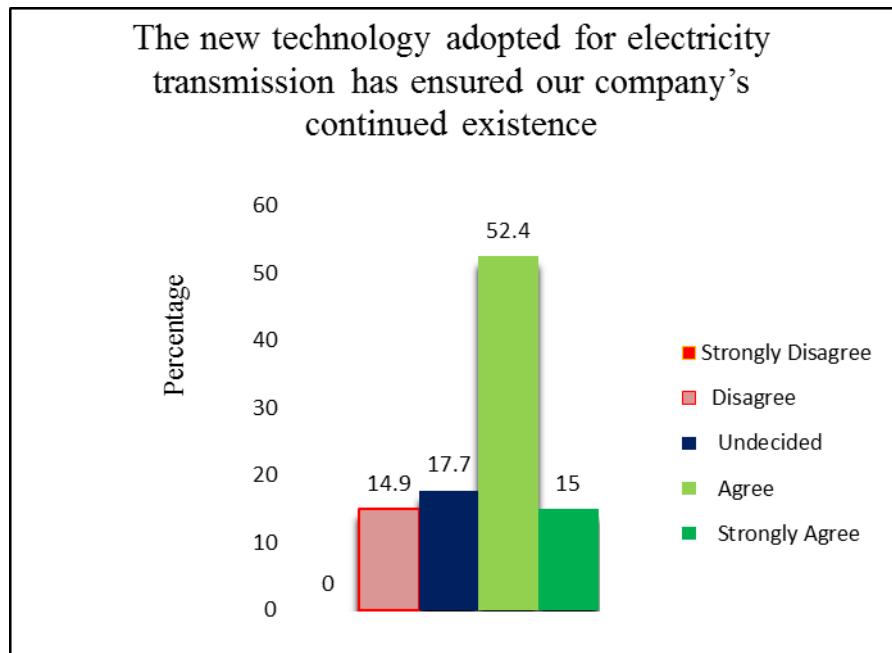

**Figure 4.28: The new technology adopted for electricity transmission has ensured our company's continued existence**

Source: Authors Field Survey 2016

**Improved electricity product in our company has resulted in an increase in consumer base:**

Table 4.29 and figure no. 4.29 below shows that 2.4% of the respondents strongly disagree that Improved electricity product in the company has resulted in an increase in consumer base, 12.5% disagreed, 20.1% of the respondents were undecided, 54.9% of the respondents agreed, and 10.1% of the respondents strongly agreed to the affirmation.

	Frequency	Percentage	Valid Percentage	Cumulative Percentage
Valid Strongly Disagree	09	2.4	2.4	2.4
Disagree	46	12.5	12.5	14.9
Undecided	74	20.1	20.1	35.0
Agree	202	54.9	54.9	89.9
Strongly Agree	37	10.1	10.1	100.0
Total	368	100.0	100.0	

**Table 4.29: Improved electricity product in our company has resulted in an increase in consumer base**

Source: Authors Field Survey 2016

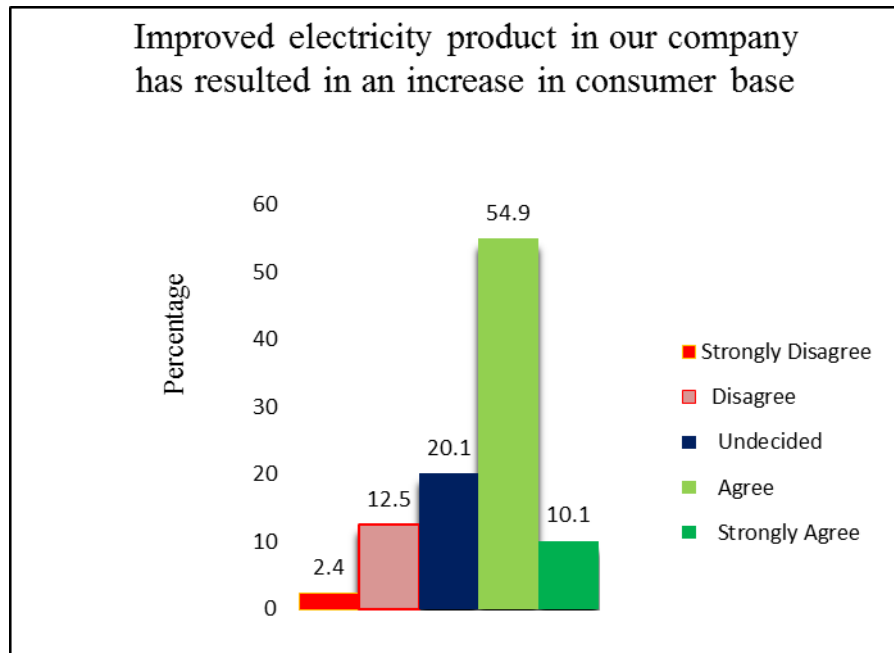

**Figure 4.29: Improved electricity product in our company has resulted in an increase in consumer base**

Source: Authors Field Survey 2016

**Improved electricity product development program in our company has led to high sales turnover:**

Table 4.30 and figure no. 4.30 below shows that 2.4% of the respondents strongly disagree that Improved electricity product development program in the company has led to high sales turnover, 22.6% disagreed, 29.9% of the respondents were undecided on the proclamation, 35.1% agreed, and 10.0% of the respondents strongly agreed to the assertion.

	Frequency	Percentage	Valid Percentage	Cumulative Percentage
Valid Strongly Disagree	09	2.4	2.4	2.4
Disagree	83	22.6	22.6	25.0
Undecided	110	29.9	29.9	54.9
Agree	129	35.1	35.1	90.0
Strongly Agree	37	10.0	10.0	100.0
Total	368	100.0	100.0	

**Table 4.30: Improved electricity product development program in our company has led to high sales turnover**

Source: Authors Field Survey 2016

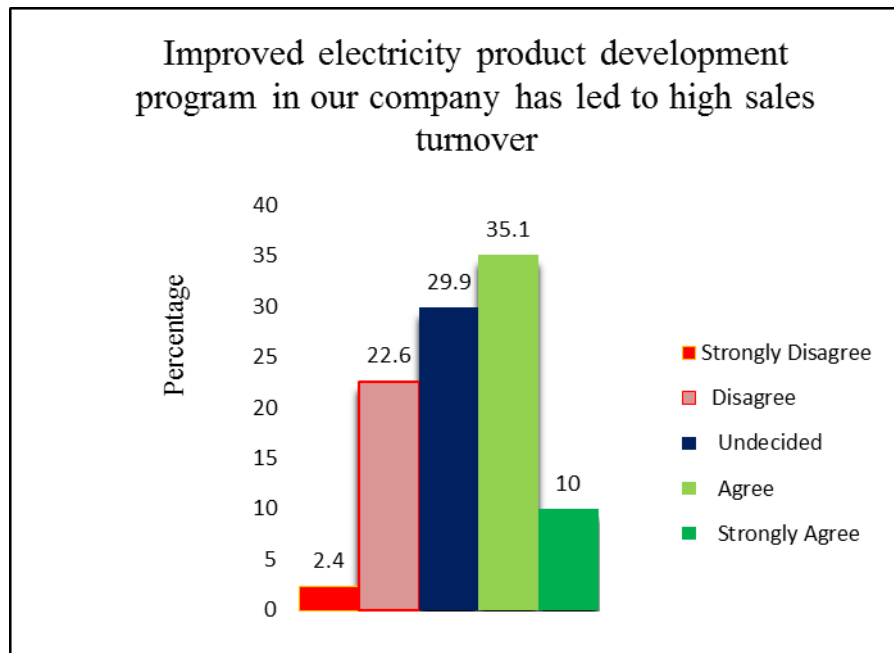

**Figure 4.30: Improved electricity product development program in our company has led to high sales turnover**

Source: Authors Field Survey 2016

## Chapter 5. Results and Discussion

The entrepreneurial performance of the electricity transmission company under study is based on the following dimensions: product quality, new technology, improved product development, and business performance. In this chapter, findings will be based on the dimensions outlined above:

### 5.1 Product Quality

In order to capture how creative and innovative product quality influences entrepreneurial performance in the Transmission Company of Nigeria, five items in the survey question was used to analyse product quality dimension, in order to know the extent employees believe that the company is creative and innovative or willing to be creative and innovative. These are items No. 6 – 10, in the questionnaire as presented below;

6	The quality of our company's electricity product has made it more acceptable in the electricity market
7	The goodwill of our company has improved as a result of quality electricity product delivered to customers
8	Our company engage in activities that lead to the creation of quality electricity product
9	Our company's electricity quality control process has been of great advantage
10	The quality of our company's electricity product has enhanced the pricing of electricity

From the survey, it can be seen that most of the respondents believe that the Transmission company of Nigeria emphasizes on incremental creativity and innovation, by providing positive response to items 6, 7, 8, and 9. The degree of agreement for these items has the highest average compared to item 10 in the survey questionnaire, which majority of the employees of the company did not agree on, thereby negating this statement. Based on the answers given to items 10, it might be said that the company is not so much creative and innovative, but employees who have agreed on this statement also did agreed on items 6, 7, 8, and 9. Hence, comparing the five items it will be logical to say that the company is fairly creative and innovative in terms of product quality. As a conclusion it is believed that all in all the company enjoys an acceptable level of creativeness and innovativeness. This could not have been reached without continuous improvement in electricity product quality delivered to customers. The graphical illustration for the comparison of all items on the questionnaire for product quality is shown in figure 5.1



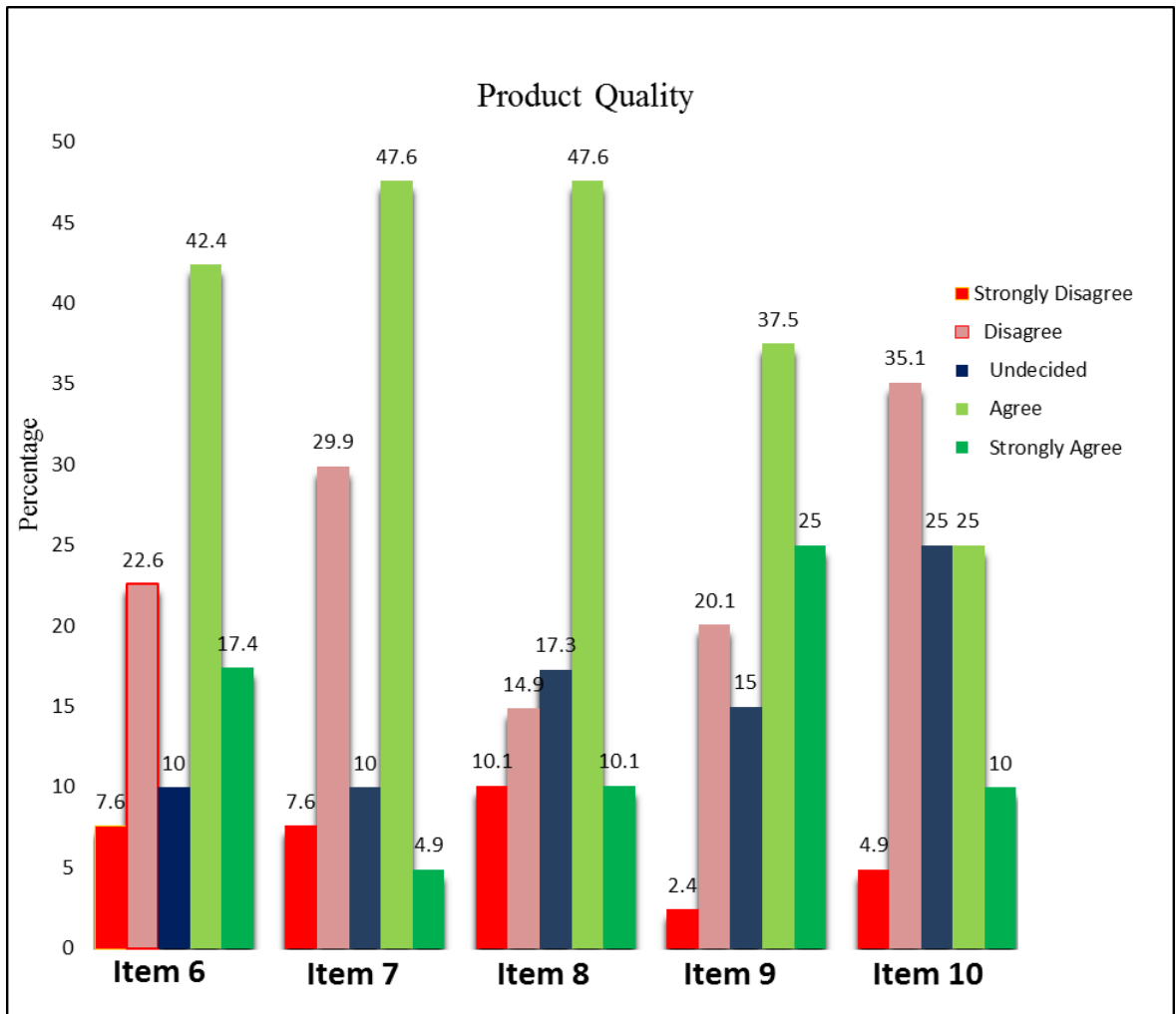

**Figure 5.1: Product Quality Dimension Analysis**

Source: Authors Field Survey 2016

## 5.2 New Technology

In order to evaluate the level of new technology dimension on the entrepreneurial performance of the Transmission company of Nigeria, five items in the survey question were used, these are items 11 - 15:

11	Our company engage new technology in the design of electricity transmission lines
12	Our company uses new technology in the transmission of electricity product
13	Our company engage the use of new technology in the efficient utilization of power lines for the transmission of electricity product
14	New technology has made the transmission process of electricity in our company easier
15	New technology in our company's electricity transmission process has cut down cost of electricity transmission

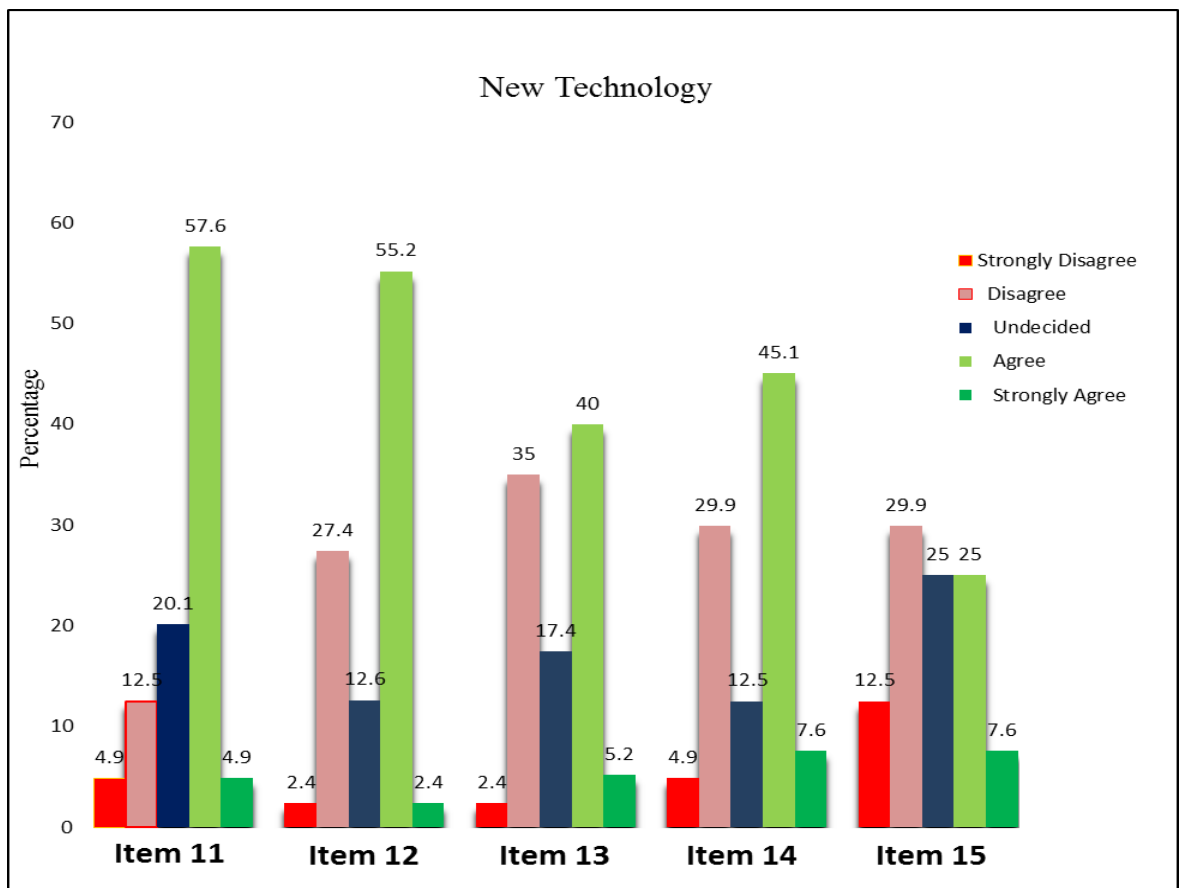

**Figure 5.2: New Technology Dimension Analysis**

Source: Authors Field Survey 2016

From items 11 – 15, the responds from employees of the company has shown that the company engages new technology in carrying out its activities. Although responds to item 15 from employees of the company suggest that they do not agree that, new technology has enhanced the company’s entrepreneurial performance. But on the average from the graph provided above in figure no. 5.2, it shows that the transmission company of Nigeria embraces new technology in its activities, since many of the employees agree as indicated in items 11, 12, 13, and 14. From the foregoing it will not be out of place to conclude that the transmission company of Nigeria creatively and innovatively utilized new technology in order to enhance the company’s entrepreneurial performance.

### **5.3 Improved Product Development**

Five items were employed to measure the level of improved product development dimension in the company. Employees were asked to agree or disagree with the following items outlined below:

16	Improved electricity product development has led to the creation of quality electricity product in our company
17	Improved electricity product development has led to the upgrade of our company’s existing electrical power transmission lines to better satisfy our consumers
18	The quality of electricity delivered to consumers has been improved by new electricity product development in our company
19	Improved electricity product development has made our company to gain continuous relevance in the electricity transmission industry
20	Our company’s electricity product quality delivered to customers has become more acceptable

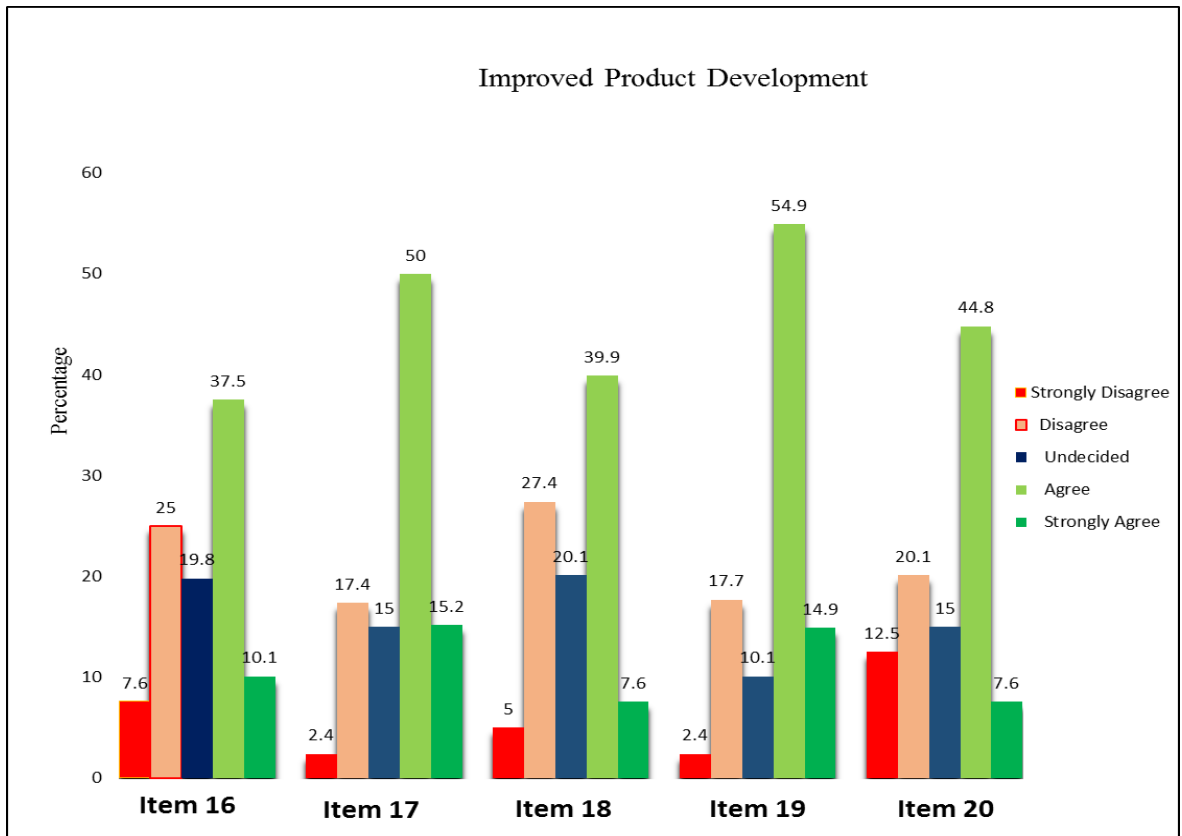

**Figure 5.3: Improved Product Development Dimension Analysis**

Source: Authors Field Survey 2016

The interesting point about the company’s involvement in improved product development is that considering the five items considered majority of the respondents agreed with the assertions. this is regarded as a very good sign showing that the Transmission Company of Nigeria has improved product development as a strategy, Therefore it is believed that the company has a good level of improved product development. more importantly it indicates that the company has successfully provided the picture for employees that they are willing and will improve its electricity product development. This is graphically shown in figure no. 5.3 above..

## 5.4 Business Performance

The last dimension examined is the level of business performance, ten items have been critically examined, these are items 21 -30. The assertion are outlined below:

21	The quality of our company's electricity product has resulted to consumer satisfaction and an increase in their number
22	The quality of our company's electricity product has led to an increase in revenue inflow
23	The quality of our company's electricity product has evidently influenced the level of profitability
24	Our continued existence as electricity transmission company can be greatly linked to the quality of electricity product delivered to customers
25	The use of new technology has led our company to design transmission power lines and create electricity product that gives our company competitive advantage
26	The new technology acquired for electricity transmission has greatly increased our company's level of productivity
27	The revenue of our company has increased as a result of the new technology employed in the transmission of electricity product
28	The new technology adopted for electricity transmission has ensured our company's continued existence
29	Improved electricity product in our company has resulted in an increase in consumer base
30	Improved electricity product development program in our company has led to high sales turnover

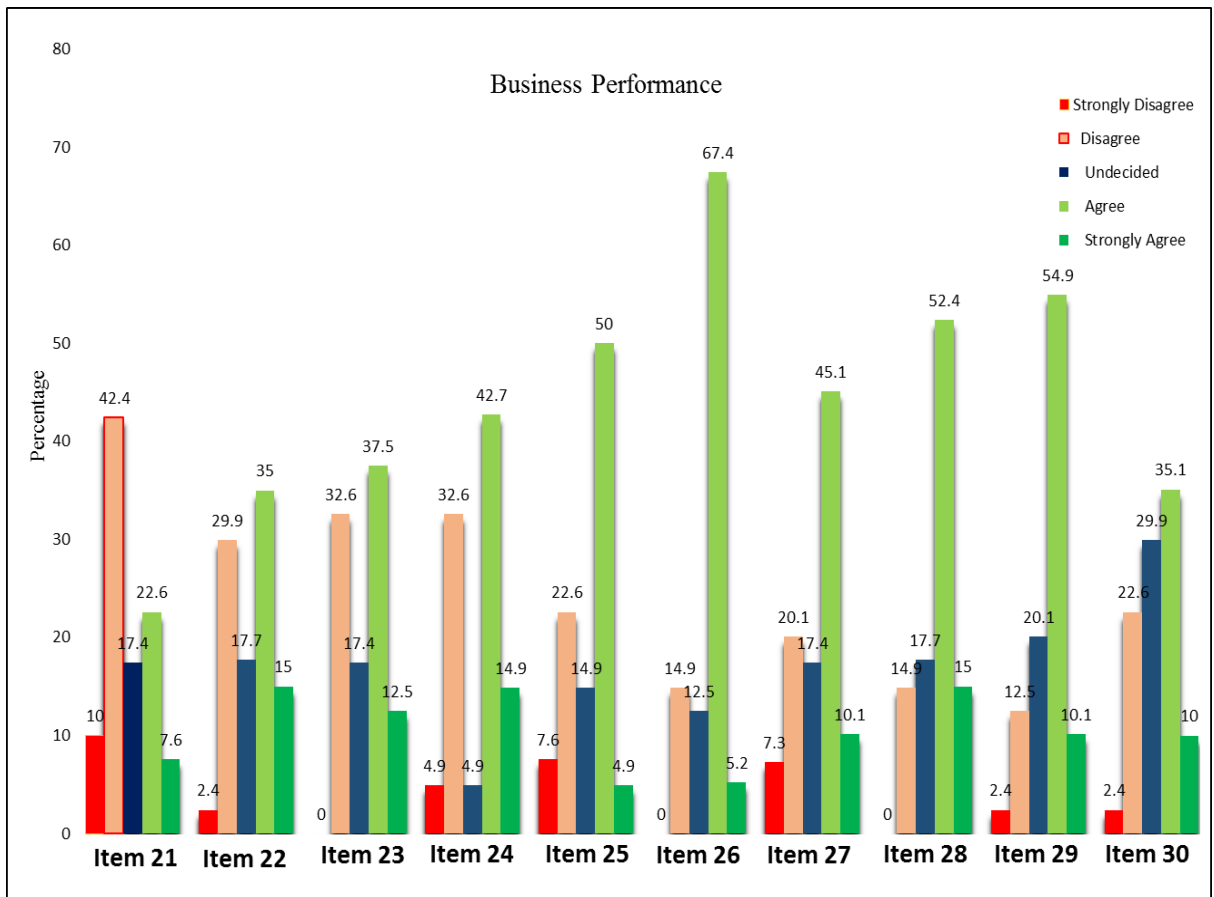

**Figure 5.4: Business Performance Dimension Analysis**

Source: Authors Field Survey 2016

The degree of agreement for item 26 has the highest average comparing to other items on the survey questionnaire, indicating that the company has successfully perform well as regards to business activities, though still under the monopoly of government. It is a positive sign for the industry, as government is planning to totally deregulate the entire sector in the nearest future. Item 21 shows that some employees do not agree that the quality of the company’s electricity product has resulted to consumer satisfaction and an increase in their number, but this is just one out of ten items. Hence, it will be logical to state that the company has performed relatively well as a business organization with regards to items 22 – 30. Therefore, it can be stated that the company is involve in creative and innovative business activities that has enhanced its entrepreneurial performance.

## **Chapter 6. Conclusion, Suggestion and Recommendations**

### **6.1 Conclusion**

This research survey examined the influence of creativity and innovation on the entrepreneurial performance of a public electricity transmission company. The study has proven that creativity and innovation has a significant effect on the profitability, productivity and sales turnover of electricity transmission companies. The different dimension examined have shown valuable relationship which is a pointer for enhanced performance of electricity transmission companies. Considering the data collected and presented, the level of creativeness and innovativeness as regards to product quality, new technology and business performance of the Transmission Company of Nigeria although adequate, is not extraordinary. In the meanwhile the company's level of improved product development is considered fairly high as explained earlier. Therefore in relation to these findings it is necessary to conclude that electricity transmission companies engage in creative and innovative activities which help to enhance their performance and sustainability over time

### **6.2 Suggestion for Further Studies**

This research work focused on the influence of creativity and innovation on the entrepreneurial performance of a public electricity transmission company. The study examined the effect of specific creativity and innovation variables such as product quality, new technology, and new product development on the entrepreneurial performance of an electricity transmission company. The researcher therefore suggests that further studies in the research topic be carried out using more innovation and especially creativity variables.

### **6.3 Recommendations**

Based on the findings of this research survey, the following recommendations are hereby given below;

1. Given the importance of electricity transmission to the economy of a country, it is essential that electricity transmission companies adopt creativity and innovation in their daily operations to enhance their productivity as this research survey have proven beyond doubt that creativity and innovation has a significant positive impact on the performance of electricity transmission companies.

2. Electricity transmission companies should engage in improved product development as this leads to the production of a quality and better electricity product which in turn increases sales turnover as well as profitability.
3. The importance of new technology cannot be overemphasized in electricity transmission. Hence, electricity transmission companies should employ the use of new technology as this enhances productivity and to a large extent reduces the cost of production.
4. Finally electricity transmission companies should be involved in extensive employee empowerment through trainings so as to foster the growth of a creative and innovative way of reasoning in employees.



## References

- Tallapragada PVSN, (2009). *Nigeria's Electricity Sector- Electricity and Gas Pricing Barriers*. International Association for Energy Economics, First Quarter 2009, pp: 29-34.
- Centre for People and Environment (CPE) and Tryby Energy, Minerals and Environmental Corporation, (2009). *Pre-Feasibility Study of Electricity Generation from Nigerian Coalmine Methane*, Ibadan, Oyo State, Nigeria.
- Famous O. Igbinoia, (2014). *An Overview of Renewable Energy Potentials in Nigeria: Prospects, Challenges and the Way Forward*. Energetika Journal. Prague, Czech Republic. November 2014. P 570-579. Index 46 507, ISSN 0375-8842
- Iwayemi A, (2008). *Investment in Electricity Generation and Transmission in Nigeria: Issues and Options*. International Association for Energy Economics, First quarter 2008, pp: 37-42.
- Elusakin J, 2013. *Privatization and Electricity Problem in Nigeria*. National Mirror Newspaper. January 6, 2013, p. 18.
- Titus Olugbenga Koledoye, Abdul-Ganiyu A. Jumah, Phillips D. A, (2013). *The current and future challenges of electricity market in Nigeria in the face of deregulation process*, African Journal of Engineering Research Vol. 1(2), pp. 33-39, March 2013 Review,
- World Nuclear Association, (2015). *Electricity Transmission Systems* [Online] Available from: <http://www.world-nuclear.org> October 2015
- J. C. Molburg, J. A. Kavicky, K. C. Picel, (2007) *The Design, Construction, and Operation of Long – Distance High-Voltage Electricity Transmission Technologies*. Argonne National Laboratory, November 2007, [Online] Available from: <http://www.osti.gov/bridge>
- Matthew H. Brown, Richard P. Sedano, (2004). *Electricity Transmission: A Primer, National Council on Electricity Policy*. 2004 by the National Conference of State Legislatures. ISBN 1-58024-352-5 [Online] Available from: <http://energy.gov>

Osaenwe Timothy Adegboyega (2012), *Effects of Creativity and Innovation on the Entrepreneurial Performance of Family Business (A Case Study of Selected Family Businesses in Lagos State)*. Masters Thesis, Covenant University, Ota, Nigeria.

Kuczarski, T.D., Middlebrooks, A., & Swaddling, J. (2000). *Innovating the corporation: Creating value for customers and shareholders*. New York: McGraw-Hill Trade.

The Edison Foundation (2014), *Innovations Across the Grid*, December, 2014 by the Institute for Electric Innovation, Volume II, Printed in the United States of America. [Online] Available from: <http://www.edisonfoundation.net>

Folake Elias Adebawale, Sally Udoma, Chukwuka Eze, and Aniekan George Ikott (2013), *Privatisation of the Power Holding Company of Nigeria: recent developments*, International Law Office, July 01 2013 [Online] Available from: <http://www.internationallawoffice.com>

Bloomberg Business (n.d), *Company Overview of Transmission Company of Nigeria PLC*. [Online] Available from: <http://www.bloomberg.com/research>

Nigeria Electricity System Operator, [Online] Available from: <http://www.nsong.org>

Onohaebi, O.S., (2009). *Power Outages in the Nigeria Transmission Grid*. Research Journal of Applied Sciences. Year: 2009 | Volume: 4 | Issue: 1 | Page No.: 1-9

Anil, P., H. Mark and T.R. Gaunt, (2007). *Estimation of outages in overhead distribution systems of South Africa and of manhattan*, KANSAS, USA. Proceedings of the 7th International Conference on Power System Operation and Planning, Cape Town, South Africa.

PHCN, (2006). National Control Centre Oshogbo Generation and transmission grid operations Annual Technical Report for 2005.

Nigeria Compass (2013), *Nigeria's Power Generation hits 5,228 Mega Watt*”, May 4, 2013. [Online]. Available: <http://www.compassnewspaper.org> [Accessed 28 Mar., 2016].

Chibuzo Nnonyelu and Theophilus Chukwudolue Madueme (2013), *Power System Contingency Analysis: A Study of Nigeria's 330KV Transmission Grid*. Conference Paper July 2013. [Online] Available from: <https://www.researchgate.net/publication> [accessed 28 Mar, 2016]

Dawson, Catherine, (2002), *Practical Research Methods*, New Delhi, UBS Publishers' Distributors

Kothari, C.R.,(1985), *Research Methodology- Methods and Techniques*, New Delhi, Wiley Eastern Limited.

Kumar, Ranjit, (2005), *Research Methodology-A Step-by-Step Guide for Beginners*,(2nd.ed.),Singapore, Pearson Education.

Business Dictionary (n.d), [Online]. Available from: [www.businessdictionary](http://www.businessdictionary) [accessed 28 Mar, 2016]

Vogt, W.P. (1993) *Dictionary of Statistics and Methodology*. Newbury Park: Sage.

Kerlinger F.N. (1983). *Introduction to Research Methodology*. New York: Exposition Press.

Collis, J. and Hussey, R. (2003). *Business research: A practical guide for undergraduate and postgraduate students*. 2nd Edition. London: Palgrave Macmillan.

David Wilkinson and Peter Birmingham (2003), *Using Research Instruments, A Guide for Researchers*. Taylor & Francis e-Library, 2003., ISBN 0-203-42299-6 Master e-book ISBN, ISBN 0-203-42473-5 (Adobe eReader Format), ISBN 0-415-27279-3 (Print Edition)

Bryman, A. and Bell, E. (2003). *Business research methods*. Oxford University Press.

Toma Martinkute and Kian Skandarioon (2013), *Work Processes and Entrepreneurial Climate: Teamwork & Individual work*. Master Thesis-Corporate Entrepreneurship and Innovation, Lund University, Sweden. April 2013.

National Electric Power Authority (2004). *Power reform and power-generation plans in the public and private sectors*. Abuja, Nigeria. November 2004.

International Energy Agency (2005). *Energy statistics and balances of non-OECD countries*. 2005 Edition. Paris: IEA; 2005.

The World Bank (2002). *Nigeria: public and private electric provision as a barrier to manufacturing competitiveness*. Findings, Paper 221, December 2002. Available from: <http://www.worldbank.org/afr/findings>

F.I. Ibitoye, A. Adenikinju (2006), *Future demand for electricity in Nigeria*, Applied Energy 84 (2007) 492–504, Elsevier, [Online]. Available from: <http://ac.els-cdn.com>

KuNal MeHta (2014), *Electricity transmission, Technology*. Published on Sep 18, 2014. [Online]. Available from: <http://www.slideshare.net> [accessed 31 Mar, 2016]

Electrical4u.com (n.d), *Electrical Power Transmission System and Network*, [Online]. Available from: <http://www.electrical4u.com> [accessed 30 Mar, 2016]

Solar Energy Development Programmatic EIS Information Center (n.d), *Electric Transmission and Transmission Facilities*, [Online]. Available from: <http://solareis.anl.gov> [accessed 30 Mar, 2016]

Ali Arif Merchant and Michael F. Thompson (2010), *The Electric Power Transmission and Distribution Industry*. Incontext, Indiana Business Research Center, Indiana University Kelley

School of Business, July-Aug 2010, Vol. 11, No. 4 [Online]. Available from: <http://www.incontext.indiana.edu> [accessed 30 Mar, 2016]

IER (2014), *Electricity Transmission*, Institute for Energy Research. September 2, 2014. [Online]. Available from: <http://instituteforenergyresearch.org> [accessed 30 Mar, 2016]

Matthew H. Brown, and Richard P. Sedano (2004), *Electricity Transmission A Primer*, National Council on Electric Policy, June 2004, Published by the National Conference of State Legislatures. ISBN 1-58024-352-5

EESI (n.d), *Transmission and Smart Grids*. Environmental and Energy Study Institute (EESI). [Online]. Available from: <http://www.eesi.org/topics/transmission> [accessed 31 Mar, 2016]

Adewale Ajayi, Chibuzor Anyanechi, Segun Sowande, Marie-Therese Phido (2013), *A Guide to the Nigerian Power Sector*, KPMG Nigeria. December 2013. [Online]. Available from: <http://www.kpmg.com> [accessed 31 Mar, 2016]

SAC (2012), *Introduction and Importance of Power Transmission and Transformation*. Guodian Nanjing Automation Co., Ltd, 2012-09-19. [Online]. Available from: <http://www.sac-world.com> [accessed 1 April, 2016]

Borenstein, Severin, James Bushnell, and Steven Stoft (2000), *The Competitive Effects of Transmission Capacity in a Deregulated Electricity Industry*, RAND Journal of Economics, 31(2): 294–325.

Wolak, Frank (2012), *Measuring the Competitiveness Benefits of a Transmission Investment Policy: The Case of the Alberta Electricity Market*, Working Paper.

Ryan, Nicholas (2013), *The Competitive Effects of Transmission Infrastructure in the Indian Electricity Market*, Working Paper.

Lucas W. Davis, Catherine Hausman (2014), *The value of transmission in electricity markets: Evidence from a nuclear power plant closure*, VOX, 16 June 2014 [Online]. Available from: <http://www.voxeu.org> [accessed 1 April, 2016]

A. S. Sambo, B. Garba, I. H. Zarma and M. M. Gaji (2010), *Electricity Generation and the Present Challenges in the Nigerian Power Sector*, January, 2010. Researchgate. Available from: Abubakar Sambo Retrieved on: 31 March 2016 <https://www.researchgate.net>

Claudius A. Awosope (2014), *Nigeria Electricity Industry: Issues, Challenges and Solutions*. Public Lecture Series. Vol. 3, No. 2, Covenant University Press, Ota, Ogun State, Nigeria. October, 2014. ISSN 2006...0327.

Odion Omonfoman (2016), *Electricity Distribution Companies – The Challenges and Way Forward*. Premium Times, January 4, 2016. [Online]. Available from: <http://blogs.premiumtimesng.com> [accessed 1 April, 2016]

World Bank (2003). *Making services work for the poor people*. World Development Report 2004. Washington DC: The World Bank and Oxford University Press.

Akin Iwayemi (2008), *Investment in Electricity Generation and Transmission in Nigeria: Issues and Options*. International Association for Energy Economics, First Quarter 2008. 37-42. [Online]. Available from: <http://www.iaee.org> [accessed 1 April, 2016]

Victor Okolobah, Zuhaimy Ismail (2013). *On The Issues, Challenges and Prospects of Electrical Power Sector in Nigeria*. International Journal of Economy, Management and Social Sciences, 2(6) June 2013, Pages: 410-418. ISSN 2306 – 7276.

Felix Anyanrouh (2013), *The Challenges of the Nigerian Electric Power Sector Reform*. Vanguard, March 5, 2013 [Online]. Available from: <http://www.vanguardngr.com> [accessed 1 April, 2016]

Linda Naiman (n.d), *What is Creativity? Creativity at Work*, [Online]. Available from: <http://www.creativityatwork.com> [accessed 2 April, 2016]

Fillis, I. and Rentschler, R. (2010). *The Role of Creativity in Entrepreneurship*. Journal of Enterprising Culture. Vol. 18, No. 1, pp. 49-81.

Amabile, T. M. 1996. *Creativity and Innovation in Organizations*. Harvard Business School Publishing, Boston. USA.

Halim, M. A. S and Mat, A. C. (2010). *Craftmakers: A Significant study on entrepreneurial Creativity and Competitive Advantage*. Canadian Social Science. Vol. 6, No. 3, pp. 59-66.

Phong-Inwong, P., and Ussahawanitchakit, P. (2011). *Creativity, marketing innovation and marketing success: Evidence from home decoration export business in Thailand*. International Journal of Business Research, 11(4), 89–103.

Constantine Andriopoulos, (2001) *Determinants of organisational creativity: a literature review*, Management Decision, Vol. 39 Iss: 10, pp.834 – 841

Shad S Morris and Scott A Snell (2011), *Intellectual capital configurations and organizational capability: An empirical examination of human resource subunits in the multinational enterprise*. Journal of International Business Studies Vol. 42, No. 6 (August 2011), pp. 805-827

Kotler, P., Bowen, J.T. & Makens, J.C. (2006). *Marketing for hospitality and tourism* (4th ed.). Upper Saddle River: Prentice-Hall.

Aliu, A. (2011): Proyección y planificación estratégica en la industria turística: enfoque comparativo y modelo híbrido. Estudio y Perspectivas en Turismo 20 (6), 1324–1344 (2011)

Henrik Berglund (2007). *Risk conception and risk management in corporate innovation: lessons from two Swedish cases*. International Journal of Innovation Management Imperial College Press, Vol. 11, No. 4 (Dec. 2007) pp. 497–513.

Agboli, M., and Ukaegbu C. C. (2006). *Business environment and entrepreneurial activity in Nigeria: implications for industrial development*. Journal of Modern African Studies, 44(1), 1–30.

Marnix Assink, (2006) *Inhibitors of disruptive innovation capability: a conceptual model* European Journal of Innovation Management, Vol. 9 Iss: 2, pp.215 - 233

Mahesh C and Neelankavil P. James, (2008), *Product development and innovation and innovation for developing countries; Potential and Challenges*. Journal of Management Development Vol. 27 No. 10, 2008 pp. 1017-1025.

Knight, F.H., (1971), *Risk, Uncertainty and Profit*. University of Chicago Press, Chicago

Trott, P. (2013), *Managing innovation within, Innovation Management and New Product Development*, 5 th Edition, Pearson Education Limited 2013.

Henry, J., and Walker, D., (1991), *Managing Innovation*, London: Sage.

A. Smith, J.-P. Voß, J. Grin, (2010), *Innovation studies and sustainability transitions: the allure of the multi-level perspective and its challenges* Res. Policy, 39 (4) (2010), pp. 435–448

Matthew Lockwood, (2016), *Creating protective space for innovation in electricity distribution networks in Great Britain: The politics of institutional change*. Environmental Innovation and Societal Transitions. Elsevier, Volume 18, March 2016, Pages 111–127

Kotler, N. G., Kotler, P., and Kotler, W. I. (2008), *Museum marketing and strategy: Designing missions, building audiences, generating revenue and resources* (2nd ed.). San Francisco: Wiley.

Stalk, G. (2006) *Hardball Innovation*. Research Technology Management , 49(2), p.20-28

Epetimehin, F.M. (2011) ‘*Achieving Competitive Advantage in Insurance Industry: The Impact of Marketing Innovation and Creativity*’, Journal of Emerging Trends in Economics and Management Sciences (JETEMS), Volume 2, No. 1, pp. 18-21.



- Brown, R. (1992) *Managing the “S” curves of innovation*. J. Consumer Marketing, 9: 61-72.
- Letenyei, L., 2001. *Rural innovation chains*. Rev. Soc., 7: 85-100.
- Clayton M. Christensen, Michael E. Raynor and Rory McDonald (2015), *What Is Disruptive Innovation?* Harvard Business Review, December 2015 Issue.
- Clayton Christensen institute (n.d), *Disruptive Innovation*, [Online]. Available from: <http://www.christenseninstitute.org> [accessed 2 April, 2016]
- The Economist (2015), *What disruptive innovation means*, Jan 25th 2015,
- Clayton M. Christensen (n.d), *Disruptive Innovation*, *Interaction Design Foundation*. The Encyclopedia of Human-Computer Interaction, 2nd Ed. Mads Soegaard and Rikke Friis Dam (EDS). [Online]. Available from: <https://www.interaction-design.org> [accessed 2 April, 2016]
- INNOSIGHT (n.d), *Driving New Growth through Disruptive Innovation*, [Online]. Available from: <http://www.innosight.com> [accessed 2 April, 2016]
- Raymond Seah (2006), *New Market Disruptioin vs Low-end-disruption*, Raymond Seah Blog, December 18th, 2006, [Online]. Available from: <http://www.raymondseah.com> [accessed 3 April, 2016]
- Schumpeter, J. (1942), *Capitalism, Socialism and Democracy*, New York: Harper, 1962.
- Litz, R. A. and Kleysen, R. F. 2001. *Your Old Men Shall Dream, Your Young Men Shall See Visions: Toward A Theory Of Family Firm Innovation With Help From The Brubeck Family*. Family Business Review, 14, 335-351.
- Wu, J., Kuo, H., et al (2008). *International Exchanges on Creativity Education between Taiwan and other countries*. In *The Practice of Creativity Education* (pp. 382-389). Taipei, Taiwan: Ministry of Education.

Heunks F. J, (1998), *Innovation, creativity and success*, *Small Business Economics* 10: 263-272

Hanif, A., and Manarvi, I. A. (2009), *Influence of quality, innovation and new product/services design on small and medium enterprises*. Proceedings of the World Congress on Engineering, London, U.K. July, 2009.

Gary Hamel and Nancy Tennant (2015), *The 5 Requirements of a Truly Innovative Company*, Harvard Business Review. Harvard Business Publishing, April 27, 2015 <https://hbr.org>

Eric Almquist, Mitchell Leiman, Darrell Rigby and Alex Roth (2013), *Taking the measure of your innovation performance*, Bain and Company, Business Insights. May 08, 2013. <Http://www.bain.com>

Garvin, D., (1984). *What Does Product Quality Really Mean?*, Sloan Management Review, Fall, pp.25-43.

Mahmood M. Hajjat, and Fatimah Hajjat (2014), *The Effect of Product Quality on Business Performance in Some Arab Companies*, Journal of Emerging Trends in Economics and Management Sciences (JETEMS) 5(5):498-508 Scholar link Research Institute Journals, 2014 (ISSN: 2141-7024)

Petr Suchánek, Jiří Richter, Maria Králová (2015), *Customer Satisfaction, Product Quality and Performance of Companies*, *Review of Economic Perspectives*. Volume 14, Issue 4, Pages 329–344, ISSN (Online) 1804-1663, DOI: 10.1515/revecp-2015-0003, January 2015 <http://www.degruyter.com>

S. Hao and B. Yu (2011), *The Impact of Technology Selection on Innovation Success and Organizational Performance*, *iBusiness*, Vol. 3 No. 4, 2011, pp. 366-371. doi: 10.4236/ib.2011.34049.

Li, Lam, and Fag (2000) Li, J., K. Lam, and Y. Fang. (2000). *Manufacturing firms' performance and technology commitment - the case of the electronics industry in China*. *Integrated Manufacturing Systems* 11(6): 385-392.

Donglin Wu (2009), *Measuring Performance in Small and Medium Enterprises in the Information and Communication Technology Industries*. Doctorate of Philosophy Thesis, School of Management, College of Business, RMIT University, Melbourne, Victoria. Australia. February 2009.

Xing Luo, Jihong Wang, Mark Dooner, Jonathan Clarke (2015), *Overview of current development in electrical energy storage technologies and the application potential in power system operation*. Elsevier, *Applied Energy*, Volume 137, 1 January 2015, Pages 511–536

## Appendix 1

Faculty of Economics and Management,  
Czech University of Life Sciences in Prague,  
Czech Republic,  
5<sup>th</sup> October, 2015.

Chief Executive Officer,  
Transmission Company of Nigeria.

Dear Sir/Madam,

### **Influence of creativity and innovation on the entrepreneurial performance of a public electricity transmission company**

As a candidate for the Master of Science (M.Sc.) degree in Business Administration at Czech University of Life Sciences in Prague, Czech Republic. I am conducting a research on the above topic and request your participation in my research study. The goal of this study is to determine the influence of creativity and innovation on the performance of a public electricity organization. By examining the relationship between creativity and innovation, corporations will have the knowledge necessary to assess their current organization and, if needed, develop themselves into an organization that enhances its own performance in the market place.

I have enclosed a copy of the survey for onward distribution to respondents and subsequent return. It is to your discretion which employees receive the survey and the confidentiality of the responses. Participation in this research is voluntary. There are no risks associated with participation in this study. However, the findings of this study will benefit organizations to better understand the importance of creativity and innovation as it affects the performance of an organization.

All responses will remain confidential to all but me as the researcher. A summary of the data will be placed in my research paper but no references will be made to identify contributors of any particular data.

Should you have any questions about this study or other matters concerning your requested participation in this study, feel free to contact my thesis supervisor; PhDr. Oldřich Ludwig Dittrich, Ph.D. at +420 22438 2157 or by email at dittrich@pef.czu.cz

Enclose is the research survey. Your response is much appreciated.

Thank You.

Yours Sincerely,

Igbinovia O. Famous

## Appendix 2

Faculty of Economics and Management,  
Czech University of Life Sciences in Prague,  
Czech Republic,  
5<sup>th</sup> October, 2015.

Dear Respondent,

### **Influence of creativity and innovation on the entrepreneurial performance of a public electricity transmission company**

I am a candidate for the Master of Science (M.Sc.) degree in Business Administration at Czech University of Life Sciences in Prague, Czech Republic.. I am conducting research on the above topic. I seek your candid response to the questions in the questionnaire. Please, note that this exercise is purely for academic purpose and as such, your response to the questions would be treated with utmost confidentiality.

Should you have any questions about this study or other matters concerning your requested participation in this study, feel free to contact my thesis supervisor; PhDr. Oldřich Ludwig Dittrich, Ph.D.at +420 22438 2157 or by email at dittrich@pef.czu.cz

Enclose is the research survey. Your response is much appreciated.

Thank You.

Yours faithfully,

Igbinovia O. Famous

## Appendix 3

### QUESTIONNAIRE

SECTION A: **BIODATA** (Please tick whichever is applicable)

1. Sex: Male {.....} Female {.....}
2. Marital Status: Single {.....} Married {.....} Others {.....}
3. Work experience: 1-5 yrs {.....} 6-10yrs {.....} 11-15 yrs {.....} over 15 yrs {.....}
4. Educational qualification: Primary School{...} SSCE{...} HND/ BSc{...} MSc/MBA {...} PhD{...}Others {...}
5. Management Category: Lower level {.....} Middle level {.....} Top level {.....}

SECTION B: Please tick as: SA-strongly agree, A-agree, U-undecided, D-disagree, SD-strongly disagree

	<b>PRODUCT QUALITY</b>	<b>SA</b>	<b>A</b>	<b>U</b>	<b>D</b>	<b>SD</b>
6	The quality of our company's electricity product has made it more acceptable in the electricity market					
7	The goodwill of our company has improved as a result of quality electricity product delivered to customers					
8	Our company engage in activities that lead to the creation of quality electricity product					
9	Our company's electricity quality control process has been of great advantage					
10	The quality of our company's electricity product has enhanced the pricing of electricity					
	<b>NEW TECHNOLOGY</b>					
11	Our company engage new technology in the design of electricity transmission lines					
12	Our company uses new technology in the transmission of electricity product					
13	Our company engage the use of new technology in the efficient utilization of power lines for the transmission of electricity product					
14	New technology has made the transmission process of electricity in our company easier					
15	New technology in our company's electricity transmission process has cut down cost of electricity transmission					
	<b>IMPROVED PRODUCT DEVELOPMENT</b>					

16	Improved electricity product development has led to the creation of quality electricity product in our company					
17	Improved electricity product development has led to the upgrade of our company's existing electrical power transmission lines to better satisfy our consumers					
18	The quality of electricity delivered to consumers has been improved by new electricity product development in our company					
19	Improved electricity product development has made our company to gain continuous relevance in the electricity transmission industry					
20	Our company's electricity product quality delivered to customers has become more acceptable					
	<b>BUSINESS PERFORMANCE</b>					
21	The quality of our company's electricity product has resulted to consumer satisfaction and an increase in their number					
22	The quality of our company's electricity product has led to an increase in revenue inflow					
23	The quality of our company's electricity product has evidently influenced the level of profitability					
24	Our continued existence as electricity transmission company can be greatly linked to the quality of electricity product delivered to customers					
25	The use of new technology has led our company to design transmission power lines and create electricity product that gives our company competitive advantage					
26	The new technology acquired for electricity transmission has greatly increased our company's level of productivity					
27	The revenue of our company has increased as a result of the new technology employed in the transmission of electricity product					
28	The new technology adopted for electricity transmission has ensured our company's continued existence					
29	Improved electricity product in our company has resulted in an increase in consumer base					
30	Improved electricity product development program in our company has led to high sales turnover					

## List of Figures

Figure 1.0: Nigeria Electricity Transmission Grid Network

Figure 1.1: One-line Diagram of Nigeria 330-KV Transmission Grid

Figure 3.0: Transmission and Distribution Grid Structure within the Power Industry

Figure 3.1: Electricity Transmission Line

Figure 3.2: Pearson's Uncertainty Map

Figure 3.3: The Disruptive Innovation Model

Figure 3.4: New-Market and Low-End Disruption Strategies

Figure 4.1: Gender of the Respondents

Figure 4.2: Marital Status of Respondents

Figure 4.3: Work experience of respondents

Figure 4.4: Educational qualification of respondents

Figure 4.5: Management category of respondent

Figure 4.6: The quality of our company's electricity product has made it more acceptable in the electricity market

Figure 4.7: The goodwill of our company has improved as a result of quality electricity product delivered to customers

Figure 4.8: Our company engage in activities that lead to the creation of quality electricity product

Table 4.9: Our company's electricity quality control process has been of great advantage

Table 4.10: The quality of our company's electricity product has enhanced the pricing of electricity

Figure 4.11: Our company engage new technology in the design of electricity transmission lines

Figure 4.12: Our company uses new technology in the transmission of electricity product

Figure 4.13: Our company engage the use of new technology in the efficient utilization of power lines for the transmission of electricity product

Figure 4.14: New technology has made the transmission process of electricity in our company easier

Figure 4.15: New technology in our company's electricity transmission process has cut down cost of electricity transmission

Figure 4.16: Improved electricity product development has led to the creation of quality electricity product in our company



Figure 4.17: Improved electricity product development has led to the upgrade of our company's existing electrical power transmission lines to better satisfy our consumers

Figure 4.18: The quality of electricity delivered to consumers has been improved by new electricity product development in our company

Figure 4.19: Improved electricity product development has made our company to gain continuous relevance in the electricity transmission industry

Figure 4.20: Our company's electricity product quality delivered to customers has become more acceptable

Figure 4.21: The quality of our company's electricity product has resulted to consumer satisfaction and an increase in their number

Figure 4.22: The quality of our company's electricity product has led to an increase in revenue inflow

Figure 4.23: The quality of our company's electricity product has evidently influenced the level of profitability

Figure 4.24: Our continued existence as electricity transmission company can be greatly linked to the quality of electricity product delivered to customers

Figure 4.25: The use of new technology has led our company to design transmission power lines and create electricity product that gives our company competitive advantage

Figure 4.26: The new technology acquired for electricity transmission has greatly increased our company's level of productivity

Figure 4.27: The revenue of our company has increased as a result of the new technology employed in the transmission of electricity product

Figure 4.28: The new technology adopted for electricity transmission has ensured our company's continued existence

Figure 4.29: Improved electricity product in our company has resulted in an increase in consumer base

Figure 4.30: Improved electricity product development program in our company has led to high sales turnover

Figure 5.1: Product Quality Dimension Analysis

Figure 5.2: New Technology Dimension Analysis

Figure 5.3 Improved Product Development Dimension Analysis

Figure 5.4: Business Performance Dimension Analysis

## List of Tables

Table 4.1: Gender of the Respondents

Table 4.2: Marital Status of Respondents

Table 4.3: Work experience of respondents

Table 4.4: Educational qualification of respondents

Table 4.5: Management category of respondent

Table 4.6: The quality of our company's electricity product has made it more acceptable in the electricity market

Table 4.7: The goodwill of our company has improved as a result of quality electricity product delivered to customers

Table 4.8: Our company engage in activities that lead to the creation of quality electricity product

Table 4.9: Our company's electricity quality control process has been of great advantage

Table 4.10: The quality of our company's electricity product has enhanced the pricing of electricity

Table 4.11: Our company engage new technology in the design of electricity transmission lines

Table 4.12: Our company uses new technology in the transmission of electricity product

Table 4.13: Our company engage the use of new technology in the efficient utilization of power lines for the transmission of electricity product

Table 4.14: New technology has made the transmission process of electricity in our company easier

Table 4.15: New technology in our company's electricity transmission process has cut down cost of electricity transmission

Table 4.16: Improved electricity product development has led to the creation of quality electricity product in our company

Table 4.17: Improved electricity product development has led to the upgrade of our company's existing electrical power transmission lines to better satisfy our consumers

Table 4.18: The quality of electricity delivered to consumers has been improved by new electricity product development in our company

Table 4.19: Improved electricity product development has made our company to gain continuous relevance in the electricity transmission industry

Table 4.20: Our company's electricity product quality delivered to customers has become more acceptable

Table 4.21: The quality of our company's electricity product has resulted to consumer satisfaction and an increase in their number

Table 4.22: The quality of our company's electricity product has led to an increase in revenue inflow

Table 4.23: The quality of our company's electricity product has evidently influenced the level of profitability

Table 4.24: Our continued existence as electricity transmission company can be greatly linked to the quality of electricity product delivered to customers

Table 4.25: The use of new technology has led our company to design transmission power lines and create electricity product that gives our company competitive advantage

Table 4.26: The new technology acquired for electricity transmission has greatly increased our company's level of productivity

Table 4.27: The revenue of our company has increased as a result of the new technology employed in the transmission of electricity product

Table 4.28: The new technology adopted for electricity transmission has ensured our company's continued existence

Table 4.29: Improved electricity product in our company has resulted in an increase in consumer base

Table 4.30: Improved electricity product development program in our company has led to high sales turnover