

Mendel University in Brno  
Faculty of Forestry and Wood Technology  
Department of Wood Science

**Bio-based wood adhesive derived from  
brewers spent grain**

Diploma Thesis

2016/2017

Author: Vladislava Muselíková

## **Declaration**

I hereby declare, that this thesis entitled *Bio-based wood adhesive derived from brewers spent grain* was written and completed by me. I also declare that all the sources and information used to complete the thesis are included in the list of references. I agree that the thesis could be made public in accordance with Article 47b of Act No. 111/1998 Coll., Higher Education Institutions and on Amendments and Supplements to Some Other Acts (the Higher Education Act), and in accordance with the current Directive on publishing of the final thesis.

I am aware that my thesis is written in accordance to Act. 121/2000 Coll., on Copyright and therefore Mendel University in Brno has the right to conclude licence agreements on the utilization of the thesis as a school work in accordance with Article 60(1) of the Copyright Act.

Before concluding a licence agreement on utilization of the work by another person, I will request a written statement from the university that the licence agreement is not in contradiction to legitimate interests of the university, and I will also pay a prospective fee to cover the cost incurred in creating the work to the full amount of such costs.

In Brno, April 14<sup>th</sup> 2017

.....

Vladislava Muselíková

## **Acknowledgement**

Firstly, I would like to thank my supervisor, prof. Dr. Ruppert Wimmer and my consultant Mgr. Zuzana Paschová, Ph.D. for their professional help and patient approach throughout writing this thesis.

Secondly, many thanks to Ing. Tomáš Pipíška for his precise hand during the sample preparation.

Thirdly, my dearest thanks go to all kind and willing people at the Mendel university in Brno and Universität für Bodenkultur in Wien. I would never finish this thesis without their support.

Last but not least, my sincere thanks go to my family and friends for their everlasting love.

Thank you, Vladislava

## **Abstract**

Title: Bio-based adhesive from brewers spent grain

Brewers spent grain (BSG) is an abundant waste material from the brewing process, representing approximately 85% of total by-products generated, is rich in cellulose and non-cellulosic polysaccharides and has a strong potential to be recycled. One of the main components of the BSG is protein, which has a potential to be extracted, modified and used as an adhesive for the woodworking adhesive. This work deals with the protein extraction through alkali treatment and its subsequent modification, crosslinking with glyoxal. The crosslinked adhesive was tested through ABES method to find, that ideal content of glyoxal is 20%. Subsequent adjusted standard tests for the lap shear strength and bend strength (MOE and MOR values) were used to compare its values to commercially available PVAc adhesive. The lap shear strength results were 2,7 times lower to PVAc, the bend strength values were, on the other hand, 1,5 times higher. The PVAc was partially replaced (50 and 25%) by the protein adhesive showing that the extracted adhesive could serve as a partial replacement to lower the ecological impact of the PVAc adhesive.

Key words: BSG, brewers spent grain, wood adhesive, protein, glyoxal, crosslinking, modification, plywood, bend strength, lap shear strength

## Abstrakt

Název: Lepidlo na bázi proteinu z použitého pivovarnického mláta

Použité pivovarské mláto je nadbytečný odpadní materiál z procesu při vaření piva, reprezentující přibližně 85 % veškerých vygenerovaných vedlejších produktů, je bohatý jak na celulóznové, tak necelulóznové polysacharidy a má silný potenciál k recyklaci. Jednou z hlavních složek pivovarského mláta je protein vhodný k extrakci a modifikaci a následnému použití jako lepidlo ve dřevozpracujícím průmyslu. Tato práce se zabývá extrakcí proteinů v zásaditém prostředí a následným síťováním glyoxalem. Zesíťovaný protein byl testován ABES metodou, která sloužila k nalezení optimální koncentrace glyoxalu, 20%. Následně upravené standardizované testy na smykovou a ohybovou pevnost (MOE a MOR hodnoty) byly použity pro zjištění hodnot, které byly srovnány s komerčně dostupným PVAc lepidlem. Výsledky smykové zkoušky byly 2,7krát nižší než výsledky pro PVAc, hodnoty ohybových zkoušek byly, na druhou stranu, 1,5krát vyšší. PVAc bylo částečně (z 25 a 50 %) nahrazeno proteinovým lepidlem a výsledky ukázaly, že extrahované lepidlo je možné použít jako částečná náhrada ke snížení ekologického dopadu PVAc lepidla.

Klíčová slova: pivovarnické mláto, dřevařské lepidlo, protein, glyoxal, síťování, modifikace, překližka, ohybová pevnost, smyková pevnost

## Index of abbreviations

ABES	The Automated Bonding Evaluation System
BPC	BSG protein concentrate
BSG	Brewer's spent grain
ESO	Epoxidized soybean oil
EVA	Ethylene-vinyl acetate
HPF	Hydroxymethyl phenol
MDI	Methylene-phenyl isocyanate
MMT	Montmorillonite
MOE	Modulus of elasticity
MOR	Modulus of rupture
MUF	Melamine urea formaldehyde
PF	Phenol-formaldehyde
pMDI	Polymeric methylene-phenyl isocyanate
POSS	Polyhedral oligomeric silsesquioxanes
PP	Plastic Polypropylene
PRF	Phenolic resol formaldehyde
PVAc	Polyvinyl acetate
RF	Resol formaldehyde
SC	Solid content
SDBS	Sodium dodecyl benzene sulphate
SDS	Sodium dodecyl sulphate
Soy-PF-B	Soy phenol-formaldehyde-B
SPI	Soy protein isolate
UF	Urea formaldehyde
ANOVA	Analysis of variance
HPLC-ELSD	High pressure liquid chromatography - evaporative light scattering detector
EN	European norm
ČSN	Československá norma
DTT	Dithiothreitol
AX	Arabinoxylans
PI	Isoelectric point
PH	Potential of hydrogen
VAT	Value after taxes

## Contents

1. Introduction .....	10
2. Brewers spent grain characterization .....	12
2.1. Composition.....	12
2.2. Application .....	13
2.2.1. Cattle feed .....	13
2.2.2. Human nutrition .....	14
2.2.3. Energy production .....	14
3. Wood adhesives.....	15
3.1. Brief history .....	15
3.2. Adhesion agents.....	15
3.3. Adhesion theories .....	17
3.4. Water resistance of wood adhesives .....	18
3.5. Selected wood adhesives properties .....	19
3.5.1. Molecular weight.....	20
3.5.2. Viscosity and gel time .....	20
3.5.3. Tack.....	20
3.6. Wood adhesives overview .....	22
3.7. Adhesives from renewable natural resources .....	23
3.7.1. Lignocellulosic residues .....	24
3.7.2. Plant protein adhesives .....	25
4. Proteins.....	26
4.1. Protein extraction.....	26
4.1.1. Protein solubility .....	27
4.2. Protein modification through crosslinking .....	28
4.3. Glyoxal treatment .....	30
4.3.1. Basic characterization .....	30
4.3.2. Glyoxal as a crosslinking agent.....	31

5.	Goals.....	33
6.	Materials and Methods .....	34
6.1.	Chemicals .....	34
6.1.1.	Protein content analysis.....	34
6.1.2.	HPLC-ELPS carbohydrates analysis.....	34
6.1.3.	BSG treatment .....	34
6.1.4.	Adhesive testing and comparison.....	34
6.2.	Extraction and modification .....	35
6.2.1.	Protein content analysis.....	35
6.2.2.	Sample preparation.....	35
6.2.3.	Calibration.....	35
6.2.4.	Test.....	36
6.2.5.	Determination of carbohydrates by HPLC-ELSD method .....	36
6.2.6.	Preparations of BSG protein concentrate.....	37
6.2.7.	Extract modification .....	40
6.2.8.	Screening test .....	40
6.3.	Resin characterization.....	42
6.3.1.	pH-Value .....	42
6.3.2.	Solid content.....	42
6.3.3.	Viscosity .....	43
6.3.4.	Resin calculation .....	43
6.4.	Testing of mechanical properties.....	43
6.4.1.	Plywood preparation .....	44
6.4.2.	Lap shear samples .....	45
6.4.3.	Bend samples.....	46
6.4.4.	Lap shear testing.....	46
6.4.5.	Bend strength testing.....	47
6.4.6.	Moisture content of the samples.....	48
7.	Results and discussion.....	49
7.1.	Protein analysis.....	49
7.2.	HPLC-ELSD analysis.....	51



7.3.	Extract modification .....	52
7.4.	Screening test.....	53
7.5.	Resin characterization.....	55
7.6.	Lap shear test .....	58
7.7.	Bend strength – MOR, parallel to grain .....	62
7.8.	Bend strength – MOE parallel to grain.....	64
7.9.	Bend strength – MOR perpendicular to grain .....	66
7.10.	Bend strength – MOE perpendicular to grain .....	68
7.11.	Moisture content .....	71
7.12.	Economic analysis .....	71
8.	Conclusion.....	72
	Shrnutí.....	74
	List of tables .....	76
	List of figures .....	77
	References .....	78
	Appendices .....	84

# 1. Introduction

We are living in the age of never-ending cycle of pollution and subsequent recycling. Social and political pressure is pushing all kinds of industries to at least reduce, better delete, their ecological traces. These aspects, along with the economical and moral ones, lead to a new point of view, which does not consider the residue as a waste product but as a raw material for further processing.

Compared to other industries, the brewing industry can be considered as environmentally friendly even though the amount of residue is large. This includes by-products and waste such as spent hops, spent grain and yeast. It is partially influenced by the nature of the industry in the meaning that the waste generated in agriculture is generally easy to recycle.

From the waste products mentioned, the spent grain is the most abundant. This type of residue corresponds to 85% of total number of by-products produced during the brewing process. Brewers spent grain (BSG) is available at low cost and in large quantities throughout the year, from both large and small breweries. Despite a large amount of BSG produced there has been only small effort and little attention paid to value added products from the waste material. Based on Townsley's research (1979) it was found that the spent grain accounts approximately 31% of original malt weight. For example, Brazil, the world's fourth largest beer producer, 8.5 billion litres/year, exceeded only by the United States of America (23 billion), China (18 billion) and Germany (10.5 billion) (Berto, 2003), in 2002 generated around 1.7 million tonnes of spent grain.

The Czech Republic does not stand behind in these statistics and the beer brewing has a long tradition and storied history. An annual production was estimated to 18 million hectolitres and it means that the beer consumption per capita is the highest in the world. With an estimated amount of 20 kilogram BSG per hectolitre of beer, the number of brewers spent grains in the Czech Republic is estimated at 360.000 tons/annum.

The connection between this thesis and the brewing industry lies in the utilization of the BSG for further processing and manufacturing of a wood adhesive. Adhesives are required

in many wood processing industries involving the production of particleboards, fibreboards or plywood and composites.

The call for new waste-based, bio-based and sustainable adhesives is raising from the increasing oil prices together with different chemical and low-emission regulations. Many of these adhesives are protein-based, presented and produced as biodegradable, therefore seen as agricultural products with added value (Kumer et al., 2002). Several issues such as poor water resistance (Wimmer et al. 2013, Mannes et al. 2014), and low bonding strength has been studied. Successful results have been obtained in the research with formaldehyde donors, sulphur compounds, and inorganic complexing salts that have been added to improve water resistance through crosslinking (Nordqvist 2012). As another example, Gao et al. (2012) have demonstrated that additions of cellulose nanowhiskers enhanced the performance of soybean adhesives which led to the improvement of water resistance by 20%. Enhancement of thermosetting adhesives through small additions of cellulose nanofibrils have been shown by e.g. Veigel et al. (2011).

Nevertheless, there is still a great potential in development and improvement of new green ways of wood bonding by adhesion. Usage of different proteins which are available in the central Europe region, lowering the formaldehyde content to the minimum or finding new possibilities of crosslinking are just examples of what can be achieved.

## 2. Brewers spent grain characterization

### 2.1. Composition

There have been several studies reporting on the approximate composition of BSG. In general, BSG contains protein, fat, cellulose, hemicellulose and lignin. Table 1 shows varieties reported by several authors. The variations arise due to differences in the grain, barley respectively, which is influenced by harvesting time, characteristics of hops and the brewing technology (Santos et al., 2003). Schematically (Figure 1), the spent grain husks consist of pericarp-seed coat layers rich in cellulose, other polysaccharides, lignin, protein and fat and there is a reflection of this composition in the overall composition of the matter displayed in Table 1. Based on the results BSG can be considered as lignocellulosic material. Huige (1994) went for further analysis and found out that the vitamins present are biotin, folic acid, niacin, choline, riboflavin and thiamine, pantothenic acid and pyroxidine. BSG is also reported to contain minerals such as Ca, Cu, Fe, Mn, K and Na and both essential (including lysine, histidine, methionine, phenylalanine, tryptophan) and non-essential (including alanine, serine, glycine, proline) amino acids.

Table 1 Chemical composition of BSG as reported in the literature

Components (% dry weight)	Kanauchi et al. (2001)	Russ et al. (2001)	Mussatto and Roberto (2006)	Mussatto et al. (2008)	Adeniran et al. (2008)	Khidzir et al. (2010)
Cellulose	25,4	23-25	16,8	16,8±0,8	-	-
Hemicellulose	-	30-35	28,4	28,4±2,0	-	-
Lignin	11,9	7-8	27,8	27,8±0,3	-	-
<b>Proteins</b>	<b>24</b>	<b>19-23</b>	<b>15,3</b>	-	<b>2,4±0,2</b>	<b>6,4±0,3</b>
Ashes	2,4	4-4,5	4,6	4,6±0,2	7,9±0,1	2,3±0,8
Extractives	-	-	5,8	-	-	-
Others	-	-	-	22,4±1,2	-	-
Carbohydrates	-	-	-	-	79,9±0,6	-
Crude fibre	-	-	-	-	3,3±0,1	-
Lipid	10,6	-	-	-	-	2,5±0,1
Acid detergent fibre	-	-	-	-	-	23,3
Total carbon (%)	-	-	-	-	-	35,6±0,3
Total nitrogen (%)	-	-	-	-	-	1,025±0,05

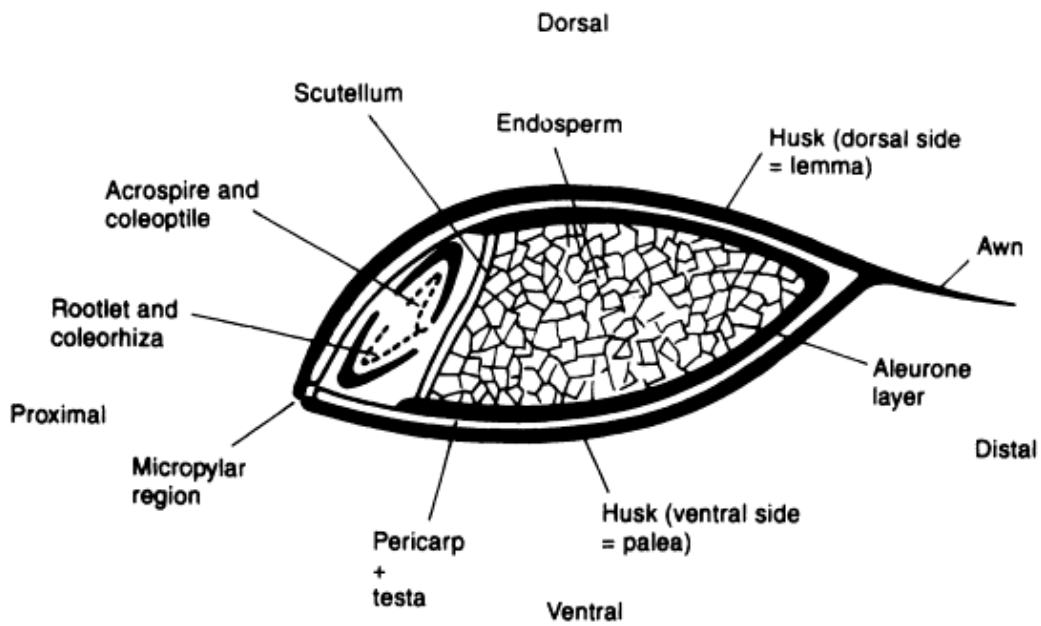

Figure 1 Schematic representation of a barley kernel in the longitudinal section (Adapted from Lewis and Young, 1995).

## 2.2. Application

### 2.2.1. Cattle feed

High protein content and amino acid profile of the spent grain make the waste material rich in nutrition. On the other hand, the amount of lignocellulosic matter makes it impossible to digest for the majority of animal species, therefore BSG is typically used as a feed to ruminants which are able to process the fibre content. The cattle fed with BSG showed higher milk production. The issue of this way feeding lies in the environmental impact of greenhouse gases produced by the kettle fed by this hard to digest the material. The impact was calculated 21 meaning that the impact is approximately 21 times greater than that of carbon dioxide.

However, BSG is much easier available and cheaper to obtain than widely used soya. Furthermore, there are fractionation methods for BSG that separates the matter into protein-rich and fibre-rich streams. This subsequently means that the protein-rich extraction can be considered as value added ingredient of cattle feed (Cook, 2011).

### **2.2.2. Human nutrition**

Similarly, to animal nutrition, BSG can be considered as potential source for manufacturing of flakes, whole-wheat bread, biscuits and aperitif snacks. (Mussatto et al., 2006) However based on numerous experiments (Hassona, 1993; Öztürk et al., 2002) the BSG needs a conversion to flour due to its granular nature. The flour was successfully incorporated into numerous products such as muffins, cookies, cereals, waffles, tortillas and many others (Huige, 1994).

Here is a list of BSG flour properties compiled by Huige (1994) to illustrate the benefits and potential use for example in the countries where poor malnutrition exists:

- Ease of blending
- High water sorption capacity
- Provides valuable minerals such as Ca, P, Fe, Cu, Zn and Mg
- Low-fat absorption (beneficial for batters and coating)
- High fibre content
- High protein content

### **2.2.3. Energy production**

There are three main methods how to produce energy from BSG (Cook, 2011):

- Combustion – burning the grain using a biomass boiler. Nevertheless, the process needs an additional pre-drainage to 55% moisture content and during the level of NOx and dust emissions is high (Meyer-Pittroff, 1988).
- Use as a source of sugars for bioethanol production – hemicellulose and cellulose components consist of polymeric sugars. These sugars could be liberated and and fermented to generate bioethanol, then substantial net fuel savings might be achieved. The research is in its beginnings (Cook, 2011).
- Anaerobic fermentation – needs to be divided into hydrolytic and methanogenic step. Hydrolysis is necessary to use for the degradation of the material. Anaerobic digestion utilises specific mixtures of microorganisms ('consortia') to digest biodegradable materials with the ultimate aim of generating biogas (predominantly a mixture of methane and carbon dioxide, which may be burnt to liberate energy) (Cook, 2011).

### **3. Wood adhesives**

#### **3.1. Brief history**

The use of adhesive is almost as old as the humankind itself (Keimel, 2003). Bonding wood together can be dated back to ancient Egypt and China which means at least 3000 years back in time (Skeist and Miron, 1990). Until World War I, the adhesive market consisted mainly of plant and animal based adhesives. As mentioned before, these adhesives, used for example for aircraft plywood bonding suffered when exposed to water and also their resistance to microorganisms was really poor and due to these reasons, the main application was limited to interior use (Lambouth, 2003).

These aspects led to the development of new petroleum synthetic based adhesives with improved properties. First to enter the market were the phenol-formaldehyde (PF) followed by urea-formaldehyde (UF) adhesives. Another breakthrough in the history of adhesion was the invention of epoxy resins which have even better properties. The petroleum based adhesives had the advantage of low price and high availability. Subsequently, these reasons led to a displacement of natural adhesives. For instance, phenolic and urea formaldehyde resins have replaced blood-, soybean-, and starch-based glues, resorcinol-formaldehyde resins replaced casein-based resins and polyvinyl acetate (PVAc) replaced collagen-based adhesives (Lambouth, 2003).

Industry and approach to environment issues greatly developed from the 1960s. The concern about rising prices of crude oil and new strict environmental regulations regarding emissions of volatile formaldehyde compounds led to the development of environmentally friendly wood adhesives. Current research in this area is focused on the development of new ways of improving the moisture and mould resistance (Liu, 2007).

#### **3.2. Adhesion agents**

For a better understanding of the issue it is always better to define basic terminology:

- Adherend (substrate) is any material or substance bonded together with an adhesive. By the term is usually meant solid material whose surface physical and chemical properties define the performance of the adhesive behaviour. In case of wood adhesive bonding, there are anatomical features such as lumen size, cell distribution or roughness and chemical composition of the surface influenced mainly by the nature of non-structural molecules and polymers (Douglas et al., 2014).
- Adhesives are polymeric materials capable of bonding to adherends and keeping the mechanical load. They are viscoelastic and often liquid. The necessary conditions are an effective interaction with the surface and the ability of wetting the surface (Douglas et al., 2014).
- Adhesive joint in the most basic concept is the assembly of two adherends and the adhesive. The simplest form consists of adherend-adhesive-adherend. Nevertheless, the complexity of adhesion lies in the bonds at the interphase level. The interphase is also examined which means that adherend and adhesive can influence each other in chemical and/or physical composition. Figure 2 shows the possible interphases in the adhesive (Douglas et al., 2014).

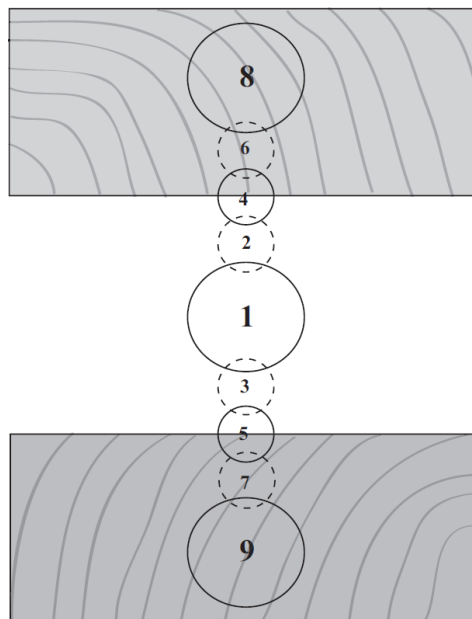

Figure 2A representation of adhesive bond “anatomy”

The links are identified, top to bottom, as follows: Bulk adherend [8], adherend interphase [6], adhesive–adherend interphase [4], adhesive interphase [2], bulk adhesive [1], adhesive interphase [3], adhesive–adherend interphase [5], adherend interphase [7], and bulk adheren [9]. Adapted from Introduction to Wood and Natural Fiber Composites (Stokke et al., 2013)



### 3.3. Adhesion theories

Bonding by adhesives is one of the main application of adhesion, often preferred to mechanical techniques such as bolting or riveting. Its competitiveness lies in better stress distribution, weight and aesthetics. The term adhesion covers multiple areas of application and one must distinguish whether the subject is analysed from the molecular, microscopic, or macroscopic point of view or whether one talks about the formation of the interphase or failure of the formed system. This fact, that the study of the mechanism of adhesion lies at the boundary of several scientific fields, is one of the main difficulties. On one hand, theories can support each other, on the other hand, they are sometimes contradictory. Following theoretical models, these theories were suggested (Schultz and Nardin, 2003):

- Mechanical interlocking is model proposed by MacBain and Hopkins (1924) and it studies adhesion from the point of view of mechanical penetration of adhesives into pores and asperities of the surface. The theory was supported by consistent results of measurements between rubber and textile materials (Borroff and Wake, 1950) but also disproved by the fact that it possible to establish good adhesion between two smooth surfaces, for example metals, therefore Gent and Schultz (1972) suggested to involve also the thermodynamic interaction as multiplying factor for the strength. The equation (1) for the strength calculation of adhesion energy  $G$  is:

$$G = (\text{constant}) \times (\text{mechanical keying component}) \times (\text{interfacial interactions component}) \quad (1)$$

- Electronic theory suggests that an electron transfer mechanism between the substrate and adhesive if having a different electronic band structures can occur to equalize the total chemical potential of electrons (Fermi levels). This phenomenon could induce the formation of a double electrical layer at the interphase, and Derjaguin and Krotova (1948) have proposed that the resulting electrostatic forces can contribute significantly to the adhesive strength.
- Theory of weak boundary layers and concept of interphase discuss the adhesion and reasons for potential failure. First observed by Bikerman (1961), the theory is based on the probability of considerations showing that the fracture is never present only along the adhesive-adherend interphase but the cohesive failure within the weaker

material is a more likely to happen. In theoretical situation, the combination of air, adherend and adhesive gives the potential of 7 weak boundary layers: air, adherend, adhesives, combinations of any two or combination of all three components, as well as e.g. short polymer chains (Bikerman, 1961).

- Adsorption (thermodynamic) theory model is the most widely used approach and was defined by Sharpe and Schonhorn (1963). The belief behind is that the adhesive adheres to the adherend because of interatomic and intermolecular forces present at the interphase. Among the most common forces are van der Waals and Lewis acid-base interactions and their magnitude can be related to thermodynamic quantities as potential surface energy. Preconditions for application of this model are good wetting possibilities and the energies of surface and interphase.
- Diffusion theory is based on the existence of adhesion strength in polymers themselves (autohesion) or adhesion to each other due to mutual diffusion (interdiffusion) of macromolecules across the interphase. It implies that macromolecular chains or its segments are mobile and mutually soluble (Voyutskii, 1963).
- Chemical bonding theory implies that apart from secondary force interactions between the interphases which lead to physical strength (hydrogen bonding, van der Waals forces), there are also primary chemical bonds such as covalent and ionic bonds. The terms *primary* and *secondary* refer to relative strength or bond energy of each type of interaction. Since covalent bonds are much stronger than secondary forces such as van der Waals interactions and hydrogen bonds (100–1,000 kJ/mol versus  $\leq 50$  kJ/mol), it might be reasoned that covalent bonds are required for good adhesion. However, the sheer number of secondary interactions between substrate and adhesive often produces more than adequate bond strength without the need for covalent bonds (Douglas et al., 2014).

### **3.4. Water resistance of wood adhesives**

Water is a persistent problem in wood bonding, it has its effect from both sides – outside and inside. Local moistening is a result of water movement inside the wood as the glue acts as a barrier and is exposed to stressed conditions. Even a small amount of water uptake in adhesives may influence the mechanical performance of glue, with the risk of jeopardising

the safety of glued wood products. It was found that under the water-immersed condition, the elastic modulus and hardness of various wood adhesives were reduced by up to half of the dry-state values (Konnerth et al. 2010).

The water resistance of the adhesive joint is dependent on the type of the chemical bonding, specifically the hydrogen bond formation. Hydrogen bonding is sharing of a hydrogen atom between two polar groups, common in compounds with nitrogen, oxygen, and sulphur groups with attached hydrogens, and carbonyl groups. This type of bond is extremely likely to be present in wood and its adhesive because all wood components have enough of the proper polar groups and some have carboxylic acid and ester groups which have very strong internal hydrogen bonding. This is what gives wood its strength but also makes it inclinable to external hydrogen bonds. The presence of polar groups available to form internal and external hydrogen bonds are usually an assumption for wood adhesives. It is most certainly valid for the bio-based adhesives, which heavily depend on hydrogen bonds for their adhesive and cohesive strength. On the other hand, the synthetic adhesives have internal crosslinks, which support the cohesive strength but not the adhesive one, which is again formed by the hydrogen bond. Here is the connection to water resistance. The limitation of the hydrogen bond is its ability to be disrupted in the presence of water, which can insert itself, along with other hydrogen groups, between two groups in the bond. It leads to softening the inter-chain bonds and the joint is no longer able to hold the applied loads.

### **3.5. Selected wood adhesives properties**

Even if there is no single theory and the ideas and opinions differ, the overall mechanism of many adhesives has been understood and it is possible to say the same about the chemistry. Many adhesive reactions, synthesis and cures have been characterised and the most used adhesives have basic similarities in these processes in common. The majority of wood adhesives are polymers and are either natural based or synthesised from petrochemical resources. Organic polymers are difficult for characterisation but for the matter of adhesion, there are descriptors which are simple to understand measure and use-molecular weight, viscosity, gel time, and tack (Stokke, 2013).

### **3.5.1. Molecular weight**

Generally, for the bonding purpose, it is possible to say that more crosslinked polymers (higher molecular weight) are better. Most of the adhesives consist of monomers and/or oligomers and it is needed to activate the polymerization. This could be done through heat, pH, catalyst and others. On the other hand, for the bond formation, the adhesive needs to be able to flow and get into lumens and cell walls, and it easier with lower molecular weight. The adhesive with higher molecular weight will cure faster but it could lead to problems with solubility and stability. Thus, it is needed to find a balance between low molecular weight for a good wetting of the wood and higher molecular weight for the more rapid set and to resist flow once the bond is formed (Stokke, 2013).

### **3.5.2. Viscosity and gel time**

Viscosity is a measure of the thickness of the liquid with a relation to the molecular weight. Higher molecular weight leads to higher viscosity. It also gives an idea about shelf time, in other words, time when it is still possible to apply the resin. Eventually, the resin will increase in viscosity and form a gel. The gelled resin is then unusable, signalling the end of the pot life. Viscosity is represented by the lowercase Greek letter eta,  $\eta$ . Strictly, “viscosity of a fluid can be defined as the ratio of shear stress to shear rate during flow, where shear stress is the frictional force exerted by the fluid per unit area ( $\tau$ ), and shear rate is the velocity gradient perpendicular to the flow direction ( $\gamma'$ )” (Groover, 2007).

### **3.5.3. Tack**

Last, commonly defined property of adhesives is tack. According to Marra (1992) it is: “the property of an adhesive that enables it to form a bond of measurable strength immediately after adhesive and adherend are brought into contact under low pressure, that is, stickiness”. It is mainly important for composite gluing, for example when manufacturing medium density fibreboard; it enables the mattress of wood to remain intact. Adhesive tack allows the mat to retain its integrity between the prepress and the final pressing operation (Stokke, 2013).

For better understanding of wood adhesive complexity, Table 2 shows the enormous variety of possibilities, which can occur in the adhesive, wood, process and service. Table 3 presents an overview of recommended values of different variables.

Table 2 Wood bonding variables (Adapted from Rowell, 2013)

Resin	Wood	Process	Service
Type	Species	Adhesive amount	Strength
Viscosity	Density	Adhesive distribution	Shear modulus
Molecular weight distribution	Moisture content	Relative humidity	Swell–shrink resistance
Mole ratio of reactants	Plane of cut: radial, tangential, transverse, mix	Temperature	Creep
Cure rate	Heartwood vs. sapwood	Open assembly time	Percentage of wood failure
Total solids	Juvenile vs. mature wood	Closed assembly time	Failure type
Catalyst	Earlywood vs. latewood	Pressure	Dry vs. wet
Mixing	Reaction wood	Adhesive penetration	Modulus of elasticity
Tack	Grain angle	Gas-through	Temperature
Filler	Porosity	Press time	Hydrolysis resistance
Solvent system	Surface roughness	Pretreatments	Heat resistance
Age	Drying damage	Posttreatments	Biological resistance: fungi, bacteria, insects, marine organisms
pH	Machining damage	Adherend temperature	Finishing
Buffering	Dirt, contaminants		Ultraviolet resistance
	Extractives		
	pH		
	Chemical surface		

Table 3 Characteristics of wood durable bond (Adapted from Stokke, 2014)

Satisfactory adhesion criteria (Pocius, 2002)	Criteria met by durable wood adhesive bonds (2006)
Choose an adhesive that is soluble or diffuses into the adherends.	Durable wood adhesives such as PF and pMDI resins have similar solubilities to the lignin in the wood cell wall.
Choose an adhesive with a critical wetting tension less than the surface energy of the adherend.	Most wood adhesives exhibit adequate wetting on properly prepared wood substrates.
Choose an adhesive with a viscosity low enough so the equilibrium contact angle can be attained during the assembly time.	The dynamic behavior of wood adhesive wetting ensures proper contact angles will be obtained during assembly.
Choose an adhesive compatible with the weak boundary layer or remove the weak boundary layer.	Inherently, wood has microscopic and nanoscopic morphology.
For exterior exposure, choose an adhesive which can provide covalent bonding between the adherend and the adhesive.	In producing a fresh surface for adhesive bonding, the chemical weak boundary layer is removed in wood, and mechanical damage inherent to the machining process may facilitate adhesive bonding in many types of wood composite elements. In addition, adhesives can be formulated to handle extractive contamination of the wood.

### 3.6. Wood adhesives overview

There are several ways how to classify and characterise adhesives, classification by origin, resistance to heat or structural integrity (Stokke, 2013). The classification according to the heat resistance includes two big groups: thermosetting and thermoplastic polymers. Most of the commercially available adhesives are thermosetting meaning once the adhesive is cured, the process cannot be reversed. Structural identity is a complementary distribution and describes the purpose and use of the adhesive based on the strength properties as follows: structural/exterior, semi-structural/limited exterior and non-structural/interior. Classification by origin is shown in Figure 3.

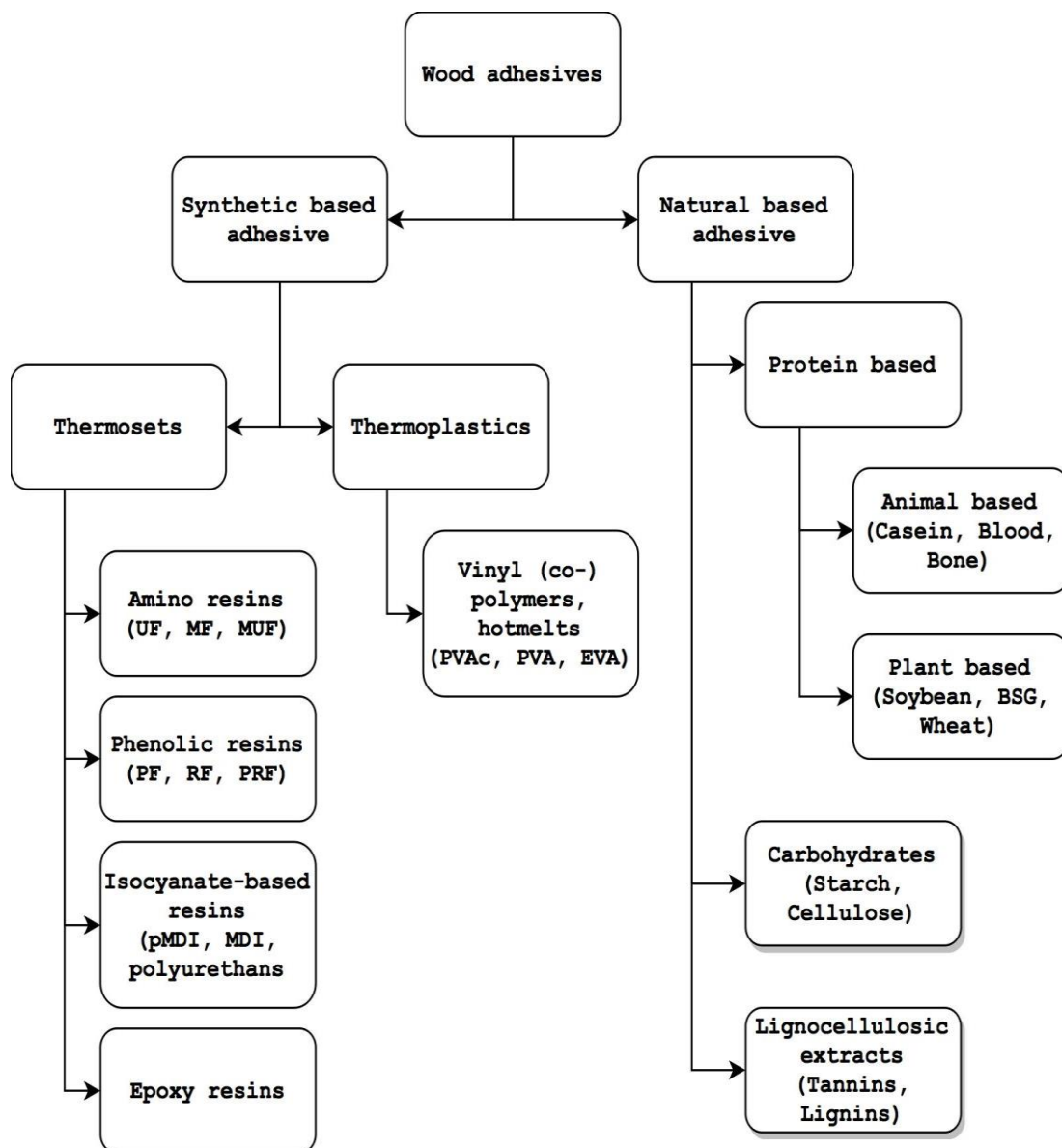

Figure 3 Wood adhesives classification as mentioned in Vick (1999)

### 3.7. Adhesives from renewable natural resources

As mentioned several times before, the topic of wood adhesion or specifically wood adhesives is extremely broad. Therefore, for the purpose of this thesis this chapter will focus on natural-based adhesives, mainly protein-based. Vick (1999) systematically describes the most common, commercially available adhesives from natural resources (Table 4).

Table 4 Adhesives from natural adhesives (Adapted from Stokke, 2014)

Source	Form and colour	Preparation and application	Strength properties	Typical uses
Carbohydrate, including cellulose derivatives, starch and gums	Films, powders, hot melts, white to yellow to dark brown	Methods of application vary widely; cellulose derivatives may be solvent-borne or solid hot-melts; starches are prepared variously and mixed with borax, plasticizers, water-resistance additives (e.g., UF, MF, or RF polymers, polyvinyl acetates, etc.), viscosity stabilizers, fillers and other additives and are generally applied as liquid formulations ranging from watery to paste-like viscosities; gums are dispersed in hot or cold water to form gel-like materials	Low strength relative to other adhesive classes, but adequate for the intended purposes; water or moisture resistance varies with type of derivative; not intended for use in the wood and fibre composites	Cellulose derivatives are used as paper sizings and coatings, wallpaper adhesives, leather processing aids, additives to paints, solvent- and hot-melt adhesives, and so on.; starch is a common adhesive for book binding, corrugated box manufacturing, wettable adhesives for envelopes and stamps, and as a paper and textile sizing agent; pressure-sensitive tape, denture adhesives, pharmaceutical tablet binders,
Lignocellulosic residues and extracts, primarily lignins and condensed tannins	Powder or liquid; may be blended with phenolic adhesive; dark brown bondline	Blended with extender and filler by user; adhesive cured in hot-press ranging from 130°C to 205°C depending on type of lignocellulosic extract used in adhesive formulation	Good dry strength; moderate to good wet strength; durability improved by blending with phenolic adhesive	Partial replacement for phenolic adhesive in composite and plywood panel products; condensed tannins may be formulated as standalone adhesives for plywood and composites
Soybean, protein; soy protein (and a carbohydrate fraction) is generally obtained as a by-product of soy oil extraction	Powder with added chemicals; white to tan, similar colour in bondline	Mixed with cold water, lime, caustic soda, and other chemicals; applied and pressed at room temperature, but more frequently blended with blood adhesive; contemporary research has introduced chemical cross-linkers and alternative applications	Moderate to low dry strength; moderate to low resistance to water and damp atmospheres; moderate resistance to intermediate temperatures	Softwood plywood for interior use, now replaced by phenolic adhesive. New fast-setting resorcinol-soybean adhesives for finger-jointing of lumber has seen limited use; new formaldehyde-free adhesive has likewise seen limited use for particleboard and interior plywood
Animal, protein; from hides, bones, sinew; protein from fish skin	Solid and liquid, brown to white bondline	Solid form added to water, soaked, and melted; adhesive kept warm during application;	High dry strength; low resistance to	Assembly of furniture and stringed musical instruments; repairs of antique furniture; "hide

		liquid form applied directly; both pressed at room temperature; bonding process must be adjusted for small changes in temperature	water and damp atmosphere	glues" are also preferred for high-end laminated table tennis paddles
Casein, protein	Powder with added chemicals; white to tan bondline	Mixed with water; applied and pressed at room temperature	High dry strength; moderate resistance to water, damp atmospheres, and intermediate temperatures; not suitable for exterior uses	Original adhesive for structural glue-laminated timbers, now replaced by synthetics in this application; interior doors
Blood, protein	Solid and partially dried whole blood; dark red to black bondline	Mixed with cold water, lime, caustic soda, and other chemicals; applied at room temperature; pressed either at room temperature or 120°C or greater	High dry strength; moderate resistance to water and damp atmosphere and to microorganisms	Interior-type softwood plywood, sometimes in combination with soybean adhesive; mostly replaced by phenolic adhesive

### 3.7.1. Lignocellulosic residues

Spent lignin, in other words, technical lignin, is the term describing residue after isolation of cellulose in the pulping process. Unfortunately, only small fraction of the spent lignin can be used for further processing into adhesives, specifically the lignin from sulphite pulping process. Lignin is a polyphenolic substance and it could be expected that it would behave in the same manner as petrochemically derived phenols. This hypothesis was proved to be wrong because the condensation reactions are less effective, due to fewer free reaction sites and also the purity of obtained lignin is not perfect. These issues limit the use of lignin as an extender to synthetic phenol resins. Research in this area includes cross-linking by condensation reactions or oxidative coupling, employment of long press times and post-heating treatment, curing with sulfuric acid or hydrogen peroxide, methylenation of lignin, or combining lignin with PF or UF resins (Pizzi, 2003).

Tannins, on the other hand, are phenolic extracts with high reactivity, higher than synthetic phenol and cannot be used as resoles. They are obtained from bark, leaves and fruits and used as a replacement in phenolic resins.



### **3.7.2. Plant protein adhesives**

The topic is very often limited to soybean proteins, but research has been done also in the field of wheat gluten protein. These proteins were hydrolysed and modified with either formaldehyde or glyoxal, and then further combined with other crosslinkers, e.g. isocyanate (pMDI) (Lei et al., 2010). El-Wakil et al. (2007) modified wheat gluten in combination with an UF resin as a binder in particleboard of reed. The standard requirements have been met up when this modified protein replaced up 80% of the UF resin.

Soybean protein adhesives have been objects of studies devoted to improving the adhesion strength, reduce the cost and to improve the water resistance. The protein extraction and crosslinking are discussed further.

## 4. Proteins

### 4.1. Protein extraction

Deutscher (1990) describes the protein extraction as “more of an art than a science”. It is necessary to design in accordance with objectives of the project which may require different purity or quantity. In general, the plant proteins extraction is done in following steps (Deutscher, 1990) :

1. Efficient extraction from biological material done through enzymatic/alkali hydrolysis, with support of thermomechanical reaction. This leads to chemical denaturation, “opening” of the protein for further modification. Certain reagents such as guanidine hydrochloride, urea, sodium dodecyl benzene sulphonate (SDBS) and sodium dodecyl sulphate (SDS) denature protein as well as improved their gluing strength and water resistance, so the modification is done less steps (Huang and Sun, 2000). Different treatments for BSG protein extractions were suggested by authors:
  - a. “Proteins in unmalted and malted barley and in brewers’ spent grain (BSG) obtained after mashing were fractionated on the basis of their differential extractability in different media Albumins and globulins were first extracted with 5.0% NaCl and hordeins (barley prolamins) were extracted with 55.0% 1-propanol in the presence, or absence, of 1.0% DTT. Glutelins were then extracted with 2.0% SDS/6.0 M urea/1.0% DTT or with 55.0% 1-propanol/6.0 M urea/1.0% DTT/0.036 M Tris-HCl (pH 8.4)” (Celus et al., 2006).
  - b. “A sequential extraction of proteins and arabinoxylans (AX) from BSG with increasing alkali (KOH or NaOH) concentrations of 0.1 M, 0.5 M, and 4 M, was optimized. A ratio of 1:2 (w/v) (weight of BSG by volume of alkali solution) at room temperature for 24 h was preferred to minimize reagents and energy consumption. To fully integrate the process, alkaline extracts were acidified to pH3 with citric acid, to obtain the protein-rich fractions. This integrated extraction process allowed a yield of 82–85% of the BSG total proteins and 66–73% of total AX with formation of a cellulose rich residue almost devoid of nitrogen” (Veira et al., 2014).
2. Separation from non-protein components.
3. Precipitation steps, initially to recover the bulk protein from a crude extract, followed by preliminary resolution into manageable fractions

The extraction of BSG protein for adhesive production has not been studied yet but the research in soybean adhesives showed that the treatment with strong alkaline, such as NaOH

or trisodium phosphate is necessary to expose and disperse more amide functional groups to maximize the adhesion. This relies on the concept that by breaking the internal hydrogen bonds in the coiled protein molecules (unfolding), the polypeptide chains become more available for adhesion to the wood surface.

#### **4.1.1. Protein solubility**

Protein solubility is its physicochemical property, which is a prerequisite to the protein extraction in a way discussed in this work. Various factors influence the potential of the protein to be dissolved. According to Zayas (1997) amino acids, their composition, sequence and content of polar and nonpolar groups, along with the molecular weight are all variables influencing the solubility. Apart from the protein composition, there are environmental factors affecting the solubility: ionic strength, type of solvent, pH, temperature, and processing conditions as mentioned before.

The degree of protein solubility in an aqueous medium is the result of electrostatic and hydrophobic interactions between the protein molecules. If the electrostatic repulsion between molecules is higher than hydrophobic interactions, the solubility is increased. All molecules have the isoelectric point (pI) leading to insolubility. Therefore, the proper adjustment of pH is needed to ensure that protein can interact with water. Even if the interaction get higher both ways, it was observed that the solubility is higher in alkali environment. Alkali treatment usually increases soy and other plant-protein solubility by causing dissociation and disaggregation of the proteins (Zayas, 1997).

There is no unique solution for temperature setting to increase protein solubility. The temperature leads to irreversible changes of the conformation resulting in difficult processes during the precipitation. For most of the proteins, the solubility rises with the temperature up 50 °C. Higher temperatures and subsequent denaturation can lead to decrease of the solubility (Zayas, 1997).

Apart from factors mentioned, ionic strength and processing conditions such as mechanical treatment, pH of extraction, precipitation, and neutralization, ratio of matter/solvent, time, size of particles (milling and grinding as pre-processing) and added salts are also important.

A concrete and relevant example can be seen with the soy protein. Kinsella (1979), in his research describes soy protein as characteristic for its solubility in salt solutions, easily affected by the pH. Minimal solubility was observed at pH 4,2-4,6. Zayas (1997) confirms the theory, he describes the best solubility of the protein at pH 6-8, between the pI points and describes the production of protein isolate: “The principle of the soy isolate production is the extraction at pH 7-9 and then recovery of protein by acidifying the extracts to pH 4-5.” He also mentions the effect of temperature, according to him the best temperature for the protein solubility is to increase the temperature to 70 °C. Increase of temperature (120 °C) and exposure to strong alkali environment (11 pH) was experimentally proved as treatment leading to an increase of protein solubility but also to irreversible change of the protein structure and therefore also properties due to the disaggregation (Zayas, 1997).

## **4.2. Protein modification through crosslinking**

Crosslinking is the process of chemically joining two or more molecules by a covalent bond. Parts of the molecules which answers to reactions are called reagents and contain reactive ends which can be bonded to specific functional groups, mainly i.e. amines, sulfhydryls on proteins. Assumption of crosslinking is that several chemical groups in proteins (peptides) are available for conjugation (Thermo Sciences, 2014).

The crosslinking and modification of adhesives is done for example to:

- Improve water resistance
- Adjust viscosity
- Improve mechanical strength
- Protect the adhesive from fungi attacks
- Prolong the working life
- Increase molecular weight
- Reduction of solubility

With high probability, the BSG protein could be compared to the commercially used soy protein in adhesives. Soy protein has many reactive groups (e.g.,  $-NH_2$ ,  $-OH$ , and  $-SH$ ) that are susceptible to crosslinking reactions in addition to naturally existing disulphide crosslinking. Crosslinking of soy-protein leads to the formation of larger aggregates, accompanied by an increase in molecular weight, reduction of solubility, and reduced

elasticity (Bjorksten, 1951). Following Table 5 contains a list of examples of possible crosslinking methods found in the literature. Ideas included were successfully implemented. The list includes traditional (formaldehyde, SDS), bio-based (epoxidized soybean oil) and modern, innovative crosslinking agents (POSS method).

Table 5 Chemical crosslinking as found in the literature

Crosslinker	Protein	Use	Result	Source
Furfuryl	Soy	Further study of morphology and biodegradability	It has been found out that water absorption decreases with the increase of furfuryl. The temperature of molding effected positively the tensile strength, elongation, yield strength and Young's model.	Swain et al. (2004)
TriSilanolPhenyl polyhedral oligomeric silsesquioxanes (POSS) + 3glycidoxypropyltrimethoxysilane	Soy	Enhancement of the mechanical and water-resistant properties of soy protein isolate (SPI) based films	The elongation at break was reduced by 52.6%, the tensile modulus, tensile strength and 10% offset yield strength were significantly increased by 86.6%, 34.0% and 56.8%,	Xia et al. (2016)
Epoxidized soybean oil	Soy	Improvement of tensile strength and water resistance of soy protein isolate (SPI)-based films.	The best performance of the SPI-based films was achieved when the ESO addition was 2.5%, for which tensile modulus, tensile strength and 10% offset yield strength were increased to 265.0 MPa, 9.8 MPa and 6.8 MPa, respectively.	Xia et al. (2015)
Neopentyl glycol diglycidyl ether	Soy	Production of an intrinsic toughening effect to reduce the brittleness and improve the water resistance of a soybean meal-based adhesive.	Improvement of the water resistance of the soybean meal-based adhesive by 12.5%. Tensile shear was 286% higher than without the crosslinker.	Luo et al. (2016)

Hydroxymethyl phenol	Soy	Improvement of tensile strength and water resistance of soy-based adhesive	The soy-based adhesive cross-linked with HPF cured at a lower temperature than the adhesive without HPF. The former showed better mechanical performance and heat resistance than the latter.	Lei et al. (2016)
Polyethylene glycol, sodium hydroxide, melamine-urea-formaldehyde	Soy	Improvement of tensile strength and water resistance of soy-based adhesive	The wet shear strength of plywood bonded by the adhesive was increased to 0.95 MPa, meeting interior standards. Improved viscosity.	Gao et al. (2012)
Formaldehyde	Soy	Reducing of the amount of petroleum based content (phenol, formaldehyde) in adhesives	Formaldehyde stabilises the protein against further hydrolysis and also activates it for reaction with PF resins. Soybean flour adhesives have been produced that give satisfactory performance at adhesive levels and press times comparable to those of commercial PF resins. A Soy-PF-B adhesive of 40% soybean was equal in performance to the PF when used under the same pressing conditions; higher percentages of soybean, 66%, can be used if longer press times are utilized.	Frihart and Wescott (2004)
Montmorillonite (MMT) nano modification of soy protein followed by crosslinking by Methylene diphenyl diisocyanate(MDI)/ Glyoxal	Soy	Improvement of tensile strength and water resistance of soy-based adhesive, prolonging its pot life	Improved bond strength of crosslinked protein, longer pot life with MMT modification.	Zhang et al. (2013)

### 4.3. Glyoxal treatment

#### 4.3.1. Basic characterization

Glyoxal (Figure 4), the smallest, non-volatile and non-toxic dialdehyde, is a highly reactive chemical intermediate used primarily in the preparation of pharmaceuticals, paper and textiles. It is miscible in water and has a weak sour odour. Table 6 shows possibilities of application.

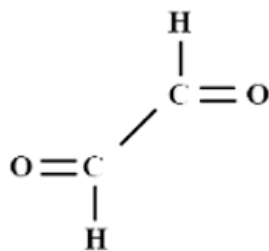

Figure 4 Glyoxal (C<sub>2</sub>H<sub>2</sub>O<sub>2</sub>) structure

Table 6 Applications of glyoxal (Adapted BASF, 2016)

Application	Characteristic	Benefit
Textiles	Crosslinking agent or building block for crosslinker	Softer and less wrinkled textiles
Paper	Crosslinking agent or building block for crosslinker	Paper wet strength (e.g. toilet paper) Paper dry strength (e.g. recycled paper) Efficient paper coating additive for high-quality papers
Leather	Crosslinking in tanning process	Preservation of leather quality
Cosmetics	Use of glyoxal-crosslinking polymers (hydrocolloids)	Better viscosity
Epoxy	Building block for specific epoxy applications	Higher epoxy stability performance
Wood Hardening	Crosslinking agent or building block for crosslinker	Cures wood Protection from moisture

#### 4.3.2. Glyoxal as a crosslinking agent

Glyoxal can alter mechanic-physical properties of polymers, leading to i.e. higher viscosity and decreases the water uptake. It can be compared to properties of formaldehyde and other aldehydes, but it is not so volatile and toxic. It perfectly reacts with alcohols and amines.

Worldwide company BASF came with innovative approaches of possible usage of glyoxal, especially as a crosslinker and scavenger. In context to wood-working industry, their successful implementation in the binding of cellulose and wood hardening should be mentioned.

Apart from commercially available products, glyoxal has been used as a crosslinker in soy-protein products (Vaz et al, 2003), in PVAc adhesives crosslinking, in urea-glyoxal adhesive (Younesi-Kordkheili and Pizzi, 2016), melamine-glyoxal adhesive (Wu et al., 2016), tannin-glyoxal adhesive (Ballerini et al., 2005). Figure 5 shows a possible reaction of the glyoxal. On the side could be PVA polymer, cellulose or protein.

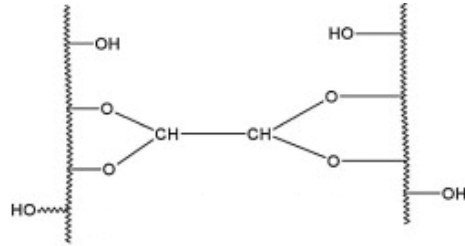

Figure 5 Example of polymer linking by glyoxal



## 5. Goals

Based on the research done in the field it has been hypothesised that if the protein extraction is done successfully, the protein concentrate can be further modified and used as an adhesive. The goals of this thesis were to:

1. Extract the protein from the BSG
2. Find a way of modification of the protein
3. Test the new adhesive according chosen EN standards (ČSN respectively)
4. Compare the BSG based adhesive with commercially available adhesive

## 6. Materials and Methods

### 6.1. Chemicals

#### 6.1.1. Protein content analysis

The protein content analysis was done by spectrometry method based on Biuret reaction. The sample was dissolved in a) distilled water and b) sodium hydroxide provided by Sigma Aldrich, Czech Republic. For the analysis was used a commercially available kit by Sigma Aldrich (Czech Republic) composed of:

Potassium sodium tartrate .....	15 mmol/l
Sodium iodide .....	100 mmol/l
Potassium iodide .....	15 mmol/l
Copper sulphate .....	5 mmol/l

#### 6.1.2. HPLC-ELPS carbohydrates analysis

The protein extract was submitted to a carbohydrates analysis with the HPLC-ELSD method. Methanol, 50% solution in distilled water, was used as the dissolvent for the analysis. The mobile phase consisted of 75% acetonitrile in distilled water.

#### 6.1.3. BSG treatment

The BSG used in this research was obtained from a microbrewery of the Department of Food Science, Mendel University in Brno, Czech Republic. The material was washed with distilled water as soon as it was obtained until a neutral pH was reached, after which it was stored at -5 °C until further utilisation. The stored material was then dried at  $103-130 \pm 5$  °C for 24 h to attain 10% moisture content (untreated material). The dried material was further stored in dry conditions. The reagents used in chemical treatment were: sodium hydroxide (NaOH, 39,997 g/mol, purity 98%) and hydrochloric acid (HCl 36,46 g/mol, purity 35% in H<sub>2</sub>O). All chemicals were purchased from Sigma Aldrich (Czech Republic) and used without any further purification.

#### 6.1.4. Adhesive testing and comparison

The final BSG-based adhesive was prepared with glyoxal (C<sub>2</sub>H<sub>2</sub>O<sub>2</sub>, 58,04 g/mol, purity 40% in H<sub>2</sub>O) purchased from Sigma Aldrich (Czech Republic). The mechanical and physical properties were compared with PVAc adhesive which was kindly provided by DYAS (Czech Republic). PVAc adhesive has following basic properties (Table 7):

Table 7 PVAc VINALEP 830 basic parameters

Viscosity (ISO R2555)	15.000 – 23.000 mPas
pH	2,5-4,0
Solid content	49-52 %
Spread rate	130-200 g/m <sup>2</sup>
Open time	3-7 min
Moisture content of the wood	6-12 %
Water resistance (ČSN EN 204), no hardener	D3
Water resistance (ČSN EN 204), with hardener LEABOND WBN (20:1)	D4
Shell temperature	+5 to +30°C (-25 °C)

## 6.2. Extraction and modification

### 6.2.1. Protein content analysis

Biuret method of detection of a total amount of proteins was used to evaluate protein content in two stages of the process. Firstly, it was applied on the dried grain and secondly, on the protein concentrate after the alkali/acid treatment. The biuret test detects the peptide bonds, which together with copper sulphate form violet-coloured coordination complexes in an alkaline solution.

### 6.2.2. Sample preparation

1g of milled BSG, respectively the protein concentrate, was added to a PP test-tube and filled with 10ml of a) distilled water, b) 0,1M NaOH. Prepared samples were put into the Vortex (BenchMixer R, Spectrum R), shaken for 15 min and subsequently centrifuged (Rotina 380/380 R, Hettich) for 10 min at 6000rpm at 4°C. The liquid part was collected and ran through the test. The extracted protein was tested only with the distilled water.

### 6.2.3. Calibration

100 mg of albumin was added into a microtube and together with 10 ml of distilled water was shaken for 5 min until complete dissolution. The solution was diluted to produce calibration line (Figure 6) with concentrations between 10 mg/ml and 100 mg/ml.

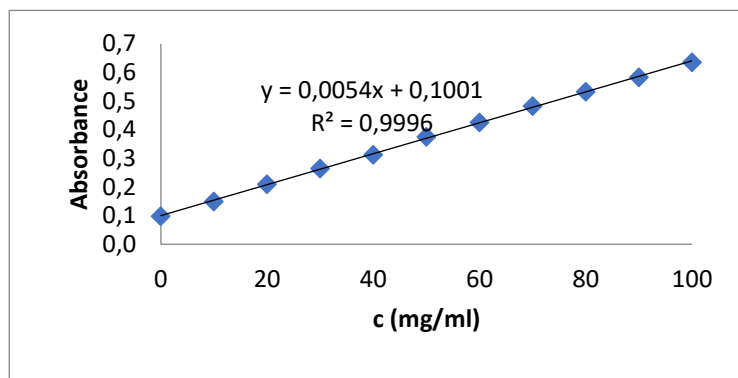

Figure 6 Calibration line of the albumin

#### 6.2.4. Test

The tests were performed in the laboratory of chemical analysis and at Chemistry department, Faculty of Agriculture, Mendel university. Both, calibration line and prepared samples were put into the reaction disc of the automatic analyser (BS 400, Mindray) and test was ran. The automatic analyser was set as follows:

Wave length: 546 nm

Reaction time: 10 min

Biuret reagent: 180  $\mu$ l

Sample: 45 $\mu$ l

#### 6.2.5. Determination of carbohydrates by HPLC-ELSD method

Carbohydrates of interest were analysed from the protein extract with the liquid chromatography with ELS detection. The basic principle of the method is separation of compounds based on their different solubility in mobile and stationary phase lined in the separation column. Mobile phase consists of liquid (75% acetonitrile in distilled water), which is pushed through the column with a high-pressured pump.

Stationary phase is based in still carrier which is inside the chromatography column. Column used for this analysis has dimensions 4,6 x 250 mm, 5  $\mu$ m (ZORBAX NH<sub>2</sub>, Agilent Technologies, USA). Evaporative Light Scattering Detector (ELSD) is a chromophore/fluorophore-free compound detector, e.g., as in this case, carbohydrates analysis. ELS considers the light dispersion on the analyte particles which are formed after nebulization of eluent and subsequent evaporation of the solvent. The photodetector answer is directly proportional to the extract mass passing through the optical ray.

Extraction of carbohydrates from the protein mass done as follows:

- 0,1 g of the protein extract was put into a PP test tube with 2ml of the dissolvent.
- The sample was shaken on vortex for 15 min/150rpm at laboratory temperature
- The sonication at ultrasound bath for 15 min.
- The sample treated like this was shaken on vortex for another 15 min at laboratory temperature.
- The sample was filtered.

1 ml of sample treated like this was evaporated off to the dried state in the dry bath. The sample was dissolved in 200 µl of mobile phase, followed by the HPLC analysis.

The analysis was performed in the laboratory of chemical analysis and at Wood science department, Faculty of Forestry and Wood Technology, Mendel university on liquid chromatographer (Agilent 1260 Infinity, Agilent Technologies USA). The samples were analysed through OpenLAB CDS ChemStation software.

#### **6.2.6. Preparations of BSG protein concentrate.**

The alkali treatment is to dissolve the protein, denature it and open it for further modification. Acidic precipitation is to obtain the physical protein which is otherwise in the liquid form. Dried and milled BSG was extracted with (17 % w/v) with 1 l of 0.1 M NaOH at 60-80<sup>0</sup>C for 60 min with continuous manual stirring at 30 rpm (EL 20, Kavalier). Proteins were precipitated using 0.5 M HCl to pH 4 and subsequently centrifuged (Universal 32 R, Hettich) at 4000rpm for 10 min at 4<sup>0</sup>C. After centrifugation residue was collected and termed as BSG protein concentrate (BPC). BPC was neutralised, lyophilised (PL3000, Heto) and stored. Following figures show the flow of treatments, including the modification (Fig. 7) and the visual form of the treated material in different stages of the extraction (Fig. 8). The extraction process was designed as a part of internal IGA project. The steps are in general agreement with the alkali protein extraction as suggested e.g. by Veira et al. (2014)

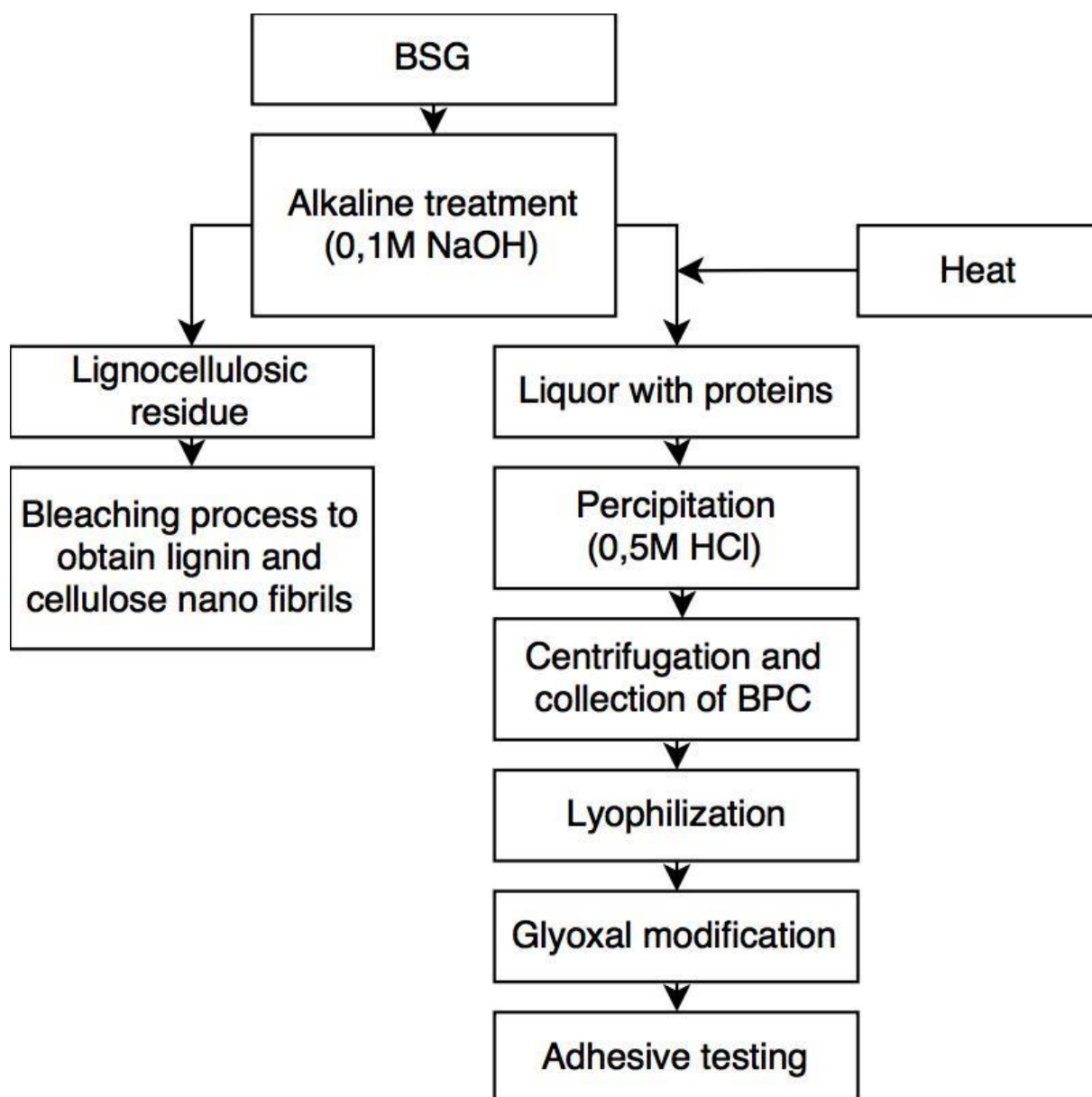

Figure 7 Scheme showing the flow of thermo-mechanical and chemical treatments of BSG.

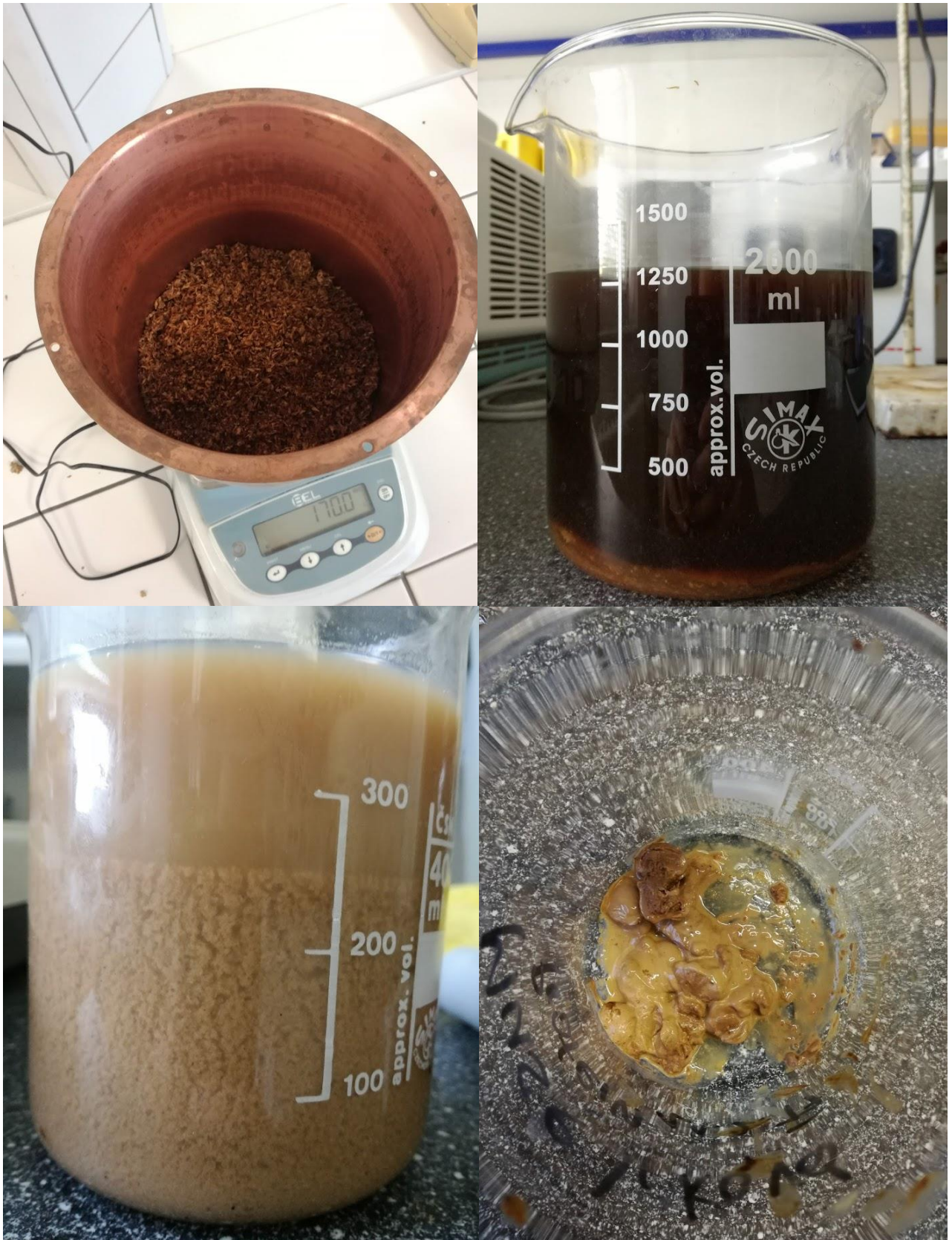

Figure 8 Various stages of the protein extraction: BSG matter is weighted (top left corner) and dissolved with NaOH, the black liquor is collected (top right) and the liquid part is precipitated (down left) and subsequently centrifuged and the residue is collected (down right corner)

### 6.2.7. Extract modification

Lyophilised samples were mixed together with substances to see if any bonding mechanism exists. It was experimentally tried with glyoxal and furfural alcohol in different ratios (Table 7), for various curing times and temperatures. All samples were exposed to a load  $F=20$  N for 20 min before the heat cure.

Table 8 Modification of the extract

Crosslinker	Glyoxal	Glyoxal	Glyoxal	Furfural	Furfural	Furfural
% v/v	20	15	10	75	20	10
Time (min)	15	15	20	15	25	25
Temperature (°C)	60/103	120	103	103/120	120	103

### 6.2.8. Screening test

After the discovery that there is a working bonding mechanism, it was necessary to understand what are the optimal ratios and conditions. This included finding out the proper treatment of the BPC and the curing procedure. The screening test had the purpose of investigation of the amount of glyoxal and temperature.

The Automated Bonding Evaluation System (ABES) is a desktop instrument which enables the kinetics of adhesion to be evaluated: how fast adhesive bonds develop their strength under a wide range of precisely and dynamically controlled thermal, chemical and stress conditions. It is used to understand how adhesion plays into the creation of diverse composite materials and bonded products - to tailor adhesive cure characteristics to specific applications (Ghorbani et al., 2016).

The adhesive bonding strength was determined by use of self-constructed ABES device. This ABES device was mounted on a Zwick/Roell Z100 universal testing machine (Zwick GmbH & Co. KG, Ulm, Germany) using a control hot press temperature. For this test, two beech veneer strips (0.58 mm thickness, 20 mm width, and 147 mm length) stored at 20 °C and 65% relative humidity were glued together with an overlap length of 5 mm (Figure 9) using a spread rate of 200 g/m<sup>2</sup>.



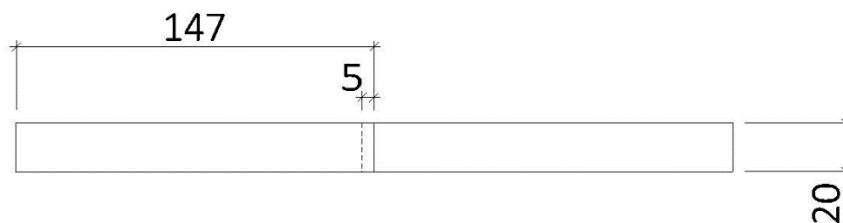

Figure 9 Samples for ABES testing

20 mg ± 1mg of the adhesive was spread over the 5 mm x 20 mm area. The second strip was put over the area. Veneer strips prepared in this way were transferred to the testing machine (Figure 10) and exposed to temperature 100-120°C and load 0,45 MPa ± 0,01 MPa. Distance between the testing jaws was 220 mm, according to the dimensions of the veneer samples. Every batch had 3-7 replications. The protein content in the adhesive was always 16 g/100 g. Following (Table 9) concentrations and conditions were tested:

Table 9 Conditions and concentrations for the ABES testing

Temperature (°C)	100	100	120	120	120	120	120
Glyoxal concentration (%)	5	15	10	15	20	30	100

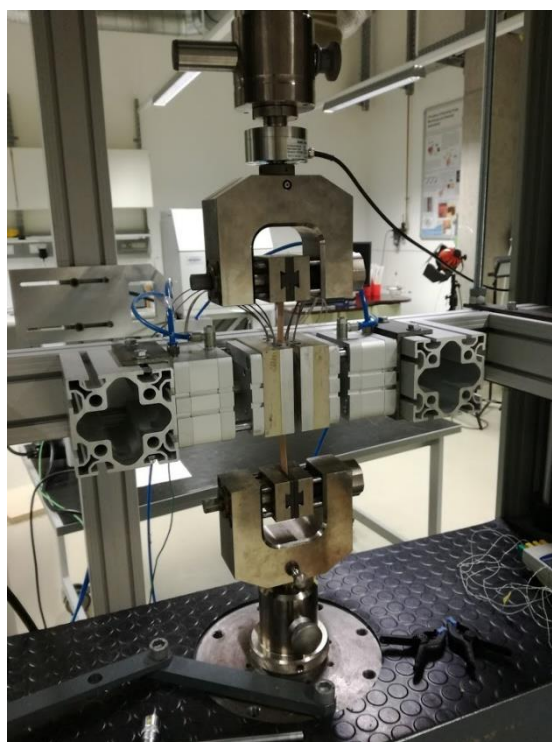

Figure 10 ABES testing setup

The results were expressed in the same way as for lap shear samples (chapter 6.5.4).

## 6.3. Resin characterization

### 6.3.1. pH-Value

The pH-value was determined at room temperature immediately after the resin was prepared according to ČSN EN 1245. 50ml of the tested adhesive was dissolved in 50 ml of distilled water. Samples were measured on previously calibrated pH meter (pH 8, Chromservis). The testing was done in two sets for each sample.

### 6.3.2. Solid content

Solid content (SC) has been determined according to ČSN EN 827. Two metal dishes with a diameter of the base  $60 \pm 5$  mm were used for the test. The dishes were dried in the oven for 30 minutes and subsequently left in the desiccator for 15 minutes.

The test required two sets of testing and amount of the resin should be equal to  $2 \pm 0,2$  g. The dish was also weighted and the result was marked as  $m_1$ . The second measurement to be determined before the drying was the total weight of the resin with the dish –  $m_2$ .

The sample was transferred to the oven and dried for  $120 \pm 1$  min at  $105^\circ\text{C} \pm 1^\circ\text{C}$  and subsequently left in the desiccator for 15 minutes. The result weight was marked as  $m_3$ . Result is counted according to the following equation (2):

$$C_1 = \frac{m_3 - m_1}{m_2 - m_1} \times 100 (\%) \quad (2)$$

To determine the constant weight, the sample was dried for another 2 hours ( $105^\circ\text{C} \pm 1^\circ\text{C}$ ). The method was replicated in 30 minutes' intervals until the difference was not higher than 2 mg. The final weight was marked as  $m_4$  and the result was recalculated as in the equation (3):

$$C_1 = \frac{m_4 - m_1}{m_2 - m_1} \times 100 (\%) \quad (3)$$

### 6.3.3. Viscosity

Determination of viscosity was based on ČSN EN 12092 with following procedure: The viscosity measurement was done with ford cup with hard metal insert and calibrated nozzle with an orifice length 4 mm and with a diameter of 4 mm. The cup was completely filled with the tested adhesive and the lower nozzle was unclogged and the time of the flow was measured. The testing is finished once the cup is completely empty. The result is in seconds.

### 6.3.4. Resin calculation

The extracted adhesive showed the best properties when in ratio of the protein and glyoxal 20% was 1:5 (6 parts in total). This means that for 100 g of the prepared adhesive was used following amount of substances (4), (5), (6):

- Protein:

$$100g:6 = \mathbf{16,6\ g} \quad (4)$$

- Distilled water ( $\rho = 1\ \text{g/cm}^3$ ), in the rest of the adhesive there is the 20% glyoxal, meaning that the water and 100% glyoxal are in the 1:5 ratio. This means there 4 parts of distilled water in total.

$$100g:6 = 16,6g$$

$$16,6g \times 4 = \mathbf{66,4g} \quad (5)$$

- Glyoxal 100% ( $\rho = 1,27\ \text{g/cm}^3$ ), meaning that in 20% solution is 1/5 of 100% glyoxal.

$$\frac{16,6\ g}{1,27\ \frac{\text{g}}{\text{cm}^3}} = \mathbf{13,1\ ml} \quad (6)$$

## 6.4. Testing of mechanical properties

Testing was based on partially adjusted standards ČSN EN 314-1, ČSN EN 314-2 and ČSN EN 326-1. After the adhesive was synthesized and characterized, it was applied to 3-layer plywood consequently cut into smaller samples with adhesive layer to test the longitudinal tensile shear strength, bend strength in both, parallel and perpendicular direction in relation to the grain. All the testing was done during one day.

### 6.4.1. Plywood preparation

3-layer plywood (600x600 mm) were prepared from beech veneers, each 1,2 mm thick. These veneers were glued together with the extracted adhesive and PVAc adhesive in these combinations:

Table 10 Combinations of adhesives for the plywood testing

Temperature (°C)	100	100	100	100	100	150	150
PVAc (%)	100	100	0	50	75	100	0
Extracted adhesive (%)	0	0	100	50	25	0	100

All adhesives were applied in spread rate of 180 g/m<sup>2</sup>. Due to the short open time, especially of the PVAc adhesive (10 min), it was necessary to press the boards immediately after the spreading. The press was set to 100°C, resp. 150°C with the load of 5 MPa. The curing time was 5 min for 100°C and 2,5 min for 150°C. After the pressing the boards were stored in controlled conditions in a climate room. According to the standard, the glued boards had to be cut to samples after three days of storage at 20°C and 65% humidity (standard climate). The cutting scheme (Figure 11) was designed to produce 10 samples for each bunch of testing.

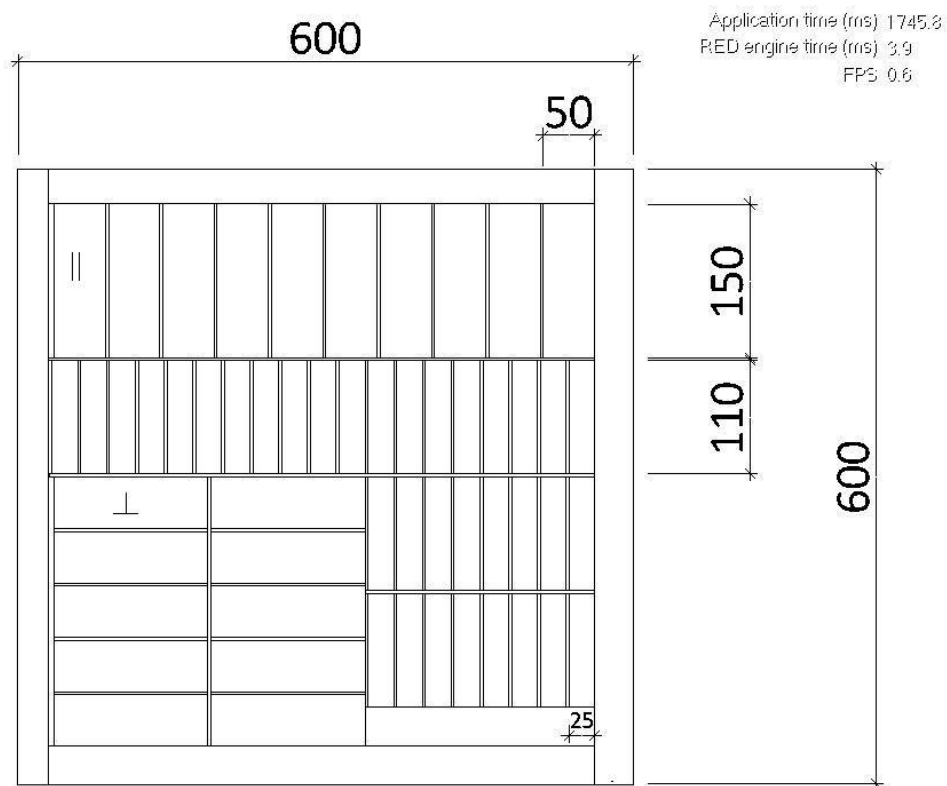

Figure 11 Cutting scheme for the plywood boards. ⊥ is the symbol for samples which were tested perpendicular to grain and ||parallel to the grain.

### 6.4.2. Lap shear samples

The samples for the lap shear testing were produced in two different dimensions. This was adjusted to ensure that the tested samples would break in either the adhesive layer or in the wood, not in the veneer. The standard requires overlapping area  $25 \times 25 \text{ mm} \pm 0,5 \text{ mm}$ . Due to the number of samples from each board, it was possible to obtain 8 samples according to the standard and the rest had the overlapping area  $15 \times 25 \text{ mm} \pm 0,5 \text{ mm}$  as pictured in Figure 11 and Figure 12. All samples had one perpendicular cut of approx. 3mm on each side.

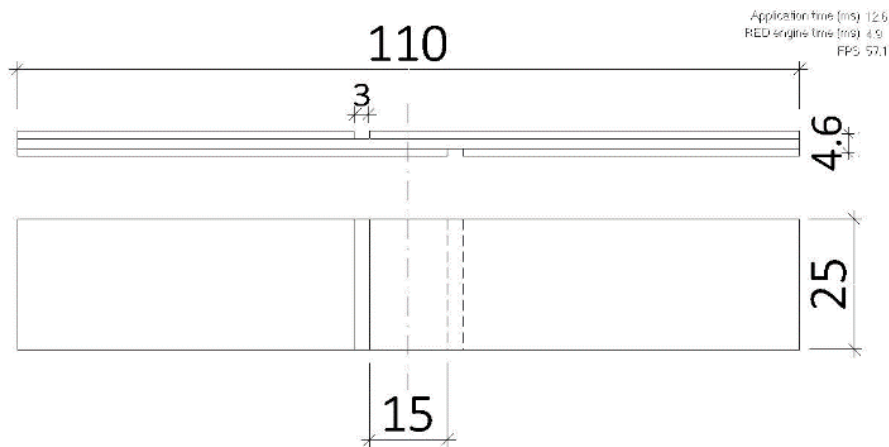

Figure 13 Lap shear sample with overlapping area  $15 \times 25 \text{ mm} \pm 0,5 \text{ mm}$

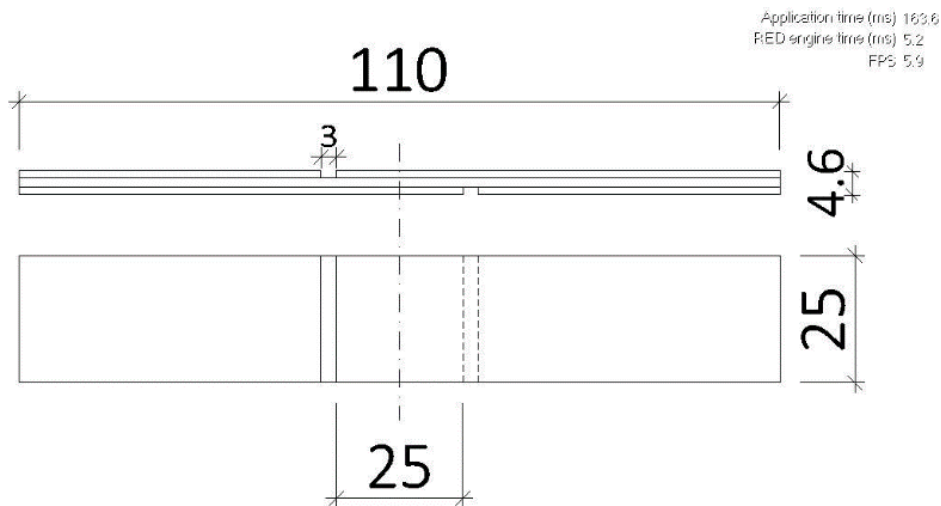

Figure 12 Lap shear sample with overlapping area  $25 \times 25 \text{ mm} \pm 0,5 \text{ mm}$

### 6.4.3. Bend samples

Bend samples were cut in two bunches from each board according to the standard ČSN EN 326-1. 10 pieces were tested for the bending strength across the grain and 10 pieces were cut to test the bending strength parallel to the grain. The dimensions are displayed in Figure 14.

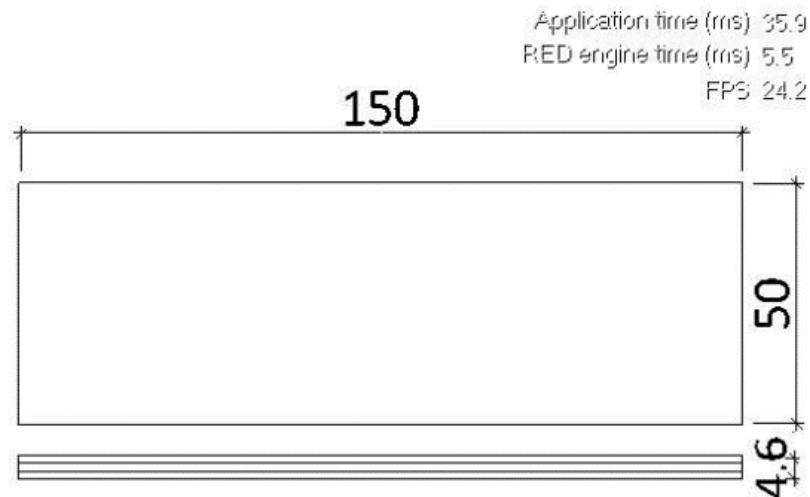

Figure 14 Bend strength testing samples

### 6.4.4. Lap shear testing

The samples were tested on ZWICK 2050 according to the ČSN EN 314-1. The standard requires the samples to break in the interval  $30 \pm 10$  s, to achieve this, the jaws were moving at the speed of 5 mm/min. Along with the force, the results had to be visually evaluated for the wood/adhesive failure found in the appendix of ČSN EN 314-1 expressed in wood failure percentage the force is calculated according the the following equation (7):

$$f = \frac{F_{\max}}{ab} \left[ \frac{N}{\text{mm}^2} \right] \quad (7)$$

Where:  $F_{\max}$  is the maximal force in the moment of fracture expressed in N,  $a$  and  $b$  are exact dimensions of the overlapping area in mm.

### 6.4.5. Bend strength testing

The samples were tested according to ČSN EN 310. The picture (Figure 15) schematically shows the testing setup.

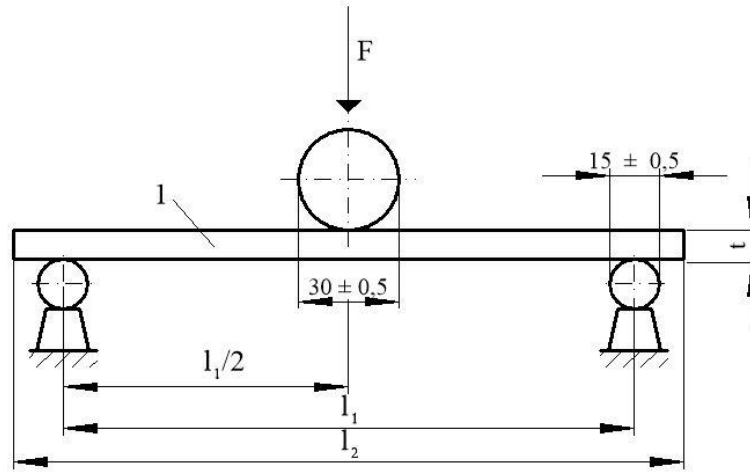

Figure 15 Loading scheme

Where:  $F$  is the force in N,  $l$  is the sample,  $t$  is the thickness,  $l_1$  length which answers to  $20t$ ,  $l_2$  is  $l_1 \pm 50$  mm. The dimensions of the tested samples are in Figure 14.

The results of the test are expressed through equations of the modulus of elasticity (MOE) (8) and the modulus of rupture (MOR) (9). The results are expressed in MPa.

$$E_m = \frac{l_1^3 * (F_2 - F_1)}{4 * b * t^3 * (a_2 - a_1)} \quad (8)$$

Where:  $l_1$  is the distance between the centres of the supports in mm,  $b$  is the breadth of the sample in mm,  $t$  is the thickness of the sample in mm,  $F_2 - F_1$  is the increase of the force in the linear part of the force graph.  $F_1$  is approx. at 10 % and  $F_2$  at 40%,  $a_2 - a_1$  is the increase of the sag in mm during the load of the forces  $F_2 - F_1$ .

$$f_m = \frac{3 * F_{max} * l_1}{2 * b * t^2} \quad (9)$$

Where:  $F_{max}$  is the load at the moment of rupture in N,  $l_1$  is the distance between the supports in mm,  $b$  is the breadth of the sample in mm,  $t$  is the thickness of the sample in mm.

#### 6.4.6. Moisture content of the samples

The samples were tested for the moisture content, according to ČSN EN 322. Samples (one from each type of the board) were dried until constant moisture content. The samples were weighted and subsequently dried at  $103 \pm 3$  °C for 24 hours. After the testing, the samples were put into a desiccator for 15 mins and weighted. The procedure was repeated in 6-hour interval until the difference between tests was not greater than 0,1% of the sample mass. The result was calculated as follows (10):

$$H = \frac{m_h - m_0}{m_0} 100 [\%] \quad (10)$$

Where:  $m_H$  is the mass of the sample before drying,  $m_0$  is the mass of the sample after the last drying.



## **7. Results and discussion**

### **7.1. Protein analysis**

Following table (Table 11) shows the results of protein analysis. The first part of the table, samples BSG, shows results obtained for the dried material. First four samples were dissolved in NaOH and other four samples in distilled water. From general theory, it is known, that globulins are proteins soluble in weak acid or weak base environment and albumins dissolve in water. From the table it is clear that the samples contained 12,32% globulins and 2,03 % albumins. If compared to the literature review, it is possible to say, that the results were within the range. Various sources (Table 1) show that the protein content varies from 24% to 2,2 %. The sources do not include the specification of the protein analysis method and the specification of the protein (globulins/albumins or others) therefore the results have only general referential meaning. BSG is natural material and as every other organic material, its property widely differs. The harvesting time, place and further processing influence the composition, as well as the method of analysis and the chemicals entering the process, can affect the final value.

Last four rows contain results of the analysis of the extracted sample. The results are comparable to the number of albumins in the BSG. Due to the money, time and material restrictions, it was possible to do the analysis only in one repetition in distilled water. For this reason, it was not possible to determine exactly, what was the final protein content of the extracted sample. To explain this, it is necessary to consider the fact, that globulins, proteins soluble in weak alkali or acidic environment, are the core proteins of soy protein and in theory also the core of the BSG protein.

Table 11 Protein content of the BSG/extraction

Sample	c (mg/ml)	C with sample weight 1 g (mg/in 10ml)	Protein content converted to %	
1BSG NaOH	17,09		<b>12,32</b>	<b>Globulins</b>
1BSG NaOH	12,57	14,81		
2BSG NaOH	8,90			
2BSG NaOH	10,79	9,84		
3BSG H <sub>2</sub> O	1,72		<b>2,03</b>	<b>Albumins</b>
3BSG H <sub>2</sub> O	1,68	1,70		
4BSG H <sub>2</sub> O	1,44			
4BSG H <sub>2</sub> O	3,30	2,36		
Extracted sample 1 H <sub>2</sub> O	2.94		<b>1,92</b>	
Extracted sample 1B H <sub>2</sub> O	4.24	3.59		
Extracted sample 2 H <sub>2</sub> O	-0.02			
Extracted sample 2B H <sub>2</sub> O	0.54	0.26		

As mentioned in methods, the process of extraction was based on the internal IGA research at Wood Science department, Mendel university. The process was taken as validated. Nevertheless, the results of the extraction showed that there is probably a way how to maximise and purify the amount of the extracted proteins and how to optimise the process. Focus should be on the timing, temperature, concentration of the substances added through the process and purification during single steps. Following suggestions should be considered:

- Temperature can influence the protein content even during the pre-treatment of the BSG, during the drying process. Temperatures found throughout the literature (e.g. Mussatto et al., 2006) were in the range between 50 °C and 90 °C. This could not have been applied in this case, because the BSG during these temperatures started to putrefy in the centre layers. In other words, the process was highly inefficient, because instead of drying the matter was only warmed and started to decay before dried completely. Even more important are the temperatures during the alkali treatment. It directly influences the protein solubility and properties of the protein extract. The ideal temperature for protein solubility is between 60 °C and 70 °C.

- Another value which needs to be checked during the extraction process is the pH value. If we consider the pI point, there is a necessity to keep the solution above or below to ensure that protein can react with the water. The literature suggests that for the soy protein, the pI is around 4,6 of pH. For weak alkali treatment the value should be around 8 pH. The precipitation phase has an effect of getting solid, protein rich concentrate. For soy protein, it is 4-5 pH. (Zayas, 1997). This means that the pH should be measured and concentrations of NaOH/HCl, or other base/acid, modified.
- The processing of the matter is important in mainly two aspects. Firstly, the mechanical pre-treatment of the BSG. In this experiment, the BSG was only slightly milled. The protein is located in germ of the grain and to obtain the protein efficiently, the husk barrier should be broken before any further treatment. Secondly, the liquid after the alkali treatment needs to be purified as precisely as possible. This means, ideally, centrifuged after proper filtration, but due to the nature of experiment, the thorough filtration should do. This ensures, that the brown liquid, will not contain any significant fractures of lignocellulosic material and ashes, which can affect further treatment of the extract.
- Finally, it is necessary to consider the composition and previous treatment of the BSG. As mentioned several times before, the composition varies with the harvesting time and place and other factors. The samples were taken from one brewery but the grain was not treated equally before the protein extraction.
- Among further suggestions, stepping slightly away from the process followed in this thesis, are e.g. modification of the extraction. Enzymatic hydrolysis might be considered as a suitable alternative to the alkali treatment.

## **7.2. HPLC-ELSD analysis**

Protein extract was tested for these carbohydrates: fucose, rhamnose, ribose, xylose, fructose, mannose, glucose, galactose, saccharose and cellobiose. Table 12 shows carbohydrates which were possible to detect. The result revealed that the extract does not include any significant amount of the carbohydrates, leading to the conclusion that apart from the proteins and carbohydrates, in quite a low the extract also includes probably also lignin and a bigger volume of ashes.

Table 12 HPLC-ELSD carbohydrates analysis results

Carbohydrates	c (mg/g)
Fruktosa	2,41
Glukosa	2,45
Cellobiosa	8,88

The analysis of carbohydrates was done in addition to the protein analysis and due to the nature of results and absence of possible comparison, it does not have any important impact on further work.

### 7.3. Extract modification

Following table (Table 13) shows results of the pre-testing of the adhesive. The pre/test showed the possibility of the adhesion and allowed to specify the final product. All the samples were exposed to a load and subsequently cured in an oven.

Table 13 Testing of crosslinking of glyoxal and furfural

Crosslinker	Glyoxal	Glyoxal	Glyoxal	Furfural	Furfural	Furfural
% v/v	20	15	10	75	20	10
Time (min)	15	15	20	15	25	25
Temperature (°C)	60/103	120	103	103/120	120	103
Ease of splitting*	P/I	I	I	P	N/A	N/A

\*Not holding together at all (N/A), it was possible to split the sample by hands (P), impossible to split it by hands (I)

The results of the test showed that the glyoxal modification had a better effect on the extract than the furfural treatment. The properties of the adhesives rose with higher temperature and the best results were understood during the treatment with 15% solution of glyoxal and 120 °C. Even if the method of experiment was not exact, this test allowed to specify further treatment of the adhesive in a general range and helped to find the functionality of glyoxal as an eligible crosslinker.

The literature review (Table 5) suggests many other crosslinking options. Due to the availability and money restrictions, it was necessary to limit these options to the glyoxal

and furfural. From these two, the glyoxal is the more ecological and less harmful one. Glyoxal is still a synthetic substance and one of the goals of the thesis was to suggest possibility of improvement of the modification of the protein. There are natural crosslinkers, such as the epoxidized soybean oil (Table 5) or naturally based rubbers that could lead to potentially good results if applied properly.

## **7.4. Screening test**

Screening test results were analysed by single factor analysis of variance (ANOVA) (Fig. 16), box graph (Fig. 17) and due to the nature of result  $p < 0,05$ , the Scheffe test (Table 14) is also included because there is a statistically significant difference.

The tests revealed that the adhesive has the highest lap shear strength when the solution includes 20% glyoxal and with curing temperature 120 °C. The mean value of strength for this treatment is 5.09 MPa. This way of treatment was tested on different batches of the extraction, leading to the same result (5,07 MPa). This means that the BSG in the experiment had consistency in composition or that it reacted in the same way to the treatment, even from different harvesting places and times. After addition of extra 10 % of glyoxal, the strength did not grow anymore but was more stabilized (5,06 MPa). The lower addition of glyoxal had an effect mainly on the variance. The standard deviation for the 5 % addition of the glyoxal (100 °C) was 1,11, whilst for 20% (120 °C) was much smaller 0,534. The greatest consistency, showed results for the 30% treatment.

As a referential value, the pure glyoxal was tested. The statistically insufficient amount of repetition (3) led to a quite consistent result. Pure glyoxal had lap shear strength equal to 3,25 MPa.

The Scheffe test for multiple comparisons shows that there are similarities in treatments: (1) all types, except the treatment with 5%/100 °C, (2) 5%/100 °C with pure glyoxal, with 10%/120°C and 15%/100°C. The most comparable results have treatments 10%/120 °C and 15%/100 °C meaning that both, glyoxal and temperature are important for the treatment.

The result of the screening test led to the decision to continue further on with the adhesive with 20 % glyoxal, to reduce the glyoxal content to minimum but to get the best possible results during the modified standard testing.

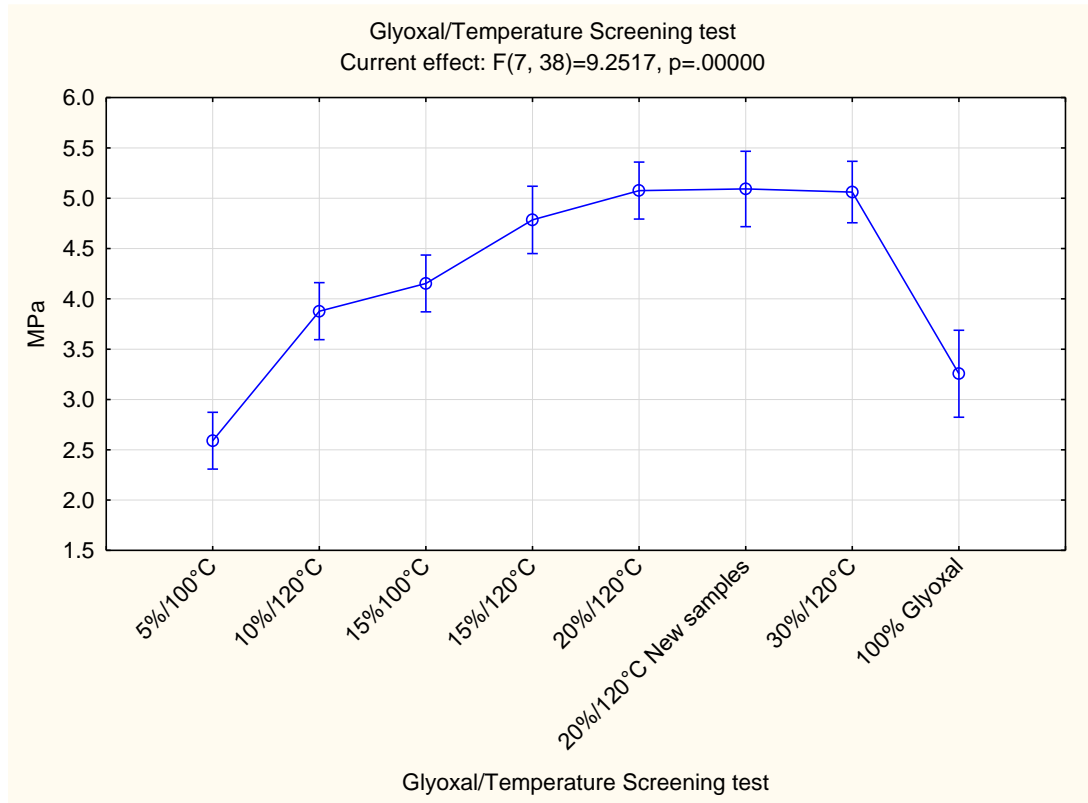

Figure 16 ANOVA for glyoxal and temperature screening test

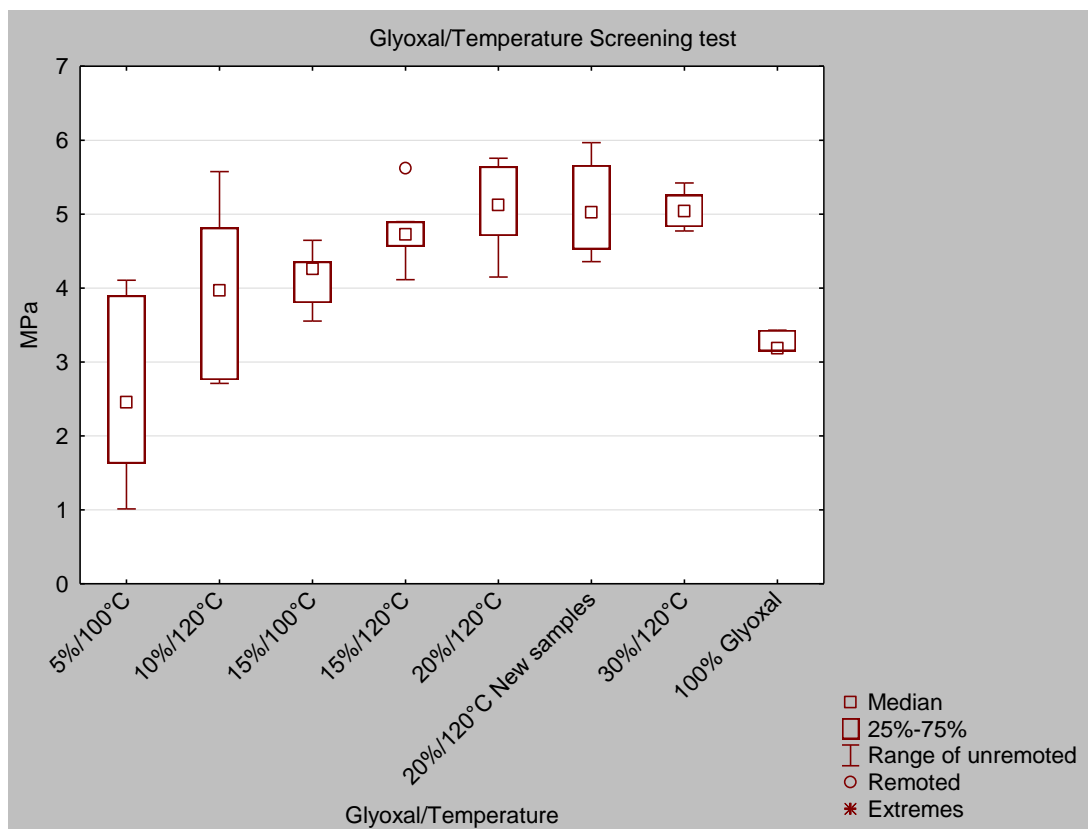

Figure 17 Box graph for the glyoxal and temperature screening test

Table 14 Scheffe test for the screening test

Scheffe test, Homogenic group, alfa = .05000 . PČ = .55968, sv = 38.000				
Position	Glyoxal/Temperature	MPa Mean	1	2
1	5%/100°C	2.590245		****
8	100% Glyoxal	3.255893	****	****
2	10%/120°C	3.877643	****	****
3	15%/100°C	4.153023	****	****
4	15%/120°C	4.784965	****	
7	30%/120°C	5.061276	****	
5	20%/120°C	5.075891	****	
6	20%/120°C New samples	5.092213	****	

## 7.5. Resin characterization

Table 15 shows overall results of the resin characterization. Along with the mechanical properties of the extracted adhesive, in comparison with the synthetic PVAc adhesive, the characterization of selected adhesive properties, specifically pH, viscosity and solid content.

Viscosity and solid content are closely connected to the molecular weight and tack, mentioned in chapter 3.5. All the measurements were tested according to the standards.

The value of pH was the highest for 100% extracted adhesive (4,28) and with additions of PVAc adhesive, the value was dropping till the 3,63 for the pure PVAc adhesive. Generally, it is possible to say that if the pH value is too low, the adhesive starts to stiffen through the condensation. High pH, on the other hand, means that the adhesive reacts aggressively with the surface of the adherend. For PVAc adhesive, the higher pH (approx. 6) also means lower curing temperature, around 30 °C. PVAc is not adhesive which requires an acidic environment for proper curing. Overall, pH of the extracted adhesive would have to be studied and tried in different values to determine its effect on its adhesion, physical and mechanical properties.

In the scope of this thesis, the pH of adhesive does not play a significant role. Figure 18 shows the dependence between protein content and pH.

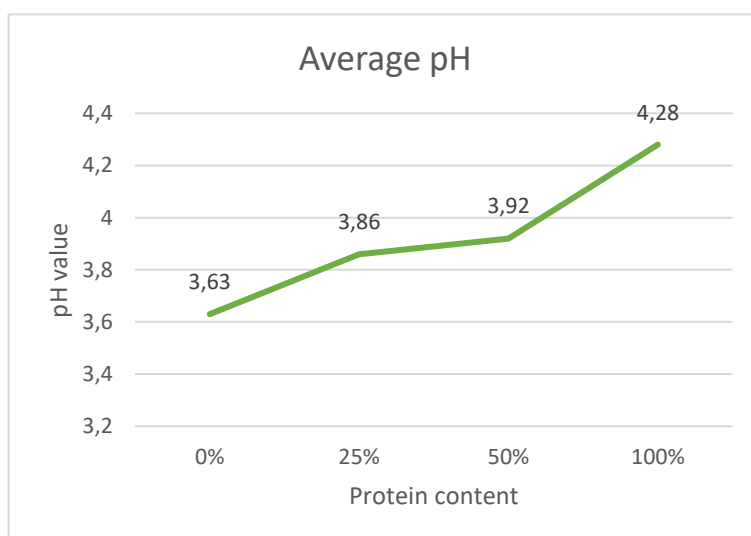

Figure 18 Average pH dependent on the protein content

The second measured property was the viscosity in seconds according to the ČSN EN 1245. Adhesives with high viscosity can have potential problems with the wetting of the surface and making the mechanical lock. From the results, it is obvious that the extracted adhesive has the lowest viscosity by far and probably also the molecular weight. It also affects the open time of the adhesive; the extracted adhesive has the open time much longer than the referential PVAc (5-8 min). In the practice this means, that the extracted adhesive was easier



to apply on the surface and to operate with. Partial replacement of the PVAc adhesive led to a drastic change of the viscosity, it is possible to say that, in this case, the curve is exponential. Only 25 % of addition of the extracted adhesive had reduced the viscosity 15 times. Figure 19 shows the dependence between viscosity and protein content.

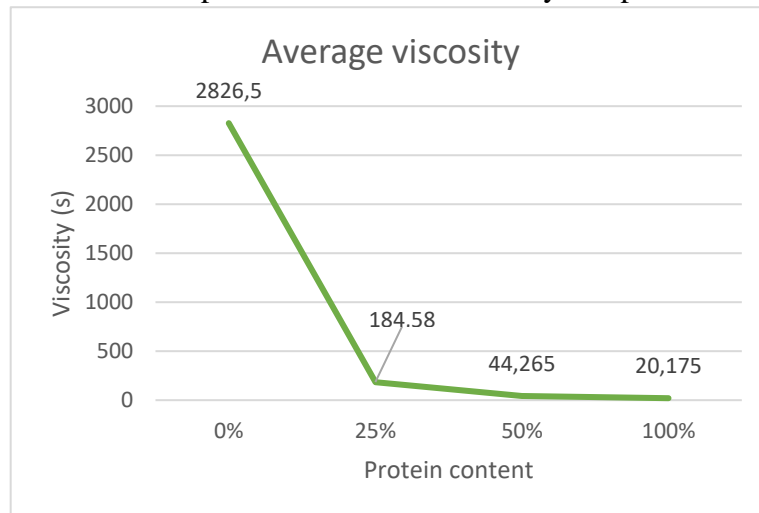

Figure 19 Average viscosity dependent on the protein content

Last property to evaluate was the solid content, directly proportional to the values of viscosity, but with smaller difference. The average solid content for the extracted adhesive was 60 % and for the PVAc 76 %. This value does not correspond with the official technical description which says that the content should be around 50%. In relation to this issue, the solubility of the extracted adhesive should be mentioned. The adhesive was not 100% soluble in the glyoxal/water solvent. This could potential lead to the inconsistency of the spread rate and influence of the results in the meaning that some parts of the plywood could

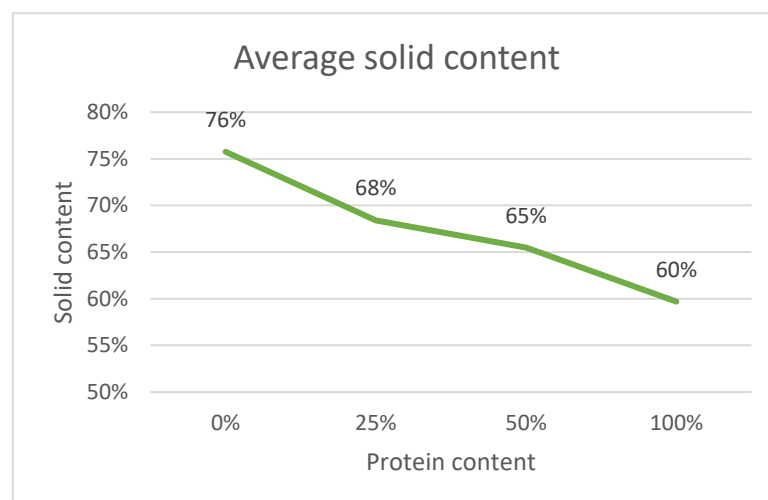

Figure 20 Average solid content dependent on the protein content

be bond together with the higher content of the crosslinked content or other compound enhancing the properties of the joint. Figure 20 shows average solid content dependent on the protein content.

Table 15 Results of the resin characterization test – pH, viscosity and solid content

<b>Protein content</b>	<b>0%</b>	<b>25%</b>	<b>50%</b>	<b>100%</b>
<b>pH 1</b>	3.65	3.89	3.9	4.22
<b>pH 2</b>	3.6	3.82	3.93	4.33
<b>Average pH</b>	3.63	3.86	3.92	4.28
<b>Viscosity 1 (s)</b>	2761	175.4	44.92	19.08
<b>Viscosity 1 (s)</b>	2892	193.76	43.61	21.27
<b>Average viscosity</b>	2826.5	184.58	44.265	20.175
<b>Solid content 1</b>	78%	67%	64%	58%
<b>Solid content 2</b>	73%	70%	67%	62%
<b>Average Solid content</b>	76%	68%	65%	60%

## 7.6. Lap shear test

Lap shear test results were analysed by single factor ANOVA (Figure 21), box graph (Figure 22) and due to the nature of result  $p < 0,05$ , the Scheffe test (Table 16) is also included because there is a statistically important difference.

Lap shear tests were done in different batches, the difference was in temperature, pressing time, load and the overlapping area. From the ANOVA is possible to say, that the overlapping area did not have a major impact on the results. Nevertheless, there were samples (25×25) which had to be classified as invalid, due to the nature of the fracture – the rapture was present in the veneer not the wood or adhesive. PVAc cured at 150 °C was affected by the properties of the adhesive, specifically short open time and lower temperatures recommended for the curing process. The effect of this was that the PVAc adhesive was cured before the press closed, therefore the board was partially delaminated.

From the analysis, it is obvious that the extracted adhesive cannot be compared in the lap shear strength to the PVAc. The mean value for the pure PVAc adhesive is 4,85 MPa, whilst

the extracted adhesive has the lap shear strength equal to 1,36 MPa, 3,5 times lower. The difference is lower if compared with the extracted adhesive cured at 150 °C – 1,75 MPa, 2,7 times lower.

The PVAc adhesive was mixed with the extracted adhesive to understand if the extracted part influences the properties. Firstly, the PVAc was replaced by 50 %, secondly by 25 %. The difference between the results of 50% and 25% replacement was very small 0,13 MPa. This small difference could be a result of the bad solubility of the extracted adhesive in PVAc, which leads to a potentially deficient performance of both, PVAc and the extracted adhesive. On the hand, these two adhesives showed the greatest consistency during the testing. In the comparison to the 100% PVAc, the lap shear strength values of these two mixed adhesives dropped by 1,46 MPa.

The lap shear test was the only test where the wood failure was visually examined. The testing was performed on dry samples only and due to this fact, none of the adhesives could be evaluated according the ČSN EN 314-2. The best results had 100% PVAc – 89% of wood failure, followed by a mixture of 25% added extracted adhesive. If we consider the modification of the tested method – the dry method and different dimensions of the samples, then the samples with 0, 25 and 50 % of protein passed the requirements in the standard ČSN EN 314-2.

The Scheffe test for multiple comparisons shows that there are similarities in treatments (1) with 100% extracted adhesive with PVAc cured at 150 °C, (2) with blends of the PVAc and extracted adhesive and with PVAc1 100°C/25\*25, (3), (4) with PVAc 100%.

Another issue, which could be mentioned in the relation to the lap shear strength test is the characteristics of the wood bond (Table 3), closely connected to the wood failure evaluation. Apparently based on the lap shear test, there is an existence of weak boundary layers and the chemical bonds are weaker than the covalent ones. The adhesive seems to have more of cohesion rather than adhesion problems, especially due to the failure type. The adhesive was equally spread on both sides of the bond.

Finally, yet importantly, there is a significant difference between the ABES testing and the standardised tests. The difference in the case of the adhesive with 20% glyoxal content,

cured at 120 °C, respectively 150 z was 3,28 MPa, ABES results were almost three times higher. The results could be influenced by following factors:

- Different spread rate (ABES 200g/m<sup>2</sup>, standard tests 180 g/m<sup>2</sup>)
- ABES testing was performed immediately after the curing, there was no conditioning of the samples
- Thickness of the material used and overlapping area

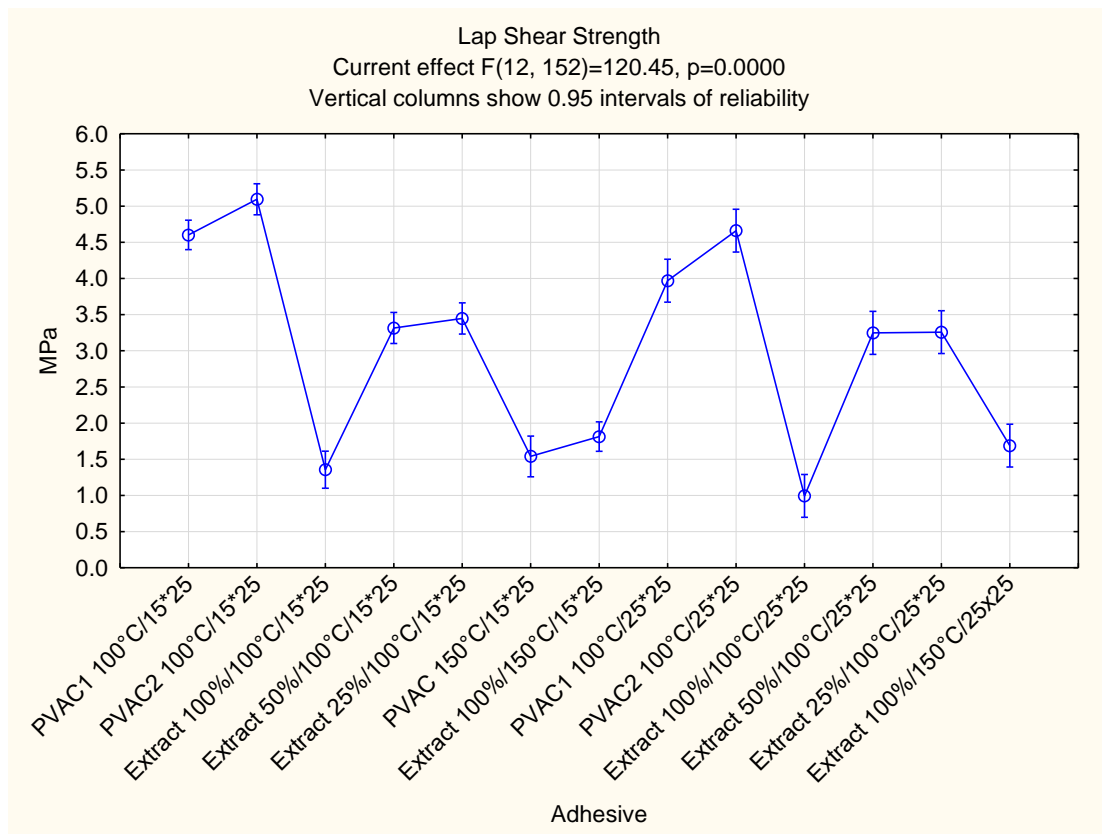

Figure 21 ANOVA for the lap shear strength test

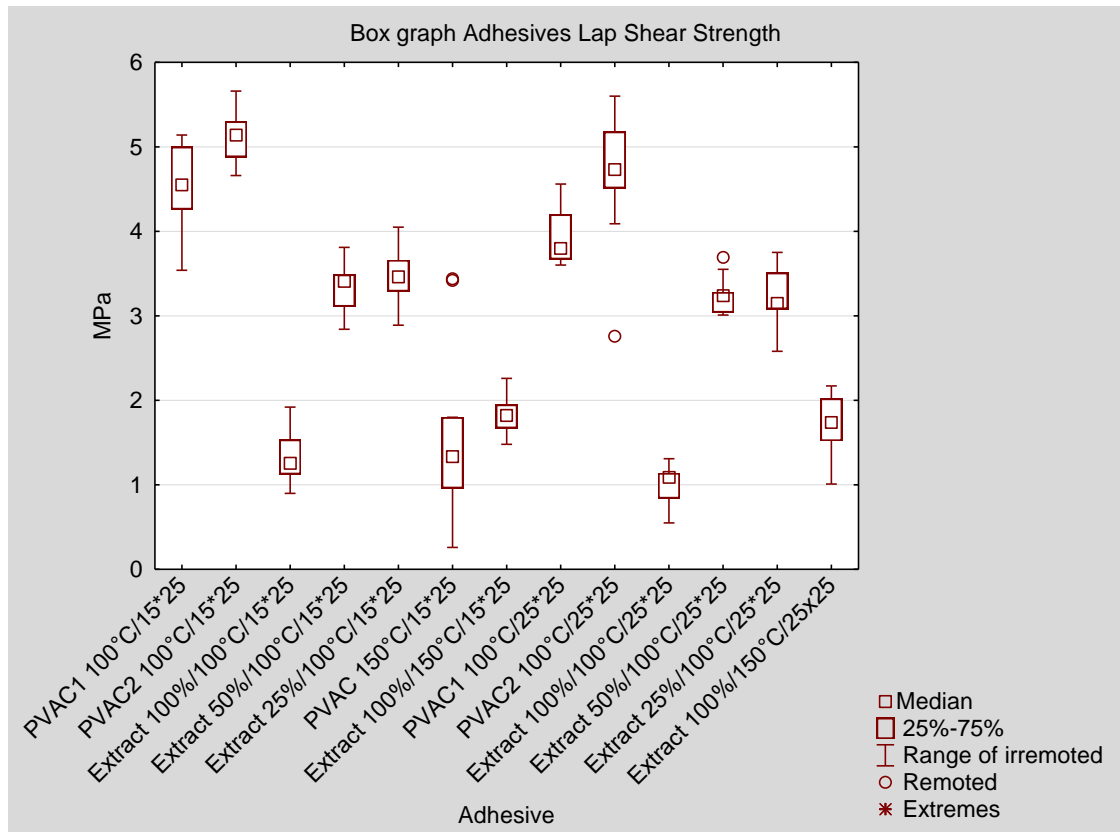

Figure 22 Box graph for the lap shear strength test

Table 16 Scheffe test for the lap shear strength test

Scheffe test, Homogenic group, alfa = .05000. PČ = .20233, sv = 152.00						
Position	Adhesive	MPa Mean	1	2	3	4
10	Extract 100%/100°C/25*25	0.993333	****			
3	Extract 100%/100°C/15*25	1.356667	****			
6	PVAC 150°C/15*25	1.540000	****			
13	Extract 100%/150°C/25x25	1.688889	****			
7	Extract 100%/150°C/15*25	1.814211	****			
11	Extract 50%/100°C/25*25	3.247778		****		
12	Extract 25%/100°C/25*25	3.257778		****		
4	Extract 50%/100°C/15*25	3.315294		****		
5	Extract 25%/100°C/15*25	3.447059		****		
8	PVAC1 100°C/25*25	3.968889		****	****	
1	PVAC1 100°C/15*25	4.601579			****	****
9	PVAC2 100°C/25*25	4.661111			****	****
2	PVAC2 100°C/15*25	5.094706				****

## **7.7. Bend strength – MOR, parallel to grain**

Bend strength test results were analysed with single factor ANOVA (Figure 23), box graph (Figure 24) and due to the nature of result  $p < 0,05$ , the Scheffe test (Table 17) is also included because there is a statistically crucial difference.

In contrast to the lap shear test results, MOR in the direction parallel to grain, had significantly better results for the pure extracted adhesive, with 115,7 MPa. Here, the temperature treatment had an enormous impact. From the lowest value 70, 7 MPa, when treated at 100 °C, to the highest value 115,7 MPa. Also, when cured at 100 °C, there was the highest standard deviation, 15,7. Other treatments showed consistent results between 80 and 90 MPa.

Scheffe test showed similar results, except similarities found with adhesives treated at 100 °C with extract concentration 25%, 50% and 100%.

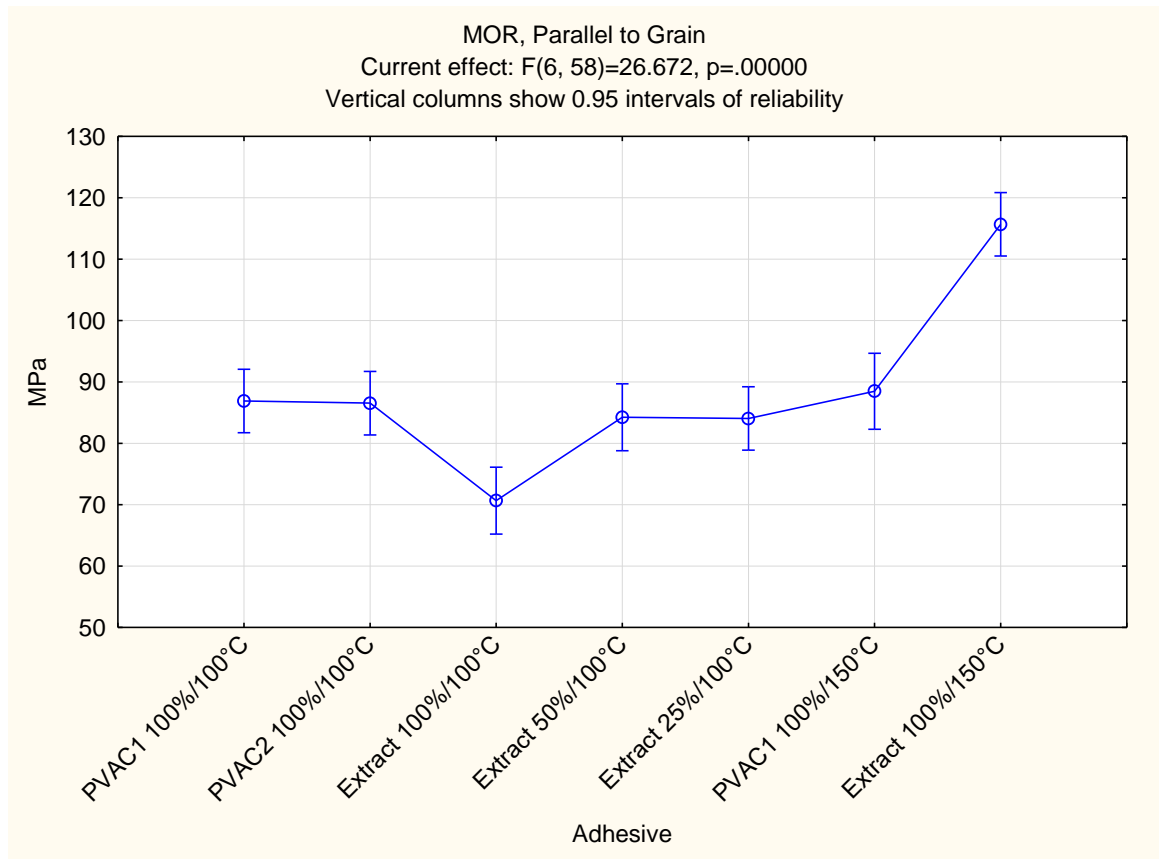

Figure 23 ANOVA for the bend strength test, MOR parallel to grain

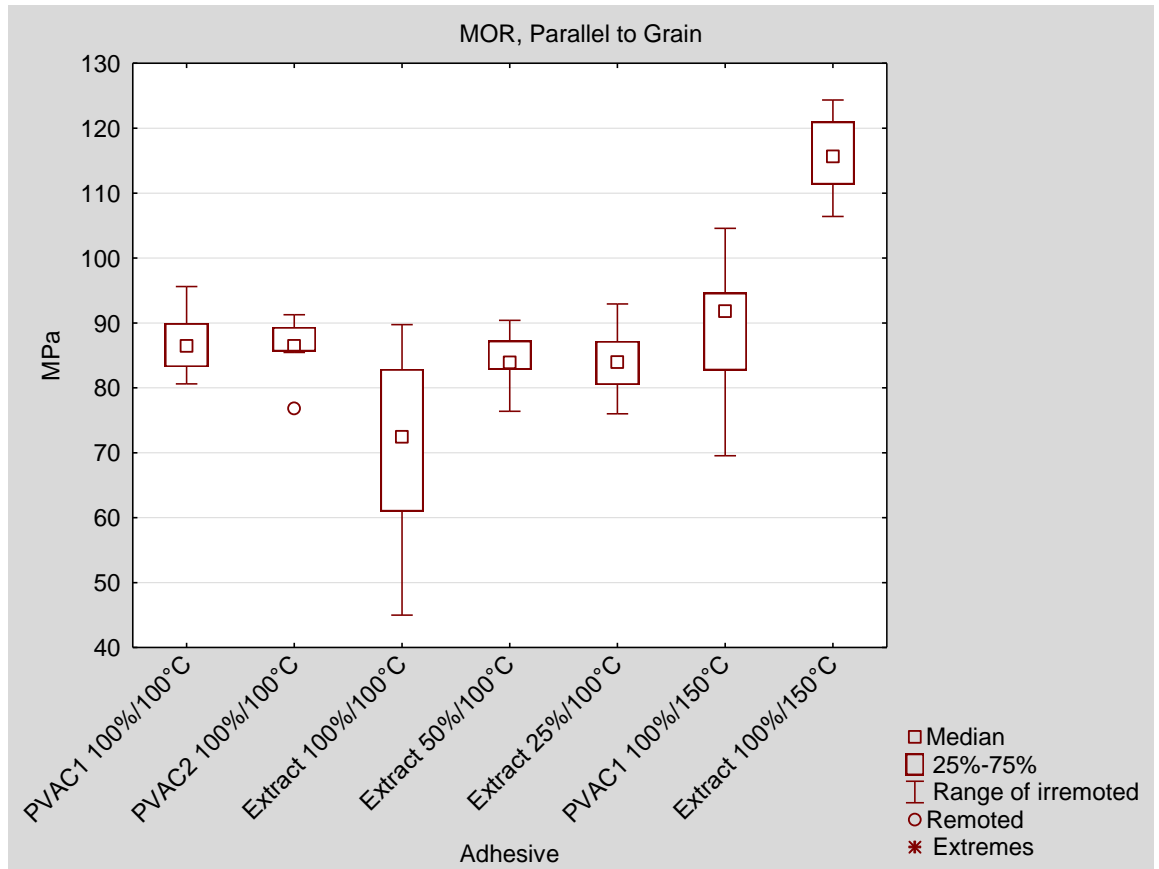

Figure 24 Box graph for the bend strength test, MOR parallel to grain

Table 17 Scheffe test for the MOR parallel to grain testing

Scheffe test, Homogenic group, alfa = .05000 PČ = 66.735, sv = 58.000					
Position	Adhesive	MPa Mean	1	2	3
3	Extract 100%/100°C	70.6500		****	
5	Extract 25%/100°C	84.0560	****	****	
4	Extract 50%/100°C	84.2411	****	****	
2	PVAC2 100%/100°C	86.5410	****		
1	PVAC1 100%/100°C	86.9000	****		
6	PVAC1 100%/150°C	88.4814	****		
7	Extract 100%/150°C	115.6810			****

## 7.8. Bend strength – MOE parallel to grain

Bend strength test results were analysed by single factor ANOVA (Figure 25), box graph (Figure 26) and due to the nature of result  $p < 0,05$ , the Scheffe test (Table 18) is also included, because there is a statistically major difference.

The test confirmed the highest values of MOR with the treatment 100% of extracted adhesive cured at 150 °C with the value of MOE 12,6 GPa. On the contrary, the second highest value was measured with the extracted adhesive cured at 100 °C. This leads to a conclusion the extracted adhesive has an impact on the elasticity in a positive way. The lowest value was found with the 25 % replacement of the PVAc, taking the worst from both adhesives.

Scheffe test found the similarities in values with the (1) PVAc1 100%/100°C with extract 50%/100 °C, with PVAc1 100%/150°C, with PVAc2 100%/100°C, and with extract 100%/100°C; (2) extract 25%/100°C with PVAc1 100%/100°C with extract 50%/100 °C, and with PVAc1 100%/150°C. The extracted adhesive 100%/150 °C stood on its own.



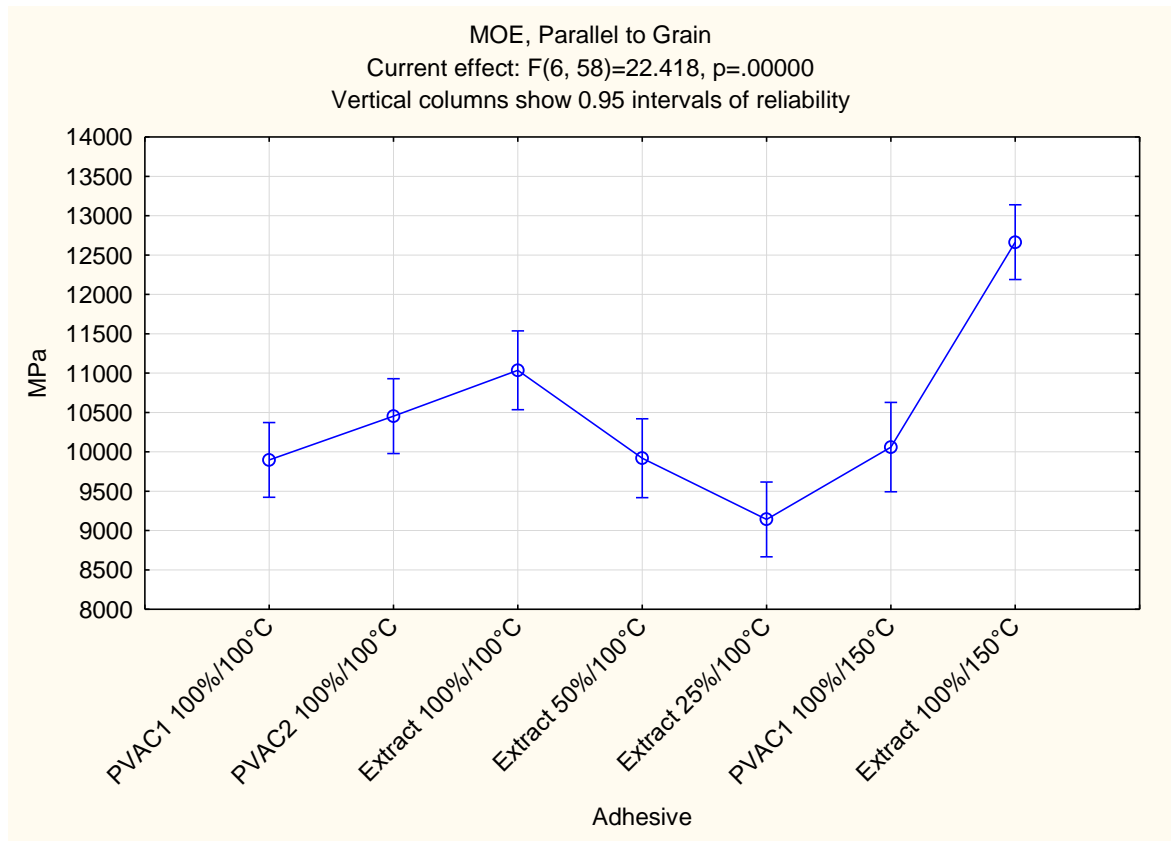

Figure 25 ANOVA for the bend strength test, MOE parallel to grain

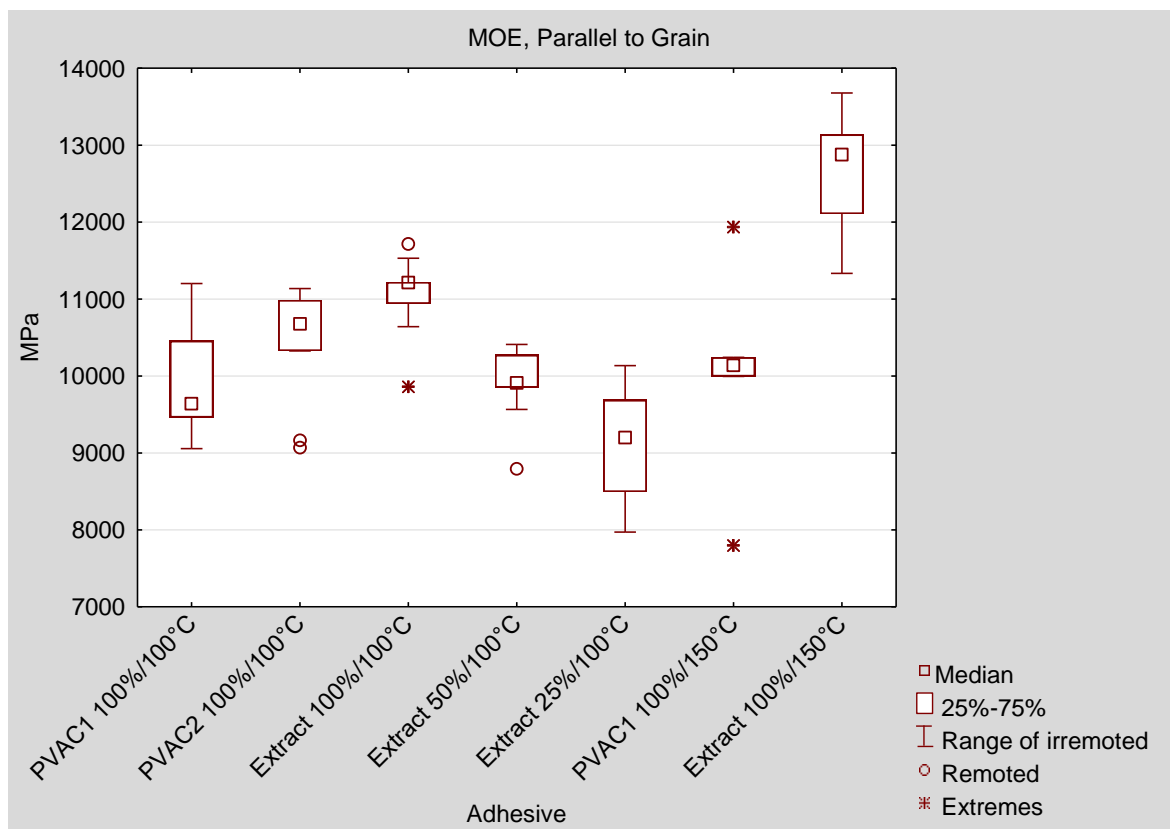

Figure 26 Box graph for the bend strength test, MOE parallel to grain

Table 18 Scheffe test for the MOE parallel to grain testing

Postition	Scheffe test, Homogenic group, alfa = .05000 PČ = 66.735, sv = 58.000				
	Adhesive	MPa Mean	1	2	3
5	Extract 25%/100°C	9141.40		****	
1	PVAC1 100%/100°C	9898.13	****	****	
4	Extract 50%/100°C	9919.77	****	****	
6	PVAC1 100%/150°C	10060.98	****	****	
2	PVAC2 100%/100°C	10454.11	****		
3	Extract 100%/100°C	11036.54	****		
7	Extract 100%/150°C	12664.08			****

## 7.9. Bend strength – MOR perpendicular to grain

Bend strength test results were analysed with single factor ANOVA (Figure 27), box graph (Figure 28) and due to the nature of result  $p < 0,05$ , the Scheffe test (Table 19) is also included, because there is a statistically major difference.

The result of the bend strength perpendicular to measurements showed little bit different results in comparison to the results of the measurements parallel to the grain. Best results for the resin with extracted protein had the 100% extracted adhesive cured at 150 °C, 17,5 MPa average. Overall, the best values had the PVAc cured at 100°C, 18,4 MPa. The difference was not so high if we consider the remoted values.

The test was partially influenced by the setting of the machine. First, the jaws were moving too slow but even after the change of the speed, the samples did not break properly. The testing time was 30 seconds longer in average in comparison to the standard recommended testing times.

Scheffe test showed significant similarities within these groups: (1) all types of the adhesives except the extract 50%/100 °C and (2) all types of the adhesives except one referential PVAc sample, cured at 100 °C.

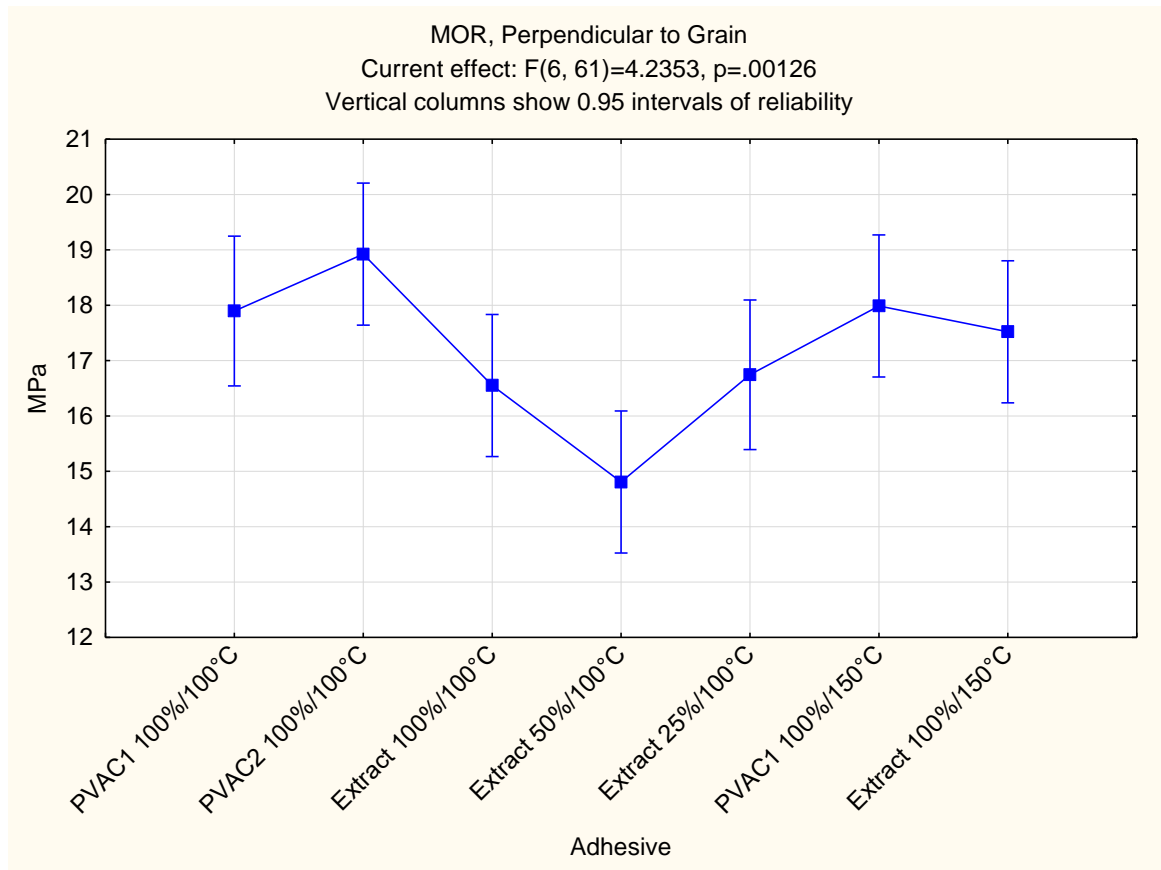

Figure 27 ANOVA for the bend strength test, MOR perpendicular to grain

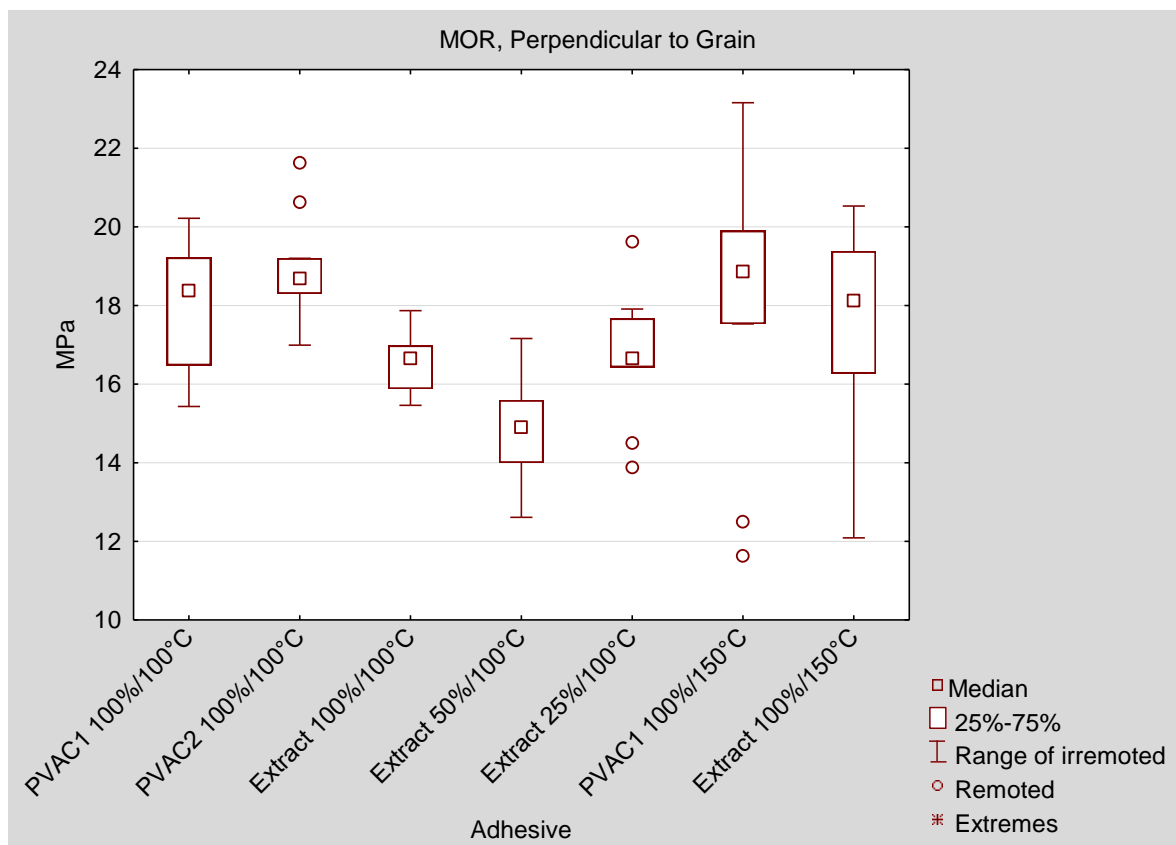

Figure 28 Box graph for the bend strength test, MOR perpendicular to grain

Table 19 Scheffe test for the MOR perpendicular to grain testing

Scheffe test, Homogenic group, alfa = .05000 PČ = 66.735, sv = 58.000				
Position	Adhesive	MPa Mean	1	2
4	Extract 50%/100°C	14.80800	****	
3	Extract 100%/100°C	16.55000	****	****
5	Extract 25%/100°C	16.74444	****	****
7	Extract 100%/150°C	17.52100	****	****
1	PVAC1 100%/100°C	17.89556	****	****
6	PVAC1 100%/150°C	17.98800	****	****
2	PVAC2 100%/100°C	18.92300		****

## 7.10. Bend strength – MOE perpendicular to grain

Bend strength test results were analysed with single factor ANOVA (Figure 29), box graph (Figure 30) and due to the nature of result  $p < 0,05$ , the Scheffe test (Table 20) is also included, because there is a statistically crucial difference.

The results of the MOE perpendicular to the grain were closer to the MOE parallel to the grain results than in the case of MOR comparison. The highest value had, with an enormous difference, the extracted adhesive 100% cured at 150 °C, 1,12 GPa. The lowest value had the PVAc with 25% replacement by the modified extract, 0,57 GPa. The second highest value had the PVAc cured at 100 °C with the average result similar to the 100% extracted adhesive.

Scheffe test of multiple comparison showed similarities within following groups: (1) Extract 25%/100°C with extract 50%/100°C, with PVAC1 100%/150°C and with PVAC2 100%/100°C; (2) extract 50%/100°C, with PVAC1 100%/150°C and with PVAC2 100%/100°C, and with extract 100%/100°C; (3) PVAC1 100%/150°C with PVAC2 100%/100°C, with extract 100%/100°C, and with PVAC1 100%/100°C. The Extract 100%/150°C was alone due to the significant difference.

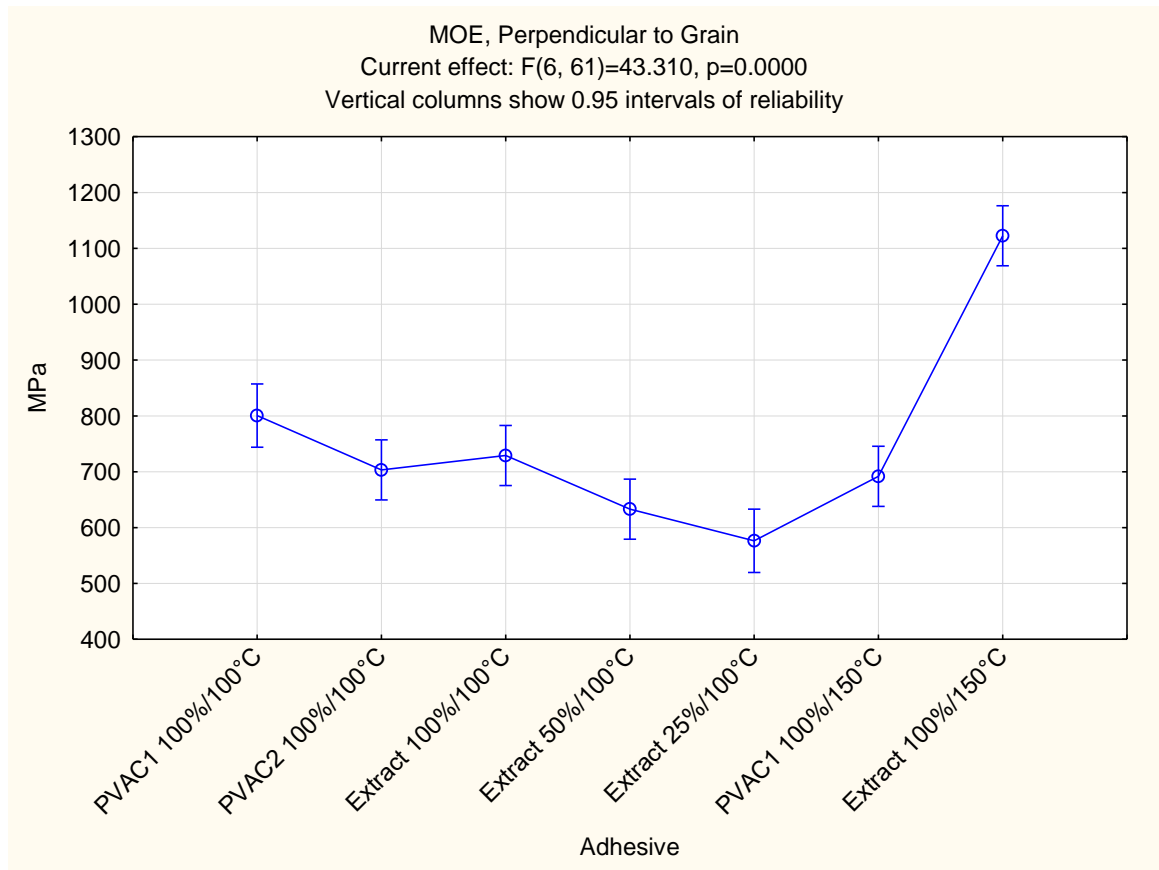

Figure 29 ANOVA for the bend strength test, MOE perpendicular to grain

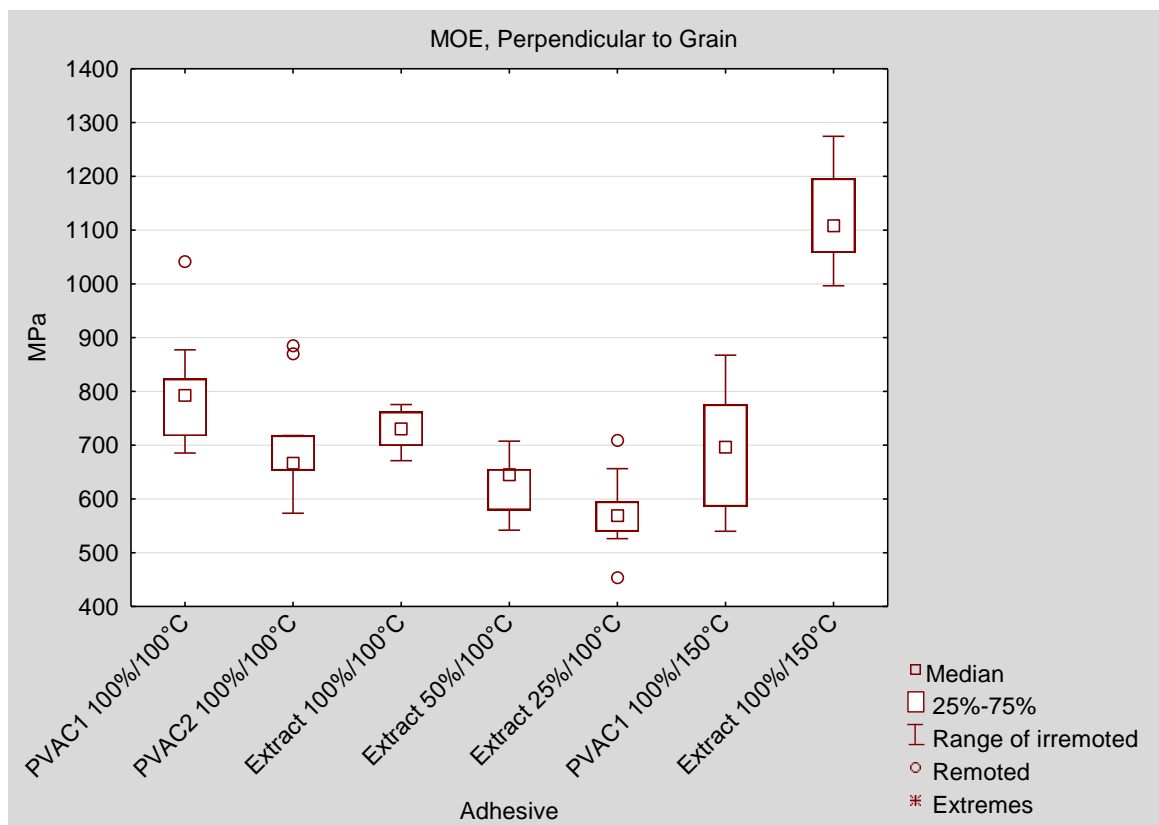

Figure 30 Box graph for the bend strength test, MOE perpendicular to grain

Table 20 Scheffe test for the MOE perpendicular to grain testing

Position	Scheffe test, Homogenic group, alfa = .05000 PČ = 66.735, sv = 58.000					
	Adhesive	MPa Mean	1	2	3	4
5	Extract 25%/100°C	576.256	****			
4	Extract 50%/100°C	632.986	****	****		
6	PVAC1 100%/150°C	691.885	****	****	****	
2	PVAC2 100%/100°C	703.331	****	****	****	
3	Extract 100%/100°C	729.071		****	****	
1	PVAC1 100%/100°C	800.523			****	
7	Extract 100%/150°C	1122.565				****

The results of the bend strength testing showed a relatively big difference from the result of the lap shear testing. The reason for this was not found and reliably verified in literature but certain deductions can be made if we consider information from the Table 2. The bend strength is widely influenced by the wood quality, which is a natural material and varies significantly. However, this conclusion does not completely correspond with the results of the adhesive with content of the extract 100 %, cured at 100 °C. The results were not as extreme as with the 100 % extracted protein adhesive cured at 150 °C but they were also higher. Therefore, it is necessary to consider the variable properties (Table 2) of the resin as well. Generally, it is possible to say that higher MOE, the better strength properties of material are. This fact could help in the further optimisation of the resin. Following table shows overall average results of the tested mechanical properties.

Table 21 Overall average values of the mechanical tests

Temperature (°C)	100	100	100	100	100	150	150
PVAc (%)	100	100	0	50	75	100	0
Extracted adhesive (%)	0	0	100	50	25	0	100
Lap shear test (MPa) (15x25 overlapped area)	4.6	5.09	1.36	3.32	3.45	1.54	1.81
MOR parallel to grain (MPa)	86.9	86.5	70.7	84.2	84.1	88.5	115.7
MOE parallel to grain (MPa)	9898.1	10454	11036.5	9919.8	9141.4	10061	12664.1
MOR perpendicular to grain (MPa)	17.9	18.9	16.6	14.8	16.7	18	17.5
MOE perpendicular to grain (MPa)	800.5	703.3	729.1	633	576.3	691.9	1122.6

## 7.11. Moisture content

The moisture content of the samples was determined for all adhesive types used for the testing. Average results are showed in Table 20. It is possible to say that the average moisture content equal to 11,7% with standard deviation 0,5 should not affect the mechanical properties of the samples. All the samples were conditioned and the test confirmed that the moisture was in the range 12 %, which is required by the standard.

Table 22 Average moisture content

Temperature (°C)	100	100	100	100	100	150	150
PVAc (%)	100	100	0	50	75	100	0
Extracted adhesive (%)	0	0	100	50	25	0	100
<b>Moisture content (%)</b>	<b>12.0</b>	<b>11.5</b>	<b>11.0</b>	<b>11.8</b>	<b>12.4</b>	<b>12.0</b>	<b>11.2</b>

## 7.12. Economic analysis

The BSG material is an abundant waste material available at very low prices or free. The extracted protein adhesive is value added material from the waste material but there are other inputs during the process. The protein extract adhesive was compared to the PVAc adhesive commercially available (Table 23).

For 100g of the adhesive, the difference between PVAc and extracted protein adhesive is 4,91 Kč (VAT excl.) in favour of the PVAc adhesive. The most expensive substance in the whole manufacturing process is the glyoxal which could be possibly replaced by a cheaper crosslinker. One need to consider that the adhesive is from waste material with no formaldehyde added, which is a long-term goal in the adhesive industry. Some manufacturers invest a big amount of money into the research and development in order to lower the emissions and make their products sustainable and ecological.

Table 23 Direct costs comparison of PVAc and protein extracted thesis

Substance	Package volume	VAT price (Kč)	VAT 21% excl. (Kč)	Volume for 100 g of the extract (ml/g)	VAT 21% excl. (Kč)	VAT price for 100 g of the extract
glyoxal 40%	1 l	1096	906	13.1 ml	11.34	14.36
hydrochloric acid 35% 1l	1 l	56	44	8 ml	0.35	0.45
NaOH 99% 1 kg	1 kg	49	39	24 g	0.93	1.18
BSG	-	0	0	1020 g	0	0.00
				<b>total</b>	<b>12.62</b>	<b>15.98</b>
PVAc	5 kg	488	403	100 g	7.71	9.76
				<b>total</b>	<b>7.71</b>	<b>9.76</b>

## 8. Conclusion

The thesis *Bio-based wood adhesive derived from brewers spent grain* dealt with the topic of manufacturing of protein adhesive from brewers spent grain, which is a major by-product of the brewing process. The protein was extracted through alkali treatment and subsequent acidic precipitation. Extract prepared like this was analysed for the protein and carbohydrates content.

Consequently, the protein was modified with furfural and glyoxal, with significantly better results for the glyoxal. The ABES screening test showed, that the protein extract has the highest lap shear strength, when the concentration of glyoxal is 20 %.

This resin was characterised for viscosity, solid content and pH. The adhesive prepared like this was tested and compared to the PVAc adhesive, according to slightly modified standards ČSN EN 314-1 and ČSN EN 310, for lap shear strength and bend strength. The adhesive (180 g/m<sup>2</sup>) was applied to 3-layer beech plywood (1,2 mm) and tested with different contents of the protein: 0, 25, 50, 100 % of protein cured at 100 °C and 0 and 100 % protein at 150 °C.

In lap shear test the value of the strength for 100 % extracted protein adhesive, cured at 150 °C was 2,7 times lower in comparison to 100 % PVAc. The variations between had values around 3,4 MPa. Bend strength values were higher for the 100 % extracted protein adhesive, specially MOE values in both directions, parallel and perpendicular to grain.

Following highlighted conclusions have been made:

- Parameters of the protein extraction needs to carefully optimized, especially the time, temperature, concentrations and separation from the lignocellulosic residue.
- The protein showed a potential to be further modified.
- Protein adhesive have better properties when exposed to higher temperatures.
- The results showed the protein adhesive have 1/3 strength in lap shear. Bend strength results were significantly better but this could be influenced by the wood quality.



- The results of PVAc adhesive partially replaced by the protein (25% and 50%) reached lap shear strength values around 3,4 MPa. They were tested only in dry conditions, but the measured values would be accepted by the ČSN EN 314-2 standard. This means that the adhesive could possibly serve to reduce the amount of chemically synthesized and commercially available PVAc adhesive.
- The adhesive is formaldehyde free, which can significantly influence its impact.

Based on the results, the author of the thesis recommends further theoretical and experimental research, focused mainly on the extraction and modification of the protein from BSG.

## Shrnutí

Práce *Lepidlo na bázi proteinu z použitého pivovarnického mláta* se zabývala tématem výroby lepidla z proteinu v pivovarském mlátě, které je hlavním vedlejším produktem při vaření piva. Protein byl rozpuštěn zásaditou úpravou a poté vysrážen kyselinou. Takto připravený extrakt byl podroben analýze obsahu proteinů a sacharidů.

Následně byl protein modifikován s furfurelem a glyoxalem, s daleko lepšími výsledky pro glyoxal. Testování metodou ABES ukázalo, že proteinový extrakt má největší smykovou pevnost, když je k němu přidán glyoxal o koncentraci 20 %.

Lepidlo by charakterizováno z pohledu viskozity, sušivého obsahu a pH. Takto připravené lepidlo bylo testováno a srovnáno s PVAc lepidlem podle lehce přizpůsobených norem ČSN EN 314-1 a ČSN EN 310 na smykovou a ohybovou pevnost. Lepidlo bylo aplikováno (180 g/m<sup>2</sup>) na 3-vrstvou překližovanou bukovou desku (1,2 mm) s různými obsahy proteinu: 0, 25, 50, 100 % protein vytvrzeného při 100 °C a 0 a 100 % proteinu vytvrzeného při 150 °C.

Smyková pevnost lepidla z extrahovaného proteinu vytvrzovaného při 150 °C byla 2,7krát nižší ve srovnání s PVAc lepidlem. Varianty mezi 0% a 100% měly hodnoty smykové zkoušky okolo 3,4 MPa. Ohybové pevnosti byly vyšší pro 100 % lepidlo z proteinového extraktu, zvláště pak pro hodnoty modulu pružnosti ve směrech podélně i příčně k vláknu.

Byly vyvozeny následující závěry:

- Je nutné zoptimalizovat proteinovou extrakci, zvláště pak parametry čas, teplotu, koncentrace přidávaných látek a separaci od lignocelulózových zbytků.
- Protein ukázal potenciál k další modifikaci.
- Proteinové lepidlo má lepší vlastnosti, pokud je vystaveno vyšším teplotám.
- Výsledky ukázaly že proteinové lepidlo má třetinovou smykovou pevnost. Naproti tomu, ohybová pevnost byla nejvyšší v případě 100 % proteinové lepidla, což může být do jisté míry ovlivněno kvalitou dřeva.

- Výsledky PVAc lepidla, které bylo částečně nahrazeno (z 25 a 50 %) proteinovým lepidlem vykazaly pevnost ve smyku okolo 3,4 MPa. Tělíška byla testovaná pouze v suchém stavu, nicméně pokud naměřené hodnoty by byly akceptovány normou ČSN EN 314-2. To znamená, že by proteinové lepidlo mohlo případně sloužit ke snížení chemického, syntetického a komerčně dostupného PVAc lepidla.
- Lepidlo je bez formaldehydu, což může znatelně ovlivnit jeho dopad.

Na základě výsledků práce, autorka práce doporučuje další teoretický a experimentální výzkum, zaměřený převážně na extrakci a modifikaci proteinu z pivovarského mláta.

## List of tables

Table 1 Chemical composition of BSG as reported in the literature .....	12
Table 2 Wood bonding variables .....	21
Table 3 Characteristics of wood durable bond.....	21
Table 4 Adhesives from natural adhesives.....	23
Table 5 Chemical crosslinking as found in the literature.....	29
Table 6 Applications of glyoxal .....	31
Table 7 PVAc VINALEP 830 basic parameters .....	35
Table 8 Modification of the extract.....	40
Table 9 Conditions and concentrations for the ABES testing.....	41
Table 10 Combinations of adhesives for the plywood testing .....	44
Table 11 Protein content of the BSG/extraction .....	50
Table 12 HPLC-ELSD carbohydrates analysis results.....	52
Table 13 Testing of crosslinking of glyoxal and furfural.....	52
Table 14 Scheffe test for the screening test.....	55
Table 15 Results of the resin characterization test – pH, viscosity and solid content.....	58
Table 16 Scheffe test for the lap shear strength test.....	61
Table 17 Scheffe test for the MOR parallel to grain testing .....	64
Table 18 Scheffe test for the MOE parallel to grain testing.....	66
Table 19 Scheffe test for the MOR perpendicular to grain testing .....	68
Table 20 Scheffe test for the MOE perpendicular to grain testing.....	70
Table 21 Overall average values of the mechanical tests.....	70
Table 22 Average moisture content .....	71
Table 23 Direct costs comparison of PVAc and protein extracted thesis .....	71

## List of figures

Figure 1 Schematic representation of a barley kernel in the longitudinal section .....	13
Figure 2A representation of adhesive bond “anatomy” .....	16
Figure 3 Wood adhesives classification as mentioned in Vick (1999) .....	22
Figure 4 Glyoxal (C <sub>2</sub> H <sub>2</sub> O <sub>2</sub> ) structure .....	31
Figure 5 Example of polymer linking by glyoxal .....	32
Figure 6 Calibration line of the albumin .....	36
Figure 7 Scheme showing the flow of thermo-mechanical and chemical treatments of BSG. 38	
Figure 8 Various stages of the protein extraction .....	39
Figure 9 Samples for ABES testing .....	41
Figure 10 ABES testing setup .....	41
Figure 11 Cutting scheme for the plywood boards. ....	44
Figure 12 Lap shear sample with overlapping area 25×25 mm ±0,5 mm.....	45
Figure 13 Lap shear sample with overlapping area 15×25 mm ±0,5 mm.....	45
Figure 14 Bend strength testing samples.....	46
Figure 15 Loading scheme .....	47
Figure 16 ANOVA for glyoxal and temperature screening test.....	54
Figure 17 Box graph for the glyoxal and temperature screening test .....	55
Figure 18 Average pH dependent on the protein content.....	56
Figure 19 Average viscosity dependent on the protein content .....	57
Figure 20 Average solid content dependent on the protein content .....	57
Figure 21 ANOVA for the lap shear strength test.....	60
Figure 22 Box graph for the lap shear strength test .....	61
Figure 23 ANOVA for the bend strength test, MOR parallel to grain.....	63
Figure 24 Box graph for the bend strength test, MOR parallel to grain .....	63
Figure 25 ANOVA for the bend strength test, MOE parallel to grain .....	65
Figure 26 Box graph for the bend strength test, MOE parallel to grain.....	65
Figure 27 ANOVA for the bend strength test, MOR perpendicular to grain.....	67
Figure 28 Box graph for the bend strength test, MOR perpendicular to grain .....	67
Figure 29 ANOVA for the bend strength test, MOE perpendicular to grain .....	69
Figure 30 Box graph for the bend strength test, MOE perpendicular to grain.....	69

## References

- Adeniran, H., Abiose, S., & Ogunsua, A. (2008). Production of Fungal  $\beta$ -amylase and Amyloglucosidase on Some Nigerian Agricultural Residues. *Food And Bioprocess Technology*, 3(5), 693-698. <http://dx.doi.org/10.1007/s11947-008-0141-3>
- BASF. (2008). *Glyoxal The Sustainable Solution for Your Business* [Brochure]. Author. Retrieved February 13, 2017, from [http://www.intermediates.basf.com/chemicals/web/en/function/conversions:/publish/content/news-and-publications/brochures/download/BASF\\_Glyoxal\\_Brochure.pdf](http://www.intermediates.basf.com/chemicals/web/en/function/conversions:/publish/content/news-and-publications/brochures/download/BASF_Glyoxal_Brochure.pdf)
- Ballerini, A., Despres, A., & Pizzi, A. (2005). Non-toxic, zero emission tannin-glyoxal adhesives for wood panels. *Holz Als Roh- Und Werkstoff*, 63(6), 477-478. <http://dx.doi.org/10.1007/s00107-005-0048-x>
- Bikerman, J. (1961). *The Science of Adhesive Joints* (1st ed.). New York: Academic Press.
- Bjorksten, J. (1951). Cross Linkages in Protein Chemistry. *Advances In Protein Chemistry*, 343-381. [http://dx.doi.org/10.1016/s0065-3233\(08\)60507-0](http://dx.doi.org/10.1016/s0065-3233(08)60507-0)
- Borroff, E., & Wake, W. (1950). Adhesion of Rubber and Textiles. IV. Function of Staple Fiber in Rubber to Fabric Adhesion. *Rubber Chemistry And Technology*, 23(2), 500-511. <http://dx.doi.org/10.5254/1.3547029>
- Celus, I., Brijs, K., & Delcour, J. (2006). The effects of malting and mashing on barley protein extractability. *Journal Of Cereal Science*, 44(2), 203-211. <http://dx.doi.org/10.1016/j.jcs.2006.06.003>
- Cook, D. (2017). BREWERS' GRAINS: OPPORTUNITIES ABOUND. *Brewers' Guardian*, 60-63.
- Derjaguin, B., & Krotova, N. (1948). The electrical theory of adhesion (sticking) films to hard surfaces and its experimental study. *UFN*, 36(11), 387-406.
- Deutscher, M. (1990). *Methods in enzymology. - 182: Guide to protein purification* (1st ed.). San Diego, Calif.: Academic Press.
- El-Wakil, N., Abou-Zeid, R., Fahmy, Y., & Mohamed, A. (2007). Modified wheat gluten as a binder in particleboard made from reed. *Journal Of Applied Polymer Science*, 106(6), 3592-3599. <http://dx.doi.org/10.1002/app.24499>

Frihart, C. R., & Wescott, J. M. (2004, September). Improved water resistance of bio-based adhesives for wood bonding. In *Proceedings, 1st International Conference on Environmentally Compatible Forest Products, September* (pp. 22-24).

Gao, Q., Li, J., Shi, S., Liang, K., & Zhang, X. (2012). SOYBEAN MEAL-BASED ADHESIVE REINFORCED WITH CELLULOSE NANO-WHISKERS. *Bioresources*, 7(4). <http://dx.doi.org/10.15376/biores.7.4.5622-5633>

Gao, Q., Shi, S., Zhang, S., Li, J., Wang, X., & Ding, W. et al. (2012). Soybean meal-based adhesive enhanced by MUF resin. *Journal Of Applied Polymer Science*, 125(5), 3676-3681. <http://dx.doi.org/10.1002/app.36700>

Gardner DJ. Adhesion mechanisms of durable wood adhesive bonds. In: Stokke DD, Groom LH, editors.

Gent, A., & Schultz, J. (1972). Effect of Wetting Liquids on the Strength of Adhesion of Viscoelastic Material. *The Journal Of Adhesion*, 3(4), 281-294. <http://dx.doi.org/10.1080/00218467208072199>

Ghorbani, M., Liebner, F., Van Herwijnen, H., Pfunzen, L., Krahofer, M., Budjav, E., & Konnerth, J. (2016). Lignin Phenol Formaldehyde Resoles: The Impact of Lignin Type on Adhesive Properties. *Bioresources*, 11(3). <http://dx.doi.org/10.15376/biores.11.3.6727-6741>

Groover, M. (2007). *Fundamentals of Modern Manufacturing: Materials, Processes, and Systems* (1st ed.). Hoboken, NJ: John Wiley & Sons.

Hassona, H. (1993). High fibre bread containing brewer's spent grains and its effect on lipid metabolism in rats. *Food / Nahrung*, 37(6), 576-582. <http://dx.doi.org/10.1002/food.19930370609>

Huang, W., & Sun, X. (2000). Adhesive properties of soy proteins modified by sodium dodecyl sulfate and sodium dodecylbenzene sulfonate. *Journal Of The American Oil Chemists' Society*, 77(7), 705-708. <http://dx.doi.org/10.1007/s11746-000-0113-6>

Huige, N. (1994). Brewery by-products and effluents. In W. Hardwick, *Handbook of Brewing* (1st ed., pp. 501-550). New York: Marcel Dekker, Inc. *Characterization of the Cellulosic Cell Wall*. Iowa: Blackwell Publishing Professional; 2006. pp 254–265.

Kanauchi, O., Mitsuyama, K., & Araki, Y. (2001). Development of a Functional Germinated Barley Foodstuff from Brewer's Spent Grain for the Treatment of Ulcerative Colitis. *Journal Of The American Society Of Brewing Chemists*, (59), 59-62. <http://dx.doi.org/10.1094/asbcj-59-0059>

- Khidzir, K. M., Abdullah, N., & Agamuthu, P. (2010). Brewery spent grain: chemical characteristics and utilization as an enzyme substrate. *Malaysian Journal of Science*, 29(1), 41-51.
- Kinsella, J. (1979). Functional properties of soy proteins. *Journal Of The American Oil Chemists' Society*, 56(3), 242-258. <http://dx.doi.org/10.1007/bf02671468>
- Konnerth, J., Stöckel, F., Müller, U., & Gindl, W. (2010). Elastic properties of adhesive polymers. III. Adhesive polymer films under dry and wet conditions characterized by means of nanoindentation. *Journal Of Applied Polymer Science*, (118), 1331–1334. <http://dx.doi.org/10.1002/app.32342>
- Kumar, R., Choudhary, V., Mishra, S., Varma, I., & Mattiason, B. (2002). Adhesives and plastics based on soy protein products. *Industrial Crops And Products*, 16(3), 155-172. [http://dx.doi.org/10.1016/s0926-6690\(02\)00007-9](http://dx.doi.org/10.1016/s0926-6690(02)00007-9)
- Lei, H., Pizzi, A., Navarrete, P., Rigolet, S., Redl, A., & Wagner, A. (2010). Gluten Protein Adhesives for Wood Panels. *Journal Of Adhesion Science And Technology*, 24(8-10), 1583-1596. <http://dx.doi.org/10.1163/016942410x500963>
- Lei, H., Wu, Z., Cao, M., & Du, G. (2016). Study on the Soy Protein-Based Wood Adhesive Modified by Hydroxymethyl Phenol. *Polymers*, 8(7), 256. <http://dx.doi.org/10.3390/polym8070256>
- Lewis, M., & Young, T. (1995). *Brewing* (1st ed., pp. 36-47). London: Chapman & Hall.
- Liu, Y., & Li, K. (2007). Development and characterization of adhesives from soy protein for bonding wood. *International Journal Of Adhesion And Adhesives*, 27(1), 59-67. <http://dx.doi.org/10.1016/j.ijadhadh.2005.12.004>
- Luo, J., Luo, J., Zhang, J., Bai, Y., Gao, Q., Li, J., & Li, L. (2016). A New Flexible Soy-Based Adhesive Enhanced with Neopentyl Glycol Diglycidyl Ether: Properties and Application. *Polymers*, 8(9), 346. <http://dx.doi.org/10.3390/polym8090346>
- Mannes, D., Sanabria, S., Funk, M., Wimmer, R., Kranitz, K., & Niemz, P. (2014). Water vapour diffusion through historically relevant gluten-based wood adhesives with sorption measurements and neutron radiography. *Wood Science And Technology*, 48(3), 591-609. <http://dx.doi.org/10.1007/s00226-014-0626-3>
- Marra, A. (1992). *Technology of wood bonding* (1st ed.). New York, N.Y: Van Nostrand Reinhold.



McBain, J., & Hopkins, D. (1924). On Adhesives and Adhesive Action. *The Journal Of Physical Chemistry*, 29(2), 188-204. <http://dx.doi.org/10.1021/j150248a008>

Meyer-Pittroff, R. (1988). Utilization of spent brewers' grain for energy production. *Brauwelt*, 128, 1156–1158.

Mussatto, S., Dragone, G., & Roberto, I. (2006). Brewers' spent grain: generation, characteristics and potential applications. *Journal Of Cereal Science*, 43(1), 1-14. <http://dx.doi.org/10.1016/j.jcs.2005.06.001>

Mussatto, S., Rocha, G., & Roberto, I. (2008). Hydrogen peroxide bleaching of cellulose pulps obtained from brewer's spent grain. *Cellulose*, 15(4), 641-649. <http://dx.doi.org/10.1007/s10570-008-9198-4>

Nordqvist, P. (2012) Exploring the wood adhesive performance of wheat gluten. Dissertation at KTH Chemical Science and Engineering. TRITA-CHE-Report 2012:23, ISSN 1654-1081

Öztürk, S., Özboy, Ö., Cavidoğlu, İ., & Köksel, H. (2002). Effects of Brewer's Spent Grain on the Quality and Dietary Fibre Content of Cookies. *Journal Of The Institute Of Brewing*, 108(1), 23-27. <http://dx.doi.org/10.1002/j.2050-0416.2002.tb00116.x>

Pocius, A. (2002). *Adhesion and adhesives technology, An Introduction* (2nd ed., pp. 1-14). Munich: Hanser Publications.

Rowell, R. (2013). *Handbook of wood chemistry and wood composites* (1st ed.). Boca Raton [etc.]: CRC Press.

Rowell, R. (2013). *Handbook of wood chemistry and wood composites* (1st ed.). Boca Raton [etc.]: CRC Press.

Russ, W., Mörtel, H., & Meyer-Pittroff, R. (2005). Application of spent grains to increase porosity in bricks. *Construction And Building Materials*, 19(2), 117-126. <http://dx.doi.org/10.1016/j.conbuildmat.2004.05.014>

Santos, M., Jiménez, J., Bartolomé, B., Gómez-Cordovés, C., & del Nozal, M. (2003). Variability of brewer's spent grain within a brewery. *Food Chemistry*, 80(1), 17-21. [http://dx.doi.org/10.1016/s0308-8146\(02\)00229-7](http://dx.doi.org/10.1016/s0308-8146(02)00229-7)

Sharpe, L., & Schonhorn, H. (1963). 'Symposium on Contact Angles. *Chem. Eng. News*, 15(67).

Schulz, J., & Nardin, M. (2003). Theories and Mechanisms of Adhesion. In A. Pizzi & K. Mittal, *Handbook of Adhesive Technology* (2nd ed., pp. 53-67). New York, Basel: Marcel Dekker, Inc.

Stokke, D., Wu, Q., & Han, G. (2014). *Introduction to wood and natural fiber composites* (1st ed.). Chichester: John Wiley & Sons.

Swain, S., Rao, K., & Nayak, P. (2004). Biodegradable polymers. III. Spectral, thermal, mechanical, and morphological properties of cross-linked furfural-soy protein concentrate. *Journal Of Applied Polymer Science*, 93(6), 2590-2596.  
<http://dx.doi.org/10.1002/app.20729>

Thermo Fisher Scientific Inc. (2012). *Thermo Scientific Crosslinking Technical Handbook* [Brochure]. Author. Retrieved January 18, 2017, from <https://tools.thermofisher.com/content/sfs/brochures/1602163-Crosslinking-Reagents-Handbook.pdf>

Townsley, P. M. (1979). Preparation of commercial products from brewer's waste grain and trub. *MBAA Tech Q*, 16(130), 4th ser.

Vaz, C., de Graaf, L., Reis, R., & Cunha, A. (2003). In vitro degradation behaviour of biodegradable soy plastics: effects of crosslinking with glyoxal and thermal treatment. *Polymer Degradation And Stability*, 81(1), 65-74.  
[http://dx.doi.org/10.1016/s0141-3910\(03\)00063-6](http://dx.doi.org/10.1016/s0141-3910(03)00063-6)

Veigel, S., Rathke, J., Weigl, M., & Gindl-Altmutter, W. (2012). Particle Board and Oriented Strand Board Prepared with Nanocellulose-Reinforced Adhesive. *Journal Of Nanomaterials*, 2012, 1-8. <http://dx.doi.org/10.1155/2012/158503>

Vick, Charles B. (1999). Adhesive bonding of wood materials in Wood handbook : wood as an engineering material. Madison, WI : USDA Forest Service, Forest Products Laboratory. General technical report FPL.

Vieira, E., Rocha, M., Coelho, E., Pinho, O., Saraiva, J., Ferreira, I., & Coimbra, M. (2014). Valuation of brewer's spent grain using a fully recyclable integrated process for extraction of proteins and arabinoxylans. *Industrial Crops And Products*, 52, 136-143.  
<http://dx.doi.org/10.1016/j.indcrop.2013.10.012>

Vojutskij, S. (1963). *Autohesion and adhesion of high polymers* (1st ed.). New York: Wiley-Interscience.

Wimmer, R., Kläusler, O., & Niemz, P. (2013). Water sorption mechanisms of commercial wood adhesive films. *Wood Science And Technology*, 47(4), 763-775. <http://dx.doi.org/10.1007/s00226-013-0538-7>

Wu, Z., Lei, H., Cao, M., Xi, X., Liang, J., & Du, G. (2016). Soy-based adhesive cross-linked by melamine–glyoxal and epoxy resin. *Journal Of Adhesion Science And Technology*, 30(19), 2120-2129. <http://dx.doi.org/10.1080/01694243.2016.1175247>

ČSN EN 310	Desky ze dřeva. Stanovení modulu pružnosti v ohybu a pevnosti v ohybu
ČSN EN 204	Klasifikace lepidel pro nekonstrukční stavební díly ke spojování dřeva a dřevitých materiálů
ČSN EN 1245	Lepidla - Stanovení pH
ČSN EN 827	Adhesives - Determination of conventional solids content and constant mass solids content
ČSN EN 12092	Lepidla - Stanovení viskozity
ČSN EN 314-1	Překližkované desky. Kvality lepení. Část 1: Zkušební metody
ČSN EN 314-2	Překližkované desky. Kvalita lepení. Část 2: Požadavky

## Appendices

### Appendix 1: Protein content analysis

SAMPLE	A1	A2	A3	Average	c (mg/v 10 ml)	Average concentration	Sample weight	C if sample weight 1 g (mg/ v 10 ml)	Average (mg/ in 10 ml of extraction)
1A NaOH	0.1939	0.1915	0.1918	0.192	17.09				<b>12.32</b>
1B NaOH	0.1683	0.1686	0.167	0.168	12.57	14.83	1.0015	14.81	
2A NaOH	0.1489	0.147	0.1486	0.148	8.90				
2B NaOH	0.1586	0.1582	0.1583	0.158	10.79	9.85	1.001	9.84	
3A voda	0.1102	0.1091	0.1088	0.109	1.72				<b>2.03</b>
3B voda	0.1092	0.109	0.1093	0.109	1.68	1.70	1.0004	1.70	
4A voda	0.1081	0.1084	0.1072	0.108	1.44				
4B voda	0.1186	0.1175	0.1176	0.118	3.30	2.37	1.0032	2.36	
Extracted sample 1	0.1007	0.1296	0.1188	0.116	2.94				<b>1.92</b>
Extracted sample 2	0.1199	0.12	0.1297	0.123	4.24	3.59	1.0004	3.59	
Extracted sample 3	0.1001	0.1001	0.1004	0.1	-0.02				
Extracted sample 4	0.1087	0.1002	0.1002	0.103	0.54	0.26	1.0032	0.26	

Appendix 2: Screening test results

Glyoxal percentage	Overlapping area (mm <sup>2</sup> )	F Max (N)	Wood failure (%)		Shear strength (Mpa)		
			Single Value	Mean	Single Value	Mean	Std. Deviation
<b>100°C</b>							
5%	93.07	362.84	75	<b>24</b>	3.90	<b>2.59</b>	<b>1.112</b>
5%	98.95	100.24	0		1.01		
5%	99.96	173.66	0		1.74		
5%	101.40	165.20	0		1.63		
5%	99.09	243.29	0		2.46		
5%	102.02	335.86	85		3.29		
5%	92.02	377.86	5		4.11		
15%	97.27	414.38	50	<b>34</b>	4.26	<b>4.15</b>	<b>0.341</b>
15%	89.71	340.98	50		3.80		
15%	97.76	402.08	25		4.11		
15%	94.70	336.66	10		3.56		
15%	90.89	394.40	5		4.34		
15%	97.90	426.54	5		4.36		
15%	95.24	442.43	95		4.65		
<b>120°C</b>							
10%	86.03	309.82	0	<b>0</b>	3.33	<b>3.88</b>	<b>0.978</b>
10%	81.38	237.28	0		2.76		
10%	86.03	342.48	0		3.98		
10%	74.38	218.95	0		2.71		
10%	90.65	414.70	0		5.58		
10%	82.80	358.11	0		4.81		
10%	90.65	359.92	0		3.97		
15%	88.35	417.66	5	<b>4</b>	4.73	<b>4.78</b>	<b>0.493</b>
15%	83.16	379.43	0		4.56		
15%	86.02	421.45	0		4.90		
15%	74.80	420.53	0		5.62		
15%	79.64	327.59	15		4.11		
20%	83.26	345.51	5	<b>21</b>	4.15	<b>5.08</b>	<b>0.534</b>
20%	86.85	499.87	5		5.76		
20%	84.04	430.71	30		5.13		
20%	86.85	351.46	50		4.75		
20%	85.95	485.05	5		5.64		
20%	85.95	464.42	50		5.40		
20%	87.89	413.72	5		4.71		
NEW20%	91.68	399.39	0	<b>18</b>	4.36	<b>5.09</b>	<b>0.619</b>
NEW20%	96.50	516.48	0		5.35		
NEW20%	92.61	543.34	20		5.97		
NEW20%	94.86	445.21	50		4.69		

30%	94.08	454.24	5	<b>13</b>	4.83	<b>5.06</b>	<b>0.226</b>
30%	85.05	506.84	25		5.26		
30%	85.05	495.13	25		5.42		
30%	86.02	410.57	5		4.77		
30%	89.77	470.46	20		5.04		
30%	90.24	455.25	0		5.04		
100%	93.50	294.33	0	<b>0</b>	3.15	<b>3.26</b>	<b>0.126</b>
100%	92.16	293.76	0		3.19		
100%	85.50	293.46	0		3.43		

Appendix 3: Lap shear test results

Group	Sample Number	Overlapping area (mm <sup>2</sup> )	F Max (N)	Wood failure (%)		Shear strength (Mpa)		
				Single Value	Mean	Single Value	Mean	Std. Deviation
<b>100°C/15x25</b>								
PVAC1 100%	<b>140</b>	385.7	1365.378	85	<b>98</b>	3.54	<b>4.60</b>	<b>0.417</b>
PVAC1 100%	<b>141</b>	392.1	2007.552	75		5.12		
PVAC1 100%	<b>142</b>	398.3	1664.894	100		4.18		
PVAC1 100%	<b>143</b>	395.1	1683.126	100		4.26		
PVAC1 100%	<b>144</b>	390.5	1952.5	100		5		
PVAC1 100%	<b>145</b>	394.9	1887.622	100		4.78		
PVAC1 100%	<b>146</b>	393.9	1981.317	100		5.03		
PVAC1 100%	<b>147</b>	394.6	1913.81	100		4.85		
PVAC1 100%	<b>148</b>	394	2025.16	100		5.14		
PVAC1 100%	<b>149</b>	393.2	1903.1	100		4.84		
PVAC1 100%	<b>150</b>	385.8	1639.65	100		4.25		
PVAC1 100%	<b>151</b>	385.4	1641.804	100		4.26		
PVAC1 100%	<b>152</b>	384.6	1749.93	100		4.55		
PVAC1 100%	<b>153</b>	389.6	1764.888	100		4.53		
PVAC1 100%	<b>154</b>	389.2	1708.588	100		4.39		
PVAC1 100%	<b>155</b>	388.3	1615.328	100		4.16		
PVAC1 100%	<b>156</b>	391.7	1782.235	100		4.55		
PVAC1 100%	<b>157</b>	391.7	2001.587	100		5.11		
PVAC1 100%	<b>158</b>	392.3	1918.347	100	4.89			
PVAC2 100%	<b>230</b>	393.5	2038.3	90	<b>80</b>	5.18	<b>5.09</b>	<b>0.267</b>
PVAC2 100%	<b>231</b>	392.9	2082.4	100		5.3		
PVAC2 100%	<b>232</b>	394	2115.8	100		5.37		
PVAC2 100%	<b>233</b>	393	1921.8	100		4.89		
PVAC2 100%	<b>234</b>	393	1953.2	100		4.97		
PVAC2 100%	<b>235</b>	394.2	1990.7	100		5.05		
PVAC2 100%	<b>236</b>	391.8	2017.8	30		5.15		
PVAC2 100%	<b>237</b>	392	2218.7	100		5.66		
PVAC2 100%	<b>238</b>	392.7	2026.3	50		5.16		
PVAC2 100%	<b>239</b>	389.1	1867.7	30		4.8		
PVAC2 100%	<b>240</b>	388.7	1865.8	50		4.8		
PVAC2 100%	<b>241</b>	393.7	2094.5	10		5.32		
PVAC2 100%	<b>242</b>	392.9	1917.4	100		4.88		
PVAC2 100%	<b>244</b>	393.3	1887.8	100		4.8		
PVAC2 100%	<b>245</b>	392.9	2019.5	100		5.14		
PVAC2 100%	<b>246</b>	393.5	1833.7	100		4.66		
PVAC2 100%	<b>247</b>	391.1	2143.2	100		5.48		
Extract 100%	<b>333</b>	392.5	471.0	100		<b>12</b>		
Extract 100%	<b>335</b>	394.2	433.62	10	1.1			
Extract 100%	<b>336</b>	394.1	453.215	0	1.15			
Extract 100%	<b>337</b>	392.6	592.826	10	1.51			
Extract 100%	<b>338</b>	394.4	453.56	0	1.15			
Extract 100%	<b>339</b>	395.4	616.824	10	1.56			
Extract 100%	<b>343</b>	390.8	351.7	0	0.9			
Extract 100%	<b>344</b>	391.1	512.3	0	1.31			
Extract 100%	<b>345</b>	389.5	428.5	0	1.1			

Extract 100%	<b>346</b>	387.4	736.1	0		1.9		
Extract 100%	<b>347</b>	385.3	739.8	10		1.92		
Extract 100%	<b>348</b>	354	523.92	0		1.48		
Extract 50%	<b>430</b>	394.3	1376.107	0	<b>0</b>	3.49	<b>3.32</b>	<b>0.277</b>
Extract 50%	<b>431</b>	394.4	1356.736	0		3.44		
Extract 50%	<b>432</b>	398.1	1146.528	0		2.88		
Extract 50%	<b>433</b>	396.8	1511.808	0		3.81		
Extract 50%	<b>434</b>	393.8	1382.238	0		3.51		
Extract 50%	<b>435</b>	393.8	1118.392	0		2.84		
Extract 50%	<b>436</b>	396.3	1196.826	0		3.02		
Extract 50%	<b>437</b>	396.8	1325.312	0		3.34		
Extract 50%	<b>438</b>	377.8	1288.298	0		3.41		
Extract 50%	<b>439</b>	395.5	1360.52	0		3.44		
Extract 50%	<b>440</b>	352.3	1264.8	0		3.59		
Extract 50%	<b>441</b>	391.6	1245.3	0		3.18		
Extract 50%	<b>442</b>	389.5	1351.6	0		3.47		
Extract 50%	<b>443</b>	391.8	1336.0	0		3.41		
Extract 50%	<b>445</b>	394.4	1124.0	0		2.85		
Extract 50%	<b>446</b>	392	1219.1	0		3.11		
Extract 50%	<b>447</b>	393.1	1403.4	0		3.57		
Extract 25%	<b>530</b>	393.6	1361.9	80	<b>35</b>	3.46	<b>3.45</b>	<b>0.327</b>
Extract 25%	<b>531</b>	394	1426.3	10		3.62		
Extract 25%	<b>532</b>	393	1517.0	0		3.86		
Extract 25%	<b>534</b>	395.1	1240.6	0		3.14		
Extract 25%	<b>535</b>	396.1	1390.3	50		3.51		
Extract 25%	<b>536</b>	396	1152.36	0		2.91		
Extract 25%	<b>537</b>	394.6	1168.016	50		2.96		
Extract 25%	<b>538</b>	349.9	1011.211	40		2.89		
Extract 25%	<b>539</b>	391	1431.06	40		3.66		
Extract 25%	<b>540</b>	388.7	1496.495	40		3.85		
Extract 25%	<b>541</b>	393.4	1451.646	10		3.69		
Extract 25%	<b>542</b>	391.8	1308.612	20		3.34		
Extract 25%	<b>543</b>	391.4	1287.706	20		3.29		
Extract 25%	<b>544</b>	392.1	1391.955	35		3.55		
Extract 25%	<b>545</b>	391.9	1328.541	100		3.39		
Extract 25%	<b>546</b>	393.8	1350.734	100		3.43		
Extract 25%	<b>547</b>	393.3	1592.865	0		4.05		
<b>150°C/15x25</b>								
PVAC 100%	<b>620</b>	392.7	377.0	100	<b>18</b>	0.96	<b>1.54</b>	<b>1.057</b>
PVAC 100%	<b>621</b>	390.4	1335.2	80		3.42		
PVAC 100%	<b>622</b>	393.3	491.6	0		1.25		
PVAC 100%	<b>623</b>	393	389.1	0		0.99		
PVAC 100%	<b>624</b>	388.6	551.8	0		1.42		
PVAC 100%	<b>625</b>	395.6	102.9	0		0.26		
PVAC 100%	<b>626</b>	394	709.2	0		1.8		
PVAC 100%	<b>627</b>	392	619.4	0		1.58		
PVAC 100%	<b>628</b>	393.7	110.2	0		0.28		
PVAC 100%	<b>629</b>	394	1355.4	0		3.44		
Extract 100%	<b>730</b>	397.2	679.2	60	<b>12</b>	1.71	<b>1.81</b>	<b>0.198</b>
Extract 100%	<b>731</b>	398.5	809.0	50		2.03		
Extract 100%	<b>732</b>	395.9	764.1	20		1.93		
Extract 100%	<b>733</b>	401.2	613.8	0		1.53		



Extract 100%	<b>734</b>	397.6	727.6	30		1.83		
Extract 100%	<b>735</b>	396.8	682.5	0		1.72		
Extract 100%	<b>736</b>	398.8	725.8	20		1.82		
Extract 100%	<b>737</b>	398.9	777.9	5		1.95		
Extract 100%	<b>738</b>	396.8	805.5	30		2.03		
Extract 100%	<b>739</b>	342.2	773.4	0		2.26		
Extract 100%	<b>740</b>	389.8	721.1	0		1.85		
Extract 100%	<b>741</b>	395.4	632.6	20		1.6		
Extract 100%	<b>742</b>	393.3	688.3	0		1.75		
Extract 100%	<b>743</b>	393	715.3	0		1.82		
Extract 100%	<b>744</b>	391.6	673.6	0		1.72		
Extract 100%	<b>745</b>	393.5	838.2	0		2.13		
Extract 100%	<b>746</b>	394.2	646.5	0		1.64		
Extract 100%	<b>747</b>	393.2	581.9	0		1.48		
Extract 100%	<b>748</b>	395.2	660.0	0		1.67		
<b>100°C/25x25</b>								
PVAC1 100%	<b>120</b>	645.8	2660.7	80		4.12		
PVAC1 100%	<b>121</b>	645.3	2368.3	100		3.67		
PVAC1 100%	<b>122</b>	645.3	2452.1	80		3.8		
PVAC1 100%	<b>123</b>	644.5	2938.9	70		4.56		
PVAC1 100%	<b>124</b>	644.3	2796.3	not valid	<b>90</b>	4.34	<b>3.97</b>	<b>0.325</b>
PVAC1 100%	<b>125</b>	644.5	2320.2	100		3.6		
PVAC1 100%	<b>126</b>	655.9	2754.8	100		4.2		
PVAC1 100%	<b>127</b>	657.6	2472.6	not valid		3.76		
PVAC1 100%	<b>128</b>	650.9	2388.8	100		3.67		
PVAC2 100%	<b>250</b>	625.7	3241.1	not valid		5.18		
PVAC2 100%	<b>251</b>	625.7	1726.9	80		2.76		
PVAC2 100%	<b>252</b>	624.5	2903.9	not valid		4.65		
PVAC2 100%	<b>253</b>	627.5	3514.0	100		5.6		
PVAC2 100%	<b>254</b>	627.5	3375.95	not valid	<b>93</b>	5.38	<b>4.66</b>	<b>0.802</b>
PVAC2 100%	<b>255</b>	629.3	2573.837	not valid		4.09		
PVAC2 100%	<b>256</b>	626	3161.3	100		5.05		
PVAC2 100%	<b>257</b>	629	2836.79	not valid		4.51		
PVAC2 100%	<b>258</b>	627.3	2967.129	not valid		4.73		
Extract 100%	<b>350</b>	631	700.41	0		1.11		
Extract 100%	<b>351</b>	624.8	712.272	0		1.14		
Extract 100%	<b>352</b>	624.7	768.381	0		1.23		
Extract 100%	<b>353</b>	622.5	522.9	0		0.84		
Extract 100%	<b>354</b>	625.5	344.025	0	<b>0</b>	0.55	<b>0.99</b>	<b>0.237</b>
Extract 100%	<b>355</b>	624.7	437.29	0		0.7		
Extract 100%	<b>356</b>	621	602.37	0		0.97		
Extract 100%	<b>357</b>	624	817.44	0		1.31		
Extract 100%	<b>358</b>	619.7	675.473	0		1.09		
Extract 50%	<b>450</b>	628.8	1892.688	50		3.01		
Extract 50%	<b>451</b>	626.7	2312.523	0		3.69		
Extract 50%	<b>452</b>	628	2059.84	not valid		3.28		
Extract 50%	<b>453</b>	624.2	1897.568	0		3.04		
Extract 50%	<b>454</b>	626.2	1891.124	0	<b>0</b>	3.02	<b>3.25</b>	<b>0.224</b>
Extract 50%	<b>455</b>	624.7	1961.558	0		3.14		
Extract 50%	<b>456</b>	625.5	2220.525	0		3.55		
Extract 50%	<b>457</b>	621.8	2014.632	0		3.24		
Extract 50%	<b>458</b>	625	2037.5	0		3.26		

Extract 25%	<b>551</b>	624.7	1611.726	not valid	<b>0</b>	2.58	<b>3.26</b>	<b>0.357</b>
Extract 25%	<b>552</b>	625.5	2345.625	0		3.75		
Extract 25%	<b>553</b>	626.2	2197.962	0		3.51		
Extract 25%	<b>554</b>	627.8	1977.57	0		3.15		
Extract 25%	<b>555</b>	628	1934.24	0		3.08		
Extract 25%	<b>556</b>	623.5	1858.03	0		2.98		
Extract 25%	<b>557</b>	620.5	1917.345	0		3.09		
Extract 25%	<b>558</b>	623	2186.73	0		3.51		
Extract 25%	<b>559</b>	623.7	2288.979	0		3.67		
<b>150°C/25x25</b>								
Extract 100%	<b>750</b>	625	1325.0	0	<b>0</b>	2.12	<b>1.69</b>	<b>0.366</b>
Extract 100%	<b>751</b>	622.7	1257.9	0		2.02		
Extract 100%	<b>752</b>	625.7	1357.8	0		2.17		
Extract 100%	<b>753</b>	624.5	1105.4	0		1.77		
Extract 100%	<b>754</b>	624.7	1087.0	0		1.74		
Extract 100%	<b>755</b>	624	948.5	0		1.52		
Extract 100%	<b>756</b>	626.2	983.1	0		1.57		
Extract 100%	<b>757</b>	630.5	807.0	0		1.28		
Extract 100%	<b>757</b>	625	631.3	0		1.01		

Appendix 4: Bend strength test results

Group	Sample No.	Thickness (mm)	Breadth (mm)	F Max (N)	MOR (Mpa)			MOE (MPa)			Density (kg/m <sup>3</sup> )				
					Single Value	Mean	Std.Deviation	Single Value	Mean	Std.Deviation					
<b>100°C/parallel to grain</b>															
PVAC1 100%	111	4.42	50.33	598.5	91.3	<b>86.9</b>	<b>4.6</b>	9056.2	<b>9898.1</b>	<b>691.8</b>	722				
PVAC1 100%	113	4.56	50.33	562.5	80.6			9461.8			699				
PVAC1 100%	114	4.62	50.21	601.5	84.2			9479.2			685				
PVAC1 100%	112	4.58	50.33	633.1	90.0			9761.8			696				
PVAC1 100%	115	4.63	50.28	600.5	83.6			9688.5			684				
PVAC1 100%	116	4.63	50.5	591.7	82.0			9298.0			680				
PVAC1 100%	117	4.65	50.27	603.1	83.2			9591.9			681				
PVAC1 100%	118	4.6	50.31	629.4	88.7			10983.9			707				
PVAC1 100%	119	4.62	50.4	644.4	89.9			10456.9			695				
PVAC1 100%	1110	4.56	50.19	665.2	95.6			11203.1			713				
PVAC2 100%	211	4.53	50.31	589.7	85.7			<b>86.5</b>			<b>3.9</b>	10579.1	<b>10454.1</b>	<b>707.2</b>	721
PVAC2 100%	212	4.52	50.3	592.3	86.5	10922.1	707								
PVAC2 100%	213	4.61	50.36	547.9	76.8	9162.7	692								
PVAC2 100%	214	4.51	50.4	596.8	87.3	11136.6	721								
PVAC2 100%	215	4.51	50.43	611.1	89.4	11002.6	714								
PVAC2 100%	216	4.56	50.34	603.2	86.4	10702.6	706								
PVAC2 100%	217	4.54	50.28	628.7	91.0	10657.0	710								
PVAC2 100%	218	4.55	50.43	594.9	85.5	9065.1	680								
PVAC2 100%	219	4.55	50.34	634.1	91.3	10987.4	723								
PVAC2 100%	2110	4.61	50.29	610.1	85.6	10325.9	723								
Extract 100%	311	4.47	50.29	580.7	86.7	<b>70.7</b>	<b>15.3</b>		11531.3	<b>11036.5</b>		<b>510.9</b>			696
Extract 100%	312	4.46	50.11	550.7	82.9			11220.6	679						
Extract 100%	313	4.57	50.35	348.0	49.6			9861.6	662						
Extract 100%	314	4.56	50.41	426.0	61.0			11212.0	699						
Extract 100%	315	4.54	50.52	464.8	67.0			10938.3	694						
Extract 100%	317	4.46	50.3	483.5	72.5			11714.8	719						
Extract 100%	318	4.47	50.52	302.8	45.0			11214.2	704						
Extract 100%	319	4.46	50.4	599.8	89.7			10995.0	703						
Extract 100%	3110	4.41	50.33	531.9	81.5			10641.0	694						
Extract 50%	411	4.37	50.33	579.3	90.4			<b>84.2</b>	<b>3.9</b>		9891.7		<b>9919.8</b>	<b>475.9</b>	726
Extract 50%	412	4.54	50.27	576.6	83.5						9564.9				716
Extract 50%	41	4.49	50.38	591.9	87.4	10305.9	728								
Extract 50%	414	4.55	50.48	532.3	76.4	8795.2	696								
Extract 50%	415	4.52	50.33	598.1	87.2	10411.6	703								
Extract 50%	416	4.53	50.26	569.4	82.8	9910.5	686								
Extract 50%	417	4.53	50.46	554.8	80.4	9850.6	712								
Extract 50%	418	4.52	50.29	574.6	83.9	10274.7	702								
Extract 50%	4110	4.52	50.24	589.6	86.2	10273.0	699								
Extract 25%	511	4.41	50.4	534.0	81.7	<b>84.1</b>	<b>4.5</b>			9688.9	<b>9141.4</b>	<b>648.8</b>			727
Extract 25%	512	4.52	50.34	576.5	84.1					9200.0					682
Extract 25%	513	4.54	50.51	558.5	80.5			7972.6	691						
Extract 25%	514	4.56	50.4	561.8	80.4			8494.5	691						
Extract 25%	515	4.5	50.34	598.2	88.0			9202.3	724						
Extract 25%	516	4.57	50.33	532.6	76.0			8375.7	700						
Extract 25%	517	4.59	50.34	592.8	83.8			9042.2	691						

Extract 25%	518	4.56	50.42	649.6	92.9			9569.7			698
Extract 25%	519	4.53	50.31	600.1	87.2			10136.3			709
Extract 25%	5110	4.45	50.31	570.4	85.9			9731.8			699
<b>150°C/parallel to grain</b>											
PVAC 100%	611	4.33	50.31	437.3	69.5	<b>88.5</b>	<b>10.2</b>	7799.5	<b>10061.0</b>	<b>1114.4</b>	697
PVAC 100%	612	4.33	50.38	578.3	91.8			10138.1			697
PVAC 100%	613	4.39	50.36	545.1	84.2			9995.3			708
PVAC 100%	614	4.39	50.26	611.1	94.6			10115.9			684
PVAC 100%	615	4.28	50.33	564.6	91.9			10242.3			709
PVAC 100%	616	4.25	50.36	501.6	82.7			10200.3			715
PVAC 100%	617	4.23	50.37	628.3	104.6			11935.5			756
Protein 100%	711	4.38	50.34	765.3	118.9	<b>115.7</b>	<b>5.8</b>	13140.8	<b>12664.1</b>	<b>750.3</b>	729
Protein 100%	712	4.35	50.34	761.2	119.9			13678.9			731
Protein 100%	713	4.38	50.38	724.6	112.5			12562.3			702
Protein 100%	714	4.4	50.32	710.9	109.5			12786.5			700
Protein 100%	715	4.4	50.32	691.1	106.4			11523.4			696
Protein 100%	716	4.38	50.37	718.2	111.5			12105.9			696
Protein 100%	717	4.39	50.24	781.1	121.0			13007.6			728
Protein 100%	718	4.38	50.33	800.4	124.3			12969.8			716
Protein 100%	719	4.38	50.31	716.5	111.4			11333.9			698
Protein 100%	7110	4.33	50.32	764.5	121.6			13531.7			725
<b>100°C/perpendicular to grain</b>											
PVAC1 100%	12	4.58	50.43	116.2	16.5	<b>17.9</b>	<b>1.5</b>	717.1	<b>800.5</b>	<b>104.9</b>	705
PVAC1 100%	13	4.6	50.42	116.1	16.3			685.3			695
PVAC1 100%	14	4.61	50.56	131.7	18.4			823.3			698
PVAC1 100%	15	4.6	50.66	137.6	19.3			821.6			689
PVAC1 100%	16	4.63	50.36	111.1	15.4			692.3			694
PVAC1 100%	17	4.61	50.34	144.2	20.2			1041.3			734
PVAC1 100%	18	4.58	50.41	122.4	17.4			792.8			703
PVAC1 100%	19	4.32	50.42	120.6	19.2			877.3			732
PVAC1 100%	110	4.59	50.27	129.8	18.4			753.7			685
PVAC2 100%	21	4.54	50.26	149.4	21.6			<b>18.9</b>			<b>1.3</b>
PVAC2 100%	22	4.63	50.37	148.5	20.6	885.4	746				
PVAC2 100%	23	4.63	50.32	135.5	18.9	666.2	713				
PVAC2 100%	24	4.53	50.46	132.6	19.2	718.0	712				
PVAC2 100%	25	4.55	50.38	128.3	18.5	699.2	702				
PVAC2 100%	26	4.65	50.37	123.4	17.0	573.5	708				
PVAC2 100%	27	4.56	50.34	132.5	19.0	654.4	729				
PVAC2 100%	28	4.53	50.45	126.3	18.3	653.0	707				
PVAC2 100%	29	4.62	50.33	126.6	17.7	646.0	694				
PVAC2 100%	210	4.52	50.31	126.9	18.5	667.3	693				
Extract 100%	31	4.42	50.3	111.2	17.0	<b>16.6</b>	<b>0.7</b>	721.5	<b>729.1</b>	<b>33.4</b>	687
Extract 100%	32	4.46	50.38	112.5	16.9			723.5			681
Extract 100%	33	4.53	50.3	109.3	15.9			671.2			675
Extract 100%	34	4.49	50.29	105.6	15.6			686.6			679
Extract 100%	35	4.43	50.33	106.5	16.2			736.4			685
Extract 100%	36	4.44	50.33	109.5	16.6			764.6			714
Extract 100%	37	4.54	50.31	115.9	16.8			750.7			707
Extract 100%	38	4.53	50.32	123.0	17.9			775.4			704
Extract 100%	39	4.56	50.46	108.2	15.5			699.0			677
Extract 100%	310	4.49	50.43	117.6	17.4			761.8			688
Extract 50%	41	4.45	50.21	96.6	14.6	<b>14.8</b>	<b>1.3</b>	632.9	<b>633.0</b>	<b>50.2</b>	730

Extract 50%	42	4.66	50.58	92.3	12.6			542.0			678
Extract 50%	43	4.6	50.41	93.1	13.1			574.5			687
Extract 50%	44	4.54	50.48	110.3	15.9			652.4			716
Extract 50%	45	4.48	50.34	94.3	14.0			707.5			723
Extract 50%	46	4.44	50.36	101.4	15.3			579.3			701
Extract 50%	47	4.43	50.3	96.3	14.6			646.6			699
Extract 50%	48	4.49	50.43	116.3	17.2			695.7			708
Extract 50%	49	4.54	50.48	108.2	15.6			655.1			684
Extract 50%	410	4.63	50.29	109.1	15.2			643.9			676
Extract 25%	51	4.43	50.36	91.5	13.9	16.7	1.6	453.5	576.3	69.8	681
Extract 25%	52	4.49	50.33	119.5	17.7			595.0			714
Extract 25%	53	4.65	50.26	119.0	16.4			539.3			699
Extract 25%	54	4.53	50.2	120.2	17.5			555.6			709
Extract 25%	56	4.57	50.32	101.6	14.5			526.2			691
Extract 25%	57	4.43	50.27	129.1	19.6			708.9			756
Extract 25%	58	4.42	50.35	117.4	17.9			656.3			732
Extract 25%	59	4.54	50.42	115.3	16.7			569.1			710
Extract 25%	510	4.5	50.25	112.2	16.5			582.6			716
<b>150°C/perpendicular to grain</b>											
PVAC 100%	61	4.23	50.37	114.5	19.1	18.0	3.3	788.1	691.9	101.2	717
PVAC 100%	62	4.26	50.32	113.7	18.7			743.3			733
PVAC 100%	64	4.27	50.32	141.7	23.2			867.4			748
PVAC 100%	64	4.38	50.26	127.9	19.9			696.4			694
PVAC 100%	65	4.39	50.24	129.6	20.1			775.6			699
PVAC 100%	66	4.33	50.19	123.8	19.7			696.3			712
PVAC 100%	67	4.44	50.18	82.5	12.5			539.8			680
PVAC 100%	68	4.56	50.39	81.2	11.6			558.4			679
PVAC 100%	69	4.51	50.32	119.6	17.5			586.2			675
PVAC 100%	610	4.55	50.31	122.3	17.6			667.4			671
Extract 100%	71	4.26	50.36	118.1	19.4	17.5	2.4	1274.6	1122.6	83.9	743
Extract 100%	72	4.33	50.24	123.7	19.7			1195.9			725
Extract 100%	74	4.32	50.27	105.5	16.9			1203.6			726
Extract 100%	73	4.42	50.31	124.2	19.0			1101.4			718
Extract 100%	75	4.38	50.31	104.7	16.3			1058.0			714
Extract 100%	76	4.38	50.33	77.8	12.1			1016.1			721
Extract 100%	77	4.38	50.32	97.7	15.2			1172.1			714
Extract 100%	78	4.39	50.31	121.8	18.9			1115.1			716
Extract 100%	79	4.47	50.34	116.7	17.4			1092.6			703
Extract 100%	710	4.47	50.33	137.6	20.5			996.4			688