

Diplomová práce
Vizualizace

09.06.2020

Místo : Zbůch

Zákazník :

Zprac. : Bc. Eng. Lukáš, DiS

M : 1 : 100.00

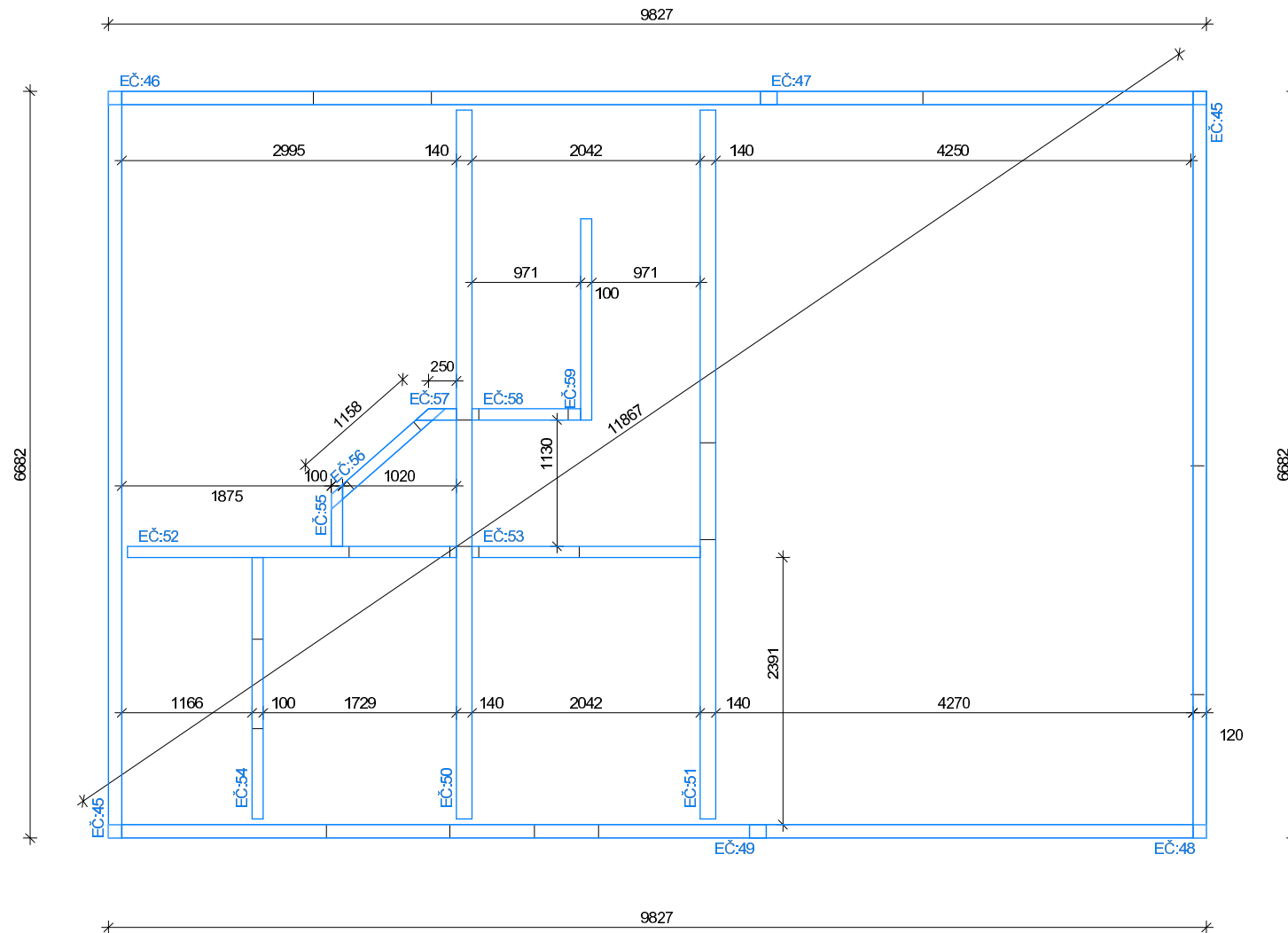

Diplomová práce
Základové prahy 1.NP

09.06.2020

Místo : Zbůch
Zákazník :
Zprac. : Bc. Eng. Lukáš, DiS

M : 1 : 60.00



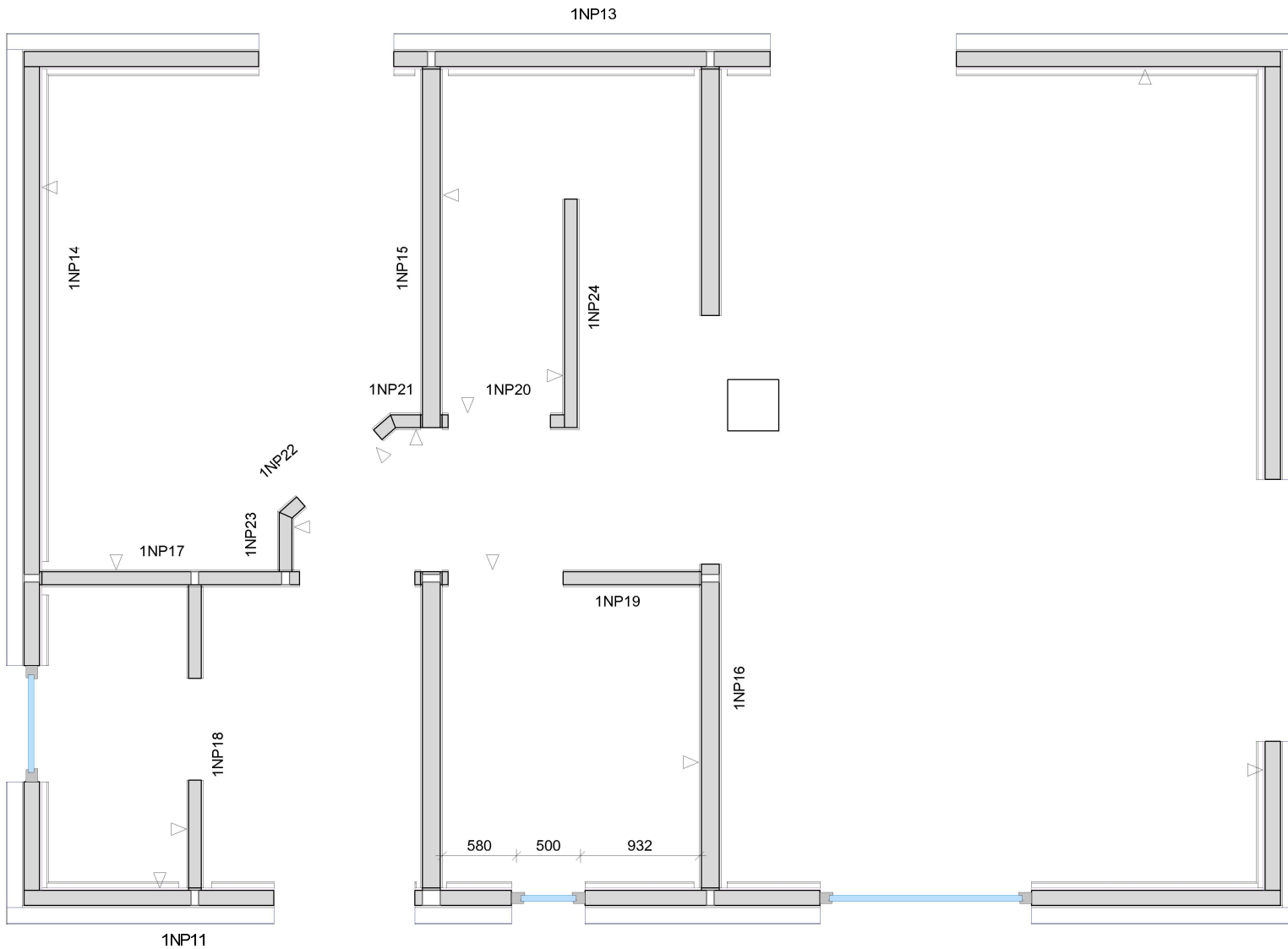

Diplomová práce
Stěny 1. NP

09.06.2020

Místo : Zbůch
Zákazník :
Zprac. : Bc. Eng. Lukáš, DiS

M : 1 : 50,00



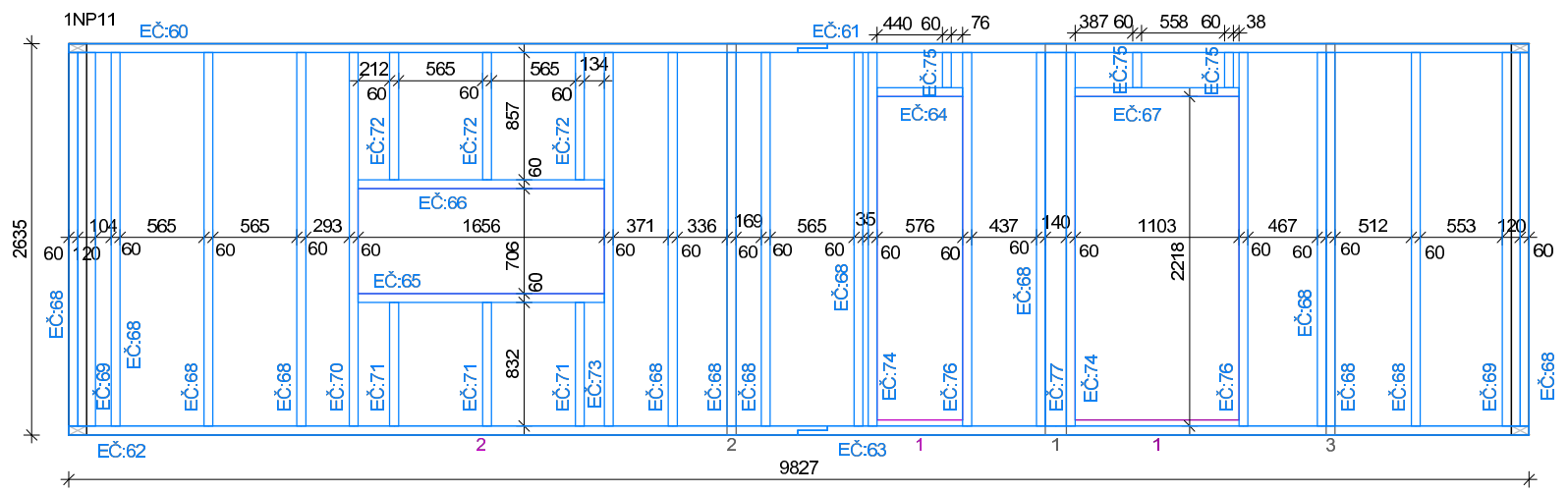

Ver 1

Hor 1

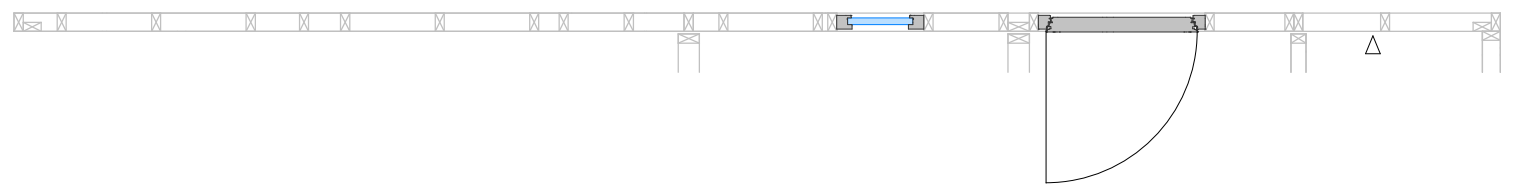

Diplomová práce

Místo : Zbůch
 Zákazník :
 Zprac. : Bc. Eng. Lukáš, DiS

Číslo plánu: 1
 Formát: A4
 M: 1:50,00

Číslo stěny: 1NP11

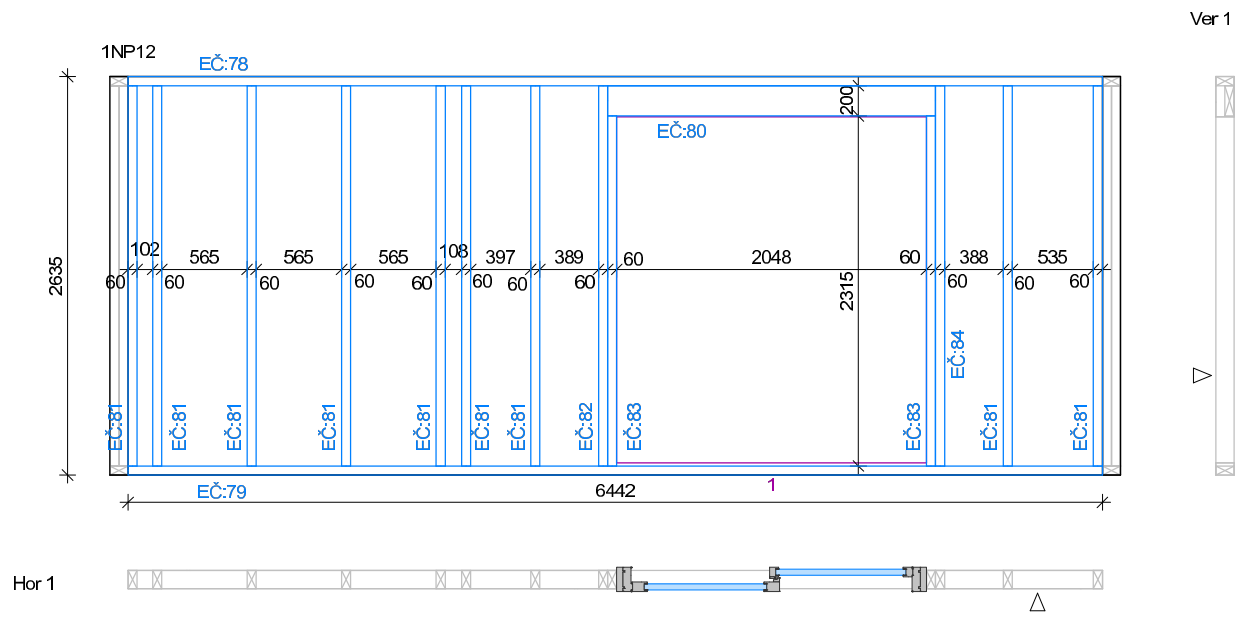

Diplomová práce

Místo : Zbůch	Číslo plánu: 2
Zákazník :	Formát: A4
Zprac. : Bc. EngI Lukáš, DiS	M: 1 : 50,00
Číslo stěny: 1NP12	

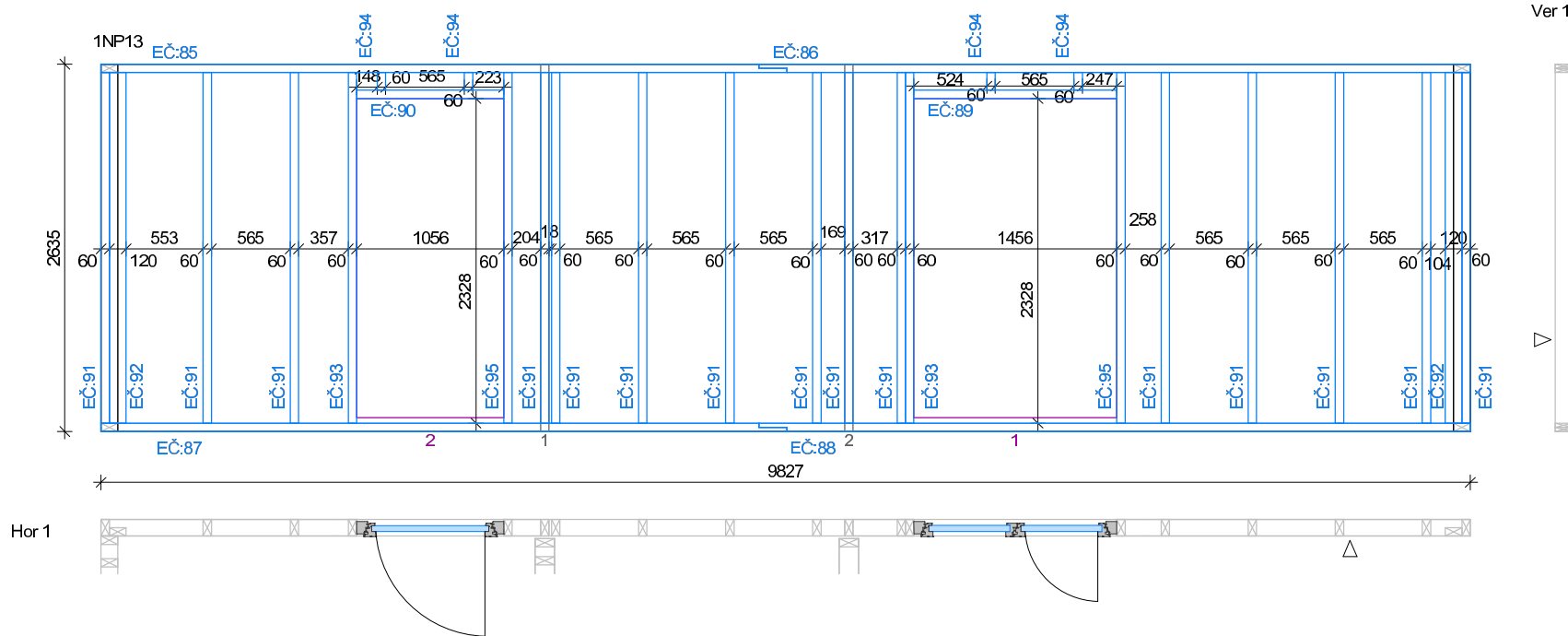

Diplomová práce

Místo : Zbůch
 Zákazník :
 Zprac. : Bc. EngI Lukáš, DiS

Číslo plánu: 3
 Formát: A4
 M: 1:50,00

Číslo stěny: 1NP13

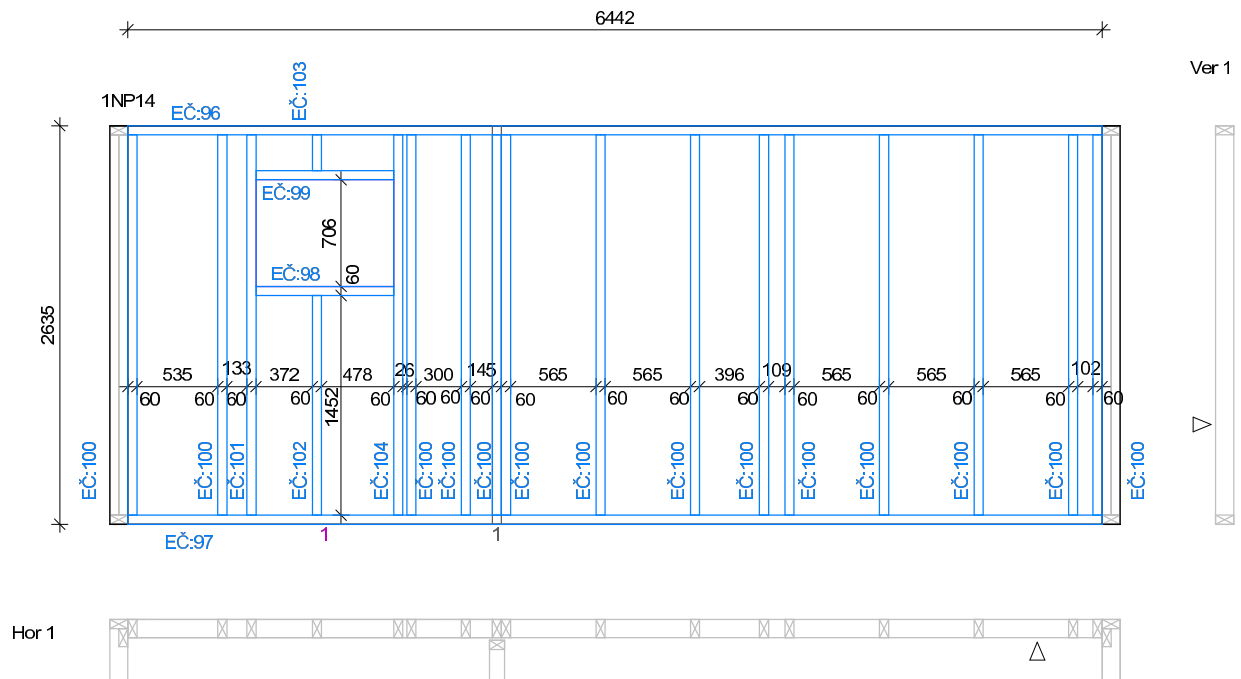

Diplomová práce

Místo : Zbůch	Číslo plánu: 4
Zákazník :	Formát: A4
Zprac. : Bc. Eng. Lukáš, DiS	M.: 1 : 50,00

Číslo stěny: 1NP14

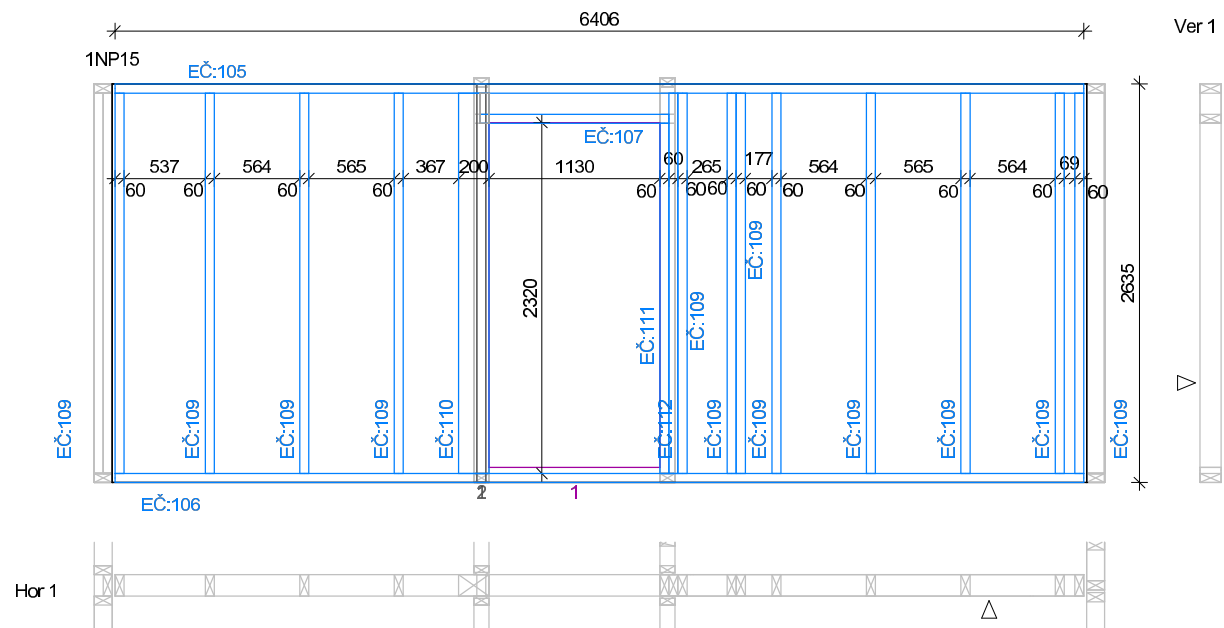

Diplomová práce

Místo : Zbůch
 Zákazník :
 Zprac. : Bc. Eng. Lukáš, DiS

Číslo plánu: 5
 Formát: A4
 M.: 1 : 50,00

Číslo stěny: 1NP15

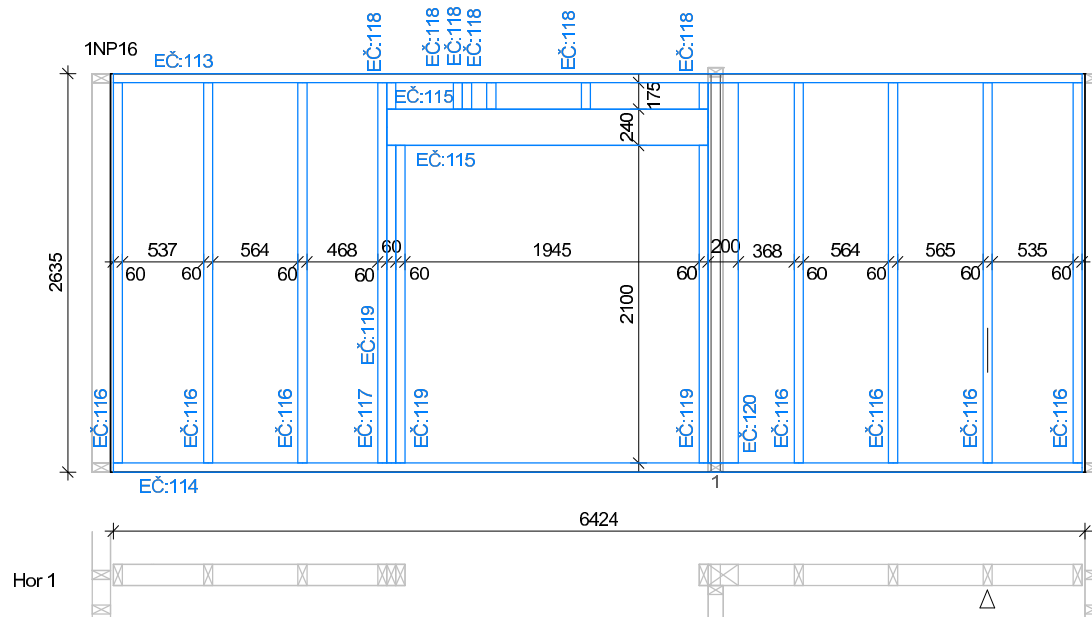

Ver 1



Hor 1

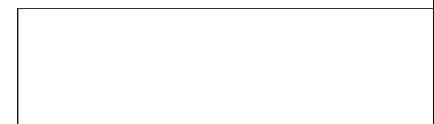
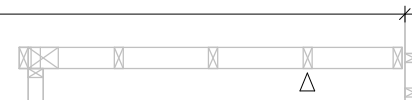

Diplomová práce	
Místo : Zbůch	Číslo plánu: 6
Zákazník :	Formát: A4
Zprac. : Bc. Eng. Lukáš, DiS	M: 1: 50,00
Číslo stěny: 1NP16	

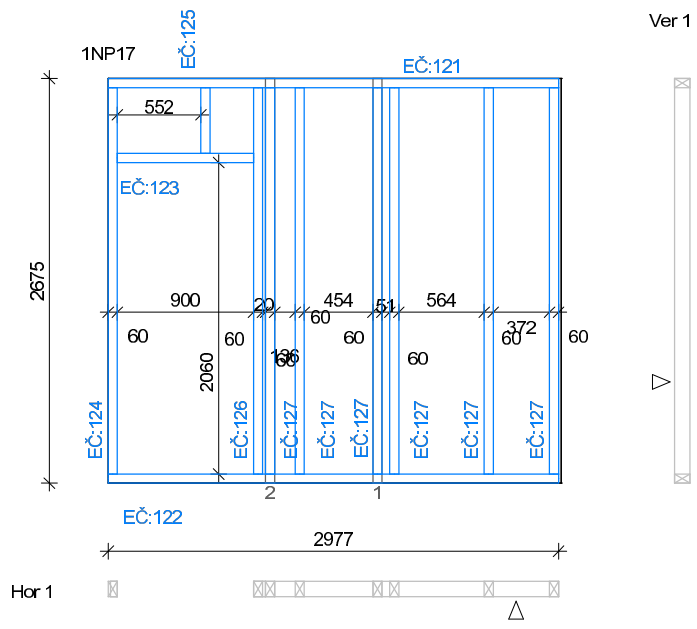

Diplomová práce	
Místo : Zbůch	Číslo plánu: 7
Zákazník :	Formát: A4
Zprac. : Bc. Eng. Lukáš, DiS	M: 1: 50,00
Číslo stěny: 1NP17	

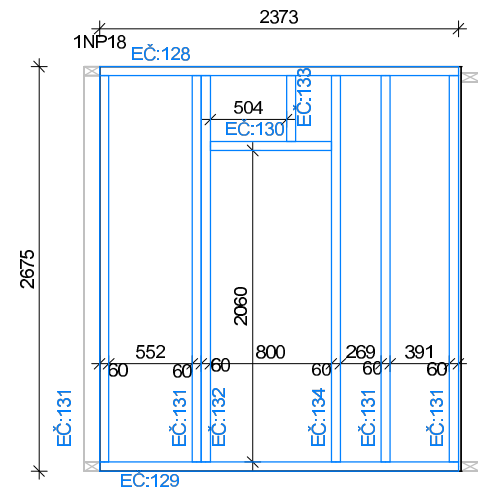

Ver 1



Hor 1



Diplomová práce	
Místo : Zbůch	Číslo plánu: 8
Zákazník :	Formát: A4
Zprac. : Bc. EngI Lukáš, DiS	M: 1 : 50,00
Číslo stěny: 1NP18	

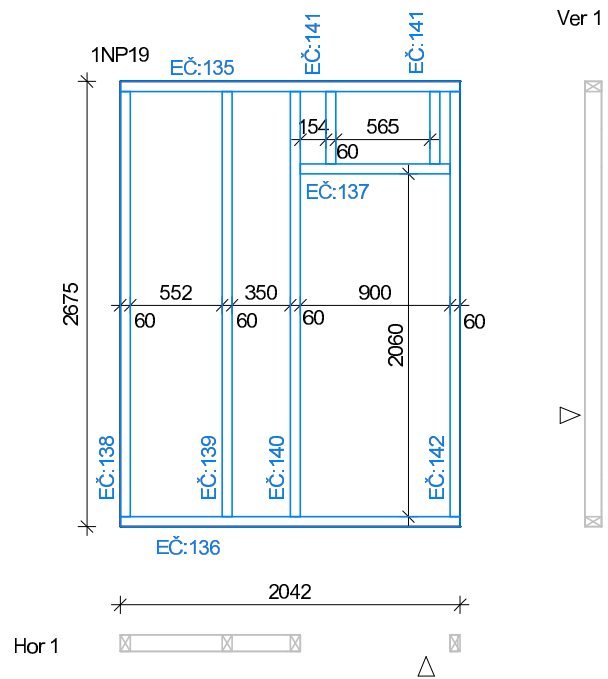

Diplomová práce

Místo : Zbůch
Zákazník :

Číslo plánu: 9

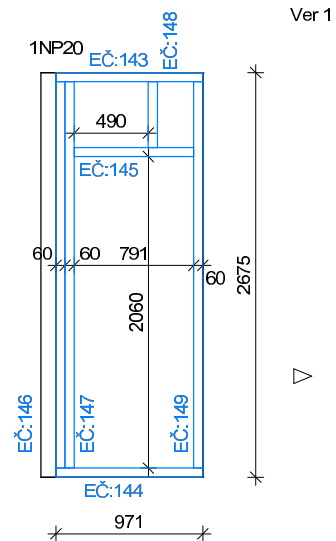

Hor 1



Diplomová práce	
Místo : Zbůch	Číslo plánů: 10
Zákazník :	Formát: A4
Zprac. : Bc. Eng. Lukáš, DiS	M.: 1 : 50,00
Číslo stěny: 1NP20	

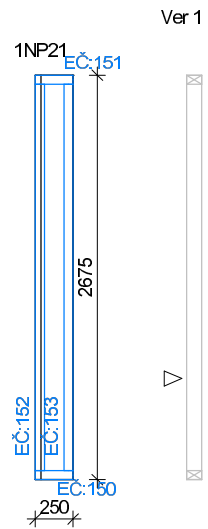

Ver 1

Hor 1



Diplomová práce	
Místo : Zbůch	Číslo plánu: 11
Zákazník :	Formát: A4
Zprac. : Bc. EngI Lukáš, DiS	M.: 1 : 50,00
Číslo stěny: 1NP21	

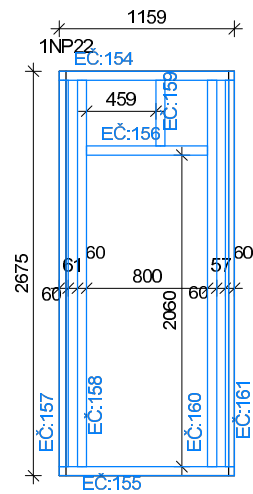

Ver 1



Hor 1



Diplomová práce	
Místo : Zbůch	Číslo plánu: 12
Zákazník :	Formát: A4
Zprac. : Bc. Eng. Lukáš, DiS	M: 1 : 50,00
Číslo stěny: 1NP22	

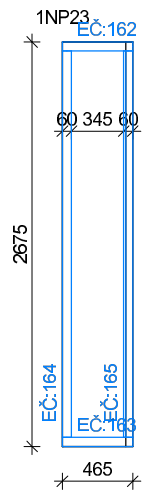

Ver 1



Hor 1



Diplomová práce	
Místo : Zbůch	Číslo plánu: 13
Zákazník :	Formát: A4
Zprac. : Bc. EngI Lukáš, DiS	M: 1: 50,00
Číslo stěny: 1NP23	

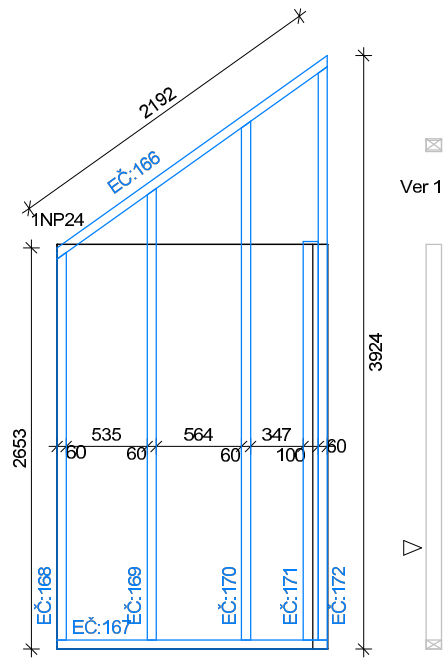

Hor 1



Diplomová práce	
Místo : Zbůch	Číslo plánu: 14
Zákazník :	Formát: A4
Zprac. : Bc. Eng. Lukáš, DiS	M: 1: 50,00
Číslo stěny: 1NP24	

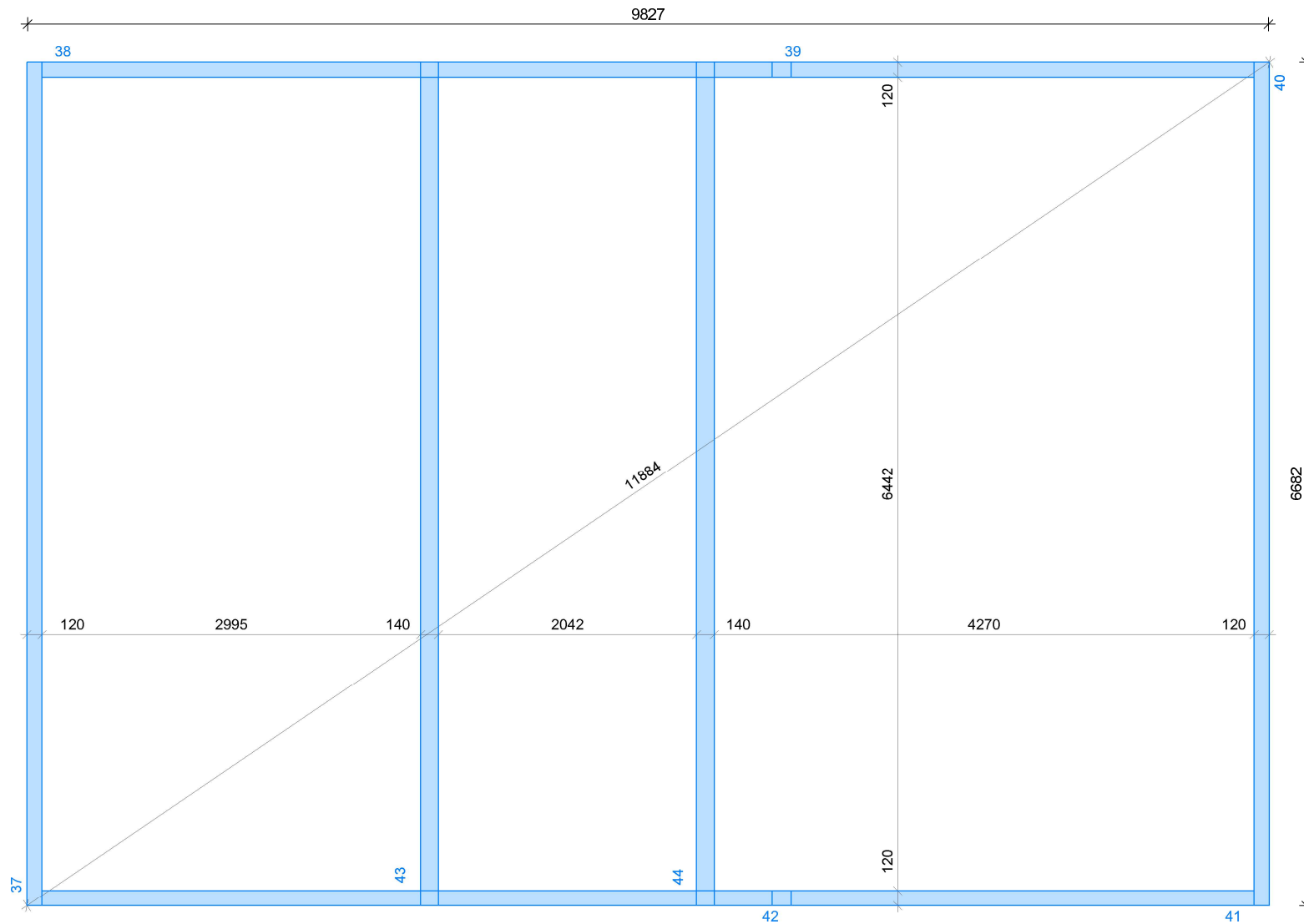

Diplomová práce
Věvec **09.06.2020**

Místo : Zbůch
Zákazník :
Zprac. : Bc. EngI Lukáš, DiS

M : 1 : 50,00

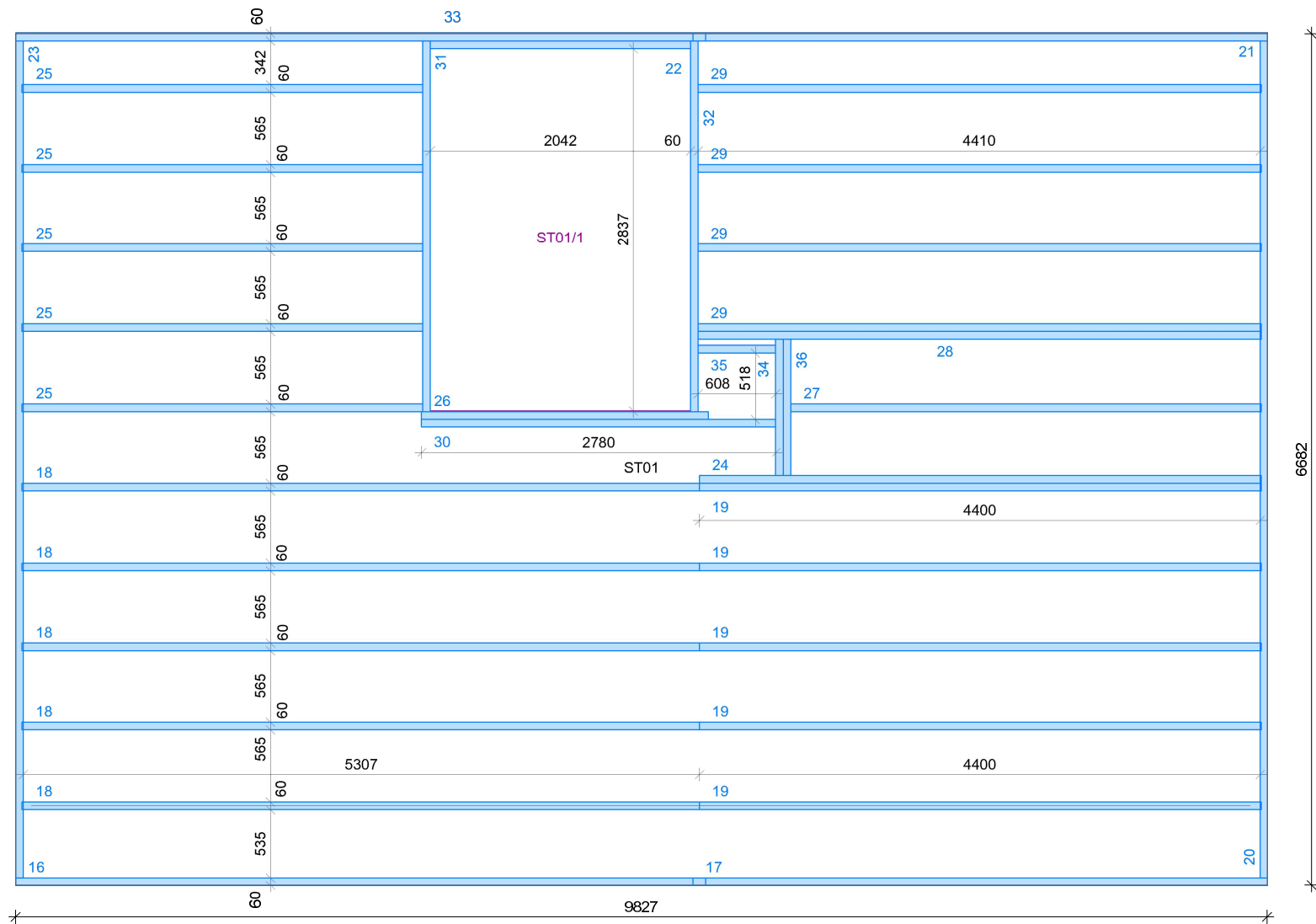

Diplomová práce
Stropy

09.06.2020

Místo : Zbůch

Zákazník :

Zprac. : Bc. Eng. Lukáš, DiS

M : 1 : 50.00

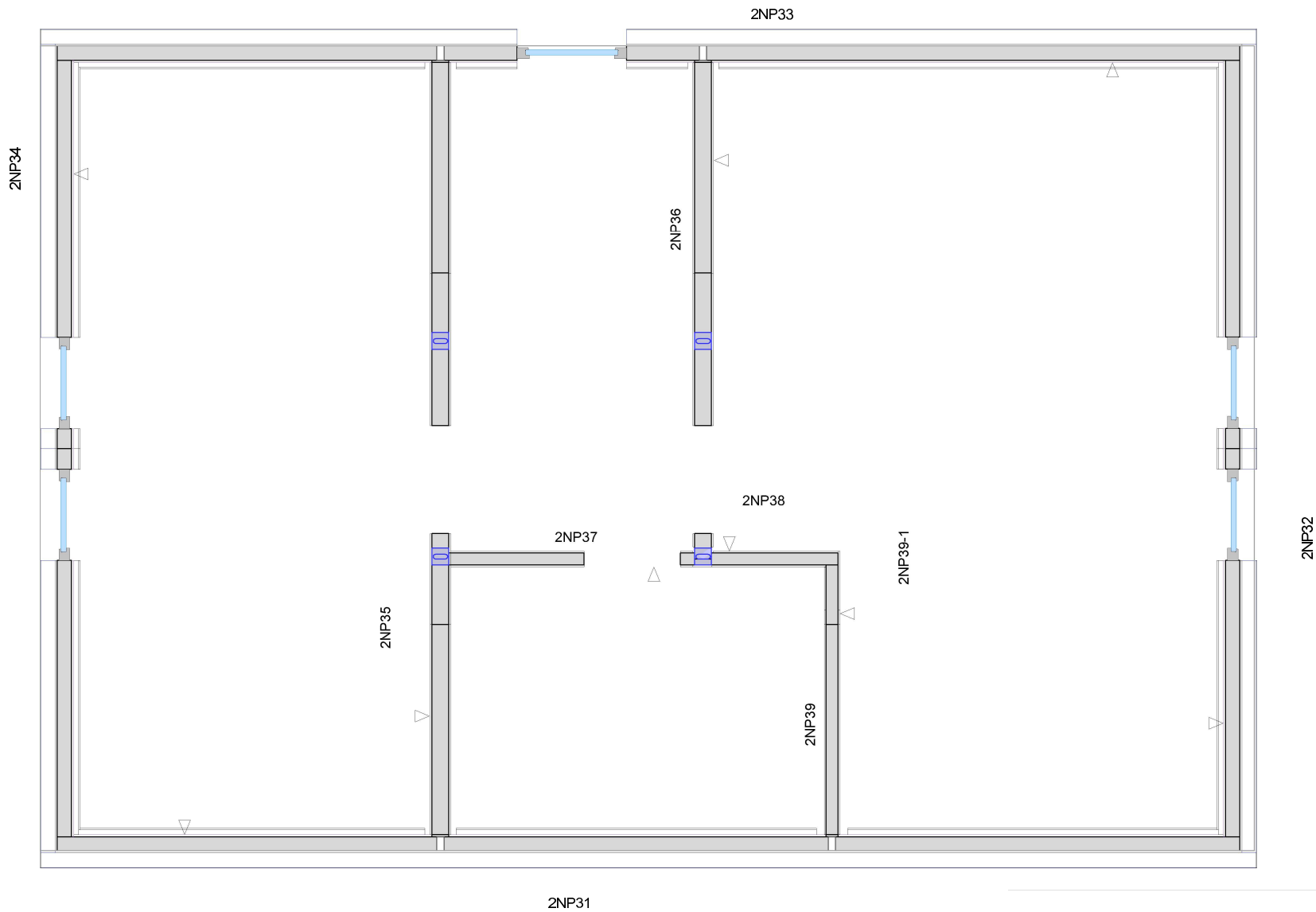

2NP31

Diplomová práce
Stěny 2.NP

09.06.2020

Místo : Zbůch

Zákazník :

Zprac. : Bc. Eng. Lukáš, DiS

M : 1 : 50,00

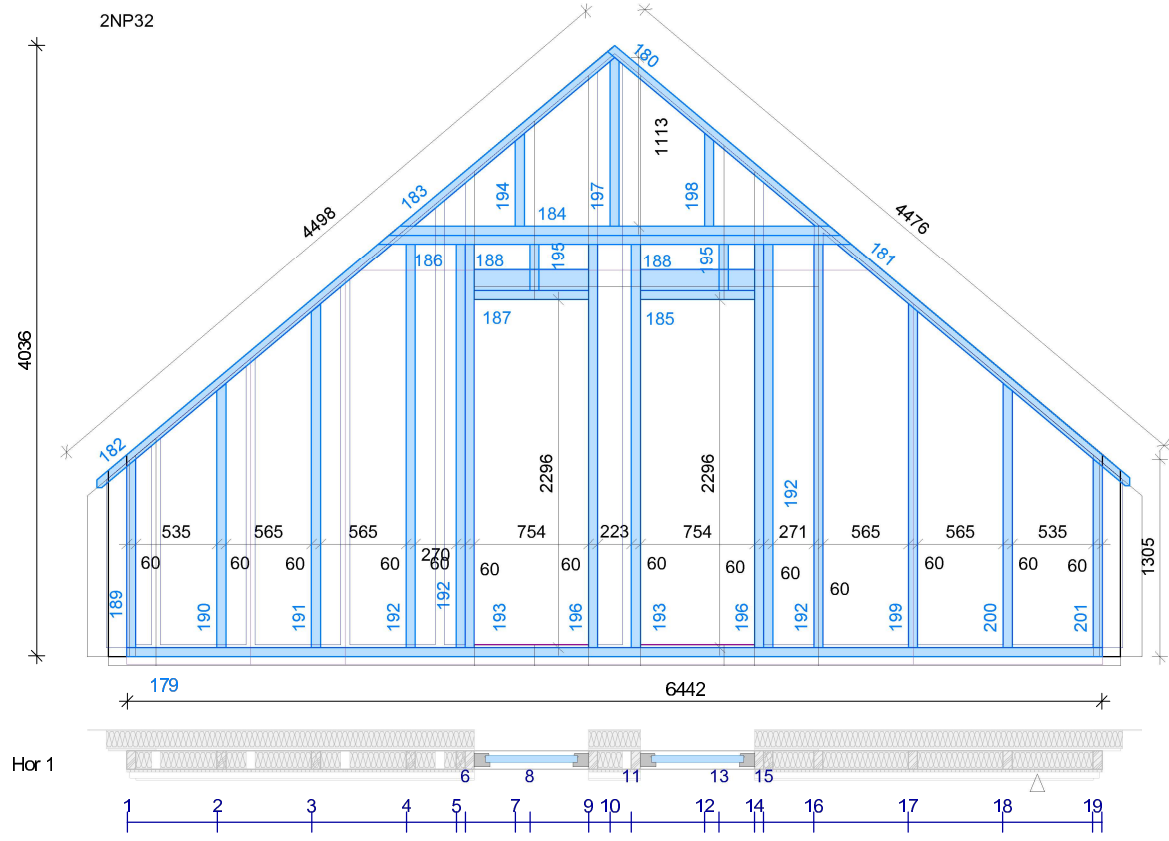

Ver 1

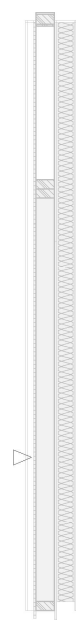

Hor 1



Diplomová práce

Místo : Zbůch	Číslo plánu: 26
Zákazník :	Formát: A4
Zprac. : Bc. EngI Lukáš, DiS.	M: 1: 50,00
Číslo stěny: 2NP32	

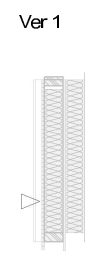
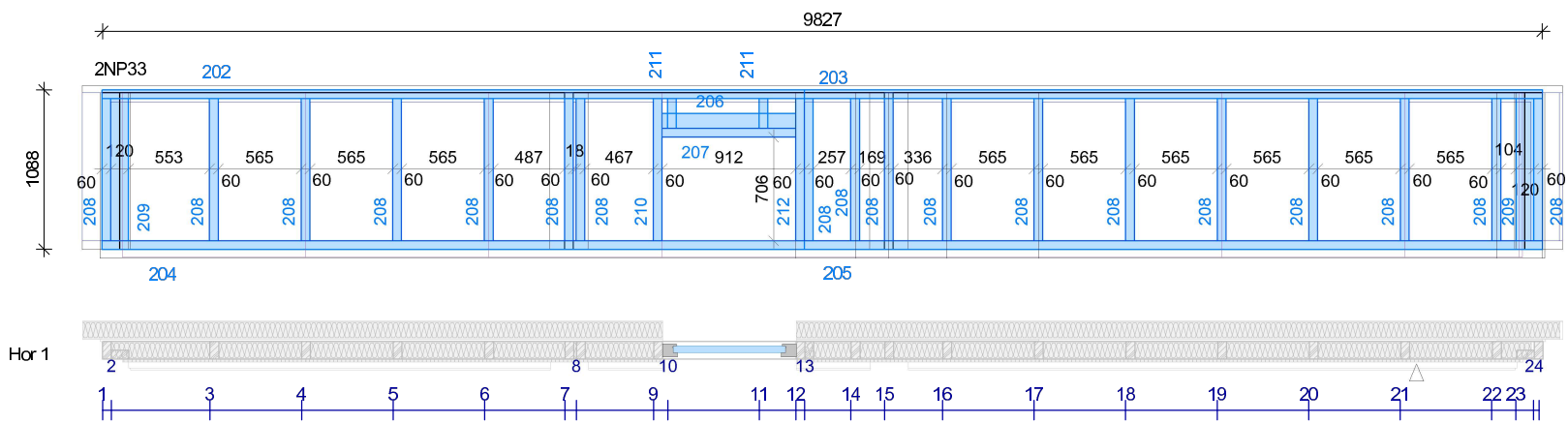

Diplomová práce

Místo : Zbůch
 Zákazník :
 Zprac. : Bc. Eng. Lukáš, DiS.

Číslo plánu: 27
 Formát: A4
 M: 1:50,00

Číslo stěny: 2NP33

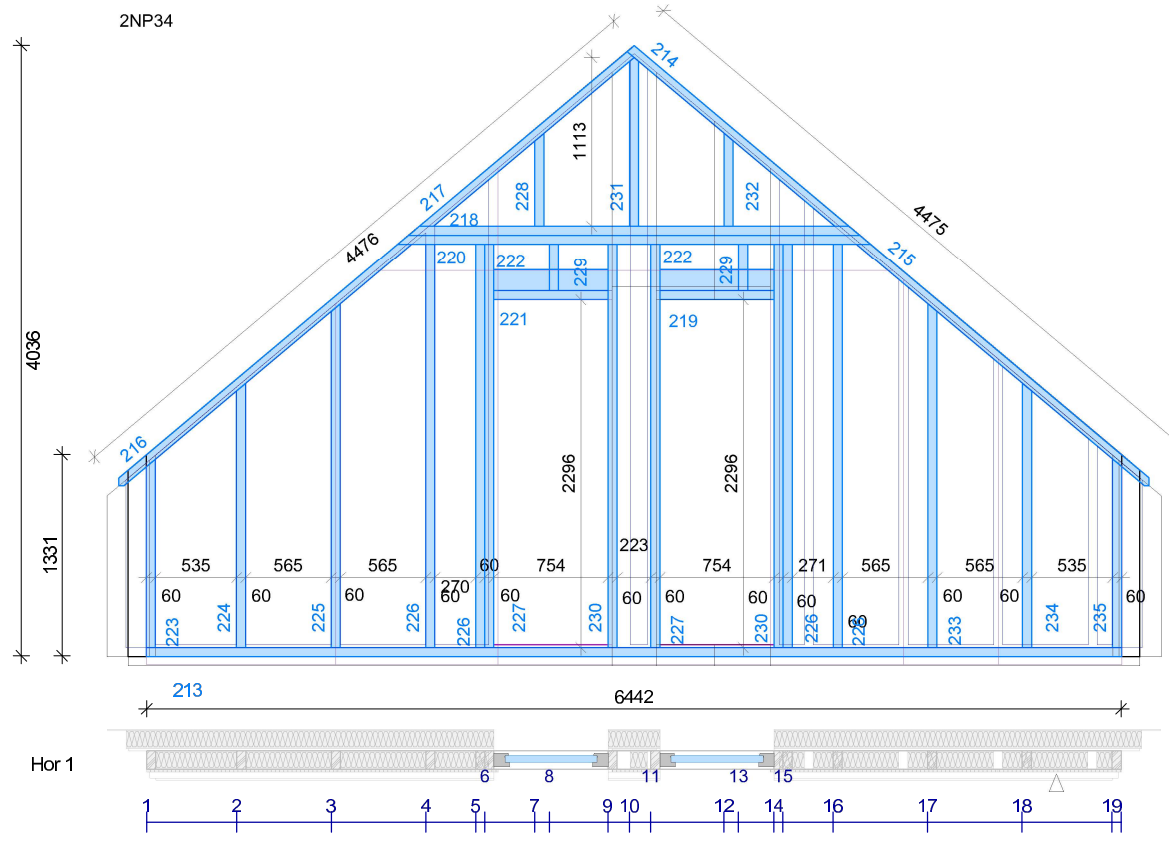

Ver 1

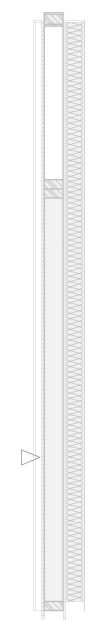

Diplomová práce	
Místo : Zbůch	Číslo plánu: 28
Zákazník :	Formát: A4
Zprac. : Bc. EngI Lukáš, DiS.	M: 1 : 50,00
Číslo stěny: 2NP34	

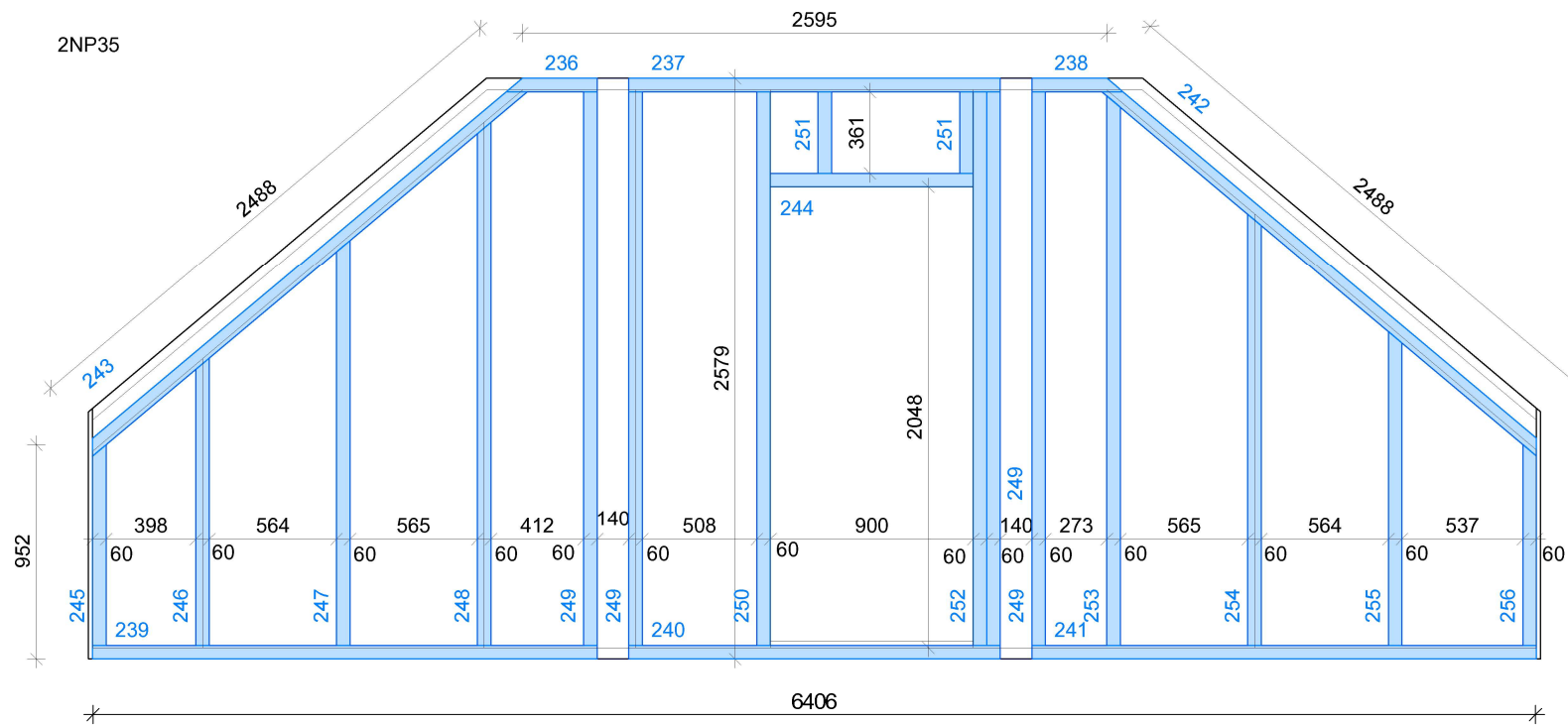

Ver 1



Hor 1

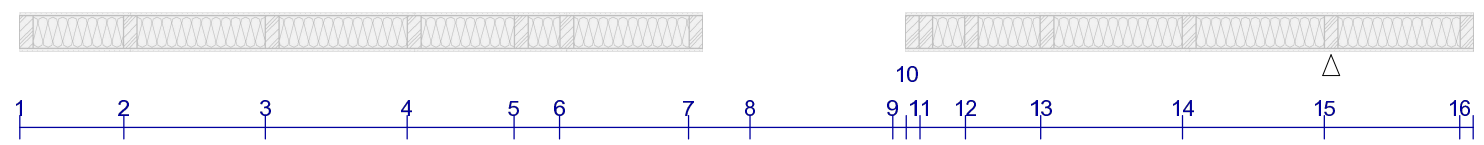

Diplomová práce

Místo : Zbůch	Číslo plánu: 29
Zákazník :	Formát: A4
Zprac. : Bc. EngJ Lukáš, DiS.	M: 1 : 33,33
Číslo stěny: 2NP35	

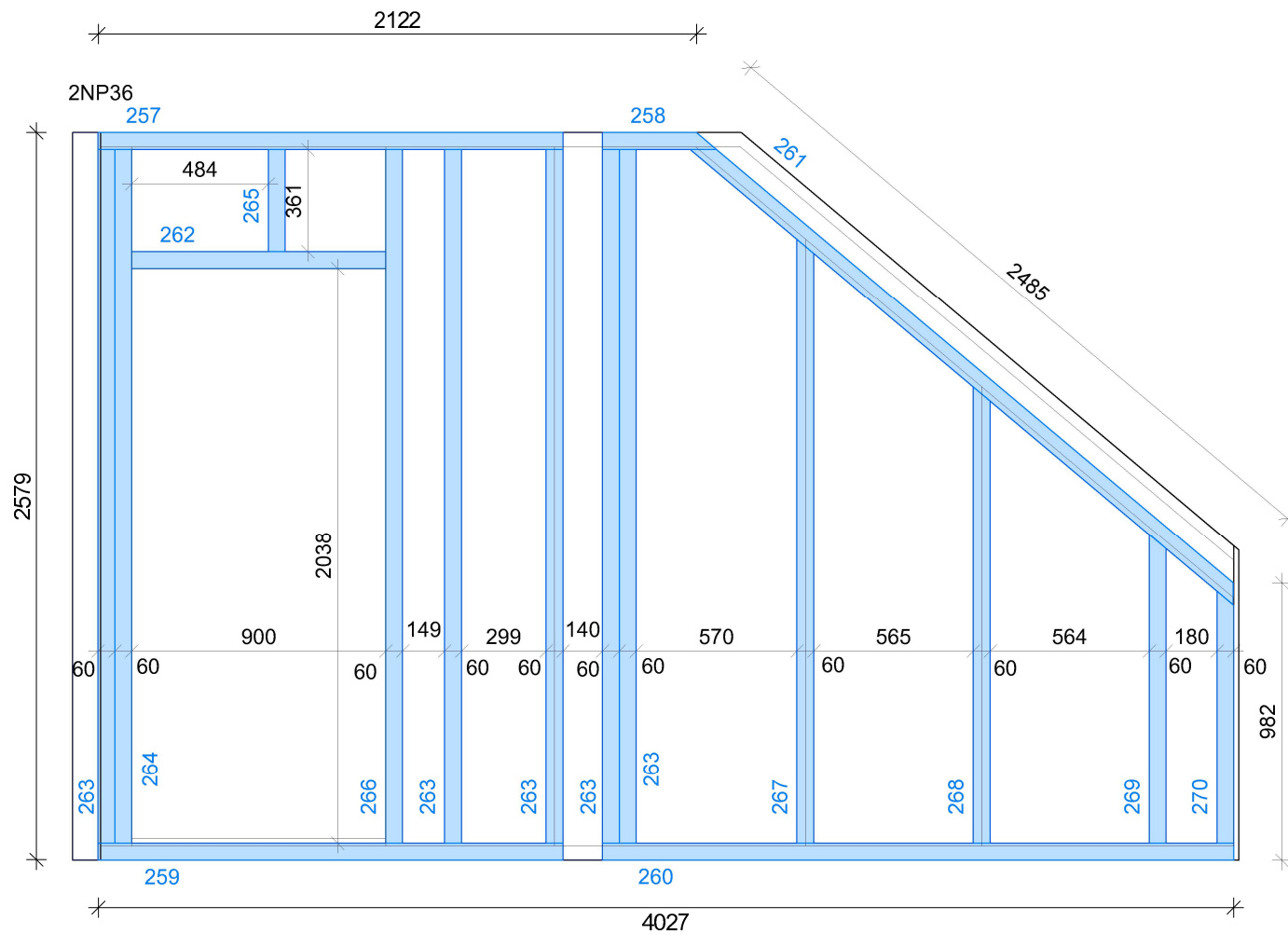

Ver 1



Hor 1

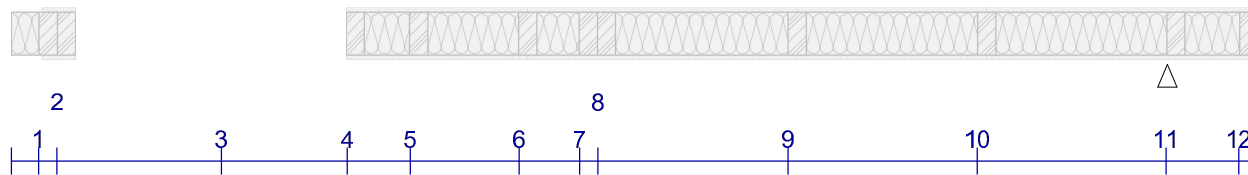

Diplomová práce

Místo : Zbůch
 Zákazník :
 Zprac. : Bc. EngI Lukáš, DiS.

Číslo plánu: 30
 Formát: A4
 M: 1 : 25,00

Číslo stěny: 2NP36

2NP37
271

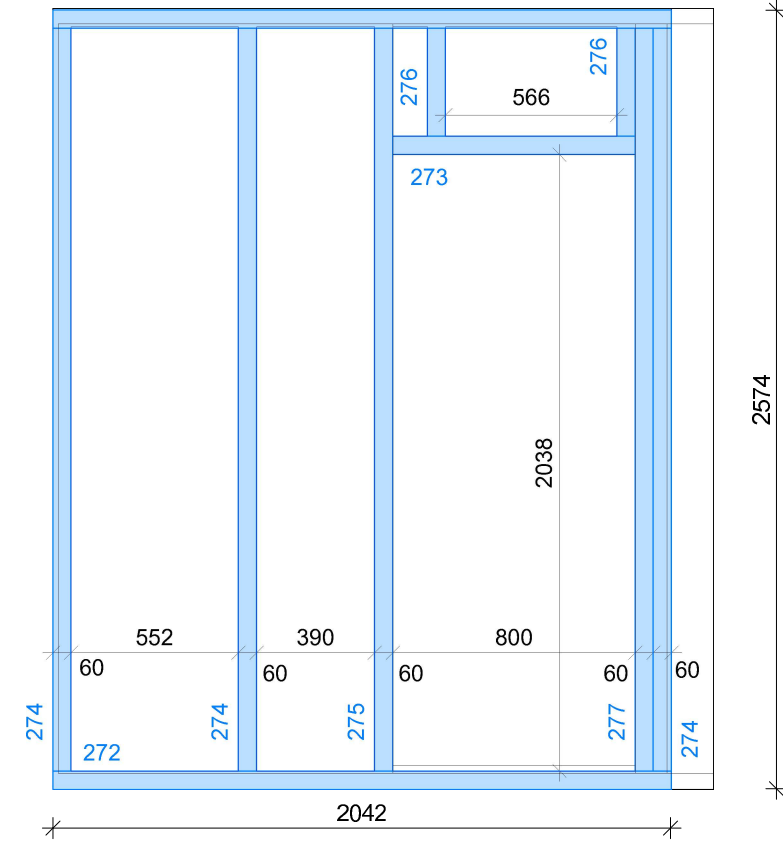

Ver 1



Hor 1

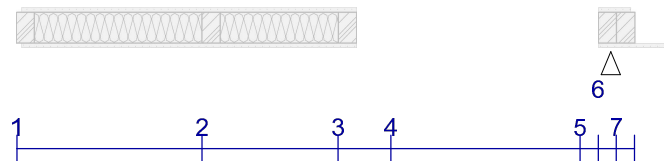

Diplomová práce

Místo : Zbůch
Zákazník :
Zprac. : Bc. EngI Lukáš, DiS.

Číslo plánu: 31
Formát: A4
M: 1 : 25,00

Číslo stěny: 2NP37

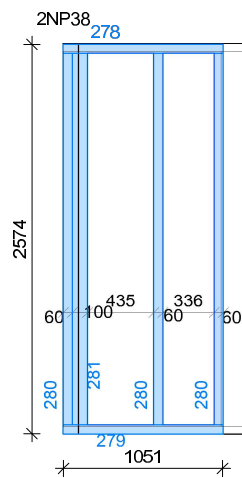

Ver 1

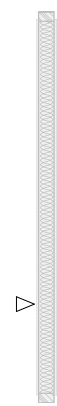

Hor 1

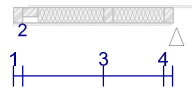

Diplomová práce

Místo : Zbůch	Číslo plánu: 32
Zákazník :	Formát: A4
Zprac. : Bc. EngI Lukáš, DiS.	M: 1 : 50,00
Číslo stěny: 2NP38	

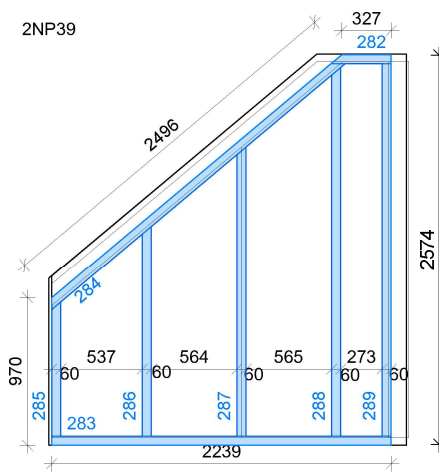

Ver 1

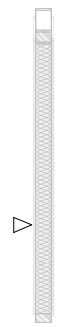

Hor 1

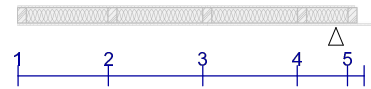

Diplomová práce

Místo : Zbůch	Číslo plánu: 33
Zákazník :	Formát: A4
Zprac. : Bc. EngI Lukáš, DiS.	M: 1 : 50,00
Číslo stěny: 2NP39	

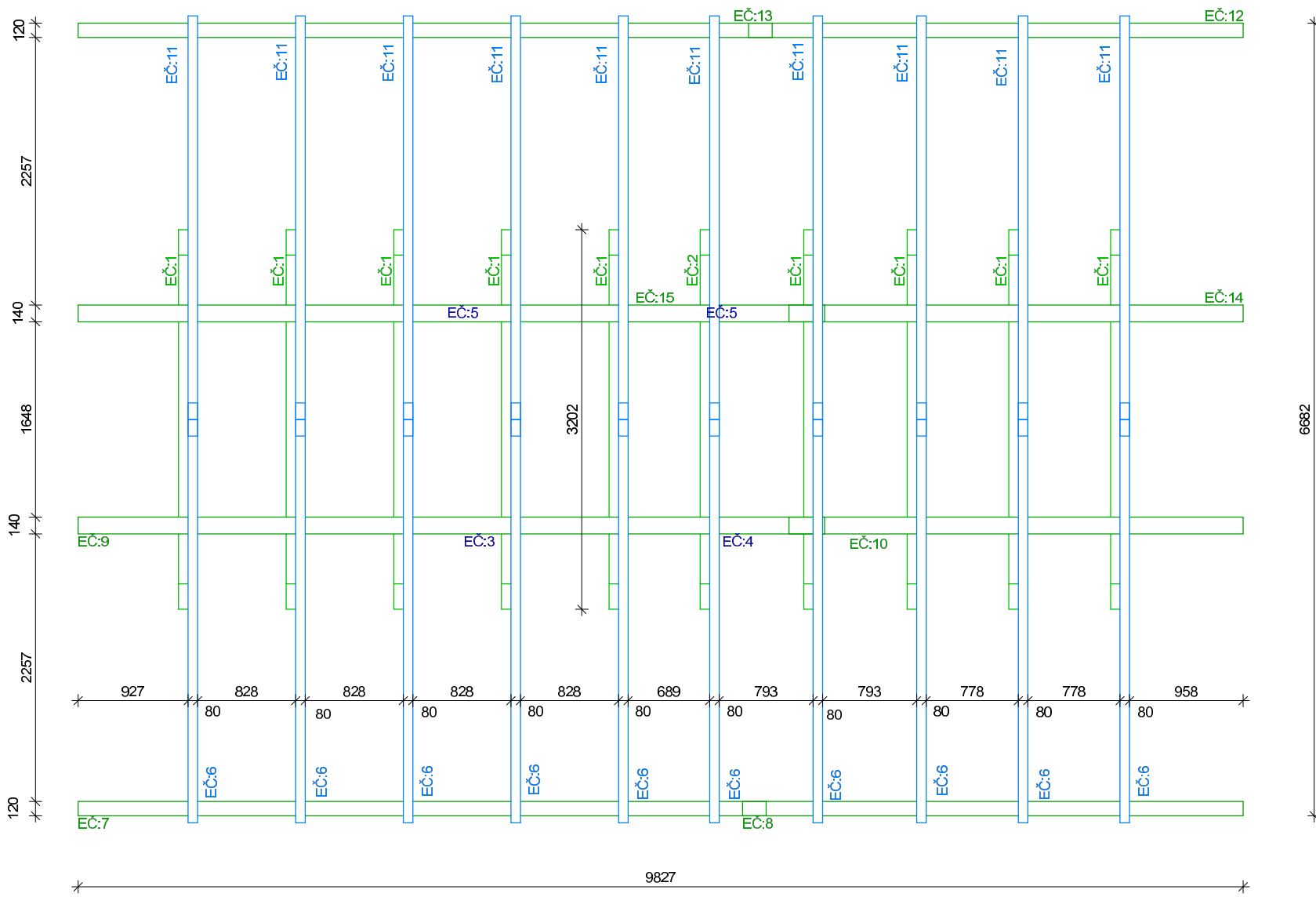

Diplomová práce
 Půdorys krovu
 Místo : Zbůch
 Zprac. : Bc. Eng. Lukáš, DiS

09.06.2020

M : 1 : 50.00

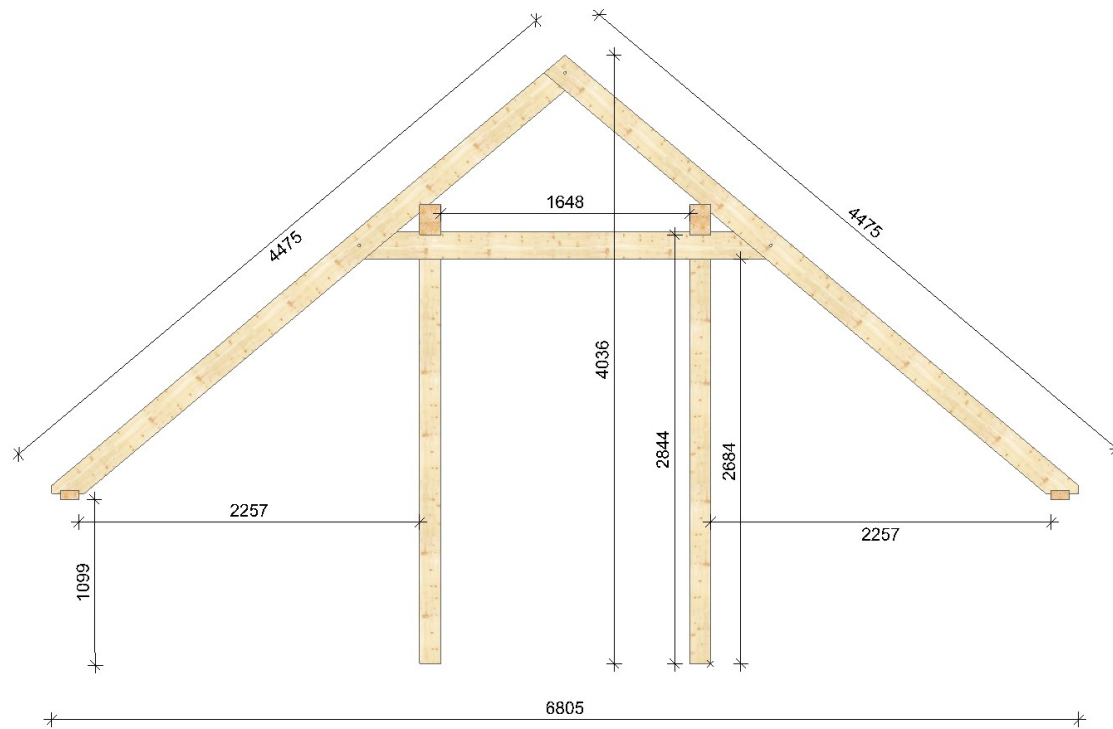

Diplomová práce
Příčný řez krovem

09.06.2020

Místo : Zbůch
Zákazník:
Zprac. : Bc. EngI Lukáš, DiS

M : 1 : 50.00

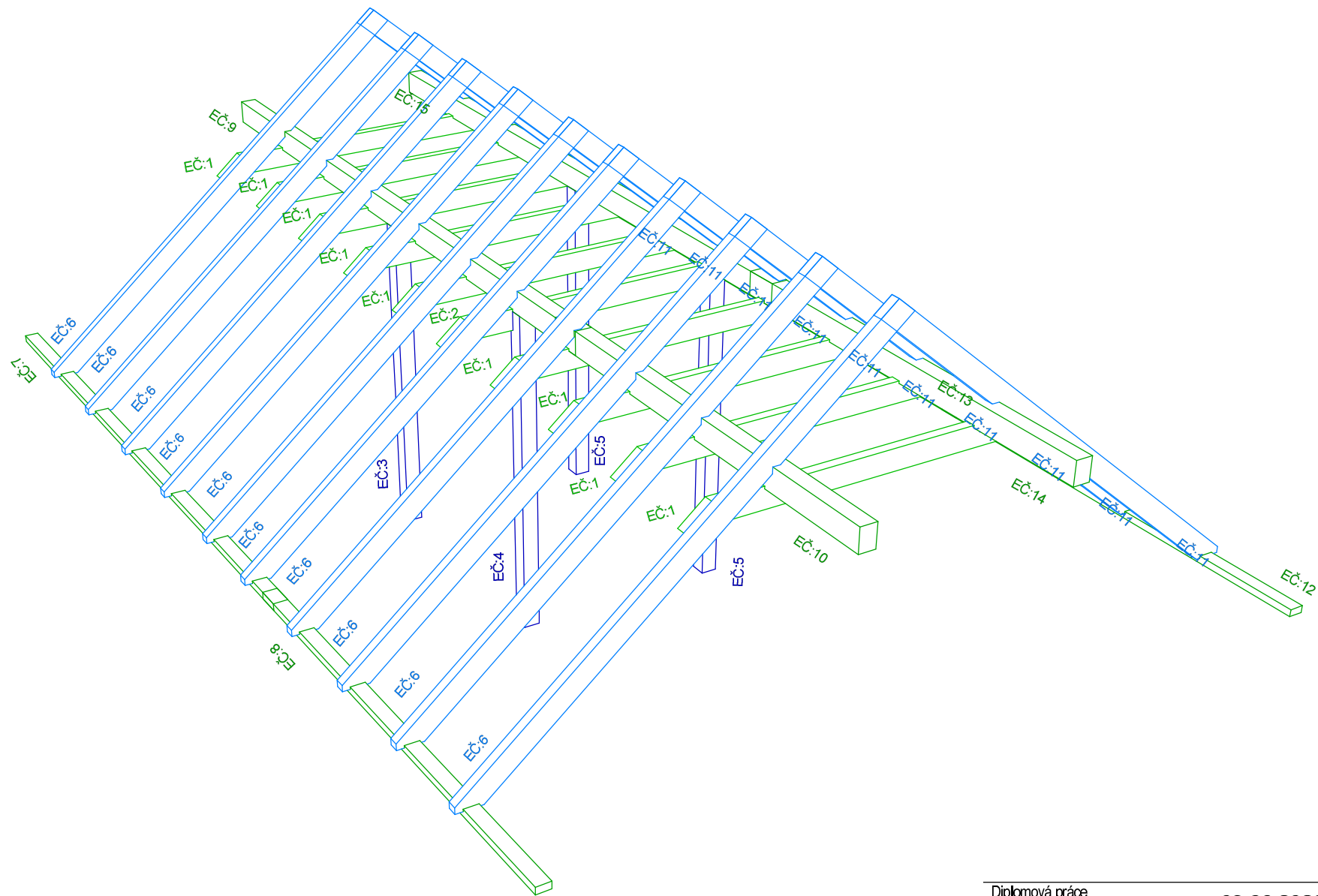

Diplomová práce
3D pohled na krov

09.06.2020

Místo : Zbůch
Zákazník:
Zprac. : Bc. Eng. Lukáš, DiS

M : 1 : 50.00

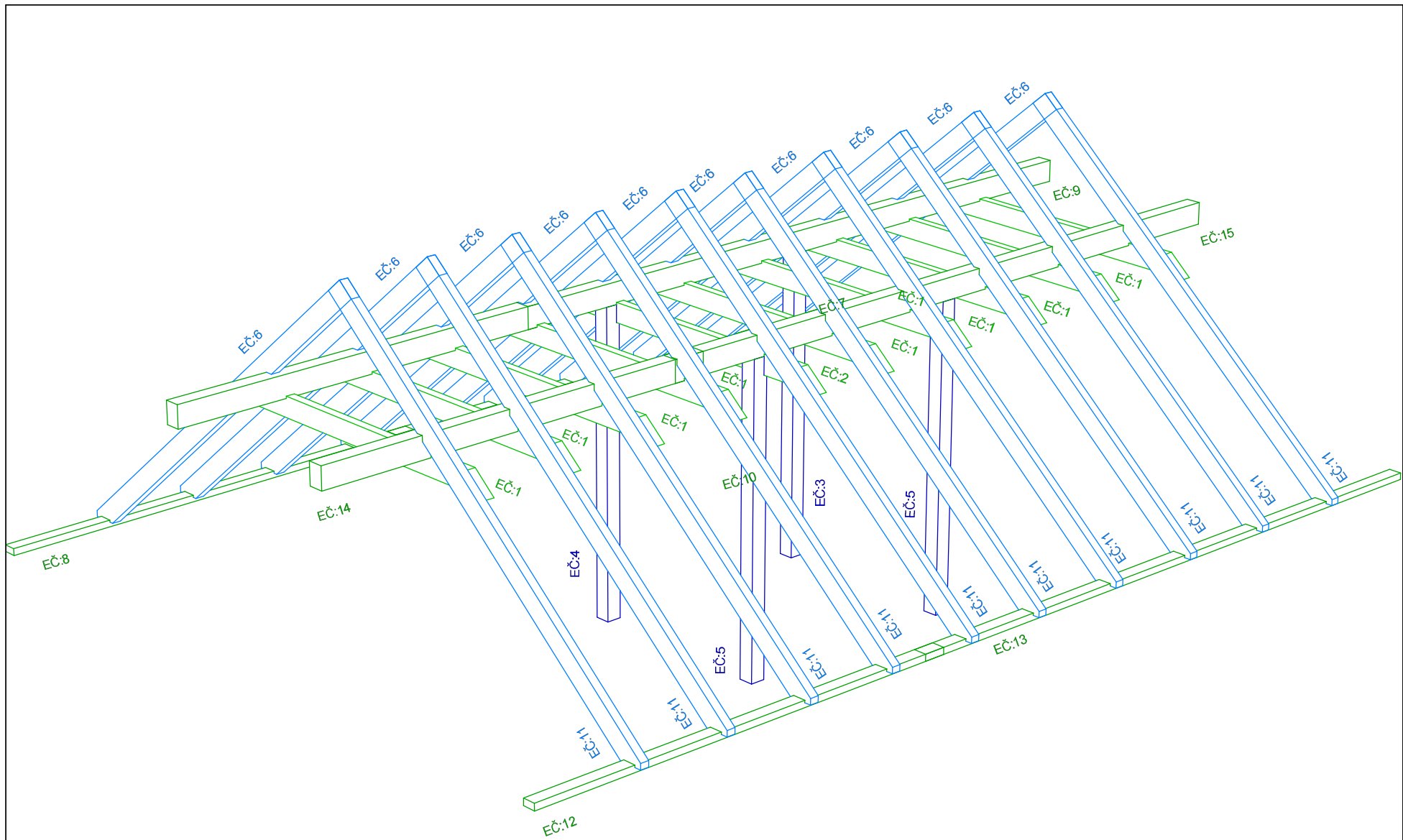

Diplomová práce
3D pohled na krov 2

09.06.2020

Místo : Zbůch
Zákazník:
Zprac. : Bc. Eng. Lukáš, DiS

M : 1 : 55.00

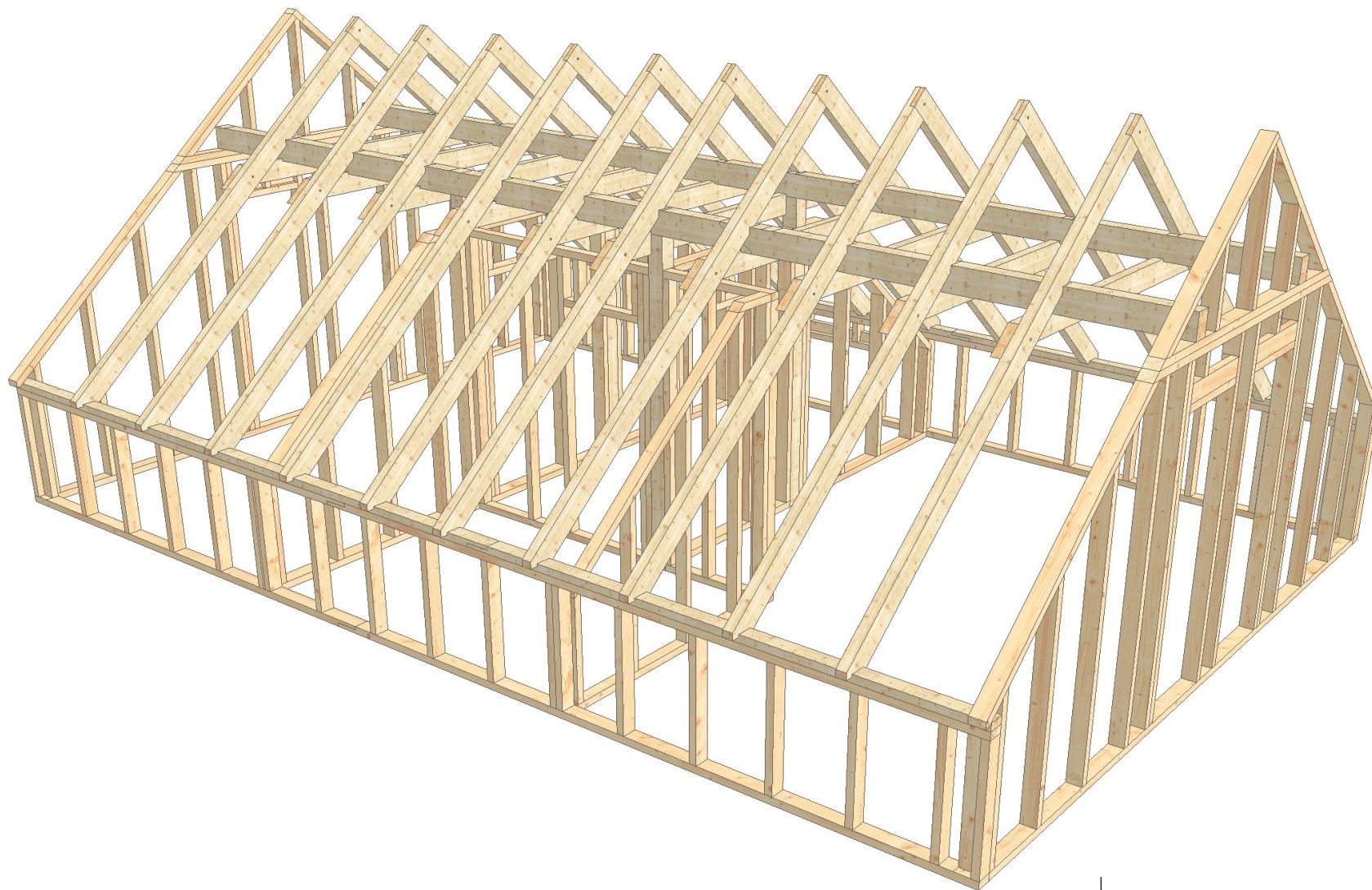

Diplomová práce
Zobrazení uložení krovu

8.6.2020

Místo : Zbůh
Zákazník :
Zprac. : Bc.Engl Lukáš, DiS

M : 1 : 100.00