

CZECH UNIVERSITY OF LIFE SCIENCES PRAGUE

Faculty of Tropical AgriSciences



**Evaluation of drying efficiency of two innovative
Tent Solar Dryers for food processing**

MASTER'S THESIS

Prague 2024

Author: Bc. Daniel Braniš

Chief supervisor: prof. Ing. Jan Banout, Ph.D.

Declaration

I hereby declare that I have done this thesis entitled **Evaluation of drying efficiency of two innovative Tent Solar Dryers for food processing** independently, all texts in this thesis are original, and all the sources have been quoted and acknowledged by means of complete references and according to Citation rules of the FTA.

In Prague 25.4.2024

.....

Daniel Braniš

Acknowledgements

I would like to thank the faculty of Tropical AgriScience for this interesting course, which gave a lot of knowledge and insight into interesting and important topics which can make a big difference for people who might really need it. I would like to thank my supervisor prof. Ing. Jan Banout, Ph.D for this interesting topic and help with my diploma thesis and as well as to all the people who were here for me during my whole university period.

I would like to thank my mom because without her I wouldn't be able to study, and to my grandfather who pushed me to keep studying.

Abstract

This diploma thesis investigates the pivotal role of solar drying in addressing food security challenges in developing countries, with a specific focus on the evaluation of two innovative Tent Solar Dryers. In regions where access to conventional drying methods is limited, solar drying emerges as a sustainable and accessible solution, offering immense potential for reducing post-harvest losses and enhancing food preservation.

Despite its promise, traditional sun drying methods prevalent in many developing countries encounter significant challenges such as dependency on weather conditions, vulnerability to contamination, and inconsistent drying rates. These obstacles hinder the efficiency and reliability of food drying processes, exacerbating food insecurity issues.

The data collection and sensory evaluation was done. Different parameters were collected during the data collection which was done on the faculty of Tropical AgriScience during summer relatively hot days to get as close as possible to weather conditions in mainly developing countries. The results revealed the efficiency of both tents and one direct solar dryer achieved slightly better results, making it a better and more suitable option for the farmers.

Key words: solar energy, drying, dryer solar dryers, food processing

Contents

1. Introduction	1
2. Literature review	2
2.1. Drying principles	2
2.1.1. Quality aspects of drying	3
2.1.2. Mechanism of drying	6
2.1.3. Drying techniques	15
2.1.4. Mechanical drying methods	17
2.2. Food drying in developing countries	26
2.2.1. Dried food products in developing countries	27
2.2.2. Food preservation techniques in developing countries	29
2.2.3. Post-harvest losses	33
2.2.4. Conditions for selecting drying techniques in developing countries	
34	
2.2.5. Types of solar dryers.....	37
3. Aims of the Thesis.....	40
3.1. Specific objectives	40
4. Materials and methods.....	41
4.1. Tent solar dryers	41
4.2. Data collection.....	42
4.3. The used devices.....	43
4.4. Calculation of drying effectiveness	43
4.5. Color measurement.....	44
4.6. Sensory analysis	45
5. Results.....	46
5.1. Data collection – solar dryer tents	46
5.1.1. Initial dryers measuring - empty	46
5.1.2. Indirect and Direct Solar Dryer Comparison	50
5.2. Calculation of Drying Effectiveness of the Solar Tent Dryers.....	56

5.3.	Color and appearance test.....	59
5.4.	Sensory analysis evaluation.....	60
6.	Discussion	62
7.	Conclusions	66

List of tables

Table 1: Comparison between types of dryers (masud et al. 2020).....	27
Table 2: Average values data collected during the first three days with empty dryers .	46
Table 3: Ambient relative humidity and humidity of direct and indirect dryers	56
Table 4: Color measurements	59
Table 5: Average sensory evaluation results for each sample (1 is the lowest score, 10 is the highest)	60
Table 6: ANOVA for sensory analysis	61

List of figures

Figure 1: Rate factors in drying (king et al. 1977)	6
Figure 2: Water activity-stability diagram (labuza et al. 1977).....	7
Figure 3: Psychrometric chart.....	8
Figure 4: Typical sorption isotherm showing hysteresis loop (labuza et al. 1972)	10
Figure 5: Moisture content vs. Time (ekechukwu et al. 1999).....	11
Figure 6 and 7: Drying-rate curves (ekechukwu et al. 1999)	12
Figure 8: Open sun drying principle (lingayat et al. 2020).....	21
Figure 9: Direct solar dryer principle (mezrhab et al. 2010)	23
Figure 10: Closed solar drier (masud et al. 2020)	23
Figure 11: Indirect solar drier process (fudholi et al. 2015)	25
Figure 12: A large-scale solar drying facility with forced convection (pawar et al. 1995)	26
Figure 13: Exported canned food from developing countries to developed countries (masud et al. 2020)	30
Figure 14: Semi-cylindrical solar tunnel drying system developed by garg and kumar et al. 2000	39
Figure 15: Indirect solar dryer filled with apple samples	41
Figure 16: Samples of dried apple prepared for sensory evaluation	45
Figure 17: Solar radiation in empty dryers (w/m^2).....	47
Figure 18: Air flow data collection in empty dryers (m/s).....	47
Figure 19: Empty dryers ambient temperature ($^{\circ}c$)	48
Figure 20: Ambient relative humidity patterns of drying air in empty dryers (%).....	48
Figure 21: Relative humidity patterns of drying air in direct and indirect solar dryers (%)	49
Figure 22: Temperature of the air in the indirect and direct dryers ($^{\circ}c$).....	49
Figure 23: Solar radiation in filled solar tent dryers (w/m^2).....	50
Figure 24: Ambient temperature of the air in indirect and direct solar dryers ($^{\circ}c$)	51
Figure 25: Ambient relative humidity in indirect and direct solar dryers (%)	51
Figure 26: Air flow comparison between direct and indirect solar dryers (m/s).....	52

Figure 27: Solar tent dryers temperature comparison between direct and indirect dryers (°c)	53
Figure 28: Dryers relative humidity of air in direct and indirect solar dryers (%).....	53
Figure 29: The first batch of apple drying - comparison between direct and indirect dryer (g)	54
Figure 30: The second batch of apple drying - comparison between direct and indirect dryer (g)	55

List of the abbreviations used in the thesis

SDG	Sustainable Development Goals
FAO	Food and Agriculture Organization
TdB	Dry-bulb temperature
Twb	Wet-bulb temperature
Tdp	Dew point temperature
SMER	Specific Moisture Extraction Rate
OSD	Open Sun Drying
EHD	Electrohydrodynamic
APHLIS	African post-harvest loss information system
LGB	Larger grain borer
DALYs	Disability-adjusted life years
PAHs	Polycyclic aromatic hydrocarbons
EU	European Union
CIE	Commission Internationale de l'Éclairage

1. Introduction

Food is a necessary component and international concern, directly linked to poverty and inequality conditions in a society. By the year 2030, The United Nations wants to reach one of their Sustainable Development Goals (SDG), that aims to end hunger, achieve food security and improve nutrition for all people (Prosekov et al. 2018).

Agricultural production needs to be improved and rise faster than the population growth, without damaging the environment (Bozsik et al. 2022). The main goal of growth is sustainable intensive farming, which is more effective use of agricultural land and water resources (Fróna et al. 2019). At the moment, agriculture increases productivity quickly, but it also comes at a significant cost in terms of excessive energy use and resource consumption (Vasa et al. 2017).

Despite population growth and growth in production of agriculture, food losses and post-harvest losses are still major problems in the sector. According to Food and Agriculture Organization of the United Nations (FAO) and Lipinski et al. (2013), nearly one third of a production is lost or wasted. Every year nearly 1.3 billion tons of food is wasted, which also results in significant economical waste and 3.3 Gt of carbon dioxide emissions (Gliessman et al. 2016). Despite the importance of the agricultural sector which receives huge amounts of investments that go into growing crops, a lot of produce is lost due to poor post-harvest practices (Ahmed et al. 2023). In the developing countries the losses can be as high as 50 % of the production, which is a significant problem (Sun et al. 2015).

Various food preservation techniques have been employed globally for an extensive duration, with ongoing advancements to enhance their efficacy further. In developed nations, many procedures are outfitted with the help of modern technology. Despite the prevalence of numerous preservation methods in developing countries, they often lack some scientific foundation and characterized by a antiquity (Masud et al. 2019). The sun drying is a widespread cost effective (free) technique, but possess a lot of health risks (Lingayat et al. 2020). Therefore it is very crucial to find an affordable dryer which also does not harm the environment and is cheap to build and run.

2. Literature review

2.1. Drying principles

Drying principles are principles using airflow and heat to remove moisture from agricultural produce. The key factors of drying are humidity, temperature, and airflow (Keey et al. 1972).

One of the earliest, simplest, and safest ways to preserve food for later use is food drying. It sufficiently dries out the food to prevent the growth of bacteria, yeasts, and mold. Because drying causes the food to shrink and lose weight while simultaneously removing moisture, it also slows down the action of enzymes (Gould et al. 1920). For a very long time, drying has been utilized to increase the market value of various agricultural products while also lowering post-harvest losses (Gatea et al. 2011). Food drying is also done to minimize packaging needs and lighten shipping loads. It stands as a time-tested technique for food preservation, ranking among the foremost methods pivotal to both society and the food processing industry. Historically, fish and meat were sun-dried as far back as 2000 B.C., dried vegetables have been sold for nearly a century, and dried soups have been preserved for much longer (Sablani et al. 2008). The oldest method of food preservation is sun drying, which is still employed today in underdeveloped nations for drying fruit and other types of food. Smoke was used in drying in the 18th century to speed up the drying processes, although this approach indicates some significant flavor alterations (Gould et al. 1920). Despite all the positive aspects, drying has its downsides, and one of them is how it affects the sensorial properties of the food products (Baker et al. 1997; Hledman & Hartel 1997). Over the past few decades, many attempts to comprehend the chemical and biological changes occurring during dehydration and to create strategies to mitigate adverse quality losses have been made (Hui et al. 2008). Several researchers have studied various agricultural produce drying methods, including solar drying, vacuum drying, foam mat drying, and spray drying (Patel & Kar et al. 2012; Gatea, 2011; Radhika 2011). It has been discovered that drying results in the physical changes of dried goods, including color change, shrinkage, porosity, and texture (Gatea, 2011, Radhika et al., 2011). Important drying process elements including cultivar, pre-treatments, and drying conditions should be taken into

consideration based on these and help in obtaining dried products with good quality (Gatea, 2011).

2.1.1. Quality aspects of drying

In general, quality is associated with the degree to which a product satisfies the requirements of the user (Joardder et al. 2019). In the context of food quality, it includes physical properties, sensory properties, optical properties, kinetic properties, and nutritional properties (Duc Pham et al. 2019).

Structure

Food materials are structurally classified as porous materials, they have a complex water transport mechanism in contrast to the non-porous material (Datta et al. 2007). There is considerable difficulty in the water migration inside food tissue following different pathways because of its porous structure (Joardder et al. 2019). The cell membrane of each food material prior to food drying normally remains intact (Joardder et al. 2017). As the drying begins, a gradual onset of microstructure deterioration takes place gradually affecting moisture removal rate (Fanta et al. 2014). At the initial stage, drying does not result in substantial damage to microstructure and hence structure is almost preserved (Khan et al. 2016). On the other hand, as dehydration proceeds temperature rises, and cell membrane is destroyed severely (Joardder et al. 2013).

Porosity

Porosity is an important quality attribute that defines the shrinkage tendency of a food tissue during drying (Ayrosa et al. 2003). It is referred to as the void spaces in terms of total volume. The porosity and rehydration ability also differ a lot in different drying methods (Joardder et al. 2013). Both physical properties greatly influence the final dried-food quality (Joardder et al. 2015). The relationship between porosity and bulk density is inverse.

Texture

Most of a food's texture comes from its physical attributes, and this has a big effect on how customers perceive it (Moyano et al. 2007). Porosity has a substantial impact on how food textures are defined (Schubert et al. 1987). Achieving a wanted texture requires

an identification of the link between process parameters and dried food condition (Joardder et al. 2015). The way that dried food crumbles and releases taste in the food structure and viscosity affects the mouth (Schubert et al. 1987). The water content of food items has a significant effect on their textural features. Foods with an intermediate to greater water content are juicy, soft, tender, chewy, and moist; on the other hand, foods with a low water content are crunchy, hard, and crisp (Blahovec et al. 2007).

Rehydration properties

At a constant time and temperature of the water, rehydration efficiency is defined as fresh weight gained by original dried samples during re-watering. Drying and subsequent processing conditions are the determining factors of rehydration efficiency. On the other hand, rehydration characteristics are also affected by porosity of dried products (Lewicki et al. 1998).

2.1.1.1. Optical properties

Color

One of the most significant characteristics of a product is its color, which can change because of many different chemical and biological reactions that occur during drying (Chua et al. 2000). The zero-order reaction kinetics approach is used to study color change responses (Maskan et al. 2002). The Maillard reaction, caramelization, and ascorbic acid browning are a few chemical processes that can have a big impact on the color of dry food ingredients (Masud et al. 2020).

Consumer appeal

Since the look of dried food materials is a combination of the shape, color, and texture of the food, it cannot be adequately described in a single term. Customers are more likely to find dried items appealing if they resemble fresh meals (Oikonomopoulou et al. 2013). A food material's color will change as it dries, and food tissue's structure will noticeably affect how color changes in features (Reyes et al. 2002). Furthermore, implausible color changes in dried goods could result from shrinkage and browning processes, which could significantly influence consumer choice (Mahiuddin et al. 2018). Therefore, it is essential to adjust these drying characteristics based on customer requirements (Masud et al. 2020).

2.1.1.2. Sensory properties

Food products that have been dried may have altered sensory qualities depending on the drying procedure parameters. The flavor (sensory attribute) is significantly impacted by physio-chemical alterations in the food matrix and pores during drying (Lafarge et al. 2008).

Aroma

While the food produced is drying, the fragrance components quickly disappear because of their extreme volatility. Therefore, it is crucial to adjust the drying process settings to decrease the loss of fragrance ingredients. Furthermore, correct storage practices can help preserve the aroma of dried foods (Masud et al. 2020).

Taste

If consumers realize dried food has an enjoyable taste, then dried food will become more popular. A critical sensory characteristic of dried food products is taste, even though it is a biased attribute that differs from person to person (Masud et al. 2020).

Retention of nutrients

Tissue structure, environmental factors, and processing conditions entirely have a major effect on the bio-accessibility of food nutrients (Sensoy et al. 2014). Given that many nutrients are contained into the cellular matrix or endure the intricacy of food structure may hold up the bio accessibility of nutrients inside cells (Waldron et al. 2003). Since most nutrients are found in cells and cell walls, food items, whether treated or fresh, have porous attributes that allow nutrients to move with the least amount of resistance (Parada et al. 2007). The decline of nutritional quality is also influenced by porosity, storage temperature, exposure to light and oxygen, and other variables (Sablani et al. 2006). Over-drying may provide a lower-quality dried product with more nutrient loss (Franzen et al. 1990). As a result, finding the ideal mixture of the different process parameters is fundamental to achieving the required dry food quality (Ghnimi et al. 2017).

2.1.2. Mechanism of drying

To increase the shelf life of an agricultural or industrial product by lowering the moisture content to a predetermined level, drying is a straightforward operation. Two simultaneous processes, which can be seen on Figure 1, are engaged in the moisture removal: the application of heat to the product to cause evaporation, and the transfer of the mass of moisture from the product surface to air. For this reason, the drying process is referred to as a simultaneous heat and mass transfer operation. Evaporation of moisture from the surface of the product continues till it reaches the equilibrium condition (Key et al. 1972).

In the drying process, moisture transfer takes place at two places:

- External mass transfer – evaporation of moisture from the product surface to the surrounding air
- Internal mass transfer – movement of moisture from inside to surface

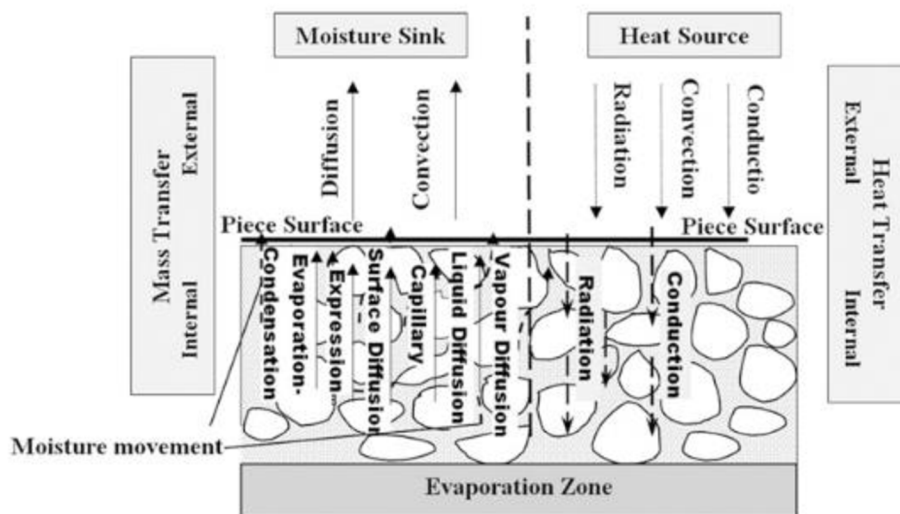

Figure 1: Rate factors in drying (King et al. 1977)

Water activity

The crucial factor that is linked to the quality and safe storage time of food goods is water activity. Food items with a high moisture content are typically extremely prone to deterioration. The presence of water in wet materials may be seen in two different ways: as bound moisture or as free water. The pace of reactions can be decreased by keeping the water activity below $0.6a_w$ in a wet product since it has a significant impact on chemical reactions (both enzymatic and non-enzymatic reactions), spore germinations,

and the development of microorganisms like bacteria, molds, yeasts, and fungus (Erkmen et al. 2016).

If the water activity is greater than $0.7a_w$, it demonstrates that bacteria, yeast, mold, and other microorganisms have a major impact on the quality of food goods which is shown on Figure 2. The development of microorganisms is regulated by a variety of parameters in addition to water activity, including temperature, nutritional content, pH level, preservatives, other food ingredients, and oxygen concentration (Chirife et al. 1996).

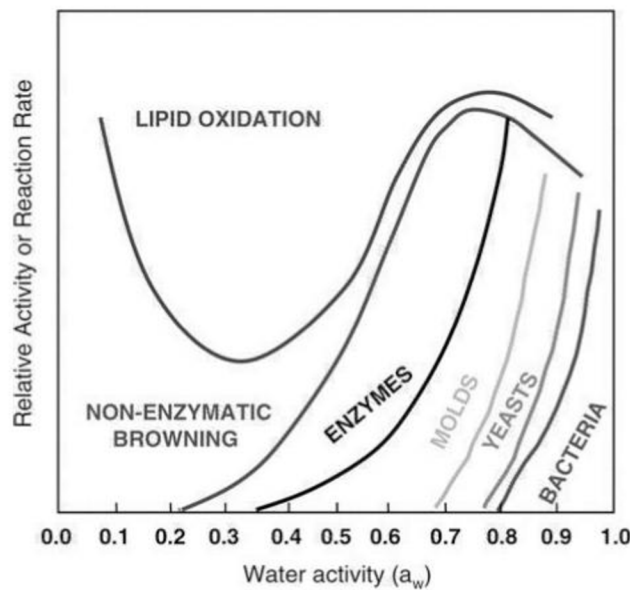

Figure 2: Water activity-stability diagram (Labuza et al. 1977)

Air drying properties

Most dryers in use are convective dryers, which heat the air using any heating source and provide it to wet products to remove moisture. Therefore, it is crucial to comprehend the characteristics of air (Vega-Marcado et al. 2001).

Dry and wet bulb temperatures

Dry-bulb temperature, commonly abbreviated as T_{db} , is the temperature of the air as determined by a conventional thermometer. The temperature is known as wet-bulb temperature, or T_{wb} , if the thermometer's bulb is covered with a wet wick or piece of tissue. The temperatures of the wet and dry bulbs will be identical in saturated air, but

under some circumstances, the dry bulb temperature will be higher. Wet-bulb depression is the term for the difference between dry-bulb and wet-bulb temperatures.

Dew point temperature

At a steady pressure and humidity, the air will decrease to a temperature where water vapor will reach saturation and condense as dew. The temperature at which a dew develops is referred to as the dew point. Tdp stands for the dew point temperature.

Specific humidity and relative humidity

The parameters' specific humidity and relative humidity are used to determine how much water vapor is present in the atmosphere, and they serve as indicators of that content. The mass of water vapor per unit mass of dry air in the combination of vapor and air is known as the specific humidity, or simply humidity. The usual unit of measurement is grams of water per kilogram of dry air (Sukumar et al. 1999).

$$\text{specific humidity} = \frac{\text{mass of water vapour}}{\text{mass of dry air}}$$

Psychrometric charts

The characteristics of the air-water vapor combination have a major role in how the drying process is defined. Psychrometric charts show the relationships between all significant characteristics of an air-water vapor combination. According to dry-bulb temperature, the psychrometric chart represents the absolute humidity, dew point temperature, and specific volumes. Psychrometric chart can be seen on Figure 3.

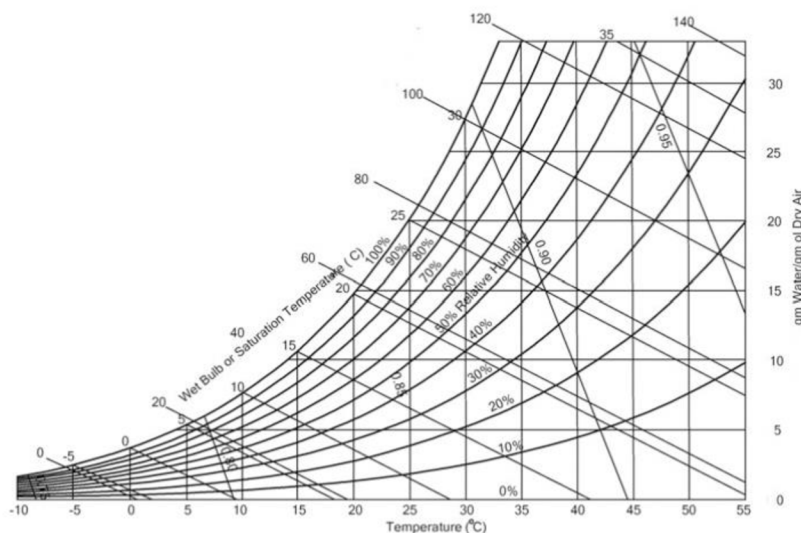

Figure 3: Psychrometric chart

Moisture content

Almost all agricultural and industrial goods, with very few exceptions, have a moisture content. Both a percentage and a decimal ratio can be used to represent this moisture content. There are two ways to represent how much moisture is present in a product. Wet basis (% w.b) and dry basis (% d.b) are the two terms (Belessiotis and Delyannis et al. 2011).

Materials may be divided into two categories: hygroscopic materials and nonhygroscopic materials depending on how much moisture they contain. The moisture content of nonhygroscopic materials is present in a free or loosely held state (unbound moisture). While hygroscopic materials include moisture in the form of bound moisture that will be present inside of the closed capillaries, this sort of moisture content might be fully eliminated by evaporation throughout the drying process. The bound moisture will thus always be present in the substance as residual moisture (Belessiotis and Delyannis et al. 2011).

Determination of moisture content

There are other ways to determine how much moisture is present in a material, but oven drying is the method that is most frequently used to determine how much moisture is present in agricultural products. This process involves taking a tiny sample of the product and heating it in an oven at a certain pressure and temperature until all moisture has been eliminated. The dry weight that was measured was lost along with the moisture content (Bennett et al. 1954). An infrared moisture analyzer is the other method commonly used. This apparatus has a balance and an infrared heater that can test moisture content in tiny samples on its own.

Equilibrium moisture content

A substance will attain an equilibrium moisture content with the surrounding air when exposed to air at a constant temperature and relative humidity. Water in the product has a vapor pressure equal to the atmospheric partial pressure (Sukumar et al. 1999). Currently, moisture absorption by the ambient air and moisture absorption by the product are equal. It indicates that there isn't a moisture transfer between the substance and the air. Another way to put it is that the solids either acquire or lose moisture to the air around them (Ekechukwu et al. 1999).

Sorption isotherms

Figure 4 shows the relationship between the equilibrium moisture content and the relative humidity of the air around it at a specific temperature which is called sorption isotherms. Adsorption occurs when a porous material is subjected to an air stream with rising humidity at a given temperature, and the curve that follows is known as an isotherm of adsorption. In a similar manner, the desorption isotherm curve is produced by exposing the solid to air with a constant temperature and decreasing humidity. The partial pressure of water vapor within the material is lower during the adsorption process than the atmospheric pressure outside, and the opposite is true during the desorption process. This difference in partial pressure causes moisture to migrate from solid to air and from solid to solid (Sukumar et al. 1999).

The difference between the EMC curves produced during the desorption and adsorption processes is known as moisture hysteresis, and it occurs in solids. Product to product varies along this curve (Labuza et al. 1972).

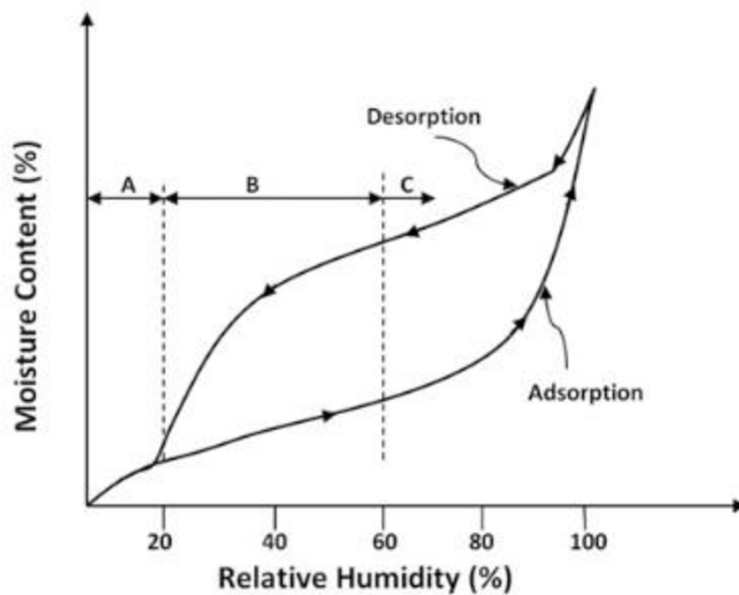

Figure 4: Typical sorption isotherm showing hysteresis loop (Labuza et al. 1972)

Drying curves

Drying curves can be used for explaining drying characteristics, there are three curves for drying:

- Variation of moisture content vs. time which is shown on Figure 5
- Drying rate vs. time
- Drying rate vs. moisture content

The fluctuation in moisture content for a product throughout a drying process is established over time and shown as a curve in and 7: Drying-rate curves (Ekechukwu et al. 1999). This graph describes how a product's moisture content decreases, and the associated drying rate is computed. Figure 5 describes drying curves of variation of moisture and time, curves for drying and time can be seen on and 7: Drying-rate curves (Ekechukwu et al. 1999)6. The kind of material and its structure have a major role in how the drying-rate curve varies from product to product (Sukumar et al. 1999).

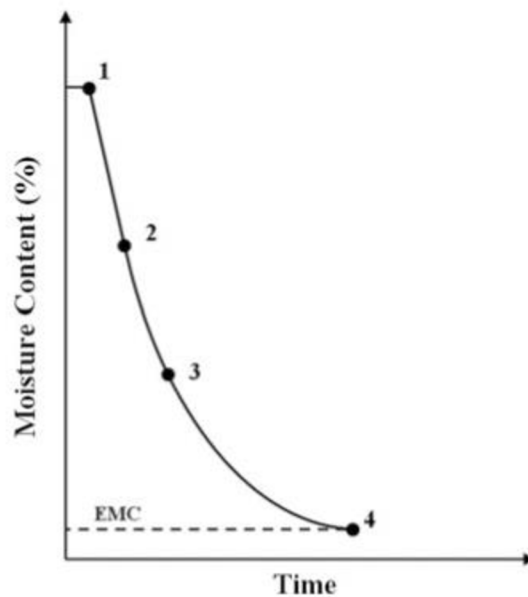

Figure 5: Moisture content vs. time (Ekechukwu et al. 1999)

The mass of water removed per unit time per unit mass of dry material, or the mass of water removed per unit time per unit area is considered the drying rate. The drying-rate curves are a crucial piece of information for describing a product's drying characteristics. Figure 4 and Figure 5 illustrate a typical drying-rate curve and highlight the key parameters. The time from 1 to 2 is referred to as the constant drying period since

the pace of drying is consistent during this time, the product's surface is saturated, and the transport of the moisture occurs by diffusion at a steady pace. The drying rate decreases at a steady state (i.e., changes linearly) during the first falling-rate period from 2 to 3, the product's moisture level has reached a critical level, meaning there isn't enough moisture on the surface for it to quickly evaporate. The product's drying rate decreases steadily as it forms a straight line, and the second falling-rate period occurs between 3 and 4, the product's surface is almost completely dry, and moisture is slowly moving from the interior to the surface. Until equilibrium is reached and drying ceases, the moisture content keeps dropping (Belessiotis and Delyannis et al. 2011).

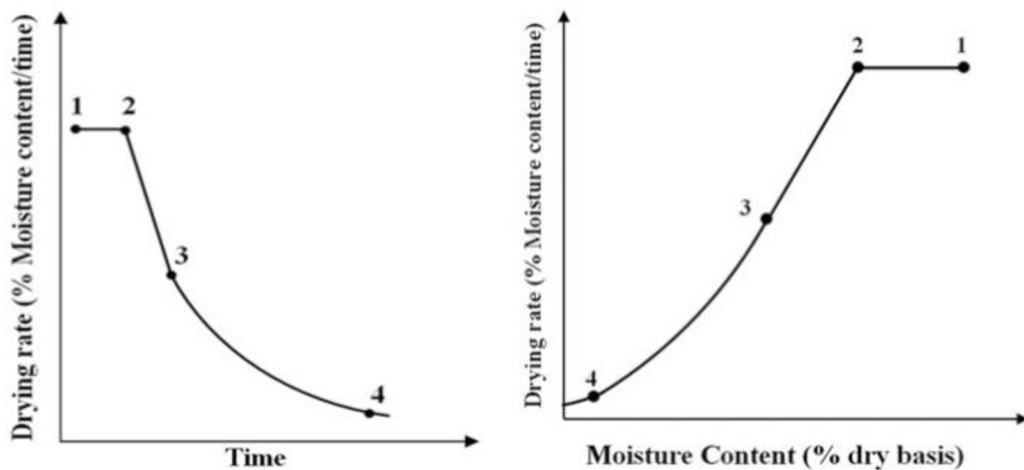

Figure 6 and 7: Drying-rate curves (Ekechukwu et al. 1999)

Constant drying-rate period

Drying occurs from the product's surface and is only the evaporation of moisture from the free-water surface over a constant drying-rate time. The internal resistance to moisture transfer is far lower than the outward resistance currently to the removal of water vapor from the surface. In addition to keeping the product's surface at a consistent temperature that is almost equivalent to the wet-bulb temperature of the surrounding air, the moisture evaporation rate is nearly constant during this time (Sukumar et al. 1999).

The rate of moisture removal during this period mostly depends on the difference between the partial pressure of water vapor at the surface and the ambient air. In addition, extra air-related factors including airflow rate, product surface area exposed to drying, and thermodynamic state and transport qualities may also have an impact on drying rate.

This continuous drying process continues until the product's essential moisture content is reached (Ekechukwu et al. 1999).

Falling-rate drying period

When the product reaches its critical moisture content or when the constant drying-rate period comes to an end, the falling-rate period starts. The critical moisture content is the minimum moisture content at which the maximum rate of moisture evaporation from the surface equals the minimum rate of free moisture migration from the interior to the surface of the product. As the product's equilibrium moisture content is reached, the drying rate gradually slows down. Hygroscopic materials often have two or more falling-rate phases, whereas non-hygroscopic materials typically have just one (Sukumar et al. 1999). The rate of moisture evaporation from the product's surface falls off significantly during the falling-rate phase compared to the pace at which moisture moves from the product's interior to its surface. Dry areas come from the decreased evaporation rate at the surface, which raises the temperature (Chung and Chang et al. 1982). By regulating the air's temperature and humidity, the optimum drying rate may be attained. Temperature and RH of the air's impact on the drying rate is diminishing, and moisture movement from the inside to the surface is a significant factor (Ekechukwu et al. 1999).

Drying kinetics

While drying dynamics covers variations in the temperature and moisture profiles across the drying body, drying kinetics shows how average material moisture content and average temperature vary over time in a drying body. The quantity of moisture evaporated, drying time, energy consumption, and other associated factors may be calculated using knowledge of a product's drying kinetics, which is regarded to be a highly essential characteristic as it is utilized for the design and modeling of dryers (Fontaine and Ratti et al. 2007). In addition, drying kinetics provides a thorough explanation of the transport characteristics, including mass transfer coefficient, moisture diffusion, heat transfer, etc. The relationship between the variables controlling drying and drying rate is known as drying kinetics (Sukumar et al. 1999).

Energy analysis of dryers

Given that drying is a process that uses a significant amount of energy, energy analysis is crucial for dryers. In developed nations, the national industrial energy consumption for thermal dehydration operations ranges from 10 to 25 percent. To compete with others on the global market, the drying industry is focused on lowering energy consumption for the drying process. The main cause of increased energy use in the convective drier is the process of eliminating the product's moisture content by delivering the latent heat of vaporization. This dryer's energy-aspect study will show you exactly where the system's performance may be enhanced. Reducing heat losses in a process is one way to generate energy savings in that process. The potential heat losses during the convective drying process may be divided into following categories: heat loss from the product, heat loss from the dryer's radiation, heat loss from air leakage, and heat loss from over drying items (Sukumar et al. 1999).

Different performance metrics, such as drying efficiency, specific energy consumption, energy efficiency, and specific moisture extraction rate, may be used to describe the performance of any dryer. Precise energy consumption and energy efficiency are thought to be crucial factors in determining how energy-efficient a dryer is. The examination of the dryer's energy use and efficiency is covered in the section that follows (Kudra et al. 2012).

Another important performance indicator of a drying system is the specific moisture extraction rate (SMER), which is the amount of water evaporated per unit energy consumption. SMER is usually mentioned in kg/kWh (Fudholi et al. 2014):

$$SMER = \frac{\text{mass of water removed } kg}{\text{total energy consumption } kWh}$$

Drying effectiveness

Drying performance is the ratio of air's output relative humidity to its entrance relative humidity during the drying process. Since drying is essentially a process of humidification, better drying efficacy is preferred (Chauhan and Kumar et al. 2016):

$$SMER = \frac{\text{relative humidity of air at outlet}}{\text{relative humidity of air at inlet}}$$

Reducing the heat losses in the systems can enhance the performance of the drying units. The first and most important stage is to design a drying machine that is appropriate for the specific application. The right choice of additional parts, such as a heater, drying chamber, blower or fan, tunnels, conveyors, etc., will also aid in lowering the energy need. Following is a list of typical energy-saving techniques (Kemp et al. 2007):

- Reducing energy requirement for drying (e.g. dewatering the feed)
- Prevention of heat losses by using better thermal insulations
- Adopting suitable heat recovery methods
- Using low-cost heat sources
- Using heat pumps to recover exhaust waste heat

Heat recovery is the major strategy for raising the system's energy effectiveness. Heat recovery from the dryer output and the use of heat pumps are the two most used ways of heat recovery in industries.

2.1.3. Drying techniques

Drying is a mass transfer method for removing moisture from food products to make agricultural produce less bulky (Gate et al. 2011; Radhika et al., 2011). Modern drying will aim to use less energy, increase the effectiveness of the drying process, and produce high-quality products for the least amount of money possible because (Doymaz et al. 2011).

The most popular technique for removing moisture from food products is convective hot air drying. The drawbacks of this technology, however, include a slow and extended drying process, high energy consumption, contamination of food products due to careless handling, and low energy efficiency (Sarimeseli et al. 2011). However, the employment of microwave and dielectric heating methods for drying agricultural produce is promoted to lessen the issues and to obtain a more effective and quicker thermal drying process (Sarimeseli et al. 2011). Higher drying rates, shorter drying times, lower energy usage, and better-quality dried goods are characteristics of microwave and electric heating technologies, which make them more popular than convective hot air drying (Sarimeseli et al. 2011). The two main categories of drying techniques are natural and artificial drying techniques. Solar radiation is used in the natural drying process to eliminate moisture from food goods. This method is quite unreliable because it depends on the fluctuation of

meteorological conditions (Toshniwal & Karal et al. 2013). However, artificial drying is favoured over natural drying because it has a faster drying rate, is more effective at eliminating a significant quantity of moisture from food and produces better-quality dried goods (Toshniwal & Karale et al. 2013). Additionally, there is improved control over several drying process variables, including temperature, drying air flux, and drying time. The effectiveness and efficiency of drying operations during artificial drying can be increased by using mechanical or electrical equipment, such as fans (Adeyey & Ashaolu et al. 2022).

Drying methods can be divided into natural and artificial. Other classifications are based on the method of operation or heat supply. and solar drying methods are classified either based on the method of operation or of heat supply to the drying process.

Classification based on type of operation:

- Open sun drying
- Controlled drying

Classification based on working principle:

- Direct solar drying
- Indirect solar drying

Classification based on convection:

- Active Dryers
- Passive Dryers

Different types of dryers:

- Cabinet dryers with normal or reverse absorber (Passive)
- Greenhouse dryers (Passive)
- Integral dryers (Active)
- Distribution dryers with and without storage (Active)
- Mixed dryers (Active)
- Tunnel dryers (Active)

Other ways to classify dryers include the type of drying medium (air, gas, or steam), the physical characteristics of the finished product (solid, liquid, or slurry), the operating pressure (high pressure, atmospheric, or vacuum), the type of material handling

involved (tray, tunnel, rotary, vibratory, gravity, or dispersion), etc. The hardest step is choosing the right dryer for the job; if you don't, you'll get dried goods of low quality, waste energy, etc. (Vijayan & Arjunan et al. 2017).

There are three major categories of active or passive solar drying systems, according to Ekechukwu and Norton (1999). They differ primarily in the way that system components are designed to work together and how solar heat is utilized.

2.1.4. Mechanical drying methods

Procedures of mechanical drying are fundamental in the food industry to dry many different types of products and prolonging their shelf life as well. Drying processes like freeze drying, drying by radiation, or ultrasound drying are examples of technologies using controlled environment to dry out water content in an efficient manner (Pinheiro et al. 2010). These approaches not only prevent adverse changes in taste, color, or nutrients, but also play a vital role in obtaining conveniently healthy food products; therefore, they form an important basis for modern preparation and preservation. The choice of a particular drying process is determined according to the nature of food, final output, and economic issues within different industries (Adeyeye et al. 2022).

2.1.4.1. Mechanical drying methods

Convective drying

Modern heating equipment utilizes convective drying techniques to extract moisture from agricultural produce through heat transfer. This process involves the application of hot air, which transfers heat to the food products, effectively eliminating excess moisture (Brennan and Gradison et al., 2015). One example of a convective drying technique is the hot air tunnel dryer, commonly used for drying food (Morales-Delgado et al., 2014). Additionally, the combination of osmotic and convective drying methods has been employed to dry various fruits and vegetables, such as ginger (Loha et al., 2012), jackfruit (Kaushal and Sharma et al., 2014), and button mushrooms (Mehta et al., 2013). These integrated methods have also been applied to drying grapes and hold potential for the preservation of numerous other food products.

Drying by radiation

Radiation drying presents an alternative solution to the challenges encountered by convective drying methods. Microwave drying occurs through the application of heat using from radiant energy (Adeyeye et al. 2022). This method requires lower temperature and less time to remove moisture, and finished products have overall better quality (Kahyaoglu et al. 2012), and is compatible with other drying techniques, such as vacuum drying (Borquez et al. 2014).

Freeze drying

This approach uses freezing to eliminate food-related solvents through direct sublimation, followed by the dehydration of the food product (Prosapio et al. 2017). This characteristic distinguishes freeze-drying from most conventional techniques, which rely on heat for water evaporation (Fellows et al. 2017). Freeze-drying results in foods with the finest quality compared to other drying methods because aroma and structural integrity are retained (Rey and May et al. 2016). However, freeze-drying is costly and is therefore recommended for drying relatively high-value products such as seasonal fruits and vegetables, coffee, or items intended for consumption by military personnel, astronauts/cosmonauts, and hikers (Fellows et al. 2017).

Ultrasound drying

Food is dried by ultrasound which also enhance product properties and quality. It is also possible to use ultrasonic energy alone or in combination with other forms of energies such as hot air. In this way, ultrasound lowers temperature or treatment time leading to improved product quality (Adeyeye et al. 2022).

Osmotic drying

By employing a hypertonic solution, osmotic drying facilitates the dehydration of food products (Ishfaq et al., 2016). This process consists of immersing the desired food to be dried in a hypertonic solution, inducing a concentration difference between the food and the solution, which prompts the removal of water from plant tissues (Shete et al., 2018). Osmotic drying operates through the natural phenomenon of osmosis across cell membranes, leading to water loss (Ishfaq et al., 2016). The elevated osmotic pressure of the hypertonic solution serves as the driving force for water diffusion from the tissue into the solution (Shete et al., 2018).

Dielectric drying

Dielectric drying uses electromagnetic energy to dry food products. Electromagnetic waves of microwave and radio frequency are focused on the food center that is heated at a rapid rate to dry up the products (Abbasi & Azari 2009). In contrast to the traditional drying method, dielectric heating quickly raises food product temperature up to target despite volumetric-heating phenomena (Wang et al., 2012).

Air impingement

This drying process uses a high-velocity blast of air directed at the product surface to eliminate the moisture boundary layer, while also using cold air to expedite heat transfer, thereby reducing the required drying time for products. This approach is applied to dry corn tortillas, carrot cubes and grapes (Xiao et al. 2010a).

Low pressure superheated steam drying

The superheated steam drying method has been employed for drying various food products, distinguished by its environmental friendliness and absence of fire and explosion hazards. Additionally, it requires lower energy consumption and exhibits a high drying rate, therefore yielding quality dried products (Meziane et al. 2011). However, it has some limitations when applied to drying heat-sensitive foods (Sa-adchom et al., 2011).

2.1.4.2. Solar drying methods

Food products have been dried by the sun for ages since it is a free, and serves as an endless source of energy utilized everywhere. There are two types of drying methods: direct and indirect. This is a traditional method of drying food that utilizes sun. Food products are exposed to sunlight for several days to remove moisture from the produce. This is common in developing countries where the resources, finances and fuel are limited and costly (Fudholi et al. 2010). Because of its ease of use and low cost, sun drying is a popular method of drying (Sontakke & Salve et al. 2015).

However, major drawbacks of this drying method are poor product quality due to insect attack, contamination with dust and dirt, long drying time, unregulated sunlight exposure, and poor heat transmission rate due to condensation of evaporated moisture (Masud et al. 2020).

Solar drying could be used to improve the sun drying method. Chamber type, chimney type, and wind-ventilated dryers are examples of solar dryers. In the indirect method of solar drying, a solar system is used to generate heat, which is then directed into the food to be dried via air flow, which heats the product. The drying chamber is vented at the top to remove the evaporated moisture (Toshniwal and Karale et al. 2013).

2.1.4.2.1 Open sun drying

Open sun drying is a popular drying method used in developing countries. The materials are dried on the ground and spread into thin layers and on trays, mats and concrete floor, hence there is exposure to open wind such that it enhances product's cooling (Lingayat et al. 2020). The produce is exposed to the short wavelength solar radiation, and it starts the process of water evaporation. Some portion of this energy gets reflected and some part falls on the surface depending upon the crops color. The absorbed radiation is converted into heat energy and the temperature of food produced starts to rise. Besides long wavelength radiation loss, there is additional convective heat loss resulting from the blowing wind over moist air above crop surface. Moisture evaporation occurs as an evaporative loss, and the crop dries (Sharma et al. 2009). In addition, some fraction of absorbed thermal energy is conducted through the inner body of product. This leads to an increase in temperature and condenses water vapor within the crop that diffuses toward the surface of crops, loses thermal energy for evaporation. These moisture removals occur quickly in the early stages due to the existence of wet surfaces on which drying air is imposed (Sodha et al. 1985). Shade type open sun drying uses a rack which is provided as series or parallel racks to support the wet materials for drying (Lingayat et al. 2020). Traditional ventilation is beneficial as OSD does not depend on other energy sources, there are no further precautions needed to dry the product, it's the cheapest drying method and unskilled labor can also be used (Muhlbauer et al. 1986).

Open sun drying might sound like a good drying technique which requires no investment but unfortunately it also comes with some disadvantages (Lingayat et al. 2020). The principle of open sun drying can be seen on Figure 8. Here are some of the disadvantages:

- High risk of produce getting damaged and infested by animals, birds, and insects.

- Direct exposure to sun irradiation, storms, air humidity, rain and dew can cause product degradation.
- Weather conditions such as rain and storms cannot be affected by farmers.
- Degradation of the produce by dirt, dust, and pollutions
- Possibility of over-drying
- Growth of micro-organisms can lead to product spoilage.
- All these factors can lead to product losses.

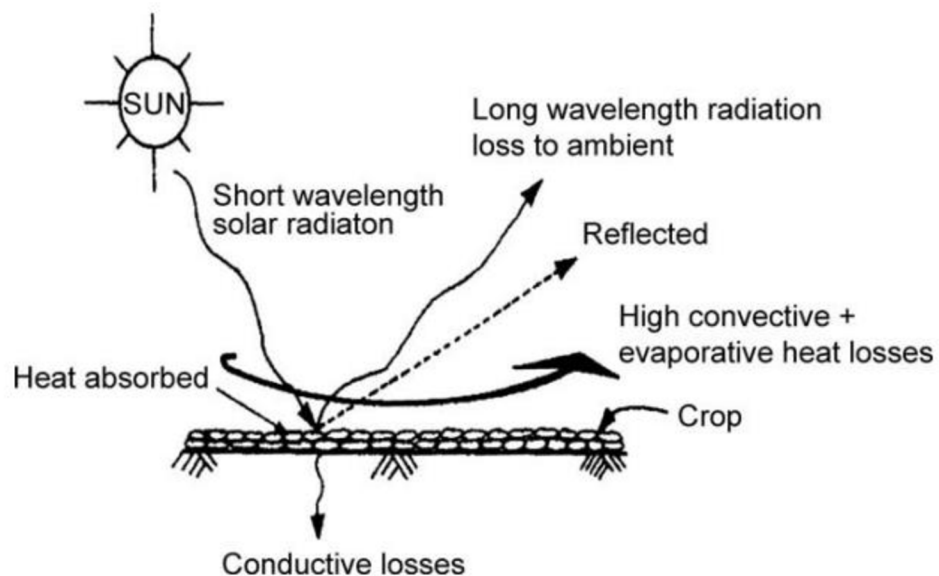

Figure 8: Open Sun Drying Principle (Lingayat et al. 2020)

2.1.4.2.2 *Controlled drying*

Controlled drying is type of more advanced drying method compared to open sun drying but it also requires initial investment. Controlled drying has different forms and types and can be divided into direct solar type dryers and indirect type solar dryers and these two techniques are further used in different types of dryers (Lingayat et al. 2020).

The drying parameters nowadays can be easily measured to reach perfect final moisture and products. Parameters which are crucial to be measured are temperature, humidity, air velocity, and moisture content (Wilkins et al. 2018).

Controlled dryers also deal with environmental issues related to drying such as dust, rain, dirt, pollution and protect the produce against insects, animals, and birds. Other

advantages are shorter drying times, consistent product quality and the possibility to dry higher volumes (Pangavhane et al. 2002).

Controlled drying systems can store solar energy in two forms which can be utilized during night or cloudy days. Heat can be stored as sensible heat or latent heat (Lingayat et al. 2020).

2.1.4.2.3 Direct type solar dryers

Transparent glasses are used in direct type solar dryers to direct sun energy onto food goods (Ampratwum et al. 1998). The drying chamber temperature can be raised in these dryers because convective losses must be decreased (Rathore et al. 2010). A few types of direct sun dryers are greenhouse dryers, glass roof solar dryers, box type dryers, and solar cabinet dryers (Mezrhab et al. 2010). Figure 9 shows how the direct solar dryer operates and on Figure 10, an example of closed direct solar dryer can be seen.

Advantages of direct type solar dryers (Babic et al. 2020):

- Enclosure provided by transparent cover offers low contamination
- Protection from environmental impact such as rain, dew etc
- Better product quality
- Cheaper than indirect dryer with the same capacity

Disadvantages (Babic et al. 2020):

- The quality and color can deteriorate while the product is exposed directly to sunlight
- Slower times might happen due to improper removal of vapor moisture
- Can be mostly used only for small scale due to smaller capacity
- Transmissivity of glass cover reduces because of moisture condensation inside of glass cover

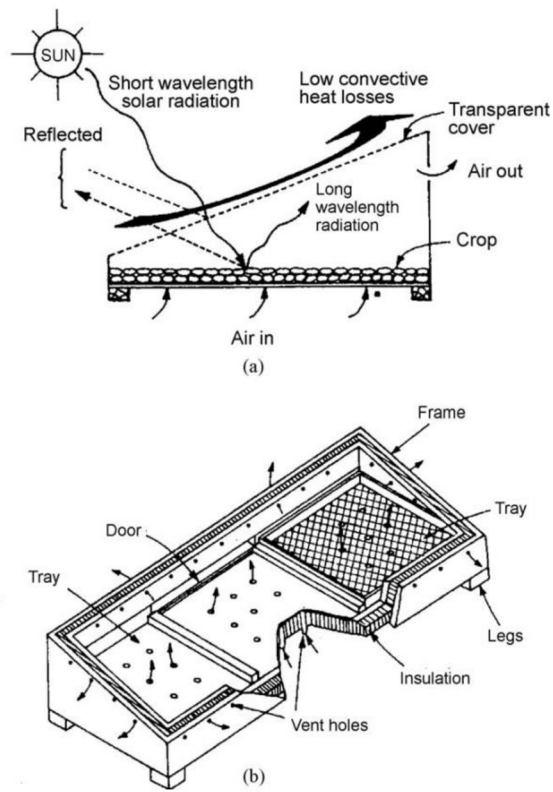

Figure 9: Direct Solar Dryer principle (Mezrhab et al. 2010)



Figure 10: Closed solar drier (Masud et al. 2020)

2.1.4.2.4 Indirect type solar dryers

Indirect solar dryers have two different methods, natural circulation or forced circulation (Kumar et al. 2016). To reduce surface discoloration and cracking, the crop is not exposed to direct sunlight (Sharma et al. 2009).

The first type is natural circulation type which can also be called passive solar dryer because of the air resource being a natural circulation. Hot air heats the produce and the moisture contained in the product is eliminated to outside through the chimney which is at the top of the drying chamber by natural circulation (Sharma et al. 2009).

Different types of solar dryers and their components:

- Conventional: It is made from a chamber to hold the food for drying and a solar air collector (SAC) to heat the incoming air (Arunsandeeep et al. 2018)
- With chimney: main components are solar air collector, chimney to create the draft and drying cabinet (Lingayat et al. 2020)
- Chimney and heat storage system: The dryers use both chimney and heat storage to store solar thermal energy which can be used during night or cloudy days (Yadav et al. 2018)

The second type is forced circulation type which is an active solar drying system. A fan or a blower is used for air circulation into or out of the dryer. It comes with a huge advantage which is a control over the drying process such as drying rate and possibility to change the air velocity if needed (Lingayat et al. 2020). Two examples of active solar dryers are greenhouse collector or a tunnel type dryer with integral collector (Fudholi et al. 2015).

Figure 11 shows how the indirect solar dryer operates, the sun energy is transferred into the dryer without direct sunlight.

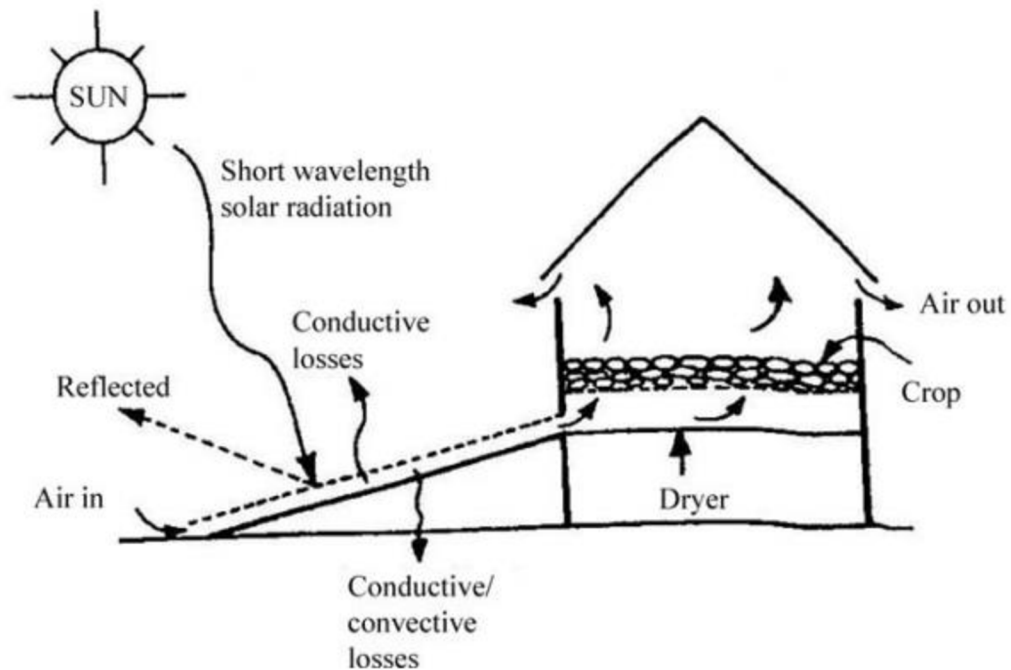

Figure 11: Indirect solar drier process (Fudholi et al. 2015)

2.1.4.2.5 *Passive solar drying systems (natural circulation)*

Passive solar drying systems use environmental air flow instead of active forced air flow. Offer an inexpensive and environmental solution for drying various agricultural produce by connecting solar energy through the strategic use of materials and design, these systems speed up the drying process without relying on mechanical or electrical support. The air is heated and circulated naturally. Cabinet and greenhouse dryers both operate in passive mode and belong to passive solar drying systems group (Sadeghi et al. 2012). Conventional passive solar drying system contains drying cabinet/storage some sort of chimney and solar air collector (Arunsandeeep et al 2018).

2.1.4.2.6 *Active solar drying systems (forced circulation)*

Active solar drying systems are a large stride forward in agricultural drying technology. These types of systems use fans/blowers that improve the air flow rate and speed up the drying process (Bennamoun et al. 2013).

Arata and Sharma created a small-scale dryer that is both affordable and sustainable for small farmers using design and materials easily found in any location. The authors also spoke with farmers about small-scale manufacturing employing inexpensive,

locally sourced materials. Additionally, they concluded that farmers could benefit greatly from a basic design technique (Arata and Sharma et al. 1991).

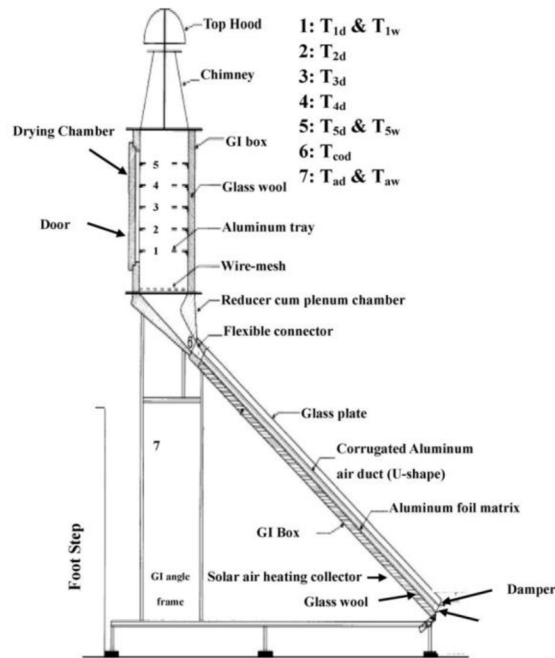

Figure 12: A large-scale solar drying facility with forced convection (Pawar et al. 1995)

Figure 12 presents a large-scale solar drying facility with forced convection developed by Pawar. Drying system with forty solar collectors as well as three drying cabinets that have a blower. The efficiency of the dryer was demonstrated together with cheaper running cost compared to sun drying and other dryers requiring gas to be operated (Pawar et al. 1995).

2.2. Food drying in developing countries

Drying is one of the most popular preservation techniques of food. Some of the techniques require zero to very small financial investment, while some more advanced techniques can be very costly. In developing countries, small-scale or economically accessible dryers are commonly prevalent. (Karim et al. 2005).

The predominant drying method employed in developing countries is open sun-drying, using sunlight as the primary drying source due to its cost-effectiveness and affordability, with minimal additional investments required. However, this method entails various risks (Karim et al. 2005), which further indicates that economic viability plays a significant role when choosing the right drying method (Masud et al. 2020). Besides the

constraints of power and initial investment, fuel and raw materials have an undisputed impact on the choice of drying technologies in developing countries (Karim et al. 2004).

Table 1 compares sun drying and solar drying methods.

Ideal features of dryers for developing countries are:

- Low installation cost
- Lesser fuel requirement
- Cheap raw materials
- Less external power requirement

Table 1: Comparison between types of dryers (Masud et al. 2020)

Drying Technology	Cost	Energy Required	Dried Food Quality	Drying Speed	Environmental Pollution
Sun Drying	Low	Low	Low	Low	Low
Solar Drying	Medium	Low to Medium	Medium	Medium	Low

2.2.1. Dried food products in developing countries

In Nigeria dried meat products are very popular and commonly used type of food and preservation method. Several different dried products have been developed over time, for example Balangu (smoked chunks of meat), Kilishi (sliced, coated and sundried meat) tinko meat (boiled and sundried meat) and many more (Muhammad et al., 2010; Ajiboye et al., 2011; Adeyeye et al., 2016). Different animal species meat is consumed and dried in Nigeria, for example donkey, camel, horses, or buffalo to name a few (Ajiboye et al. 2011). Kilishi, a popular ready-to-eat meat product, is traditionally produced in Northern Nigeria. Originally made from cattle, it is now also made from sheep, goat, pig, and camel. The production involves four stages: meat preparation, spice infusion, heat application, and storage/packaging (Ayorinde et al. 2015).

Tinko is a Yoruba term for sun-dried meat, also known as banda in Igbo and Kundi in Hausa (Ajiboye et al., 2011). Like kilishi, it's made from the carcass of cattle or transport animals, often from rejected or discarded ones. Popular in Nigeria and other African countries, it's affordable, readily available, and has a long shelf life (6–12

months). It's also a good source of protein. The production of Tinko involves collection of meat, cubing, cooking for 15-30mins, drying, and smoking for 18-30hrs, and finally cooling, storage and packaging (Falowo et al. 2023).

Dambu-nama, a nutritious dried meat product, is popular in the northern region of Nigeria. It's typically produced from fresh meat sourced from cattle, goat, sheep or camel carcasses. Dambu-nama is preferred by consumers for its tender and soft texture, unlike the harder kilishi product (Eke et al. 2012). According to a study by Eke, Dambu-nama contains about 5.50 -7.60 % moisture, 39.19-46.51 % protein, 0.015- 0.72 % fiber, 15.65-24.94 % fat and 22.64- 26.54 % carbohydrate (Eke et al. 2013).

Dragon fruit, also known as 'Kamalam', has potential as a profitable crop that can thrive in harsh ecosystems, in addition to its various health benefits. Indian farmers have begun large-scale commercial cultivation, and production is expected to grow exponentially across 50,000 hectares of rainfed and barren lands in the next three years. Since it's a non-climacteric perishable fruit crop with a short shelf life of around 5-7 days and is primarily consumed fresh, it's crucial to focus on reducing postharvest losses (Wakchaure et al. 2023).

Fresh, disease-free pitaya fruits are harvested, washed, peeled, and sliced. The slices are blanched to preserve color and dried at ideal temperature (60-70 °C) and humidity (10-35 %) conditions. The process takes 15-20 hours and includes four steps: Step I (60 °C, 35% RH, 2 h), Step II (70 °C, 25% RH, 8 h), Step III (65 °C, 15% RH, 8 h), and Step IV (60 °C, 10% RH, 1 h). The resulting dried slices, with a moisture level around 10-15 %, are packaged for consumption. During the offseason, dry slices are consumed as a snack (Wakchaure et al. 2023).

Fish, a crucial source of animal protein, is often praised for its rich content of protein and other necessary nutrients that contribute to maintaining a healthy body, a significant portion of this comes from dried fish (Arannilewa et al. 2005). In Bangladesh for example fish supplements about 60 % of people protein daily intake, and it is also very important for the national economy. Dried fish is a very popular food item among the people of Southeast Asia and has a significant market value (Khan and Ahmed et al. 2001). Dried fish maintain important nutritional values, vitamins, and minerals (Koffi-Nevry et al. 2011). Dried fish products significantly prolong shelf-life but at the same time dried fish can be consumed by people who would not eat fresh caught fish.

In Bangladesh around 240 different freshwater fish species are used for drying. The majority are smaller species like mole, dhela, puti, batachi or chapila. Most of the fish goes through sorting, washing, scaling, and gutting, salting, application of insecticides, sun drying, packaging and storage. Sun drying takes usually 2 to 6 days, for washing beel water is used, 50 to 250 grams of salt is used for 1 kilogram of a fish, the dried fish product is packed in plastic bag, jute bag or bamboo baskets, and fish product can be stored for 6 to 10 months (Amin et al. 2023).

Okra is an important vegetable with a good source of dietary fiber, vitamins, protein, carbohydrates, low saturated fat and high moisture content (Olajire et al. 2018). It is widely used in parts of Africa, Asia, and the Caribbean. Due to the high moisture content, it has relatively short shelf-life when fresh and it is prone to phytochemical degradation and spoilage (Md Saleh et al. 2020). Reducing moisture level to inhibit microbial growth is very important to extend shelf life of okra and maintain the quality (Nurkhoeriyati et al. 2021). In Nigeria a cabinet-tray dryer was used to dry okra. Fresh okra was bought from a local market at Idi-Oro. Okra was sliced into 2 mm thick samples and put into the dryer which has a capacity of 20 kg. Drying times were from 90 minutes to 450 minutes with drying temperature of 40–80 °C, relative humidity 60-80 % and air velocity 0.0-2 m/s (Afolabi et al. 2022).

2.2.2. Food preservation techniques in developing countries

In developing countries, food preservation techniques often face limitations stemming from a lack of scientific underpinnings and technological resources. While traditional methods are prevalent due to their simplicity and affordability, they may not always provide optimal outcomes. The absence of modern technologies and scientific knowledge lowers the efficiency and effectiveness of preservation processes. Therefore, the methods used have several characteristics in common (Masud et al. 2019):

- Absence of scientific basis
- Low initial, maintenance, and operating cost
- Easy in fabrication with local available materials
- No complicated mechanical or electrical systems
- Easy maintenance
- Free source of energy

2.2.2.1. Pretreatment

Cooking

In addition to one of the pretreatments, cooking also improves the flavor of the meal (Kivanç et al. 1988). Food's appeal may rise in proportion to cooking. Depending on how the meal is heated, there are many approaches to completing the cooking process (Ramesh et al. 2004).

Blanching

The pretreatment of various food processing methods, such as freezing, canning, and drying, is called blanching. Enzymes are typically rendered inactive, color and freshness are preserved, and nutritional quality and texture are stabilized through blanching. Furthermore, blanching releases intercellular air and significantly eliminates microorganisms (Masud et al. 2019).

2.2.2.2. Canning

The steps of food canning start with pretreatment of food, preparation of can, filling the can, closure of the can, heating, cooling and storage. Different products require different approaches, thus all products should be appropriately processed (Masud et al. 2019). Canned food is relatively uncommon in developing countries, with nearly 25 % of all canned fruits and vegetables originate from European nations (Masud et al. 2019). Figure 13 shows exported canned food from 2011 until 2015 from developing countries to developed countries.

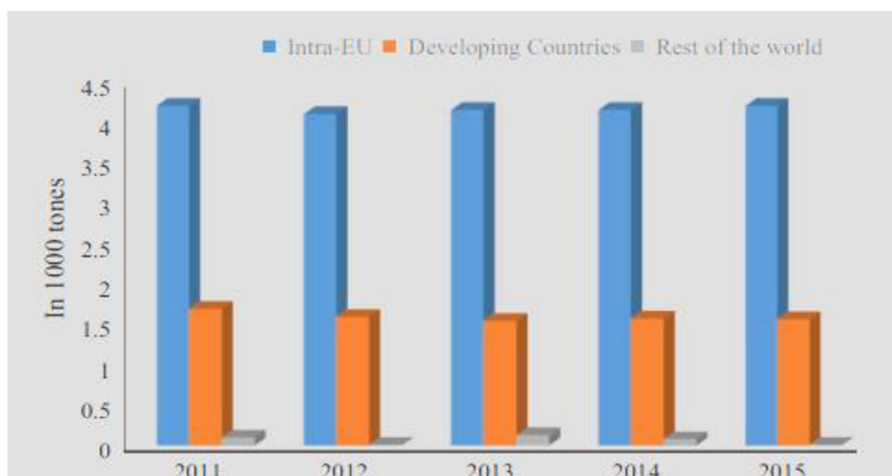

Figure 13: Exported canned food from developing countries to developed countries (Masud et al. 2020)

2.2.2.3. Fermentation

In the food processing industry, fermentation is a technique that converts carbohydrates into organic acids or alcohol by utilizing microorganisms such as bacteria or yeasts in anaerobic environments (Vuppala et al. 2015). During this time, both the additional sugar and the natural sugar found in raw meals are converted into acid. Taste, texture, and every other characteristic are created by the activity of lactic acid bacteria. This procedure highly prolongs shelf life of the product (Ofor et al. 2011).

2.2.2.4. Pasteurization

The process of pasteurization encompasses heating liquid food, such as milk and fruit juices, to a specific temperature to inhibit the growth of microorganisms. In developing nations, milk and fruit juices are commonly pasteurized through natural means. However, it is crucial to note that pasteurization involves both heating and chilling procedures (Masud et al. 2019). While effective in preserving liquid food, pasteurization can lead to a reduction in heat-sensitive substances, including minerals, fatty acids, and vitamins A, B6, B12, C, and D (Masud et al. 2019).

2.2.2.5. Salting

Salting, a method with ancient roots, remains a prevalent and enduring preservation technique even in modern times. Utilizing edible salt, this method has been used for centuries to preserve various foods (fish, meat, or crops of cabbage or runner beans) due to its simplicity and cost-effectiveness. In developing countries, processed foods such as salted fish and salt-cured meat are widely available due to their ease of production. The hypertonic nature of salt creates an inhospitable environment to most bacteria, fungi, and other potentially harmful organisms, leading to their demise or temporary dormancy during the salting process. Through osmosis, the cellular dehydration induced by salting contributes to the preservation of food materials (Nummer et al., 2002).

2.2.2.6. Smoking

Another ancient technique (with modern utilization) used in many underdeveloped countries for preserving meat and fish is smoking (Burgess et al. 1963), where food is flavored and cooked by introduction to smoke from burning wood (Adeyeye et al. 2016).

2.2.2.7. Packing

Both fresh and processed foods commonly face two primary types of damage during storage and transportation. First is physical damage due to sudden vibrations, shocks, and compressions, while the second is environmental damage caused by exposure to water, light, gases, odors, and microbes. Packaging systems play a crucial role in mitigating these forms of damage, offering protection against environmental factors. Additionally, packaging can help minimize temperature fluctuations, thereby further protecting products during transit and storage (Robertson et al., 2011).

2.2.2.8. Frying

Frying lowers the moisture content of food, which makes it more stable than fresh food (Setyawan et al. 2013). Fried fruits and vegetables have an extended shelf life, as well as improved taste, which makes frying one of the most prevalent and affordable techniques for preserving food (Mujumdar et al. 2008). Conventional deep-fat frying and vacuum frying are the two main methods that are typically used to process food (Garayo et al. 2002). On the other hand, redundant consumption or using wrong frying oil leaves consumers' health at risk (Inprasit et al. 2011).

2.2.2.9. Storage

Various food preservation methods are used both at personal and business levels within the developing nations worldwide (Adeyeye et al., 2016). However, many modern storage facilities, often known for their high energy consumption, are unsuitable for storing food in these regions. However, under some traditional techniques in underdeveloped nations, food can be stored with no specific care for as little as one day or for several months, depending on how perishable it is (Abedin et al. 2012).

2.2.3. Post-harvest losses

Developing countries heavily rely on cereal grains, particularly rice, wheat, and maize. In Bangladesh, rice makes up approximately 70 % of the calorie intake and over 90 % of the food produced (Abedin et al., 2012). However, despite Nigeria's leading production status, a significant portion of its population continues to struggle with undernourishment. Similarly, Bangladesh (ranked fourth in rice production) faces a severe hunger problem (Kumar et al., 2017). One prominent issue responsible for these challenges is post-harvest loss, which not only impacts food availability but also contributes to economic instability.

According to the FAO, in 2021, the African post-harvest loss information system (APHLIS) reported losses in Ethiopia amounting to 17.6 % for maize and 14.1 % for wheat. Conversely, in 2016, maize losses were recorded at 21.4 %, and wheat losses at 18.4 % (FAO, 2023).

Storage losses

Most food losses happen during the storage phase due to a lack of adequate infrastructure. Storage losses can be divided into two groups. Direct losses, encompassing physical loss of commodities, and indirect loss, encompassing loss in quality and nutrients (Brauw et al. 2021). In the context of food preservation, the distinction between damage and loss is important. Damage refers to physical evidence of deterioration, such as holes in apples, primarily impacting the quality of the produce (Kumar et al., 2017). On the other hand, loss entails the complete disappearance of food (Kumar et al., 2017). The rate of rejection varies depending on individual economic status and cultural influences. While a farmer may still consume slightly damaged produce, a consumer in a developed country may reject it (Boxall et al., 2002).

The storage losses are influenced by several factors which can be either biotic or abiotic (Abedin et al. 2012). Biotic factors entail insect, pest, rodents or fungi, where abiotic factors refer to temperature, humidity or rain.

Mold grows mostly in relative humidity of more than 70 % and in temperatures of 20 to 40 °C (Abedin et al. 2012). Minimizing the temperature difference between inside and outside of the storage structure can regulate presence of the mold (Abedin et al. 2012).

Final moisture and quality of grains are crucial for storing longevity. Damaged product can result in infection and cause deterioration (Shah et al. 2013).

In South Asia, Africa and other developing countries, produce and especially grains are stored in bags in simple granaries constructed from materials like straw, bamboo, mud, and bricks. In Asia plastic containers, mud bins, straw structures and pots are common storage structures (Baloch et al. 2010). Steel or plastic drums are commonly used for long duration storage while plastic or polythene bags for short duration (Kumar et al. 2017).

Insect infestation

Insect pests are around 30 to 40 % of all produce losses in all biotic factors (Abass et al. 2014). In 2002 in Ghana around 50 % of maize losses were due to insect infestation (Boxall et al. 2002). In Cameroon stored maize losses were reported from 12 % to 44 % and about 23 % in Benin while grains were stored for six months mainly because of infestation (Tapondjou et al. 2002). Larger grain borer (LGB) is the major pest in the case of maize and is nowadays found in most parts of Africa and is considered the most threatening pest, it can cause extensive damage in a very short time (Tefera et al. 2011). At farm level storage, more than 30 % of food losses were reported (Tefera et al. 2011). In 2014 Abass reported that LGB was responsible for 56.7 % of storage losses in the case of maize which was stored for more than six months (Abass et al. 2014).

Mycotoxin contamination

It is another big challenge especially for maize, it makes it inedible for both human and animals. Between 25 % and 40 % of cereals grains are contaminated by storage fungi worldwide (Kumar et al. 2007). The most common and important mycotoxins are aflatoxins, fumonisins, deoxynivalenol and ochratoxin. For example, aflatoxins can cause liver cancer and affect growth in young children and high concentration can lead to death (Suleiman et al. 2015).

2.2.4. Conditions for selecting drying techniques in developing countries

Developing countries are facing a lot of food loss and food crisis thus post-harvest processes are very important to decrease food loss (Karim et al. 2005). Effective moisture content removal can prolong perishable food shelf life. Drying is the most sustainable

approach among other possibilities to remove moisture (Joardder et al. 2019). Quality of food is very important, high-quality food is produced when the microbial growth and color change is minimal (Masud et al. 2020).

2.2.4.1. Energy and time

Of all the industrial procedures, drying is by far the most energy-intensive method, accounting for over 15 % of total industrial energy use (Kumar et al. 2016). Profits in the drying business may increase by as much as 10 % if energy efficiency was simply 1 % greater (Chou et al. 2001). Consequently, even a little improvement in drying technology's energy efficiency could result in efficient and long-lasting global energy conservation (Kumar et al. 2014).

Heat is generated at various phases of processing to provide energy. For example, the energy required to remove moisture when drying is done at 50 °C is about 1.5×10^6 kJ/t. But given the difference in process variables and the kind of food sample, the amount of energy needed can change (Billiris et al. 2011).

2.2.4.2. Cost and safety

The accessibility of natural resources in a developing nation should be respected when evaluating its capacity for adoption. A developing country hindered by inadequate natural resource reserves. Undoubtedly, infertile land will face greater challenges when using cutting-edge industrial drying methods than in a developed country with access to such resources (Masud et al. 2020). However, these restrictions on adaptivity can be somewhat diminished with the use of readily available technologies and renewable energy sources. For instance, several sun drying devices have been created, which can greatly decrease reliance on conventional energy sources (Karim et al. 2004). It is considerably simpler to take advantage of the benefits of new drying technology when farms work together to create sustainable drying facilities (Desjardins et al. 2019).

2.2.4.3. Challenges in sustainable food drying techniques

Environmental cleanliness

When choosing a drying type to process the given food, attention should be made for cleanness and hygiene. It is crucial that the dryer remains clean and sanitized to obtain a quality finished product. With continued use of the dryer, its drying chamber becomes

contaminated. Small solid particles lodged between the drying trays or in small, perforated holes may be a source of microbial growth. When the drying chambers are not cleaned after certain intervals, microbial growth can increase rapidly. If this happens, bacteria, dust and fragments may cause great degradation of dried food. Moreover, the operator handling food materials should ensure that he/she uses clean utensils or must properly wash hands before and after taking some foods (Masud et al. 2020).

Specialized equipment

Different types of dryers require different equipment which can be very difficult to acquire in some parts of the developing countries, mainly in remote areas. Some types also require chemicals which can also be hard to obtain. Many different parts of the driers need to be replaced after several drying operations. Very important equipment mainly for developing countries with high humidity is dehumidifier and vacuum sealer for proper products storing (Masud et al. 2020).

Drying time

The drying process is considerably time consuming despite the advancement in the dryers. Driers with faster drying times are usually more expensive and more advanced to operate. Usually, it takes around a few hours to reach goal final moisture (Masud et al. 2020).

Energy required

Driers require enormous amounts of energy to run whole days or even just a few hours a day. Many driers run on fossil fuels or fossil fuels-based electricity which increases cost significantly. The energy factor should be considered carefully because it is involved in both drying and heating processes (Khan et al. 2016). From a short period of time perspective, it is cheaper to run low-cost fossil fuel based drying techniques than renewable energy-based which were way more expensive in the beginning (Khan et al. 2017). In the long run renewable energy driers are going to be cheaper and better option. Optimizing the energy efficiency of driers has always been a challenge (Masud et al. 2006).

Nutrition content

The quality of dried food has improved greatly in recent years based on the development of drying technology. Nevertheless, no drying methods are present in the

market that can preserve the intact nutritional value of fresh food once it is dried. Improper drying can result in the irreversible destruction of a large proportion of vitamins and minerals found in food samples. In addition, drying operation makes some dried foods rich in salt and sugar. However, if the quantity of salt and sugar concentration is not maintained properly once ingested it may increase the blood pressure level in an individual. They observed that the content of salt in dried snacks is larger than the recommended adult intake level. It is always one of the difficult tasks to design drying technologies in such a way that there should be an adequate level of nutrition locked up inside dried food samples (Masud et al. 2020).

Taste of food

However, dried food is also usually too hard or must be softened again before it can be eaten. Under such circumstances, the consumer could hate dried food. Even inadequate drying may worsen the softness and tenderness characteristic of fruits and vegetables, which many people do not like. Thus, it is crucial to make sure that the consumer enjoys dried items as tasty and appealing. One should consider the taste in choosing drying methods (Masud et al. 2020).

2.2.5. Types of solar dryers

Cabinet dryer

A cabinet dryer is a direct solar type of dryer (Sharma et al. 2009). It consists of three different parts which are solar collector, solar drying cabinet, and air blower. The most important factor in the drying rate is the temperature of the air inside of the cabinet; less important is the speed of air and can be neglected (Al-Juamily et al. 2007). A portion of the sun radiation that strikes the glass cover is reflected into space, with the remaining portion entering the cabin drier. Additionally, a portion of the radiation that is delivered is reflected by the crop's surface. The crop's surface absorbs the remaining portion. In contrast to open sun drying, crop temperature rises because of solar radiation absorption, and the crop begins to emit long wavelength radiation that is prevented from escaping to space by the presence of glass covering. As a result, the temperature within the chamber rises above the crop (Sharma et al. 2009).

Cabinet dryers' limitations:

- Only used for small scale drying.
- Discoloration is due to the direct solar radiation exposure.
- Transmissivity reduction overtime due to moisture condensation.
- Insufficient rise in crop temperatures can affect moisture evaporation.
- Restricted use of selective coatings on the absorber plate.

Greenhouse dryers

The greenhouse dryer is a sizable solar collector where the drying, curing, and planting processes are carried out for efficient year-round solar energy use in agricultural production. It is an eco-friendly technology which uses the heat of the sun for drying different agricultural products. This system operates within a controlled environment by combining the principles of greenhouse and solar drying technology using sun energy in dehydrating crops fruits and vegetables to reduce farm waste (Grabowski et al. 2003). The greenhouse structure is solar powered, it heats up and creates warmth with a dry atmosphere where the produce dries off quickly but safely. Adjustable ventilation and temperature controls allow the farmers to control drying conditions that will maintain overall nutritional value as well as prolong shelf-life (Raman et al. 2011). This sustainable approach not only reduces reliance, but also improves food security situations by curbing post-harvest losses (Sharma et al. 2008).

Mixed mode type solar dryer

It mixes both direct and indirect solar drying technologies. The product is dried because of both direct exposure to sun and indirectly from solar air collector (Tripathy et al. 2009). This synergistic mixture of technologies is not only an eco-friendly, adaptable solution that greatly increases the entire drying process efficiency but also provides for comprehensive control over several agricultural items (Ayua et al. 2017).

Tunnel solar dryer

A tunnel solar dryer is a solar drying system in which agricultural produce can be dried uniformly and efficiently. Its unique design is characterized by a long, enclosed tunnel covered with transparent glass to provide sunlight and heat the interior (Patil et al. 2016). This design improves the drying process by creating a controlled atmosphere, suitable temperature, and moisture level. For fruit and vegetable drying, in particular –

tunnel solar dryers are an excellent tool that provides a reliable method reducing post-harvest losses without compromising the quality of dried products (Akter et al. 2022).

Figure 14 shows a type of a tunnel solar dryer called semi-cylindrical.

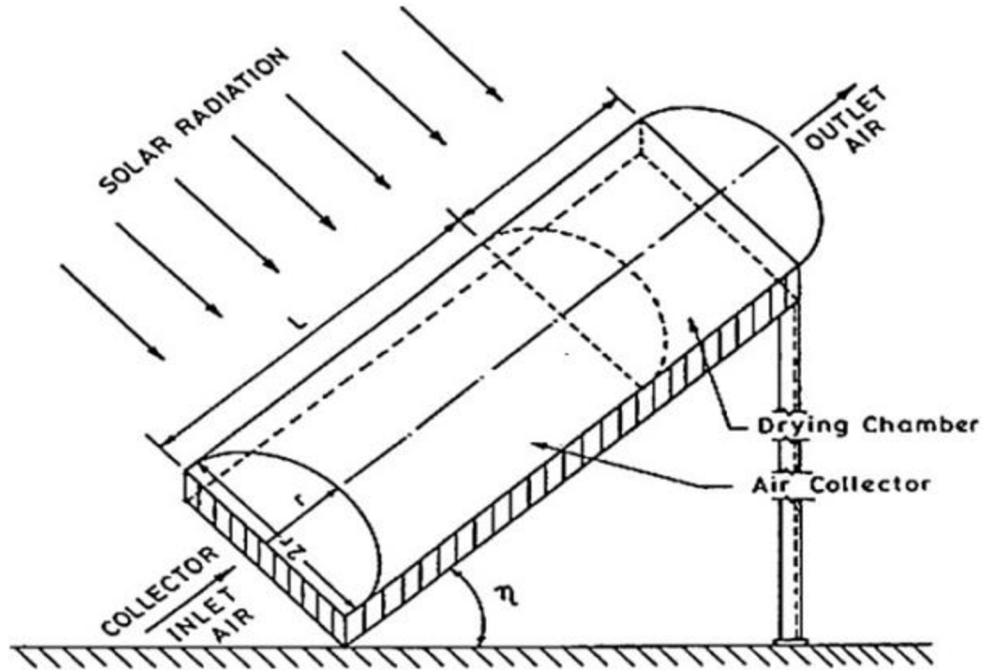

Figure 14: Semi-cylindrical solar tunnel drying system developed by Garg and Kumar et al. 2000

2.2.5.1.1 Recent advancements - electrohydrodynamic drying

Aerodynamic action of the so-called coronawind, ionic wind, or electric wind causes water to be removed from wet material exposed to intense electric fields. This process is known as electrohydrodynamic (EHD) drying. This wind is caused by ions leaving an electrically conducting pin (needle) or horizontal wire and impinging on the surface of the material being dried. It starts from the sharp end of these pins or wires (Martylenko et al. 2017). Some key factors are:

- Electrical characteristics (voltage, current, AC vs DC, polarity etc.)
- Electrode geometry (needles/wires, spacing, gap, collector electrode design)
- Environmental parameters (temperature, relative humidity, pressure, velocity, and direction of airflow)
- Material properties (moisture content, capillarity, surface profile, porosity, tendency to shrinkage or swelling, and equilibrium moisture content)

3. Aims of the Thesis

This master's thesis aims to explore an investigation and comparison of two types of solar dryers. Adopting an innovative approach, the study explores the use of a tent as the foundational structure for a solar dryer. The objective is to compare both dryers among themselves to find the better solution, but also to understand its comparison to other conventional solar dryer models. The thesis also aims to evaluate the dried samples attributes in sensory analysis to determine if there is any difference between the dryers.

3.1. Specific objectives

1. Compare the driers among themselves to conclude the more efficient drier.
2. Evaluate food dried samples attributes in sensory evaluation to determine the best drier.

4. Materials and methods

4.1. Tent solar dryers

Two innovative tents solar dryers were designed for this experiment. The direct solar dryer had white to almost transparent color which let the produce to be directly exposed to sunlight. The indirect solar dryer had black color which did not allow any sunlight exposure.

Figure 15 below shows the indirect solar dryer filled with apples (Granny Smith apples with moisture content of 82 to 85 % (Masoudi et al. 2007)). Both dryers are the same size and have the same equipment (fan and photovoltaic panel). The dryer has three trays for the produce, the top tray size is 60 x 60 cm, the middle tray size is 75 x 75 cm and the bottom tray, which is also the biggest is 87 x 87 cm. The base of the dryer is 140 x 140 cm which was also used for the calculation of the effectiveness of the dryer as the area of the collector.

At the top of the dryer a fan was built in to provide the dryer with air flow. The fan was charged by the photovoltaic panel which was placed against the bench for the best sunlight exposure.



Figure 15: Indirect solar dryer filled with apple samples

4.2. Data collection

The drying experiment took place on the roof of the Faculty of Tropical AgriSciences (FTA), CULS Prague, Czech Republic. The data collection started on 15th July 2021.

The data collection was measuring important parameters for the evaluation of both dryers. The initial data collection was measuring the parameters while both dryers were empty and was going on for three days. The parameters measured during the data collection were solar radiation (W/m²), air flow (m/s), relative humidity (%), dryers' humidity (%), ambient temperature (°C) and dryers' temperature (°C). These are the parameters necessary to evaluate the effectiveness of the dryers to compare them with each other but also to compare them to other small-scale solar dryers.

The first data collection collected parameters from the empty dryers and the interval to collect the parameters was every 20 minutes. The first day started at 10 AM and finished at 5 PM. The second day started at 9 AM until 5 PM. The last day of the data collection started at 9 AM and ended at 4:45 PM.

The second and third data collection was done while the dryers were filled with apple samples. The top and bottom racks were fully filled with the apples and the middle rack contained three apples samples which were the testing samples. These testing samples were put on a scale to find the weight loss and after the apples reached final weight, the moisture content was measured. During the second data collection all parameters were measured as in the case of the first data collection. The second data collection used different batches of the apples than during the third data collection, but both were using the same granny smith apples. The apples were thinly sliced into 0.75mm and all the parameters were measured every 30 minutes. The testing samples can be seen in figure 15 on the middle rack.

The initial weight of the apple samples from the first batch from the indirect solar dryer were 7.766 g, 10.448 g, and 8.153 g. The initial weight of the apples from the first batch from the direct solar dryer were 8.727 g, 7.048 g, and 9.626 g. The initial weight of the samples from the second batch from the indirect solar dryer were 7.755 g, 8.745 g, and 8.948 g. The initial weight of the apples from the second batch from the direct solar dryer were 6.932 g, 8.808 g, and 8.155 g.

The first day of the data collection of the first batch filled in the dryers started at 9:30 AM and finished at 5 PM. During the second day of the data collection both dryers were able to reach the optimal moisture levels, which is under 22 % for dried apples with no pre-treatment according to United Nations. The second and the final day for the first batch data collection started at 9 AM. The direct solar tent dryer was able to reach under 22 % of moisture content at 10:51 AM, the indirect solar dryer reached it at 2:47 PM.

The first day of the data collection for the second batch of the apples inside of the dryers started at 9 AM and finished at 5 PM. The second day started at 9 AM and the first dryer, which was the direct solar dryer finished at 11:07 AM and the indirect solar dryer finished at 12 PM.

When the apples reached final optimal moisture below 22 %, they were put into sealed plastic bags and vacuumed to retain the quality, moisture, and color. The plastic bags were stored in the faculty building in the laboratory room in the cabinet. The bags were stored there right after the finished data collection of the dryers and kept there until the sensory analysis in room temperature.

4.3. The used devices

The devices which were used for collection of data were Testo 925 (Testo, Germany) for dryers temperature and humidity, anemometer Testo 425 (Testo, Germany) for air flow, a Kern PNJ (KERN & SOHN, Germany) scale for weighting apple samples, photovoltaic panels as source of energy to run a small fan inside of the dryers, slicer for slicing apples, Radwag AS 220.R2 (Radwag, Poland) for measuring the final moisture of the samples. Konica Minolta CM 600-d (Konica Minolta, Japan) was used for color measurement.

4.4. Calculation of drying effectiveness

System drying efficiency is parameter understood as the comparison between the energy needed to evaporate the moisture and the energy provided to the dryer. In the case of a solar collection, the heat given to the dryer is the sunlight received by the collector. The formula to calculate the dryer's effectiveness is shown below.

$$\eta_d = W \cdot \Delta H_l / I_d \cdot A_c$$

- η_d = system drying efficiency
- W = moisture evaporated, kg
- ΔH_l = latent heat of vaporization of water, 2320 kJ.kg⁻¹
- I_d = total daily insolation incident upon collector
- A_c = area of collector

The W (moisture evaporated) was calculated based on the capacity of the dryer of the top, bottom, and the middle rack. During the experiment on the middle rack, there were only three samples placed which were the samples put on the scale and later used for moisture content test. The W was calculated as difference from the weight of the apple samples before the drying and final weight after the drying.

The latent heat of vaporization of water was calculated using the temperature inside of the dryers. The average temperature measured during the whole experiment was calculated and later used to calculate water specific heat of vaporization using a calculator.

The I_d (total daily insolation incident upon collector) was calculated using the average solar radiation, which was measured during the data collection, and had to be converted to joules. The time of the drying was converted to seconds to convert W/m^2 into J/m^2 .

The last parameter of the formula was the area of the collector which had to be in m^2 . The racks were in the shape of a square, and it was calculated as area of a square.

4.5. Color measurement

The color measurement was done after drying. The spectrophotometer used for measuring the surface color was Konica Minolta CM 600-d (Konica Minolta, JP). The device uses the Commission Internationale de l'Éclairage (CIE) (L, a, b) color system. L stands for lightness/darkness, a is redness/greenness and b is yellowness/blueness.

The apple samples were taken from both solar dryers and from the first and the second batch of apples. The first group of apple samples were samples with number 582 which were taken from the indirect solar dryer from the first batch of drying. The second

group number was 839, these samples were from the first batch and direct solar dryer. The group with number 964 was taken from the second batch from the direct solar tent dryer. The last group from the second batch and indirect dryer had number 173.

To calculate the results for color measurement, mean values for L, a, and b were calculated. The results were also supported by the sensory analysis answers and analysis of variance test.

4.6. Sensory analysis

Sensory analysis took place in the Sensory Analysis Laboratory at the Faculty of AgriSciences (FTA). The first day was 31st May 2022 and the second day was 1st June 2022. During those two days, 14 people with previous experience and training took part in the sensory analysis.

A google form evaluation sheet was made with several questions and was available for respondents to fill it out while tasting the samples of the apples. The sensory analysis contained eight variables, appearance, color, aroma, taste, texture, toughness, overall acceptability with scale 1 to 10, where 10 was the highest and 1 was the lowest.

Figure 166 shows the samples of the apples which were used for the sensory analysis with number written on each plate.



Figure 16: Samples of dried apple prepared for sensory evaluation

5. Results

The chapter describes the results of the data collection. The calculation of the system drying efficiency. The results from the sensory analysis and the color measurements.

5.1. Data collection – solar dryer tents

The chapters in data collection describe the data collection during the experiment with empty and filled tents. The parameters measured are very important to compare the dryers and calculate the system effectiveness.

5.1.1. Initial dryers measuring - empty

On the first day the relative ambient humidity average per measuring window was 57.30 % and temperature was 20.79 °C. During the second day ambient relative humidity was 51.86 % and temperature was slightly more than during the first day and it was 21.85 °C. Third day was the hottest day with temperature average reaching 23.82 °C and relative ambient humidity was 76.96 %. Table 2 shows the average values of the parameters collected during the first three days of drying.

Table 2: Average values data collected during the first three days with empty dryers

Day	Temperature (°C)	Relative Humidity (%)	Solar Radiation (W/m ²)
1	20.79	57.3	565
2	21.85	51.68	417
3	23.82	76.96	701

The graph below shows solar radiation during the first three days of data collection. The first day the data collection started at 10 AM and continued till 5 PM with the highest solar radiation of 1077 W/m^2 at 2:40 PM. The second day average solar radiation was lower than during the first and third day and peaked at 12:20 AM with value of 1017 W/m^2 . On the last day the highest radiation was measured, which was 1086 W/m^2 at 1:40 PM (as seen in Figure 17).

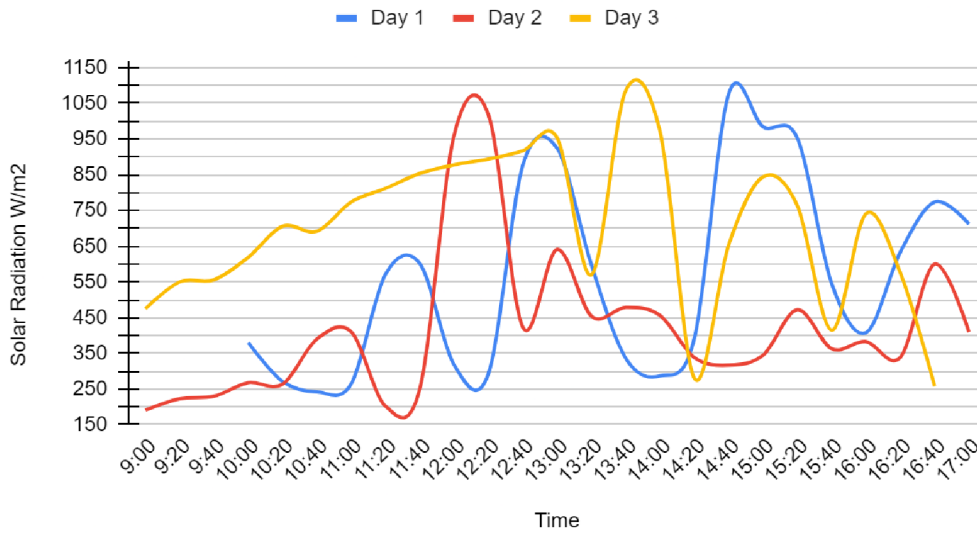

Figure 17: Solar radiation in empty dryers (W/m^2)

The air flow data was collected as well during the initial data collection period. The first day average air flow was 0.182 m/s , the second day was 0.137 m/s , and the last day was 0.242 m/s (in Figure 18).

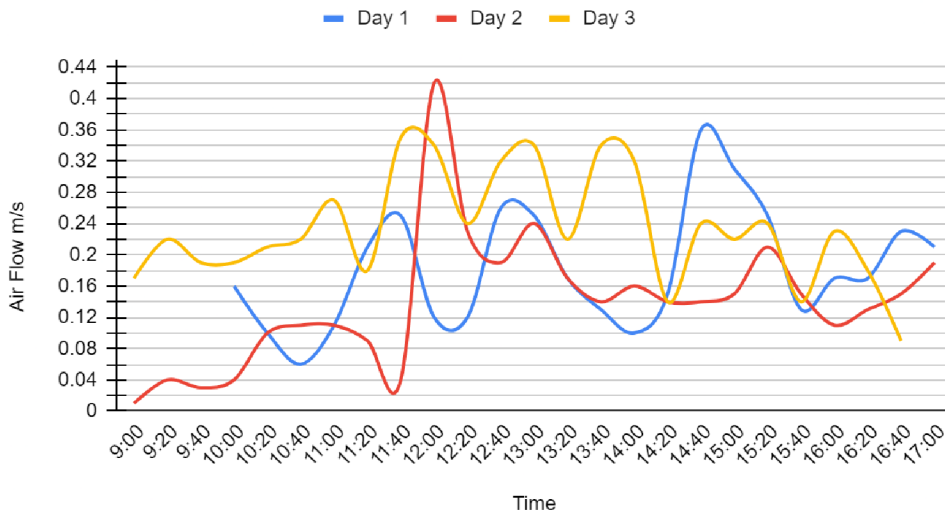

Figure 18: Air flow data collection in empty dryers (m/s).

Figure 19 shows ambient temperature. In average the hottest day was the last day with temperatures of 23.82 °C. During the second day the temperature rose until 11 AM but then went down compared to the first day where the temperature was similar during the whole day.

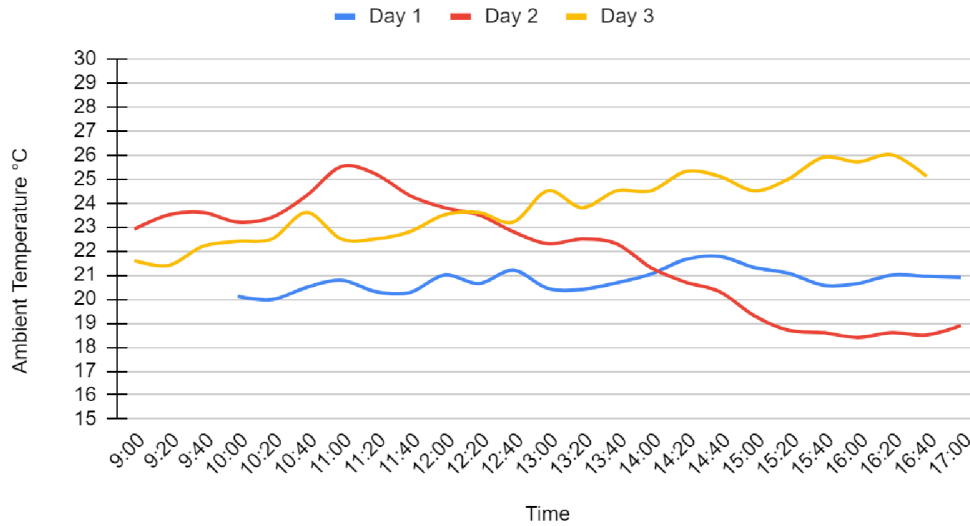

Figure 19: Empty dryers ambient temperature (°C)

The ambient relative humidity graph (Figure 20) shows that the final day with the highest temperature also had high ambient relative humidity which averaged 76.96 %. The other two days had lower ambient relative humidity which helps drying times (Ekechukwu et al. 1999).

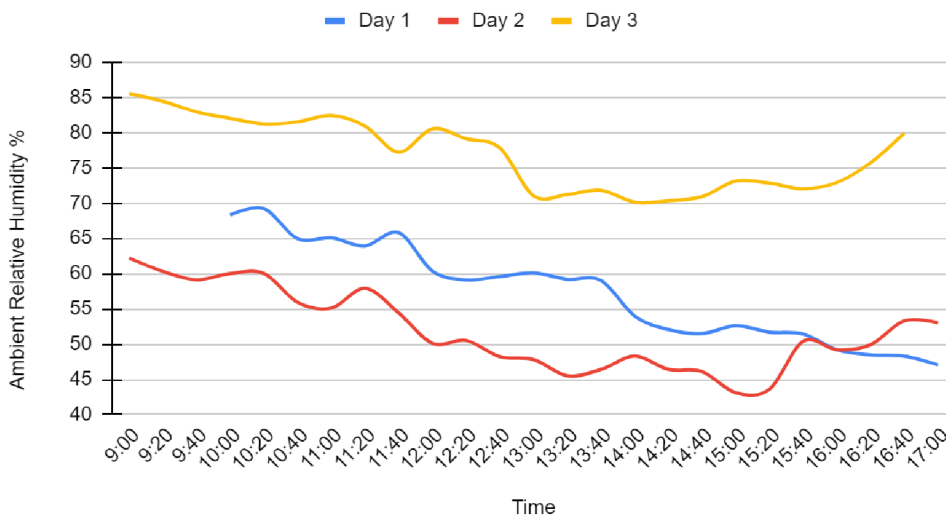

Figure 20: Ambient relative humidity patterns of drying air in empty dryers (%)

Figure 21 shows the comparison of relative humidity patterns of drying air in direct and indirect solar dryers. The indirect solar dryer averaged higher humidity compared to the direct solar dryer. The highest humidity in the direct solar dryer was measured during day three which was still lower humidity than during day two where the lowest humidity was measured for the indirect solar dryer.

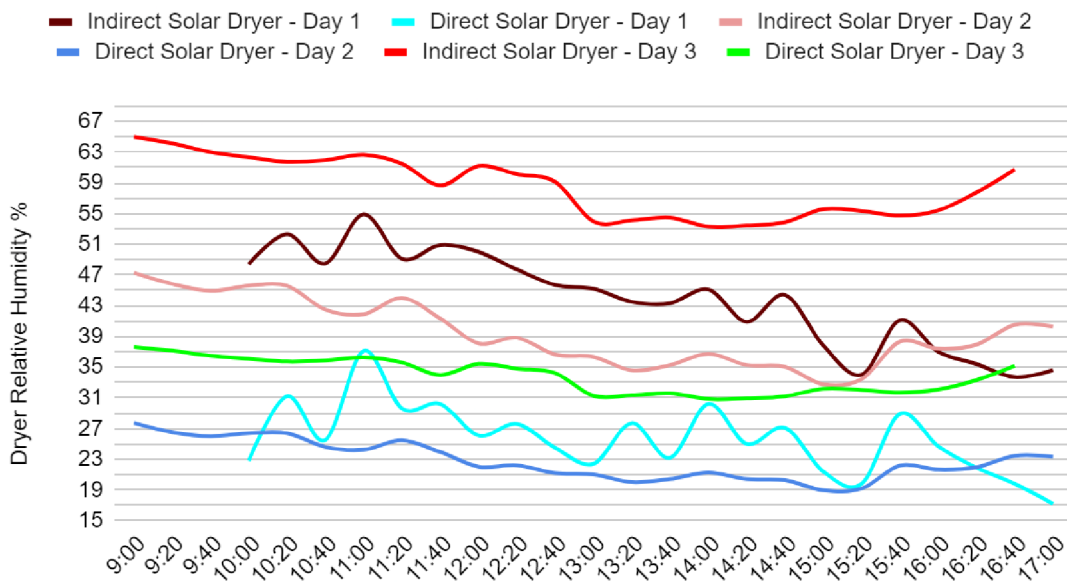

Figure 21: Relative humidity patterns of drying air in direct and indirect Solar Dryers (%)

Figure 22 below shows the temperature measured in both solar dryers. During the first three days indirect solar dryer maintained lower temperature than direct dryer which is not desired. The higher temperature helps food evaporate water faster and make the whole process more efficient.

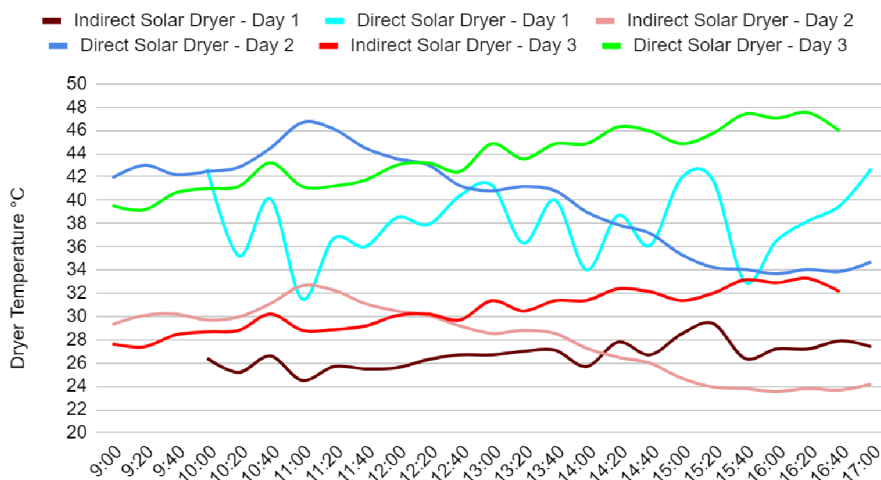

Figure 22: Temperature of the air in the indirect and direct dryers (°C)

5.1.2. Indirect and Direct Solar Dryer Comparison

This chapter compares the indirect and direct solar dryers. Figure 23 shows solar radiation during all four days of the data collection. From the graph it is visible that the solar radiation varies a lot even during days with similar temperatures and relative humidity, day two was cloudier compared to the other days. Day one and day three were very similar except for the time frame from 12:30 PM until 2:30 PM.

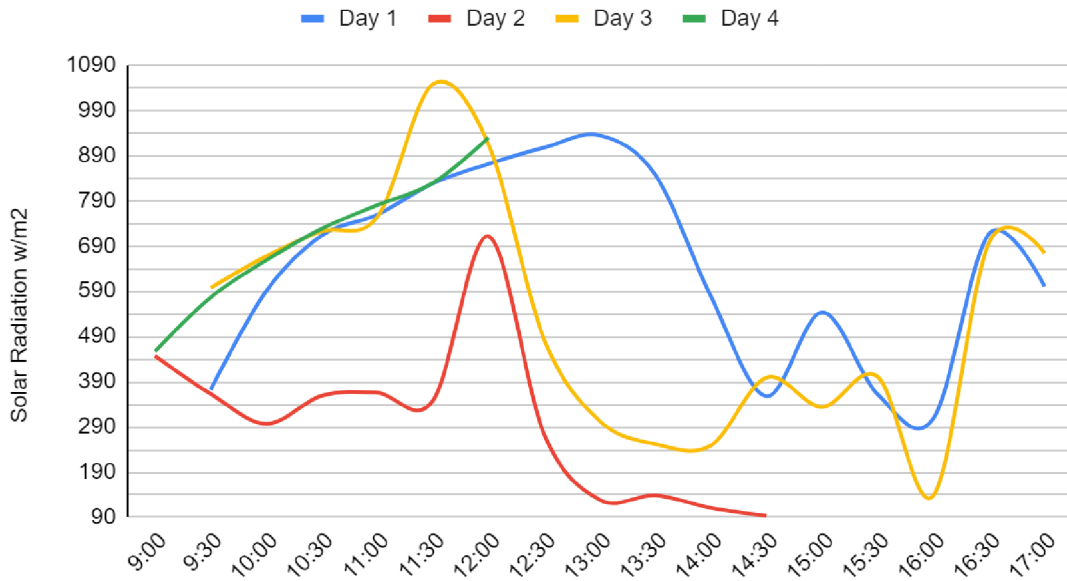

Figure 23: Solar radiation in filled solar tent dryers (W/m²)

Figure 24 shows temperature data from four days of measuring inside of the dryers. The day one was colder than day two and three. The day two and three temperatures were similar. The day four was the hottest day, temperature at 9 AM already reached almost 25 °C which is almost the peak temperature from the day two and three, while during the day one temperature did not reach 24 °C.

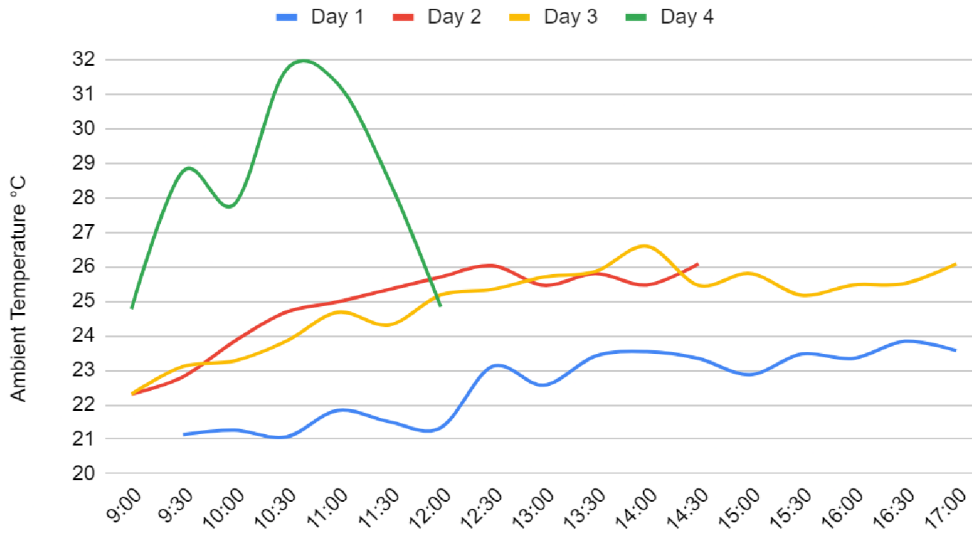

Figure 24: Ambient temperature of the air in indirect and direct solar dryers (°C)

Figure 25 shows similar graph results to the ambient temperature. Day 4 ambient relative humidity was the highest as in the case of the highest ambient temperature from the previous graph. Day one, two and three are very similar and are also similar to the values from the ambient temperature.

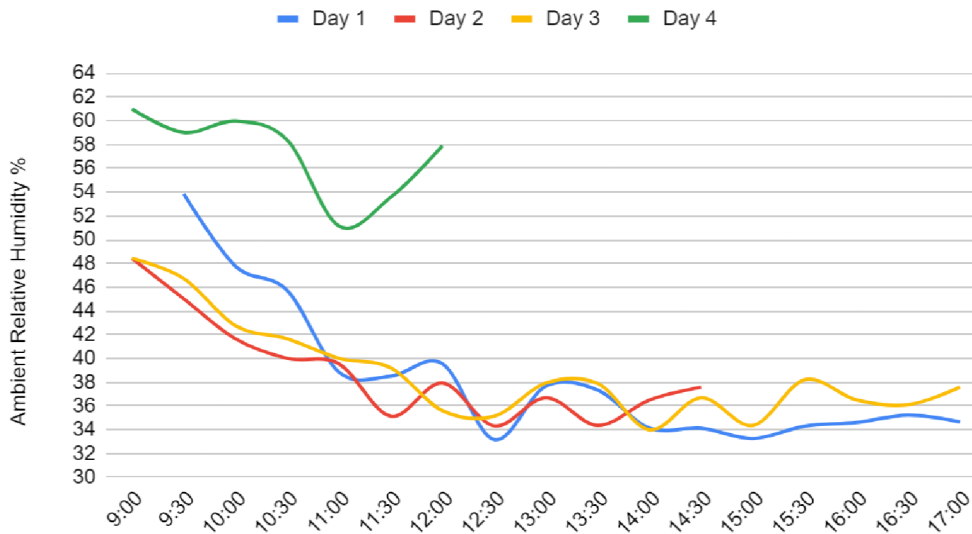

Figure 25. Ambient relative humidity in indirect and direct solar dryers (%)

Figure 26 shows a comparison between air flow in direct and indirect dryer. The first day the indirect dryer averaged air flow of 0.252 m/s and direct 0.26 m/s. On the second day, lower solar radiation led to less energy for the fans, resulting in an average air flow of 0.094 m/s for the indirect solar dryer and 0.17 m/s for the direct dryer, which finished drying earlier. At the same time frame the indirect dryer averaged 0.112 m/s. The first day average of indirect dryer was 0.169 m/s and 0.19 m/s for direct solar dryer. On the last day, the indirect solar dryer averaged higher airflow than the direct dryer for the first time, at 0.288 m/s vs. 0.25 m/s. This was due to the direct dryer finishing at 11:07 AM, after which the airflow data from the indirect dryer nearly doubled. Both dryers were using the same equipment and were placed next to each other, but the direct dryer averaged higher air flow which is vital component for drying.

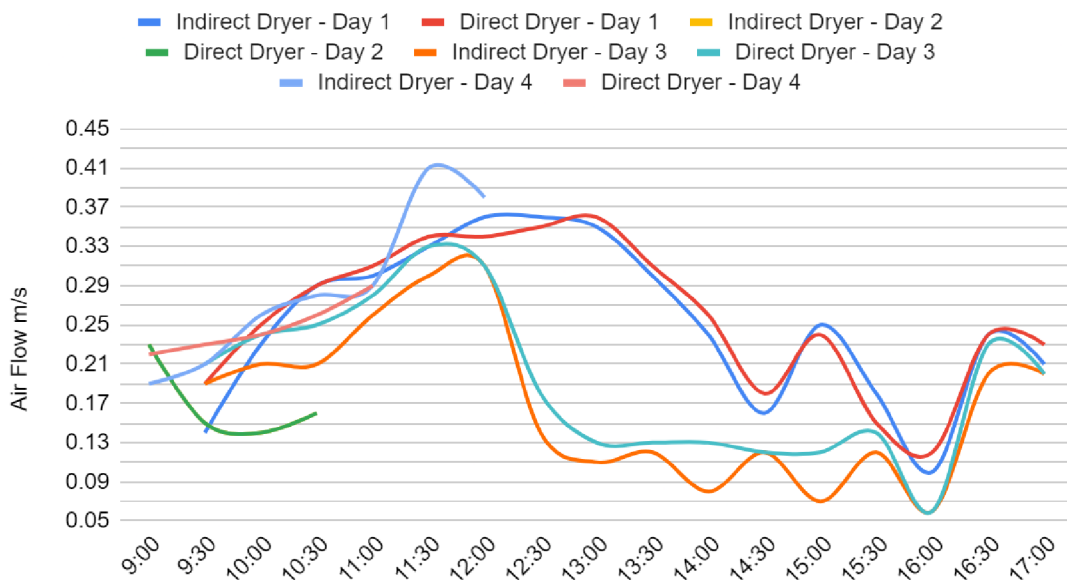

Figure 26: Air flow comparison between direct and indirect solar dryers (m/s).

Figure 27 below shows the difference in temperature between both dryers. Direct dryers were able to increase and maintain higher temperatures than in the case of indirect dryer.

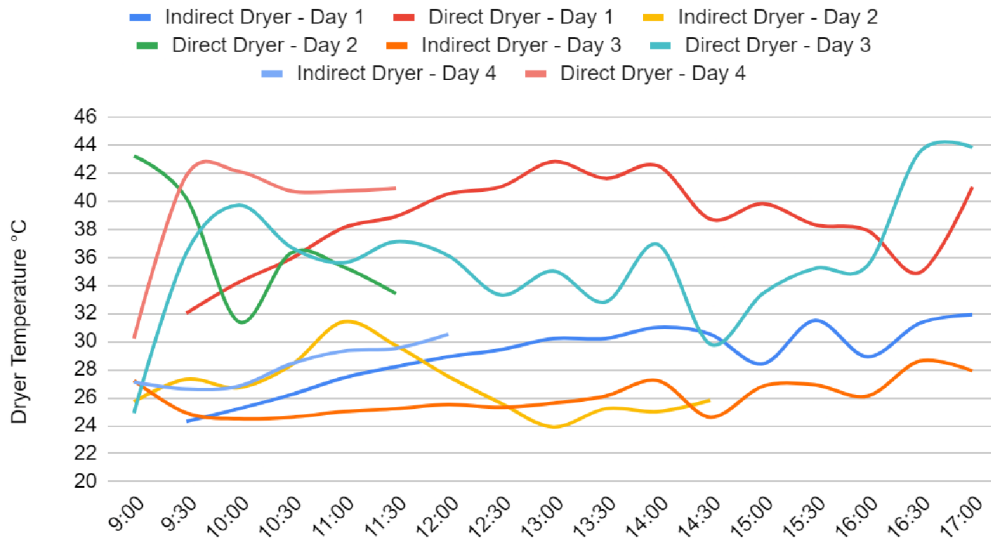

Figure 27: Solar tent dryers temperature comparison between direct and indirect dryers (°C)

The relative humidity in both dryers corresponds to the temperatures from the previous graph. Indirect solar dryers averaged higher humidity than direct solar dryer. The average for indirect solar dryer was 44.473 % during the four days of measuring and it was almost 50 % less for direct dryer which humidity was 25.796 %, as seen in Figure 28.

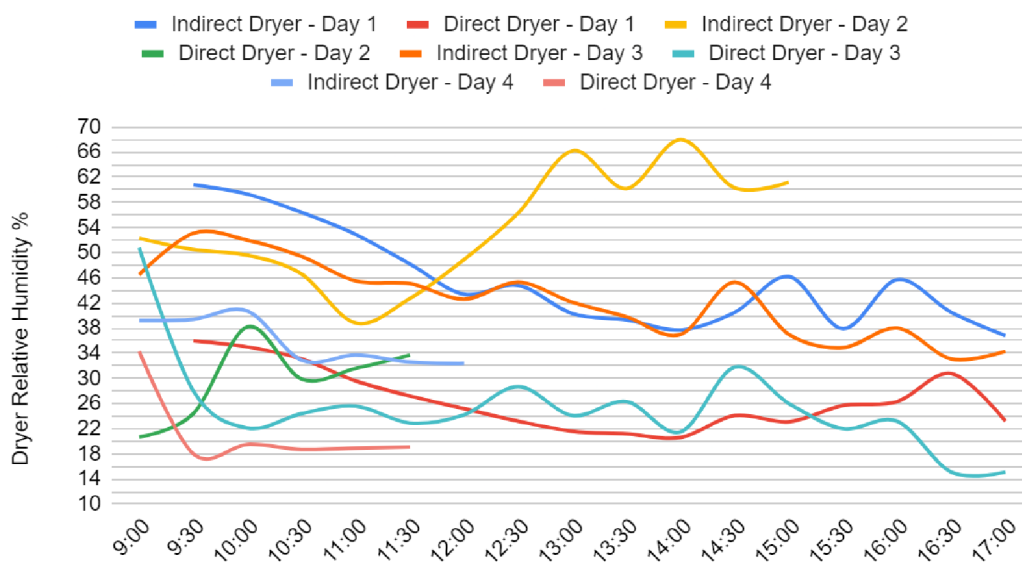

Figure 28: Dryers Relative Humidity of air in Direct and Indirect Solar Dryers (%)

Figure 29 shows the comparison between indirect dryer and direct dryer during the first batch of apple drying. The drying started at 9:30 AM and finished at 5 PM. The samples from the direct dryer lost over 80% which is considered already as an optimal weight loss because that is the moisture content already feasible for dried apple product prolonging the shelf-life and maintaining the quality of the products.

In average the samples from direct dryer lost 80.92 % of the initial weight, for example sample 1 lost 7.127 g (82.18 %). Indirect dryer was less efficient than direct dryer and in average samples lost almost 2 grams less than direct dryer, only 5.539 g (63.25 %) in average.

The samples were kept in the dryer and put back in the faculty building and the second day drying started at 9 AM. The direct dryer finished drying at 10:51 AM, the samples were losing almost no water at that point, and it took the dryer to reach these numbers in 9 hours and 21 minutes. The indirect dryer finished at 2:47 PM and the total time was 13 hours and 17 minutes. The direct dryer was losing 9.01 % of the weight per hour while indirect only 6.26 %.

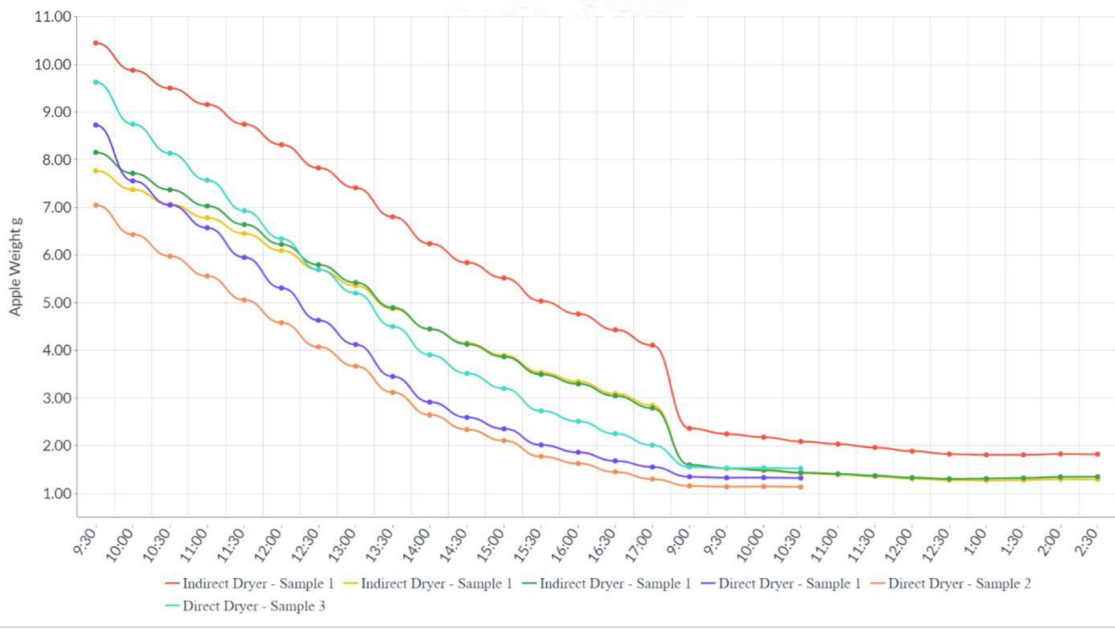

Figure 29: The first batch of apple drying - comparison between direct and indirect dryer (g)

Figure 30 shows similar results to the first graph. The average initial weight for indirect dryer was 8.483 g and for direct dryer it was 7.965 g. The drying during the first day started at 9 AM and finished at 5 PM. In average indirect solar dryer lost 67 % of the weight while direct dryer lost in average 78.823 % which is slightly less than during the first batch. The samples were left in the dryers longer than during the first batch to find out if lower moisture content would have a positive or negative effect during sensory analysis which is described in the following chapter. The indirect dryer finished drying at 12 AM while direct dryer stopped drying 53 minutes earlier. It took 11 hours to reach the final moisture for the indirect dryer and 10 hours and 7 minutes for direct dryer. The weight loss per hour is not as different as it was during the first batch because of the longer drying period for direct dryer. The indirect dryer lost 8.08 % of the weight per hour while direct dryer 8.82 % an hour.

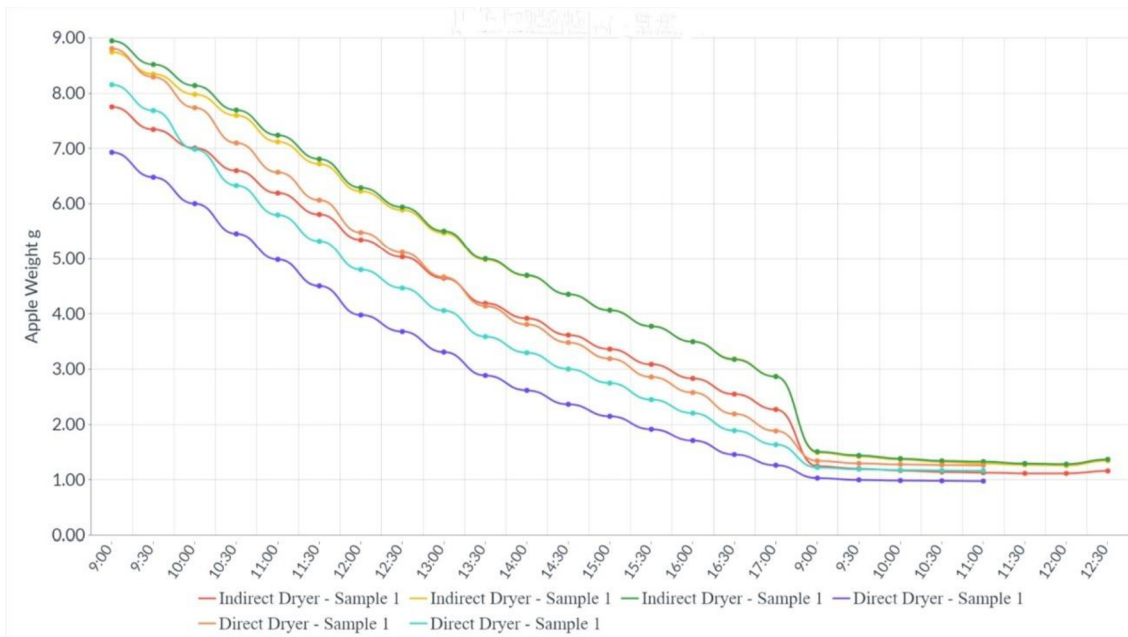

Figure 30: The second batch of apple drying - comparison between direct and indirect dryer (g)

Drying effectiveness

The average ambient relative humidity was calculated for all four days of measuring, first two days were for the first batch, the last two days for the second batch. The averages were also calculated for relative humidity collected inside of both drying dryers. The averages of relative humidity found in direct dryer were lower than in case of indirect solar dryer which helps to dry food produce faster which was also shown on the graphs that the direct solar dryer was more efficient. Table 3 shows the ambient relative humidity, indirect and direct dryer humidity during the four days while the dryers were filled with the apple samples.

Table 3: Ambient relative humidity and humidity of direct and indirect dryers

Day	Ambient Relative Humidity (%)	Indirect Dryer Humidity (%)	Direct Dryer Humidity (%)
Day 1	38.299	45.668	26.618
Day 2	38.935	53.969	29.75
Day 3	38.754	42.411	25.400
Day 4	57.271	35.842	21.416

5.2. Calculation of Drying Effectiveness of the Solar Tent Dryers

Totally four calculations were done. The first two calculations were done to replicate the data collection, where the middle tray inside of both dryers contained only three samples which were used for weighting and moisture content test. That means, the solar dryer was not fully filled with apples and the drying effectiveness is different from the dryer being fully filled with the apples which was calculated afterwards.

Experiment effectiveness calculations

During the experiment both solar dryers had 224 apple samples inside. The top rack had 71 samples, the middle rack had 3 samples used for the tests and the biggest bottom rack had 150 samples. The total weight of the 224 samples at the beginning of the

measuring in the direct solar tent dryer was 1.903 kg (sample average 8.497 g), in the indirect solar tent dryer the total weight was 1.938 kg (sample average 8.655 g). The final weight of the samples in direct solar dryer was 275.968 g and in indirect solar dryer it was 303.744 g. The W (moisture evaporated) is 1.634 kg for the indirect solar dryer and 1.627 kg for the direct solar dryer.

The average temperature inside of the direct solar dryer was 37.57 °C and 27.50 °C for the indirect solar dryer. These values were used to calculate the latent heat of vaporization of water which was 2411.8 kJ/kg in case of the direct solar dryer and 2435.8 kJ/kg in case of the indirect solar dryer.

To calculate total daily insolation incident upon collector solar radiation was measured with average of 539.431 W/m² and converted to J/m² with knowing how much time the dryer was exposed to the solar radiation which was 35040 seconds for the direct solar dryer and 43710 seconds for the indirect solar dryer. These two values are average drying times taken from two data collections which were done during the experiment.

The area of the collector was 140x140 cm which is 1.96 m².

Calculation for the direct solar dryer during the experiment:

$$\eta_d = 1.627 \times 2411.8 / 18901 \times 1.96$$

$$\eta_d = 3923.998 / 37045.96$$

$$\eta_d = 10.59 \%$$

Calculation for the indirect solar dryer during the experiment:

$$\eta_d = 1.634 \times 2435.8 / 23578 \times 1.96$$

$$\eta_d = 3980.097 / 46212.88$$

$$\eta_d = 8.61 \%$$

Solar tent dryer full potential effectiveness calculations

During the experiment the tent was not fully filled with apples. The full capacity of the dryer is 332 apple samples, which is 108 samples more than it was during the data collection. The total weight of all apple samples would be 2.821 kg in the case of the direct solar dryer with the same average sample weight of 8.497 g as it was during the

data collection, and 2.873 kg in the indirect solar dryer (average sample weight 8.655 g). The final weight in the indirect solar dryer would be 409.024 g and 450.192 g for the direct solar dryer. Moisture evaporated in the indirect solar dryer would be 1.634 kg and in the direct solar dryer it would be 1.627 kg.

The rest of the values would be the same as for the previous calculations.

Calculation of the full potential of the direct solar dryer:

$$\eta_d = 2.370 \times 2411.8 / 18901 \times 1.96$$

$$\eta_d = 3923.998 / 37045.96$$

$$\eta_d = 15.42 \%$$

Calculation of the full potential of the indirect solar dryer:

$$\eta_d = 2.464 \times 2435.8 / 23578 \times 1.96$$

$$\eta_d = 3980.097 / 46212.88$$

$$\eta_d = 12.98 \%$$

5.3. Color and appearance test

Table 4: Color measurements

Sample Number	L (mean)	a (mean)	b (mean)
582 (indirect)	66.844	12.18	56.598
839 (direct)	71.952	11.905	58.678
964 (direct)	70.636	12.34	58.766
173 (indirect)	73.162	12.075	60.278

Table 4 shows color measurements for all four groups of the apple samples from both solar dryers. 582 and 964 are groups of samples from the direct solar dryer, 839 and 173 are groups of samples from the indirect solar dryer. The lowest *L (mean)* values were measured within samples 582 which was the indirect solar dryer group while the highest was recorded for the group 173 which was also the indirect solar dryer group. The *a (mean)* values were the highest and lowest for both direct solar dryer sample groups, while indirect solar dryer produced samples with similar *a* value (12.18 and 12.075). The *b (mean)* values were similar to *L* values, the highest and the lowest were recorded for groups 582 and 173, both from the indirect solar dryer.

Sensory analysis evaluation contained one question about the color of the samples. The results are shown in Table 5 for the sensory evaluation and Table 6 for ANOVA. There was no significant color change when comparing samples from the two types of dryers (seen in

Table 6 where $p = 0.284$).

5.4. Sensory analysis evaluation

The taste test was carried out in the faculty of Tropical AgriSciences in one of the labs with a special room for sensory analysis. During those two days, 14 people with previous experience and training took part in tasting. The table below shows the averaged results from the participants (10 being the highest score, 1 being the lowest). Two samples were taken from an indirect solar dryer and two from a direct solar dryer. As seen in Table 6, there was no significant difference in any variable between samples from direct and indirect solar dryer (the level of significance for each variable is greater). The biggest difference, yet still not significant, can be seen within the aroma variable.

Table 5: Average sensory evaluation results for each sample (1 is the lowest score, 10 is the highest)

	582 (Indirect)	173 (Indirect)	839 (Direct)	964 (Direct)
Appearance	6.4	6.5	6.63	6.5
Color	7.27	7.19	7.18	7.30
Aroma	6.02	6	5.92	6.1
Taste	7.1	6.92	6.9	6.90
Texture	6.78	6.68	6.79	6.72
Toughness	7.71	6.63	6.74	6.58
Overall Acceptability	6.95	6.88	6.92	6.87

Table 6: ANOVA for sensory analysis

		Sum of Squares	df	Mean Square	F	Sig.
appereance	Between Groups	7,143	1	7,143	2,012	,162
	Within Groups	191,714	54	3,550		
	Total	198,857	55			
color	Between Groups	3,018	1	3,018	1,173	,284
	Within Groups	138,964	54	2,573		
	Total	141,982	55			
aroma	Between Groups	14,000	1	14,000	3,046	,087
	Within Groups	248,214	54	4,597		
	Total	262,214	55			
taste	Between Groups	6,446	1	6,446	1,766	,189
	Within Groups	197,107	54	3,650		
	Total	203,554	55			
texture	Between Groups	3,500	1	3,500	1,075	,304
	Within Groups	175,857	54	3,257		
	Total	179,357	55			
toughness	Between Groups	6,446	1	6,446	1,782	,188
	Within Groups	195,393	54	3,618		
	Total	201,839	55			
overall acceptability	Between Groups	2,161	1	2,161	,916	,343
	Within Groups	127,393	54	2,359		
	Total	129,554	55			

6. Discussion

The developing countries still face numerous challenges in food production chain and unfortunately massive food losses. Poor food handling practices, pre and post-harvest practices also play vital roles in food losses. Farmers need to be educated and introduced to new approaches. One of the preservation techniques which is relatively affordable is solar drying, which uses sun to remove moisture out of the products. As was previously mentioned, it is crucial to choose the right method which is affordable and efficient. Food losses during post-harvest practices are not helping against food hunger in the developing countries. For those reasons, many researches were conducted on this topic, indicating that these dryers might be solution for some of those challenges.

The calculations of the drying effectiveness were done both for the drying during the experiment but also for the full dryer potential while filled fully with a food product. From the graphs and total drying times, it is visible that the direct solar dryer was able to dry apples faster. During the first batch of drying, total drying time of the direct dryer was 9 hours and 21 minutes, whereas the total drying time of the indirect dryer was 13 hours and 17 minutes. The effectiveness calculated for direct solar dryer was 10.59 % and the result from the indirect solar dryer was 8.61 %. The difference of effectiveness is 1.98 % which makes the direct solar dryer more effective. The calculation for the full potential further supported the dominance of the direct solar dryer. The effectiveness of direct dryer was 15.42 % and 12.98 % for the indirect solar dryer, making the direct dryer 2.44 % more effective.

All dryers are a little bit different with different advantages and disadvantages. Small-scale dryers are even more unique as they are mostly tailored to fit local conditions and needs. The comparison of solar tent dryers was done with four different small-scale

dryers, one used to dry figs in Morocco, the second was used to dry maize in Zimbabwe, the third was drying onions in India, and the last was also in India but dried apples. The dryers were built to improve the quality of the produce and lower post-harvest losses by preserving the food. They were also all built in an affordable manner.

The fig dryer was able to evaporate half of the water content during the first 50 hours of drying and average time to reach final moisture content in average was 102 hours (Noutfia et al. 2018). The figs contain more water than apples, but the drying time of the fig dryer compared to the solar tent dryer is five times longer, unfortunately the study did not provide the drying effectiveness calculation. The maize dryer in Zimbabwe had a little bit bigger capacity of 1500 kg of maize and was able to dry maize within 8 hours from 25 % to 12.5 % (Muusha et al. 2022). The maize dryer compared to the solar tent dryers has bigger capacity, which is beneficial to dry more food at the same time. The onion dryer had three different modes of use. The sun drying of onions took 15 hours to reach final moisture, the first mode lowered the drying time by 70.47 %, second by 45.75 % and the last mode by 21.5 % (Bhange et al. 2023). The onion dryer compared to the solar tent dryer has different modes of operation while the solar tent dryers do not have any modes and cannot be controlled which can be a drawback compared to the onion dryer, but in the right conditions the simplicity of the solar tent dryers would be more beneficial than more complicated small-scale dryers. After all the dryers must be easy to fix and to operate.

Another dryer experiment was carried out in Thanjavur, India to dry apples. The dryer used for the experiment was an evacuated tube collector based solar dryer. The samples were also thinly sliced. The solar radiation during the experiment varied from 206 to 1051 W/m² and the temperature inside of the drying chamber was 36 to 59 °C. The drying chamber was filled with 200 grams of apples. The dryer was able to dry apples to 1.5 % (wb) moisture content in five hours, with the efficiency of 16.05 % (Veeramani et al. 2017).

In Thailand a small-scale solar dryer was built by Tarigan in 2007. The dryer was using a biomass burner and heat storage back-up heater. The capacity of the dryer is unknown, but the dimensions are bigger than the solar tent dryers. The biomass burner dryer could store energy to continue drying during night which compared to solar tent

dryers is a big advantage but at the same time the run cost increases due to cost of the firewood.

In 2005 a solar dryer was built by Bolaji from inexpensive local available materials to make it affordable. The product tested during the experiment were yam chips (4mm average thickness), the weight was measured before and after drying every hour. The drying rate was 0.46 kg/h which is system efficiency of 59 %. The average temperature recorded inside of the dryer was 47.3 °C (Bolaji et al. 2005). A more efficient direct tent solar dryer averaged temperature of 37.57 °C during the data collection, which is 10 °C less, which can affect effectiveness of the dryer. Full potential in the conditions during the data collection the direct solar tent dryer would have effectiveness of 15.42 %, which is less than the dryer built by Bolaji in Thailand conditions.

It is difficult to compare different small-scale dryers because of different ambient conditions and different produce with different moisture contents and final moisture values. The aforementioned small-scale dryer project in Thanjavur, India could serve as a good comparison to our solar tent dryers. The dryer was able to dry the apples within five hours with the effectiveness of 16.05 %, which is both faster and more effective than in case of the solar tent dryers, but at the same time the dryer was more advanced, more expensive to build and repair which can be crucial for the farmers while choosing the optimal solar dryer. The effectiveness of the dryers differs by 0.63 %, and considering the higher cost, this fact might make farmers pick the solar tent over the more expensive dryer. The difference would be more significant factor if the production was commercial or in bigger scale.

Compared to the different small-scale dryers, the solar tent dryer offers an affordable price, both for initial investment but also for the operation cost and possible replacements of the dryer parts. Another important advantage is the possibility to move the dryer from place to place, which can be utilized in many ways and make drying easier. For example, instead of transporting produce and risking losses during transportation, the dryers can be transported to the field and used right after the harvesting or after pre-treatment right after the harvest. According to the FAO, in 2021 APHLIS reported post-harvest losses in Ethiopia of 17.6 % for maize, 14.1 % for wheat and other products (FAO, 2023). Due to the dried products losing size and weight, and because of that more produce can be transported at once, the transport will be cheaper as well. Dried products might

also skip the fresh produce storage phase, which is not only expensive to maintain, but also brings a great risk for contamination with following losses.

The data collection was done in seven days during summertime in Prague, to get as close as possible to weather in developing countries, mainly countries with better weather conditions for drying. The first three days with empty dryers already provided information that direct solar drier (white dryer) might be a more effective option, which was already proven during the first day of data collection. It maintained higher temperatures while humidity was significantly lower than in case of indirect solar drier which are two important values for drying. Air flow was similar in both cases, the data were collected at the same time. The same photovoltaic panels and fans were used, so there should not be any major difference. During the first day, average samples from indirect solar dryer lost 63.26 % of weight while samples from direct solar dryer lost 80.92 %, which is considered as a safe value for final dried apples products. The second day the samples from direct solar dryer lost another 1.97 % of its weight after an hour and 51 minutes. The indirect solar dryer was drying for another 5 hours and 47 minutes and the samples lost 19.18 % with final moisture content of 19.090 % while it took less time for direct solar drier to reach 12.189 % final moisture. This indicates that the direct solar dryer is more effective than the indirect solar dryer, due to the fact the direct solar dryer was able to reach lower final moisture content in less time. The second batch of apples and data collection further supported the results from previous days. During the first day and within the same time frame, indirect solar dryer lost on average 67 % of the sample weight, in comparison to the direct solar dryer, that lost 78.82 % of sample weight on average. The goal of the second batch was to reach lower final moisture in the samples (below 10 %), which took more time than in the case of the first batch, where samples from indirect solar dryers were under 20 %. The end of the measuring was at 12 AM for indirect solar dryer and 11:07 AM for direct solar dryer with is only 53 minutes of a difference. The difference in final moisture in average was also not significant, as the black dryer value was 9.406 %, while white dryer averaged 8.822 %.

The sensory analysis contained six questions and 14 participants took part in the sensory analysis during the two days. The results did not provide any significant differences between samples and dryers in any measured variable, which was also supported by the results from ANOVA analysis. All apple samples were dried in the exact

same weather conditions, and the total drying times were several hours apart. Also, the samples were stored in the same conditions in vacuum sealed plastic bags and the same room and a cabinet. Both drying times and the same storage conditions resulted in similar samples properties.

7. Conclusions

The data collection has provided enough data that allows for a robust comparison of both dryers, which might be suitable choices for small-scale farmers. Out of the two options, the direct dryer performed better than the indirect solar dryer, achieving notably faster drying times. Because of that reason, the direct solar dryer makes more sense to be adopted and used in the real-world scenarios. The sensory analysis results indicated that the varying drying times did not significantly impact any of the parameters associated with drying apples. In fact, both batches and samples from both dryers yielded remarkably similar results. Both dryers would be able to produce similar products, and drying times did not affect the products.

The solar tent dryers' performance would be different if the experiment was done in a place with longer sunlight hours and different weather conditions. The system efficiency would be higher and the drying times would decrease.

The solar tent dryers might not be the fastest dryers but are effective enough to dry the products in decent time frames. The biggest advantage of these dryers is affordability which is very important especially for small-scale farmers, availability of the parts and price of the parts, and possibility of the dryer being moved from place to place, creating a helpful and suitable solution for farmers in developing countries.

References

- Abass AB, Ndunguru G, Mamiro P, Alenkhe B, Mlingi N, Bekunda M 2014. Post-harvest food losses in a maize-based farming system of semi-arid savannah area of Tanzania. *Journal of Stored Products Research*. DOI: 10.1016/j.jspr.2013.12.004.
- Abbasi S, Azari S 2009. Novel microwave-freeze drying of onion slices. *Journal of International Food Science and Technology* 44. DOI: 10.1111/j.1365-2621.2008.01774.x.
- Abedin M, Rahman M, Mia M, Rahman K 2012. In-store losses of rice and ways of reducing such losses at farmers' level: An assessment in selected regions of Bangladesh. *Journal of the Bangladesh Agricultural University* 10(1). DOI: 10.3329/jbau.v10i1.12105.
- Adeyeye SAO, Ashaolu TJ, Babu A 2022. Food Drying: A Review. *Agricultural Reviews*. DOI: 10.18805/ag.R-2537.
- Adeyeye SAO, Oyewole OB 2016. An overview of traditional fish smoking in Africa. *Journal of Culinary Science & Technology* 14(2). DOI: 10.1080/15428052.2015.1102785.
- Ahmed V 2023. Preserving the harvest: The importance and techniques of post-harvest technology. *Journal of Agricultural Science and Botany* 7(2). DOI: 10.35841/2591-7366-7.2.175.
- Akter T, Sharna TH, Saha CK 2022. Evaluation of solar tunnel dryer for drying of cabbage. *Journal of the Bangladesh Agricultural University* 20(3). DOI: 10.5455/JBAU.102921.
- Al-Juamili KEJ, Khalifa AJN, Yassen TA 2007. Testing of the performance of a fruit and vegetable solar drying system in Iraq. *Desalination* 209(1-3). DOI: 10.1016/j.desal.2007.04.026.
- Ampratwum DB, Dorvlo ASS 1998. Evaluation of a solar cabinet dryer as an air-heating system. *Journal of Applied Energy* 59(1). DOI: 10.1016/S0306-2619(97)00043-3.

Arata A, Sharma VK 1991. Performance evaluation of solar assisted dryers for low temperature drying applications-I. Plants description. *Renewable Energy* 1(5-6). DOI: 10.1016/0960-1481(91)90020-P.

Arunsandeep G, Lingayat A, Chandramohan VP 2018. A numerical model for drying of spherical object in an indirect type solar dryer and estimating the drying time at different moisture level and air temperature. *International Journal of Green Energy* 15(3). DOI: 10.1080/15435075.2018.1433181.

Ayrosa ANAMIB 2013. Influence of plate temperature and mode of rehydration on textural parameters of precooked freeze-dried beef. *Journal of Food Processing and Preservation* 27(3). DOI: 10.1111/j.1745-4549.2003.tb00510.x.

Ayua E, Mugalavai V, Simon J, Wller S 2017. Comparison of a mixed modes solar dryer to a direct mode solar dryer for African indigenous vegetable and chili processing. *Journal of Food Processing and Preservation* 41(6). DOI: 10.1111/jfpp.13216.

Babic M 2020. Advantages and disadvantages of direct and indirect drying of mercantile grain and seeds. *Journal of Processing and energy in Agriculture* 24(2). DOI: 10.5937/jpea24-29698.

Baker CGJ (1997) *Industrial Drying of Foods*. Springer Science & Business Media. 309 p.

Balachandran KK. 2001. *Post-harvest technology of fish and fish products*. Daya Books, Daryaganj, Delhi, India.

Baloch UK (2010) *Wheat: Post-Harvest Operations*; Lewis, B., Mejia, D., Eds.; Pakistan Agricultural Research Council: Islamabad, Pakistan. pp. 1–21.

Belessiotis V, Delyannis E 2011. Solar drying. *Journal of Solar Energy* 85(8). DOI: 10.1016/j.solener.2009.10.001.

Belessiotis V, Delyannis E 2011. Solar drying. *Solar Energy*. DOI: 10.1016/j.solener.2009.10.001.

Bennamoun L 2013. Integration of Photovoltaic Cells in Solar Drying Systems. *International Journal of Drying Technology* 31(11). DOI: 10.1080/07373937.2013.788510.

- Bennett A, Hudson JR 1954. Study of methods for determination of moisture in malt. *Agricultural and Food Sciences*. DOI: 10.1002/J.2050-0416.1954.TB02745.X.
- Bhange S, Sanjay S. 2023. Performance Evaluation of y Hybrid Solar Dryer for Onion. 38th NCMC 2023. Nagpur, India.
- Billiris MA, Siebenmorgen TJ, Mauromoustakos A 2011. Estimating the theoretical energy required to dry rice. *Journal of Food Engineering* 107(2). DOI: 10.1016/j.jfoodeng.2011.06.015.
- Blahovec J. 2007. Role of water in food and product texture. *Journal of International Agrophysics* 21(3): 209-215.
- Borquez R, Melo D, Saavedra C 2014. Microwave-vacuum drying of strawberries with automatic temperature control. *Food and Bioprocess Technology* 8(2). DOI: 10.1007/s11947-014-1400-0.
- Boxall R 2002. Damage and loss caused by the larger grain borer *Prostephanus truncatus*. *Journal Integrated Pest Management*. DOI: 10.1023/A:1026397115946.
- Brauw A, Bulte E 2021. Storage and Post-harvest Losses. *African Farmers, Value Chains and Agricultural Development*. DOI: doi.org/10.1007/978-3-030-88693-6_7.
- Brennan JG, Grandison AS (2006). *Evaporation and Dehydration*. *Food Processing Handbook*. Wiley VCH Verlag GmbH and Co. KGaA, Weinheim, Germany. 53 p.
- Burgess GHO, Bannerman AM. 1963. *Fish smoking; a Torry kiln operator's handbook*. Her Majesty's Stationery Office, Edinburgh.
- Chauhan PS, Kumar A 2016. Performance analysis of greenhouse dryer by using insulated north-wall under natural convection mode. *Energy Reports*. DOI: 10.1016/j.egy.2016.05.004.
- Chirife J, Buera MD 1996. Water activity, water glass dynamics, and the control of microbiological growth in foods. *Critical Reviews in Food Science and Nutrition* 36(5). DOI: 10.1080/10408399609527736.
- Chou SK, Chua KJ 2001. New hybrid drying technologies for heat sensitive foodstuffs. *Journal of Trends in Food Science & Technology* 12(10). DOI: 10.1016/S0924-2244(01)00102-9.

- Chua KJ, Mujumdar AS, Chou SK 2000. Convective drying of banana, guava and potato pieces: Effect of cyclical variations of air temperature on drying kinetics and color change. *Journal of Drying Technology* 18(4-5). DOI: 10.1080/07373930008917744.
- Chung DS, Chang DI 1982. Principles of Food Dehydration. *Journal of Food Protection* 45(1). DOI: 10.4315/0362-028X-45.5.475.
- Doymaz I, Ismail O 2011. Mathematical Modeling and Determination of Effective Diffusivity of Mesquite during Convective Drying. *American Journal of Plant Sciences* 7(6). DOI: 10.1016/j.fbp.2010.03.006.
- Ekechukwu O, Norton V 1999. Dehydration of Agro Products in a Hybrid Solar Dryer Controlled through a Fuzzy Logic System. *International Journal of Modern Nonlinear Theory and Application* 3(3). DOI: /10.1016/S0196-8904(98)00093-4.
- Erkmen O, Bozoglu TF 2016. Food Preservation by Reducing Water Activity. *Journal of Food Microbiology: Principles into Practice* 4. DOI: 10.1002/9781119237860.ch30.
- Fanta SW, Abera M, Aregawi W 2014. Microscale modeling of coupled water transport and mechanical deformation of fruit tissue during dehydration. *Journal of Food Engineering* 124(89-96). DOI: 10.1016/j.jfoodeng.2013.10.007.
- FAO. 2023. Report on pre- and post- harvest crop losses pilot survey (2021-2022). Food and Agriculture Organization of the United Nations and Ethiopian Statistics Service, Rome and Addis Ababa.
- Fellows P. 2017. Food processing technology: principles and practice. Principles and Practice. Woodhead Publishing, California.
- Fontaine J, Ratti C 2007. Lumped-parameter approach for prediction of drying kinetics in foods. *Journal of Food Process Engineering* 22(4). DOI: 10.1111/j.1745-4530.1999.tb00486.x.
- Franzen K, Singh R, Okos M 1990. Kinetics of nonenzymatic browning in dried skim milk. *Journal of Agricultural and Food Sciences* 11(3). DOI: 10.1016/0260-8774(90)90029-8.

- Fróna D., Szenderák J., and Harangi-Rákos M., “The Challenge of Feeding the World,” 2019, doi: 10.3390/su11205816
- Fudholi A, Sopian K, Bakhtyar B, Gabbasa M 2015. Review of solar drying systems with air based solar collectors in Malaysia 51. DOI: 10.1016/j.rser.2015.07.026.
- Fudholi A, Sopian KB, Othman MY 2014. Energy and exergy analyses of solar drying system of red seaweed. *Journal of Energy and Buildings* 68(121). DOI: 10.1016/j.enbuild.2013.07.072.
- Fudholi A, Sopian KB, Ruslan MH 2010. Review of solar dryers for agricultural and marine products. *Journal of Renewable and Sustainable Energy Reviews* 14(1). DOI: 10.1016/j.rser.2009.07.032.
- Garayo J, Moreira R 2002. Vacuum frying of potato chips. *Journal of Food Engineering* 55(2). DOI: 10.1016/S0260-8774(02)00062-6.
- Garg HP, Kumar R 2000. Studies on semi-cylindrical solar tunnel dryers: thermal performance of collector. *Journal of Applied Thermal Engineering* 20(2). DOI: 10.1016/S1359-4311(99)00017-4.
- Gatea AA (2011). Performance evaluation of a mixed-mode solar dryer for evaporating moisture in beans. *Journal of Agricultural Biotechnology and Sustainable Development* 3(4): 65-71.
- Ghnimi S, Abdullah SU, Karim A, Kamal-Eldin A 2016. Date fruit (*Phoenix dactylifera* L.): An underutilized food seeking industrial valorization. *NFS Journal* 6. DOI: 10.1016/j.nfs.2016.12.001.
- Gliessman S 2016. Transforming food systems with agroecology. *Journal of Agroecology and Sustainable Food Systems: 10th Anniversary Collection*. DOI: 10.1080/21683565.2015.1130765.
- Gould GW. 1989. *Mechanisms of action of food preservation procedures*. Elsevier Applied Science, New York.
- Gould WA (1920) *Fundamentals of Food Processing and Technology*. Lutherville Timonium: CTI Publications. 128 p.
- Grabowski S, Ramaswamy HS, Marcotte M 2003. Drying of Fruits, Vegetables, and Spices. *Handbook of Postharvest Technology*. DOI: 10.1201/9780203911310.ch23.

- Hidayat DD, Siregar SHP. 2011. Evaluasi unit proses 'vacum frying'. Skala Industri Kecil Menengah, Indonesia.
- Hii CL, Jangam SV, Ong SP, Mujumdar AS. 2012. Solar drying: fundamentals, applications and innovations. TPR Gr Publ, Singapore.
- Hossen KI, Wellard M, Nagy SA 2016. Investigation of bound and free water in plant-based food material using NMR T2 relaxometry. *Journal of Innovative Food Science & Emerging Technology* 38. DOI: 10.1016/j.ifset.2016.10.015.
- Hui YH, Clary C, Farid MM (2008) *Food Drying Science and Technology. Chemistry, Agricultural and Food Science*. 807 p.
- ILRI. 2010. Demand for pork by Vietnamese consumers: Implications for pro-poor livestock policy and development agenda in Vietnam. Project brief 1. Nairobi, Kenya.
- Inprasit C. 2011. Vacuum frying. Department of Food Engineering, Kasetsart University, Bangkok.
- Ishfaq A, Mabood IQ, Jamal S 2016. Developments in osmotic dehydration technique for the preservation of fruits and vegetables. *Journal of Innovative Food Science and Emerging Technologies* 34. DOI: 10.1016/j.ifset.2016.01.003.
- Janjai S, Lamlert N, Intawee P 2009. Experimental and simulated performance of a PV-ventilated solar greenhouse dryer for drying of peeled longan and banana. *Journal of Solar Energy* 83(9). DOI: 10.1016/j.solener.2009.05.003.
- Joardder MUH, Karim A, Kumar C 2013. Effect of Temperature Distribution on Predicting Quality Of Microwave Dehydrated Food 5. DOI: 10.15282/jmes.5.2013.2.0053.
- Joardder MUH, Karim A, Kumar C, Brown RJ. 2015. *Establishing the Relationship between Drying Parameters and Dried Food Quality*. Springer.
- Joardder MUH, Kumar C, Karim A 2015. Food Structure: Its Formation and Relationships with Other Properties. *Journal of Critical Reviews in Food Science and Nutrition*. DOI: 10.1080/10408398.2014.971354.
- Joardder MUH, Masud M 2019. Effectiveness of Food Preservation Systems. DOI: 10.1007/978-3-030-11530-2_5.

- Joardder MUH, Masud M 2019. State of Bound Water: Measurement and Significance in Food Processing. *Journal of Agricultural and Food Sciences*. DOI: 10.1007/978-3-319-99888-6.
- Joardder MUH, Masud M, Nasif S 2019. Development and performance test of an innovative solar derived intermittent microwave convective food dryer. *AIP Conference Proceedings* 2121(1). DOI: 10.1063/1.5115881.
- Kahyaoglu LN, Sahin S, Sumnu G 2012. Spouted bed and microwave assisted spouted bed drying of parboiled wheat. *Journal of Food and Bio-products Processing* 90(2). DOI: 10.1016/j.fbp.2011.06.003.
- Karim A, Hawlader M 2004. Development of solar air collectors for drying applications. *Journal of Energy Conversion and Management* 45(3). DOI: 10.1016/S0196-8904(03)00158-4.
- Karim A, Hawlader M 2005. Drying characteristics of banana: Theoretical modelling and experimental validation. *Journal of Food Engineering* 70(1). DOI: 10.1016/j.jfoodeng.2004.09.010.
- Kaushal P, Sharma HK 2014. Osmo-convective dehydration kinetics of jackfruit (*Artocarpus heterophyllus*). *Journal of the Saudi Society of Agricultural Sciences* 2(2). DOI: 10.1016/j.jssas.2014.08.001.
- Key RB (1972) *Drying*. University of Canterbury: Pergamon. 358 p.
- Kemp IC 2007. Reducing Dryer Energy Use by Process Integration and Pinch Analysis. *Journal of Drying Technology* 23(9). DOI: 10.1080/07373930500210572.
- Khan MIH, Wellard RM, NAGY SA, Joardder MUH, Karim MA 2011. Investigation of bound and free water in plant-based food material using NMR T2 relaxometry. *Journal of Innovative Food Science & Emerging Technologies* 38(A). DOI: 10.1016/j.ifset.2016.10.015.
- Khan MIH, Wellard RM, NAGY SA, Joardder MUH, Karim MA 2017. Experimental investigation of bound and free water transport process during drying of hygroscopic food material. *International Journal of Thermal Sciences*. DOI: 10.1016/j.ijthermalsci.2017.04.006.

- King CJ 1977. Heat and mass transfer fundamentals applied to food engineering. *Journal of Food Process Engineering* 1(1). DOI: 10.1111/j.1745-4530.1977.tb00168.x.
- Kudra T 2012. Energy Performance of Convective Dryers. *Journal of Drying Technology* 30(11). DOI: 10.1080/07373937.2012.690803.
- Kumar A, Kumar S, Kumar S, Kalita P, Rausch K (2017). Effect of hot air velocity on drying kinetics undergoing str drying of paddy. *International Journal of Science, Environment and Technology* 6(5): 2735-2743.
- Kumar C, Joardder MUH, Farrel TW, Millar GJ, Karim MA 2015. A Mathematical Model for Intermittent Microwave Convective (IMCD) Drying of Food Materials. *Journal of Drying Technology* 34(8). DOI: 10.1080/07373937.2015.1087408.
- Kumar C, Karim MA, Joardder MUH 2014. Intermittent drying of food products: A critical review. *Journal of Food Engineering* 121. DOI: 10.1016/j.jfoodeng.2013.08.014.
- Kumar M, Sansaniwal SK, Khatak P 2016. Progress in solar dryers for drying various commodities. *Renewable and Sustainable Energy Reviews* 55. DOI: 10.1016/j.rser.2015.10.158.
- Kumar R, Mishra AK, Dubey N, Tripathi Y 2007. Evaluation of *Chenopodium ambrosioides* oil as a potential source of antifungal, antiaflatoxigenic and antioxidant activity. *International Journal of Food Microbiology* 115(2). DOI: 10.1016/j.ijfoodmicro.2006.10.017.
- Kumar R, Mishra AK, Dubey N, Tripathi Y 2007. Evaluation of *Chenopodium ambrosioides* oil as a potential source of antifungal, antiaflatoxigenic and antioxidant activity. *International Journal of Food Microbiology* 115(2). DOI: 10.1016/j.ijfoodmicro.2006.10.017.
- Labuza TP, McNally L, Gallagher D 2006. Stability of intermediate moisture foods. 1. Lipid oxidation. *Journal of Food Science* 37(1). DOI: 10.1111/j.1365-2621.1972.tb03408.x.

- Lafarge C, Bard MH, Breuvert A 2008. Influence of the Structure of Cornstarch Dispersions on Kinetics of Aroma Release. *Journal of Food Science* 73(2). DOI: 10.1111/j.1750-3841.2007.00645.x.
- Lewicki PP 1998. Some remarks on rehydration of dried foods. *Journal of Food Engineering* 36(1). DOI: 10.1016/S0260-8774(98)00022-3.
- Lingayat AB, Chandramohan VP, Raju VRK, Meda V 2020. A review on indirect type solar dryers for agricultural crops – Dryer setup, its performance, energy storage and important highlights 258. DOI: 10.1016/j.apenergy.2019.114005.
- Lipinski B, Hanson C, Lomax J, Kitinoja L. 2013. Reducing Food Loss and Waste. Installment 2 of „Creating a Sustainable Food Future“.
- Liu Y, Wang S, and Chen B 2019. Optimization of national food production layout based on comparative advantage index. *Journal of Energy Procedia*. DOI: 10.1016/j.egypro.2019.01.862.
- Loha C, Dar R, Choudhury B 2012. Evaluation of air-drying characteristics of sliced ginger (*Zingiber officinale*) in a forced convective cabinet dryer and thermal conductivity measurement. *Journal of Food Processing and Technology* 3(6). DOI: 10.4172/2157-7110.1000160.
- Mahiuddin M, Khan IH, Kumar C, Rahman MM, Karim MA 2018. Shrinkage of Food Materials During Drying: Current Status and Challenges. *Journal of Comprehensive reviews in food science and food safety* 17(5). DOI: 10.1111/1541-4337.12375.
- Martynenko A, Astatkie T, Riaud N 2017. Driving forces for mass transfer in electrohydrodynamic (EHD) drying. *Journal of Innovative Food Science & Emerging Technology* 43. DOI: 10.1016/j.ifset.2017.07.022.
- Maskan A, Kaya S, Maskan M 2002. Effect of concentration and drying processes on color change of grape juice and leather (pestil). *Journal of Food Engineering* 54(1). DOI: 10.1016/S0260-8774(01)00187-X.
- Masud M, Karim A, Ananno AA, Ahmed A 2020. Sustainable Food Drying Techniques in Developing Countries: Prospects and Challenges. DOI: 10.1007/978-3-030-42476-3.

Masud MH, Akram MW, Ahmed A 2019. Towards the effective E-waste management in Bangladesh: A review. *Journal of Environmental Science and Pollution*. DOI: 10.1007/s11356-018-3626-2.

Masud MH, Joardder MUH, Karim MA 2018. Effect of hysteresis phenomena of cellular plantbased food materials on convection drying kinetics. *Journal of Drying Technology* 37(10). DOI: 10.1080/07373937.2018.1498508.

Mehta BK, Jain SK, Sharma GP 2013. Optimization of Osmotic Drying Parameters for Button Mushroom (*Agaricus bisporus*). *Journal of Applied Mathematics* 3(10). DOI: 10.4236/am.2012.330186.

Meziane S 2011. Drying kinetics of olive pomace in a fluidized bed dryer. *Journal of Energy Conversion and Management* 52(3). DOI: 10.1016/j.enconman.2010.10.027.

Mezrhab A, Elfarh L, Naji H, Lemonnier D 2010. Computation of surface radiation and natural convection in a heated horticultural greenhouse. *Journal of Applied Energy* 87(3). DOI: 10.1016/j.apenergy.2009.05.017.

Morales-Delgado DY, Tellez-Medina DI, Rivero-Ramerez NL (2014). Effect of convective drying on total anthocyanin content, antioxidant activity and cell morphometric parameters of strawberry parenchymal tissue. *Revista Mexicana de Ingeniera Quimica*. 92 p.

Moyano PC, Troncoso E, Pedreschi F 2007. Modeling Texture Kinetics during Thermal Processing of Potato Products. *Journal of Food Science* 72(2). DOI: 10.1111/j.1750-3841.2006.00267.x.

Muhlbauer W 1986. Present status of solar crop drying. *Journal of Energy in Agriculture* 5(2). DOI: 10.1016/0167-5826(86)90013-6.

Muusha P, Mhlanga S, Sarema B. 2022. Design of a Small-Scale Solar Maize Dryer. *EuroSun 2022 Conference Proceedings*. Kessel, Germany.

Noutfia Y, Benali A, Alem C 2018. Design of a solar dryer for small-farm level use and studying fig quality. *Journal of Acta Scientiarum Polonorum, Technologia Alimentaria* 17(4). DOI: 10.17306/J.AFS.2018.0599.

Ofor OM. 2011. Traditional Methods of Preservation and Storage of Farm Produce in Africa. Federal University of Technology, Owerri, Nigeria.

- Oguntade AE, Thylmann D, Deimling S. 2014. Post-harvest losses of rice in Nigeria and their ecological footprint. Deutsche Gesellschaft für Internationale Zusammenarbeit (GIZ).
- Oikonomopoulou VP, Krokida MK 2013. Novel aspects of formation of food structure during drying. *Journal of Drying Technology* 31(9). DOI: 10.1080/07373937.2013.771186.
- Pangavhane DR, Sawhney RL 2002. Review of research and development work on solar dryers for grape drying 43(1). DOI: 10.1016/S0196-8904(01)00006-1.
- Patel K, Kar A. 2012. Heat pump assisted drying of agricultural produce - An overview. *Journal of Food Science and Technology* 49(2). DOI: 10.1007/s13197-011-0334-z.
- Patil R, Gawande R 2016. A review on solar tunnel greenhouse drying system. *Journal of Renewable and Sustainable Energy Reviews* 56. DOI: 10.1016/j.rser.2015.11.057.
- Pawar RS, Takwale MG, Bhide VG 1995. Solar drying of custard powder. *Energy Conversion and Management* 36(11). DOI: 10.1016/0196-8904(94)00083-C.
- Pham N, Hossen KI, Joardder MUH. Quality of plant-based food materials and its prediction during intermittent drying. *Journal of Critical Reviews in Food Science and Nutrition* 59(8). DOI: 10.1080/10408398.2017.1399103.
- Pinheiro ACM, Vilas Boas EDB (2010). Prolongamento da vida pós-colheita de bananas-maçã submetidas ao 1-metilciclopropeno (1- MCP): Qualidade sensorial e física. *Ciência e Tecnologia de Alimentos*, Campinas. 6 p.
- Pokharkar SM, Prasad S. 1998. Mass transfer during osmotic dehydration of banana slices. Association of Food Scientists and Technologists, Mysore, India.
- Prosapio V, Norton I, Marco I 2017. Optimization of freeze-drying using a Life Cycle Assessment approach: Strawberries' case study. *Journal of Cleaner Production*. DOI: 10.1016/j.jclepro.2017.09.125.
- Prosekov AY, Ivanova SA (2018). "Food security: The challenge of the present," *Geoforum*. pp. 73–77.

- Radhika GB, Satyanarayana SV, Rao DG, Raju BV (2011) Mathematical model on thin layer drying of finger millet (*Elusine coracana*). *Advanced Journal of Food Science and Technology* 3. 131 p.
- Rathore NS, Panwar NL 2010. Experimental studies on hemki cylindrical walk-in type solar tunnel dryer for grape drying. *Journal of Applied Energy* 87(8). DOI: 10.1016/j.apenergy.2010.03.014.
- Reyes A, Alvarez PI, Marquardt FH 2002. Drying of carrots in a fluidized bed. I. Effects of drying conditions and modelling. *Journal of Drying Technology* 20(7). DOI: 10.1081/DRT-120005862.
- Robertson GL 2011. Packaging and food and beverage shelf life. In: *Food and beverage stability and shelf life*. Journal of Woodhead Publishing in food science, technology, and nutrition 210(7). DOI: 10.1016/B978-1-84569-701-3.50007-4.
- Sa-adchom P, Swasdisevi T, Nathakaranakule, A, Soponronnarit S 2011. Drying kinetics using superheated steam and quality attributes of dried pork slices for different thickness, seasoning and fibers distribution. *Journal of Food Engineering* 104(1). DOI: 10.1016/j.jfoodeng.2010.12.002.
- Sablani SS, Shrestha AK. 2008. A new method of producing date powder granules: Physicochemical characteristics of powder. *Journal of Food Engineering* 87(3). DOI: 10.1016/j.jfoodeng.2007.12.024.
- Sadeghi G, Taheri O, Mobadersani F 2012. New technologies of solar drying systems for agricultural and marine products. *The 1st Middle-East Drying Conference*: 1-6.
- Sagar VR, Kuma S 2010. Recent advances in drying and dehydration of fruits and vegetables: A review. *Journal of Food Science and Technology* 47(1). DOI: 10.1007/s13197-010-0010-8.
- Sarimeseli A 2011. Microwave drying characteristics of coriander (*Coriandrum sativum* L.) leaves. *Journal of Energy Conversion and Management*. DOI: 10.1016/j.enconman.2010.10.007.
- Schubert H 1987. Food particle technology. Part I: Properties of particles and particulate food systems. *Journal of Food Engineering* 6(1). DOI: /10.1016/0260-8774(87)90019-7.

Sensoy I 2014. A Review on the Relationship Between Food Structure, Processing, and Bioavailability. *Journal of Critical Reviews In Food Science and Nutrition* 54(7). DOI: 10.1080/10408398.2011.619016.

Setyawan ADWI, Sugiyarto S, Susilowati ARI. 2013. Physical, physical chemistries, chemical and sensorial characteristics of the several fruits and vegetables chips produced by low-temperature of vacuum frying machine. *Nusantara Bioscience*.

Shah D (2013) Assessment of Pre and Post Harvest Losses in Tur and Soyabean Crops in Maharashtra; Agro-Economic Research Centre Gokhale Institute of Politics and Economics: Pune, India.

Sharma A, Chen CR, Lan NV 2009. Solar-energy drying systems: A review. *Renewable and Sustainable Energy Reviews* 13(6-7). DOI: 10.1016/j.rser.2008.08.015.

Sharma R 2012. Food structures and delivery of nutrients. *Journal of Food Materials Science and Engineering* 8. DOI: 10.1002/9781118373903.ch8.

Shete YV, Chavan SM, Champawat PS, Jain SK. 2018. Reviews on osmotic dehydration of fruits and vegetables. *Journal of Pharmacognosy and Phytochemistry*.

Sisquella M, Viñas I, Picouet P, Torres R, Usall J 2014. Effect of host and *Monilinia* spp. variables on the efficacy of radio frequency treatment on peaches. *Journal of Postharvest Biology and Technology* 87(6). DOI: 10.1016/j.postharvbio.2013.07.042.

Sodha MS, Dang A, Bansal PK, Sharman SB 1985. An analytical and experimental study of open sun drying and a cabinet tire drier. *Journal of Energy Conversion and Management* 25(3). DOI: 10.1016/0196-8904(85)90042-1.

Sontakke MS, Salve SP (2015). Solar Drying Technologies: A Review. *International Refereed Journal of Engineering and Science (IRJES)*. 7 p.

Sukumar N, Biswal BK, Vijayan M 1999. Structures of orthorhombic lysozyme grow at basic pH and its low-humidity variant. *Acta Crystallographica Section D Structural biology*. DOI: 10.1107/s0907444998015522.

Suleiman RA, Kurt RA. 2015. Current maize production, postharvest losses and the risk of mycotoxins contamination in Tanzania; *Proceedings of the American Society*

of Agricultural and Biological Engineers Annual International Meeting; New Orleans, LA, USA.

Sun R, Liu C, Zhang H, Wang Q 2015. Benzoylurea Chitin Synthesis Inhibitors. *Journal of Agricultural Food Chemistry* 63(31). DOI: 10.1021/acs.jafc.5b02460,

Tapondjou L, Adler C, Bouda H, Fontem D 2002. Efficacy of powder and essential oil from *Chenopodium ambrosioides* leaves as post-harvest grain protectants against six-stored product beetles. *Journal of Stored Products Research* 38(4). DOI: 10.1016/S0022-474X(01)00044-3.

Tefera T, Mugo S, Likhayo P 2011. Effects of insect population density and storage time on grain damage and weight loss in maize due to the maize weevil *Sitophilus zeamais* and the larger grain borer *Prostephanus truncatus*. *African Journal of Agricultural Research*.

Toshniwal U, Karale SR 2013. Design of Fruits Solar Energy Dryer under Climatic Condition in Jordan. *Journal of Power and Energy Engineering* 5(2). DOI: 10.4236/jpee.2017.52007.

Tripathy PP, Kumar S 2009. Modeling of heat transfer and energy analysis of potato slices and cylinders during solar drying. *Journal of Applied Thermal Engineering* 29(5-6). DOI: 10.1016/j.applthermaleng.2008.04.018.

Vasa L, Angeloska A, Trendov NM 2017. Comparative analysis of circular agriculture development in selected Western Balkan countries based on sustainable performance indicators. *Journal of Economic Annals-XXI* 168(11-12). DOI: 10.21003/ea.V168-09.

Veerameni PE. 2017. A review of solar dryers for drying agricultural products.

Vijayan S, Arjunan TV, Kumar A 2017. Fundamental Concepts of Drying. *Green Energy and Technology*. DOI: 10.1007/978-981-10-3833-4_1.

Vuppala G, Murthy RK. 2015. Fermentation in food processing. *Journal of Microbiology and Biotechnology*. Andhra Pradesh, India.

Wang H, Zhang M, Zhai G, Jiang H 2012. Comparison of physicochemical and sensory quality of *Lentinus edodes* granular condiment prepared by different prilling

and drying methods. *International Journal of Food Science & Technology*. DOI: 10.1111/J.1365-2621.2012.02968.X.

Wilkins R, Brusey J, Gaura E 2018. Modelling uncontrolled solar drying of mango waste. *Journal of Food Engineering*. DOI: 10.1016/j.jfoodeng.2018.05.012.

Wu F, Groopman JD, Pestka JJ 2014. Public health impacts of foodborne mycotoxins. *Annual Review of Food Science and Technology*. DOI: 10.1146/annurev-food-030713-092431.

Xiao H, Gao Z, Lin H, Yang W 2010. Air impingement drying characteristics and quality of carrot cubes. *Journal of Food Process Engineering* 33(5). DOI: 10.1111/j.1745-4530.2008.00314.x.

Yadav S, Lingayat AB, Chandramohan VP, Raju VRK 2018. Numerical analysis on thermal energy storage device to improve the drying time of indirect type solar dryer. *Journal of Heat and Mass Transfer* 54. DOI: 10.1007/s00231-018-2390-7.

