

Czech University of Life Sciences Prague
Faculty of Engineering

**RESEARCH OF INFLUENCES ON
RETROREFLECTIVITY OF TRAFFIC SIGNS**

Department of Vehicles and Ground Transport

Doctoral Thesis

Ing. Mariia Khrapova

2023

Declaration

I declare that I have worked on my doctoral thesis titled "Research of influences on retroreflectivity of traffic signs" by myself and I have used only the sources mentioned at the end of the thesis. As the author of the doctoral thesis, I declare that the thesis does not break the copyrights of any other person.

NAME AND SURNAME: Ing. Mariia Khrapova

SIGNATURE:

DATE: 20.02.2023

Acknowledgement

I would like to thank doc. Ing. Miroslav Růžička, CSc., for his advice and support during my work on this thesis. I would like to extend my gratitude to my family for their support: Shapovalova Larisa, Khrapova Nina, and Arunov Ray.

Abstract

The retroreflectivity of traffic signs plays a crucial role in ensuring the safety of road users. However, this optical property is highly susceptible to the influence of a range of external factors. The main focus of this study was to investigate the effect of various external factors on the level of retroreflectivity of traffic signs, including accelerated natural weathering, climate conditions, dirtiness, precipitation, exposure to sunlight, the material of the sign panel, measurement conditions and equipment, orientation, and regulations. The study was conducted by formulating and testing 17 hypotheses based on a thorough literature review. The results of this thesis provide valuable insights into the factors that can impact the retroreflectivity of traffic signs and present recommendations for the maintenance and replacement of traffic signs to ensure their adequate visibility.

Keywords: retroreflective sheeting, in-service traffic signs, coefficient of retroreflection, external factors, measurement conditions, a national standard

Abstrakt

Retroreflexní vlastnost dopravních značek hraje zásadní roli při zajišťování bezpečnosti účastníků silničního provozu. Tato optická vlastnost je však velmi citlivá na vliv řady vnějších faktorů. Hlavní náplní této studie bylo zkoumání vlivu různých vnějších faktorů na úroveň retroreflexivity dopravních značek, včetně zrychleného přirozeného zvětrávání, klimatických podmínek, znečištění, srážek, vystavení slunečnímu záření, materiálu podkladu značky, podmínek a zařízení pro měření, orientace a legislativy. Studie byla provedena prostřednictvím formulace a testování 17 hypotéz na základě důkladného přehledu literatury. Výsledky této práce poskytují cenné poznatky o faktorech, které mohou ovlivnit retroreflexivitu dopravních značek, a předkládají doporučení pro údržbu a výměnu dopravních značek s cílem zajistit jejich dostatečnou viditelnost.

Klíčová slova: retroreflexní fólie, dopravní značky v provozu, koeficient retroreflexe, vnější faktory, podmínky měření, legislativa

Table of contents

Declaration	ii
Acknowledgement.....	iii
Abstract.....	iv
Abstrakt	v
Table of contents	vi
List of Figures.....	viii
List of Tables	xi
List of abbreviations	xii
1 Introduction.....	1
2 Overview of the current state of the problem	2
2.1 Target variables	3
2.1.1 Material of the surface of a sign	4
2.1.2 Sign surface damage.....	15
2.1.3 Relative position to the direction of the sun	18
2.1.4 Positioning of traffic signs in various environment	20
2.2 Lighting variables.....	21
2.2.1 Vehicle headlights	21
2.2.2 External contrast.....	22
2.2.3 Internal contrast	26
2.3 Receptor variables	29
2.3.1 Human factor	29
2.3.2 Vehicle camera system.....	33
2.3.3 Position of receptor.....	35
2.4 Legislation	36
3 Goals and Hypothesis	38
4 Materials and Methods.....	40
4.1 Test samples	40
4.2 Study locations	42
4.2.1 In-service traffic signs in Czechia and China.....	42
4.2.2 In-service traffic signs along highways and major arterials.....	43
4.2.3 Retroreflective samples in particular environments.....	44
4.3 Methodology	44
4.3.1 Durability.....	45
4.3.2 Atmospheric characteristics.....	45
4.3.3 Meteorological conditions	45
4.3.4 Exposure to sunlight (UV radiation)	46
4.3.5 Material of sign panel.....	46
4.3.6 Measurement conditions and equipment.....	46

4.3.7	Orientation.....	48
4.3.8	Recognition by the vehicle camera system	48
4.4	Data analysis.....	49
5	Results and Discussions.....	50
5.1	Accelerated natural weathering	50
5.1.1	Degradation of retroreflective materials over time	50
5.1.2	Manufacturer	57
5.1.3	Colour.....	59
5.2	Atmospheric characteristics.....	59
5.3	Dirtiness and precipitation.....	61
5.3.1	Dirtiness.....	62
5.3.2	Precipitation on the surface of the sign	63
5.4	UV radiation	65
5.5	Material of sign panel.....	68
5.6	Measurement conditions and equipment	69
5.6.1	Temperature and relative humidity	69
5.6.2	Retroreflectometers	71
5.6.3	Entrance angles.....	72
5.7	Orientation.....	74
5.8	Recognition by the vehicle camera system	77
6	Conclusions and Recommendations.....	82
6.1	Accelerated natural weathering	82
6.2	Atmospheric characteristics.....	83
6.3	Dirtiness and precipitation.....	84
6.4	Exposure to sunlight.....	85
6.5	Material of the sign panel.....	86
6.6	Measurement conditions and equipment	86
6.7	Orientation.....	87
6.8	Recognition by the vehicle camera system	88
6.9	Recommendation for road agencies	88
	References.....	90
	Appendix A.....	96
	Appendix B	98
	Appendix C.....	99
	Appendix D.....	101

List of Figures

Fig. 1 The principle of retroreflectivity and primary angles.	2
Fig. 2 The hierarchy of factors affecting retroreflectivity.....	3
Fig. 3 The main sign attributes and variables prescribed in the Czech national standard.....	3
Fig. 4 The sketch from the patent that explains the structure of retroreflective elements on the letter "A".	4
Fig. 5 The sketch from the patent that explains the structure of the reflexing lens.....	4
Fig. 6 (Left) An example of cataphotes reflective power on a "Stop" sign. (Right) Single cataphotes	5
Fig. 7 The sketch from the patent that explains the structure of the button copy	5
Fig. 8 The legend of the sign with modified button copy retroreflectors.....	6
Fig. 9 The sketch from the patent that explains the structure of the reflecting surface of the semi-spherical shape.	7
Fig. 10 A sectional view of retroreflective elements	8
Fig. 11 (Left) Roll of flexible retroreflective sheeting. (Right) Sectional view of retroreflective elements	9
Fig. 12 (Left) Schematic cross-sections of the exposed lens. . (Right) The sketch of a sectional view of retroreflective elements embedded in pigment bonding	9
Fig. 13 Schematic cross-sections of the modern enclosed lens.....	10
Fig. 14 Schematic cross-sections of the modern encapsulated lens	11
Fig. 15 (Left) Rear view of reflector embodying. (Right) Example of arrangement of prisms	12
Fig. 16 (Left) Rear view of microprismatic retroreflective material embodying. (Right) A sectional view of the metallised retroreflective material along line 2-2	13
Fig. 17 Sectional view of a structure of encapsulated unmetalled microprismatic sheeting.....	13
Fig. 18 The compartment of active areas in the structure of microprismatic sheeting (Left) and the structure of Diamond Grade DG3 sheeting (Right).	15
Fig. 19 The graph of results from Kirk et al. work that describes the retroreflectivity values against the installation year.....	16
Fig. 20 Dramatic durability difference between two Type III sheetings after accelerated natural exposure in Florida.....	20
Fig. 21 The evolution of headlights	21
Fig. 22 The classification of surrounding luminance	23
Fig. 23 Theoretical correlation between light variables and sign's visual performance	25
Fig. 24 Correct identifications as a function of sign brightness (bright, ultrabright) and background complexity (low, moderate, highest).	26
Fig. 25 Accident contributing factors	29
Fig. 26 Comparison between the visual acuity performance of younger and older subjects	32
Fig. 27 Correlation between detection distance and average visual noise ratio by age	32
Fig. 28 Reaction time as a function of observer age and the visual (background) complexity	33
Fig. 29 An example of the TSDR system. (Left) The detection of traffic signs by a camera. (Right) A pictogram of a recognised traffic sign on dashboard.	34
Fig. 30 Different angles of observation for cars, SUVs and trucks.....	35
Fig. 31 The CIE System for Measuring Retroreflectors.	37
Fig. 32 Representation of the selected five locations in Prague and Horoměřice in the Czech Republic..	42
Fig. 33 Representation of the selected areas in China. (Left) A selected area in Beijing. (Right) A selected area in Shanghai.....	42
Fig. 34 Selected highway sections in China and Czechia. (Left) The road section of Jingling highway in Beijing, in both directions. (Right) The road section of D0 highway in Prague, in both directions	43

Fig. 35 The representation of selected road sections of the Czech Republic	43
Fig. 36 Test desk with the retroreflective sheeting samples on the roof of the Faculty of Engineering, CULS Prague	44
Fig. 37 The front plate of Zehntner ZRS 6060 with the label of the calibration standard (at the top) and calibration standard (at the bottom).	47
Fig. 38 RoadVista 933 Retroreflective Workstation.	47
Fig. 39 The example of measuring report generated in the 'MappingTools'	49
Fig. 40 The screen view of two visualization filters of ADTF	49
Fig. 41 Degradation trends of R_A ($\text{cd}\cdot\text{lx}^{-1}\cdot\text{m}^{-2}$, $\alpha = 0.33^\circ$, $\beta_1 = 5^\circ$) for white glass bead sheeting Class RA1 exposed to accelerated natural weathering	51
Fig. 42 Degradation trends of R_A ($\text{cd}\cdot\text{lx}^{-1}\cdot\text{m}^{-2}$, $\alpha = 0.33^\circ$, $\beta_1 = 5^\circ$) for red glass bead sheeting Class RA1 exposed to accelerated natural weathering	51
Fig. 43 Degradation trends of R_A ($\text{cd}\cdot\text{lx}^{-1}\cdot\text{m}^{-2}$, $\alpha = 0.33^\circ$, $\beta_1 = 5^\circ$) for blue glass bead sheeting Class RA1 exposed to accelerated natural weathering	52
Fig. 44 Degradation trends of R_A ($\text{cd}\cdot\text{lx}^{-1}\cdot\text{m}^{-2}$, $\alpha = 0.33^\circ$, $\beta_1 = 5^\circ$) for white microprismatic sheeting Class RA2 exposed to accelerated natural weathering	52
Fig. 45 Degradation trends of R_A ($\text{cd}\cdot\text{lx}^{-1}\cdot\text{m}^{-2}$, $\alpha = 0.33^\circ$, $\beta_1 = 5^\circ$) for red microprismatic sheeting Class RA2 exposed to accelerated natural weathering	53
Fig. 46 Degradation trends of R_A ($\text{cd}\cdot\text{lx}^{-1}\cdot\text{m}^{-2}$, $\alpha = 0.33^\circ$, $\beta_1 = 5^\circ$) for blue microprismatic sheeting Class RA2 exposed to accelerated natural weathering	54
Fig. 47 Degradation trends of R_A ($\text{cd}\cdot\text{lx}^{-1}\cdot\text{m}^{-2}$, $\alpha = 0.33^\circ$, $\beta_1 = 5^\circ$) for white microprismatic sheeting Class RA3 exposed to accelerated natural weathering	54
Fig. 48 Degradation trends of R_A ($\text{cd}\cdot\text{lx}^{-1}\cdot\text{m}^{-2}$, $\alpha = 0.33^\circ$, $\beta_1 = 5^\circ$) for red microprismatic sheeting Class RA3 exposed to accelerated natural weathering	55
Fig. 49 Degradation trends of R_A ($\text{cd}\cdot\text{lx}^{-1}\cdot\text{m}^{-2}$, $\alpha = 0.33^\circ$, $\beta_1 = 5^\circ$) for blue microprismatic sheeting Class RA3 exposed to accelerated natural weathering	55
Fig. 50 Degradation trends of R_A ($\text{cd}\cdot\text{lx}^{-1}\cdot\text{m}^{-2}$, $\alpha = 0.33^\circ$, $\beta_1 = 5^\circ$) for green microprismatic sheeting Class RA3 exposed to accelerated natural weathering	56
Fig. 51 Magnified images of the microprismatic structure of retroreflective materials Class RA1 (Left), Class RA2 (Center), and Class RA3 (Right).	56
Fig. 52 Comparison of degradation rate in R_A (in %) for white, blue, and red glass bead sheeting Class RA1 from three manufacturers	57
Fig. 53 Comparison of degradation rate in R_A (in %) for white, blue, and red microprismatic sheeting Class RA2 from three manufacturers	58
Fig. 54 Comparison of degradation rate in R_A (in %) for white, blue, and red microprismatic sheeting Class RA2 from three manufacturers	58
Fig. 55 An example of dew (Left) and hoarfrost (Right) on the surface of the traffic sign.	64
Fig. 56 Box plot of degradation rate (in %) for five test groups of red sheeting	66
Fig. 57 Box plot of degradation rate (in %) for five test groups of white sheeting	67
Fig. 58 The degradation trendlines of R_A ($\text{cd}\cdot\text{lx}^{-1}\cdot\text{m}^{-2}$, $\alpha = 0.33^\circ$, $\beta_1 = 5^\circ$) for one white glass-bead Class RA1 sample from four study locations	68
Fig. 59 The box plot of degradation rate of retroreflective sheeting applied on two different panel's material for outdoor exposure without the influence of sunrays for 46 months	69
Fig. 60 Comparison of measured R_A ($\text{cd}\cdot\text{lx}^{-1}\cdot\text{m}^{-2}$, $\alpha = 0.33^\circ$, $\beta_1 = 5^\circ$) of calibration standard with calculated R_A specified by manufacturer	70
Fig. 61 Comparison of retroreflective performance under two different rotation angles (ϵ)	71

Fig. 62 Comparison of the degree of difference in R_A measurements taken with Roadvista 933 and Zehntner ZRS 6060 at various combinations of observation angle, entrance angle, and rotation angle	72
Fig. 63 Comparison of the degree of difference in R_A measurements taken with Roadvista 933 at entrance angles (-4 °, 5 °) and rotation angles (-50 °, -25 °, 25 °, 90 °)	73
Fig. 64 The means and ranges of retroreflective coefficient ($\text{cd}\cdot\text{lx}^{-1}\cdot\text{m}^{-2}$, $\alpha = 0.2^\circ$, $\beta_1 = 5^\circ$) of white microprismatic Class RA3 retroreflective film from BG3 and PD0 highways according to the face orientation of traffic signs (North and South)	74
Fig. 65 Means and ranges of R_A for white microprismatic Class RA2 and RA3 retroreflective materia ..	75
Fig. 66 The box and whisker plot of RDs grouped by the lateral position.....	79
Fig. 67 Demonstration of the issue in recognizing two traffic signs on a single post in three steps	80
Fig. 68 The impact of contrast and coefficient of retroreflection on the recognition distance of a single sign on a slope	81
Fig. B.1 Algorithm for selecting a statistical test to analyse the measurements made in this work.....	81
Fig. C.1 The average high and low temperatures in Beijing and Prague	99
Fig. C.2 2 The average monthly rainfall in Beijing and Prague.....	100

List of Tables

Tab. 1 The predictive models for sign sheeting degradation.	17
Tab. 2 The predictive models for sign sheeting degradation.	17
Tab. 3 Literature review of influence sign's orientation on the retroreflectivity.	19
Tab. 4 Optimal sign's luminance values ($\text{cd}\cdot\text{m}^{-2}$) according to levels of surrounding luminance.	24
Tab. 5 Comparison of types of retroreflective sheeting and the level of ambient luminance based on the standards in the USA.	24
Tab. 6 The comparison of optimal IC values from different studies and works.	27
Tab. 7 The description of participants' characteristics and results of studies examined the influence of human factor on the recognition of traffic signs.	31
Tab. 8 The dimensions of the main vehicle parameters in the context of the receptor position	36
Tab. 9 Retroreflective requirements for new retroreflective sheeting.....	36
Tab. 10 Retroreflective requirements for retroreflective sheeting after outdoor weathering	37
Tab. 11 Range of observation and entrance angles in Chinese and Czech standards	37
Tab. 12 The number of microprismatic (or in brackets, glass bead) retroreflective test samples according to their location, colour and class/type.....	40
Tab. 13 Test samples according to the manufacturer, colour and type	41
Tab. 14 The sample groups for studying the effects of solar radiation depending on location, time of exposure, the material of the sign panel.	46
Tab. 15 Angles for R_A measurements with Zehntner and RoadVista 933 retroreflectometers	48
Tab. 16 Results of Tukey's post hoc test on the influence of three different colours on the degradation rate of retroreflective sheeting exposed to accelerated natural weathering.....	59
Tab. 17 The atmospheric characteristics of Beijing, Shanghai, and Prague for 2018.....	60
Tab. 18 Comparison of R_A values of 3M 3930 blue microprismatic film (RA2) at four locations using Tukey's post hoc test	60
Tab. 19 Comparison of R_A values of 3M 4000 white microprismatic film (RA3) at four locations.....	61
Tab. 20 Comparison of R_A values of 3M 3930 white microprismatic film (RA2) at four locations using Tukey's post hoc test	61
Tab. 21 Comparison of R_A values of 3M 3930 red microprismatic film (RA2) at four locations using Tukey's post hoc test	61
Tab. 22 The results of a one-way repeated measures ANOVA and Tukey's post hoc test for the pairs of conditions WR, AMR, AHR, and AC.....	62
Tab. 23 Results of ANOVA for repeated measures and post hoc test, presented as p-values for pairs of different precipitation on the sign's surface.....	64
Tab. 24 The results of ANOVA tests for red retroreflective sheeting samples, for pairs of groups.....	66
Tab. 25 The results of ANOVA tests for white retroreflective sheeting samples for pairs of groups.....	66
Tab. 26 Results of t-test for independent samples showing main statistical parameters for three factors .	79
Tab. 27 Multifactorial main effect ANOVA results showing the influence of sign surface factors, including area, contrast, and retroreflection coefficient, on statistical parameters	80
Tab. 28 Factorial ANOVA results for interaction between sign surface retroreflection coefficient and contrast.....	81
Tab. C.1 The climatic characteristics of Beijing and Prague.	99
Tab. C.2 One-way ANOVA results for five types of sheeting in four locations	100
Tab. D.1 Paired T-test results for measurements taken with Roadvista 933 and Zehntner ZRS 6060	101

List of abbreviations

AC	artificially cleaned
AD	Avery Dennison
ADAS	advanced driver assistance systems
ADTF	automotive data and time-triggered framework
AHR	after heavy rain
AMR	after moderate rain
ANOVA	analysis of variance
AQI	air quality index
ASTM	American society of testing and materials
B46	samples from a Box after 46 months
<i>BCD</i>	Chaoyang district in Beijing
<i>BG3</i>	Beijing Jingtai highway G3
C	retroreflective internal contrast
<i>Df</i>	degree of freedom
EC	external contrast
EG	Engineer Grade retroreflective sheeting
G46	samples from Garden after 46 months
HI	High Intensity retroreflective sheeting
IC	internal luminance contrast
IS46	in-service signs after 46 months of natural exposure
LC	luminance contrast
MA	two sections of the major arterials, number I/11 and I/35
N	number of samples
η_p^2	Eta squared partial
<i>M</i>	mean
OR	Oralite
<i>P6H</i>	Prague 6 and Horoměřice
<i>PD0</i>	Prague highway D0
R^2	coefficient of determination
R_A	coefficient of retroreflection
RD	recognition distance
<i>SD</i>	standard deviation
SEG	Super Engineer Grade retroreflective sheeting
<i>SSD</i>	Songjiang district in Shanghai
TAS	travel assist system
TD12	samples from the Test desk after 12 months of acceler. natural weathering
TD46	samples from the Test desk after 46 months of acceler. natural weathering
TSDR	traffic sign detection and recognition systems
WR	without rain

1 Introduction

Traffic signs have been acknowledged as an indispensable component in road safety and traffic management. The signs serve as a means of communication between road authorities and road users, conveying essential information and instructions to ensure a safe and orderly traffic flow. Implementing traffic signs is a crucial aspect of road design, as it plays a vital role in preventing accidents, reducing traffic congestion, and improving road user behaviour.

Traffic signs should be visible and legible under all lighting and weather conditions since they guide and warn road users. The retroreflective sheeting is used to ensure the high visibility of traffic signs under low-light conditions, particularly in the absence of street lighting. Nevertheless, the effectiveness of such sheeting may be affected by various factors.

Multiple studies have been conducted worldwide to identify the factors influencing the retroreflective performance of traffic signs. These studies were used to develop national standards for retroreflective traffic signs. However, the legislation governing signs' quality throughout their lifespan differs across countries. For example, there is a standard for new retroreflective signs in the Czech Republic, but no clearly defined program of maintenance and replacement criteria for in-service signs.

The establishment of minimum requirements for in-service traffic signs is a resource-intensive process. It includes identifying the impact of all factors that affect retroreflective performance, which may vary across countries. Furthermore, this research should be ongoing due to the continuous evolution of retroreflective materials and vehicle technology. However, establishing a standard with end-of-service life values is particularly important in the growing use of vehicle camera systems for traffic sign recognition. These systems have the potential to improve road safety by enabling drivers to respond more quickly to changing road conditions.

2 Overview of the current state of the problem

A literature review of this work is intended to analyse existing knowledge of the factors that influence retroreflectivity.

Retroreflectivity is the property of a traffic sign when light rays are reflected in directions close to the direction of the incident rays (Austin and Schultz, 2009; International Commission on Illumination, 2001) (Fig. 1). The coefficient of retroreflection (hereinafter referred to as “ R_A ”) is a measure of retroreflectivity for a traffic sign. According to the International System of Units, the coefficient is expressed in units as candelas per lux per square meter ($\text{cd}\cdot\text{lx}^{-1}\cdot\text{m}^{-2}$).

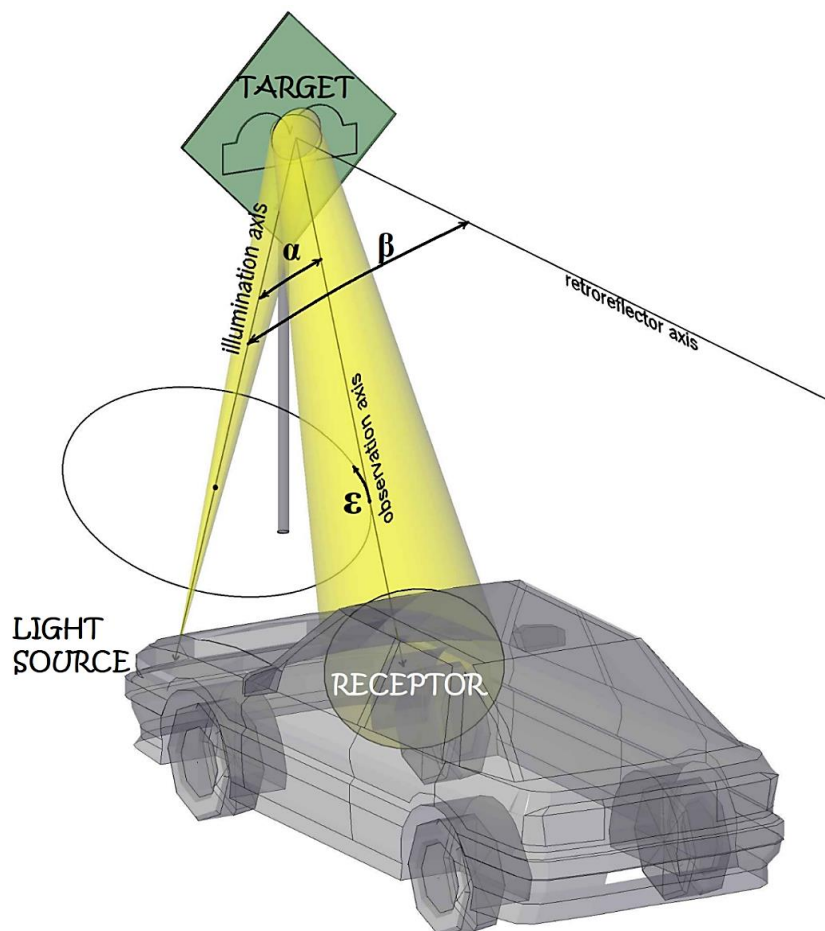

Fig. 1 The principle of retroreflectivity and primary angles. Source: Author's work

A system comprising three primary angles is utilised to describe the retroreflection phenomenon (Fig. 1). These angles are the observation angle (symbolised as " α "), the entrance angle (indicated as " β "), and the rotation angle (represented as " ϵ ").

According to the author of this work, this optical phenomenon can be divided into three components: the light source (the amount of light reaching the sign), the target (the reflective surface) and the receptor (human or camera eye). Consequently, the factors that influence this phenomenon have been classified into three main groups, illustrated in Fig. 2, along with examples of independent factors that can be attributed to the main ones.

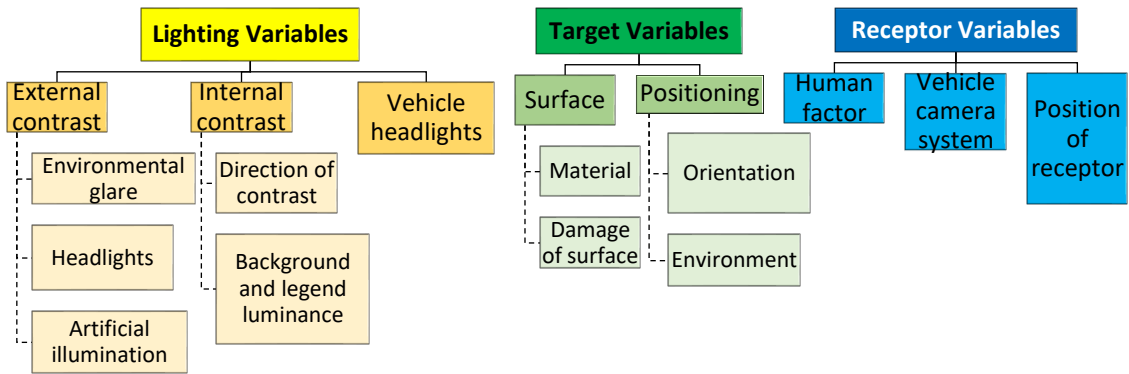

Fig. 2 The hierarchy of factors affecting retroreflectivity. Source: Author's work

During data collection, discrepancies in terminology were identified in scientific literature, so this study adopted a unified terminology (Appendix A) and the European metric system to facilitate the organization of the research.

2.1 Target variables

Some apparent factors influence the sign's retroreflectivity. These include variables such as the size and shape of the background, boulder, and legend; colour scheme; lateral offset and vertical clearance; siting (Fig. 3).

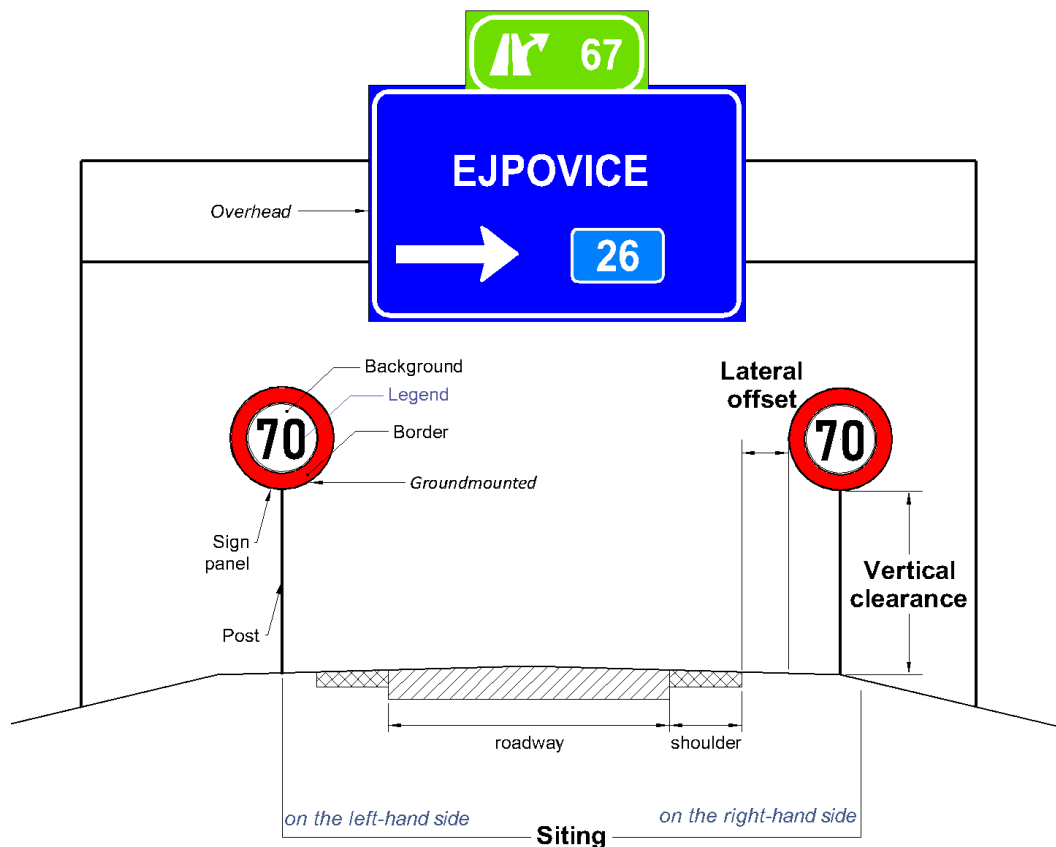

Fig. 3 The main sign attributes and variables prescribed in the Czech national standard. Source: Author's work

The optimal values of these parameters were already prescribed in the relevant documents. They will not be discussed in the literature review due to the limited space and resources. Besides, these factors can be attributed not only to retroreflective signs but also to non-reflective and luminescent (TP 65, 2013).

2.1.1 Material of the surface of a sign

The next chapter is devoted to the history of the development of various retroreflective units and sheeting to demonstrate their advantages and disadvantages.

Individual reflectors

Harry Heltzer is considered the father of retroreflective traffic signs; however, the history of retroreflective elements began long before. It isn't easy to establish the exact date of the creation of the retroreflective elements and their characteristics, as there are not many historical references linked with this topic. Nevertheless, patent documentation from the beginning of the 30th years of the last century has shown the first retroreflectors that could be used for road signs. It was an invention of Philip Sandford, who designed a reflective element which could be used for letters on traffic signs (in 1924). He suggested an individual reflector with a transparent spherical front face (lens) and with six right-angled tetrahedra on the backside (Sandword, 1933) (Fig. 4).

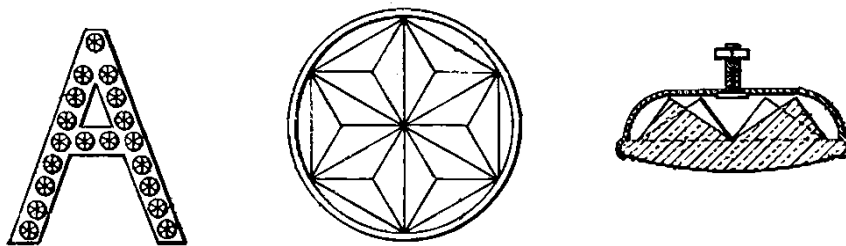

Fig. 4 The sketch from the patent that explains the structure of retroreflective elements on the letter “A”. Source: retrieved from Sandword (1933)

Continuing with the idea of the individual reflective unit, Englishman Murray (Hollins, 1926) created reflexing lens (Fig. 5), which formed the basis for the invention of ‘cat's eyes’ or cataphotes (Fig. 6).

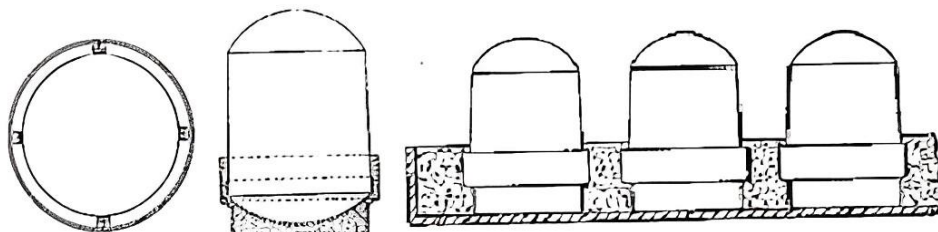

Fig. 5 The sketch from the patent that explains the structure of the reflexing lens. Source: retrieved from Hollins (1926)

The first cataphotes (1933) are associated with Percy Shaw's name (*Reflectors in Traffic*, 2018). The term 'cataphotes' is not commonly used to describe vertical road signing. It is used more commonly for a horizontal signing. However, cataphotes can be considered the first implemented retroreflective units on real traffic signs that began to be mass-produced.

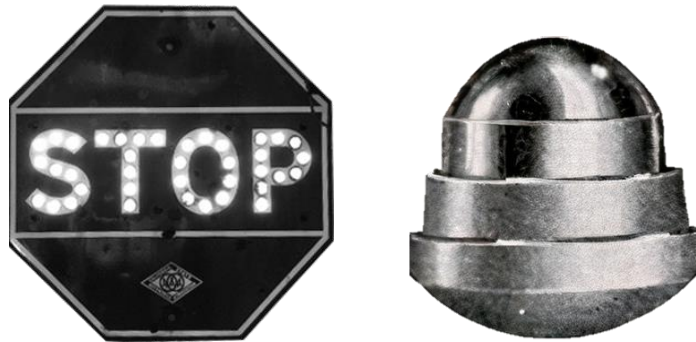

Fig. 6 (Left) An example of cataphotes reflective power on a "Stop" sign. (Right) Single cataphotes. Source: retrieved from *Reflectors in Traffic* (2018)

The implementation of retroreflective elements in the '20s of the last century was confirmed in the second edition of the National Signing Manual containing information on the use of reflecting letters illuminated by headlights of vehicles in 1929 (Hawkins, 1992; *History MUTCD*, 2003) (i.e. the principle of retroreflection).

The method of arranging reflectors in rows to form letters, symbols or borders is known as 'button copy' (*Manual on Uniform Traffic Control Devices for Streets and Highways [MUTCD]*, 1961) (Fig. 7). The **advantage** of these retroreflectors is that a small number of elements at an appropriate distance gives the visual effect of continuous lines or areas of light because of irradiation (scattering of light in the eye) (Olson & Bernstein, 1977). As can be seen from the Fig. 7, large glass spheres (10 to 20 mm in diameter (Lloyd, 2008)) were implemented in the sign surface (Fig.7, 3-3) and protuberances having angular or oblique sides (Fig. 7, 4-4).

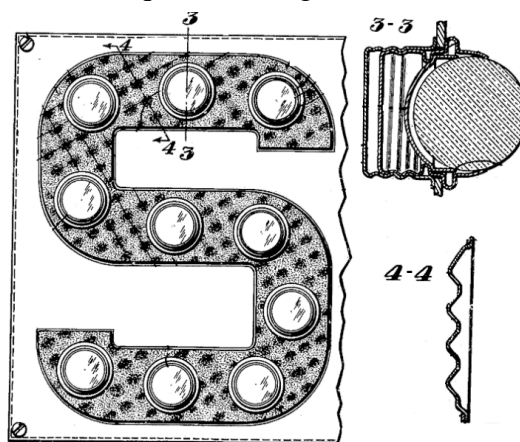

Fig. 7 The sketch from the patent that explains the structure of the button copy. 3-3 is a sectional view of implementing spherical elements, 4-4 is a sectional view of implementing protuberances. Source: retrieved from MacDonald et al. (1933)

The effectiveness of the introduction of the first retroreflectors can be judged from one of the early works in this field – the study of Forbes & Holmes (1940). In their work, they examined the size and type of font for signs with individual reflectors (the suggestion based on the study's time). The study showed that the reflectorised letters are as effective as the floodlighted ones at night against a dark background. However, the authors noticed that such reflectors reduced daytime legibility if the letters were too large (Hawkins, 1992a).

Studies of the second half of the twenties century confirm that the legibility distance for signs with button copy reflectors is longer than for non-reflective traffic signs (Cleveland, 1966; Jones & McNees, 1988). Such signs provide sufficient visibility in some cases, and no additional external lighting is needed (Gordon, 1984).

The button copy became typical for the USA, and inventors tried to improve the structure. Since the 1970s, it was modified, and individual reflectors were made of glass or transparent plastic with lenses or prisms (Fig. 8).

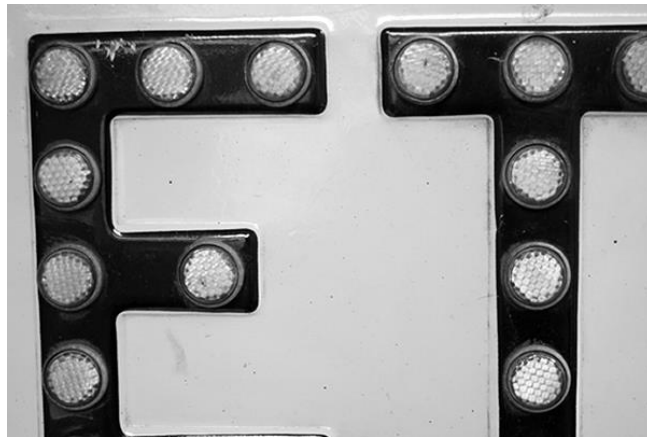

Fig. 8 The legend of the sign with modified button copy retroreflectors. Source: retrieved from Road Traffic Signs (2020)

Richardson (1976) concluded that individual retroreflective units on the legend were superior to cut-out legend against any “background. He explored combinations of button-copy and Type III legends on non-reflective, Type I, and Type III backgrounds¹ (Richardson, 1976). Stein et al. (1989) also compared the night-time performance of overhead guide signs constructed from different materials. The button copy legend was brighter than the Types I, III¹ and IV² sheeting (Stein et al., 1989).

However, the fact that the production of button copies was finished in the 2000s (Road Traffic Signs, 2020) makes it evident that the performance efficiency of button copy was low compared to retroreflective sheeting, which has been significantly improved since the '90s. The main **disadvantage** of ‘buttons’ is – they occupy only about 20 % of the area of a letter (Olson & Bernstein, 1977), which means less than 10 % of the

¹ The I and III type of retroreflective sheeting is discussed in the further chapter “Glass bead”

² The IV type of retroreflective sheeting is discussed in the chapter “Microprismatic”

whole area of the sign reflects the light to the driver (without considering the losses). According to Woltman & Youngblood (1977), button copy is only sufficient at 120 to 180 m (450 to 600 ft).

Another reason for discontinuing the use of the individual units was uneconomic production and maintenance. The non-obvious drawback is the impossibility (or greater complexity) of determining the R_A , which makes it challenging to decide on the maintenance of the sign (Carlson & Hawkins, 2003).

The button copy technology was superseded by sheeting materials, whose technology was the use of glass spheres and microprisms.

Glass bead

According to Lloyd (2008), “in the 1930s”, the first glass ‘beads’ (millimetre diameter spheres) were used on the cinema’s ‘silver screens’ for brighter images by American company Potters. However, these elements were not immediately implemented in road signs.

In 1931, Samuel F. Arbuckle and Guy H. Coulter were the first to emphasise the need to use solid films (coatings) for traffic signs, which not only return light in all directions but also in a narrow range. They explained that “if light deflected backwardly in a zone approximately 25 degrees square, its intensity is increased approximately 50 times” (Arbuckle & Coulter, 1936). The authors also emphasized that creating a continuous band of reflected rays without dark spots is necessary. Furthermore, as a result, as one of the modifications of their invention, they proposed the structure depicted in Fig. 9 that illustrated the reflected surface of the semi-spherical shape disposed of in diagonal rows.

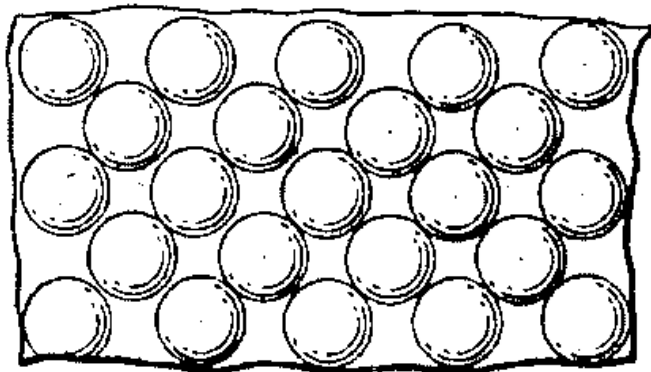

Fig. 9 The sketch from the patent that explains the structure of the reflecting surface of the semi-spherical shape. Source: retrieved from Arbuckle & Coulter (1936)

Inventors described in detail the effect that correctly ordered retroreflective elements could achieve. However, there was no mention of how they might be produced or placed on the road sign's surface. The materials from which the road sign should be made were also not specified.

Several other researchers have made similar findings. Gill (1933) concluded that using smaller ‘reflex-reflecting elements’ was more economical and efficient. Incidentally, it is essential to note that this was the first researcher who used this combination of words. In previous works, the term ‘reflecting’ was only used. Separately from previous authors, he concluded that small elements should be “arranged substantially in contact with each other to avoid the appearance of dark spots” (Gill, 1933). He also mentioned material that can be used - regularly shaped pieces of a transparent material such as glass in the form of spheres, cubes, and cylinders. One of the suggestions was to use spherical elements of 0.8 mm (*1/32 inch*) in diameter. Small glass spheres are half embedded into the enamel or suitable coating on a metal basement of a traffic sign. The sphere is covered by a protective layer made of transparent, colourless material. This technology became a prototype of glass bead sheeting with an enclosed lens and an encapsulated lens that are commonly used nowadays.

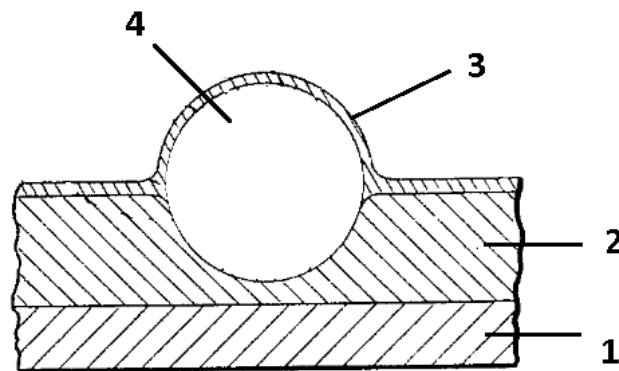

Fig. 10 A sectional view of retroreflective elements. 1 – sign plate, 2 – the enamel layer, 3 – colourless covering, 4 – spherical element. Source: retrieved from Gill (1933)

Despite the above, H. Heltzer is considered the inventor of retroreflective traffic signs (Douglas, 2005; *Reflective Traffic Signs*, 2020, *The science behind reflective traffic signs*, 2012). In 1939, 3M company (before it was Minnesota, Mining & Manufacturing Company) erected on a Minneapolis Street Scotchlite™ Reflective sheeting that Heltzer designed. The main difference from his other inventions was the unit’s technology principle and the easy application of the sheeting on the sign’s surface (Fig.11, Left). The composition of each layer and the sheeting manufacturing are described in his patent in collaboration with John Edmund Clarke (Heltzer & Clarke, 1940).

He invented retroreflective sheeting with partially embedded glass beads into a flexible weatherproof bead-bonding coat (Fig.11, Right). The glass beads might have a diameter of about 0.1 to 0.25 mm, an index of refraction of about 1.0 to 2.0³, and the spheres are embedded to 3/8 to 5/8 of their diameter. The critical improvement was the pigmented sizing film (Fig. 11, Right) (in other variations is reflecting sizing

³ The refractive index for air is around 1.0

film) that has a metallic pigment such as flaked aluminium to make a ‘mirror’ (Heltzer & Clarke, 1940). Nevertheless, the number of reflected rays was not high since it was a thick layer below the spheres.

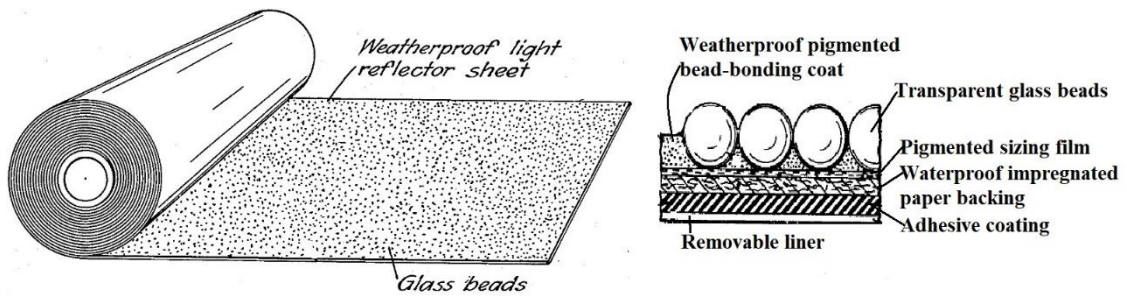

Fig. 11 (Left) A roll of flexible retroreflective sheeting. (Right) A sectional view of retroreflective elements. Source: retrieved from Heltzer & Clarke (1940)

Also, it was a new principle of manufacture where glass beaded retroreflective sheeting might be produced continuously and supplied in rolls. The advantage of sheeting was that it could be easily cut into desired shapes and adhesively united to any desired base or backing. Moreover, according to Heltzer (1940), waterproof bonding allows resisting the combined effects of sunlight, heat, cold, water, varying humidity, and mechanical impact. However, a disadvantage of the sign was found after installation (Heltzer & Clarke, 1940). The exposed beads (without a covering layer) lost all reflectivity in heavy rain, and dirt collected in the tiny spaces between the beads (Lloyd, 2008).

The first improvement was in changing the bonding layer by adding the pigment (aluminium flakes that give a silver colour) (Fig. 12). The combination of ‘silver’ beads and reflectors (glass spheres) constitutes an optical system which reduced the losses of light (Lloyd, 2008).

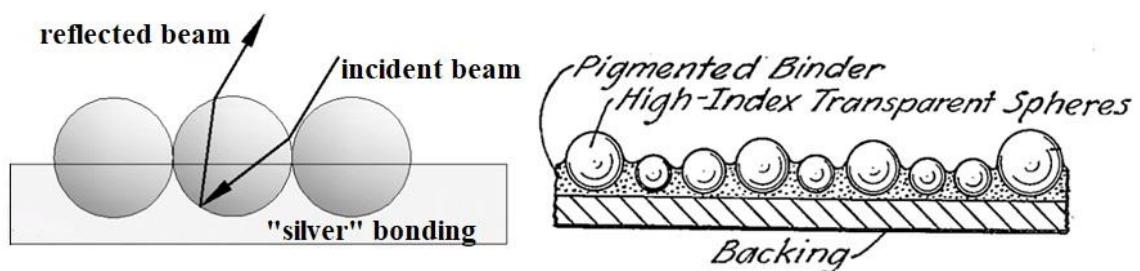

Fig. 12 (Left) Schematic cross-sections of the exposed lens. Source: Author's work. (Right) The sketch of a sectional view of retroreflective elements embedded in pigment bonding. Source: retrieved from Gebhard et al. (1943)

Another improvement was applying a layer of transparent plastic on the beads to fill the crevices between them and produce a smooth glossy top surface. Another improvement was bead adhesive. The final product was named Engineer Grade (hereinafter referred to as “EG”) sheeting and became a commercial sheeting product in 1948. The beads in such sheeting are ‘enclosed’ by a fluid face layer that fills the gaps

between them. The face layer solves the problem of heavy rains and gives a smooth surface to a certain degree (decreasing the influence of dirt). However, the glass beads lose their retroreflective performance because of the additional layer that changes the reflective index. EG is still used, but it has some limitations in some countries. According to the American standard (*ASTM D4956-19, 2019*)⁴, this sheeting refers to Type I. The modern construction of this type of sheeting is represented in Fig. 13.

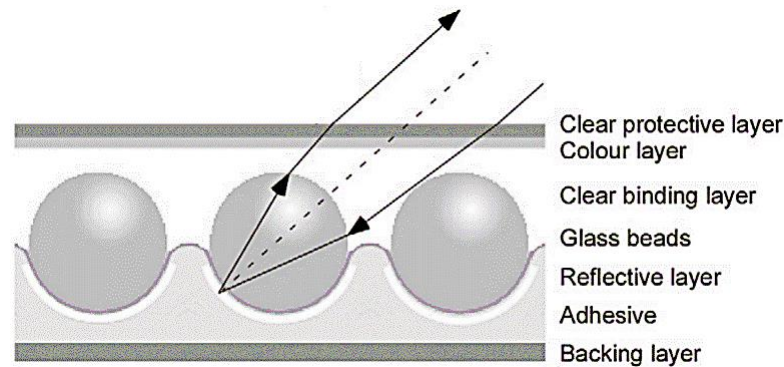

Fig. 13 Schematic cross-sections of the modern enclosed lens.

Source: retrieved from Burgess et al. (2011)

So, the main **advantage** of enclosed lens technology is durability (its ability to withstand rough handling) (*Retroreflective sign sheetings, 2019*). It can be easily cut without harming the structure. The **disadvantages** are low efficiency (returned only 8 % of light as the retroreflected image (Lloyd, 2008)) and big dead spaces between beads.

In order to improve the efficiency, the number and size of glass beads were increased, but the technology is the same as for EG. The new material was named Super Engineer grade (hereinafter referred to as “SEG”) and was enrolled in Type II (*ASTM D4956, 2019*). It uses larger glass beads and provides about twice the level of reflectivity of EG (*Retroreflective Sign Sheetings, 2019*).

In 1971, the High Intensity (hereinafter referred to as “HI”) sheeting was introduced and referred to as Type III (*ASTM D4956, 2019*). It solved the problem with light losses because the melted face layer fills the gaps between the glass beads. That is why the 3M company began to use a thin performed sheet that ‘are standing’ on the ribs (walls) that divided the surface into a honeycomb of small hexagonal pockets (each about 6 mm across) with the beads covering each ‘pocket’ (Lloyd, 2008) (Fig. 14).

Forbes et al. (1976) made a compartment of encapsulated and enclosed retroreflective materials and concluded that the encapsulated glass bead sheeting gave better legibility than the enclosed one. Legibility increased with the logarithm of luminance (of either the legend or background) (Forbes et al., 1976).

⁴ The American standard is used for classification because most works were written in the USA. ASTM D4956 is used because the described classification is the most extended.

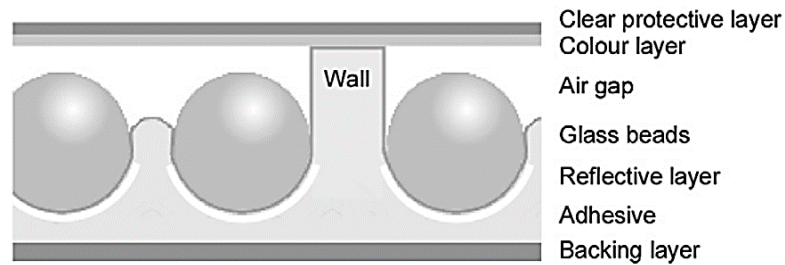

Fig. 14 Schematic cross-sections of the modern encapsulated lens.

Source: retrieved from Burgess et al. (2011)

Woods & Rowan (1976) also made a compartment of these two types of sheeting in conditions with/without external lightning. The authors concluded that HI overhead sign is effective without external illumination when the background brightness is not excessive, and the minimum direct line to the sign is at least 450 m. However, for other conditions and materials, the retroreflectivity was insufficient, which is why the authors recommended using external illumination for overhead signs (Woods & Rowan, 1976).

Robertson & Shelor (1977) compared non-illuminated signs with Type III sheeting and artificially illuminated signs with Type I sheeting. The luminance of the unlit type was inferior to another when the signs were viewed from a single vehicle with low beams. However, the authors believed that the conditions of measurements were atypical because the light was only from one car (Robertson & Shelor, 1977).

Van Noreen (1978b) has not found any difference between signs with HI legend on painted, EG, or HI backgrounds. Furthermore, he concluded that the background retroreflectivity does not influence legibility. However, McNees & Jones (1986) made the opposite conclusion that background materials for signs have a more significant effect on sign legibility than legend material. Also, the authors investigated the legibility distances for different combinations of retroreflective materials in lighted and unlighted conditions. They found that SEG sheeting with button copy and EG sheeting with button copy had the most extended legibility distances in both lighted and unlighted conditions (around 275 m). In lighted conditions combination of sheeting (background + legend) III + III, non-reflective + button copy, I + III, III + button copy, and II + III had the poorest legibility distances (less than 210 m). In unlighted conditions, the worst results were for SEG or EG background with HI legend (McNees & Jones, 1986).

Two years later, in the report made by the same authors, McNees & Jones (1986) concluded that EG sheeting or HI background with button copy on legend provided adequate legibility distances in both lighted and unlighted conditions.

The knowledge that only the changes made to the material's structure could be assumed that HI should have better retroreflective performance than materials invented before. However, from the studies mentioned above, it is evident that Type III sheeting was not competitive for a long time. The author of this work suggests that the imperfect production technology caused it, and only after improving it the HI sheeting showed a high level of retroreflectivity. This hypothesis is confirmed by Stein et al. (1989), where

the authors found that HI sheeting is brighter than type EG sheeting, which is brighter than the porcelain sign material (Stein et al., 1989).

Nowadays, the efficiency of the retroreflective properties was increased, and about 30 % of light reflects from the HI sheeting (Lloyd, 2008). This sheeting is considered the most effective among technologies with glass beads. The main disadvantage of the material is difficulties with cutting the sheeting. When the film is cut, the cells on edge are exposed, and water intrusion can occur if the cell is not sealed using the transparent coating.

Nonetheless, when HI sheeting was established by 3M, the competing company had already prepared the next generation of retroreflective technology.

Microprismatic

The glass sphere relates to the simplest reflector, but only 28 % of the area of its surface sufficiently returns the light at favourable angles (Lloyd, 2008). Therefore, it is unsurprising that another geometric shape has been investigated for retroreflectivity. In addition to spheres, each jeweller knows and uses another form of the geometric body – a prism.

Martinek & Detroit (1934) proposed modified prisms as retroreflectors for traffic signs. They claimed that invention readily to the inexpensive manufacturing process. The glass reflector includes a transparent disk with facets grouped in a three-sided inverted pyramidal configuration, as shown in Fig. 15. The patent also includes the dye description for the casting of the reflector (Martinek & Taylor, 1934). This investigation can be assumed as a prototype for modern micro prismatic retroreflective sheeting.

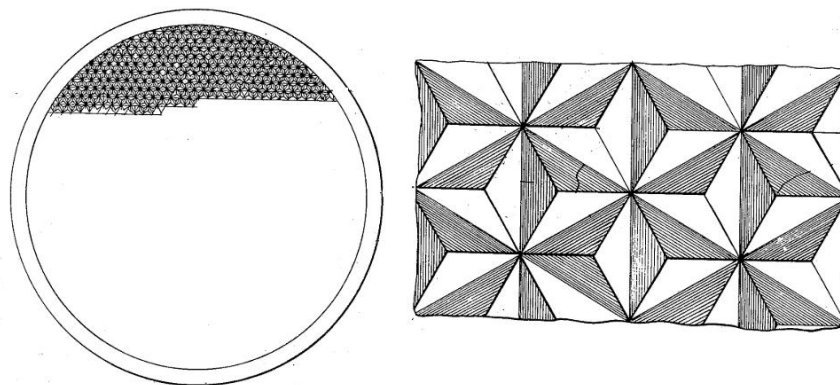

Fig. 15 (Left) Rear view of reflector embodying. (Right) Example of arrangement of prisms. Source: retrieved from Martinek & Taylor (1934)

However, this invention took more than one year to find commercial application. In 1973 Reflexite Corporation (nowadays Orafol) began to sell microprismatic sheeting. The technology was patented by the Rowlands in 1972 (Martinek & Taylor, 1934).

Fig.16 (Left) are represented the system of microprismatic retroreflective material. The cube corner formations with three planar faces are disposed in planes perpendicular to each other and intersecting alongside edges. The investigator indicated

the preferred side edge dimension – not more than 0.25 mm – most desirably on the order of 0.1–0.2 mm.

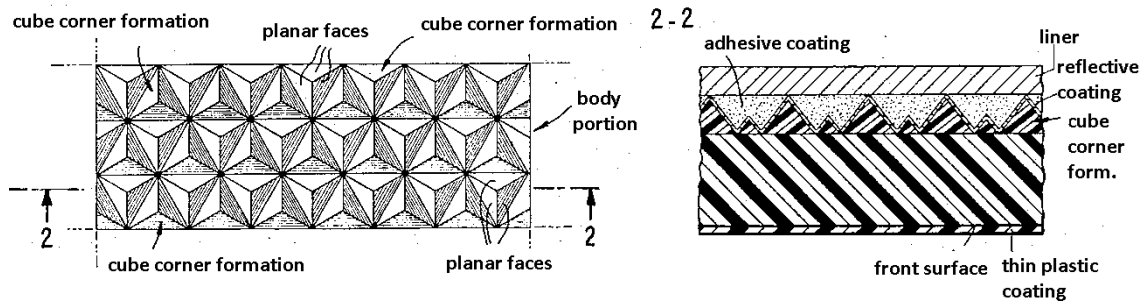

Fig. 16 (Left) Rear view of microprismatic retroreflective material embodying. (Right) A sectional view of the metallised retroreflective material along line 2-2.

Source: retrieved from Martinek & Taylor (1934)

The preferred material is composite retroreflective synthetic plastic. In Fig. 16 (Right), a sectional view shows a reflective coating applied on the surface of the cube corner formations. This layer is metallised to enhance its reflectivity. The adhesive coating is applied to the back, and a release liner is used. It is done by heating, which is why metallised prismatic will not delaminate.

Microprismatic retroreflective sheeting was the first sheeting where the metallised reflective coating was removed. Since the metal layer no longer flowed around the prisms, it was necessary to use an ‘encapsulated’ technology to separate reflective elements from other layers using a wall (or bridge), as shown in Fig. 17.

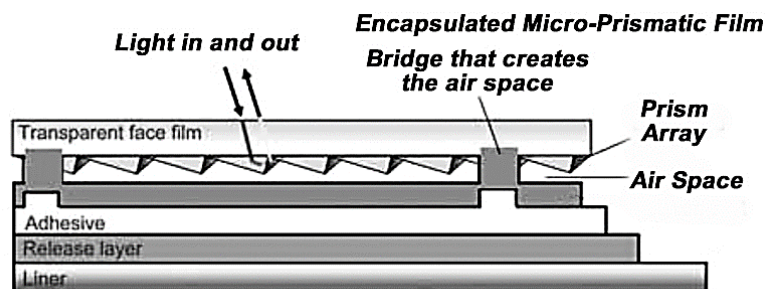

Fig. 17 Sectional view of a structure of encapsulated unmetalled microprismatic sheeting. Source: retrieved from Stein et al. (1989)

Such sheeting was named High Intensity unmetalled microprismatic sheeting, which refers to Type IV according to *ASTM D4956* (2019). It is retroreflective sheeting, typically with unmetalled microprisms (Fig. 17). The **advantage** of not using metallisation of microprism is a vivid colour. The structure uses a white background versus a metallised ‘mirror’ background. However, the **disadvantage** of this type is more prone to delamination.

In the 1970s, new American and Japanese products entered the market with microprismatic retroreflective sheeting. This fact is not surprising since the retroreflective

performance of new materials is ten times higher than for enclosed lenses and four times higher than encapsulated lenses (Stein et al., 1989).

In 1989, 3M company presented the first generation of Diamond Grade L.D.P. (Long Distance Performance) (*Road traffic signs*, 2020). It was developed specifically for use on highways and main arterials, and the signs made from these materials are legible from greater distances (Scukanec et al., 2014). According to *ASTM D4956* (2019), this sheeting refers to Type VIII.

According to Tranchida et al. (1996), there is a statistical difference in legibility distance between Diamond Grade LDP and HI or EG.

In 1994, Then 3M Diamond Grade V.I.P. (Visual Impact Performance) (*Road traffic signs*, 2020). This type of sheeting enables better performance over short distances and is ideal for signs in city traffic (Scukanec et al., 2014). According to *ASTM D4956* (2019), this sheeting refers to Type IX. According to the United States survey, this type of sheeting is the most commonly used retroreflective sheeting for overhead guide sign legends (Obeidat et al., 2014).

The research made by Tranchida et al. (1996) showed similar legibility distances for retroreflective sheeting Type VIII and Type IX.

Zwahlen et al. (2003) evaluated the different retroreflective overhead-sign sheeting combinations. The test-material combinations were compared for lighted and unlighted conditions. The best results in conspicuity and legibility were achieved for a combination of white Type IX legend and green glass bead background of Type III sheeting. The Type VIII legend and Type III glass bead background signs were slightly lower. The combination of Type IX legend on Type IX background received slightly lower results, and the worst combination was the glass bead Type III legend on a beaded Type III background (Obeidat et al., 2014).

In 2005, 3M Diamond Grade DG3 became a sensation in retroreflective sheeting that combined the **best features** of microprismatic technology. This sheeting excludes 'dead corners' at the edges of each cell. It can be used for a traffic sign that should be legible from long and short distances, suitable for both shallow and wide angles. It provides greater retroreflectivity in unfavourable sign positions (e.g. on the right-hand side or over the road), where the light from vehicle headlights is not focused on the sign (King, 2010).

The invention of the new structure achieved advantages. The new prism design was called Full Cube Technology – the ineffective corners are discarded from the basic pyramid unit (Fig. 18). These reflective centres are replicated side by side, creating a 100 % retroreflective surface. This sheeting was referred to as Type XI, and its retroreflective efficiency is around 58 % (*Retroreflective sign sheeting*, 2019).

The price is the **disadvantage** of this sheeting that makes it impossible to use it everywhere.

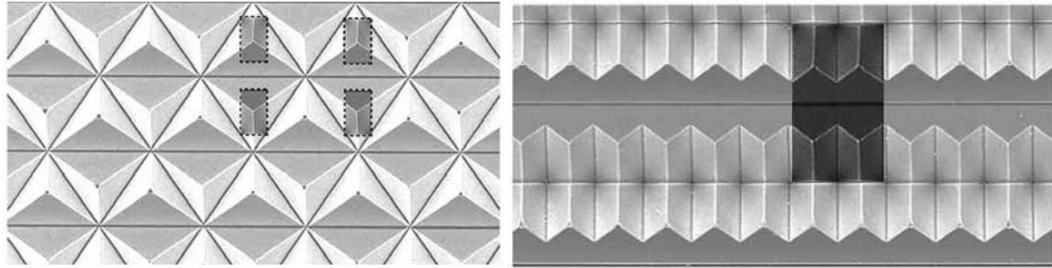

Fig. 18 The compartment of active areas in the structure of microprismatic sheeting (Left) and the structure of Diamond Grade DG3 sheeting (Right).

Source: retrieved from Lloyd (2008)

Moreover, the results of studies showed that type IV is sufficient for distances around 75 m (Obeidat et al., 2016). Obeidat et al. (2016) did not find a statistical difference between Type XI and Type IV. Both types of retroreflective sheeting were determined to have suitable visibility for drivers at night. However, EG sheeting was not recommended for overhead guide signs.

2.1.2 Sign surface damage

Degradation (Age) and Colour

Clearly, the sheeting age is one of the most significant variables affecting sign retroreflective performance (Black et al., 1992b). However, the degradation rate of different types is not so obvious. The retroreflective abilities of sheeting from different manufacturers are also different. Analysing the influence of ageing on retroreflective properties is essential since this factor is a basement for minimum retroreflective standards. Examining existing products on the market in the context of retroreflective properties guides local road agencies regarding the preferred use of retroreflective films.

Shober (1977) ranked the retroreflective intensity of 5 existing retroreflective films on the market. After 3.5 years of field exposure, he found Sunlite and 3M Engineer grade sheeting had better performance than Adcolite and Maclite. The last one was the worst (Shober, 1977).

The degradation rate differs in material, manufacturer, and colour. Therefore, the colour will also act as a variable in subsequent analysis.

Black et al. (1992a) surveyed 6,275 signs from 1 to 12 years of age. Four sheeting colours – red, yellow, green, and white and two types of glass bead sheeting – EG (Type II) and HI (Type III) – were explored. All average values of R_A except red Type III sheeting exceed the existing minimum requirements. The yellow and Type III sheeting tended to have a tighter grouping of R_A values. However, the red Type III sheeting performance increased R_A values over time. The explanation of the authors was unexpected. Red-coloured sheeting was typically manufactured by screening red ink over white retroreflective sheeting. Over time, the red ink fades, and more of the white background becomes visible. It means that retroreflectivity levels of the sign face should increase over time; however, the contrast between the legend and background decreases.

For white and yellow colours Type III sheeting, the retroreflectivity over 12 years decreased by less than 30 %. Worse results were obtained for all colours of Type II sheeting. The R_A values for 12-year-old traffic signs were almost twice smaller as for new ones (Black et al., 1992a).

Kirk et al. (2001) measured the retroreflectivity of 80 traffic signs with HI (Type III) sheeting of four colours – red, yellow, green and white. All signs were at one location. The installation year ranged from 1985 to 1997. However, the results were unexpected. As seen from Fig. 19, the trend lines show little relationship between the age of signs and their retroreflectivity values. The authors gave two explanations of the results. First, the installation year data might be wrongly identified. Second, the age range of the signs may not have been significant enough to provide a complete picture of sign performance over time (Kirk et al., 2001). They concluded that the level of retroreflectivity is not related to signage. The variability of results is increased because a sign's clear plastic surface suffers the effects of abrasion from precipitation, dirt and dust (Kirk et al., 2001).

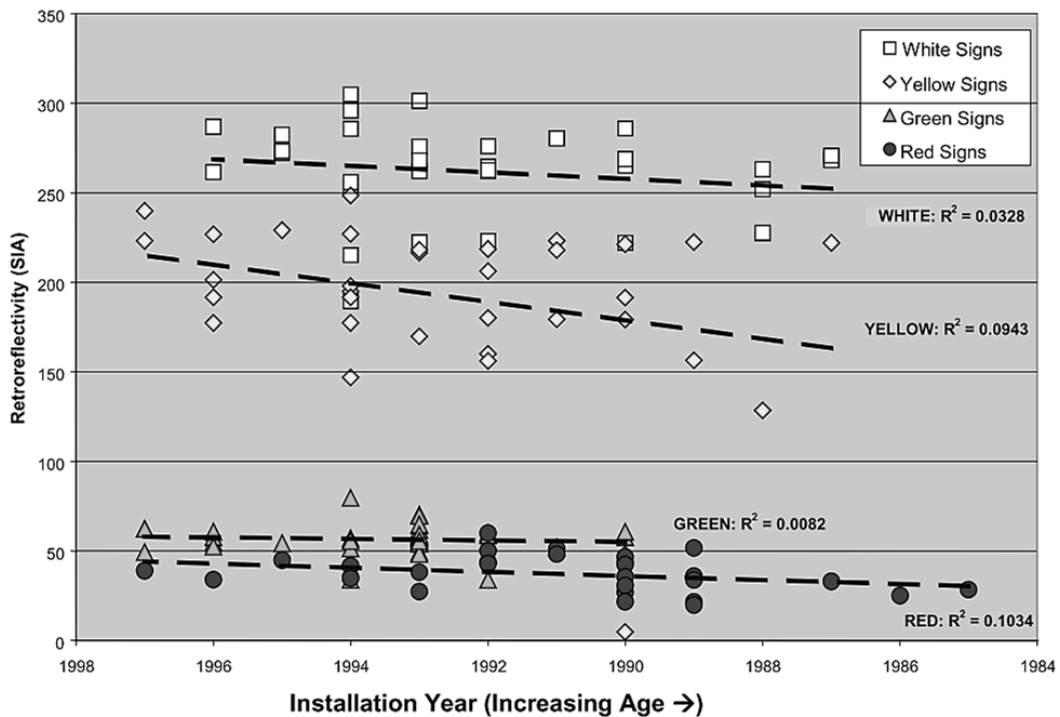

Fig. 19 The graph of results from Kirk et al. work that describes the retroreflectivity values against the installation year. Source: retrieved from Kirk et al. (2001)

Bischoff & Bullock (2002) did similar research but with a larger number of signs (1,341). Type III sheeting of different colours was studied. The authors' main aim was to find if the existing traffic signs meet the minimal retroreflective requirements (Bischoff & Bullock, 2002). The same goal can be found in several other works. For example, Rasdorf et al. (2006), Kipp & Fitch (2009), Ré et al. (2010), Jackson et al. (2013), Babić et al. (2017) indicated the relevance of the problem and to the present.

The deterioration models are made to describe the measurements and create a predictive model. Rasdorf et al. (2006) generated five deterioration models for white, yellow, red, and green colours and Types I and III. Kipp & Fitch (2009) measured in-service signs with Type III and Type IX retroreflective sheeting. Ré et al. (2010) created a linear prediction model for Type III retroreflectivity signs which exhibited a poor correlation between predicted and measured values.

Jackson et al. (2013) created predictive models for sign sheeting degradation according to its type and technology. However, the R square values for Type III, IV, VIII, and IX indicated a weakness in the predictive models (Tab. 1).

Tab. 1 The predictive models for sign sheeting degradation.

Source: retrieved from Jackson et al. (2013)

ASTM Sheeting Type		Prediction Model	R Square Value
Beaded	Type I	$1-0.0335 \cdot \text{Age}$	0.97
	Type II	$1-0.0224 \cdot \text{Age}$	0.90
	Type III	$1-0.009 \cdot \text{Age}$	0.53
Prismatic	Type IV, VIII, IX	$1-0.0246 \cdot \text{Age}$	0.49

In the literature review, Babić et al. (2017) concluded that most studies that developed predictive models had relatively poor accuracy. However, their research had better results, but R^2 were still not higher than 0.79, which means the results' weakness. The authors recommended conducting further research.

Tab. 2 The predictive models for sign sheeting degradation.

Source: retrieved from Babić et al. (2017)

Class I	White (n=209)		Red (n=45)		Blue (n=164)	
Equation	R ²	Function	R ²	Function	R ²	Function
Lin	0.567	$R_A=83.905-3.121t$	0.452	$R_A=14.565-0.789t$	0.484	$R_A=3.999-0.225t$
Log	0.522	$R_A=83.684-10.428\log(t)$	0.383	$R_A=14.366-2.526\log(t)$	0.434	$R_A=3.969-0.742\log(t)$
Exp	0.568	$R_A=84.684 \cdot \exp(-0.045t)$	0.474	$R_A=15.007 \cdot \exp(-0.075t)$	0.437	$R_A=4.106 \cdot \exp(-0.078t)$
Class II	White (n=35)		Red (n=10)		Blue (n=25)	
Equation	R ²	Function	R ²	Function	R ²	Function
Lin	0.600	$R_A=231.454-4.988t$	0.516	$R_A=39.935-2.603t$	0.781	$R_A=28.228-2.083t$
Log	0.547	$R_A=231.002-16.590\log(t)$	0.496	$R_A=40.000-8.887\log(t)$	0.724	$R_A=28.111-6.984\log(t)$
Exp	0.600	$R_A=232.106 \cdot \exp(-0.024t)$	0.474	$R_A=42.131 \cdot \exp(-0.100t)$	0.783	$R_A=30.330 \cdot \exp(-0.115t)$
Class III	Yellow (n=12)		Red (n=12)			
Equation	R ²	Function	R ²	Function		
Lin	0.511	$R_A=524.401-10.150t$	0.649	$R_A=149.139-9.292t$		
Log	0.460	$R_A=523.147-33.512\log(t)$	0.584	$R_A=148.013-30.695\log(t)$		
Exp	0.518	$R_A=525.411 \cdot \exp(-0.021t)$	0.643	$R_A=156.471 \cdot \exp(-0.091t)$		

Nevertheless, the research of Babić et al. (2017) had a significant value since it was the first study done in Europe and Croatia. Tab. 2 are shown predictive models for three classes according to the European standard (EN 12899-1, 2007). Class I is similar to Type I and II; Class II – to Type III and IV; Class III – to Type VIII, IX and X.

Dirtiness

The dirtiness is a factor that reduces the optical properties of the traffic sign surface (Department for Transport, 2013). Woltman (1982) found that dirt on the surface of a sign reduces its retroreflectivity by 50 %. Nevertheless, the measure of the effect of dirt on the reflective properties of a traffic sign is not so obvious. Wolshon et al. (2002) determined that cleaned signs have about 33 % higher retroreflectivity than unwashed signs. Jackson et al. (2013) found that dirt reduces the sign's R_A by about 10 %. It can be inferred from these results that new retroreflective materials have improved properties that cancel out the effects of dirt on their surfaces.

Meteorological conditions

Weather conditions such as rain, drizzle, fog, dew, and hoarfrost impair the 'instantaneous' visibility of the traffic signs by changing the refraction and scattering of the light beams and rendering less bright signs (Woltman, 1965). Although these factors often lead to a significant number of accidents (Abdel-Aty et al., 2010; Shahabi et al., 2012; *Unified transport vector map*, 2017), there are only four works devoted to the study of the influence of these factors on traffic sign retroreflection. The results of the three of them were based on the participants' subjective assessment. Munehiro et al. (2005) have concluded that fog during the night does not have an as significant adverse effect as in the daytime. However, 'the subjective visibility values of targets under the cloudy night-time condition were worse than those under the daytime dense fog condition.

According to Waard et al. (2005), for 9 % of the participants, fog or dew was a reason for the worse legibility of the signs. Hutchinson & Pullen (1978) have rated the relative effects of dew and frost on target values of different types of retroreflective materials for the sign's legend and background. Only in two studies the conclusion was made based on the measurement of R_A value (Hildebrand, 2003; Hildebrand and Bergin, 2004). According to Hildebrand (2003), frost reduces the retroreflective level of the in-service traffic signs on average by 79 % and dew – on average by 60 %. The type of retroreflective material and its colour significantly influence the degree of degradation of the retroreflective values under dew and frost conditions (Hildebrand, 2003).

2.1.3 Relative position to the direction of the sun

According to Bischoff & Bullock (2002), it is believed that sheeting facing the south directions deteriorates faster than sheeting facing north due to the year amount of sun exposure, and as a result, such sheeting would have lower retroreflectivity values after fewer years than signs facing other directions (Bischoff & Bullock, 2002).

Tab. 3 summarises the literature review of the influence sign's orientation on retroreflectivity. One of the first researchers comparing the influence of the sun's

orientation was Shober (1977) who found that sheeting facing north has higher R_A than sheeting facing south. He explained the latter's prolonged exposure to the sun. Black et al. (1992a) explored 6,275 signs of glass bead EG and HI sheeting in 17 locations in the USA. He concluded that solar radiation and orientation to the sun are not acceptable predictors of in-service R_A (Black et al., 1992a).

Tab. 3 Literature review of influence sign's orientation on the retroreflectivity.

Source: Author's work

Study	Influence of orientation to the sun	The results of the performance
(Shober, 1977)	Yes	North-facing had better retroreflectivity than South facing
(Awadallah, 1988)	No	
(Black et al., 1992a)		
(Wolshon & Degeyter, 2000)		
(Kirk et al., 2001)	Maybe	Variability of results for West and South facing
(Bischoff & Bullock, 2002)	No	Variability of results for South facing
(Kipp & Fitch, 2009)	Yes	North-facing had better retroreflectivity than South facing
(Jackson et al., 2013)	No	

Awadallah (1988) did not find a statistically significant correlation between the orientation of the sign face and its performance. The same conclusion was made by Wolshon & Degeyter (2000).

Kirk et al. (2001) have studied Type III sheeting of four colours and their degradation over time according to the orientation of the sign surface to the sun. They found that yellow and white sheeting facing west, red and green sheeting facing south showed higher variability than those facing other directions. However, the opaque measurements showed 19 % incorrectly recorded results (Kirk et al., 2001). So, the reliability of the results is questionable.

Bischoff & Bullock (2002) did not find a difference in retroreflectivity with orientation. However, they mentioned a variability of retroreflectivity for south-facing red signs.

Nevertheless, all research above has studied sheeting with low performance (Types I to III). Kipp & Fitch (2009) measured different oriented Type III and Type IX retroreflective sheeting. North-facing signs were observed to have better retroreflective performance than south-facing signs. However, the authors mentioned the small sample size in the study (Kipp and Fitch, 2009).

Jackson et al. (2013) divided all examined signs into two groups according to their direction: South and West, North and East. The mean values have shown that sheeting facing East and North has a higher retroreflectivity than those facing West and South. However, the authors concluded that direction does not affect sign performance because the difference was caused by chosen sheeting type (prismatic and glass bead).

Khalilikhah & Heaslip (2016) evaluated the influence of the direction factor through the percentage of dirty signs since the retroreflectivity performance loses its effectiveness when the sign is dirty. They found little changes in the rate of dirty signs concerning the direction.

2.1.4 Positioning of traffic signs in various environment

ASTM D4956 (2019) was developed by the American Society of Testing and Materials (hereinafter “ASTM”) based on research examining the retroreflectivity of traffic signs in different US states (Black et al., 1992b; Brimley and Carlson, 2013; Jackson et al., 2013; Ré et al., 2010) and includes specifications for testing sheeting in outdoor exposures in two different climates (tropical summer rain and hot desert). The results of such outdoor exposure are widely recognized as a standard for evaluating the durability of various materials and products (ASTM D4956, 2019).

However, a more detailed analysis by Ketola (1999) found no general relationship between samples and climates. Some samples exhibited poor durability in wet climates, others in dry climates, and others showed poor durability in both wet and dry climates or good durability in both. It was concluded that due to the significant differences in durability observed between two samples of the same type (Fig. 20), individual testing of each sample is necessary for each climate zone (Ketola, 1999).

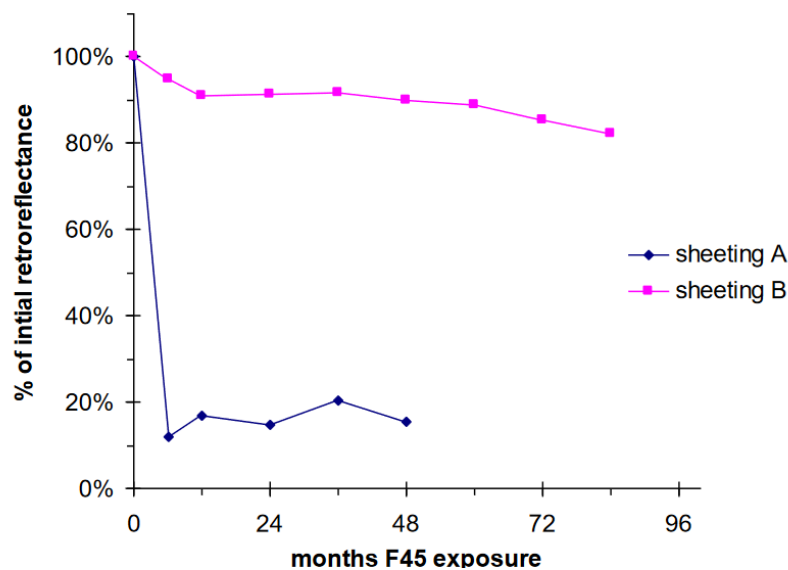

Fig. 20 Dramatic durability difference between two Type III sheetings after accelerated natural exposure in Florida. Source: retrieved from Ketola (1999)

2.2 Lighting variables

Garvey et al. (2011) introduce the term ‘lighting variables’ to describe the main components of highway sign visibility. Headlamp light is one of the critical elements determining the amount of light reaching the sign at night. Luminance contrast (LC) of the sign's surface is another lighting variable that includes a large number of other factors associated with the sources of light (e.g. artificial illumination, environmental glare) and luminance of the elements of the sign surface (background and legend). LC is divided into two components: external and internal sign contrast.

2.2.1 Vehicle headlights

The luminance intensity of headlights is one of the main components that impact the visibility and legibility of a sign. There is one problem with the comparison of studies on the influence of headlamps on retroreflectivity that is not considered in literature reviews. The headlight systems have improved and changed over the last decades (Fig. 21). In 1939, sealed beam headlights were introduced in the same year as the first retroreflective sheeting (Scotchlite). From 1958 till 1978, sealed beam headlamps were used in the USA, while halogen lamps have been used in Europe since 1962. In the USA, halogen lamps were used only from 1979. Xenon headlights were introduced in 1992. The LED headlamps that are known today made their appearance in 2004.



Fig. 21 The evolution of headlights. (From left to right) vehicles by type of optics: carbide (acetylene), simple electric lamps, halogen lamps (two cars in a row), Philips X-tremeVision halogen lamps, and LED matrix headlights. Source: retrieved from “Volvo Car ” (2019)

Therefore, only a summary of the main findings is given in these works.

- The traffic signs have better performance under high beams than under low beams (Cleveland, 1966; Richardson, 1976) (legibility is approximately 20 % higher) (Allen, 1958; Woods & Rowan, 1976) in the condition of high ambient luminance (Allen & Straub, 1956).

- The legibility of traffic signs is significantly increased only under low headlight conditions in the condition of low surround luminance (Allen & Straub, 1956; Hicks, 1976; Richardson, 1976).
- There is no difference in legibility distances between non-reflectorized and reflectorized (EG, HI) signs with retroreflective legends under high beams (Van Norren, 1978).

Modern headlamps have changed dramatically regarding the light sources, optics, and their specified aiming method for each headlamp (Schoettle et al., 2007). In 1997, 'harmonised beam patterns' occurred worldwide when the U.S. headlight specification accommodated the European and Japanese specifications to create a global headlamp specification. Accordingly, several compromises changed the standard in U.S. vehicles (National Highway Traffic Safety Administration, 2002).

The main change was in decreasing the amount of light in the horizontal plane, reducing the amount of light that falls on the sign's surface, especially overhead signs. Chrysler et al. (2003) assessed the amount and variability of illumination provided by various types of vehicles on the sign surface. The results showed the necessity of changing the materials used for freeway guide signs – a material with a higher retroreflective performance than Type III material should be used (Chrysler et al., 2003).

The degradation of the headlamp lenses also influences the amount of output light. The sealed beam headlamps changed to replaceable bulbs suffer from yellowing and fogging. The ageing of headlamps might also be considered for evaluating the retroreflectivity of traffic signs (Chrysler et al., 2003).

2.2.2 External contrast

External contrast (EC) is the ratio of the sign's average luminance and the luminance of the area directly surrounding the sign (Garvey et al., 2011). This parameter dramatically influences the sign's detection, which plays a vital role in analysing traffic signs by autonomous vehicles (Fleyeh & Dougherty, 2005). The conspicuity of the sign during driving is the most complex step in automatic traffic sign recognition (Prieto & Allen, 2009), which is why the EC should acquire the optimal meaning for each type of occurrence. Unfortunately, the value of the EC cannot be calculated because of its space-time inconstancy. The mean of the sign's luminance is permanent, but the value of the surrounding luminance is temporary because many factors influence it.

A few factors affect the ambient luminance in the dark period: the presence of night luminaries and their location in the sky (environmental glare), glare from the headlights, the level of artificial illumination and the visual complexity of the background scene.

Environmental glare

Environmental glare had little effect on sign legibility, except at the smallest angle and highest glare levels, and its effect can be reduced by increasing background luminance, surround luminance, and IC value (Olson et al., 1983).

Legibility improves with a glare source (illuminance 0.17 or 0.017 lx) with an angle of 2 °. The disability glare effect was observed for a glare angle of 0.2 ° (illuminance of 0.0098 lx) (Sivak & Olson, 1982). The deterioration or improvement of readability occurs only under a small glare angle or high glare level. Sivak & Olson (1982) concluded that the legibility of retroreflective signs is relatively unaffected by glare.

Artificial illumination

Based on the artificial illumination, the mean of surround luminance is usually defined according to different types of developed settlements (urban, suburban and rural areas). Only a few authors (Van Norren, 1981a; Olson et al., 1983) classified the most typical surround luminance with an indicative numerical range for them. Based on their works, the surrounding luminance was divided into three main categories, shown in Fig. 22.

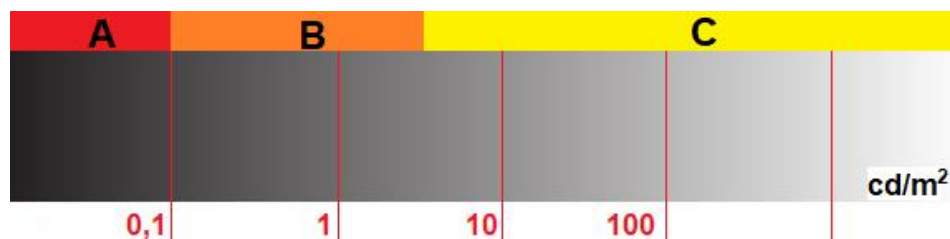

Fig. 22 The classification of surrounding luminance. Source: Author's work

Each category corresponds to three typical areas: A – rural areas without public lighting at night (Van Norren, 1981a), B – moderately lit urban, and C – brightly lit urban surround (Olson et al., 1983). Some authors divided surrounding luminance into high and standard (or low) levels. The author of this work made the following division: low surround level includes categories A and B, and a high level of surround luminance corresponds to category C to facilitate comparison of works.

Among the first authors who studied dependence legibility on the surround luminance was Allen (1958). He concluded that in the bright area, the sign's luminance should be high, but in the dark open road, a high-reflectance sign caused the irradiation⁵. Olson & Bernstein (1979) reached the same conclusion that increasing surround luminance (from level A to level C) reduces the effect of high legend luminance, especially for low background luminance of the sign. However, unlike Allen (1958), Olson & Bernstein (1979) mentioned in their research that a highly illuminated urban environment (category C) does not require excessive legend luminance and significantly improves the visibility of the sign by increasing the legibility distance.

Forbes (1969) studied the correlation between the detectability and surround luminance (0.03–15.25 cd·m⁻²) and concluded that detectability increases with the logarithm of luminance of the sign. Van Norren (1981a) adjusted the conclusions of Forbes (1969) by analysing signs in the range of surround luminance of 0–4,200 cd·m⁻². He found that linear increase persists for surrounds until 50 cd·m⁻²; above this value,

⁵ The phenomenon when the value of EC is so high that legibility of the sign deteriorates

the relationship between visual acuity and log luminance of the sign is described as a second function (Van Norren, 1981a). Zwahlen et al. (2007) concluded that external lighting of overhead signs does not provide adequate visibility if the legend Types VII or IX are on the green background type III (classification according to ASTM 2011).

Tab. 4 Optimal sign's luminance values ($cd \cdot m^{-2}$) according to levels of surrounding luminance. Source: Author's work

The research	A	B	C
(Smyth, 1947)	24	86	
(Allen et al., 1967)	34	70	685
(Dahlstedt, 1974)		60	
(Sivak & Olson, 1983)		55	
(Schnell et al., 2004)		80	
<i>(Retroreflective Road Traffic Signs: Minimum and Optimal Luminance Requirements, 1991)</i>	20	50	
(Frank, 1994)		40 – 250 (<i>from 0.1 $cd \cdot m^{-2}$ to 10 $cd \cdot m^{-2}$</i>)	

In essence, the purpose of the study of the relationship between ambient luminance and detectability is the establishment of the optimum luminance values over a sign face for different types of surround luminance. Tab. 4 shows the results of the studies of some authors according to the level of illumination. Respectively, there is no standard or regulation for the optimal value of the EC.

Nevertheless, the type of retroreflective material shall be selected according to the level of the surround luminance or by area type. In the USA and Australia, each kind of material roughly corresponds to the ambient level of luminance (Tab. 5).

Tab. 5 Comparison of types of retroreflective sheeting and the level of ambient luminance based on the standards in the USA.

Source: retrieved from ASTM D4956 (2017) and AS 1906.1 (2017)

Category of surround luminance	The type of retroreflective sheeting	
	USA (ATSM D4956-17)	Australia (AS 1906.1: 2017)
A	<i>Engineering Grade (I)</i>	<i>300, 100</i>
B	<i>High-Intensity Prismatic (IV)</i>	<i>400</i>
C	<i>Diamond Grade (IX)</i>	<i>1100, 900</i>

Nevertheless, in Europe, the level of surround brightness (standard and high level) is only one parameter in the multilevel choice for determining the correct type of retroreflective sheeting (Oralite, 2011). In the 'post-Soviet states', illuminance and luminance levels are not rationed at all (*GOST-DSTU 4100, 2015; GOST 32945, 2016*). Though according to Mace & Pollack (1983), the measurement of surround luminance predicts visual performance better than sign internal luminance contrast and luminance.

The visual complexity

Mace & Pollack (1983) suggested that visual complexity is a better predictor for sign detection and recognition than sign contrast and luminance (the term 'brightness' is used in work). They created a theoretical model of the relationship between visual performance, sign's brightness and visual complexity of the surround (Fig. 23) based on the laboratory and field studies.

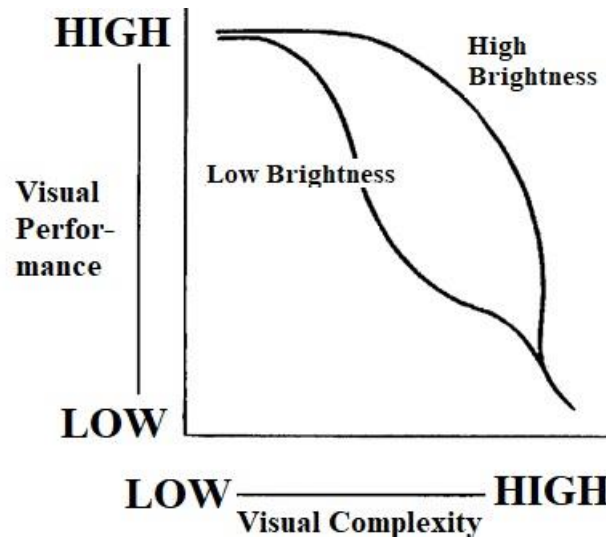

Fig. 23 Theoretical correlation between light variables and sign's visual performance.

Source: retrieved from Mace & Pollack (1983)

The field study of Akagi et al. (1996) revealed that the recognition distance of a highway number sign and the background complexity of the visual noise ratio had a negative correlation. It means that the detection distance decreased as background complexity increased.

Schiebe & Goodspeed (1997) proved the theoretical model of Mace & Pollack (1983) by testing two types of signs (bright 5–15 $\text{cd}\cdot\text{m}^{-2}$; and ultrabright 50–120 $\text{cd}\cdot\text{m}^{-2}$) in three background scenes (the low – an isolated 2-lane rural highway, the moderate – a typical street in the commercial district in a small city, the highest – a downtown street of an urban area with illuminated billboards) (Schieber & Goodspeed, 1997). From Fig. 24, it is clear that for the low background complexity condition, the brightness of the sign did not affect accuracy. However, with increasing background complexity levels, the brighter signs demonstrated significantly greater resistance to the reductions in response accuracy of identification (Schieber & Goodspeed, 1997).

The experimental work of Bildstein (2002) proved that the background scene's visual complexity significantly affects subject responses. The statistical testing indicates differences between driving conditions with high visual-complexity surroundings (metropolitan setting) and low visual-complexity surroundings (a two-lane rural highway).

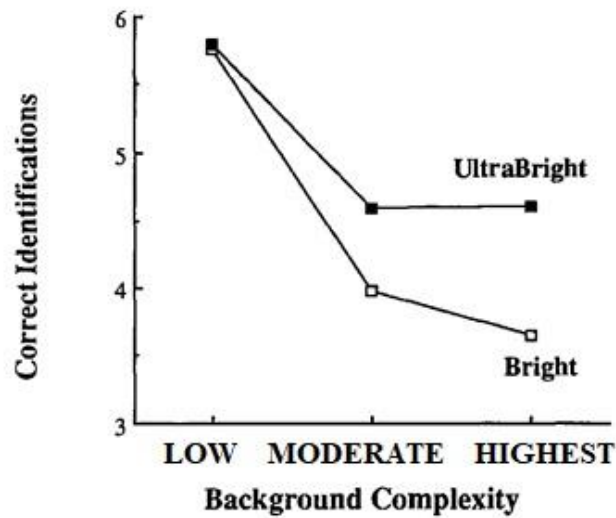

Fig. 24 Correct identifications as a function of sign brightness (bright, ultrabright) and background complexity (low, moderate, highest).

Source: retrieved from Schieber & Goodspeed (1997)

Schnell et al. (2004) found that background complexity is not a statistically significant variable. The results of the experiment may have been influenced by the static nature of the study, as the participants knew exactly where to look (Schnell et al., 2004).

2.2.3 Internal contrast

The internal luminance contrast (IC) is the ratio of a sign's legend luminance value (or the coefficient of retroreflection) and its background luminance (or the coefficient of retroreflection) that has a significant influence on the sign's legibility (Garvey et al., 2011). Since the sign's IC impacts its legibility, much research focused on determining the optimal ratio of the legend/background contrast. Not only the IC value was the aim of the investigation, but the direction of contrast was also studied.

Direction of contrast

According to the contrast direction, IC is divided into positive (light legend on dark background) and negative (dark legend on a light background) (Garvey et al., 2011). The legibility depends on the legend luminance for the positive contrast. For the negative contrast, the readability is determined by the background luminance (Hills & Freeman, 1970; Olson et al., 1983).

Forbes (1969) noticed that signs with retroreflective letters were as effective as floodlighted on a dark background at night. However, the study of Smyth (1947) has shown that the direction of contrast has no significant effect on the readability of the sign. Allen (1958) refuted the results, concluding that light letters in the dark are superior to dark letters on a light background (except at high luminance levels (Hind et al., 1976)). The minimal IC for negative directions should be higher than for positive, according to

Forbes (1969), 5:1 and 3:1, respectively. Van Norren (1981b) clarified that the effect of the direction of contrast depends on the stimulus duration. There is no difference in the direction of contrast for unlimited stimulus duration. However, the IC is crucial for short stimulus time (200 ms), especially for positive contrast. The legibility of signs with light legend increased when the IC is reduced from 250:1 to 10:1 (except at very high surround luminance). For signs with negative contrast, legibility did not increase with a decrease in IC under different surround luminance (Van Norren, 1981b).

Background and legend luminance

The summary of all works with the comparison of optimal IC values is given in Tab. 6.

Tab. 6 The comparison of optimal IC values from different studies and works.

Source: Author's work

Study	Type of work/study	Suggested values for IC	Additional requirements for background
(Allen et al., 1967)	field	20:1 is superior to 4:1	
(Hills & Freeman, 1970)	laboratory	7.5:1	
		7:1	green colour
		6:1–7:1	blue colour
		8:1–10:1	red colour
(Forbes et al., 1976)	laboratory	6:1–13:1	
(Olson & Bernstein, 1977)	laboratory	16:1 25:1	$R_A = 30 \text{ cd}\cdot\text{lx}^{-1}\cdot\text{m}^{-2}$ $R_A = 10 \text{ cd}\cdot\text{lx}^{-1}\cdot\text{m}^{-2}$
(Sivak et al., 1981)	field	10:1–15.8:1	
(Sivak & Olson, 1982)	field	9:1–33:1	
(Olson et al., 1983)	laboratory	30–60:1 5:1	luminance 0.4 to 3.8 $\text{cd}\cdot\text{m}^{-2}$ luminance above 34 $\text{cd}\cdot\text{m}^{-2}$
	field	33:1, 9:1	
(Sivak & Olson, 1983)	literature research	12:1	
(<i>Retroreflective Road Traffic Signs: Minimum and Optimal Luminance Requirements</i> , 1991)	report	$\geq 7:1$	minimal requirements for positive contrast (guide) signs
(Paniati & Mace, 1993)	computer model	$\geq 4:1$	
(Schnell et al., 2004)	laboratory	6.7:1–9.1:1	luminance 3.5–82 $\text{cd}\cdot\text{m}^{-2}$
(<i>The Manual on Uniform Traffic Control Devices</i> , 2022)	USA standard	$\geq 3:1$	minimal requirements for positive contrast signs, red background

The legibility improves with increasing luminance (Allen & Straub, 1956). Legibility rapidly rises with contrast, but it is valid only for a particular contrast value. Beyond this value, the legibility decreases. Thus, it was determined that legibility is an inverted U-function of contrast for most background luminance levels (Hind et al., 1976; Van Noreen, 1978; Olson et al., 1983; Olson & Bernstein, 1979). Consequently, the optimal luminance contrast is the crest of the function. However, Olson & Sivak (1983) found that achieving the optimal contrast value is not easy because there are many inverted U-shaped functions, which differ for each combination of IC. Allen (1956) concluded that for the negative luminance contrast, the legibility improves with the background luminance.

Olson & Bernstein (1977) figured out that the background luminance has little effect on the legibility distance of the sign for positive contrast. It should be noticed that they tested only three background reflective levels (non-reflective, 10 and 30 $\text{cd}\cdot\text{lx}^{-1}\cdot\text{m}^{-2}$) that were available in the market from 1974 to 1976. They found that the optimal IC of the signs for the maximal legibility distance depends on the sign's position and the type of the headlight's beam. The black no-reflective legend is better for symbol signs, where the background luminance provides the sign's conspicuity to a greater extent than its legibility. Moreover, the primary differences among backgrounds are in conspicuity, colour rendition, and ability to maintain maximum legibility distance under various illumination conditions. The authors recommended not to use legends and backgrounds from the same family of materials because IC will be below optimum, and the legibility distances also decrease 10–15 % below the maximal possible value. In order to provide the necessary IC value throughout the service life of the road sign, legend material should be chosen to deteriorate more slowly than the background (Olson & Bernstein, 1977).

In further research, Olson et al. (1983) concluded that IC depends on background luminance. The contrast requirements decrease with increasing background luminance. The IC that exceeds the maximal recommended value (e.g. when legend or background is not reflectorized) decreases legibility for elderly drivers (average age is 68).

Shnell et al. (2004) designed research for negative contrast symbol signs and proved that the luminance contrast significantly affects the sign's recognition distance. Increasing the contrast (studied range was 1:1–9.1:1) improves recognition, but for high contrast (above 6.7:1), the increase in background luminance above 82 $\text{cd}\cdot\text{m}^{-2}$ does not improve recognition. In the case of low contrast (less than 1.6:1), increasing the luminance beyond 82 $\text{cd}\cdot\text{m}^{-2}$ continued to improve recognition. Nevertheless, unlike other authors, Schnell et al. (2004) noticed that above this crucial luminance level until 942 $\text{cd}\cdot\text{m}^{-2}$, there is no improvement but no decrement in recognition of negative contrast signs. In the other paper, Schnell et al. (2009) investigated the effect of luminance (from 3.2 $\text{cd}\cdot\text{m}^{-2}$ to 80 $\text{cd}\cdot\text{m}^{-2}$) and contrast (6:1 and 10:1) on the information acquisition time and transfer accuracy from simulated traffic signs. Schnell et al. (2009) found that the

increasing luminance level of positive contrast signs leads to faster information acquisition, which means an increase in reading time (e.g. increase in luminance from $3.2 \text{ cd}\cdot\text{m}^{-2}$ to $10 \text{ cd}\cdot\text{m}^{-2}$ gives 52 % additional reading time). Nevertheless, increasing the IC value does improve information acquisition time at the investigated luminance levels.

2.3 Receptor variables

Retroreflective signs are signs with a retroreflective covering which reflects the light from headlights almost directly back to the observer. The term ‘observer’ means, in most cases, a person. However, since the creation of the Traffic Sign Detection and Recognition Systems (hereinafter “TSDR”), the viewer or receptor is not only the person but also the vehicle camera systems. Accordingly, both factors will be discussed below.

2.3.1 Human factor

The human behaviour factor is the main factor in 93 % of all traffic accidents in the world (World Road Association [WRA], 2003) (Fig. 25). Petridou & Moustaki (2000) distinguished those behavioural factors into categories: those that promote risk-taking behaviour with long- or short-term impact, those that reduce capability on long- or short-term basis.

Factors that reduce capability on a long- or short-term basis (e.g. non-use of seat belt or helmet, inappropriate sitting while driving, intake of alcohol and psychotropic drugs (Petridou & Moustaki, 2000)) will not be discussed in this work because, in these cases, a driver deliberately violates traffic rules.

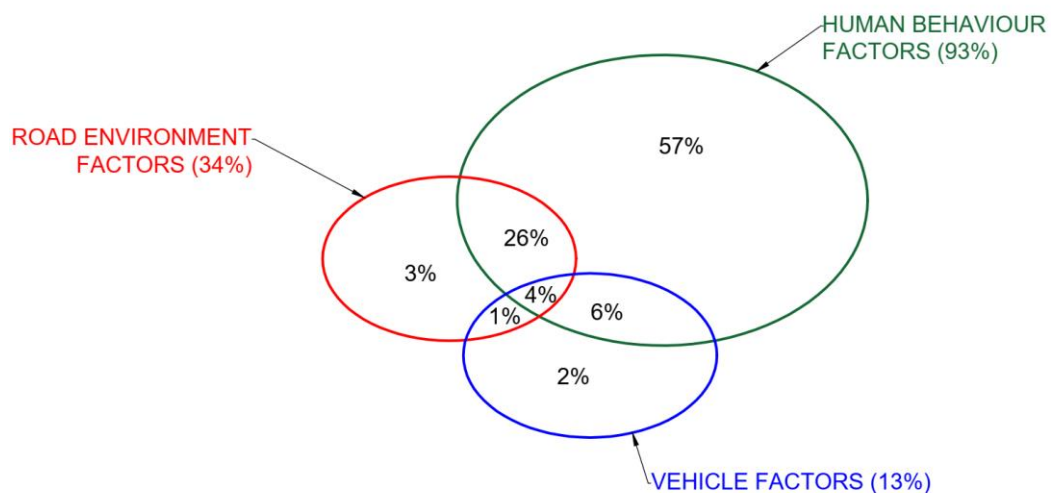

Fig. 25 Accident contributing factors. Source: retrieved from WRA (2003)

Factors that reduce capability on a long-term basis, including age and inexperience, were investigated in many types of research. However, the work of Hicks (1976) stands out from the rest.

Behavioural factors that reduce capability on a short-term basis

Hicks (1976) proved that alcohol-impaired drivers (blood alcohol concentrations were 0.00 %, 0.08 %, 0.15 %) require significantly brighter signs. This study is unique among works dedicated to examining the speed and accuracy of recognition of road signs by humans because the relationship between highway sign retroreflectivity and alcohol impairment under night driving conditions. According to the study, signs with 2871 Yellow Scotchlite reflective HI sheeting (high-reflectance sign) ameliorate more the degrading influence of alcohol impairment on sign-reading ability than signs that were covered with 2271 Yellow Scotchlite reflective EG sheeting (low-reflectance signs) (Hicks, 1976). This study seems to have no practical use since driving under the influence of intoxicants is prohibited. Contrarily, Dawson & Reid (1997) demonstrated that drivers' psychomotor performance after a period of 24-hour sustained wakefulness was equivalent to that of individuals with a blood alcohol concentration of 0.10%. That means that signs with higher brightness may reduce the influence of behavioural factors that reduce capability on a short-term basis (drowsiness and fatigue, short-term drug effects, acute psychological stress, and temporary distraction (Petridou & Moustaki, 2000)).

Behavioural factors that reduce capability on a long-term basis

The ability to see at night decreases with age. After 20, the amount of light we need to see objects at night doubles every 13 years (Marland, 1967). It is, therefore, logical to assume that older people need more time to identify and recognize road signs, especially at night. Moreover, many researchers confirm this fact. However, some studies argued that there is no significant difference between age groups. Tab. 7 represents the results and the conditions of experimental studies dedicated to the human factor. The table also contains information about the number of study participants, their age group and visual acuity.

Allen et al. (1967) were the first researchers who studied the correlation between the legibility of retroreflective traffic signs and the age of the observers. Observers from three age groups with the same average visual acuity (Tab. 7) took part in the night driving. The legibility distance of three-letters words has been measured. According to the results, the authors concluded that older subjects performed worse than younger subjects but only in the conditions of the low sign luminance level of traffic.

Olson & Bernstein (1977) examined the relationship between the age, visual acuity of observers and different characteristics of retroreflective materials (internal contrast, letter high, background luminance) in laboratory conditions (Fig. 26). Fig.26 presents results only for signs with white legend on a green background. The older subjects had much poorer performance than younger ones (Olson & Bernstein, 1977). As seen in Fig. 26, younger subjects had a higher percentage of correct answers than older ones. Even

they have the same visual acuity mean (Tab. 7). Olson & Bernstein (1977) concluded that other variables besides visual acuity should influence sign recognition.

Tab. 7 The description of participants' characteristics and results of studies examined the influence of human factor on the recognition of traffic signs. Source: Author's work

Work	Number of participants	Age (years)	Visual acuity (mean value)	Results	Additional conditions for results		
(Allen et al., 1967)	15	18–37	20/20	Older performed worse than younger subjects	the low luminance level of signs		
	15	38–57					
	15	>58					
(Olson & Bernstein, 1977)	7	20–35	20/20 or better		Almost the same performance	laboratory test, high contrast visual acuity test	
	5	67–72					
(Sivak et al., 1981)	12	18–24	20/18.3			Older performed worse than younger subjects	high-luminance - high contrast visual acuity test
	12	62–76	20/18.7				
(Sivak & Olson, 1982)	6	20–30	20/36	Almost the same performance			low-luminance - high contrast visual acuity test
	6	59–75	20/39				
(Jones & McNeese, 1988)	17	<40	20/20	Older performed worse than younger subjects	Overhead and ground-mounted signs		
		>40					
(Akagi et al., 1996)	2	<30	not given		Almost the same performance	observer attribute (age, sex) & background complexity	
	5	30–60					
	2	>60					
(Schieber & Goodspeed, 1997)	20	22–44	20/15			Almost the same performance	observer age & background complexity
	20	61–80	20/22				
(Schnell et al., 2004)	20	19–32	20/25.5	Almost the same performance			
	20	60–76	20/24.5				

Sivak & Olson (1982) found that visual deficits, not information-processing shortages, cause the age-related decrease in night-time legibility. The conclusion was based on two studies by Sivak & Olson (1982) and Sivak et al. (1984) with the opposed results. The first study showed that the mean legibility distance for older subjects is 23–35 % lower than for younger ones with similar high luminance/high contrast visual acuity (Sivak et al., 1981). However, the older subjects performed the same results in the following study as the young subjects (Sivak and Olson, 1982). Both groups of observers have similar low luminance/high contrast visual acuity, which assured good performance under the test conditions.

Jones & Mcneese (1988) found that for overhead and ground-mounted traffic signs, the older drivers performed worse than younger drivers (the average legibility distance is 9 m shorter). Nevertheless, the authors mentioned in the report that 25 ft (almost 8 m) difference is negligible because it is traversed in 0.31 s at regular freeway speeds.

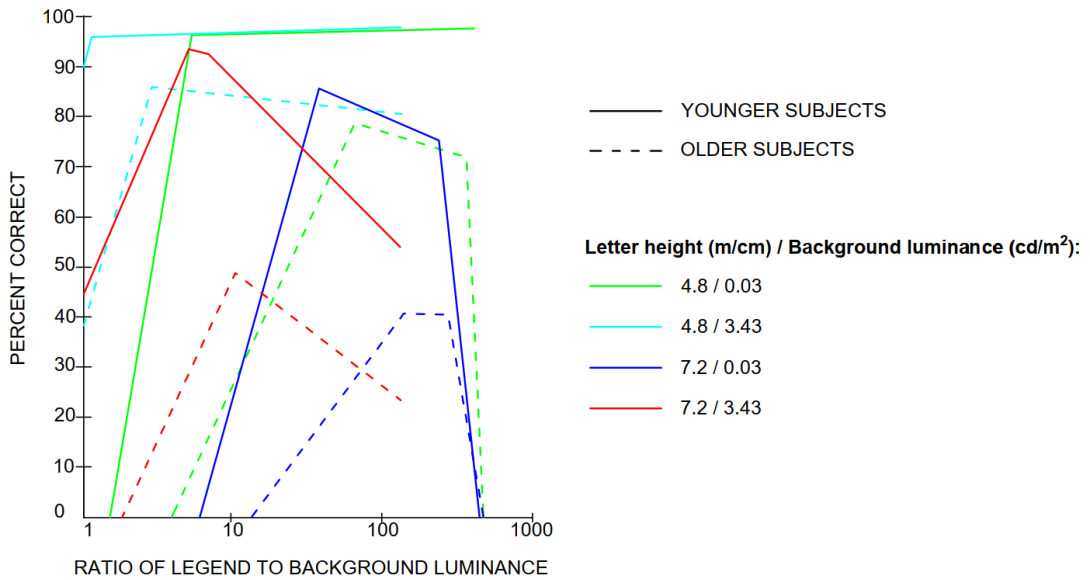

Fig. 26 Comparison between the visual acuity performance of younger and older subjects. Source: retrieved from Olson & Bernstein (1977)

A study conducted in Japan by Akagi et al. (1996) stands out from the rest of the work.

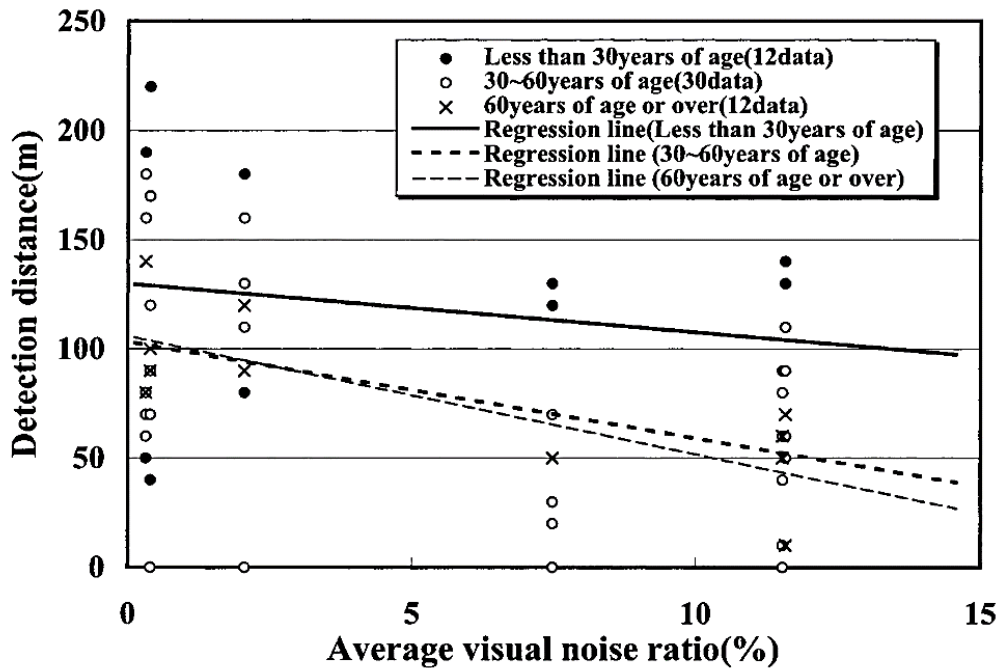

Fig. 27 Correlation between detection distance and average visual noise ratio by age. Source: retrieved from Akagi et al. (1996)

The correlation between the detection of distance and the background complexity (a term used in the study – average visual noise ratio) was analysed by classifying the observers by age and sex. Men are more affected by visual noise than women. Older drivers are considered more susceptible to background complexity than younger drivers.

The detection distance for observers less than 60 years old was much shorter than for older drivers (Fig. 27). The authors explained the results by differences in mental concentration and the means of perceiving roadside conditions while driving.

A similar study was conducted by Schieber & Goodspeed (1997). The reaction time and accuracy of recognition highway signs were examined as a function of sign brightness, background scene complexity and observers'.

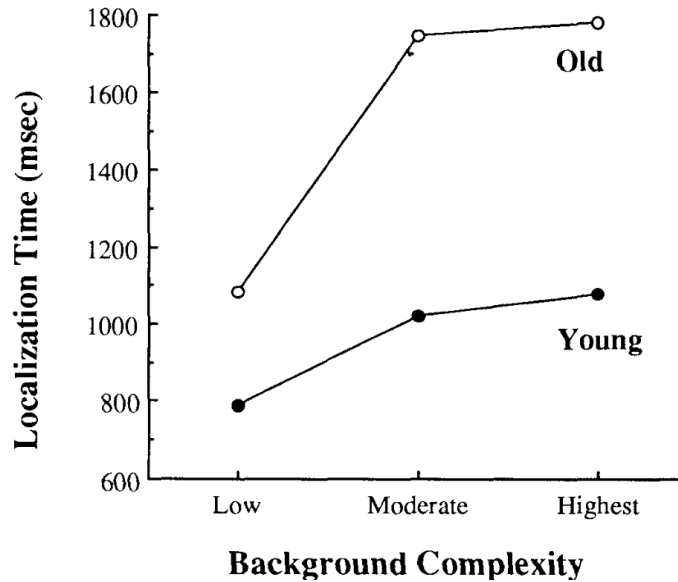

Fig. 28 Reaction time as a function of observer age and the visual (background) complexity. Source: retrieved from Schieber & Goodspeed (1997)

The statistical analysis of results has shown that older drivers are more susceptible to background complexity while searching the environment for traffic sign information (Fig. 28). The results of Schnell et al. (2004) study indicated that the observer age is not a statistically significant variable. The authors explained the results by good health conditions for participants of the research, for whom visual performance was not related to age but the overall health of the individual (Schnell et al., 2004).

2.3.2 Vehicle camera system

In order to eliminate the risk of traffic accidents due to driver negligence, Advanced Driver Assistance Systems (hereinafter “ADAS”) were developed (Hechri et al., 2015). One of the main components of these systems is TSDR, which offers real-time information to drivers about road restrictions. TSDR system makes driving safer by using the vehicle's camera and navigation systems.

The system uses a monochromatic fixed-focus multi-function camera installed on the windscreen in front of the rear-view mirror. The camera captures and identifies traffic signs on the relevant road section. An image processing module searches the scanned images for known signs and compares the results with the Columbus or Amundsen navigation data (Fig. 29).

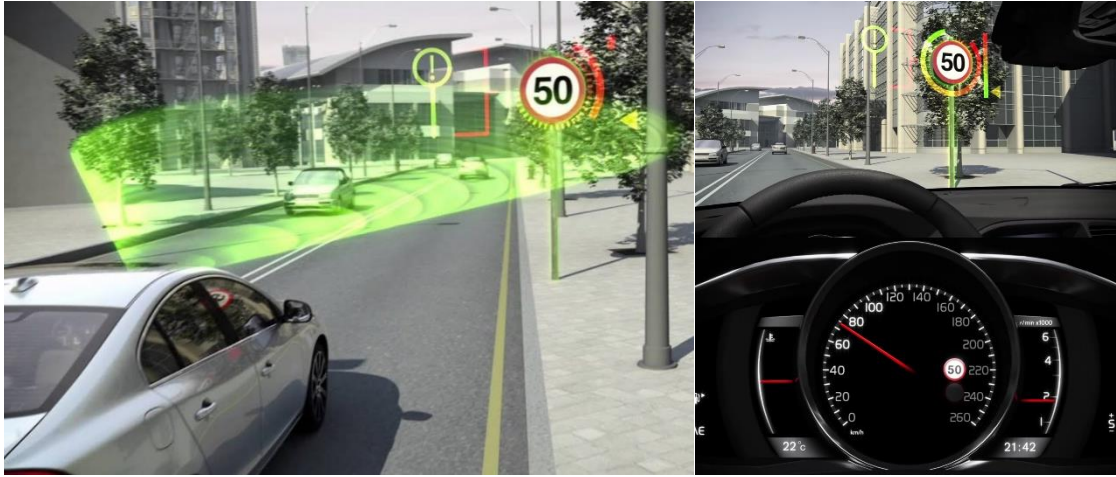

Fig. 29 An example of the TSDR system. (Left) The detection of traffic signs by a camera. (Right) A pictogram of a recognised traffic sign on dashboard.

Source: retrieved from Volvo Car (2019)

The effectiveness of this system is crucial as a large number of signs and heavy traffic increase the possibility that the driver may not notice some crucial signs. TSDR eliminates this problem by displaying critical traffic information on the control panel and providing (optionally) a sound signal warning.

Nevertheless, the TSDR system has limitations based on the difficulties of sign recognition. The main problems of identification of traffic signs may be divided into three main groups: outdoor condition (i.e. presence of obstacles in front of the sign, weather and lighting conditions, scene complexity), vehicle camera system (i.e. vibration by a moving vehicle, quality of video source), properties of traffic sign (i.e. damage of sign surface, location of the sign, shape, size and colour) (Fang et al., 2004; Hsu & Huang, 2001; Escalera et al., 2003; Paclík et al., 2000; Ritter et al., 1995; Toth, 2012; Wali, 2015).

In recent years there has been a growing interest in developing an efficient and trustworthy TSDR system that increases the accuracy of detection and recognition signs by developing new algorithms and methods to minimize the effect of factors influencing traffic signs. However, it is worth mentioning that many researchers tested their algorithms using existing traffic sign databases (i.e. Sweden Traffic Signs Dataset (Yin et al., 2015), German TSDR Benchmark (Khan et al., 2018; Yin et al., 2015; Zaklouta & Stanciulescu, 2014; Zhou et al., 2017; Zhu et al., 2016), Korean Traffic Sign Dataset (Khan et al., 2018; Lim et al., 2017), Chinese Traffic Sign Detection Benchmark (Zhu et al., 2016)). These databases of traffic signs scene and images representing them are an essential requirement for improving the TSDR system (Wali, 2015; Wali et al., 2019) because it is used for self-adaptive systems that 'are able to adapt their behaviour at runtime without human intervention' (Dajsuren & Van den Brand, 2019). However, using databases in research has a significant limitation - they can become outdated due to the development of new technologies ("German Traffic Sign Benchmarks," 2013) or changes in legislation.

For instance, the Czech Republic introduced 15 new sign classes and installed numerous new traffic signs between 2015 and 2016 (*The Decree No 294, 2015; The Decree No 84, 2016*).

In many studies, the evaluation of the accuracy of the new methods or algorithms was based on determining the percentage of correctly defined signs to the total number of signs (Fatmehsari et al., 2010; Hechri & Mtibaa, 2012; Khan et al., 2018; Laguna et al., 2014; Tohidul et al., 2017; Vitabile et al., 2001; Zhu et al., 2017). Moreover, only a few researchers for assessment TSDR system also used the recognition speed (Yin et al., 2015), the average time needed for recognition (Gomes et al., 2017; Zaklouta & Stanciulescu, 2014). Gao et al. (2006) simulated traffic signs at different distances to test their method for recognising traffic signs.

2.3.3 Position of receptor

The position of the receptor is one of the main parameters because it influences the angle of observation, which is different for each type of vehicle (Fig. 30).

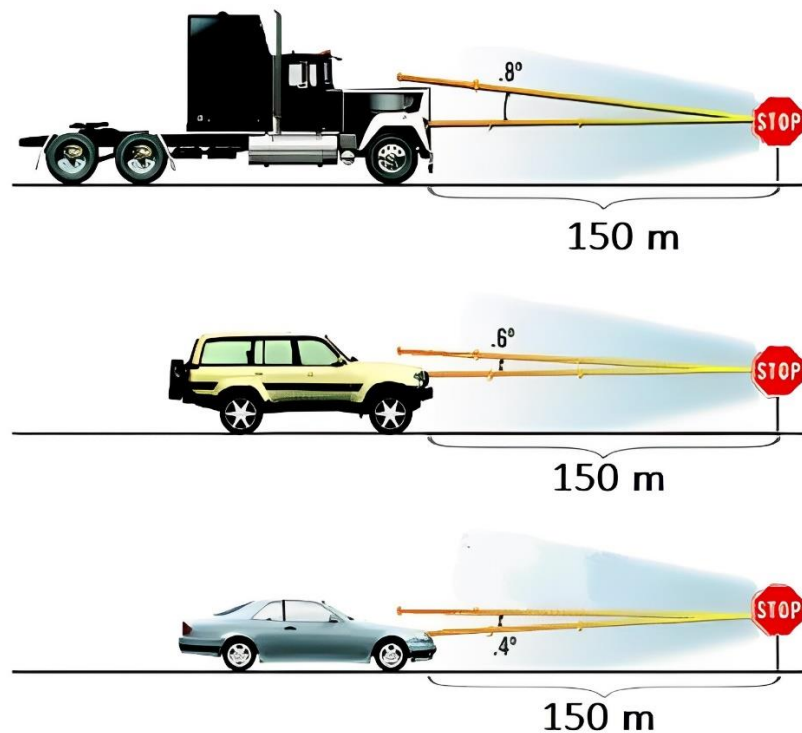

Fig. 30 Different angles of observation for cars, SUVs and trucks. Source: retrieved from How Visible is a Stop Sign? (2018)

The height of the driver's eye above the road is equally important as the height of the headlights above the road. It has been changed with the improvement and creation of new car models. Tab. 8 represents the vehicle dimensions of a modern vehicle. Furthermore, the national standards have already considered these dimensions (*ASTM D4956, 2019; EN 12899-1, 2007, MUTCD, 2022*).

Tab. 8 The dimensions of the main vehicle parameters in the context of the receptor position. Source: retrieved from Paulus (2010)

Vehicle Type	Vehicle Dimensions (meters)				
	Height of Headlamps above Road	Distance Between Headlamps	Height of Driver's Eye above Road	Transverse Distance of Eyes from Left Headlamp	Distance of Eyes Behind Headlamps
Passenger Car	0.7	1.3	1.2	0.3	2.1
Light Truck	0.9	1.5	1.5	0.3	2.1
Heavy Truck	1.1	1.9	2.3	0.4	2.2

However, in the context of modern technology, one parameter is not considered, namely the location of the vehicle's camera.

2.4 Legislation

In this chapter, the legislation related to the use of retroreflective sheeting materials, specifically in Czechia and China, is discussed. While both countries have standards in place for testing the quality of new road signs (*ČSN EN 12899-1, 2007*; *GB/T 18833, 2012*), they do not currently have mandatory requirements for the minimum levels of retroreflectivity for in-service signs. This lack of a comprehensive standard can lead to inadequate maintenance and visibility for road users. Additionally, the existing Czech standard is based on outdated research (from 1939 to 1984) and does not consider that vehicle camera systems can also recognize modern traffic signs. It is necessary to investigate the feasibility of utilizing the findings of research conducted in other countries, despite the potential difficulties posed by variations in legislation.

Tab. 9 Retroreflective requirements for new retroreflective sheeting. Sources: retrieved from *ČSN EN 12899-1 (2007)* and *GB/T 1883 (2012)*

Class or Type according to		β_1 (°)	α (°)	R_A (cd·lx ⁻¹ ·m ⁻²)				
Czech	Chinese			white	red	green	blue	yellow
RA1	≈ I (different value)	-4/5	0.2	70	14.5 (14)	9	4	50
RA2	≈ III (different value)			250	45 (50)	45	20	170 (175)
RA3	≈ IV (different value)		1	35	7 (5.2)	3.5 (4)	2.5 (2)	23 (26)

Tab. 9 shows the values of R_A for types and classes of new retroreflective sheeting that match each other in Chinese (*GB/T 1883, 2012*) and Czech (*ČSN EN 12899-1, 2007*) standards. It should be noted that there are variations in entrance angles, with -4° for the Chinese standard and 5° for the Czech standard. However, as can be observed from Tab. 9, the values of R_A remain relatively consistent. The retroreflective requirements after outdoor natural weathering for types of retroreflective sheeting are presented in Tab. 10.

Tab. 10 Retroreflective requirements for retroreflective sheeting after outdoor weathering. Sources: retrieved from ČSN EN 12899-1 (2007) and GB/T 1883 (2012)

Type or class according to		Minimum R_A ($\text{cd}\cdot\text{lx}^{-1}\cdot\text{m}^{-2}$)	Outdoor weathering time (Month)
ČSN EN 12899-1	GB/T 1883		
	I	50 % of Tab. 6	24
RA1, RA2, RA3	III, IV	80 % of Tab. 6	36

Even the minimum values of R_A confirm some correspondence between the different types of materials of these two standards for the selected pairs of angles α and β_1 , presented in Tab. 11.

Tab. 11 Range of observation and entrance angles in Chinese and Czech standards. Sources: retrieved from ČSN EN 12899-1 (2007) and GB/T 1883 (2012)

	GB/T 18833-2012	ČSN EN 12899-1:2007	
	for all types	RA1, RA2	RA3
Observation angle (α)	<u>0.2</u> °, 0.5°, <u>1</u> °	<u>0.2</u> °, 0.33°, 2°	0.33°, <u>1</u> °, 1.5°
Entrance angle (β_1 , $\beta_2 = 0$)	<u>-4</u> °, 15°, 30°	<u>5</u> °, 30°, 40°	<u>5</u> °, 20°, 30°, 40°

However, the similarity of standards is based on the assumption that R_A is similar for entrance angles -4° and 5° (underlined as the same in Tab. 11) since the axis of β_1 is perpendicular to the plane containing the illumination and observation axes, as shown in Fig. 31.

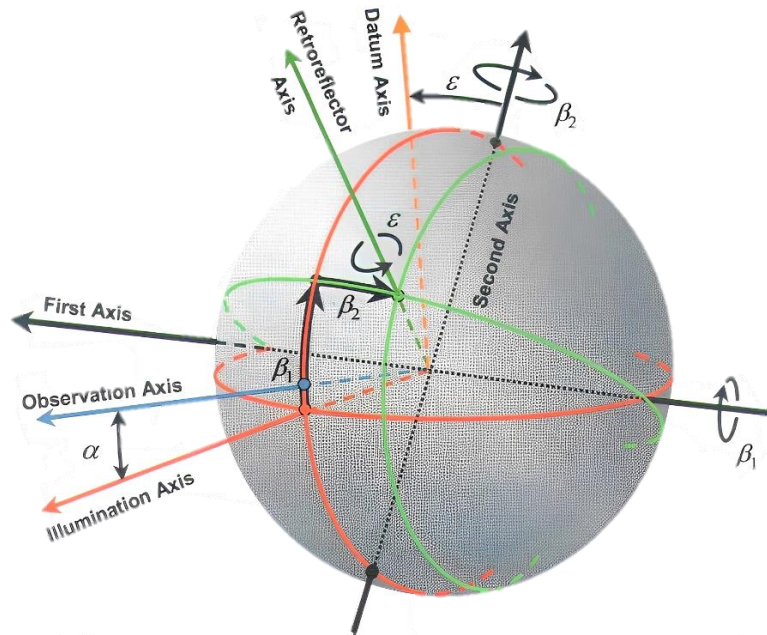

Fig. 31 The CIE System for Measuring Retroreflectors.

Source: retrieved from International Commission on Illumination (2001)

3 Goals and Hypothesis

The main goal of this research is to determine the effect of external factors on the level of retroreflectivity of traffic signs. To achieve this goal, 17 hypotheses have been formulated based on a thorough literature review. These hypotheses are designed to confirm or disprove statements relating to the influence of:

- accelerated natural weathering;
- atmospheric conditions;
- dirtiness, precipitation;
- exposure to sunlight;
- material of sign panel;
- measurement conditions and equipment;
- orientation;
- recognition by the vehicle camera system.

Accelerated natural weathering

Hypothesis 1.1: The retroreflection coefficient of test specimens exposed to accelerated natural weathering for 36 months will be higher than the minimum required values from ČSN EN 12899-1.

Hypothesis 1.2: The degradation rate of the retroreflective film over time is better described by a linear function.

Hypothesis 1.3: The trend of retroreflectivity deterioration in the same class and colour will be similar from manufacturer to manufacturer.

Hypothesis 1.4: The level of retroreflective degradation will depend on the colour of the retroreflective film.

Atmospheric characteristics

Hypothesis 2: The level of retroreflectivity of traffic signs will vary significantly depending on the atmospheric characteristics of the location.

Dirtiness, precipitation, drizzle, and dew

Hypothesis 3.1: Dirtiness and precipitation on the surfaces of traffic signs will significantly influence the coefficient of retroreflection.

Hypothesis 3.2: The influence of dirtiness and precipitation on retroreflectivity will depend on the sheeting material.

Hypothesis 3.3: Raindrops on the sign surface will have a worse effect on retroreflectivity than dew.

Exposure to sunlight:

Hypothesis 4.1: The influence of solar radiation is the central degradation factor for retroreflective sheeting.

Hypothesis 4.2: Specimens installed outdoors but without exposure to direct solar radiation will have a higher R_A over time than in-service traffic signs.

Hypothesis 4.3: The R_A of samples stored in a box will not change over time.

Material of sign panel:

Hypothesis 5: The material of the sign panel will not affect the retroreflective properties of traffic signs.

Measurement conditions and equipment:

Hypothesis 6.1: The R_A does not depend on ambient temperature and relative humidity of the air.

Hypothesis 6.2: Different retroreflectometers devices do not show significant differences in measurements of the R_A of traffic signs.

Hypothesis 6.3: There is no statistical difference in R_A measurements taken at entrance angles of -4° or 5° .

Orientation:

Hypothesis 7: The orientation of traffic signs will not impact their retroreflectivity.

Recognition by the vehicle camera system:

Hypothesis 8: The efficiency of recognition of traffic signs by the vehicle's system depends on the level of retroreflectivity.

4 Materials and Methods

A methodology was developed based on the goal and hypotheses of this thesis. The number of materials and their positioning was chosen to analyse the selected factor's influence on the test samples' retroreflective properties.

4.1 Test samples

All the retroreflective test sheeting samples are presented in Tab. 12.

Tab. 12 The number of microprismatic (or in brackets, glass bead) retroreflective test samples according to their location, colour and class/type. W – white, R – red, B – blue, G – green, F – yellow-green fluorescent, Y – yellow

Country	Location	Class/ Type	Colour					
			W	R	G	B	F	Y
Czechia	Prague 6, Horoměřice	RA1	4 (51)	3 (31)				
		RA2	8					
		RA3	2	6			8	
China	Chaoyang District, Beijing	I	1	3	0	2		0
		III	45	9	2	28		0
		IV	7	1	0	4		1
	Songjiang District, Shanghai	I	19	6	0	10		0
		III	12	2	0	11		0
		IV	16	0	1	12		1
Czechia	D0, Prague	RA3	27	17	6	5		
	I/11 and I/35, Hradec Králové	RA1	17	13				
		RA2	14	10				
		RA3	65	54		4		
China	G3, Beijing	IV	11	5	6	3		4
		V	4	0	0	0		0
Czechia	Test desk	RA1	1 (3)	1 (3)		4		
		RA2	3	3		3		
		RA3	3	3	5	5		
	Garden	RA1	(4)	(2)				
		RA2	2					
		RA3	3	6			3	
	Box	RA1	1 (3)	1 (3)		4		
		RA2	3	3		3		
		RA3	3	3	5	5		
China	Storage	I	3	1	1	1		3
		III	3	2	2	2		3
		IV	3	3	3	3		3
		V	3	3	3	3	3	3

In Tab. 12, the samples were divided according to the following categories:

- the country – Czechia or China;
- the form of application – in-service traffic sign, applied sheeting on the metal desk or samples from the roll;
- location – districts (e.g. Prague 6), sections of the road (e. g. G3 in Beijing), particular environment (e.g. laboratory);
- technology – glass bead and microprismatic;
- performance Classes in accordance with *TP 65 (2013)* (RA1, RA2, RA3) or Types under *GB/T 18833 (2012)* (I, III, IV, V);
- by the colour – white, red, green, blue, yellow or fluorescent yellow-green.

It is also worth noting that ‘sample’ refers to a retroreflective sheeting of the same type, class, colour and manufacturer. For example, in-service traffic sign B28 (according to *TP65 (2013)*) includes two test samples as it consists of two colours – blue and red.

All retroreflective sheeting was presented from three manufacturers: Avery Dennison (hereinafter “AD”), Oralite (hereinafter “OR”), and 3M (Tab. 13).

Tab. 13 Test samples according to the manufacturer, colour and type. W – white, R – red, B – blue, G – green, F – yellow-green fluorescent, Y – yellow

Manufacturer and serial number	Colour					
	W	R	B	G	F	Y
AD 1500	x	x	x			
OR 5710	x	x	x			
3M 3200	x	x	x			
AD 6500	x	x	x			
AD 7500	x	x	x	x		
OR 5710	x	x				
OR 5910	x	x	x			
OR 6910	x	x	x	x		
3M 3400	x	x	x	x		x
3M 3930	x	x	x	x		x
3M 3940	x	x	x	x		x
3M 4000	x	x	x	x	x	x

All retroreflective films utilised in this research were self-adhesive and, in the majority of cases, were applied on a metal panel. For in-service traffic signs in China and Czechia, retroreflective sheeting was applied by manufacturers on FeZn panels. Test samples from the location ‘*Test desk*’ and ‘*Box*’ were also applied to the FeZn panel. Only 2/3 of test samples from ‘*Garden*’ were applied on FeZn, and others on Al panels. ‘*Storage*’ samples have not been applied on any metal panel.

Dimensions of the samples for the *Test desk* were 210 mm by 297 mm, while the samples for the *Garden* were prepared following standards (*ČSN EN 12899-1, 2007*;

EAD 120001-00-0106, 2016). Microprismatic test samples were 200 mm by 200 mm, and glass bead were 100 mm by 100 mm.

4.2 Study locations

This part is dedicated to a detailed analysis of the locations presented in Tab. 12.

4.2.1 In-service traffic signs in Czechia and China

The study covered in-service traffic signs located in five locations in Prague 6 and Horoměřice (hereinafter “P6H”) in the Czech Republic (Fig. 32). Since 96 % of all types of road signs in this country contain white and/or red elements on them (TP 65, 2013), all selected signs contain elements of these colours. All traffic signs were from one manufacturer. The age of the selected road signs varied from one year to at least seven years.

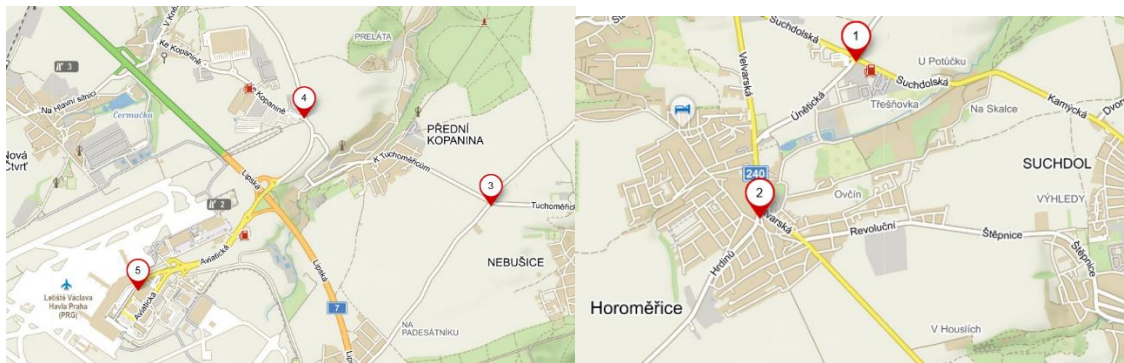

Fig. 32 The representation of the selected five locations in Prague and Horoměřice in the Czech Republic. Source: retrieved from *Mapy.cz* (2020)

One hundred signs in two areas in Beijing (Chaoyang District) (Fig. 33, Left) and Shanghai (Songjiang District) (Fig. 33, Right) were randomly selected for measurements (fifty in each district). Chaoyang District is hereinafter referred to as “BCD”, and Songjiang District is hereinafter referred to as “SSD”.

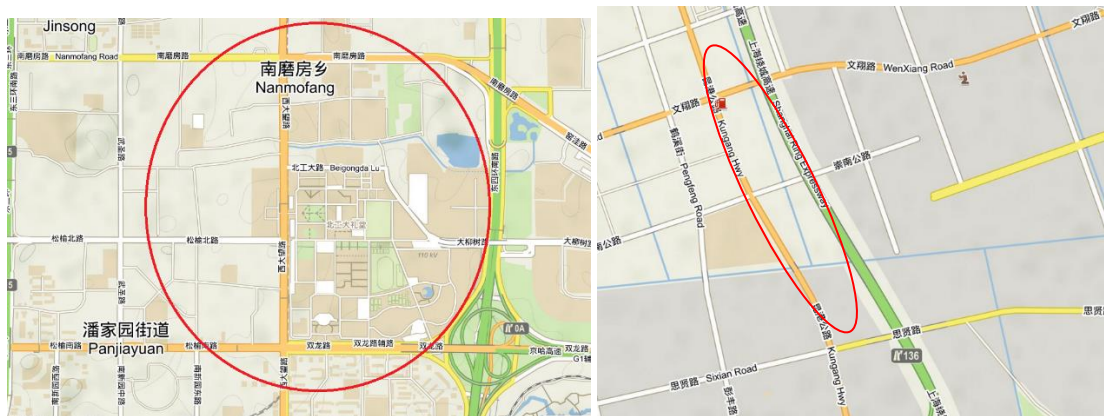

Fig. 33 The representation of the selected areas in China. (Left) A selected area in Beijing. (Right) A selected area in Shanghai. Source: retrieved from *Mapy.cz* (2020)

4.2.2 In-service traffic signs along highways and major arterials

Sections of the highways with similar conditions were selected in Prague and Beijing. One section of the Beijing Jingtai highway G3 (hereinafter “BG3”) in both directions (Fig. 34, Left) has been selected because the time of installation of the signs and the type and class of reflective films were known. The approximate daily traffic intensity has been calculated using *TP 189* (2018). Based on traffic intensity and traffic sign orientation, a section of the D0 highway (hereinafter “PD0”) was selected in Prague (Fig. 34, Right). Data on traffic intensity were taken from the official website of the Technical Road Administration of Prague (*TSK Praha*, 2018).



Fig. 34 Selected highway sections in China and Czechia. (Left) The road section of Jingling highway in Beijing, in both directions. (Right) The road section of D0 highway in Prague, in both directions. Source: retrieved from *Mapy.cz* (2020)

Two sections of the major arterials (‘silnice I. třídy’), number I/11 and I/35 (hereinafter “MA”), were selected as a part of co-operation work with Škoda Auto a.s. The selected road sections are presented in Fig. 35. These arterials were deliberately selected because of their recent pavement reconstruction, which entailed replacing vertical road traffic signs.

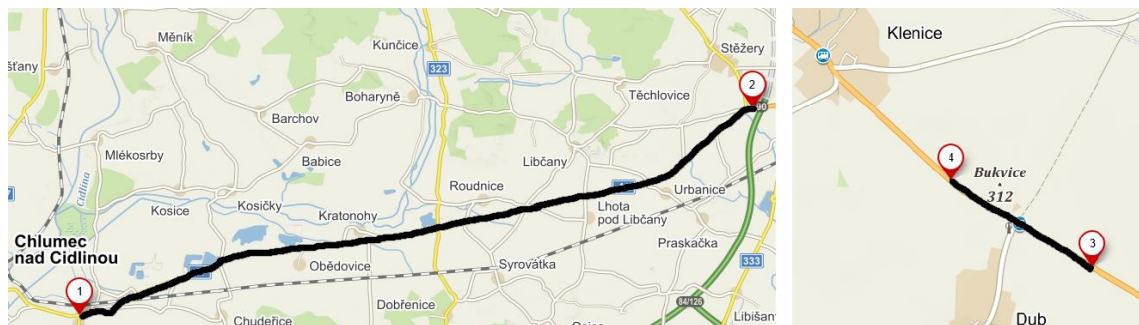

Fig. 35 The representation of selected road sections of the Czech Republic. (Left) Section of the major arterials number I/11 from Nové Dvory, in the direction of Hradec

Králové. (Right) Section of the major arterials number I/35 from Hradec Králové, in the direction of Klenice. Source: retrieved from Mapy.cz (2020)

4.2.3 Retroreflective samples in particular environments

A particular environment for retroreflective test samples means conditions different from natural weathering.

The *Test desk* from Tab. 12 referred to the group of retroreflective samples placed on the test desk, which was installed on the flat roof of the Faculty of Engineering of CULS Prague (Fig. 36). It was inclined at an angle of + 45 ° and oriented face to the south for accelerated natural weathering under the Czech standard (*ČSN EN 12899-1*, 2007).



Fig. 36 Test desk with the retroreflective sheeting samples on the roof of the Faculty of Engineering, CULS Prague. Source: Author's photo

The retroreflective test samples from the *Garden* (Tab. 12) were installed in the open air (garden) of the Faculty of Engineering of CULS Prague. The desk was inclined at - 45 ° so that direct sunlight did not reach the retroreflective surface.

In the location corresponding to the name *Box* (Tab. 12), the samples were put into the black box in the laboratory. The samples were not exposed to any meteorological influences or the influence of sunlight.

Storage from Tab. 12 means where the retroreflective films were stored in rolls without exposure to the environment or daylight at a room temperature of 21–25 °C.

4.3 Methodology

The basic principle of establishing the influence of a particular factor on the sign's retroreflectivity will be the comparison of R_A values obtained as a result of measurements made under different conditions.

The methodology of measurement R_A will be similar for almost all measurements. The handheld retroreflectometer Zehntner ZRS 6060 will be used for measurements of

the whole practical part of the study. The measuring principle with the retroreflectometer is the same for all measurements. The first step is calibrating the device using a calibration standard mounted on the ‘calibration side’. Then the front plate is mounted on the ‘measuring side’. The second stage is the direct measurement, when the instrument is planted on the surface of the traffic sign, and the trigger is pulled. Three or more readings of each sign colour will be collected using the handheld retroreflectometer.

The methodology of data collection in specific contexts is presented below.

4.3.1 Durability

Accelerated natural weathering is one of the durability tests. Samples will be exposed to accelerated natural weathering (ČSN EN 12899-1, 2007) for 46 months on the *Test desk* (Tab. 12). All samples' R_A will be measured using a handheld retroreflectometer six times. In the beginning, the new samples will be measured. Then the measurements will be repeated after 4 months, 14 months, 20 months, 30 months, and 46 months.

4.3.2 Atmospheric characteristics

The retroreflective test samples will be compared from four locations. The new sheeting samples from *Storage*, 32 months old traffic signs from *BG3*, 30 months old sheeting - from the *Test desk*, and 107 months old traffic signs from *P60*. Traffic signs will be uncleaned to represent their actual retroreflective performance.

Firstly, traffic signs in China will be measured. The type of sheeting will be determined using the “Traffic sign retroreflective sheeting identification guide” (2014). Then the same materials of traffic signs will be found in the *P6H* location using a marking label on the back of each sign. Then all materials from previous measurements will be found in *Storage*, and their R_A will be measured.

4.3.3 Meteorological conditions

In this study, the influence of dirt, dew, frost, and drizzle on the retroreflective performance of traffic signs will be investigated by measuring the R_A of in-service signs from group *P6H* in different conditions. The influence of dirt will be tested in four steps: measuring uncleaned signs, measuring the same signs three days after heavy rain (rainfall intensity is higher than 10 mm per hour), measuring the same signs after moderate rain (the intensity of rainfall is between 2.5–10 mm per hour), and measuring cleaned signs.

An investigation of the impact of precipitation on the reflectivity of traffic signs will be conducted through the examination of the reflectivity of the signs under various weather conditions, including dew, hoarfrost, and light drizzle, from October to December. Additionally, the signs' reflectivity will also be measured in the absence of moisture. Specifically, measurements of the reflectivity of traffic signs covered in frost will be conducted in December.

4.3.4 Exposure to sunlight (UV radiation)

From four locations, five groups of samples will be formed according to the conditions in which the retroreflective sheeting will be studied and the exposure time of samples (Tab. 14).

Tab. 14 The sample groups for studying the effects of solar radiation depending on location, time of exposure, the material of the sign panel. Source: Author's work

Location	Test desk	Test desk	P6H	Box	Garden
Number of samples	10				
Time of exposure (months)	22	12			
Ambient temperature (°C)	-5-35			18-32	-5-35
Relative humidity of air (%)	25-100			45	25-100
Orientation to the sun	South			-	
Material of sign panel	FeZn				

Ten retroreflective sheeting will be chosen. Using the Zehntner ZRS 6060, the R_A of each sheeting will be found. Then sheeting will be applied on the FeZn panel, and thirty samples will be created. Ten samples will be installed on the *Test desk* according to the Czech standard (*ČSN EN 12899-1, 2007*) for accelerated natural weathering. The R_A of cleaned samples will be measured after 12 months and 46 months. Another ten samples will be stored in the *Box*. The samples will be unpacked after 46 months, and their R_A will be measured. The last group will be formed from the remaining samples. Ten samples will be installed in the *Garden* to avoid direct sun rays, while samples will be under natural weathering. After 46 months, the samples will be cleaned, and the R_A of these samples will be measured.

The same retroreflective sheeting material will be found on the in-service signs in the *P6H* location. The time of installation of traffic signs will be 46 months. The R_A of such retroreflective sheeting will be measured using a handheld retroreflectometer.

4.3.5 Material of sign panel

The twenty samples of ten types of retroreflective sheeting (without any sign panel) will be measured by retroreflectometer under laboratory conditions (*ČSN EN 12899-1, 2007*). Then ten retroreflective samples will be applied on a 1 mm thick FeZn panel. Another ten samples will be applied on 2 mm thick Al panel. All twenty samples will be placed in the location *Garden* (Tab. 12). After 46 months, the same samples' R_A measurement will be repeated.

4.3.6 Measurement conditions and equipment

In order to determine the effects of temperature and relative humidity, it will be necessary to exclude all other factors that could affect the retroreflectivity of the material.

The calibration standard, a small piece of retroreflecting material (Fig. 37) not exposed to the external environment, will be used for this purpose.



Fig. 37 The front plate of Zehntner ZRS 6060 with the label of the calibration standard (at the top) and calibration standard (at the bottom). Source: Author's foto

It will be measured when the front plate of the retroreflectometer is mounted on the 'calibration side'. One thousand four hundred measurements will be conducted at an ambient temperature from -3°C to +25 °C, and the air's relative humidity range will be 25 % – 100 %.

In order to compare the results of R_A measurement obtained using different types of retroreflectometers, samples from Storage will be measured using the handheld Zehntner ZRS 6060 and the stationary RoadVista 933 (Fig. 38) under the same conditions prescribed in the standard (ČSN EN 12899-1, 2007).



Fig. 38 RoadVista 933 Retroreflective Workstation. Source: Author's foto

The RoadVista 933 will be chosen for its ability to accurately measure at various angles, including α , β_1 , and ε . The RoadVista 933 is a benchtop device equipped with a three-axis moving plate on which the sample is placed and fixed. Each sample will be measured twice, first with the Zehntner and then with the RoadVista. The temperature and relative humidity will be also recorded during the measurement.

Tab. 15 Angles for R_A ($cd \cdot lx^{-1} \cdot m^{-2}$) measurements with Zehntner and RoadVista 933 retroreflectometers. Source: Author's work

Retroreflectometer	α (°)	β_1 (°)	ε (°)
<i>Zehntner ZRS 6060</i>	0.2	5	-75
	0.33		-50
	2		-25
<i>RoadVista 933</i>	0.5	-4	0
	1		25
	1.5		90

The first set of measurements will be conducted using the Zehntner and the RoadVista, while the second set will be only conducted using the RoadVista. The second set of measurements will be to determine if the results from other countries could be used to revise the Czech standard (*ČSN EN 12899-1, 2007*). To present the various combinations of angles at which the measurements will be taken, a table (Tab. 15) was created. The table includes the values of α , β_1 , and ε for both sets of measurements, allowing for a comprehensive understanding of the experimental design.

4.3.7 Orientation

Two groups of sheeting samples will be made to find the influence of sign-facing direction. The first group will be north and south-orientated signs in *BG3, PD0*. Only traffic signs with known age and white colour will be measured. The second group will be different oriented signs in *SSD, BCD* and *P6H*. The signs will be chosen randomly in *SSD* and *BCD* locations. The material of retroreflective sheeting will be identified using the Guide (*Traffic sign retroreflective sheeting identification guide, 2014*). The same sheeting materials will be selected for measuring traffic signs in *P6H*.

4.3.8 Recognition by the vehicle camera system

The traffic signs in the *MA* location will be examined in two steps. The first step will be to analyze the accuracy of recognition and recognition distance (hereinafter “RD”) of traffic signs using the vehicle TSDR system and the Automotive Data and Time triggered Framework development environment (hereinafter “ADTF”).

The second step will be measuring the R_A of the same signs using a handheld retroreflectometer Zehntner ZRS 6060. In order to eliminate the influence of relative humidity and ambient temperature, both steps will be made under the same weather conditions and temperature range.

4.4 Data analysis

The software ‘MappingTools’ will be used for data analysis to export measured data from the retroreflectometer and generate measuring reports (Fig. 39).

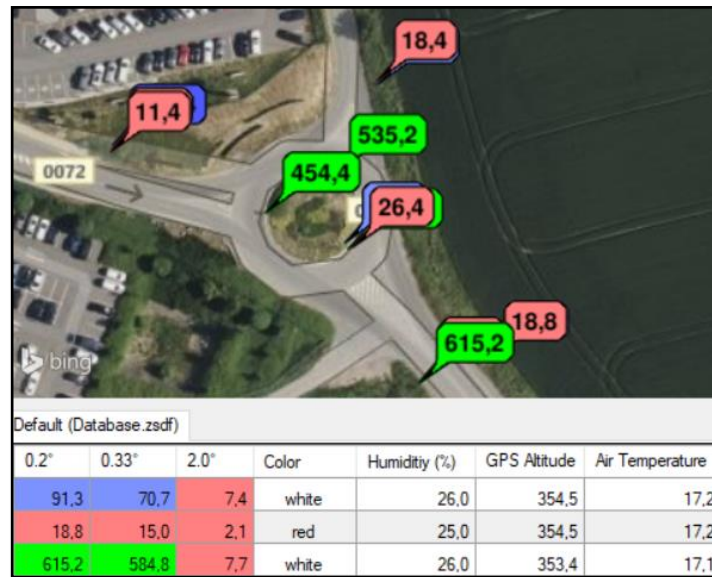

Fig. 39 The example of measuring report generated in the ‘MappingTools’. The report consists of the map position of measured road signs and details of the measurements in a table. Source: MappingTools environment

For analysing data from the vehicle, the ADTF will be used. ADTF enables playback stored data from camera memory, processing, and visualization (Fig. 40).



Fig. 40 The screen view of two visualization filters of ADTF. (Left) Video widget with the filter of recognition of traffic signs. (Right) Coordinate graph for determining recognition distance to the signs. Source: ADTF environment

The ‘STATISTICA’ software will be used for statistical analysis of measurements made using retroreflectometers Zehntner ZRS 6060, RoadVista 933 and ADTF environment. There are different ways to analyse the data, so the author compiled a single algorithm (Fig. B.1) for selecting a statistical test.

5 Results and Discussions

The results of this thesis are presented clearly and organised by dividing this chapter into sections corresponding to each factor under examination. The results of relevant statistical analyses are presented and discussed within each section, highlighting any trends or patterns that emerge from the data. Furthermore, the results of this thesis are compared to previous research findings from the literature review, where applicable, to provide a more comprehensive understanding of the impact of the corresponding factor on the retroreflectivity of traffic signs.

5.1 Accelerated natural weathering

The purpose of this section is to present the results of the thesis examining the influence of accelerated natural weathering on the retroreflectivity of traffic signs. Accelerated natural weathering is a technique used to simulate the effects of long-term materials exposure to natural weathering conditions. In this doctoral thesis, the test specimens were exposed to accelerated natural weathering on the *Test desk* for 46 months to investigate the degree of degradation in their retroreflective properties.

5.1.1 Degradation of retroreflective materials over time

Figures 41 through 46 present the results of six measurements conducted to evaluate the accuracy of Hypothesis 1.1 and Hypothesis 1.2. These hypotheses relate to the degradation of retroreflective materials over time and use predictive models to describe this degradation. The y-axis of each graph represents the coefficient of retroreflection, while the x-axis represents time in months or years. The class, technology, and colour of the retroreflective material categorise the measurements. Each figure displays the measurement results of three samples subjected to accelerated natural weathering from different manufacturers: AD, OR, and 3M. The figures also include trend lines predicting the degradation of the sheeting up to the approximate end of its service life (7 years for glass bead technology and 10 years for microprismatic technology). The trend line equations and R^2 values for each sample are included. Additionally, the figures include the minimum requirements specified in Chapter 2.4, Tab. 9.

Glass bead sheeting exhibits lower retroreflective performance than microprismatic sheeting (Lloyd, 2008), leading to its classification in the lowest retroreflective class, RA1. Despite this, it is commonly used for signs on local roads and parking spots in *P6H*. The white glass bead Class RA1 retroreflective sheeting results are shown in Fig. 41. The linear trendlines describe the measurements well, with R^2 values of 0.60, 0.75, and 0.85. None of the measurements was below the minimum requirement of $40 \text{ cd}\cdot\text{lx}^{-1}\cdot\text{m}^{-2}$, and the trendlines predict values much higher than the minimum requirement even at the expected end of the service life (after 84 months).

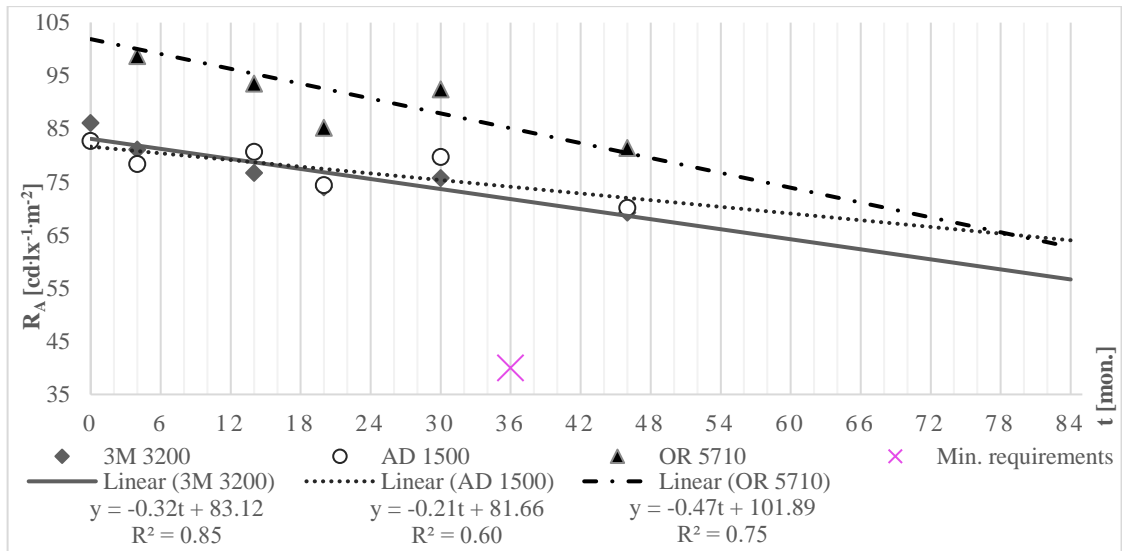

Fig. 41 Degradation trends of R_A ($\text{cd}\cdot\text{lx}^{-1}\cdot\text{m}^{-2}$, $\alpha = 0.33^\circ$, $\beta_1 = 5^\circ$) for white glass bead sheeting Class RA1 exposed to accelerated natural weathering. Source: Author's work

Fig. 42 represents the results for red glass bead Class RA1 sheeting. The linear trendlines have R^2 values of 0.60, 0.75, and 0.85, demonstrating that they effectively describe the degradation of the material. The trendlines are relatively similar, with only slight differences in slope. The forecast for trendlines at the end of service life (after 84 months) is close to the minimum level of $5.6 \text{ cd}\cdot\text{lx}^{-1}\cdot\text{m}^{-2}$, but still slightly higher.

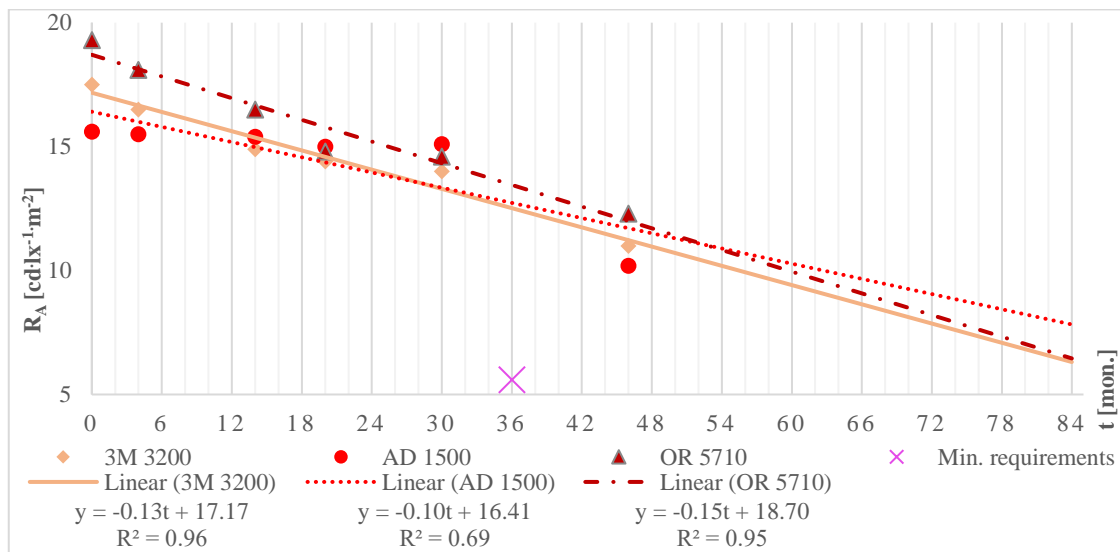

Fig. 42 Degradation trends of R_A ($\text{cd}\cdot\text{lx}^{-1}\cdot\text{m}^{-2}$, $\alpha = 0.33^\circ$, $\beta_1 = 5^\circ$) for red glass bead sheeting Class RA1 exposed to accelerated natural weathering. Source: Author's work

The results for blue glass bead Class RA1 retroreflective sheeting are shown in Fig. 43. Some of the measurements for the 3M 3200 sample are below the minimum requirement of $1.12 \text{ cd}\cdot\text{lx}^{-1}\cdot\text{m}^{-2}$. However, this sheeting initially had a low R_A , which only slightly exceeded the minimum allowable values. The linear trend poorly describes the results, with only the OR sample having an R^2 value of 0.64. The OR 5710 and AD 1500

samples have higher values of the coefficient of retroreflection than the minimum requirement.

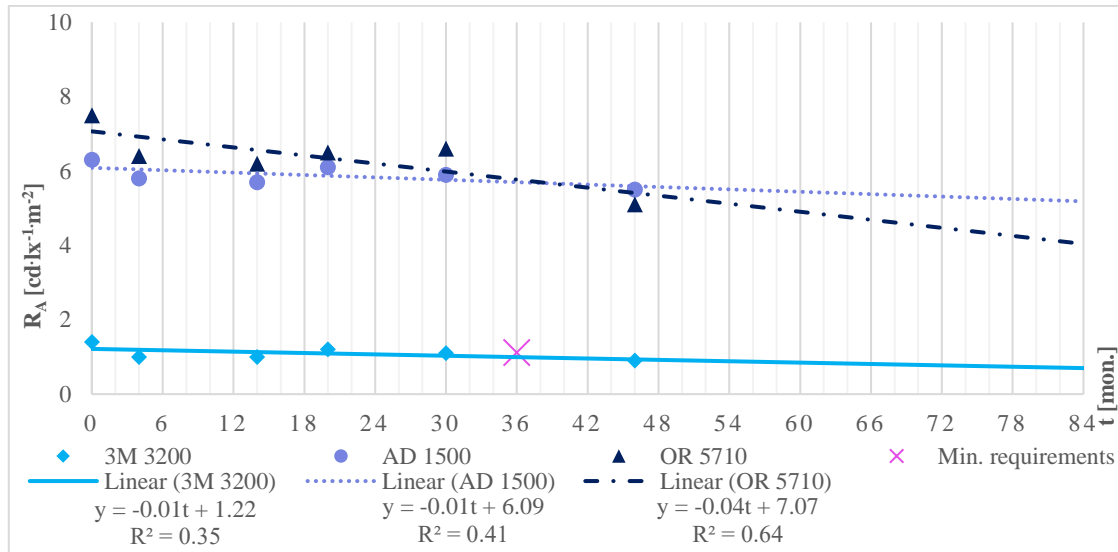

Fig. 43 Degradation trends of R_A ($\text{cd}\cdot\text{lx}^{-1}\cdot\text{m}^{-2}$, $\alpha = 0.33^\circ$, $\beta_1 = 5^\circ$) for blue glass bead sheeting Class RA1 exposed to accelerated natural weathering. Source: Author's work

Microprismatic technology has better retroreflective performance and can meet the requirements for all three classes of the Czech standard (RA1, RA2, RA3) (ČSN EN 12899-1, 2007).

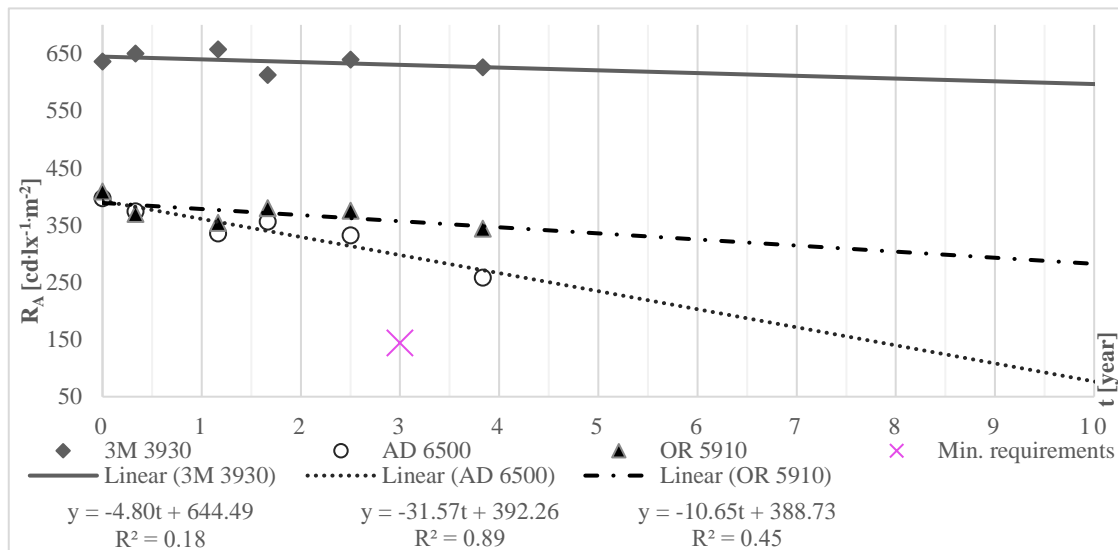

Fig. 44 Degradation trends of R_A ($\text{cd}\cdot\text{lx}^{-1}\cdot\text{m}^{-2}$, $\alpha = 0.33^\circ$, $\beta_1 = 5^\circ$) for white microprism. RA2 sheeting exposed to accel. natural weathering. Source: Author's work

Additionally, in some countries such as China, only microprismatic sheeting is available due to its more environmentally friendly production process than glass bead sheeting (AGC Glass Europe, 2020). The degradation trends of microprismatic Class RA2 retroreflective sheeting subjected to accelerated natural weathering are demonstrated in Fig. 44 through 46. Fig. 44 presents measurements of white

retroreflective sheeting. The results for this sheeting show that the linear trendline fits well for the AD 6500 sample, with an R^2 of 0.89. However, for the other two samples (3M 3930 and OR 5910), the current results do not provide enough information to create a reliable trendline. Despite this, all samples had a level of retroreflectivity above the minimum requirement of $144 \text{ cd}\cdot\text{lx}^{-1}\cdot\text{m}^{-2}$ after three years of exposure. The forecast for the AD 6500 sample shows a rapid degradation, with the coefficient of degradation reaching minimum values after 7 years of accelerated exposure.

The red microprismatic Class RA2 sheeting results are presented in Fig. 45. The linear trendlines fit well for the AD and OR samples, with R^2 values of 0.86 and 0.83, respectively. All measurements were more significant than the minimum level of $14 \text{ cd}\cdot\text{lx}^{-1}\cdot\text{m}^{-2}$. However, the forecast for the 3M 3930 sample shows that it will reach the minimum value after 90 months, while the other two will remain above the minimum value until the end of their predicted service life. It should be noted that the trendline for the 3M sample changed significantly after the last measurement, taken after 46 months of exposure.

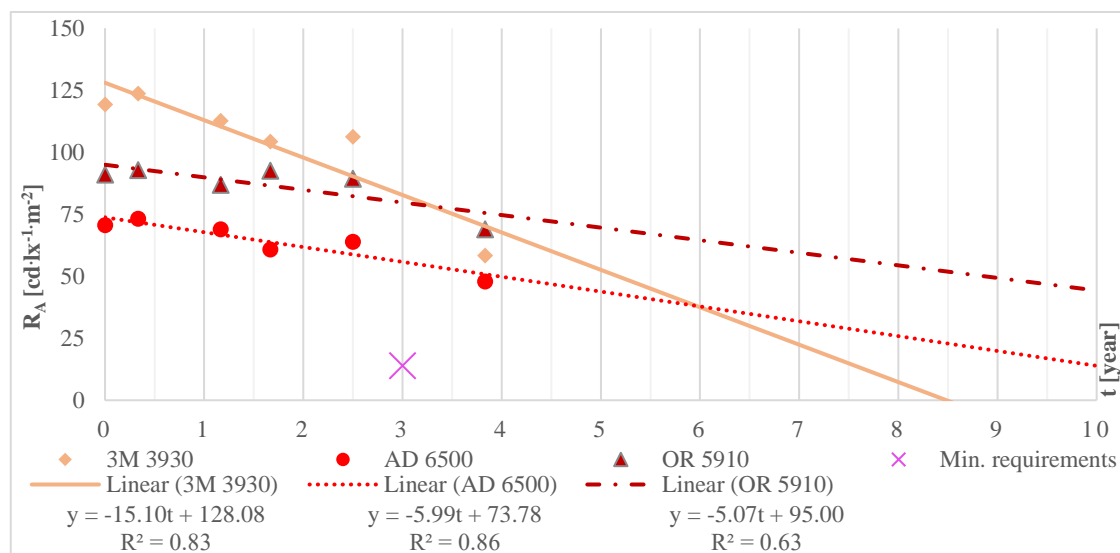

Fig. 45 Degradation trends of R_A ($\text{cd}\cdot\text{lx}^{-1}\cdot\text{m}^{-2}$, $\alpha = 0.33^\circ$, $\beta_1 = 5^\circ$) for red microprismatic sheeting Class RA2 exposed to accelerated natural weathering. Source: Author's work

The graph in Fig. 46 presents the blue microprismatic Class RA2 sheeting measurements. The blue microprismatic Class RA2 sheeting results show that the linear trend fits well for the 3M 3930 and AD 6500 samples, with R^2 values of 0.80 and 0.83, respectively. All measurements were above the minimum value of $7.84 \text{ cd}\cdot\text{lx}^{-1}\cdot\text{m}^{-2}$.

According to the forecast, the retroreflectivity of the 3M 3930 and AD 6500 samples will fall below the minimum after 7 years. The R^2 for the OR 5910 sample is low, possibly due to the significant loss in retroreflectivity after the last measurement. As a result, the forecast for this sample is not highly reliable, but it still indicates that R_A will not fall below the minimum requirements even after 10 years.

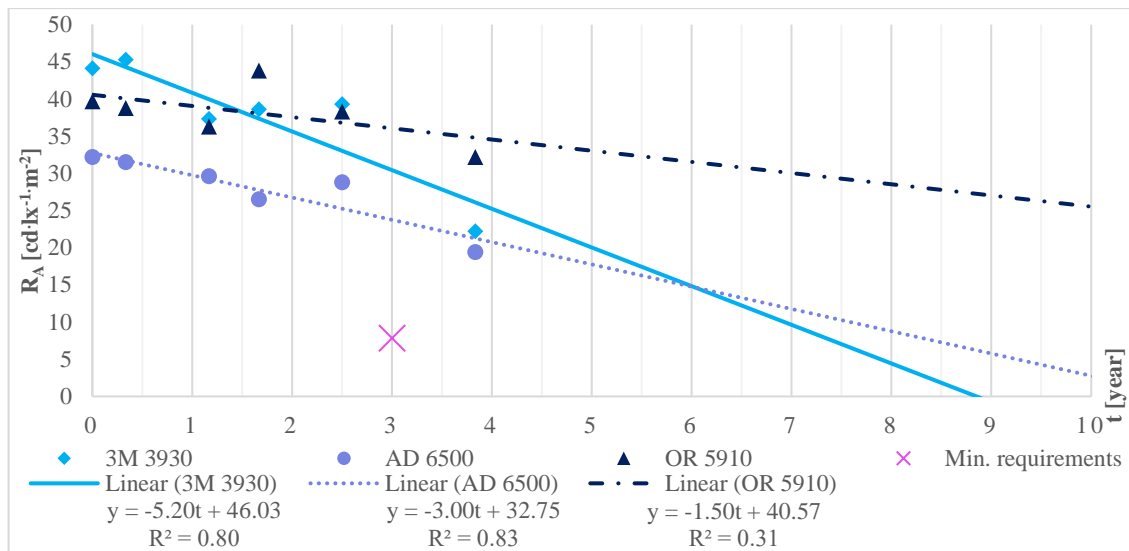

Fig. 46 Degradation trends of R_A ($\text{cd}\cdot\text{lx}^{-1}\cdot\text{m}^{-2}$, $\alpha = 0.33^\circ$, $\beta_1 = 5^\circ$) for blue microprismatic sheeting Class RA2 exposed to accelerated natural weathering. Source: Author's work

The results of the four graphs (Fig. 47 - Fig. 50) present the degradation trends of microprismatic Class RA3 sheeting over time.

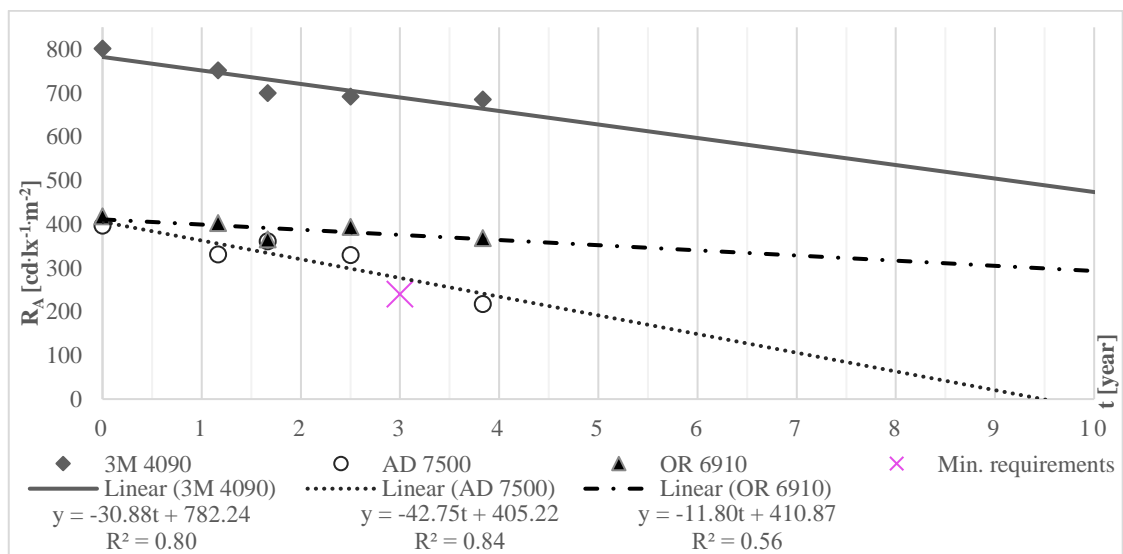

Fig. 47 Degradation trends of R_A ($\text{cd}\cdot\text{lx}^{-1}\cdot\text{m}^{-2}$, $\alpha = 0.33^\circ$, $\beta_1 = 5^\circ$) for white microprismatic sheeting Class RA3 exposed to accel. natural weathering. Source: Author's work

In Fig. 47, the white sheeting exhibits a good linear trend with R^2 values of 0.56, 0.80, and 0.84. After 46 months, the AD 7500 sample falls below the minimum requirements for retroreflection. However, according to the strong trendline, it can be assumed that the sample, after 3 years of exposure, had a coefficient of retroreflection higher than $240 \text{ cd}\cdot\text{lx}^{-1}\cdot\text{m}^{-2}$. The other two samples maintained high levels of retroreflection above the minimum requirements until the end of their service life (10 years).

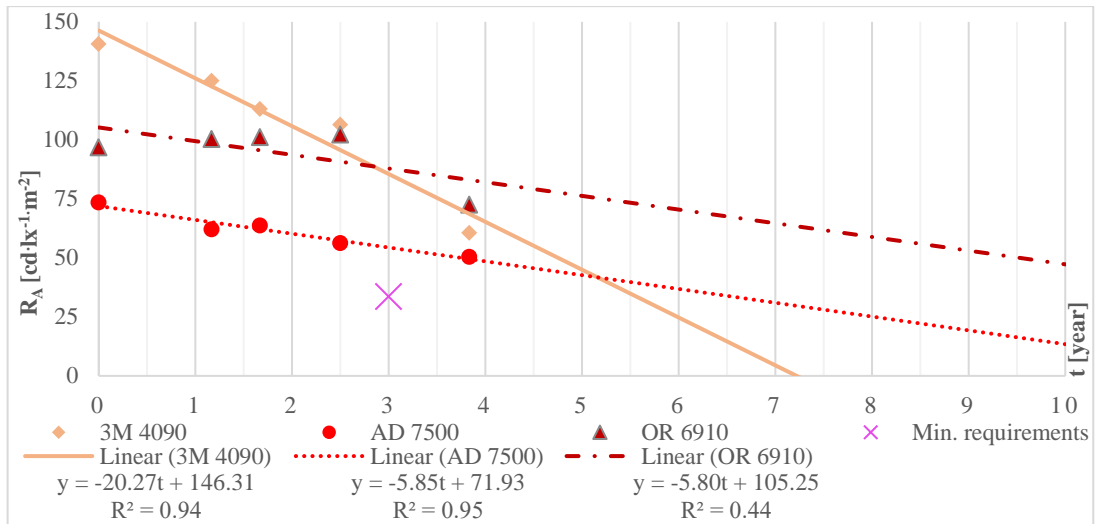

Fig. 48 Degradation trends of R_A ($\text{cd}\cdot\text{lx}^{-1}\cdot\text{m}^{-2}$, $\alpha = 0.33^\circ$, $\beta_1 = 5^\circ$) for red microprismatic sheeting Class RA3 exposed to accelerated natural weathering. Source: Author's work

Fig. 48 shows that all red Class RA3 sheeting had the R_A above the minimum requirement of $34 \text{ cd}\cdot\text{lx}^{-1}\cdot\text{m}^{-2}$. The linear trendlines demonstrate good predictive models for two samples – 3M 4090 ($R^2 = 0.94$) and AD 7500 (R^2 are 0.95). The samples will reach the minimum value after 5.5 years and 7 years, respectively. It is anticipated that the OR 6910 sample will maintain higher levels of retroreflection than the minimum required for more than a decade. However, the prediction model is weak ($R^2 = 0.44$).

Fig. 49 shows the results for the blue sheeting, with all measurements above the minimum value of $10.64 \text{ cd}\cdot\text{lx}^{-1}\cdot\text{m}^{-2}$. The trendlines for all samples fit the measurements perfectly, with R^2 values of 0.75 and 0.84. These high values indicate that the predictive values for these samples are highly reliable. All samples are expected to maintain retroreflection levels above the minimum requirement for a minimum of 6 years, with the OR 6910 and 3M 4090 samples maintaining such levels for the entire 10 years.

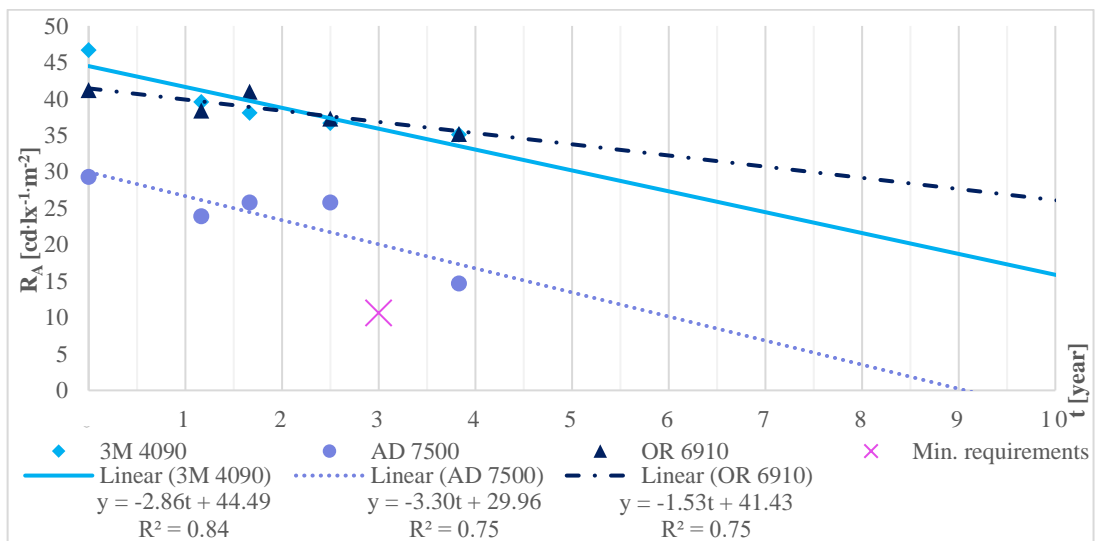

Fig. 49 Degradation trends of R_A ($\text{cd}\cdot\text{lx}^{-1}\cdot\text{m}^{-2}$, $\alpha = 0.33^\circ$, $\beta_1 = 5^\circ$) for blue microprismatic sheeting Class RA3 exposed to accelerated natural weathering. Source: Author's work

Fig. 50 presents the results for the green sheeting, with all trendlines exhibiting high reliability due to their high R^2 values of 0.72, 0.88, and 0.96. The trendlines for the OR 6910 and 3M 4090 samples have similar slope factors around -14. All measurements through 46 months are above the minimum requirements of $24 \text{ cd}\cdot\text{lx}^{-1}\cdot\text{m}^{-2}$. The 3M sample is expected to reach this value after 8.5 years, the AD 7500 sample will reach it in almost 9 years, and the OR 6910 sample is expected to reach it after 7 years.

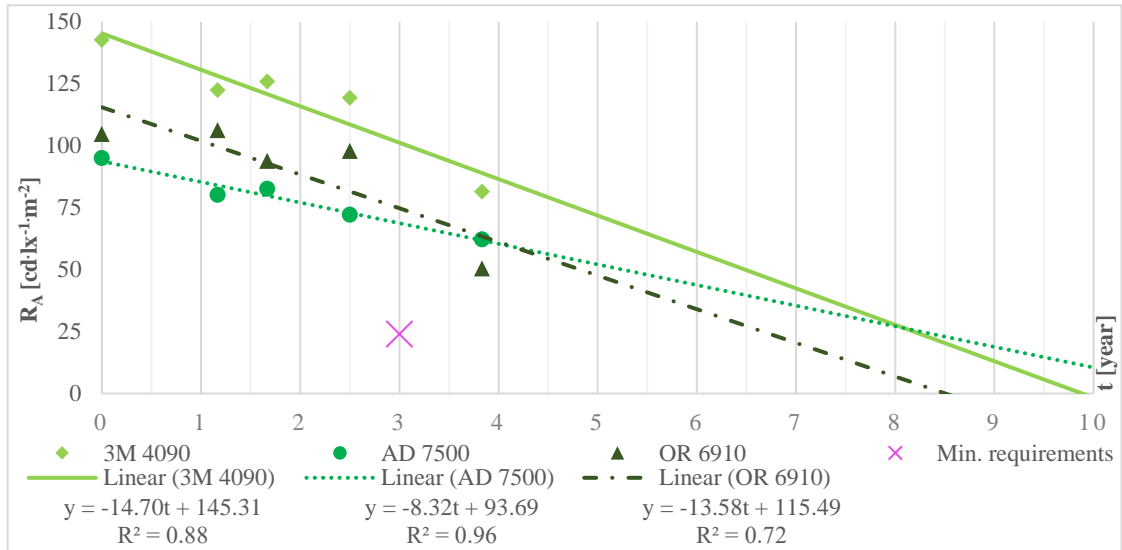

Fig. 50 Degradation trends of R_A ($\text{cd}\cdot\text{lx}^{-1}\cdot\text{m}^{-2}$, $\alpha = 0.33^\circ$, $\beta_1 = 5^\circ$) for green microprism sheeting Class RA3 exposed to accelerated natural weathering. Source: Author's work

Based on the analysis of the four graphs (Fig. 47 - Fig. 50) presenting the degradation of microprismatic Class RA3 sheeting, it can be concluded that the reflective properties of the materials do not exhibit a uniform deterioration trend. Some deviations from the expected trend may be observed in particular samples, which could be attributed to the heterogeneity of the retroreflective material (Fig. 51) and the differences in measurement points.

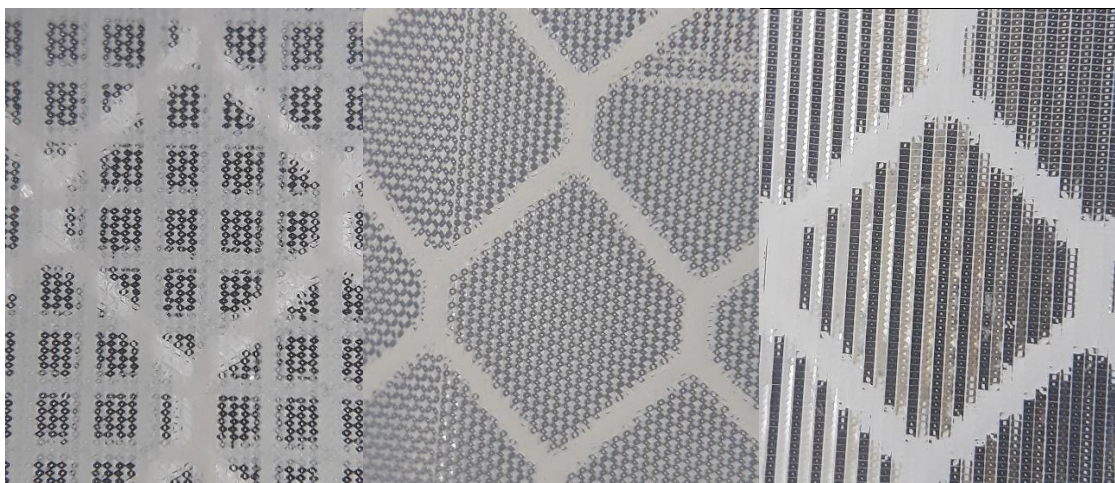

Fig. 51 Magnified images of the microprismatic structure of retroreflective materials Class RA1 (Left), Class RA2 (Center), and Class RA3 (Right). Source: Author's work

The results of the thesis show that a linear function is effective at describing the degradation rate of retroreflective film over time, with 16 % of the trendlines exhibiting a solid fit to the data (R^2 value higher than 0.9) and an additional 47 % demonstrating a good fit (R^2 value between 0.7 and 0.9). It proved that the linear model could accurately capture the changes in retroreflectivity over time for these cases. This finding is in line with those of previous studies reviewed in Chapter 2.1.1, indicating the reliability of linear trendlines as a tool for predicting the degradation of retroreflective materials. Overall, these results support using linear functions as a helpful assessment tool for determining the degradation rate of retroreflective sheeting.

Accelerated outdoor weathering is generally reliable and effectively eliminates the risk of users accepting materials that will have poor durability in their service life (Ketola, 1999). Nevertheless, exposure requirements are intended to ensure a minimum level of durability rather than predict service life (Ketola, 1999). In the Czech Republic, there are no end-life requirements specifying the R_A values when the sheeting on traffic signs should be replaced. Moreover, no information is available on the correlation between accelerated and normal sheeting ageing rates.

5.1.2 Manufacturer

In order to understand the influence of the manufacturer on the degradation rate of retroreflective sheeting, 27 samples from three different manufacturers (3M, AD, and OR) were analysed. The results were divided by class and colour. White, blue, and red glass bead sheeting Class RA1, microprismatic sheeting Class RA2, and microprismatic sheeting Class RA3 are presented in Fig. 52, Fig. 53, and Fig. 54, respectively.

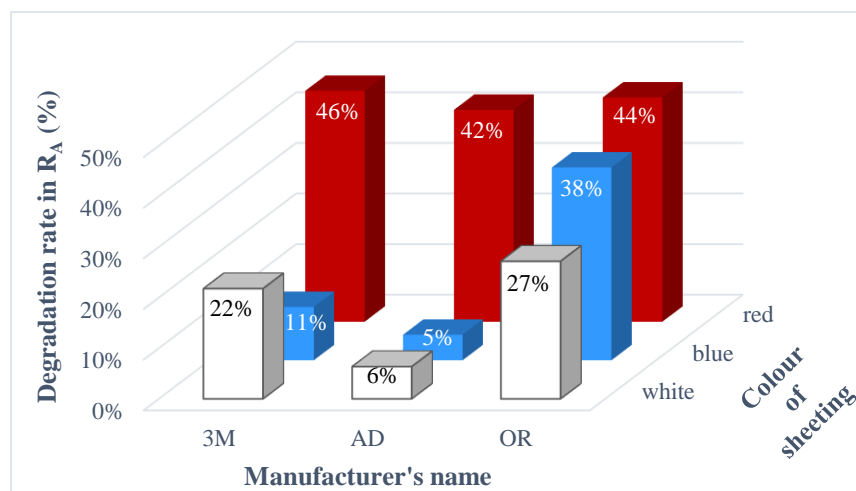

Fig. 52 Comparison of degradation rate in R_A (in %) for white, blue, and red glass bead sheeting Class RA1 from three manufacturers. Source: Author's work

As shown in Fig. 52, red-coloured samples demonstrated the highest degradation rate across all manufacturers (greater than 40%). The most significant deterioration was observed for OR samples, while samples from the AD company displayed the lowest

results. In contrast, the results for microprismatic sheeting (Fig. 53 and Fig. 54) were reversed, with OR samples showing the lowest degradation rate. Nonetheless, red-coloured samples still exhibited the highest percentage difference between the new sample and the sample after 46 months of accelerated natural weathering. The lowest degradation rate among all samples shown in Fig. 53 was observed for white microprismatic Class RA2 sheeting (approximately 2.1%).

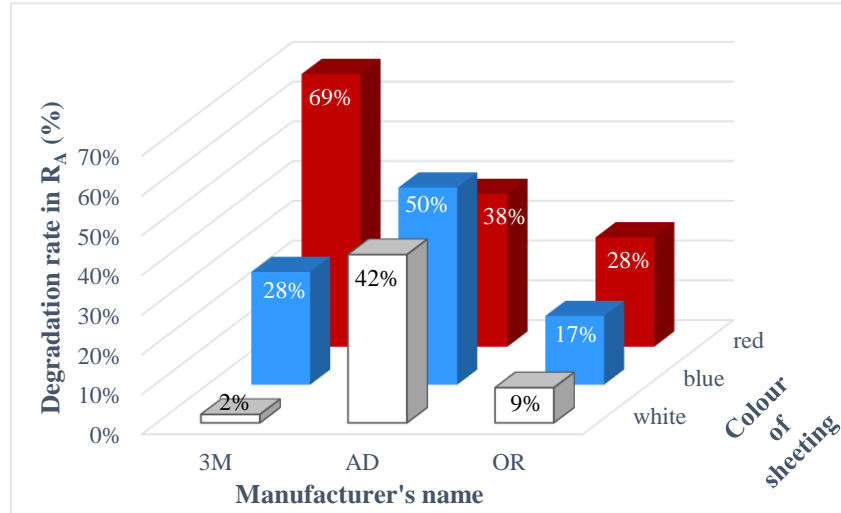

Fig. 53 Comparison of degradation rate in R_A (in %) for white, blue, and red microprismatic sheeting Class RA2 from three manufacturers. Source: Author's work

The results varied for Class RA2 and RA3 sheeting from 3M and AD manufacturers (Fig. 53 and Fig.54, respectively). A common feature was that the degradation rate for white samples was slower than for blue samples. 3M red sheeting of both classes had the highest degradation rate overall, with degradation rates of 68.6 % for Class RA2 (Fig. 53) and 79.5 % for Class RA3 (Fig. 54).

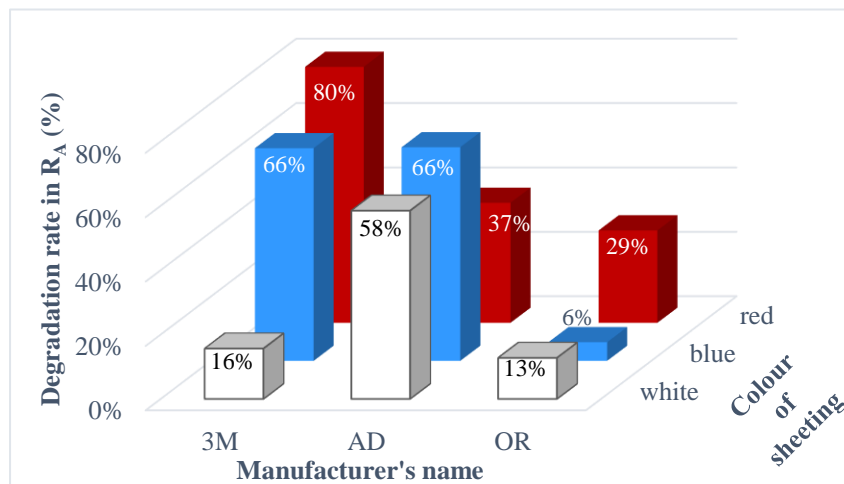

Fig. 54 Comparison of degradation rate in R_A (in %) for white, blue, and red microprismatic sheeting Class RA3 from three manufacturers. Source: Author's work

Overall, these results suggest that the manufacturer plays a significant role in the degradation rate of retroreflective sheeting, with different manufacturers experiencing varying levels of degradation. It is also essential to consider the colour of the sheeting, as red samples generally had higher degradation rates than blue or white samples.

5.1.3 Colour

The main effect ANOVA test was conducted to determine which factors, or their combination significantly impacted the degradation rate of samples after artificial natural weathering. Factors such as colour, technology, class, and manufacturer were compared. Surprisingly, only colour as a factor showed a statistical influence on degradation, with a p -value of 0.043 and a statistical power of test 0.61. A Tukey's post hoc test was then conducted to identify which colour impacted degradation (as shown in Tab. 16).

Tab. 16 Results of Tukey's post hoc test on the influence of three different colours on the degradation rate of retroreflective sheeting exposed to accelerated natural weathering.

Source: Author's work

Colour	<i>red</i>	<i>white</i>
<i>blue</i>	0.162	0.763
<i>red</i>		0.040

Only the red colour had a p -value lower than the significance level ($p = 0.040$). These results suggest that red colour may significantly influence the degradation rate of retroreflective material compared to other colours.

5.2 Atmospheric characteristics

The durability and performance of microprismatic retroreflective sheeting are influenced by various factors such as thermal, chemical, biological, mechanical, oxidizing, and climatic conditions due to the materials used in their production, which include polyacrylate, polyethene, and other polymers (KUČEROVÁ, 2007).

In this research, samples were selected from a single continental climate (Appendix C) to investigate the influence of other atmospheric conditions on the degradation rate of microprismatic retroreflective sheeting. The same latitude allowed for comparing samples exposed to accelerated natural weathering at a +45 ° incline and natural weathering at a +90 ° slope while still receiving the same amount of UV radiation. The average annual values of ozone (O₃), particulate matter (PM_{2.5} and PM₁₀), and the air quality index (AQI) were considered as atmospheric factors. The R_A was measured for the same retroreflective sheeting in four locations: *PD0*, *Test desk*, *BG3*, and *Storage*. The R_A of samples in BG3 and Storage was measured in collaboration with the Beijing University of Technology. Tab. 17 summarises the average values observed during the

service life of traffic signs in *PD0*, *BG3*, and during the accelerated exposure of sheeting in the *Test desk*. Samples from *Storage* were used as a control group.

Tab. 17 The atmospheric characteristics of Beijing, Shanghai, and Prague for 2018.

Sources: retrieved from (AQI study, 2019; Czech hydrometeor. institute, 2019)

Location	The average values for the time of exposure				TSI*
	AQI	O ₃	PM _{2.5}	PM ₁₀	
	-	μg m ⁻³	μg m ⁻³	μg m ⁻³	kWh m ⁻²
PD0	2	57	20	23	7288
Test desk	2	55	18	21	2750
BG3	2	97	47	73	2963

*– Total solar irradiation (TSI) = Annual solar irradiation · time of exposure in years

A one-way ANOVA and post hoc test were conducted to determine if there was a significant difference in R_A measurements between different locations. The results of the ANOVA test for each group and their interaction are presented in Table C.2. This chapter will only show the post hoc test results, which indicate pairs of locations with a significant difference in R_A .

It was expected that the R_A of new samples presented as a control group from *Storage* would have significantly higher results than those exposed to long-term environmental influence. However, according to *Tukey's* test for blue samples (Tab. 18), there was no significant difference between samples from the control group and those from *BG3* or *PD0*.

Tab. 18 Comparison of R_A values of 3M 3930 blue microprismatic film (RA2) at four locations using *Tukey's* post hoc test. Source: Author's work

Location	<i>BG3</i>	<i>Test desk</i>	<i>PD0</i>
<i>Storage</i>	0.52	0.022	0.48
<i>BG3</i>		0.008	0.89
<i>Test desk</i>	0.008		0.17

Additionally, for blue 3M 3930 samples, significant differences were observed between *Storage* – *Test desk* and *BG3* – *Test desk* pairs. These results suggest that, for blue Class RA2 samples, solar irradiation may not have as significant an impact on retroreflective performance as air pollutants.

According to *Tukey's* post hoc test results, there are significant differences between the retroreflection values of white microprismatic Class RA3 retroreflective sheeting in different locations, except pair *BG3* – *PD0* (Tab. 19). This analysis suggests that the amount of solar radiation in *PD0* is able to compensate for the higher levels of air pollutants in *BG3*. The amount of solar radiation was 2.46 higher in *PD0* than in *BG3*. In

BG3, the coefficients of the presence of O₃, PM_{2.5} and PM₁₀ were 1.70, 2.35 and 3.17, respectively.

Tab. 19 Comparison of RA values of 3M 4000 white microprismatic film (RA3) at four locations using Tukey's post hoc test. Source: Author's work

Location	BG3	Test desk	PD0
Storage	<u>0.000</u>	0.037	<u>0.000</u>
BG3		0.021	0.082
Test desk	0.021		<u>0.000</u>

0.000 – values lesser than three decimal places after the decimal point were neglected

This conclusion can also be drawn for white, red, and blue 3M 3930 sheeting based on the results presented in Tab. 20, Tab. 21, and Tab. 18, respectively.

Tab. 20 Comparison of RA values of 3M 3930 white microprismatic film (RA2) at four locations using Tukey's post hoc test. Source: Author's work

Location	BG3	Test desk	PD0
Storage	<u>0.000</u>	0.009	<u>0.000</u>
BG3		0.071	0.93
Test desk	0.071		<u>0.025</u>

0.000 – values lesser than three decimal places after the decimal point were neglected

Although the *p*-values for the groups BG3 – Test desk and BG3 – PD0 in Tab. 20 and Tab. 21 are higher than the significance level, it is still important to note their values. The results suggest that air pollutants have a more significant impact on white 3M 3930 sheeting than on red.

Tab. 21 Comparison of RA values of 3M 3930 red microprismatic film (RA2) at four locations using Tukey's post hoc test. Source: Author's work

Location	BG3	Test desk	PD0
Storage	<u>0.000</u>	<u>0.000</u>	<u>0.000</u>
BG3		0.17	0.087
Test desk	0.17		<u>0.000</u>

0.000 – values lesser than three decimal places after the decimal point were neglected

Additionally, the sensitivity of red 3M 3930 to solar radiation (Tab. 21) supports the conclusions drawn in Chapter 5.1.3.

5.3 Dirtiness and precipitation

While it is widely understood that preserving the retroreflective properties of traffic signs is essential for ensuring their visibility and safety on the road, in actual use, traffic signs are still subjected to environmental factors that can impact their retroreflective performance. Dirt and precipitation accumulating on the surface of traffic signs can

potentially decrease the retroreflective properties of signs. This chapter aims to examine their influence on the retroreflective properties of traffic signs and to understand the magnitude of these effects. The measurement of 82 in-service traffic signs from *P6H* were conducted to evaluate the accuracy of Hypothesis 3.1 to 3.3. The results of these experiments, along with their corresponding discussions, are presented in this section.

5.3.1 Dirtiness

The term ‘dirty traffic sign’ does not clearly define the level of contamination of the sign. Without a maintenance program for cleaning traffic signs, the only way to remove contamination is through exposure to atmospheric phenomena, such as rain. It is believed that rain can effectively clean traffic signs. To assess this hypothesis, R_A values were measured for uncleaned signs (hereinafter referred to as “WR”), for signs after moderate rain (hereinafter referred to as “AMR”), for signs after heavy rain (hereinafter referred to as “AHR”), and for artificially cleaned signs (hereinafter referred to as “AC”).

The results of the one-way repeated measures ANOVA and Tukey's post hoc test, presented in Tab. 22 as p -values for pairs of conditions WR, AMR, AHR, and AC, indicate that the dirtiness of the traffic signs does not have a significant influence on their retroreflective properties in the case of red microprismatic RA1 and RA3 sheeting, as indicated by p -values higher than 0.05. However, it is essential to note that this analysis does not consider other factors, such as the elevation of the traffic sign or traffic intensity, which may also affect the level of dirtiness of the sign and, thus, its retroreflective performance (Khalilikhah and Heaslip, 2016).

Tab. 22 The results of a one-way repeated measures ANOVA and Tukey's post hoc test for the pairs of conditions WR, AMR, AHR, and AC are presented in the table as p - values. Source: Author's work

Statistical method			ANOVA	Tukey's					
Technology	Class	Colour		WR vs AMR	WR vs AHR	WR vs AC	AMR vs AHR	AMR vs AC	AHR vs AC
Microprismatic	RA1	red	0.099						
		white	0.026	0.188	0.076	0.021	0.869	0.322	0.684
	RA2	white	0.048	0.830	0.453	0.039	0.781	0.118	0.283
		red	0.078						
	RA3	white	0.010	0.052	0.058	0.007	0.989	0.557	0.518
		red	0.000	0.000	0.000	0.000	0.260	0.007	0.411
Glass Bead	RA1	white	0.000	0.001	0.000	0.000	0.009	0.002	0.955
		red	0.000	0.001	0.001	0.000	0.989	0.700	0.675
	RA2	white	0.000	0.000	0.000	0.000	0.060	0.001	0.350
		red	0.000	0.000	0.000	0.000	0.060	0.001	0.350

0.000 – values lesser than three decimal places after decimal point were neglected

The results of the one-way repeated measures *ANOVA* and *Tukey's* post hoc test, presented in Tab. 22, show that dirt affects all types of glass bead sheeting and white microprismatic RA1 and RA3 sheeting. *Tukey's* post hoc test was conducted for these data sets to identify pairs of groups where the mean difference was statistically significant. The results of significant differences between couples are also presented in Tab. 22. Based on the obtained *p*-values, there are substantial differences between unwashed and artificially washed traffic signs (pair 'WR vs AC'). For all types of glass bead sheeting, the intensity of rainfall is a decisive factor, as there are significant differences between the pairs 'WR-AMR' and 'WR-AHR' (Tab. 22). For microprismatic sheeting, the presence of precipitation is not as substantial, as even after heavy rain, the R_A values do not significantly increase. This suggests that the influence of dirt on the retroreflective performance of traffic signs depends on the type of sheeting material and the precipitation intensity.

The analysis showed that dirt significantly impacted the retroreflective performance of all types of glass bead sheeting and white microprismatic RA1 and RA3 sheeting. *Tukey's* post hoc test was performed to identify pairs of groups with statistically significant mean differences. As shown in Tab. 22, the results indicated significant differences between unwashed and artificially washed traffic signs (pair 'WR vs AC') for all types of glass bead sheeting. The rainfall intensity was also a decisive factor, with significant differences between pairs 'WR-AMR' and 'WR-AHR' for all types of glass bead sheeting (Tab. 22). However, for microprismatic sheeting, the presence of precipitation did not significantly affect the R_A values.

The most considerable difference in average values was observed for red microprismatic RA3, at 64 %, while the slightest difference was found for red glass bead RA2, at 8 %. The difference in mean values between AHR and AMR ranged from 9 % for most sheeting types, except red microprismatic RA3, for which the difference was 14 %. It is worth noting that almost all types of unwashed sheeting (WR) met the standards (*ČSN EN 12899-1*, 2007), and their retroreflective coefficient significantly exceeded the minimum level. However, 71 % of signs with glass bead RA2 sheeting were below the minimum retroreflective level and only increased above it after heavy rain.

In this thesis, the comparability of results with prior research investigating the impact of dirtiness, such as Woltman (1982), Wolshon et al. (2002), and Jackson et al. (2013), is limited due to the indeterminate level of contamination in those works.

5.3.2 Precipitation on the surface of the sign

The effect of precipitation, including dew, frost, and drizzle, on the retroreflective properties of traffic signs was studied in this section. It is worth noting that these types of precipitation differ in the water phase and the size of the droplets that form on the sign's surface. For example, dew typically results in larger surface droplets than a drizzle.

Fig. 55 illustrates the dew and hoarfrost observed on the surface of a traffic sign during the measurements.

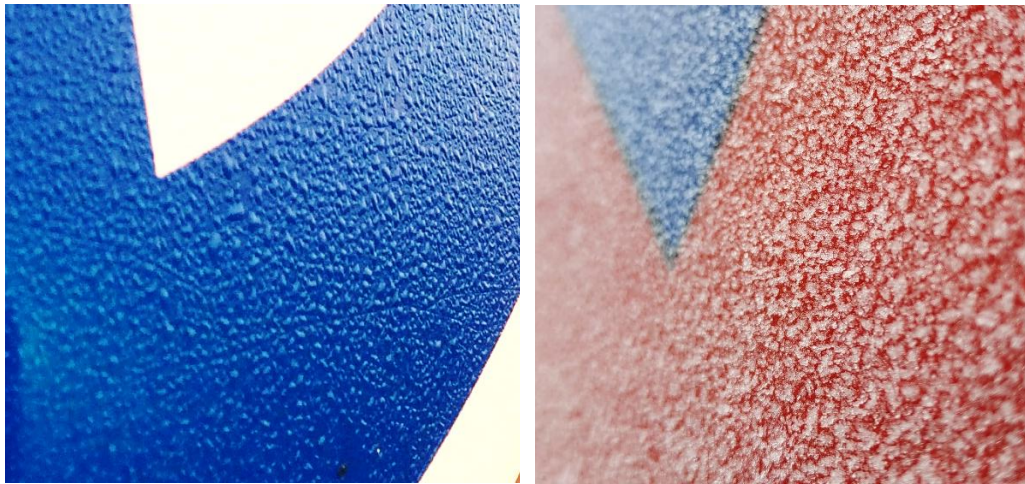

Fig. 55 An example of dew (Left) and hoarfrost (Right) on the surface of the traffic sign.

Source: Author's work

In contrast to the previous series of measurements, a sufficient number of measurements was not collected for all types of materials for this thesis. The frost effect was only studied for microprismatic RA2 and glass bead RA. The measured data were analyzed using a one-way repeated measures ANOVA, with the sign's retroreflectivity with different types of precipitation compared to each other. The resulting p -values are presented in Tab. 23. Almost all p -values did not exceed 0.05 (except for red glass bead RA1 sheeting), indicating significant differences between the data sets. The presence of water droplets did not significantly impact the level of retroreflection for red glass bead RA1 sheeting as it did for microprismatic sheeting. This difference may be due to the low required minimum R_A values for red glass bead RA1, meaning that even significant differences in R_A values are not statistically significant.

Tab. 23 Results of ANOVA for repeated measures and post hoc test, presented as p -values for pairs of different precipitation on the sign's surface. Source: Author's work

Statistical method			ANOVA	Tukey's					
Technology	Class	Colour		AC vs dew	AC vs fog	AC vs frost	dew vs fog	dew vs frost	Fog vs frost
Microprismatic	RA1	red	0.001	0.004	0.036	0.002	0.036	0.886	0.013
		white	0.010	0.037	0.659	0.015	0.247	0.951	0.109
	RA3	red	0.047	0.670	0.524	0.031	0.965	0.186	0.249
		white	0.011	0.194	0.296	0.006	0.994	0.208	0.145
Glass Bead	RA1	white	0.000	0.078	0.069	0.000	0.988	0.114	0.124
		red	0.088						

0.000 – values lesser than three decimal places after the decimal point were neglected

As shown in Tab. 23, the difference between clean signs and signs with the hoarfrost on the surface is significant for microprismatic and glass bead sheeting. However, the influence of other types of precipitation is not observed, except for microprismatic RA1 sheeting. For this material, dew, fog, and frost all decrease the retroreflective properties. The average R_A values showed that hoarfrost on the sign's surface reduces the retroreflective properties by more than 76 %. Hildebrand (2003) arrived at a comparable finding in his research, wherein a decrease in R_A values by 79% was observed on the surface of the sign due to frost. Conversely, in contrast to this study, Hildebrand (2003) observed that the impact of dew was also noteworthy, with a reduction of approximately 60%.

Additionally, 93 % of traffic signs in a frosty condition do not meet the standards, as their R_A values are significantly below the minimum retroreflective levels. It is worth noting that dew negatively impacts the retroreflectivity of microprismatic sheeting. The presence of dew on the surface of microprismatic RA1 significantly reduced the retroreflectivity by approximately 83%, falling below the minimum level.

Hildebrand (2003) drew a similar conclusion that the retroreflective values' degradation under dew and frost conditions is considerably affected by the retroreflective material's type and colour.

5.4 UV radiation

In this thesis, the effect of UV radiation on the retroreflectivity of road signs was analysed by forming five groups from four different locations. These groups included samples from the *Test desk* after 12 months of accelerated natural weathering (hereinafter “*TD12*”), from the *Test desk* after 46 months of accelerated natural weathering (hereinafter “*TD46*”), in-service signs after 46 months of natural exposure (hereinafter “*IS46*”), from the *Box* (hereinafter “*B46*”), and from the *Garden* (hereinafter “*G46*”). The samples were also divided by colour (red and white), as previous analysis had shown that the degradation of road signs depends more on the material's colour than on the manufacturer, class, or even technology.

The first step involved calculating the percentage decrease in retroreflectivity for each sample. The results were checked for normality using the *Shapiro–Wilk* test and the *Kolmogorov–Smirnov* test, which both indicated that the data was normally distributed ($p > 0.05$). Following this, a one-way *ANOVA* was conducted to investigate whether there were significant differences between the five groups for each colour at a significance level of 0.05.

The results of the *ANOVA* test for red samples showed $p < 0.05$, indicating that the averages of some groups were not equal. A *Tukey's* post hoc test was then carried out to identify which factors significantly impacted R_A . The results in Tab. 24 showed that the means of the following pairs differed significantly: *TD12* – *TD46*, *TD46* – *IS46*, *TD46* – *B46*, and *TD46* – *G46*.

Tab. 24 The results of ANOVA tests for red retroreflective sheeting samples, presented as p -values for pairs of groups. Source: Author's work

Test group	TD46	IS46	B46	G46
TD12	0.000	0.975	0.527	0.5215
TD46		0.000	0.000	0.000
IS46	0.000		0.210	0.121
B46	0.527	0.210		0.975

0.000 – values lesser than three decimal places after the decimal point were neglected

The highest decline was observed in samples exposed to accelerated natural weathering (Fig. 56). It is worth noting that the η_p^2 value of 0.75 indicated a high level of reliability for this test.

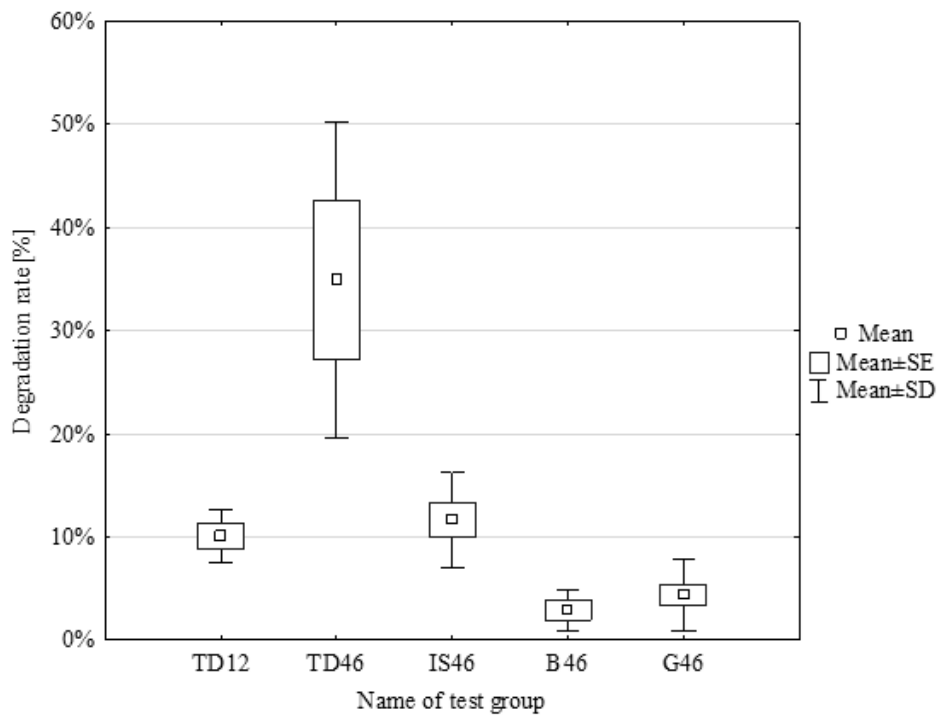

Fig. 56 Box plot of degradation rate (in %) for test groups of red sheeting. Source: Author's work

The results of the ANOVA test for white samples were similar, with a p -value of 0.002. However, the results from Tukey's post hoc test were different. From Tab. 25, it is clear that only the pairs $TD46 - B46$ and $TD46 - G46$ had significantly different means.

Tab. 25 The results of ANOVA tests for white retroreflective sheeting samples, presented as p -values for pairs of groups. Source: Author's work

Test group	TD46	IS46	B46	G46
TD12	0.062	0.973	0.927	0.812
TD46		0.1094	0.008	0.001
IS46	0.1094		0.570	0.773
B46	0.008	0.570		0.997

The box plot in Fig. 57 shows the range of values and means for the five groups. The highest mean degradation level was observed in *TD46*, at 16 %. It was also unexpected that the decrease in retroreflectivity in the box was almost equal to or even slightly higher than the samples outdoors but not exposed to direct sun rays. The red sheeting had higher average degradation values, but the degradation range for white samples was wider. The maximum degradation value for red sheeting was 56 %, while for white, it was 51 %.

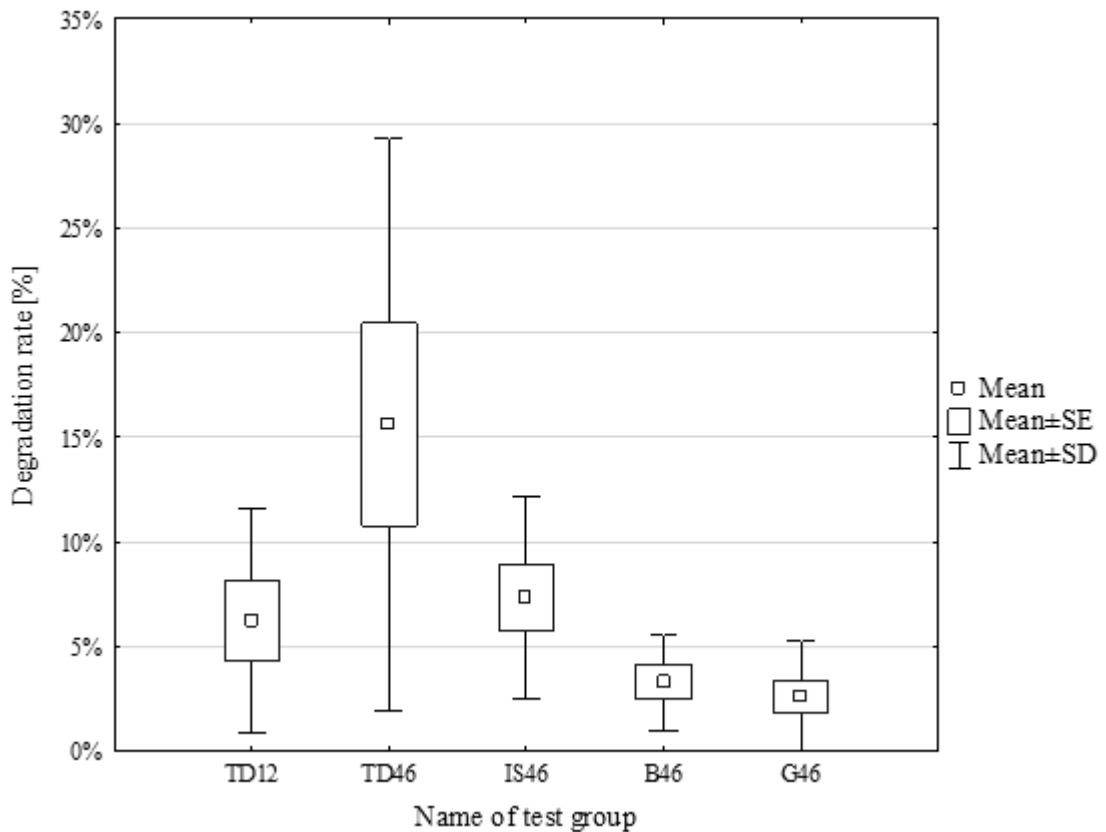

Fig. 57 Box plot of degradation rate (in %) for five test groups of white sheeting.

Source: Author's work

The main finding of this analysis is the acceleration factor of natural weathering. Red signs had 3.00 times faster decline in retroreflectivity compared to natural conditions, while for white signs, this factor was 2.25. These results provide valuable insights into the effect of UV radiation on the durability of retroreflective sheeting.

It is important to note that the measurement of retroreflectivity is sensitive; therefore, it can be difficult to determine the decline in R_A accurately. For example, in Fig. 58, it can be seen that the subsequent measurements do not always have a lower R_A value than the previous ones.

The purpose of Fig. 58 is not to estimate the final degradation values but rather to show the degradation trend. In this example, it can be seen that the best model is built for samples that were stored in a box and not exposed to the external environment.

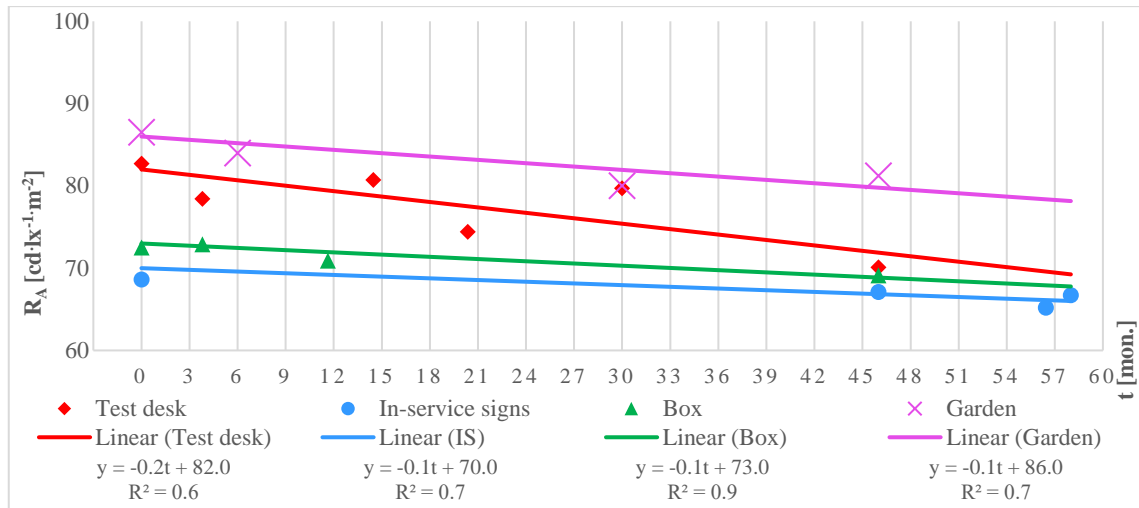

Fig. 58 The degradation trendlines of R_A ($\text{cd}\cdot\text{lx}^{-1}\cdot\text{m}^{-2}$, $\alpha = 0.33^\circ$, $\beta_1 = 5^\circ$) for one white glass-bead Class RA1 sample from four study locations. Source: Author's work

However, it is also interesting to note that the R^2 value for the degradation trend for in-service traffic sign sheeting and sheeting samples from the garden is the same at 0.74. It suggests that the impact of sunlight on road signs may not be as significant as previously thought. However, this conclusion should be taken cautiously as the trend line is only a rough estimation tool. The trend equations also support the earlier conclusion that the rate of decline in reflective properties for white reflective sheets after the test for accelerated natural weathering is approximately two (based on a comparison of the slope coefficients of the lines).

5.5 Material of sign panel

The material of the sign panel can significantly impact the degradation rate of retroreflective sheeting. In the Czech Republic, aluminium sign panels are not currently used for economic reasons, but it is still essential to understand the potential impact of this factor on sign retroreflectivity.

Measurements of retroreflective sheeting were taken before and after application on iron-zinc (FeZn) and aluminium (Al) desks and after outdoor exposure in the garden for 46 months. A t -test for dependent samples was conducted to compare the retroreflectivity of sheeting before and after application on the FeZn panel. The p -value was 0.104, indicating no statistical difference between the groups. The same test was conducted for the sheeting applied on the Al panel, with a p -value of 0.129. These results suggest no significant difference in retroreflectivity between the sheeting applied on the FeZn and Al panels. It is worth noting that for all samples, the retroreflectivity was higher for the sheeting without the panel and decreased by approximately 4.1 % after application on the FeZn or Al panel. It should be taken into account by manufacturers of sheeting and traffic signs. A t -test for independent samples was also conducted to compare

the degradation rates of the samples on the FeZn and Al desks after outdoor exposure for 46 months in the *Garden* (without the influence of direct sunlight). The p -value was 0.029, indicating a statistically significant difference between the groups. The box plot of the degradation rates for these two groups shows that the mean degradation rate after 46 months of exposure in the garden was 7.3 % for the FeZn panel and 10.5 % for the Al panel (Fig. 59).

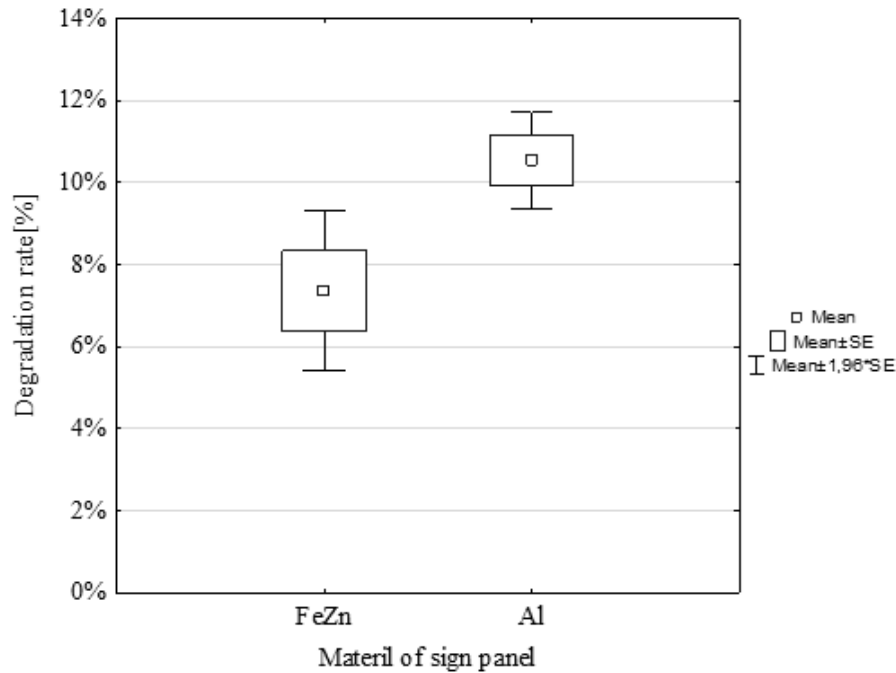

Fig. 59 The box plot of degradation rated of retroreflective sheeting applied on two different panel's material for outdoor exposure without the influence of sunrays for 46 months. Source: Author's work

Interestingly, the difference in degradation rates did not change significantly compared to the results after one year of exposure in the garden. According to Khrapova et al. (2020), the difference in degradation rates for different panel materials after one year of exposure was 3.8 %, while after almost 4 years, it was 3.2 %. Based on these results, the FeZn panel appears to be the better choice as a traffic sign panel in terms of cost and retroreflective performance.

5.6 Measurement conditions and equipment

5.6.1 Temperature and relative humidity

The ambient temperature and relative humidity of air were analysed for their influence on the retroreflective coefficient of a calibration standard. A total of 1,400 measurements were conducted, and a multiple linear regression analysis was performed as a linear equation (Equation 1) to determine the impact of each factor. The results showed that temperature significantly influenced the retroreflective coefficient, with a coefficient of determination of 0.917.

$$R_A = 225.243 + 0.942 \cdot T - 0.109 \cdot \varphi \quad (1)$$

where: R_A – the coefficient of retroreflection ($\text{cd} \cdot \text{lx}^{-1} \cdot \text{m}^{-2}$, $\alpha = 0.33^\circ$, $\beta_1 = 5^\circ$); T – temperature ($^\circ\text{C}$); φ – relative humidity (%).

The accuracy of the model was tested by comparing the predicted retroreflective coefficient to the manufacturer's standard values ($R_A = 239.2 \text{ c } \text{cd} \cdot \text{lx}^{-1} \cdot \text{m}^{-2}$ for $\alpha = 0.2^\circ$ and $\beta_1 = 5^\circ$) under specific temperature and humidity conditions ($23 \pm 3^\circ\text{C}$, $50 \pm 5\%$). The predicted values using Equation 1 were found to be within the error range specified by the manufacturer.

It is important to note that the small scatter of the measured R_A values does not necessarily indicate no significant difference from the permissible values specified by the manufacturer. In fact, statistical analysis using a t -test has shown that the measured values do significantly differ from the allowable values ($t(1414) = -56.9$, $p < 0.05$) (Fig. 60). This finding indicates that the error margins for retroreflectometers may need to be revised to take into consideration the fluctuations of R_A values in both standard and real-world conditions. It is essential as it can help ensure that the measurement of R_A is accurate and reliable under a range of conditions. It is vital to consider the error margins of measurement tools to accurately interpret the results and make informed decisions based on the data. Additionally, this finding highlights the importance of considering the influence of ambient temperature and humidity on the measurement of R_A , as these factors can significantly impact the accuracy of the measurement. It may be necessary to perform additional testing or to use correction factors to account for the effects of temperature and humidity on the measurement of R_A . Overall, this emphasizes the need to carefully consider the conditions under which R_A measurements are taken to ensure the results' accuracy and reliability.

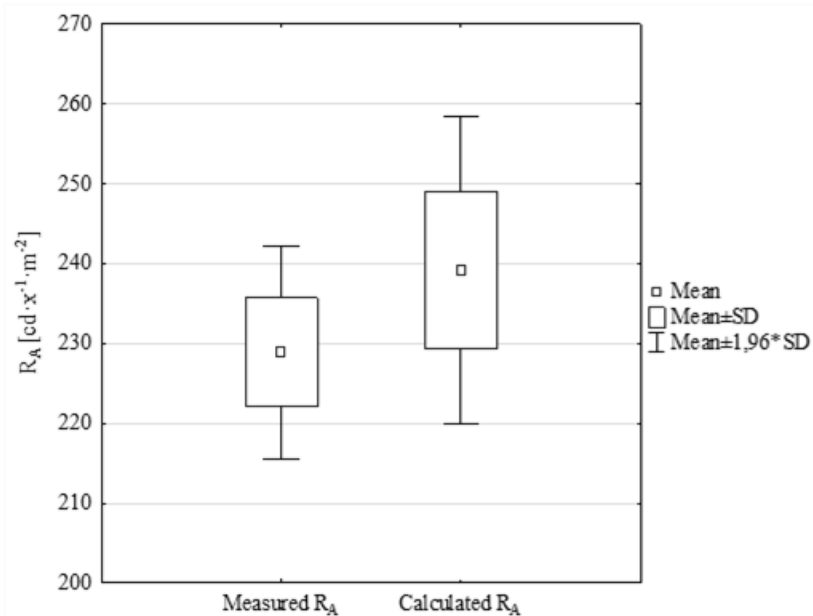

Fig. 60 Comparison of measured R_A ($\text{cd} \cdot \text{lx}^{-1} \cdot \text{m}^{-2}$, $\alpha = 0.33^\circ$, $\beta_1 = 5^\circ$) of calibration standard with calculated R_A specified by manufacturer. Source: Author's work

5.6.2 Retroreflectometers

This chapter examines whether different types of retroreflectometers produce different results in measuring the R_A of microprismatic sheeting. Samples from Storage of different colours and four classes (classified according to GB/T 18833 (2012)) were measured under the same conditions at various combinations of α , β , ϵ angles (Tab. 15).

The first step was to conduct a paired t -test to determine if there is difference in R_A measurements made by Zehntner ZRS 6060 and RoadVista 933. It was found that there was a significant difference between the measurements made by Zehntner and RoadVista for the same β_1 value of 5° ($t(355) = -8, p < 0.05$).

The second step involved finding the difference in R_A between the measurements and conducting a main effect ANOVA to identify the first-order effects. It was found that colour, class, and α impacted the value of the difference, while ϵ angle had a p -value greater than 0.05. Since the null hypothesis was not rejected for the ϵ angle, it confirms that the measurements using the Zehntner retroreflectometer were conducted correctly. The rotation angle has a noticeable effect on the retroreflective performance, which can be observed visually (as shown in Fig. 61), supporting this conclusion.

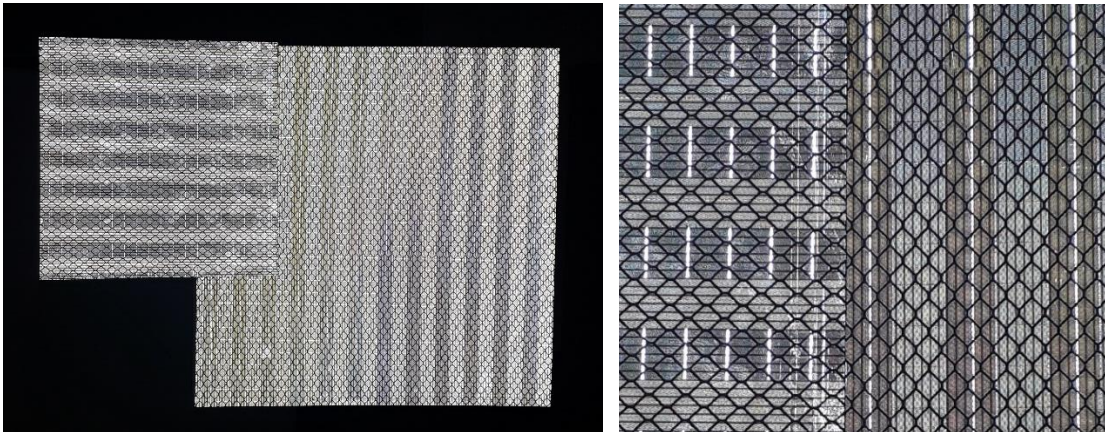

Fig. 61 Comparison of retroreflective performance under two different rotation angles (ϵ). (Left) View of two test samples from one sheeting with the 90-degree difference in rotation angles. (Right) Close-up view of the same samples. Source: Author's photo

In the third step, a factorial ANOVA was conducted on the three significant factors to analyse the effect of their combination. For pairs class – colour, colour – α , and class – colour – α , the p -value was below the significant level, and post hoc tests confirmed the significance between some combinations of factors.

In the final step, all R_A measurements were separated by class and colour, and paired t -tests were conducted for each α angle. The detailed results are presented in Tab. D.1. Fig. 62 shows the degree of difference in R_A between pairs of measurements made by the two retroreflectometers. From Fig. 62, it is clear that for most pairs of measurements, the difference is not too high (less than 10 %), but for blue Type IV sheeting, there is a significant difference between Zehntner and RoadVista reflectometers.

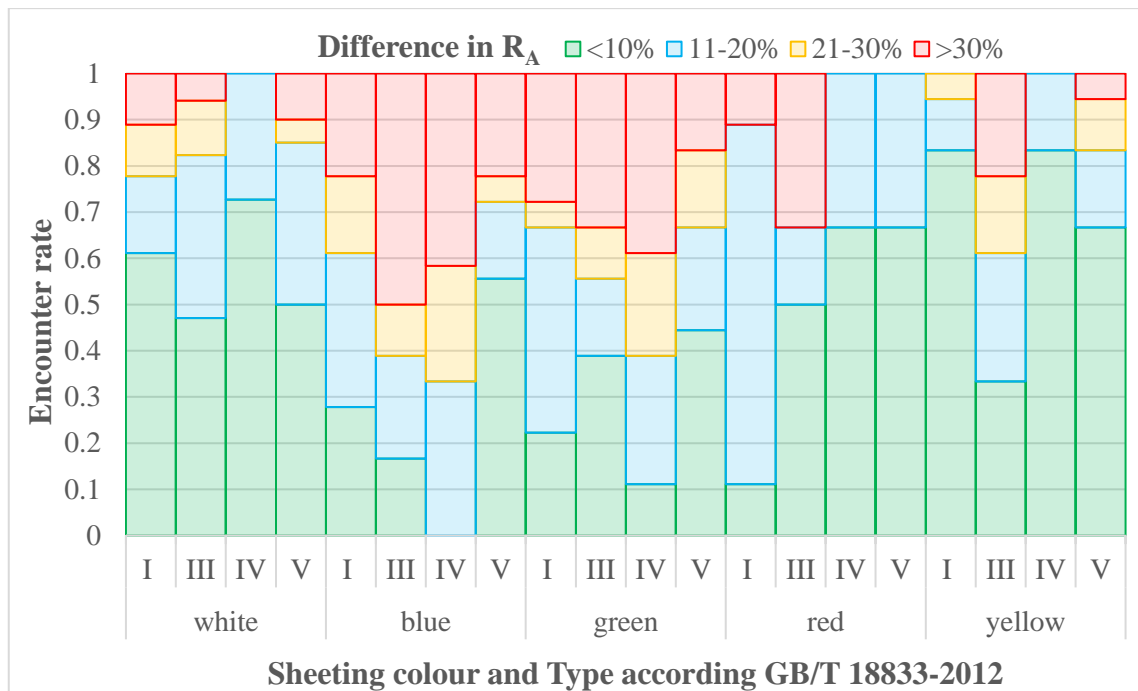

Fig. 62 Comparison of the degree of difference in R_A measurements taken with Roadvista 933 and Zehntner ZRS 6060 at various combinations of observation angle, entrance angle, and rotation angle. Source: Author's work

The best sheeting for measurement was yellow sheeting. A total of 43 pairs of measurements had a difference in R_A of less than 10 %, followed by white and green.

5.6.3 Entrance angles

In this section, the effect of entrance angles on the measurement of retroreflective performance using the RoadVista 933 was analysed. A total of 636 measurements were taken at various combinations of the entrance, observation, and rotation angles (see Tab. 15 for details). The results were presented according to the GB/T 18833 standard, which provided a greater range of classes for comparison.

The results of a paired t -test ($t(635)=7.69, p < 0.05$) showed a significant difference in R_A measurements taken at entrance angles -4° and 5° . A main factor ANOVA statistical analysis revealed a high observed power of each factor (colour, class, α , ϵ) on the difference in the pairs of measurements. However, based on the results of a post hoc test, the following conclusions were made:

- ✓ Only Type V showed a significantly different result than the other classes, even though the 3M 4000 sheeting of this class was expected to have the same high performance across a range of angles. It is worth noting that this diversity was not found in comparison to measurements taken with the Zehntner ZRS 6060 (see Tab. D.1).
- ✓ A meaningful difference was found for pairs of rotation angles -75° and 0° , 0° and 90° , which only demonstrated a visual difference in retroreflective

performance (see Fig. 61). However, this difference in rotation angles is not a problem, as measurements of in-service signs are conducted at a rotation angle of 90 °. In addition, this means that slight deviations from the angle of 90 ° due to human factors are not critical when using a handheld retroreflectometer.

Based on these conclusions, the measurements at rotation angles -75 ° and 90 ° were excluded from the analysis, the same as Type V sheeting. A factorial ANOVA was conducted to determine the influence of combinations of factors such as colour, class, and observation angles on the difference between measurements taken at two entrance angles. Any factor or combination of the overmentioned did not significantly influence the results ($p > 0.05$). The statistical analysis results indicate no significant difference in the R_A measurements taken at entrance angles of -4 ° or 5 °, except for Type V sheeting.

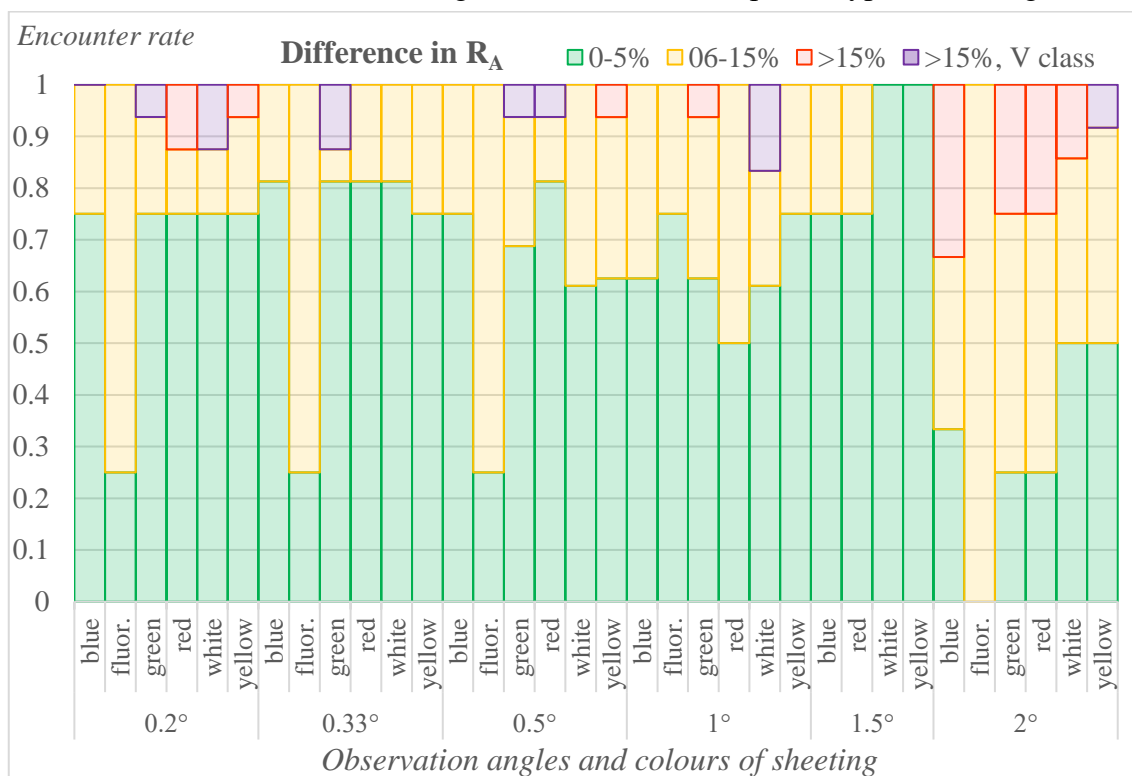

Fig. 63 Comparison of the degree of difference in R_A measurements taken with Roadvista 933 at entrance angles (-4 °, 5 °) and rotation angles (-50 °, -25 °, 25 °, 90 °). Source: Author's work

Fig. 63 displays the analysis results of the encounter rate of measurement pairs with different degrees of difference between measurements. The purple column in the figure represents only the fraction of Type V sheeting pairs with a difference of more than 15 %. However, Fig. 63 also shows that the number of pairs with a difference of more than 15 % is relatively high for the observation angle of 2 °, except for fluorescent colour sheeting.

5.7 Orientation

The influence of orientation on the degradation of retroreflective materials was examined through measurements of R_A of traffic signs along the G3 highway in Beijing (*BG3*) and the D0 highway in Prague (*PD0*) based on their north or south orientation. The road signs were 32 months old in Beijing and 109 months in Prague. The results were reported according to the Chinese standard GB/T 18833 (2012) because of the difference.

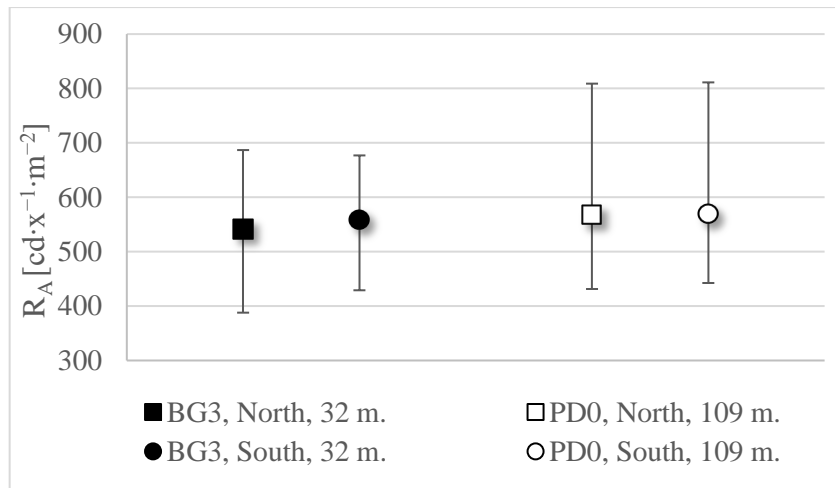

Fig. 64 The means and ranges of retroreflective coefficient ($\text{cd}\cdot\text{lx}^{-1}\cdot\text{m}^{-2}$, $\alpha = 0.2^\circ$, $\beta_1 = 5^\circ$) of white microprismatic Class RA3 retroreflective film from BG3 and PD0 highways according to the face orientation of traffic signs (North and South). Source: Author's work

In Fig. 64, the average R_A values of the traffic signs ranged from $540 \text{ cd}\cdot\text{lx}^{-1}\cdot\text{m}^{-2}$ to $570 \text{ cd}\cdot\text{lx}^{-1}\cdot\text{m}^{-2}$ as shown. The range of measurements was also very close according to the location. The R_A values varied from $390 \text{ cd}\cdot\text{lx}^{-1}\cdot\text{m}^{-2}$ to $690 \text{ cd}\cdot\text{lx}^{-1}\cdot\text{m}^{-2}$ in Beijing and ranged from $430 \text{ cd}\cdot\text{lx}^{-1}\cdot\text{m}^{-2}$ to $815 \text{ cd}\cdot\text{lx}^{-1}\cdot\text{m}^{-2}$ in Prague. It is worth noting that the R_A ranges for south-facing signs were smaller in Beijing (around 17 %) and Prague (around 2 %).

Fig. 65 illustrates the R_A distribution depending on the sign's orientation and the city of measurement. White microprismatic Type IV retroreflective sheeting was analysed in the *SSD*, and white Type III sheeting was assessed in the *BCD* and the *P6D*. All east-oriented signs had the highest mean value. However, there was no significant difference from other orientations in *BCD*.

Type IV results were significantly higher than mandatory requirements after natural weathering ($288 \text{ cd}\cdot\text{lx}^{-1}\cdot\text{m}^{-2}$ according to GB/T 18833 (2012)). R_A values in the *BCD* were almost at the limit of permissible values. The lowest value for the north-oriented sheeting was below the required level after natural weathering after 36 months ($200 \text{ cd}\cdot\text{lx}^{-1}\cdot\text{m}^{-2}$ according to GB/T 18833 (2012)). The minimal value of north-oriented signs in the *P6H*

was also below the required level. The opposite results were for the traffic signs with face orientation different from northern; R_A values were much higher than $200 \text{ cd}\cdot\text{lx}^{-1}\cdot\text{m}^{-2}$.

A considerable variation of values is observed in Fig. 65 for every direction and location. The highest range was for north-oriented traffic signs in Prague, while the lowest range was for west-oriented signs in Beijing. However, a more significant variation of R_A values was typical for the *SSD* and the *P6H*.

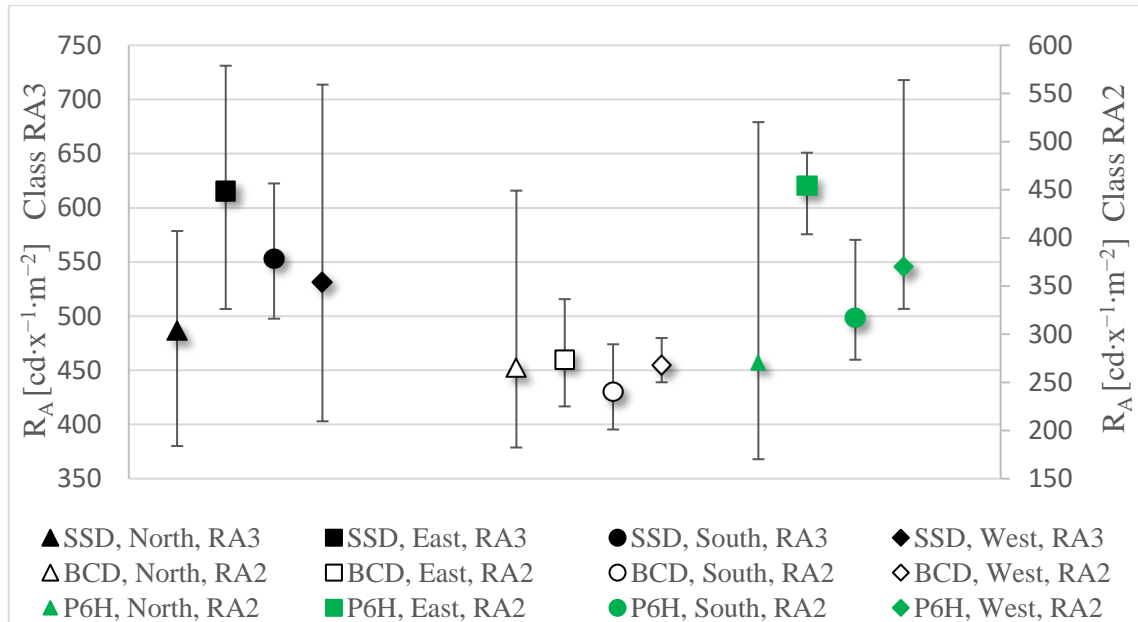

Fig. 65 The means and ranges of RA for white microprismatic Class RA2 and RA3 retroreflective material from BCD, SSD, and P6H sites based on the orientation of traffic signs, measured at $\alpha = 0.2^\circ$ and $\beta_1 = 5^\circ$. Source: Author's work

The deterioration of microprismatic retroreflective sheeting depends on the amount of solar radiation received by the signs since they are made of polymeric materials. The location and climate also determine the time and intensity of sunlight. At the same time, there may be the effect of air pollution. Therefore, it should be assumed that R_A should be less for in-service traffic signs facing south than for signs facing north. The reason is that the yearly amount of sun exposure (Bischoff & Bullock, 2002; Kipp & Fitch, 2009; Shober, 1977) proved an assumption that north-facing signs had better retroreflectivity than south-facing signs. It is probably why test panels with retroreflective sheeting shall be oriented to the south for outdoor accelerating weathering according to standards (*ČSN EN 12899-1*, 2007; *GB/T 1883*, 2012). However, it was found that south-facing reflective signs did not always have worse retroreflective performance than north-oriented signs. As shown in Fig. 65, for the Type V sheeting, the orientation direction was not crucial for north and south-oriented traffic signs. These results are highly credible since many factors coincided or were considered. Two factors were different for these types of sheeting – climate and age. These two factors made the variation of the results in Prague higher than in Beijing. In the author's opinion, age

had a more significant impact since traffic signs in the *PDO* were three times older than in the *BG3*.

The signs facing north had the lowest mean R_A value in Shanghai and Prague (Fig. 65), considering the four cardinal directions. The signs facing east had the best performance by comparing the average values, but the high variability of the results for all directions does not allow unambiguous conclusions. Furthermore, the age of the traffic signs in Beijing and Shanghai was unknown. An unexpected result was that the group with the best results in Prague (Fig. 65) included traffic signs 10 years old.

The high variability of different oriented traffic signs was described by Kirk et al. (2001). They found that some colours have more significant variability of results in one direction than those facing other directions. That is why it is not easy to find a strong correlation between the orientation of the sign and its age. Bischoff & Bullock (2002) and Jackson et al. (2013) also did not find a relationship between sign performance and orientation.

The methodology employed in this thesis shares similarities with the investigation conducted by Khalilikhah & Heaslip (2016), wherein the impact of orientation was assessed by measuring the retroreflectivity performance losses of soiled signs. Their findings indicated negligible changes in the rate of degradation for dirty signs in relation to their orientation. The present thesis arrived at a similar conclusion.

The explanation for such a variety of results might be the angle of the sun's rays. The angle of sun illumination of the sign varies during the day and throughout the year. Therefore, the degradation caused by solar radiation is not uniform for in-service signs. However, the inclined angle to the horizontal strongly influences the retroreflective performance more than its orientation. Ketola (1989) found that samples exposed at $+45^\circ$ tilt angle receive 50 % more solar UV annually than those exposed vertically. According to Khrapova et al. (2020), a 45° angle of the samples increases the deterioration rate almost twice during the first year of exposure. This angle is used for accelerated testing of outdoor weathering in the Czech Republic and the People's Republic of China. However, there is no research to prove that this angle is the most effective for each country. There is only experimental proof that other exposure angles have not shown considerable increases in failure rates than those seen in 45° exposures (Davis et al., 1983).

In the author's view, the angle for testing may need to vary with latitude, as the sun's highest position also varies. For example, the most elevated position of the sun is 63° in Prague, in Beijing – 73° , and in Shanghai – 82° ; results for 22 June, at noon) (*Azimuth and Altitude Table*, 2020). The Chinese standard provides a possibility: “test panels shall be oriented at an angle of $45^\circ \pm 1^\circ$ from the horizontal or at an angle equal to local latitude“ (*ČSN EN 12899-1*, 2007).

5.8 Recognition by the vehicle camera system

This chapter investigated the recognition distance (hereinafter “RD”) of traffic signs by a vehicle camera system. The impact of various factors on RD of traffic signs was analysed, including the age, lateral offset, siting, number of signs on a post and retroreflective properties of the signs. The TSDR system's effectiveness is evaluated based on the percentage of successfully recognized traffic signs. However, the RD was used in this research to measure the TSDR system's effectiveness and performance. The recognition distance is the distance at which the TSDR system correctly recognizes the traffic sign. A longer recognition distance allows the driver more time to react and can improve driving safety.

During the analysis of measurement data from *MA* and video recordings from the ADTF environment, it was found that two factors not previously mentioned in the literature had an impact on the retroreflective performance of traffic signs. These factors are the area of colour (Appendix A) and the retroreflective internal contrast.

Area of colour – the proportion of the area occupied by one colour to the total area of the sign, expressed as a percentage.

Retroreflective internal contrast (hereinafter “C”) is a contrast of retroreflective sign calculated using R_A value, not the value of luminances. The contrast was derived using the Michelson equation of luminance contrast:

$$C_M = \frac{L_{\max} - L_{\min}}{L_{\max} + L_{\min}} \quad (2a)$$

where C_M – Michelson luminance contrast (-); L_{\min} and L_{\max} – the minimum and maximum luminance of two colours ($\text{cd}\cdot\text{m}^{-2}$).

The definition of R_A :

$$R_A = R_L \cdot \cos\beta = \frac{L \cdot \cos\beta}{E} \quad (2b)$$

where R_A – coefficient of retroreflection of one colour ($\text{cd}\cdot\text{lx}^{-1}\cdot\text{m}^{-2}$); β – is the entrance angle of the light incident on the road sign ($^\circ$); L – the luminance of one colour ($\text{cd}\cdot\text{m}^{-2}$); E – is the illuminance at the sign plate created by the light source, perpendicular to the direction of illumination (lx).

The retroreflective contrast equation C is expressed as follows:

$$\begin{aligned} C &= \frac{\frac{R_{A(B)} \cdot \cos\beta}{E} - \frac{R_{A(BO)} \cdot \cos\beta}{E}}{\frac{R_{A(B)} \cdot \cos\beta}{E} + \frac{R_{A(BO)} \cdot \cos\beta}{E}} = \frac{\frac{\cos\beta}{E} (R_{A(B)} - R_{A(BO)})}{\frac{\cos\beta}{E} (R_{A(B)} + R_{A(BO)})} = \\ &= \frac{R_{A(B)} - R_{A(BO)^1}}{R_{A(B)} + R_{A(BO)^1}} \quad (3) \end{aligned}$$

where C – internal retroreflective contrast (-); $R_{A(B)}$ – coefficient of retroreflection for background ($\text{cd}\cdot\text{lx}^{-1}\cdot\text{m}^{-2}$); $R_{A(BO)}$ – coefficient of retroreflection for border ($\text{cd}\cdot\text{lx}^{-1}\cdot\text{m}^{-2}$); β – is the entrance angle of the light incident on the road sign ($^\circ$); E – is the illuminance at the sign plate created by the light source, perpendicular to the direction of illumination (lx);¹ – for the retroreflective sign with legend only R_A of legend is used.

In order to investigate the recognition distance of traffic signs by a vehicle camera system, it was necessary first to establish an informational database for the signs. It was a complex task due to the lack of a unified information system and a large number of suppliers and manufacturers involved., Manual site visits were necessary to collect information on each sign. The Czech standard requires manufacturers to affix a marking on the backside of the sign with important information such as the date of affixation, visibility properties (class of retroreflective sheeting), durability, and weather resistance (*ČSN EN 12899-1, 2007*). However, this marking does not provide information on the specific type of reflective film used, which can vary in retroreflective properties within the same class.

To create the database, three photos were taken of each traffic sign: a general photo to determine the category of the sign, a photo of the marking, and a photo of the structure of the reflective film to identify the type of film. Based on these photos, GPS coordinates, sign orientation, lateral and vertical positioning, and area of colour, an information database was created for 100 traffic signs. The signs were then divided into categories, technology, and the class of retroreflective sheeting. Six main categories of traffic signs were tested: mandatory, prohibitory, priority, direction, position, or indication signs; information, facilities, or service signs; and additional panels (classified according to the Czech Decree (*The Decree No 10/2019, 2015*)).

During the establishment of the database, it was found that the ADRF system recognized three signs, but the RD could not be determined. These signs were direction signs and additional panels. The level of retroreflection for two of these signs was significantly higher than the minimum requirement, while the third sign did not meet the reflective property requirements. These signs were excluded from further statistical analysis. Also, four road signs were not detected; three signs had R_A values below the mandatory minimum retroreflective level and were excluded from the dispersion analysis and t -tests for independent samples.

A dispersion analysis was conducted to understand the variation of RD values. The results showed that the average RD was 41.7 ± 11.5 m, and the data was highly varied, with a coefficient of variation more significant than 20 %. This high value of the coefficient of variation indicates the presence of factors that affect the RD. A t -test for independent samples was conducted further to investigate the impact of these factors on the RD. The factors were divided into two groups: properties of the sign's surface and other sign characteristics (e.g. position of the sign in space and number of signs on the post).

Three t -tests were conducted to analyse the influence of the distance from the roadside edge (lateral positioning), location relative to the road (on the left or right side), and the number of signs on the post on the RD. These tests were conducted separately because of the different number of samples in each group. Before completing the tests, all variables were checked for normality using the *Shapiro–Wilk* test ($p > 0.05$) and the *Kolmogorov-Smirnov* test ($p > 0.2$).

The first *t*-test compared RD for signs that did or did not conform to the Czech standard for lateral positioning (TP 65, 2013). Tab. 23 indicates no significant difference in RDs ($p > 0.05$).

Tab. 26 Results of *t*-test for independent samples showing main statistical parameters for three factors. Source: Author's work

Parameter	<i>p</i> -value	<i>t</i> -value	<i>df</i>	Group number 1			Group number 2		
				μ	<i>N</i>	<i>SD</i>	μ	<i>N</i>	<i>SD</i>
Lateral offset	0.06	1.9	87	45.5	41	4.1	41.3	46	12.3
Siting	0.14	-1.5	23	50.7	13	8.1	46.2	12	6.6
Number of signs	0.003	3.1	65	44.7	38	9.8	35.6	28	11.9

The medians of the two groups were not statistically different, but the range of RDs was not similar. A box plot (Fig. 66) further illustrates the range of values in the two groups.

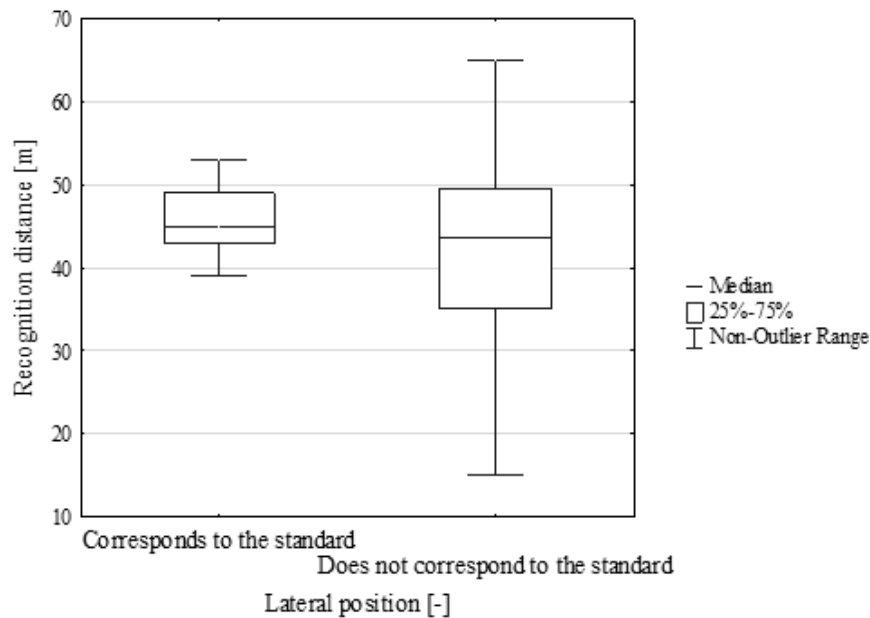

Fig. 66 The box and whisker plot of RDs grouped by the lateral position. Source: Author's work

The second *t*-test analysed the influence of location relative to the side of the road on RD, using only the 'no overtaking' sign, which was located on both the right and left sides of the road. The results in Tab. 26 show no significant difference in RDs between the two sides (p -value much higher than the significance level of 0.05).

The third *t*-test examined the influence of the number of signs on RD, using only posts with one or two signs because the number of posts with three signs was not large enough. The results, shown in Tab. 26, reject the null hypothesis ($p < 0.05$), indicating a significant difference in RDs between the two groups.

An additional *t*-test was conducted to determine if there was a difference between two road signs on the same post. The results showed no significant difference in R_A values between these two signs, with a $p = 0.34$.

Overall, the effect sizes of these four tests were medium to high, indicating sufficient reliability for the results. These tests suggest that the number of signs on the same post significantly influences RD, while lateral positioning, location relative to the road, and the level of retroreflection do not considerably impact RD.

The decrease in the RDs can be attributed to the formation of a non-standard reflective area due to the proximity of traffic signs with similar retroreflective levels. This situation is illustrated in Fig. 67. The recognition process was divided into three stages, and it was found that in the first stage, the shape and code of the sign were incorrectly identified. In the second stage, the determining area was divided into two, and in the third stage, the traffic signs were correctly recognised, and the correct codes were assigned.



Fig. 67 Demonstration of the issue in recognizing two traffic signs on a single post in three steps. Source: adapted from ADTF development environment, edited by the author

In this statistical analysis, the main aim was to determine the influence of properties of the sign surface on its RD. The properties considered in the analysis were the highest R_A , the area of the sign with the highest R_A , and the sign's contrast. The analysis only considered signs that were located alone on their posts, as the RD may be affected by the number of signs on a single post, and it is not possible to evaluate the individual parameters of a sign when two signs are located closely together.

To analyse the data, the main effect ANOVA was used. The R_A values were separated into four ranges: 0–150, 151–300, 301–450, and 451–600 $\text{cd}\cdot\text{lx}^{-1}\cdot\text{m}^{-2}$. The area of sign with the highest R_A was divided into values: less than or equal to 50 % and values greater than 50 %. The values of Contrast were also divided into two groups: $C \leq 1.0$ and $C > 1.0$. This grouping allowed for the normalization of the datasets.

Tab. 27 Multifactorial main effect ANOVA results showing the influence of sign surface factors, including area, contrast, and retroreflection coefficient, on statistical parameters. Source: Author's work

Factor	<i>Df</i>	<i>F-value</i>	<i>p-value</i>	η_p^2
Area of colour	1	0.41	0.53	0.01
Contrast	1	15.49	0.000	0.28
R_A	3	7.29	0.000	0.35

0.000 – values lesser than three decimal places after the decimal point was neglected

The results of the main effect ANOVA (Tab. 27) showed that both the R_A and contrast significantly impact the RD. However, the size of the area with the highest R_A was not found to be statistically significant.

A factorial ANOVA was conducted further to investigate the interaction between R_A and contrast. Tab. 28 presents the analysis results indicating a considerable effect of this pair of variables on the RD. Tukey's post hoc test results also showed that the combination of R_A values and contrast significantly affected the RD.

Tab. 28 Factorial ANOVA results for interaction between sign surface retroreflection coefficient and contrast. Source: Author's work

Factor	Df	F-value	P-value	η_p^2
Contrast	1	18.57	0.000	0.33
R_A	3	17.89	0.000	0.59
Contrast x R_A	3	5.16	0.000	0.29

0.000 – values lesser than three decimal places after the decimal point was neglected

The η_p^2 values for R_A in both the main effect ANOVA and the factorial ANOVA were relatively high, at 35 % and 59 %, respectively, indicating that the highest retroreflective level is an essential factor in determining the RD. However, the combination of R_A and contrast also had a significant effect, as the η_p^2 value for this combination was much higher than 14 %.

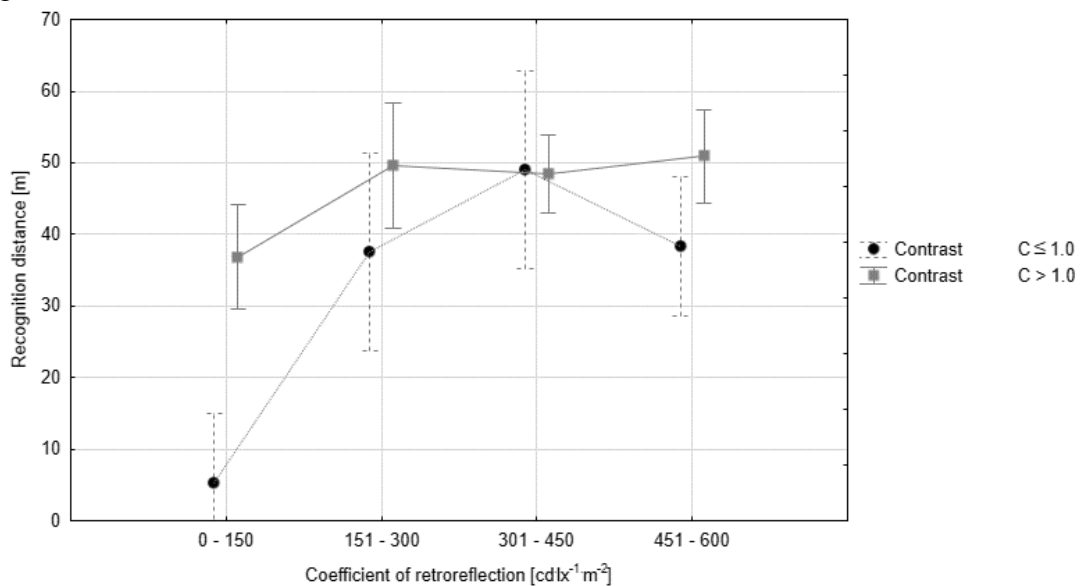

Fig. 68 The impact of contrast and coefficient of retroreflection on the recognition distance of a single sign on a slope. Source: Author's work

The graphical representation of the general linear model is displayed in Fig. 68, which illustrates two non-parallel lines. These lines demonstrate a statistically significant interaction between the variables of R_A and contrast. The lowest RD values, which are significantly different from other values, are observed in the range of R_A from 0 to 150 $\text{cd} \cdot \text{l} \cdot \text{x}^{-1} \cdot \text{m}^{-2}$ and $C \leq 1$.

6 Conclusions and Recommendations

The aim of this chapter is to present the conclusions and recommendations of this doctoral thesis, which focuses on identifying and investigating the impact of various external factors on the level of retroreflectivity of traffic signs and retroreflective sheeting. The hypothesis of the thesis concerned the influence of accelerated natural weathering, climate conditions, dirtiness and precipitation, exposure to sunlight, sign panel material, measurement conditions and equipment, orientation, and recognition by the vehicle camera system on the retroreflective properties of traffic signs. The experiments and analyses conducted in this thesis made it possible to confirm or disprove these hypotheses and draw conclusions and recommendations based on the obtained results. The following sections summarize the main findings and recommendations of this thesis.

6.1 Accelerated natural weathering

This part of the thesis aimed to investigate the effects of accelerated natural weathering on the retroreflective properties of test specimens. Four hypotheses were proposed and tested using the results of the investigation.

Hypothesis 1.1: The retroreflection coefficient of test specimens exposed to accelerated natural weathering for 36 months will be higher than the minimum required values from ČSN EN 12899-1.

The hypothesis was partially confirmed. The results showed that the retroreflective coefficient of test specimens exposed to accelerated natural weathering for 36 months was generally higher than the minimum required values specified in ČSN EN 12899-1, except for blue glass bead Class RA1 sheeting. The trendlines for some materials predicted values above the minimum requirement even at the end of the service life (84 months for Class RA1; 120 months for Class RA2 and RA3).

Hypothesis 1.2: The degradation rate of the retroreflective film over time is better described by a linear function.

This hypothesis was confirmed. The degradation rate of the retroreflective film over time was generally better described by a linear function, with a few exceptions for specific materials and manufacturers. The thesis results show that a linear function effectively describes the degradation rate of retroreflective film over time, with 16 % of the trendlines exhibiting a solid fit to the data and an additional 47 % demonstrating a good fit. However, the reflective properties of the materials do not show a consistent deterioration trend, which can be explained by the heterogeneity of the retroreflective material, especially of microprismatic sheeting.

Hypothesis 1.3: The trend of retroreflectivity deterioration in the same class and colour will be similar from manufacturer to manufacturer.

This hypothesis was not confirmed. The rate of deterioration for this type of sheeting varies significantly among different manufacturers. The only degree of degradation for red glass bead Class RA1 sheeting from different manufacturers was relatively similar. The products from Oralite manufacture showed the lowest degradation rate for microprismatic Class RA2 and Class RA3 sheeting for white, blue and red colours compared to 3M and Avery Dennison.

Hypothesis 1.4: The level of retroreflective degradation will depend on the colour of the retroreflective film.

This hypothesis was partially confirmed, as the degree of degradation varied for red samples of the same class and technology of retroreflective sheeting. Only red has a statistically proven effect on the reflective material's degradation rate compared to the other colours. Also, the red colour sheeting from 3M showed the most significant degradation rate after 46 months of accelerated natural exposure for all classes.

Nevertheless, it is worth noting that the degradation rate for white samples was slower than for blue samples during accelerated natural weathering.

Based on the results of this part thesis, the following recommendations can be made:

- ✓ Microprismatic sheeting Class RA1 can also be used for local roads due to its superior performance compared to glass bead sheeting, comparable degradation rate, and more environmentally friendly production process.
- ✓ Road authorities should carefully consider the manufacturer of retroreflective materials when selecting them for traffic signs, as this can affect their performance over time.
- ✓ Using materials from different manufacturers for long-term studies is recommended to ensure that the results are not biased towards a specific manufacturer.
- ✓ The service lifetime of red retroreflective material should be reconsidered due to its susceptibility to deterioration.
- ✓ The angle for accelerated testing should vary from country to country based on its latitude.

6.2 Atmospheric characteristics

This chapter presents the results of the investigation into the impact of AQI on the retroreflective performance of traffic signs. The effect of the type of sheeting material on the sensitivity of traffic signs to atmospheric conditions is also examined.

Hypothesis 2: The level of retroreflectivity of traffic signs will vary significantly depending on the atmospheric conditions of their location.

This hypothesis was partially confirmed. It was found that the durability and performance of microprismatic retroreflective sheeting can be affected by certain air pollutants regulated by the Clean Air Act and included in the air quality index (such as O₃, PM_{2.5}, and PM₁₀), particularly for white and blue microprismatic sheeting. Additionally, coefficients for the relationship between solar radiation and air pollutants were established. However, for red microprismatic Class RA2 sheeting, the impact of air pollutants was not as significant as the amount of solar irradiation.

Based on the results of this part of the thesis, the following recommendations can be made:

- ✓ The results of accelerated natural weathering can be used for predictive models with different amounts of air pollutants.
- ✓ Road authorities should consider the levels of air pollutants in their area when selecting retroreflective materials for traffic signs.

6.3 Dirtiness and precipitation

The effects of dirtiness and meteorological conditions on retroreflection and sign visibility are presented in this chapter. Three hypotheses were proposed and tested using the results of the thesis.

Hypothesis 3.1: Dirtiness and precipitation on the surfaces of traffic signs will significantly influence the coefficient of retroreflection.

This hypothesis was partially confirmed. The presence of precipitation on traffic signs was found to significantly impair their retroreflective properties, particularly in the case of hoarfrost. The RA for all types of retroreflective sheeting decreases by more than 76 %, often falling below the minimum level. Dew and drizzle also had a significant effect, though to a lesser extent.

Red microprismatic RA1 and RA3 sheeting are not significantly affected by dirtiness, while other types of retroreflective sheeting are. However, almost all types of uncleaned sheeting still meet the ČSN EN 12899-1 requirements. Heavy rain was found to return the value of retroreflection above the minimum, even in cases where the uncleaned signs had values below the minimum. ‘Natural cleaning’ was found to have a similar effect as manually washing with water.

Hypothesis 3.2: The influence of dirtiness and precipitation on retroreflectivity will depend on the sheeting material.

This hypothesis was partially confirmed. The presence of dirt significantly impacted the retroreflective performance of all types of glass bead sheeting and white

microprismatic RA1 and RA3 sheeting. However, red microprismatic sheeting was not significantly affected by dirtiness. In contrast, the presence of frost significantly impacted the retroreflective performance of all types of sheeting. Only red microprismatic RA1 sheeting lost retroreflective performance in the presence of drops on its surface.

Hypothesis 3.3: Raindrops on the sign surface will have a worse effect on retroreflectivity than dew.

It was found that the size of the water droplets on the surface of traffic signs significantly affects the level of retroreflection. Larger raindrops had a worse impact on retroreflectivity compared to dew. The large raindrops caused a significant distortion of the light reflection angles, resulting in a lower level of retroreflection.

Based on the results of this part of the thesis, the following recommendations can be made:

- ✓ The road authorities should ensure that traffic signs are regularly cleaned to maintain their performance and visibility, especially in winter, when the amount of precipitation is the smallest.
- ✓ Microprismatic sheeting is recommended for use in traffic signs due to its improved performance in the presence of precipitation and dirtiness. Road authorities need to consider the cleaning and maintenance needs of traffic signs when selecting retroreflective materials.

6.4 Exposure to sunlight

The influence of solar radiation on the degradation of retroreflective sheeting was evaluated in this thesis.

Hypothesis 4.1: The influence of solar radiation is the central degradation factor for retroreflective sheeting.

This hypothesis was not confirmed. It was found that solar radiation is not always the primary factor affecting the degradation of retroreflective sheeting. In the case of white microprismatic Class RA2 sheeting, air quality had a more significant impact. However, the effect of solar exposure varied based on the samples' tilt angle. Tilting the samples at a +45 ° degree angle increased the degradation rate for red sheeting by 3.00 times and for white sheeting by 2.25 times.

Hypothesis 4.2: Specimens installed outdoors but without exposure to direct solar radiation will have a higher R_A over time than in-service traffic signs.

This hypothesis was not confirmed. Samples with a time of exposure of 46 months were compared. The impact of sunlight on vertical road signs is insignificant, even for signs with red sheeting.

Hypothesis 4.3: The RA of samples stored in a box will not change over time.

This hypothesis was confirmed. The degradation of samples in the box was around 3%, within the measurement error range. However, it was surprising that the degradation rate of white samples in the box was higher than for samples exposed to natural weathering without the influence of sunlight.

Based on these findings, it is recommended:

- ✓ Road authorities consider the minimum end-of-service life values for in-service traffic signs, considering the correction factors for the white and red colours. Further research should be conducted to determine the correction factor for blue.
- ✓ It is unnecessary to store retroreflective signs in entirely dark places, as it is sufficient to avoid direct sunlight exposure.

6.5 Material of the sign panel

This chapter presents the results of an analysis that examines the impact of the sign panel material on the retroreflective performance of road signs.

Hypothesis 5.1: The material of the sign panel will not affect the retroreflective properties of traffic signs.

This hypothesis was not confirmed, as the results showed that the degree of degradation of Al sign panels was generally higher than that FeZn sign panels. After 46 months of exposure in the garden, degradation rates were 7.3 % for the FeZn panel and 10.5 % for the Al panel. Interestingly, the difference in degradation rates did not change significantly compared to the results after one year of exposure in the garden.

Based on the results of this part of the thesis, the following recommendations can be made:

- ✓ FeZn panel appears to be the better choice as a traffic sign panel in terms of cost and retroreflective performance.

6.6 Measurement conditions and equipment

This part of the thesis aimed to assess the impact of ambient temperature and humidity and the type of retroreflectometer used on the R_A of retroreflective sheeting. Three hypotheses were proposed and tested using the results of the thesis.

Hypothesis 6.1: The R_A does not depend on ambient temperature and relative humidity of the air.

This hypothesis was not confirmed. The thesis's results showed that ambient temperature and humidity in the measurement of R_A could significantly impact the accuracy of the measurement. The linear equation was created to determine each factor's

impact. Also, measured results were compared with the determined results from the manufacturer. The statistical analysis shows the meaningful difference between values.

Hypothesis 6.2: Different retroreflectometers devices do not show significant differences in measurements of the RA of traffic signs.

This hypothesis was not confirmed. The combination of such factors as class, colour and observation angles makes a significant difference in measurements done by Zehntner ZRS 6060 and RoadVista 933. The most notable difference was between measurements of blue Type IV sheeting; there was a considerable difference between Zehntner and RoadVista reflectometers. It can be assumed that red sheeting is sensitive to degradation and measurement error. The best sheeting for measurement was yellow sheeting, followed by white and green.

Hypothesis 6.3: There is no statistical difference in RA measurements taken at entrance angles of -4° or 5° .

This hypothesis was partially confirmed. The measurements of vertical traffic signs might be similar for two entrance angles of -4° or 5° , except for Type V sheeting (classification according to GB/T 18833-2012).

Based on the results of this part of the thesis, the following recommendations can be made:

- ✓ It is essential to carefully control the ambient temperature and relative humidity during R_A measurement to ensure the accuracy and reliability of the results.
- ✓ The error margins for retroreflectometers should be reevaluated to consider the fluctuations in R_A values under the conditions specified in the standard and real-world conditions, including the error of the retroreflectometer.
- ✓ Different retroreflectometers should not be used in the same study, as the results of measurements taken with different devices may not be comparable.
- ✓ The Czech standard for retroreflective sheeting may be revised based on research conducted in the USA or China, except for Type V sheeting.

6.7 Orientation

This chapter presents the results of the investigation into the influence of orientation on the retroreflective properties of traffic signs and the extent of its impact.

Hypothesis 7: The orientation of traffic signs will not impact their retroreflectivity.

This hypothesis was partially confirmed through measurements taken in Prague, Beijing, and Shanghai, which detected differences in the retroreflective performance of signs with different orientations. However, the high variability of the results for all

directions makes it difficult to draw definite conclusions. Additionally, the age of the traffic signs in Beijing and Shanghai was unknown. A uniform conclusion cannot be drawn from the literature review either, indicating that while orientation may have some influence on the degradation of retroreflective sheeting, it is not a key factor.

6.8 Recognition by the vehicle camera system

One of the goals of this thesis was to determine which of the parameters or traffic sign characteristics has a significant impact on the recognition of traffic signs by vehicles with the TSDR system. A hypothesis was proposed regarding the influence of a single parameter.

Hypothesis 8: The efficiency of recognition of traffic signs by the vehicle's system depends on the level of retroreflectivity.

This hypothesis was partly confirmed, as the combination of internal contrast and the RA of the sign significantly influenced the recognition distance of the TSDR system. It was also found that the number of signs on the post (one or two) affected the recognition distance, especially when the signs had the same level of retroreflection, forming an atypical area for determination.

Based on the results of this part of the thesis, the following recommendations can be made for road authorities:

- ✓ For posts with two or more signs, the R_A of each sign should be different in order to achieve a retroreflective contrast value of more than 1.
- ✓ Further research is recommended to clarify the factors that impact the recognition of traffic signs by TSDR systems.

6.9 Recommendation for road agencies

In conclusion, the main recommendation for local road agencies is to establish a single national database for all signs, at least for the major arterials and highways, to track the degradation of signs over time. This system should include information about each sign, including the retroreflective material manufacturer and series, the original retroreflectivity data, and subsequent retroreflectivity measurements. The measurement data must consist of the R_A value at a certain angle and the temperature and relative humidity during the measurements. To achieve this, a new label for each sign, a QR code, could be added to provide complete information about the sign, as current labels do not provide enough information about the retroreflective sheeting used for the sign.

Creating a unified database will help establish a comprehensive research base for updating the national standard with end-of-service values for all types and colours of retroreflective signs. It will also save money by allowing signs to be removed only in the

case of low coefficients of retroreflection and will improve safety by ensuring that the level of retroreflectivity is sufficient. Moreover, the research will also help to identify the best manufacturers for different types of signs. For example, it was found that 3M sheeting is frequently used for retroreflective traffic signs, but it showed the worst results for red sheeting and may not be used for traffic signs. The products of Oralite showed better results for microprismatic sheeting than for glass-bead. These results should be proven on a high number of samples.

In terms of maintenance, despite the lack of a standardised sign maintenance system, almost all signs at the studied locations exceeded the minimum requirements of ČSN EN 12899-1. The findings of this thesis have demonstrated that heavy precipitation can effectively maintain the retroreflection of road signs. However, this maintenance strategy is only practical during the spring-autumn seasons. Conversely, during the winter months, when precipitation levels in the Czech Republic are relatively low, frost accumulation can negatively impact the retroreflective properties of signs, resulting in values that fall below outlined in the national standard. Based on the above, it is mandatory to maintain road signs at least once a year before winter to ensure good sign visibility. For maintenance, the author proposes to wash the signs with water and spray anti-freeze on the surface of the signs.

In future research, the results also show that the deterioration of reflective properties can be described by a linear function, making it easier to find the light reflectance values at any given time. However, conducting studies for a minimum of 10 years of each material from different manufacturers is necessary to draw unambiguous conclusions. Alternatively, red micro-prismatic samples could be exposed to natural weathering for 40 months and white samples for 54 months. It should be noted, however, that the frequency of measurements should be at least once a quarter, as measurements are influenced not only by dirt and precipitation but also by temperature and humidity. All measurements should be made with a single retroreflectometer to observe the exact change in the light reflectance, but the final results can be compared with results from other countries, like the USA, which has different legislation but is still comparable to the Czech standards.

Additionally, research on the retroreflectivity of road signs should also include studies with vehicle camera detection of signs. Research results have shown that the retroreflection coefficient and the retroreflective contrast are crucial for modern sign detection systems. The number of signs on a single post, and the contrast between the signs placed on it, is also an essential factor.

References

- Abdel-Aty, M. A., Oloufa, H., Hassan, M., Ahmed, C., Siddiqui, A. E. and Huang, H.S. (2010). Developing an early detection system for reduced visibility, *FDOT Report BDK78*, pp. 61–62.
- AGC Glass Europe (2020). *The major environmental impact of glass production is caused by atmospheric emissions from melting activities*. Available at: <https://www.agc-glass.eu/en/sustainability/environmental-achievements/environmental-impact> (Accessed: 6 March 2022)..
- Akagi, Y., Seo, T. and Motoda, Y. (1996). Influence of Visual Environments on Visibility of Traffic Signs, *Transportation Research Record: Journal of the Transportation Research Board*, 1553(1), pp. 53–58. doi: 10.1177/0361198196155300108.
- Allen, T. M. (1958). Night legibility distances of highway signs, *Highway Research Board bulletin*, 191, pp. 33–40.
- Allen, T. M. *et al.* (1967). Luminance Requirements for Illuminated Signs, *Highway Research Record*, 179, pp. 16–37.
- Allen, T. M. and Straub, A. L. (1956). Sign brightness and legibility, *Highway Research Board bulletin*, 127, pp. 1–14.
- AQI study* (2019).. Available at: www.aqistudy.cn.
- Arbuckle, S. F. and Coulter, G. H. (1936). Sign reflecting in predetermined direction. Patent US2043690
- ASTM D4956-19. Standard Specification for Retroreflective Sheeting for Traffic Control* (2019). West Conshohocken, PA: ASTM International. doi: 10.1520/D4956-19.
- ASTM D4956 Standard Specification for Retroreflective Sheeting for Traffic Control* (2017). doi: 10.1520/D4956-17.
- Austin, R. L. and Schultz, R. J. (2009). *Guide To Retroreflection Safety Principles And Retroreflective Measurements*. San Diego: RoadVista.
- Awadallah, F. I. (1988). Prediction of the service life of warning signs, *Public Roads*, 51(4)..
- Azimuth and Altitude Table* (2020).. Available at: <https://planetcalc.ru/4270/> .
- Babić, D., Šćukanec, A. and Babić, D. (2017). Determining the impact of directionality on road markings retroreflectivity using dynamic method, *Transport*, pp. 1–9. doi: 10.3846/16484142.2017.1339208.
- Beck, H. E. Zimmermann, N. E., McVicar, T. R., Vergopolan, N., Berg, A. and Wood, E. F. (2018). Present and future Köppen-Geiger climate classification maps at 1-km resolution, *Scientific Data*, 5(1), pp. 180–214. doi: 10.1038/sdata.2018.214.
- Bildstein, A. F. J. (2002). The effect of environmental illumination on traffic sign conspicuity and retroreflectivity. Available at: <https://www.researchgate.net/publication/35252762>.
- Bischoff, A. and Bullock, D. (2002). *Sign Retroreflectivity Study. Report FHWA/IN/JTRP-2002/22*.
- Black, K. L., Hussain, S. F. and Paniati, J. F. (1992a). Deterioration of retroreflective traffic signs, *ITE journal*, 62(7), pp. 16–22.
- Black, K. L., McGee, H. W. and Hussain, S. F. (1992b). *Implementation strategies for sign retroreflectivity standards*. Transportation Research Board, Virginia, 43 pp.
- Brimley, B. K. and Carlson, P. J. (2013). The Current State of Research on the Long-Term Deterioration of Traffic Signs, in *Transportation Research Board 92nd Annual Meeting*, p. 14. Available at: <https://static.tti.tamu.edu/tti.tamu.edu/documents/TRB-130033.pdf>.
- Burgess, G., Shortis, M. R. and Scott, P. (2011). Photographic assessment of retroreflective film properties, *ISPRS Journal of Photogrammetry and Remote Sensing*, 66(5), pp. 743–750. doi: 10.1016/j.isprsjprs.2011.07.002.
- Carlson, P. J. and Hawkins, H. G. (2003). *Minimum retroreflectivity levels for overhead guide signs and street-name signs. Report FHWA-RD-03-082*. Edited by Texas Transportation Institute. Available at: <https://www.fhwa.dot.gov/publications/research/safety/03082/>.
- Chrysler, S. T., Carlson, P. J. and Hawkins, H. G. (2003). *Headlamp illumination provided to sign positions by passenger vehicles*.
- Cleveland, D. E. (1966). *Overhead Sign-Illumination Relationships*. Texas Transportation Institute.
- ČSN EN 12899-1. Stálé svislé dopravní značení - Část 1: Stálé dopravní značky* (2007). Český normalizační institut.
- Czech hydrometeorological institute* (2019). Available at: <https://www.chmi.cz/?l=en>.
- Dahlstedt, S. (1974). Luminance uniformity and legibility of traffic signs, *Lighting Research & Technology*, 6(4), pp. 217–221. doi: 10.1177/096032717400600405.
- Dajsuren, Y. and van den Brand, M. (eds). (2019). *Automotive Systems and Software Engineering*. Cham: Springer International Publishing. doi: 10.1007/978-3-030-12157-0.
- Davis, A., Sims, David and Sims, D (1983). *Weathering of polymers*. Springer Science & Business Media.

- Dawson, D. and Reid, K. (1997). Fatigue, alcohol and performance impairment, *Nature*, 388(6639), p. 235. doi: 10.1038/40775.
- Department for Transport (2013). *Traffic signs manual*, Department for Transport. Available at: https://www.gov.uk/government/uploads/system/uploads/attachment_data/file/traffic-signs-manual-chapter-07.pdf
- DIN EN 12899-6 Fixed vertical road traffic signs - Part 6: Performance of retroreflective sign face materials (2012).. European committee for standardization.
- Douglas, M. (2005). Harry Heltzer, 94, Inventor of Reflective Signs, Dies, *The New York Times*. Available at: <https://www.nytimes.com/2005/09/28/business/harry-heltzer-94-inventor-of-reflective-signs-dies.html>.
- EAD 120001-00-0106 Microprismatic retro-reflective sheetings (2016).
- EN 12899-1 Fixed, vertical road traffic signs (2007). Available at: http://www.afesp.pt/documentos/EN12899-1_-_Sinais_Fixos.pdf.
- Fang, C. Y. *et al.* (2004). An automatic road sign recognition system based on a computational model of human recognition processing, in *Computer Vision and Image Understanding*. Academic Press Inc., pp. 237–268. doi: 10.1016/j.cviu.2004.02.007.
- Fatmehsari, Y. R., Ghahari, A. and Zoroofi, R. A. (2010). Gabor wavelet for road sign detection and recognition using a hybrid classifier, in *2010 International Conference on Multimedia Computing and Information Technology (MCIT)*.. IEEE, pp. 25–28. doi: 10.1109/MCIT.2010.5444860.
- Fleyeh, H. and Dougherty, M. (2005). Road and traffic sign detection and recognition, *10th EWGT Meeting and 16th Mini-EURO Conference*, (January 2006), pp. 644–653. doi: 10.1103/PhysRevB.33.8207.
- Forbes, T. W. and Holmes, R.S (1940). Legibility distances of highway destination signs in relation to letter height, letter width, and reflectorization, *Highway Research Board Proceedings*, 19, pp 321-335.
- Forbes, T. W. (1969). Factors in highway sign visibility, *Traffic Engineering, Inst Traffic Engr*, 39(2), pp. 20–27. Available at: <https://trid.trb.org/view/116757>.
- Forbes, T. W., Saari, B. B., Greenwood, W. H., Goldblatt, J. G. and Hill, T. E. (1976). Luminance and Contrast Requirements for Legibility and Visibility of Highway Signs, *Transportation Research Record*, 562, pp. 59–72.
- Frank, H. (1994). *Lichttechnische Anforderungen an vertikale Verkehrszeichen bei Dunkelheit*. Technische Hochschule Darmstadt, Darmstadt.
- Gao, X. W., Podladchikova, L., Shaposhnikov, D., Hong, K. and Shevtsova, N. (2006). Recognition of traffic signs based on their colour and shape features extracted using human vision models, *Journal of Visual Communication and Image Representation*, 17(4), pp. 675–685. doi: 10.1016/j.jvcir.2005.10.003.
- Garvey, P. M., Kuhn, B. T. and Kutz, M. (2011). Highway sign visibility, in *Handbook of Transportation Engineering, Volume II: Applications and Technologies, Second Edition*. McGraw Hill Professional, Access Engineering. Available at: <http://citeseerx.ist.psu.edu/viewdoc/download?doi=10.1.1.452.7608&rep=rep1&type=pdf> (Accessed: 15 November 2018).
- GB/T 1883. *Retroreflective sheeting for traffic control* (2012). Available at: <https://www.codeofchina.com/standard/GBT18833-2012.html>.
- Gebhard, M. L., Heltzer, H., Edmund, J. and Davis, E. P. (1943). Reflex light reflector. Patent US2326634
- German Traffic Sign Benchmarks (2013).. Available at: <http://benchmark.ini.rub.de/?section=gtsrb&subsection=dataset>.
- Gill, E. R. (1933). Sign. Patent US1902440.
- Gomes, S. L. *et al.* (2017). Embedded real-time speed limit sign recognition using image processing and machine learning techniques, *Neural Computing and Applications*, 28(1), pp. 573–584. doi: 10.1007/s00521-016-2388-3.
- Gordon, D. A. (1984). *Night Visibility of Overhead Guide Signs: A Review of the Literature*.
- GOST-DSTU 4100-2014 Traffic signs. General Technical conditions. Application. (2015). Kyiv.
- GOST 32945-2014 Automobile roads of the general use. Road signs. Technical requirements (2016). Moscow.
- Hawkins, H. G. (1992a). Evolution of the MUTCD: Early Standards for Traffic Control Devices. *ITE journal*, 7, pp.23-26.
- Hawkins, H. G. (1992b). Evolution of the MUTCD: the Mutcd Since World War II. *ITE journal*, 62(11), pp. 17-23.
- Hechri, A., Hmida, R. and Mtibaa, A. (2015). Robust road lanes and traffic signs recognition for driver assistance system, *International Journal of Computational Science and Engineering*, 10(1), p. 202. doi: 10.1504/IJCSE.2015.067046.
- Hechri, A. and Mtibaa, A. (2012). Automatic detection and recognition of road sign for driver assistance system, in *2012 16th IEEE Mediterranean Electrotechnical Conference*. IEEE, pp. 888–891.
- Heltzer, H. and Clarke, J. E. (1940). Light reflector sheet. Patent US2354018A.
- Hicks, J. A. (1976). An Evaluation Of The Effect Of Sign Brightness On The Sign-Reading Behavior Of Alcohol-Impaired Drivers, *Human Factors*, 18(1), pp. 45–52. Available at:

- <http://citeseerx.ist.psu.edu/viewdoc/download?doi=10.1.1.905.764&rep=rep1&type=pdf>.
- Hildebrand, E. (2003). Reductions in Traffic Sign Retroreflectivity Caused by Frost and Dew, *Transportation Research Record: Journal of the Transportation Research Board*, 1844(1), pp. 79–84. doi: 10.3141/1844-10.
- Hildebrand, E. and Bergin, T. (2004). Traffic sign retroreflectivity and the canadian environment, in *CITE Conference*. Moncton, 24 pp.
- Hills, B. L. and Freeman, K. D. (1970). An evaluation of the luminance contrast requirements of highway signs. Available at: <https://trid.trb.org/view/139664>.
- Hind, P. R., Tritt, B. H. and Hoffmann, E. R. (1976). The effects of level of illumination, stroke-width, visual angle and contrast on the legibility of numerals of various fonts, 8(1). Available at: <https://trid.trb.org/view/59532>.
- History MUTCD* (2003). Available at: https://safety.fhwa.dot.gov/roadway_dept/night_visib/sign_visib/fhwas03002/appendixa.htm.
- Hollins, M. (1926). Light-reflecting device or unit. Patent US1625905. Available at: <https://patents.google.com/patent/US1625905>.
- How Visible is a Stop Sign? Cars vs SUVs vs Trucks* (no date).. Available at: <https://www.roadtrafficsigns.com/article-stop-sign-visibility>.
- Hsu, S. H. and Huang, C. L. (2001). Road sign detection and recognition using matching pursuit method, *Image and Vision Computing*, 19(3), pp. 119–129. doi: 10.1016/S0262-8856(00)00050-0.
- Hutchinson, J. W. and Pullen, T. A. (1978). Performance of signs under dew and frost conditions, *Transportation research record*, 681, pp. 16–20.
- International Commission on Illumination (1988). *Roadsigns. CIE Publication No.74*. Available at: <https://www.doc88.com/p-6902875632798.html>.
- International Commission on Illumination (2001). *Retroreflection: definition and measurement. CIE 54.2*. Commission Internationale de l'Éclairage.
- International Commission on Illumination (2011). *CIE 74*. Available at: <http://cie.co.at/>.
- Jackson, N. M., Carlson, P. J., Ye, F. and Jackson, G. R. (2013). Use of high intensity reflective sheeting in lieu of external lighting of overhead roadway signs, *Transport*. Dept. of Transportation, Florida. doi: 10.3846/16484142.2016.1264469.
- Jones, H. D. and McNees, R. W. (1988). *Functionality of Guide signs*.
- Ketola, W. (1999). Laboratory-Accelerated Versus Outdoor Weathering for Retroreflective Sheeting Specifications, *Transportation Research Record: Journal of the Transportation Research Board*, 1657, pp. 63–70. doi: 10.3141/1657-09.
- Ketola, W. D. (1989). Durability Testing for Retroreflective Sheetings, *Transportation Research Record*, 1230, pp. 67–76.
- Khalilikhah, M. and Heaslip, K. (2016). Analysis of factors temporarily impacting traffic sign readability, *International Journal of Transportation Science and Technology*, 5(2), pp. 60–67. doi: 10.1016/j.ijst.2016.09.003.
- Khan, J., Yeo, D. and Shin, H. (2018). New Dark Area Sensitive Tone Mapping for Deep Learning Based Traffic Sign Recognition, *Sensors*, 18(11), p. 3776. doi: 10.3390/s18113776.
- Khrapova, M., Marčev, D. and Růžička, M. (2020). Determining the degradation rate of retroreflective sheeting for traffic signs, in *International Conference of Young Scientists ICYS 2020, 14-15th September 2020, Prague Czech Republic*, pp. 142–151.
- King (2010). Advances in retroreflective technologies for road signage, vehicle visibility and pavement markings, delivering safer roads for all. Available at: <http://acrs.org.au/wp-content/uploads/King-and-Turner.pdf>.
- Kipp, W. M. E. and Fitch, J. M. V (2009). Evaluation of measuring methods for traffic sign retroreflectivity, *Vermont Agency of Transportation, Montpelier, VT*.
- Kirk, A. R., Hunt, E. A. and Brooks, E. W. (2001). *Factors affecting sign retroreflectivity*. Oregon. Available at: <http://www.oregon.gov/ODOT/Programs/ResearchDocuments/FactorsAffectSignRetroreflectivity.pdf>.
- KUČEROVÁ, I. (2007). *Koroze a degradace polymerních materiálů*. Available at: <https://www.vscht.cz/studijni-system/predmety/S/predmet/N106023/rok/2019>.
- de la Escalera, A., Armingol, J. M. and Mata, M. (2003). Traffic sign recognition and analysis for intelligent vehicles, *Image and Vision Computing*, 21(3), pp. 247–258. doi: 10.1016/S0262-8856(02)00156-7.
- Laguna, R. Barrientos, R.L., Felipe B. and Miguel, L. J. (2014). Traffic sign recognition application based on image processing techniques, *IFAC Proceedings Volumes*, 47(3), pp. 104–109.
- Lim, K., Hong, Y., Choi, Y. and Byun, H. (2017). Real-time traffic sign recognition based on a general purpose GPU and deep-learning, *PLoS ONE*, 12(3).. doi: 10.1371/journal.pone.0173317.
- Lloyd, J. (2008). A brief history of retroreflective sign face sheet materials. Available at: <http://www.rema.org.uk/pub/pdf/history-retroreflective-materials.pdf>.

- Long, Z., Li, H., Bu, X., Ma, W. and Zhao, L. (2013). Solar radiation on vertical surfaces for building application in different climate zones across China, *Journal of Renewable and Sustainable Energy*, 5(2).. doi: 10.1063/1.4798492.
- MacDonald, W. J. M., William, R. M. and Gill, E. R. (1933). Sign.
- Mace, D. J. and Pollack, L. (1983). Visual Complexity and Sign Brightness in Detection and Recognition of Traffic Signs., *Transportation Research Record*, pp. 33–41.
- Manual on Uniform Traffic Control Devices for Streets and Highways* (1961). United States: Bureau of Public Roads. Available at: https://play.google.com/store/books/details?id=g2G_wERTu08C&rdid=book-g2G_wERTu08C&rdot=1.
- Manual on Uniform Traffic Control Devices (MUTCD)*. 2009th edn (2022). Department of Transportation. Federal Highway Administration.
- Mapy.cz (2020).. Available at: <https://mapy.cz/>
- Marland, R. E. (1967). *Lets Shed Some Light on Pedestrian and Cyclist Safety - An Approach to the Problem*.
- Martinek, A. L. and Taylor, A. N. (1934). Signal. Patent US1950560
- McNees, R. W. and Jones, H. D. (1986). *Functionality of overhead freeway guide signs, target value, sign lighting guidelines and executive summary*. Available at: <https://static.tti.tamu.edu/tti.tamu.edu/documents/TTI-1986-ID1618.pdf>.
- Munehiro, K. Tokunaga, R., Asano, M and Hagiwara, T. (2005). Signing and Marking Materials: Effect of Time and Foggy Conditions on Subjective Visibility: Evaluation of Retroreflective Traffic Control Devices, *Transportation Research Record: Journal of the Transportation Research Board*, 1911, pp. 84–104.
- National Highway Traffic SafetyAdministration (2002). Lamps, Reflective Devices, and Associated Equipment, *Federal Motor Vehicle Safety Standards, Standard*, 108, p. 49.
- Obeidat, M. S. Rys, M. J., Russell, E. R. and Gund, A. (2014). Determining Cost-Effective Policy for Visibility of Overhead Guide Signs on Highways, *Journal of the Transportation Research Forum*, 53(2), pp. 45–58. doi: 10.22004/AG.ECON.207434.
- Obeidat, M. S. Rys, M. J., Rys, A.N. and Du, J. (2016). Evaluation of overhead guide sign sheeting materials to increase visibility and safety for drivers, *Applied Ergonomics*, 56, pp. 136–143. doi: 10.1016/j.apergo.2016.03.016.
- Olson, P. L. and Bernstein, A. (1977). *Determine the luminous requirements of retroreflective highway signing*. Citeseer.
- Olson, P. L. and Bernstein, A. (1979). The Nighttime Legibility of Highway Signs as a Function of Their Luminance Characteristics, *Human Factors*, 21(2).. pp. 145–160. doi: 10.1177/001872087902100202.
- Olson, P. L., Sivak, M. and Egan, J. C. (1983). *Variables influencing the nighttime legibility of highway signs. Final report*. Available at: <http://141.213.232.243/handle/2027.42/246>.
- Oralite (2011). *Overview of Retroreflective Materials. Guidelines for the use of different materials in different traffic sign types*.
- Paclík, P. Novovičová, J., Pudil, P. and Somol, P. (2000). Road sign classification using Laplace kernel classifier, *Pattern Recognition Letters*, 21(13–14).. pp. 1165–1173. doi: 10.1016/S0167-8655(00).00078-7.
- Paniati, J. F. and Mace, D. J. (1993). Minimum retroreflectivity requirements for traffic signs.
- Paulus, S. (2010). A Retroreflective Sheeting Selection Technique for Nighttime Drivers Needs. Texas A & M University.
- Petridou, E. and Moustaki, M. (2000). Human factors in the causation of road traffic crashes, *European journal of epidemiology*, 16(9).. pp. 819–826.
- Prieto, M. S. and Allen, A. R. (2009). Using self-organising maps in the detection and recognition of road signs, *Image and Vision Computing*, 27(6).. pp. 673–683. doi: 10.1016/j.imavis.2008.07.006.
- Rasdorf, W. J. Hummer, J.E., Harris, E. A., Pavan, V., Immaneni, K. and Yeom, C. (2006). *Designing an Efficient Nighttime Sign Inspection Procedure to Ensure Motorist Safety*. Available at: https://connect.ncdot.gov/projects/planning/RNAProjDocs/FinalReport_2005-08.pdf.
- Ré, J. M., Miles, J. D. and Carlson, P. J. (2010). An analysis of in-service type iii high intensity traffic sign retroreflectivity and deterioration rates in texas. Available at: <http://docs.trb.org/prp/11-2542.pdf>.
- Reflective Traffic Signs* (2020).. Available at: <https://www.zumar.com/blog/science-reflective-traffic-signs> (Accessed: 10 May 2020)..
- Reflectors in Traffic. A Brief History* (2018). Available at: <https://www.visibelreflective.com/us/reflectors-in-traffic-a-brief-history/>.
- Retroreflective materials and devices for road traffic control purposes* (2017).. Available at: www.standards.govt.nz.
- Retroreflective Road Traffic Signs: Minimum and Optimal Luminance Requirements* (1991).. Geneva, Switzerland: International Road Federation.
- Retroreflective sign sheeting* (2019). Available at: <https://www.3m.com>.
- Richardson, W. C. (1976). *Comparison of Legibility Potential of Reflective Sign Components*.

- Ritter, W., Stein, F. and Janssen, R. (1995). Traffic sign recognition using colour information, *Mathematical and Computer Modelling*, 22(4–7).. doi: 10.1016/0895-7177(95).00131-K.
- Road Traffic Signs (2020).. Available at: <https://www.roadtrafficsigns.com/a-history-of-the-cataphote-reflector>.
- Robertson, R. N. and Shelor, J. D. (1977). Using encapsulated-lens reflective sheeting on overhead highway signs, *Transportation research record*, 628, pp. 49–52.
- Sandword, P. P. (1933). Reflecting device. Patent US1895173
- Schieber, F. and Goodspeed, C. H. (1997). Nighttime Conspicuity of Highway Signs as a Function of Sign Brightness, Background Complexity and Age of Observer, *Proceedings of the Human Factors and Ergonomics Society Annual Meeting*, 41(2).. pp. 1362–1366. doi: 10.1177/1071181397041002140.
- Schnell, T., Aktan, F. and Li, C. (2004). Traffic Sign Luminance Requirements of Nighttime Drivers for Symbolic Signs, *Transportation Research Record: Journal of the Transportation Research Board*. doi: 10.3141/1862-04.
- Schnell, T., Yekshatyan, L. and Daiker, R. (2009). Effect of Luminance and Text Size on Information Acquisition Time from Traffic Signs, *Transportation Research Record: Journal of the Transportation Research Board*, 2122, pp. 52–62. doi: 10.3141/2122-07.
- Schoettle, B., Sivak, M. and Takenobu, N. (2007). *Market-Weighted Trends in the Design Attributes of Headlamps in the U.S.* Available at: <http://www.umich.edu/~industry/>.
- Scukanec, A., Babic, D. and Sokol, H. (2014). Methodology for measuring traffic signs retroreflection, *European Scientific Journal, Special Edition*, 3, pp. 135–142.
- Shahabi, M. Hlaing, A., Martinelli, D. R. and Unnikrishnan, A. (2012). *Fog Detection for Interstate and State Highways*. West Virginia University Morgantown, 71 pp. Available at: <http://www.mautc.psu.edu/docs/WVU-2010-01.pdf>.
- Shober, S. F. (1977). *Reflective sign sheeting study*.
- Sivak, M. and Olson, P. L. (1982). Nighttime legibility of traffic signs: conditions eliminating the effects of driver age and disability glare, *Accident Analysis & Prevention*, 14(2).. pp. 57–93. doi: [http://dx.doi.org/10.1016/0001-4575\(82\).90075-6](http://dx.doi.org/10.1016/0001-4575(82).90075-6).
- Sivak, M. and Olson, P. L. (1983). *Optimal and Replacement Luminances of Traffic Signs: A Review of Applied Legibility Research*.
- Sivak, M., Olson, P. L. and Pastalan, L. A. (1981). Effect of Drivers Age on Nighttime Legibility of Highway Signs, *Human Factors*, 23(1).. pp. 59–64. doi: 10.1177/001872088102300106.
- Smyth, J. S. (1947). The Brightness and Legibility at Night of Road Traffic Signs, *Lighting Research and Technology*, 12(4), pp. 71–94. doi: 10.1177/147715354701200401.
- Stein, A. C., Parhehian, Z., Allen, R. W. and Wolf, C. E. (1989). *Overhead guide sign visibility factors: Final report. The atlas of the Prague's environment* (2019).. Available at: <https://www.geoportalpraha.cz/en/atlas-zivotniho-prostredi>.
- The Decree No 10/2019 Coll. Decree implementing the road traffic rules* (2015). Available at: <https://www.zakonyprolidi.cz/cs/2015-294>.
- The Decree No 294/2015 Coll. implementing the road traffic rules* (2015). Available at: <https://www.zakonyprolidi.cz/cs/2015-294>.
- The Decree No 84/2016 Coll. implementing the road traffic rules* (2016).. Available at: <https://www.zakonyprolidi.cz/cs/2016-84/zneni-20160321>.
- The Science Behind Reflective Traffic Signs* (2012). Available at: <http://www.reflectivetrafficsigns.com/science-behind-reflective-traffic-signs.html>.
- The weather year round anywhere on Earth* (2022). Available at: <https://weatherspark.com/>.
- Tohidul, I., Gopal, R. R. and Mujtaba, G. (2017). Recognition of Traffic Sign Based on Bag-of-Words and Artificial Neural Network. doi: 10.3390/sym9080138.
- Tomáš Matuška (2016). *Lecture of solar energy* .
- Toth, Š. (2012). Difficulties of Traffic Sign Recognition, in *The 7-th winter school of mathematics applied to ICT*. Sachticky, pp. 7–10.
- TP 189. Determination of traffic volumes on roads* (2018). (in Czech). Available at: http://www.pjpk.cz/data/USR_001_2_8_TP/TP189.pdf.
- TP 65 Principles for traffic signs on communications* (2013). (in Czech). Available at: http://www.pjpk.cz/data/USR_001_2_8_TP/TP_65.pdf.
- Traffic Sign Retroreflective Sheeting Identification Guide* (2014). Available at: https://safety.fhwa.dot.gov/roadway_dept/night_visib/sign_visib/sheetguide/.
- Traffic signs (2008). *Traffic engineering manual*. Ohio Department of Transportation Office of Traffic Engineering, p. 164.

- Tranchida, D., Arthur, E. and Stackhouse, S. P. (1996). *Retroreflective sheting materials on highway signs*.
- TSK Praha (2018). Available at: <https://www.tsk-praha.cz/wps/portal>.
- Unified transport vector map (2017).. Available at: <http://www.jdvm.cz/>.
- Van Norren, D. (1978a). *Overhead signs without external illumination? Part I. Literature review and calculations*. Soesterberg, The Netherlands:
- Van Norren, D. (1978b). *Overhead Signs without External Illumination; Part II. Experiment on Legibility Distances*. Soesterberg, The Netherlands.
- Van Norren, D. (1981). Visual Acuity in a Condition of Traffic Sign Viewing: The Effects of Luminance Changes, *Optometry and Vision Science*, 58(9). Available at: https://journals.lww.com/optvissci/Fulltext/1981/09000/Visual_Acuity_in_a_Condition_of_Traffic_Sign.3.aspx.
- Vitabile, S. *et al.* (2001). Road signs recognition using a dynamic pixel aggregation technique in the HSV color space, in *Proceedings 11th International Conference on Image Analysis and Processing*. IEEE, pp. 572–577.
- Volvo Car (2019). Available at: <https://www.volvocars.com>.
- Waard, D., Brookhuis, K. and Mesken, J. (2005). Evaluation of legibility of not properly reflecting signs, *International Journal of Industrial Ergonomics*, 35(7), pp. 645–651. doi: 10.1016/j.ergon.2005.01.008.
- Wali, S. (2015). Comparative Survey on Traffic Sign Detection and Recognition: a Review, *Przegląd Elektrotechniczny*, 1(12), pp. 40–44. doi: 10.15199/48.2015.12.08.
- Wali, S. B. *et al.* (2019). Vision-Based Traffic Sign Detection and Recognition Systems: Current Trends and Challenges., *Sensors (Basel, Switzerland)*, 19(9). doi: 10.3390/s19092093.
- Wolshon, B. and Degeyter, R. (2000). Performance of traffic sign retroreflectivity, *IMSA journal*, 38(4)
- Wolshon, B., Swargam, J. and Degeyter, R. (2002). Analysis and Predictive Modeling of Road Sign Retroreflectivity Performance, in *16th Biennial Symposium on Visibility and Simulation*, p. 9. Available at: <http://citeseerx.ist.psu.edu/viewdoc/download?doi=10.1.1.197.776&rep=rep1&type=pdf>.
- Woltman, H. L. (1965). A Study of Dew and Frost Formation on Retro-Reflectors, *Highway Research Record*, 70, pp. 63–66.
- Woltman, H. L. and Youngblood, W. P. (1977). Evaluating nighttime sign surrounds, *Transportation research record*, 628, pp. 44–48.
- Woltman, H. L. (1982). Use of retroreflectors in the improvement of nighttime highway visibility, *Color Research & Application*, 7(3), pp. 247–251. doi: 10.1002/col.5080070307.
- Woods, D. L. and Rowan, N. J. (1976). Overhead signs without external illumination, *Transportation research record*, 611, pp. 38–44.
- World Road Association (2003). Road safety manual, *Piarc technical committee on road safety*, pp. 216–225.
- Xrite (2019). Available at: <https://www.xrite.com/>
- Yin, S. *et al.* (2015). Fast Traffic Sign Recognition with a Rotation Invariant Binary Pattern Based Feature, *Sensors*, 15, pp. 2161–2180. doi: 10.3390/s150102161.
- Zaklouta, F. and Stanciulescu, B. (2014). Real-time traffic sign recognition in three stages, *Robotics and Autonomous Systems*, 62(1), pp. 16–24. doi: 10.1016/j.robot.2012.07.019.
- Zhou, H., Chen, H. and Baratian-Ghorgi, F. (2017). Prediction of intermittent sight distance obstruction at unsignalized intersections with conventional right-turn lanes, *Journal of Transportation Safety & Security*, 9(1), pp. 64–81. doi: 10.1080/19439962.2015.1116478.
- Zhu, Y. *et al.* (2016). Traffic sign detection and recognition using fully convolutional network guided proposals, *Neurocomputing*, 214, pp. 758–766. doi: 10.1016/j.neucom.2016.07.009.
- Zhu, Z. *et al.* (2017). An Optimization Approach for Localization Refinement of Candidate Traffic Signs, *IEEE Transactions on Intelligent Transportation Systems*, 18(11), pp. 3006–3016. doi: 10.1109/TITS.2017.2665647.
- Zwahlen, H. T., Russ, A. and Vatan, Ş. (2003). *Nighttime Expert Panel and Photometric Evaluations of Unlighted Overhead Guide Signs*. National Research Council. doi: 10.3141/1844-09.

Appendix A

Glossary

Area of colour	the proportion of the area occupied by one colour to the total area of the sign, expressed as a percentage (introduced by author).
Background	the element of the sign with the largest surface area of the sign.
Border	the element that is different in colour (material) from the background.
Brightness	is a subjective attribute of light. Brightness is perceived and cannot be measured objectively (but scaled, e.g. in %) (<i>Xrite</i> , 2019).
Coefficient of retroreflection	measured in $\text{cd}\cdot\text{lx}^{-1}\cdot\text{m}^{-2}$ refers to the light returning efficiency of a material at specified angles relative to the light source and the observer. The English unit is $\text{cd}\cdot\text{fc}^{-1}\cdot\text{ft}^{-2}$. The term Specific Intensity per unit Area (S.I.A.) was used in the past to refer to the coefficient of retroreflection. The lay term “candlepower” is often used as a substitute when referring to the coefficient of retroreflection of a sign sheeting material (Chrysler et al., 2003).
Comprehensibility	measure of how readily an observer can understand the message intended to be conveyed by the sign (International Commission on Illumination, 2011).
Conspicuity	quality of a sign to attract (attention conspicuity) or gain (search conspicuity) the driver's attention (International Commission on Illumination, 2011).
Credibility	the message should be such that the reader believes what is conveyed and acts upon it (International Commission on Illumination, 1988).
External contrast	is the ratio of the sign's average luminance and the luminance of the area directly surrounding the sign (Garvey et al., 2011)
Illuminance	measured in lux (lx) refers to the amount of light falling on a sign face, measured at the sign face. The English unit is footcandles (Chrysler et al., 2003).

Lateral offset	a distance from the edge of the shoulder of the road to the nearest edge of that sign (<i>Traffic signs</i> , 2008)
Legend	the message on the face of a sign panel (including text, arrows, route markers and special symbols) (<i>Traffic signs</i> , 2008)
Legibility	measure of how readily an observer may recognize the symbols or words. It is usually measured in terms of the threshold distance at which the sign becomes legible (International Commission on Illumination, 2011).
Luminance	is the luminous intensity, projected on a given area and direction. It is measured in candelas per square meter (<i>Xrite</i> , 2019), measured in $\text{cd}\cdot\text{m}^{-2}$ refers to the amount of light produced per unit area of the object. Human visual systems interpret luminance as brightness. The English unit is footlambert (Chrysler et al., 2003; <i>Xrite</i> , 2019).
Luminous intensity	measured in candelas (cd) refers to the amount of light produced by the headlamps in a particular direction. The English unit is candles (Chrysler et al., 2003).
Retroreflective internal contrast	contrast between background and border of retroreflective sheeting
Refractive index (or index of refraction)	measure of the bending of a ray of light when passing from one medium into another.
Sign panel	a separate panel or piece of material containing a word, symbol, and/or arrow legend that is affixed to the face of a sign (<i>MUTC</i> , 2022)
Sign post	a post bearing a sign
Siting	traffic signs are sited on the right-hand or left-hand sides of the road
Vertical clearance	the height from the lowest edge of the sign plate to the road surface (<i>Traffic signs</i> , 2008)

Appendix B

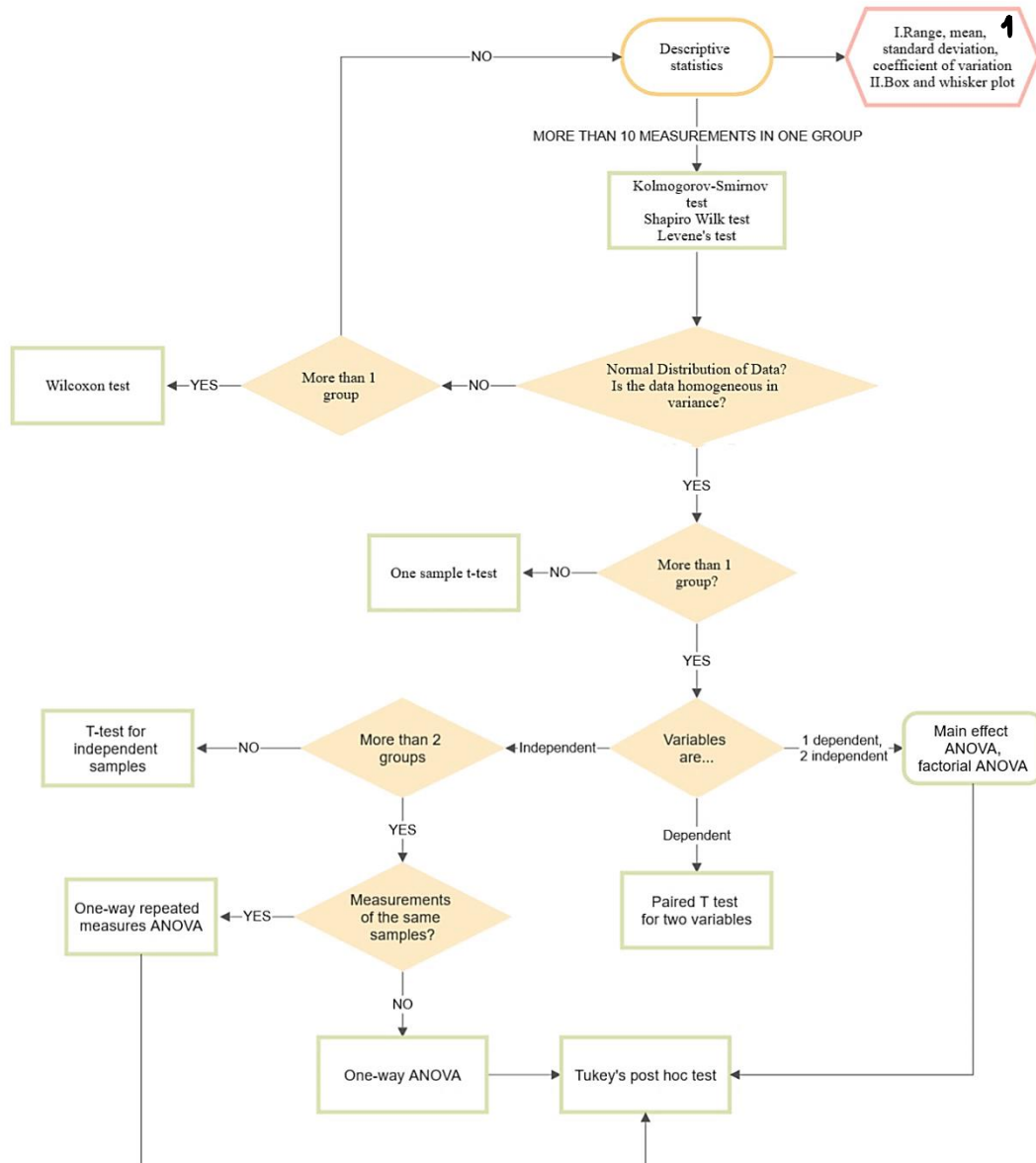

Fig. B.1 Algorithm for selecting a statistical test to analyse the measurements made in this work. Source: Author's work

- 1 The results in Chapter 5.7 are presented as dot-and-whisker plots, where the mean value and range of measurements are the main characteristics of a single variable. The lower value of the range is the minimum value of the dataset minus the measurement error for a given value. The maximum value is the largest in the group plus the measurement error for a given value. The measurement error is indicated in the documentation for the retroreflectometer.

Appendix C

The climate zones in Prague and Beijing were defined using the Köppen-Geiger system, which is based on monthly air temperature and precipitation data from 1980 to 2016 (Beck et al., 2018). According to the system, Prague refers to a mild **continental** humid climate (Dfb), and Beijing belongs to a warm **continental** climate with dry winters (Dwa). Both cities belong to continental climate. Table C.1 shows the main climatic characteristics of these two locations, including temperature (T), humidity (HUM), amount of precipitation, and the number of rainy days. The table also includes the annual total solar radiation for Prague and Beijing.

Tab. C.1 The climatic characteristics of Beijing and Prague. Sources: retrieved from AQI study (2019), The atlas of the Prague's environment (2019); Long et al. (2013); Tomáš Matuška (2016)

Location	Incline angle of the surface	Annual solar irradiation	The average monthly values			
			T	HUM	Precipitation	
	[°]	[kWhm ⁻²]	[C°]	[%]	[mm]	[days]
Prague	+90	825	9	78	36	7
	+45	1100				
Beijing	+90	1111	13	61	35	4

Although Prague and Beijing are located in different climate zones, they have several similar climatic characteristics, including temperature range (Fig. C.1).

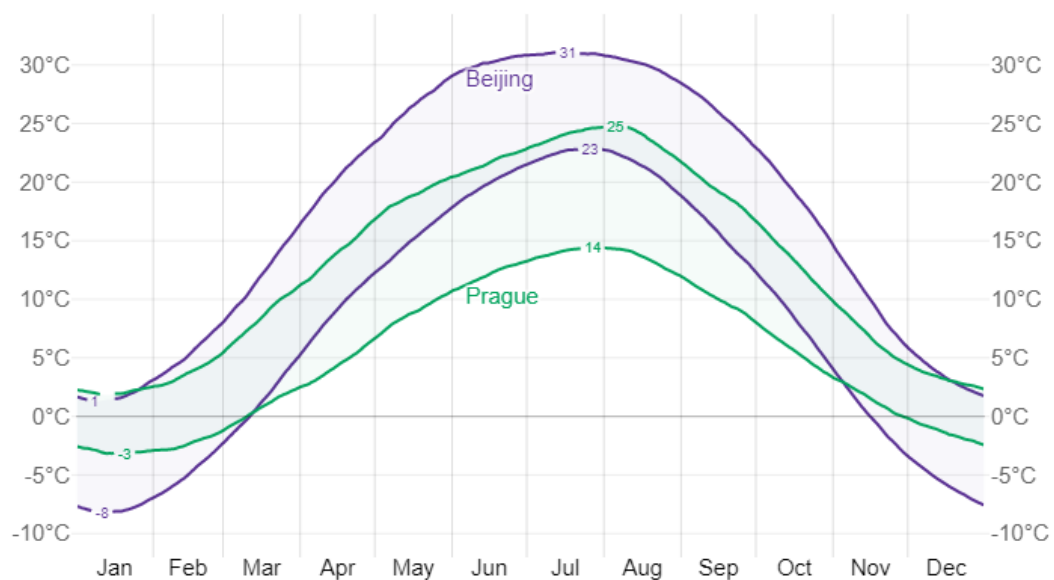

Fig. C.1 The average high and low temperatures in Beijing and Prague. Source: retrieved from The weather year round anywhere on Earth (2022)

However, the distribution of precipitation in Beijing is uneven compared to Prague (Fig. C. 2), but both locations have similar average amounts of precipitation (Tab. C.1).

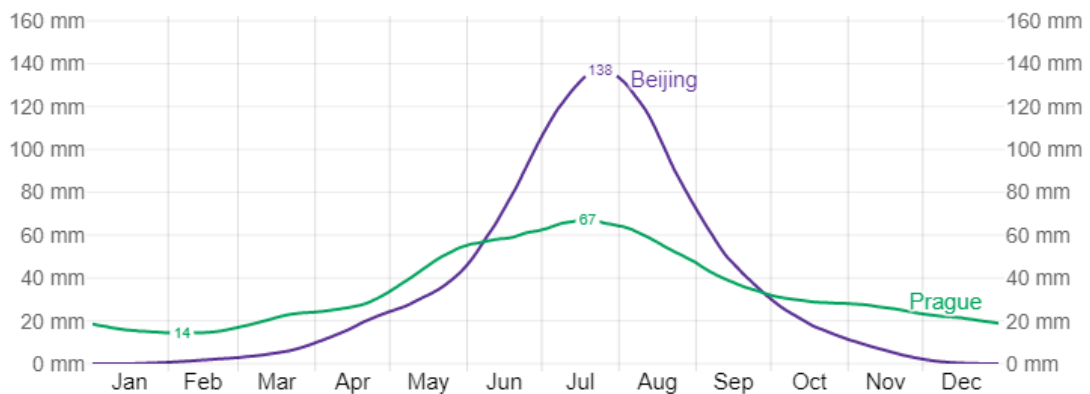

Fig. C.2 The average monthly rainfall in Beijing and Prague. Source: retrieved from *The weather year round anywhere on Earth (2022)*

Tab. C.2 One-way ANOVA results for five types of sheeting in four locations, including basic statistical parameters. Source: Author's work

Sheeting	Location	Normality	Mean	Standard deviation	p
White 3M 4000					0.000
	Storage	0.917	972.463	57.333	
	BG3	0.173	700.109	61.903	
	Test desk	0.661	837.150	52.800	
	PD0	0.252	615.25	94.577	
White 3M 3930					0.000
	Storage	0.861	881.500	12.128	
	BG3	0.494	554.353	79.579	
	Test desk	0.588	700.125	97.001	
	PD0	0.856	547.586	139.457	
Red 3M 3930					0.000
	Storage	0.045	218.333	33.268	
	BG3	0.174	114.624	6.897	
	Test desk	0.244	130.683	12.963	
	PD0	0.999	100.550	14.932	
Blue 3M 3930					0.022
	Storage	0.366	68.545	4.101	
	BG3	0.935	60.856	11.992	
	Test desk	0.336	39.35	8.964	
	PD0	0.073	59.171	16.334	

0.000 – values lesser than three decimal places after the decimal point were neglected

Appendix D

Tab. D.1 Paired T-test results for measurements taken with Roadvista 933 and Zehntner ZRS 6060. Source: Author's work

Colour	Type	$\beta_1 = 5^\circ; \varepsilon = -75, -50, -25, 0, 25, 90^\circ$		
		α		
		0.2	0.33	2
white	<i>I</i>	0.740	0.260	0.047
	<i>III</i>	0.006	0.260	0.097
	<i>IV</i>	0.031	0.657	
	<i>V</i>	0.126	0.000	0.200
yellow	<i>I</i>	0.503	0.799	
	<i>III</i>	0.046	0.332	0.208
	<i>IV</i>	0.001	0.170	
	<i>V</i>	0.100	0.004	0.300
green	<i>I</i>	0.015	0.008	0.293
	<i>III</i>	0.065	0.012	0.022
	<i>IV</i>	0.000	0.000	0.003
	<i>V</i>	0.200	0.048	0.315
red	<i>I</i>	0.008	0.006	0.430
	<i>III</i>		0.280	0.000
	<i>IV</i>	0.001	0.303	
	<i>V</i>	0.236	0.403	0.116
blue	<i>I</i>	0.004	0.120	0.002
	<i>III</i>	0.012	0.013	0.000
	<i>IV</i>	0.002	0.001	
	<i>V</i>	0.099	0.007	0.017

0.000 – values lesser than three decimal places after the decimal point were neglected