



Master Thesis

Analysis of the digitization accuracy of the optical 3D scanner MetraScan

Study programme: N0715A270018 Machines and Equipment Design
Author: **Elaganesh Elakkuvan**
Thesis Supervisors: doc. Ing. Radomír Mendřický, Ph.D.
Department of Manufacturing Systems and Automation

Liberec 2023



Master Thesis Assignment Form

Analysis of the digitization accuracy of the optical 3D scanner MetraScan

Name and surname: **Elaganesh Elakkuvan**
Identification number: S21000172
Study programme: N0715A270018 Machines and Equipment Design
Assigning department: Department of Manufacturing Systems and Automation
Academic year: 2022/2023

Rules for Elaboration:

The aim of the thesis will be to analyse the accuracy of digitization of optical 3D scanner MetraScan 350 within the measuring space of C-Track.

Recommended methods for elaboration:

1. Get acquainted with the laboratory equipment needed to implement the practical part of the work (optical 3D scanning system MetraScan 350 + C-Track, SW GOM Inspect, etc.), with the principles of optical digitization and the so-called Acceptance tests.
2. Research of works on a similar topic – an overview of the current state of knowledge (will be part of the theoretical part of the thesis). Search for procedures used to assess the measurement accuracy of optical 3D systems.
3. Formulation of the solved problem and its analysis, proposal of a methodical approach to the solution.
4. If necessary – design and manufacture a calibration standard that will allow the implementation of procedures for testing the accuracy of optical 3D scanners. Determine the nominal dimensions of the standard (e.g. by CMM). Using the standard, determine the accuracy of digitization within the entire measuring range of the C-Track. Process the obtained results and, if necessary, compare them with the data provided by the device manufacturer.
5. Evaluation and analysis of results, discussion, conclusion.
6. Prepare paper on this topic for publication in a technical journal or conference.

Scope of Graphic Work: according to need
Scope of Report: about 60 pages
Thesis Form: printed/electronic
Thesis Language: English

List of Specialised Literature:

- [1] ZHANG, S. *Handbook of 3D Machine Vision: Optical Metrology and Imaging*. Boca Raton: CRC Press, 2013. ISBN: 978-1-4398-7219-2.
- [2] GOM MbH. *GOM Software 2018: Inspection Basic*. Braunschweig (Germany): GOM MbH, 2018.
- [3] GOM MbH. *ATOS: Process Description, GOM Acceptance Test according to the Guideline VDI/VDE 2634 Page 3*. Braunschweig (Germany): GOM MbH, 2010.
- [4] VDI/VDE 2634, Blatt 3. *Bildgebende Systeme mit flächenhafter Antastung in mehreren Einzelansichten*. Düsseldorf: Verein Deutscher Ingenieure – Verband der Elektrotechnik Elektronik Informationstechnik, 2008
- [5] KERSTEN, ThomasP., Heinz-Jurgen PRZYBILLA a Maren LINDSTAEDT. *Investigations of the Geometrical Accuracy of Handheld 3D Scanning Systems*. *Photogrammetrie – Fernerkundung – Geoinformation* [online]. 2016, 2016(5), 271–283. ISSN 1432-8364. DOI:10.1127/pfg/2016/0305
- [6] CREAFORM, SOLIDVISION. User manuals and technical documentation for the MetraScan system and SW VXelements.

Thesis Supervisors: doc. Ing. Radomír Mendřický, Ph.D.
Department of Manufacturing Systems and Automation

Date of Thesis Assignment: November 20, 2022

Date of Thesis Submission: May 20, 2024

doc. Ing. Jaromír Moravec, Ph.D.
Dean

L.S.

Ing. Petr Zelený, Ph.D.
Head of Department

Declaration

I hereby certify, I, myself, have written my master thesis as an original and primary work using the literature listed below and consulting it with my thesis supervisor and my thesis counsellor.

I acknowledge that my master thesis is fully governed by Act No. 121/2000 Coll., the Copyright Act, in particular Article 60 – School Work.

I acknowledge that the Technical University of Liberec does not infringe my copyrights by using my master thesis for internal purposes of the Technical University of Liberec.

I am aware of my obligation to inform the Technical University of Liberec on having used or granted license to use the results of my master thesis; in such a case the Technical University of Liberec may require reimbursement of the costs incurred for creating the result up to their actual amount.

At the same time, I honestly declare that the text of the printed version of my master thesis is identical with the text of the electronic version uploaded into the IS/STAG.

I acknowledge that the Technical University of Liberec will make my master thesis public in accordance with paragraph 47b of Act No. 111/1998 Coll., on Higher Education Institutions and on Amendment to Other Acts (the Higher Education Act), as amended.

I am aware of the consequences which may under the Higher Education Act result from a breach of this declaration.

May 22, 2023

Elaganesh Elakkuvan

Acknowledgment

I hereby acknowledge the support given by my university in proceeding with this work and allowing me to develop my skills in the field of engineering and machine design.

I'm very thankful for my thesis supervisor, **doc. Ing. Radomír Mendřický, Ph.D.**, for his dedication, helpful approach, proper consultation, and commitment to measure.

I would also like to thank our head of the department, **Ing. Petr Zeleny Ph.D.**, He has aided us in pursuing our academic goals in every manner. Without his assistance, I might not have overcome success.

Finally, I want to express my gratitude to my whole family and friends for their unwavering support, tolerance, and encouragement throughout my academic career.

THEME: Analysis of the digitization accuracy of the optical 3D scanner MetraScan

ABSTRACT: This thesis focuses on the analysis of the digitization accuracy of the optical 3D scanner MetraSCAN 350 within the measuring space of C-Track. The study encompasses several phases, including a comprehensive understanding of the scanner and other essential components necessary to conduct the practical work, such as the 3D contactless scanner Metra-Scan and SW GOM Inspect. Furthermore, the research delves into the concepts of optical digitization and acceptance tests. To evaluate the accuracy of the optical 3D scanner MetraSCAN Four Etalon bars, including three large ones and one small, all conforming to the VDI/VDE/2634-3 standard, are utilized for measurements. The assessment of Metrascan's digitization accuracy considers five different parameters: orientation, resolution, calibration, distance, and dynamic referencing system. By employing this methodology, the accuracy of Metrascan's digitization process is thoroughly assessed.

KEYWORDS: Metrascan, Optical 3D scanner, Accuracy, Acceptance test, GOM Inspect, Calibration standard

TÉMA: Analýza přesnosti digitalizace optického 3D skeneru MetraScan

ABSTRAKT: Tato práce se zaměřuje na analýzu přesnosti digitalizace optického 3D skeneru MetraSCAN 350 v rámci měřicího prostoru C-Track. Studie zahrnuje několik fází, včetně komplexního pochopení procesu 3D skenování a dalších nezbytných součástí potřebných k realizaci praktické části práce, jako je 3D bezkontaktní skener Metra-Scan a SW GOM Inspect. Dále se výzkum věnuje principům optické digitalizace a akceptačních testů. Pro vyhodnocení přesnosti optického 3D skeneru MetraSCAN se pro měření používají čtyři etalonové tyče, včetně tří velkých a jedné malé, všechny splňující normu VDI/VDE/2634-3. Hodnocení přesnosti digitalizace MetraSCANu bere v úvahu pět různých parametrů: orientaci, rozlišení, kalibraci, vzdálenost a dynamický referenční systém. Použitím této metodiky je důkladně posouzena přesnost digitalizačního procesu Metrascan.

KLÍČOVÁ SLOVA: MetraSCAN, Optický 3D skener, Přesnost, Akceptační test, GOM Inspect, Kalibrační standard

Contents

List of Figures	10
List Of Tables	11
List Of Graphs.....	12
List of Abbreviations and symbols:	13
1. Introduction	14
1.1. 3D scanning.....	15
1.2. Hand held scanners.....	17
1.3. Triangulation	18
1.3.1. Active triangulation	18
1.3.2. Passive triangulation	19
1.4. Purpose of 3D scanners	20
2. Aim Of Thesis	21
3. 3D scanner Metrascan	21
3.1. Brief introduction of Metrascan	22
3.2. Working of scanner	23
3.3. Modes in MetraSCAN.....	23
3.3.1. Static mode.....	23
3.3.2. Dynamic referencing.....	24
3.3.3. Standard mode (Three lines).....	24
3.4. C-Track.....	25
3.4.1. C-Track operating Principles	26
3.4.2. C-Track Triangulation	27
3.5. Main Features of Metra Scan	27
4. Accuracy of scanners.....	28
4.1. Single scan accuracy vs volumetric accuracy	29
4.2. Accuracy depending factors	30
4.3. 3D Resolution.....	30
4.3.1. Mesh Resolution	31
4.3.2. Measurement resolution.....	32
4.4. Acceptance tests	32
4.5. Acceptance test parameters	33
4.5.1. Probing error form	34
4.5.2. Probing error size.....	35

4.5.3.	Sphere spacing error	35
4.5.4.	Length measurement error	35
5.	Review of Previous work	36
5.1.	Adjusting 3D scanner calibration	36
5.2.	Ideal scanning conditions	36
5.3.	Hand held vs structured light projection	37
5.4.	Laser system vs white light projection system.....	38
5.5.	Correctness of complicated structures' geometry.....	38
5.5.1.	Experimental uncertainty	38
5.6.	Useful technique for optical scanners	39
5.7.	Optical scanner's capacity to measure.....	39
5.8.	Error and repeatability in simple vs. complicated shapes	40
5.9.	Dependence of accuracy and precision on shapes	41
5.10.	Different measurement strategies	41
5.11.	In relation with Metrascan	42
6.	Method of Measurement.....	43
6.1.	Object used for measurement.....	43
6.1.1.	Etalon Bars.....	43
6.2.	Calibration Process.....	45
6.2.1.	Calibration setup of C-Track with measuring area	45
6.2.2.	Calibration of MetraScan Head	46
6.3.	Scanning Procedure.....	46
6.4.	Importing Scanned results to the GOM software.....	47
6.5.	Measuring methods	48
6.5.1.	Scanning with Different Coordinate axis.....	48
6.5.2.	Scanning with different resolution.....	48
6.5.3.	Scanning with different calibration.....	49
6.5.4.	Scanning with different distances	49
6.5.5.	Scanning with static and dynamic referencing system	50
7.	Results	52
7.1.	Analysis of results	52
7.1.1.	Graphs of different orientations	52
7.1.2.	Graphs of different Resolution.....	55
7.1.3.	Graphs of different calibrations	57
7.1.4.	Graphs of different distances	60

- 7.1.5. Graphs based on the dynamic referencing system.....62
- 7.2. Summary of overall results65
 - 7.2.1. Result graph from Sphere spacing error of big etalon65
 - 7.2.2. Result graph from sphere spacing error of small etalon67
 - 7.2.3. Result graph from probing error size of small etalon69
 - 7.2.4. Result graph from probing error form of small etalon.....70
- 8. Discussion.....72
- 9. Conclusion.....74
- 10. References.....76

List of Figures

Figure 1 Schematic representation of 3D scanning [1]..... 14

Figure 2 Object to model and inspection [1] 15

Figure 3 Process of 3D scanning file conversion [2]..... 16

Figure 4 Cloud points and polygonal mesh triangles [3]..... 17

Figure 5 Active triangulation [4] 18

Figure 6 Passive triangulation [6]..... 19

Figure 7 Metrascan 350 [8]..... 22

Figure 8 Proper scanning distance [11] 22

Figure 9 Measurement volume [11]..... 23

Figure 10 Static mode example [10]..... 23

Figure 11 Standard mode example [11]..... 25

Figure 12 C-Track [11] 26

Figure 13 Operating principles [11]..... 26

Figure 14 C-Track triangulation [11]..... 27

Figure 15 Etalon acceptance test [15]..... 28

Figure 16 Accuracy vs Precision [14]..... 29

Figure 17 Resolution differences [14] 31

Figure 18 GOM Acceptance test [17]..... 32

Figure 19 Probing error form [19] 34

Figure 20 Probing error size [19]..... 35

Figure 21 Sphere spacing error [19] 35

Figure 22 Length measurement error [19] 36

Figure 23 Three long etalon bars [26]..... 44

Figure 24 Sample of one long bar with values [26]..... 44

Figure 25 Small etalon reference [27] 45

Figure 26 C-Track calibration..... 45

Figure 27 Calibration of metrascan head 46

Figure 28 Method of scanning 47

Figure 29 Measuring volume 47

Figure 30 Gaussian best fit selection 47

Figure 31 Different coordinate axis 48

Figure 32 Resolutions 49

Figure 33 Different distances..... 49

Figure 34 Dynamic referencing system 50

Figure 35 Different scanned positions 51

List Of Tables

Table 1 Parameters Table.....	43
Table 2 Nominal value of Big Etalon	43
Table 3 Nominal value of small Etalon	44
Table 4 Reference Table	52
Table 5 Sphere spacing error of Big Etalon.....	53
Table 6 Probing error Size	54
Table 7 Probing error Size-Resolution	55
Table 8 Probing error form-Resolution.....	56
Table 9 Sphere spacing error big etalon-Calibration	58
Table 10 Probing error size-Calibration	59
Table 11 Sphere spacing error-Distance	60
Table 12 Probing error size-Distance	61
Table 13 Sphere spacing error of Big Etalon- DRS.....	63
Table 14 Probing error size-DRS.....	64
Table 15 Combined table of Sphere spacing error of big etalon	65
Table 16 Combined table of Sphere spacing error of small etalon.....	67
Table 17 Combined table for Probing error size.....	69
Table 18 Combined table for Probing error form	70

List Of Graphs

Graph 1 Sphere spacing error of big etalon53
Graph 2 Probing error Size54
Graph 3 Probing error Size-Resolution.....56
Graph 4 Probing error form-Resolution.....57
Graph 5 Sphere spacing error big etalon-Calibration58
Graph 6 Probing error size-Calibration.....59
Graph 7 Sphere spacing error-Distance61
Graph 8 Probing error size-Distance.....62
Graph 9 Sphere spacing error of Big Etalon- DRS.....63
Graph 10 Probing error size-DRS64
Graph 11 Combined graph of Sphere spacing error of big etalon66
Graph 12 Combined graph of Sphere spacing error of small etalon.....68
Graph 13 Combined graph for Probing error size69
Graph 14 Combined graph for Probing error size71

List of Abbreviations and symbols:

- 2D-Two dimensional
- 3D-Three dimensional
- CAD-Computer Aided Design
- CMM-Coordinate Measuring Machine
- CT-Computed Tomography
- DRS- Dynamic Referencing System
- MRI-Magnetic Resonance Imaging
- PT-Prototype
- STL-Stereolithography

1. Introduction

In recent years 3D scanning technology has been used in an enormous number of fields, and it enables users to obtain the required 3D model through some forms like STL files or sometimes using a CAD model. Compared to the technologies which are used in the past 3D technology stands alone with its ability to Scan objects despite size whether large or small. One of the main benefits of 3D scanning is that a 3D model can be obtained easily in a short span of time despite the size, structure, and color. The output from the 3D scanner depends on the quality of the scanner used, it decides the quality of the scanned object. There are two types of model creation image-based and ranger based. Side by side the increased use of 3D scanners in industries helped people to create more innovative products with more detailed information obtained from the scanners, which also paved the way for creating products with more accurate and precise information. With the help of laser lights, 3D scanners are able to recognize the object and represent the 3D model with more precise details. The cameras attached to the scanners collect information about the surfaces within their field of view. Therefore, it produces a picture of the scanned objects from a distance to the surface of each point.

Sometimes we need to do multiple scans to obtain a more accurate model because a single scan is not effective partially, for getting clarified and detailed information from the scanned object, we need to do the scanning from all sides and from most of the angles. which will commonly come under a reference system, called alignment. By merging the measured scanning output the 3D model has been created[1].

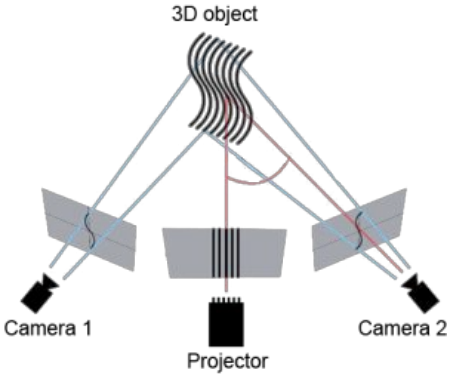

Figure 1 Schematic representation of 3D scanning [1]

1.1. 3D scanning

3D scanning is a process of collecting data about the shape and appearance of an object in three dimensions. This data can be used to create a digital model of the object, which can be manipulated and reproducing using 3D printing or other means. 3D scanning can be used to create accurate models of object for engineering or other purposes. It can also be used to create 3D models of objects for entertainment or artistic purposes. There are variety of ways to collect data for 3D scanning. One common method is to use a laser scanner. Laser scanners work by projecting a laser beam onto the surface of the object and measuring the reflected light. This data is then used to create a 3D model of the object. Another common method is to use a structured light scanner. This type of scanners projects a pattern of light onto the object and

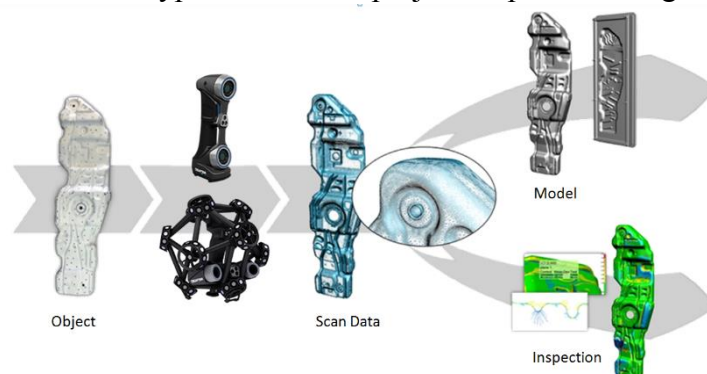

Figure 2 Object to model and inspection [1]

measures the deformation of the pattern. This data is then used to create a 3D model of the object. 3D scanning can also be done with scanners that use CT or MRI data. These scanners take advantage of the fact that different tissues in the body have different densities. By taking multiple images of the object from different angles, these scanners can create a 3D model of the object. It can also be used to create a virtual environment. This is done by scanning a real environment and then creating a digital model of it. This model can be used to create a virtual reality environment that can be explored by people using VR headsets. There is a wide range of software available nowadays to scan objects in 3D and they are very precise in representing the 3D digitalized models. 3D scanning technology is one of its ways to become the Industrial revolution 4.0. It is mostly linked that the production world will be networked until everything is connected with everything else. 3D scanning technologies play an important role in measuring tools. They are used for many purposes like comparison and verification. They are advanced in many ways like portability, easy use, decreasing costs, and robustness. 3D scanning technologies are becoming a significant tool and a common tool on the shop floor (or) assembly line.

Nowadays due to the intuitiveness and ease of use of the advanced 3D scanner, it becomes easy for people with minimal training to operate the equipment.

Even though the 3D scanning technology has so many benefits like the ability to quickly gather part data, the ability to shorten cycle times in product design and prototyping, and the ability to provide data for accuracy and design verification, they are still constrained to limit today's technologies[2].

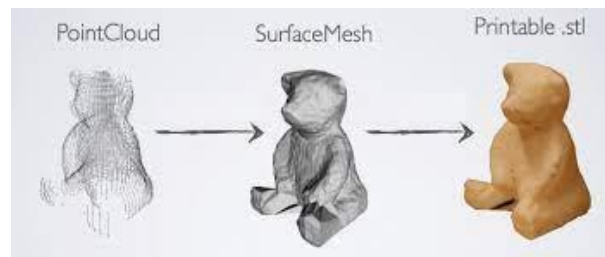

Figure 3 Process of 3D scanning file conversion [2]

With increased demands for high-quality products, there is also high accuracy need in nowadays 3D scanning systems and the challenges depend not on the training of people to use it but to develop engineers. The quality parameters are specified for assessing the accuracy of the measuring systems.

3D scanners can be defined as devices that are capable of automatically determining the spatial coordinates of the object's points after entering the scanning parameters. The 3D scanner is part of the so-called scanning system, which also consists of a control unit, a program for controlling the scanning, a program for processing the data already obtained by measuring and other accessories, such as an external battery, cables or a tripod.

Basically, a 3D scanner is a device capable of capturing the shape, texture and possibly color of a given physical object. Usually, points on the object's surface are scanned, with the help of which the object is displayed in a computer program as a cluster of points - we can refer to it as a cloud of points. This cloud can be converted into a so-called geometric, three-dimensional model using polygons (mostly it is a polygonal network made up of triangles). Both the point cloud and the polygon mesh can be seen in Figure 4.



Figure 4 Cloud points and polygonal mesh triangles [3]

The obtained data can be merged into a complete model automatically already during the scanning itself or only in the next step during their further processing. During subsequent editing, adjustments are also made, such as cleaning data from unwanted points from the point cloud, filling holes, correcting errors, smoothing the surface, etc.

Today, there are a large number of devices on the market that allow the conversion of three-dimensional objects into digital form. However, when choosing them, it is necessary to take into account some criteria, because each scanner is more or less suitable for a given purpose. Aspects considered include, for example, the following: dimensions of the object, required accuracy, material, and texture of the object, ambient conditions, and desired data output.

1.2. Hand held scanners

A 3D picture is produced by handheld laser scanners using the triangulation technique. A hand-held device projects a laser dot or line onto the target, and a sensor (usually a charge-coupled device or position-sensitive device) determines how far away the target is from the surface. Data is gathered with respect to an internal coordinate system; therefore, it is necessary to know the scanner's position in order to capture data while it is moving. The location can be established by the scanner either by utilizing external tracking techniques or by employing reference features on the surface being scanned (usually sticky reflecting tabs, but natural features have also been employed in research work). External tracking frequently takes the shape of a laser tracker (to supply the sensor location) with an integrated camera (to determine the orientation of the scanner) or a photogrammetric solution employing three or more cameras to offer all six degrees of freedom of the scanner. Both methods frequently make use of infrared light-emitting diodes that are mounted to the scanner and visible to the camera(s) only through filters that are resistant to ambient light[3].

Computers gather information and store it as data points in three dimensions. After processing, this information may be transformed into a triangulated mesh and subsequently a computer-aided design model, frequently as non-uniform rational B-spline surfaces. To create (or "reverse engineer") a complete 3D model, portable laser scanners can combine this information with passive visible-light sensors, which record the surface textures and colours [3].

1.3. Triangulation

Active scanners that employ laser light to explore the surroundings include 3D laser scanners that rely on triangulation. Regarding time-of-flight 3D laser scanning, the triangulation laser uses a laser to illuminate the target and a camera to locate the laser dot. The location of the laser dot in the camera's field of vision varies depending on how close the laser is to the surface being hit. Because the laser emitter, the camera, and the laser dot create a triangle, this method is known as triangulation. The triangle's one-side length as well as the separation between the laser emitter and camera are both known. It is also known what angle the corner of the laser emitter is. By observing where the laser dot is situated inside the camera's field of vision, it is possible to calculate the angle of the camera corner. The triangle's size, shape, and position of the laser dot corner are all determined by these three bits of information. To expedite the acquisition procedure, a laser stripe is typically used rather than a single laser dot to sweep across the object. In 1978, the National Research Council of Canada was one of the pioneering research organizations to create the triangulation-based laser scanning technique. It's divided into two types active and passive triangulation[4].

1.3.1. Active triangulation

An active triangulation approach is used in practice the most frequently, due of its reliability and simplicity, this technique relies on simultaneous CCD scanning and

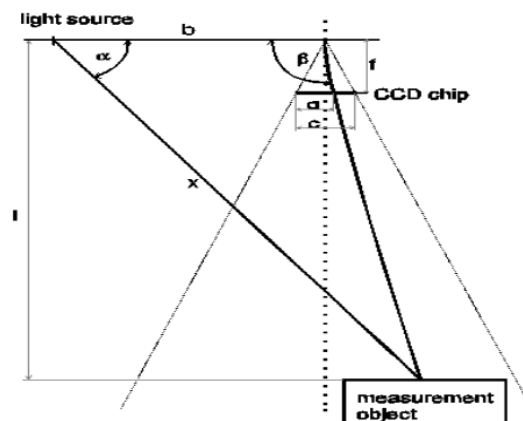

Figure 5 Active triangulation [4]

photogrammetric reconstruction of the measured object's surface sensor. Fig 5. depicts the technique's basic idea. A triangle is formed by the light source, the detector, and the lit portion of the item being measured. The triangulation optical foundation is the connection (b) between the light source and the detector. The angle of the light source's rays is constant, while the angle on the detector side is changeable and is determined by a variable lighted spot on the CCD chip. The distance may be calculated using two angles, one side of the triangle, the characteristics of the camera, and the objective (chip and objective focal length).

According to the light source we distinguish these variants: -

1-D triangulation – light point, 2-D triangulation – light stripe and 3-D triangulation – light volume.

1.3.2. Passive triangulation

Two detectors are used in passive triangulation (fig. 6), and their locations are known to each other. Both detectors record information about a spot, which enables the localization of an item.[5] Both a camera and a projector, as well as two cameras, are capable of triangulation. There are three observations for three unknown data in the first scenario, meaning that the data fidelity is biased by the negative impact of temperature. This is a problem since there are no duplicate data, making it unable to weed out possibly incorrect data. As a result, the validity of the measurement data acquired is in doubt. Temperature impact is removed when two cameras are used for triangulation, and there are four observations for every three unknown data points (positive redundancy of data). That is the most appropriate method for obtaining high-quality measurement data.[5]

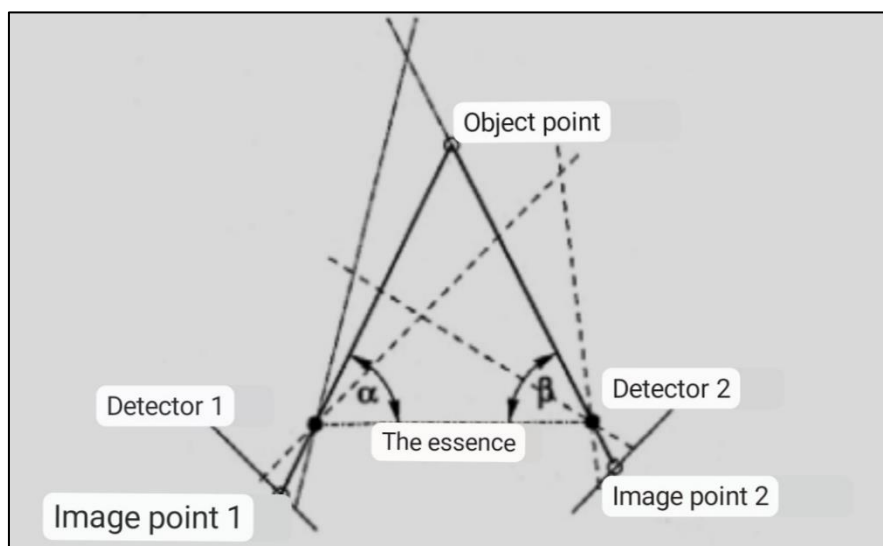

Figure 6 Passive triangulation [6]

1.4. Purpose of 3D scanners

A new generation of 3D scanners is providing unprecedented levels of accuracy for a wide range of applications in manufacturing, healthcare, entertainment and beyond. The latest generations of scanners can achieve sub-millimetre accuracy, making them ideal for a wide range of uses in which precise measurements are required. There are so many applications existed for the purpose of using 3D scanners in real life. They are as follows.,

➤ Design process

It's used in improving precision while dealing with intricate pieces and forms, coordinating the design of products employing components from several sources, replacing outdated CD images with ones made using more recent technologies, replacing obsolete or missing components, Enabling as-built design services, for instance at car production facilities, "bringing the plant to the engineers" using web-shared scans, and reducing travel expenses all result in cost savings[3].

➤ 3D photography

The combination of cameras with 3D scanners is developing to accurately depict 3D things. Since 2010, businesses that produce 3D portraits of people have started to appear (3D figurines or 3D selfie)[3].

➤ Reverse engineering

A detailed digital representation of the replicable items is required for reverse engineering a mechanical component. A precise digital model can be represented by a polygon mesh, a collection of flat or curved NURBS surfaces, or, for mechanical components, preferably, a CAD solid model rather than a series of points. A 3D scanner may be used to digitize prismatic geometries as well as free-form or gradually changing shaped components, whereas a coordinate measuring machine is often only utilized to get the basic measurements of a highly prismatic model. Using specialist reverse engineering tools, these data points are subsequently processed to produce a viable digital model[3].

➤ Medical CAD/CAM

In the fields of orthotics and dentistry, 3D scanners are used to record the 3D form of a patient. It eventually replaces tiresome plaster casts. 3D scanning is being used to create more accurate prosthetic limbs and implants. This not only improves the function of the devices, but also

increases the comfort level for patients. The orthosis, prosthesis, or dental implants are then created using CAD/CAM software[3].

➤ Quality assurance and industrial metrology

In many application sectors, the digitalization of physical items is crucial. This technique is specifically used in industrial quality assurance to assess the correctness of geometric dimensions. Industrial operations like assembly are intricate, heavily mechanized, and frequently reliant on CAD data. The issue is that quality assurance calls for a similar level of automation. Putting together a contemporary automobile, for instance, is a highly difficult undertaking since it has numerous pieces that must all fit together at the very end of the manufacturing process. Quality assurance mechanisms ensure that this process operates at its peak efficiency. In order to ensure that the metal components have the proper dimensions, fit together, and ultimately function properly, their geometry in particular has to be examined[3].

➤ Manufacturing

In manufacturing, for example, 3D scanners can be used to create highly accurate models of components and products. This allows manufacturers to quickly and easily create prototypes and test new designs before committing to expensive tooling and production processes[3].

2. Aim Of Thesis

The aim of the thesis will be to analyse the accuracy of digitisation of optical 3D scanner MetraSCAN 350 within the measuring space of C-Track.

- To study about the problem with accuracy in the measuring volume.
- Detailed Research work based on scanners and accuracy.
- Comparison of scanned results using the excel sheet.
- To find the perfect solution for the problem by analyzing the measuring volume.

3. 3D scanner Metrascan

3D scanner MetraSCAN is a hand-held 3D scanning device developed by a company called Creoform from Canada, for industrial and metrology experts who do not want to sacrifice on quality or efficiency, MetraSCAN has a series of 3D optical CMM scanners. While expediting 3D measuring operations, it can resist any manufacturing environment, including shop floor vibrations, part motions, and environmental instability. The 3D geometrical surface

inspections and metrology-grade measurements that may be performed by this optical CMM scanner are extremely accurate and reproducible[6].

3.1. Brief introduction of Metrascan

In a system of really small to pretty large objects in a single system, we can do 3D scanning and 3D probing.



Figure 7 Metrascan 350 [8]

The metrascan has different components of the system. It has three main components.

- ❖ The first one is the camera system which is called C-Track.
- ❖ The second one is the scan head for scanning, it is a laser-based 3D scanner.
- ❖ The third one is the probing system for probing, it's a standard Renishaw m4-type connection.

The metrascan head has these different round circles (or) targets as we call them reflectors those infrared lights are shining out that light and they are retro-reflective targets and lightning them up and the camera is seeing them if there are so many no matter what position. The C-Track is able to see the targets. The proper scanning distance of the scanner is given in the figure 8.

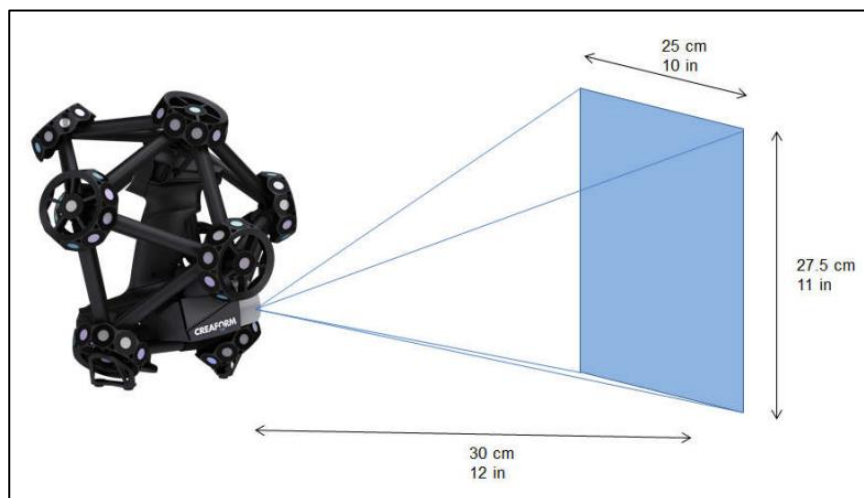

Figure 8 Proper scanning distance [11]

This C-Track system has a 16-meter volume. That means it kind of fans out in a cone shape. There's a standoff distance so about 4 feet away. There it goes out quite a space of car without moving the C-Track. Basically, in a single setup, we can scan very large objects whether it's scanning (or) probing[6].

3.2. Working of scanner

We basically have two cameras at the bottom and then we have the laser in the middle of the two cameras. And we admit that the laser stripes and then these cameras are actually picking up that 3D shape. So, the C-Track always sees the head itself. It doesn't look at the laser lines and doesn't understand even what they are all it knows about is the scan head and the reference targets (dynamic referencing)[8].

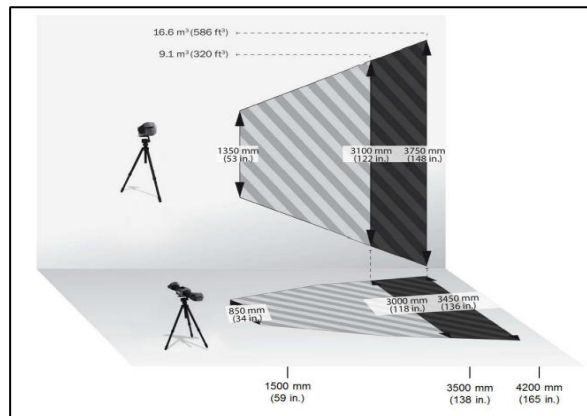

Figure 9 Measurement volume [11]

There are two operations one is tracking it in 3D shape and the sensors measuring it in 3D shape [9].

3.3. Modes in MetraSCAN

3.3.1. Static mode



Figure 10 Static mode example [10]

In this mode, the part can't move and the C-Track can't be moved like any other scanning system it has to be fixed in one place and the accuracy will be affected if it moves. Since the accuracy is the important thing while scanning any object or component, the C-Track needs to be in a place where it won't be disturbed by any external force or a person. Some of the tests shown that the accuracy of the scanned object differs from static mode to dynamic mode, likewise the accuracy is higher in the dynamic mode and lower in the static mode [11].

3.3.2. Dynamic referencing

What dynamic mode is with the metrascan system that actually allow things to move around while we scan them and still holds the accuracy, it's a pretty unique setup and really why we say this shop floor friendly as because on most shop floor we have vibration, we have noise and things moving around and it's not the perfect world environment for inspecting and this is truly a system that can work out on the shop floor. we will get some of the targets which are the scan head and probe head. They are both magnetic and also get rolls of targets. These targets are a little different in their size, they are 12 millimetres targets whereas on the scan head we have 10 millimetres targets. So that allows the camera system to differentiate between two sets of targets so with the kit and the box of stickers. We can add targets to our parts and then track our parts. So that allows our part to move or our C-Track to move and as long as it can see, the targets then it's good. It has a combination of swivel, magnetic, and sticker targets. So a person who is doing the scanning can do the scanning by moving the part and even sometimes the C-Track, the accuracy won't be affected and it also be higher when compared to the static mode, in this mode the scanner is working with the help of targets on the head and the scanning object. It gathers the information from the head and object to do the scanning.

3.3.3. Standard mode (Three lines)

This is the normal mode used to do the scanning, in this mode there will be 3 laser lines to do the scanning. To position the Metrascan 350, the C-Track needs to observe at least 9 retroreflective targets, while complete detection and precision are only possible with at least 15 targets. Under the visibility plane in the system panel, the scanner's visibility is shown as a percentage. The range of images that the scanner may capture when scanning is known as the field of vision. Out of the scanner's range of vision, no data will be collected. An appropriate stand-off distance must be observed for better surface results and to provide an ideal field of

vision. It is feasible to scan at an angle, but the scanner must be as perpendicular to the surface as possible. It is important to place the scanner in relation to the component such that both cameras pick up the identical areas of the laser grid pattern.



Figure 11 Standard mode example [11]

3.4. C-Track

If we talk about C-Track, it is a camera system and there are basically two cameras on either side and around these camera lenses are some infrared lights that pulse out basically a light and what that's going to do is that's going to either track the scan head or the probe itself and it's going to track it in space. It allows the scanning of very large objects and these cameras basically where to converge where the two cameras kind of share the same space anything is there meaning the metrascan (or) the handy probe will track it in 3D space[12].

A dual camera optical sensor that offers highly accurate readings is the C-Track. In the Industrial, aerospace and automotive sectors, this tool is employed in production lines together with the Handy PROBE and Metrascan 3D. C-Track elite is the highest accuracy model. There is also the standard model.

A group of LEDs surround two digital cameras that are part of the C-Track. Reflectors may be measured using lighting sensors in a certain volume of use 9.1 m^3 and 16.6 m^3 for C-Track and C-Track elite.

The volumetric accuracy is that if took measurements anywhere within that volume in 3D space everything within that volume would be within under 80 microns it's 78 microns is what it's

been verified, it's a very good accuracy in a very large volume. It has one normal feature called static mode and a special feature called dynamic referencing.



Figure 12 C-Track [11]

3.4.1. C-Track operating Principles

The program can triangulate the location of the reference target as well as its surroundings with the help of the simultaneous acquisition of positioning targets by the C-Track cameras. The cameras examine the object presented Infront of them, and register it to the system for further processing. The angle of the two cameras meets at one point and that's where the actual scanning takes place and it starts to record the images in the 3D form. The fixed angle will move towards with the head connected to it.

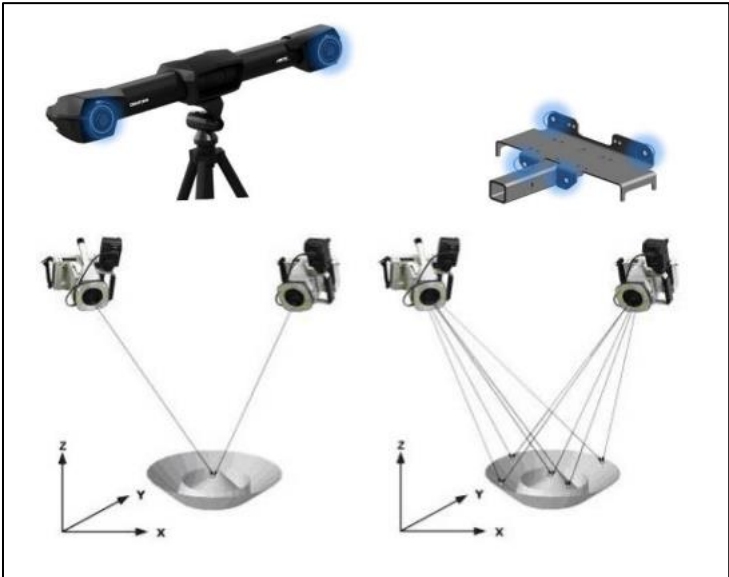

Figure 13 Operating principles [11]

3.4.2. C-Track Triangulation

The C-Track cameras see the scanners positioning target pattern. The software determines the scanners position in space through triangulation. While operating the scanning head first thing we need to calibrate is the head with the C-Track, then the head is ready for the operation and starts to do the scanning. The process of calibration will affect if any object interrupts the view between the C-Track and the scanning head.



Figure 14 C-Track triangulation [11]

3.5. Main Features of Metra Scan

- Quality control and Quality assurance.
- Product development and design.
- Maintenance, Repair, and Overhaul.
- Fast and accurate 3D scanner and portable CMM for the shop floor.
- Noncontact 3D measurement.
- Rotary unit for a complete analysis of the sample.
- Measure complex shapes and surfaces.
- High measurement reproductivity.
- Part size range (recommended): - 0.2-6 m (0.7-20 ft)

4. Accuracy of scanners

Accuracy is the main thing which is more important when using the 3D scanners to scan some components, it plays a major role in the scanning process. The accuracy of 3D scanners has come a long way in recent years, and the technology is only going to continue to improve. This is making them an increasingly valuable tool for a wide range of industries and applications. When we talk about accuracy in metrascan it stands alone compared to other scanners. At the moment, the components are being examined. Typically employing traditional measurement techniques, such as the contact method with a coordinate measuring machine, this examination entails measuring dimensions and form correctness.

Despite being extremely exact, such measurement only provides a small amount of discrete information, often confined to the measurement and comparison of the specified dimensions and tolerances of shape and location in relation to the design. Therefore, despite the fact that part was examined using the a forementioned procedure and is typically in compliance with the given dimensions, assembly issues or collision scenarios of more complicated assemblies and mechanisms may still arise [13].

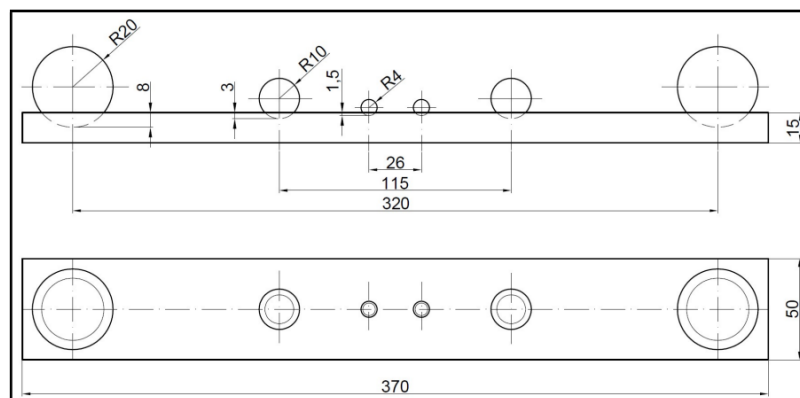

Figure 15 Etalon acceptance test [15]

In most cases, accuracy refers to how closely a measurement resembles its actual value. Accuracy in 3D scanning often relates to single scan accuracy, however volumetric accuracy is another option[14].

There are also two possible options for resolution in 3D scanning, which is generally defined as the sharpness of an image that may be presented. The distance between points in a point cloud (3D mesh) is referred to as mesh resolution by 3D scanner OEMs when describing resolution. Some do, however, additionally mention measurement resolution[14].

Accuracy is often defined as how closely a measurement resembles its actual or acceptable value. It is frequently mixed up with accuracy, which measures how closely two measurements (of the same target) agree. The distinction between accuracy and precision is depicted in the straightforward image below

Accuracy in 3D scanning refers to how well the measurements match the actual dimensions of the thing. It is very wrong if you use an industrial caliper to measure a cube and get a width of 200mm, but your scanner measures the cube as 205mm wide.

In 3D capture, there are two different kinds of accuracy requirements: single scan accuracy and volumetric accuracy[14].

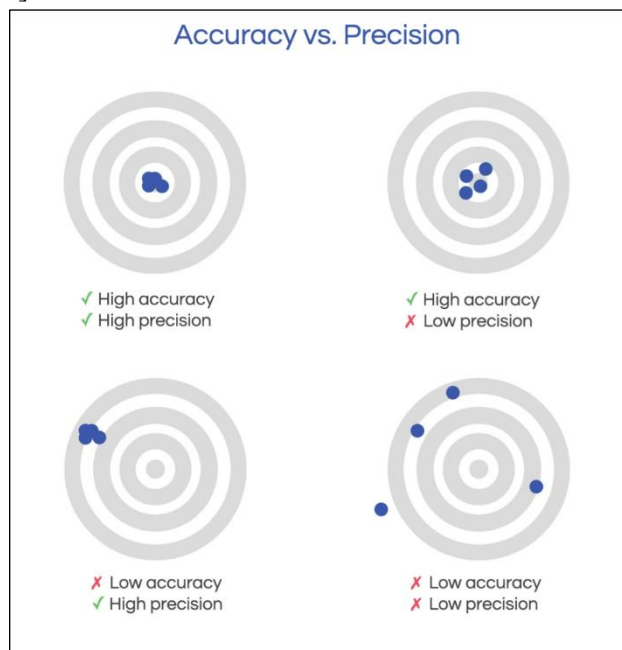

Figure 16 Accuracy vs Precision [14]

4.1. Single scan accuracy vs volumetric accuracy

Accuracy on spec sheets frequently refers to single scan accuracy. The precision of a single picture capture.

Example: Accuracy of 0.05mm.

The majority of 3D scanner OEMs additionally include volumetric accuracy. It is the accuracy of numerous captures, and the larger the scanned component is, the less accurate it is overall.

For instance, 0.05mm + 0.15mm/m.

Using our example as a guide, the accuracy of your scanner will be $0.05 + (0.15 \cdot 2) = 0.35\text{mm}$ if your part is 2 meters in length. That's a significant departure from the precision of the first

scan! Therefore, if you're going to 3D scan massive things, volumetric accuracy is more crucial to take into account than single scan accuracy (e.g., cars).

Nevertheless, certain 3D scanners with built-in photogrammetry modules may create an initial 3D model of the object using sticky markers before adding the remainder. In the same way that a connect-the-dots design is a precise reference point for 3D scanners, markers are. Your data will undoubtedly be more accurate if you use a "skeleton" that was derived via photogrammetry[14].

4.2. Accuracy depending factors

Manufacturers provide specs, which are top values attained under perfect circumstances. It doesn't necessarily follow that you would be able to attain the same accuracy in-house just because the manufacturer reported an accuracy of 0.05mm in its lab.

The accuracy of a scanner can vary depending on several elements:

- Temperature (at 40°C, a 3D scanner will operate differently than at 20°C)
- Calibration: Did you calibrate your 3D scanner correctly? Do you frequently calibrate it?
- Although there is less possibility for error with sensors of today and future and more user-friendly software, the person conducting the scan

Another crucial point is that different 3D scanner manufacturers use different metrics to assess the accuracy of their scanners. Consider companies with VDI/VDE and/or ISO certifications, for instance, if high precision is crucial for your application[14].

4.3. 3D Resolution

Resolution has a wide range of meanings depending on the context (photography, filmmaking, printing, etc.), but its core meaning remains the same. It is a technical word used in computer science to describe "how accurately the reality was recorded."

For example, the resolution of a screen is related to the amount of pixels that may be used to reconstruct a picture. More pixels equal higher resolution and higher-quality images (the cleaner and crisper your image will seem). With the following circle example, we can plainly understand what we mean:

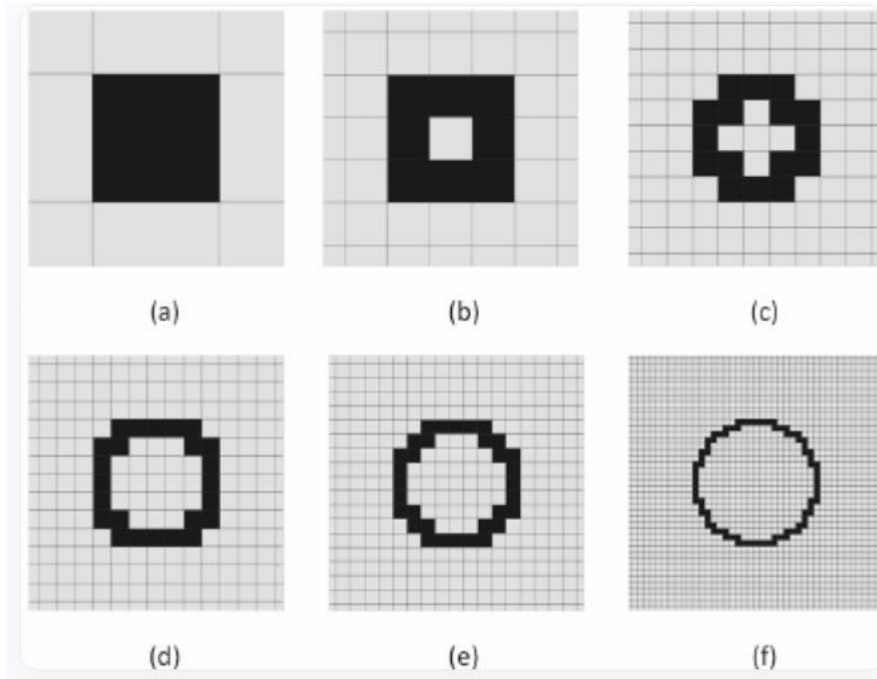

Figure 17 Resolution differences [14]

The resolution of your 3D mesh, also known as "mesh resolution," is the primary form of resolution used in 3D scanning. However, some producers additionally include "measurement resolution"[14].

4.3.1. Mesh Resolution

The resolution of the generated 3D mesh is most frequently meant when "resolution" or "3D resolution" is used in spec sheets. Due to the fact that it is the most understandable, it is primarily measured in point-to-point distance, or the separation between two 3D points in a dot cloud. Your mesh will seem better if its points are more closely spaced apart. Point distance or "spatial distance between points" are other names for point-to-point distance.

PPS may also be used to measure resolution (points per scan). Your mesh will appear smoother and more detailed the more points it has. This may be compared to the quality of a 2D print, where the sharper the print, the more PPI (points per inch) your file includes.

Remember that larger files and slower loading times result from greater mesh resolution. It serves little use to tax your RAM, GPU, and hard drive if you don't actually require an incredibly high definition[14].

4.3.2. Measurement resolution

The measurement resolution relates to the number of points the sensor can record in a specific space. The better, the more points there are per unit of surface.

The mesh resolution that may be acquired and utilized in the program after calculation, however, is ultimately what matters. Sometimes the program creates a single mesh point by averaging many measurement points (a vertex).

It is important to keep in mind that the requirements for mesh resolution are relative and not absolute: on a sharp edge, a strong resolution is required; on a flat surface, just a few points are required. Some 3D scanning software packages optimize meshes in this way to prevent storing large amounts of useless data (and clogging your PC) that aren't needed.

On manufacturer websites and spec sheets, several distinct terminologies are used. Volumetric accuracy and mesh resolution are what truly matter[14].

4.4. Acceptance tests

By measuring calibrated artefacts, acceptance testing and re-verification of the measuring system are assured. These must be created in a way that prevents their characteristics from having any discernible influence on the quality metrics that will be assessed.[15]

It is examined to see if the measurement errors fall within the parameters set by the user or the manufacturer.

The effects of moving the sensor or the item to be measured are examined in addition to acceptance testing and re-verification in accordance with VDI/VDE 2634 Part 3. In order to create a better object coordinate system, the measuring system must be able to merge many clouds of measuring points that have all been measured using different positions and alignments of the sensor.



Figure 18 GOM Acceptance test [17]

The measurement system's capacity is examined.

The artefacts are to be probed in such a manner that in each individual image, their position relative to the sensor is constantly varied, so order to account, if feasible, for all uncertainty influences.

The sensor's measuring volume is the amount of space it measures each time and records in a single picture. It often has a lower measuring volume than the sum of all single images.

The size of the artifacts are linked to the sensor measuring volume's spatial diagonal or to a cuboid that fully encloses the sensor measuring volume. The maker must specify the shape and size of the sensor measuring volume.

The purpose of the acceptance test is to determine that measuring system complies with the requirements for quality that have been set by the manufacturer or agreed upon in the contract. These preparations include, for example: turning on and setting up the measuring system for measurement operation configuration & qualification of the sensor fixing of artifacts so that they are sufficiently stable. The manufacturer must disclose the relevant information. The manufacturer's recommended operating & environmental conditions must meet during testing.

If the evaluation of the measuring device is based on polygonised measurement data (for example, STL data), triangulated measurement data must also be used to determine the quality parameters because the resolution is also impacted by the thinning of the measuring points in overlapping regions or regions with only minor surface curvature. Additionally, the inclusion of new, calculated (triangular) points might introduce new sources of inaccuracy into the length measurement and probing processes.

The measuring apparatus and the artifacts must have taken the average temperature of the measured volume as their starting point. If the artifacts' and the measurement system's mean temperatures considerably deviate from the DIN EN ISO 1 reference temperature, appropriate temperature modifications must be implemented as long as they are also used during normal device operation.

4.5. Acceptance test parameters

- ❖ Probing error form
- ❖ Probing error size
- ❖ Sphere spacing error
- ❖ Length measurement error [16]

The measurement accuracy of scanning equipment is assessed using these parameters. The acceptance test is conducted using the guidelines provided by GOM VDI/VDE 2634. Usually, in order to conduct an acceptance test, a calibration standard is made up of standard, common shapes like spheres, cylinders, gauge blocks, holes, and ribs, among others.

The nominal dimensions of these shapes are measured using a coordinate measuring machine (CMM), as this tool provides the most accurate values for dimensions.[17]

4.5.1. Probing error form

To find the matching current parameter values for a sphere pair, the program derives the best-fit spheres from the measurement data. The program uses the least squares approach for the calculation. The standard deviation is caused by a parameter of the kind (sigma) of the test mistake.[17]

The radial distance of all the observed points on a sphere is used to calculate the standard deviation with regard to the matching appropriate sphere with a freely specified diameter. This parameter often provides information regarding shape deviation, or the range between the highest and least sphericity deviations.

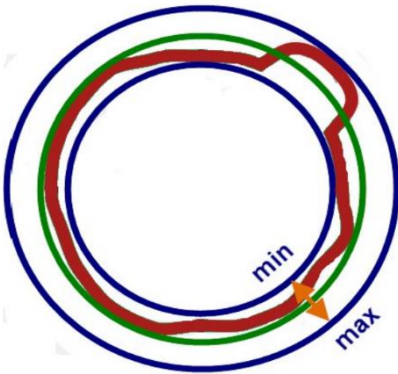

Figure 19 Probing error form [19]

PF (sigma) = σ

PF(range) = | max-min |

4.5.2. Probing error size

The discrepancy between the nominal diameter and the measured diameter is known as the probing error size. This characteristic informs us of the sphere dimension's divergence from its nominal value.[17]

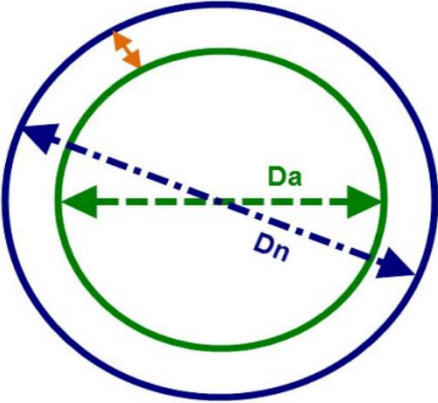

Figure 20 Probing error size [19]

$PF (size) = D_a - D_n$ (D_a - Measured diameter, D_n - Nominal diameter)

4.5.3. Sphere spacing error

The sphere spacing error displays the spacing deviation, or departure of the sphere centers. This parameter is often used to calculate the pitch distance error between two spheres using the fitting sphere technique.[17]

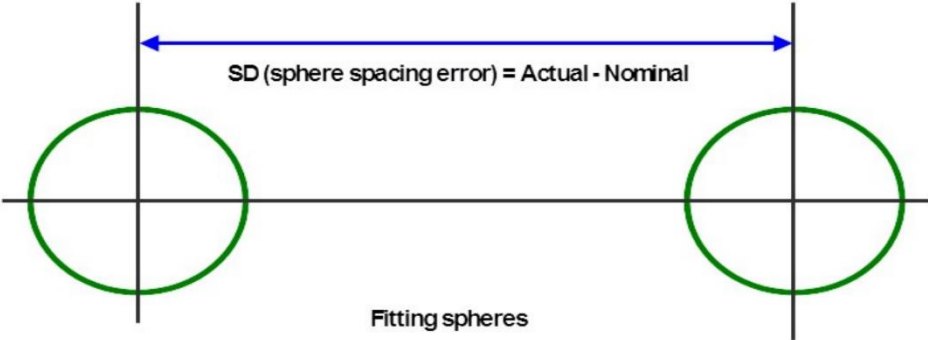

Figure 21 Sphere spacing error [19]

4.5.4. Length measurement error

The difference between two length opposing points and the accompanying calibrated spacing of them and the estimated error is the length measurement error. Using a bi-directional probe, this measurement is made by taking the nominally parallel surfaces in the direction that is perpendicular to one of the surfaces.[17]

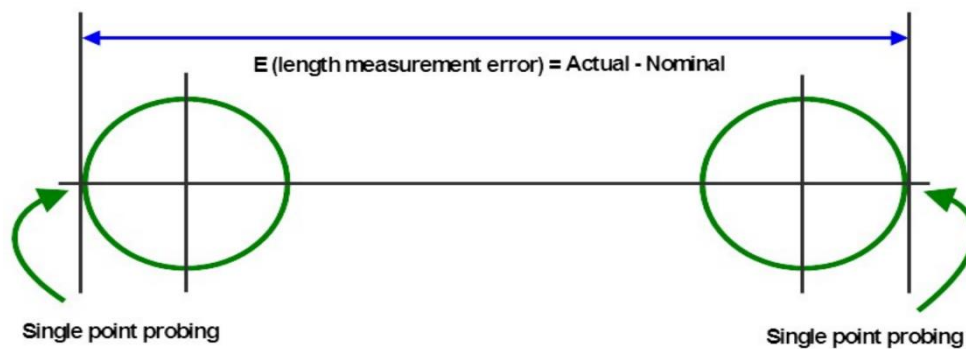

Figure 22 Length measurement error [19]

5. Review of Previous work

5.1. Adjusting 3D scanner calibration

Before beginning the 3D digitization, the user needs to do calibration as an additional element. For particular measurements, the manufacturer advises doing calibration once a year or more frequently depending on the item to be tested or industries to achieve a good variety of outcomes.

In general, calibration is required when a device is relocated from one location to another, when the scanner's optics are changed, and when the ambient circumstances change.

The device is autonomous enough to be able to alert the user when calibration is required. However, if the device is utilized in steady scanning mode, it won't alert the user to the need for calibration, discouraging the user from doing so. In the study, the experiment was run five times following calibration, and the results were consistent across all five-time measurements. There are differences between the results obtained with and without calibration. This variation is not a negligible departure from the nominal dimension [16].

5.2. Ideal scanning conditions

The accuracy of optical 3D scanners is affected by several external elements, such as light, temperature, humidity, dust, etc., as was stated in the introduction. These variables affect the scanning data's quality, which leads to erratic models as a result of 3D digitization. Data from the manufacturers are not obtained using customary methods since they do the measurement in a dedicated facility with conducive circumstances for digitization. In the study investigation, an experiment was done to see how much of an effect the meteorological

conditions and these characteristics had on the precision and form of the final product. The experiment's parameters include

- the calibration,
- scanning angle,
- number of photos,
- camera shutter,
- scanner heat-up procedure,
- quality of employed reference points,
- exposure duration.

The study came to the conclusion that reference points, device calibration, and scanner warm-up had a significant influence on the resultant form and accuracy of sphere diameter and spacing. When there are more scans, the results are better for sphere diameter and cylinder and for sphericity as well. and for sphere spacing and cylindricity, the opposite is true. The accuracy is unaffected by other factors like previously utilized reference material. With a high scanning angle and cylindricity, the deviation is greater. The experiment found that, even while external influences only slightly alter an object's form and accuracy by a margin of 30 microns, it is nevertheless vital to take all of these aspects into account when taking measurements.

The precision of digitization, point capture, and the object's smooth mesh all play a major role in the scanning process' quality. Additionally, as digitization methods have a significant influence on the final accuracy, scanning should take these into account as well. The acquisition of point clouds, from which the item's surface is produced, has a major role in determining the final shape of the object. The calibration, distance between the surface and the scanner, and movement of the scanner are the primary determinants of point cloud capture. There are several digitizing methods, including the laser scanner and the fringe projection method. [16]

5.3. Hand held vs structured light projection

The perfect replacement for structured light projection systems is a handheld 3D scanner. Even though handheld scanners are less expensive and easier to use than more expensive steady light systems, their accuracy, stability, and performance fall short of rigid systems. In the comparative study, various medium-priced handheld 3D scanners were compared to steady or

structured light projection systems. The study provides comprehensive details on the geometrical accuracy of several scanners. It was shown that accuracy for portable scanners is quite low when compared to steady light systems after using stable reference bodies of complicated forms.

Thus, it is concluded that an experienced operator is required to achieve the appropriate precision.

3D scanners are now widely utilized by various sectors for digitization, and they are regarded as standard inspection tools in a variety of industries, including the automotive and aerospace industries. Only a small measuring range, i.e., one to a few meters, may be employed with 3D scanners. Because certain scanners offer high accuracy in a specific range of environmental circumstances, users should be aware of the established criteria for using equipment offered by manufacturers to satisfy the requirements. [18]

5.4. Laser system vs white light projection system

The goal of the research was to create point clouds more smoothly by reducing the number of points acquired, removing noise, and producing a smooth triangular mesh in order to provide a decent meshed surface. It's also important to know how many scans, points, and polygons there are. The study came to the conclusion that it is challenging to capture data using laser systems for small objects, complicated forms, and abrupt changes in shape. Additionally, a system that projects white light has high accuracy, and computer tomography technology also improved accuracy by filtering points to create a smoother mesh. [19]

5.5. Correctness of complicated structures' geometry

The research investigated the attainable accuracy of optical scanners using various gauge blocks to check their accuracy. The research was primarily focused on the geometric correctness of complicated forms for scanners. This study was primarily conducted in preparation for the project's usage of the GOM Atos II three-dimensional scanner. As was already said, two cameras will capture the reference points that will be connected to or on the outside of the item for scanning the object from various angles. The cameras record the picture that can be seen in both of them. [20]

5.5.1. Experimental uncertainty

The uncertainty of the experiment was also covered in this study. Gauge blocks, step gauges, ball plates, rings, and balls are among the objects used in the calibration and acceptance

tests for CMM. However, there aren't any similar protocols for optical scanners. The makers of optical equipment have created their own standards and will conduct routine inspections for their clients, often known as acceptance tests.

Gauge blocks were initially scanned, and cloud points were collected. Cloud points were also transformed into a three-dimensional polygonal mesh for additional examination. Inspection was conducted using gauge blocks of three different lengths: 20mm, 30mm, and 70mm. The size of the gauge blocks had no bearing on the measurement variation from the nominal value. The propagation law was used to calculate the standard uncertainty, which is 12 microns or less for the gauge blocks.

complex metal-like form the accuracy was assessed using the sphere. Additionally, employing a sphere for the experiment has the benefit of just requiring one scan, ignoring the scan assembly mistake that develops when there are two or three scans. According to the study's findings, gauge blocks exhibit a greater variation from nominal value than spheres because scan assembly is necessary because there are two scans. [20]

5.6. Useful technique for optical scanners

The study concentrated on several applications for optical scanners as well as the ideal circumstances that maximize their efficiency. There are two ways to scan an object scan type include destructive and non-destructive.

Destructive scanning involves breaking down the object to be scanned into smaller pieces before scanning is done. This technique is mostly used on historical artifacts like monuments and excavation finds. On the other hand, scanning and non-destructive testing are carried out without harming the object. It is required to reverse the patterns that are projected onto the object from bright to dark and from dark to bright in order to get rid of the shadow that is produced. The range of the images will therefore be from negative to positive. To get the right picture, the two patterns are removed. Finally, objects with non-reflective surfaces work best for scanning. It is preferable to have white or bright objects since dark objects make it challenging to discern between light and dark stripes. [21]

5.7. Optical scanner's capacity to measure

The research focuses on the optical three-dimensional scanner's measurement capabilities. In this study, a hard metal rod represents the item, and the scanner being utilized is the ATOS triple scan II. When employing various measurement volumes, the parameter that

has to be examined is rod diameter. Specific procedures must be performed by the operator for setup and ideal scanning circumstances while measuring using optical equipment. Rod diameter is 12 mm, and MV100 and MV170 are the two measurement volumes. The rod's diameter was assessed using three reference portions, or focus of 10mm, 25mm, and 40mm. In this first assessment, the finding capacity is determined by the average diameter value from three parts. In the second examination, the device's capacity is established by taking the average value from each part independently. This investigation shows that ATOS is unable to measure such minute, exact things with such small tolerances. Consequently, ATOS is ideally suited for digitalization and produces superior results with medium- and large-sized items due to its larger tolerances. [22]

5.8. Error and repeatability in simple vs. complicated shapes

The study examines the precision and reproducibility of low-cost and expensive laser scanners when they scan a gage block and a bone femur. The major objective is to establish if the manufacturer's value of accuracy can be applied to all objects, regardless of shape complexity, from simple to more complicated. The investigation employed five laser scanners, and one inexpensive scanner was compared to expensive scanners. It is understood from earlier research studies that complicated forms cannot be captured by a laser scanner with more resolution. The typical component of a laser scanner is a laser sensor, which calculates the location of the item from the laser source, and a motion tracking device, which establishes the position and orientation of the object in three dimensions. Typically, a measuring arm or photogrammetric equipment is employed manually for motion tracking. It is possible to instantly see the data gathered about the three-dimensional item with this motion tracking gadget. To check the accuracy, the gage block and distal femur were submitted to the manufacturer. The manufacturer provided the researcher the scanned file in stereolithography format after scanning both models ten times. Due to lesser bias, it is discovered that the arm-based laser scanner is more accurate than a photogrammetric system. Additionally, the manufacturer's indicated total error was less than the root mean square of the gage block measurement readings. The gage block has a lower mean root mean square value than the bone femur. The accuracy of inexpensive scanners is equivalent to that of expensive scanners; however, it may vary when working with large-sized objects. Therefore, repeatability is best for basic forms and mostly depends on the geometry of the item. As a result, when scanning basic forms, the manufacturer data may be used. To sum up, the bias between low-cost and high-cost scanners differs the most, but their levels of precision are comparable. [23]

5.9. Dependence of accuracy and precision on shapes

We learn about the precision and accuracy parameters for structured light systems through the research. The calibration parameters, the angular range of the scanner for calibration, and the number of observations needed for calibration were the key topics of this study. Using two cameras and a projector, the researcher created their own structured light system and compared it to the GOM ATOS Triple scanner. The following variables are taken into account in the experiment: flatness, sphere distance error, probing error form, and probing error shape. It is preferable to calibrate with a wider camera angle for accuracy. To sum up, as compared to ATOS, the user system gave good results for probing error forms. However, Atos had good results with flatness and spherical diameters. Therefore, typical standards for scanners are based on some common forms rather than complicated ones, meaning that accuracy and precision depend on the complexity of the object being scanned. [24]

5.10. Different measurement strategies

The study focuses on the measuring approach for optical scanners to assess measurement accuracy. Large objects that are larger than the scanner measuring volume were employed by the user for this investigation. The measuring approach is independent of the scanner, thus it is impossible to apply the same guidelines to all geometries. This study focuses on a certain geometry, meaning that the geometry of the item affects how conditions change. For the experiment, four tactics were taken into consideration.

- The first is that the item does not move in relation to the reference points during scanning and that its size is lower than the measuring volume.
- The second one makes use of objects that are larger than the measurement volume, and the reference points for each scan are established first using the photogrammetric approach.
- The third one assembles the individual scans based on shared reference points without employing the photogrammetry method (three common points).
- The final one, which is based on a best-fit assembly of scans into a three-dimensional object, lacks reference points.

According to this study, a second technique based on photogrammetry yielded superior results for huge items that were near to the nominal value. [25]

5.11. In relation with Metrascan

In the research paper they discussed the origin and special features of Metrascan, it described as follow. It was designed by the company called Creoform and its portable. It is one among the accurate 3D scanner device in the market and further they discussed it ability to work in some difficult conditions like lightning, different laboratories and outdoor environment. As they said it has the ability to produce the image without any irregularities and blurs. And one of the main advantage of Metrascan is we don't need to coat it with any special powders, because they scan any shiny and glossy surfaces.[17]

They also described the use of C-Track in finding the position of the scanner and the object in the scanning environment, tracker in the metrascan system provides the user with the accurate captured image. And further about the ability to recalculate the position of the object while moving, its larger measuring volume, accuracy, and its measurement rate.[17]

In this research paper they not only described about metrascan but also about so many scanners, they compared a lot of scanners accuracy by conducting so many tests and described some parameters based on the result obtained from the scanning. They did the comparison using ATOS Triple scan, REVSCAN, METRAScan, LEICA 3D scanner, Ein scan pro 2X. They initially calibrated the devices and setup the scanners for scanning. And they did the inspection in GOM, and after that analyzed the results of acceptance test from SW GOM Inspect of all the scanners. Finally they did the summary of the results of comparison between each scanners and discussed the results in this paper. [17]

6. Method of Measurement

6.1. Object used for measurement

We used Etalon bars for the measurement. The Nominal values of the big Etalon bar and small Etalon bars are derived from the Diploma thesis of Mr. Jan Farář[26] and Mr. Frkal Martin[27] from our university. We used four Etalon bars in my measurement. Our Etalon bars are manufactured by using carbon, the main advantage of using carbon as the material is they won't deform while there is a change in the temperature of the bar.

Table 1 Parameters Table

Basic parameters	Values
Temperature	20.5°C
Humidity	50%
Resolution	0.2mm
Shutter	0.15ms

6.1.1. Etalon Bars

We used four Etalon bars in my measurement. The etalon bars used are three 1m bar and one 0.3m bar. The big three etalons are referred as A, B, and C. Each of the big etalons have four spheres, two big spheres, two small spheres. And small etalon has six spheres two big spheres, two medium spheres, two small spheres. The etalon bars are placed in the table setup for measurement in the measuring volume.

Table 2 Nominal value of Big Etalon

Big Etalon	Nominal Value
A bar Spacing S2	998.857
B bar Spacing S2	999.157
C bar Spacing S2	1000.184
A bar Spacing S1	319.513
B bar Spacing S1	319.592
C bar Spacing S1	319.601

The nominal dimensions of the Etalon Bars are given below, the pictures of etalons from the diploma works are shown below and the big etalon bar with sectional view and values are shown below, the other etalons are similar like this.



Figure 23 Three long etalon bars [26]

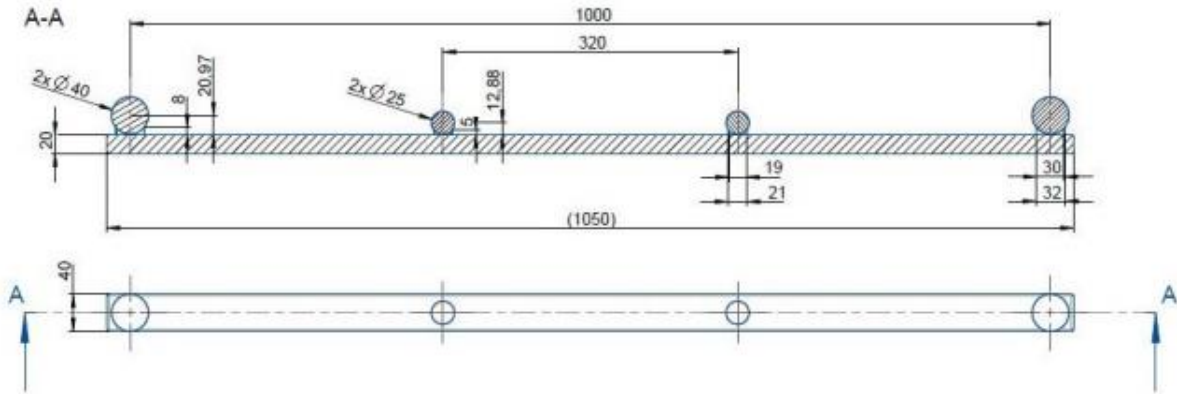

Figure 24 Sample of one long bar with values [26]

Table 3 Nominal value of small Etalon

Small Etalon	Nominal Value
Spacing S3	319.933
Spacing S2	115.006
Spacing S1	26.017

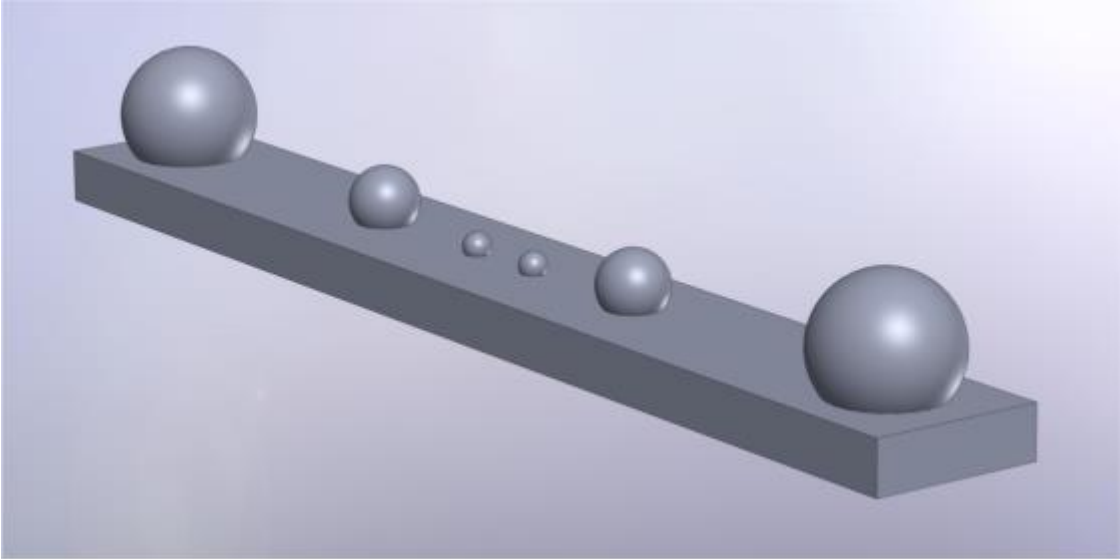

Figure 25 Small etalon reference [27]

6.2. Calibration Process

6.2.1. Calibration setup of C-Track with measuring area

First, we need to complete the calibration for the C-Track and Metrascan head. For the calibration of the C-Track we have one long bar which will be placed parallel and perpendicular to the C-Track in the shown position to calibrate it.

Calibration setup is the process which is to calibrate the measuring area to the C-Track. It enables you to select where it should be in relation to the calibration plate. This will alter the

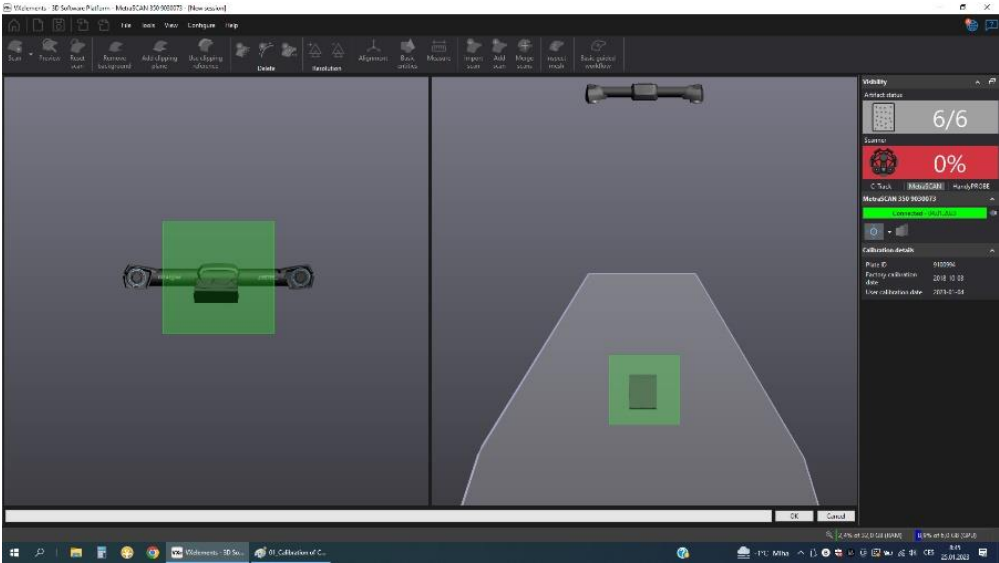

Figure 26 C-Track calibration

3D viewer's calibration views to make the calibration process more understandable. Before determining that a scanner is out of calibration, several details need to be reviewed if the calibration fails.

6.2.2. Calibration of MetraScan Head

After calibrating the C-Track, Metrascan head can be calibrated using the calibration plate. The calibration plate can be placed inside the measuring volume, and Metrascan head with laser strips projected into the calibration plate and then the head will be projected.

This calibration plate will be used to calibrate the head with the C-Track. The plate will be connected to the system using an USB port and the process of calibration will take place.

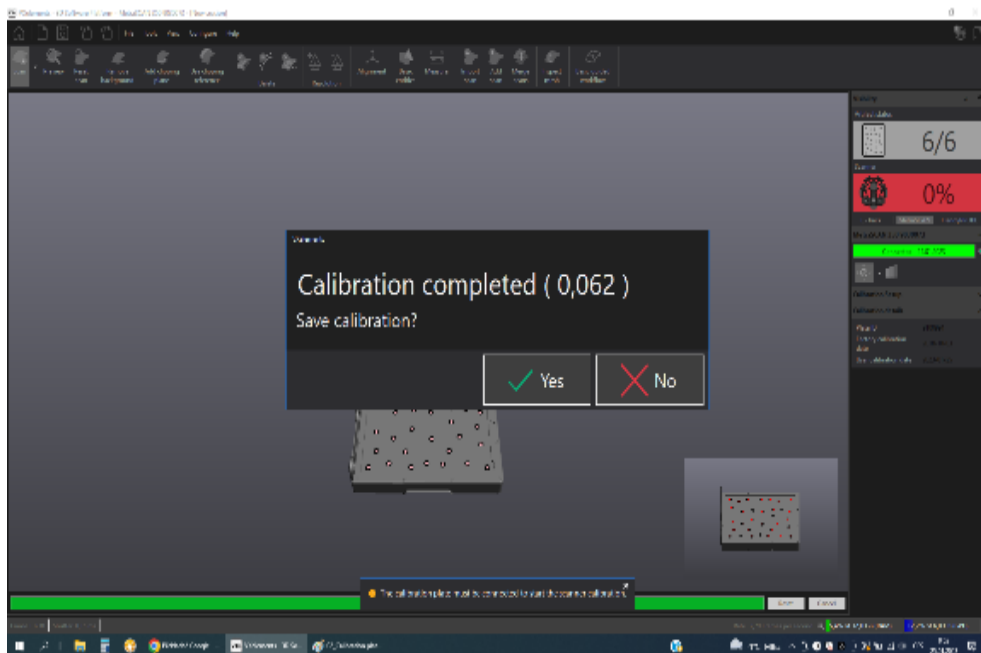

Figure 27 Calibration of metrascan head

Care must be taken while handling the calibration plate because it is needed to calibrate the metrascan 3D. The metrascan 3D uses the C-Track to determine its location in 3D space by using a laser, two cameras, and retroreflective targets.

6.3. Scanning Procedure

After setting up the measuring space or volume, we can start the scanning process and do the scanning. The scanner with complete setup of C-Track and head will be connected with the computer system and we can monitor the scan which we already done and what we are

doing currently. If we miss some position in the scan, we can find them and do the scanning at the specific place.



Figure 28 Method of scanning

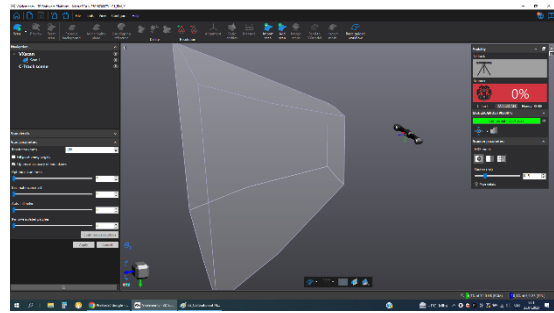

Figure 29 Measuring volume

6.4. Importing Scanned results to the GOM software

For evaluating the scanned object, we need to evaluate it using the GOM software. After

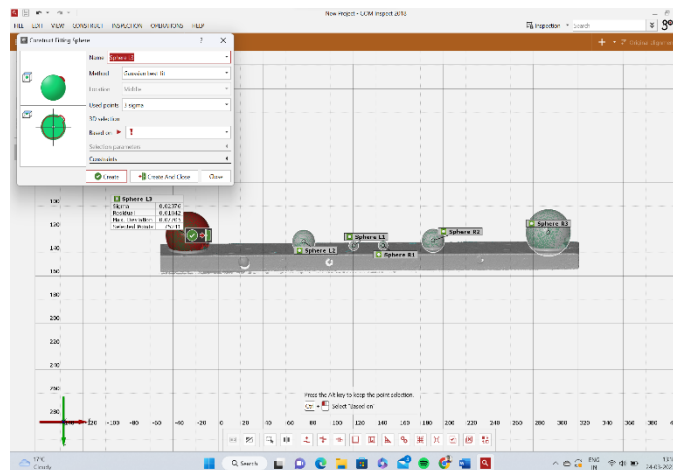

Figure 30 Gaussian best fit selection

uploading the scanned file in the software, select the required area in the scanned object, the task is to select the spheres in the scanned object in the software. The spheres are created using two methods in the object, one is “Gaussian Best fit” and the other one is “Chebyshev Best fit”. After creating all the spheres, we can create the spacing between the sphere using the option called “2-Point distance” in the option “Distance” in the “CONSTRUCT” column where the

sphere option also locate, those distances will be used as the nominal values in the calculations for both the big and small etalon.

The parameters like Sphere spacing error from the big and small etalons, probing error form (range) and probing error size are calculated from the values.

6.5. Measuring methods

We did like total of 15 method of scanning like different axis of coordinate system, different distances, different resolution, different calibrations, static and dynamic referencing systems. In each method we did three scannings, so it came like 46 measurements.

6.5.1. Scanning with Different Coordinate axis

The three coordinate axes used in this approach are the X, Y, and Z axes. For each measurement in the measuring volume, the item is positioned in the appropriate axis. And for all other approaches, the X axis is used as the reference measurement.

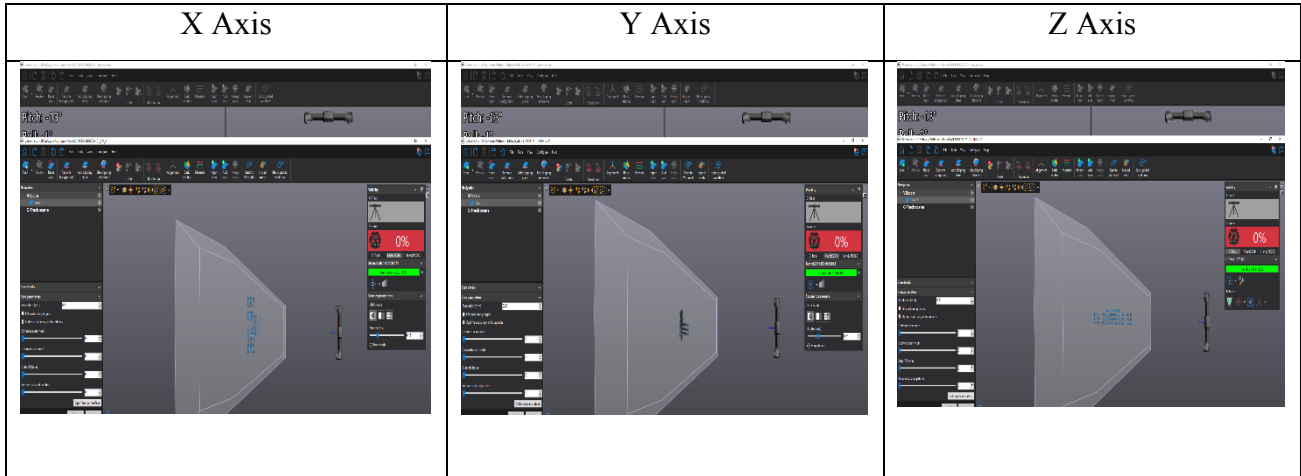

Figure 31 Different coordinate axis

In X-axis orientation, the item was positioned in the X-axis coordinate system within the measurement volume, and the scan was finished. After that the object is placed in Y axis and scanning was completed and placed in Z axis and also the same. In the all-axis coordinate system, we performed three scans. Figure 32 displays the software picture of the item being scanned in every coordinate system.

6.5.2. Scanning with different resolution

Resolution plays an important role in the accuracy of the scanning. For the scans using the different resolution, X axis is taken as the reference measurement and the resolutions are

changed in the software. The resolutions used in the experiment are 0.2mm, 0.5mm, 1mm, and 2mm. The accuracy of the object was changed according to the resolution. The images of the resolutions are described in the table 4, the change in resolutions is clearly shown in the images.

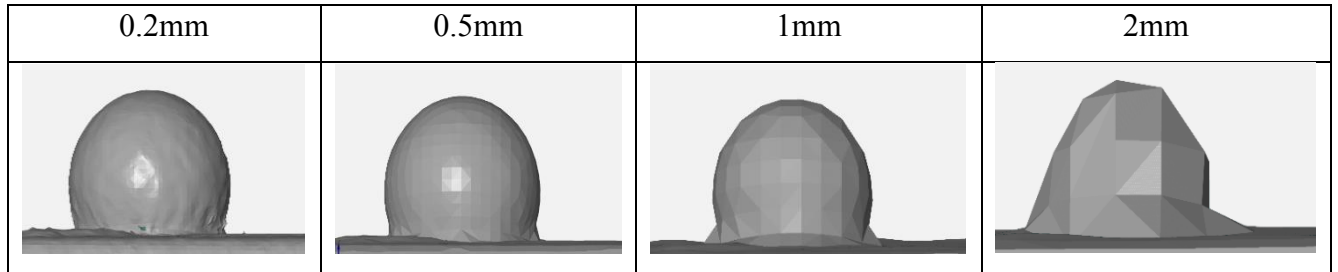

Figure 32 Resolutions

6.5.3. Scanning with different calibration

While starting the scanning process as we said before, we did the calibration for both Metrascan head and C-Track. For the calibration part, there are total of 3 types of calibration done, they are old calibration (calibration done in the beginning of all the measurements), calibration of C-Track after two weeks and calibration of Metrascan head (reference measurement X axis). We did the scanning after the calibration at the start and we also did the scanning after 2 weeks of calibration and after doing the calibration of head and C-Track, we completed the new scannings in the new calibration. For all these scans X-axis is taken as the main axis.

6.5.4. Scanning with different distances

In this method of scanning the scanning object is placed in three different places for three different positions. The three different positions are minimum, normal and maximum distance.

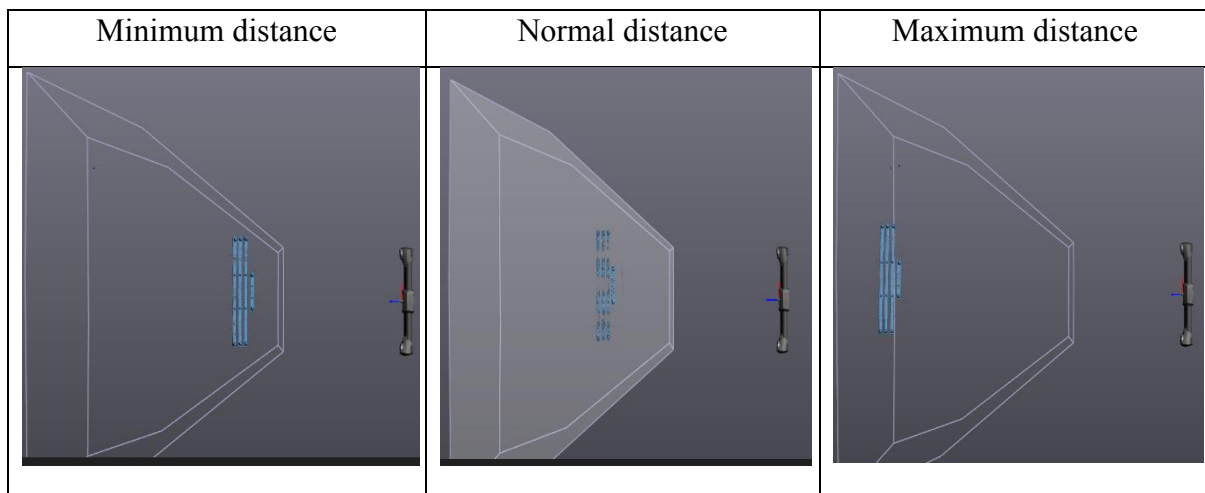

Figure 33 Different distances

In minimum position the object is placed in the nearest position for the C-Track in the measuring volume, for the normal distance it is placed in the center of the measuring volume that is like the reference position X-axis, and the maximum distance is like the object is placed far away from the C-Track it is like the end of the measuring volume.

6.5.5. Scanning with static and dynamic referencing system

Static mode is like the normal method and a special method called dynamic referencing is also used in this system. Dynamic referencing system is the system in which the reference points will act as the coordinate system.

We used the first experiment of X axes and Normal distance to combine with static experiment for some better result. At first glance in the dynamic referencing measurement, the reference points are placed near the object and we did the scanning of whole object but in dynamic referencing the coordinate system based on the reference points not in C-Track.

The other experiments mentioned as A, B and C are taken in three different directions. Each of them has two experiments, in all of them the object is placed in the fixed position, The C-Track and reference points are rotated according to match with the coordinate axes. Both static method and Every method of measurement in the dynamic are mentioned in the figure.

In the experiments A, B and C the color the C-track denotes the arrow in which the direction of the scanning is undergone.

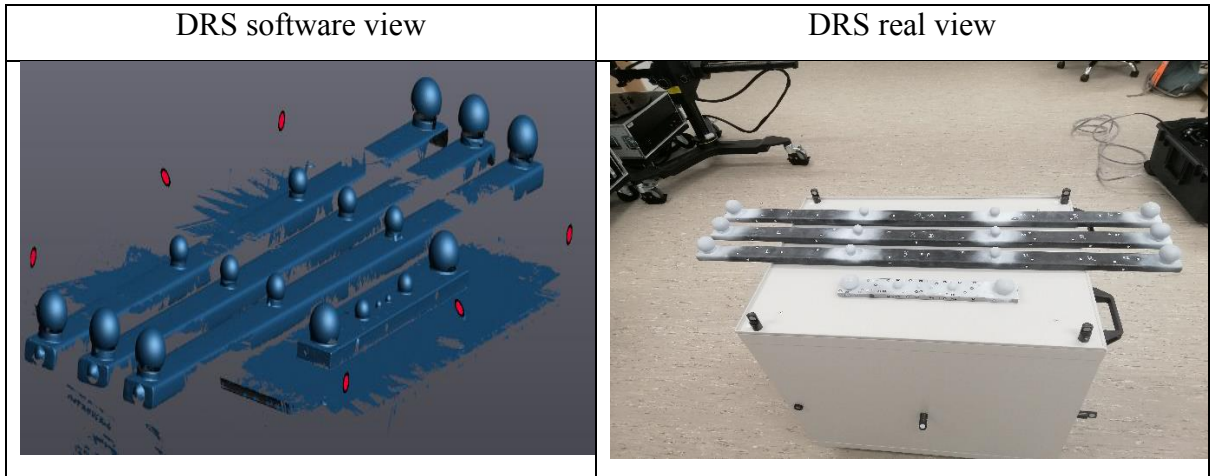

Figure 34 Dynamic referencing system

In figure 34, it is shown as how the dynamic referencing system setup will look like and how the reference points are placed near the object, and how it will look like in the software. The red dots in the software picture represents the reference points.

<p>Static Exp 01=09=13</p>	
<p>Dynamic Exp 12=14</p>	
<p>A 01,02</p>	
<p>B 03,04</p>	
<p>C 05,06</p>	

Figure 35 Different scanned positions

7. Results

As we discussed in the previous chapter, in each of the method there are totally 3 scanings are done. The deviations are calculated from the actual values that are obtained from the scanned components as we already know the nominal values of the etalon bars. The deviation is nothing but the difference between the actual and the nominal values.

From the values of calculated deviations average value is obtained and some of the graphs are drawn using the calculated average values.

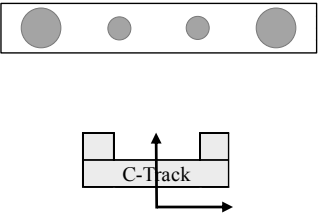
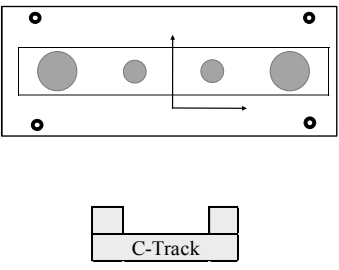
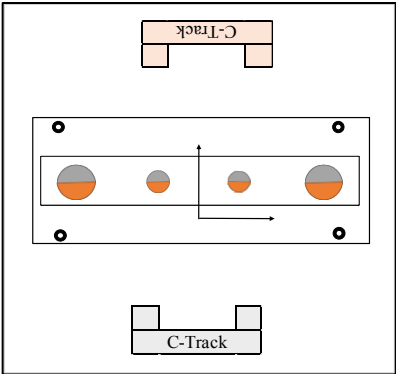
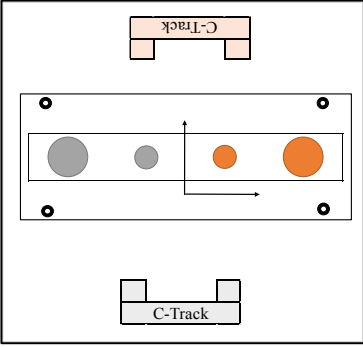
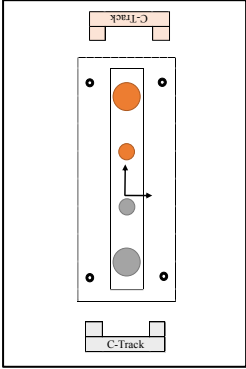
At the same time from the maximum and minimum values the range graph is calculated.

7.1. Analysis of results

For example, the deviation values calculated from the first measurement X-axis given for the reference, the format is same for all the methods.

Table 4 Reference Table

X	Measurement 1	Measurement 2	Measurement 3	Average
A_S2	0.038	0.039	0.032	
B_S2	0.027	0.023	0.022	
C_S2	0.041	0.003	0.015	
Average	0.035	0.022	0.023	0.027
A_S1	0.018	0.011	-0.007	
B_S1	0.010	0.006	0.009	
C_S1	0.024	0.026	0.026	
Average	0.017	0.014	0.009	0.014

There are five methods are used in the scanning, they are orientation, calibrations, resolution, distance and dynamic references. And totally four types of graphs are calculated from the values like Sphere spacing error for big etalons, Sphere spacing error for small etalons, probing error size-PS and probing error form-PF.

7.1.1. Graphs of different orientations

In the orientation method there are totally three axis used X, Y and Z. in each axis we did three scanning, so it's like a total of 9 measurements from orientation section. The actual values from the calculated values are used for calculating the deviations. From the calculated deviations values, the tables are arranged and graphs are plotted according to the tables. The

difference in the measurements and values are clearly shown in the graph. The table for sphere spacing error of the big etalon in orientation is shown in the figure.

Max and Min denoted in the table are the values of maximum and minimum in the average values. T.max and T.min are the maximum and minimum of all the values in the deviations of 3 measurements.

Table 5 Sphere spacing error of Big Etalon

			Average	Max	Min	T. Max	T.min
Sphere spacing error – SD	X	S2 (1000)	0.027	0.035	0.022	0.041	0.003
		S1 (320)	0.014	0.017	0.009	0.026	-0.007
	Y	S2 (1000)	0.016	0.026	0.000	0.045	-0.018
		S1 (320)	0.013	0.027	0.000	0.051	-0.013
	Z	S2 (1000)	0.036	0.047	0.023	0.059	0.021
		S1 (320)	0.005	0.012	-0.009	0.021	-0.013

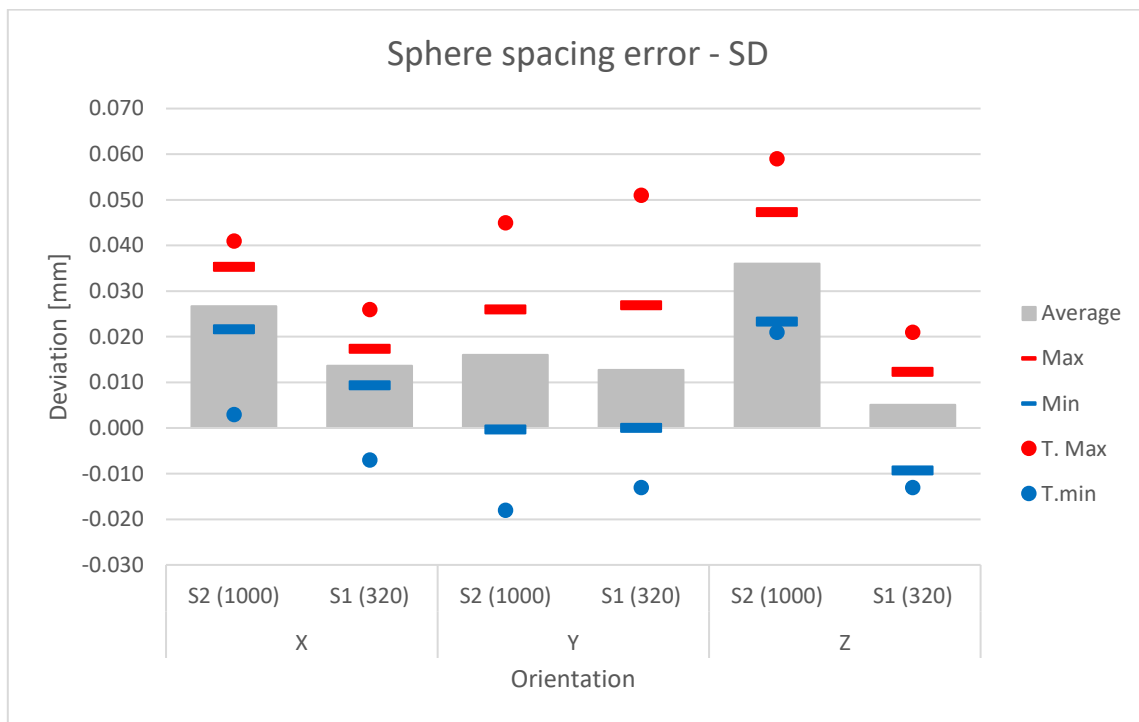

Graph 1 Sphere spacing error of big etalon

Table 6 Probing error Size

			Average	Max	Min	Range
Probing error size – PS	X	40 mm	-0.029	-0.006	-0.048	0.042
		20 mm	-0.032	-0.013	-0.038	0.025
		8 mm	-0.059	-0.041	-0.078	0.037
	Y	40 mm	0.093	0.114	0.045	0.069
		20 mm	0.067	0.094	0.038	0.056
		8 mm	0.029	0.070	-0.032	0.102
	Z	40 mm	0.020	0.050	-0.006	0.056
		20 mm	-0.002	0.025	-0.028	0.053
		8 mm	-0.032	-0.014	-0.053	0.039

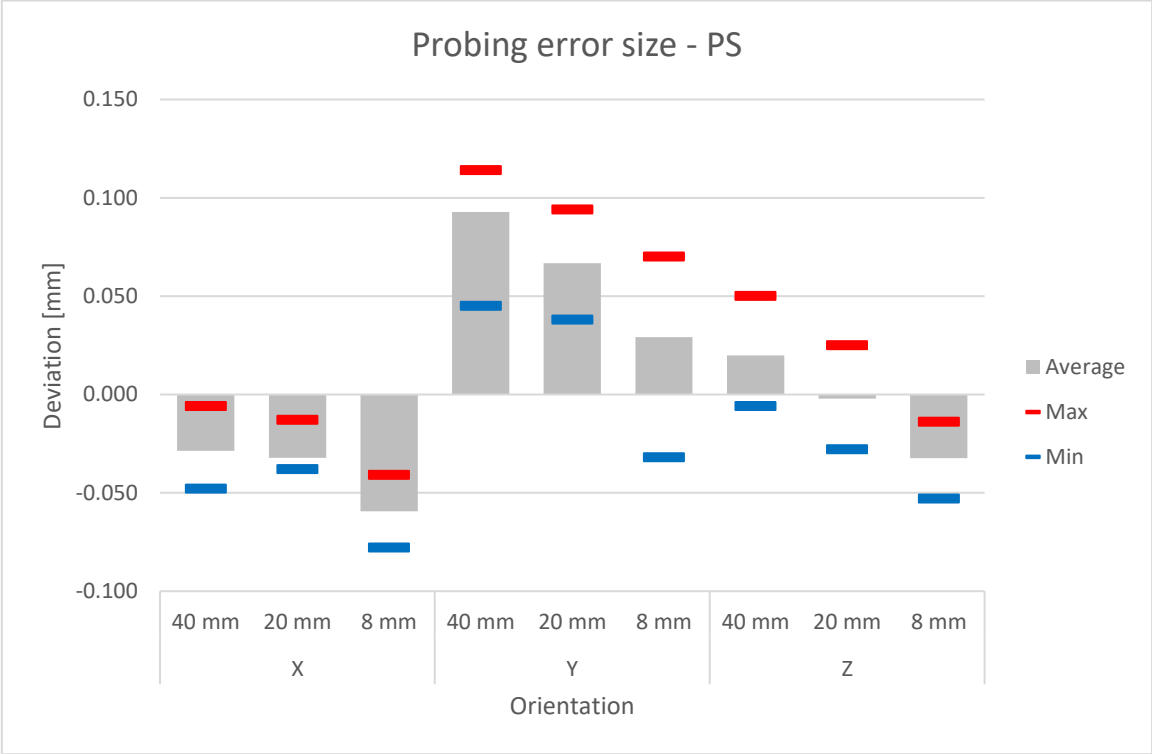

Graph 2 Probing error Size

As we can see in the graph that the value in the Y axis is showing the positive value and the others like X and Z axis are showing some values in the negative values. But the maximum difference between the values in the X, Y and Z axis is like 0.1mm. Since the difference in the value is very small, we can know that the accuracy is mostly same in the orientations.

We also did the sphere spacing error of the small etalon and probing error form of the small etalon. The values in the table and graph are with minimum deviation and mostly similar. So that the tables and graphs are not shown here.

7.1.2. Graphs of different Resolution

Considering the fact that resolution is the most important thing for accuracy, we did the resolution part with four resolutions 0.2mm, 0.5mm, 1mm and 2mm. X axis is taken as the reference measurement. X axis measurement is done by using resolution 0.2mm. For the other resolutions as I said before the value of resolutions in the reference measurement X axis in software are changed and the changes are recorded as the new resolution scannings measurements.

Hence there will be a total of four measurements and each have 3 scanned values, so in the resolution part, there are totally 12 measurements with a lot of deviations in the values. The calculated values from the scanned results are used for calculating the deviations and using the deviations, the graphs are plotted according to the values.

In every part there are like 4 graphs, for resolution the important factor is the range, so the range graph is shown below with the table of values in which the graph was plotted.

Table 7 Probing error Size-Resolution

			Average	Max	Min	Range
Probing error size – PS	0.2mm	40 mm	-0.029	-0.006	-0.048	0.042
		20 mm	-0.032	-0.013	-0.038	0.025
		8 mm	-0.059	-0.041	-0.078	0.037
	0.5mm	40 mm	-0.023	-0.006	-0.043	0.037
		20 mm	-0.034	-0.015	-0.040	0.025
		8 mm	-0.070	-0.049	-0.088	0.039
	1mm	40 mm	-0.029	-0.010	-0.048	0.038
		20 mm	-0.045	-0.025	-0.052	0.027
		8 mm	-0.113	-0.091	-0.127	0.036
	2mm	40 mm	-0.045	-0.027	-0.067	0.040
		20 mm	-0.089	-0.075	-0.114	0.039
		8 mm	-0.470	-0.272	-0.680	0.408



Graph 3 Probing error Size-Resolution

Table 8 Probing error form-Resolution

			Average	Max	Min	Range
Probing error form – PF (range)	0.2mm	40 mm	0.325	0.395	0.277	0.118
		20 mm	0.208	0.264	0.171	0.093
		8 mm	0.200	0.269	0.134	0.135
	0.5mm	40 mm	0.166	0.246	0.116	0.130
		20 mm	0.103	0.107	0.099	0.008
		8 mm	0.167	0.614	0.065	0.549
	1mm	40 mm	0.110	0.149	0.088	0.061
		20 mm	0.077	0.083	0.069	0.014
		8 mm	0.090	0.102	0.065	0.037
	2mm	40 mm	0.104	0.124	0.087	0.037
		20 mm	0.167	0.185	0.135	0.050
		8 mm	0.424	0.604	0.276	0.328

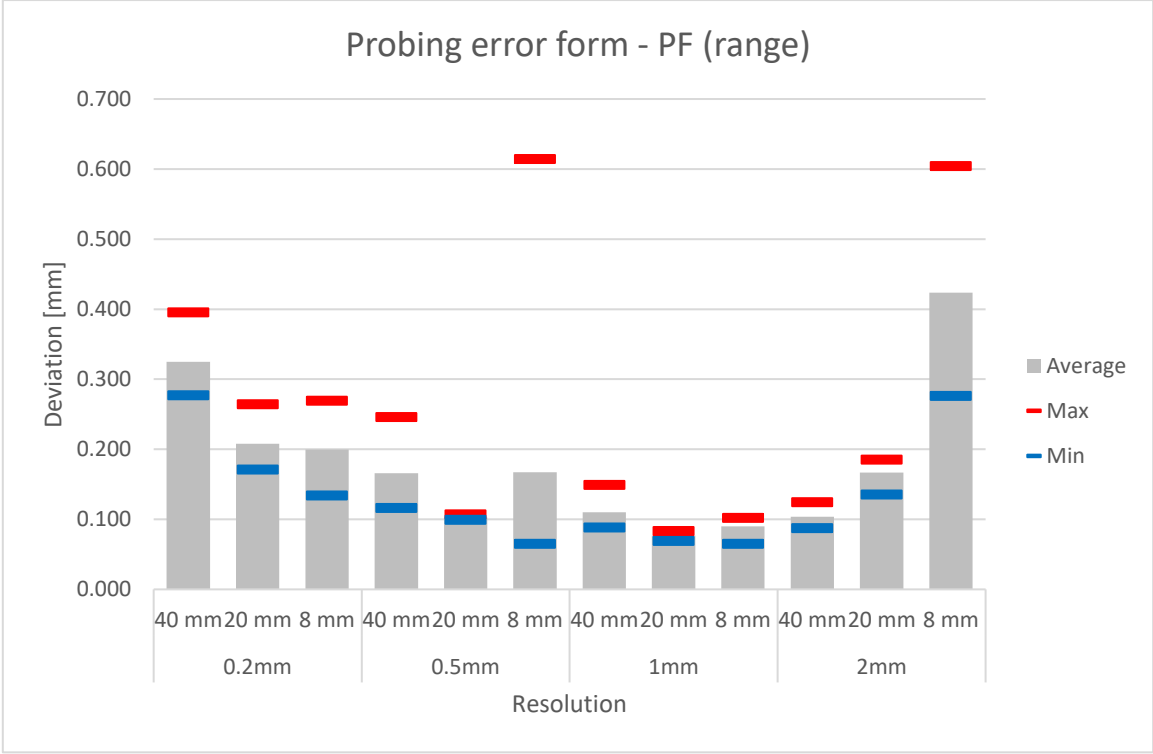

Graph 4 Probing error form-Resolution

The readings in the smaller sphere of the etalon 8mm in the resolution 0.5mm and 2mm are having a difference of roughly 0.4mm and 0.3mm in both the probing error size and probing error form. The area of the spheres that were chosen in the GOM inspect software may be the reason for the variance. When choosing an item, the resolution is important since low-resolution results in better accuracy and high-resolution results in lower accuracy.

Other tables like sphere spacing error of big and small etalons are listed, but the values in the tables are similar with very less differences, hence we know that the resolution plays a major role in the probing error form and size chart. Therefore, range is more important in the resolution method.

7.1.3. Graphs of different calibrations

In this experiment we did 3 calibration methods and in each of them, there are like 3 scanning, so in total we got 9 different experiment results from the calibration setups. Hence the calibration of metrascan head is same as the X axis measurement, therefore the values will be same like that. The table and graph for Sphere spacing error of big etalon is shown below for the reference.

Table 9 Sphere spacing error big etalon-Calibration

			Average	Max	Min	T. Max	T.min
Sphere spacing error – SD	Old	S2 (1000)	0.053	0.066	0.039	0.076	0.030
		S1 (320)	0.032	0.037	0.024	0.047	0.019
	C-Track	S2 (1000)	0.025	0.030	0.022	0.039	0.011
		S1 (320)	0.018	0.025	0.008	0.029	-0.002
	Metra + C-Track	S2 (1000)	0.024	0.030	0.020	0.035	0.009
		S1 (320)	0.007	0.013	-0.001	0.022	-0.012

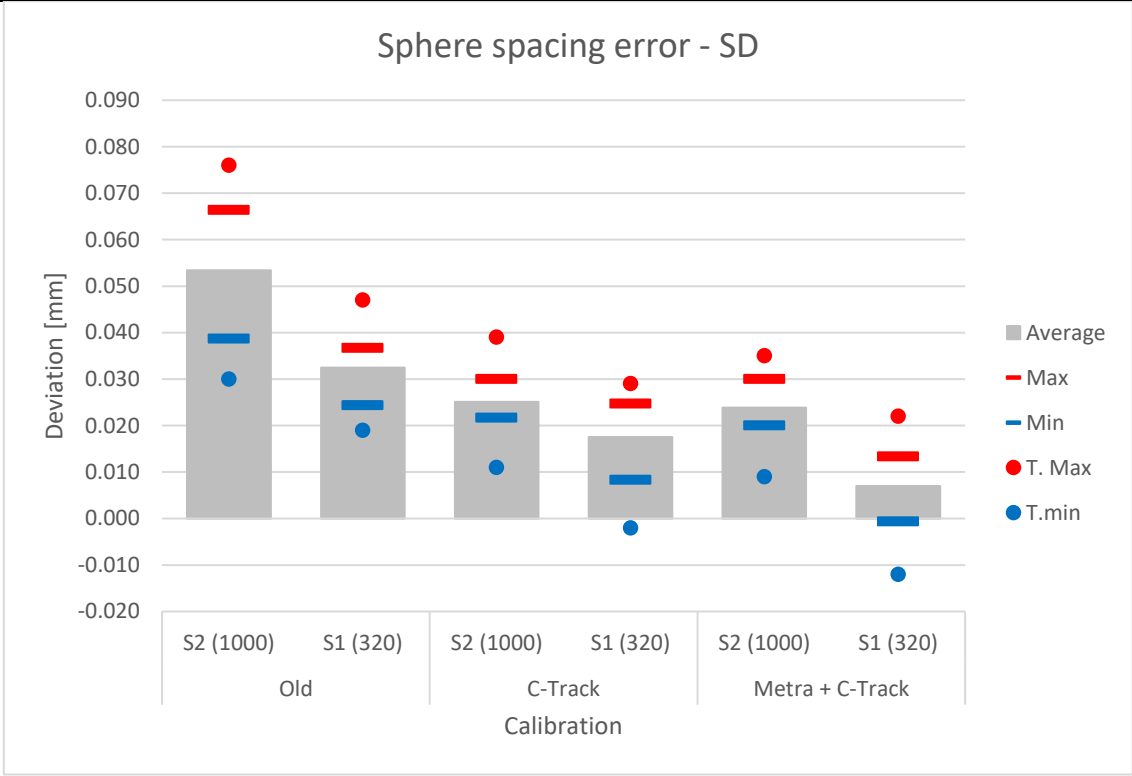

Graph 5 Sphere spacing error big etalon-Calibration

The deviations in the graph shows that values after the calibration have some differences and the differences is nearly like 0.02mm.

Table 10 Probing error size-Calibration

			Average	Max	Min	Range
Probing error size - PS	Old	40 mm	0.018	0.031	0.006	0.025
		20 mm	-0.010	0.007	-0.027	0.034
		8 mm	-0.053	-0.036	-0.073	0.037
	C-Track	40 mm	-0.003	0.014	-0.015	0.029
		20 mm	-0.016	-0.002	-0.033	0.031
		8 mm	-0.059	-0.037	-0.066	0.029
	Metra + C-Track	40 mm	0.008	0.023	-0.015	0.038
		20 mm	-0.011	-0.001	-0.027	0.026
		8 mm	-0.052	-0.026	-0.084	0.058

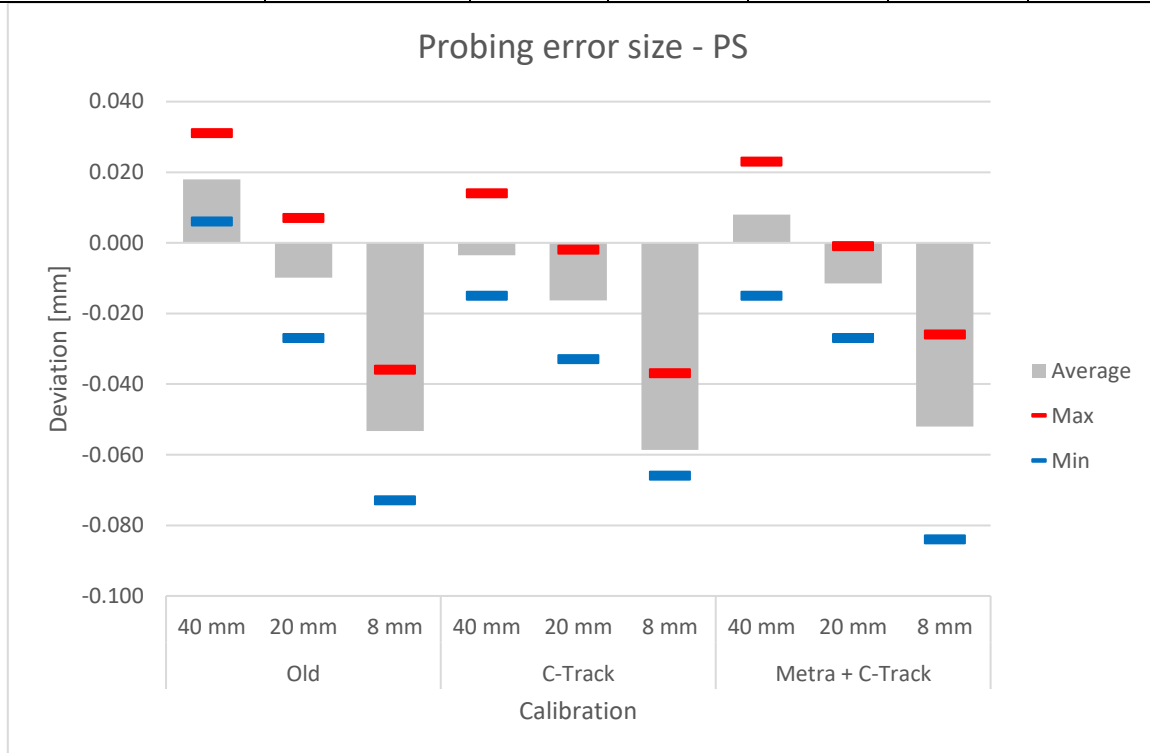

Graph 6 Probing error size-Calibration

In this probing error size chart, the values in the 40mm sphere in the calibration of old one and the calibration head is showing the positive values meanwhile all other values are in the negative range, it shows that calibrating the scanner before measurement has some changes in the value.

In the other tables like sphere spacing error of small etalon and probing error form are showing less differences compared to this tables and graphs. Calibration didn't have a much influence in the other tables and graphs.

7.1.4. Graphs of different distances

Different placements of the object inside the measurement volume also result in varying results. Therefore, the ideal position will be determined by utilizing this measuring technique, whether placing the object close by or far away. Using this technique, objects were positioned at various distances, including the minimum, average, and maximum. The normal distance is the reference measurement X axis since the lowest distance and maximum distance are the new measurements.

Table 11 Sphere spacing error-Distance

			Average	Max	Min	T. Max	T.min
Sphere spacing error - SD	Minimum Distance	S2 (1000)	-0.004	-0.002	-0.006	0.003	-0.013
		S1 (320)	0.004	0.016	-0.002	0.025	-0.004
	Normal Distance	S2 (1000)	0.027	0.035	0.022	0.041	0.003
		S1 (320)	0.014	0.017	0.009	0.026	-0.007
	Maximum Distance	S2 (1000)	0.036	0.048	0.016	0.051	0.010
		S1 (320)	0.013	0.022	0.008	0.025	0.003

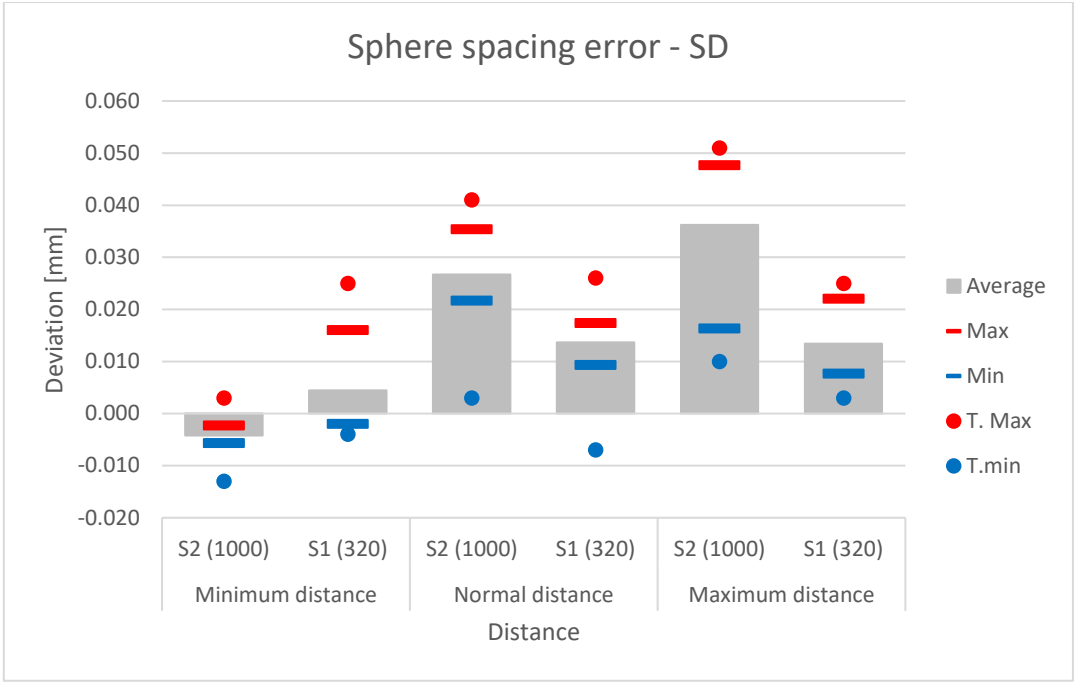

Graph 7 Sphere spacing error-Distance

In this graph, the minimum and maximum distances are contrasted, with the minimum having some average values in the negative range and the maximum having all positive values. The lowest exhibits less variation and higher precision when compared to the maximum.

Other table and graph of Probing error size also included for some better references, shown below

Table 12 Probing error size-Distance

			Average	Max	Min	Range
Probing error size - PS	Minimum distance	40 mm	0.020	0.047	0.001	0.046
		20 mm	-0.010	0.006	-0.031	0.037
		8 mm	-0.048	-0.030	-0.071	0.041
	Normal distance	40 mm	-0.029	-0.006	-0.048	0.042
		20 mm	-0.032	-0.013	-0.038	0.025
		8 mm	-0.059	-0.041	-0.078	0.037
	Maximum distance	40 mm	0.008	0.019	-0.006	0.025
		20 mm	-0.004	0.009	-0.014	0.023
		8 mm	-0.053	-0.026	-0.074	0.048

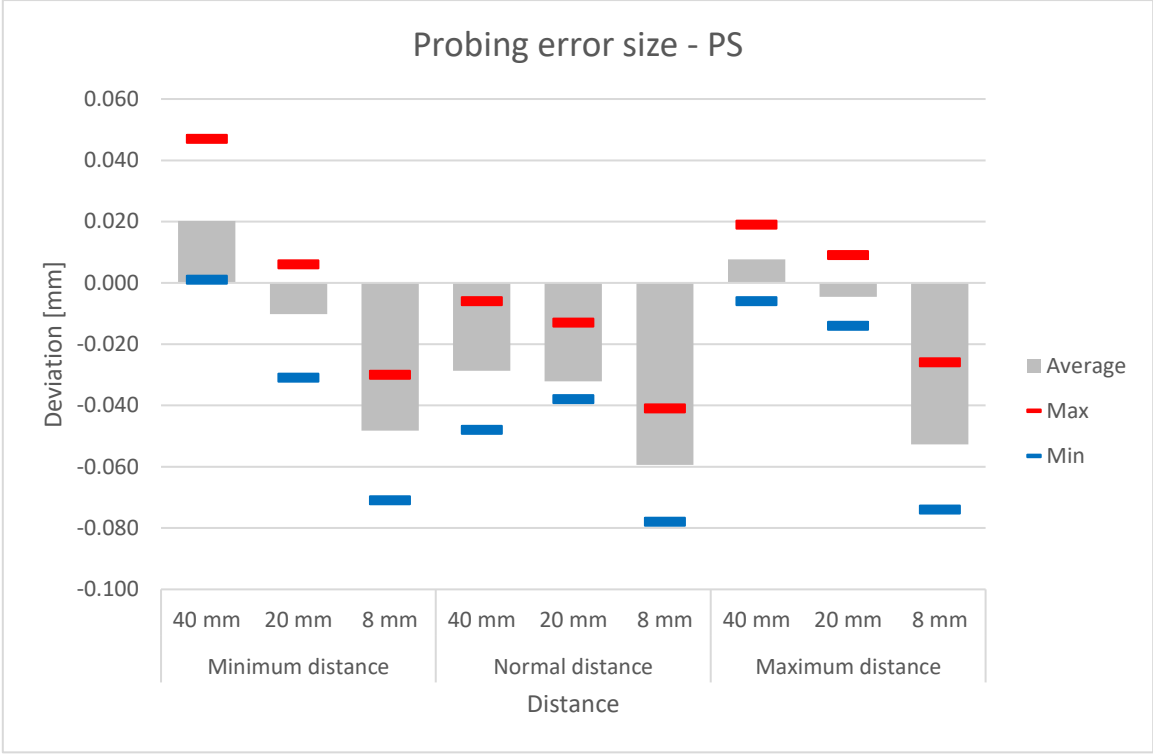

Graph 8 Probing error size-Distance

In this graph as we can see the normal distance measurement is differed from maximum and minimum distance graphs.

The other two like Sphere spacing error of small etalon and probing error form values and graphs are with more common values and similar in the graph. Distance parameter didn't have a much impact in the two graphs of spacing and probing size of small etalons.

7.1.5. Graphs based on the dynamic referencing system

Dynamic referencing system is differed from the other system, in this system there are four methods of measurement, first one is not a dynamic type of measurement, it is static mode (reference measurement) and the other four are dynamic referencing system-based experiments. There are total of 12 scanning results were obtained in the dynamic referencing system. The table and graphs of sphere spacing error of big etalon and Probing error size are shown below.

Table 13 Sphere spacing error of Big Etalon- DRS

			Average	Max	Min	T. Max	T.min
Sphere spacing error - SD	13_Static	S2 (1000)	0.030	0.033	0.026	0.050	0.019
		S1 (320)	0.031	0.034	0.028	0.041	0.021
	14_Dyn	S2 (1000)	0.024	0.028	0.018	0.038	0.013
		S1 (320)	0.012	0.014	0.010	0.029	0.001
	15_A	S2 (1000)	0.005	0.014	-0.004	0.020	-0.013
		S1 (320)	0.003	0.006	0.000	0.012	-0.003
	15_B	S2 (1000)	0.047	0.054	0.039	0.063	0.037
		S1 (320)	0.043	0.045	0.041	0.053	0.033
	15_C	S2 (1000)	0.101	0.103	0.100	0.106	0.097
		S1 (320)	0.073	0.084	0.061	0.087	0.059

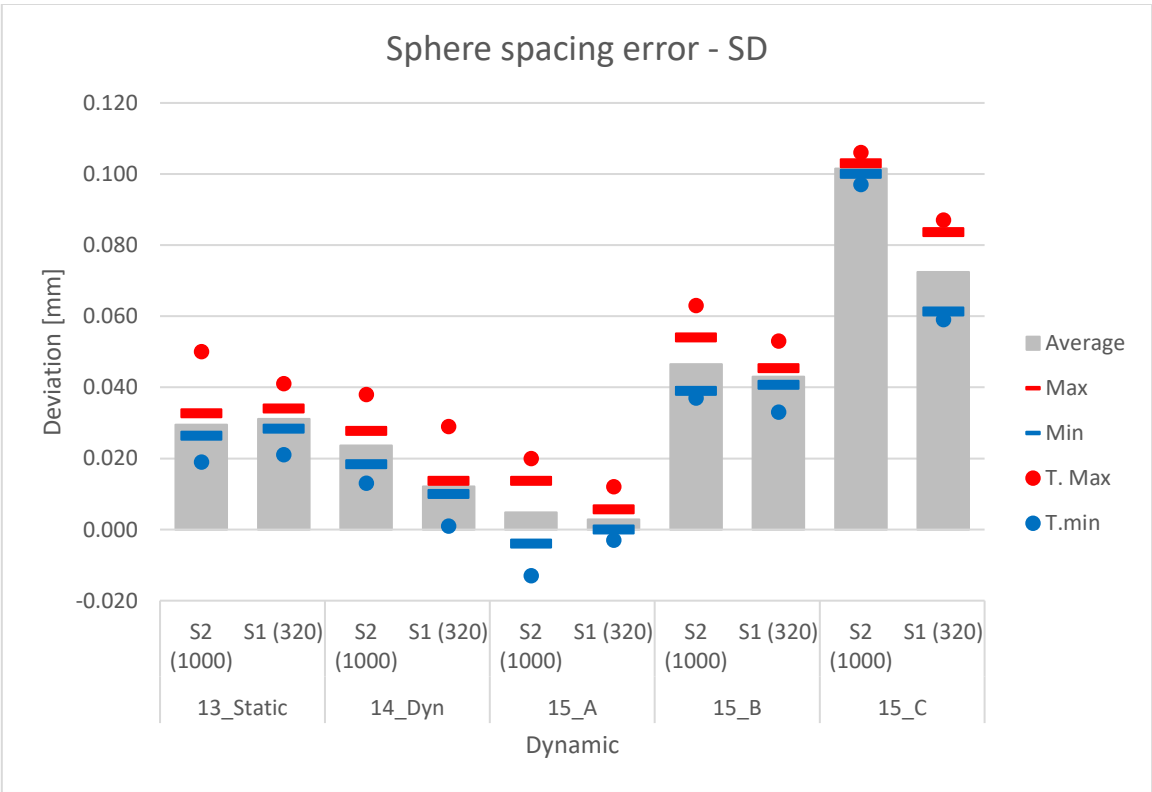

Graph 9 Sphere spacing error of Big Etalon- DRS

Table 14 Probing error size-DRS

			Average	Max	Min	Range
Probing error size - PS	13_Static	40 mm	0.033	0.055	0.013	0.042
		20 mm	0.016	0.050	-0.017	0.067
		8 mm	-0.018	0.025	-0.060	0.085
	14_Dyn	40 mm	0.011	0.017	0.002	0.015
		20 mm	-0.014	0.003	-0.025	0.028
		8 mm	-0.054	-0.047	-0.070	0.023
	15_Dyn cha A	40 mm	0.055	0.079	0.031	0.048
		20 mm	0.042	0.058	0.031	0.027
		8 mm	0.000	0.031	-0.015	0.046
	15_Dyn cha B	40 mm	0.014	0.038	-0.003	0.041
		20 mm	0.006	0.024	-0.017	0.041
		8 mm	-0.011	0.011	-0.027	0.038
	15_Dyn cha C	40 mm	0.031	0.080	-0.018	0.098
		20 mm	0.009	0.040	-0.012	0.052
		8 mm	-0.096	-0.076	-0.130	0.054

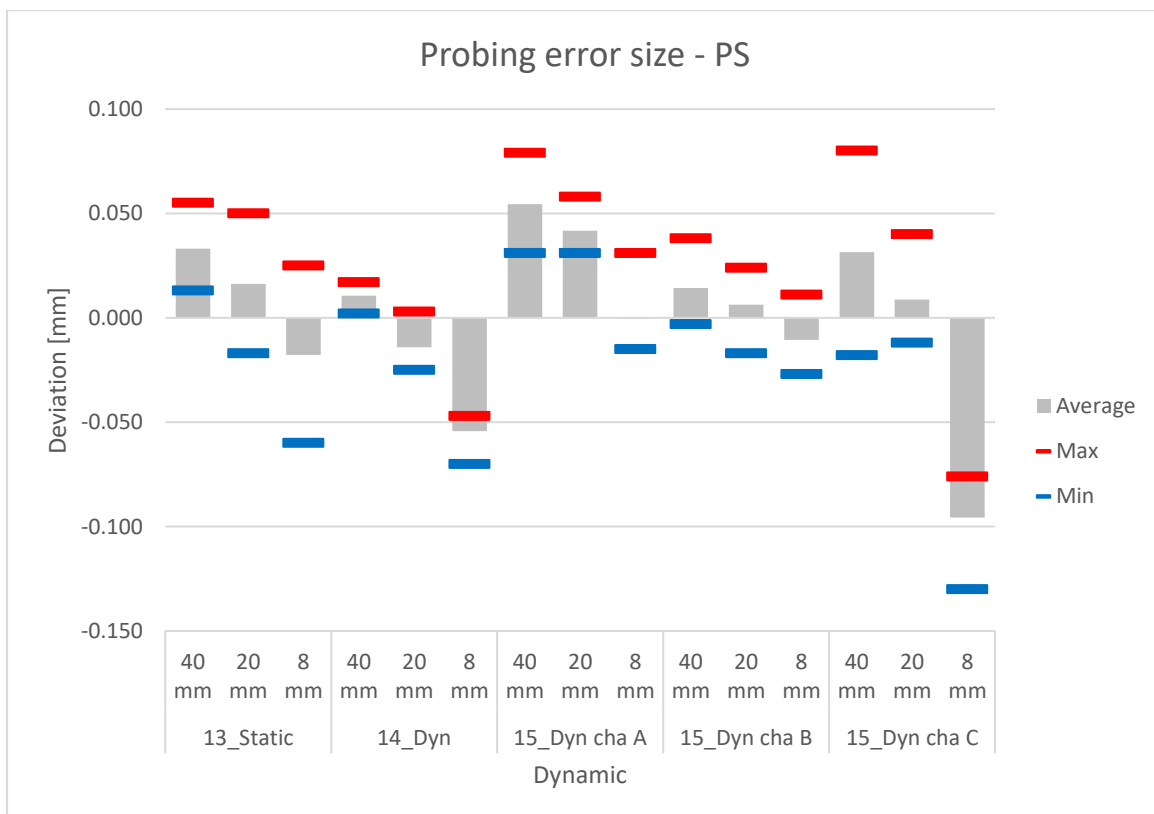

Graph 10 Probing error size-DRS

The values in the C Group differ significantly between the two graphs and exhibit a significant departure from the other values. However, we can see that the values in the A position of the dynamic referencing system are displaying the lowest deviation when compared to the other values in the graph, therefore we may infer that A is the best and C is the worst position in the dynamic referencing system.

The other two, small etalon sphere spacing error and probing error, have more typical values and a graph that is comparable. The distance parameter has little effect on the two graphs showing the spacing and probing size of small etalons.

7.2. Summary of overall results

The Values from the overall graphs, such as orientation, resolution, calibration, distance, and dynamic referencing system, are grouped in a single graph for better reference; at a look, we can tell how one value differs from the others. The table and graph indicate the average values from each of the measurements.

7.2.1. Result graph from Sphere spacing error of big etalon

Table 15 Combined table of Sphere spacing error of big etalon

		Average	Max	Min	T.Max	T.min
Reference	X	0.020	0.026	0.015	0.034	-0.002
Orientation	Y	0.014	0.026	0.000	0.048	-0.015
	Z	0.021	0.030	0.007	0.040	0.004
Resolution	0.5	0.019	0.027	0.013	0.033	-0.003
	1	0.015	0.019	0.012	0.031	-0.003
	2	0.019	0.027	0.013	0.032	-0.001
Calibration	OLD	0.043	0.052	0.032	0.062	0.025
	C-Track	0.021	0.027	0.015	0.034	0.005
Distance	MIN	0.000	0.007	-0.004	0.014	-0.008
	MAX	0.025	0.035	0.012	0.038	0.006
Dynamic referencing	DYN SOME	0.018	0.021	0.014	0.024	0.007
	A	0.004	0.010	-0.002	0.016	-0.008
	B	0.045	0.050	0.040	0.058	0.035
	C	0.087	0.093	0.081	0.096	0.078

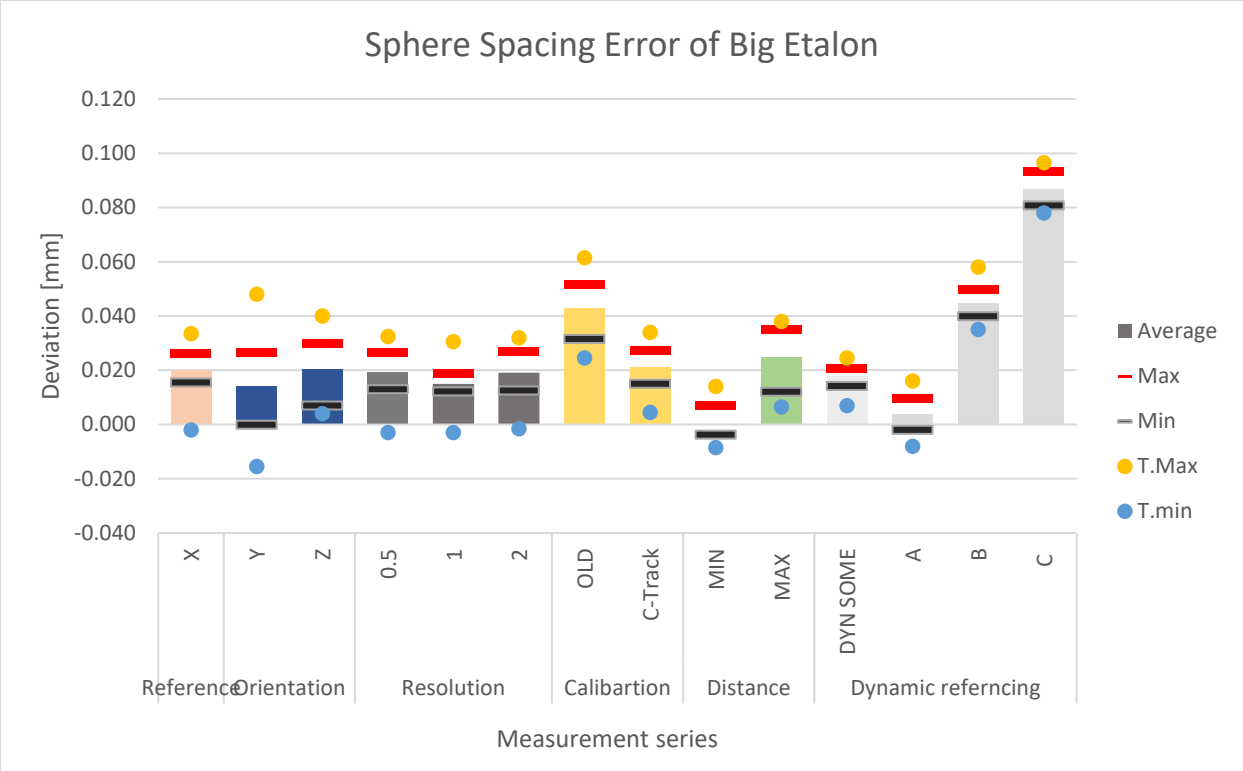

Graph 11 Combined graph of Sphere spacing error of big etalon

As we can see in the graph the parameters are arranged in the order of measurement starting from the reference measurement of X axis, Orientation (Y, Z), Resolution (0.5mm,1mm,2mm), Calibration (Old, C-Track), Distance (Minimum, Maximum), and Dynamic referencing (Dynamic some, Position A, Position B, Position C).

According to the data in the graph, the smallest average value is the minimal distance, and the maximum average value is the dynamic referencing of Position C. The dynamic referencing position B and the values of the previous calibration are practically identical, with position B's average being a little higher than the other values. As a result, the graph demonstrates that, when evaluating the values, the lowest distance is the optimal spot for the Sphere spacing error of the large etalon.

7.2.2. Result graph from sphere spacing error of small etalon

Table 16 Combined table of Sphere spacing error of small etalon

		Average	Max	Min
Reference	X	0.008	0.024	-0.006
Orientation	Y	0.009	0.038	-0.015
	Z	0.004	0.043	-0.016
Resolution	0.5	0.006	0.019	-0.005
	1	0.006	0.019	-0.008
	2	-0.012	0.024	-0.125
Calibration	OLD	0.015	0.047	-0.004
	C-Track	0.013	0.027	-0.001
Distance	MIN	0.007	0.026	-0.025
	MAX	0.010	0.021	-0.004
Dynamic referencing	DYN SOME	0.012	0.032	-0.005
	A	0.007	0.020	-0.004
	B	0.020	0.041	-0.003
	C	0.038	0.078	0.001

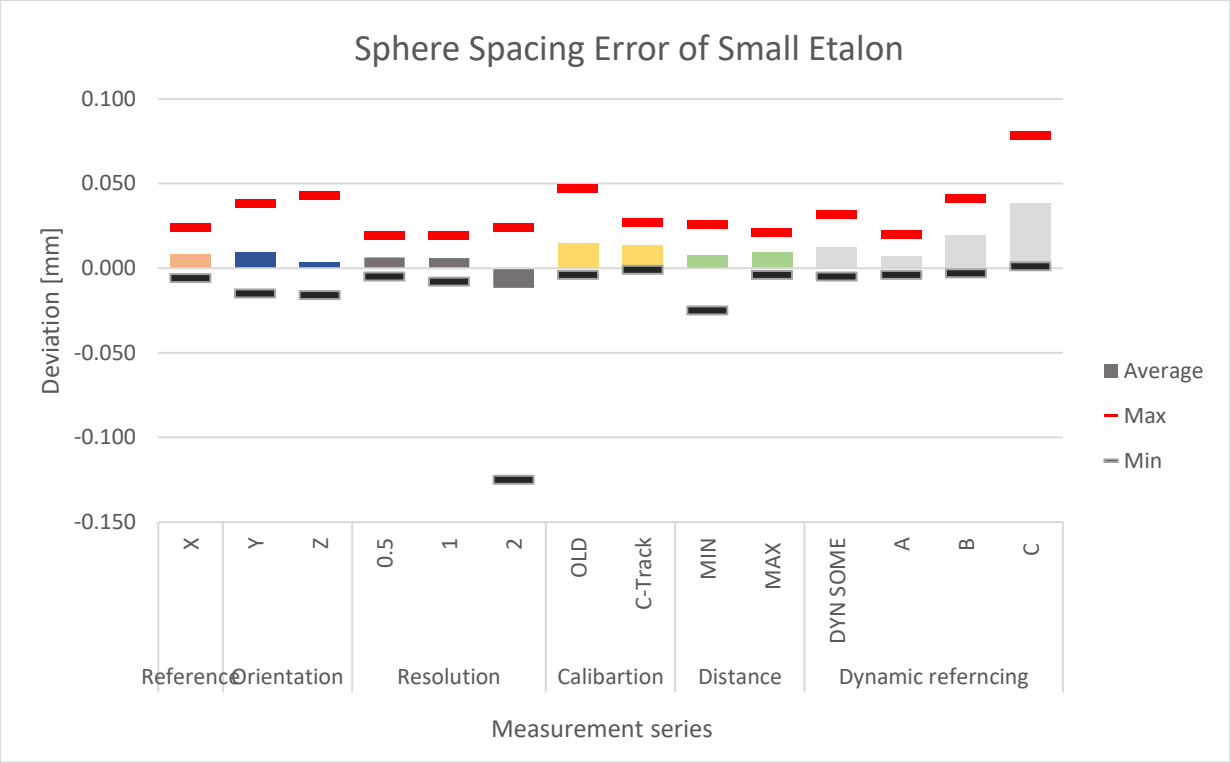

Graph 12 Combined graph of Sphere spacing error of small etalon

The values in the average of the Z axis are showing smaller values in this small etalon sphere spacing error, whereas the values in the dynamic referncing of Position C are showing larger values. The lowest minimum value in the whole dataset is found in the Resolution 2mm, where the minimum value is about -0.125mm. As I said before in the graph result in the chapter, the difference in the resolution 2mm minimum value is caused by the GOM software's sphere selection. It is preferable to scan tiny or average-sized items at the least resolution because the increasing resolution will reduce the number of objects available in the coordinate system. We can thus achieve the highest level of accuracy.

Therefore, the Z axis is the location with the highest accuracy in the small etalon's sphere spacing error, and Dynamic referncing positioning C is the position with the lowest accuracy. Therefore, it is evident that the point with the lowest accuracy is recognized to be the dynamic reference position C in both Sphere spacing errors of the small and big etalon.

7.2.3. Result graph from probing error size of small etalon

Table 17 Combined table for Probing error size

		Average	Max	Min
Reference	X	-0.040	-0.020	-0.055
Orientation	Y	0.063	0.093	0.017
	Z	-0.005	0.020	-0.029
Resolution	0.5	-0.043	-0.023	-0.057
	1	-0.062	-0.042	-0.076
	2	-0.201	-0.125	-0.287
Calibration	OLD	-0.015	0.001	-0.031
	C-Track	-0.026	-0.008	-0.038
Distance	MIN	-0.013	0.008	-0.034
	MAX	-0.016	0.001	-0.031
Dynamic referencing	DYN SOME	-0.019	-0.009	-0.031
	A	0.032	0.056	0.016
	B	0.003	0.024	-0.016
	C	-0.018	0.015	-0.053

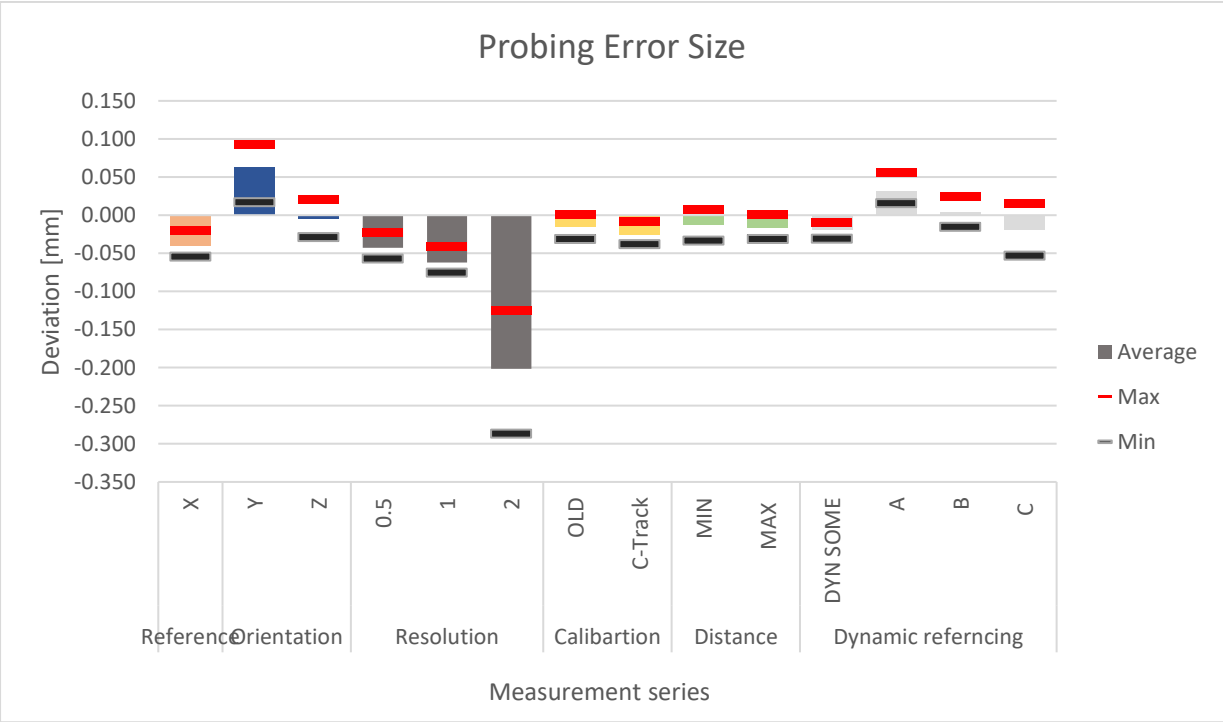

Graph 13 Combined graph for Probing error size

The majority of the values on the probing error size graph are located near the center line, and the resolution of 2 mm, where the average value is close to -0.201 mm and there are more maximum minimum values as well, exhibits the largest difference. Which unmistakably demonstrates that the resolution's maximum variation of 2 mm indicates that it has the lowest accuracy when compared to the other methods and measurements. Dynamic referencing Position B, with a value of 0.003mm, is the position with the highest precision. In considering this, we can say that when probing small etalons, Dynamic referencing system position B is the optimum place to scan from, whereas Resolution 2mm is the worst. When the resolution is greater, the selection of the item in the coordinate system will be smaller, which results in less attention to the object from the software. This problem with the Resolution of 2mm is similar to the small etalon sphere spacing inaccuracy.

7.2.4. Result graph from probing error form of small etalon

Table 18 Combined table for Probing error form

		Average	Max	Min
Reference	X	0.244	0.309	0.194
Orientation	Y	0.346	0.447	0.266
	Z	0.274	0.362	0.202
Resolution	0.5	0.145	0.322	0.093
	1	0.092	0.111	0.074
	2	0.231	0.304	0.166
Calibration	OLD	0.153	0.202	0.117
	C-Track	0.153	0.218	0.118
Distance	MIN	0.158	0.187	0.131
	MAX	0.168	0.217	0.142
Dynamic referencing	DYN SOME	0.176	0.176	0.125
	A	0.179	0.200	0.164
	B	0.160	0.214	0.123
	C	0.171	0.233	0.131

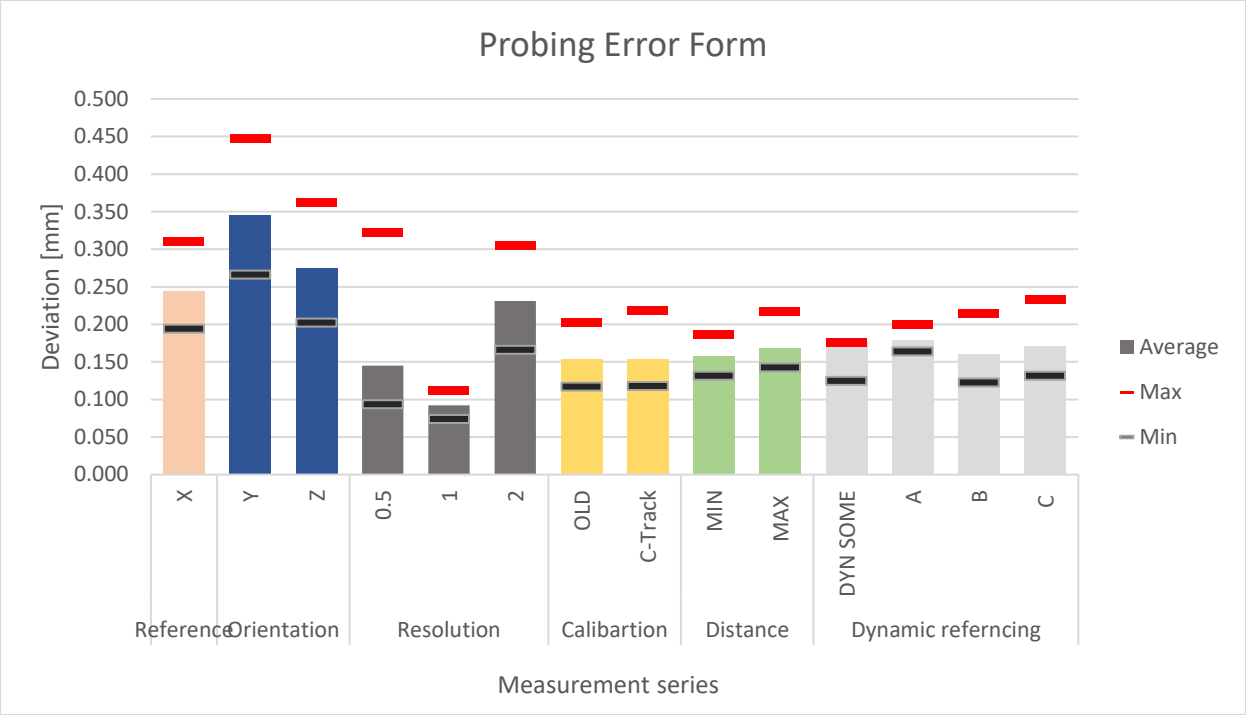

Graph 14 Combined graph for Probing error size

The graph's data demonstrate that the majority of the values have a common average, although the average on the Y-axis is only 0.346 mm, and the least average value is 0.092 mm for resolutions of 1 mm. The object's position in the coordinate system's axis is the cause of the difficulty with the value difference. The item is positioned in the Y-axis' horizontal position, therefore how it is positioned within the coordinate system will greatly affect how accurately the scanning is done.

8. Discussion

In this chapter, I'll discuss the results that are displayed on each graph, their variations, and the causes of those variations. As previously said, the thesis's objective is to examine the Metrascan's accuracy in the C-Track's measuring volume, thus we carried out a lot of scanning in various places and with various scanning parameters, including orientation, resolution, calibration, distance, and dynamic reference system. Every measurement is performed at the KSA/TUL laboratory, and the calibration standards utilized are VDI-VDE 2634-3 standards.

The X-axis is used as the reference measurement for several other studies, such as resolutions, calibrations, and distances, when scanning is complete in the measuring volume. Resolutions merely modify the value of resolutions to new resolutions, which are then stored in the system and covered in detail in earlier chapters.

Three measurements are made in the X-axis orientation at first, and we then moved on to the Y and Z axes. Before beginning any scanning, the C-Track and Metrascan heads were calibrated. The item is then positioned in various locations, such as minimum and maximum, with the normal position serving as the reference point for the X-Axis, and lastly, scans using the dynamic referencing system were performed.

The STL file is loaded into the GOM program when all the scans have been completed, where the real model is compared to the nominal value of the CAD model and deviations are then computed. According to the requirements of acceptance testing, the findings for each parameter in the previous chapter were compared to one another using sphere spacing, probing error type, and probing error size. GOM's defined procedure for evaluating accuracy serves as the primary basis for adopting the calibration standard with spheres and acceptance test criteria.

As a result, the results are represented in the graphs of the first section of Chapter 7. In comparing the values of the graphs, we selected the graphs that exhibit the greatest difference in departures from the mean. Neglected are the graphs with more comparable values.

Four separate graphs are drawn from the Sphere spacing error of big and small etalon, and the size and form of the small etalon probing error later in chapter 7. While comparing the values in the graphs, it is shown that some of the positions or some methods having a maximum value when compared to the other values, which will be described as follows. In the four different

graphs, the parameters are lined up and the total average, maximum, and minimum are calculated.

Examining all four graphs, it is evident that the minimum location for measuring volume has the highest accuracy and lowest deviation values, however the accuracy increases when the item is brought closer to the C-Track and the scanning is performed. Additionally, while viewing the graphs, location C of the dynamic reference system is displaying the data with the greatest variation and the lowest degree of precision. This may be as a result of scanning being performed when the item was in the Z axis position relative to the C-Track.

As a consequence, these parameters' findings are established for the accuracy assessment of each position and may be taken into account for future accuracy assessments and part digitalization.

9. Conclusion

After conducting my thesis using the MetraScan 350 system, which aimed to analyze the digitization accuracy within the measuring volume, I focused on several key parameters including resolution, orientation, calibration, distances, and the dynamic referencing system. Through the analysis of these parameters and the comparison of their values in graphs, I have reached several important conclusions.

Acceptance testing was done using the calibration standard, also known as Etalon, which was created in prior research at the department by FRKAL[27], FARAR [26]and MENDRICKY[28].As was mentioned in the study section, this etalon is often made using forms that are typical of numerous industrial components. The measuring procedure used to evaluate the scanner's accuracy is specified in the so-called acceptance test. In accordance with VDI / VDE directive 2634, this test is described.

Firstly, I observed that all the parameters exhibited relatively low deviations when compared to one another. This suggests that the MetraScan 350 system generally performs well across these studied parameters, indicating a consistent level of accuracy in digitization.

However, when examining the results more closely, two specific issues were identified. The first relates to the resolution parameter, specifically when set to 2 mm. It was found that this particular resolution setting resulted in a decrease in accuracy due to poor quality of the scanned output. This indicates that lower resolutions may not provide the necessary level of detail and precision required for accurate digitization using the MetraScan 350 system. Therefore, it is advisable to avoid using a resolution setting of 2 mm for optimal accuracy.

The second issue pertains to the dynamic referencing system, specifically in position C. In this position, the accuracy was observed to be compromised. This discrepancy could be attributed to various factors, such as the placement of objects in relation to the C-Track during scanning. Further investigation is recommended to identify the precise causes behind this reduced accuracy and to explore potential solutions or improvements to enhance accuracy in this specific position.

On a positive note, my analysis revealed that the position with the minimum distance from the scanner to the object exhibited the maximum accuracy. This finding suggests that proximity between the scanner and the object being scanned positively influences accuracy. Therefore,

minimizing the distance between the scanner and the object is beneficial for achieving higher accuracy in digitization.

In conclusion, my thesis findings demonstrate that the MetraScan 350 system performs well in terms of digitization accuracy across various parameters. However, it is crucial to avoid a resolution setting of 2 mm due to the associated decrease in accuracy caused by poor-quality scanned output. Additionally, further attention should be given to the dynamic referencing system in position C, as it exhibited compromised accuracy. By considering these conclusions, future accuracy assessments and optimization of the digitization process using the MetraScan 350 system can be informed to enhance overall accuracy and achieve more precise results.

10.References

- [1] *Types of 3D scanning technologies: comparison, advantages and applications - Bitfab* [online]. [accessed. 2022-11-13]. Available at: <https://bitfab.io/blog/types-of-3d-scanning/>
- [2] *3D掃描中的Point Cloud 是什麼東西? - 3D Lab Store* [online]. [accessed. 2022-11-20]. Available at: <https://3dlabstore.com.hk/blog/3d-scanning-guide/what-is-point-cloud-in-3d-scanning>
- [3] *3D scanning - Wikipedia* [online]. [accessed. 2022-11-30]. Available at: https://en.wikipedia.org/wiki/3D_scanning
- [4] KALOVÁ, Ilona and Marek LISZTAN. ACTIVE TRIANGULATION TECHNIQUE. no date, 7.
- [5] WIECZOROWSKI, M, M GRZELKA, G BUDZIK and J AUGUSTYN-PIENIAZEK. The use of optical scanning for analysis of casting shape. no date, **11**(2), 6.
- [6] *MetraSCAN 3D | Handheld [Optical CMM 3D Laser Scanner] by Creaform* [online]. [accessed. 2022-12-12]. Available at: <https://www.creaform3d.com/en/optical-3d-scanner-metrascan>
- [7] *usage of metrascan* [online]. [accessed. 2022-11-20]. Available at: <https://www.creaform3d.com/en/optical-3d-scanner-metrascan>
- [8] *Onsite 3D Scanning Services | Scansite 3D – Scansite* [online]. [accessed. 2022-12-20]. Available at: <https://scansite.com/onsite-3d-scanning-services/>
- [9] CREOFORM. *VXelements 10.0.2*. B.m.: Creoform Inc. 2022
- [10] *MetraScan - UserManual.pdf*
- [11] *MetraSCAN 3D – 3D Scanning | 3DSCAN* [online]. [accessed. 2022-12-20]. Available at: <https://www.3d-skenovani.cz/skenery/ukoncene-produkty/metrascan-3d/>
- [12] *MetraSCAN BLACK boasts certified .025 mm accuracy at impressive speeds | Geo Week News | Lidar, 3D, and more tools at the intersection of geospatial technology and the built world* [online]. [accessed. 2022-12-26]. Available at: <https://www.geoweeknews.com/news/metrascan-black-boasts-certified-025-mm-accuracy-and-gets-the-job-done-fast>
- [13] MENDŘICKÝ, Radomír. Using Contactless Scanners for Quality Inspection. *MATEC Web of Conferences* [online]. 2017, **89**, 01011 [accessed. 2022-11-13]. ISSN 2261-236X. Available at: doi:10.1051/matecconf/20178901011
- [14] *3D scanner accuracy and resolution: What you need to know* [online]. [accessed. 2023-01-16]. Available at: <https://www.aniwaa.com/insight/3d-scanners/3d-scanner-accuracy-resolution-basics/>
- [15] BEUTH VERLAG, gmbh. *VDI-VDE 2634-3 ED*. B.m.: Düsseldorf, Germany. 2008

- [16] MENDRICKY, Radomir. ASPECTS AFFECTING ACCURACY OF OPTICAL 3D DIGITISATION. *MM Science Journal* [online]. 2018, **2018**(01), 2267–2275 [accessed. 2023-01-16]. ISSN 18031269, 18050476. Available at: doi:10.17973/MMSJ.2018_03_2017106
- [17] RAMESH, Lakshman kumar. *Measuring the accuracy of digitization of contactless scanners*. Liberec, Czech Republic, 2021. Diploma thesis. Technical University of Liberec.
- [18] KERSTEN, Thomas P., Heinz-Jürgen PRZYBILLA and Maren LINDSTAEDT. Investigations of the Geometrical Accuracy of Handheld 3D Scanning Systems. *Photogrammetrie - Fernerkundung - Geoinformation* [online]. 2016, **2016**(5–6), 271–283 [accessed. 2023-01-16]. ISSN 1432-8364. Available at: doi:10.1127/pfg/2016/0305
- [19] BARBERO, Basilio Ramos and Elena Santos URETA. Comparative study of different digitization techniques and their accuracy. *Computer-Aided Design* [online]. 2011, **43**(2), 188–206 [accessed. 2023-01-16]. ISSN 00104485. Available at: doi:10.1016/j.cad.2010.11.005
- [20] BRAJLIH, Tomaz, Tadej TASIC, Igor DRSTVENSEK, Bogdan VALENTAN, Miodrag HADZISTEVIC, Vojko POGACAR, Joze BALIC and Bojan ACKO. Possibilities of Using Three-Dimensional Optical Scanning in Complex Geometrical Inspection. *Strojniški vestnik – Journal of Mechanical Engineering* [online]. 2011, **57**(11), 826–833 [accessed. 2023-01-16]. ISSN 00392480. Available at: doi:10.5545/sv-jme.2010.152
- [21] BÖHLER, Wolfgang, Monica BORDAS VICENT, Guido HEINZ, Andreas MARBS and Hartmut MÜLLER. *High Quality Scanning and Modeling of Monuments and Artifacts*. 2004.
- [22] VAGOVSĚKÝ, Juraj, Ivan BURANSĚKÝ and Augustín GÖRÖG. Evaluation of Measuring Capability of the Optical 3D Scanner. *Procedia Engineering* [online]. 2015, **100**, 1198–1206 [accessed. 2023-01-16]. ISSN 18777058. Available at: doi:10.1016/j.proeng.2015.01.484
- [23] CAMPANELLI, Valentina, Stephen M. HOWELL and Maury L. HULL. Accuracy evaluation of a lower-cost and four higher-cost laser scanners. *Journal of Biomechanics* [online]. 2016, **49**(1), 127–131 [accessed. 2023-01-16]. ISSN 00219290. Available at: doi:10.1016/j.jbiomech.2015.11.015
- [24] EIRÍKSSON, E. R., J. WILM, D. B. PEDERSEN and H. AANÆS. PRECISION AND ACCURACY PARAMETERS IN STRUCTURED LIGHT 3-D SCANNING. *The International Archives of the Photogrammetry, Remote Sensing and Spatial Information Sciences* [online]. 2016, **XL-5/W8**, 7–15 [accessed. 2023-01-16]. ISSN 2194-9034. Available at: doi:10.5194/isprs-archives-XL-5-W8-7-2016
- [25] KOTERAS, Robert, Michał WIECZOROWSKI, Piotr ZNANIECKI and Natalia SWOJAK. Measurement strategy as a determinant of the measurement uncertainty of an optical scanner. *Archives of Mechanical Technology and Materials* [online]. 2019,

39(1), 26–31 [accessed. 2023-01-16]. ISSN 2450-9469. Available at:
doi:10.2478/amt-2019-0005

- [26] JAN, Farar. *Vliv strategie 3D skenování na výsledky měření*. B.m.: Technical university of Liberec. 2021
- [27] MARTIN, Frkal. *Návrh kalibračního etalonu pro stanovení přesnosti měření optických 3d skenerů*. B.m.: Technical university of Liberec. 2017
- [28] MENDRICKY, Radomir. DETERMINATION OF MEASUREMENT ACCURACY OF OPTICAL 3D SCANNERS. *MM Science Journal* [online]. 2016, **2016**(06), 1565–1572 [accessed. 2022-10-24]. ISSN 18031269, 18050476. Available at:
doi:10.17973/MMSJ.2016_12_2016183