

Czech University of Life Sciences Prague

Faculty of Forestry and Wood Sciences

Department of Applied Ecology
(Faculty of Environmental Sciences)



**Faculty of Forestry
and Wood Sciences**

**Possible utilization of LCA principles to assess the
impact of the ski industry and project its future
development**

Diploma thesis

Author: Šimon Svoboda

Supervisor: Ing. Zdeněk Keken, Ph.D.

2024

CZECH UNIVERSITY OF LIFE SCIENCES PRAGUE

Faculty of Forestry and Wood Sciences

DIPLOMA THESIS ASSIGNMENT

Bc. Šimon Svoboda

Forestry, Water and Landscape Management

Thesis title

Possible utilization of LCA principles to assess the impact of the ski industry and project its future development

Objectives of thesis

The first part of the thesis reviews the scientific literature of various LCA principles and their possible utilization to assess the impact of the ski industry and utilization for projections.

Ski industry activities are categorized as follows:

- Downhill skiing and snowboarding
- Cross country skiing
- Ski touring (Freeriding)

The second part of the thesis is a case study. For this purpose, data was mostly gathered in the Giant Mountains (Krkonoše) region. Simplified LCAs are made for ski area operations. The significance of various aspects is discussed, and projections for several future scenarios are proposed based on the information gathered.

Methodology

The review of the scientific literature is based on official guidelines and ISO standards. Furthermore, scientific books and case studies are also reviewed. The case study follows guidelines of E-LCA, SLCA and LCC. Discovered key factors are used for subsequent projections.

The proposed extent of the thesis

50 pages of text

Keywords

Environmental impact, Mountain resort tourism, Outdoor sports, Skiing, Environmental education, Environmental problems awareness, S-LCA, E-LCA, LCC, Snowmaking, Ski industry projection

Recommended information sources

Environmental Life Cycle Assessment (Olivier Jolliet, Myriam Saadé-Sbeih, Shanna Shaked, Alexandre Jolliet, Pierre Crettaz – CRC press, 2016)
HUNKELER, D. – LICHTENVORT, K. – CIROTH, A. – HUPPES, G. – KLÖPFFER, W. – RÜDENAUER, I. – STEEN, B. – REBITZER, G. – REBITZER, G. *Environmental life cycle costing*. Boca Raton: CRC Press, 2008. ISBN 978-1-4200-5470-5.
Impact assessment of tourism Economics (Alvaro Matias, Peter Nijkamp, Joao Romao – Springer, 2016)
Impact of skiing on mountain nature: review of the present knowledge and situation in the Krkonoše/Giant Mts (Flousek, Jiří. – Opera Corcontica 2016)
Life Cycle Assessment (LCA) – A guide to best practice (Walter Kloepffer, Birgit Grahl – Wiley-VCH 2014)
Life Cycle Assessment (LCA) and Life Cycle Analysis in Tourism (Viachaslau Filimonau – Faculty of Management Bournemouth University 2016)
Social Life Cycle Assessment – An Insight (Subramanian Senthilkannan Muthu – Springer 2015)

Expected date of thesis defence

2022/23 SS – FFWS

The Diploma Thesis Supervisor

Ing. Zdeněk Keken, Ph.D.

Supervising department

Department of Applied Ecology

Electronic approval: 23. 3. 2023

prof. Ing. Jan Vymazal, CSc.

Head of department

Electronic approval: 31. 3. 2023

prof. Ing. Róbert Marušák, PhD.

Dean

Prague on 31. 03. 2023

Declaration

I declare that I have written this diploma thesis on the topic: *Possible utilization of LCA principles to assess the impact of the ski industry and project its future development* independently and quoted all information sources that I used in the work, and which I also listed at the end of the work in the list of references.

I am aware that my diploma thesis is fully covered by Act No. 121/2000 Coll., On Copyright, on Rights Related to Copyright and on the amendment of certain acts, as amended, in particular the provisions of Section 35, Paragraph 3 of this Act, i.e., on the use of this work.

I am aware that by submitting my diploma thesis I agree with its publication pursuant to Act No. 111/1998 Coll., On Higher Education Institutions and on Amendments to Other Acts, as amended, regardless of the result of its defence.

With my signature, I also declare that the thesis electronic version is identical to the printed version and that the data provided in it was handled in connection with GDPR.

Kadov, 3.4.2024

Signature

Acknowledgments

Foremost, I would like to express my sincere gratitude to my Supervisor Ing. Zdeněk Keken, Ph.D. for his continuous support during the creation of my thesis. I would especially like to highlight his friendly and calm approach.

Possible utilization of LCA principles to assess the impact of the ski industry and project its future development

Abstract

This diploma thesis examines the possibilities of applying LCA methods to an assessment of the ski industry. The aim of the thesis is to introduce a tool into the often tense debate between ecologists and representatives of ski resorts, which would objectively evaluate both the positive and negative impacts of ski tourism. This work does not evaluate a specific ski area but makes general observations about areas where it was possible to obtain input data. The author of this thesis has worked in the ski industry for over twenty seasons, so this thesis combines his experience with information obtained from detailed research of available materials. Simplified LCA studies have been incorporated according to current methodologies and standards. The aim of these LCA studies was primarily to reveal key impact hotspots and to propose an ideal application of the methodology for the ski industry. Furthermore, the possibility of using LCA methods for future development projections was investigated. Lastly, a calculation system was designed, which includes specific processes in the operation of ski resorts, such as snow production or slope maintenance. It is necessary to point out that the complete study exceeds the possibilities and scope of a diploma thesis. Therefore, the main output and contribution of this diploma thesis is primarily the proposal of a methodological procedure for a future study, which would eventually be processed as a doctoral dissertation study or as a scientific project.

Key words: Environmental Impact, Mountain resort tourism, Outdoor sports, Skiing, Environmental education, Environmental problems awareness, S-LCA, E-LCA, LCC, LCSA, Snowmaking, Ski industry projection

Možné využití principů LCA k posouzení vlivu lyžařského průmyslu a projektování jeho budoucího rozvoje

Souhrn

Tato diplomová práce zkoumá možnosti aplikace LCA metod na hodnocení lyžařského průmyslu. Cílem práce je vnést do často napjaté debaty mezi ekology a zástupci lyžařských středisek nástroj, který by objektivně hodnotil jak pozitivní tak negativní dopady lyžařského turismu. Tato práce nehodnotí konkrétní lyžařský areál, ale zůstává v obecné rovině, ve které bylo možno získat více vstupních dat. Autor této práce odpracoval přes dvacet sezón v lyžařském průmyslu, takže se v této diplomové práci mísí jeho zkušenosti s informacemi získanými detailní rešerší dostupných materiálů. Podle aktuálních metodik a standardů byly zpracovány zjednodušené LCA studie. Cílem těchto LCA studií bylo především odhalení klíčových oblastí a navržení ideální aplikace metodiky pro lyžařský průmysl. Dále byla zkoumána možnost využití LCA metod k projekcím budoucího vývoje. Také byl navržen systém výpočtu, který zahrnuje specifické procesy v provozu lyžařských středisek jako je například výroba sněhu nebo úprava sjezdovek. Je nutné podotknout, že kompletní studie přesahuje možnosti a rozsah diplomové práce a proto hlavním výstupem a přínosem této diplomové práce je především návrh metodického postupu pro budoucí studii, která by byla případně zpracována v rámci doktorantského studia nebo v rámci odborného projektu.

Klíčová slova: Dopad na životní prostředí, Turismus v horských střediscích, Outdoorové sporty, Lyžování, Environmentální vzdělávání, Povědomí o environmentálních problémech S-LCA, E-LCA, LCC, LCSA, Umělé zasněžování, Projekce v lyžařském průmyslu

Contents

Contents	8
1. Introduction	11
2. Objectives of the diploma thesis	13
3. Methodology	14
3.1. Review of the scientific literature	14
3.2. Case study	14
4. Review of scientific literature	15
4.1. LCA methods	15
4.1.1. Types of LCA.....	15
4.1.2. History of LCA	16
4.1.3. ISO	17
4.2. E-LCA and general LCA concepts	18
4.2.1. Goal of the study	18
4.2.2. Scope of the study	18
4.2.3. Life Cycle Inventory (LCI) Analysis	20
4.2.4. Life Cycle Impact assessment (LCIA).....	21
4.2.5. Life Cycle Interpretation	23
4.3. SLCA	23
4.3.1. Conducting S-LCA – Goal and scope.....	24
4.3.2. Conducting S-LCA – Inventory	25
4.3.3. Conducting S-LCA – Impact assessment.....	25
4.3.4. Conducting S-LCA – Interpretation.....	27
4.4. LCC	27
4.4.1. Types of LCC.....	27
4.4.2. Important aspects in LCC	28
4.4.3. Conducting LCC	28
4.5. LCSA	29
4.5.1. Conducting LCSA – Goal and scope	30
4.5.2. Conducting LCSA – Inventory, Impact analysis and Interpretation	31
4.6. Tourism and Ski industry	31
4.6.1. Ski industry in the Czech Republic.....	32
4.6.2. Winter sports classification	33
4.6.3. The environmental impact of winter sports	33
4.7. Ski resort operation – lifts and slope preparations	35
4.7.1. Ski lift technologies	35

4.7.2.	Snowmaking systems	37
4.7.3.	Slope preparation	40
4.8.	LCA and other assessment methods in tourism	41
4.8.1.	Application of LCA in tourism	41
4.8.2.	Categorization in tourism	42
4.8.3.	Limitations of LCA application in tourism	42
4.8.4.	Other assessment approaches in tourism	43
4.9.	Transportation.....	44
4.9.1.	Holistic approach to assess the transportation impact	44
4.9.2.	Engines, fuels and batteries.....	46
4.9.3.	Transportation conclusion.....	47
4.10.	Projections of future development	48
4.10.1.	Climate projections	48
4.10.2.	Energetic projections.....	49
4.10.3.	Environmental Impact Assessment – EIA	51
4.10.4.	Projections in the ski industry	52
5.	Case study	54
5.1.	The most important specifics of the ski industry	54
5.1.1.	Definition of the ski resort	54
5.1.2.	Skiing culture	55
5.1.3.	Seasonality	55
5.2.	Preliminary evaluation	56
5.2.1.	Study type	56
5.2.2.	Choice of LCA method	57
5.2.3.	Verification of study feasibility	57
5.3.	Case study settings	58
5.3.1.	LCA for cross-country skiing and ski touring	61
5.3.2.	Possible FU alternatives in LCA studies settings	62
5.3.3.	Possible boundaries settings.....	65
5.4.	S-LCA – Ski industry overview	66
5.4.1.	Preface to the Guidelines application.....	66
5.4.2.	Goals	66
5.4.3.	Scope and service definition	66
5.4.4.	Functional Unit	67
5.4.5.	System boundaries	67
5.4.6.	Cut-off criteria.....	68
5.4.7.	Stakeholders and impact subcategories.....	69
5.4.8.	Collecting data	71

5.4.9. Basic assessment of social hotspots	71
5.5. Suggestion of calculation model.....	74
5.5.1. Input data.....	75
5.5.2. Accommodation	79
5.5.3. Transportation	80
5.5.4. Interconnection between LCA methods.....	81
5.5.5. Using the basic input calculation model	82
5.5.6. Using the energy projection calculation model.....	87
5.5.7. Calculation model conclusion.....	89
6. Summary of the study objectives	90
7. Discussion	91
8. Conclusion.....	93
9. References.....	95
10. List of abbreviations	103
11. List of Figures.....	104
12. List of Tables	108
13. Annex 1 – Snowmaking system	109
14. Annex 2 – Questionnaire.....	111
15. Annex 3 – Details of modeled scenarios	113
15.1. Model scenario one	113
15.2. Model Scenario two	116
15.3. Model Scenario three	117
15.4. Using the energy projection calculation model.....	121

1. Introduction

“The sustainability revolution will, hopefully, be the third major social and economic turning point in human history, following the Neolithic revolution – moving from hunter-gathering to farming and the industrial revolution.”

King Charles of Great Britain

The Quote from King Charles reminds us of two main society developments in our past, the Neolithic and industrial revolutions. All disturbing information about natural resource depletion, pollution, or global warming give truth to King Charles' words. There is a need to re-evaluate many human activities and practices so that future generations can live peacefully on planet Earth.

Unfortunately, our public space is flooded by much false information that is contradictory to actual research results. Therefore, qualified debate based on adequate methodology is necessary. Life cycle assessment (LCA) methods are the most suitable because they consider the entire life cycle of products or services, from the cradle to the grave. These methods quantify the broad impact of such products or services and are therefore already used by the European Commission's Strategy for Sustainable Consumption and Production (Shaked et al. 2015). LCA methods evolved from an environmental impact-oriented approach to a complex system of methods that can be applied to assess all three major pillars of sustainability: economy, society, and ecology.

Tourism has traditionally been assessed by other tools, primarily from the socioeconomic perspective. Its environmental impact has generally been either underestimated or merely observed locally. Toward the end of the twentieth century, more holistic assessment approaches began to be used, identifying the entire range of impacts associated with tourism (Filimonau 2016). LCA methods, whose implementation reveals greater interconnections among various stakeholders, are still uncommon in tourism research, most of which uses reduced LCA methodologies because full LCA is very time-consuming and expensive.

Even when compared to other tourism services, the ski industry is highly complex. The conflict between the ski industry and various environmental groups makes it difficult for scientists to obtain accurate data directly from ski resorts (Cetara, Angelini 2006). In the area of the Giant Mountains, representatives from ski resorts are extremely cautious about sharing

any kind of information, especially that which is related to environmental impact. Despite the fact that the ski industry contributes approximately 10 billion (0.6% of the Czech GDP) and employs 36,000 people (AHS-KPMG ©2014), some studies analysing the environmental impact even contradict facts about the social and economic benefits (Flousek 2016). As a result, scientific investigations rely on external data, as in the case of the study on snowmaking problems in the Giant Mountains, where data about water pumping is acquired by the difference in values above and below the pumping point (Tremel 2022).

LCA methods, and particularly the Life Cycle Sustainability Assessment (LCSA) method, have a lot of potential to bring clarity to this discussion. However, the power of this tool must be understood by ski industry leaders and at the same time respected by ecological activists. When LCA methodologies are utilised as part of a dynamic assessment with numerous scenarios for future development projections, they can become an even more powerful tool. As the ski business is one of the industries most affected by global warming and global crises such as the recent COVID-19 pandemic, such a tool has the potential to attract all stakeholders.

Initially, the goal of this diploma thesis was to conduct a simplified but complete LCA study at one of the major Czech ski resorts. However, after a two-year period of employment at two major Czech ski resorts, the author has decided to give up the effort to gather real data due to the lack of collaboration from ski resort stakeholders and has shifted the focus of the work to an overall evaluation of the usability of LCA methods and the design of a methodology for future research. The author hopes that his work will persuade concerned parties of the usefulness of LCA studies and pave the road for improved data sharing.

2. Objectives of the diploma thesis

The primary objective of this diploma thesis is to evaluate the potential application of LCA methods in the ski industry by weighing up their benefits and drawbacks.

Following objectives are researched:

- Environmental Life Cycle Assessment (E-LCA).
 - The possibility of utilising the same boundary and Functional Unit (FU) setting as in other LCA methods to provide usable data for LCSA.
 - Optimal settings and key categories.
- Social Life Cycle Assessment (S-LCA).
 - The possibility of utilising the same boundary and FU settings as in E-LCA to provide usable data for LCSA.
 - Usage of positive impact categories.
- Life Cycle Costing (LCC).
 - The possibility of utilising the same boundary and FU settings as in E-LCA to provide usable data for LCSA.
- Life Cycle Sustainability Assessment (LCSA).
 - A comparison of different settings and their advantages and disadvantages.

Another objective is to assess the use of LCA principles for projections. The following questions are investigated:

- How to set up a dynamic model for LCA methods?
- Which elements of the ski industry supply chain should be emphasized?
- How to implement the following complex key variables into the calculation?
 - Climate change (temperature).
 - Electricity production development.

The final objective is to suggest a calculation model for any given ski resort. Yet, for such a complex model, the scope of this diploma thesis has substantial limitations.

3. Methodology

3.1. Review of the scientific literature

The first section of the thesis provides a scientific literature review, which evaluates state-of-the-art LCA approaches, particularly in sectors related to the ski industry. Furthermore, an overview of the tourism and ski industry was conducted using available sources of information. Lastly, projection studies applicable to the modelling of the ski industry's development were explored. An iterative approach was applied due to the vast scale of the information gathered. After the case study was conducted, the literature review was shortened to fit the boundaries of the diploma thesis.

The literature review has two main objectives. First it provides an introductory summary of the problems involved. Second, it gathers data and values that are later used for calculations in the case study. Thus, the literature review was written in stages as information about key segments in the ski industry were discovered.

3.2. Case study

Important elements in the ski industry are identified using E-LCA, S-LCA and LCC methods, and potential research settings are suggested to ensure the most accurate results. LCSA is ultimately carried out by merging these earlier LCA methods (E-LCA, S-LCA and LCC). The ski industry takes great care to protect its data; thus, this work uses data from public and anonymous sources in the industry. Therefore, the case study does not reflect any particular ski town or resort. Nevertheless, the majority of the data comes from the Giant Mountains region.

The case study was carried out in compliance with ISO 14040 and 14044, as well as individual method standards and guidelines. Details of methodology are part of the case study, as one of the objectives of this thesis is to evaluate possible utilisation of LCA methods and suggest appropriate application of the methodology.

4. Review of scientific literature

This diploma thesis covers a broad topic. The review was done on two levels. Firstly, the general information and guidelines were studied, and secondly, specific studies related to the topic were investigated. It was discovered that there aren't many LCA studies being conducted in the ski industry; therefore, other LCA studies were investigated to identify similar studies that could serve as models or sources of data for the upcoming case study.

4.1.LCA methods

This chapter describes different LCA methods. Since some of the terminologies used in this thesis may have slightly different meanings as LCA principles evolve over time, it is crucial to define them up front. In this thesis, LCA stands for life cycle assessment, however the same abbreviation can also be found as life cycle analysis with the same meaning in another study (Jacob-Lopes et al. 2021). Historically, the LCA abbreviation was used for E-LCA. With the development of other LCA methods, E-LCA started to be used to distinguish between the designation of an overall concept, and one particular method. This work adopts the same distinction and uses both abbreviations, as can be found, for example, in "Review on Social Life Cycle Assessment" (Quintana Cayuelas 2013).

4.1.1. Types of LCA

The term life cycle thinking (LCT) can be defined as an approach that considers all elements of sustainability of a product or service over the duration of its whole life (Farjana et al. 2021). Sustainable development and LCT are closely related concepts. The three main pillars of sustainability are the economy, society, and environment (Mazzi 2020). In the context of LCT, these three pillars are represented by Environmental Life Cycle Assessment (E-LCA), Social Life Cycle Assessment (S-LCA), and Life Cycle Costing (LCC) respectively. The sum of these three methods forms is the Life Cycle Sustainability Assessment (LCSA) (Guinée 2016). Individual methods will be explained in the following chapters. For a better understanding of the terms in this chapter, see figure 1, where LCT is depicted as an

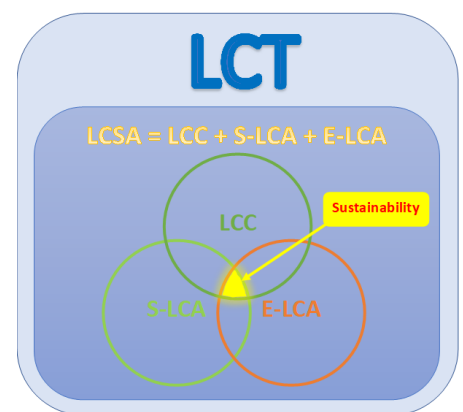

Figure 1 - Graphic representation of the LCA terms used in this work and their interconnections

overall thinking concept, LCSA as the sum of other methods, and sustainability as the intersection of these methods. Another graphical explanation is presented in figure 2.

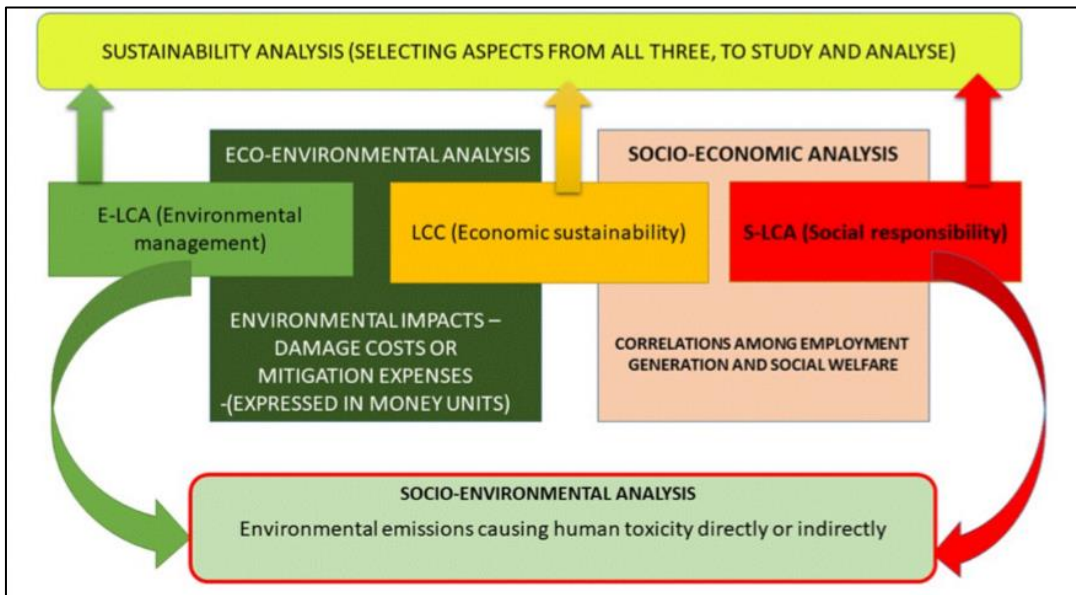

Figure 2 - Graphic explanation of the interconnections between LCA methods (Govindarajan 2018).

4.1.2. History of LCA

This diploma thesis is dedicated to sustainability through LCA methods. The word “sustainability” was used for the first time by Hans Carl von Carlowitz in his book, *Sylvicultura Oeconomica (Silviculture and Economics)* in the year 1713 (Brüggemeier 2019). From the perspective of LCA, LCC concepts had already appeared in the United States (US) in the 1930s. The concept emerged in agriculture and later found use in other sectors, such as weaponry. However, the first LCA methodology didn't come until the late 1980s (Hunkeler et al. 2008).

LCA can be traced back to 1972, when the first LCA study on bottle packing was conducted in the US. The International Organization for Standardization (ISO), the United Nations Environment Program (UNEP), and the Society of Environmental Toxicology and Chemistry (SETAC) were the three primary institutions that contributed to the creation and standardization of LCA (Shaked et al 2015). A significant role was played by the Centre of Environmental Science at Leiden University in the Netherlands. Their methodology, published in 1992, is considered a breakthrough by experts (Gabathuler 1997). One of the crucial elements for future development was the “peer review” for LCA that SETAC suggested in 1993 in a document called “Code of Practise” (Klöpffer 2012). However, the most important work was done by the ISO Technical Committee from the year 1993 until the UN CEFAC Steering Group meeting in Geneva in 1997. Overall, 37 nations (97% of voting nations) agreed on a set

of International Standards named "Environmental Management - Life Cycle Assessment - Principles and Framework," also known as ISO 14040 (Marsmann 1997).

4.1.3. ISO

ISO is an independent, non-governmental organization financed by subscription fees from its country members based in Geneva, Switzerland. It serves as a platform for knowledge exchange and the creation of consensus-based standards to assist innovations and tackle global issues (ISO). ISO standards 14040 – 14043 were developed between 1997 and 2000. As shown in figure 3, an upgrade in 2006 consolidated these standards into ISO 14040 (LCA – principles and framework) and ISO 14044 (LCA – requirements and guidelines) (Finkbeiner 2006). The quantity of criticism levelled against the earlier standards significantly decreased as a result of consolidation (Pryshlakivsky, Searcy 2013).

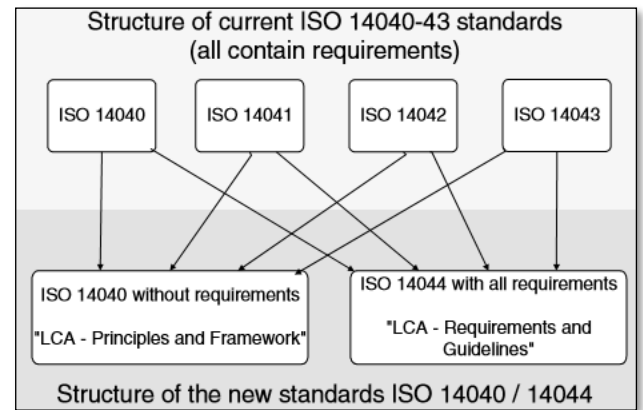

Figure 3– Consolidation of ISO standards (Finkbeiner et al. 2006)

These two standards are related to each other and serve as reference standards for other specialised norms (e.g., ISO 14067 – Carbon footprint) (Klöpffer 2012). ISO has also launched the 14070 series, which has been designed primarily to assess organizational environmental performance (e.g. ISO 14072:2014 Environmental management – Life cycle assessment – Requirements and guidelines for organizational life cycle assessment) (Filimonau 2016). So far, the most recent upgrade occurred in 2020. This revision brought minor changes and is considered useful but is also referred to as a "lost opportunity" as some of the major problems of LCA analysis, such as the omission of the system expansion, were not solved (Heijungs et al. 2021). The case study for this diploma thesis is based on ISO standards 14040 and 14044. More references will appear throughout the work.

4.2. E-LCA and general LCA concepts

This chapter introduces the main concept of LCA analysis. Originally it was developed for E-LCA but the basic framework is also used for other methods. There are differences between the applications, but mostly in the interpretation of different LCA methods. LCC provides numerical results expressed in monetary units. E-LCA also

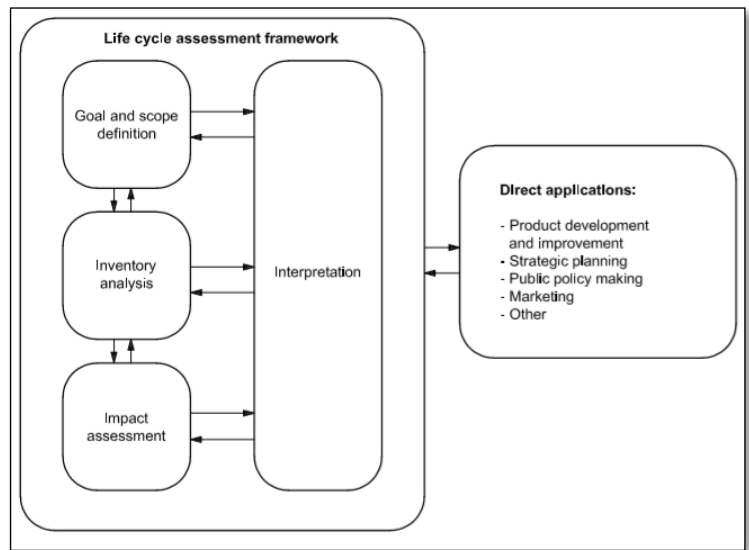

Figure 4 – Stages of LCA (CSI ©2006a).

produces numerical results, but interpreting and aggregating them is difficult. S-LCA provides only some numerical results. Instead, it offers meta-information about social hot spots (Traverso et al. 2020). However, the main process based on the LCT concept remains the same. The basic guideline for all of the methods is ISO 14040 and 14044.

4.2.1. Goal of the study

Every LCA study must start with study objectives. This descriptive section of the work is critical because it affects all subsequent steps. The reason for carrying out the study and its further application must be explained to whomever it is going to serve as well as whether it is going to be used as a comparative study (CSI ©2006b; Shaked et al. 2015). To avoid ambiguity, more information regarding the evaluated product or service should be included. The purpose could be to analyse an existing or new product. It should be specified whether the outcome will be utilised solely for description, regulation, or to support a political decision or strategic management planning (Shaked et al. 2015).

4.2.2. Scope of the study

The goal of the research study can be summarised in a few sentences, while the scope of the study can span several pages. ISO 14044 defines 14 elements that must be considered and described. Only those relevant to the case of this thesis are detailed.

System Function, Functional Unit and Reference flow

The System Function and the FU are closely related. Because a system can have multiple functions, describing its function is not always easy. In complicated cases, the main and secondary functions should be defined (Shaked et al. 2015). The FU provides normalised mathematical results that meet the goal and scope of a particular study (CSI ©2006b). Some examples of the FU and its settings are shown in tables [3](#), [4](#) and [5](#). "Product tree, flowchart or flow diagram" is a concept that is frequently used to provide graphical explanation of a product or service system. It is a diagram that shows all the processes that occur during the life of a product or service, as well as their interconnections (Klöpffer, Grahl 2014). There are several graphical ways to depict the flowchart. An example can be seen in the case study in figure 35. The Reference Flow is another term used to describe the studied system. The reference flows for a given FU are the quantity of products or services acquired to perform the function and generate the FU (Shaked et al. 2015). For a better understanding see Table 1.

System	FU (Service Offered)	Reference Flows (What is Purchased)	Key Parameters (Linking Reference Flows to FU)
Ski resort visit	1 day spent in resort by one guest	1/7 of the holiday (week holiday)	Length of the stay
Ski lift	Vertical metres by ski lift (e.g., 1000m) by one passenger	Total energy consumption of the 1000m (vertical) lift divided by the number of transported guests	Vertical distance covered by lift Actual number of transported guests per time unit. Energy consumption of the lift per person or mass unit related to different occupancy
Snowmaking	1 m ³ of snow	Amount of water used in ideal conditions Amount of water used in bad conditions	Coefficients for conditions

Table 1 – Example of FU, Reference flow, and Key parameters (inspired by (Shaked et al. 2015))

System Boundaries and Cut-off criteria

While modelling the system, the system boundaries define which individual elements are included or excluded. The main processes that need to be considered are depicted in figure 5. These are intended to preferably encompass all the needed processes, from the cradle to the

grave, to accomplish the function of LCA. However, due to the broad scope of the researched service, this may become extremely complicated, as it did in this thesis' case study (see figures 32 and 33) (Shaked et al. 2015). Boundaries are often determined as either temporal or geographical (Klöpffer, Grahl 2014). Aside from the accuracy of the results, system boundaries define the study's time consumption.

System boundaries are further defined by cut-off criteria that exclude parts of the system or individual processes that are unimportant in terms of the final results. ISO 14044 states three cut-off criteria: mass, energy and environmental relevance. A proportion under 1% of the overall system is often used as the cut-off value (CSI ©2006b; Klöpffer, Grahl 2014).

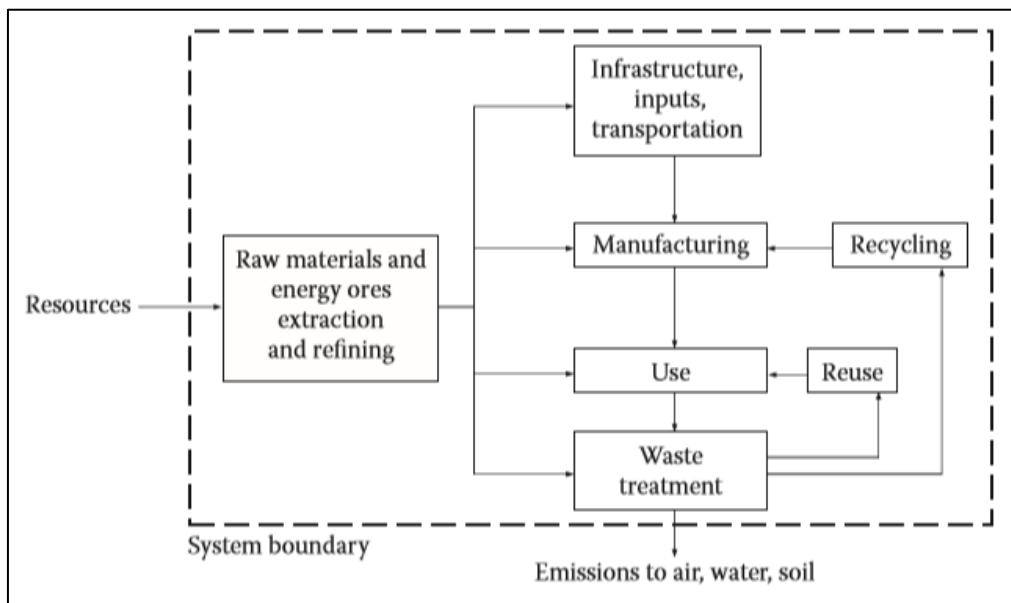

Figure 5 - Flowchart of major processes and stages in the life cycle of a product (Shaked et al. 2015)

4.2.3. Life Cycle Inventory (LCI) Analysis

The LCI phase contains data collection and its first quantification and assessment. LCA is an iterative method, so during LCI new facts about the system may be found, requiring an adjustment of scope and even goals to be considered (CSI ©2006a). Two main methods for LCI are proposed (Shaked et al. 2015):

- **A process-based approach**, which searches for inputs and direct emissions for each process unit. By summing all of the reference flows and FU, the total emissions and extractions are calculated.
- **An input-output approach**, which calculates the energy consumption, extraction and emissions based on monetary flows generated in the various economic sectors engaged

in the researched product or service. This approach yields less detailed but more comprehensive results.

There are various databases for both approaches. The correctness and volume content of these databases are critical for reliable outcomes. More rules on how to collect and allocate data are found in ISO 14040, and in the guidelines cited in this chapter.

4.2.4. Life Cycle Impact assessment (LCIA)

The goal of LCIA is to evaluate the magnitude and importance of potential environmental impacts through the assignment of LCI results to impact categories (Klöpffer, Grahl 2014). According to ISO 14044 and 14040, LCIA has mandatory and optional elements which are graphically depicted in figure 6. LCA methodology is fragmented into midpoint and endpoint levels, with impact categories belonging to the midpoint level (see figure 7).

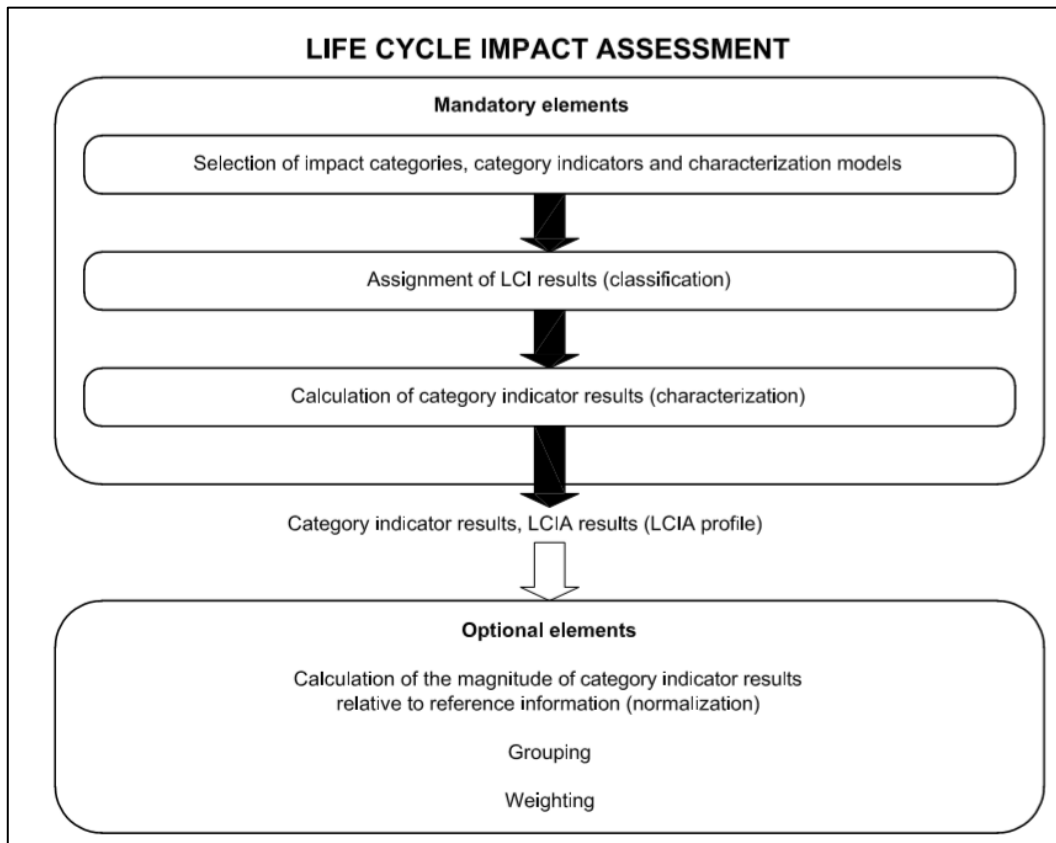

Figure 6 – Elements of the LCIA phase (CSI ©2006a)

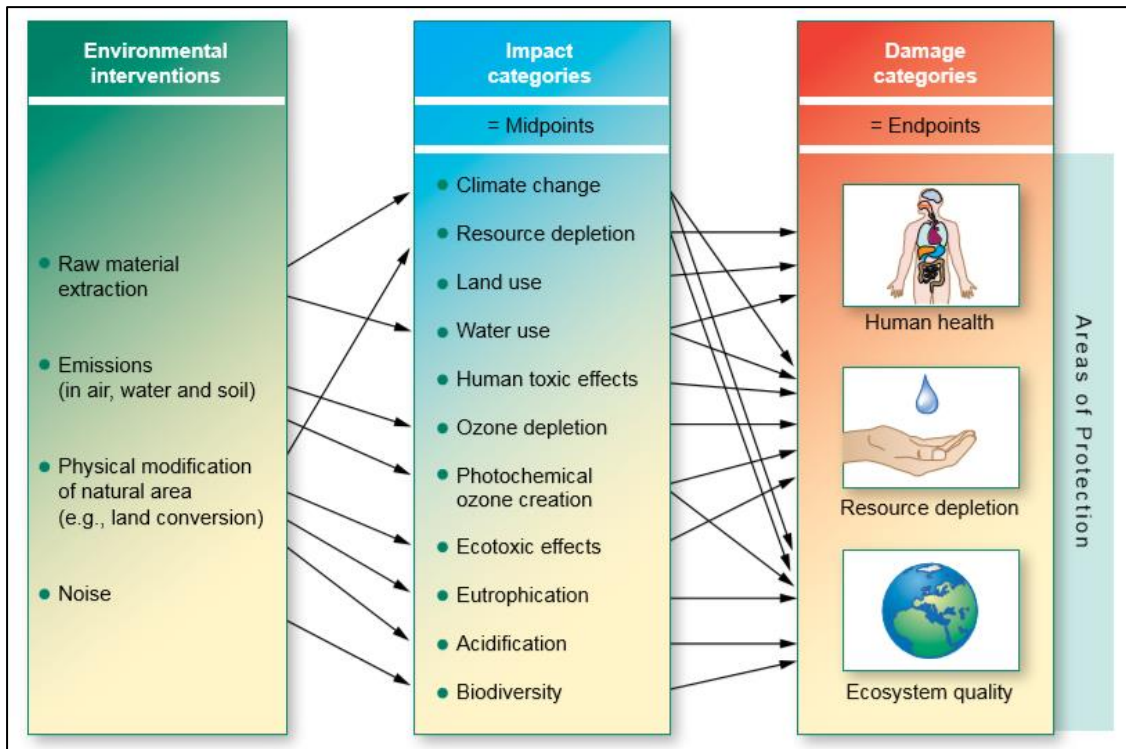

Figure 7 – Linkage of LCI results via midpoint categories to damage categories (Ciroth et al. 2011)

Impact categories, category indicators and characterization models

The choice of the impact categories and category indicators must reflect the goal and scope of the studied system. For better understanding see the figure 8, which describes all concepts based on environmental mechanism. There are existing impact categories, category indicators and models to choose from. However, if none of the existing ones are suitable, new ones can be defined. The characterization model derives characterization factors that describe the relationship between LCI and category indicators (CSI ©2006b).

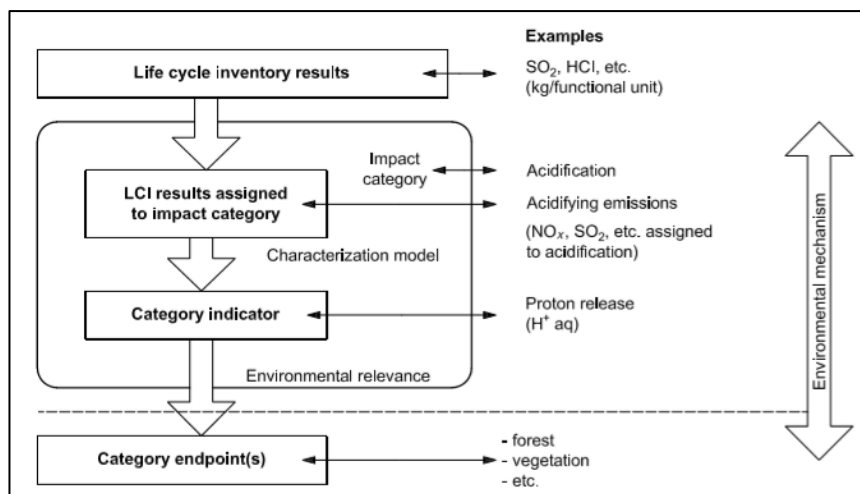

Figure 8 – Concept of category indicators (CSI ©2006b)

4.2.5. Life Cycle Interpretation

Life cycle interpretation explains results of a conducted study. Interpretation must be carefully performed, as it corresponds to inputs and outputs and not to actual environmental impact. It should also re-evaluate the study's setup (system function, FU and system boundary) and identify limitations using data quality evaluation and sensitivity analysis. The steps that follow are involved in interpretation (CSI ©2006b):

- **Identification of the significant issues** based on previous LCA steps.
- **Evaluation to boost confidence in reliability of results:** the completeness check, sensitivity check and consistency check are used as evaluation techniques.
- Conclusions, limitations, and recommendations.

LCA software, databases, methods

Several software programs exist to perform LCA. The main commercial software programs are SimaPro and Gabi, while free software programs include OpenLCA (Shaked et al. 2015). OpenLCA software can be used for calculations of E-LCA, LCC, S-LCA, carbon and water footprints, and some ecolabelling calculations (Dr A. Ciroth 2020). OpenLCA offers several free databases, but they offer only a limited amount of data. In this thesis, the Ecoinvent database was used. Conducting LCA requires a choice of adequate impact assessment methods. In Europe, a commonly used method is ReCiPe 2016, created by cooperation between a few universities in the Netherlands (Huijbregts et al. 2016).

4.3.SLCA

S-LCA research focuses on the concept of human well-being. The definition of well-being was already broached by great men such as Aristotle. S-LCA transforms the abstract concept of well-being into a mathematical and quantitative approach based on socioeconomic data (Muthu 2014). The second half of the 1990s saw the beginning of discussion on the inclusion of social aspects in LCA studies. At the turn of the century the first approaches contained social criteria. Several of them were named S-LCA studies. The 2004 SETAC European Conference in Prague saw the formation of a working group for S-LCA guidelines. As a result of their work, "Guidelines for Social Life Cycle Assessment of Products" was published in 2009 (Andrews 2009). However, the new guidelines by UNEP, which serve as the primary source of information for this thesis, were released in 2020. It is beyond the scope of this thesis to provide all the necessary information to fully study S-LCA.

The new guidelines define S-LCA as follows: “*S-LCA is a methodology to assess the social impacts of products and services across their life cycle (e.g., from extraction of raw material to the end-of-life phase, e.g., disposal).*” In recent years, Social Organizational LCA (SO-LCA) has been developed to assess not only products or services but all organizations (Benoît Norris 2020).

4.3.1. Conducting S-LCA – Goal and scope

Before the new guidelines were published, several approaches were adopted by various scientists. In his book Muthu (2014) lists the major approaches and case studies. Norris’s SLCA is based on life expectancy, where economic income from industry is taken as a positive aspect and pollution from industry causing illnesses is a negative aspect. Another SLCA method listed is Dreyer’s SLCA, which is based on personal interview surveys, or Weidema’s SLCA, which deals with adverse health effects. The new guidelines very effectively integrate the previously uncompact world of S-LCA. The Following paragraphs summarize the basic steps to conduct S-LCA according to the Guidelines for Social Life Cycle Assessment of Products (Benoît Norris et al. 2020).

Two main approaches are suggested:

- The Reference Scale Approach (RS SLCIA), which focuses on social risk and social performance.
- The Impact Pathway Approach (IP SLCIA), which focuses on the social impact of the product system.

The ISO 14040 framework is basis for S-LCA and is therefore also built on the four fundamental LCA phases, as shown in figure 4. S-LCA is an iterative process, therefore repeated evaluation can greatly improve the quality of the results. Defining the scope and goal, including the FU choice and product flow, is very similar to the process used in E-LCA and fundamentally affects result of the whole study.

An S-LCA evaluation is built around the stakeholder categories. The Guidelines suggest these categories: Workers, Local communities, Value chain actors (e.g., suppliers), Consumers, Children, and Society. Other categories would need to be reasonably justified. The case study in [figure 36](#) contains an example of stakeholder categories (Benoît Norris et al. 2020).

The impact categories are the next level of S-LCA. Common impact categories include Human rights, Working conditions, Cultural heritage, Governance, and Socioeconomic

ramifications. Four reference scale approach subcategories are used, where we find, for example, "a fair salary" and "hours of work" linked to the impact category "working conditions." The guidelines include a more comprehensive list of potential categories and subcategories. The S-LCA framework, as well as stakeholder and impact categories, show clear links to the 17 Sustainable Development Goals according to United Nations (Benoît Norris et al. 2020).

4.3.2. Conducting S-LCA – Inventory

The studied system must be divided into interconnected processes with assigned flow amounts (e.g., energy consumed for the process unit). For this calculation and modelling background system, LCI databases are commonly used. Afterward, total amounts for reference flow are quantified. However, systems can also be divided into sectors (Benoît Norris et al. 2020). The sector approach is used in this thesis' case study.

Data collection for S-LCA is often not easy. Apart from gathering the data directly from the investigated process, databases such as the Product Social Impact Life Cycle Assessment database and the Social Hotspot Database are used. These two databases are the most used, but there are others to be found. Another option is to gain data from non-profit organizations and international organizations such as the United Nations statistical division, the OECD (Organization for Economic Co-operation and Development), or the World Bank databases (Harmens et al. 2022).

4.3.3. Conducting S-LCA – Impact assessment

The Impact assessment part differs significantly in its two main approaches: the RS S-LCIA focuses on social performance or social risk; and the IP S-LCIA is based on the cause-effect chain to assess social impacts (Benoît Norris et al. 2020).

RS S-LCIA can be divided in following steps (Benoît Norris et al. 2020):

- Accessing data against the reference scale –a critical step is to sort the data collected in the inventory phase. We use scales to assess social performance or risk (see figures 9 and 10).
- Applying the activity variable (optional).
- Final weighting of results (optional).





Scale level	Description
	Very high risk
	High risk
	Medium risk
	Low risk

Figure 9 – Example of reference scale for social risk evaluation (Benoît Norris et al. 2020)

The IP S-LCIA is in many ways similar to the E-LCA approach and therefore is more suitable for LCSA. Beside the RS S-LCIA approach IP S-LCIA doesn't focus primarily on stakeholder categories but it evaluates social impacts by midpoint and/or endpoint indicators. This approach works overwhelmingly with negative impacts (Benoît Norris et al. 2020).

Scale level	Description
	Ideal performance. Best in class
	Beyond compliance
	Compliance with local and international laws and/or basic societal expectations
	Slightly below compliance level
	Starkly below compliance level

Figure 10 – Example of reference for social performance evaluation (Benoît Norris et al. 2020)

4.3.4. Conducting S-LCA – Interpretation

Several steps should be performed in the Interpretation phase (Benoît Norris et al. 2020):

- Completeness check – reviews all assessment phases.
- Consistency check – ensures that chosen methods are consistently used.
- Sensitivity and data quality check – this step evaluates a role of assumptions made during previous phases.
- Materiality assessment – determines significant social impacts, performances, stakeholder categories, etc.
- Critical review – an independent review is recommended to enhance a credibility.
- Conclusions, limitations, and recommendations – the main questions set by the goal of the study should be answered.

4.4.LCC

LCC can be defined as the sum of all expenses related to a product's life cycle, with expenses linked to real money. A particular study can cover one or more actors along the life cycle chain (Hunkeler et al. 2008). However, terminology inconsistencies can be found, as some researchers interpret LCC as an assessment of all actors, not just one (Kambanou, Lindahl 2016). Preferring one actor, Govindarajan's explanation of LCC as the total cost of ownership, which is the sum of the initial cost, operation and maintenance expenses, and disposal costs, can serve for better understanding (Reddy 2015). LCC is a powerful tool that can contribute to cost reduction or the comparison of different options within a project or between different projects. Nonetheless, as with every LCA study, it can be very time-consuming, sensitive to data quality, and expansive (Dhillon 2009).

4.4.1. Types of LCC

There are three types of life-cycle costing (Hunkeler et al. 2008):

- **Conventional LCC** – is the original LCC method, which doesn't always include the entire life cycle of the product or service.
- **Environmental LCC (eLCC)** – is the method that follows the LCA framework (FU, boundaries, etc.) and is used as a complement to ELCA.

- **Societal LCC (sLCC)** – aims to encompass social and environmental impacts on a large set of stakeholders, which are also indirectly affected. It was developed for cost-benefit analysis.

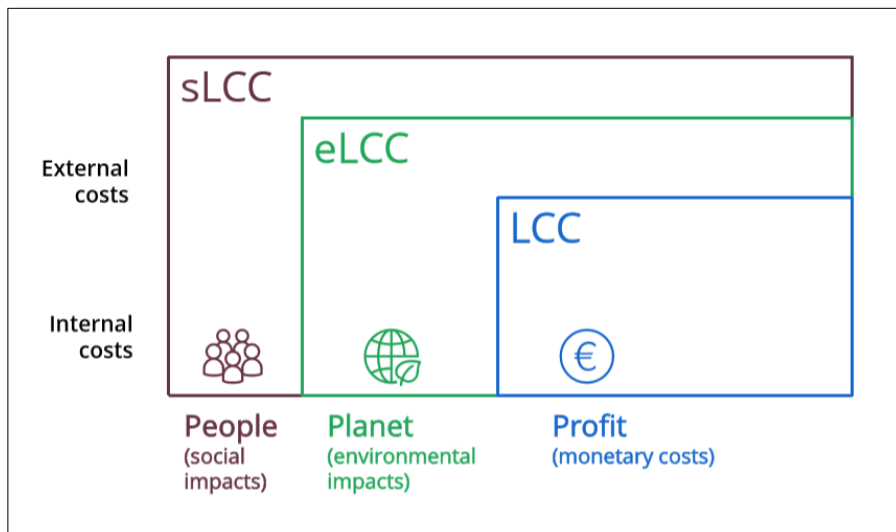

Figure 11 – Types of LCC (SimaPro ©2022)

4.4.2. Important aspects in LCC

It is divided into costs and revenues from the standpoint of the LCC. For practical reasons, revenues are frequently omitted from research. Costs can be further subdivided into external and internal costs, which can be allocated to initial costs, operating costs, maintenance costs, and disposal costs using LCT principles. External costs are typically ignored in conventional LCC, which is often performed from the perspective of only one stakeholder. On the other side, external costs are a substantial part of the sLCC and eLCC, and their integration is one of the key processes of these studies (Hunkeler et al. 2008).

4.4.3. Conducting LCC

LCC studies are conducted in a similar way to every other LCA study, using the same framework and stakeholder/process approach (see figure 12). However, proper application of this method, apart from knowledge of LCT principles, requires sufficient economic knowledge. LCC is quantified and calculated in monetary units (e.g., dollars or euros), which are direct impact values. Terms like “capital value” and “inflation” should

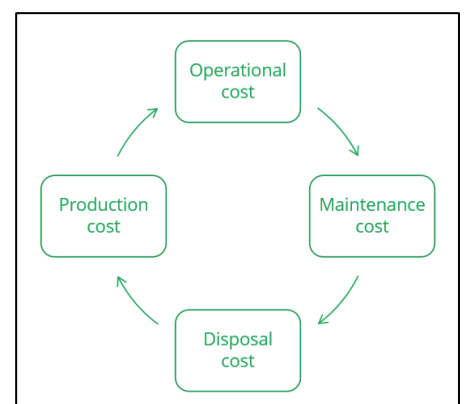

Figure 12- LCT approach LCC (SimaPro ©2022)

be absolutely clear to the person performing LCC. Another complicated part is including external impacts in the study (Hunkeler et al. 2008). Figure 13 depicts the complexity of LCC approaches, particularly when environmental and social impacts are included (Reddy 2015).

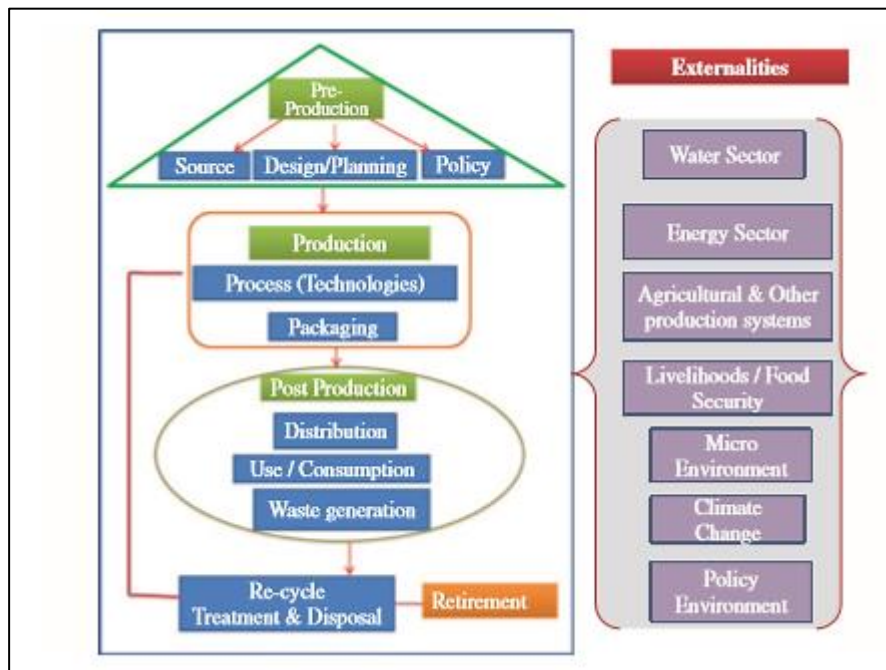

Figure 13 – LCC framework (Reddy 2015)

The sLCC typically uses a broader system boundary to encounter all possible impacts. A thorough analysis is important to correctly allocate all external and internal costs to avoid doubling or missing some. The difficulty of conducting sLCA significantly increases with an expanded time frame of analysis (Hunkeler et al. 2008). The eLCC can be understood as a tool alongside the E-LCA to cover economic aspects of environmental impacts.

4.5. LCSA

Klöpffer (2008) proposed a formula for a sustainability approach based on LCA methods. Based on a well-known sustainability model, often called the tripple-bottom-line, commonly known as “the three pillars of sustainability” (the environmental, economic and social pillars), he suggested following an LCT approach:

$$LCSA = LCA + LCC + SLCA$$

By giving a broader view of the benefits and drawbacks along the product life cycle, LCSA provides a better understanding of the interconnections between sustainability pillars. Therefore, it can significantly affect awareness of sustainability issues among stakeholders, companies, decision-makers, and product or service consumers. LCSA corresponds to ISO

14040 and 14044, which were discussed in Chapter 4.1.3. However, there are some specifications for conducting LCSA. The interpretation and assessment phases might be fairly complicated due to the different nature of particular LCA studies. Results of an LCSA study should help in describing the connections between economic benefits and social or environmental problems (Ciroth et al. 2011).

4.5.1. Conducting LCSA – Goal and scope

Setting the basic parameters of individual LCA studies should, from the beginning, be designed with the intended LCSA goal and scope in mind. It also includes the choice of an adequate FU for every LCA, ideally an identical FU for all of them, and one which covers LCA. The FU unit should describe the social and technical characteristics of the products or services. Boundary settings are clearly demonstrated in figure 14. LCAs should cover all processes relevant to at least one of the LCAs. The same approach should be applied to impact categories (Ciroth et al. 2011).

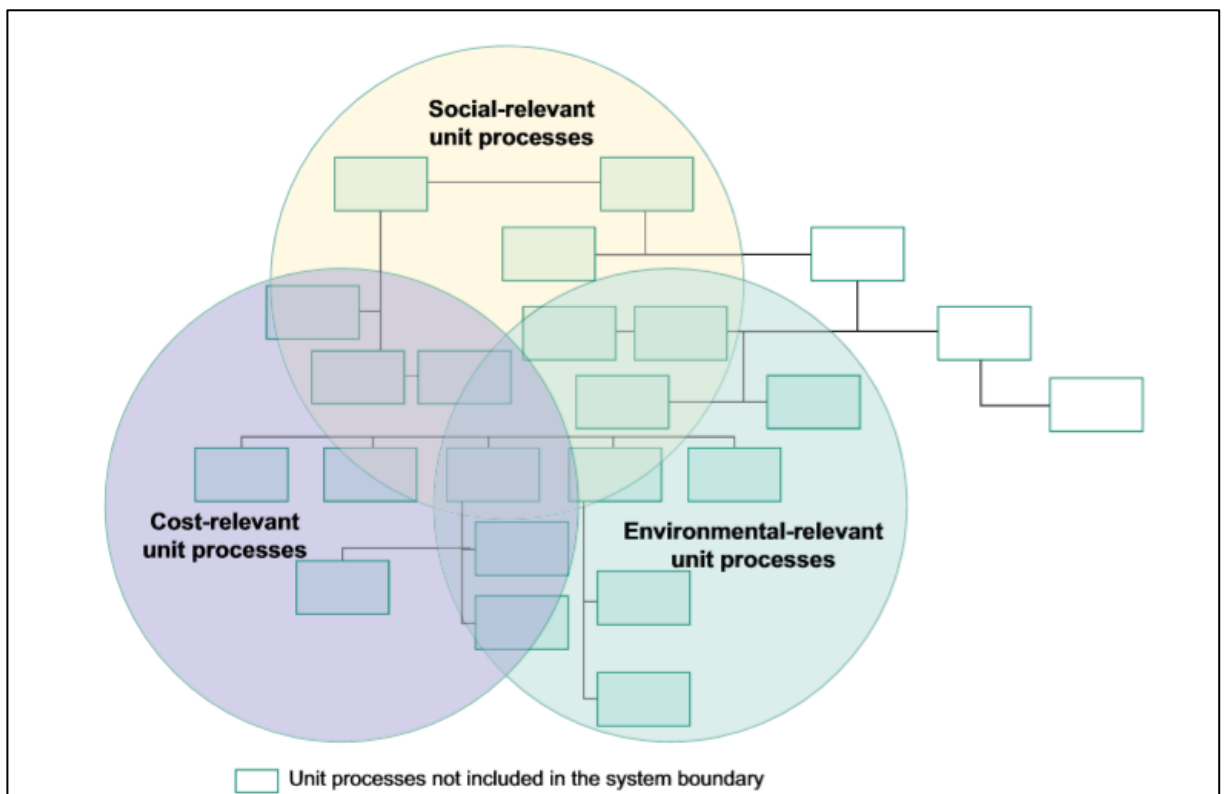

Figure 14 – System boundaries of LCSA (Ciroth et al. 2011)

4.5.2. Conducting LCSA – Inventory, Impact analysis and Interpretation

Data are collected at the level of a particular LCA method. As already mentioned, individual methods should be designed in order to fit the needs of LCSA. It is recommended to collect data at the process unit and organization levels to achieve better consistency (see Figure 15). Due to the complicated or impossible aggregation of data from individual LCA methods, analysis and interpretation are often carried out by displaying the results of individual methods together (Ciroth et al. 2011).

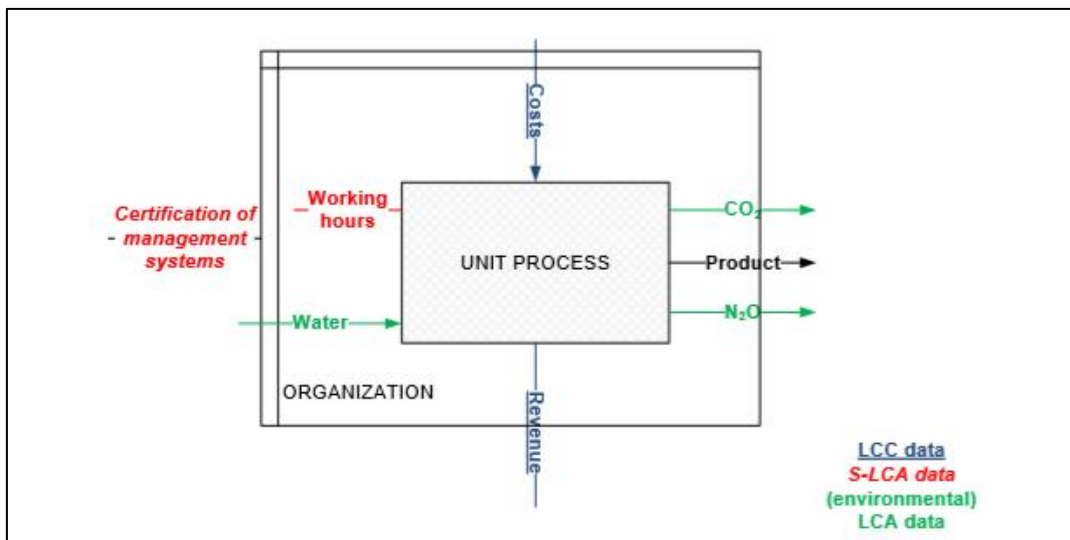

Figure 15 – Example of LCSA inventory data for unit process and organization levels (Ciroth et al. 2011)

4.6. Tourism and Ski industry

Tourism is an important sector of global economics. Before the COVID-19 pandemic, travel and tourism contributed 10.3% to global GDP (WTTC ©2022). According to the 2021 International Report on Snow & Mountain Tourism, there are 5716 outdoor ski areas in 68 countries worldwide, with 400 million skier visits yearly. There are also around 90 indoor ski centres operating (36 of them in China) (Vanat 2021). Due to its significance for the economies of many mountain areas, ski resorts must adapt their operations to the changing world. Climate change impact is a key factor that needs to be implemented in strategic planning. Besides other recommendations, the study from the UNWTO-UNEP recommends seasonal diversification, implementing more efficient snow-making systems, and improving ski-slope grooming to reduce snow depth requirements (Scott et al. 2008).

The majority of ski resorts are located in the northern hemisphere. Skiing in the southern hemisphere is limited to relatively small resorts in New Zealand, Australia, and South America, and very few resorts can be found in South Africa. Numerous European glacier ski resorts used

to be opened all year. Summer 2022 was the first season in European skiing history in which the general public was unable to ski during the entire summer. The same applied to specialised summer glacier resorts such as the Folgefonna Glacier in Norway. In the Alps, only a few glacier resorts remained open and offered training slopes for sports teams.

4.6.1. Ski industry in the Czech Republic

Most of the data related to the socioeconomic state of the Czech ski industry and some technical data are sourced from the Association of Mountain Resorts (AHS). Skiing has a long tradition in the Czech Republic, as the first ski race was held in 1893 and the first cable lift was opened in 1920. The Czech mountains do not reach high elevations (the highest mountain is Sněžka, at 1602 m), but the local climate provides considerably good snow conditions. The average snow season in the 49 ski resorts included in the survey was 113 days in the 2012-2013 season (AHS reports 92 active ski resorts as of 8 December 2021) (AHS-KPMG ©2015).

Ski resorts in the Czech Republic contribute 0.6% to the GDP (approximately 10 billion CZK). It employs 36,000 people. Almost 1 billion CZK was donated (85% from European foundations) for ski resort development and cross-country skiing tracks between 2007 and 2013 (AHS-KPMG ©2014). In terms of visitors, 81% are Czech; only 19% are foreign guests; over 40% are from Germany, followed by 33% from Poland. It is important to say that 60% of all foreign tourists head to the Giant Mountains (AHS-KPMG ©2015). The biggest ski resorts in the Czech Republic are listed in Table 2.

Ski resort	Number of Chairlifts/cable cars	Number of ground lifts	Capacity person/hour	Length of ski slopes (m)	Snowmaking percentage of slope length
Černá hora - Pec	8	43	50 304	50 200	74
Klínovec	5	16	25 930	31 400	68
Špindlerův Mlýn	6	11	21 293	27 000	72
Rokytnice nad Jizerou	2	22	15 365	21 500	71
Lipno	4	4	12 800	13 400	96

Table 2 – Table of major ski resorts in Czech Republic (AHSCR ©2021)

The AHS survey showed the main reason that tourists come to the mountain resort. Downhill skiing is cited as a primary reason by 80% of visitors while cross-country skiing attracts 8% of visitors (AHS-KPMG ©2015). This ratio might vary in different resorts according to cross-country track access and the quality of the slopes.

4.6.2. Winter sports classification

Winter sports can be classified in different ways. Hudson divides them into classical winter sports and alternative winter sports, where, for example, curling belongs to classical while snowboarding belongs to alternative (Hudson 2004). In the same source, Hudson later renames these categories as "traditional and contemporary (Hudson, Hudson 2015). One way to assess winter sport would be to follow the professional sports scene. Not all the winter sports that are present at the Olympic Games have relevance to the ski industry. The sport known as "skeleton sledding" is barely practised and is not known by the general public. However, ski jumping is also not common, but it plays a significant economic role for some ski resorts due to its popularity, which draws thousands of spectators (for example, at Bishopshofen or previously at Harachov). In the case of skeleton sledding or bobsledding, which are only performed by a small number of athletes, we find close relatives in snowtubing or general sledding, both of which are widely commercially supported activities in ski resorts. Sledding would also have a significant impact on the LCA study results, as the track must be groomed on a regular basis and guest transportation is required (for example, in Špindlerův Mlýn, customers are transported by diesel buses via the mountain road in the first zone of the national park).

However, this thesis focuses on skiing activities and the main emphasis is on downhill skiing, which also includes snowboarding, telemark skiing, and some fairly new activities involving ski bikes and snowskates. Simply put, this thesis covers all activities that utilise ski lifts and groomed slopes. The second activity reviewed in this thesis is cross-country skiing, which has lately changed from operating in untouched nature to a "jogging style" activity where participants require well-prepared tracks. The final assessed activity is ski touring (which includes splitboarding). Ski touring has grown significantly in popularity in recent years. Ski touring has the lowest demand on track preparation when participants search for untouched areas in the backcountry. However, there is a great deal of discussion on its environmental impact; for example, in the Giant Mountains, participants very often do not respect no-go zones in the national parks.

4.6.3. The environmental impact of winter sports

The source of information for this chapter is a report from Flousek (2016). The report describes the impact of skiing activities in the Giant Mountains and provides connections to related studies conducted in the Czech Republic or other countries. The following text

summarizes a very comprehensive report in a few paragraphs. Some of the major impacts significantly related to E-LCA are later discussed in a case study.

Impact from construction and maintenance of ski resorts

- **Impact on soil, water resources, and soil fauna** - due to terrain changes, the structure and chemical characteristics of soil horizons are typically altered. Several studies proved that microorganism activity have declined. Other impacts mentioned are increased runoff and the changing hydrological characteristics of soils.
- **Impact on vegetation** – forest ecosystems are typical in mountainous areas, particularly in the Giant Mountains. Their fragmentation makes them fragile to wind or bark beetle. The species structure on the slopes changes due to the different conditions created by the pressed snow from slope grooming and due to the use of re-cultivation grass mixtures with different species compositions.
- **Impact on animals** – problems are caused for many animals due to missing transitional ecotones and altered species composition in grasslands. Birds, mostly grouse, are endangered by the ropes from lifts and by the safety nets along slopes. The black grouse, a symbol of nature preservation in the Giant Mountains, is particularly endangered by tourist traffic. Ski touring and freeriding in remote zones affect the population of these birds in particular.

Impact from the operation of the ski resorts and their operation

- **Snowmaking** – a significant impact comes from the construction of snowmaking infrastructure. Pipelines placed along the fall line act as a drainage system and drain the water out of the area. Significant losses of water from the natural hydrocycle are due to sublimation and evaporation from reservoirs. Another issue with technical snow is its slow melting, which is appreciated by ski resort operators but has a significant effect on vegetation. Impacts related to energy consumption are discussed in [Chapter 5.5.5](#).
- **Noise and light pollution** – constant noise from ski resort operation (music, lifts, snoguns, snowmobiles, grooming machines) in the vicinity of ski resorts can be harmful for animals. For some species, this significantly complicates hunting or defense against predators. Light pollution from public lighting and especially from night skiing can negatively affects the biological clock of animals.

Impact of skiing activities

The increasing movement of people and vehicles fragments animal habitats. This then makes it difficult for populations of species that depend on specific mountain ecosystems to survive.

Climate change

The Last part of the Flousek (2016) report is dedicated to climate change. This topic is discussed in [Chapter 4.10.4](#).

4.7. Ski resort operation – lifts and slope preparations

This chapter explains processes important to running ski operations from the point of view of LCA analysis. Ski resorts can be characterised by three main factors. Geographical factors such as latitude, altitude, or local climate conditions are important for snow quality or season length. Spatial factors can describe the size of the skiable area, whether it is groomed or ungroomed, and the slope difficulty. Technical factors describe the technologies used for transportation of skiers (lifts), snowmaking, and grooming. The technical factors are explained in the following paragraphs. Geographical and spatial factors are only discussed in the case study.

4.7.1. Ski lift technologies

Lifts are a fundamental part of every ski resort. Ski lifts can be classified into three main groups according to their operation type:

- Aerial lifts (cableways) – passengers travel in the air attached to the ropes. We recognise chairlifts, gondolas, and funifors (a gondola attached to more ropes).
- Ground-based lifts - Passengers stay in their skis and glide on the snow in the case of T-bars and button lifts, or "magic carpets," where passengers stay in their skis and are moved uphill by a kind of escalator.
- Railway-based - Train-like transportation often uses a funicular and cogwheel system where two carriages are balanced against each other. A famous funicular is, for example, in Saas Fee in Switzerland, which is completely underground.

Operation of the lifts

The use of lifts is not limited only to mountains; they can also be found in cities as an ecological alternative to traditional transportation systems (Težak, Marjan 2019). However, most ski lifts are found in mountainous regions and operate mostly in the winter as a service for skiers. Operation of ski lifts is described by lift capacity (persons per hour), the length of the lift (metres), maximum allowed speed, etc. For the operators, capacity is a crucial parameter that affects the satisfaction of customers, who don't want to spend much time waiting in line. Nonetheless, chairlift capacity must be synchronized with slope capacity, which is a fundamental matter of safety (Težak 2012).

Lift technology and energy consumption

The key factor for faster transport is providing a solution for loading and exiting areas. The technology (depicted in figure 16) of a detachable grip involves the use of a different rope circuit for the chair or gondola in the station area to increase transportation speed rapidly (Težak 2012). Another option is the use of a moving carpet in the station area, which either transports skiers faster to the loading zone (often used in combination with detachable grip technology) or acts as a speeding system for the skiers to reduce the actual speed of the in-coming chair.

The energy efficiency of lifts depends significantly on the dissipation effect. The operators' main interest should always be to decrease the dissipation forces from the rolling resistance of the lift construction parts. Reduction of the rolling resistance can be achieved by using a less viscous elastomer insert. From the operational perspective, there are options to adjust the velocity of the lift or the number of seats to reduce energy consumption (see figure 17). However, these adjustments decrease lift capacity, so their usage can be applied during lower demand in the low season (Szlosarek et al. 2019).

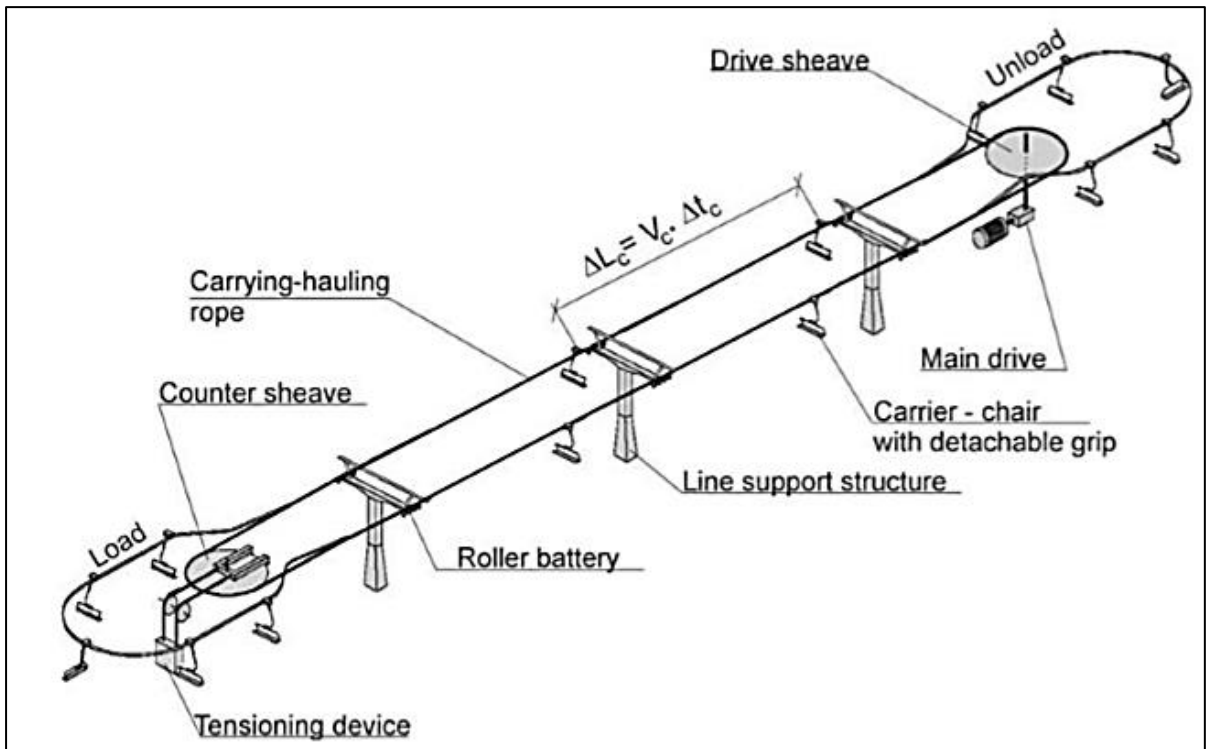

Figure 16 – Chairlift with detachable grips (Težak 2012)

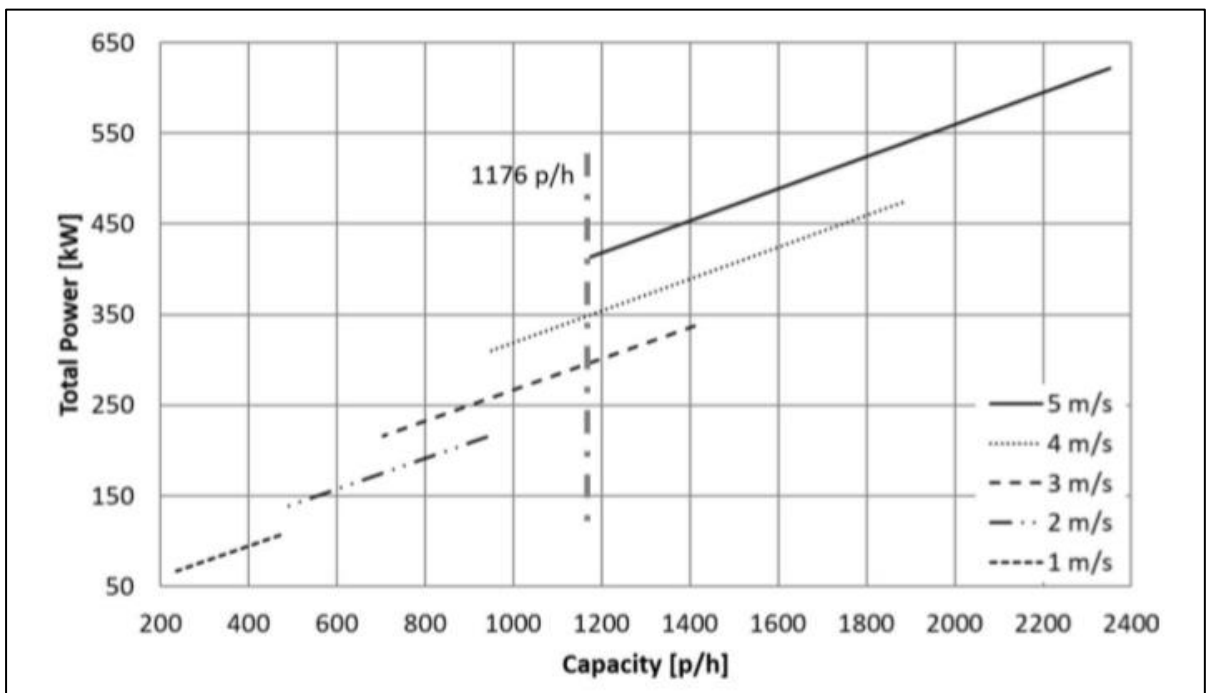

Figure 17 – The influence of velocity on total power (Szlosarek et al. 2019)

4.7.2. Snowmaking systems

Snowmaking has become a fundamental element of the ski industry in recent decades. Although its effectiveness will most likely decrease, there is no sign of decreasing investments

in this technology (Berard-Chenu et al. 2022). Most skiers prefer skiing on natural snow, however artificial snow is more practical for ski resorts operators. Artificial snow is denser and more compact and resists wind, water and temperature changes better. Only 20 cm of artificial snow is enough to create sufficient skiing conditions which correspond to 80 cm of natural snow (Lintzén 2022). Snowmaking is a fairly complex process requiring intricate planning to build an effective and sufficient system (see Annex 1).

The science of snowmaking

The process of turning water into snow is mostly dependent on two main factors: water temperature and ambient conditions. Snowmaking can be understood as a heat exchange process with many variables involving this process. The three main variables are wet bulb temperature (see figure 18), which is the relationship between temperature and humidity; nucleation temperature; and droplet size. Nucleation is the process by which liquid water becomes a solid. We recognise homogeneous nucleation, which occurs only in pure water with no other substances around, and heterogeneous nucleation, which is the process that occurs during snowmaking. Heterogeneous nucleation requires the presence of foreign material that acts as an embryo. Freezing temperature is affected by the type of embryo material. Droplet size affects snow quality and water loss during the process. Snow machines break the water into small particles. It is important for every droplet to contain a nucleus when it leaves the snow gun nozzle (Snow at home ©2023). Extra additives are added to the water to raise the nucleation temperature. One of the most commonly used additives is Snowmax and Drift, which significantly help with snow production but, unfortunately, have a negative impact on the environment due to eutrophication which produces plant growth anomalies (Flousek 2016).

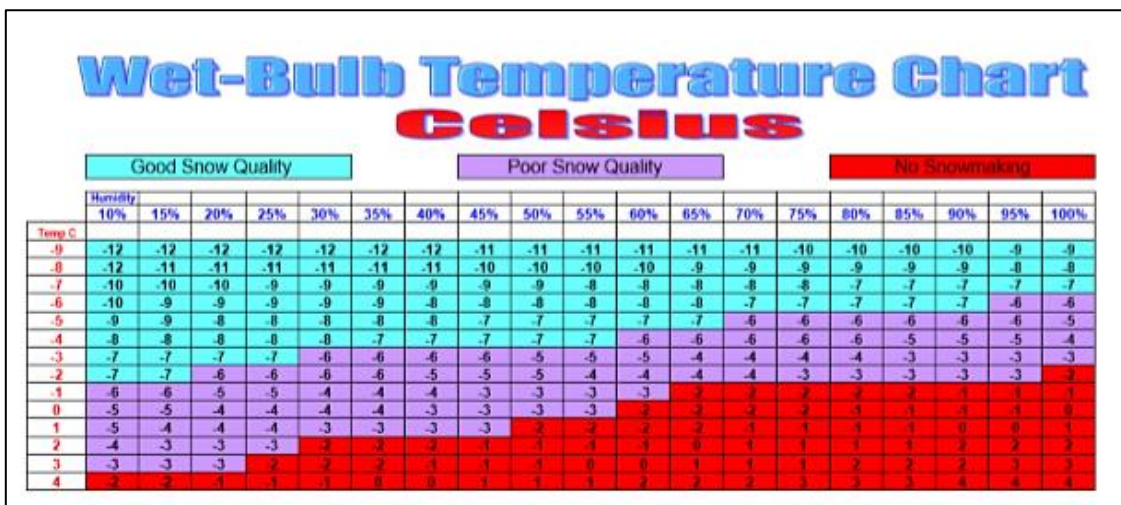

Figure 18 – Wet-bulb temperature chart (Snow at home ©2023)

Snowmaking system and technologies

There are a few companies manufacturing snowmaking technologies, such as Demaclenko or TechnoAlpin, which are both based in South Tyrol, Italy, while Snow Machines Inc. (SMI) is found in the US. Companies offer a complete solution, including engineering planning, installation, and staff training. Apart from these big companies, a few specialised companies could be found offering installation, optimisation, or staff training. However, ski-resort operation (as observed in Czech ski resorts) is often based on the knowledge of a few experienced people who have learned the science of snowmaking through praxis.

Figure 19 depicts very basic scheme of snowmaking. The primary requirement of snowmaking is water, which can be pumped directly from streams, rivers, or lakes. In the Giant Mountains, most resorts pump water directly from creeks. There is considerable discussion about water pumping because the quantity of water flowing in creeks in the exposed months (November–January) is usually very small. Water pumping is forbidden when the water flow drops below a certain level. According to Treml research (Treml 2022), many resorts pump water during these restricted periods.

Lately, reservoirs to supply water demand have been built. For example, in Austria, resorts have built these reservoirs on a massive scale, some of which are sophisticated projects offering tourist use during the summer. Construction of reservoirs could help in the Giant Mountains, where there is already a reservoir at Černá Hora, however other projects have run into complications obtaining construction approval, even though the resulting environmental impact of the Černá Hora reservoir is not negative (Křenová et al. 2020).

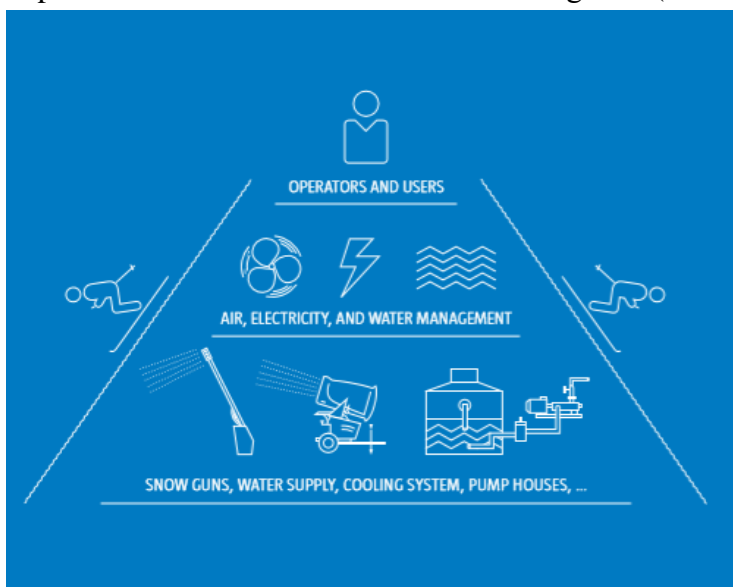

Figure 19 – Basic scheme of snowmaking (Demaclenko ©2023).

Reservoirs can positively affect the energy consumption of the whole snowmaking system. Water must be filtered and cooled (to optimise snow production) and then pumped through pumping stations to the snow machines positioned in ski resorts. Apart from water, compressed air is needed for snowmaking. Snow machines can be divided into stationary systems and mobile systems, which can be moved around ski resorts and attached to the connection points built in ski resort. Two main types of stationary systems are used: snow lances and fan guns (Demacenko ©2023). For more details, please see [Annex 1](#), where schemes and photos are shown.

4.7.3. Slope preparation

Most of the slopes require terrain changes to be suitable for skiing operations. Terrain changes made prior to the season have a significant impact on safety and also on the operational costs of grooming and snowmaking. The first thing that should be considered when a new lift is designed or upgraded is slope capacity. The study from Težak (Težak 2012) states that slope capacity should be equal to or greater than lift capacity. Furthermore, the study suggests the amount of safe space needed by the skier in relation to the skier's speed (see figure 20). Unfortunately, this is rarely observed, especially in Czech ski resorts.

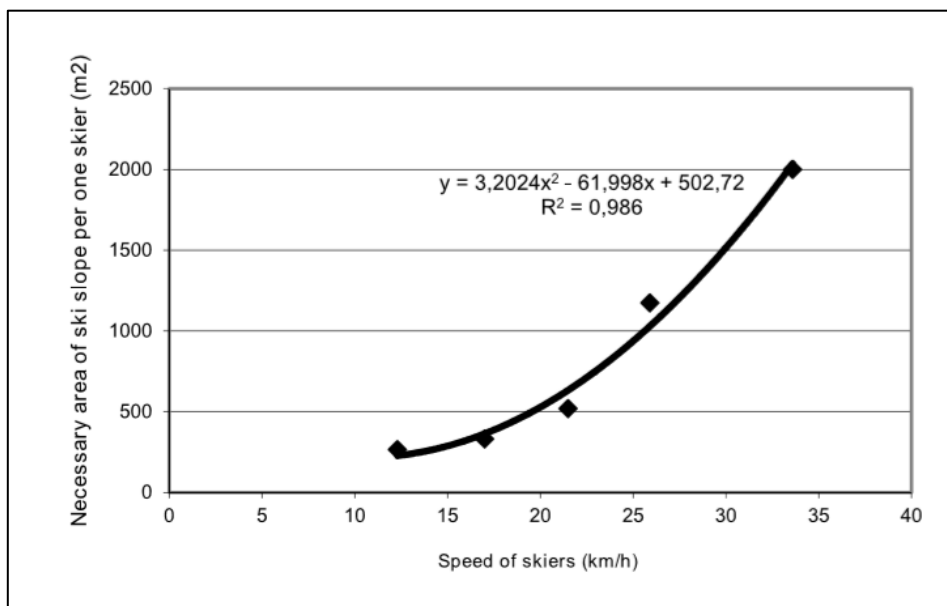

Figure 20 – Necessary area of ski slope (Težak 2012)

Grooming

Ski resort competition increases the demand for perfectly prepared slopes. Reasons for grooming slopes include the length created, a commonly promoted fact about ski resorts; safety considerations; and the operation's reason. Groomed slopes last longer. To be specific, in the

beginning of the season, ski operators focus on creating a solid cover of snow on the slopes, preferably a compacted layer of artificial snow, which then forms the basis for the season.

Grooming machines (also called snowcats) are used for grooming slopes. The most common company is Pisten Bully, which sells a variety of machines that differ in size, power, and attached accessories such as the winch for very steep slopes. Grooming is mostly about individual driver skill and knowledge. Often, it takes a few seasons to train a driver to an adequate level. Considerably new is the use of satellite technologies to track the grooming machines and, more recently, using 3D models of the slopes together with GPS to measure snow depth. These technologies can considerably shorten working hours (Söderström et al. 2013).

4.8. LCA and other assessment methods in tourism

This chapter is based on a book "Life Cycle Assessment (LCA) and Life Cycle Analysis in Tourism." This book is most likely the strongest available resource for those interested in LCA in tourism. Additional materials were also studied, but the chapter's foundation is based on this book (Filimonau 2016).

4.8.1. Application of LCA in tourism

Despite the fact that it would be beneficial to move the tourism industry closer towards the goals of sustainability, there are very few studies that use LCA. One of the reasons is that these methods have not been appreciated by tourism academics. The other reason is the nature of tourism, which involves a large number of stakeholders who deflect attention away from the overall impact of its products (Filimonau 2016). Tourism has always been explored from social and economic perspectives (Xiao, Smith 2006). With growing attention paid to the problem of global warming, studies on the carbon footprint of tourism activities have increased (Gossling 2010). Certain tourism studies have emphasised the relevance of broader investigations and the use of LCA, but even so, direct implementation of ISO standards is quite limited. As Filimonau (2016) summarises in the first part of his book, tourism studies have evolved over time and have increasingly drawn attention to the impacts of tourism. In conclusion, he strongly suggests a holistic approach to tourism evaluation and the use of LCA as a powerful tool.

4.8.2. Categorization in tourism

Systematic classification in large LCA studies, such as tourism studies, is very important. Gössling et al. (2005) in his study works with three categories: tourist transport, tourist infrastructure and tourist activities. These categories can be further split into multiple subcategories, which are typically interconnected (Filimonau 2016). The interconnection is not only between different categories related to the researched tourism sector, but also to other functions (for example, road infrastructure serves not only tourists, but also the local community, which is frequently not entirely involved in the tourism sector). This cross-cutting complicates LCA research even more. Chapter 4.9. describes the state of the art in LCA research in transportation, which is the biggest contributor of emissions in tourism.

4.8.3. Limitations of LCA application in tourism

Filimonau (2016) classifies limitations in several categories which are described below. Comments relevant to this diploma thesis and its focus, the ski industry, are added to the categories.

- **E-LCA potential and its advantages are poorly known.** Even though it is proposed as part of LCSA, ski industry managers are extremely cautious of E-LCA. Obviously, the experience with ecologically focused studies has been negative. The unanswered question is who is to blame for this situation.
- **The tourism industry is complex.** This is particularly significant in the ski industry. In comparison to other tourism destinations, ski resorts provide a diverse range of products, and skiing in particular is extremely complex. The research would become even more challenging if summer activities were included (which is not the case in this thesis).
- **Data intensity and time requirements – LCA can be expensive.** Accurate results can take a long time because each part of the product chain must be assessed, at least in the inventory section, before it can be discarded based on the cut-off criteria.
- **The high costs of databases and their irregular updates.** In the case of the ski industry, databases do not even contain the relevant data.
- **Data can be inaccurate.** According to Filimonau, even data from air transportation can be false. Data is a big mystery in the ski industry, particularly when snowmaking is

involved. Multiple scientists from various institutions have already attempted to obtain the correct data. Such factors have a considerable impact on the validity of study results.

- **A holistic approach is less established.** Using LCT to evaluate tourism as a whole necessitates a more comprehensive approach. At lower levels, E-LCA may be useful. In the ski sector, for example, the impact of two different lift technologies may be assessed. The evaluation of the ski industry and tourism in general makes more sense at the LCSA level.
- **Subjectivity can play a role.** This is an issue with many assessment methods. Further research that highlights key categories and potential hotspots which may lead to subjectively impacted outcomes could help to solve this problem.

4.8.4. Other assessment approaches in tourism

The Tourism Area Life Cycle Model (TALC)

The TALC approach was created in the 1970s to assist traditional tourism academics. It incorporates some elements of LCT, but it focuses on the local area where a specific study is conducted. Although it sometimes addresses things such as the impact on wild populations, it is mostly concerned with socioeconomic issues in order to establish models of tourism growth in a specific location (Butler 2006). Tourism planners and developers can use TALC to determine whether tourist resorts can adapt over time. It models the potential development of tourist facilities and their interaction with the local community and available resources throughout the life of a tourist attraction (Rahman 2023). It is unquestionably a tool that could be used in advanced LCC and SLCA.

The concept of Propensity to Travel

Propensity to travel is part of demand studies and it is one of the most essential notions in tourism research. It can be explained as the willingness of a person to become a tourist. Socio-demographic factors (e.g., age, education, income) are assessed in propensity studies (Matias et al. 2016).

The Greenhouse Gas Protocol Initiative

The Greenhouse Gas Initiative was established in the late 1990s. The Greenhouse Gas (GHG) protocol provides an internationally recognised tool to calculate GHG emissions. Emissions are calculated on three levels, where the first is at the user or company level and the

other two are encountered further down the supplier chain, like LCA methods. Unlike LCA, databases are not provided (Filimonau 2016).

4.9. Transportation

Transportation is a significant part of the impact of tourism. Figure 21 displays the contribution of several tourism elements to CO₂ emissions from a study released in 2005 by the United Nations World Tourism Organization and the United Nations Environment Programme (UNWTO-UNEP) (Scott et al. 2008). Despite the fact that the ratio of these elements for the ski industry differs and despite the fact that a complex LCA also identifies other hotspots, the necessity of incorporating transportation into the complex ski industry evaluation is clear. Therefore, significant attention was paid to surveying existing LCA studies in transportation. The data gathered in this survey was used for the case study to model the impact of tourist transportation.

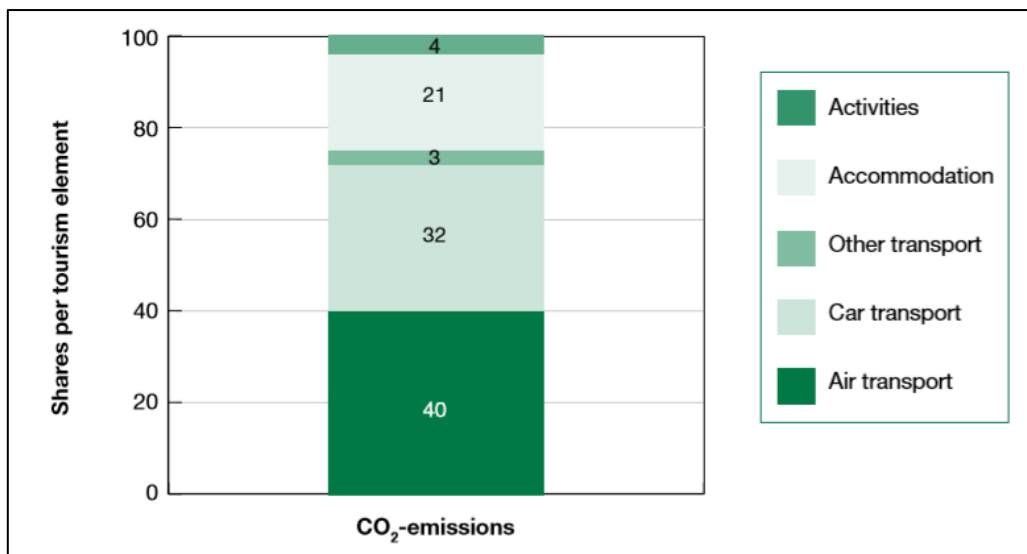

Figure 21 – Contribution of various tourism sub-sectors to CO₂ emissions (%) (Scott et al. 2008)

4.9.1. Holistic approach to assess the transportation impact

The debate over the efficiency of transportation has increased with the rise in use of electric cars. Unfortunately, there are numerous false statements in the public domain, some of which stem from wrongly performed LCA research (T&E ©2020). Nonetheless, LCA studies have revealed many important facts about the actual impact of transportation. A good example of accessible and understandable enlightenment can be found on the page <http://transportationlca.org/>, which provides a good graphic comparison of different types of

transportation and their impact during their life cycle. Most importantly, it depicts the impact of inseparable parts of the transport infrastructure (e.g., roads, airports, railways, etc..) (Chester, Horwath 2008); the Chester and Horwath study (2009), which is one of the primary sources of data for the stated website; and identifies the large indirect emissions from manufacturing, maintenance, fuel production, and other infrastructure and supply chain processes.

In the case of GHG, the increase in overall emissions over direct operation emissions owing to indirect emissions is 63% for on-road transport, 155% for railways, and 31% for air systems. It can be 800 times higher in the case of air pollution emissions. The study offers results in various impact categories, with automobiles ranking as the worst option. In this study, the FU used was passenger-kilometre-travelled (PKT), which is heavily dependent on occupancy level. Vehicle-kilometre-traveled (VKT) is presented as another FU that might be used to evaluate technological advances. A very valuable part of the study is calculation of sensitivity to passenger occupancy represented in figure 22. A similar study on goods transportation finds a greater disparity between on-road transport by heavy duty trucks and rail or cargo ships. The FU tonne-kilometre was used in this study (Nahlik et al. 2016). The single vehicle manufactured can also be used as an FU to evaluate the influence of various materials. This approach provided interesting research findings in evaluating Volkswagen Golf 1-6 models, where the replacement of steel by aluminium raised the GHG impact to such an extent that it is only partially compensated during vehicle operation (Danilecki et al. 2017).

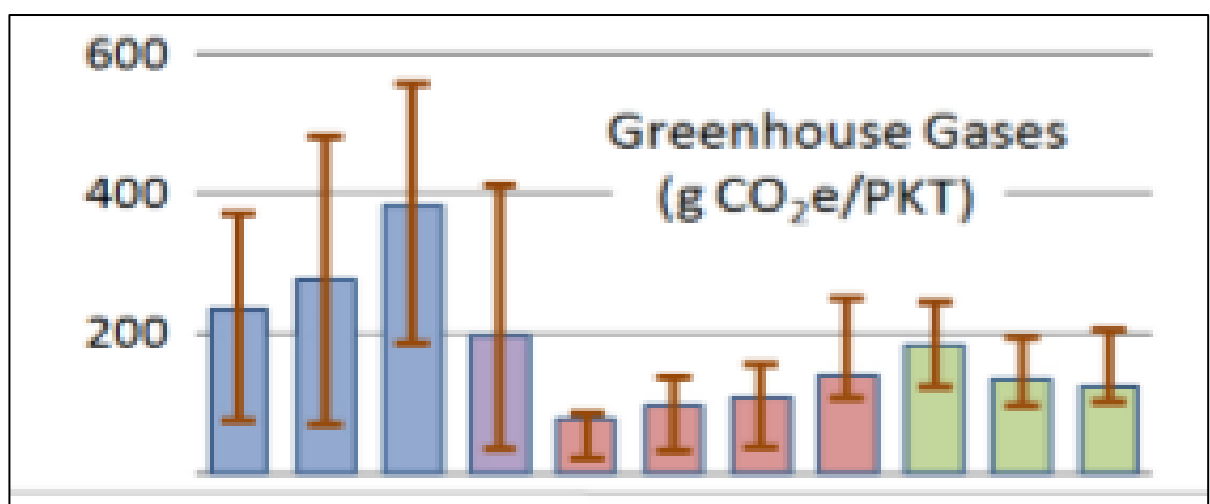

Figure 22 – Occupancy sensitivity and life-cycle sensitivity (from the left – blue bars: Conventional Gasoline Sedan, Conventional Gasoline SUV, Conventional Gasoline Pickup; Urban Diesel Bus – mauve bar; Metro, Commuter Rail, Light Municipal rail, Light Boston Rail – red bars; Small Aircraft, Midsize Aircraft, Large Aircraft – green bars) (Nahlik et al. 2016).

An important factor that needs to be implemented is travel distance. Longer distances favour aviation transport, which requires a lot of energy during take-off and landing as well as ground support at the airport. The breaking point in this case between a low-occupancy car and a plane is 700-800 km (Liu et al. 2016). LCA studies can also focus on optimising a particular segment of transportation, as, for example, in the case of Kalluri's Master's Thesis (Kalluri 2016). The FU in this case is a tonne of iron ore transported from the mine site to the port. Different transport options are investigated over a 20-year horizon, including the construction and maintenance of roads and rails.

4.9.2. Engines, fuels and batteries

The environmental impact of transportation can be reduced by optimising engines, fuels, and batteries. One alternative is biodiesel, which, when compared to regular diesel, can dramatically reduce GHG emissions while increasing PM₁₀ and NO_x emissions although biodiesel also contributes to eutrophication (Nanaki, Koroneos 2012). In general, the results and comparison of various vehicle types are determined by the impact categories used in the particular research. Electric vehicles perform better in terms of GHG emissions, and in the case of a study using current Belgium electricity supply mix, this performance might be up to five times better if the electricity supply mix is entirely renewable (Boureima et al. 2009).

Batteries are largely dependent on the portion of green energy provided in an electric grid. Improvement of battery manufacturing, as well as battery disposal and recycling are necessary. The consumption of battery resources and their toxic impact on human health cannot be overlooked (Xia, Pengwei 2022). The type of battery is important, as, for example, the NiMH batteries used in hybrid cars have a considerable impact on air acidification due to the use of nickel during battery production (Boureima et al. 2009).

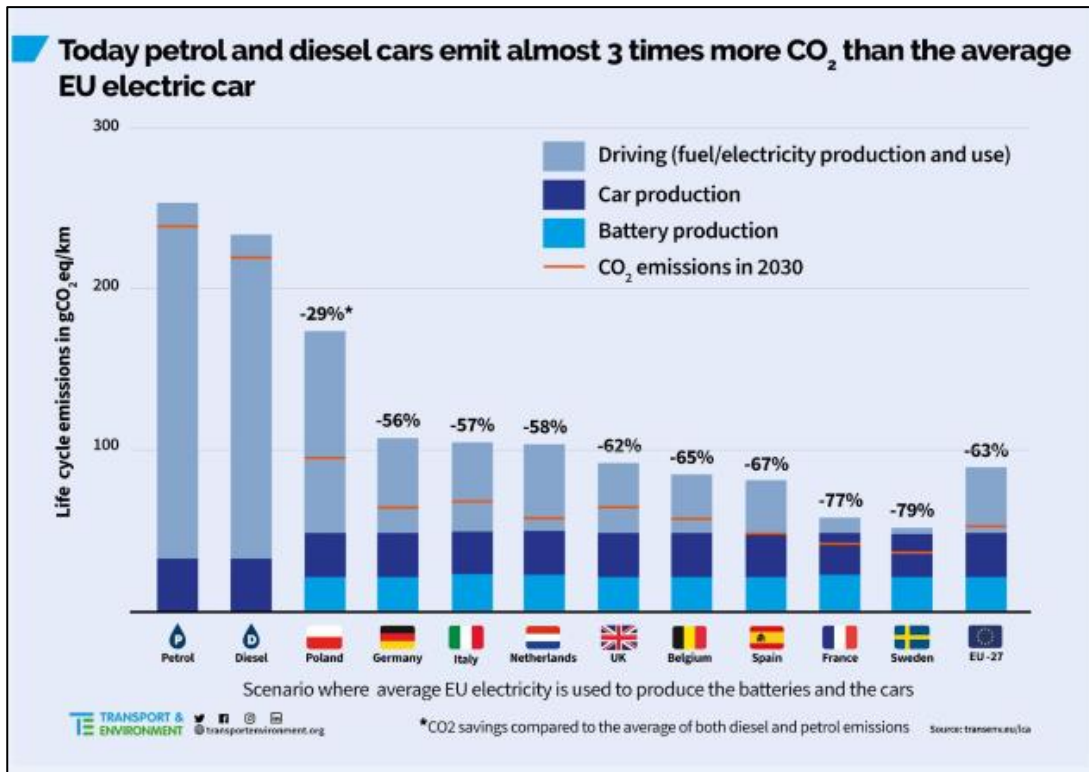

Figure 23 – The influence of national electricity grid on electric cars, petrol and diesel cars (T&E ©2020).

4.9.3. Transportation conclusion

The transportation sector provides an example of the necessity for complex LCA studies. Omitting one part of the life cycle or related infrastructure that is needed for a particular transportation method can lead to misleading results. Figure 24 depicts a comparison of different vehicle types where we can see the influence of their lifespan. However, this chart calculates only GHG and doesn't account precisely for the disposal and recycling part of the LCA.



Figure 24 – A comparison of different vehicle types over their lifetime (T&E ©2020).

4.10. Projections of future development

Projections of future developments in the ski industry are very helpful as they depend on earnings from only a short period of the year. Lost revenue could be economically disastrous for the operation of ski resorts and their related services. This chapter contains a summary of climate change research, as global warming has a significant impact on the operation of ski resorts and may result in the closure of many resorts. The prospects for the electricity supply mix are then described. Renewable energy sources have the potential to significantly reduce emissions. This chapter concludes with an overview of recent studies in the ski business that have previously been conducted.

4.10.1. Climate projections

Climate change is a widely discussed topic and is extremely important for the ski industry. Climatology started to develop in nineteenth century when data collection from different locations began. Climate science evolved with pressure and wind maps that assisted our understanding of cyclones and anticyclones and different climate zones, which were initially described as having different types of vegetation. The turning point came in the 1960s when paleoclimatology research started. Observation of the global climate system and an understanding of the interconnections of different elements (ocean, wind, radiation forcing, etc.) lead to the creation of comprehensive climate models (Barry, Chorley 2009).

The majority of scientists warn against global warming, which is largely supported by statistics that correlate greenhouse gas content in the atmosphere to temperature. The data were collected over the last approximately 100 years and supplemented with data from paleoclimatological research. A major role is played nowadays by the IPCC, which brings together scientists from various fields to work on climate change research. The IPCC also collects data about GHG emissions. Countries that have signed the Paris Agreement have committed to regular reporting and the reduction of emissions. In the Czech Republic, reporting is a concern of the Czech Hydrometeorological Institute. Climate modelling is very complex,

with an enormous number of variables that are often not fully understood. Warming scenarios from the IPCC are taken for the purpose of this work (see figure 25).

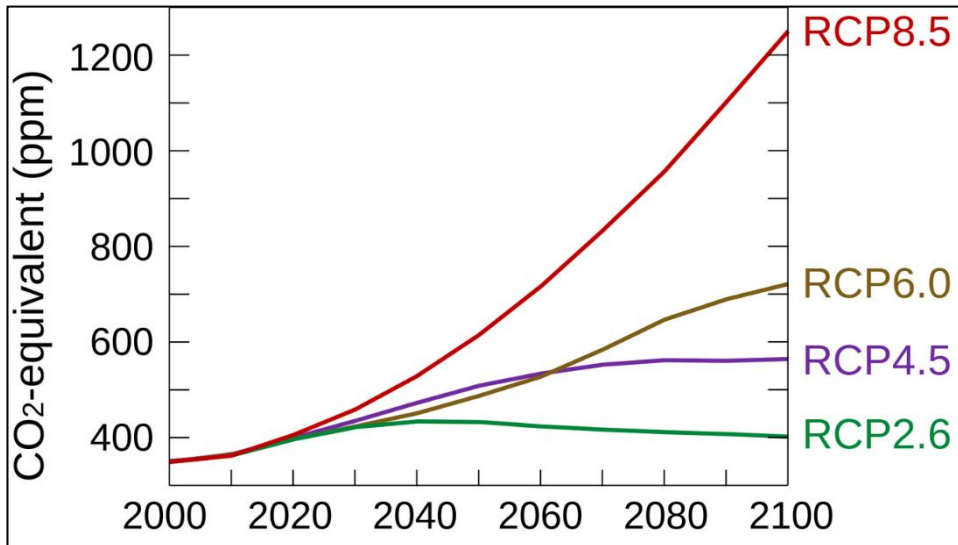

Figure 25 – IPCC Representative Concentration Pathways (Wikipedia ©2023)

4.10.2. Energetic projections

Electricity usage is a major contributor to emissions in many industries, including the ski industry. The development of clean electricity production is tightly connected to the improvement of the ski industry's environmental performance, in which the key factor is the source of electricity. The LCA method is used to calculate the average volume of emissions per KWh (figure 26). However, in most reports, only the GHG impact category is presented. The report "Life Cycle Assessment of Electricity Generation Options" (UNECE ©2022) provides comprehensive results, including more impact categories. Figure 27 shows results for nuclear energy, which is often discussed due to the problem with radioactive waste.

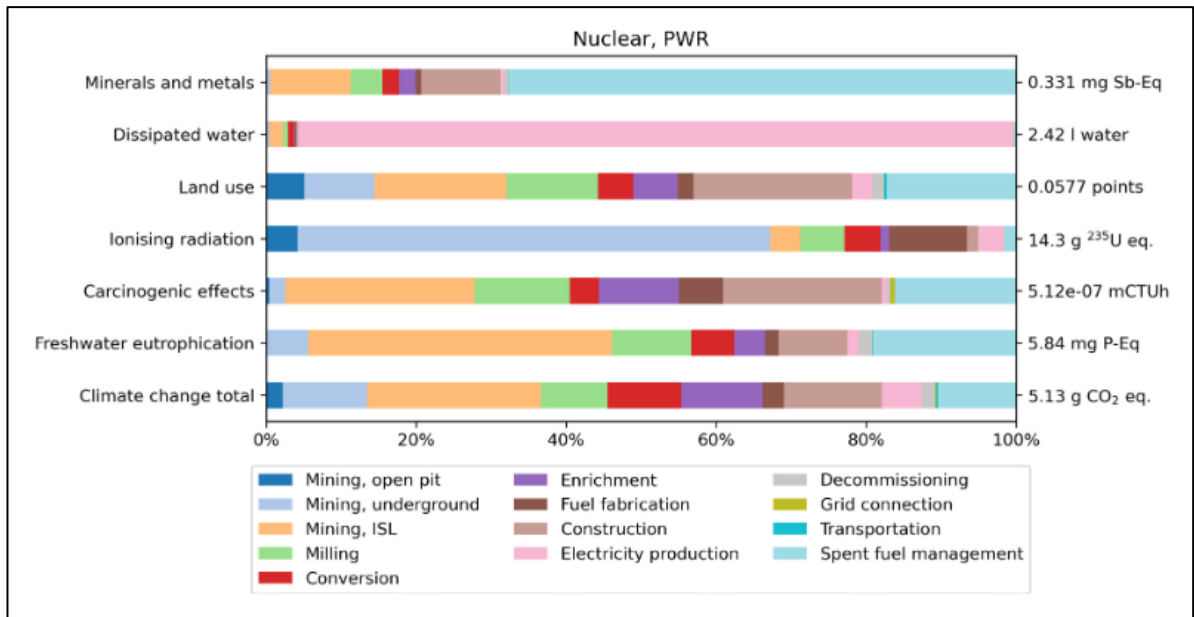

Figure 26 – Average life-cycle CO₂ Equivalent emissions (Schlomer et al. 2014).

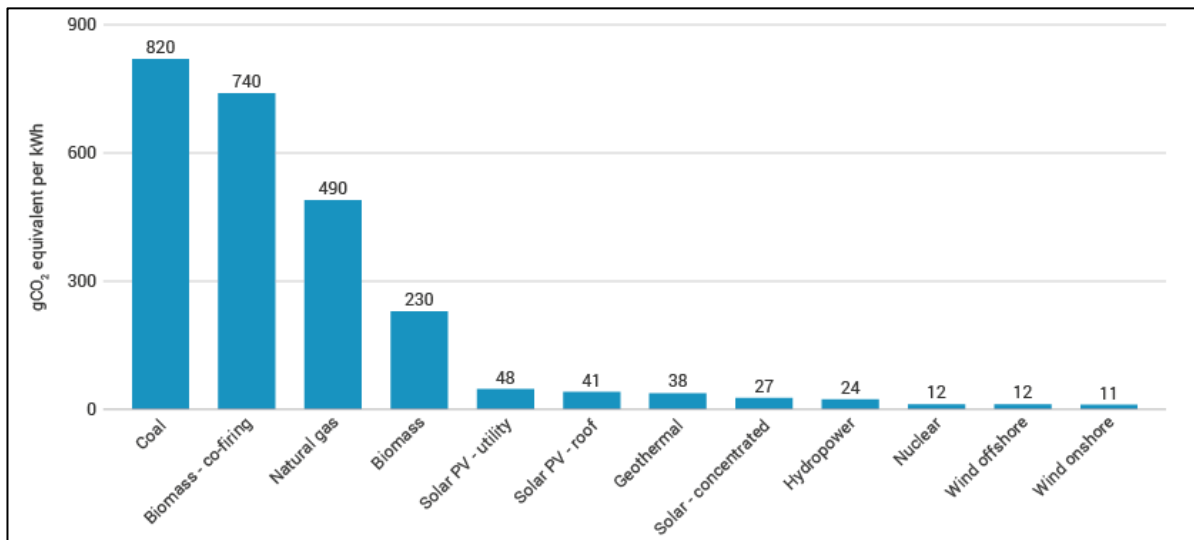

Figure 27 – Lifecycle impacts of nuclear power, global average reactor, per kWh and activity (UNECE ©2022).

In order to decrease GHG emissions, there are plans on how to rebuild energy systems. Several studies suggest a potential change in energy sources, which are highly dependent on their geographical location in a particular country and its available resources. For example, Norway and Austria get a considerable part of their energy production from hydrological energy due to their large mountains. Options in the Czech Republic are limited compared to other sources. The transition to greener electricity is part of the European Union's climate target. The Czech Republic's transition strategy can be seen in the document "National Energy and Climate Plan of the Czech Republic" (MPO ©2020). An alternative plan is proposed by Greenpeace, which includes various scenarios based on the amount of investment involved and the energy

saving potential (Greenpeace ©2012). On the European level, the European Network for Transmission System Operators of Electricity (ENTSO-E) provides thorough projections about the energy supply mix (figure 28).

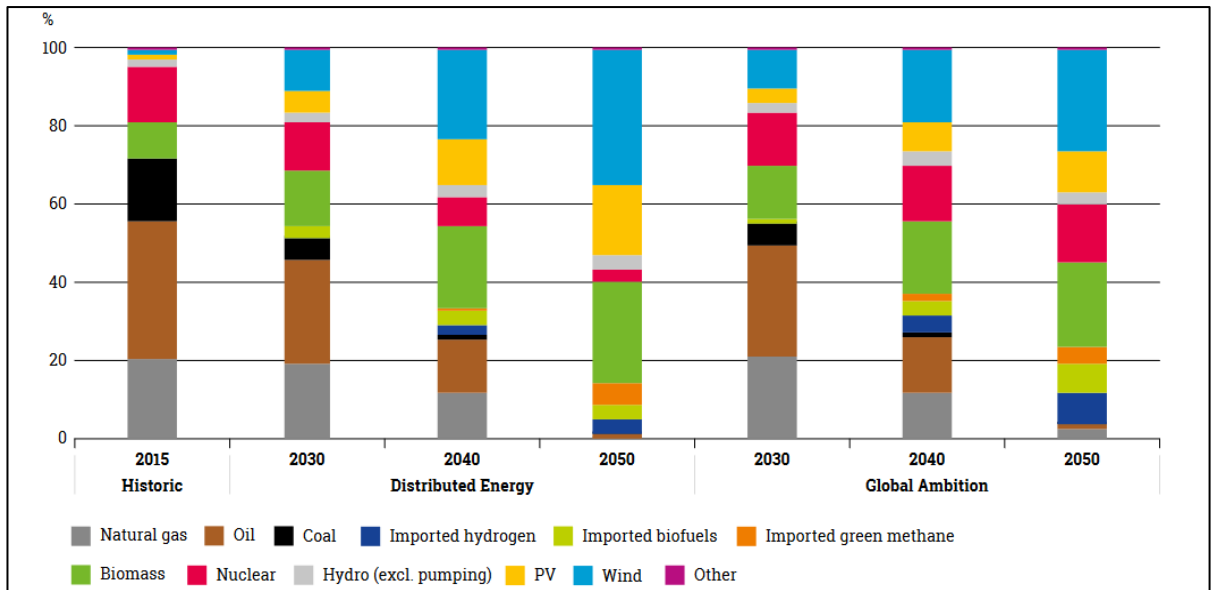

Figure 28 The primary energy supply mix in COP 21 scenarios for energy and non-energy use for EU27 (TYNDP ©2022)

4.10.3. Environmental Impact Assessment – EIA

EIA is a decision-supporting method that evolved at the end of the 1960s in the US. Nowadays it is part of the legislation of many countries including the European Union (Jay 2007). EIA is a document that is required by law (in the Czech Republic by Act No. 100/2001 Coll. on environmental impact assessment) to be attached to the approval procedure for the construction of, for example, ski lifts. The EIA document is compiled by authorized persons who describe the individual segments (local community, flora, fauna, ecosystem soil, water resources, etc.) concerning the possible impact of the assessed construction plan on the environment. The EIA process has four phases: documentation phase, assessment phase, public discussion, and EIA standpoint (EIA ©2023). In general, the EIA assessment can be understood as an opportunity for the public to participate in the construction approval process. The form of the EIA study is much more descriptive compared to the LCA. However, years of experience with the EIA method could provide an interesting model for greater integration of LCA into legislative processes. The inclusion of these methods or the incorporation of some LCT concepts into the EIA is also something to think about.

4.10.4. Projections in the ski industry

The ski industry is highly threatened by climate change, both from the point of view of rising temperatures and uneven rainfall. Awareness of this danger is felt among representatives of the ski industry and can also be seen in the steeply increasing number of studies devoted to this topic (see figure 29) (Steiger 2019).

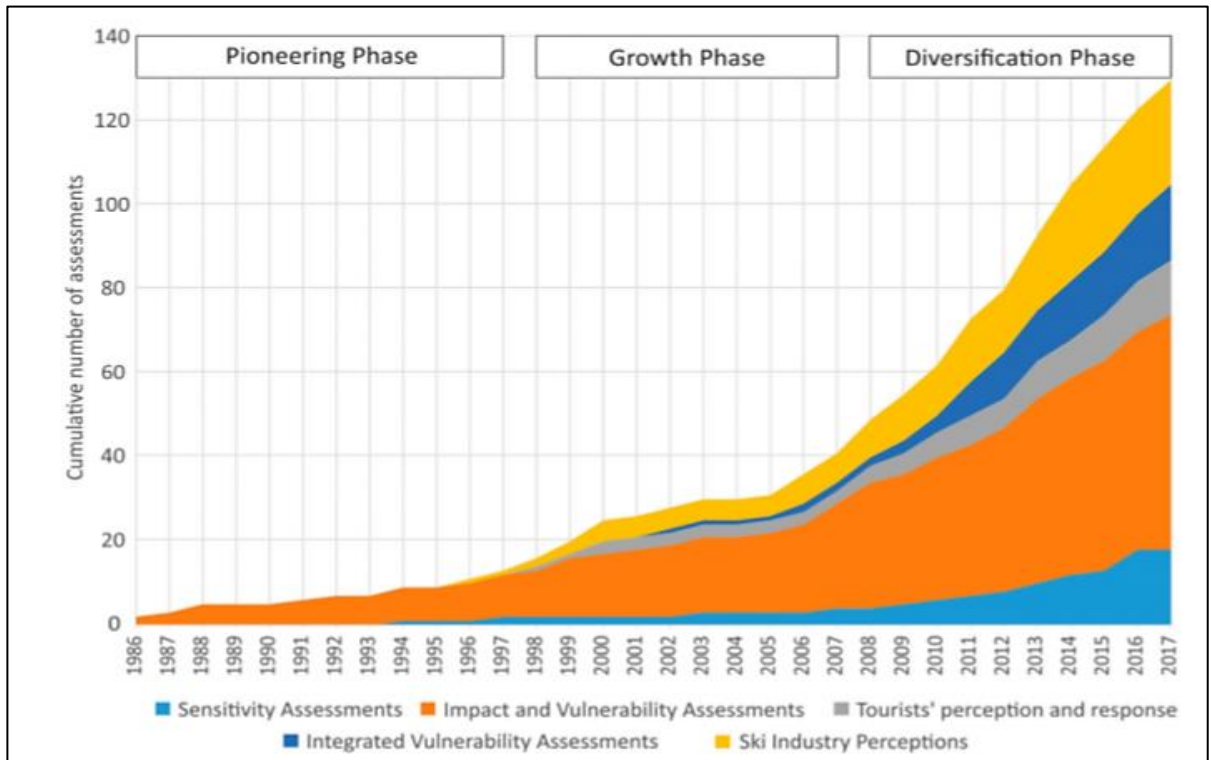

Figure 29 – The evolution of peer-reviewed climate change and skiing tourism literature (Steiger 2019).

Adaptation to global warming is not only about increasing snowmaking capacity, but about the overall concept of sustainability (see Figure 30) (Steiger, Stotter 2013). Various indicators are investigated in studies using statistics or modelling techniques. Variability of wet bulb temperatures were investigated in period between 1967 – 2007 by Fisher et al. (2011) at the glacier resort in Austria. No significant change was discovered. Same study highlights sensitivity to natural snow cover. The probability of natural snow in autumn and spring months decreases significantly. Steiger, Scott (2020) claims that projected impacts can be manageable for the majority of the resorts until 2050 even with the worst emission scenario RCP 8.5 (see Figure 25) or until 2080s with RCP 4.5. However, the impact differs by geographical location and snowmaking possibilities.

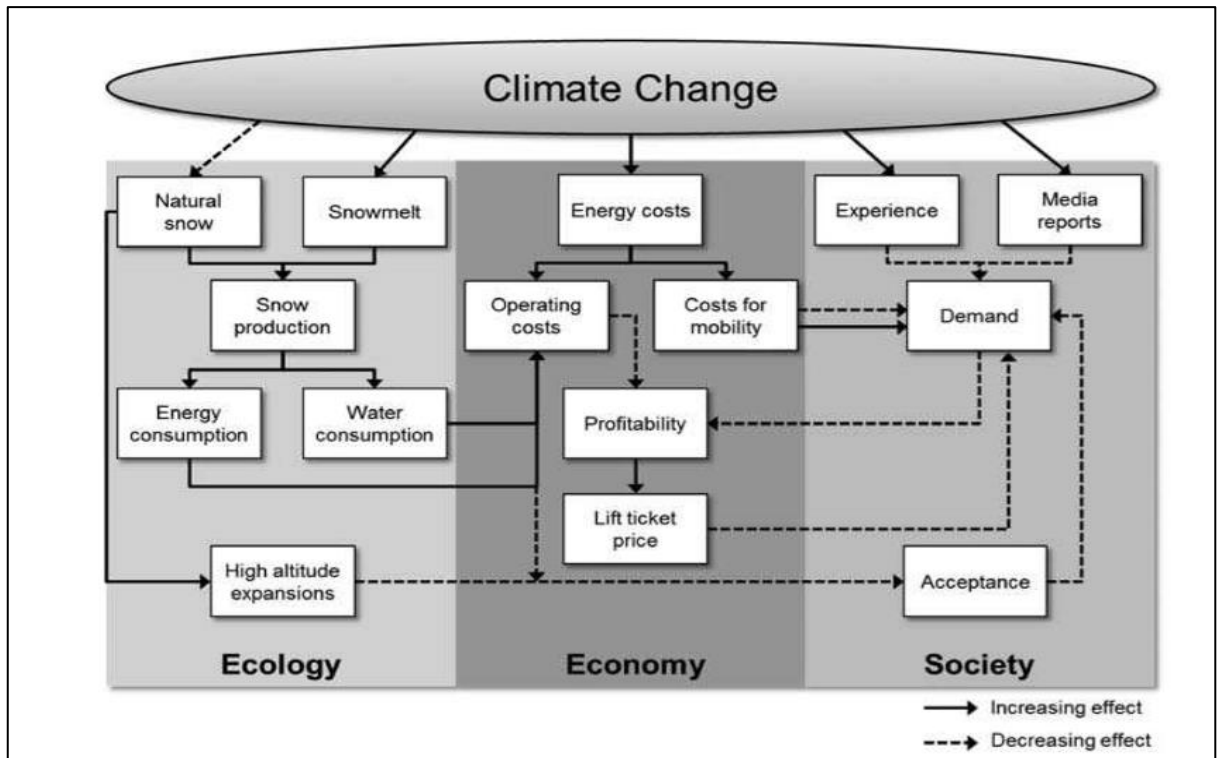

Figure 30 – The three dimensions of the climate change and skiing tourism system (Steiger, Stotter 2013)

5. Case study

The case study discusses the possible application of LCA methods in the ski industry. The first section of this case study performs a preliminary evaluation of the feasibility of conducting an LCA study within a ski resort. It is followed by a discussion of different study setting approaches and their utilisation. There is a separate chapter dealing with S-LCA, where, aside from outlining ideal settings, new subcategories specific to the ski industry are proposed. The core section of the thesis is the suggestion of a mathematical calculation model for LCA within the ski industry.

5.1. The most important specifics of the ski industry

The tourism industry is a very complex industry, and the ski industry is one of the most complicated. There are major limitations to using LCA in tourism ([see chapter 4.8.3](#)). Application of LCA principles to assess ski resorts has several specifics that need to be assessed and evaluated before the start of the intended study. Even for a small resort, the scope of an LCA study would be huge, necessitating certain compromises. A lack of data and a limited willingness on the part of ski resort operators to cooperate must be expected. Before even considering LCA in ski tourism, the following points and their role should be clear.

5.1.1. Definition of the ski resort

For the purpose of this work, a "ski resort" refers to a town or village with skiing facilities where the main purpose of a visit is winter sport tourism, especially downhill skiing. Nonetheless, not all places are oriented purely toward skiing. In fact, the majority of the ski resorts offer various products and services. According to AHS research, 88% of guests visit Czech resorts for the purpose of skiing (downhill skiing + Cross-country skiing) (AHS-KPMG ©2015).

A definition of ski resorts and what is included in a study should be very clear when conducting comparison studies because there is such a wide range of ski resorts. On one side of the spectrum, we find places like Zell am See, Liberec, or the ski slopes around Innsbruck, which are directly linked to crowded settlements. On the other side of the spectrum, we have resorts like Perisher in Australia or Folgefonna Glacier in Norway, which are literally in the middle of nowhere. Folgefonna, for example, is a summer glacier resort outside Bergen that is not even accessible by road during the winter.

5.1.2. Skiing culture

In the Czech Republic, for example, a “skiing week” is required in the school curriculum. In Austria, skiing is both a "religion" and a national sport. In Australia, many people have never seen the snow, but there are still approximately 1.2 million (5% of the population) active skiers (Snow Australia ©2023). Obviously, there are countries with almost no active skiers where only very rich people participate in this sport. Such examples demonstrate that the skiing culture in a researched region plays a significant role in understanding the overall picture of the assessed resort particularly in the socioeconomic sphere.

5.1.3. Seasonality

Seasonality is a big problem for most of the tourist destinations (Matias et al. 2016) and ski resorts are no exception. Some resorts operate only during the winter (e.g., Flachauwinkl, Austria) or only during the summer (e.g., Folgefonna glacier, Norway). Some resorts have dual-season operations (e.g., Saalbach–Hinterglemm) due to downhill biking, hiking, or nature sightseeing in summer. There are projects like Moníec, in the Czech Republic, that operate all-year round due to the various products they offer, such as wellness, skiing, biking, or teambuilding programs.

From the perspective of all LCA methods, seasonality plays a significant role. In the case of the E-LCA ratio of the pre-operation phase, there is a significant overall impact due to year-round utilisation. The socio-economic aspect for the local community is also enormous. Resorts with only winter operations become "ghost towns" during the summer season, and this significantly affects the results of many research categories.

5.2. Preliminary evaluation

Figure 31 outlines the steps that must be taken before an LCA study begins.

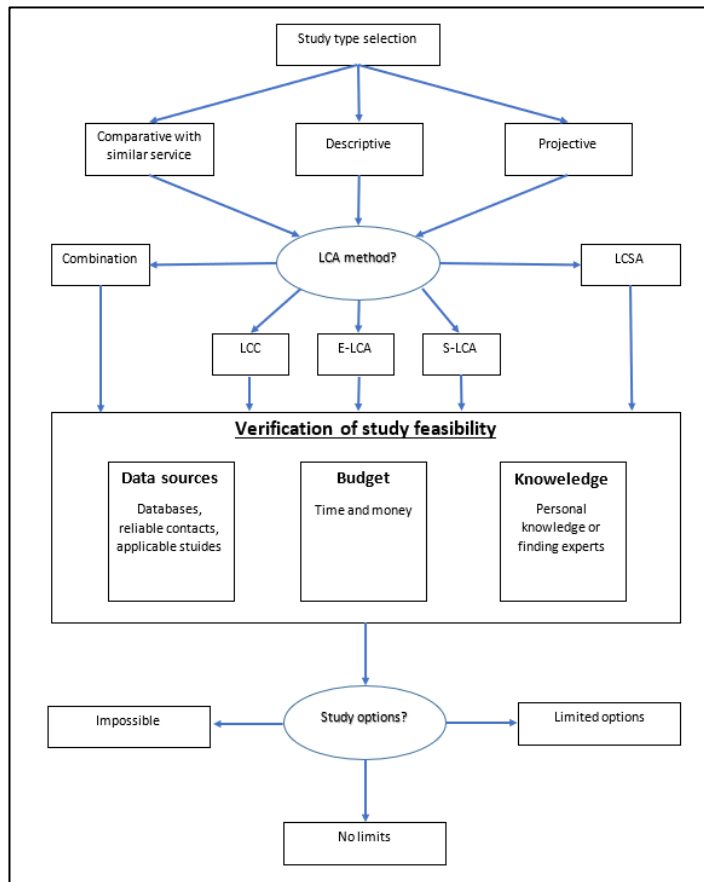

Figure 31 Scheme of preliminary evaluation steps

5.2.1. Study type

Three types of LCA studies are suggested for consideration:

- **Descriptive** – This type of LCA study can be understood as “conventional LCA,” where static data input is taken to a model operation phase. Conventional LCA studies work with things such as inflation as in the case of LCC, but there are no intended scenarios implemented in the calculation.
- **Projective** – A projective study works with various scenarios (e.g., global warming or the electricity supply mix). For the ski industry, projections of various scenarios, like the impact of global warming, are very important.
- **Comparative with similar service** – This type of study can be descriptive or projective. The reason why this is stated alone is that the overall setup of such a study must be designed in primary alignment with the study of the compared service or product.

Alternative approaches are possible. For example, one can decide initially whether the study will be comparative or not, and in the second phase decide whether it will be descriptive or projective.

5.2.2. Choice of LCA method

The goal of the study plays a crucial role in this decision. However, it must be emphasized that the LCA method and type of study will fundamentally affect whether the ski resort operators will cooperate. From the experience of trying to obtain data for this diploma thesis, it should be emphasized that descriptive E-LCA will not attract much cooperation, in fact it may even provoke the opposite. The author recommends always considering the inclusion of the projective type of the study, ideally with the implementation of economic data from which the cooperating ski resort can obtain information to optimize operations. Know-how and data in the ski industry are invaluable.

5.2.3. Verification of study feasibility

Three main questions must be answered:

- Are there enough resources to conduct the LCA study?
- Does the researcher or his team have enough knowledge to cover all topics related to the study?
- Are there data sources for the LCA study?

Data gathering

Data collection is typically done during the inventory analysis phase, after which goals and scope should be reviewed and revised. However, such an enormous study can be considered only after thoroughly examining data collection possibilities. In the case of this diploma thesis, the core settings had to be altered several times because it was discovered that there were no data sources for significant items. Cooperation with stakeholders on data sharing must be conducted very diplomatically, as the depth of LCA studies and hence their time consumption is hard to imagine and understand at first. Data can be gathered on three different levels:

- Using existing databases, including assessing impact based on the similarity of items (e.g., using a 32-tonne lorry to assess another heavy machinery (Ekerholt 2017)).
- Using LCA studies on similar products – For example this case study uses the results from Chester, Horwath (2009) research in transportation.

- Performing new LCA studies for subproducts based on data collected from operations.

There are very few LCA studies about the ski industry. The existing ones deal only with particular segments, as in Luthe et al. (2013) LCA study of the impact of ski production. Existing studies typically use just partial and simplified LCA methods (e.g. Faney et al. 2010; Masotti et al. 2018).

Many studies that investigate the ski industry mention the lack of cooperation from the ski operators. Cetara, Angelini (2006) conducted research in northern Italy and claims that this reluctance is primarily due to competitive and commercial factors and that this problem appears to be common in other countries also. The problem appears to be exacerbated at Czech ski resorts by various ecological groups and national park representatives who utilise the data against the ski lift operators rather than for rational discussion. Another issue is the fact that some types of data simply do not exist. Even big ski resorts work with aggregate data from all operations or just some segments. Segregated data about a single lift operation, for example, is often unavailable.

5.3. Case study settings

The objectives of this diploma thesis are primarily to evaluate the optimal calibration of LCA methods for their use and combination to conduct LCSA study. The overall picture of the ski industry depicted in flowchart (figure 32, an alternative can be seen in figure 33) illustrates the broad nature of the studied topic. These flowcharts could be divided and expanded into numerous sub-flowcharts for various products and processes in the supply chain, which can be found in databases. However, one doesn't typically find ski industry-specific products like snowmaking machines, grooming machines, etc.

The main objective is to find optimal settings to connect LCA studies together. The flowchart in figure 33 shows the settings for the studies processed in this thesis. The FU chosen for these studies encompasses the entire service system from the perspective of the guest, during a 24-hour stay at a ski resort. The green, red and blue arrows represent the processes included in simplified LCA studies. S-LCA is reviewed from a broad perspective. E-LCA and LCC were carried out only for the operation phase of downhill skiing. Transportation is not included here because it has been reviewed in [Chapter 4.9](#).

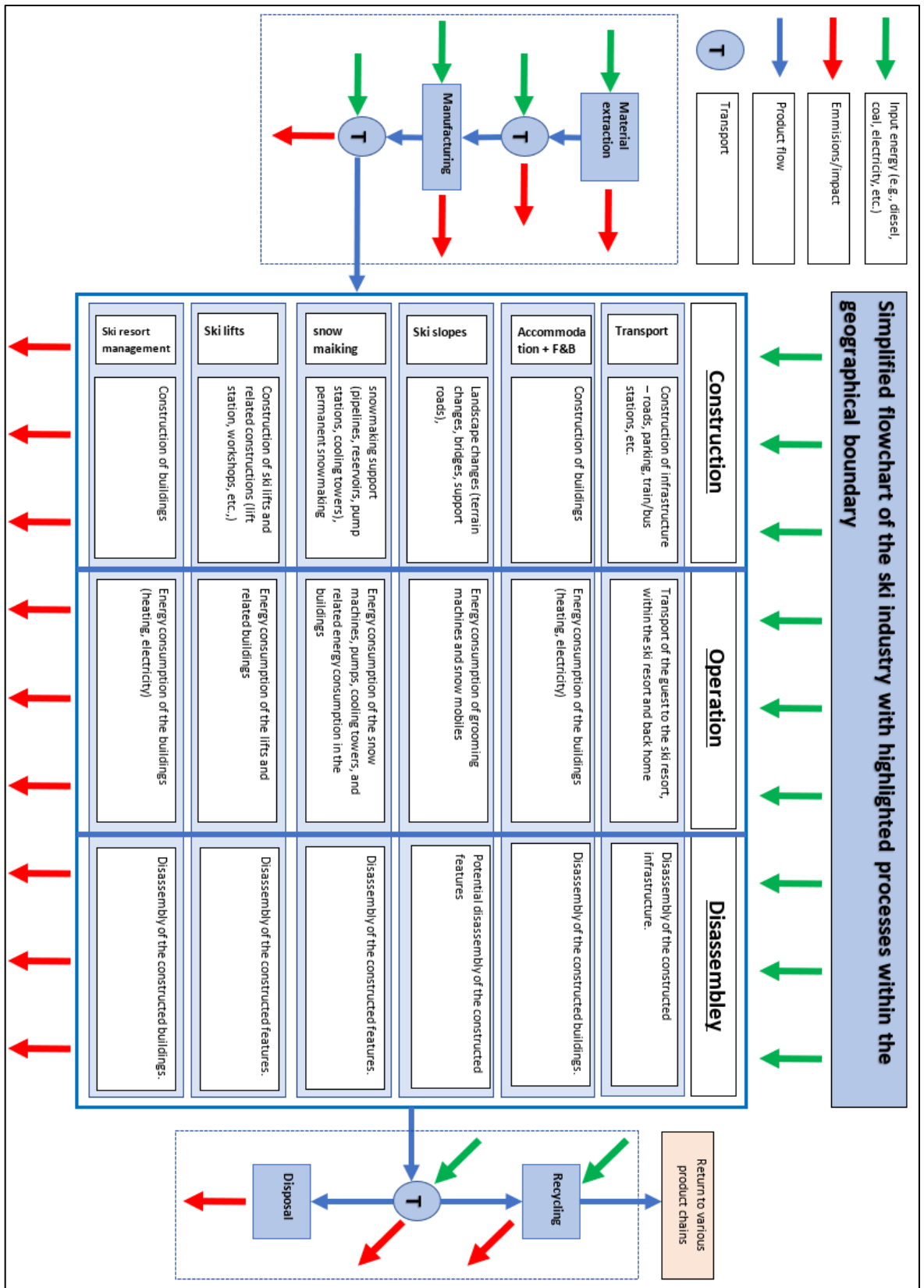

Figure 32 - A flowchart tabulating the key processes in the ski industry

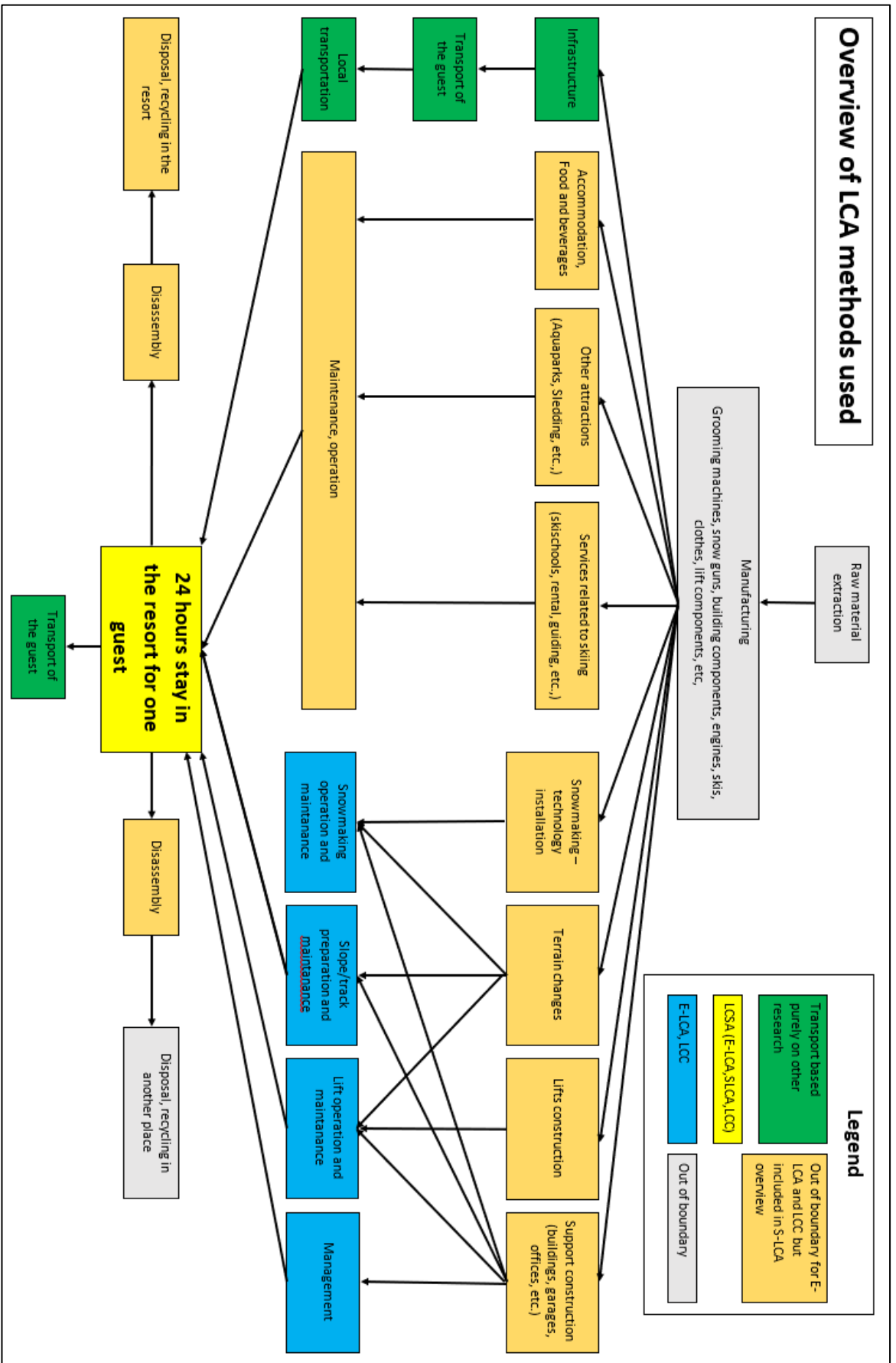

Figure 33 - Flowchart with highlighted spans of LCA methods in this thesis

5.3.1. LCA for cross-country skiing and ski touring

Although cross-country skiing and ski touring are only marginally discussed in this thesis, certain processes that require inclusion in the calculations of an LCA study are analyzed in more depth in the case of downhill skiing.

Cross-country skiing

Nowadays, cross-country skiing is primarily practised on tracks that have been machine-groomed. Ski resorts, or larger tourist regions, advertise the length of their groomed tracks. There are even tracks in the vicinity of Vrchlabí that produce their own snow and provide their own lighting. A rare study by Ekerholt (2017) uses E-LCA methods to analyse a cross-country ski loop in Norway. It specifically focuses on comparing the technology of snow production and snow storage during the summer. However, this study only works with the Global Warming Potential (GWP) impact category and with estimated input data for snowmobiles or snowmaking machines. The study deals with seasonal operation, i.e. it works with an FU of 181 days for the 5-km loop.

In the case of this thesis, it is better to set up E-LCA (ideally in combination with eLCC) from the point of view of a possible comparison between track locations, for example, that between the Vrchlabí tracks mentioned above (500m a.s.l.) and the ridge tracks in the Giant Mountains. Figure 34 shows the calculation procedure when considering the FU of a 1km track for 1 day.

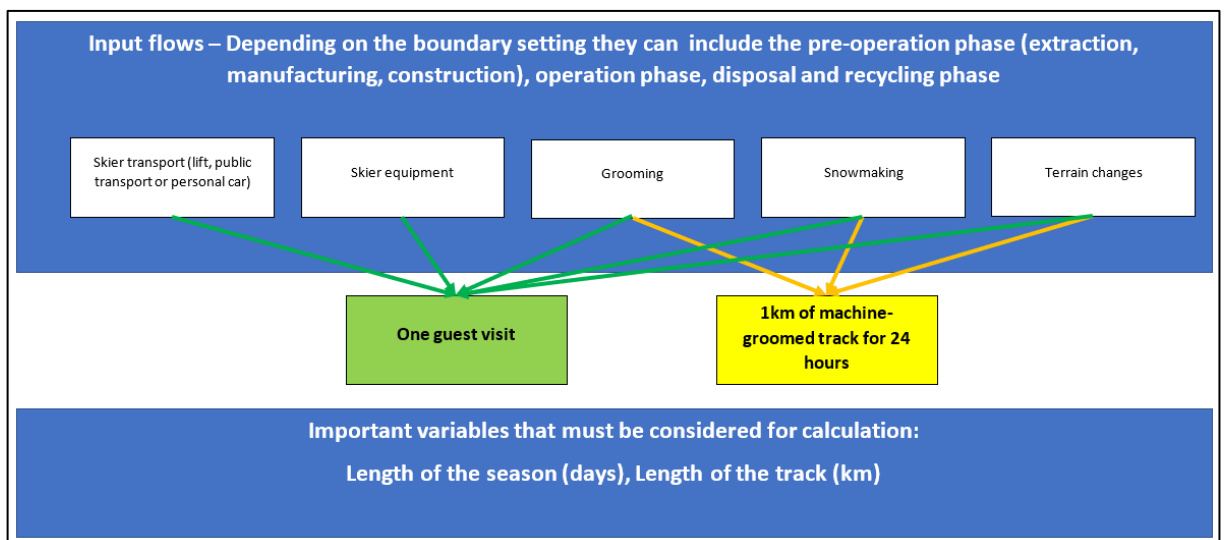

Figure 34 - Basic flowchart for cross-country skiing

An FU of 1km of track per day is suitable for comparing the costs and impacts of different cross-country skiing tracks. However, if this study were to be included in the study of

the entire resort with the FU guest on a 24-hour visit (day), one would have to determine how many people were using the tracks. This would require more effort than for downhill skiing, where the data can be obtained from liftgate scanners. The easier option would be to include the modification of cross-country skiing tracks in the summary calculation for the entire ski resort and all its ski activities.

Skitouring

Ski touring is a relatively simple matter from the point of view of any LCA study. Only a few aspects such as the equipment and the use of a lift (some skiers take a single ride on the lift) would need to be evaluated from the point of view of LCA and eLCC. If accommodation and transport were also evaluated, it would of course be more complicated. However, in the overall evaluation of the ski resort, the group of guests engaged in this sport would be included in the total number of guests, from which other impacts could be calculated and estimated. The movement of ski alpinists in the prohibited zones of the national park is a problem in the Giant Mountains but it could be assessed in some of the subcategories in S-LCA (Society – Natural heritage) or possibly quantified in the subcategory of Loss of biodiversity in E-LCA.

5.3.2. Possible FU alternatives in LCA studies settings

The following paragraphs and tables discuss different settings of FU for LCA studies for downhill skiing operation. Three main operational parts are discussed – snowmaking, lift operation and slope preparation.

Alternatives for LCA studies for snowmaking

The following table 3 describes the settings for an LCA study with the main goal of comparing snowmaking technologies where the function is snowmaking and the product is snow mass represented in cubic metres. A product, in particular, can be a topic of discussion in the context of the whole picture. In fact, the product is not snow itself, but a skiable slope. In S-LCA and LCSA studies, the results relate to the whole season and represent the overall picture better.

LCA method	Functional Unit	Pros	Cons	Use
E-LCA	Spatial unit of snow	Relatively easy calculation	Does not take into account the allocation of snow (excludes the water pumping distance and any related impacts of the pipeline).	Ecological comparison of different technologies for company level.
E-LCA	Spatial unit of snow including its allocation (distribution). Ideally the assessment of snow production should also include ambient (weather) conditions.	Covers all impacts related to pipelines and pumping. Can be used to compare static and movable snowmaking systems.	The calculation includes a complex concept of space distribution. Ideally, it should take into account how much further the snow will have to be moved with grooming machines.	Ecological comparison of different technologies – more accurate (company level).
S-LCA	Problematic Possibly: lift operation (day, season or lifespan)	Social assessment of snowmaking could be used in a traditional way to assess the impact on stakeholder category value chain actors.	Socially, it does not make much sense to assess snowmaking without including skiing.	Justification of project and its social benefits and drawbacks
LCC	Spatial unit of snow including its allocation (distribution)	Covers all costs related to pipelines and pumping	Includes a complex concept of space distribution in the calculation. Possible difficulty to allocate maintenance costs for a particular snowmaking system – aggregate data are usually used).	Economic planning at company level
LCSA	Seasonal Operation	Provides an overall picture	Problematic inclusion of S-LCA and space distribution of snow, difficult estimation of global warming.	Useful for emerging ski resorts or technological upgrades

Table 3 - Alternative FU settings for snowmaking

Lift technologies

The following table 4 describes settings for an LCA study with the main goal of comparing lift technologies, where the function is to transport a person (or potentially material), and where a product is safely transported over a given distance.

LCA method	Functional Unit	Pros	Cons	Use
E-LCA	Normalized distance 1km of 30% slope per person	Comparison of different technologies	Does not cover actual skiing or ski slope access. Distortion appears mostly in bigger ski resorts (e.g. connection lifts)	Ecological comparison of different lifts at company level
S-LCA	Lift operation (day, season or lifespan)	Social-LCA can be useful to assess impact, particularly impact on the community	Without including skiing, it does not reveal much about winter operation	Justification of project and its social benefits and drawbacks
LCC	Normalized distance 1km of 30% slope per person per season	Economical view – important for investors	Does not cover actual skiing – The ski slope access. Distortion appears mostly in bigger ski resorts (e.g. connection lifts)	Economic planning at company level
LCSA	Seasonal operation	Bigger picture	Problematic inclusion of S-LCA	Useful for emerging ski resorts or lifts, or technology upgrades

Table 4 - Alternative FU settings for lift operation

Slope Preparation

The following table 5 describes settings for an LCA study where the main goal is to compare different grooming machines and approaches, where an FU is a groomed (skiable) slope, and where a product is a spatial unit of the prepared slope.

LCA method	Functional Unit	Pros	Cons	Use
E-LCA	Area unit of slope per season	Comparison of different machines and technologies, Impact of terrain changes	Difficult to assess impact of snow conditions	Ecological optimization of slope preparation process
E-LCA	Area unit of slope per day in particular conditions	Comparison of different machines and technologies, Impact of terrain changes and impact of snow conditions	Can be used for global warming impact modelling	Ecological optimization of slope preparation process
S-LCA	Preparation of slopes – seasonal	Traditional S-LCA approach	Separate slope preparation is only a small fraction of the overall picture	Traditional S-LCA approach outcomes
LCC	Area unit of slope per season (or possibly as E-LCA in particular conditions)	Economical view – useful for micromanagement	Highly dependent on natural snow – better to use for risk assessment (bad scenarios)	Economic optimization of slope preparation process
LCSA	Preparation of slopes – seasonal	Bigger picture	Separate slope preparation is only a small fraction of the overall picture	Does not make much sense on this level

Table 5 - Alternative FU settings for slope preparation

5.3.3. Possible boundaries settings

In the case of this thesis, two basic approaches are proposed - Temporal boundaries and Spatial boundaries. Temporal boundaries can be further divided into:

- Complete life cycle (no boundaries)
- Pre-operation phase (extraction, manufacturing, transport, construction)
- Operation phase
- After-operation phase (disassembly, disposal, recycling)
- Exclusion of after-operation
- Exclusion of pre-operation.

Spatial boundaries can be further divided into:

- Complete life cycle
- Areas beyond the ski resort
- Areas inside the ski resort.

5.4. S-LCA – Ski industry overview

This chapter deals with the application of SLCA to the ski industry. The following text is basically a methodology proposal and at the same time a simplified SLCA study. Data were gathered from publicly available resources and surveys conducted both online and in ski resorts in the Giant Mountains. The study was performed on the basis of ISO 14040 and Guidelines for Social Life Cycle Assessment of Products and Organizations 2020 (Benoît Norris et al 2020). Almost no studies were found that applied SLCA to tourism. A unique study from which the methodology was drawn is Social Life Cycle Assessment as a Management Tool: Methodology for Application in Tourism (Arcese 2013).

5.4.1. Preface to the Guidelines application

Guidelines for Social Life Cycle Assessment of Products and Organizations 2020 (Benoît Norris et al. 2020) has been followed to perform this study. However, SLCA studies are primarily concerned with industry, mining, etc. The tourism and ski industries, differ significantly in terms of their function in society. They provide non-essential services and target the richest strata of the population. Many impact subcategories that SLCA studies normally deal with, such as child labour, are irrelevant (especially when the spatial boundaries are applied) but positive subcategories gain importance. The health category is proposed in this study as a positive category where an indicator is the active movement of tourists. Furthermore, the environmental education category is proposed due to the huge potential of the ski industry to point out ecological problems, especially global warming. A relatively large part of the evaluation in this study is based on the expert judgement of the author, who has worked in the ski industry for over 20 winter seasons.

5.4.2. Goals

The main goals of this chapter 5.4 are to access information for the thesis objectives stated in [chapter 2](#). For this reason, in the following paragraphs possible alternatives for the study settings are discussed.

5.4.3. Scope and service definition

The complex and interconnected world of ski resorts makes it difficult to divide it into individual segments (e.g., accommodation or lifts only) as they cannot exist without each other,

at least on the scale we see in current ski resorts. The purpose of the ski resort is to provide leisure activities, usually skiing, although others are often offered. From the point of view of most stakeholder categories, the ski industry should be assessed as a whole, although segregation might be suitable for some stakeholder categories, such as the worker category.

5.4.4. Functional Unit

The FU for this thesis is the 24-hour stay of a guest at a ski resort. This approach seeks a compromise with LCA methods so that they can be applied in LCSA. In contrast to the E-LCA, where results may be computed for one day in a ski resort or for just one ski lift run, the S-LCA may be more challenging as the social interconnections, which are affected by seasonality, cannot be overlooked. So, when assessing the sociological impacts during the winter season, everything can appear positive (high salaries, employment) or, on the contrary, negative (for the local community – noise, traffic), and in the off-season it can be the other way around. Therefore, it makes more sense to regard the entire season, an all-year-round operation, as a temporal unit. Table 6 compares different FU settings.

SLCA	Functional Unit	Pros	Cons	Use
Variant 1	A 24-hour visit to a ski resort per one guest	Easily comparable to other LCA methods	Difficult to implement negative aspects of off-season	Good for comparison with E-LCA, LCC but problematic to correctly assess some impact categories
Variant 2	Winter season operation	In some social aspects, it would be better to relate results on this time scale	Difficult to implement negative aspects of off-season.	Good for LCSA and has potential for a better description of some important social impacts
Variant 3	All-year-round operation	Cover the off-season negative aspects	It might be difficult to compare with technical data from E-LCA	Recommended for stay-alone S-LCA study

Table 6 - Alternative FU settings for S-LCA

5.4.5. System boundaries

System boundaries should ideally encompass the entire service system. In the case of the ski industry, this would result in vast research requiring comprehensive databases for all different subproducts and materials. Assessments of leisure activities, particularly outdoor sports, should consider the significant benefits they provide for the entire society, therefore the benefits should be implemented. Application of spatial boundaries would not work very well for S-LCA, as for example, in the case of E-LCA. They would lead to the exclusion of some

stakeholder categories. This would negate the essence of the ski resort's existence and the study would then not make much sense. The Guidelines suggest a physical or effect perspective (Benoît Norris et al. 2020) – one based on the localized economic flow seems optimal so it is applied in this thesis.

5.4.6. Cut-off criteria

In general, it can be said that the cut-off criteria step can be used when there are funds for an extensive study. In the case of a smaller and simplified study with a small budget like this thesis, the procedure depicted in Figure 35 was applied. It could be called “add-on criteria”. This procedure is not methodologically desirable, but it can bring preliminary results on the basis of which a plan for a more detailed study can then be created.

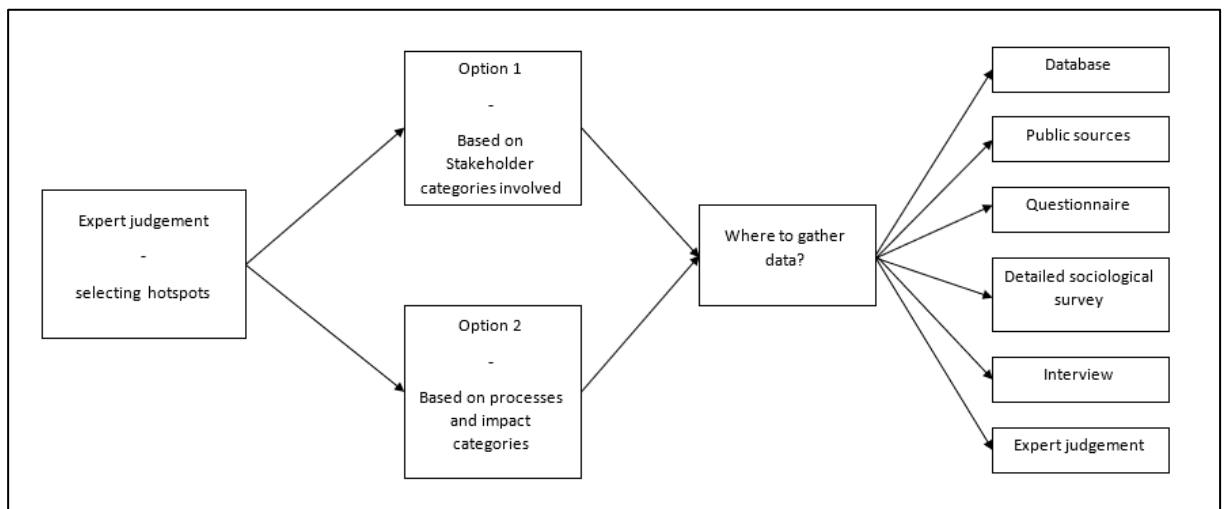

Figure 35 - "Add-on criteria" flowchart

Figure 35 suggests two possibilities. Option one is to first think about which stakeholder category needs to be included and then subcategories can be assigned to them according to the Guidelines. Option two, on the other hand, would primarily deal with subcategories in which there is the greatest social risk or benefit. Subsequently, around these subcategories, stakeholders would be assigned and other subcategories added. Ideally, both options are combined to not miss any important aspect. The second phase – choosing the method of data collection – is absolutely essential for the time and financial demands of the study. Data collection is discussed in [chapter 5.4.8.](#)

5.4.7. Stakeholders and impact subcategories

Stakeholders and subcategories must be chosen carefully. Figure 36 shows the selection proposed for ski industry S-LCA. However, additional subcategories could be added (e.g. working hours). Stakeholder category Value Chain Actors is completely omitted due the study boundary settings. The following text contains a description of the specifics of individual stakeholder categories in the ski industry. Subcategories are briefly described in [chapter 5.4.9](#).

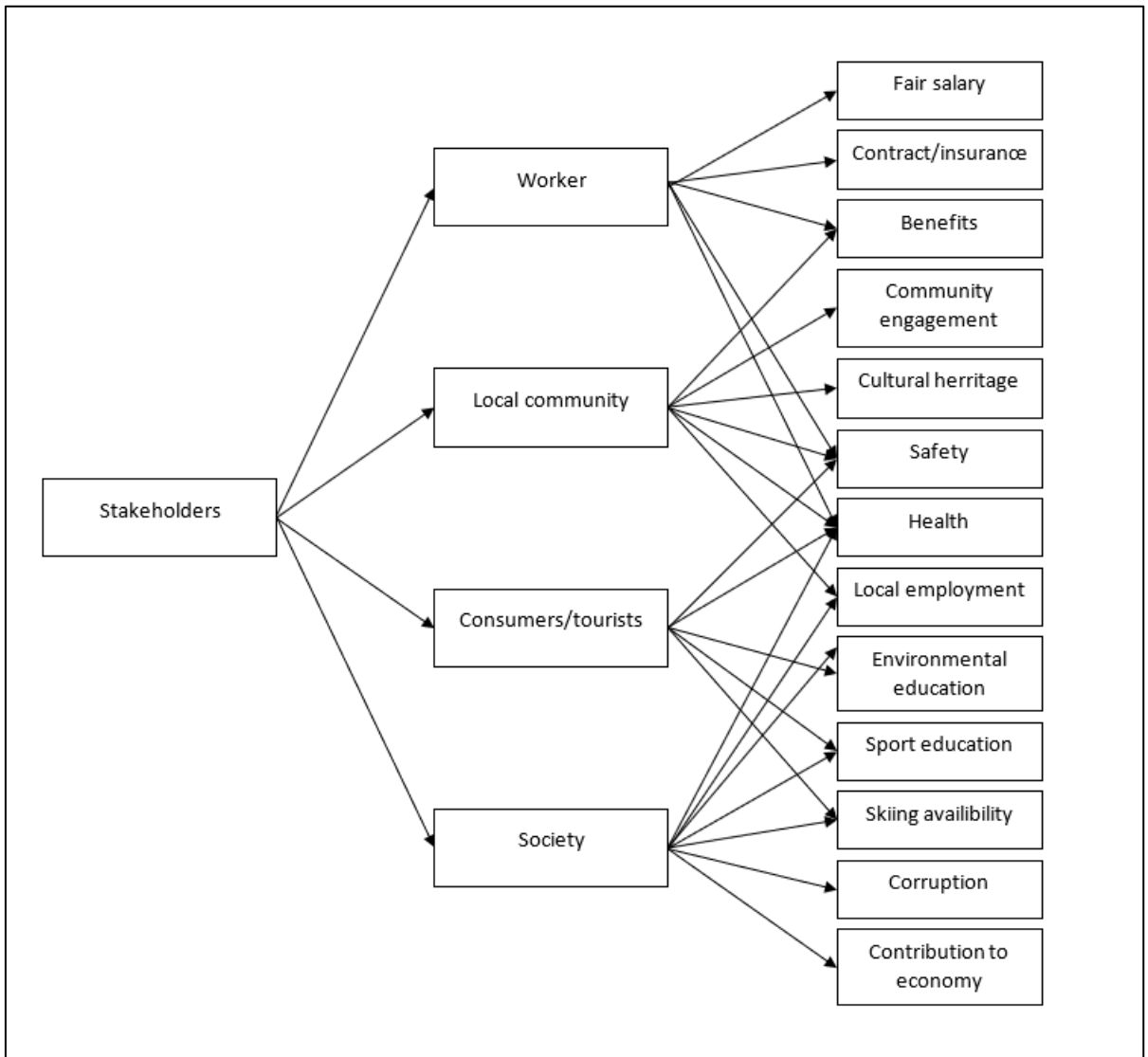

Figure 36 - Proposed selection of stakeholder categories and subcategories for S-LCA

Workers

In the majority of ski resorts around the world seasonal job positions prevail. There are several resorts with dual seasons or even all-year operation but most of the workload is distributed over winter. Ski lifts operators or hospitality services employ only a few workers all-year around. Therefore, most of the workers also have a summer job, typically in another

tourist destination or in summer labour jobs (e.g., farming, gardening, construction). There are a significant proportion of students working within the ski industry and a small community of professional workers follow the snow around the globe (typically snowsport instructors or coaches, ski resort operating managers, snowmaking technicians or snow machines drivers).

Local community

This stakeholder group can vary a lot from resort to resort. Some ski resorts are located in very remote places without original local communities. Other resorts can be found in the vicinity of big cities (e.g., Innsbruck). It is important to emphasize that the definition of a local community isn't always straightforward. A lot of people began to settle around skiing resorts decades ago because of skiing activities. The original local communities, which made a living by farming, mining or forestry, either no longer live in these towns/resorts or form a minority among permanent residents. Mountain resort municipalities often try to attract permanent residents (to receive more income from the State budget) by making the sale of apartments conditional on registering for permanent residency. For these reasons, such a study should define precisely which people form the local community, because the original from traditional SLCA is certainly not fulfilled in many ski resorts.

Consumers

Consumers or in this case tourists can be a very diverse group. As was already described in [chapter 4.6.1](#), almost 90% of tourists head to the ski resorts for skiing in the winter season. It is worth considering dividing this category into children and consumers (adults). The category of children often appears in S-LCA studies in the form of subcategories that refer to child abuse and/or illegal child labour. But in this case study, the category of children reflects the ski culture in the Czech Republic, where skiing is part of the school curriculum and is part of the trend to motivate children to adopt healthy lifestyle habits. Therefore, evaluating the impact of ski resorts on children and youth is a moderately important aspect that should appear in any comprehensive study that aims to objectively evaluate the performance of a ski resort.

Society

The society category appears in most S-LCA studies and we can use the same subcategories in the ski industry. However, the society stakeholder category should include the positive impacts of skiing. The negative impacts are reflected in other stakeholder categories (such as e.g. local community or workers). It must be noted that the negative impacts of skiing are often linked to environmental impacts. If S-LCA is conducted together with E-LCA, then

these aspects will already appear in the numerical results of E-LCA, which provide a lot more information than for example, the reference scale used in S-LCA.

Value chain actors

The value chain actor category was excluded from this work to limit the boundaries of the study and avoid a dramatic increase in the overall scope of the study. Data from extensive databases would definitely have to be used to process such a study.

5.4.8. Collecting data

Data acquisition from the ski industry can be quite different from conventional LCA studies. Most of the data related to stakeholder categories and subcategories chosen in this study cannot be found in ordinary databases. Therefore, questionnaires and other methods must be used as depicted in Figure 35.

For the purpose of this thesis, three methods of data collection were used. A questionnaire was conducted both in person in Špindlerův Mlýn and online engaging three groups. A total of 158 completed questionnaires were collected (13 from ski instructors, 37 from people taking breaks in mountain huts outside ski lifts, 28 in the town of Špindlerův Mlýn, and 79 online). Detailed results appear in [Annex 2](#). The final assessment in table 5 is based on the results the questionnaires, expert judgement and on AHS studies (AHS-KPMG ©2015, AHS-KPMG ©2014).

5.4.9. Basic assessment of social hotspots

Table 7 assesses selected subcategories that are most relevant to the ski industry. The importance of particular categories is described by attributing ‘High risk’ and ‘Low risk’ for potentially negative impacts, ‘Neutral’ for subcategories that can go either way, and ‘Very positive’ or ‘Positive’ for potentially positive impacts.

Negative impact subcategories

Contract/Insurance was highlighted as a high-risk subcategory because many employees do not have a permanent contract. Instead, they may have a verbal work agreement which allows the employer to avoid taxes. Employees are typically uninsured and can be fired at the drop of a hat. The trial period of a contract is often misused to get rid of employees after peak time, in cases of bad snow conditions, or the COVID-19 pandemic. ‘High risk’ was also attributed to the ‘Cultural heritage’ subcategory because of the developers’ projects that change

the traditional character of the mountain towns. Safety should also always be carefully assessed, as snow sports are classified as extreme sports and mountain environments are generally considered dangerous.

Stakeholder category	Subcategory	Importance
Worker	Fair Salary	Neutral
	Contract/Insurance	High risk
	Benefits	Positive
	Health	Very positive
	Safety	Low risk
Local community	Benefits	Positive
	Community engagement	Neutral
	Cultural heritage	High risk
	Safety	Low risk
	Health	Very positive
	Local Employment	Positive
Consumers/ tourist	Safety	High risk
	Health	Very positive
	Environmental education	Very positive
	Sport education	Very positive
	Skiing availability	Low risk
Society	Health	Very positive
	Local employment	Positive
	Environmental education	Very positive
	Sport education	Very positive
	Corruption	Low risk
	Contribution to economy	Positive
	Skiing availability	Low risk

Table 7 - Assessment of subcategories performances in S-LCA

Positive impact subcategories

The main purpose of tourism is to entertain, educate and relax people. Therefore, in assessing the social impact of tourism there must be positive attributes to counterbalance negative impacts both from environmental and social points of view. The ski industry offers mostly outdoor sports activities and spending active time in nature is desirable for human health so the 'Health' category is proposed and includes positive impacts on all stakeholder categories. Negative impacts on 'Health' would be assessed under the subcategory 'Safety'.

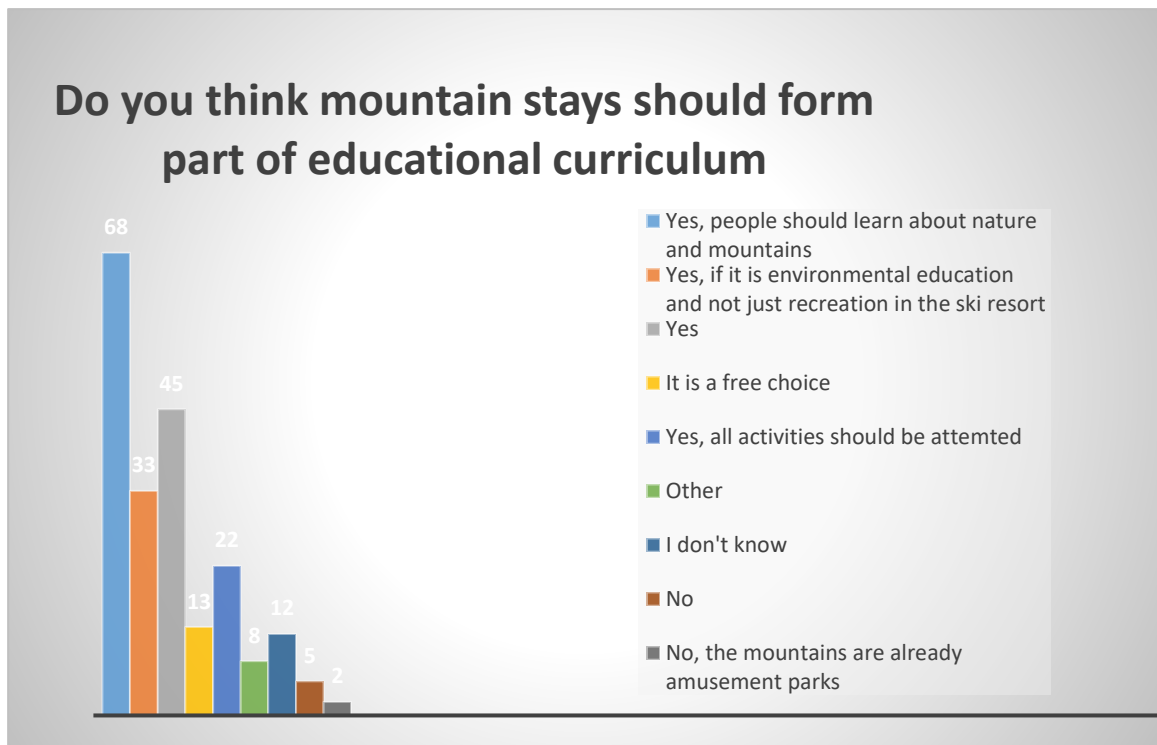

Figure 37- Questionnaire result concerning the educational value of mountain visits

Specific to the mountain environment and therefore the ski industry is the proposed subcategory of 'Environmental education' and 'Sports education'. Environmental education in particular should be considered as a main positive subcategory. Research conducted for the purpose of this thesis (see [Annex 2](#) for details) shows that almost 90% of respondents (figure 37) think that staying in a mountain environment should form part of an educational curriculum. However, the same research shows that what respondents enjoy most during a mountain stay are nature, peace, silence, and fresh air. Research done by AHS however, claims that 80% of guests come to the resort for the purpose of downhill skiing (AHS-KPMG ©2015). An actual assessment of the environmental education benefit provided by individual ski resorts should be further investigated.

5.5.Suggestion of calculation model

The reason one needs to create a calculation model rather than use available programs such as OpenLCA relates to the specific nature of ski resorts. The possibility of incorporating these specifics and projections into LCA studies and setting up dependencies between individual processes is suggested and explored. It must be remembered that this thesis works predominantly on a theoretical level with estimates and publicly available data, until such time as there is more cooperation from ski resorts.

MS Excel was chosen as the software to calculate and aggregate results because of its user-friendly working environment. Other professional tools, such as R-studio, Elasticsearch, or Python, might be better suited for sophisticated calculations. However, for the scale of this thesis, MS Excel is adequate. Details of the calculations for particular processes are explained in the following chapters.

Several steps were designed to obtain comparisons for different ski resort setups, including implementation of basic scenarios to project future impacts. The accuracy and depth of the calculation were affected primarily by the scope of this study and the limited available data sources.

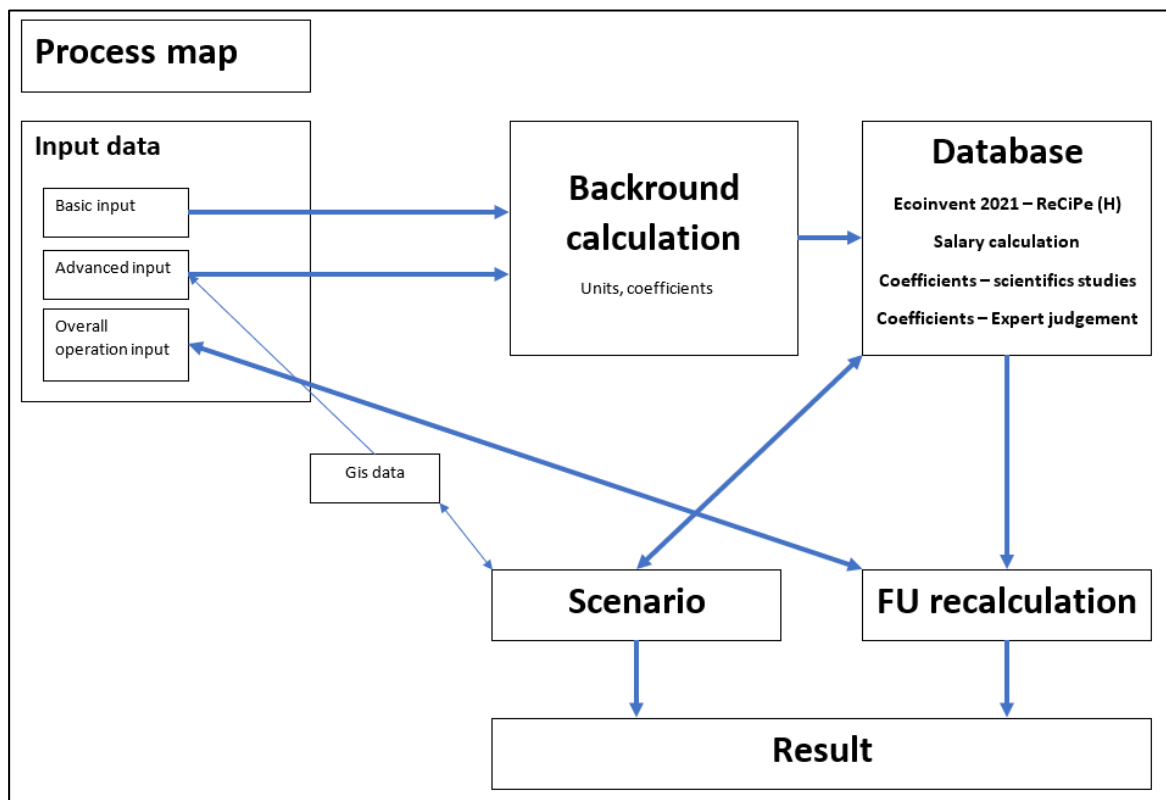

Figure 38 - Flowchart of calculation steps

Figure 38 shows the process map of the calculation model, which allows you to change input data and immediately see the results both graphically and numerically. Graphic results appear on the front page as charts (see figure 39) which can be adjusted using Excel functions to display desired impact categories.

5.5.1. Input data

The input is designed to provide a comparison between alternative ski resort arrangements and holiday types (distance travelled, length of stay, accommodation type). Different outcomes can be obtained by modifying the input information, and therefore different configurations can be compared. This method allows researchers to see the impact of various technologies and configurations, and ski industry operators can use it to optimize their operations.

There are two approaches used in this thesis:

- Basic Input (operation phase only)
- Energy projection based on the different countries' electricity mix

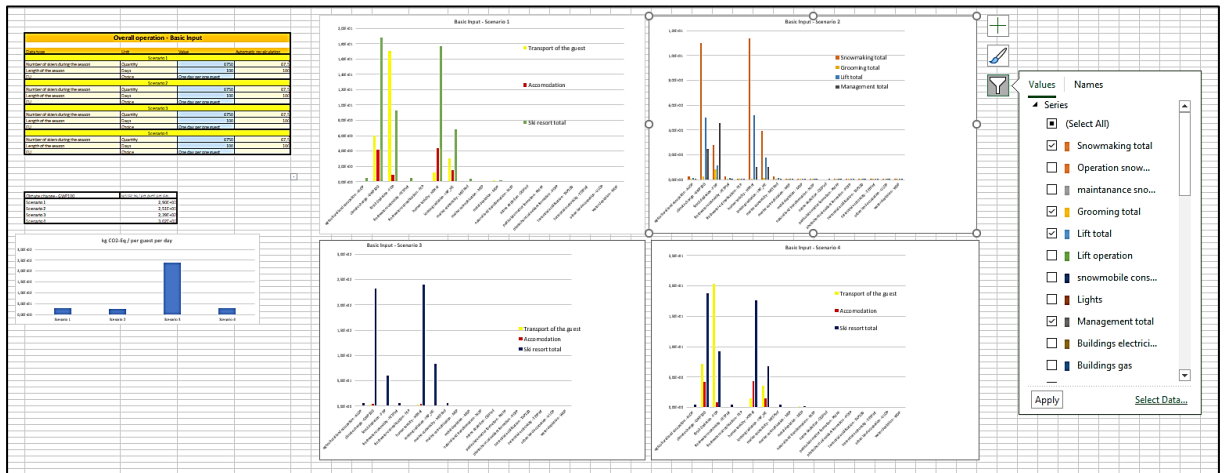

Figure 39 - The charts of the main input page

Overall operation input

The overall operation input (figure 40) controls the overall scope of the study and FU. Two key variables are needed – the length of the season and the number of guests (sum of day entries). These values can be obtained from the lift gate scanning system. The correctness of

this value is extremely important to compare the ratio between skiing and non-skiing impacts (e.g. transport).

Overall operation - Basic Input			
Data type	Unit	Value	Automatic recalculation
Scenario 1			
Number of skiers during the season	Quantity	6750	67,5
Length of the season	Days	100	100
FU	Choice	One day per one guest	
Scenario 2			
Number of skiers during the season	Quantity	6750	1
Length of the season	Days	100	100
FU	Choice	One day whole resort	
Scenario 3			
Number of skiers during the season	Quantity	6750	1
Length of the season	Days	100	1
FU	Choice	Full season whole resort	
Scenario 4			
Number of skiers during the season	Quantity	6750	67,5
Length of the season	Days	100	100
FU	Choice	One day per one guest	
		One day whole resort	
		One day per one guest	
		Full season whole resort	

Figure 40 - Overall operation input table: Scenario 1 refer to FU guests per 24 hours, Scenario 2 refers to FU day operation of the resort, and Scenario 3 refers to FU season operation. For Scenarios 2&3, transportation and accommodation of a guest must be excluded from the results.

Database

In an ideal situation, software like Elasticsearch would be directly connected to some of the existing LCA databases. Nevertheless, the licences for suitable databases are very expensive, and they do not provide all relevant data to the ski industry. A small database was created for this study to demonstrate the concept of the calculation approach employed in this thesis. The base of the database comes from the Ecoinvent database (figure 41). Exports of basic electricity mixes, fuels, and materials were exported by method ReCiPe (H).

Other options like week operation (which can be used to calculate activity during peak season) are possible, but they would require particular input data. Some adjustment to the model would be necessary to encompass the energy consumption of the preseason preparations, such as snowmaking.

GIS data

Although not used in this thesis, GIS software can be used to assess the impact of a new project, providing important data such as slope area or gradient (steepness), and so on. For advanced scenario calculations, functions such as slope orientation and elevation could be used to provide data to project snow evaporation or optimal snow storage places during different times of the season.

Scenario

A scenario can be defined as a model of a hypothetical situation. The basic input in this thesis allows the user to input different entry data for a chosen situation and observe the differences on the main page. A few examples are shown in [chapter 5.5.5](#).

Basic input calculation steps

The calculation for a small, hypothetical situation was conducted. Input data was discussed with long-time professionals who have assessed energy demand and working hours. Several variables were changed to evaluate the significance of different variables. Generally, the basic input model works when aggregate data are known for season operation. The basic input level only refers to the operation phase.

Snowmaking input

Data can be added through the value of KWh if it is known or through the value of artificially created snow in cubic metres (figure 42). In the case of cubic metres, the input value is recalculated using the results of a study from Masotti et al. (2018) about snowmaking in the Fiemme Valley. Almost 4 KWh of energy are needed per cubic metre of snow. This value is in the middle of the range stated by Flousek (2016) and also confirmed by snowmaking experts from Giant Mountains.

		Scenario 1			
		BASIC INPUT - operation phase only			
Snowmaking input					
	Data type	Unit	Value	Control mechanism	
Snowmaking input	Input version 1 Snowmaking consumption per season	KWh	0	ok	
	Input version 2 Amount of snow needed	Cubic meter	22000	ok	
	Maintenance (working hours)	hours	200		
	snowmaking machine transport and maintenance consumption	litres of diesel	1900		

Figure 42 - Snowmaking input: one cubic meter of snow per square meter was calculated

Lift, grooming and management input

Lift and grooming data were obtained from expert assessment. In the case of grooming consumption per hour and time for a hectare of grooming by machine, a Pisten Bully 400 was used. Apart from consumption data, working hours are also taken into account. Working hours data can be used to perform LCC and provide evidence for S-LCA evaluations (Stakeholder category: ‘Worker’). In management input, the impact of buildings is assessed. In this case, no data were available, so an assumption was made based on publicly available data about average consumption in a family house of 100 m². The value of the family house was extended as extra energy was anticipated for a workshop or lift station (figure 43).

Data type	Unit	Value
Lift consumption	KWh	40000
Maintenance (working hours)	hours	3000
Lift support transport (snowmobiles)	litres of diesel	200
Light consumption (night skiing)	KWh	
Data type	Unit	Value
Grooming machine consumption	litres of diesel	3600
Maintenance (working hours grooming machines drivers)	hours	250
Data type	Unit	Value
Building electricity consumption	KWh	5000
Building gas consumption	cubic meter	10500
Maintenance (working hours)	hours	2000
Transportation (management car)	litres of diesel	500

Figure 43 - Lift, grooming and management data input

5.5.2. Accommodation

The hospitality impact should be incorporated into the calculation. For the purpose of basic input, three options are available (see figure 44). A simplified calculation (see figure 45) was used to assess these values. An interesting study about the impact of tourist accommodation was conducted by Filimonau et al. (2011). The results from this study (incorporated as option “luxury accommodation”) are higher, in fact double that of this thesis assessment. However, one might review whether or not to include the impact of accommodation. In reality, since the

majority of the guests are from a higher socioeconomic class and most likely use a smaller, separate living space for skiing, their energy use might well be lower. This raises an important question about tourism assessment: should everything be included in calculations, or only the impacts over and above people's 'normal' lives? Nevertheless, in this calculation, the ski accommodation was included to compare the accommodation impact with other processes.

Data type	Unit	Value
Type of accommodation	type	Accommodation budget
		Accommodation Luxury
		Accommodation normal
		Accommodation budget

Figure 44 - Input option for accommodation

<p>Electricity consumption calculation: Consumption family house yearly 2000-3200 KWh yearly Electric heating yearly (heat pump) 5000 KWh Water heating per person yearly 1160 KWh</p> <p>Assumption: 4 person in family house -> 2910 - 3210 KWh per person yearly -> 8 - 8.8 KWh daily</p> <p>Source: https://www.srovnejto.cz/blog/jaka-je-prumerna-spotreba-elektriny-u-rodinneho-domu/</p> <p>For the luxury accommodation option, the following study was used: Filimonau et. al (2011) (detail in the database file).</p>	
Accommodation	
	Electricity consumption KWh per person per day
Accommodation luxury	16
Accommodation normal	8
Accommodation budget	5

Figure 45 - Background sheet with explanation of value assessment

5.5.3. Transportation

Transportation was thoroughly discussed in [Chapter 4.9](#), because it is highlighted as a main source of impact in tourism in several studies (e.g. Scott et al. 2008). Therefore, a more advanced calculation was created for the basic input stage. Figure 46 shows the input choices, which are generally based on the distance travelled and the type of transportation. An important variable is the length of stay.

Data type	Unit	Value
Distanced travelled - diesel transport	Km	270
Distance travelled - electric transport	Km	0
Distance travelled - plane	Km	2300
Number of days in the resort (average or for one guest)	days	5
		Bus
		Electric car 2 passenger
		Train
		Electric car 1 passenger
		Electric car 2 passenger
		Electric car 4 passenger

Figure 46 - Transportation input settings: in this case, the return journey, including flights between Oslo and Prague and bus transport to Špindlerův Mlýn was input

Figure 47 shows the background calculation sheet with an explanation of how the consumption values were gathered.

Transport				
	Diesel consumption 1km/per person (škoda octavia diesel 5l/100)			Scenario 1
Car 1 passenger		0,05		
Car 2 passengers		0,025		Calculation based on input data
Car 4 passengers		0,0125		
Bus		0,0445	Transport consumption diesel litres	12,015
	kWh /km passenger			
Train		0,21128	Transport consumption kWh	#N/A
Electric car 1 passenger		0,2		
Electric car 2 passengers		0,1		
Electric car 4 passengers		0,05		
	kg kerosene/km passenger			
Plane		0,02325	Transport consumption kerosene kg	53,475
Sources:				
Bus according to: http://transportationlca.org/tlcadb-passenger.php Average between peak and off-peak operation - 2,26MJ/km passenger Caloric value from https://vytapani.tzb-info.cz/tabulky-a-vypocty/11-vyhrevnosti-paliv - 42,61MJ/kg -> 0,05304kg Diesel/km passenger -> 0.0445 l diesel/km passenger				
Train according to http://transportationlca.org/tlcadb-passenger.php Data taken from Light Rail San Francisco 0,76MJ/km passenger -> 0,21128 kWh/km passenger				
Plane according to http://transportationlca.org/tlcadb-passenger.php Average from values for planes = 1,047MJ/km passenger -> 45MJ/kg -> 0,02325 kg kerosene/km passenger -> 0,0186 l				
Electric car - https://www.virta.global/blog/ev-charging-101-how-much-electricity-does-an-electric-car-use Average car 0,2 kWh/km				

Figure 47 - Background calculation for transportation

5.5.4. Interconnection between LCA methods

The model recalculates collected data, which can be further refined for other LCA methods. Figure 48 shows a result sheet that calculates working hours and operational costs. It offers results in various time spans that would match a desirable FU for LCC or S-LCA (e.g., stakeholder category Local Community, subcategory Local Employment). One use of the concept is demonstrated through the recalculation of CO₂ equivalent emissions. It is based solely on electricity and gas consumption, and it provides a value that might be important for the national level planning to reach carbon zero plans. The table provides recalculation into EU Emissions Trading System (EU ETS). The CO₂ equivalent is further recalculated using the current price per tonne.

Ski resort total - season							
Electricity	CZK	330272,5		330272,5		330272,5	330272,5
Diesel	CZK	229400		166200		166200	166200
Gas	CZK	157500		157500		157500	157500
Salaries	CZK	1530000		703000		703000	703000
Working hours	hours	5450		5450		5450	5450
TOTAL	CZK	2247172,5		1356972,5		1356972,5	1356972,5
Ski resort per day							
Electricity	CZK	3302,725		3302,725		3302,725	3302,725
Diesel	CZK	2294		1662		1662	1662
Gas	CZK	1575		1575		1575	1575
Salaries	CZK	15300		7030		7030	7030
Working hours	hours	54,5		54,5		54,5	54,5
TOTAL	CZK	22471,725		13569,725		13569,725	13569,725
Ski resort per guest per day							
Electricity	CZK	0,4893		0,4893		0,4893	0,4893
Diesel	CZK	0,3399		0,2462		0,2462	0,2462
Gas	CZK	0,2333		0,2333		0,2333	0,2333
Salaries	CZK	2,2667		1,0415		1,0415	1,0415
Working hours	hours	0,0081		0,0081		0,0081	0,0081
TOTAL	CZK	3,33		2,01		2,01	2,01
EU ETS costs per season	tones of CO2 eq.	111,00		111,00		111,00	111,00
	CZK	277493		277493		277493	277493

Figure 48 - Recalculation of operation costs, working hours and calculation for EU ETS

5.5.5. Using the basic input calculation model

The Excel “*Ski_resort_impact_calculation_basic.xlsx*” is submitted with this thesis to check its functionality. The model is created to perform four scenarios in one. For the purpose of this thesis, several scenarios were performed and a few of them are displayed here in the form of scans.

Model one – Influence of the length of the stay and travel

It has the same input for all entry variables (see figure 62 in [Annex 3](#)) except travel and the length of stay. The luxury accommodation option was chosen for all scenarios.

- **Basic Input - Scenario 1** – Bus 270 km (Praha – Špindlerův Mlýn – Praha), Plane 2300 km (Oslo – Praha – Oslo), a 5 day-stay
- **Basic Input - Scenario 2** – Bus 270 km, Plane 2300 km, a 14-day-stay
- **Basic Input - Scenario 3** – Electric car 4 people, 230 km, a 5-day-stay
- **Basic Input - Scenario 4** – Electric car 4 people, 230 km, a 14-day-stay.

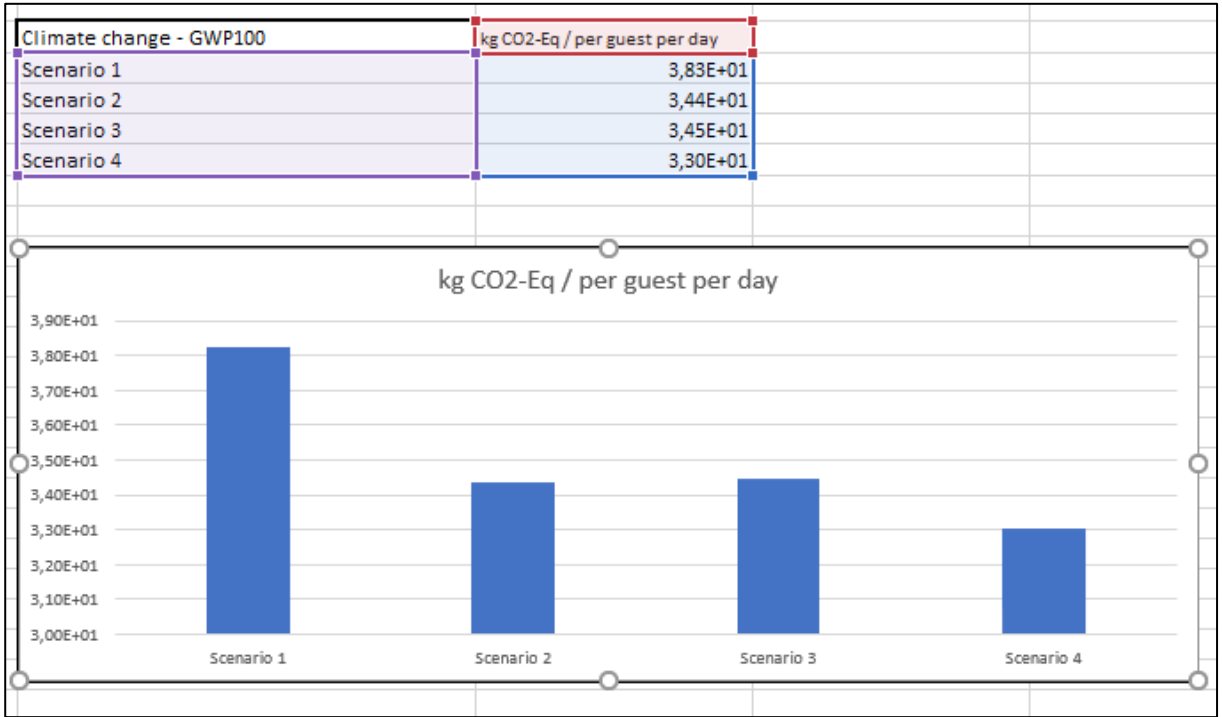

Figure 49 - Influence of the length of the stay and travel distance on GWP.

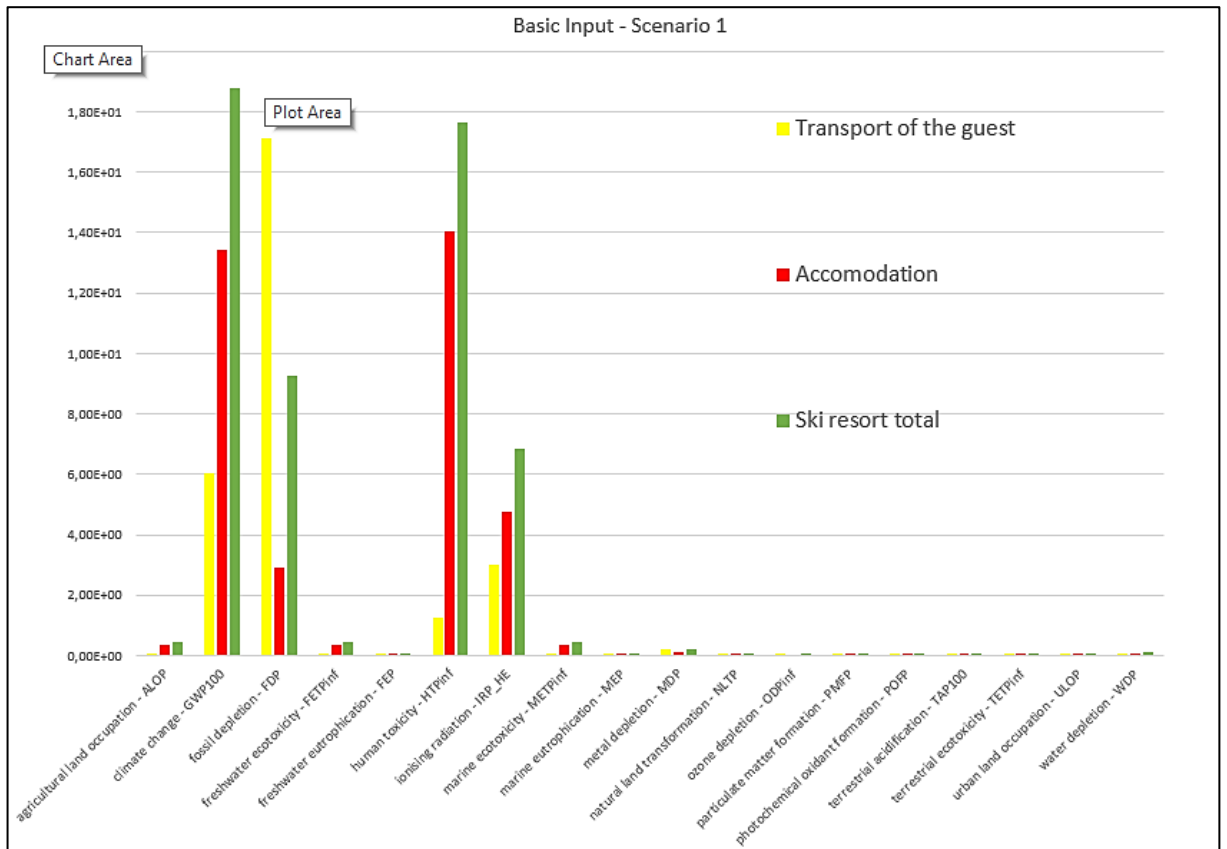

Figure 50 - Influence of the length of the stay and travel distance - a 5-day-stay, bus 270 km, 2300 km plane, luxury accommodation.

It can be seen that the impact of transport is not as significant as the ski resort impact. In GWP, the impact of transport reaches about 30 percent of the impact from ski resort operations. Other scans from this model are in Annex 3.

Model two – Influence of the size of groomed slope and increased snowmaking

This model shows the situation when a very large slope belongs to a small lift. The increased snowmaking can be understood as modelling for a warmer season when the effectivity of snowmaking is low or the snow loss is high due to increased evaporation or melt caused by a high amount of rain (see figure 66 in [annex 3](#)).

- **Basic Input - Scenario 3** - Normal values for ski resort operation input, Travel by bus for 100 km, no accommodation (see figure 51).
- **Basic Input - Scenario 4** – Double values for slope preparation and snowmaking, travel by bus for 100 km, no accommodation (see figure 52).

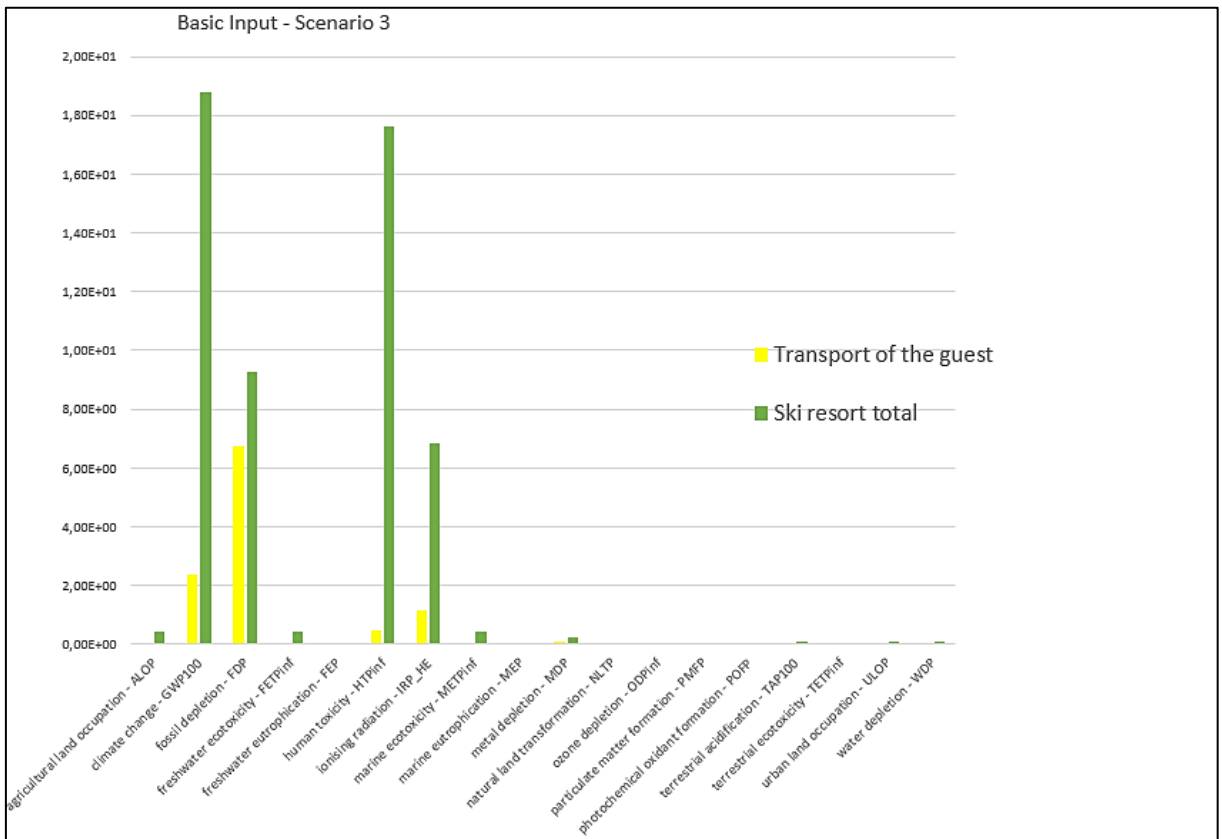

Figure 51 - Normal values for ski resort align with expert judgement, travel by bus for 100km, no accommodation.

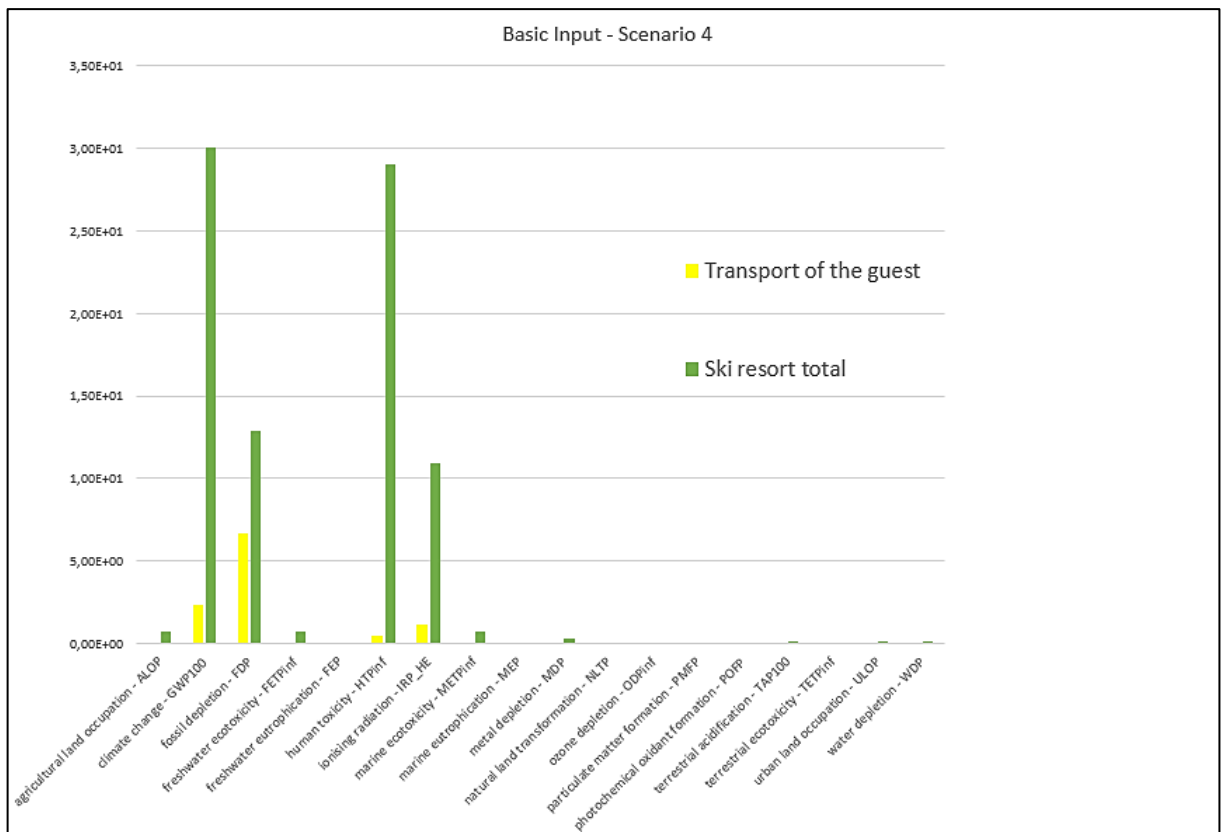

Figure 52 - Double values for slope preparation and snowmaking, travel by bus for 100 km, no accommodation.

Model three – Influence of the size of groomed slope and increased snowmaking in comparison with distance travelled and length of stay

This model shows the situation when a very large slope belongs to a small lift. The increased snowmaking in comparison with different travel scenarios suggests that long-distance travel might not have as much of an impact as snowmaking and slope preparation itself (see figure 53 and [Annex 3](#)).

- **Basic Input - Scenario 1** – Normal values for ski resort operation input, bus 270 km, plane 2300 km, a 7-day stay, luxury accommodation.
- **Basic Input - Scenario 2** – Double values for slope preparation and snowmaking, bus 270 km, Plane 2300 km, a 7-day stay, luxury accommodation.
- **Basic Input - Scenario 3** – Normal values for ski resort operation input, bus 100 km, a 2-day stay, budget accommodation.
- **Basic Input - Scenario 4** – Double values for slope preparation and snowmaking, Bus 100 km, a 2-day stay, budget accommodation.

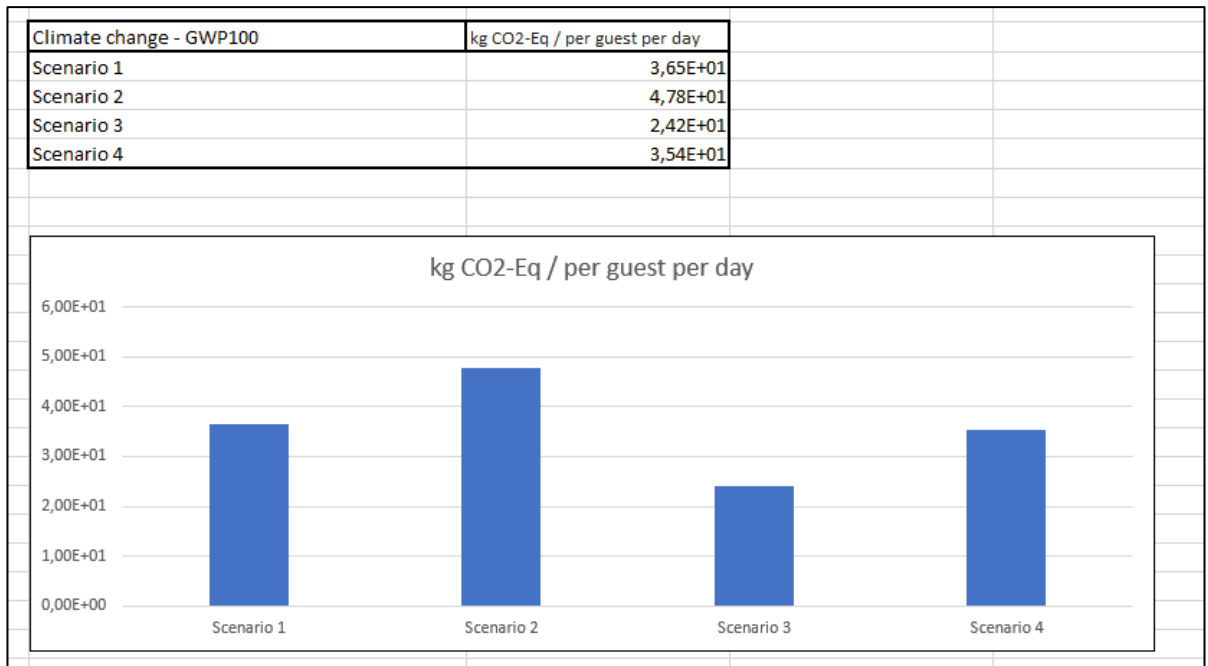

Figure 53 - Influence of the size of groomed slope and increased snowmaking in comparison with distance travelled and length of stay on GWP.

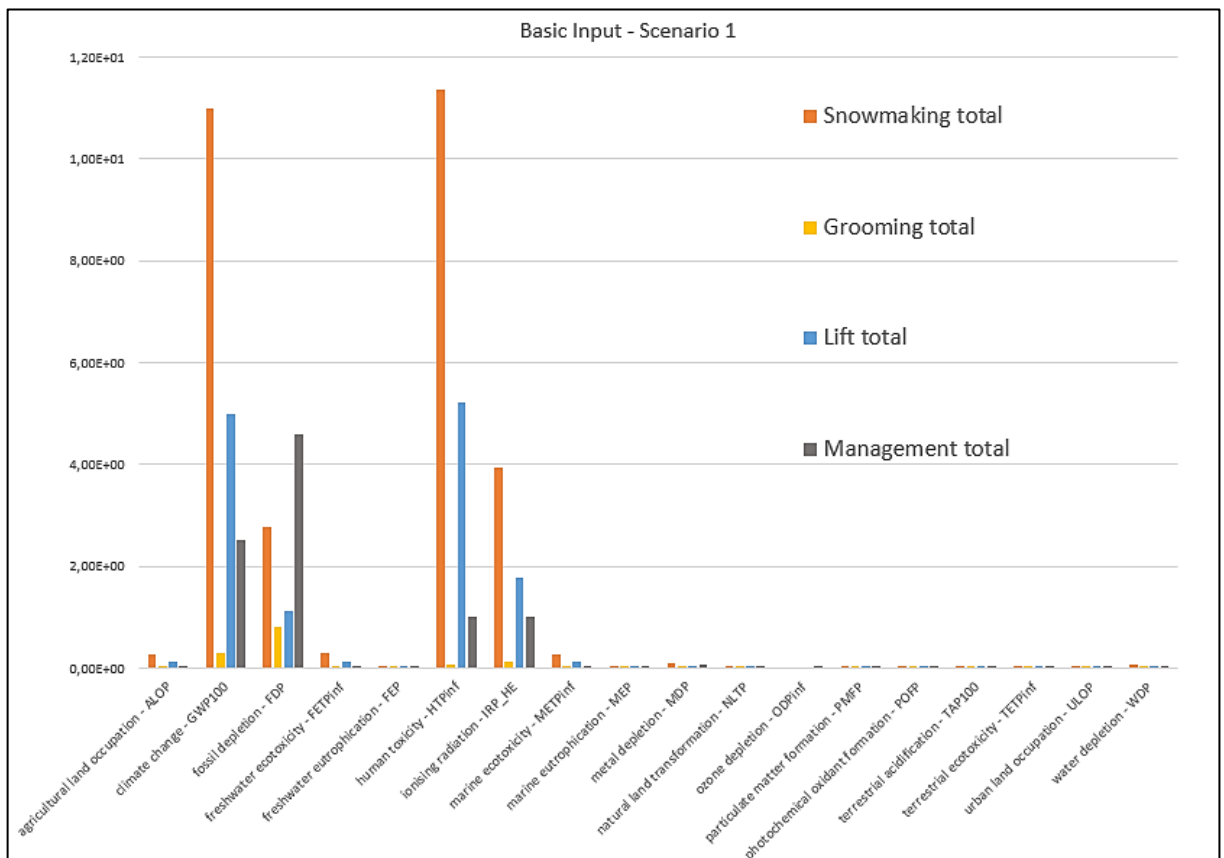

Figure 54 - Comparison of operational impact from different parts of ski resort operation based on input data from figure 62.

Model four – Comparison of operational impact from different parts of ski resort operation

Figure 54 depicts a comparison between particular segments of ski resort operations. The results show that snowmaking is the main cause of impact.

Summary of the basic input

To evaluate the effects of various holiday trip settings and compare them with two snowmaking scenarios, a few models were developed. It has been disproven that the most significant impacts in tourism come from transportation and accommodation in the snowsport industry (see [figure 21](#)). It is important to keep in mind that the data used for this thesis were quite sparse limited and that estimates from previous research were employed. Nonetheless, simulations demonstrate the major impact of ski resort operations and how quickly this would intensify in the event that additional artificial snow was required. From GWP's perspective, it is preferable for a guest to travel to a remote resort rather than ski at a resort that relies heavily on artificial snow production, as demonstrated by the contrast in model three.

5.5.6. Using the energy projection calculation model

The basic input Excel sheet was modified to an advanced version called “*Ski_resort_impact_energy.xlsx*,” where each of the four scenarios was connected to a different electricity mix database representing different countries. Apart from the Czech electricity mix (scenario 1), a German (scenario 2), Danish (scenario 3), and French mix (scenario 4) were chosen. The power of E-LCA is demonstrated in Figure 71 in [Annex 3](#), where we can see the impact if the nuclear energy source is the main part of the grid.

Scenario 2 - German energy mix				Scenario 3 - Denmark energy mix				Scenario 4 - France energy mix			
BASIC INPUT - operation phase only				BASIC INPUT - operation phase only				BASIC INPUT - operation phase only			
Value	Control mechanism	Unit	Value	Control mechanism	Unit	Value	Control mechanism	Unit	Value	Control mechanism	Unit
22000	ok	KWh	22000	ok	KWh	22000	ok	KWh	22000	ok	KWh
200	ok	Cubic meter	200	ok	Cubic meter	200	ok	Cubic meter	200	ok	Cubic meter
1900	ok	Hours	1900	ok	Hours	1900	ok	Hours	1900	ok	Hours
40000	ok	Hours	40000	ok	Hours	40000	ok	Hours	40000	ok	Hours

Figure 55 - Preview of the energy excel sheet

Data input for these comparisons are based on expert judgement and were already used (see [figure 62](#)). Figure 55 shows the GWP 100 impact of different electricity grids for 2 passengers travelling to the ski resort in an electric car and staying for a total of 7 days.

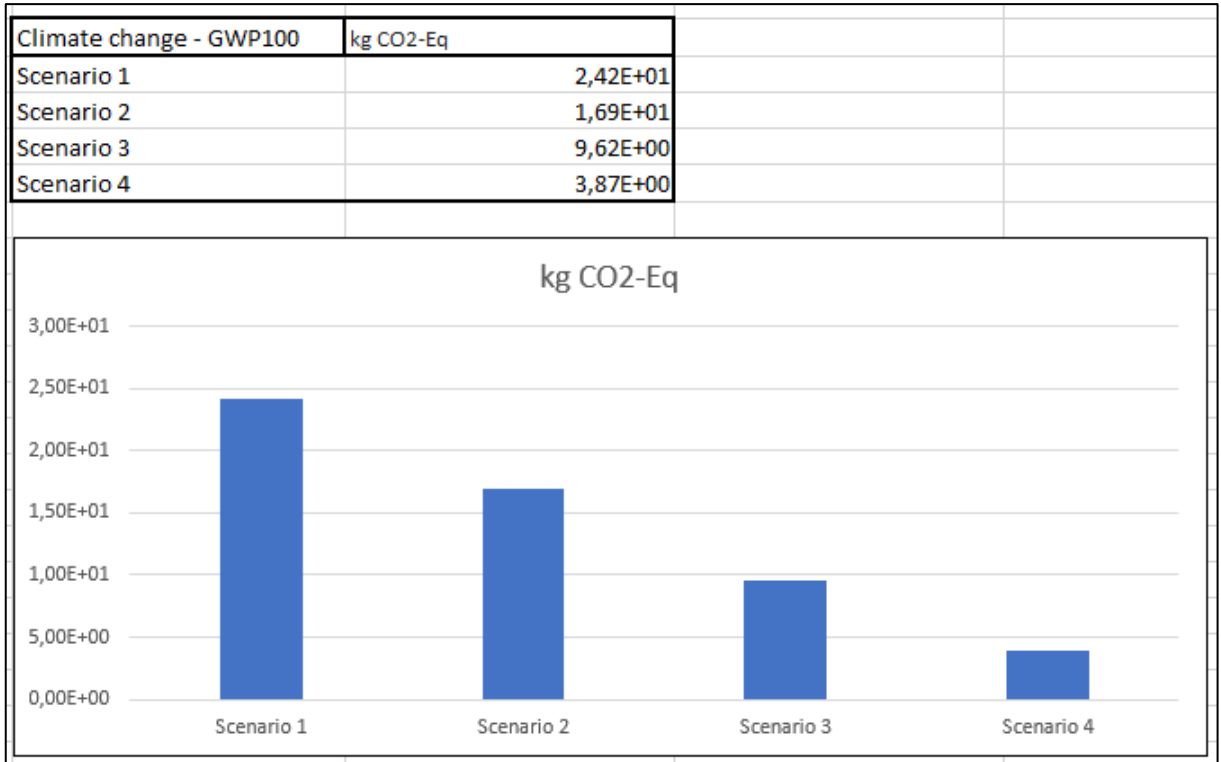

Figure 56 - GWP 100 comparison for different electricity grids

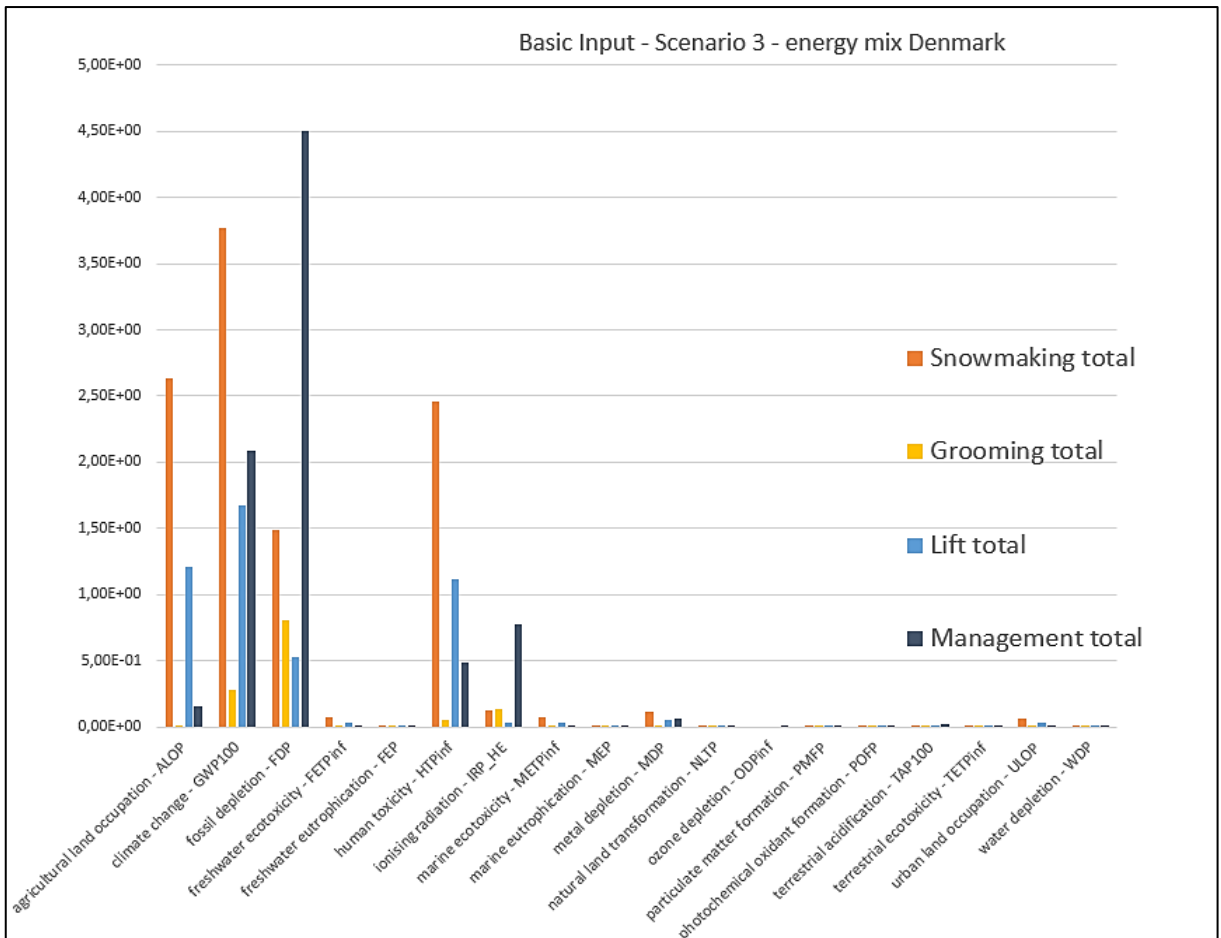

Figure 57 - Comparison of operational impact from different parts of ski resort operation based on input data from figure 62. Figure 57 can be directly compared with figure 53 (the Czech electricity grid).

Summary of the energy projection calculation model

This model is a useful tool to see the differences if the electricity mix changes. For future projection, it can be significantly helpful to see if electrification of some segments of the ski industry would decrease the impact in some categories or increase the impact in other categories. However, some model settings should be revised to reach more accurate results (e.g., new technologies should be incorporated into projections). [Figure 71](#) demonstrates the power of LCA to reveal the impact on all categories. Nuclear energy has a very small impact on the GWP 100 category, but its performance in the ionising radiation category is very significant.

5.5.7. Calculation model conclusion

The model contributes to calculations involving the operational part of the ski industry. To calculate other life cycle phases, the database needs to be completed with specific items related to the ski industry (snowguns, compressors, grooming machines, etc.). The additional benefit of the model is its function to connect LCC calculations with E-LCA and also provides basic information that can be used in S-LCA.

6. Summary of the study objectives

Benefits and drawbacks of LCA methods

LCT is without any doubt a very important way to reach sustainability goals. However, this thesis has discovered that the application of a methodologically correct approach to LCA methods might prove complex. The nature of the ski industry, dominated as it is by a highly competitive private sector, means that the biggest issue is data accessibility. On the other hand, LCT can reveal very interesting interdependencies, which may well be appreciated by ski industry operators.

LCA methods settings

Settings were discussed, and several approaches for setting FUs and boundaries were proposed. If the main goal is to provide an overall and fair assessment of the ski industry, the LCSA approach is recommended. The main goal of LCSA should be to try to collect the maximum amount of available data from individual LCA methods, to highlight the hotspots, and to define interlinkage with other processes, ideally represented by some quantifiable relationship. Gate to grave (operation to disposal) settings are more likely to be appreciated by ski industry operators, as would the combination of LCC alongside E-LCA. An assessment of the operations over an entire year should be considered, even if a certain level of study simplification is required.

Hotspots

It was discovered that the ski industry impact hotspots differ from those in other tourism sectors. The biggest impact is caused by snowmaking. The social impacts of the ski industry should not be omitted. The author is strongly persuaded that positive social impact should be further discussed in order to find a way to incorporate it fairly into a more complex assessment.

Projections

Apart from projections, which are commonly implemented in LCA studies and various strategic planning studies (e.g., optimal electricity mix or transportation), a global warming adaptation must be researched. The snowmaking process and grooming of slopes should be optimised in particular.

Dynamic model

A simple model was proposed with modelling functions that can quickly demonstrate the impact of different spatial or technological choices. The author is strongly convinced that such an approach might attract the attention of ski industry operators and foster cooperation.

7. Discussion

LCA is a powerful tool which reveals the environmental and socioeconomic impacts in the value chains of a product or service. The results provide quantitative information which enables qualified discussion among scientists and decision makers. E-LCA in particular plays a significant role in the European Commission's decision-making process to reach sustainability goals (Shaked 2015). The power of LCA is demonstrated in studies like *Life Cycle Assessment of Electricity Generation Options*, which offers a thorough comparison of electrical energy sources (UNECE ©2022) on the basis of which strategic decisions can be made leading to the fulfilment of sustainability goals. However, the scale of these studies is enormous and requires precise data sources. The UNECE (©2022) study is official research conducted in an industry which is under state control, and which allows access to data. The problem with ski industry research is the competitive private environment where there is little willingness to cooperate on environmental topics (e.g. (Flousek 2016), (Cetara, Angelini 2006), (Tremel 2022), (Faney et al. 2010)).

E-LCA has a long history and its use in some fields has reached a high level of accuracy. Scott et al. (2008) claim that the main impact of tourism comes from transport. Therefore, the thesis gave transportation a lot of consideration. For the transport impact calculation studies from Chester and Horwath (2009) were used for its complexity (including all infrastructure related to transportation). However, the studies are highly diverse and they either do not include all parts of the life cycle or they omit parts of some impact categories. This is the biggest weakness of all LCA studies, which should therefore always be critically evaluated before use. The final report in an LCA study should contain a critical review (Klöpffer 2012).

Despite its advantages, the use of LCA methods in tourism has several limitations. The major issue is the lack of information in databases and the cost of gathering the required data. This might change with voluntary industry action and researcher collaboration to create free-to-use databases (Filimonau 2016). However, this thesis found out that voluntary action from ski industry operators is unlikely. The solution may be to implement LCC analysis, which may help to optimise the operation of ski resorts, or to add S-LCA techniques to highlight some of

the positive contributions of ski tourism. Merging all three methods into LCSA would provide a very holistic overview of the industry, but the scale of such a study would be both time-consuming and expensive.

Ciroth et al. (2011) is convinced that the development of LCSA will follow in the footsteps of other LCA methods, which have improved as their usage has increased and as databases have become more accessible. However, the ski industry and tourism in general are, by their very nature, completely different products, or rather services, than, for example, those of food production or waste management. This raises the question of whether the same methodology should be used. Some of the tourism-specific effects on society can be expressed throughout the positive impacts in S-LCA (Arcese et al. 2013). In his review, Flousek (2016) describes the various impacts of skiing on the mountain environment. Some of the discussed influences produce changes in nature (in species composition) or changes in the hydrological cycle. Such impacts are not easy to include in quantified E-LCA results, or rather would lead to a debate on the magnitude of the assessed impact.

LCA in the context of tourism and ski resorts

Historically, tourism studies were focused only on local impacts, and only recently have studies begun to highlight its broader impact, particularly the GWP of tourism (Filimonau 2016). Globally increasing competition between tourist destinations favours traditional impact assessments of tourism based on a socioeconomic approach. These impact studies often concentrate on maximizing the economic benefits of tourism for the hosting area (Matias et al. 2016). Decision makers in tourism often base their planning only on local impact assessments and are oriented towards future development. This approach is closely related to boundary and FU settings, which were discussed in this thesis.

Ideally, all life cycles should be assessed, but on the scale required for a ski resort, this is hardly feasible. A similar study done by Faney et al. (2010) used a spatial boundary and assessed only direct impacts in ski resorts. Masotti et al. (2018) calls the boundary settings 'cradle to gate', but in fact the manufacturing of machines is omitted. Cradle in this case means only the start of water pumping for snowmaking. Filimonau et al. (2013) sets the boundaries as door to door for a holiday trip to Portugal. The impact is calculated from the moment a tourist leaves his home until he returns. Basically, the same approach was used in the "Basic input calculation" of this thesis.

The FU recommended in this thesis is a guest visit at a ski resort for 24 hours, which is the same as that used by Faney et al. (2010). However, it is noted that, particularly for S-LCA studies, it would be useful to consider a longer time period due to the seasonality specifics. Seasonality and its related fluctuation in the operation of any tourism destination is a big issue (Matias et al. 2016). To provide a complex assessment, the entire year's operation should be evaluated.

Seasonality is related to the implementation of projections into LCA studies, which was also reviewed in this thesis. Seasonal diversification for ski resorts is recommended due to the risk of global warming (Scott et al. 2008), which can significantly affect the operation of many ski resorts. The impact of global warming will affect mostly resorts with insufficient snowmaking systems, in the lower altitudes, but generally it will not cause any major damage (Steiger 2020). Steiger (2019) in his other work notes that not only technical reactions are needed but mostly common discussion among all stakeholders.

The biggest impact of the ski tourism sector comes from snowmaking and ski resort operation. Therefore, implementation of different scenarios should be done mostly at this level. Global warming scenarios should be implemented on the level of snowmaking and grooming. The ski operators would likely be interested only in the operation and disposal parts of the life cycle.

8. Conclusion

This thesis evaluates the possibilities of using LCA principles as a tool to contribute to the discussion about the sustainability of the ski industry. If there is an intention to conduct a full LCA study within the ski industry, this thesis serves as an addition to the existing LCA methodologies. It sums up all the specifics of the ski industry in the context of LCA studies. LCA studies in tourism are very limited; the few that exist within the ski industry work only with the operational phase of the life cycle, calculating impact mostly through energy and fuel consumption. The positive attributes of showing the interconnectedness of individual processes are still utilised, but the overall picture, which should be the main benefit of LCA, is not. Application of LCA in the ski industry is very limited due to a lack of cooperation from the mostly private ski industry sector and the very vast scope of the study. Environmental data in particular are very hard to obtain, and they significantly affect the accuracy of results.

The calculations conducted in this thesis have disproven that the main impact hotspots are transportation and accommodation for guests, as they are in other tourism sectors. Even

long-distance travel for ski holidays can have a minor impact in comparison with snowmaking and ski resort operations. Therefore, it is recommended to focus primarily on the sectors related to ski resort operation to minimize the impact of ski tourism.

Part of the study was focused on the social impacts of skiing. The questionnaire has proved that culturally, skiing or staying in a mountain environment is viewed very positively and is regarded as a valuable part of one's education. It raises the question of whether or not the future of the ski industry lies in colder destinations with enough natural snow. Ski resorts with natural snow might have better results in E-LCA even if skiers travel further. However, the impact assessment of ski tourism will always be difficult due to the personal preferences of each individual and scarcity of reliable data. Life Cycle Thinking and LCA methods have the potential to contribute rational information to the decision-making process about the future development of the ski industry.

9. References

1. AHS – Asociace horských středisek. Analytická činnost. ahscr.cz AHS-KPMG. Horská střediska v ČR - identifikace přínosů pro regionální rozvoj a veřejné rozpočty 2014. © 2023 [cit. 2023-03-15]. Available from: <https://www.ahscr.cz/pro-cleny/analyticka-cinnost/>
2. AHS – Asociace horských středisek. Analytická činnost. ahscr.cz AHS-KPMG. Analýza návštěvnosti horských středisek v České republice 2014/2015. © 2023 [cit. 2023-03-15]. Available from <https://www.ahscr.cz/pro-cleny/analyticka-cinnost/>
3. AHS – Asociace horských středisek. dokumenty pdf. ahscr.cz. Hodnocení 2021. © 2023 [cit. 2023-03-15]. Available from: https://www.ahscr.cz/media/uploads/dokumenty_pdf/hodnoceni_08.12.2021_web_3s..pdf.
4. Andrews, E. S. 2009. Guidelines for social life cycle assessment of products: social and socio-economic LCA guidelines complementing environmental LCA and Life Cycle Costing, contributing to the full assessment of goods and services within the context of sustainable development. UNEP/Earthprint.
5. Arcese, G., Luchetti, M. C., Merli, R. 2013. Social life cycle assessment as a management tool: methodology for application in tourism. *Sustainability*, 5.8: 3275-3287.
6. Barry, R. G., Chorley, R. J. 2009. Atmosphere, weather and climate. Routledge.
7. Benoît Norris, C., Traverzo, M., Neugebauer, S., Ekener, E., Schaubroeck, T., Russo Garrido, S. 2020. Guidelines for social life cycle assessment of products and organizations 2020.
8. Berard-Chenu, L., François, H., Morin, S., George, E., 2023. The deployment of snowmaking in the French ski tourism industry: a path development approach. *Current Issues in Tourism*, 26.23: 3853-3870.
9. Boureima, F. S., Messagie, M., Matheys, J., Wynen, V., Sergeant, N., Van Mierlo, J., De Caemel, B. 2009. Comparative LCA of electric, hybrid, LPG and gasoline cars in Belgian context. *World Electric Vehicle Journal*, 3.3: 469-476.
10. Brüggemeier, F. J., Sustainability – a historical overview. Guest commentary for basf.com, © 2023 [cit. 2023-01-14]. Available from <https://www.basf.com/global/en/who-we-are/history/25-years-sustainability/conceptual-history.html>

11. Butler, R. 2006. The tourism area life cycle. Vol. 1. Edition ed.: Channel view publications.
12. Chester, M. V., Horvath, A. 2008. Environmental life-cycle assessment of passenger transportation: A detailed methodology for energy, greenhouse gas and criteria pollutant inventories of automobiles, buses, light rail, heavy rail and air v. 2.
13. Chester, M. V., Horvath, A. chains., 2009. Environmental assessment of passenger transportation should include infrastructure and supply. Environmental research letters 4.2.
14. Cetara, L., Angelini, P. 2006. Data and Elaboration on the Italian Alpine and Pre-Alpine Ski Stations, Ski Facilities and Artificial Snowmaking.
15. Ciroth, A., Finkbeiner, M., Traverso, M., Hildenbrand, J., Kloepffer, W., Mazijn, B., Vickery-Niederman, G. 2011. Towards a life cycle sustainability assessment: making informed choices on products. Edition ed.: UNEP/SETAC Life Cycle Initiative.
16. Ciroth A., Lohse, T., Srocka, M. 2020. Manual, openLCA 1.10 Comprehensive User.
17. CSI. ČSN EN ISO 14040 (010940). 2006a. Environmentální management - Posuzování životního cyklu - Zásady a osnova. In. Czechia: Czech Standard Institute.
18. CSI. ČSN EN ISO 14044 (010944). 2006b. Environmentální management - Posuzování životního cyklu - Požadavky a směrnice. In. Czechia: Czech Standard Institute.
19. Danilecki, K., Mroziak, M., Smurawski, P. 2017. Changes in the environmental profile of a popular passenger car over the last 30 years—Results of a simplified LCA study. Journal of Cleaner Production 141, 208-218.
20. Demaclenko. downloads. demaclenko.com. *Snow with system*. © 2023 [cit. 2023-02-22]. Available from Internet: <<https://www.demaclenko.com/company/downloads/>>.
21. Dhillon, B. 2009. Life cycle costing for engineers. Edition ed.: Crc Press, 2009.
22. EIA, Informační systém. EIA Metodika doporučení. 2023, vol. 2023, no. 30 March. © 2023 [cit. 2023-01-22]. Available from: https://portal.cenia.cz/eiasea/dokumenty/eia_metodicka_doporuzeni?lang=cs
23. Ekerholt, R. S. 2017. Analysis of resource consumption of methods for snow production to ski resorts. Master's Thesis. NTNU.

24. Faney, T., Faucher de Corn, H., Harrell, T., Zimmer, V. E. 2010. Ski resort sustainability review, with a snow-gun life-cycle assessment. *Civil Systems and the Environment-Cee E*, 268.
25. Farjana, S. H., Mahmud, M., Huda. 2021. *Life Cycle Assessment for Sustainable Mining*. Edition ed.: Elsevier.
26. Filimonau, V. 2016. *Life cycle assessment (LCA) and life cycle analysis in tourism*. Edition ed. Berlin/Heidelberg, Germany: Springer.
27. Filimonau, V., Dickinson, J., Robbins, D., Huijbregts, M. A. 2011. Reviewing the carbon footprint analysis of hotels: Life Cycle Energy Analysis (LCEA) as a holistic method for carbon impact appraisal of tourist accommodation. *Journal of Cleaner Production*, 2011, 19.17-18: 1917-1930.
28. Filimonau, V., Dickinson, J., Robbins, D., Reddy, M. V. 2013. The role of 'indirect' greenhouse gas emissions in tourism: Assessing the hidden carbon impacts from a holiday package tour. *Transportation Research Part A: Policy and Practice* 54: 78-91.
29. Finkbeiner, M., Inaba, A., Tan, R., Christiansen, K., Klüppel, H. J. 2006. The new international standards for life cycle assessment: ISO 14040 and ISO 14044. *The international journal of life cycle assessment* 11.2, 80-85.
30. Fischer, A., Olefs, M., Abermann, J. 2011. Glaciers, snow and ski tourism in Austria's changing climate. *Annals of Glaciology*, 52(58), 89-96.
31. Flousek, J. 2016. Vliv lyžování na horskou přírodu: shrnutí současných poznatků a stav v Krkonoších.
32. Gabathuler, H. 1997. LCA History: Centrum voor Milieukunde Leiden (CML). *The International Journal of Life Cycle Assessment* 2.4, 187-194.
33. Gössling, S. 2010. *Carbon Management in Tourism: Mitigating the Impacts on Climate Change*. Edition ed. Oxon: Routledge.
34. Gössling, S., Peeters, P., Ceron, J. P., Dubois, G., Patterson, T., Richardson, R. B. 2005. The eco-efficiency of tourism. *Ecological economics* 54.4, 417-434.
35. Govindarajan, V., Venkatesh. 2018. "Industrial ecology tools as decision-making aids for sustainable phosphorus recovery: A methodology paper. *Vatten* 74.3, 107-121.

36. Greenpeace. Energetická revoluce. greenpeace.org. Energetická (r)evoluce trvale udržitelná koncepce pro českou Republiku. © 2023 [cit. 2023-02-11]., Available form: <https://www.greenpeace.org/czech/publikace/861/energeticka-revoluce-pro-ceskou-republiku/>
37. Guinée, J. 2016, Life cycle sustainability assessment: what is it and what are its challenges? In Taking stock of industrial ecology. Springer Open, 2016, p. 45-68.
38. Harmens, R. G., Alvarenga, M., Boone, R.A.F., Martinez, L., Zanchi, E., Zamagni, L., Sonderegger, A., Ruiz, T., Saling, E., Cordella, P., Orienting M. 2022 D1.2 Critical evaluation of social approaches.
39. Heijungs, R., Allacker, K., Benetto, E., Brandão, M., Guinée, J., Schaubroeck, S., Zamagni, A. 2021. System expansion and substitution in LCA: a lost opportunity of ISO 14044 amendment 2. *Frontiers in Sustainability* 2.
40. Hudson, S. 2004. Winter Sport Tourism in North. *Sport tourism: Interrelationships, impacts and issues* 14.
41. Hudson, S., Hudson, L. 2015 Winter sport tourism: working in winter wonderlands. Edition ed.: Goodfellow Publishers Ltd.
42. Huijbregts, M. A., Steinmann, Z. J., Elshout, P. M., Stam, G., Verones, F., Vieira, M., Van Zelm, R. 2016. ReCiPe 2016: a harmonized life cycle impact assessment method at midpoint and endpoint level report I: characterization.
43. Hunkeler, D., Lichtenvort, K., Rebitzer, G. 2008. Environmental life cycle costing. Edition ed.: Crc press, 2008.
44. Jacob-Lopes, E., Zepka, L. Q., Deprá, M. C. 2021. Chapter 5 - Assistant's tools toward life cycle assessment. In *Sustainability Metrics and Indicators of Environmental Impact*. Elsevier, 2021, p. 77-90.
45. Jay, S., Jones, C., Slinn, P., Wood, C. 2007. Environmental impact assessment: Retrospect and prospect." *Environmental impact assessment review* 27.4: 287-300.
46. Kalluri, S. 2016. Comparative Life Cycle Assessment of Road and Multimodal Transportation Options - A Case Study of Copperwood Project

47. Kambanou, M. L., Lindahl, M. 2016. A literature review of life cycle costing in the product-service system context. *Procedia Cirp* 47, 186-191.
48. Klöpffer, W. 2008. Life cycle sustainability assessment of products. *The International Journal of Life Cycle Assessment* 13, 89-95.
49. Klöpffer, W. 2012 The critical review of life cycle assessment studies according to ISO 14040 and 14044. *The International Journal of Life Cycle Assessment* 17.9. 1087-1093.
50. Klöpffer, W., Grahl, B. 2014. *Life cycle assessment (LCA): a guide to best practice*. Edition ed.: John Wiley & Sons.
51. Křenová, Z., Bílek, O., Zýval, V. 2020. Does artificial snow fertilise the soil of mountain meadows in the Krkonoše National Park? *European Journal of Environmental Sciences* 10.1 23-41.
52. Lintzén, N. 2022 *Snowmaking and snow storage*. Luleå tekniska universitet.
53. Liu, H., Stockwell, N., Rodgers, M. O., Guensler, R. 2016. A comparative life-cycle energy and emissions analysis for intercity passenger transportation in the US by aviation, intercity bus, and automobile. *Transportation research part d: transport and environment* 48, 267-283.
54. Luthe, T., Kägi, T., & Reger, J. 2013. A systems approach to sustainable technical product design: combining life cycle assessment and virtual development in the case of skis. *Journal of Industrial Ecology*, 17(4), 605-617.
55. Marsmann, M. 1997. Editorial: ISO 14040-The first project. *The International Journal of Life Cycle Assessment* 2.3, 2, 122-123.
56. Matias, Á., Nijkamp, P., Romao, J. 2016 *EDS. Impact assessment in tourism economics*. Edition ed.: Springer International Publishing.
57. Masotti, Paola, Bogoni, P., Campisi, B. 2018. A Preliminary LCA Analysis of Snowmaking in Fiemme Valley. In: *Proceedings of 12th Italian LCA Network Conference*. ENEA-Italian National Agency for New Technologies, Energy and Sustainable Economic Development, p. 241-249.
58. Mazzi, A. Introduction. *Life cycle thinking*. In *Life cycle sustainability assessment for decision-making*. Elsevier, 2020, p. 1-19.

59. MPO. energy. mpo.cz. National Energy and Climate Plan. © 2023 [cit. 2023-01-30]. Available from Internet: <https://www.mpo.cz/en/energy/strategic-and-conceptual-documents/the-national-energy-and-climate-plan-of-the-czech-republic--252018/>
60. Muthu, S. S. 2014. ED. *Social life cycle assessment: an insight*. Edition ed.: Springer.
61. Nahlik, M. J., Kaehr, A. T., Chester, M. V., Horvath, A., Taptich, M. N. 2016. Goods movement life cycle assessment for greenhouse gas reduction goals. *Journal of Industrial Ecology* 20.2, 317-328.
62. Nanaki, E. A., Koreneos, C. J. 2012. Comparative LCA of the use of biodiesel, diesel and gasoline for transportation. *Journal of Cleaner Production* 20.1, 14-19.
63. Pryshlakivsky, J., Searcy, C. 2013. Fifteen years of ISO 14040: a review. *Journal of Cleaner Production* 57, 115-123.
64. Quintana Cayuelas, S. 2013. Review on Social Life Cycle Assessment (SLCA) for application to olive oil production.
65. Rahman, M. 2023. Butler's Tourism Area Life Cycle Model (TALC). Available from: <https://www.howandwhat.net/butler-tourism-area-life-cycle-model-talc/>.
66. Reddy, V. R. 2015. *Life-cycle Cost Approach for Management of Environmental Resources A Primer*. Edition ed.: Springer.
67. Scott, D., Amelung, B., Becken, S., Ceron, J. P., Dubois, G., Gössling, S. & Simpson, M. 2008. *Climate change and tourism: Responding to global challenges*. Edition ed. Madrid: World Tourism Organization.
68. Shaked, S., Crettaz, P., Saade-Sbeih, M., Jolliet, O. 2015. *Environmental life cycle assessment*. Edition ed.: CRC Press.
69. Schlomer, S., Bruckner, T., Fulton, L., Hertwich, E., McKinnon, A., Perczyk, D., Wisser, R. 2014. Technology-specific cost and performance parameters." *Climate Change 2014: Mitigation of Climate Change. Contribution of Working Group III to the Fifth Assessment Report of the Intergovernmental Panel on Climate Change*.
70. Simapro. files. pre-sustainability.com. Life cycle costing in SimaPro. What is life cycle costing (LCC) and how can you perform LCC in SimaPro [Type of Work]. © 2023 [cit. 2023-02-15]. Available from: https://pre-sustainability.com/files/2022/09/Guideline_Life-cycle-costing-LCC-in-SimaPro.pdf.

71. Snowathome. snowmaking science. snowathome.com. © 2023 [cit. 2023-02-16]. Available from Internet: <https://www.snowathome.com/snowmaking_science.php>.
72. Snow Australia, pathway. snow.org.au. © 2023 [cit. 2023-02-16]. Available from Internet: <https://www.snow.org.au/pathways/>
73. Söderström, P., Knutsson, S., Olofsson, T., Edeskär, T., Mårtensson, S., Zeinali, A. 2013. Snow grooming using machine guidance for piste management processes: Case study: Ormberget ski piste.
74. Steiger, R., Abegg, B., Pons, M., Aall, C. 2019. A critical review of climate change risk for ski tourism. *Current Issues in Tourism*, 1343-1379.
75. Steiger, Robert, Scott, D., Abegg, B., Pons, M., & Aall, C. 2019. A critical review of climate change risk for ski tourism. *Current Issues in Tourism* 22.11. 1343-1379.
76. Steiger, R., Stötter, J. 2013. Climate change impact assessment of ski tourism in Tyrol. *Tourism Geographies* 15.4, 577-600.
77. Steiger, Robert, and Daniel Scott. 2020. Ski tourism in a warmer world: Increased adaptation and regional economic impacts in Austria. *Tourism Management* 77: 104032.
78. Szlosarek, R., Yan, C., Kröger, M., Nußbaumer, C. 2019. Energy efficiency of ropeways: a model-based analysis. *Public Transport* 11.3, 617-635.
79. T&E. wp-content. transportenvironment.org. How clean are electric cars? T&E's analysis of electric car lifecycle CO₂ emissions [Type of Work]. © 2023 [cit. 2023-02-16] Available from: <https://www.transportenvironment.org/wp-content/uploads/2020/04/TEs-EV-life-cycle-analysis-LCA.pdf>.
80. Težak, S. 2012. Modern Cableways-The Base of Mountain Sports Tourism. *Strategies for Tourism Industry-Micro and Macro Perspectives*.
81. Težak, S. Lep, M. 2019. New technological approach to cable car boarding. *Sustainability* 11.15.
82. Traverso, M., Petti, L., Zamagni, A. 2020. EDS. Perspectives on Social LCA: Contributions from the 6th International Conference. Edtion ed.: Springer International Publishing.
83. Treml, P. 2022. Results and outputs of the project entitled "Support for long-term planning in the field of water management in the Krkonoše National Park with an

- emphasis on solving the issue of the effect of technical snowmaking on the decrease in flows with the aim of. *Vodohospodářské technicko-ekonomické informace* 63.6, 54-56.
84. TYNDP 2022 - Scenario report. © 2023 [cit. 2023-01-22]. Available from: https://2022.entsos-tyndp-scenarios.eu/wp-content/uploads/2022/04/TYNDP2022_Joint_Scenario_Full-Report-April-2022.pdf
 85. UNECE. documents. unece.org. Life Cycle Assessment of Electricity Generation Options. © 2023 [cit. 2023-01-11]. available from: <https://unece.org/sed/documents/2021/10/reports/life-cycle-assessment-electricity-generation-options>
 86. Vanat, L. 2021 International Report on Snow & Mountain Tourism 2021.
 87. Wikipedia. Representative Concentration Pathway, vol. 2023, no. 30 March. © 2023 [cit. 2023-02-23] Available from: https://en.wikipedia.org/wiki/Representative_Concentration_Pathway.
 88. WTTC. research. wttc.org Economic Impact Reports. © 2023 [cit. 2023-01-25] Available from Internet: <<https://wttc.org/research/economic-impact>>.
 89. Xia, X., Li, P. 2022. A review of the life cycle assessment of electric vehicles: Considering the influence of batteries. *Science of the Total Environment*.
 90. Xiao, H., LJ Smith S. 2006. Case studies in tourism research: A state-of-the-art analysis. *Tourism management* 27.5, 738-749.

10. List of abbreviations

LCA	- Life cycle assessment
LCT	- Life Cycle Thinking
E-LCA	- Environmental Life Cycle Assessment
S-LCA	- Social Life Cycle Assessment
LCC	- Life Cycle Costing
LCSA	- Life Cycle Sustainability Assessment
ISO	- International Organization for Standardization
UNEP	- United Nations Environment Program
SETAC	- Society of Environmental Toxicology and Chemistry
SO-LCA	- Social Organisational Life Cycle Assessment
TALC	- Tourism area life cycle model
PKT	- Passenger Kilometre Travelled (PKT)
FU	- Functional Unit
LCI	- Life Cycle Inventory Analysis
LCIA	- Life Cycle Impact Assessment
eLCC	- Environmental Life Cycle Costing
sLCC	- Social Life Cycle Costing
AHS	- Association of mountain resorts
RS SLCIA	- Reference Scale Approach S-LCA
IP SLCIA	- Impact Pathway Approach S-LCA
GHG	- Green House Gases
EIA	- Environmental Impact Assessment
GWP	- Global Warming Potential
EU ETS	- European Union Emission Trading System
INECE	- International Network for Environmental Compliance and Enforcement

11. List of Figures

Figure 1 - Graphic representation of the LCA terms used in this work and their interconnections	15
Figure 2 - Graphic explanation of the interconnections between LCA methods (Govindarajan 2018).	16
Figure 3– Consolidation of ISO standards (Finkbeiner et al. 2006).....	17
Figure 4 – Stages of LCA (CSI ©2006a).....	18
Figure 5 - Flowchart of major processes and stages in the life cycle of a product (Shaked et al. 2015)	20
Figure 6 – Elements of the LCIA phase (CSI ©2006a).....	21
Figure 7 – Linkage of LCI results via midpoint categories to damage categories (Ciroth et al. 2011).....	22
Figure 8 – Concept of category indicators (CSI ©2006b).....	22
Figure 9 – Example of reference scale for social risk evaluation (Benoît Norris et al. 2020)..	26
Figure 10 – Example of reference for social performance evaluation (Benoît Norris et al. 2020)	26
Figure 11 – Types of LCC (SimaPro ©2022).....	28
Figure 12- LCT approach LCC (SimaPro ©2022)	28
Figure 13 – LCC framework (Reddy 2015).....	29
Figure 14 – System boundaries of LCSA (Ciroth et al. 2011)	30
Figure 15 – Example of LCSA inventory data for unit process and organization levels (Ciroth et al. 2011)	31
Figure 16 – Chairlift with detachable grips (Težak 2012).....	37
Figure 17 – The influence of velocity on total power (Szlosarek et al. 2019).....	37
Figure 18 – Wet-bulb temperature chart (Snow at home ©2023)	38
Figure 19 – Basic scheme of snowmaking (Demacenko ©2023).	39
Figure 20 – Necessary area of ski slope (Težak 2012).....	40

Figure 21 – Contribution of various tourism sub-sectors to CO ₂ emissions (%) (Scott et al. 2008)	44
Figure 22 – Occupancy sensitivity and life-cycle sensitivity (from the left – blue bars: Conventional Gasoline Sedan, Conventional Gasoline SUV, Conventional Gasoline Pickup; Urban Diesel Bus – mauve bar; Metro, Commuter Rail, Light Municipal rail, Light Boston Rail – red bars; Small Aircraft, Midsize Aircraft, Large Aircraft – green bars) (Nahlik et al. 2016).	45
Figure 23 – The influence of national electricity grid on electric cars, petrol and diesel cars (T&E ©2020).	47
Figure 24 – A comparison of different vehicle types over their lifetime (T&E ©2020).	47
Figure 25 – IPCC Representative Concentration Pathways (Wikipedia ©2023)	49
Figure 26 – Average life-cycle CO ₂ Equivalent emissions (Schlomer et al. 2014).	50
Figure 27 – Lifecycle impacts of nuclear power, global average reactor, per kWh and activity (UNECE ©2022).	50
Figure 28 The primary energy supply mix in COP 21 scenarios for energy and non-energy use for EU27 (TYNDP ©2022)	51
Figure 29 – The evolution of peer-reviewed climate change and skiing tourism literature (Steiger 2019).	52
Figure 30 – The three dimensions of the climate change and skiing tourism system (Steiger, Stotter 2013)	53
Figure 31 Scheme of preliminary evaluation steps	56
Figure 32 - A flowchart tabulating the key processes in the ski industry	59
Figure 33 - Flowchart with highlighted spans of LCA methods in this thesis	60
Figure 34 - Basic flowchart for cross-country skiing	61
Figure 35 - "Add-on criteria" flowchart	68
Figure 36 - Proposed selection of stakeholder categories and subcategories for S-LCA	69
Figure 37- Questionnaire result concerning the educational value of mountain visits	73
Figure 38 - Flowchart of calculation steps	74

Figure 39 - The charts of the main input page	75
Figure 40 - Overall operation input table: Scenario 1 refer to FU guests per 24 hours, Scenario 2 refers to FU day operation of the resort, and Scenario 3 refers to FU season operation. For Scenarios 2&3, transportation and accommodation of a guest must be excluded from the results.	76
Figure 41 Example of database sheet	77
Figure 42 - Snowmaking input: one cubic meter of snow per square meter was calculated....	79
Figure 43 - Lift, grooming and management data input	79
Figure 44 - Input option for accommodation.....	80
Figure 45 - Background sheet with explanation of value assessment	80
Figure 46 - Transportation input settings: in this case, the return journey, including flights between Oslo and Prague and bus transport to Špindlerův Mlýn was input	80
Figure 47 - Background calculation for transportation.....	81
Figure 48 - Recalculation of operation costs, working hours and calculation for EU ETS.....	82
Figure 49 - Influence of the length of the stay and travel distance on GWP.....	83
Figure 50 - Influence of the length of the stay and travel distance - a 5-day-stay, bus 270 km, 2300 km plane, luxury accommodation.....	83
Figure 51 - Normal values for ski resort align with expert judgement, travel by bus for 100km, no accommodation.....	84
Figure 52 - Double values for slope preparation and snowmaking, travel by bus for 100 km, no accommodation.....	85
Figure 53 - Influence of the size of groomed slope and increased snowmaking in comparison with distance travelled and length of stay on GWP.....	86
Figure 54 - Comparison of operational impact from different parts of ski resort operation based on input data from figure 62.	86
Figure 55 - Preview of the energy excel sheet.....	87
Figure 56 - GWP 100 comparison for different electricity grids.....	88

Figure 57 - Comparison of operational impact from different parts of ski resort operation based on input data from figure 62. Figure 57 can be directly compared with figure 53 (the Czech electricity grid).....	88
Figure 58 - snowmaking system (Demaclenko ©2023)	109
Figure 59 - Snow lances (Demaclenko ©2023).....	110
Figure 60 - Snow guns (Demaclenko ©2023)	110
Figure 61 – Questionnaire.....	112
Figure 62 - Model scenario one – Influence of the length of the stay and travel, input data .	113
Figure 63 - Model scenario one – Influence of the length of the stay and travel, bus 270 km, plane 2300 km, 14 day-stay	114
Figure 64 - Model scenario one – Influence of the length of the stay and travel, electric car 4 people, 230 km, 5-day-stay	114
Figure 65 - Model scenario one – Influence of the length of the stay and travel, electric car 4 people, 230 km, 14-day-stay	115
Figure 66 - Model scenario two –Influence of the size of groomed slope and increased snowmaking – Input data.....	116
Figure 67 - Influence of the size of groomed slope and increased snowmaking in comparison with travel distanced and lenght of stay – Scenario 1.....	117
Figure 68 - Influence of the size of groomed slope and increased snowmaking in comparison with travel distanced and lenght of stay – Scenario 2.....	118
Figure 69 - Influence of the size of groomed slope and increased snowmaking in comparison with travel distanced and lenght of stay – Scenario 3.....	119
Figure 70 - Influence of the size of groomed slope and increased snowmaking in comparison with travel distanced and lenght of stay – Scenario 4.....	120
Figure 71 – 7-day trip, 4 people in an electric car, 100 km. In this figure, we can see the massive influence of nuclear energy production in the category of ionising radiation.	121

12. List of Tables

Table 1 – Example of FU, Reference flow, and Key parameters (inspired by (Shaked et al. 2015)).....	19
Table 2 – Table of major ski resorts in Czech Republic (AHSCR ©2021).....	32
Table 3 - Alternative FU settings for snowmaking.....	63
Table 4 - Alternative FU settings for lift operation	64
Table 5 - Alternative FU settings for slope preparation	65
Table 6 - Alternative FU settings for S-LCA	67
Table 7 - Assessment of subcategories performances in S-LCA.....	72

13. Annex 1 – Snowmaking system



Figure 58 - snowmaking system (Demacenko ©2023)

SNOW GUNS

LANCES

The EOS lance from DEMACLENKO is available in two different configurations (automatic & manual) and with up to 8 different regulation steps. Thanks to the many configuration options, the product impresses like no other with a high level of flexibility and application options and combines maximum snow production with very low energy consumption.

EOS.
EOS A9/M8

EOS.
EOS A4/M4

EOS.
EOS A2/M2

EOS.
EOS A1/M1

EOS_{DUO}

With the EOS DUO, DEMACLENKO presents its proven lance model in a powerful double head version. It unites the usual unbeatable energy efficiency of the EOS with a strong water flow of 9 US, which doubles the snow production.

SNOW WITH SYSTEM - 22 / 23

DEMACLENKO

#4

Figure 59 - Snow lances (Demacenko ©2023)

SNOW GUNS

FAN GUNS

Our wide range of fan guns cannot fail to impress even the most demanding customer: Our fan guns are convincing thanks to the high snow production and the first class snow output produced efficiently in a short period of time.

TITAN_{4.0}

THE MOST POWERFUL SNOW GUN ON THE MARKET

TITAN_{3.0} Silent

THE SILENT HERO OF FAN GUNS

EVO_{3.0}

THE STRONGEST OF COMPACT CLASS

TITAN_{X 3.0}

UNBEATEN AT MARGINAL TEMPERATURES

VENTUS_{4.0}

POWER, TECHNOLOGY & DESIGN

SNOW WITH SYSTEM - 24 / 25

DEMACLENKO

Figure 60 - Snow guns (Demacenko ©2023)

14. Annex 2 – Questionnaire

The questionnaire was conducted in winter 2022 in Špindlerův Mlýn. A total of 120 completed questionnaires were collected (13 from ski instructors, 37 from people taking breaks in mountain huts outside ski lifts, 28 in the town of Špindlerův Mlýn). In March 2023 another 79 questionnaires were collected online. Most of the questions were not used in the final version of this diploma thesis. It must be noted that particularly in the town of Špindlerův Mlýn people often refused to co-operate which undoubtedly affected the results significantly. The online questionnaire was conducted throughout the author's Facebook profile. The questionnaire is added to the diploma thesis in Czech language. There are two files which were obtained from the website service Survio where the online version was conducted and the outdoor version was manually added to get consolidated results.

15. Annex 3 – Details of modeled scenarios

15.1. Model scenario one

Influence of the length of the stay and travel.

		Scenario 1			
		BASIC INPUT - operation phase only			
Snowmaking input					
		Data type	Unit	Value	Control mechanism
Snowmaking input	input version 1	Snowmaking consumption per season	kWh	0	ok
	input version 2	Amount of snow needed	cubic meter	22000	ok
		Maintenance (working hours)	hours	200	
		snowmaking machine transport and maintenance consumption	litres of diesel	1900	
Ski lift Input					
		Data type	Unit	Value	
		Lift consumption	kWh	40000	
		Maintenance (working hours)	hours	3000	
		Lift support transport (snowmobiles)	litres of diesel	200	
		Light consumption (night skiing)	kWh		
Slope preparation					
		Data type	Unit	Value	
		Grooming machine consumption	litres of diesel	3600	
		Maintenance (working hours grooming machines drivers)	hours	250	
Ski resort Management					
		Data type	Unit	Value	
		Building electricity consumption	kWh	3000	
		Building gas consumption	cubic meter	10500	
		Maintenance (working hours)	hours	2000	
		Transportation (management car)	litres of diesel	500	
Accommodation (one guest)					
		Data type	Unit	Value	
		Type of accommodation	type	Accommodation luxury	
Transport (one guest)					
		Data type	Unit	Value	
		Distanced travelled - diesel transport	Km	270	Bus
		Distance travelled - electric transport	Km	0	Electric car 2 passengers
		Distance travelled - plane	Km	2300	
		Number of days in the resort (average or for one guest)	days	5	ok

Figure 62 - Model scenario one – Influence of the length of the stay and travel, input data

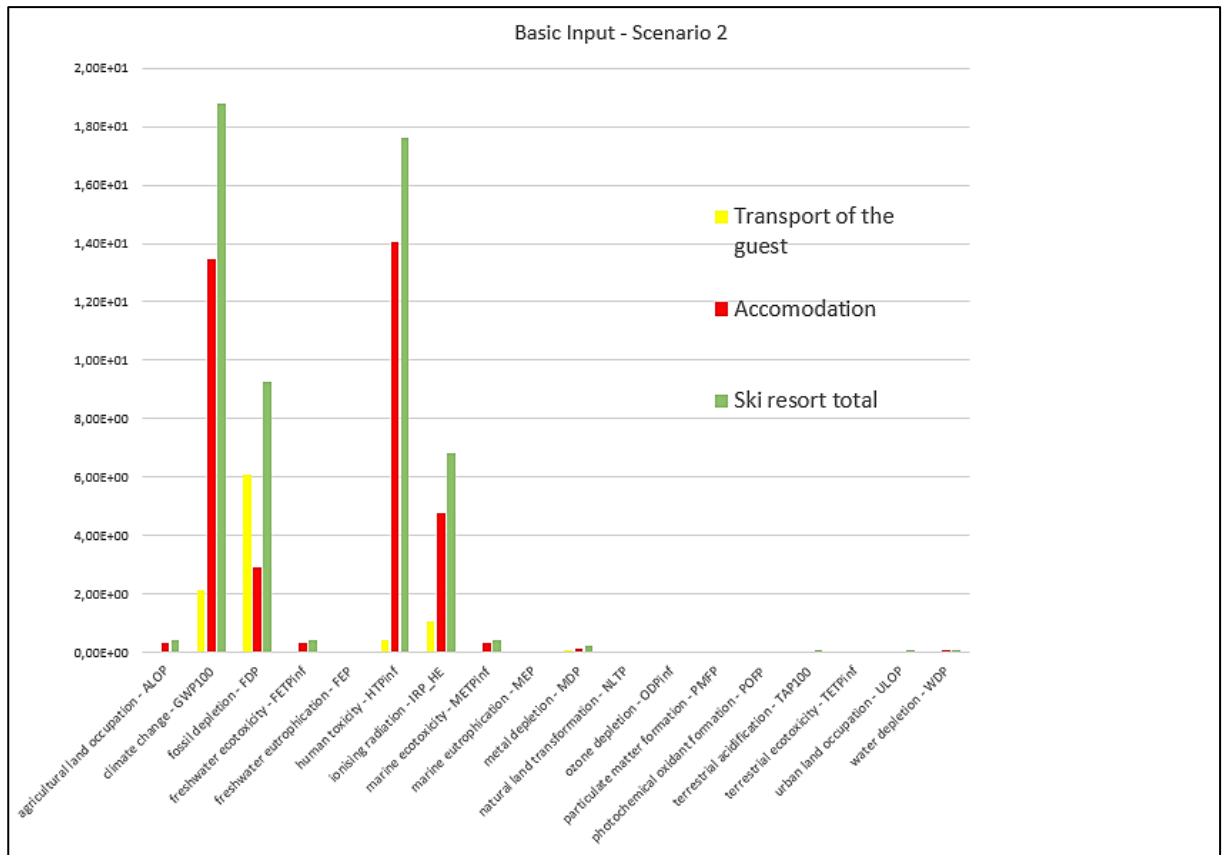

Figure 63 - Model scenario one – Influence of the length of the stay and travel, bus 270 km, plane 2300 km, 14 day-stay

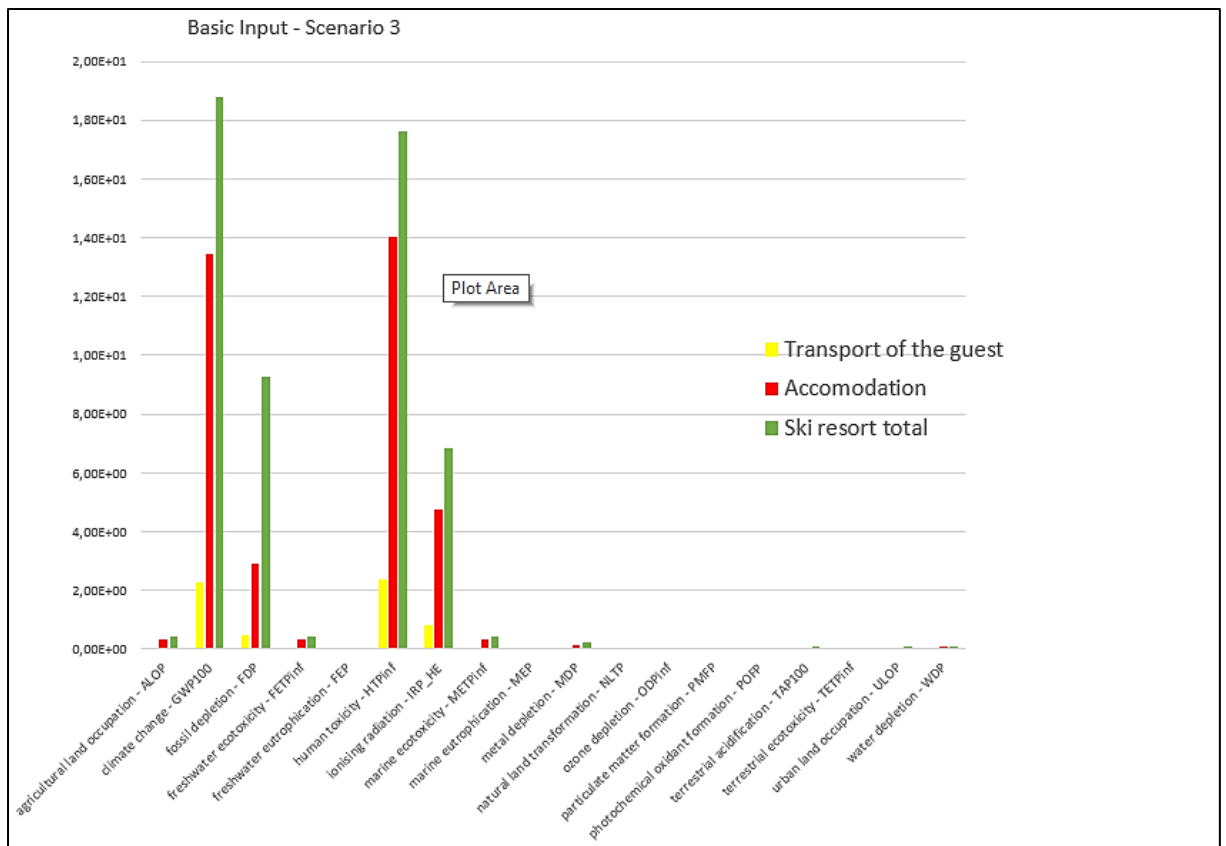

Figure 64 - Model scenario one – Influence of the length of the stay and travel, electric car 4 people, 230 km, 5-day-stay

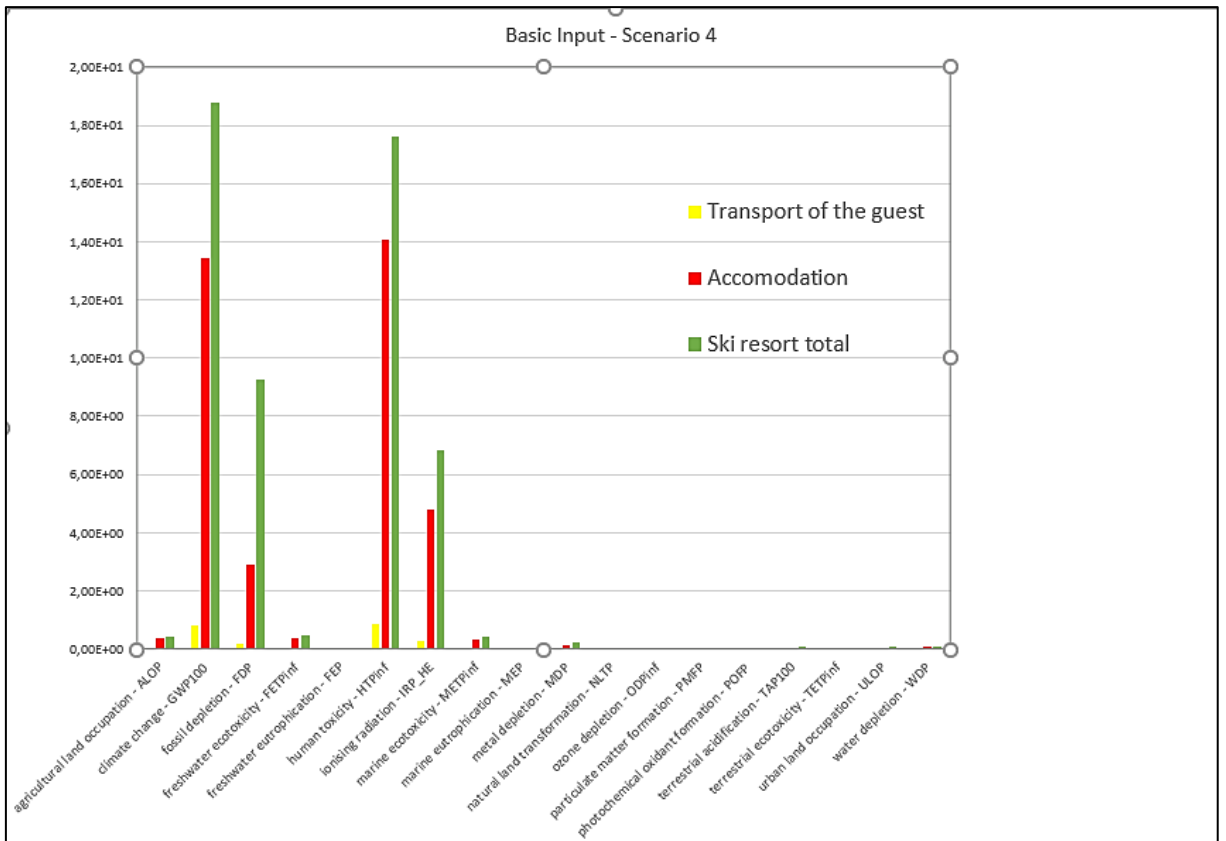

Figure 65 - Model scenario one – Influence of the length of the stay and travel, electric car 4 people, 230 km, 14-day-stay

15.2. Model Scenario two

Influence of the size of groomed slope and increased snowmaking.

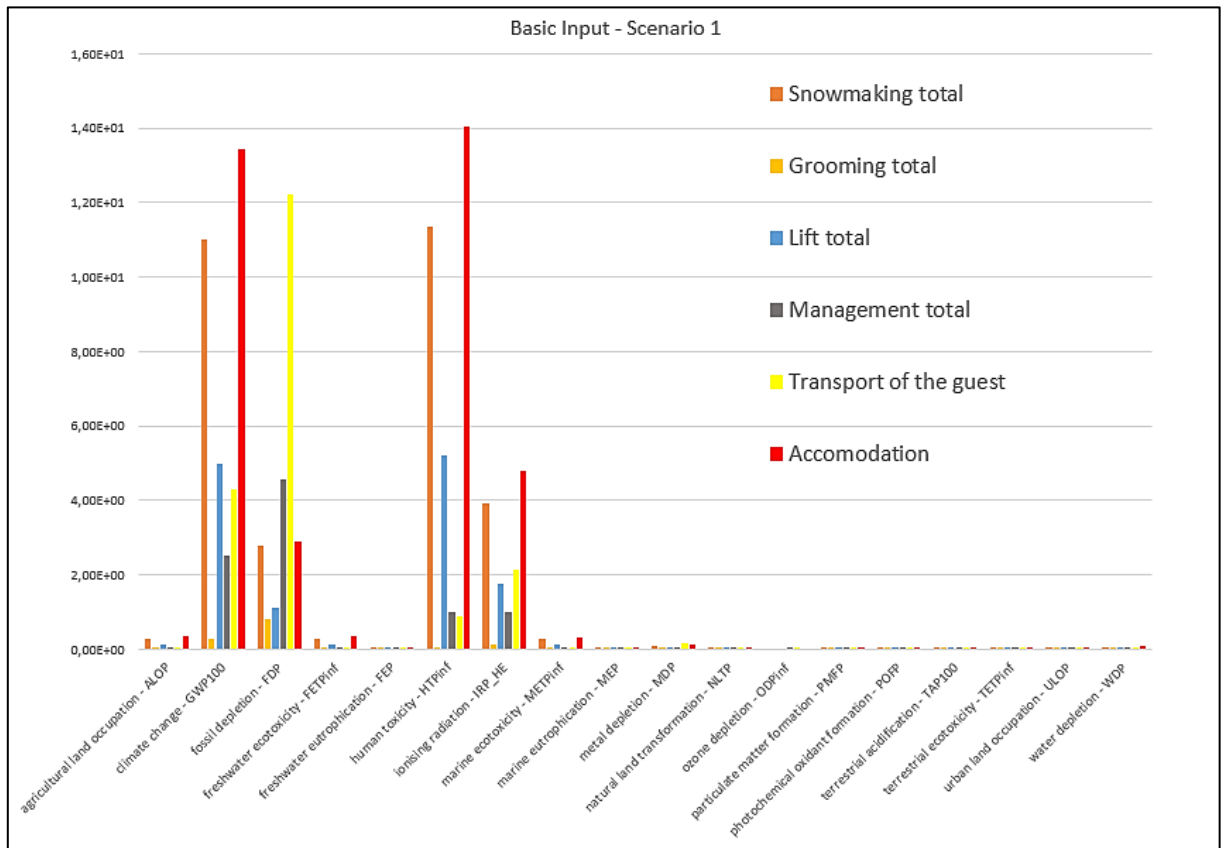

Figure 66 - Model scenario two –Influence of the size of groomed slope and increased snowmaking – Input data

15.3. Model Scenario three

Influence of the size of groomed slope and increased snowmaking in comparison with travel distanced and lenght of stay.

Scenario 3				Scenario 4			
BASIC INPUT - operation phase only				BASIC INPUT - operation phase only			
Unit	Value		Control mechanism	Unit	Value		Control mechanism
KWh	0		ok	KWh	0		ok
Cubic meter	22000		ok	Cubic meter	44000		ok
hours	200			hours	400		
litres of diesel	1900			litres of diesel	3800		
Unit	Value			Unit	Value		
KWh	40000			KWh	40000		
hours	3000			hours	3000		
litres of diesel	200			litres of diesel	200		
KWh				KWh			
Unit	Value			Unit	Value		
litres of diesel	3600			litres of diesel	7200		
hours	250			hours	500		
Unit	Value			Unit	Value		
KWh	5000			KWh	5000		
Cubic meter	10500			Cubic meter	10500		
hours	2000			hours	2000		
litres of diesel	500			litres of diesel	500		
Unit	Value			Unit	Value		
type	Accommodation luxury			type	Accommodation luxury		
Unit	Value			Unit	Value		
Km	100	Bus		Km	100	Bus	
Km	0	Electric car 4 passengers		Km	0	Electric car 4 passengers	
Km	0			Km	0		
days	1	ok		days	1	ok	

Figure 67 - Influence of the size of groomed slope and increased snowmaking in comparison with travel distanced and lenght of stay – Scenario 1

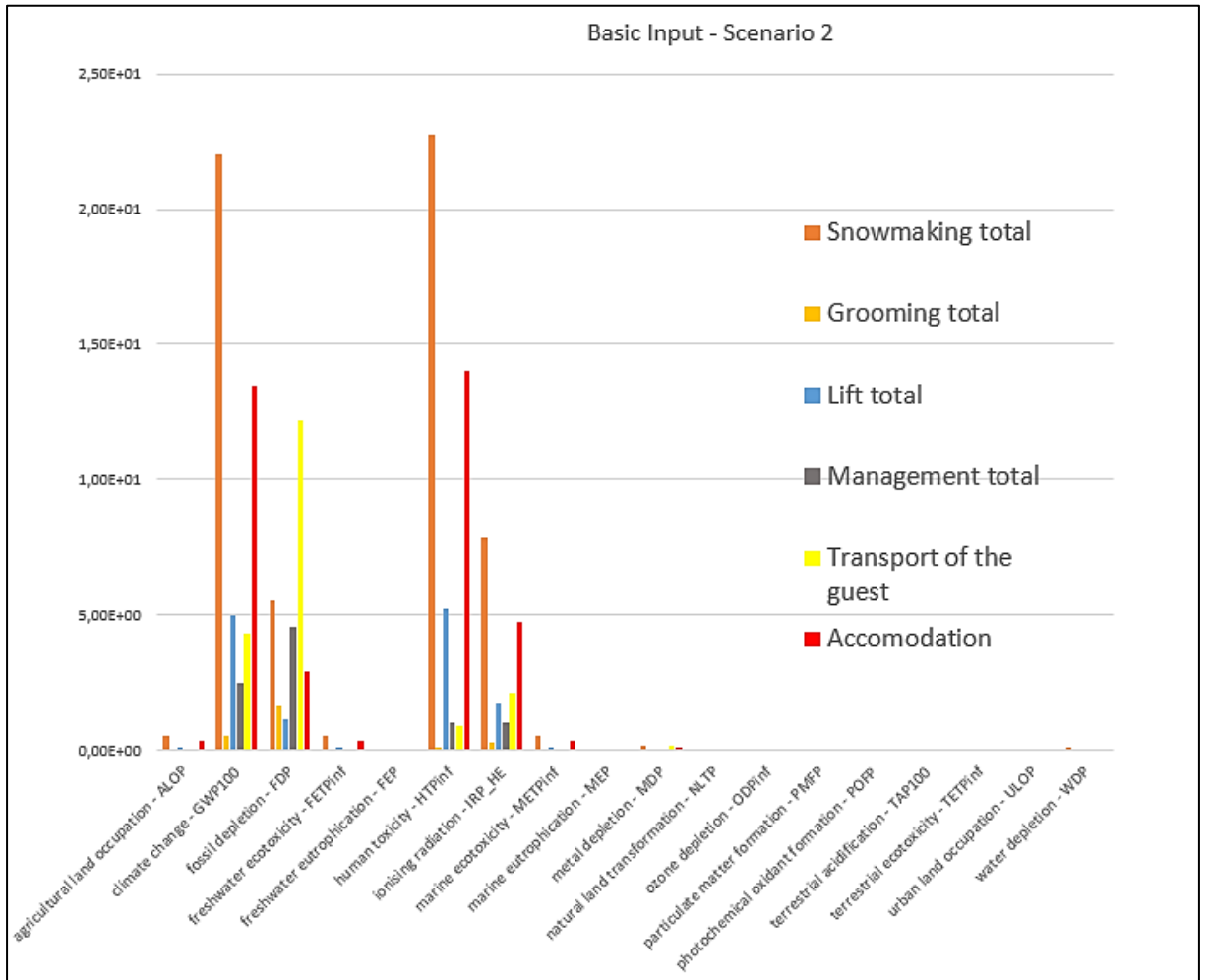

Figure 68 - Influence of the size of groomed slope and increased snowmaking in comparison with travel distanced and lenght of stay – Scenario 2

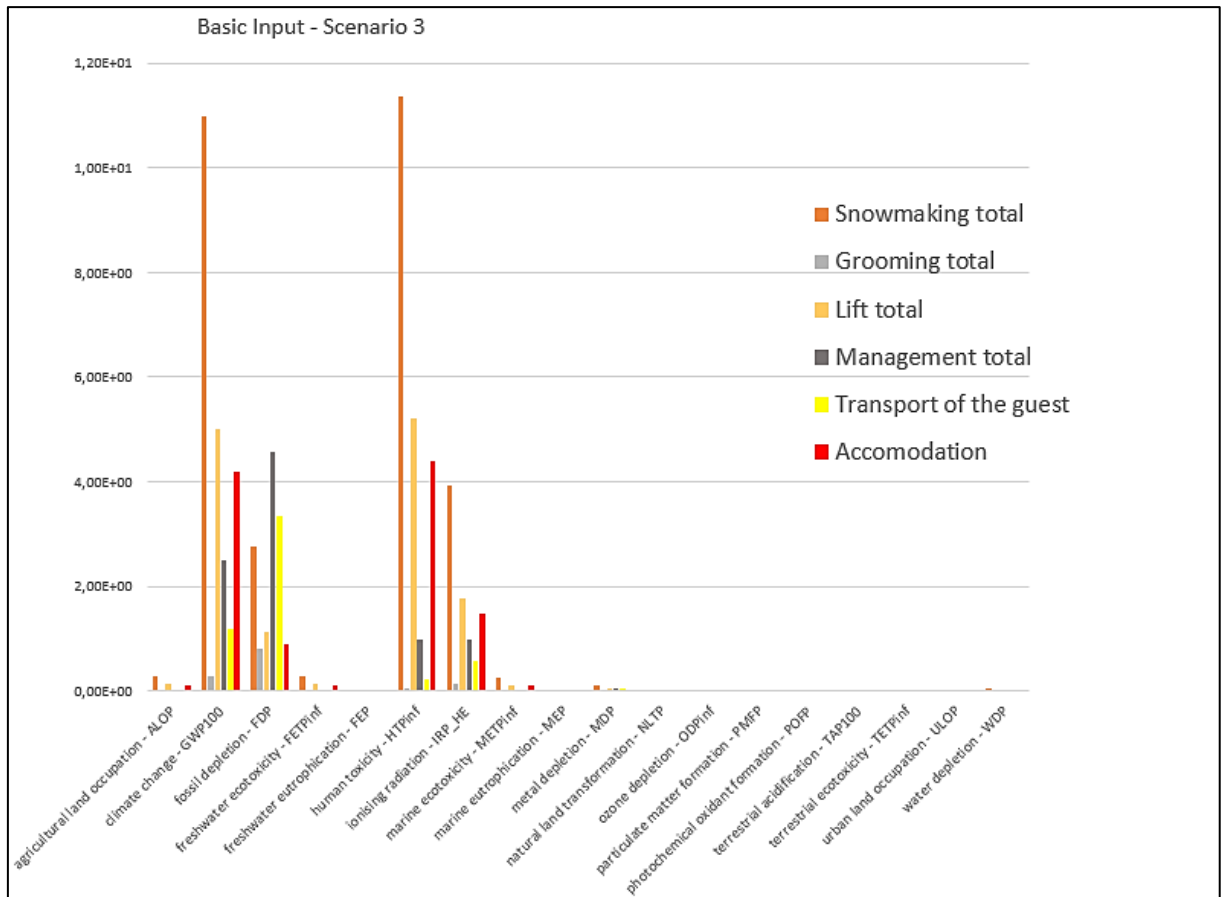

Figure 69 - Influence of the size of groomed slope and increased snowmaking in comparison with travel distanced and lenght of stay – Scenario 3

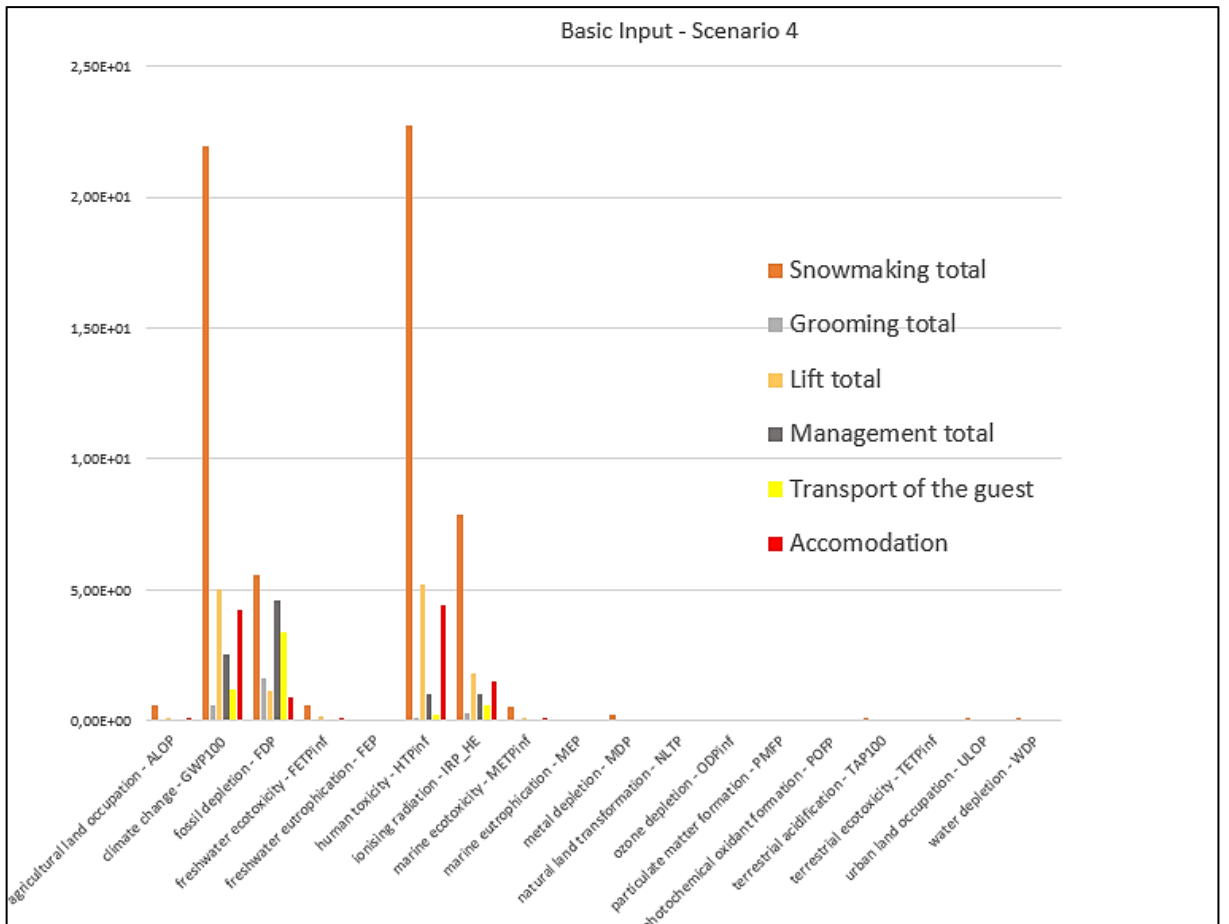

Figure 70 - Influence of the size of groomed slope and increased snowmaking in comparison with travel distanced and lenght of stay – Scenario 4

15.4. Using the energy projection calculation model

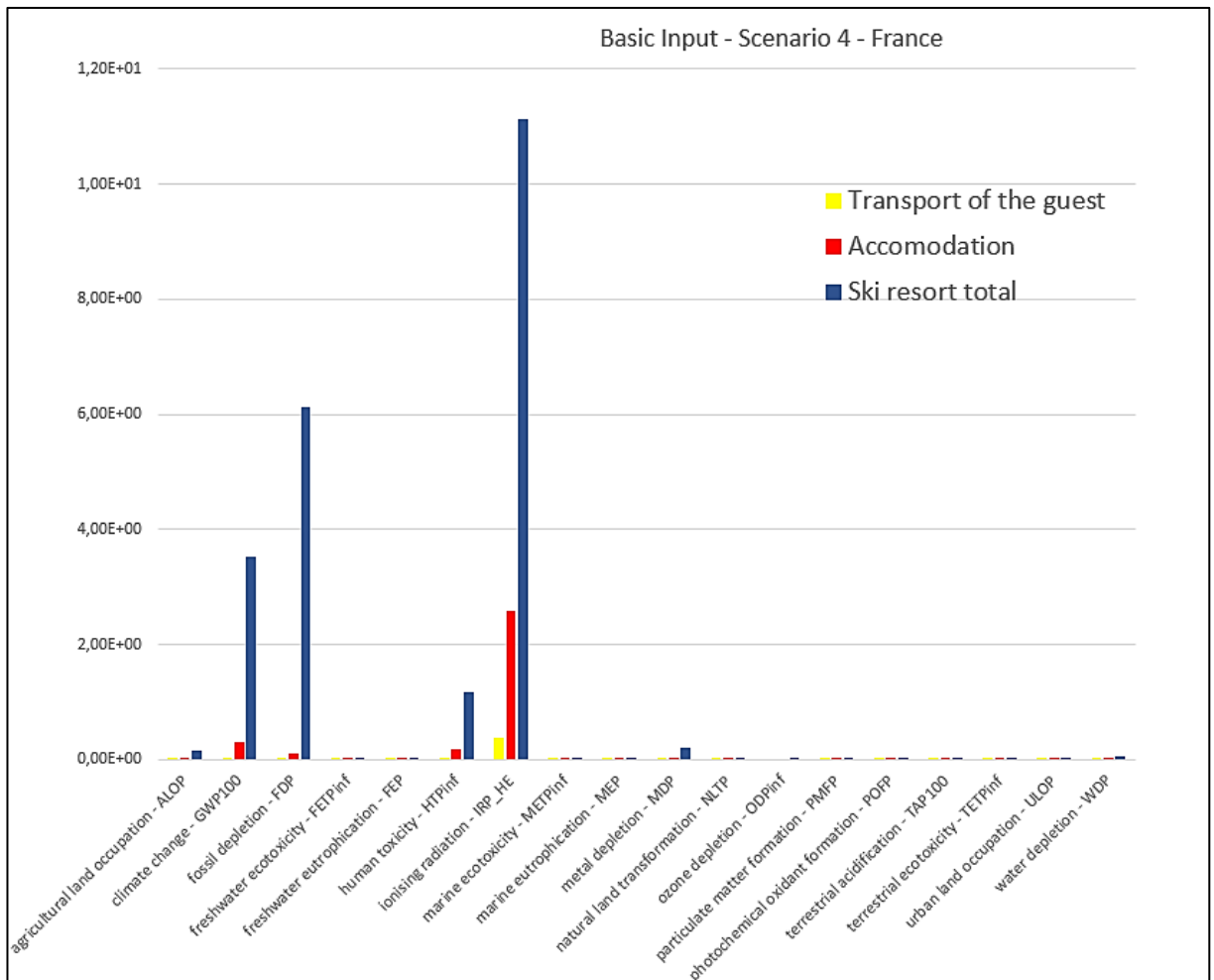

Figure 71 – 7-day trip, 4 people in an electric car, 100 km. In this figure, we can see the massive influence of nuclear energy production in the category of ionising radiation.