



Brno University of Technology
Faculty of Mechanical Engineering
Institute of Machine and Industrial Design

Vysoké učení technické v Brně
Fakulta strojního inženýrství
Ústav konstruování

BRAND IDENTITY IN DESIGN OF INDUSTRIAL PRODUCT

**IDENTITA ZNAČKY V DESIGNU
PRŮMYSLOVÉHO VÝROBKU**

Ing. Martin Ondra

Author

Autor práce

doc. Ing. arch. Jan Rajlich

Supervisor

Vedoucí práce

Doctoral Thesis

Dizertační práce

Brno 2017

ACKNOWLEDGMENT

I would like to express gratitude to my supervisor Doc. Ing. Jan Rajlich and prof. Martin Hartl for advise and consultation; especially in the time of the definition of the topic of the thesis.

Many thanks to Mr. Viktor Vrabec from the NAREX Company for his kindly help and allowance to gather the needed data for this thesis. I wish also to thank Miloslav Šindler for the short review.

Last but not least, thanks to all my closest, family and friends for support and motivation to finish this work.

DECLARATION OF SELF-RELIANCE

I hereby declare that, I have developed the submitted dissertation thesis individually based on the listed resources and the support of supervisor Doc. Ing. arch. Jan Rajlich

In Brno

.....
Ing. Martin Ondra

BIBLIOGRAPHIC CITATION

ONDRA, M. Brand identity in design of industrial product. Brno: Brno University of Technology, Faculty of Mechanical Engineering, 2016, 108 p. Supervisor of the thesis Doc. Ing. arch. Jan Rajlich

ABSTRACT

This thesis is concerned with study of the brand identity elements in the product. Current state of knowledge leads to findings about the brand identity, shape grammars and methods for exploring the similarities in the product. Works are focusing on capturing the brand identity and the development of a shape grammar tool that would help the designer in his creative process, but the literature lacks in study of the actual designing process. An actual brand identity is studied in terms of logo, colour and shape to a creation of a shape grammar. After the analysis a shape grammar based hypothesis of how the brand identity is transferred throughout the innovation process is formulated.

KEY WORDS

Brand identity, shape grammar, design similarities, innovation

ABSTRAKT

Tato práce se zabývá studiem prvků identity značky na produktech. Současný stav poznání shrnuje poznatky o branding, gramatice tvarů a metod ke studio podobnosti na produktech. Další práce se zaměřují na zachycení prvků identity značky a vytvoření nástroje, pracujícího na základě gramatiky tvarů, který by pomáhal designérovi v jeho kreativním procesu, této literatuře však schází studování designérské práce. Konkrétní identita je studována z hlediska loga, barev a tvaru až k vytvoření její gramatiky tvarů. Po analýze produktů firmy a gramatiky tvarů je předložena hypotéza o přenosu identity značky v průběhu inovačního procesu z pohledu gramatiky tvarů.

KLÍČOVÁ SLOVA

Identita značky, gramatika tvarů, podobnosti designu, inovace

CONTENTS

Introduction	10
1 Definition of solved dilemma and preliminary aim of the dissertation thesis	11
2 Current state of knowledge	12
2.1 General findings	12
2.1.1 Brand identity	12
2.1.2 Studies about colour and the brand	14
2.1.3 Shape grammars	15
2.2 Studying design products by shape grammar	18
2.3 Tools for the shape grammar support	25
3 Analysis, interpretation and assessment of findings gained through knowledge base	31
4 Definition of aim of the dissertation thesis and design of method for its solution	33
5 Materials for study	35
5.1 Gathered products	35
5.2 Design of concepts through non-generative approach	39
5.2.1 Design of the drill	39
5.2.2 Design of the angle grinder	43
6 Brand Identity of company NAREX - logo	46
Logos of other brands	47
7 Brand Identity of company NAREX - colours	49
Method	49
Method accuracy	50
Results of the narex study	52
8 Decomposition and similarity analysis	54
8.1 Decomposition	54
8.2 Proportion	55
8.2.1 Side views	55
8.2.2 Top view	59
8.2.3 Conclusion	64
8.3 Orientation	64
8.3.1 Side views	64
8.3.2 Top view	68
8.3.3 Conclusion	72
8.4 Shape analysis	72
8.4.1 Side views	72
8.4.2 Top view	78
8.4.3 Conclusion	82
8.5 Degree of similarity	83
9 Shape grammar	84
9.1 Features included to shape grammar	84
9.2 Shape grammar rules	84
9.3 Verification	89
9.4 Generating the drill concept	91
9.5 Studying the rules for innovation and brand identity	93
10 Interview with designer Miloslav Šindler	94

11 Discussion	97
11.1 Elements of brand identity	97
11.2 Transferring the innovation	98
11.3 Brand identity and the innovation	98
12 Conclusion	99
13 List of abbreviations and symbols	100
14 Bibliography	101
List of figures	105
List of tables	107
List of attachments	108

INTRODUCTION

This thesis concerns with study of brand identity and its depiction in design of industrial product. This topic is raising dilemma in todays, highly competitive market, because individual products are trying to distinguish themselves and offer more to the customer. The classical example is that some brands are spending a lot of money to be different and distinctive. This was the case of rebrand of the Pepsi coke to be different to the Coca Cola. [1]

Brand Identity is set of required associations with the brand that the managers are trying to establish and maintain. [2] This identity is forwarded to customer by position and communication of the brand, its marketing, product design and experience.

Motivation for this study is possibility to obtain larger knowledge about the methods of designers work. Deeper exploration of transforming the brand identity into a design might contribute to easier creation of product design by whatever company. Identity of the brand is precious, nonmaterial commodity in current competitive market and its clear definition may help to growth of companies.

The aspiration is finding and analysing products of certain company and through study find typical shape elements of the products. Definition of Brand identity will allow implementation of those elements to design of innovated product with possibility for use in completely new products. Products that the company will make in the future then remain recognizable for the customers. Although every identity is unique in its own way [3] it is possible to track elements, which represent it. Product design of the company may grow invariably in a way, which respects its own identity.

1 DEFINITION OF SOLVED DILEMMA AND PRELIMINARY AIM OF THE DISSERTATION THESIS

The Brand identity is becoming one of the basic strategies of company for improving its competitiveness. In order to be recognized it is essential that it is being imprinted on to the product itself. Designers developing a product are subsequently facing a challenge to make the design in way it complies with all aesthetical, functional and ergonomic rules, but also includes the philosophy of the brand that'll be manufacturing it. Because the task is getting more difficult, designers are using computer and some other types of support to achieve the goal.

Case studies of the Volvo and Nokia approach to design of their own brand identity [3] [4] show, that branding is the important point of view to achieve good position on the market or to regain position once lost. Product design is one of the key elements of identity and it is a great need for it to be distinguishable.

Generative method of shape grammar has broad possibilities of application in engineering. [5] In the industrial design it has the greatest potential of creating infinite number of alternatives from the final number of given entry elements. [6] It is indeed very quick due to the help of the computers. The disadvantage of such generated concept is it's made only of the elements given at the entry and so it does not bring any new aspects and elements to the final design, it only shows possible combinations that we might have overlooked. The second disadvantage is the similarity of generated alternatives to past designs, and sometimes the alternatives are far from the designer's aesthetic criteria.

Scientific studies focusing on the application the shape grammar at first hand examined whether it is possible to capture and generate products with same functional scheme, where the function has influence on the form itself. [7]. In spite of the proven possibility of capturing design of product by shape grammar, the subsequent studies were focused on the field of brand identity. [8] [9] [10] [11] [12]. Studies mostly focus on the design in automobile industry.

There are also publications that are developing the ideas of the shape grammar creation and focusing on the options how to support the grammar creation by software [12] [13], and automatization [14]. The basic is the usage of parameters for the grammar criteria. By adjusting these variables the generated outcome is directly influenced. The information technology eases the work of designer in the field of shape grammar this way. [15]. The studies following these publications are focusing on the method how to automatically restrain the generated alternatives in the matter of defined criteria [16] or genetic algorithms [17] [18].

Preliminary aim of this dissertation is the study of innovation processes of future product of NAREX brand depending on generative specification of its shape grammar. Part of the target is to find the typical design elements by use of decomposition [19] and method of comparing similarities in particular product group [20] 13 products of the company, which are from 3 categories and are historically bounded will be reviewed.

2 CURRENT STATE OF KNOWLEDGE

2.1 General findings

This sub-chapter sums the base knowledge of the brand, of the shape grammar method and its possible application in engineering.

2.1.1 Brand identity

Brand identity is a sum of desired properties' associated with the brand, these are to be given and cared for by the company planners [2], according to Jones and Bonevac [21] the base for brand is a name, symbol and labelling. They also suggest that the „brand“ is „definition of a company or a product itself“. Thanks to more general definition the term Brand does not limit itself to the product concepts or the philosophy or the graphical symbols (although these are included). Term Branding may then mean the process of creating such own definition for a specific brand or a product. And others are also trying to define it [22].

OLINS, W. *Corporate identity: making business strategy visible through design*. Repr. London: Thames and Hudson, 1994. ISBN 0500278083.

The publication examines commercial activities of company from the point of view of its identity as the visual style of the company affects its position on the market. Firstly it concerns with historical background of the corporate identity and explains why the company should use it. In later chapters we can find explanation of the identity's parts, types – corporate structures and strategies. The second half of the book is dedicated to educating the reader how he should proceed when creating corporate identity and strategy for launching it. In conclusion the book contains general information about brand identity. Information, every student of it should know.

WHEELER, A. *Designing brand identity: a complete guide to creating, building, and maintaining strong brands*. Hoboken: John Wiley, 2003. ISBN 0471213268.

Author describes the process of building brand identity. This process is shown on examples of visionary brand identities that already exist. The book provides helpful insight in logo, logotype, colours and other categories. According to it, the basic parts of brand identity, which are designed contain: logo, logotype, colours, and typography and their applications. The publication is also a good resource for basic definition of brand identity and how does it work.

KARJALAINEN, T. M., Designing Visual Recognition for the Brand. *Journal of Product Innovation Management*, 2010, v. 1.; č. 27.; ISSN: 1540-5885

KARJALAINEN, T.M., Strategic design language - transforming brand identity into product design elements. *Proceedings of the 10th International Product development Management Conference*, Brusel, 2003

Author is studying the problematic of communication design and its contribution to the brand. He does so, on the case studies of Volvo and Nokia companies. The company identity is told to the customer through branding and it consists of attributes through which it can be communicated. Product design itself is one of the basic components of the visual brand identity and through which the company can focus on the functions that are typical for it and are representative for the company.

Case studies

At the beginning of the 90th Volvo Company needed to change the character of produced vehicles to more dynamic design. For the reason of sustaining the identity of the brand the new design must have incorporated two basic things: “Swedishness” and the long strong heritage of the brand.

Design team led by Peter Horbury created the language of the design that included V shaped front hood, unusual bumpers, low-set nose characteristic for older Volvo cars and the very characteristic curves running from the front to the rear part of the vehicle. These elements were included in all proposed vehicle designs, gaining great positive reviews.

Second case study is about the approach of Nokia to design of their model 3310 mobile phone. Nokia unlike Volvo did not follow the earlier products with its design as the development of the mobile phone market was too fast to define a single unique language of the brand. Nokia though emphasized the product personalization and its human aspect. Each of the models was designed to address different aspects of the market segment it aimed to.

Nokia introduced the exchangeable back and front covering to allow the customers to fully personalize the hardware looks in colourful combinations, and first options to alter the software of the phone itself. With the characteristics the model 3310 was designed stressing these aspects: flawlessness, honesty, fun, relaxation, and sci-fi. The semi elliptical link round the display was introduced to emulate a face of the phone. Even though the Nokia products did not bear the same design language they were being instantly recognized by the inner values, incorporated by designers into the looks of each and every product.

Conclusion

The precise identity and the company goal are the most important elements of its success. Product design is one of the tools to bring the information to the customer. Customers often assign human characteristics to inanimate objects and on its basis they recognize these objects. The message the product is communicating toward the customer is one out three types: Direct (shape of the hood) – explicitly associated with the brand, Qualitative – design elements and stylistics that are

defined for the brand in long-term bases, enduring the time and fashion. Non-Direct – sums the information that is not expressed by a shape and are indescribable – based on metaphor and history of the brand. Every brand identity is in its design specific and unique given to cultural and historical influences. For the sake of recognition of the brand in each and every of its products the identity of the brand must be an inseparable part of such product.

2.1.2 Studies about colour and the brand

LABRECQUE, L., MILNE, G. Exciting red and competent blue: the importance of colour in marketing. *Journal of the Academy of Marketing Science* [online]. 2012, **40**(5), 711-727, DOI: 10.1007/s11747-010-0245-y. ISSN 00920703.

The authors try to find out how colour shapes consumer preferences through series of four studies. First study is about colour hue and brand personality. Secondly they try to examine the role of saturation. Next they try to show how the colour can be used strategically by brands to change the purchase intent. Finally the article tests if the colour can influence likability and familiarity of a brand.

For the study of hue effect, they examined set of fictional logos with constant saturation level. In the second study they sampled logos in different saturation level and different brightness/darkness. The purchase intent study was tested on sample of real product packages with altered colours. In the fourth part of the article, the authors are using brand names, grey scale logos and coloured logos to clarify the alteration of consumer brand perception. All these studies were conducted by different respondents by a questionnaire. The 100 brands selected for 4th study were from Top Brand report conducted by journal Interbrand in 2009.

Results and conclusion

The 4 studies are strongly supporting relationship between colour and brand personality. First study proves the connection between sincerity with white and yellow colour, excitement with red and orange hue, competence with blue hues and that the brand is sophisticated when it has black coloured logo. Second study indicates that higher saturation of colour intensifies excitement. Third part shows that the colour of the package alters the purchase intent of the customer. The last study confirms that the coloured logo shifts the effect of the brand personality on the customer. It also concludes that the shape and colour of the logo influences likability and familiarity.

LABRECQUE, L., MILNE, G. To be or not to be different: Exploration of norms and benefits of colour differentiation in the marketplace. *Marketing Letters* [online]. 2013, **24**(2), 165-176. DOI: 10.1007/s11002-012-9210-5. ISSN 09230645

Article is concerned with phenomena of differentiation of brands on the market, whether it is positive or negative in certain product categories. The brands are developing strategies to stand out on the market and that is done mainly by colours in logo. Research focuses on colour norms in product categories from 281 top brands divided to 15 categories. These are Alcoholic beverages, Apparel, Auto, Beverages, Computer/ electronics, credit cards and financial, Entertainment, Fast food, Food, Health/beauty, Household, Pharmaceuticals, Retail, Communications and Travel.

After finding the colour norms the relationship between the differentiation and the performance of the brand is found.

Results

In overall level, main colours used in logos are blue (48,2%) white (39,3%), red (31,4%) and black (26,1%). The least used colours are grey, brown and pink. Logos in apparel category were the most homogenous whereas the pharmaceuticals were not. The most colour used in category had food, beverages, pharmaceuticals and entertainment.

Conclusion

Authors find evidence that there are existing colour norms in product categories. The colour distinction of brand in category may have positive effect in certain categories but in others it can have a negative effect. The reason may be that the brands are competing in market which has a dominant leader. This dominant leader is setting the colour norm in this product category; therefore it may be more helpful to follow his trend. This happens mainly because of memorizing these colour norms among customers. The colour differentiation in product category of consumer-packaged goods is found irrelevant.

2.1.3 Shape grammars

2.1.3

STINY, G., GIPS, J., Shape Grammars and the Generative Specification of Painting and Sculpture, *Information Processing* 71, 1972, str.: 1460-1465

STINY, G., GIPS, J., Introduction to shape and shape grammars, *Environment and Planning B: Planning and Design*. 1980, č. 7, str. 343-351, ISSN:1472-3417

Articles are describing the method of generative specification of an art piece, it was firstly presented by Stiny and Gips. Goal is to use formal, generative technic for creating good art objects and the understanding development of what creates the good art objects. Created art pieces are specified by two sets (S,M) where S is shape specification in the grammar and its modification on basis of given rules. The set M is a material specification for all shapes created within given set S. Shape grammars are defined on the set of shapes and can create n-dimensional shapes. Shape is limited as alignment of direct lines defined at Cartesian coordinate system with the real axis and attached Euclid metric. Blank shape does not contain any lines.

Definition:

Shape grammar is a 4 element set. $SG = (V_t, V_m, R, I)$, where:

1. V_t is set of finite number of end shapes. V_t^* is a set of shapes made of finite number of element alignment or V_t elements, in which any element of V_t might be used multiple times in any size or with any rotation.
2. V_m is set of definite number of shapes used as labels, as so $V_t^* \cap V_m = \emptyset$. Labes allow to control of what rules are applied to the left-side shape from the set R.

3. R is a set of rules made of a definite number of aligned pairs (u,v) whereas u is left-side shape consisting of set V_t^* elements, that can be combined with a element from the V_m set and is right-side shape consisting of:
 - a. V_t^* set element contained in left-side shape „u“ or,
 - b. V_t^* set element contained in left-side shape „u“ combined with a V_m set element, or
 - c. V_t^* set element contained in left-side shape „u“ combined with another element from the V_t^* set and an element of set V_m
4. I is a default shape consisting of elements from sets V_t^* and V_m .

Every grammar starts at the default shape and ends according to rules at the final shape element.

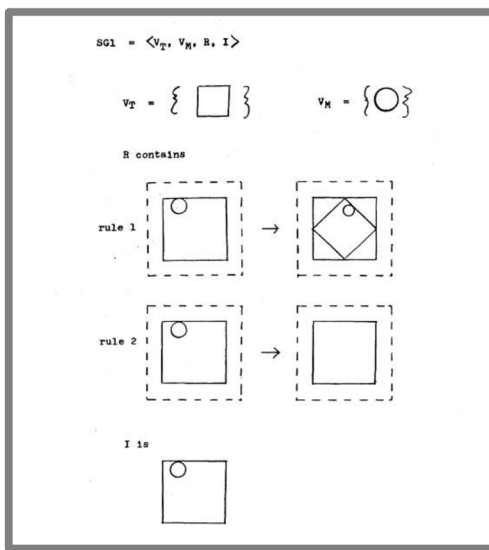

Fig. 2.1 Example of shape grammar [6]

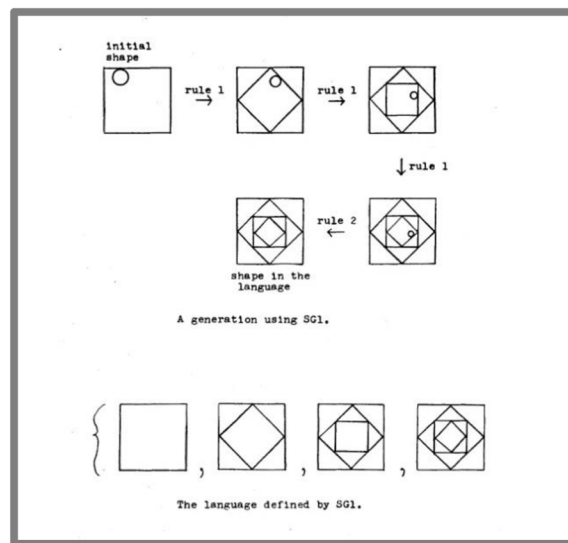

Fig. 2.2 Shapes generated by grammar from fig 2.1 [6]

Shape is generated continuously from the default shape by application of the rules. Result of rule application to any given shape is a different shape consisting of the given shape with a replaced right-side of the shape rule for to disallow the left-side of the rule occurrence.

Application of rules on the shape goes as:

Step number 1 – Finding a part of shape, that is geometrically alike to the left-side rule, where it is both not-definite or final elements.

Step number 2 – Finding a geometrical transformation (rotation, movement, scale, mirror) that will adjust the left-side to the identical one with the found part of the shape.

Step number 3 – Application of the transformation to the shape on the right-side with targeting the right-side rule and swap of the right-side of the rule by corresponding part of the shape. If it is a final shape, then it is presented identically on both sides of the rule, therefore when it is applied it can't be deleted. Process of generation ends as there is no other rule to apply.

Language „L“, defined by shape grammar (L(SG)) is a set of shape generated by grammar that does not contain any shape of V_m element. Language of the shape grammar is potentially indefinite set consisting of definite number of shape.

KNIGHT, T. W., Color grammars: designing with lines and colour. *Environment and Planning B: Planning and Design*. 1989, č. 16, str. 417-449, ISSN:1472-3417

Article is about extension of the shape grammar method. Colour grammar is defined by the shape grammar with addition of a third component to the default shape and to the shape grammar rules. This added element is the one defining value of quality, in this case the colour. This element is called colour field. It can be continuous or discontinuous body with a final content that is filled with one or more non overlapping colour. In 2-dimensional system the colour fields are colour planes, in 3D systems it may correspond either to planes or to volumes.

Colour fields are created by lower entities called colour stains (qualitative stains). Stain is in opposition to colour field only containing one colour and it is defined by geometry. The advantage of colour fields is their content definition, in contrast to lines and shapes of shape grammar that are definite without content. Thanks to this the colours can be added or subtracted on overlapping content of two stains. Colour grammar better correspond to the way the painting is made.

SMYTH, M. EDMONDS, E., Supporting design through the strategic use of shape grammars, *Knowledge-Based Systems*, 2000, v. 6, č. 13, str. 385-393, ISSN: 0950-7051

This article deals with strategies that designer uses during his work and what are possibilities of computer support to it. The important part is creation of alternative designs. These should content unexpected solutions that would be considered as good. Generative grammar can create indefinite number of entities from final number of entries but its widespread is limited by rules to define it. This should support the early phase of design process.

Authors created an experimental system using the shape grammar as a way for creating alternative solutions of the spatial arrangement of simple abstract shapes. This system was introduced to three designers as an option that they may use during their design process and a discussion followed.

Results

Interviews showed the areas where the system might find its use:

- Show implication of specific element relations.
- Empowering design evaluation processes
- Forecasting of points for creative decision
- Strengthening lateral thinking

Other less significant areas:

- Using 3D shape grammar (one of three designers disapproved)
- Using further grammar for colour

Using the option of setting rules as mandatory and voluntary
Organic growth of rules

Conclusion

Shape grammar is a system that can in some phases support the design work, although it cannot replace the work. At some points necessary creative decisions are to be made, the shape grammar does not allow application of other elements for generating a shape than those that it already includes.

KNIGHT, T., STINY, G. Making grammars: From computing with shapes to computing with things. *Design Studies* [online]. 2015, **41**, 8-28 [cit. 2016-07-28]. DOI: 10.1016/j.destud.2015.08.006. ISSN 0142694x.

The article is trying to define design process more basically. Making is described as doing and sensing with stuff to make things. This point of view is then compared to computational methods of generative specifications of shape grammars. The process and activities that designers do in reality – sensing, doing with stuff are explained on computational level.

Results:

The authors are giving 3 case studies on how their concept of making is computed: drawing with lines, knotting with a string and painting with watercolours. Each example is based on special algebra of elements that reflect the real making – sensing, doing, things and stuff. These studies are basic and demonstrate how manipulating stuff and things can be described as computation.

Conclusion

The article clearly implies on similarities among making design in reality and generating it based on shape grammars. The definition of grammar goes beyond the shapes, as they can work as any tool in real life. From my point of view the actual making is clearly a computation done by our brain, therefore the authors may be very close to description of how we should design the computation tools to aid designers in their work.

2.2 Studying design products by shape grammar

AGARWAL, M., CAGAN, J., A blend of different tastes: the language of coffee makers, *Environment and Planning B: Planning and Design*. 1998, č. 25, str. 205-226, ISSN:1472-3417

There are consumption products emerging on the market that are competing to differ themselves from the competition products. Groups of these products have mostly the same function and consist of same functional parts. Examples to this practice are Coffee machines as stated by the authors. These coffee machines, despite being from different producers, have the same functional process and part

alignment. The only parts diverting them apart are a casing colour, and the materials used for the casing.

Thanks to the same functional design it is predictable that the way of creating its form would be similar. Firstly they are using method of shape grammar to produce design of the product. As an example of application they are mentioning coffee machines, and by decomposition to functional parts they analyse 4 coffee machines (of brands Proctor-Silex, Black 'N' Decker, Braun, and Krups). On the analysis basis they put together a parametric shape grammar and generated simplified coffee machine models.

Results

Using the shape grammar, the original models of coffee machines were generated. That verified the validity of the set shape grammar. Original coffee machines, despite the fact being unique in their looks, are sharing the same system and so the changes in looks are achieved only by changing parameters during the process of generation.

Authors state, that through variables in shape grammar an infinite number of coffee machines may be generated. Parts of the work are three concepts of generated coffee machines different from the original ones.

Noted remains the fact, that the product may differ not only in its' shape. Material, colour, coating, it all may have effect on the looks of the product. All of this aspect may be applied into enhanced shape grammar.

Conclusion

Generative method of shape grammar is useful for product line and it allows during the parameterization the set of huge number of models that are in compliance with the functional design of the product. Any group of products using similar functional elements may have set its own shape grammar. Generated designs will always be a combination of elements, of which the grammar is made of, and it will not differ much from the original product.

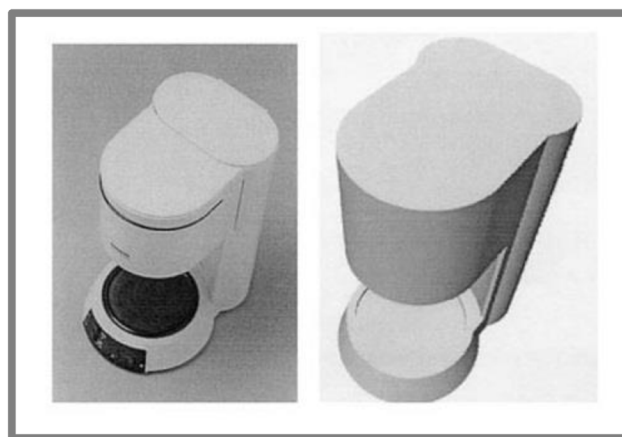

Fig. 2.3 Real and generated coffee maker [7]

McCORMACK, J. P., CAGAN, J., Designing inner hood panels through a shape grammar based Framework, *Artificial Intelligence for Engineering design, Analysis and Manufacturing*, 2002, č. 16, str. 273-290, ISSN: 0890-0604

McCORMACK, J. P., CAGAN, J., Supporting designers' hierarchies through parametric shape recognition, *Environment and Planning B: Planning and Design*, 2002, č. 29, str. 913-931, ISSN: 1472-3417

Many products go through multiple redesigning. This occurs mostly when the parameters or characteristics of final product are to be changed. Mostly the construction changes on different parts of product are to influence design of neighbouring parts. Typical example of this phenomenon is a car's hood, further most its' inner parts, that is affected by both the looks of the vehicle and the setting of engine components on the inside.

Authors assume the same logic throughout the design process whilst creation of the inner parts of the hood and they describe it using shape grammar. For the removal of unsuitable designs they do apply a program that allows them to adjust rules of shape grammar on the basis of construction demands (number of stiffeners, areas needed without stiffeners). Hood is represented by a 2D line drawing in the article; the drawing shows the distribution of the stiffeners and the free space.

Results

Shape grammar of the inner panels of the car hood shows, that via software support it is possible to generate a design of the construction on the grounds of given demands. Therefore it allows greater optimization on the basis of defined parameters that are removing unsuitable variants.

Conclusion

Parameterization of shape grammar allows quick reaction in the redesign while keeping given rules needed for the outer looks of the product. Rules may furthermore be used to define construction joints that are a necessity to follow for the manufacture of the product.

PUGLIESE, M. J., CAGAN, J., Capturing a rebel: modeling the Harley-Davidson brand through a motorcycle shape grammar, *Research in engineering design*, 2002, č. 13, v. 3, str. 139-156, ISSN: 1435-6066

In the article the problematic of capturing the identity of Harley Davidson brand through shape grammar are dealt with. Even earlier the shape grammar has proven its ability to maintain basic elements of the product [7]. But it is important that it can capture the brand identity [4]. Harley Davidson motorcycles wake a strong feeling through its powerful engine sound and robust looks. This look is maintained by using specific elements of visage that are similar throughout the company's product line.

HD motorcycles have for a quite bit mechanical looks due to the fitting of the parts to the grid. Typical is the „V“ shaped engine, or the drop shaped fuel tank and the front fender. The grids profile optically lower the back side of the motorcycle so emphasizing the image of strength.

Of the identified 45 grammar elements the shape grammar was created, and subsequently used to make 10 different models. The whole generation process underwent by using 2D representations of the motorcycle elements. On the two evaluation groups (HD owners, HD-knowledge enthusiasts) was evaluated, where the HD brand is recognized from these generated drawings of motorcycles.

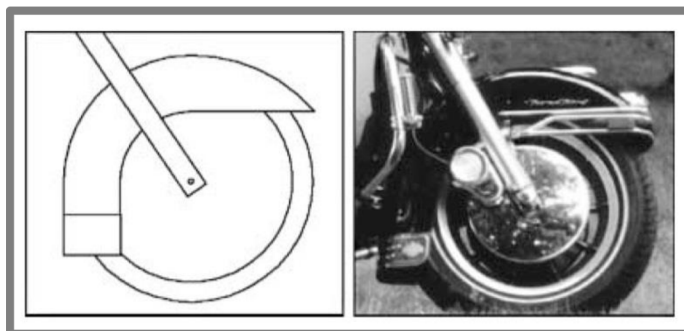

Fig. 2.4 Linear representation of front fender [8]

Results

3 of 10 models were recognized as motorcycles of HD brand. Correctness of answers was over 70%. By 5 models, where significant deviations from basic lineaments were made, the correctness was less than 16% of answers.

It was proven that the generated models can despite the high abstractivity of the drawings valuate as recognizable under the Harley Davidson brand. Therefore we can conclude that Harley Davidson brand has its' own specific shape grammar capturing it.

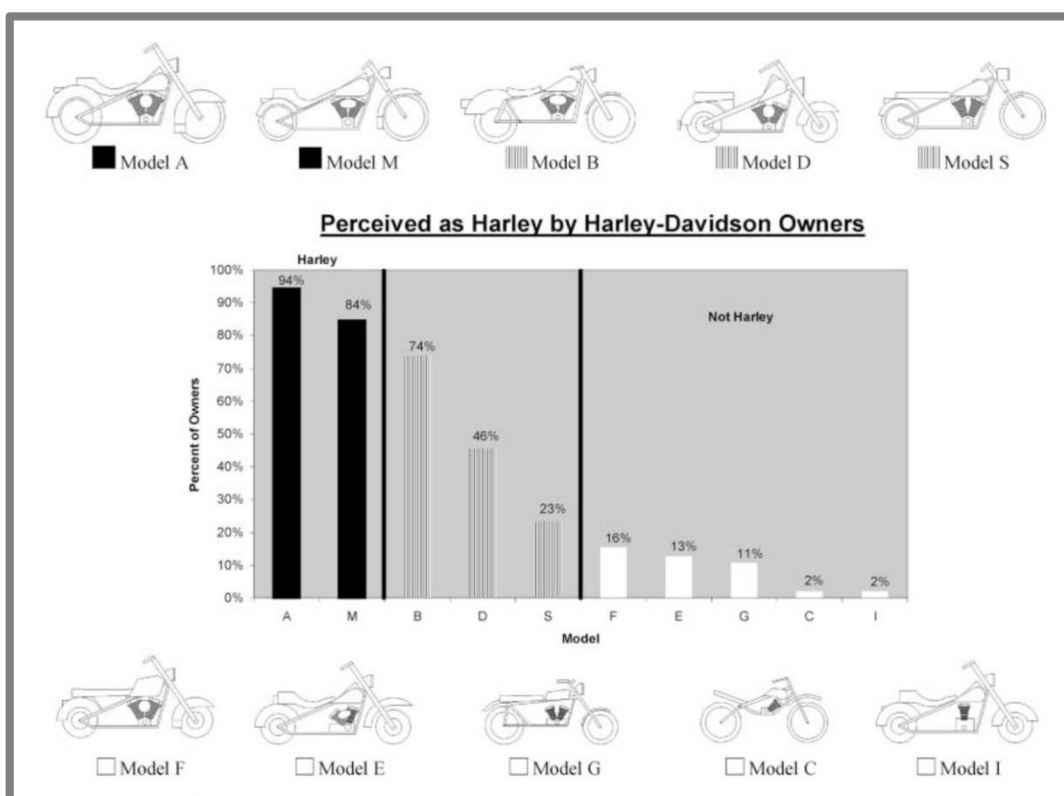

Fig. 2.5 Results of recognition of models generated by shape grammar [8]

Conclusion

Brand identity can be captured using methods of shape grammar that can furthermore be used to generate models within this identity. Importance is with keeping typical elements of the brand in the model design, thus any deviation means not recognizing the brand.

High rate of drawing abstractivity is not an obstacle for the recognition by the customer, so it simplifies the work with the shape grammar, because it is possible to use only two dimensions.

McCORMACK, J. P., CAGAN, J., CRAIG, M. V., Speaking the Buick language: capturing, understanding, and exploring brand identity with shape grammars, *Design Studies*, 2004, v. 1., č. 25., str. 1-29, ISSN: 0142-694X

Development and maintenance of the brand is important in the development of a successful product. In automobile industry, that have special care for their design it is more than important to maintain recognisability. In this article they study the possibility of capturing the brand by a method of shape grammar that was used to generate new preview of the front grid of recognizable Buick brand vehicle.

Identity is captured on the front grill because it is the most recognizable element of Buick design. Main features are the mask with round edges and some emblem like element above or inside with strong vertical line through the grid. Secondary elements are the beaded hood and current line (air current over the hood), the fencers the throughout history kept a slight changing feel and other hood lines. Third and heavy element is the fact, that the middle of the casing was always a bit raised to emphasize the current lines on the sides and put a more effect on the fencers and side elements.

Shape grammar consisting of 63 rules was developed from the past drawings of old models and from photos of actual car. All from year span 1939 - 2002. The definition of lines was analysed through length and angle of lines analysis.

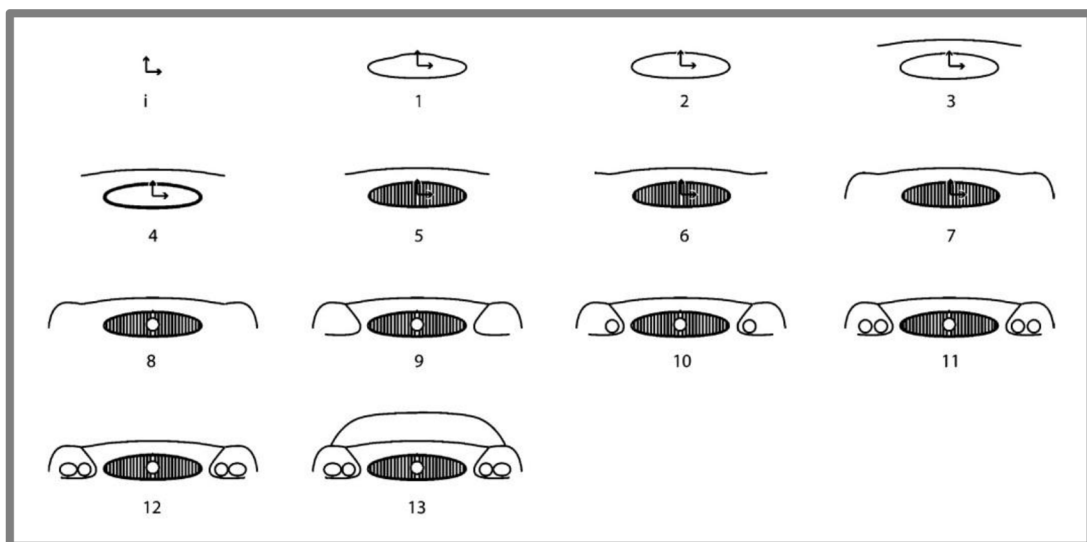

Fig. 2.6 Building front mask of a Buick with shape grammar [9]

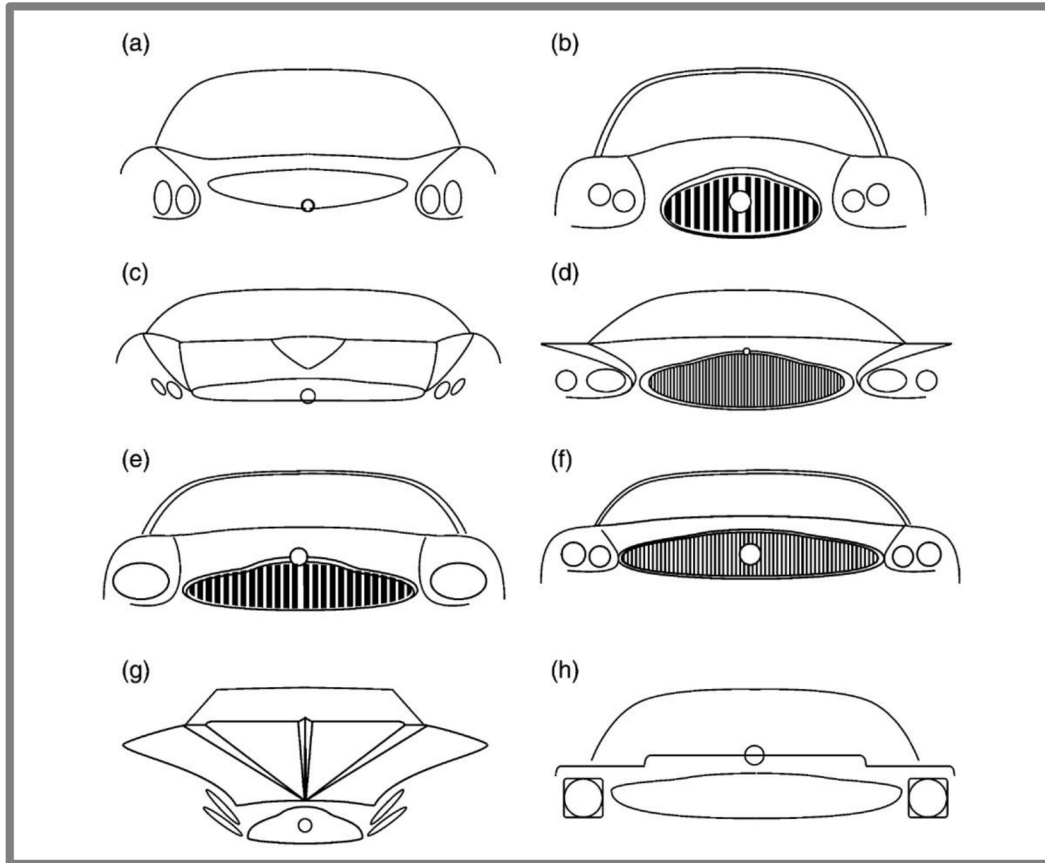

Fig. 2.7 Shape grammar generated innovative front masks [9]

Results

First a model was randomly selected from those of which the analysis consisted and a model was generated to verify that the grammar is correctly set up. Then the designers used this grammar to create a new model designs.

By combination of the rules for the next models it was observed that the complexity of shape grammar of Buick is giving birth to new concepts, but only to be very resembling to other existing models of Buick throughout its 100 years history.

Shape grammar has proven to be effective way of finding models and elements that keep the identity of the brand. And it showed which element is to be adjusted and combined to create new modern models for different market segment. Knowledge of the typical elements is very helpful to the marketing of the brand.

Conclusion

Shape grammar can be used to capture the typical elements of brand identity from various products of the same brand. Generated products will always be composed of the element used to set up the shape grammar. Setting up known parts like this can produce variants that we might have missed during the design process.

ANG, M. CH., a kol., Capturing Mini Brand Using a Parametric Shape Grammar. *Proceedings of the Second international conference on Visual informatics: sustaining research and innovations*: Berlin, Springer Verlag, 2011, číslo: 2. str. 1-12, ISBN: 978-3-642-25199-3

In their study the collective of authors analyses the theme of capturing the brand via parametric shape grammar. For analysis there were 4 models of MINI brand selected - MK1 (1959-1967), MK2 (1967-1973), Clubman (1969-1980) a BMW Mini (2001-now).

Parametric analysis was done so the curves were measured on each of the evaluated models and angles and lengths on connecting lines of shape were measured. Front view of the vehicle was derived to three sections. Roof and the top line were assigned to the Top section, fenders and headlamps, grid and emblem were assigned to the Middle section and the bumper line is the third down section.

At the end only the outer lines of the car were analysed. Emblem, bumper, and mask weren't included into the parametric study. All of the curves were mathematically described in the way that the line of same length was joined by another in accordance with the observed angle. For the reason of more precise tracing of the shapes a minimum of 4 lines were joined. For all measurement the vertical symmetric centre line was applied.

Results

MKII had the most round shape of all studied models and had more round fender in the Middle section. All models but the most modern MINI included a shapely significant front bumper that the BMW Mini lacks.

MINI is sustaining its brand identity in the look at the front face of the car, by maintaining similar looks of the headlamps and the fender line. Those elements do not differ too much from model to model. Other elements are the shape of the windshield and the keeping of the car in the segment of small cars.

Complete results cannot be reached without the definition and study of other views at the car and study of its shape grammar.

Conclusion

During the study of the brand identity it is necessary to analyse product in its complexity. Following angles and lines can represent curves.

2.3 Tools for the shape grammar support

ORSBORN, S., CAGAN, J., BOATWRIGHT, P., Identifying product shape relationships using principal component analysis. *Research in Engineering Design*. 2008, č. 18, v. 4, str. 163-180, ISSN 1435-6066

ORSBORN, S., CAGAN, J., BOATWRIGHT, P., Automating the Creation of Shape Grammar Rules. *Design Computing and Cognition*: Berlin, Springer-verlag. 2008, str. 3-22, ISBN 978-1-4020-8728-8

The shapes of some products that are consisted of many elements, e.g. cars, do have traditionally accepted definitions and relations to specific elements of looks. These elements might be the representative of some of the cars' segment characteristics. By identifying these elements it is possible to use them for the simplification and automatization of the process of creating the rules of shape grammar. The Designer creating the shape grammar often views the relations subjectively and thus he limits his creative options while composing the grammar. It is a necessity finding a sufficient method for objective evaluation of the cross-element relations between any designs.

To verify the options vehicles of three segments of the market were chosen (SUV, coupé, pick up). Data for the evaluation had to have a drawing of the design publically available, and that's of three sides (front view, back view, and a view from a side) with adequate proportions between the views.

Results

With the help of Principal component analysis method, a shape pieces were identified. On its basis an objective shape grammar was set, it was not influence by subjective position of designer. The setting of the shape grammar rules can be done easily, as consisted of known elements that are shared between the main components and those who are not shared. Afterwards the next steps to applicate Shape grammar and generation of concept may proceed.

Conclusion

When analysing the products with same functional form, it is useful to use the analysis of main components that will ease and objectify the creation of the shape grammar itself.

PRATS, M. a kol., Improving Product Design via Shape Grammar tool. *International Design Conference - DESIGN 2004*, Dubrovnik, 2004

This work is aiming into the user working with the software that will support the creative process. The tool with shape grammar is used to produce different drawings and the designer then by updating the parameters updates that whole composition to be designed. Continuously the side silhouette of the vehicle is generated, that can be edited later on. Randomized creating of concepts by the computer is fast and makes a great interval of different propositions that could be overlooked. The while the shape is generated, which the designer seeks, it can be locked so it does not change.

The designer always starts with searching randomized free curves by continues limitation of these curves thus defining it further more to maximum of the designers' desired interest. When the shape generating ends and additional change to one element is then still considered as curves generated as a part of designers' intention.

Even if the shape grammar can on the basis of given rules create an indefinite number of objects, its innovation ability is limited exactly by the same given rules that are mostly set up by concurrent objects. This issue is contemplated by the evolution grammar theme lately, it implements genetic algorithms set on the basis of artificial selection [17] [18]. The other option how to empower these software tools is to strengthen the tree structure algorithms, that is typical for shape grammar and shape detection to which the rules can be applied. [16] Other tools might be focusing on using the shape grammar for rapid prototyping. [14]

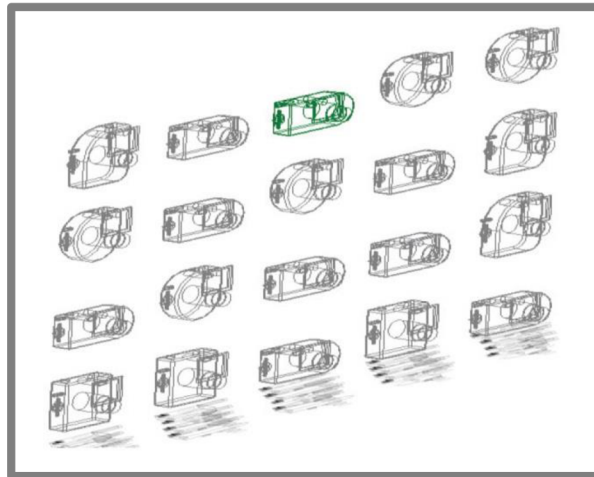

Fig. 2.8 Examples of generated products by genetic algorithm

PRATS, M., C. EARL, S. GARNER a I. JOWERS. Shape exploration of designs in a style: Toward generation of product designs. *AI EDAM*[online]. 2006, **20**(03), DOI: 10.1017/S0890060406060173. ISSN 08900604.

Generative specifications are systematically codifying established styles in fields such as architecture and product design. Article examines how designers react and explore new designs in first phases of the process. Style has great power and distinguishability. It can be recognized throughout products created by one person, groups, geographical areas and periods of time. Style is not only based on similarities that can be found on the products but also by similar principles of creating. Authors are trying to clear out the how new styles are explored developed and used or if they are only a post hoc effect of something that happened. Article focuses mainly how the designer can decomposition shape and on what levels is working with this process.

Results

Shape can be perceived and represented at different levels of abstraction. Designer can explore details as well as whole design structures and constantly switch among the levels of perception. The layers which designers are using are contour, decomposition and structure layer. In contour, general, initial ideas about the concept are formed. On the decomposition layer the designer works with elements of the outline, as he decomposes the contour. This can be done in infinite number of ways and offers to variations of the design. The structure layer combines elements and give interpretation of how to group them.

The authors are focusing on how the designer decompositions the shape because here may be the greatest potential of use of generative specifications to help the designing process. Result is that the designers can explore through the decomposition layer in two ways – by manipulating outline of elements accordingly to predefined constraints or by manipulating the decomposition lines which are formed by intersecting lines of the initiative inspiration.

Based on their findings the authors are promoting basic tool for exploring design families of products, which have the similar style.

Conclusion

The layers of the designers work which are described by the authors are logically based on designers working process. Through the early stage of designing the strength of concept is given by the initial concept and therefore the variations are not moving the design concept to be more innovative. The generative specification of product families is proving that designs of that product are based on similar features which are only arranged differently.

MCKAY, A., CHASE, S., SHEA, K. and CHAU, H. H. Spatial grammar implementation: From theory to useable software. *Artificial Intelligence for Engineering Design, Analysis and Manufacturing* [online]. 2012, **26**(02), 143-159

Authors are reviewing tools for designers, which are using generative specifications and are trying to define areas of future research interest. The tools for supporting the designers work are not encouraging creativity or ways of thinking and working of the designers. Spatial grammars and they're abilities are seen as the most usable support for the early stage of the design process. The article is using term "spatial" in opposition to shape grammar because the word shape implies work with something represented only by shape. The tools are reviewed based on requirements derived from papers specified by Gips [28] which are describing idealized general grammar tool.

Results

The authors described different implementations of shape grammars in software tools. There is anticipation that designers could work in a manner of making own shape grammars and rules to suit their own needs for style, fabrication etc. And propose mainly to capture the grammar of the fabrication processes, because it could be easily implemented to current software tools. The designer could then see optimised design for the process and could adapt it.

Conclusion:

The article gives a framework of different tools for supporting the early stage of design process. The requirements that the software tool should meet are however very far. The shape grammar is not educated in many colleges and therefore the integration to practice is very complicated. Of course the idea that every designer could create his own tool to speed up his work is vital. Usually every artistic authors as well as designers do have their own style. When the designer could capture this style he could generate designs of products in fracture of time currently needed.

2.4 Methods useful for the analysis of the product

RANSCOMBE, CH., HICKS, B., MULLINEUX, G., BALJINDER, S., Visually decomposing vehicle images: Exploring the influence of different aesthetic features on consumer perception of brand, *Design Studies*, 2011, v. 4., č. 33., str. 319-341, ISSN: 0142-694X

The article focuses on the technique of vehicle image decomposition from the three main views of the individual aesthetic elements. It is subsequently verified, whether the two-dimensional line representation of the vehicles bring enough visual data leading towards brand recognition. For this analysis 5 coupé type vehicles were selected. Vehicles were of these brands BMW, Mercedes, Audi, Ford a Honda. Decomposition underwent by the following procedure:

Outline capturing (silhouette). It defines the basic volume of the vehicle.

Capturing the shapes of windows and/or parts the light comes into the vehicle. That is important for the stance of the vehicle.

So called *muscles* which are the parts of the vehicles created by modifying the surfaces (reduction, lifting, a sharp transition) curves or surface joints.

Graphic elements, parts that note the details of the brand. e.g. Front grid mask, headlamps, licence plate place.

Details - a subset of the graphical elements that announce the brand of the vehicles as for example Logo.

Results

Decomposed vehicles in different phases of decomposition process were shown through an online questionnaire. Authors collected answers by 420 respondents of 17-63 years of age (78% men, 22% women). These results rise from their answers:

Correctness of the answers did not rise along with the number of shown elements of the decomposed vehicle.

Front look of the vehicle shown higher number of correct answers, compared to side or back views.

Respondents find it more difficult to recognize the type and the segment of the vehicle compared to the recognition of the brand.

No obvious relation between side and back views of the same vehicle or type was found.

The most correct answered pictures were decomposed to the phase which includes graphic elements.

High variability between correct answers to different phases of decomposition (3-90 %) was found and it shows that despite the visual representation of the vehicle is in high abstraction, yet the brand can still be identified.

Conclusion

Regardless the high level of abstraction it is still possible to recognize the product over its parts. These separated elements of the design may carry the visually typical shapes for the brand. Decomposition of image elements can lead to obtain aesthetical elements to analyse. These elements, in order to provide highest indication have to be extended to the graphical elements.

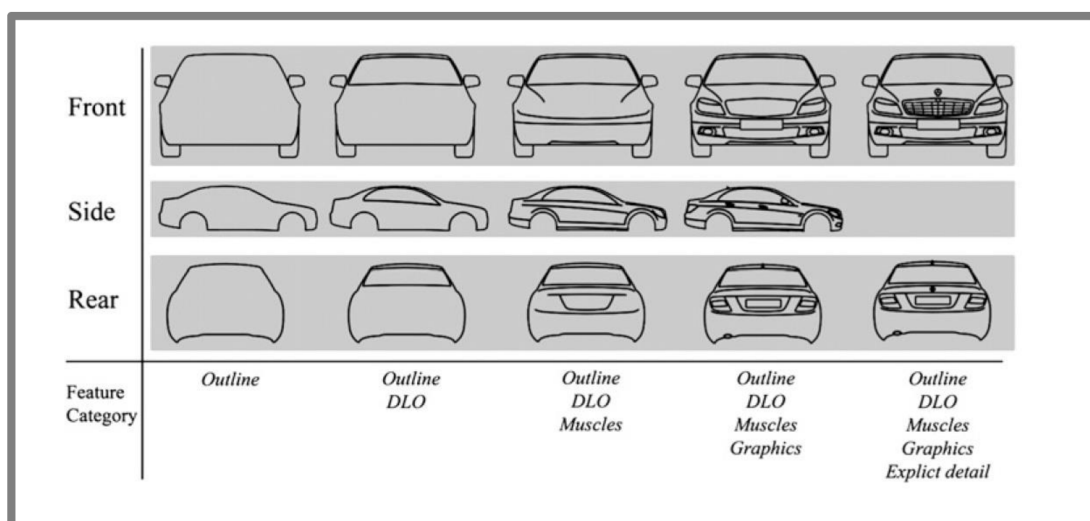

Fig. 2.9 Levels of decomposition of vehicles [19]

RANSCOMBE, CH., HICKS, B., MULLINEUX, G., Method for exploring similarities and visual references to brand in the appearance of mature mass-market products. *Design Studies*, 2012,v. 5., č. 33., str. 496-520, ISSN: 0142-694X

The aim of this article is to find a method for exploring similarities and visual references to brand in the appearance of mature mass-market products. Basic geometrical entities and their attributes might be used to set a primary analysis of the product appearance. Relative entities provide complete description of the outward element geometry. Although the analysis of these entities is done in isolation, it is a necessity to extend the analysis to considerate appearance elements in the whole appearance of the product. Thus this method complies with relation of the elements appearance to the appearance of the product as a whole.

Method consists of proportion analysis, orientation analysis, and the element shape analysis. Only on the ground of these analyses we can evaluate the similarities between elements of different products. Proportion analysis consists of measuring the sizes of the element in comparison to the size of the product as a whole. Analysis of the element position is done by coordinates of distances of element centre from the

centre of the object as a whole. Analysis of the shape is derived from the measured distances of all point of the circumference from the centre of product. Number of the points of areas must be the same in order to compare. Outcome of the analysis is a curve interspersed with points as they go in a row, followed by an analysis of the curve that may reveal similar shapes, which differ only in size or rotation transformation.

For each of the previously mentioned analysis a level of similarity can be computed. This level is different by each part of method. Whilst for the proportion analysis only the difference of values between two elements is counted. In feature position analysis a difference between coordinates is computed and by the shape analysis all point of the shape circumference distances are computed. When analysing more products the averages of the values can be computed to find out the level of division in the product line.

When analysing the results it is necessary to find the right interval that the products shall fit in. This range of the interval is influenced by the number of the products in the line and the basic level of their division. To compare one product to the other two ways are possible. We either take the product as one belonging to the product line that we analyse, or as one not belonging to that line.

Conclusion

Method is likely to be used when we have several products in a line, and we want to assess whether some that do not fit in the line is included. In the same way we may see the carry of specific elements of the brand between the products of a product line, or objectively verify, whether such product is keeping the language of the design of such brand.

3 ANALYSIS, INTERPRETATION AND ASSESSMENT OF FINDINGS GAINED THROUGH KNOWLEDGE BASE

Studies focusing on basic knowledge of brand identity state that the brand identity is an essential element of marketing strategy of any company [24] [23]. Every identity is unique. Hence it is clearly defined it can increase company's competitiveness in its field. Brand identity is communicated towards the customer through everything the company does, thus it transfers to the design of products by typical shape and other elements. The company's aim is to maintain this identity to the future, more so during the innovation of the products [3] [4]. When designing a new product it is preferable to keep some elements of the design that bond with the brand. Logo of a company is used as a straight implication of the brand and it is one of the main elements. Colours are also used as an element of the brand identity.)

The logo or the logotype the shortest link to the brand and it should be used on the brands products. It is necessary to be legible, clearly defined, and distinctive among the competition [30]. Usually brands are using logo consistently and refresh its design sometimes, which may also negatively affect their brand performance. [31]

Colours are used to distinguish the products of certain manufacturers on the market. Research shows that colours are connected to the brand personality. [25] Also the colours used on the products or packaging may be affected by the structure of the market in certain product categories. [26]

If we are maintaining some shape elements we may set a language of the brands' design. [8] By continuous sustain of these elements we are setting rules, that are limiting the design so it keeps its' brand identity. Works focusing on this issue use the shape grammar for creating the design as it's' tool [7] [8] [9] [10] [32] [33]. Generative method of shape grammar is allowing us to study many alternative concepts that we might have overlooked. [15] Every this concept is in compliance with all given parameters, that we used as default when we set it up. Design acquired via shape grammar cannot be extended by new data while it is being generated.

From the works focusing on generated design through Shape grammar, we might observe:

- We are generating concepts created by combination of default elements, where we can change parameters such as size, rotation and mirroring.
- Using shape grammars of products from one market segment we can capture and describe the shape and subsequently generate products still belonging to the given segment.
- When setting up the shape grammar for the brand identity, it is needed to come from the real historical products that carry the identity and thoroughly analyse those.
- Limitation by the rules of shape grammar will oversee the generating of products, which are carrying the brand. While generating the concepts, the typical elements of the brand must be kept.
- For recognition of the product or identity the 3D model is not needed. 2D representation of the product is sufficient. E.g. front mask of the car.
- It is possible to define construction joint that need to be kept from the point of manufacturing.

- The rules of shape grammar were not studied from the brand identity cross carrying point of view.
- Generated concept (mostly those created through ICT support) might result with insufficient product design. E.g. Bad proportion of a handle.
- Each shape grammar is limited only to the default set of elements and to generate proposed product, it cannot be enhanced by new information or ways of work.
- Some of the authors are trying to compare the actual making and designing to the grammar and similarities between the way the product is generated and the way how the product is actually designed can be found.

For the analysis of products from which to create a SG, the method of visual decomposition [19] and method of finding similarities in shape [20] might be used. Even though the grammar can be set without using of computer support [9], it is far more useful for the possibility of deepening the study. For the reason of infinite number of combination of default elements and parameters, the prior optimization of entries is needed, because when the resulting generated concepts are not constantly evaluated, then many useless designs may be generated..

4 DEFINITION OF AIM OF THE DISSERTATION THESIS AND DESIGN OF METHOD FOR ITS SOLUTION

The essence of the dissertation thesis is study of Brand Identity of the company NAREX and its products. Finding from this analysis will be used for verification if there is possibility to use shape grammars for generating completely new products, in other words if the shape grammar rules that bear the brand identity can be transformed from former products to new ones.

Aim of thesis and milestones

The aim is description of method how is brand identity transferred from past to innovated products.

- Creation of new design of drill and angle grinder using non-generative method.
- Analysis of NAREX products from available materials and finding key elements which bear the brand identity.
- Forming shape grammar rules for the NAREX brand.
- Definition of innovation of the product using shape grammar derived from past products.
- Creation of sketch of new product, using the generative shape grammar.

Method for solution:

Collecting and analysing data about products

There will be gathered available amount of pictorial documentation about products from different years through cooperation with the NAREX company in the first phase. The focus will be mainly on gathering data on product lines. It is necessary to have the photographs or drawing documentation which capture the products from 5 main views (2 side views, front and back view, top or bottom view). If there will be possibility to have the products available they could be scanned using available technology on the Institute of machine and industrial design.

Obtained documentation will be searched for similarities using the “Method for exploring similarities in mass market products [20]. By analysing the similar elements typical shapes that characterize the design can be found. Proper analysis will then help to find those components which are critical to maintain during the innovation of the product.

Building the shape grammar

Decision which parts will be generated using the shape grammar will be made accordingly to the decomposition method [19]. Relation between functional elements will be set on individual rules for generating concepts; variation through similar components will allow the parameterization of SG.

At the same time, development of simple software tool will be in progress. This software tool should allow generating design using the shape grammar. This tool will be based on platform Grasshopper a plugin in the Rhinoceros software which will be already used for method of exploring similarities. This plugin provides simple and free platform to use generative methods of designing.

Next phase will be verification of the shape grammar. The SG consists of elements derived from past products. Therefore the correct shape grammar should be able to generate products which form the grammar.

Study of transition of the brand identity

Design of the product will be created in the next step. This product should be based on generative method for combining and implementation of rules bearing the brand identity. This design should be based on definition of grammar for area of the designed product (similarly to Agarwal [7]) and definition of grammar for the brand identity. Critical will be finding the conditions, which the rules have to fulfil in order to be combined.

Afterwards some alternative of product design with brand identity elements will be generated.

Scientific question

What is the description of the process of transferring brand identity from past to innovated products?

Products are innovated mainly because of changing trends, actual fashion and consumer requests. As the market evolves, new technologies and materials are introduced. These can be used in manufacturing and designing process. In highly competitive environment it is vital for a product and its brand to be recognized.

Working hypothesis

Every company and every product it creates has its brand identity implemented. This happens even if it is not the strategy of the company. The brand identity is originated automatically with the product, its market release. If the identity is preserved and clearly defined it can bring considerable distinction from competing brands throughout long-term market evolution. The product innovation process is affected mainly by actual social and economic situation.

5 MATERIALS FOR STUDY

5.1 Gathered products

ASV18-2A

This is a cordless drill combined with a screwdriver operating on 18 V batteries. The design is consisting of plastic handle connecting the engine compartment and the battery in the bottom. The handle is covered by large portion of rubber material, which is cut in conic sections. Gearbox, partly in black colour is attached to the engine with 4 screws. It also implements control of the speed of the spindle. Product, which was available, was manufactured in year 2013. This type is first cordless tool designed and manufactured by this brand. For decomposition and colour analysis, this product is considered as a part of the brand identity.



Fig. 5.1 Right view on ASV 18-2A

CZ47037

Brands first model of cordless drill combined with a screwdriver using a 9,6V battery. This model consists of 2 large plastic, blue covers that form the handle and space for the engine. The gearbox with black plastic casing is only attached to the part by clipping, same way as the battery. This product was completely made by a contractor of NAREX, but the NAREX sold it under its brand. Start of this product manufacture was in 2000. The CZ47037 is considered for the decomposition and colour analysis as a part of the brand.

E603II

One speed drill produced between years 1955 and 1966. The NAREX was historically a Siemens factory during the 2nd World War and manufactured drill E 603 with a license. The design created by NAREX did not change nearly at all. The E603 II is completely made of aluminium. This means you could be injured by

electric current when not wearing gloves. It has a gearbox, engine and a handle part. It was replaced by a model EV 004 D which had double isolation. 53 822 pieces were produced in the range of E 603 drill. As this drill is originated in the Siemens, the product is considered as not part of the brand identity during decomposition and colour analysis.

EBU018A

Grinder for roughing work, cutting and splitting material was driven by 1 300 W engine. It was a tool which provided enhanced safety from injury by electric current as the handle was isolated. The design is consisting of large gearbox and engine compartment in grey colour. The black handle is connected to the engine by screws. The connecting part of the handle also provides venting for the engine. The EB 018A was manufactured between years 1967 and 1979. The design and production of this grinder was halted and affected by the political decision. This grinder is considered as not being the part of the brand identity.

EBU12

Introduced in 1996, the EBU 12 was first small angle grinder produced by the company. It was light and is handheld by the engine compartment. It consists of grey painted aluminium gearbox and blue engine compartment extended by another blue part of the case. The grinder is controlled by one large orange sliding button on the side and a brake button on the gearbox. This design is considered as a part of the brand identity during colour and decomposition analysis.

EBU13-14 CE

This is new model of angle grinder is held by engine part of the case. Model available for analysis was produced in year 2012. It consists from grey gearbox and two blue cases similarly to EBU 12. It is however shaped more organically. The slider button has a more complicated shape which offers better position for the finger. This model also has a break button. In difference to EBU 12 the back part has 5 venting holes for the air to go out of the machine. This model is considered as the part of the brand identity.



Fig. 5.2 Right view on EBU 13-14 CE

EBU15F

EBU 15F is a large angle grinder capable of holding large grinding discs of 150mm diameter. It is equipped with a large handle with a simple shield to protect fingers. The grey gearbox is attached to the engine by screws. Similarly the handle is attached to the engine. The handle has 6 venting holes and is black in colour. This grinder may be an iconic product of the brand so for the analysis is considered as a part of the identity.

EBU15-16CA

This model is innovated EBU 15F, but the design is very similar. The engine has been upgraded, but the shape of the casing remained the same. The addition to the design was an orange joining element between gearbox and the engine. The handle has a different shaping as well as the gearbox part. Model available was produced in year 2013. This product is taken as a part of the brand identity.

EC513D

The drill EC 513 was probably the most favourite impact drill in Czechoslovakia in years of its production. This was mainly thanks to small weight and large possibilities of drilling. It was later replaced by the new models of EVP 13 C-2 and EVP 13 C-2H3. The design is really sturdy. Rectangular shaped. It consists of gearbox with two controls of the speed and impact drilling. Then there is an engine compartment that is also a right side of the handle. This product is taken as a part of the brand identity in the further analysis. It was manufactured between years 1978 and 1991.



Fig. 5.3 EC 513D

ES312D

The predecessor of the impact drills is the EŠ 312D screwdriver. It was produced from year 1966 to 1976. It has aluminium gearbox which has a place for a second handle. The engine part is large and orange in colour. It is also a right side of

the handle which is closed and designed in a way that the user has good grip. As this is mainly a different machine it is considered to be not part of the identity in decomposition analysis.

EVP13E-2H3

This is a model which started production in year 1991. It was further equipped with continuous regulation of the speed. The main design still consisted of the grey painted gearbox joined with blue engine and handle part by an orange element. Buttons and controls were also orange.

EVP13H-2C

The EVP 13H-2C is newest model of the Narex impact drill designed by Miloslav Šindler. The gearbox on this product was redesigned to be a two part. The design was also used for the other company's brand PROTOOL. The design featured new screwing of the gearbox. This was also accentuated in the design. The drill also was equipped with rubber on the back part of the handle which helped grip on the handle.



Fig. 5.4 Left view on EVP 13H-2C

EVP13C-2H3

Successor of the famous EC 513D has a lot of common feature in shape. The black joining part between engine and the gearbox has disappeared. The Gearbox has different shaping which also affects that the screws are not placed from the front but through the engine casing. This casing remained nearly untouched. The tip on the bottom of the handle is larger and the ventilating holes are not sharp in corners. The buttons are made in orange colour and not in black as it was at the EC513D. The engine part also forms the right side of the handle.

5.2 Design of concepts through non-generative approach

Industrial products are currently designed in successive steps. The product managers decide to bring new product to the market, which has to be completely designed. In process of designing methods and engineering solutions are used to develop the product. From the perspective of a designer, when the new product is designed, it is by going through these successive steps:

- Problem definition
- Analysis of the problem
- Possibilities of the problem solution – sketching
- Choosing the best solution
- Optimisation for manufacturing
- Final design

For the purpose of this thesis, I have decided to design corded drill and angle grinder, which will be used for comparison with the generated design. Both types of the machines are traditional products of the NAREX company and are the most available. The company itself will probably release a new design of angle grinder which could be compared to generated design.

The problem is defined as creating an innovated design of these machines with accent on enhancing the users comfort. This might be done mainly by reducing the vibrations from the engine. Optimisation of the product for manufacturing is above the scope of needed design level. Optimisation from the aspect of mould creating and likewise will affect the shape minimally. If we would to retain same manufacturability we would necessarily lower the innovation of the whole design

5.2.1 Design of the drill

Analysis

Drill is a tool used to make holes in to different materials. The tool is at most electrically powered. In recent years more and more companies are starting to make drills battery powered. The battery enhances the usefulness of the drill, as the operator doesn't need a capable and can work in places where there is no electric network. The disadvantage is that, the battery will charge out after few hours of work. Secondly the tool can be used as a screwdriver, thanks to changeable bits and parts. Drill consists of three main parts grip, engine and gearbox compartment, tool attachment part and optional battery and grip for second hand.

Technical aspects

Casing of the drill usually consists of parts that are joined together through screws. In cheaper models these are two parts molded from hard plastics. In more sophisticated models there may be aluminum or metal made covers of gearbox and vents.

Engine of the drill is usually universal AC/DC and therefore not dependent on the energy source. This engine generates torque which is transferred and changed through the gearbox in front of the drill to the adapter. Performance characteristics vary accordingly to energy source and intent of the machine. For corded drills the parameters are: Energy input: 700-1 100 W, maximum torque 15- 98 Nm, rotation speeds up to 3 000 per minute. Weight of the corded drills varies from 2 to 4 kg.

For cordless drills the parameters are: Energy source voltage/capacity: 10-18V / 1,5-3 Ah maximum torque 22- 60 Nm, rotation speeds up to 1 600 per minute. Weight of the cordless drills vary from 0,9 to 2,5 kg. [34]

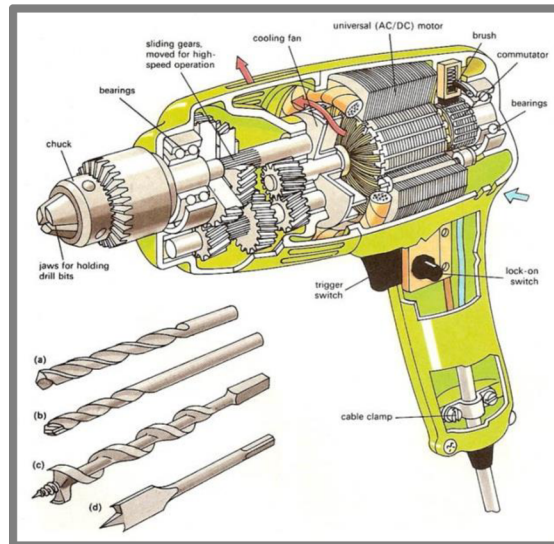

Fig. 5.5 Section through corded drill [37]

Ergonomic aspects

Today's design is concentrated on ergonomics of the tool therefore there are intentions to make the grip of the tool more comfortable. Most battery powered drills are one-hand operated, the corded drills are two-handed but less-powered models can be one-hand operated. In case of two hand operation, second grip must be attached to the drill. Current products integrate mechanisms that dampen the vibrations from the tool.

Other ergonomically important aspects are the controllers. They are usually differentiated by colour and accompanied by symbol explaining their function.



Fig. 5.6 DeWalt drill [34]

Aesthetic aspects

As for the colour of the drills, main plastic cover always bears the company colour. The gearbox compartment is usually in the colour of aluminium, if the gearbox cover is plastic, it is usually silver. Parts that are touched often are usually coloured in black or grey as they easily get dirty. Control elements are often in bright colours so that they are easy to find.

Shape of the drill is dependent on the centre of mass, if we speak about cordless drills. The grip must be positioned in ideal place so the handling of the tool is comfortable- this means between the engine with attached gearbox and the battery. In corded drills the grip is positioned in the back of the tool so the operator pushes the mass into the drilled area.

Logo of the company is placed mainly on the sides of the drill, because there is largest surface area without any hole or crease.

Sketches

In sketches the designer searches for ideas and solution of the defined problem. From the start i have thought about making the grip more comfortable. This is going to be done by reducing of the vibrations from the engine by several possibilities. Another idea was to adapt the shapes of the grip part and gearbox so that they have clear alignment with each other. Last thing was to preserve an iconic attachment of gearbox to engine, which can be seen on many Narex products.

From technical aspects, the design uses only parts that are currently available. No major change of engine and size. The design should also include place for optional vibrastop handle for second hand.

Ergonomically, the main grip is equipped with vibration dampening over, it is a normal rubber, but it is attached on the plastic cover with foam-like material. The main grip includes also safety ledge so that the hand cannot fall of.

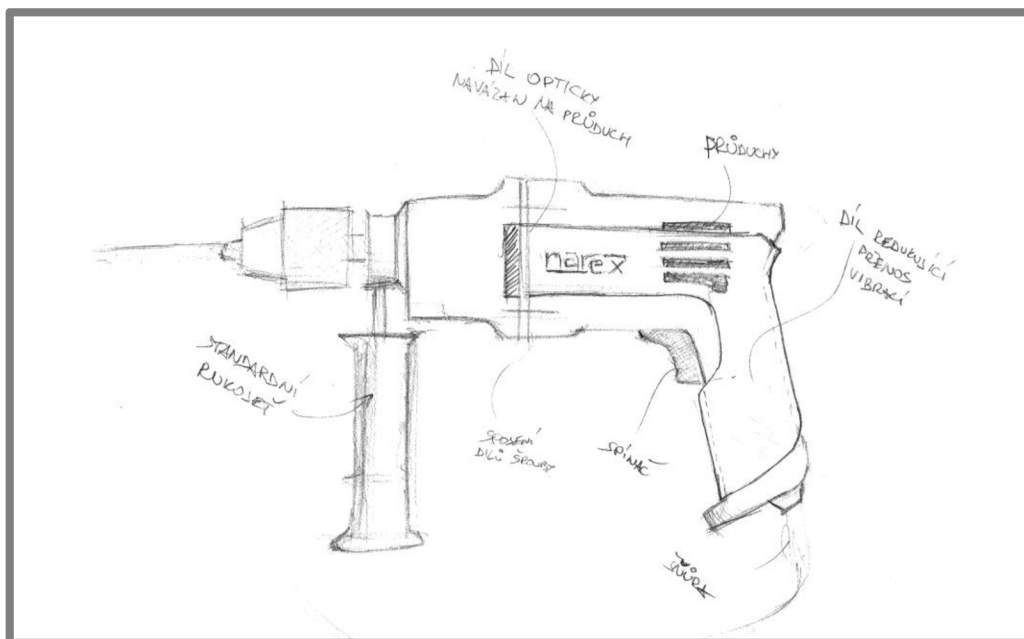

Fig. 5.7 Authors sketch of the drill

Final design

I have designed corded drill with the largest dimensions (length x width x height): 341/72/193 mm. The appearance is based on iconic EC 513D model with engine casing shaped same way in the bottom part. The side part bears a curve that goes in the same angle as the handle. Top part of the engine casing is divided by backing of the vibration dampening material – which flows from the handle to the top of the drill. The gearbox was shaped very organically as normal transition between the shape of the engine and circular shape of the placing for attachment of the vibrastop handle. The gearbox was then adapted to screws and space for tightening them up. Similarly the places for controls of the drill were done. His way the gearbox is shaped as it could be manufactured from two piece mould. Five holes for venting were added to the back part of the drill so the air can flow from the engine.

The main grip of the drill is shaped like a rounded rectangle with dimensions of 45x22 mm. It is also sloped in 7 degrees angle. In the top part the grip has a tip for leaning the wrist. In the bottom it shaped so the hand should not slip off it. However the handle should be tested before manufacturing whether it is really comfortable.

Design utilizes colours of the brand. The engine compartment and large part of the back casing are in blue colour. Control elements and part joining gearbox and engine are in bright orange. The back of the handle is in black – material colour of the vibration dampening rubber. Gearbox is left with grey, glossy paint, whereas the other parts are with matte surface.



Fig. 5.8 Concept of the impact drill

5.2.2 Design of the angle grinder

Analysis

A tool used to cut, grind and polish. It comes in many variants where the power and size are the main differencing factors. It always consists of engine compartment part, control elements, gearbox and cutting disc. It usually has a grip for the second hand which is demountable and can be position either on the left or right side (viewed from the top of disc). The tool is manufactured as corded – mainly and also in cordless variants. Cordless types are quite new, but not as powerful as the corded types.

Technical aspects

The tool's casing is made from different materials, mainly moulded plastics, which are hard and unbendable. Gearbox may have plastic or metal (usually aluminium) casing. Grip for second hand is usually made from softer plastic or rubber. The second grip is often also equipped with some vibration dampening system. Casing is holding together thanks to screws and small latches. All of the angle grinders are electrically powered. The power cord comes to the body of the tool from the side, where it doesn't interfere with hand. In case of battery powered tool, the battery is positioned the same, because of the centre of the mass. [35]

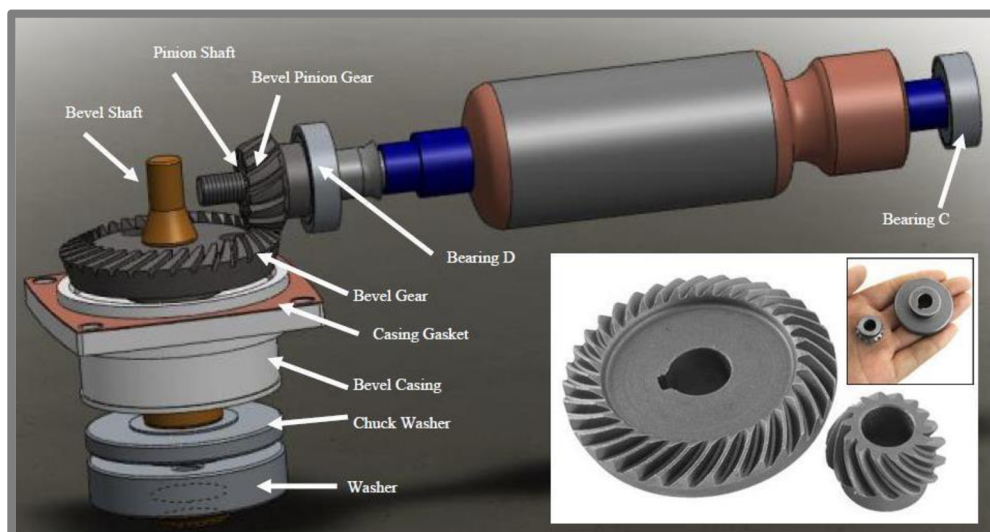

Fig. 5.9 Mechanism of an angle grinder [38]

Ergonomic aspects

The main ergonomic aspects are grip of the hand around the tool, optional grip of the second hand, recognisability of the controls and safety measures so the operator cannot injure himself easily. The corded grinders are nowadays looking the same as cordless but are lacking battery which makes them a bit lighter. Also the disadvantage of the cord is clear – not all places are reachable within the length of the cable.

Accordingly to the power of the grinder, the length of the tool varies. While the larger grinders have handle that is ideal for the hand the smaller ones do not have ideal size for one hand gripping.



Fig. 5.11 Makita angle grinder [35]

Every grinder is equipped with large on/off switch so that it can be turned off in gloves. Safety disc brakes are also positioned on every tool. Most of the tools have safety cover that ensures that no cuttings are thrown on the tool operator.

Aesthetic aspects

Casing is usually shaped in the minimum way, and where the hand touches the tool the casing is as ideal for hand as it can be (dependent on inner equipment). Sometimes manufacturers use rubber or colour to display some difference in those parts. Casing of the gearbox usually copies the shape of the inner equipment as there is need for good manoeuvrability of the tool. The casings also need to have ventilation holes for the air to flow out of the engine. The plastic parts are usually in the colour that is related to the manufacturer brand. The gearbox is in the colour of the material, in case of plastic gearbox casing, it is silver or grey so it looks like metal.

Sketches

In sketches the designer searches for ideas and solution of the defined problem. From the start i have thought about making the grip more comfortable. This is going to be done by reducing of the vibrations from the engine by several possibilities. Another idea is to adapt the shapes of the grip part and the gearbox in a way that they have clear alignment with each other. Last thing was to preserve an iconic attachment of gearbox to engine, which can be seen on many NAREX products.

From technical aspects, the design uses only parts that are currently available. No major change of engine and size. The design should also include place for optional vibrastop handle for second hand.

Ergonomically, the main grip is equipped with vibration dampening over, it is a normal rubber, but it is attached on the plastic cover with foam-like material.

Final design

Appearance of the angle grinder is based on the same curves I have used in drill design. This is mainly done in the engine part, where the side not joined to gearbox is shaped by the same curve from the side – line that goes around the body of the grinder. The gearbox utilizes same element, but it is mirrored by the joining line of the gearbox and engine. Also it is adapted for screws holding the parts together. Near the front circular brake button is the only thing that goes from the top surface of the gearbox. The bottom is just covering the rotational motion of the shaft. From front view we can also see 4 venting holes which suck the air.

Engine part is connected to part which provides space for rest of the technical parts inside the grinder. It is shaped only rotationally. This circular shape starts in the engine part and ends with angled back part. The angle is the same used on the curve of the engine compartment. This part has 5 ventilation holes for the air to go out of the angle grinder. Engine and the back part are visually joined by the grip part from vibration dampening material. The gripping part has a small ledge on the bottom and provides also better grip. The shape of the grinder control button is copying the curve that goes around the engine. The button is thick so that user can wear working gloves.

The angle grinder is in size 304x134x117 mm including the cover for the grinding disc. The design is done in brand colours. Engine and the back part are in blue, gearbox in grey colour and the control buttons are orange. The grip part is the only part which has natural black colour of the rubber.

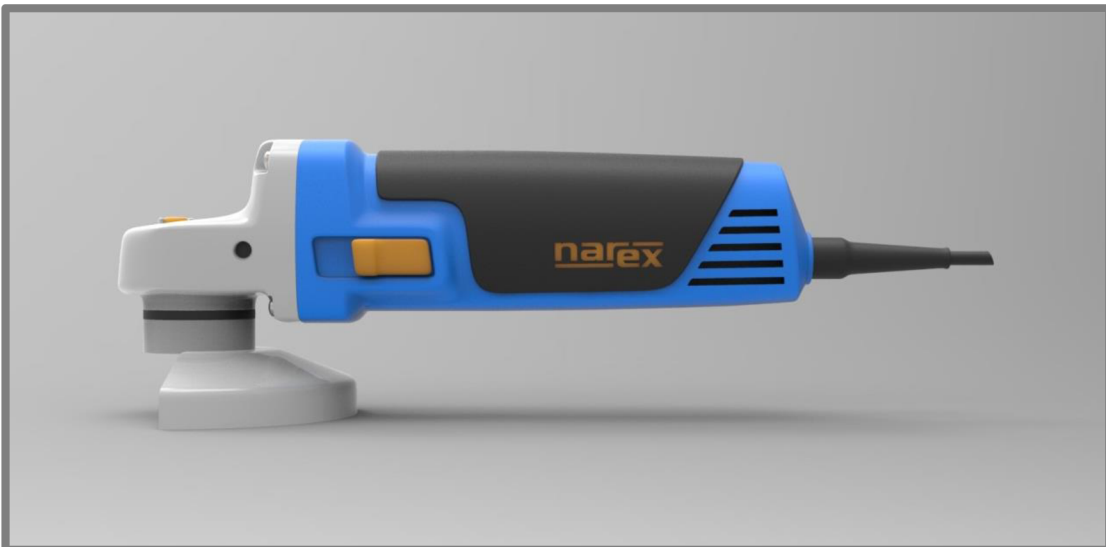

Fig. 5.12 Designed concept of angle grinder

6 BRAND IDENTITY OF COMPANY NAREX - LOGO

Logo, symbol is the main element of each brand, therefore it cannot be excluded from the study of the brand identity. The logo of the NAREX Company is a small letter 'n' clenched in clamps, which are in perspective deformed rounded square. Logotype is formed by the logo and written name 'narex'. Part of the word "nar" is placed higher than the last two letters. The height of the parts is equalled by two lines, the higher one extending the letter "r" and the other line underlining letters 'nar'. Nowadays 'narex' uses mainly only the written part of the logotype for the marketing



Fig. 6.1 Registered symbol of the narex brand [39]

The colours of the logo are also the corporate colours. It is blue in the shade of RAL 5015 and orange shade RAL 2000. Current logo uses blue rectangle as the background for the orange sign. The rectangle has white stroke around with the width of the stroke same as the spacing between letters. Same stroke width is used in the bottom line of the logotype. If we imagine rectangle around the sign 'narex', it is half the height of the blue rectangle. It is not positioned vertically in the centre of the background. The top space is bit larger; the bottom space is same as the spaces on the left and right side. The length of the 'narex' sign is 4 fifths of the background rectangle.



Fig. 6.2 Actually used logo [40]

Logo on products

Every use of corporate logo must abide rules of the aesthetics. The logo must have some gaps between other objects, true colours and cannot be skewed, trimmed or in any matter modified.

Most of the companies producing electric tools use the logo on products on similar places. The most significant is the logo in the side or both sides of the main plastic

casings. These logos are usually just a placed sticker. The second place for usage of the logo is the factory plate, which indicates basic data about the product and manufacturer and must be placed on every product. In NAREX products, the logotype on the large plastic cover is accompanied with information about the model type number. Logotype can be also located on the optional grip for second hand.



Fig. 6.3 Example of using the logotype on the product

Logos of other brands

From the figure 6.4 we can see that other brands on the market are not using only symbols as the logos for their brands. Every brand mentioned in the figure is using logotype and only 3 brands are attaching symbol to the text. Usually the text is written in some special typeface or lines are added to the text. Brand Rockwell is



Fig. 6.4 Examples of other brand logotypes [41] [42] [43]

having the sign written in rectangle with curved long lines. Bosch is a traditional trademark and uses the symbol – the logo everywhere consistently. The Black&Decker company (logotype seen on the top left) was another brand using symbol on their products but in the year 2014 re-brand happened and the new logo is in figure 6.5.



Fig. 6.5 New logo of Black & Decker brand [41]

7 BRAND IDENTITY OF COMPANY NAREX - COLOURS

Colours are integral part of the brand identity. They are used for distinguishing products between others on the market. NAREX company uses mainly colours blue in the shade of RAL 5015 and orange shade RAL 2000. Black RAL 9005 and grey RAL 7035. These colours can be used for designing any part of identity - product, service, website and so on. NAREX should adhere only to these colours when designing new product.

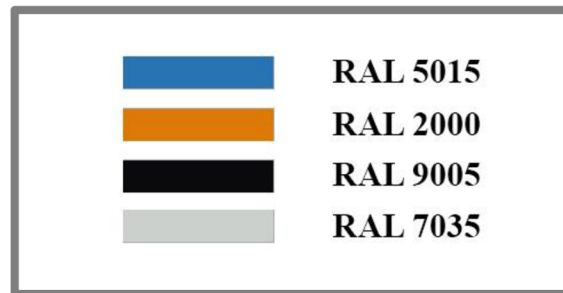

Fig. 7.1 Most probable shades used by the brand [44]

If we look on the market of the hobby tools, manufacturers use mostly hot colours with black colour. The blue of the narex is quite unique in this way so that their products are easily recognized on the shelves of markets or on any advertising. The narex have designed products without any rule or methods how to apply colours and where. They just continue where they started. On more current products they started to use orange on control elements, which is ergonomically better.

Sometimes the company has problem to determine which colour should be on certain parts and they need to decide because of the production. To adjust this, i have devised simple method of determining recommended surface coverage for colours. Based on this information, managers can decide if the part should be what colour.

Method

The method is based on analysis of the past products made by company. If the company did not have recommendations about the colour, they have identity based on the past products. From available past products and their photos we can determine perceptual coverage of the product. The accuracy of this method is firstly tested on 3D models of product designs and their photographs. These photographs are compared to real surface area covered by the colour in tested product designs.

In reality the product is created from parts that bear the colour of the material or are painted in one or more colours. For lowering the expenses on production, usually only one colour appears on part. The parts putted together then form the multi-coloured product. Also some functional parts are better not painted and are left only in raw or surface-treated material as the paint would be soon worn-off. In example cord, electric-powered drill is usually consisting from – drill holder (part in raw material), additional handle mounting, additional handle, gearbox part, clutch part, engine casing (often two plastic cases) and operational buttons and controllers. If these parts would bear only one colour and would have same outside surface area throughout the innovation we would see consistent perceptual amount of colours on the product. The product manager or designer therefore has to decide the colour for

the part. As maintaining the same outside surface area when designing new product may be difficult, we assume that standard deviation to 5 % between real and measured surface area is sufficient for the problem. Also the buyer of the product perceives usually only the outside surfaces of the product, therefore we analyse only these surfaces.

Twenty 3D models of products designed on Department of Industrial design, FME BUT were gathered, represented as following: 4 designs of jigsaw, 5 designs of writing instruments, 3 designs of staplers, 1 hair dryer, 1 dresser, 1 remote control, 2 compressors, 1 measuring device for laser spectroscopy, 1 vacuum treadmill and 1 flow meter. The accuracy of the method on the electric tools will be the main focus of this method, as drills and angle grinders of NAREX will be analysed. Photographs of the models were taken using rendering software with 50mm camera, f-stop 1, from side, front, rear and top views. This makes 5 photos for each product design.

For tracing and measuring the surface data, Rhinoceros 5.0 software was used. Firstly the acquired images from rendering were placed as background into Rhinoceros and areas with same colour were traced in NURBS curves. Afterwards all these areas were measured for surface area, which were gathered. For each photograph we calculated total surface area and percentage covered by single colours.

Method accuracy

In 7 out of 20 models a larger deviation than 3 % is measured. Deviation larger than 5% is occurring in 5 of them. From the 7 models, 2 of them are completely deviated and only one of those is a power tool – electric stapler as seen on Table 7. Many of the models performed very accurately especially when only two colours were displayed on them. The accuracy of the method is largely dependent on the shaping of the surface and of the product itself. For example the largely deviated model no. 6 – Dresser is quite rectangular shaped and should perform accurately when seen from 5 views. The inconsistency is probably made by the handles of its drawers, which has the designer shaped inwardly and part of the surface is hidden from the objective of the camera. This surface or coloured area is also hidden from the eyes of the buying customer when looked from the distance. The method could be used only on visible surfaces. The other shaping which provides inaccuracy is having a hole-like shape for hand in the handle (figure 7.2), where the product is also shaped roundly and from the top view, part of the surface area is hidden.



Fig. 7.2 One of the studied product with problematic part outlined

Table 7.1 Results of the method test on 20 3D models with marked deviations larger than 3%

ID	Design	Item	Colour 1	Colour 2	Colour 3	Colour 4	Colour 5	Colour 6
1	Portable compressor # 1	measured % of area	82,158	1,759	0,322	0,059	15,218	0,485
		real % of area	84,182	4,352	0,83	0,06	10,255	0,321
		deviation	2,024	2,593	0,508	0,001	4,963	0,164
2	Jigsaw # 1	measured % of area	75,707	23,03	1,263	0	0	0
		real % of area	74,049	23,319	2,632	0	0	0
		deviation	1,658	0,289	1,369	0	0	0
3	Vaccum treadmill	measured % of area	5,456	3,98	85,368	5,197	0	0
		real % of area	7,125	4,215	83,975	4,685	0	0
		deviation	1,669	0,235	1,393	0,512	0	0
4	Portable compressor # 2	measured % of area	37,866	58,976	3,158	0	0	0
		real % of area	36,024	59,338	4,638	0	0	0
		deviation	1,842	0,362	1,48	0	0	0
5	Hammer stapler	measured % of area	40,01	17,691	42,298	0	0	0
		real % of area	38,902	18,229	42,868	0	0	0
		deviation	1,108	0,538	0,57	0	0	0
6	Dresser	measured % of area	47,88	33,039	12,373	6,708	0	0
		real % of area	37,315	36,917	15,912	9,856	0	0
		deviation	10,565	3,878	3,539	3,148	0	0
7	Jigsaw # 2	measured % of area	5,167	62,659	32,174	0	0	0
		real % of area	5,07	67,219	27,711	0	0	0
		deviation	0,097	4,56	4,463	0	0	0
8	Hair dryer	measured % of area	69,019	19,024	0,655	11,302	0	0
		real % of area	69,134	20,85	0,889	9,127	0	0
		deviation	0,115	1,826	0,234	2,175	0	0
9	Block stapler	measured % of area	71,245	20,032	4,275	4,448	0	0
		real % of area	70,178	20,126	3,55	6,146	0	0
		deviation	1,067	0,094	0,725	1,698	0	0
10	Jigsaw # 3	measured % of area	61,598	37,45	0	0	0	0
		real % of area	60,879	37,473	0	0	0	0
		deviation	0,719	0,023	0	0	0	0
11	Jigsaw # 4	measured % of area	19,138	0,911	78,828	1,124	0	0
		real % of area	16,875	0,926	80,439	1,759	0	0
		deviation	2,263	0,015	1,611	0,635	0	0
12	Remote control	measured % of area	61,726	33,592	4,682	0	0	0
		real % of area	60,833	31,545	7,621	0	0	0
		deviation	0,893	2,047	2,939	0	0	0
13	Electric stapler	measured % of area	23,941	37,894	37,583	0,582	0	0
		real % of area	12,694	58,177	22,923	6,205	0	0
		deviation	11,247	20,283	14,66	5,623	0	0
14	Pencil tool	measured % of area	63,891	36,109	0	0	0	0
		real % of area	63,953	36,047	0	0	0	0
		deviation	0,062	0,062	0	0	0	0
15	Ballpoint pen # 1	measured % of area	64,149	35,851	0	0	0	0
		real % of area	64,794	35,206	0	0	0	0
		deviation	0,645	0,645	0	0	0	0
16	Highlighter # 1	measured % of area	64,934	35,066	0	0	0	0
		real % of area	65,775	34,225	0	0	0	0
		deviation	0,841	0,841	0	0	0	0
17	Flow meter	measured % of area	3,375	24,887	50,169	21,568	0	0
		real % of area	3,077	23,727	50,442	22,754	0	0
		deviation	0,298	1,16	0,273	1,186	0	0
18	Ballpoint pen # 2	measured % of area	23,09	50,301	26,609	0	0	0
		real % of area	32,844	44,449	22,707	0	0	0
		deviation	9,754	5,852	3,902	0	0	0
19	Highlighter # 2	measured % of area	20,979	163953	41,398	20,67	0	0
		real % of area	29,646	4,1	48,423	17,831	0	0
		deviation	8,667	163948,9	7,025	2,839	0	0
20	LIBS	measured % of area	40,245	48,17	7,336	4,249	0	0
		real % of area	41,196	53,554	2,67	2,581	0	0
		deviation	0,951	5,384	4,666	1,668	0	0

In the final the method is best used for purely rotational objects with preferably two colours. When the product is having only one colour the method shows only 100% so there is no need to use it. Also small amounts of colours on details compared to large areas of dominant colour are deviating largely in the context of their own area. These small areas may even double themselves and still wouldn't have the 5% deviation.

In the study of the NAREX products we are using the method for searching whether there are existing colour norms for the product design. So even if the method may be inaccurate it is used for comparing the products. The real percentage of colour coverage may be better studied and applied through CAD data when designing the product.

Results of the narex study

In studied tools, the most represented colour is blue by 38%, the second following colour is grey with 36%. The overall presence of the colours on the products is seen in the table 7.2. However these results are affected by several conditions. There are certain unique appearances in colour of the products. In the early phase of the company, they were producing products under license, so that they were not designed by narex. This is the case of E 603 II drill and EBU 018 angle grinder. These tools do not have blue or orange colour on their casing. The EŠ 312 D is a similar case, as there is more orange colour and no blue. Also the ASV 18-2A has uniquely large percentage of black colour due to the grip designed on the casing.

Table 7.2 Colour percentage retrieved on the basis of five views

Product	% of colour #1	% of colour #2	% of colour #3	% of colour #4
ASV18-2A	30,648	2,004	4,064	63,283
CZ47037	61,296	1,954	0,000	36,750
E603II	0,000	0,000	98,013	1,987
EBU018A	0,000	0,000	70,991	29,009
EBU12	59,055	1,875	25,440	6,199
EBU13-14E	57,378	2,579	37,168	2,875
EBU15F	31,949	0,724	36,649	30,679
EBU15-16CA	27,672	4,866	35,793	31,668
EC513D	61,033	0,000	36,170	2,797
ES312D	0,000	63,812	30,135	6,053
EVP13E-2H3	59,693	8,375	31,626	0,306
EVP13H-2C	45,448	6,300	28,850	19,402
EVP13C-2H3	60,815	4,218	34,968	0,000
Average	38,076	7,439	36,143	17,770
Average drill	56,747	4,723	32,903	5,626
New drill concept	44,855	6,630	24,639	23,876
Average grinder	35,211	2,009	41,208	20,086
New grinder concept	41,523	1,533	25,995	30,949

The average NAREX drill is painted on approximately 56.7 % of the surface area. The gearbox in grey colour covers about 32.9 %, black parts 5.6 % and orange details are present on 4.8 % of the surface. Newly designed concepts are showing the greater amount of black colour. This is formed by the handles in natural black of the rubber. The results in the drill design also shows that the gearbox part may be smaller in surface area than the current designs as it covers nearly 25% and that is about 11% less than previous models. This may show an ill designed gearbox shape or volume.

Consistency in the view on the product from the right side is probably critical. Most of the hobby markets present the tools on the shelves and only one side is visible. When the population is mostly right handed, thus the buttons are mostly present on the right side of the tool. This means that the products are arranged with the side with the controls to the customer.

The NAREX tools have quite unique combination of colours when viewed from the side. The average NAREX tool is covered with 45,9 % blue, 9,4 % orange 25,7 grey and 19% black. The new drill concept is following this trend with deviation about 3 % but is not consistent with the drill portfolio of narex. The new grinder has lower portions of orange and blue which goes to the large black part of the grip of the tool. Detailed amounts of percentage can be seen in the table 7.3.

Table 7.3 Colour percentage retrieved on the basis of right view

Product	% of colour #1	% of colour #2 %	% of colour #3 %	% of colour #4 %
ASV18-2A	32,062	3,376	6,143	58,419
CZ47037	65,371	1,779	0,000	32,850
E603II	0,000	0,000	98,973	1,027
EBU018A	0,000	0,000	61,001	38,999
EBU12	89,034	6,352	2,162	2,452
EBU13-14E	70,958	4,518	20,964	3,560
EBU15F	46,334	1,130	5,663	46,874
EBU15-16CA	37,083	6,540	15,600	40,777
EC513D	71,183	0,000	24,682	4,135
ES312D	0,000	70,726	22,882	6,391
EVP13E-2H3	66,115	8,895	24,245	0,746
EVP13H-2C	52,509	8,606	28,328	10,558
EVP13C-2H3	65,626	10,601	23,773	0,000
Average	45,867	9,425	25,724	18,984
Average drill	63,858	7,025	25,257	3,860
New drill concept	48,465	6,949	23,040	21,546
Average grinder	48,682	3,708	21,078	26,532
New grinder concept	37,534	2,761	21,238	38,466

8 DECOMPOSITION AND SIMILARITY ANALYSIS

In this part, silhouettes and parts of the products are going to be analysed in terms of shape features. I am looking to find similar features or areas that are common for the electric power tools of the NAREX brand identity. Firstly the products were traced using Rhinoceros 5.0 software. Then the curves which resulted from the tracing were analysed in the grasshopper plugin in search for similarities.

8.1 Decomposition

Every of the 13 products and 2 concepts I have for analysis is consisting of parts. Therefore the photographs of the tools were traced in a way that the parts could be analysed separately. By the same procedure the representation of features of the products were created. The photograph then is represented by 2D curves.

First level of representation is the silhouette of the product. Then the outlines of parts from which the product is made – gearbox, engine, handle, joining element etc. Next level of representations is characteristic curves, the so called muscles. These are formed by lines that are made by shaping of the parts not outlines or joining. These lines usually are not stopped by the end of the part but are flowing across the product. On the electric tools, the muscles are formed by rounded edges of the engine and gearbox compartments. The last levels are the graphic details which are made of controls, ventilation holes and other buttons. Also the place for a logo sticker is according to this level. In the top view, these levels are similar, although there are not as many details and graphic as in the side view.

The spindle holder and the cover of the angle grinder's disc were not decomposed and neither will be analysed. These parts are purely functional and therefore the brand identity cannot work with them much in terms of shaping.

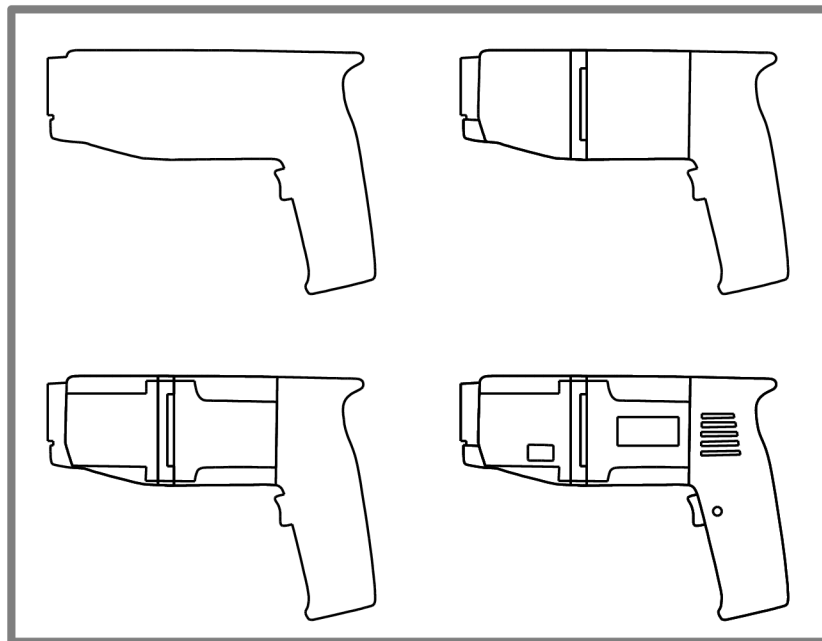

Fig. 8.1 Decomposing the EC 513D: top left – outline, top right - part features, bottom left – added muscle curves, bottom right - graphic

The products were decomposed for analysis in three views - two side views and a top view. Proportion, orientation and shape analysis were done in search for similarities in the designs.

8.2 Proportion

8.2

The proportion analysis is considering the area of the closed outline of a certain feature. From gained data average area and standard deviation are calculated as if this would be normal distribution of data. The new design concepts of drill and grinder are not in these data from which we are calculating to see whether they fall in or out of the set. Sample population will be however always small even if we doubled the amount of products analysed. Also the curves were gained by tracing photographs and therefore an error may occur. In this case the proportion analysis serves only as guidance to next levels of analysis.

8.2.1 Side views

8.2.1

An average silhouette are from the side is 24 191,706 square millimetres from the right view and 24 327,722 square millimetres for the left side. In this case we can see the error that occurred in tracing of the photos, because the two views should have the same area. However the error is less than 150 mm² which is less than 1%. The deviation is large though – 7 336,325 mm². The data for views from the side are in tables 8.1 and 8.2

Table 8.1 Right view – proportions in mm²

	Silhouette	Gearbox	Engine	Handle	Muscle	Button	Logo	Vents
ASV 18 - 2A	28726,725	3790,752	7271,030	17307,976	14142,558	356,967	886,847	160,763
CZ 47037	21657,743	3397,170	3718,337	14139,487	12892,436	270,951	1065,033	0,000
E 603 II	12973,262	2644,409	6904,734	3291,834	2924,171	82,974	0,000	0,000
EB 018 A	40195,375	10979,942	13539,560	15479,912	1521,863	195,961	0,000	0,000
EBU 12	14840,492	2886,141	4876,559	6911,042	5897,988	743,721	959,392	0,000
EBU 13-14 E	16401,526	3415,868	6039,736	6875,952	3362,516	654,261	1385,672	672,252
EBU 15 F	25512,249	3691,293	8834,756	12573,265	8280,356	169,758	2688,585	739,839
EBU 15-16 CA	28158,770	3964,875	8681,369	14295,947	8872,573	642,224	2643,987	1102,883
EC 513 D	23310,190	5173,343	6316,234	9819,195	9137,993	169,510	993,832	839,493
EŠ 312D	34387,392	7229,994	9234,076	16321,390	7979,333	395,854	0,000	0,000
EVP 13 E-2H3	21420,571	5310,609	4645,190	9729,971	5245,073	534,562	1280,169	670,051
EVP 13 H-2C	25863,613	7908,449	10887,516	5511,046	3398,874	490,819	1532,288	404,686
EVP 13C-2H3	21044,269	5047,933	5586,582	10065,237	5389,370	132,461	1442,831	906,307
Average	24191,706	5033,906	7425,821	10947,866	6849,623	372,309	1487,863	687,034
standard deviation	7336,325	2297,955	2645,740	4283,149	3677,677	214,158	N/A	N/A

From figure 8.2 we can see that mostly the products not considered as part of the brand identity are largely deviating from the average value, even when taken as a part of the drill or grinder category. The EB 018 A was of course the largest analysed product. The EŠ 312 D was the second, whereas the E 603 II is the smallest.

Table 8.2 Left view – proportions in mm²

	Silhouette	Gearbox	Engine	Handle	Muscle	Button	Joint	Vents
ASV 18 - 2A	28726,725	3790,752	7271,030	17307,976	4837,762	356,967	0,000	0,000
CZ 47037	21658,489	3401,718	3717,563	14136,543	12889,752	270,895	0,000	0,000
E 603 II	12987,179	2644,455	6904,854	3291,891	2924,222	82,899	0,000	0,000
EB 018 A	41885,797	11441,705	14108,968	16130,922	1585,865	204,202	0,000	0,000
EBU 12	14744,876	2621,350	4684,928	6538,624	5255,930	0,000	0,000	0,000
EBU 13-14 E	16442,427	3922,898	5935,042	6584,488	1914,891	0,000	0,000	650,108
EBU 15 F	25204,021	3449,907	8813,709	12543,311	8198,921	169,354	0,000	737,666
EBU 15-16 CA	27844,610	4000,847	8680,221	14294,056	8992,121	642,139	856,526	1100,012
EC 513 D	23064,710	5653,680	16072,730	16072,730	9241,925	183,523	729,102	764,933
EŠ 312D	34727,122	7229,261	9233,140	16662,952	8202,687	395,814	1601,768	0,000
EVP 13 E-2H3	21633,095	5353,141	4645,809	9731,267	5469,165	534,633	967,587	668,994
EVP 13 H-2C	25933,140	7587,576	13828,246	5209,356	3322,902	490,810	958,314	407,822
EVP 13C-2H3	21408,189	5048,198	15193,307	15193,307	5899,434	134,237	0,000	846,804
Average	24327,722	5088,114	9160,734	11822,879	6056,583	315,043	1022,659	739,477
standard deviation	7639,069	2376,143	4112,883	4720,878	3181,356	N/A	N/A	N/A

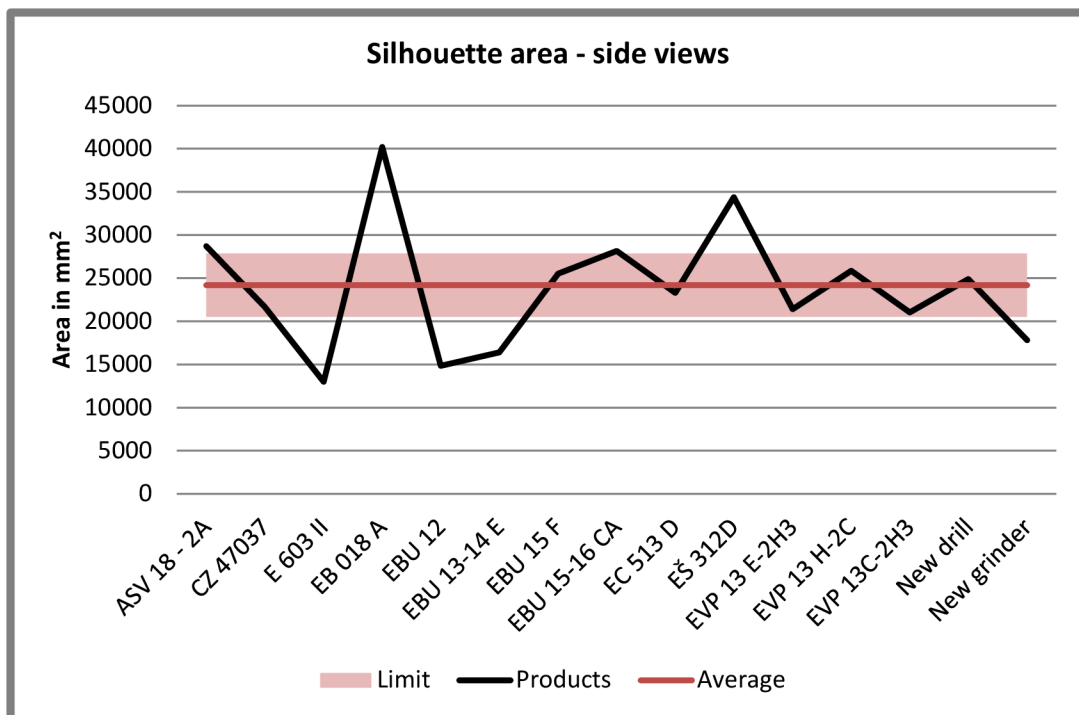

Fig. 8.2 Graph of silhouette areas

The new drill and grinder concepts are performing quite well. The drill is nearly above the average with area 24 878,451 mm². Grinder is falling out of the deviation limit and is closing on values of other small angle grinders EBU 12 and EBU 13-14. This seems right as the outline proportions should be similar.

When considering the areas of gearbox parts. The EB 018 A is again the biggest. The EVP 13 H-2C and EŠ 312 D are 2nd and 3rd respectively. Smallest

gearboxes are at product E 603 II and EBU 12. The new grinder concept has also smaller gearbox. The size of this part on the new drill concept is above average but in the deviation limit.

In the engine section batteries at cordless drills are compared to engine counterparts, therefore the deviation at CZ 47037. The EB 018A has again the largest engine part area. The EVP 13 H-2C is the second. Other values are not deviating as much from the average value.

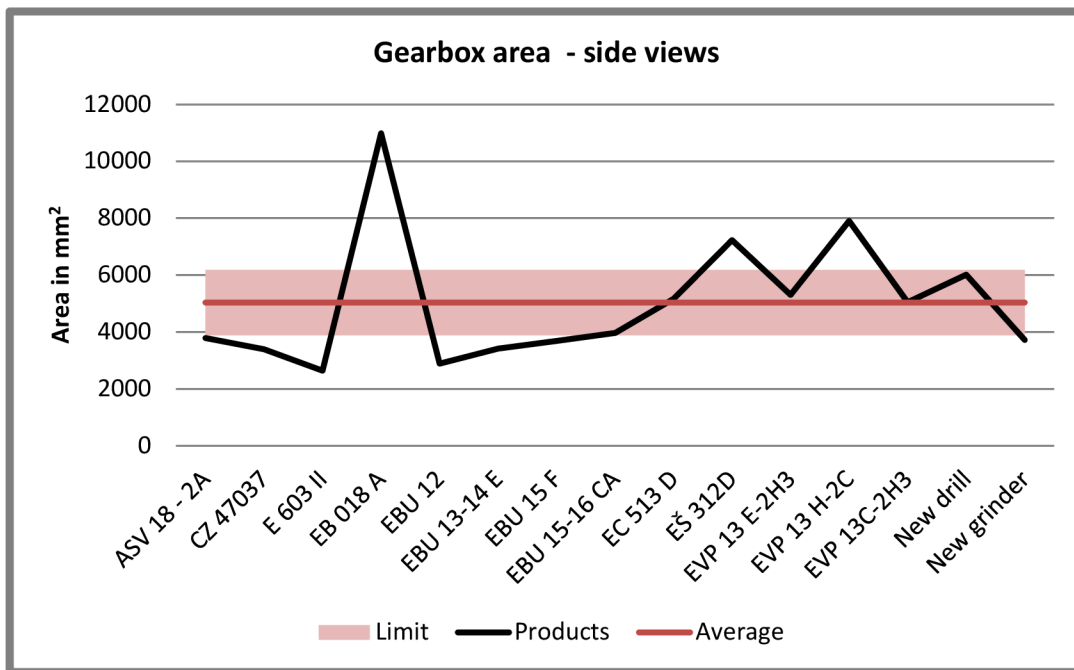

Fig.8.3 Graph of feature gearbox areas

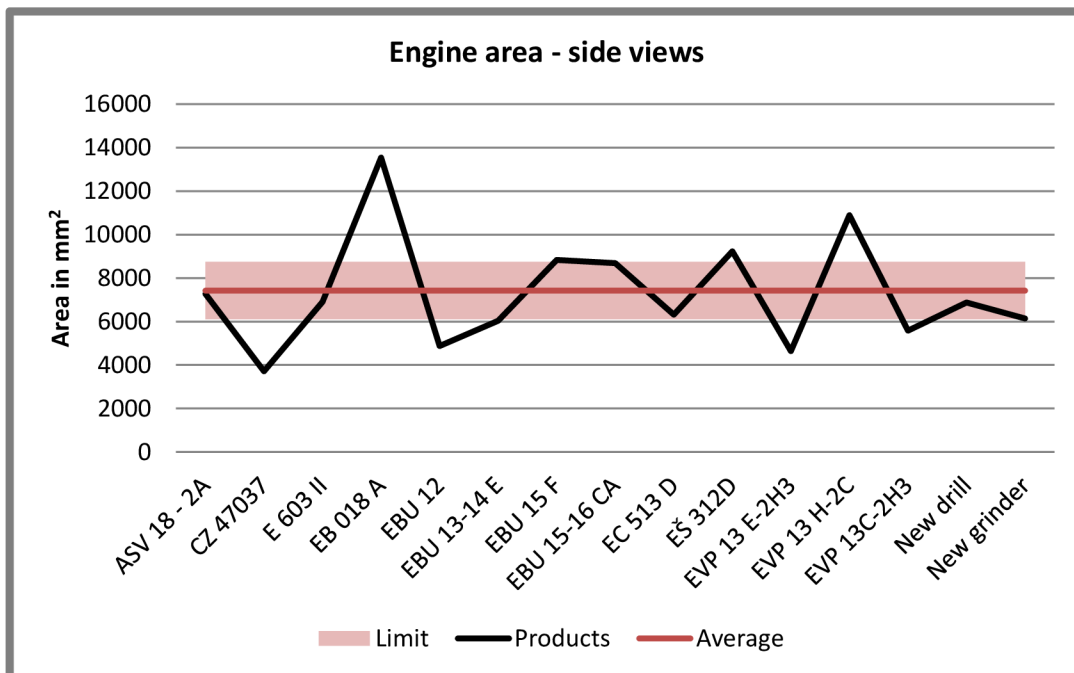

Fig. 8.4 Graph of feature engine areas

The areas of other features vary largely among the products. This buttons for example are very large on the angle grinders, because of the need to slide it with gloves, whereas the drills are using smaller buttons, because they are only pushed to the handle. The ventilating area is fairly consistent among the view. The only two deviations are caused by different shaping of handle at EBU 15-16 CA and small side venting at EVP 13 H-2C which is accompanied by ventilation on the top side of the tool – which is not seen from the side.

When taking only drills for the statistic the EC 513D, EVP 13E-2H3 and EVP 13C-2H3 are showing that they are historically joined as one was the innovation of another. This is seen also in gearbox and engine areas. However the side muscle is varying largely in area which is showing inconsistency at this feature. The new drill concept has large muscle feature as well as the EC 513D does. The concept was inspired by this drill; therefore this might point out the similarity.

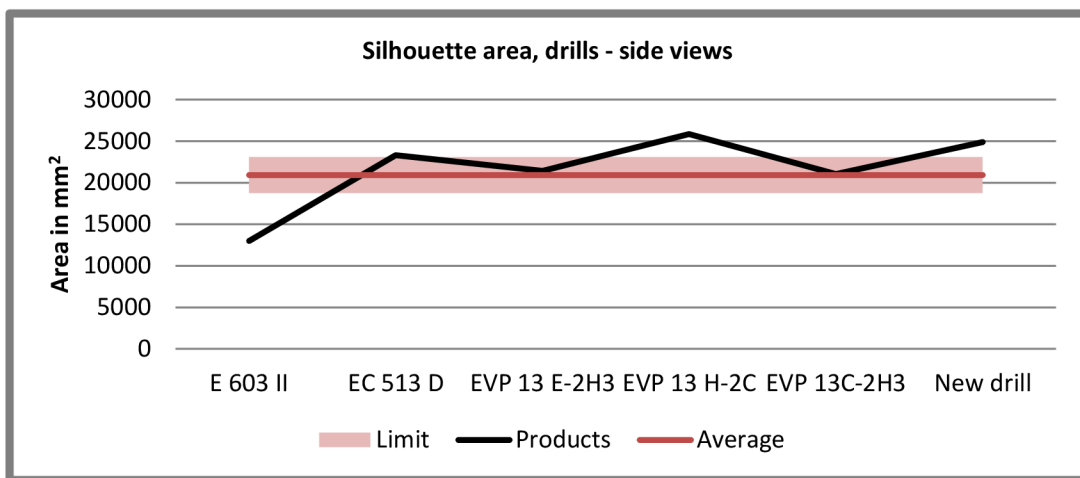

Fig. 8.5 Graph of drill silhouette areas

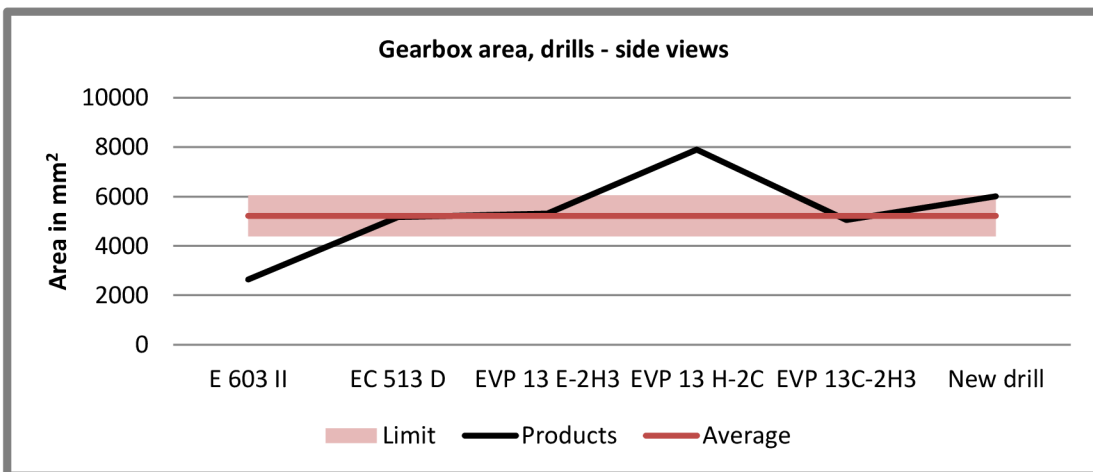

Fig. 8.6 Graph of drill gearbox areas

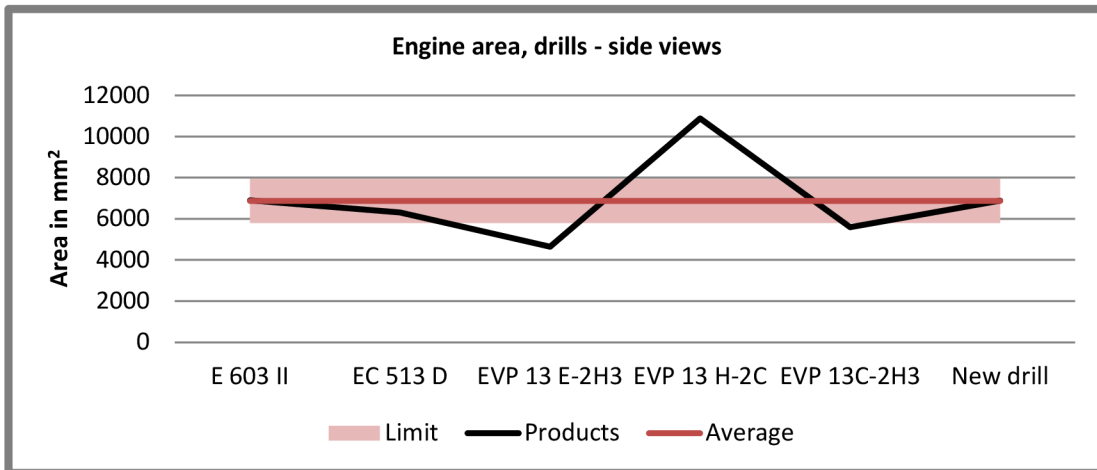

Fig. 8.7 Graph of drill engine areas

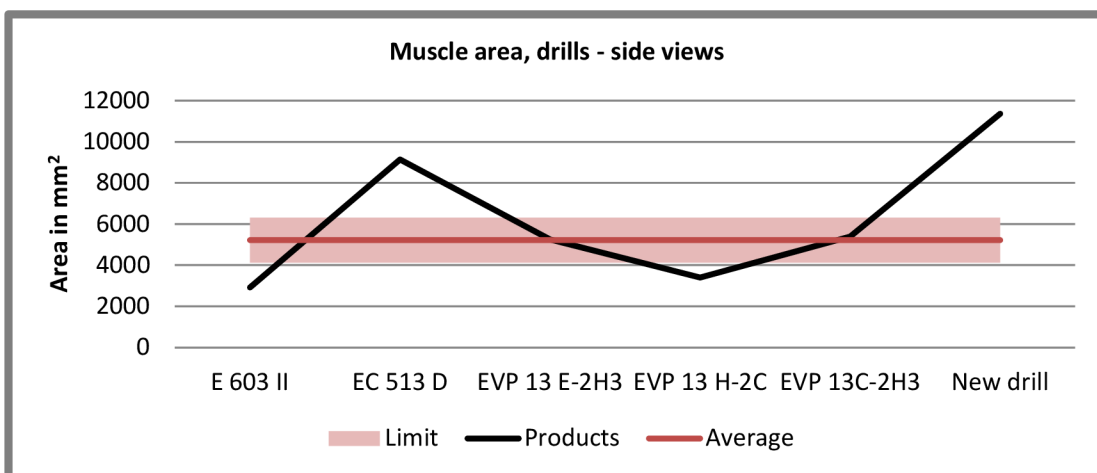

Fig. 8.8 Graph of areas made by drill muscles

8.2.2 Top view

8.2.2

The view from the top side revealed another muscle part to be analysed. This feature was located on the gearbox part and is a result of placing a button in case of the drills and in case of the grinders a result of the gearbox shaping. The average feature outline area for the top view is 19 399,562 mm². The largest product is still the EB 018 A. Photos of the cordless drills were not taken and analysed as this was problematic during the gathering of the data. Numbers about average areas for every feature analysed and deviations can be found in the table 8.3.

Outline feature graph (fig. 8.9) shows that the outline of the EB 018A is the largest and far from average value. The lowest is the E 603 II which also out of the scope. The other outlines are fairly similar in size with 5 products just out of the deviation limit. The concept of the new grinder is very close to the average feature outline area.

Table 8.3 Feature areas from top view in mm²

Top view areas	Silhouette	Gearbox	Engine	Handle	Muscle	Button	Joint	Gearbox muscle
E 603 II	7912,688	2437,239	4878,518	596,930	1066,973	295,728	0,000	0,000
EB 018 A	42591,535	12206,561	14498,873	15886,101	10754,411	0,000	0,000	10754,411
EBU 12	15795,368	4607,698	4617,716	6459,494	3234,594	78,347	0,000	2096,356
EBU 13-14 E	16209,412	5237,967	5496,634	5397,380	9626,296	206,247	0,000	2181,769
EBU 15 F	19412,396	4890,569	7495,678	6074,400	6785,233	84,481	0,000	1133,379
EBU 15-16 CA	21942,750	4935,076	7253,119	8016,978	8298,264	82,605	825,542	966,923
EC 513 D	14954,511	4381,787	7866,931	1150,881	9884,336	0,000	836,123	0,000
EŠ 312D	24953,727	6149,240	12280,471	4903,703	16242,868	0,000	1620,313	0,000
EVP 13 E-2H3	12254,480	4607,097	3766,322	3060,271	6829,568	211,831	754,708	993,252
EVP 13 H-2C	25168,340	10673,323	8610,477	4711,526	20661,708	605,951	1173,015	3000,620
EVP 13C-2H3	12199,970	4345,641	6218,813	1562,119	7989,357	0,000	0,000	0,000
Average	19399,562	5861,109	7543,959	5256,344	9215,783	223,598	1041,940	3018,101
standard deviation	8975,844	2780,524	3133,682	4047,510	5217,952	N/A	N/A	N/A

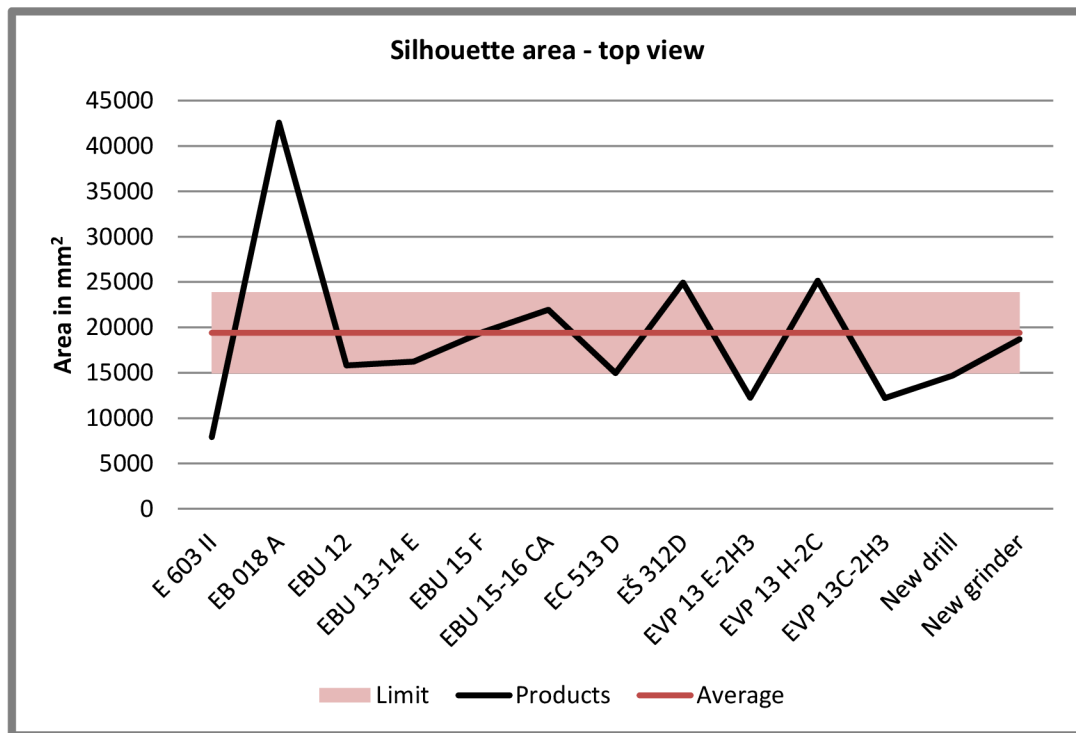

Fig. 8.9 Graph of silhouette areas from a top view

Gearbox feature has two peaks above the average – one at the largest EB 018A and second at impact drill EVP 13 H-2C. Both new concepts are within the deviation limits for the feature. Again the lowest value is at the E603II.

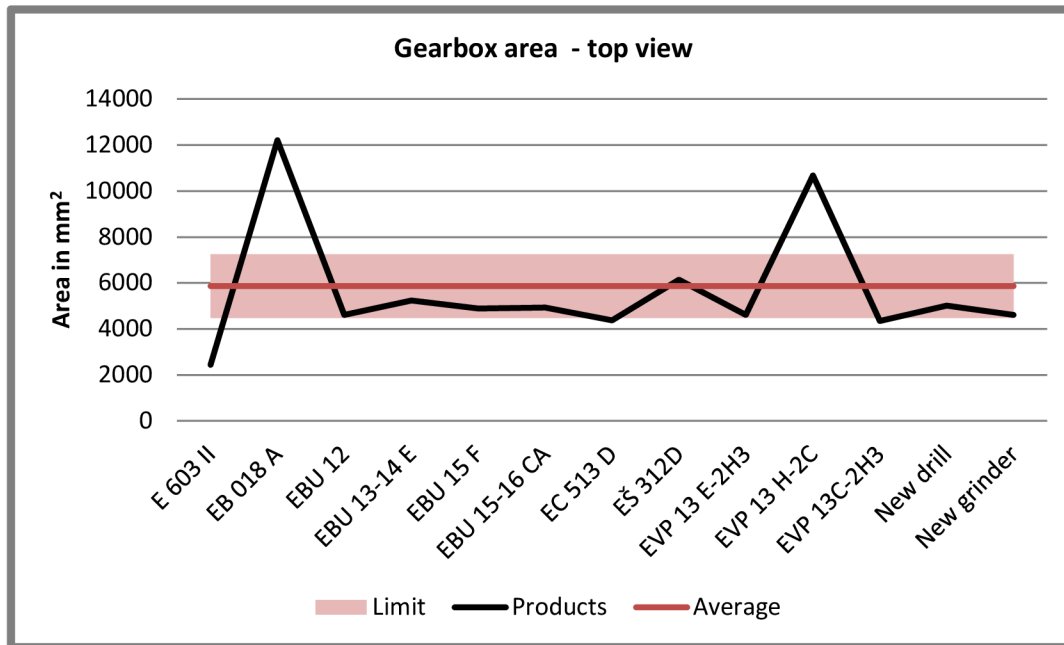

Fig. 8.10 Graph of gearbox feature areas from a top view

At the feature engine and handle the highest value is at EB 018A grinder. These features are both varied among the drills because of the construction where the casing of the engine is forming a side of the handle. This is at the products EC 513D, EŠ 312D and EVP 13C-2H3

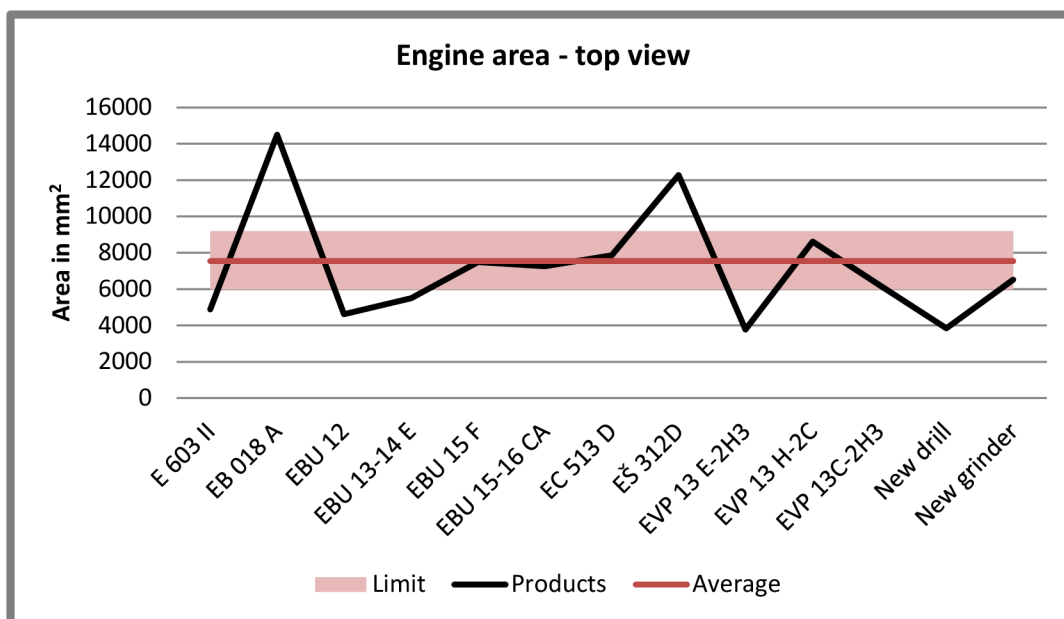

Fig. 8.10 Graph of engine feature areas from a top view

Specific part of the top view is a feature gearbox muscle. When decomposing the products similar feature was found on 7 products and the two new concepts are including it also. The muscle is located on the gearbox and is a result mainly of its shaping. The largest feature area is at EB 018A. The area is large because the muscle is defined as a curve that goes around nearly a bottom of the gearbox whereas on the other products it is located much higher on smaller places. When taken out, The EVP 13 H-2C has the largest muscle although an average in size, in this manner. Figure 8.11 is showing the distribution of the feature area.

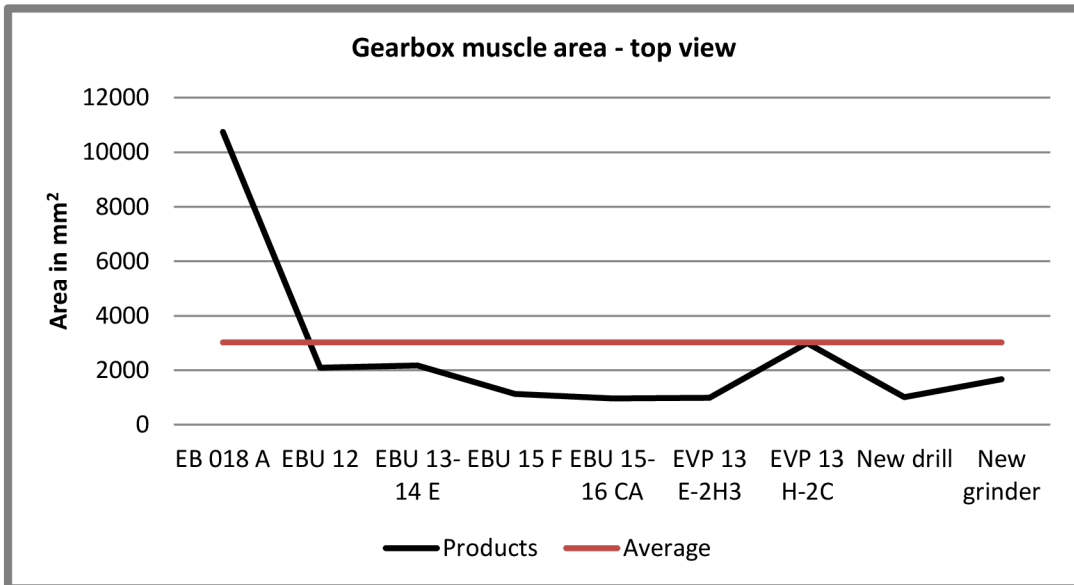

Fig. 8.11 Graph of feature muscle area from a top view

If we focus on the proportion of grinders from top view we can see that if it were without the EB 018A, the grinders would be more consistent in gearbox and engine areas. The outline is affected by different handle in products EBU 15F and EBU 15-16CA and the same happens in the handle area.

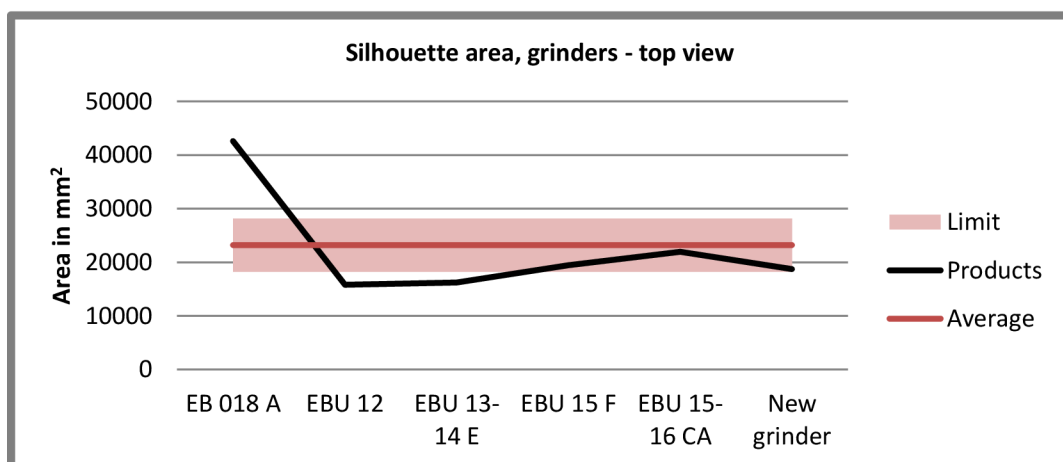

Fig. 8.12 Graph of silhouette areas of grinder from the top view

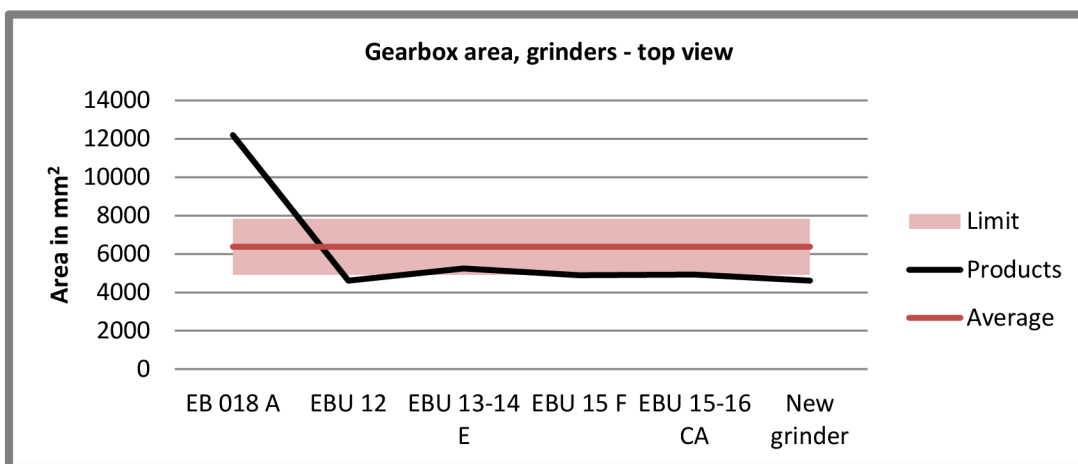

Fig. 8.13 Graph of angle grinder gearbox areas from a top view

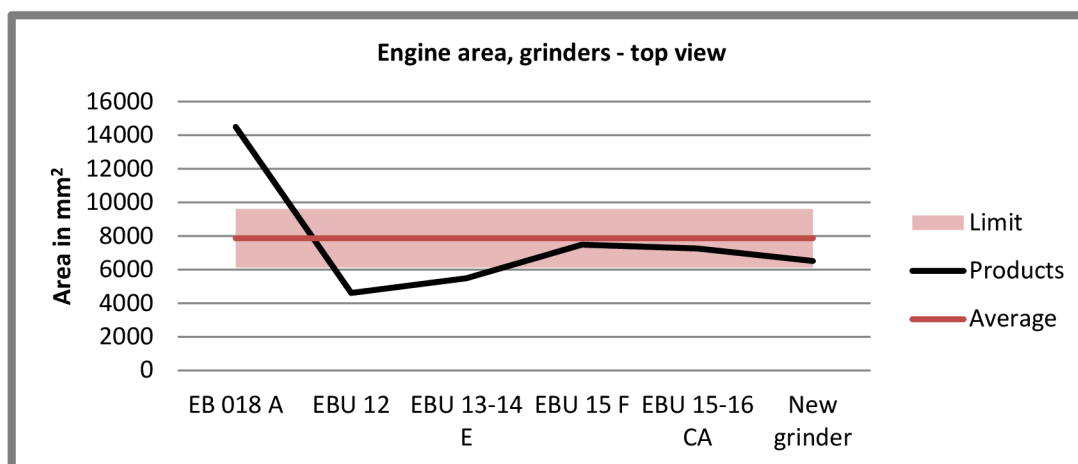

Fig. 8.14 Graph of angle grinder engine areas from a top view

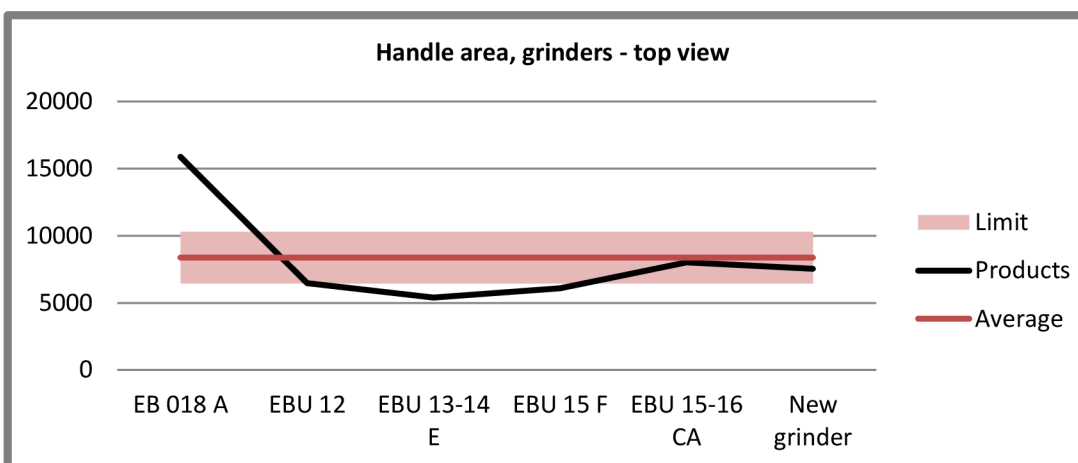

Fig. 8.15 Graph of angle grinder handle areas from a top view

8.2.3 Conclusion

The proportion analysis showed basic relations among studied designs in terms of proportions of their features. It seems that the EB 018 A is out of the range of the average area in most of the features. That means it is sized largely than the other products, whereas the E 603 II is being smaller. The guidance to next level is looking for similarities in the shapes which have mostly close proportions. However the similarities can be found even in the certain part of the shape not affected by the proportions. The different proportion of products is showing that they should not be included in the set for the brand identity.

8.3 Orientation

This analysis is reflecting the location and minimum and maximum sizes in relation to the outline feature centroid. This allows comparison of features position and size. If the features are displayed in a same place and size then they are identical. Different locations and size are pointing out inconsistency.

The feature orientation analysis is done for same views and features as the proportion analysis. New concepts of drill and grinder were also included so that their relation to current designs can be evaluated. The graphs are made in grasshopper plugin, where the minimum and maximum X and Y coordinates are calculated as the difference between the lowest or highest x and y values of the feature and coordinates of centroid of the outline feature.

In the following figures the axes are representing x and y distance from the centroid of the silhouette feature shape. This centroid is where both x and y axes have value 0 – the intersection.

8.3.1 Side views

The analysis shows that the feature gearbox part is positioned similarly in every product but the cordless tools. In the case of angle grinders the centroid of the features is approximately on the same y axis position as the centroid of the outline. This is not the case of drills where the centroid is slightly above the y level of the outline centroid. When comparing the x size, the drills have similar maximum and minimum distance from the outline centroid.

The engine part itself is the closest feature to the outline centroid. Therefore the figure 8.17 reflects this. Again there are few exceptions. The ASV 18V-2A and the CZ 47037 are showing the location of their batteries which is lower than the outline centroid. The engine part of the EVP 13 H-2C has the largest rectangle because the minimal point is very low and on the side and maximal point in approximately the same height as on other drills. This is due to the construction of the engine part where it forms a half of the handle.

New concept of drill and the grinder is following the same trend as are the other products, so they have engine and gearbox oriented similarly.

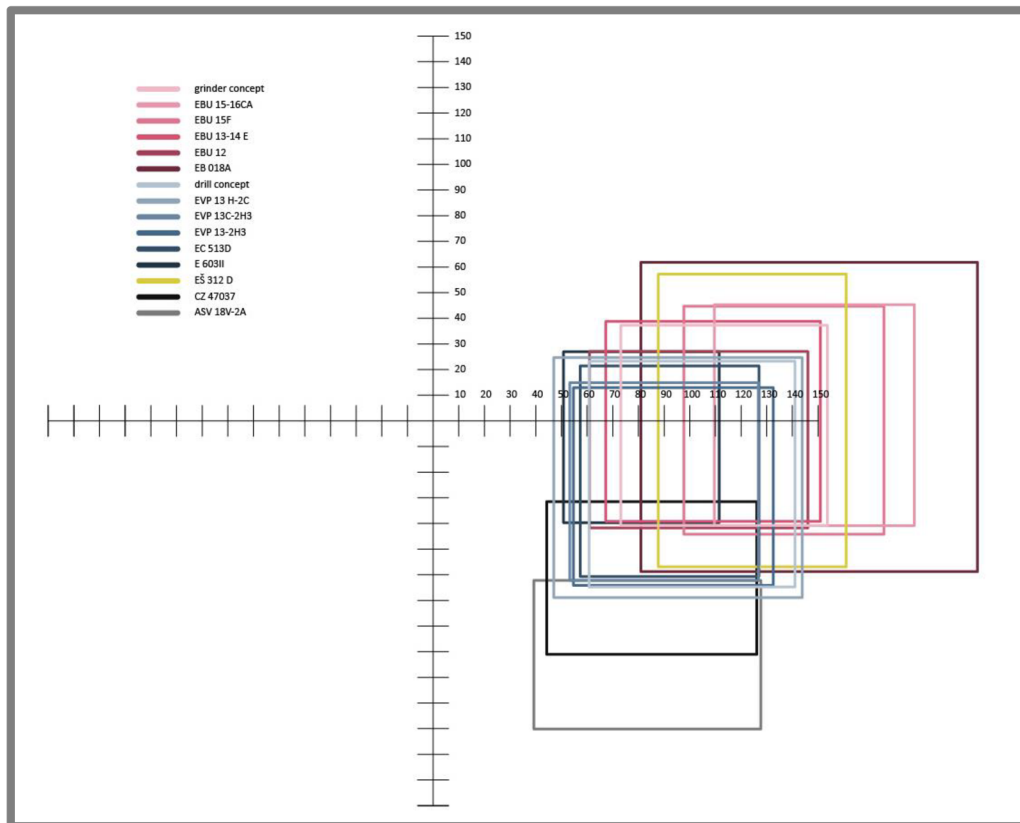

Fig. 8.16 Orientation graph, gearbox, side views

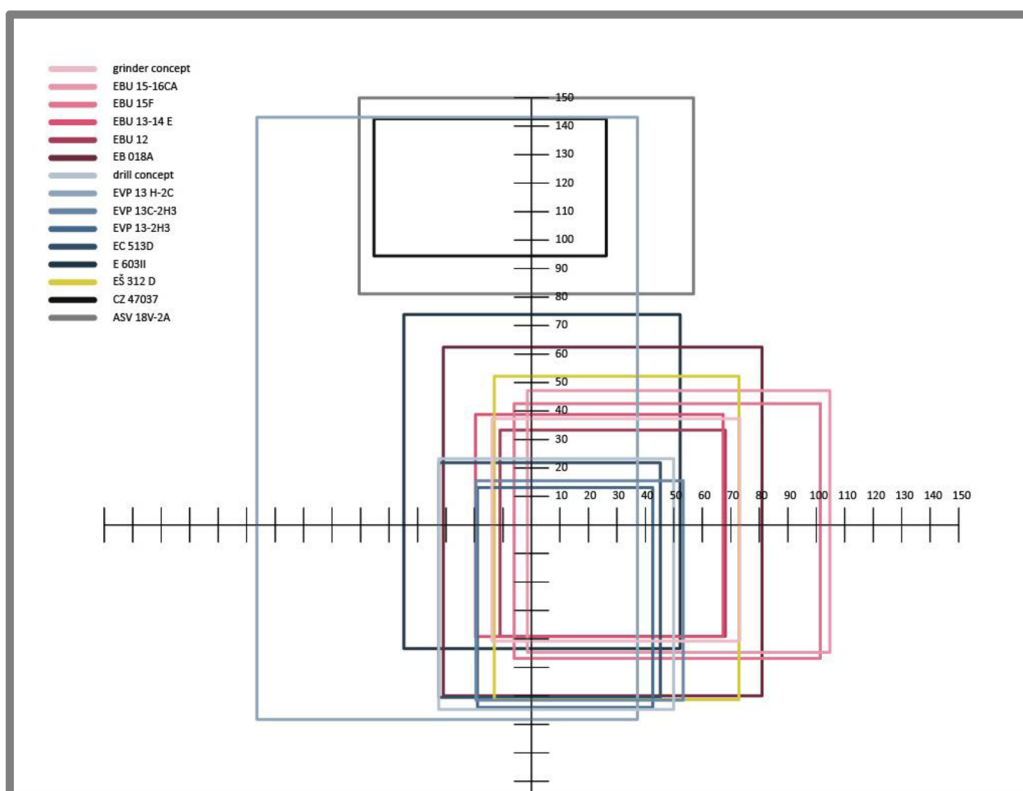

Fig. 8.17 Orientation graph, engine, side views

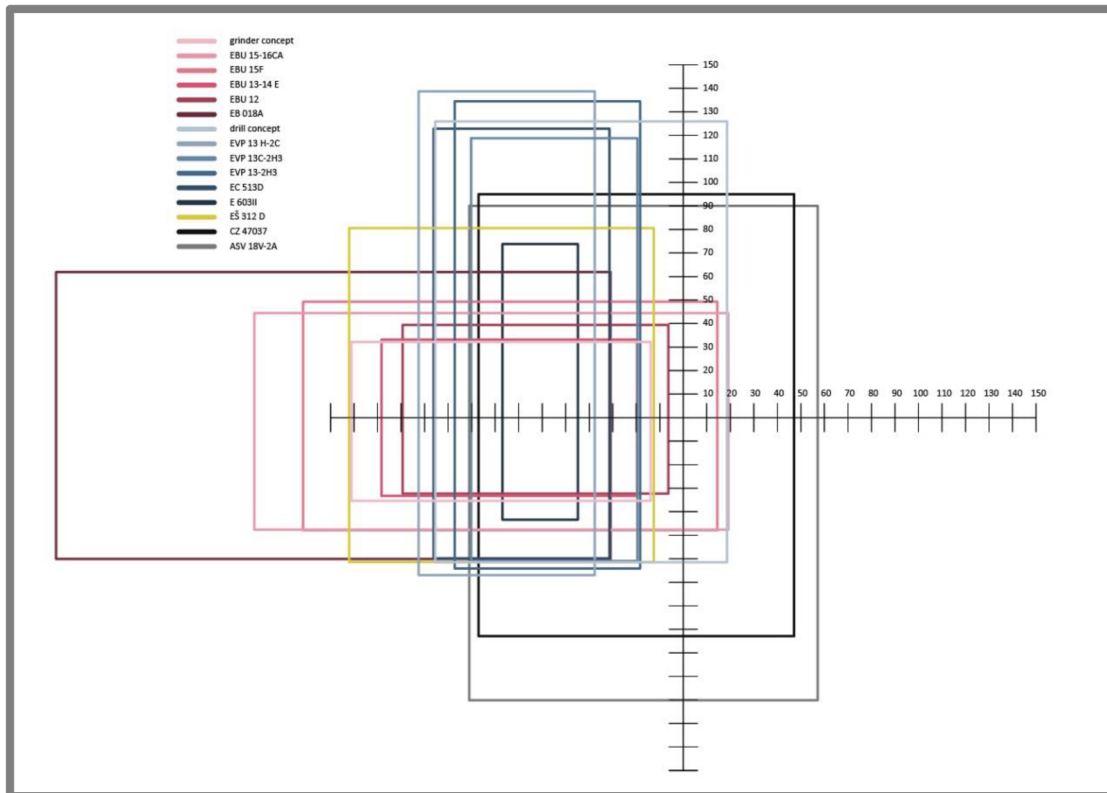

Fig. 8.18 Orientation graph, handles, side views

The handle part is oriented inconsistently in terms of maximum and minimum across all products. The feature handle parts of the drills and the grinders are however similar. The exception in this analysis is the EŠ 312D which seems to be partly located as a grinder and partly as drill. This is happening probably due to construction of the handle.

Orientation analysis of the control buttons from the right side is showing the different location of control button in drills and grinders. There are also few differences among the grinders because the large EBU 15F and EBU 15-16CA have long handle adapted to better grip, therefore their control buttons are located differently. The concept of drill has a feature button positioned in the intersection of features of other drills. In drill category Only EVP 13 H-2C is standing a bit aside. The grinder concept is located near the group created by EBU 12 and EBU 13-14 E as seen on the figure 8.19.

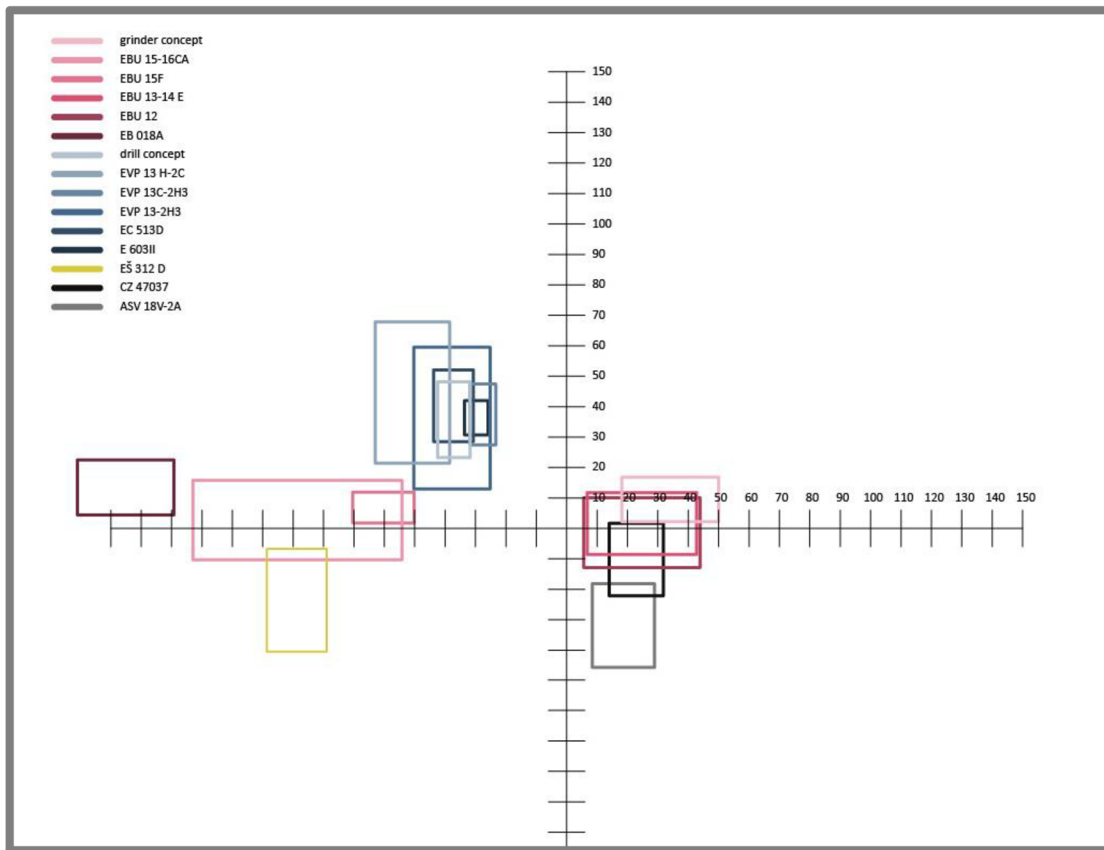

Fig. 8.19 Orientation graph, control buttons, side views

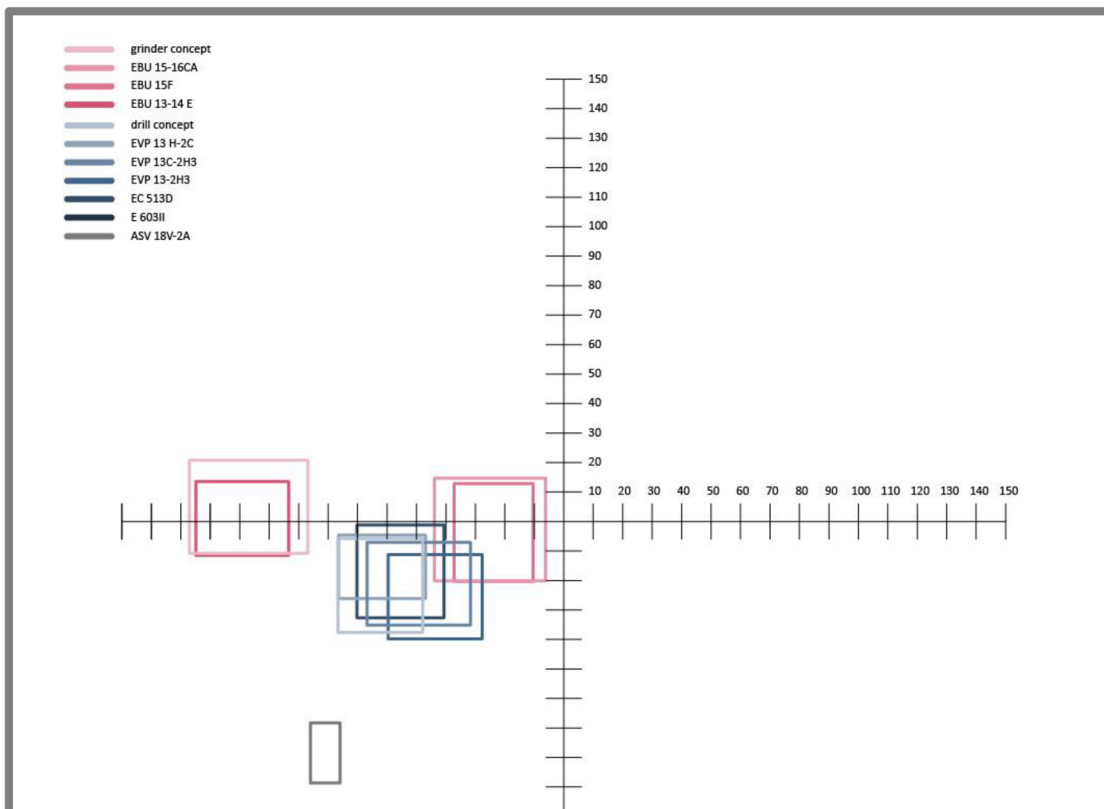

Fig. 8.20 Orientation graph, ventilation, side views

Ventilating holes and area is showing again the different construction of the EBU 12 and EBU 15-16CA. The analysed grinders are having to groups depending on their construction. The venting holes on the large grinders are closer to the outline feature centroid than at new grinder concept and EBU 13-14 E. The location of the venting holes on drills is similar to each other without any exception. I have also added the venting of cordless drill ASV 18V-2A, where it is oriented alone in the empty space above the outline centroid.

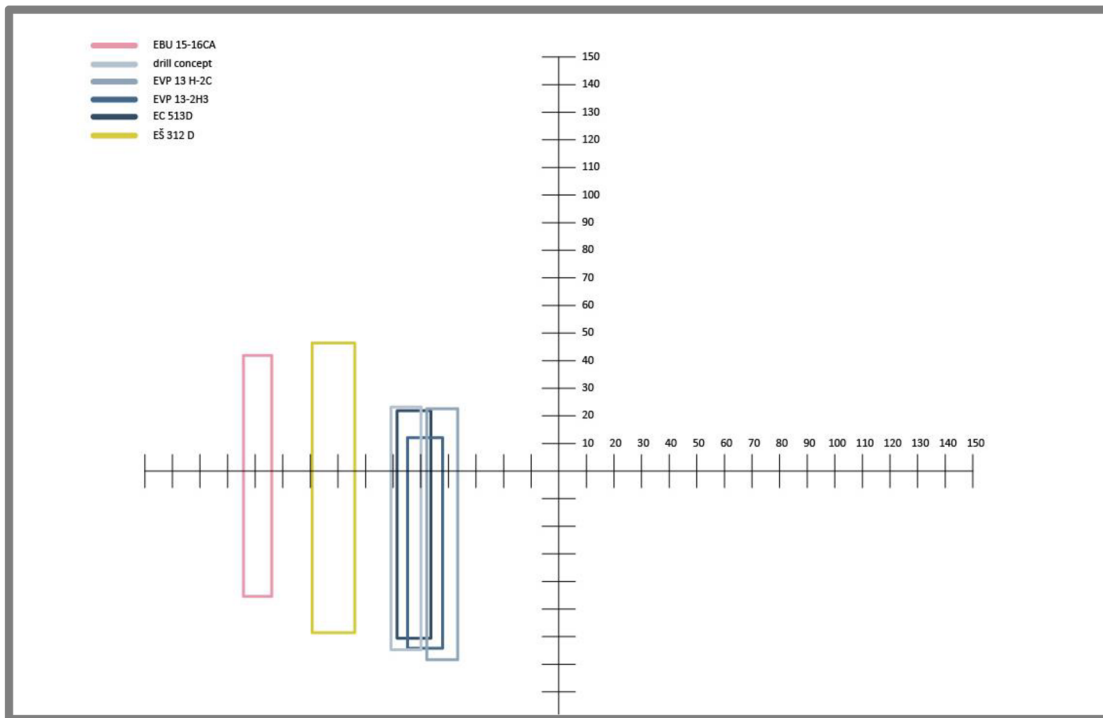

Fig. 8.21 Orientation graph, joining element, side views

The joining element, appearing at EBU 15-16CA, EVP 13-H2C, EVP 12-2H3, EC 513D, EŠ 312 D and the new drill concept is performing consistently among the drills. The features of this part on angle grinder and the electric screwdriver are located further away from the outline centroid.

8.3.2 Top view

From the top view the orientation of gearbox and engine part are nicely symmetrical and support the analysis from the side views. They also support the proportion analysis of the gearbox and engine at EB 018A where there is a largest minimum and maximum distance from the centroid at its features. Also the engine of EŠ 312D is performing far away from the centroid, which is caused by the fact that the engine part is also forming a part of the handle.

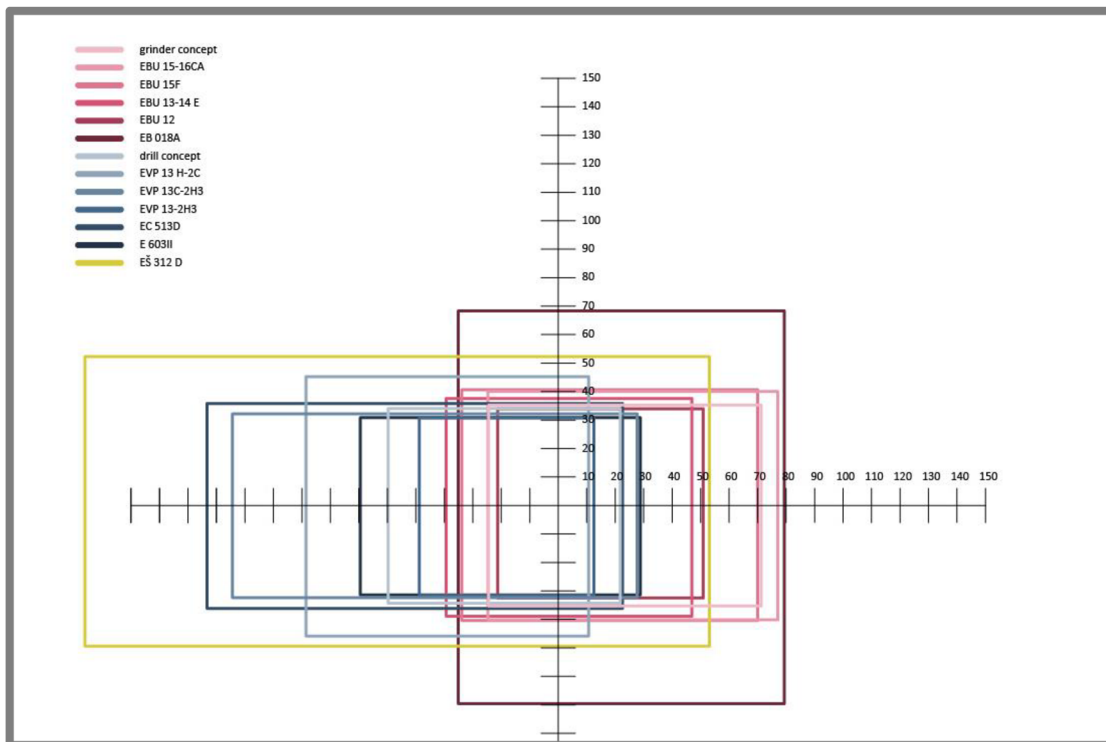

Fig. 8.22 Orientation graph, engine, top view

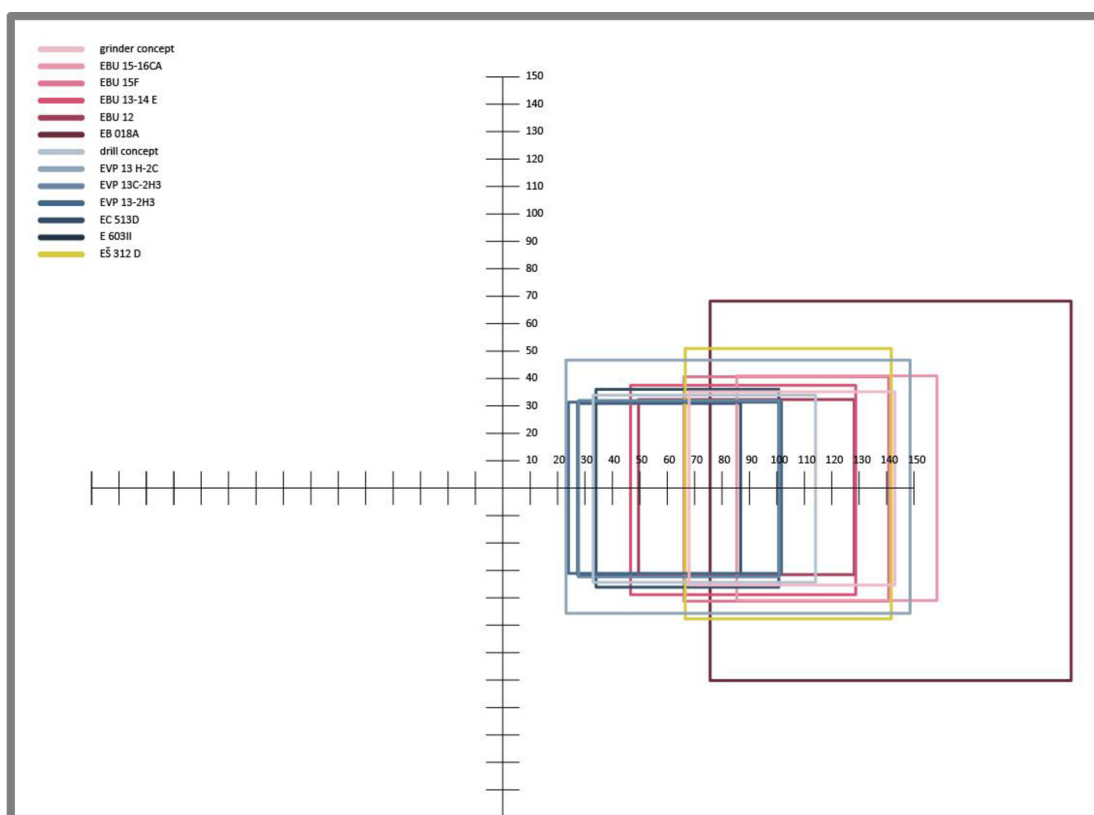

Fig. 8.23 Orientation graph, gearbox, top view

The muscles located on the top side of the object seem to be mostly located symmetrically on the front and the back part. From the figure 8.24 we can conclude that the feature muscle of the EB018A is quite similar in size and position to the gearbox feature seen on figure 8.24. The muscle of the E 603II is small and located in the back part. The EŠ 312D has these characteristic curves mainly in the back part. The new concepts have the muscle part located more in the front than is normal for their category.

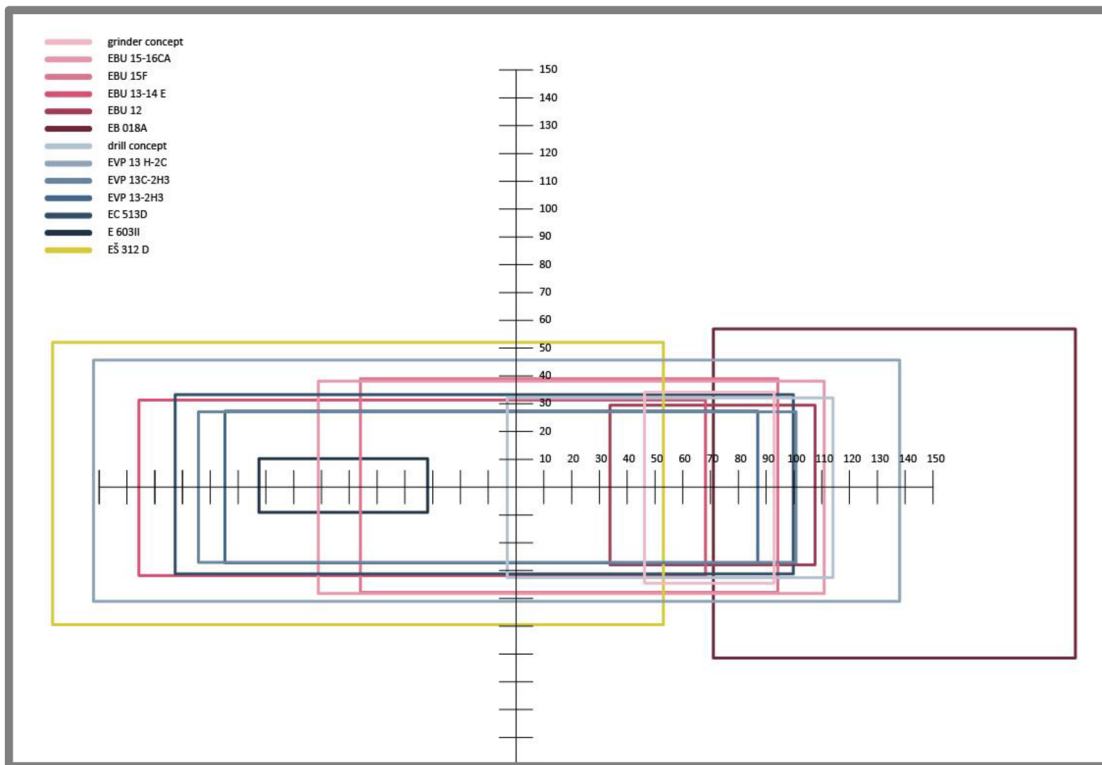

Fig. 8.24 Orientation graph, muscles, top view

Gearbox muscles are showing minor inconsistencies among the whole range of the products. The drills have the gearbox muscles located closer to the centroid of the top outline, while the grinders have these curves located further away. A muscle of the EB 018A has been added to the graph also to show that it is nearly 4 times the size of the 2nd largest gearbox muscle.

From the top side the user can also see the brake control buttons in case of the grinder and controls of the speed in drill category. The graph 8.25 is showing orientation analysis of these features.

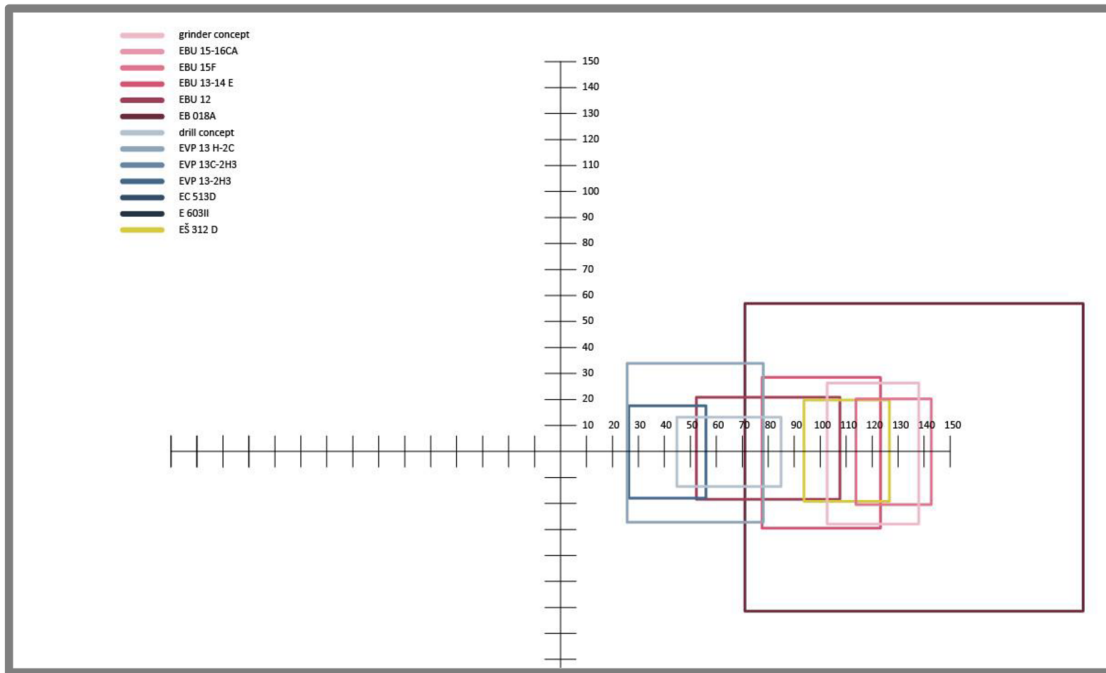

Fig.. 8.25 Orientation graph, gearbox muscle, top view

The button of E 603 II is located on the other side than it is on the modern drills. The models of EVP 13-2H3 and EVP 13 H-2C are showing on the same location but different in size. The location of the break buttons is somewhat special. Although similar in size they seem to be inconsistently located accordingly to the outline of the product. Further analysis in relation to the centroid of the gearbox feature might be needed to verify this expectation.

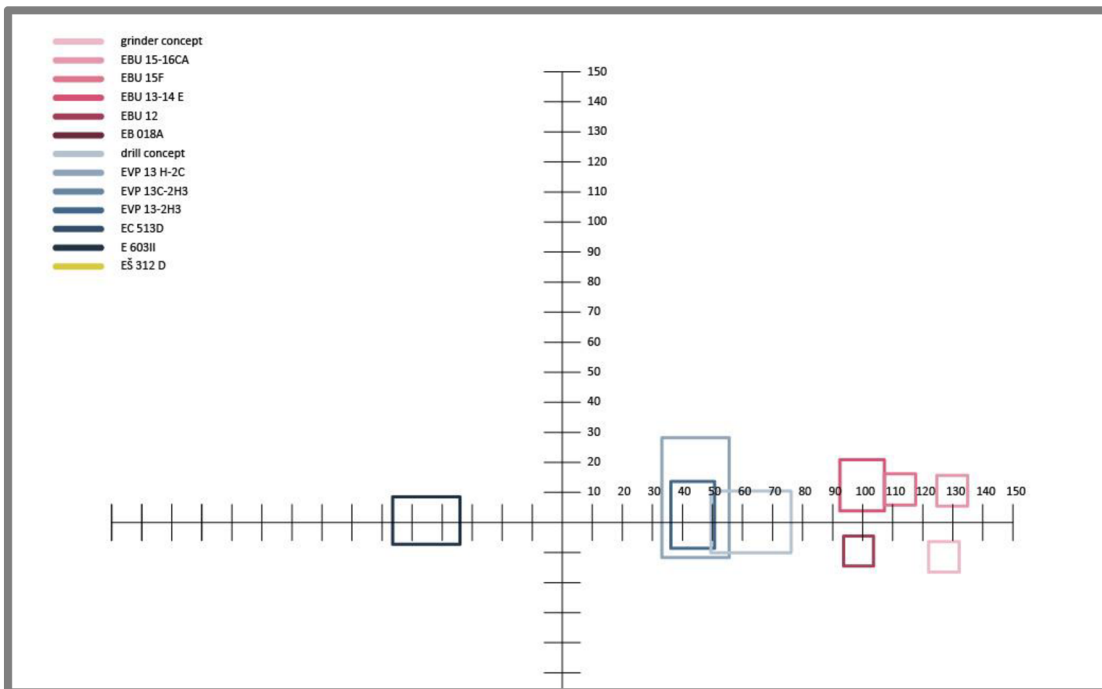

Fig. 8.26 Orientation graph, brake and speed control, top view

8.3.3 Conclusion

The orientation analysis has proven that some features are placed on similar places and are also alike in size. The new concepts of drill and the grinder are not deviating largely from the groups of their respective category. The only different category is the muscle curve which may vary among the products. The EB 018A has again shown large deviations in terms of position and mainly the size of the feature.

Features like gearbox, engine and handle are not oriented differently among the set of products. The drills and the grinders therefore have similar construction. However there are features that are positioned differently at drills and grinders for example the control button. The brake buttons position and orientation should be more consistent in brand identity.

8.4 Shape analysis

This part of analysing is done in a way that the feature is divided by a number of points to segments of equal length. After the dividing the distance of these points and the feature centroid are measured and displayed in a graph. By joining these distance points a curve graph is gained.

The same curve in graph is showing the similarity of the shape in size and throughout the length of the feature. Similar curve but farther or closer to the x axis is showing curve similar in shape but not the size. For easing this analysis I tried to use the same starting point for dividing the curves so we can receive aligned graphs. Not everywhere is this possible as some shapes are too different to pick similar starting point. However the similarity can still be found. One hundred points are always dividing the shape. This may seem few for the complete outline but for the smaller features it can capture details well.

8.4.1 Side views

The analysis of a feature outline of the product is showing that there are some similarities in between the silhouettes. Generally the outline is having the same progression but sometimes it is different in the terms of the feature size. Near the point numbered 23 the progression divides between corded drills and angle grinders, where the grinders are going more convex but the drills aren't. EBU 12 graph is moved a bit to the right but when moved to the proper position it would have the same progression near that point 23, this way the same sequence is around point 45. The EBU 15F is similar case but with convex part around point 60.

Also the cordless drills are deviating from the group of other products in certain part. This starts at point 33 and ends around point 59 where the outline of the CZ 47037 and the ASV 18V-2A is going convex but other outlines are concave.

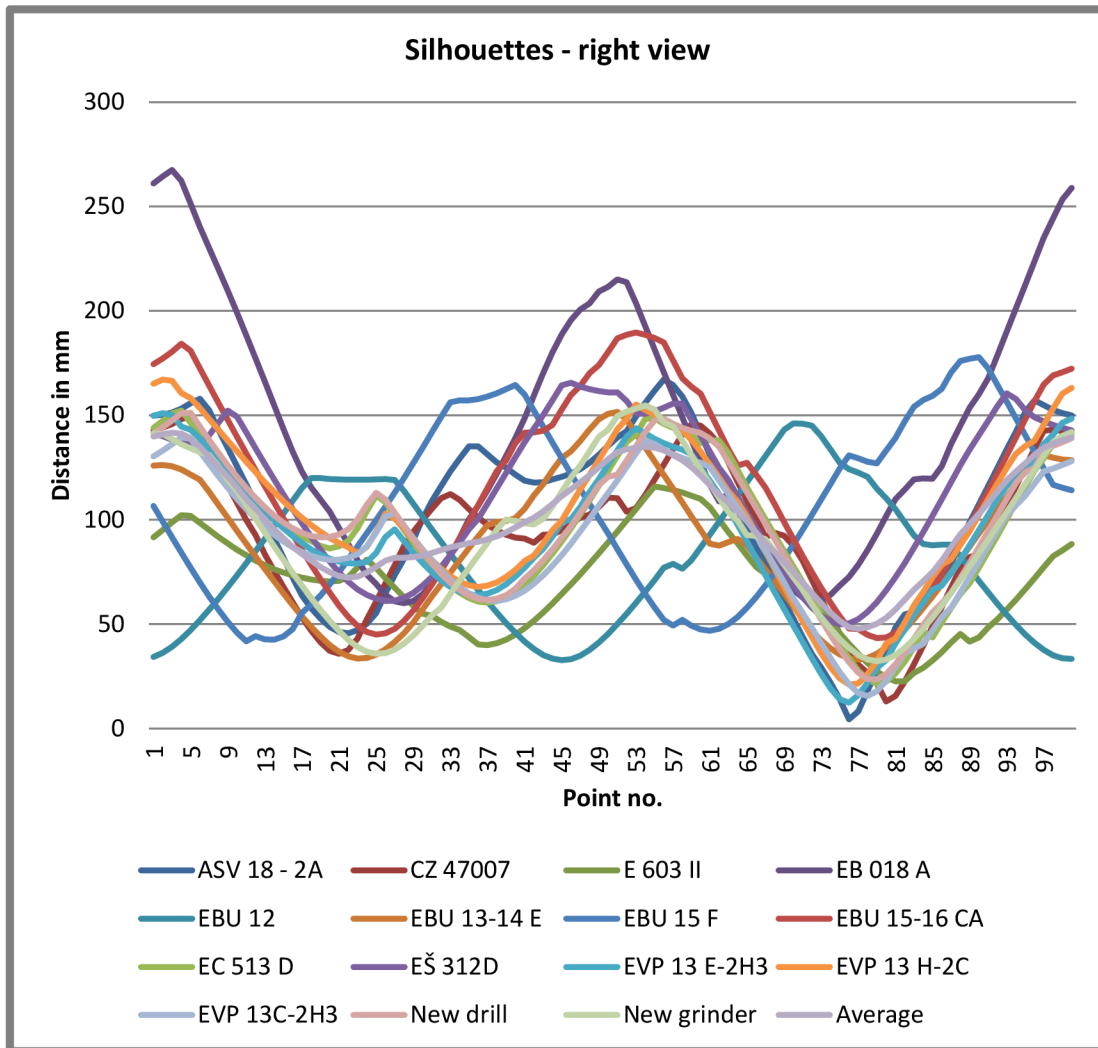

Fig. 8.27 Graph of silhouette shapes, right view

Gearbox feature outline is formed by a straight line from the start; therefore the shapes are similar from the start of the graph. Then the shapes are mostly divided between the drill and angle grinders. In case of the grinders the shape is going closer to the centroid of the feature and then steeply further away from it. Common thing is a little around point number 55 where the brake button is. A similarity between EB 018A and new grinder concept is occurring near the 90th point.

From the drill category the shapes are looking similarly with exception of EVP 13 H2-C. This drill has larger proportions around point 55 and near the point 85 the place for the screw is making the tip in the graph and differ this product from others. This happens similarly at product EVP 13C-2H3 but not so largely in proportions. The E603II's shape has closer shape to the grinders and the cordless drills. Cordless drills are similar together especially in between points 56 and 67 where a constant distance from the feature centroid is measured.

The outline shape of the engine compartment is similar throughout the set of products. From the side it is mostly rectangular. The exceptions are EBU 13-14E with new concept of the grinder- they are slightly tipped in frontal part. Same is only on side in the concept of the drill at points 36-39. The EVP 13 H-2C is deviating largely in shape because it is forming one side of the handle.

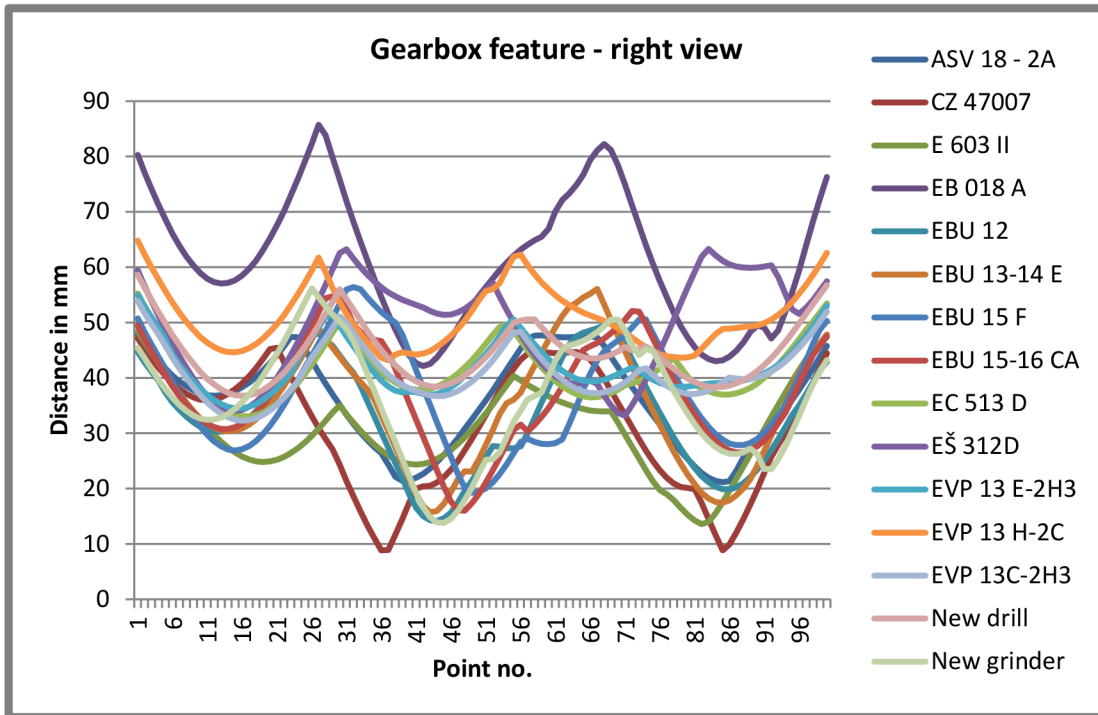

Fig. 8.28 Graph of gearbox shapes, right view

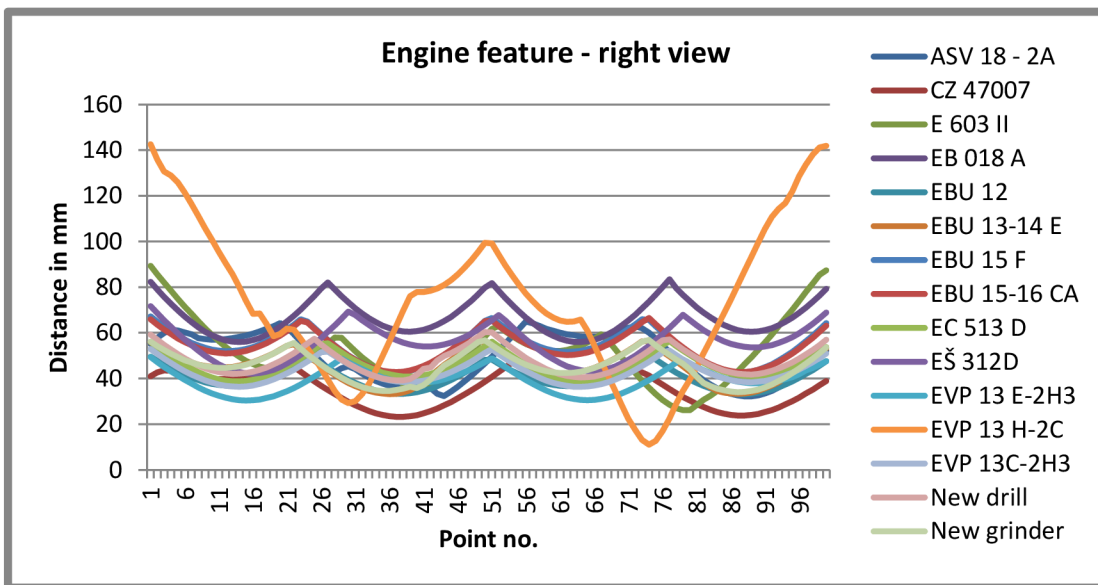

Fig. 8.29 Graph of engine shapes, right view

Handle feature part is inconsistent across the portfolio. The similarities are found between the drills near point 38 which is the tip that prevents the handle from sliding down from this point on the progress of the curves deviates. The new concept of the drill has the same tip around point 30 and then goes to a steep curve which is caused by the fact that the handle is prolonged on the top part. Small angle grinders, including the newly designed concept are showing not so similar shape but common progress along the points 39 to 58 (EBU 12 from 31 to 50). The EBU 15F and EBU 15-16CA are also similar in hole progress across the points. The EVP 13 H-2C is showing a completely different shape.

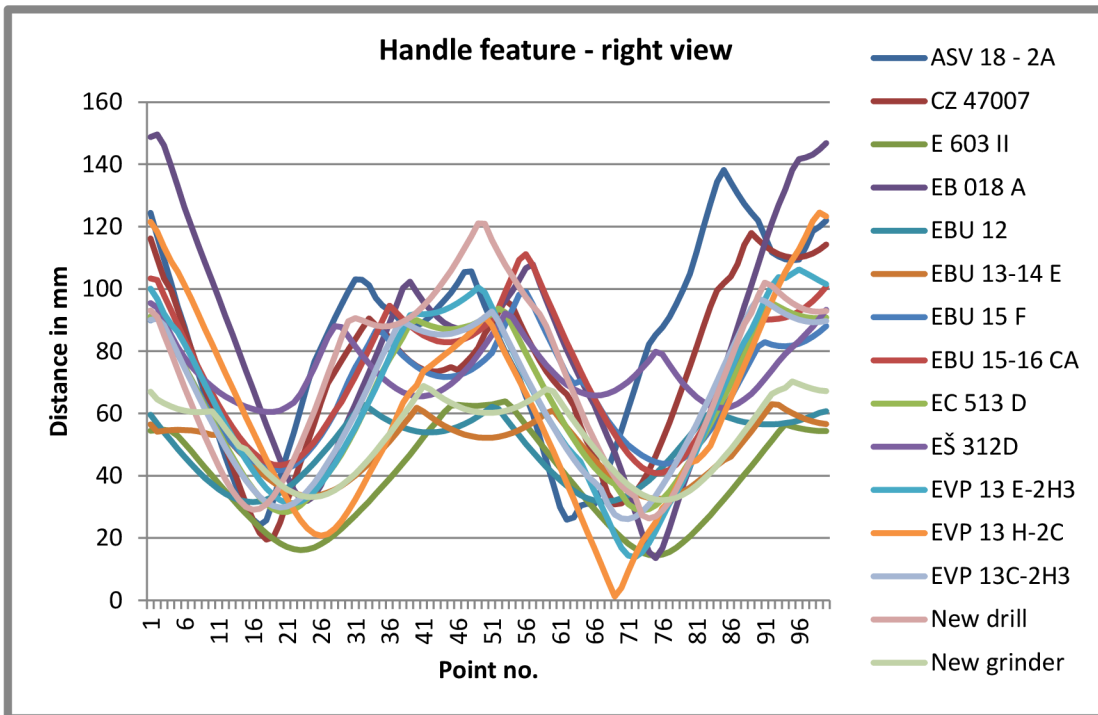

Fig. 8.30 Graph of handle shapes, right view

Control button is varying in shape from rectangular sliding button to a curved rectangle, where the curve is making the grip more comfortable. That is differing mainly among the drills and the grinders. However the EBU 15-16CA has a large control button. The buttons of EVP 13 H-2C and the EVP 13 E-2H3 are identical in the shape. The difference in the graph is probably an error formed by tracing.

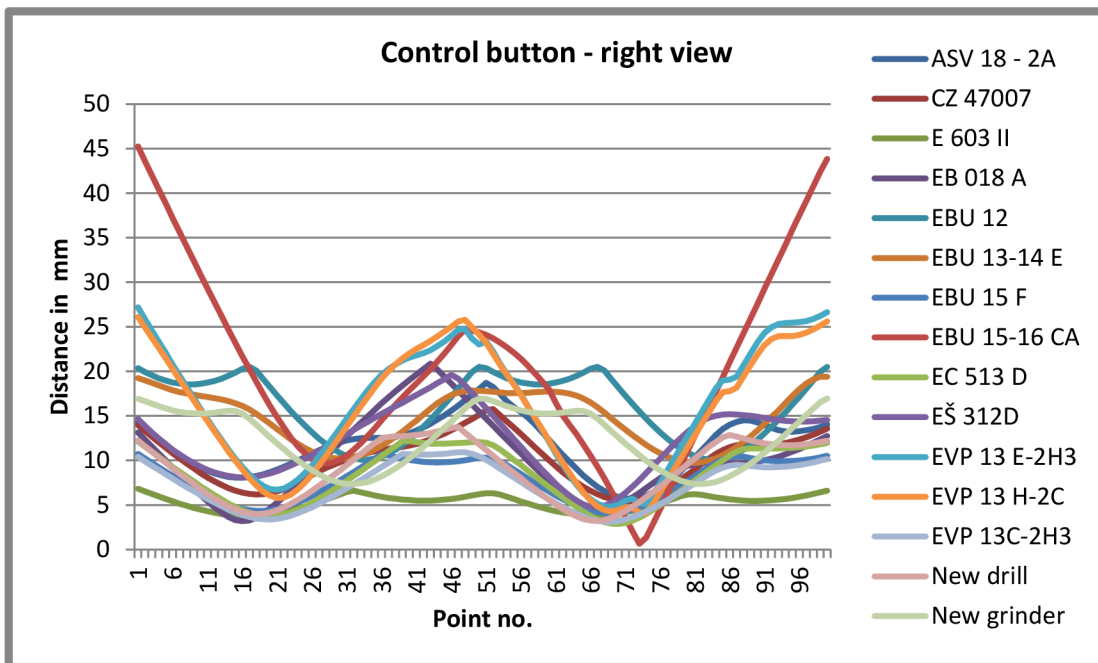

Fig. 8.31 Graph of control button shapes, right view

Analysis of the feature muscle part is shown on the figure 8.32. Here we can see that the muscle on the ASV 18-2A which is formed by the gripping rubber is largely deviating in most of the parts and has a lot of peaks in the graph. The feature of EB 018A is similar to the muscle feature at EVP 13 H-2C where is the feature bigger. At E603II we can see that its progress is fluent with just two peaks (one at starting point and 2nd at point 79). The CZ 47037 is similar in point 80 to point 75 at EŠ 312D.

New drill concept has a similar progress as the feature muscle at EC 513. These two curves are also similar to EVP 13 E-2H3 and EVP 13C-2H3 in section of points 31-62 and 79-13 in other parts the shape is made differently. The new concept of the grinder is partly similar to the new drill and the EC 513D.

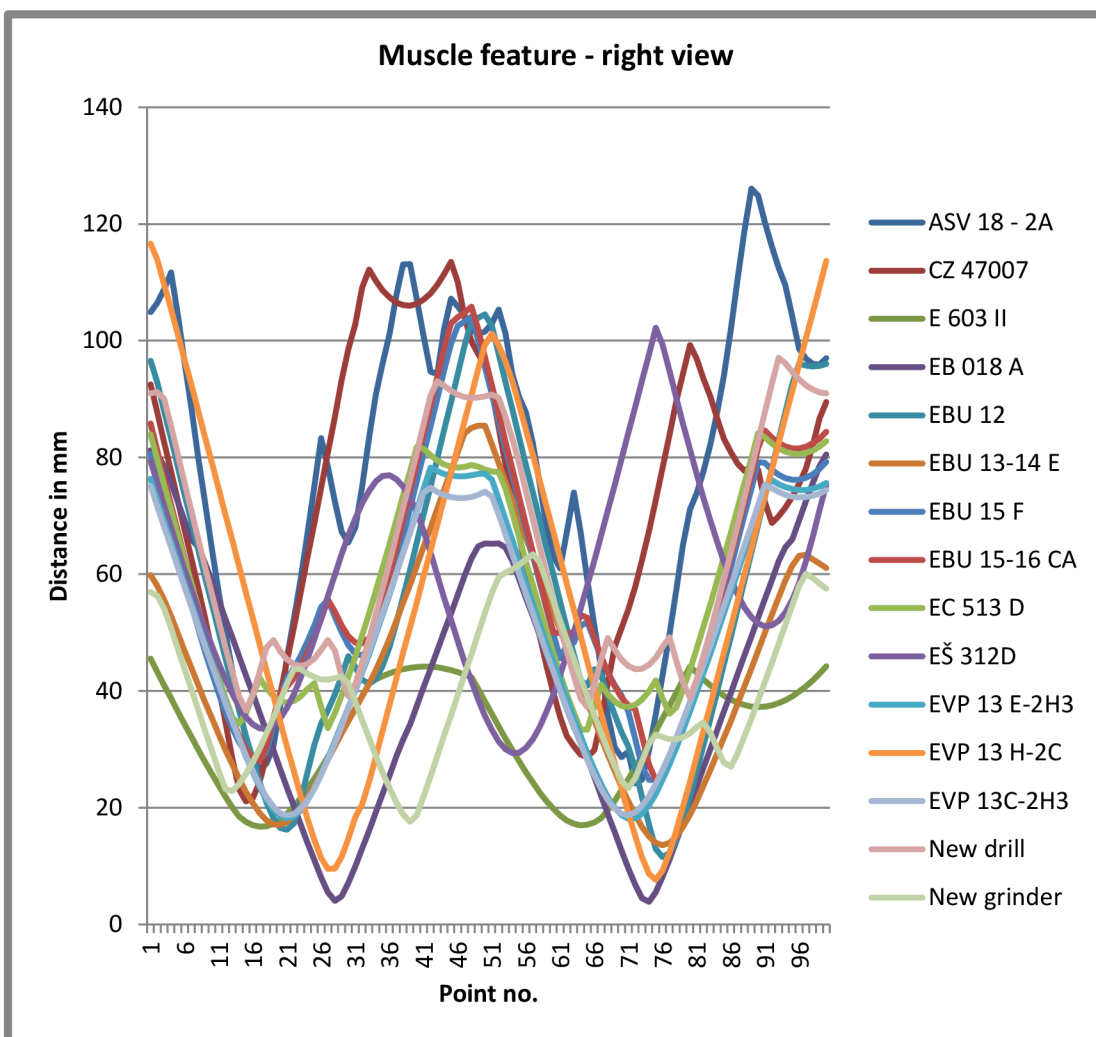

Fig. 8.32 Graph of muscle curves, right view

Logo sticker is placed on almost every NAREX product the shape is barely changing from rounded rectangle. However there are few exceptions in the cordless drills. The CZ 47037 is having an elliptic logo and the ASV 18-2A has some sort of half ellipse. This is seen on graph 8.33. The other curves are similarly shaped but differ only in the size.

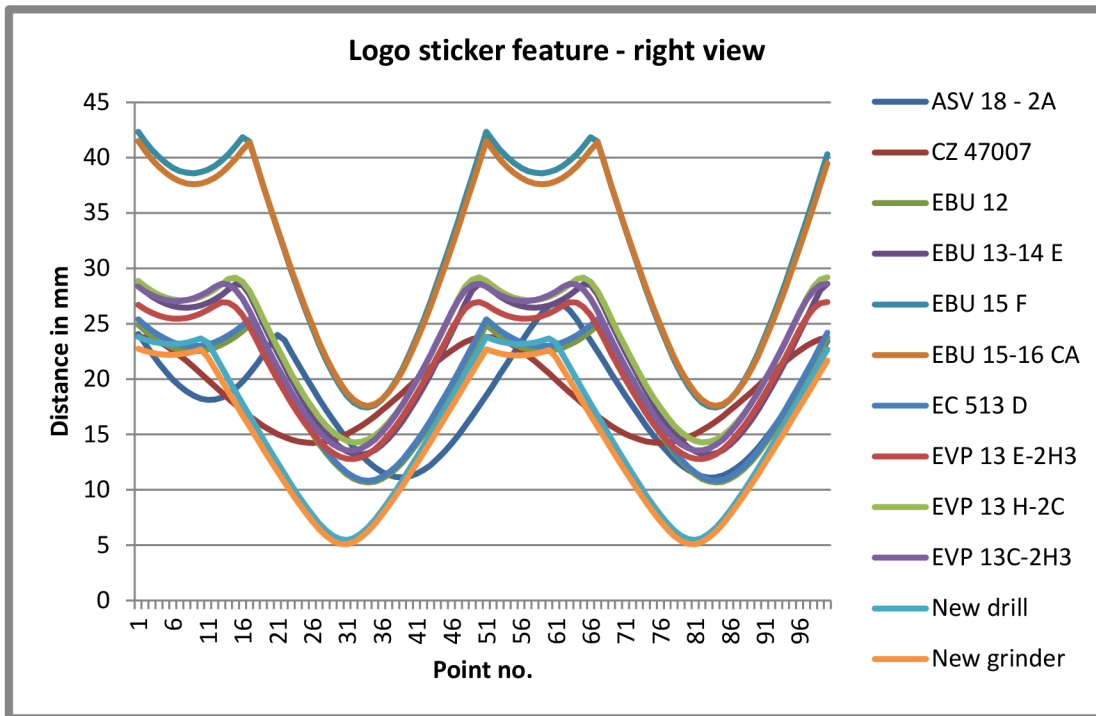

Fig. 8.33 Graph of logo sticker shapes, right view

The joining part of the engine and gearbox is nearly identical in shape. The features are differing in the size. The EŠ 312D is differing in the peaks of the graphs, because it is slightly different on the side parts. Slight bounce in the features of EC 513D and new drill concept is caused by an error which is made by tracing the hole in the product whereas at other products the hole is located on a gearbox and not in the joining part.

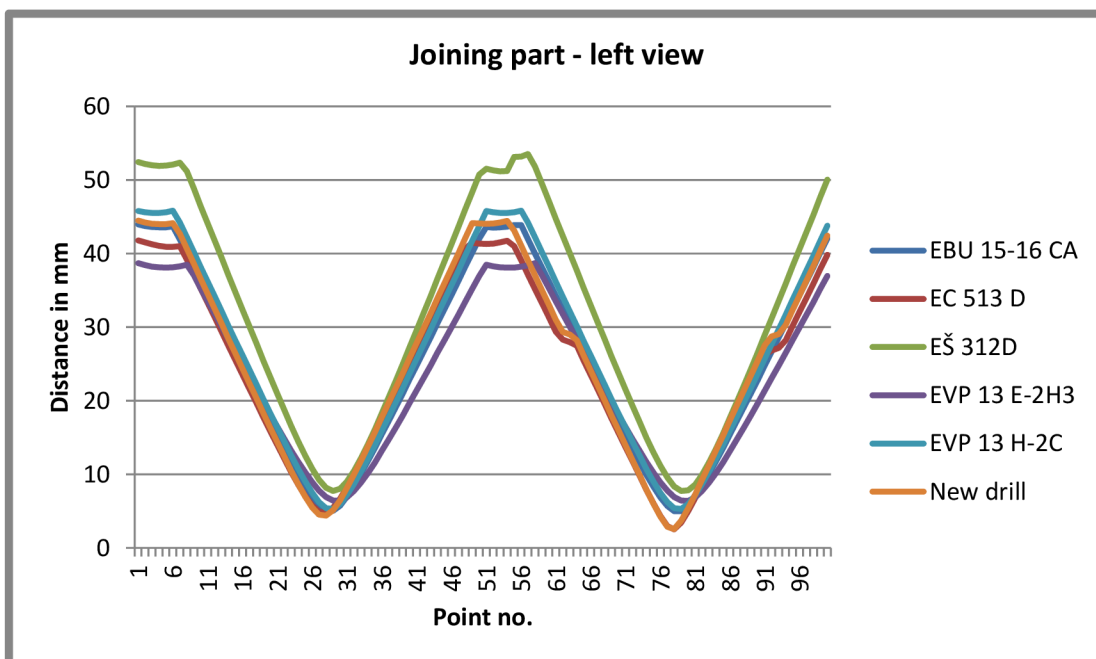

Fig. 8.34 Graph of joining element shapes, right view

8.4.2 Top view

The silhouettes of the analysed products have similar progress. They are mostly elliptic with flat front part. All curves have peak at points 0 (or 100) and around point 50 there is convex part with exception of EB 018A which has a peak. Newly designed concepts seem to follow the trends as the new drill is very similar in outline with the EC 513D. Designed angle grinder is similar to EBU 15F in the middle of the graph.

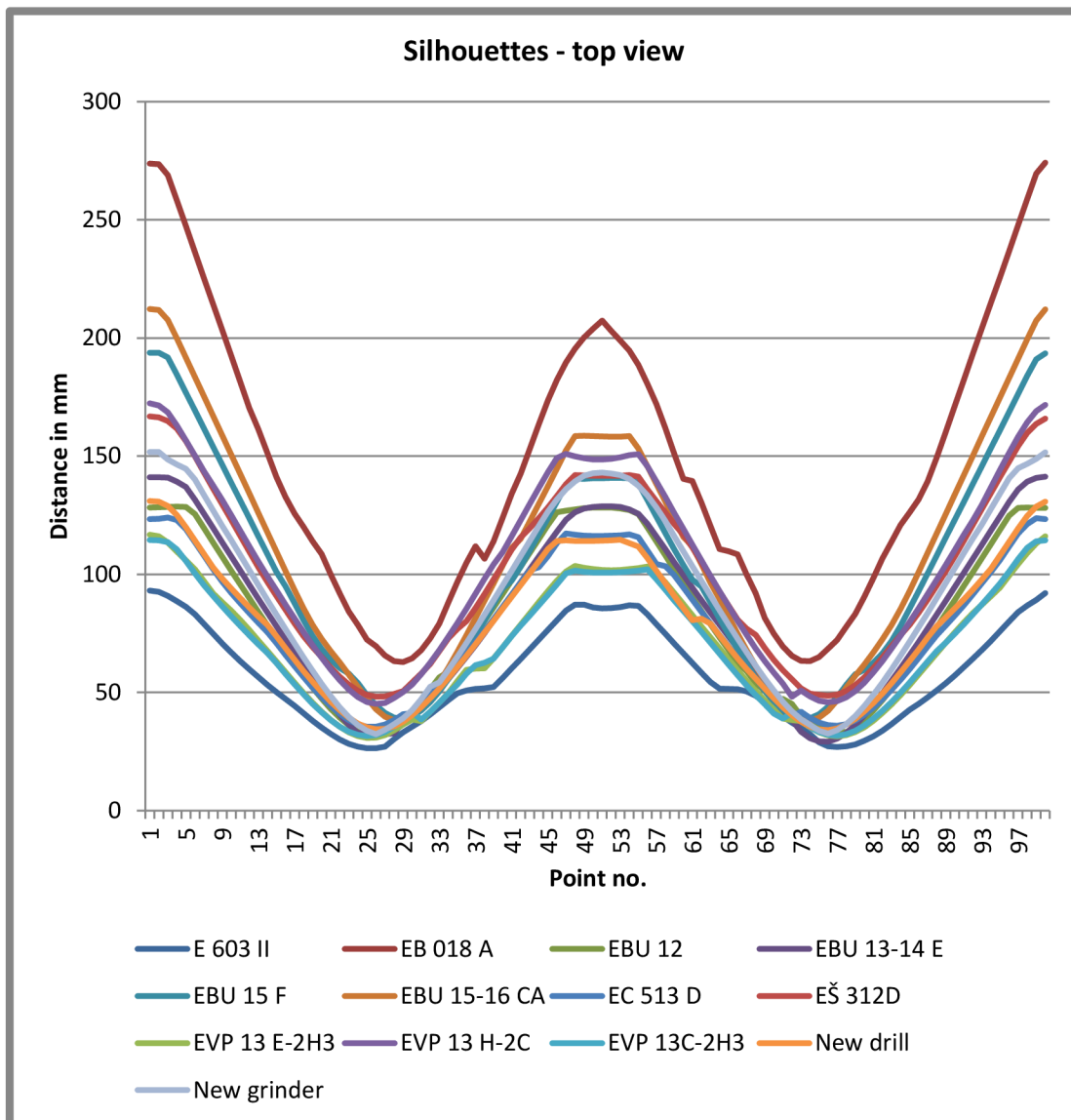

Fig. 8.35 Graph of silhouette shapes, top view

Feature gearbox part is from the top view consistent with exception of two products. The E 603II is below the group of products but similar. EVP 13 H-2C is also similar but above the group in the graph 8.36. The EB 018A and EŠ 312D are differing in the progress of the curves, therefore the gearboxes are not similar to the other products.

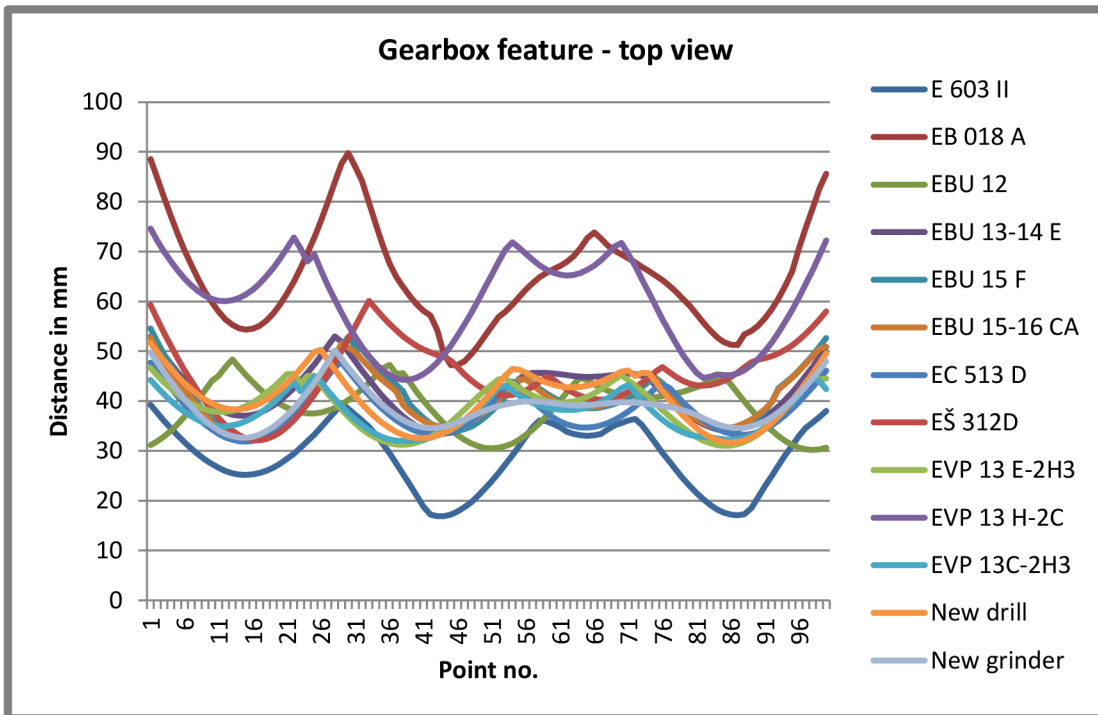

Fig. 8.36 Graph of gearbox shapes, top view

In engine compartments the EŠ 312D and the new drill concept are deviating from the mostly rectangular engine parts. In case of the new drill the handle is prolonged on the top side of the product thus the engine is shortened in the middle. Same thing but with smaller proportions is happening on EBU 15F and EBU 15-16CA which has also attached handle to the engine part. The engine casing of EC 513D and the EVP 13C-2H3 are away from the group of the other parts because they form a part of the handle. The feature engine at EBU 15F and EBU 15-16CA are appearing almost identical.

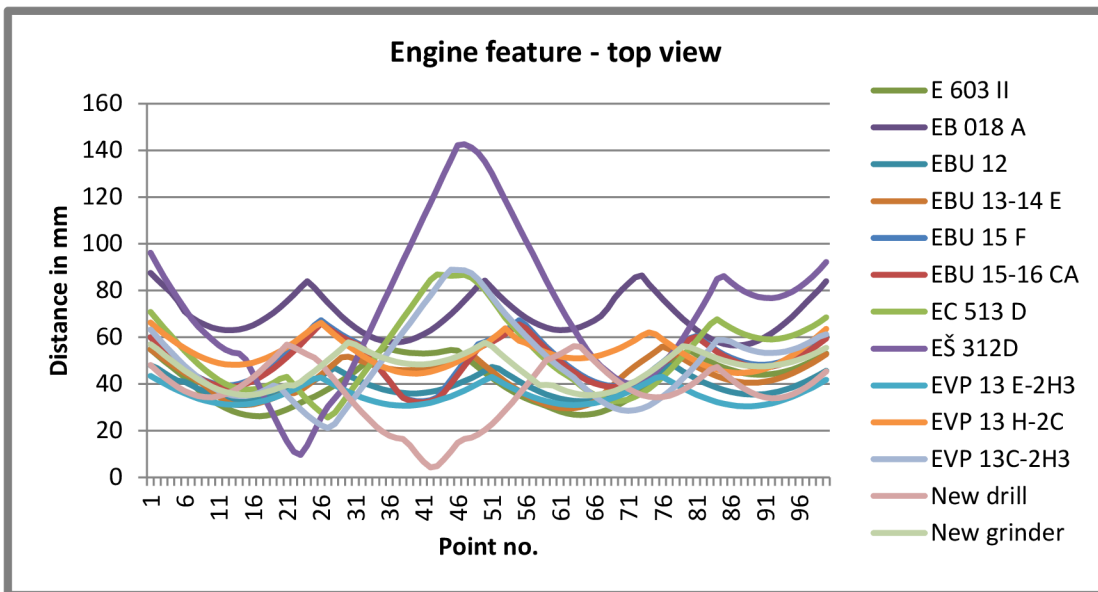

Fig. 8.37 Graph of engine shapes, top view

In handle feature shapes the E 603II is almost consistent therefore its shape is closing on being rounded, that is unfortunately different from other shapes in the analysis. New drill concept is similar only partly. The curve of the graph should be moved about 15 points to the right side of the figure 8.38. Then the part would be similar to grinders EBU 12, EBU13-14E and the new concept.

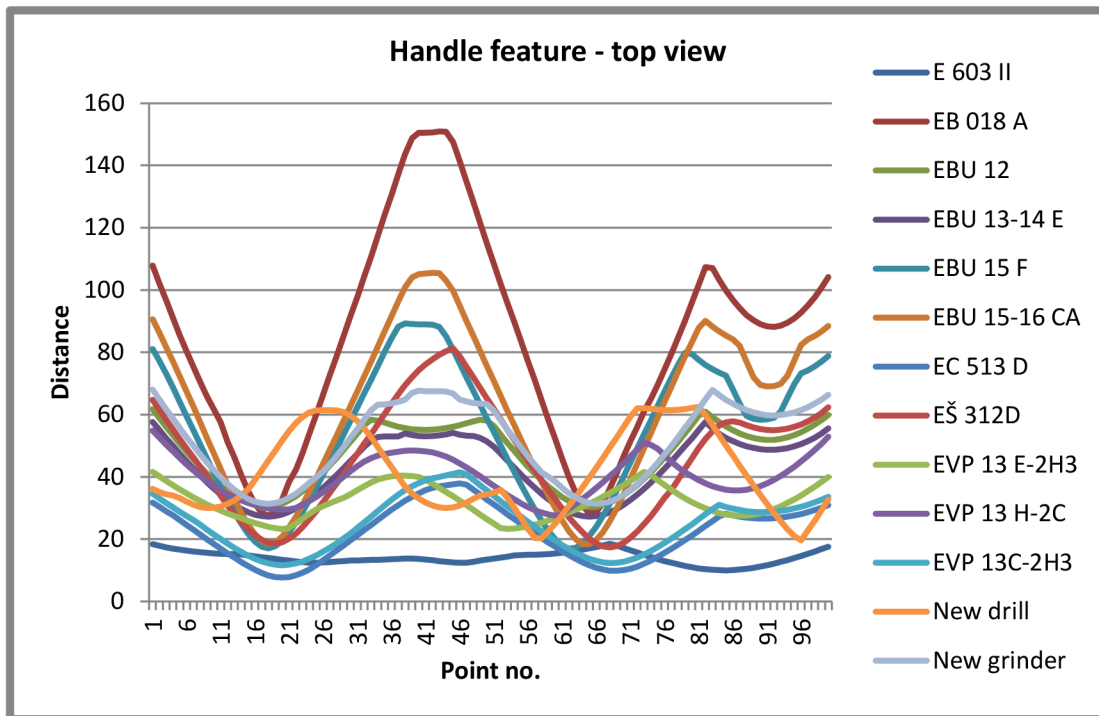

Fig. 8.38 Graph of handle shapes, top view

Similar shapes of handles occur on EB 018A, EBU 15F and EBU 15-16CA. Then EC 513D and EVP 13C-2H3 are almost identical and EŠ312D is similar to them. Other products are altogether similar to each other.

E 603 II drill is also having the smallest muscle part when viewed from the top, which is not similar to any other muscle curve as according to graph8.39. No curve is similar to the EB 018A muscle part. The largest muscle curve is located on the EVP 13H-2C which could be similar to feature on EŠ 312D which differs from it in progress between point 42 and 60. In this sec The EBU 12 and the new grinder and drill concepts are similar partly.

In the section between point 34 and point 68 at EC 513D is a peak in the middle part and two minor peaks on the sides, this is similar to grinders EBU 15F and EBU 15-16CA between point 40 and 60 where a similar manner occurs.

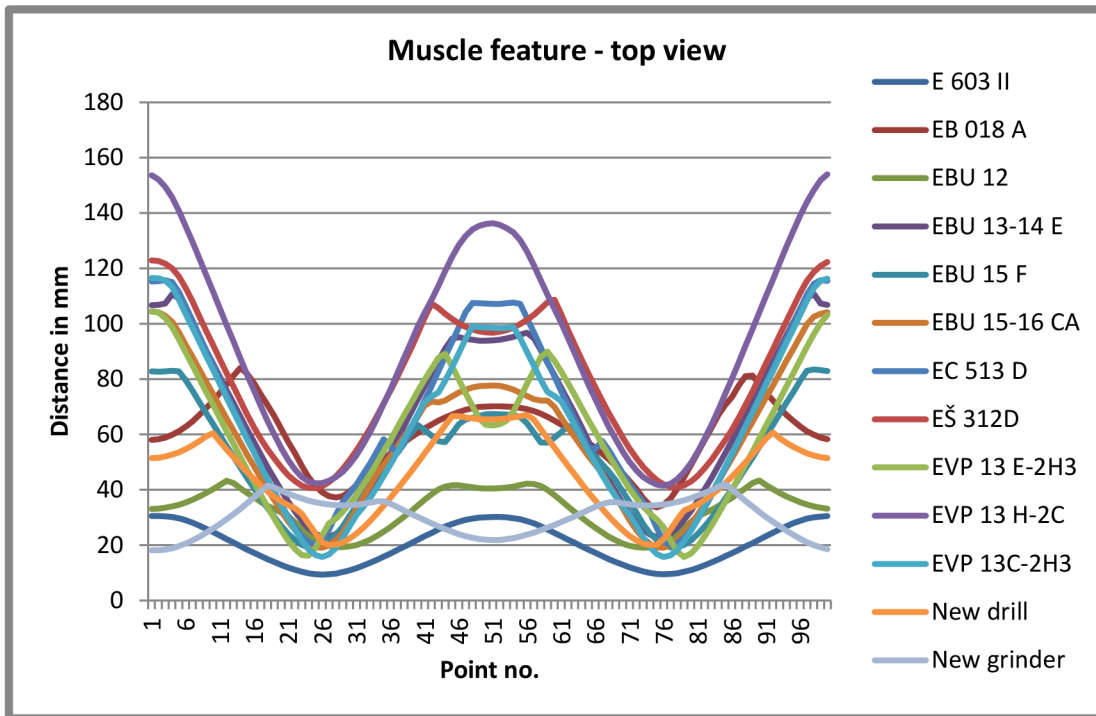

Fig. 8.39 Graph of muscle curves, top view

The feature gearbox muscle part is having consistent curves with exception of the EB 018A and the new grinder concept. The muscle curve on the concept is flowing more to the centroid of the feature, in this way the most similar shape is the EBU 13-14E. The EB 018A is having two peaks and also one other peak that is the top of the concave part. This shape is not similar to any other feature in the analysed group.

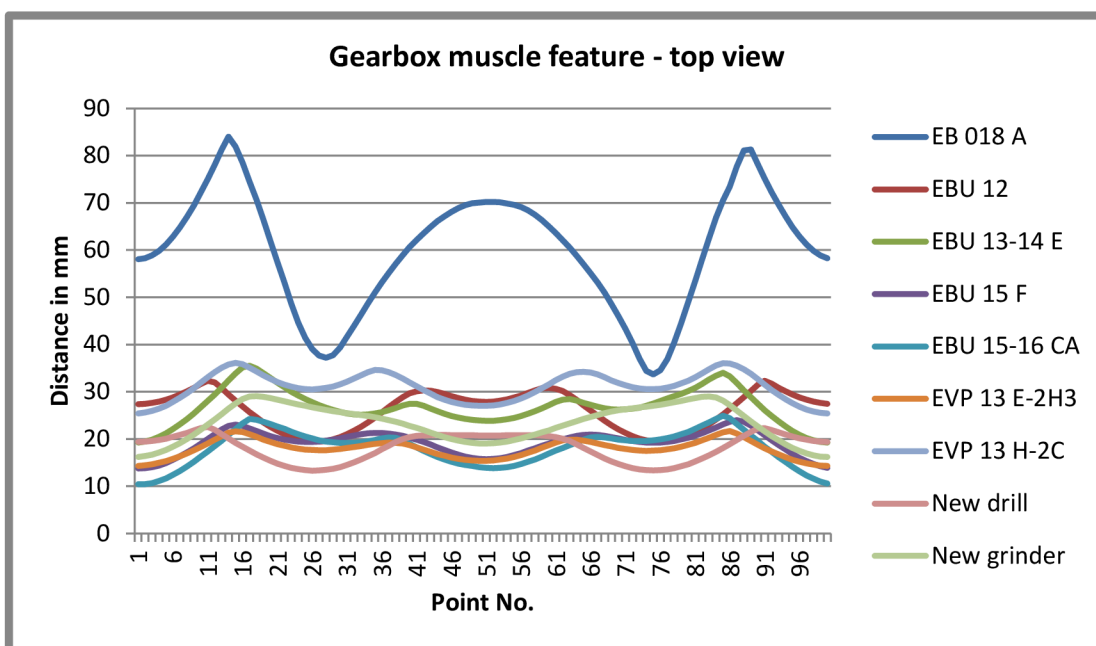

Fig. 8.40 Graph of gearbox muscle shapes, top view

From the top we can see also the brake control button on the grinders and speed or impact control button on the top of the gearbox on the drills. In case of the drills this button is mostly circular, shown in the graph 8.41 as a line— the only exception is EBU 13-14E which has a larger button and it is not a circle in shape. The drills are having a control button which has a shape that is pointing to a number or a symbol on the drill therefore the shape is more complicated. These shapes on the drills are differing but all have a peak in the tip of the pointing part. We can say that the EVP 13 H-2C and the EVP 13 E-2H3 have similar progress of the graph.

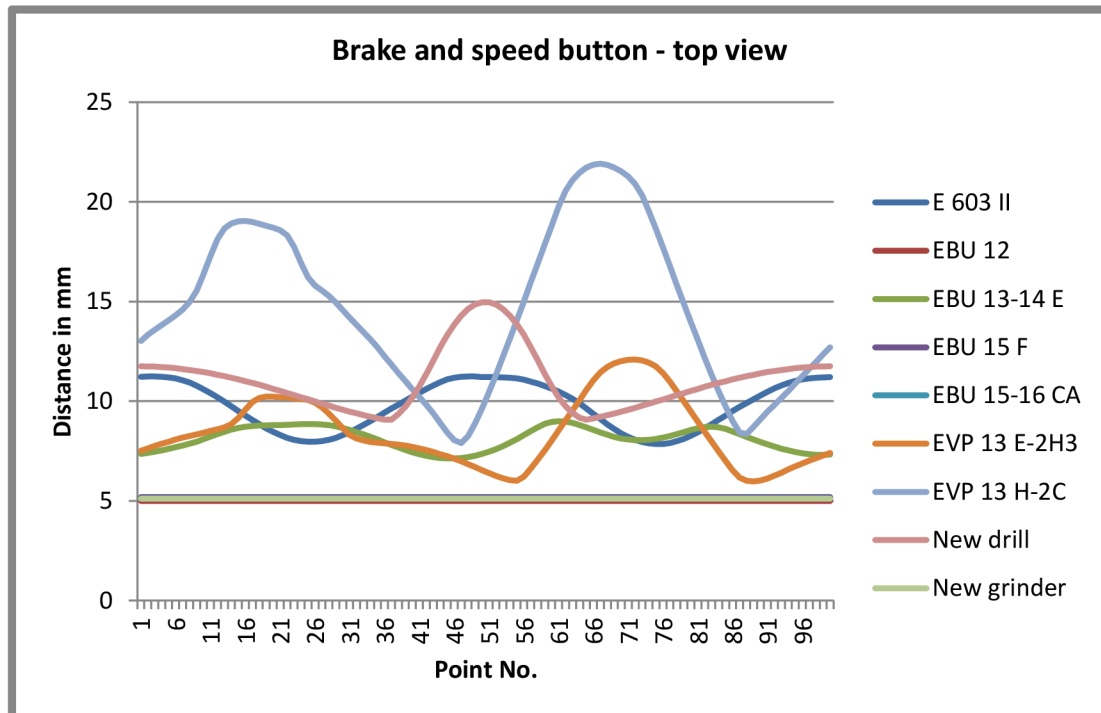

Fig. 8.41 Graph of brake and speed button shapes, top view

8.4.3 Conclusion

The shape analysis shown that there are features as for example the tip of the handle or the muscle part, which is not on all the examined products but is contained in the most similar forms. The products that should be excluded from the identity are surely the E 603 II, EB 018A and the EŠ 312D. These differ too much in many of the feature shapes. The new concepts are not differing in as many categories as are the previously mentioned products. Also the newest drill EVP 13 H-2C has different features as the side and the top muscle. The engine shaped the way in a form that it is making part of the handle is not uncommon and maybe also one of the elements that could differ the NAREX products from the competition.

There is no element that is repeated on every product included in the set. There are few elements that are repeated in more than two products. The control buttons cannot be consistent in the shaping as every tool needs different control elements. Partly similar shape features are found in the muscle part when viewed from the side. EC 513D, EBU 12, EBU 15F and EBU 15-16 CA have similar muscle shapes. As the EC 513D is maybe the core product of the brands reputation today, the brand might take advantage from making similar products. The EBU 15F was

also a core product according to interview with NAREX marketing manager V. Vrabec [36]. In the recent products the company is making impact on black colour included in the product. This is the example of ASV 18-2A and cordless screwdrivers, but the shape of the black grip is not repeated on any other product in the set. Also the shaping of the newest drill EVP 13 H-2C is deviating in many parts of the analysis. This seems like a time for the decision to brand whether to rely on the past rectangular and sharp shapes or go in more organic shapes which are modern and good for the ergonomics of the product. If the brand wants to keep a link with the past products the innovation in the brand can include some of the past elements.

8.5 Degree of similarity

Method for exploring similarities is resulting in calculating the degree of similarity. This shows how the design is similar to the group of products to which we are comparing it to. If the degree of similarity is equal to 0, it means that we have complete similarity. If the found value is higher than 1, then the design is found dissimilar. Comparing the designs created in this work to all the products in the line of the producer is not giving clear results as the products vary too much. In comparison to all the average degree always results below 1. Therefore to know if my designs are belonging to the group I have decided to compare them to its predecessors. The drill concept to drills EC 513D, EVP 13 E-2H3, EVP 13C-2H3 and EVP 13 H-2C and grinder concept to grinders EBU 12, EBU 13-14, EBU 15F and EBU 15-16CA.

Table 8.4 Degree of similarity, drill concept compared to previous drills

Degree of similarity	Silhouette	Gearbox	Engine	Handle	Muscle	Main switch	Logo	Venting
Proportion	0,409	0,053	0,003	0,424	0,971	0,355	1,496	0,167
Orientation (mean)	N/A	0,664	0,18	0,512	0,236	0,198	0,554	0,347
Shape (mean)	0,267	0,221	0,199	0,987	0,561	0,34	1,699	0,36
Average	0,338	0,312	0,127	0,641	0,589	0,297	1,25	0,291

Table 8.5 Degree of similarity, grinder concept compared to previous grinders

Degree of similarity	Silhouette	Gearbox	Engine	Handle	Muscle	Main switch	Logo	Venting
Proportion	0,256	0,215	0,244	0,302	0,421	0,186	0,187	0,85
Orientation (mean)	N/A	0,17	0,688	0,369	0,317	0,535	0,989	1,316
Shape (mean)	0,294	0,502	0,228	0,306	0,924	0,264	0,934	0,677
Average	0,338	0,312	0,127	0,641	0,589	0,297	1,25	0,291

The tables are showing average results of degree of similarity from analysing elements by the method of exploring similarities. In both designs the only feature that is not similar is the logo. Other features our found similar. From this point of view we can conclude that the concepts are belonging to the group of products and therefore to the narex brand identity.

9 SHAPE GRAMMAR

9.1 Features included to shape grammar

From the similarity analysis we can conclude that angle grinders and electric drills are similar in construction. Every drill and grinder includes the engine, handle and a gearbox part. Furthermore the engine parts are sometimes used in both categories. The joining part of the engine and gearbox is used in the more recent products as a colour element which brings more orange colour to the product. The cordless drills are very different in terms of construction and implementing a shape grammar for all three categories of the products is beyond the scope of this thesis. Considering the construction the shape grammar could be divided to be used for grinders and the drills. However this may result in having the grinders or drills joined in some hybrid form which would probably not work out well in any category. Therefore I have decided to create shape grammar for the drills in a way that it could be enhanced with the drill rules in the future.

Same way for the purpose of the thesis there is need to create only one view of the product, as it includes enough information about the evolution of the products. From the available 5 drills and 1 corded screwdriver two were found to not be similar to the other products. Therefore the SG should not include elements for constructing the E 603 II and the EŠ 312D. Also the new concept of the drill won't be included as there is a need to find whether it can be constructed from the past elements.

SG should include feature engine, gearbox, muscle and joining part. Also some of the muscle features are bearing the brand identity and should be implemented into the shape grammar. The control buttons and ventilation holes are needed to make the product whole. The logo sticker is a detail but appears on most of the products and in case of manufacture it is always there.

9.2 Shape grammar rules

Every SG consists of an initial shape, set of end shapes in the grammar, shape rules and shape that is formed by the grammar. I have chosen the engine compartment to be the initial shape that would be derived by the rules (fig. 9.1). The outline of the feature engine shape is represented only by a rectangle and set of labelled points which serve for the control which rule can be applied. The points are marked by red colour and label consisting of a letter and a number.

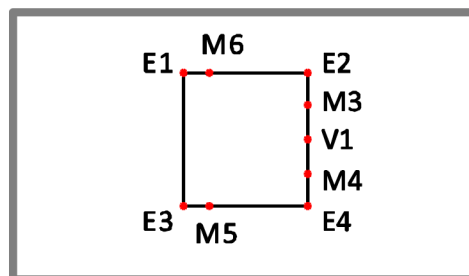

Fig. 9.1 Initial shape

The SG for the drill generating is now consisting of 57 rules. These rules are applied on the initial or other shapes which were generated before. They consist of a left hand side shape and a right hand side shape. The application goes in a way that the left hand sides of rules are searched for a same shape (transformed or oriented differently) in the current shape. When found the rule can be applied. The rules are applied further on until there is no rule left to apply. They are numbered so we can trace a generation which rules were applied.

First ten rules are used to generate different shapes of the back side of the handle. Rules 1 and 2 are searching for the right side of the initial shape and are adapting the two types of the top ledge. Rule no. 3 is enlightening the top ledge for generation of the longer handle present in EC 513D and EVP 13-2H3. Rules 4-8 are adding the back sides of the handle. Only one of the rules can be applied as the rule immediately labels the H3 point needed for the recognition of the shape as a point R1. Eighth and ninth rule are creating the rubber backing on the handle whereas the tenth rule is erasing the point R1 so the grips without the backing can be generated.

Next set of rules should generate the front part of the handle including control buttons and also close the handle to be completed. Rules 11 and 12 are looking for the right side of the initial shape and add a front curve of the grip. Next three rules are taking care of adding one of the three bottom ledges of the grip. Sixteenth and seventeenth rules are adding control buttons, which may be furtherly modified in rules 19 and 20. Rules 20 and 21 are closing the handle by joining the end points either by line or a curved bottom. Number 22 is erasing the point D1 in case we do not want the handle to be divided as a part of the engine. For this rules 23-26 are needed, this will create a cut in the handle and eform the engine part that is on a drill EVP 13 H-2C.

Joining element of the drill is or is not created by the rules 27-29. These rules are adding points for adding the air suction hole which may or may not be present on the drill – rules 30-32. Rules 33 to 35 are using points created in previous modifications to generate different types of speed control buttons.

Rules numbered 36-47 are used to generate and modify the gearbox. From the start the initial gearbox is generated using points from the joining part. This shape is then further modified to achieve shapes in different drills. The rule 36 is making clear that the front part of the drill will remain colinear with the joining part as the shapes might be present in different scale. Rules 37-39 are modifying the bottom line of the gearbox, while the rules 40-43 are modifying the top part. Rule 44 adds a front mouth present in the model EC 513D, whereas the number 45 is preventing the mouth to be generated by erasing the labeled point G4. Rule 46 is modifying the bottom part of the gearbox again so the special shape of the EVP 13 H-2C can be made. In the rule 47 a button for impact control that appears on EC 513 D is created.

Next set of rules (48-51) is used to make ventilating holes on the back of the drill. Specialty is a rule 48, which also deletes point for muscles and enables creation of the divided handle. Generation of logo stickers is done in three rules (52-54)

Rest of the rules is made to generate the muscle shapes. This part is the most problematical, as the points which should be connected by the shapes are generated in different scales. Attempts to create at least the rules for EC 513D and EVP H-2C are set.

The SG rules are shown on figures (9.2 – 9.7) on following pages. Labeled points are shown as red dots. The arrows are always pointing on the right hand side part of the rule.

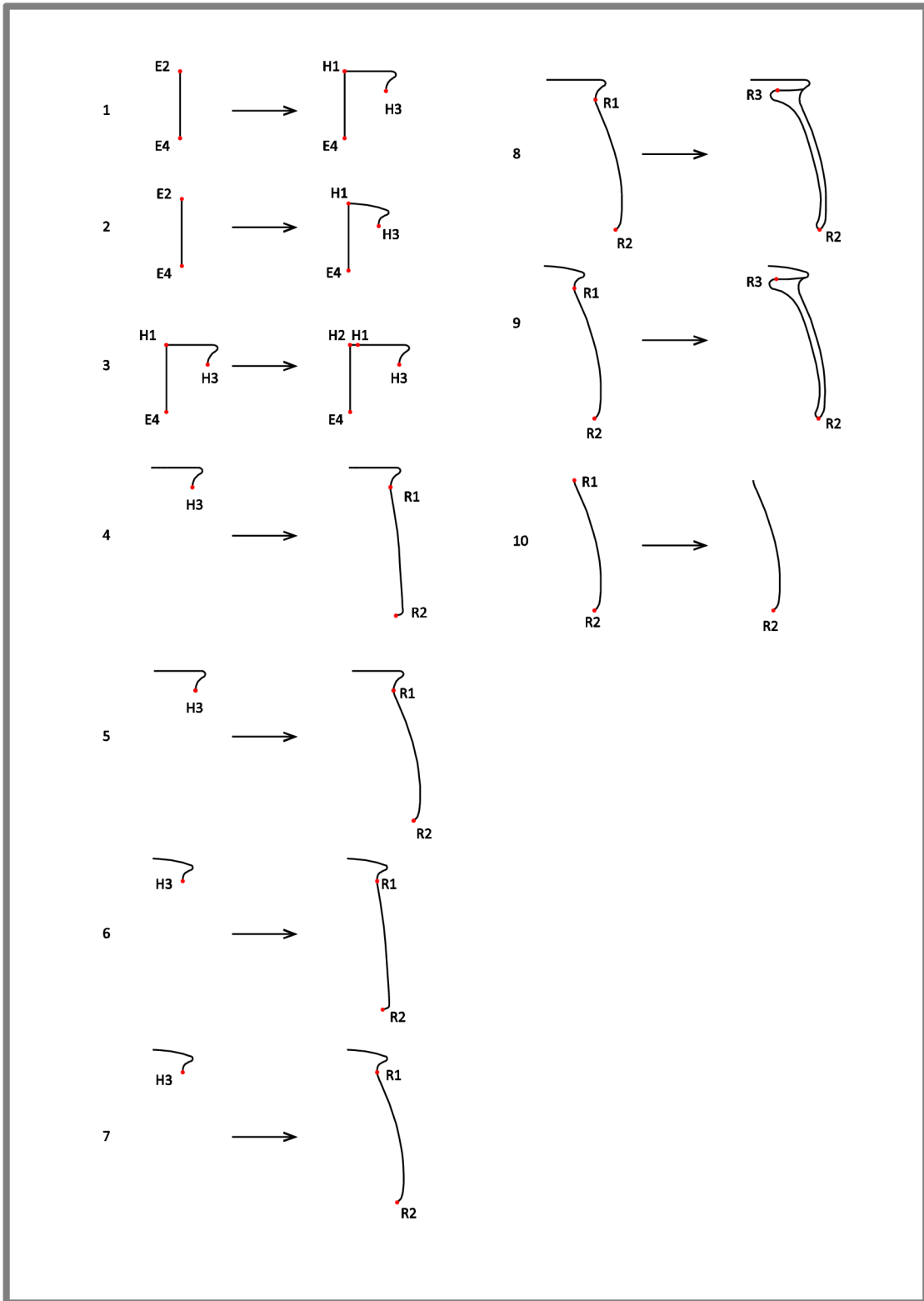

Fig. 9.2 Shape grammar rules, back of the handle

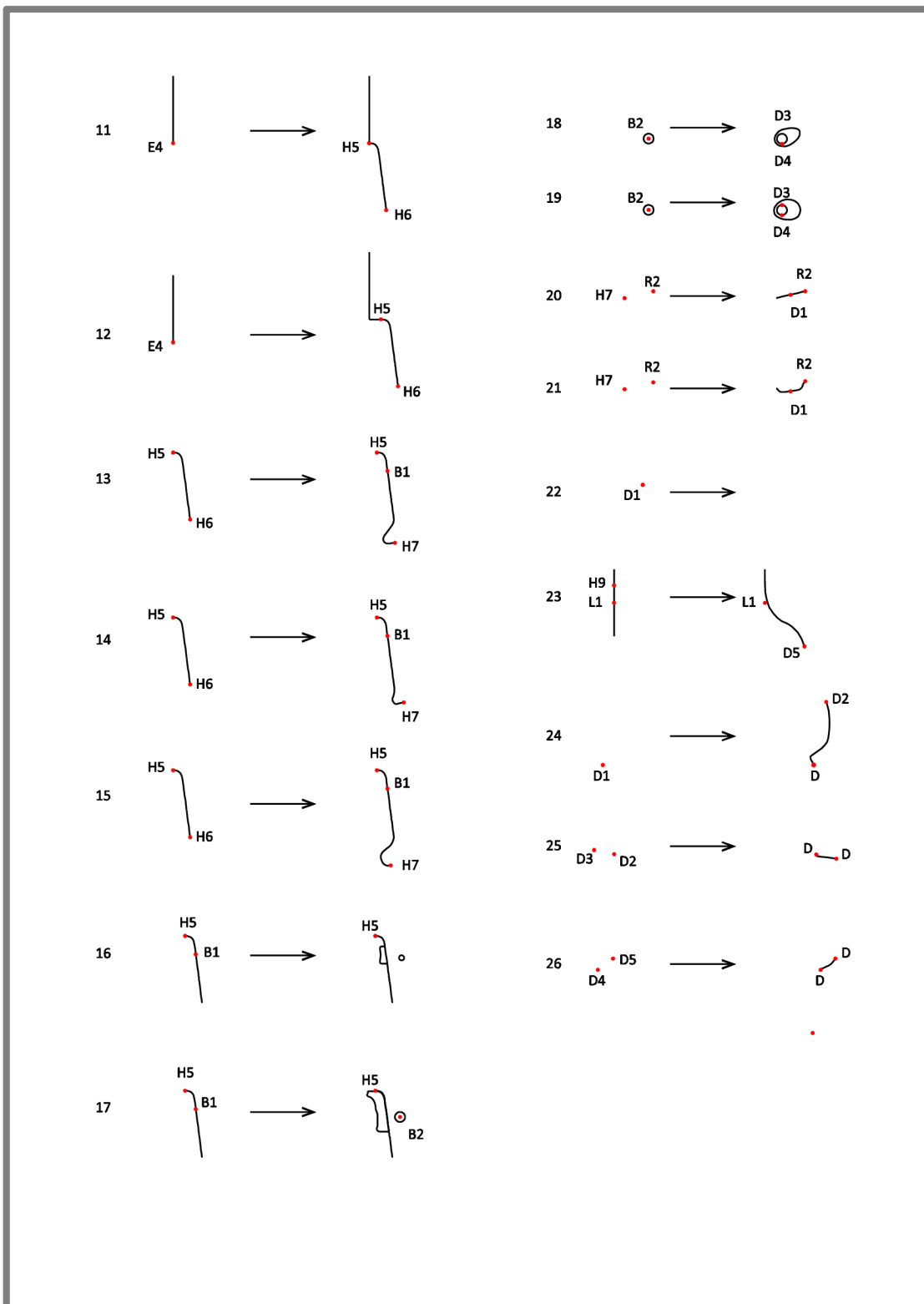

Fig. 9.3 Shape grammar rules, front of the handle, button and dividing

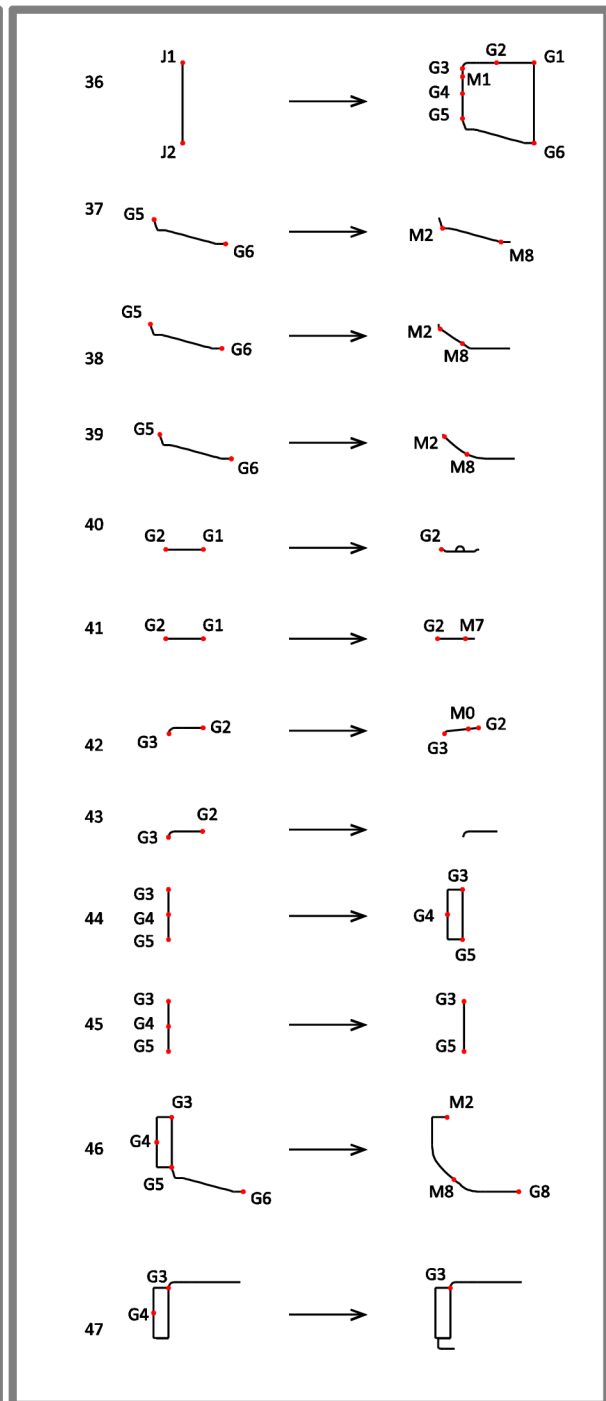
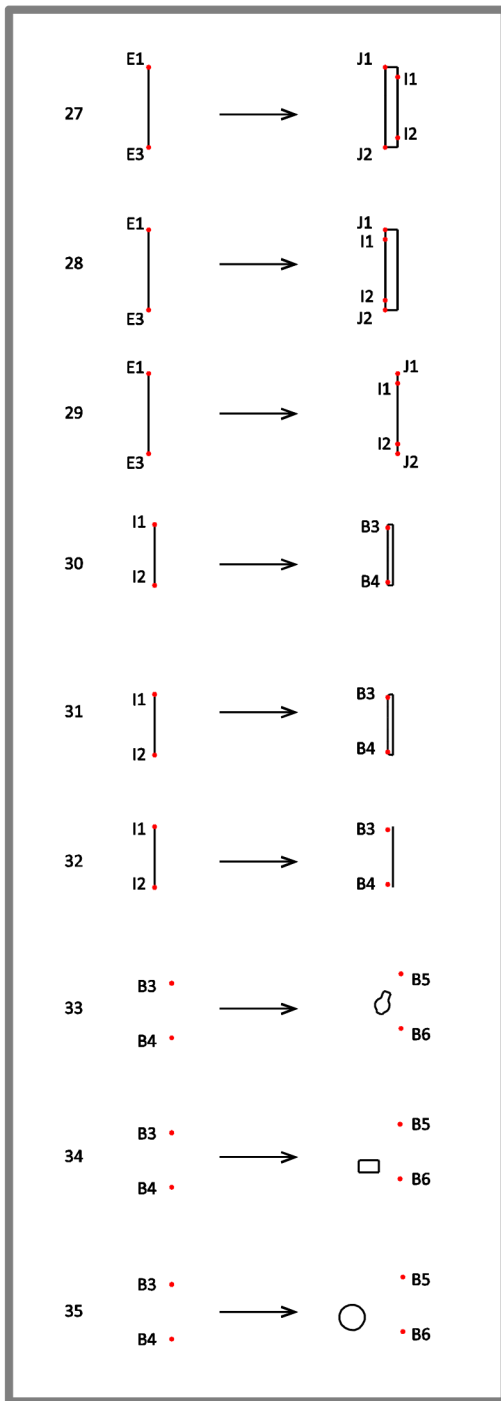

Fig. 9.4 Shape grammar rules, joining part and speed control

Fig. 9.5 Shape grammar rules, gearbox

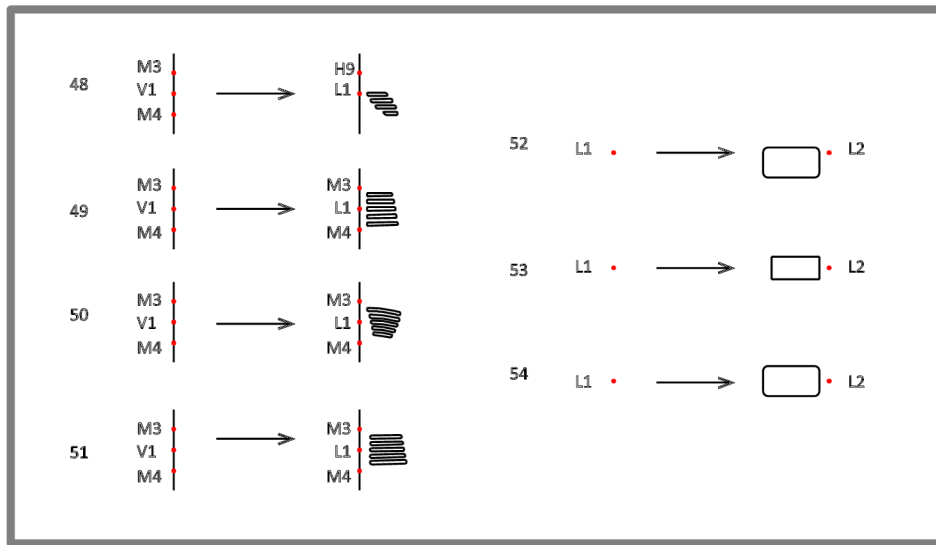

Fig. 9.6 Shape grammar rules, venting and logo

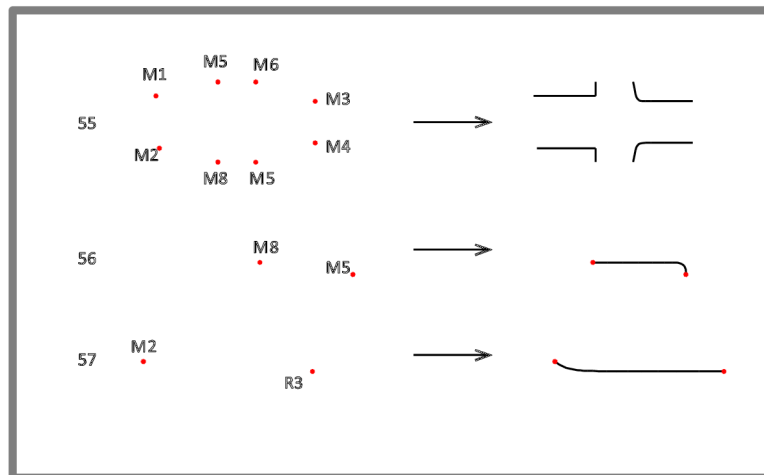

Fig. 9.7 Shape grammar rules, muscle curves

9.3 Verification

To verify the usability of the shape grammar, concepts from which the grammar is made of should be possible to be generated. As the grammar is consisting from the features that are parts of the drills EC 513D, EVP 13-2H3, EVP 13E -2H3 and the EVP 13 H-2C we should be able to create representations of them by selecting rules.

Every drill is starting at the initial shape. The EC 513 D is then made by applying rules 1, 3, 4 to create the back of the handle part. Next sequence is 11, 14, 16, 20 and 22. The handle is closed and not divided in the middle. Now joining element with the air suction may be created using rules 27 and 30. Last step seen in the figure 9.8 is rule 34 – placing a speed control button.

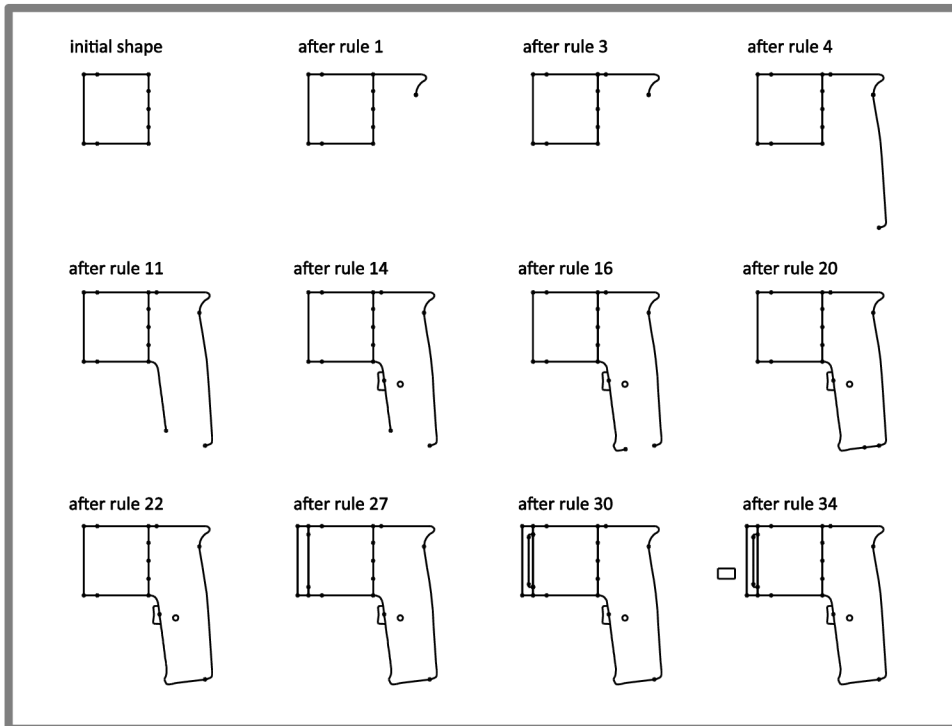

Fig. 9.8 Creating the EC 513D

With the rule 36 the gearbox is created and by rules 44, 47, 41, 43 and 37 modified. The last sequence is 49 applying the vents, 53 the logo sticker and 55 the muscle curves. After the last step no further rules can be applied.

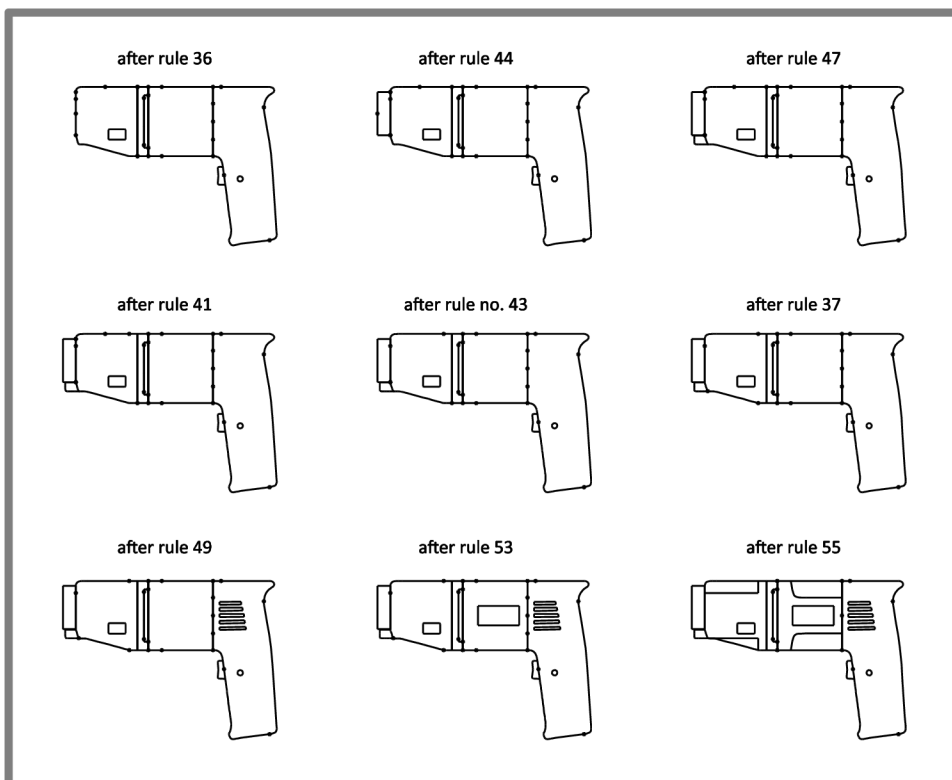

Fig. 9.9 Finishing the EC 513D

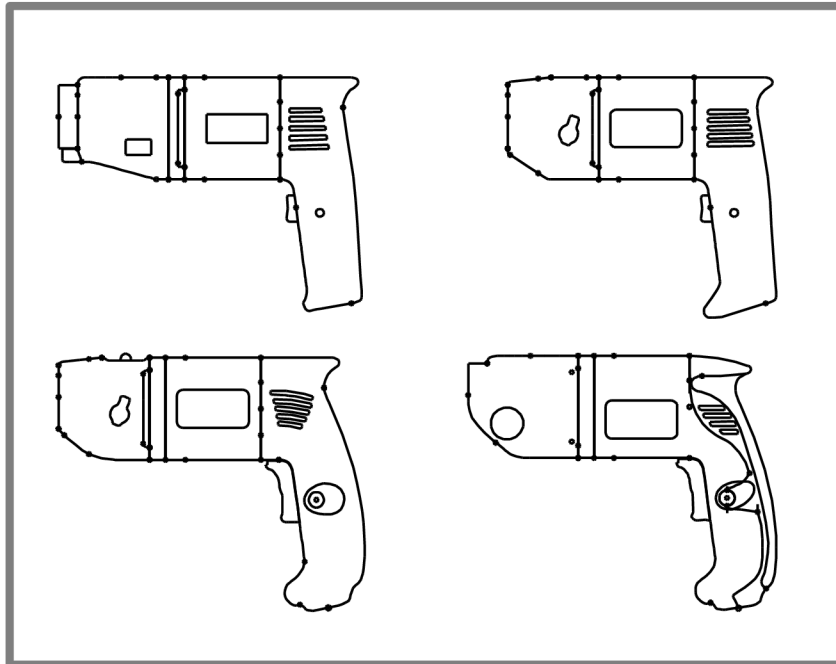

Fig. 9.10 Parental products generated by the shape grammar

Drill EVP 13-2H3 is generated by using rules 1, 3, 4, 11, 13, 16, 20, 22, 29, 30, 33, 36, 45, 38, 42, 41, 51 and 54 respectively. EVP 13E-2H3 is generated by a sequence of rules: 1, 5, 10, 12, 15, 17, 19, 21, 22, 28, 31, 33, 36, 45, 39, 42, 40, 50 and 54. The last of the parental drills can be generated using most of the rules from the 4. The generation goes by these steps: 2, 7, 9, 11, 15, 17, 18, 21, 24, 25, 48, 23, 26, 28, 32, 35, 36, 44, 46, 40, 43, 52, 56 and 57.

By creating representations of all 4 designs, the shape grammar is verified. All 4 representations without the muscle curves can be seen on figure 9.10.

9.4 Generating the drill concept

9.4

The purpose of the experiment is to generate representation of the drill that was designed as part of the thesis in the chapter 5. There is a certainty that the concept won't be generated precisely but the goal is to be as close as possible in the principles of the design and as close to the shape as possible. For example the control button of the concept simply cannot be generated but the principle is to have the control button included because anyway the producer is limited to use certain control buttons which are made by his contractor.

By application of successive rules 1, 5, 8, 11, 16, 14, 20, 22, 27, 30, 33, 36, 45, 39, 40, 42, 49 and 54 (Att 01 in attachments) we receive the most similar concept in design principle. The concept has rubber backing on the back part of the handle. Flat bottom of handle flat top of the handle, joining element, gearbox curved from the bottom and speed and impact control on the side and on the top. However there are issues that cannot be achieved by the current grammar in terms of shapes. The most problematic feature the muscle curves cannot be made similarly as at the concept (close to EC 513D) which would be rule 55, but the generation does not

create point M7 which is necessary and the muscles will be the same as the EVP 13E-2H3 has.

Possible parameterization on certain shapes could resolve some of the issues. For example if the rule 54 creating the logo sticker would be parameterized the size of the logo is not an issue. Same applies to the angle on the bottom of the handle. Most problematic for the parameterization would be the straight part of the back side of the handle, but possible. The shapes of the ventilation holes would be the same as designed when parameterized. The rubber shape that is on the handle of the concept wouldn't be as easy to manufacture therefore we may assume that, when produced, the concept would have this part looking differently. Figure 9.11 shows places where the parameterization couldn't help according to my opinion and addition of further rules would be needed.

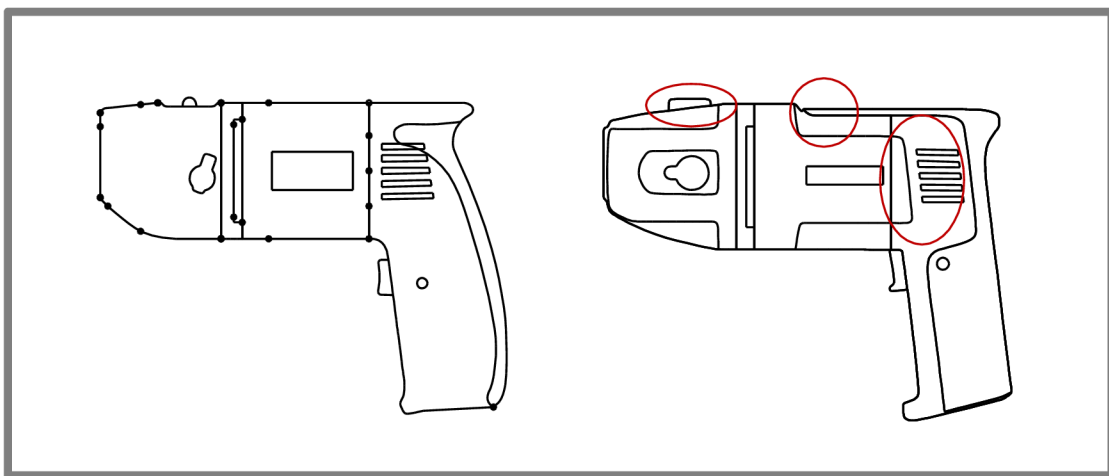

Fig. 9.11 The closest generated concept and representation of the concept used in previous analysis

The top control of the impact of the drill is not lowering the outline of the drill. This lowering is made by rule 40 which adds the button and lowers the outline. This is because the EVP 13 2H3 does not have this control on top and EC 513D has it in the front, therefore I have created the shape grammar to create the button within this rule. Simple labelling points and making it possible to have the button element inserted separately would work. At this it is a point of view of the creator of the rules if he takes the control button separately or not.

Secondly the muscle part on the engine would need modification of the rule creating the muscle curves. When changed and parameterized the issue could be solved.

The most difficult part is the top of the engine compartment. This could not be solved by parameterization as the initial shape would still be rectangular and further rule to modify this shape would have to be added, a rule that would lower or heighten the engine part above the flat line.

Still when modified, this shape grammar would not possibly generate a concept that would look like 100% same as the representation of the concept. As the concept would certainly change its look when manufactured the possibility of producing this concept by the grammar remain arguable. However the ability of creating designs that are innovation of the product can be decided by analysing the rules for creation EVP H-2C which is the successor of the EVP 13E 2H3 and the previous models.

9.5 Studying the rules for innovation and brand identity

When the rules of created shape grammar are reviewed we are able to identify which of them are innovating the models EC 513D, EVP 13E 2H3 and EVP 13 2H3 into the shape of the EVP 13 H-2C. As we are looking only for rules including shapes that are decomposed only from it.

First part of the shape that is appearing only on the newest model of the drill is rule no. 2 – this adds the rounded and lowered ledge on the back part of the handle. The rules 8 and 9 are bringing and innovation of the rubber backing and the rule 10 is declining it so it would not be needed either. As for the front part of the handle there are no rules which were not present in the foregoing tools. The rule 19 is bringing different shape around the speed locking button. The rules 23-26 with combination of rule 48 are however making large impact on the design of the drill as the handle would be divided on the front and back part – this is present only on the EVP 13 H-2C. New button for speed transmission is in by rule 35. The last of the rules that would change the design is the rule 46 which is innovation of the frontal part in a way that it looks slimmer. With these differences the muscle curves are appearing on different places with different progress.

Without the rules 2, 8, 9, 10, 19, 23, 24, 25, 26, 35, 46, 48 new concepts could be generated from the grammar based only on 3 products. However similar the generated concepts could be, the innovation of rubber backing, new transmission button and the dividing of the handle could not be brought in without rules that are coming from a new product. It was clear before that the SG can generate only concepts consisting from the elements that were put in to it. For enhancing the reach of the shape grammar usability another shapes and rules have to be added – this may be called innovation rules and shapes. The designer then controls these rules and adds another by his work. This is then a reflection to how the designer works normally, he analyses the dilemma, then inspires himself, by sketching he is searching for new rules and shapes and then adds them to currently existing grammar.

If the brand identity is given by shapes that are included in the basic set of the grammar and the innovation is set of rules and shapes given by the designer then the transfer of the brand identity happens as an adding the innovation rules and shapes to the grammar by a way that it does not interfere with the possibility of the creation of the past products. The new concept has to utilize a part of the shape grammar rules and the initial shape. In case of inserting a complete grammar for a new product it would probably cause a rebrand.

10 INTERVIEW WITH DESIGNER MILOSLAV ŠINDLER

The designer Miloslav Šindler was very kind to provide a short interview on his designs for the NAREX brand. However as he is being busy with work, there was a room for interview done by e-mail. There were 14 questions which he answered in text form, in Czech language. A translation of the lettering interview is given below.

1) Which products have you designed for the NAREX brand?

MŠ: Manual electric tools. I will not name it individually, as for the reason, that sometimes the type signification has changed, but from year 1994, when the NAREX was bought by Festo, some other products were designed by their designer in Stuttgart, others were bought in license from other brands and they were adapted for their manufacture.

2) How long are you cooperating or have you cooperated with the company?

MŠ: 1972 - 1989 and then 1994 - 2005

3) What is Your personal opinion on NAREX corporate identity and which element of the identity is vital?

MŠ: Development, correct development

4) Which NAREX product is the best representative of the company values? (The greatest icon of the NAREX brand).

MŠ: I hope, that (fortunately) none so far.

5) What do you think is a typical aesthetic, shape or construction element of the NAREX products?

MŠ: Who knows, for: "Panta rhei"

6) What were the manufacturer requirements on the design of impact drill EVP 13 H-2C?

a. Were there any particular requirements in terms of colours?

MŠ: Company colours were and are given.

b. Was there a requirement for keeping any particular shape?

MŠ: Fortunately there never was.

c. Was there any requirement for keeping any constructional element?

MŠ: This is a common thing, for example the ending of the shank for chuck, switch, cable deduction, max. width of air inlet and outlet,

areas of technical and company labels, not speaking about many pieces of the inner construction.

7) What was Your inspiration during design of EVP 13 H-2C?

MŠ: I do not take inspiration in design. For my work I took advantage of my previous experiences and from what happens around.

8) Was the EVP 13 H-2C designed as a completely new product or as an innovation of a previous one?

MŠ: New machines were designed also. Often a new product line (then with new type signification) was designed by a change in technical or performance parameters.

9) In case it was an innovation, what product did it innovate?

Unanswered

10) Did your drill design have an outreach to other products of the brand? For example, if you have designed shape or aesthetical elements, which could be repeated on other products?

MŠ: I have never proceeded like that.

11) Have you designed any distinctive aesthetic or constructional change which was not realised?

MŠ: That is after all a common progress of any design work. I have designed variant, as well as the mechanical engineers, with whom I have cooperated, designed technical solutions in possible variants, we adapted them and changed them after testing of the functional sample, even after prototype until the beginning of the production, there is no other way.

12) Estimate how long did it take to design drill EVP 13 H2C? Especially the time when sketches were used and different aesthetic solutions were researched?

MŠ: I cannot tell how long did the designing take, I went along continuously with the construction development, these were the years 2000-2001. Introductory period, when on the basis of the given technical structure (construction data) I proposed 3-4 variants of a shape, took maximally two months. Although after 1 month, the construction division was asking how far we are. I have designed the mentioned drill completely in CAID (software for design) on the computer. The mechanical engineers also modelled their solutions in CAD programs for some time, but between both applications there wasn't allowed straight transfer of the virtual model, as the IGES, STEP and so on.

And therefore I can only regret that the shape of the produced drill doesn't have exactly the smoothly tensed curves, which I have originally designed in the 3D.

Resume of the interview

Clearly the designers view is in contrast to what the research may show. As in the reality of industrial design many manufacturers restrictions are made and the shape can be distinctive than the artist designs. Mr. Šindler says that fortunately there weren't any shape requirements on the design part. This idea shows that the designers are working differently; they probably want to put some of their own creation to the design and not follow the restrictions as with following them no new design is needed.

The requirements on the construction part are however showing that the logo sticker analysis, which was introduced in chapter 8 of this work, is correct. There were some areas that can be given and maintained. Also probably the most key elements in the drill are not aesthetical but technical – chuck for the jaws. But these do not distinct the products too much on the first view.

Interesting fact is that M. Šindler thinks that the most important value of the identity is the development of the product which is in symbiosis with his answer to the product which is the most representative of the brands values. None is, as the development, when done correctly never ends.

As he concludes the searching for the shaping of the concepts took no more than two months, the question remains if using some shape grammar tool can make this work quicker. As mr. Šindler implies, the construction division wanted the solutions earlier and therefore if there were a tool that could help the designer, he could make variants sooner. But the speed of designing with the use of shape grammar tool has not yet been measured.

11 DISCUSSION

11.1 Elements of brand identity

Brand identity is a sum of desired properties' associated with the brand, these are to be given and cared for by the company planners. [3] The brand identity of NAREX is consisting of many elements and some of them are displayed also on their products. These products are communicating the identity and its message to users and customers. The thesis looked on three properties that are communicating with the customer – logo, colours and a shape.

“Power tools” is a product category where a lot of brands compete on the market with NAREX being one of them. Every brand in the basis uses a logo or a logotype to direct communication and evoking the brand. Brand itself does not differ in terms of the logo and logotype, as was shown before; the companies are having similar logotype on their products.

In terms of colours the identity is communicated mainly by the blue colour. The average perceptual area coverage from the analysis was 56,7 % for blue colour, 32,9 % for grey, 5,6 % and 4,8 % orange. This may serve as guidance for future work with the colour on the products. The recommendation is to adhere to this number whenever a new product is designed so it is not deviating from the product category. The blue should always remain the main colour and the grey or metal the second and a colour for the gearbox part. The orange details are perfect for informing the customers. The more recent black is to be decided whether the company wants to use it instead of grey or have to set a level of detail to which to use it. For example the black coverage of ASV 18-2A is out of the boundaries. But if new products will come in the future, the colour can be changed, but afterwards should be maintained consistently across the product categories.

The shape was probably the most difficult part of the identity to analyse. The feature proportion, orientation and shape analysis shown deviations across the studied range of products. In the past the possibilities of manufacturing were not as wide as they are nowadays. Therefore the shapes are changing from the easiest to produce to those most desired by the designer.

The proportion is probably based on the criteria of the mechanisms inside and the hands of the possible customer, therefore it will always change dependently on it. The orientation of the elements is based on the construction of the tool and therefore the shape would change if the construction changes. Shape outline analysis has shown the elements that are used by the designer and may be another key distinction from the competition on the market. These are the distinctive muscle lines which are appearing on EC513D drill and EBU 12, EBU 15F and EBU 15-16CA. The more novel designs such as the EVP 13E-2H3 are using muscle curves derived from the previous muscle curves. The EVP 13 H-2C and the EBU 13-14 E are using completely new lines. Here the company may decide to achieve a more consistent range of products in terms of shaping or stating some principle on which the shapes will be built upon. Also the features like bottom and top ledge of the handle are now inconsistent but in time they may become used again or derived to similar shapes to deliver more consistent brand identity.

Only the drill E603 II can be identified as not being the part of the identity, as it was primarily manufactured and designed by Siemens. Every product that was analysed is belonging to the brand identity. The identity takes all the historical

features and products with it and there cannot be made a statement as some product not being part of the identity if it was clearly manufactured by that brand and also sold under its name. The fact is the variety of the shapes used is making the brand defined less clearly than it was before.

11.2 Transferring the innovation

The shape grammars are used to generate shapes from a given set of shapes and rules. They can be parameterized and their utilisation can be enhanced by using computer support. The shape grammar is also used to capture shape elements of a group of products and then be used to generate other products that are belonging to the same group. The disadvantage is that they are always consisting of the elements from which the grammar is made of. There is a search for a tool that would support the designer when creating a new product based on the shape grammars and therefore it is important to study what happens when the product is innovated. The innovation can logically be witnessed when we know at least two products one being the innovated second.

By creating a shape grammar from a group of products I tried to generate a new design that would be similar to the one I have designed before knowing the key elements of the brand neither have created the shape grammar. The similarity of the generated product remained arguable as the shape grammar is partly a subjective. [11] However by knowing that one drill is the innovation of another I could have studied how the shape grammar would change when not having the rules which were used only on the creation of the lastly innovated design.

In my conclusion the innovation of the product is driven mainly by different aspects than a need for a new shape. In analysed drills it was for example a rubber coating on the backside of the handle; it may not change the complete outline but certainly is changing the appearance of the product. Perhaps a need for a surface that is not slippery was the thing that caused innovation of the design. These motivations for upgrading the product may be aesthetical, technical, ergonomic, consumer driven or other; however they are the reason behind the change of shape. Therefore the innovation

If the shape grammar should implement this as a tool that would support the designers work the tool should give a designer a chance to place an innovation rule or a shape into the grammar and then generate new concepts. These innovation rules may then be made from an inspirational source or given by the technological advancement that is currently being embedded to a new design.

11.3 Brand identity and the innovation

Based on a study of created shape grammar and the products from which the grammar is made a hypothesis is formulated: The brand identity is transferred to innovated product if the product can be generated by a shape grammar which consists of previously given brand identity shape grammar with its own set of initial shapes, set of shapes and a set of rules and an innovation grammar which adds to the brand identity grammar shapes and rules, but not one of the initial shape and neither all the shapes needed to generate innovated product.

12 CONCLUSION

The aim of this dissertation thesis was to study the brand identity displayed on the products through logo, colour and shape and its transfer throughout the innovation of the product. The focus was mainly on studying an actual brand identity.

Firstly the dilemma has been analysed in search for knowledge that would define the brand identity and its features and then in search for methods and approaches that can be used to study it. On the basis of this knowledge the aim has been set and method for the solution of the thesis designed.

Materials were gathered as 13 products manufactured by the NAREX. These were selected as samples throughout the history to find basic elements and core features of the brand. The successive models of the drills and grinders were photographed and retraced in software for analysis. Also new concept of a drill and an angle grinder were designed to study the brand identity in terms of shape and colour.

The materials were analysed in terms of logotype. Then they were studied in search for colour norms across the given set of products by a simple method made by the author. Afterwards the materials were searched for similarities in proportion orientation and shape by a method previously presented by Ranscombe et. Al. [20]. From these methods a partial aim of the thesis finding key elements of the brand identity was completed. As the elements are logotype, colour scheme and characteristic muscle curves and ledges. Recommendations for further work with these elements are given in previous chapters.

The shape grammar for the brand identity was created on a basis of 4 drills that were similar from the analysis. This grammar consisted of 57 rules and was verified by a possibility to generate the concepts from which it was made. This shape grammar was then used in an attempt to generate a new drill concept. Its rules were studied in search of definition how the brand identity is transferred throughout the innovation of the product. A hypothesis of how the transfer happens was given in previous chapter which means the main aim of the thesis and other partial milestones were completed.

Interview conducted with Miloslav Šindler prompts that the NAREX brand is not working consistently in terms of shape elements, but is working with colour schemes and construction elements, that they strive to maintain. The designers work as described from his perspective is different in terms of retaining key shape features to probably not restrict designer's creativity.

This work has brought a different point of view on studying how the innovation works in relation to shape grammar rules. It compared the actual designer's work and the shape grammars to find a hypothesis to make the shape grammars closer to the designers.

13 LIST OF ABBREVIATIONS AND SYMBOLS

<i>SG</i>	- shape grammar
<i>ICT</i>	- information technologies
<i>CAID</i>	- Computer aided industrial design
<i>CAD</i>	- Computer aided design
<i>HD</i>	- Harley Davidson
<i>No.</i>	- number

14 BIBLIOGRAPHY

- [1] COOPER, G. Pepsi turns air blue as cola wars reach for sky. In: *Independent* [online]. London: Independent Digital News & Media, 1996 [cit. 2016-07-07]. Available on: <http://www.independent.co.uk/news/pepsi-turns-air-blue-as-cola-wars-reach-for-sky-1302822.html>
- [2] AAKER, D. a E. JOACHIMSTHALER *Brand leadership*. New York: Free Press, 2000. ISBN 0684839245.
- [3] KARJALAINEN, T.-M. a D. SNELDERS Designing Visual Recognition for the Brand*. *Journal of Product Innovation Management* [online]. 2010, **27**(1), 6-22 [cit. 2016-07-27]. DOI: 10.1111/j.1540-5885.2009.00696.x. ISSN 07376782. Available on: <http://doi.wiley.com/10.1111/j.1540-5885.2009.00696.x>
- [4] KARJALAINEN, T. Strategic design language - transforming brand identity into product design elements. In: *Proceedings of the 10th International Product development Management Conference*. Bruxelles, 2003, s. 10-11.
- [5] Engineering shape grammars: where we have been and where we are going. CAGAN, Jonathan a Erik ANTONSSON *Formal engineering design synthesis*. 1. New York: Cambridge University Press New York, 2001, s. 65 - 92. ISBN 0-521-79247-9.
- [6] STINY, G. Introduction to shape and shape grammars. *Environment and Planning B: Planning and Design* [online]. 1980, **7**(3), 343-351 [cit. 2016-07-28]. DOI: 10.1068/b070343. ISSN 02658135. Available on: <http://epb.sagepub.com/lookup/doi/10.1068/b070343>
- [7] AGARWAL, M a J CAGAN. A Blend of Different Tastes: The Language of Coffeemakers. *Environment and Planning B: Planning and Design* [online]. 1998, **25**(2), 205-226 [cit. 2016-07-28]. DOI: 10.1068/b250205. ISSN 02658135. Available on: <http://epb.sagepub.com/lookup/doi/10.1068/b250205>
- [8] PUGLIESE, M. a J. CAGAN Capturing a rebel: modeling the Harley-Davidson brand through a motorcycle shape grammar: modeling the Harley-Davidson brand through a motorcycle shape grammar. *Research in Engineering Design*. 2002, **13**(3), 139-156. DOI: 10.1007/s00163-002-0013-1. ISSN 14356066. Available on: <http://dx.doi.org/10.1007/s00163-002-0013-1>
- [9] MCCORMACK, J., J. CAGAN a C. VOGEL Speaking the Buick language: capturing, understanding, and exploring brand identity with shape grammars: capturing, understanding, and exploring brand identity with shape grammars. *Design Studies*. 2004, **25**(1), 1-29. DOI: [http://dx.doi.org/10.1016/S0142-694X\(03\)00023-1](http://dx.doi.org/10.1016/S0142-694X(03)00023-1). ISSN 0142694x. Available on: <http://www.sciencedirect.com/science/article/pii/S0142694X03000231>
- [10] ANG, Mei, Huai CHONG, Alison MCKAY a Kok NG. *Capturing Mini Brand Using a Parametric Shape Grammar*. Berlin, Heidelberg: Springer Berlin Heidelberg, 2011, s. 1-12. DOI: 10.1007/978-3-642-25200-6_1. ISBN 9783642252006. Available on: http://dx.doi.org/10.1007/978-3-642-25200-6_1
- [11] ORSBORN, S., P. BOATWRIGHT a J. CAGAN Identifying product shape relationships using principal component analysis. *Research in Engineering Design* [online]. 2008, **18**(4), 163-180 [cit. 2016-07-28]. DOI: 10.1007/s00163-007-0036-8. ISSN 09349839. Available on: <http://link.springer.com/10.1007/s00163-007-0036-8>

- [12] ORSBORN, Seth, Jonathan CAGAN a Peter BOATWRIGHT. *Automating the Creation of Shape Grammar Rules*. Dordrecht: Springer Netherlands, 2008, s. 3-22. DOI: 10.1007/978-1-4020-8728-8_1. ISBN 9781402087288. Available on: http://dx.doi.org/10.1007/978-1-4020-8728-8_1
- [13] PRATS, M., S. GARNER, I. JOWERS a C. EARL Improving Product Design via Shape Grammar tool. In: *International Design conference - Design 2004*. Dubrovnik, Croatia, 2004, s. 6.
- [14] WANG, Y. a J. DUARTE Automatic generation and fabrication of designs. *Automation in Construction*. 2002, **11**(3), 291-302. DOI: [http://dx.doi.org/10.1016/S0926-5805\(00\)00112-6](http://dx.doi.org/10.1016/S0926-5805(00)00112-6). ISSN 09265805. Available on: <http://www.sciencedirect.com/science/article/pii/S0926580500001126>
- [15] SMYTH, M a E EDMONDS. Supporting design through the strategic use of shape grammars. *Knowledge-Based Systems*. 2000, **13**(6), 385-393. DOI: [http://dx.doi.org/10.1016/S0950-7051\(00\)00079-4](http://dx.doi.org/10.1016/S0950-7051(00)00079-4). ISSN 09507051. Available on: <http://www.sciencedirect.com/science/article/pii/S0950705100000794>
- [16] TRESCAK, T., M. ESTEVA a I. RODRIGUEZ A shape grammar interpreter for rectilinear forms. *Computer-Aided Design*. 2012, **44**(7), 657-670. DOI: <http://dx.doi.org/10.1016/j.cad.2012.02.009>. ISSN 00104485. Available on: <http://www.sciencedirect.com/science/article/pii/S0010448512000498>
- [17] LEE, H., T. HERAWAN a A. NORAZIAH Evolutionary grammars based design framework for product innovation. *Procedia Technology*. 2012, **1**, 132-136. DOI: <http://dx.doi.org/10.1016/j.protcy.2012.02.026>. ISSN 22120173. Available on: <http://www.sciencedirect.com/science/article/pii/S2212017312000278>
- [18] HSIAO, S., F. CHIU a S. LU Product-form design model based on genetic algorithms. *International Journal of Industrial Ergonomics*. 2010, **40**(3), 237-246. DOI: <http://dx.doi.org/10.1016/j.ergon.2010.01.009>. ISSN 01698141. Available on: <http://www.sciencedirect.com/science/article/pii/S0169814110000107>
- [19] RANSCOMBE, C., B. HICKS, G. MULLINEUX a B. SINGH Visually decomposing vehicle images: Exploring the influence of different aesthetic features on consumer perception of brand: Exploring the influence of different aesthetic features on consumer perception of brand. *Design Studies*. 2012, **33**(4), 319-341. DOI: <http://dx.doi.org/10.1016/j.destud.2011.06.006>. ISSN 0142694x. Available on: <http://www.sciencedirect.com/science/article/pii/S0142694X11000548>
- [20] RANSCOMBE, C., B. HICKS a G. MULLINEUX A method for exploring similarities and visual references to brand in the appearance of mature mass-market products. *Design Studies*. 2012, **33**(5), 496-520. DOI: <http://dx.doi.org/10.1016/j.destud.2012.04.001>. ISSN 0142694x. Available on: <http://www.sciencedirect.com/science/article/pii/S0142694X12000221>
- [21] JONES, C. a D. BONEVAC An evolved definition of the term 'brand': Why branding has a branding problem.: Why branding has a branding problem. *Journal of Brand Strategy*. 2013, **2**(2), 112. ISSN 2045855x. Available on: <http://search.ebscohost.com/login.aspx?direct=true&db=bth&AN=90583052&site=ehost-live>

- [22] STERN, B. What Does Brand Mean? Historical-Analysis Method and Construct Definition. *Journal of the Academy of Marketing Science* [online]. 2006, **34**(2), 216-223 [cit. 2016-07-28]. DOI: 10.1177/0092070305284991. ISSN 00920703. Available on: <http://link.springer.com/10.1177/0092070305284991>
- [23] OLINS, W. *Corporate identity: making business strategy visible through design*. Repr. London: Thames and Hudson, 1994. ISBN 0500278083.
- [24] WHEELER, A. *Designing brand identity: a complete guide to creating, building, and maintaining strong brands*. 1. Hoboken: John Wiley, 2003. ISBN 0471213268.
- [25] LABRECQUE, L. a G. MILNE Exciting red and competent blue: the importance of color in marketing. *Journal of the Academy of Marketing Science* [online]. 2012, **40**(5), 711-727 [cit. 2016-05-26]. DOI: 10.1007/s11747-010-0245-y. ISSN 00920703. Available on: <http://web.a.ebscohost.com/ehost/pdfviewer/pdfviewer?sid=cebdfa23-1054-4b5e-8dc2-0fe82dbc9997%40sessionmgr4004&vid=0&hid=4204>
- [26] LABRECQUE, L. a G. MILNE To be or not to be different: Exploration of norms and benefits of color differentiation in the marketplace. *Marketing Letters* [online]. 2013, **24**(2), 165-176 [cit. 2016-05-26]. DOI: 10.1007/s11002-012-9210-5. ISSN 09230645. Available on: <http://web.a.ebscohost.com/ehost/pdfviewer/pdfviewer?vid=8&sid=e1aa82b0-d423-4f8f-969d-03c67d40c41a%40sessionmgr4004&hid=4204>
- [27] PRATS, M., C. EARL, S. GARNER a I. JOWERS Shape exploration of designs in a style: Toward generation of product designs. *AI EDAM* [online]. 2006, **20**(03), - [cit. 2016-07-28]. DOI: 10.1017/S0890060406060173. ISSN 08900604. Available on: http://www.journals.cambridge.org/abstract_S0890060406060173
- [28] GIPS, J. *Computer implementation of shape grammars*. MIT Workshop on Shape Computation, Cambridge, USA: MIT, 1999. Available on: www.shapegrammar.org/implement.pdf
- [29] MCKAY, A., S. CHASE, K. SHEA a H. CHAU Spatial grammar implementation: From theory to useable software. *Artificial Intelligence for Engineering Design, Analysis and Manufacturing* [online]. 2012, **26**(02), 143-159 [cit. 2016-07-28]. DOI: 10.1017/S0890060412000042. ISSN 08900604. Available on: http://www.journals.cambridge.org/abstract_S0890060412000042
- [30] AD"R, G., V. ADR" a N. PASCU Logo Design and the Corporate Identity. *Procedia - Social and Behavioral Sciences* [online]. 2012, **51**, 650-654 [cit. 2016-07-28]. DOI: 10.1016/j.sbspro.2012.08.218. ISSN 18770428. Available on: <http://linkinghub.elsevier.com/retrieve/pii/S1877042812033563>
- [31] WALSH, M., K. WINTERICH a V. MITTAL Do logo redesigns help or hurt your brand? The role of brand commitment. *Journal of Product & Brand Management*. Emerald, 2010, **19**(2), 76-84. DOI: 10.1108/10610421011033421. ISSN 10610421. Available on: <http://dx.doi.org/10.1108/10610421011033421>
- [32] MCCORMACK, J. a J. CAGAN Supporting Designers' Hierarchies through Parametric Shape Recognition. *Environment and Planning B: Planning and Design* [online]. 2002, **29**(6), 913-931 [cit. 2016-08-15]. DOI: 10.1068/b12839. ISSN 02658135. Available on: <http://epb.sagepub.com/lookup/doi/10.1068/b12839>

- [33] MCCORMACK, J. a J. CAGAN Designing inner hood panels through a shape grammar based framework. *AI EDAM* [online]. 2002, **16**(04), - [cit. 2016-08-15]. DOI: 10.1017/S089006040216402X. ISSN 08900604. Available on: http://www.journals.cambridge.org/abstract_S089006040216402X
- [34] BERENDSOHN, R. Tool Test: 13 Corded Power Drills. In: *Popular mechanics* [online]. New York: Hearst communications, 2013 [cit. 2016-08-16]. Available on: <http://www.popularmechanics.com/home/tools/reviews/g1177/tool-test-13-corded-power-drills/>
- [35] BERENDSOHN, R. 7 Tough Right-Angle Grinders, Tested. In: *Popular Mechanics* [online]. New York: Hearst Communications, 2013 [cit. 2016-08-16]. Available on: <http://www.popularmechanics.com/home/tools/reviews/g1161/7-tough-right-angle-grinders-tested/>
- [36] VRABEC, V. a M. ONDRA *Interview about NAREX products from 20. 8. 2014.* Česká Lípa, 2014.
- [37] Electric Drill. In: *Blogspot* [online]. 2011 [cit. 2016-08-16]. Available on: <http://mechanicstips.blogspot.cz/2016/02/electric-drill.html>
- [38] Building a small trolling boat - forum. In: *Boat Design Net* [online]. Boat Design Net, 2012 [cit. 2016-08-16]. Available on: http://www.boatdesign.net/forums/attachments/wooden-boat-building-restoration/71309d1339199256-building-small-trolling-boat-_angle_grinder_bevel_gear_.jpg
- [39] *Úřad průmyslového vlastnictví* [online]. Czech republic, b.r. [cit. 2016-08-16]. Available on: www.upv.cz
- [40] *Webové stránky firmy Narex* [online]. Česká Lípa, b.r. [cit. 2015-09-15]. Available on: <http://www.narex.cz/>
- [41] Orange is the New Black: New Logo, Identity, and Packaging for Black+Decker by Lippincott. In: *UnderConsideration: Brand New* [online]. 2014 [cit. 2016-08-16]. Available on: http://www.underconsideration.com/brandnew/archives/new_logo_identity_and_packaging_for_blackdecker_by_lippincott.php#.V7Mb002LSUk
- [42] Power Tool Logo Collection. *Find that logo* [online]. 2016 [cit. 2016-08-16]. Available on: <http://www.findthatlogo.com/power-tool-logo-list/>
- [43] Tool Manufacturers and Tool Brands by Logo. In: *Protool reviews* [online]. 2016 [cit. 2016-08-16]. Available on: <http://www.protoolreviews.com/brands/>
- [44] List of RAL colors. In: *Wikipedia: the free encyclopedia* [online]. San Francisco (CA): Wikimedia Foundation, 2001 [cit. 2015-09-15]. Available on: https://en.wikipedia.org/wiki/List_of_RAL_colors

LIST OF FIGURES

Fig. 2.1 Example of shape grammar [5]	16
Fig. 2.2 Shapes generated by grammar from fig 2.1 [5]	16
Fig. 2.3 Real and generated coffee maker [6]	19
Fig. 2.4 Linear representation of front fender [7]	21
Fig. 2.5 Results of recognition of models generated by shape grammar [7]	21
Fig. 2.6 Building front mask of a Buick with shape grammar [8]	22
Fig. 2.7 Shape grammar generated innovative front masks [8]	23
Fig. 2.8 Examples of generated products by genetic algorithm	26
Fig. 2.9 Levels of decomposition of vehicles [18]	29
Fig. 5.1 Right view on ASV 18-2A	35
Fig. 5.2 Right view on EBU 13-14 CE	36
Fig. 5.3 EC 513D	37
Fig. 5.4 Left view on EVP 13H-2C	38
Fig. 5.5 Section through corded drill [34]	40
Fig. 5.6 DeWalt drill [33]	40
Fig. 5.7 Authors sketch of the drill	41
Fig. 5.8 Concept of the impact drill	42
Fig. 5.9 Mechanism of an angle grinder [35]	43
Fig. 5.11 Makita angle grinder [36]	44
Fig. 5.12 Designed concept of angle grinder	45
Fig. 6.1 Registered symbol of the narex brand [37]	46
Fig. 6.2 Actually used logo [38]	46
Fig. 6.3 Example of using the logotype on the product	47
Fig. 6.4 Examples of other brand logotypes [39] [40] [41]	47
Fig. 6.5 New logo of Black & Decker brand [39]	48
Fig. 7.1 Most probable shades used by the brand [42]	49
Fig. 7.2 One of the studied product with problematic part outlined	50
Fig. 8.1 Decomposing the EC 513D: top left – outline, top right - part features, bottom left – added muscle curves, bottom right - graphic	54
Fig. 8.2 Graph of silhouette areas	56
Fig. 8.3 Graph of feature gearbox areas	57
Fig. 8.4 Graph of feature engine areas	57
Fig. 8.5 Graph of drill silhouette areas	58
Fig. 8.6 Graph of drill gearbox areas	58
Fig. 8.8 Graph of areas made by drill muscles	59
Fig. 8.7 Graph of drill engine areas	59
Fig. 8.9 Graph of silhouette areas from a top view	60
Fig. 8.10 Graph of gearbox feature areas from a top view	61
Fig. 8.10 Graph of engine feature areas from a top view	61
Fig. 8.11 Graph of feature muscle area from a top view	62
Fig. 8.12 Graph of silhouette areas of grinder from the top view	62
Fig. 8.13 Graph of angle grinder gearbox areas from a top view	63
Fig. 8.15 Graph of angle grinder handle areas from a top view	63
Fig. 8.14 Graph of angle grinder engine areas from a top view	63
Fig. 8.16 Orientation graph, gearbox, side views	65
Fig. 8.17 Orientation graph, engine, side views	65
Fig. 8.18 Orientation graph, handles, side views	66
Fig. 8.20 Orientation graph, ventilation, side views	67
Fig. 8.19 Orientation graph, control buttons, side views	67
Fig. 8.21 Orientation graph, joining element, side views	68
Fig. 8.22 Orientation graph, engine, top view	69
Fig. 8.23 Orientation graph, gearbox, top view	69
Fig. 8.24 Orientation graph, muscles, top view	70
Fig. 8.25 Orientation graph, gearbox muscle, top view	71
Fig. 8.26 Orientation graph, brake and speed control, top view	71

Fig. 8.27 Graph of silhouette shapes, right view	73
Fig. 8.29 Graph of engine shapes, right view	74
Fig. 8.28 Graph of gearbox shapes, right view	74
Fig. 8.30 Graph of handle shapes, right view	75
Fig. 8.31 Graph of control button shapes, right view	75
Fig. 8.32 Graph of muscle curves, right view	76
Fig. 8.33 Graph of logo sticker shapes, right view	77
Fig. 8.34 Graph of joining element shapes, right view	77
Fig. 8.35 Graph of silhouette shapes, top view	78
Fig. 8.37 Graph of engine shapes, top view	79
Fig. 8.36 Graph of gearbox shapes, top view	79
Fig. 8.38 Graph of handle shapes, top view	80
Fig. 8.40 Graph of gearbox muscle shapes, top view	81
Fig. 8.39 Graph of muscle curves, top view	81
Fig. 8.41 Graph of brake and speed button shapes, top view	82
Fig. 9.1 Initial shape	84
Fig. 9.2 Shape grammar rules, back of the handle	86
Fig. 9.3 Shape grammar rules, front of the handle, button and dividing	87
Fig. 9.4 Shape grammar rules, joining part and speed control	88
Fig. 9.5 Shape grammar rules, gearbox	88
Fig. 9.7 Shape grammar rules, muscle curves	89
Fig. 9.6 Shape grammar rules, venting and logo	89
Fig. 9.8 Creating the EC 513D	90
Fig. 9.9 Finishing the EC 513D	90
Fig. 9.10 Parental products generated by the shape grammar	91
Fig. 9.11 The closest generated concept and representation of the concept used in previous analysis	92

LIST OF TABLES

Table 7.1 Results of the method test on 20 3D models with marked deviations larger than 3%	51
Table 7.2 Colour percentage retrieved on the basis of five views	52
Table 7.3 Colour percentage retrieved on the basis of right view	53
Table 8.1 Right view – proportions in mm ²	55
Table 8.2 Left view – proportions in mm ²	56
Table 8.3 Feature areas from top view in mm ²	60
Table 8.4 Degree of similarity, drill concept compared to previous drills	83
Table 8.5 Degree of similarity, grinder concept compared to previous grinders	83

LIST OF ATTACHMENTS

Att. 01 – Generating drill concept through shape grammar