

School of Doctoral Studies in Biological Sciences  
University of South Bohemia in České Budějovice  
Faculty of Science



## **A role of Sirt1 in the Notch signalling pathway**

Ph.D. thesis

Mgr. Matej Horváth

Supervisor: RNDr. Alena Krejčí, Ph.D.

University of South Bohemia, Faculty of science, Department of Molecular Biology  
Biology centre of the Czech Academy of Sciences, Department of Entomology

České Budějovice, 2017

This thesis should be cited as:

Horvath, M., 2017: A role of Sirt1 in Notch signalling pathway. Ph.D. Thesis. University of South Bohemia, Faculty of Science, School of Doctoral Studies in Biological Sciences, České Budějovice, Czech Republic, 113 pp.

### **Annotation**

The aim of this thesis was to examine role of Sirt1 in the Notch signalling pathway, using *Drosophila* as a model organism. Based on *in vivo* and *in vitro* studies, we conclude that Sirt1 plays a positive role in Notch signalling. In embryonic S2N cells, Sirt1 is responsible for the protection from metabolic stress-induced down-regulation of subset of E(Spl) genes. During development, Sirt1 is responsible for proper Notch-dependent specification of SOPs and wing development. Sirt1 can regulate the Notch signalling on multiple levels via deacetylation of various substrates involved in the Notch signalling revealed by our proteomic survey.

### **Declaration**

I hereby declare that my Ph.D. thesis is my work alone and that I have used only those sources and literature detailed in the list of references.

Further, I declare that, in accordance with Article 47b of Act No. 111/1998 Coll. in the valid wording, I agree to the publication of my Ph.D. thesis [in unabbreviated form – in the form arising from the omission of marked parts archived at the Faculty of Science] in electronic form in a publicly accessible part of the STAG database operated by the University of South Bohemia in České Budějovice on its webpage, with the preservation of my rights of authorship to the submitted text of this thesis. Further, I agree to the publication, via the same electronic portal, in accordance with the detailed regulations of Act 111/1998 Coll., of the reviews of the supervisor and opponents of the thesis as well as the record of proceedings and result of the defence of the thesis. I also agree to the comparison of the text of my thesis with the Theses.cz database operated by the National Registry of Theses and the Plagiarism Tracing System.

## **Declaration [in Czech]**

Prohlašuji, že svoji disertační práci jsem vypracoval samostatně pouze s použitím pramenů a literatury uvedených v seznamu citované literatury.

Prohlašuji, že v souladu s § 47b zákona č. 111/1998 Sb. v platném znění souhlasím se zveřejněním své disertační práce, a to v úpravě vzniklé vypuštěním vyznačených částí archivovaných Přírodovědeckou fakultou elektronickou cestou ve veřejně přístupné části databáze STAG provozované Jihočeskou univerzitou v Českých Budějovicích na jejích internetových stránkách, a to se zachováním mého autorského práva k odevzdanému textu této kvalifikační práce. Souhlasím dále s tím, aby toutéž elektronickou cestou byly v souladu s uvedeným ustanovením zákona č. 111/1998 Sb. zveřejněny posudky školitele a oponentů práce i záznam o průběhu a výsledku obhajoby kvalifikační práce. Rovněž souhlasím s porovnáním textu mé kvalifikační práce s databází kvalifikačních prací Theses.cz provozovanou Národním registrem vysokoškolských kvalifikačních prací a systémem na odhalování plagiátů.

České Budějovice, 25.5.2017

Matej Horváth

This thesis originated from a partnership of Faculty of Science, University of South Bohemia; Institute of Entomology, Biology Centre of the CAS and Institute of Parasitology, Biology Centre of the CAS supporting doctoral studies in the Molecular biology and genetics programme.

Part of the thesis was done in the Department of Biochemistry, Erasmus Medical Centre, Rotterdam, Netherlands



Přírodovědecká  
fakulta  
Faculty  
of Science



Institute of Parasitology  
Biology centre CAS



Institute of Entomology  
Biology centre CAS

### **Financial support**

Czech Grant Agency GACR P305-14-08583S

EMBO Installation grant

EMBO Short-Term Fellowship ASTF\_527-2012

Grant Agency of University of South Bohemia GAJU 037/2012/P

# Acknowledgments

In this part of this thesis I want to thank all people who participated by any means on my epic journey through my PhD study. This part will probably get personal and a bit emotional so if you are not interested, go directly to the science part.

First, I want to thank Alena for giving me the opportunity to work on this project and to participate on establishing the lab (which was the fun part). Thank you for securing the funding, reading and correcting “written” part of my training, teaching me how to present and sell the work I do and of course pushing me to my limits and out of my comfort zone. We had our differences but we managed to compromise and get to the finish line together and that is all that matters.

I cannot forget about our precious lab members. Namely Vierka who was my partner in crime from the start and for guarding my back. Big thanks belong to our two “Little misses Sun-shine”, always giggling and in good mood, Zorana and Dajana. For making the lab more joyful place and for listening to my “experience”. Special thanks to Raquel, the “voice” of the lab (not talking only about her amazing singing), teaching me that time is the only resource you cannot buy or recharge so make it count: be feral, be accurate, be organized and please “Don not waste my fucking time!”. Of course, our never-ending discussion about the gender and national differences and inequalities, crazy ideas and life in general were more than rewarding.

Another thanks belong: to the members of our sister labs of Dolezal’s and Bruce’s for sharing resources, space and equipment and keeping things “cool” between us; to members of PARU and ENTU for letting me expand to their territories. Special thanks belong to people from Lukes’s and Zikova’s lab for taking me under their wings and showing me that the scientists know how to party. My thanks go to Karolina from our twin lab, for writing the guide of “What to do when you expect...” and helping me realized that nerds will always stick together no matter what. Special thanks belong to Priscilla, my biochemistry guru and very close friend. Thank you for keeping me in line and checking on me, teaching me the ways of the “force”, fruitful discussions about science, music, life... No topic was a challenge for us. It was a real pleasure.

Thank you, random people of the world who came and took off but still left something in me, personal or professional. I hope for having beer with you guys, very soon.

My big thanks also belong to my family and friends outside the field who most of the time had zero idea of what I do, why I do it or what it is really for. They saw me change over the years but still stayed with me. They were doing their best to keep me human and made me to see the world from another perspective than the one from the bench.

Although, my biggest thanks are going to Marketa. No words can describe what part she played in my life during these tough years. She met me in my worst days but she still saw something good in me and stick around. She suffered a lot not only for me but also because of me and for that I am truly sorry. You were a faithful friend, a devoted partner, a true support but from another world and that is why I sucked so much in everything I did. I honestly and sincerely thank you for everything you did for me and I feel bad about the fact that I will never be able to repay you in your “currency”. I am so sorry. Be happy and be well. This thesis is dedicated to you.

Lastly, big thanks belong to David for proofreading and fixing the English.

Sincerely, your one and only

Matej

## List of papers and author's contribution

The thesis is based on the following papers (listed chronologically):

**Horvath M**, Mihajlovic Z, Slaninova V, Perez-Gomez R, Moshkin Y, Krejci A. 2016  
The silent information regulator 1 (Sirt1) is a positive regulator of the Notch pathway in *Drosophila*. *Biochemical journal*, 473, 4129-4143 (2016).  
<http://dx.doi.org/10.1042/BCJ20160563>

*Matej Horvath designed and performed all the proteomic experiments, Western Blots Co-IPs and helped with MS data analysis. Additionally, he confirmed interaction of Sirt1 with the Notch pathway and evaluation of the MS data by genetic interactions studies. He also performed pivotal and optimisation experiments for the cell culture work, regarding drug and Sirt1 RNAi treatments.*

## List of abbreviations

<b>2-DG</b>	2-deoxyglucose
<b>2-DG-P</b>	2-deoxyglucose phosphate
<b>AA</b>	Amino acid
<b>ACMS</b>	$\alpha$ -amine- $\beta$ -carboxymuconate- $\epsilon$ -semialdehyde
<b>A-CoA</b>	Acetyl-Coenzyme A
<b>ADP</b>	Adenosine diphosphate
<b>ADPR</b>	Adenosine diphosphoribose
<b>Akt</b>	Protein kinase B
<b>AMPK</b>	AMP-activated protein kinase
<b>ANK</b>	Ankyrin repeat domain
<b>ANOVA</b>	Analysis of variance
<b>ATP</b>	Adenosine triphosphate
<b>bp</b>	base pair (of DNA)
<b>cADPR</b>	Cyclic ADP-ribose
<b>CDK</b>	Cyclin dependent kinase
<b>CK</b>	Creatine kinase
<b>CSL</b>	CBF1, Su(H), Lag1 (canonical Notch transcription factors)
<b>CtBP</b>	C-terminal binding protein
<b>DMSO</b>	Dimethyl sulfoxide
<b>DNA</b>	Deoxyribonucleic acid
<b>DSHB</b>	Developmental Studies Hybridoma Bank
<b>DSL</b>	Delta, Serrate, Lag2 (canonical Notch ligands)
<b>DYRK</b>	Dual specificity tyrosine-phosphorylation-regulated kinase
<b>E(Spl)</b>	Enhancer of Split
<b>EC<sub>50</sub></b>	Half maximal effective concentration
<b>ECL</b>	Enhanced chemiluminescence
<b>EDTA</b>	Ethylenediamine tetraacetic acid
<b>ESO</b>	External sensory organ
<b>FAD</b>	Flavin adenine dinucleotide
<b>GOF</b>	Gain of function
<b>HIF</b>	Hypoxia-inducible factor
<b>HK</b>	Hexokinase
<b>HRP</b>	Horseradish peroxidase



<b>IC<sub>50</sub></b>	Half maximal inhibitory concentration
<b>ILK</b>	Integrin-linked kinase
<b>K<sub>M</sub></b>	Michaeli's constant
<b>LOF</b>	Loss of function
<b>MAPK</b>	Mitogen-activated protein kinase
<b>mTOR</b>	Mechanistic target of rapamycin
<b>NA</b>	Nicotinic acid
<b>NAD<sup>+</sup></b>	Nicotinamide adenine dinucleotide oxidized
<b>NADH</b>	Nicotinamide adenine dinucleotide reduced
<b>NADP<sup>+</sup></b>	Nicotinamide adenine dinucleotide phosphate oxidized
<b>NADPH</b>	Nicotinamide adenine dinucleotide phosphate reduced
<b>NAM</b>	Nicotine amide
<b>NAMN</b>	Nicotinamide mononucleotide
<b>N<sup>ECD</sup></b>	Notch receptor extracellular domain
<b>NES</b>	Nuclear export sequence
<b>N<sup>EXT</sup></b>	Notch receptor extracellular truncation
<b>N<sup>ICD</sup></b>	Notch receptor intracellular domain
<b>NLK</b>	Nemo-like kinase
<b>NLS</b>	Nuclear localisation sequence
<b>NMNAT</b>	NAM mononucleotide adenylyltransferase
<b>NR</b>	NAM riboside or Notch receptor
<b>NRE</b>	Notch response element
<b>NRR</b>	Negative regulatory region
<b>OPA</b>	Glutamine rich domain
<b>PAGE</b>	Polyacrylamide gel electrophoresis
<b>PARP</b>	Poly-ADP-ribose polymerase
<b>PBS</b>	Phosphate buffer saline
<b>pCAF</b>	p300/(CREB binding protein) associated factor (acetyl transferase)
<b>PCR</b>	Polymerase chain reaction
<b>PEST</b>	Proline (P), Glutamic acid (E), Serine (S), Threonine (T) rich motif
<b>PGI</b>	Phospho-glucose isomerase
<b>PI3K</b>	Phosphatidylinositol-3-kinase
<b>PTM</b>	Post-translational modification
<b>QA</b>	Quinolic acid
<b>RAM</b>	RBP-Jk-associated module

<b>RFP</b>	Red fluorescent protein
<b>RNA</b>	Ribonucleic acid
<b>RNAi</b>	Ribonucleic acid Interference
<b>ROS</b>	Reactive oxygen species
<b>SIRT</b>	Silent information regulator two
<b>SOP</b>	Sensory organ precursor
<b>Su(H)</b>	Suppressor of Hairless
<b>TACE</b>	Tumour necrosis factor-alpha converting enzyme
<b>TAD</b>	Trans-activation domain
<b>TAD</b>	Trans-activation domain
<b>T-ALL</b>	T-cell acute lymphoblastic leukaemia
<b>TCA</b>	Tricarboxylic acid cycle
<b>TD</b>	Transmembrane domain

# Table of contents

Acknowledgments .....	iv
List of abbreviations .....	vii
1.0 Introduction .....	1
1.1 The Notch signalling pathway .....	1
1.1.1 Brief history of the Notch field .....	1
1.1.2 Canonical Notch signalling pathway in <i>D. melanogaster</i> .....	2
1.1.2.1 Mechanism of the Notch signalling in <i>D. melanogaster</i> .....	4
1.1.3 Role of Notch during development of <i>D. melanogaster</i> .....	5
1.1.3.1 Lateral inhibition.....	5
1.1.3.2 Lineage decision.....	7
1.1.3.3 Boundary formation.....	8
1.2 Fine-tuning of Notch response by post-translational modifications .....	9
1.2.1 Proteolytic cleavage .....	9
1.2.2 Glycosylation .....	11
1.2.3 Acetylation.....	13
1.2.4. Phosphorylation .....	14
1.2.5 Ubiquitination.....	16
1.1.5.1 Ubiquitination of Notch ligands .....	16
1.2.5.2 Ubiquitination of Notch receptor .....	17
1.3 Connection of Notch signalling with basal metabolism .....	18
1.3.1 Overview of basal metabolism .....	19
1.3.2 Regulation of metabolism by Notch signalling .....	21
1.3.2.1 Catabolism .....	21
1.3.2.2 Anabolism .....	22
1.3.3 Regulation of Notch signalling by basal metabolism.....	22
1.4 NAD <sup>+</sup> and NAD <sup>+</sup> converting enzymes.....	24
1.4.1 Biosynthesis of NAD <sup>+</sup> .....	25
1.2.2 Overview of NAD <sup>+</sup> converting enzymes.....	26
1.4.2.1 ADP-ribose transferase (ARTs).....	28
1.4.2.2 NADase .....	28
1.4.2.3 Sirtuins.....	29
1.5 Regulation of SIRT1 activity .....	35
1.5.1 Regulation of Sirt1 activity at the transcriptional level.....	35
1.5.1.1. Regulation of SIRT1 expression as a response to changes in basal metabolism.....	36

1.5.1.2 Regulation of SIRT1 expression as a response to DNA damage .....	37
1.5.2 Post-transcriptional regulation of SIRT1 .....	37
1.5.2.1 miRNAs.....	37
1.5.2.2 RNA binding proteins .....	37
1.5.3 Post-translational regulation of SIRT1.....	38
1.5.3.1 Phosphorylation.....	38
1.5.4 Modulation of SIRT1 activity by NAD <sup>+</sup> availability .....	41
2.0 Aims .....	43
3.0 Materials and Methods.....	44
3.1 Fly Work.....	44
3.1.1 General maintenance of flies and used fly strains .....	44
3.1.2 Quantification of observed phenotype .....	44
3.1.3 Immunostaining of SOPs in wing imaginal discs .....	45
3.2 Expression studies of Notch target genes .....	46
3.2.1 Notch pathway activation.....	46
3.2.2 S2N treatments.....	46
3.2.3 mRNA quantification.....	47
3.2.4 Luciferase assay .....	47
3.3 Proteomic studies of Sirt1 interactors.....	48
3.3.1 Embryo collection.....	48
3.3.2 Nuclear protein extracts.....	48
3.3.3 Immunoprecipitation .....	48
3.3.4 Mass spectrometry.....	48
3.4 Baculovirus expression and purification of Su(H) from Hi5 cells .....	49
3.4.2 Su(H) expression .....	49
3.4.3 Quantification of Su(H) acetylation .....	49
4.0 Results .....	51
4.1 Notch pathway is sensitive to changes in cellular metabolism.....	51
4.2 Sirt1 is needed for proper expression of E(Spl) genes .....	54
4.3 Metabolic sensitivity of E(Spl) genes is mediated by Sirt1 .....	57
4.4 Sirt1 positively influences Notch pathway during development of <i>D. melanogaster</i> .....	60
4.4.1 Sirt1 positively interacts with Notch pathway during specification of SOP cells.....	60
4.4.2 Sirt1 positively interacts with Notch pathway during wing development ..	62
4.5 Sirt1 physically interacts with members of Notch pathway .....	65
4.6 Sirt1 physically interacts and deacetylates Su(H).....	68

5.0 Discussion .....	70
5.1 Known connections of Sirt1 with Notch signalling .....	70
5.2 Sirt1 activity counters the 2-DG sensitivity of several E(Spl) genes.....	72
5.3 Sirt1 may fine-tune Notch signalling via protein-protein interaction with Notch pathway members and transcription regulatory proteins .....	74
5.4 Role of Sirt1-Notch interaction in <i>Drosophila</i> development.....	77
5.5 Summary .....	78
6.0 Bibliography .....	80
7.0 Supplement.....	108

*“Sometimes doing the same thing a second time when it hasn't worked the first is indeed just foolish. But sometimes it's shrewd. Wisdom consists, in part, in knowing the difference. Flexibility is a virtue. But in most matters, flexibility properly kicks in only after persistence has been given a fair chance.”*

*Tom Morris: The definition of insanity (essay)*

# 1.0 Introduction

## 1.1 The Notch signalling pathway

### 1.1.1 Brief history of the Notch field

History of Notch field started in 1910s when typical wing phenotype showing notches in the wing margin was first described in *Drosophila melanogaster* (Dexter, 1914). Later, the Notch allele was identified and more alleles were generated covering more phenotypes (Morgan, 1917). From following genetic studies it was clear that Notch plays role not only during wing and bristle development but also during embryogenesis (Poulson, 1937). Until 1980s Notch field was more or less barren.

The golden age of Notch field started in the 1980s when *Notch* gene was first cloned and sequenced (Artavanis-Tsakonas et al., 1983; Kidd et al., 1986; Wharton et al., 1985). Sequence of the *Notch* gene helped to find orthologues in other animal species (Coffman et al., 1990; Ellisen et al., 1991; Priess et al., 1987) and confirmed its evolutionary conservancy. Together with molecular analysis, classical genetic screens were performed searching for the phenotype similar to *Notch*. *Delta*, *Mastermind* and *E(Spl)* genes were identified (Lehmann et al., 1981). In 1990s another members interacting with *Notch* were discovered: *Serrate* (Fleming et al., 1990) and Su(H) (Fortini and Artavanis-Tsakonas, 1994). In the beginning of 1990s, scientists collected enough information about structure, function and interacting partners of Notch and therefore started to postulate that Notch is a main receptor for a new kind of cell-cell type of signalling. This signalling pathway was later called Notch signalling pathway (Artavanis-Tsakonas et al., 1995), based on its known receptor. In the new millennium, Notch field is flourishing with numerous new discoveries every year.

Today we know that Notch signalling pathway is a type of cell-cell communication system conserved among all metazoans. Both receptor and ligand are transmembrane proteins, therefore signalling is restricted to neighbouring cells. Every receptor signals only once because interaction of ligand with receptor causes irreversible receptor proteolysis which starts the signalling cascade without any involvement of secondary messengers or signal amplifiers. Notch signalling plays a

crucial role during the development of metazoans and renewal of adult tissues therefore mutations in genes participated in Notch signalling result in many developmental disorders and cancer types (Artavanis-Tsakonas and Muskavitch, 2010; Gridley, 2003; Koch and Radtke, 2007; Louvi and Artavanis-Tsakonas, 2012).

**Tab. 1: Brief history of Notch field until year 2000.** (adapted from Yamamoto et al. 2014).

YEAR	Event
1914	Wing phenotype identification
1917	Identification of Notch allele
1937	Role of Notch gene in embryogenesis
1981	Identification of main Notch components: Delta, Mastermind, Enhancer of Split
1983	Cloning of Notch gene Role of Notch in cell differentiation
1985	Sequencing of Notch gene
1986	Ortholog identification in mammals
1987	Ortholog identification in <i>C. Elegans</i>
1990	Ortholog identification in <i>X.Laevis</i> Identification of Serrate ligand
1991	Connection of Notch with cancer
1992	Role of Notch in cell-cell communication and differentiation
1994	Role of Notch in regulation of gene expression Identification of Su(H)
1998	First molecular mechanism of Notch signalling
1999	Identification of $\gamma$ -secretase complex

### 1.1.2 Canonical Notch signalling pathway in *D. melanogaster*

Compared to the other metazoans the canonical Notch pathway in *D. melanogaster* is relatively simple (**Tab.2**). There is only one receptor - Notch, two ligands - Delta and Serrate, and one transcription factor - Suppressor of Hairless. Proteases responsible for receptor cleavage are Furin, TACE or Kuzbanian and  $\gamma$ -secretase complex. Depending on the status of the pathway, Su(H) interacts either with repressors – Hairless, Smarter, Groucho, CtBP or with activators: N<sup>ICD</sup>, Mastermind, p300. “Simplicity” of the Notch pathway can mislead into thinking that outcome of the pathway is straightforward but opposite is true. Result of the Notch signalling pathway is highly context dependent and therefore there are more factors responsible for fine-tuning of the outcome.



**Tab. 2: Comparison of Notch signalling pathway between selected organisms.** Table lists the key players of Notch signalling pathway in *Drosophila melanogaster*, *Caenorhabditis elegans* and mammals (adapted from Kopan & Ilgan 2009).

Component function	Type	Drosophila	Caenorhabditis	Mammals
<b>Receptor</b>		Notch	LIN-12, GLP-1	Notch 1-4
	DSL/DOS	Delta, Serrate		Dll1, Jagged 1 and 2
	DSL only		APX-1, LAG-2, ARG-2, DSL 1-7	Dll3 and 4
<b>Ligand</b>	Dos coligands		DOS1-3, OSM7 and 11	DLK-1, DLK-2/EGFL9
	Noncanonical			DNER, MAPGP-1 and 2, F3/Contactin1, NB-3/Contactin6
	CSL DNA binding Transcription Factor	Su(H)	LAG-1	RBP <sub>1</sub> /CBF-1
<b>Nuclear Effectors</b>	Transcriptional Coactivator	Mastermind	LAG-3	MAML1-3
	Transcriptional Corepressors	Hairless, SMRT, Gro, CtBP		Mint/Sharp/SPEN, NCoR/SMRT, Kyoto2
	Furin convertase (S1 cleavage)	Furin 1-2	?	PC5/6, Furin
<b>Receptor Proteolysis</b>	Metalloprotease (S2 cleavage)	Kuzbanian, TACE, Kuzbanian-like	SUP17/Kuzbanian, ADMA10/Kuzbanian, ADMA4/TACE	ADAM17/TACE
	$\gamma$ -secretase complex (S3 and S4 cleavage)	Presenilin, Nicastrin, APH-1, PEN-2	SEL-12, APH-1, APH-2, PEN-2	Presenilin 1 and 2, Nicastrin, APH-1a-c, PEN-2
	O-fucosyl-transferase	OFUT-1	OFUT-1	POFUT-1
<b>Glycotransferase modifiers</b>	O-glucosyltransferase	RUMI		Lunatic, Manic and Radical
	$\beta$ -1,3-GlcNAc-transferase	Fringe		Fringe
<b>Endosomal sorting/ membrane trafficking</b>	E3 Ubiquitin ligase - ligand endocytosis)	Windbomb 1-2, Neutralized		Windbomb, Skeletotrophin, Neutralized 1 and 2
	E3 Ubiquitin ligase - receptor endocytosis	Delta, Su(Dx), Nedd4	WWP-1	Nedd4, Itch/ALP4
	Negative regulator	Numb		Numb, Numb-like, ACBD3
<b>Regulators</b>	Neutralized inhibitors	Bearded, Tom, M4		
	Other endocytic modifiers	Sanpodo		
<b>NICD degradation</b>	F-Box Ubiquitin ligase	Archipelago	SEL-10	Fbw-7/SEL-10
<b>Target genes</b>		E(sp1)	REF-1	HES/ESR/HEY

### 1.1.2.1 Mechanism of the Notch signalling in *D. melanogaster*

Canonical Notch signalling (**Fig.1**) is dependent on a proteolytic cascade of receptor following this mechanism: When receptor interacts with ligand an irreversible proteolysis of receptor occurs. Proteolysis is mediated by Kuzbanian metalloprotease which cleaves Notch receptor in S2 site. During the normal conditions, the S2 site is hidden and the cleavage is prohibited. Two models were proposed of how the cleavage site is made available. The first model assumes that for the availability of S2 site a mechanical force is necessary. This force is provided by Kuzbanian and ligand endocytosis in a “lift and cut” manner (Gordon et al., 2007; Parks et al., 2000). In the second model, allosteric model, presumes that ligand binding triggers an allosteric conformation change of cleavage site from protease-resistant to protease-sensitive (Nichols et al., 2007) .

After the S2 cleavage, the N<sup>ECD</sup> (Notch ExtraCellular Domain) is endocytosed with ligand by signal sending cell. Rest of the receptor, the TD (Transmembrane Domain) and the N<sup>ICD</sup> (Notch IntraCellular Domain) is called N<sup>EXT</sup> (Notch EXtracellular Truncation) which is later cleaved by  $\gamma$ -secretase complex on S3 and S4 sites. N<sup>ECD</sup> must be first cleaved off at S2 site to make S3 and S4 sites available. Cleavage of N<sup>EXT</sup> by  $\gamma$ -secretase results in releasing of N<sup>ICD</sup> into the cytoplasm from which it travels to the nucleus. In nucleus N<sup>ICD</sup> interacts with Su(H) (Supressor of Hairless) which plays role as a transcription factor of Notch target genes. Under normal conditions, when no Notch signalling occurs, Su(H) forms with its corepressors (Hairless, SMRTR, CtBP, Gro) a repressor complex and blocs the transcription. Interaction of N<sup>ICD</sup> with Su(H) destabilizes the repressor complex and attracts Mastermind. Mastermind is transcriptional co-activator, responsible for recruiting other members of activating complex so the transcription switch can occur (Kopan and Ilagan, 2009).

As mentioned before, every receptor is activated once for a s limited period of time to achieve optimal signal strength. After activation of transcription, N<sup>ICD</sup> is phosphorylated by CDK8 on its PEST domain. Phosphorylation serves as a target for E3 ubiquitin ligase Archipelago. After ubiquitination degradation of N<sup>ICD</sup> occurs in proteasome. This method ensures that the cell resets itself for next round of signalling (Fryer et al., 2004a).

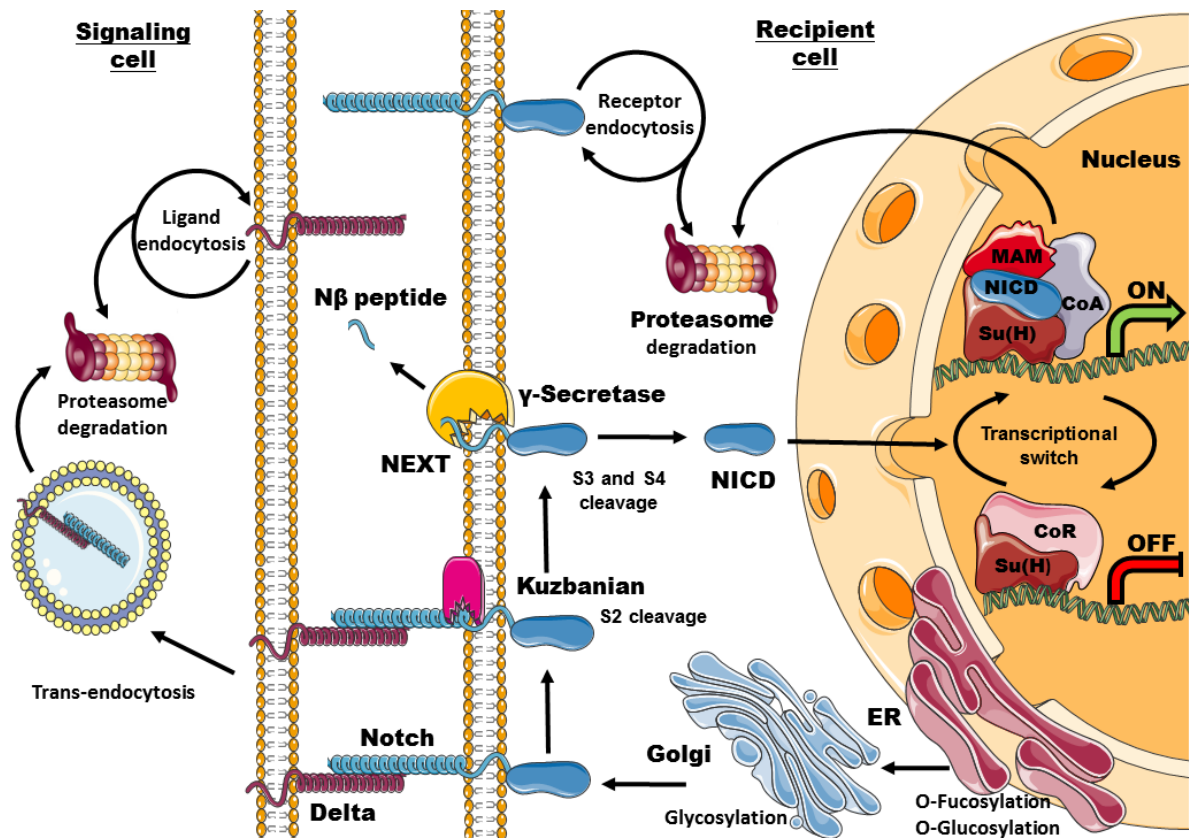

**Fig. 1: Canonical Notch signalling in *D. melanogaster*.** Notch receptor (NR) is created in the Endoplasmatic reticulum (ER), where it undergoes glucosylation and fucosylation by O-fucosyl transferase and Rumi, respectively. From ER, NR is translocated to Golgi, where it is glycosylated by Fringe. Maturated receptor travels to plasma membrane, where it is activated or recycled. Activation is triggered by interaction of Notch receptor with ligand (Delta). After ligand binding, S2 cleavage by metalloprotease (Kuzbanian) occurs and extracellular domain is cut off. N<sup>EXT</sup> (Notch EXtracellular Truncation) is then cleaved two times by  $\gamma$ -secretase complex. After S3 and S4 cleavage N<sup>ICD</sup> (Notch IntraCellular Domain) is released. N<sup>ICD</sup> travels to nucleus, where by interaction with Su(H) triggers activation of transcription (adapted from Kopan and Ilgan, 2009).

### 1.1.3 Role of Notch during development of *D. melanogaster*

Notch signalling is one of the most important signalling pathways that occurs during the development of multicellular organisms. Notch plays role in two crucial events of embryogenesis. The first role is in decision making between alternative cell fates. Decision can be made within large population of cells, process called “lateral inhibition” or between two sister cells, process called “lineage decision”. The second role is in formation of cell boundaries within various tissues.

#### 1.1.3.1 Lateral inhibition

Process of lateral inhibition is the best described Notch function to date. This process is crucial in the assignation of cell fates and their spatial patterning (Le Borgne et al., 2005a). During development, certain populations of cells have the same

ability to become specific cell type, but only some of them adapt this potential and differentiate. Cells which start to differentiate (activate the differentiating potential) prohibit surrounding cells to follow the same path. The probable model of this repression is as follows: Signalling cell stops to produce the Notch receptor and destabilizes the existing one via ubiquitin-proteasome pathway (Deltex, Nedd4, Su(Dx)) (Bray, 2006). After receptor degradation, the large amount of ligand (Delta) is produced to increase the probability of Notch/Delta interaction. Activation of Notch in signal receiving cell results in transcription activation of genes encoding proteins responsible for inhibition of cell-fate promoting genes. Additionally, Notch activation upregulates Neuralized and Minbomb, which trigger endocytosis of Delta, so the cell cannot be signalling anymore (Le Borgne et al., 2005a). This mechanism of lateral inhibition was described in bristle patterning in *Drosophila* (Fig.2) (Bardin and Schweisguth, 2006; Castro et al., 2005), in development of inner ear hair cell (Kiernan et al., 2005) and in somite formation in mammals (Ferjentsik et al., 2009).

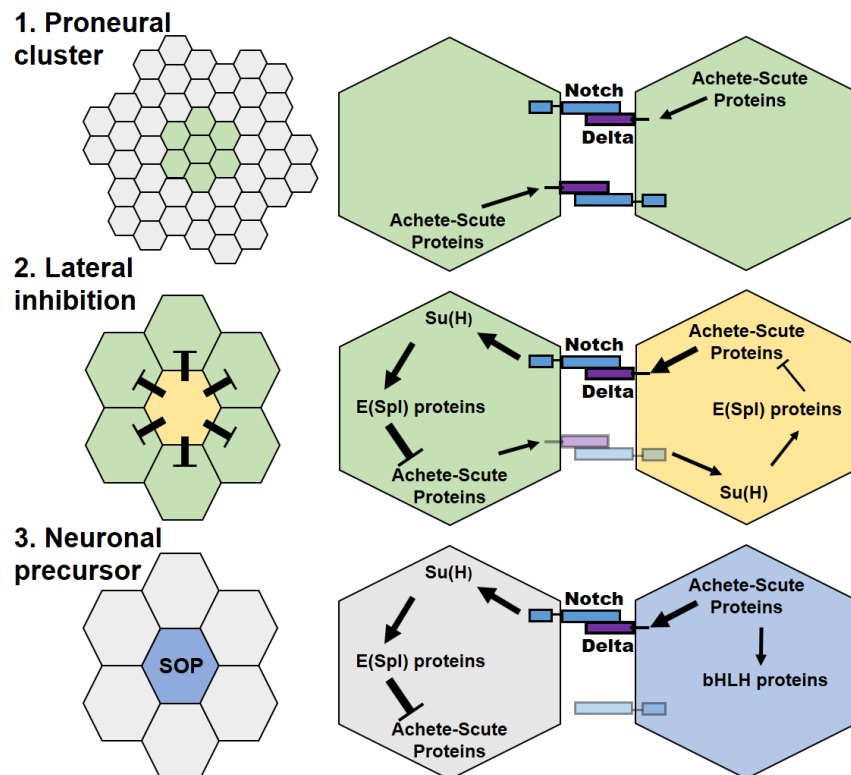

**Fig. 2: Process of adapting the SOP potential during development of bristles in *Drosophila*:** (1) In the beginning, cells with the same potential becoming the SOP form a proneural cluster. All cells of proneural cluster are sensitive to Notch signalling and can produce both receptor and ligand. (2) After some time, cell which adapted the differentiation potential starts to downregulate production of E(Spl) genes responsible for inhibition of Achete-Scute genes. This results in massive production of Delta ligand followed by endocytosis of Notch receptor. With receptor endocytosis, adapted cell become resistant to Notch signalling while triggering Notch signalling in surrounding cells and causing inhibition of their differentiation potential – lateral inhibition. (3) In last step adapted cell is fixing the SOP fate by expressing genes responsible for differentiation process. (Wolpert, 1997)

### 1.1.3.2 Lineage decision

As previously mentioned, lineage decision is made between two neighbouring cells and the mechanism is quite similar to the lateral inhibition process. Key role plays asymmetric cell division, where cell fate determinants and other regulatory proteins are distributed unequally. This process is best described during the external sensory organ (ESO) development in *Drosophila* (**Fig. 3**).

ESO is formed from SOP by undergoing four cell divisions. In first division mother cell (pI) asymmetrically divides and Numb protein, the Notch receptor endocytosis factor, is inherited by only one daughter cell (pIIb) (Rhyu et al., 1994). Presence of Numb in cell results in clearing of Notch receptor from the cell membrane which makes cell resistant to Notch signalling (Zhou et al., 2007).

After first division, pIIa cell can respond (contains Notch receptor) to Notch signalling. By responding to Notch signalling, pIIa cell is losing its SOP potential, therefore after undergoing second asymmetric division, daughter cells will form socket of the ESO (Notch sensitive cell) and shaft of the ESO (Notch resistant cell). Notch resistant cell pIIb also asymmetrically divides and its daughter cells are marked as pIII. Notch resistant cell pIIIb forms glial cell of the ESO, however in case of microchaete this cell undergoes apoptosis (Fichelson and Gho, 2003). pIIIa divides again and gives a rise to the sheath cell (Notch sensitive cell) and the neuron (Notch resistant cell) (Schweisguth, 2015).

Another example of lineage decision regulated by Notch is in the maintenance of stem cell populations. Notch dictates if the stem cell should remain in an undifferentiated state, or whether it should start to differentiate. This process is active in both embryonic and post-embryonic states of the organism (Chiba, 2006).

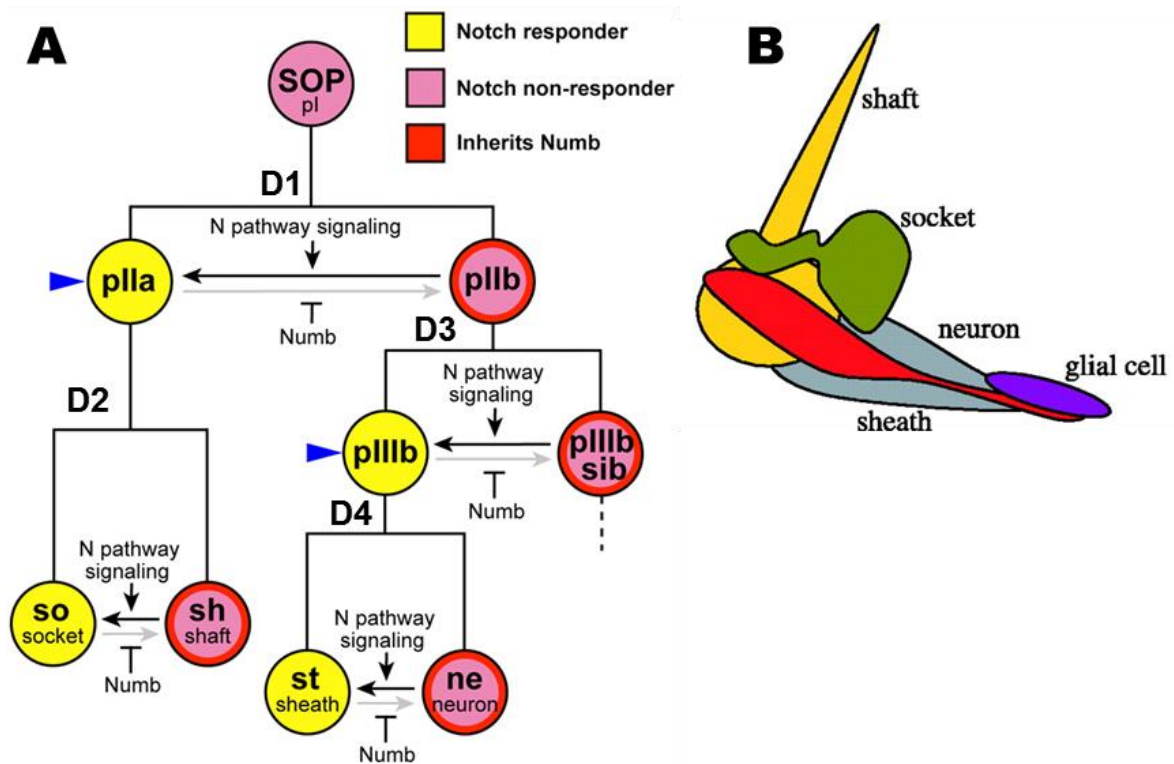
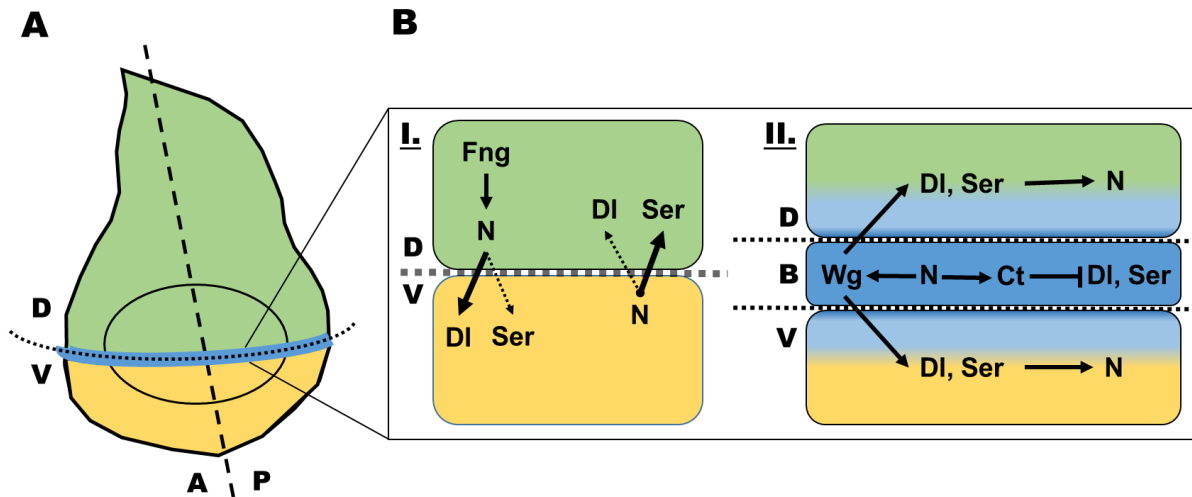

**Fig. 3: Role of Notch signalling during bristle formation in *Drosophila*:** (A) Schematic representation of four asymmetric cell divisions D1-D4 of SOP cell. D1 produces pII daughter cells from pI mother cell (SOP). D2 produces socket (so) and shaft (sh) cells from pIIa precursor cell. D3 division produces glial cell (pIIIb sib) and pIIIb precursor cell. D4 produces sheath (st) and neuron (ne) cell from pIIIb precursor cell. Cells with adapted Notch dependent cell fate are in yellow colour and cells which adapted Notch independent cell fate are in pink colour. (B) Schematic representation of fully developed ESO with relative position of building block cells: shaft - yellow, socket - green, neuron - red, sheath - grey, glial cell - purple. ( adapted from Rebeiz et al. 2011; Arias & Fiuza 2007)

### 1.1.3.3 Boundary formation

In the process of boundary formation, Notch forms two alternative signalling populations of cells. Boundary formation is connected with restricted expression of ligands and with restricted or feedback regulated expression of Fringe (Bray, 2006).

Example of this process is the Dorso-Ventral (D/V) boundary formation in wing imaginal discs of *Drosophila* (**Fig.4**). During the larval development, two populations of cells can be distinguished in wing imaginal discs. On the dorsal side of the disc are cells expressing Serrate and Fringe. In contrast, on ventral side, cells express Delta. Notch is expressed in the whole imaginal disc. The presence of Fringe in dorsal cells results in glycosylation of the Notch receptor. After glycosylation, Notch receptor is only sensitive to Delta (Zhou et al., 2007) but Delta is missing on the dorsal side, therefore signalling does not occur. As a result, Serrate can interact with unglycosylated Notch from ventral side and Delta with Notch glycosylated by Fringe, from dorsal side. This restricts Notch signalling activity to the D/V boundary (de Celis and Bray, 1997).



**Fig. 4 Formation of D/V boundary in wing disc of *Drosophila*:** (A) Axial division of larval (L3 stage) wing imaginal disc: A- anterior, P – posterior, D – dorsal (green), V – ventral (yellow), D/V boundary (blue). (B) Simplified molecular mechanism of D/V boundary formation: In the first step, certain population of cells start to express Fringe (Fng) glycosylase which results in increased signaling through Delta (DI) ligand. Opposite population of cells does not express Fringe therefore signaling is more focused towards Serrate ligand or not happening at all. This different ligand preferences forms a zone with different Notch response than the rest of the cells and give a rise to the boundary precursor. Complete boundary is formed after Notch regulated expression of Cut (Ct) and Wingless (Wg). Cut is responsible for downregulation of both ligands expression in boundary cells and Wingless for stimulating expressions of ligands in neighboring cells. This results in boundary cells being only signal receiving cells. (Buceta et al., 2007)

## 1.2 Fine-tuning of Notch response by post-translational modifications

The most fascinating aspect of Notch signalling is the fact that despite its simple molecular design, Notch is active in different developmental stages and various tissues, where under the same input, provides different output. We lack enough knowledge to explain this phenomenon, therefore many scientists are speculating and studying what is happening and how is it regulated. In this chapter I wish to focus on post-translational modifications of Notch pathway components in signal recipient cell which can play role in fine-tuning of the signal strength, duration and tissue specificity. There is no doubt that components of signalling cascade are regulated on transcriptional and posttranscriptional level, however it is out of the focus of this thesis.

### 1.2.1 Proteolytic cleavage

Cleavage of Notch receptor (NR) (Fig. 5) is an essential event in Notch signalling. In *Drosophila*, Notch receptor undergoes three ligand dependent

proteolytic cleavages in S2 (by Kuzbanian), S3 (by  $\gamma$ -Secretase) and S4 (by  $\gamma$ -Secretase) cleavage sites. However, there is an additional cleavage event that is independent from ligand interaction. After production of full length protein in endoplasmic reticulum, NR is translocated to Golgi where it is cut in S1 site by Furin convertase. This cleavage divides the receptor in two parts, which are later connected by a calcium ion and forms the Notch receptor heterodimer (Kopan and Ilagan, 2009).

In mammals, around 95% of precursor proteins are cleaved and this cleavage is essential for translocating Notch heterodimer to the cell membrane (Blaumueller et al., 1997; Logeat et al., 1998). Additionally, it was shown that Notch1 can be translocated to the cell membrane without Furin processing, but in this form it is not able to initiate signalling through CBF1 (Su(H)) transcription factor, suggesting a role in a noncanonical pathway (Bush et al., 2001).

It has been proposed that in *Drosophila*, only a small fraction of Notch receptor is cleaved by Furin and almost all receptors presented on the cell membrane are in full length form, suggesting that S1 cleavage is not crucial for Notch biological activity (Kidd and Lieber, 2002). However, Lake et al. showed that by mutating one of the predicted Furin cleavage sites they can achieve Notch loss of function phenotype in wing and embryonic nervous system. They also demonstrated that a receptor with this mutation failed to be properly localised to the cytoplasmic membrane (Lake et al., 2009).

Another nice example of regulating Notch activity through proteolytic cleavage is a discovery of Notch receptors in *Drosophila* embryos lacking the carboxyl terminus. This truncated form is missing PEST domain which contains target sites for phosphorylation by CDK8. Nuclear NICD therefore cannot be targeted for degradation which results in increased stability of ternary (NICD/Su(H)/Mam) complex and prolonged Notch activity (Wesley and Saez, 2000). Mutation in PEST domain promoting resistance to degradation signal are common in different cancer types (Bhanushali et al., 2010; Mutvei et al., 2015; Wang et al., 2015)



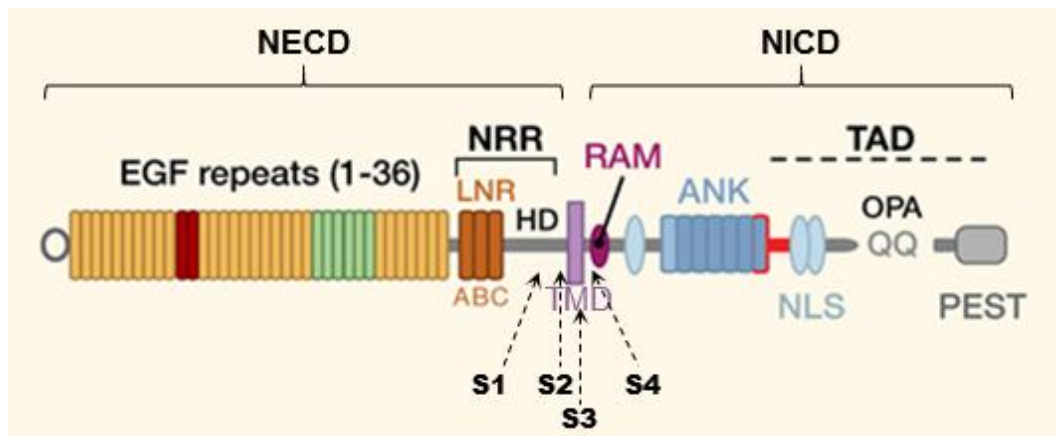

**Fig. 5: Domains and cleavage sites of Notch receptor in *Drosophila*.** Simplified diagram of *Drosophila* Notch receptor with functional domains and positions of cleavage sites important for proper receptor activation. Abbreviations: EGF - Epidermal Growing Factor like repeats, NRR - Negative Regulatory Region, LNR - Lin12-Notch Repeats, HD - Heterodimerisation Domain, TMD - Trans Membrane Domain, RAM - RBPjk Association Module, ANK - Ankyrin repeats domain, NLS - Nuclear Localisation Sequence, TAD - TransActivator Domain, OPA - Glutamine rich repeat, PEST - Proline/Glutamic acid/Serine/Threonin rich motifs, NECD - Notch ExtraCellular Domain, NICD - Notch IntraCellular domain, S2 - metalloprotease cleavage site, S3, S4 -  $\gamma$ -secretase cleavage sites (adapted from Kopan and Ilgan, 2009).

## 1.2.2 Glycosylation

Adding sugar moieties on EGF repeats, is one of the first PTMs of Notch receptor and occurs in ER or Golgi. Notch receptor is modified by one of the three basal sugar groups: O-fucose, O-glucose or O-GlcNAc (N-acetylglucosamine) (**Fig.6**) which can be further prolonged by adding other sugar moieties like: galactose, manose, sialic acid or xylose (Jafar-Nejad et al., 2010; Stanley and Okajima, 2010). In *Drosophila*, no more than three saccharide residues were observed compared to mammals, where this secondary prolongation can be even longer (Luther and Haltiwanger, 2009; Stanley, 2007; Xu et al., 2007). Almost every EGF repeat can be glycosylated, but it was shown that only repeats 11 and 12 have a crucial role in ligand binding (Harvey et al., 2016; Rebay et al., 1991).

**OFUT1:** Glycosylation is started by adding O-fucose in ER (Luo and Haltiwanger, 2005). In *Drosophila*, this modification is performed by O-fucosyltransferase 1 (OFUT1). OFUT1 mutants resemble strong notch-like phenotype suggesting a role in Notch signalling (Okajima and Irvine, 2002; Sasamura et al., 2003; Shi and Stanley, 2003). Despite the fact that exact molecular mechanism is not known, we recognise four biological processes where OFUT1 is necessary: General role of OFUT1 is to act as a chaperone for proper folding of Notch receptor (Okajima, 2007; Okajima et al., 2008) and facilitate endocytic trafficking to localise receptor to cytoplasmic membrane (Okamura and Saga, 2008a; Sasamura et al., 2007). In Fringe

positive cells, O - fucose is essential targeting mark for Fringe and an important prerequisite for ligand binding (Okajima, 2007; Okajima et al., 2008; Sasamura et al., 2007). However, it looks like that some events catalysed by OFUT1 are not dependent on fucosyltransferase activity (Okajima and Irvine, 2002; Sasamura et al., 2007; Stahl et al., 2008). In mammals, OFUT1 has multiple roles which depend on cellular context and developmental program (Guilmeau et al., 2008; Irvine and Wieschaus, 1994; Okamura and Saga, 2008b; S. Shi et al., 2005; Tsao et al., 2009).

**Fringe:** As was mentioned before O-fucose is recognised by Fringe, the N-acetylglucosamintransferase. Loss of Fringe results in fringe edges of *Drosophila* wing (Correia et al., 2003). The exact molecular mechanism of Fringe role in Notch signalling was described in the previous chapter on D/V boundary formation in wing disc (**Fig. 4**) (Xu et al., 2007). Another GlcNAc transferase identified in *Drosophila* is EOGT (EGF specific – O – GlcNAc-transferase). EOGT alone does not cause obvious developmental defects, however has a strong genetic interaction with Dumpy, a key player in lateral inhibition and wing development (Müller et al., 2013; Sakaidani et al., 2011).

**Rumi:** Last of the core sugar modifications is adding O-glucose to EGF repeats. Enzyme responsible for this event is localised in ER and is called Rumi. Rumi similarly to OFUT1 acts as a chaperon for Notch receptor, however its glucosyltransferase activity is more important. Rumi mutants show impaired lateral inhibition because Notch receptor cannot undergo S2 cleavage and is accumulated in cell membrane. This phenotype can be rescued by low temperature. In summary, this indicates that although Rumi is not necessary for ligand binding, it serves as a buffer against temperature dependent loss of Notch signalling by stabilizing N<sup>ECD</sup> and promoting proper S2 cleavage in high temperatures (Acar et al., 2008; Leonardi et al., 2011).

**Shams:** In *Drosophila*, O-glucose modification can be recognised by O-xylosyltransferase Shams. Shams negatively regulate Notch signalling by extending glucose moieties of EGF repeats with xylose. Shams overexpression results in huge decrease in available NR at the cell surface, suggesting role of xylosylation in receptor stability. (Lee et al., 2013).

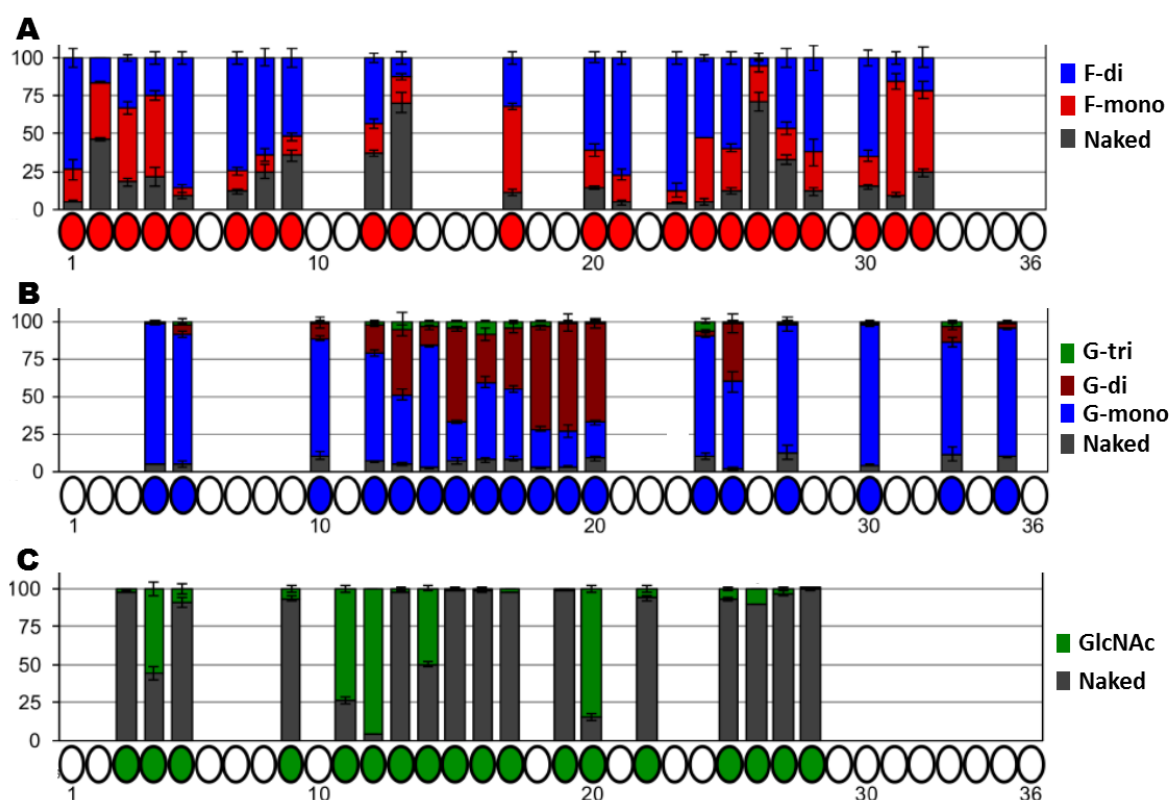

**Fig. 6: Glycosylation of Notch receptor.** Comparison of Notch EGF glycosylation sites predicted based on conserved glycosyltransferase sequence (cycles under graph) with relative percentual occupancy of different sugar moieties (graphs): **(A)** Predicted Ofut1 glycosylation sites (red cycles) and actual EGF sites containing difucose (blue), monofucose (red) or naked (grey). **(B)** Predicted Rumi glycosylation sites (blue cycles) and actual EGF sites containing triglucose (green), diglucose (bordeaux), monglucose (blue) EGF sites. **(C)** Predicted Fringe glycosylation sites (green cycles) and actual EGF sites containing GlcNAc (green) or naked (grey) (adapted from Harvey et al. 2016).

### 1.2.3 Acetylation

It is believed that one of the functions of specific lysine acetylation is to prevent protein degradation by blocking the target lysine from ubiquitination (Caron et al., 2005; Drazic et al., 2016).  $N^{ICD}$  of mammalian Notch1 was proven to be highly acetylated on its RAM domain (Guarani et al., 2011; Kim et al., 2007) and to physically interact with several acetyl transferases (Guarani et al., 2011; Kurooka and Honjo, 2000; Okajima and Irvine, 2002; Oswald et al., 2001). However, only few are able to acetylate  $N^{ICD}$ . The literature brings contradictory conclusions regarding the role of  $N^{ICD}$  acetylation and the enzymes responsible for it.

The first enzyme identified as a  $N^{ICD}$  acetyl transferase was Tip60. Under the DNA damage conditions, Tip60 acetylates  $N^{ICD}$  before its interaction with CSL which prevents formation of CSL –  $N^{ICD}$  complex. This suggest that acetylated  $N^{ICD}$  is unable to bind Su(H) which has a negative impact on initiation of Notch target genes transcription (Kim et al., 2007).

A more detailed study was done by Guarani et al. who was able to acetylate N<sup>ICD</sup> of Notch1 with p300 and PCAF acetyl transferases, although he could not confirm acetylation by Tip60. He showed that acetylation is important for N<sup>ICD</sup> turnover and that together with deacetylation by Sirt1 it is a cellular tool for modulating the amplitude and duration of Notch response (Guarani et al., 2011).

Guarani's results were confirmed by Palermo et al. He showed that p300, but not Tip60, is in fact responsible for acetylation of Notch and that acetylation prevents N<sup>ICD</sup> from ubiquitin dependent proteasome degradation. He also identified specific lysines which were targeted by HDAC1 and played role in the stability of the protein (Palermo et al., 2012).

The effect of p300 on Notch signalling is not only in acetylation of N<sup>ICD</sup>, but also in acetylation of Mastermind (MAM). Acetylated MAM has enhanced recruiting ability for other components of activation complex and stimulates acetylation of H3 and H4 by p300. This may suggest that acetylation of MAM is important for forming of activation complex and regulating its activity (Saint Just Ribeiro et al., 2007).

#### 1.2.4. Phosphorylation

Phosphorylation of notch receptor is mostly happening on Notch intracellular domain and can be mediated by multiple kinases (**Fig. 7**). Most of the phosphorylation events occur right after receptor cleavage by  $\gamma$ -secretase complex or in the nucleus. It has been proven that phosphorylation is important for proper translocation of NICD into the nucleus and initiation of transcription (Redmond et al., 2000; Ronchini and Capobianco, 2000; Shimizu et al., 2000). However, more accurate proteomic techniques discovered that phosphorylation on specific sites of Notch2 can have negative effect on expression of Notch target genes (Espinosa et al., 2003; Inglés-Esteve et al., 2001; Ranganathan et al., 2011).

**PKC $\zeta$** : Nice example of context dependent outcome of phosphorylation, is Notch1 phosphorylation by PKC $\zeta$  which specifically modifies membrane bound receptor. During the inactive Notch signalling, phosphorylation by PKC $\zeta$  targets receptor for internalisation followed by ubiquitination. However, during the active notch signalling PKC $\zeta$  stimulates S3 cleavage and release of NICD from late endosome. This way the PKC $\zeta$  mediates proper timing and efficiency of receptor processing (Sjöqvist et al., 2014).

**GSK3 $\beta$** : Another kinase with multifactorial effect on Notch receptor is GSK3 $\beta$ . In mammals, GSK3 $\beta$  specifically targets activated Notch receptor (Notch1, Notch2) and negatively controls its stability which results in insufficient activation of notch target genes (Espinosa et al., 2003; Jin et al., 2009). However Foltz et al. observed that by activating GSK3 $\beta$ , there is a reduced fraction of Notch1-ICD degraded by proteasome (Foltz et al., 2002).

**CK2 and NLK**: CK2 phosphorylates two specific sites at the beginning of ankyrin domain. Phosphorylation occurs during the formation of ternary complex and negatively affects its stability and ability to bind to DNA. Consequently, these modifications resulted in dissociation of ternary complex from DNA and decrease in Notch target gene expression (Ranganathan et al., 2011). NLK phosphorylates N<sup>ICD</sup> outside the ankyrin domain. Similarly to CK2, NLK phosphorylation prevents formation of ternary complex and subsequent Notch target gene expression. However, the spatio-temporal localisation of this event was not determined (Ishitani et al., 2010).

**DYRK1A**: Another kinase phosphorylating N<sup>ICD</sup> is DYRK1A. This kinase was found to bind N<sup>ICD</sup> in the nucleus and phosphorylate multiple sites in ankyrin domain. Overexpression of DYRK1A was connected with attenuation in Notch target gene expression, but no effect on N<sup>ICD</sup> stability was observed. Thus, inhibition effect is probably mediated by ternary complex destabilisation (Fernandez-Martinez et al., 2009)

**Akt**: Akt also phosphorylates N<sup>ICD</sup> in ankyrin domain and downregulates Notch-dependent transcription. Compared to the previously described kinases, Akt phosphorylation does not destabilise ternary complex, but inhibits proper localisation of N<sup>ICD</sup> in the nucleus. Instead, N<sup>ICD</sup> was found to be accumulated around the nuclear membrane or in the cytoplasm (Song et al., 2008).

**CDKs and ILK**: Last phosphorylation event in Notch signalling cascade is phosphorylation of PEST domain. This domain is phosphorylated mainly by CDKs as a response to activation of cyclins. Hyperphosphorylation of PEST domain is a mark for ubiquitin dependent degradation. This process eliminates N<sup>ICD</sup>, disassembles the ternary activating complex formed on DNA and resets the system for another round of signalling or for final silencing of target genes (Fryer et al., 2004a; Ishitani et al., 2010). Another phospho – degradation signal located outside the PEST domain was found. This phosphorylation site takes place in TAD domain and is mediated by ILK (Mo et al., 2007).

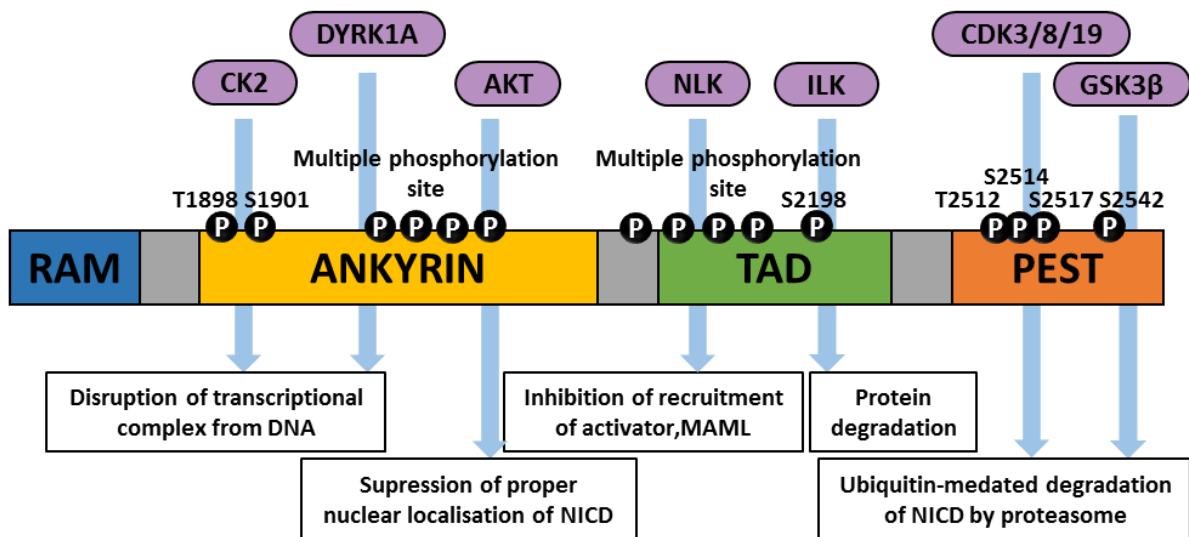

**Fig. 7 Phosphorylation sites of Notch intracellular domain:** Map of potential mammalian Notch1-ICD kinase binding sites, kinases and biological function in Notch signalling (Lee et al., 2015)

## 1.2.5 Ubiquitination

Based on the fact that Notch signalling is very sensitive to subtle changes in protein levels and subcellular localisation of pathway components, ubiquitination is one of the most important mechanisms for the spatio-temporal control of Notch signalling (Le Bras et al., 2011). This control is achieved either by receptor and ligand endocytosis, or by rapid degradation of NICD. Several ubiquitin ligases were found in the *Drosophila* genome which mutation resemble strong Notch loss of function phenotype (Fryer et al., 2004b; Hori, 2004; Lai et al., 2005; Yeh et al., 2000).

### 1.1.5.1 Ubiquitination of Notch ligands

**Neuralised and Mindbomb:** There are two E3 ubiquitin ligases responsible for monoubiquitination of Notch ligands; Neuralized and Mindbomb. Both can physically interact with Delta or Serrate, however Neuralised has higher affinity towards Delta and Mindbomb towards Serrate (Lai et al., 2005, 2001). Both enzymes are responsible for the ligand endocytosis which is an initiation step for unknown mechanism producing mature and more active ligand (Le Borgne et al., 2005a; Pitsouli and Delidakis, 2005). Mindbomb can substitute for Neuralised in some developmental processes, although reverse action was not observed (Le Borgne et al., 2005b).

**CBL:** Another ubiquitin ligase playing role in Notch signalling is CBL. This enzyme has two splice variants, where the long form (CBL-L) regulates EGFR

signalling and short form (CBL-S) regulates Notch signalling. Cbl-S preferentially targets Delta and mark it for degradation (Pai et al., 2000; Wang et al., 2010)

#### 1.2.5.2 Ubiquitination of Notch receptor

In *Drosophila* four ubiquitin ligases are responsible for ubiquitination of Notch receptor: Numb, Deltex, Suppressor of Deltex and Nedd4. These enzymes not only regulate stability but also play important role in ligand independent activation of Notch (Hori et al., 2012; Palmer and Deng, 2015). In mammals, there is one more ubiquitin ligase, Sel-10, responsible for proteasome mediated degradation of Notch receptors (Wu et al., 2001). However, the ortholog in *Drosophila* has not been described to have any role in Notch signalling (Gramates et al., 2016)

**Numb:** Numb acts as a cell-fate determinant during asymmetric cell division in developing ESOs (Rhyu et al. 1994; Caussinus & Gonzalez 2005, Chapter 1.1.3.2). Numb is asymmetrically inherited in selected cells. Cells containing Numb are resistant to Notch signaling because of Numb mediated endocytosis of the Notch receptor, previously colocalized with Sanpodo (Couturier et al., 2014, 2013). Additionally, Numb is a limiting factor responsible for balancing between Notch receptor recycling and receptor targeting to late endosomes, thus regulating Notch signaling output after asymmetric cell division (Johnson et al., 2016)

**Deltex:** Deltex (Dx) is E3 ubiquitin ligase interacting with ankyrin repeats of NICD responsible for targeting the receptor into the endosomes and helps with  $\gamma$ -secretase cleavage (Hori, 2004; Matsuno et al., 1995). However, role of Dx in canonical Notch activation is not necessary during development and seems to be important only in some contexts where it can act positively or negatively (Fuwa et al., 2006). This dual role can be explained by molecular mechanism of Dx interaction with inactivated NR. Choosing between two roles is dependent on presence of HOPS and AP-3 complexes. If these complexes are present, NR is sent towards ligand independent activation (promotion of Notch) and if they are missing, NR is targeted for degradation (silencing of Notch) (Wilkin et al., 2008; Yamada et al., 2011).

**Suppressor of Deltex:** Based on the genetic interaction studies, it is well known that Dx phenotype can be fully rescued by Suppressor of Deltex, suggesting negative role of Su(Dx) in Notch Signalling (Cornell et al., 1999; Fostier et al., 1998). However, the role of Su(Dx) is more complicated. Similarly to Dx, Su(Dx) is responsible for NR endosome sorting and deciding between activation or silencing. This decision is based on the developmental program, and more importantly, on the

temperature. In normal and low temperatures, Su(Dx) promotes ligand independent activation of NR, however at high temperatures Su(Dx) is responsible for blocking Notch signalling by NR degradation. This suggest that Su(Dx) plays a role as a guardian of suitable physiological range over which normal development can occur (Mazaleyrat et al., 2003; Shimizu et al., 2014; Wilkin et al., 2004).

**Nedd4:** Functionally very similar enzyme to Su(Dx) is Nedd4. Nedd4 acts synergically with Su(Dx) in genetic studies, and is a strong negative regulator of Notch signalling. Nedd4 is responsible for blocking Dx mediated ligand independent activation of NR, by competing with Dx for NR and also by targeting Dx for degradation (Sakata et al., 2004; Wilkin et al., 2004).

### **1.3 Connection of Notch signalling with basal metabolism**

Cells continuously change their profiles of gene expression and metabolism to adapt to the environment or developmental program. Gene regulation and metabolism modulation are very tightly connected, and sometimes it is difficult to decipher which one is superior to the other. Cells are sensitive to the availability of external nutritional resources, although at the same time, different tissues display different intrinsic metabolic characteristics that are not simply dependent on the quantity of available nutrients, but on the type and quantity of metabolic pathways active. This is reflected in different activities of metabolic sensors present in the cells, and their impact on cell survival, morphology, cell physiology or cell fate. During embryonic development of multicellular organisms, cells are provided with a rich supply of nutrients, therefore external nutritional resources play a minor role in cell regulation. Nevertheless, as cells divide and differentiate, their metabolic profiles change accordingly. Consequently, the activity of cell's metabolic sensors, influencing various parameters such as cell transcription, signalling or morphology, change too. After embryonic development, cells are dependent on nutrient availability from external sources and therefore nutrient and energy sensing pathways can modulate gene expression. Notch signalling is active during both stages of animal development, therefore it is evident that Notch can be connected with basal metabolism of the cell, as well as with external nutrient sensing pathways.



### 1.3.1 Overview of basal metabolism

Metabolism is a highly-coordinated network of chemical reactions responsible for storing or releasing energy, required to perform various functions of living organisms. Traditionally, basal metabolism is divided in two parts based on whether the energy is stored or released. Reactions which use energy to produce biomolecules from simpler components are called anabolic reactions. The opposite process, in which complicated biomolecules are degraded for building blocks or to generate energy, are called catabolic reactions (Donald Voet, Judith G. Voet, 2013).

Logically, greater importance in cell play catabolic reactions responsible for degrading nutrient molecules (**Fig 8**). Degradation produces free energy, which is stored in high energy phosphates of ATP or NADPH, and then transduced to anabolic reactions, mechanical work and the active transport of molecules. Main nutrient molecules or “macronutrients” used by cell are sugars and lipids. These molecules are processed by digestive system to generate simpler molecules which can enter energy generating pathways. Sugars are usually processed to glucose and lipids disassembled to glycerol and fatty acids (Donald Voet, Judith G. Voet, 2013). In special cases like starvation, high protein intake, high proliferation rate or hypoxia, amino acids from glutamine family can act as a source of energy (Le et al., 2012)

Glucose is utilised in cytoplasm by glycolysis. Glycolysis summarized set of ten biochemical reactions where glucose is in a stepwise manner degraded to pyruvate, later transformed into acetyl-CoA. Beside pyruvate, during the degradation process of glucose, other molecules are produced that are used in downstream pathways: ATP, NADH, water and hydrogen protons.(Donald Voet, Judith G. Voet, 2013). Water and hydrogen protons are generated during the cytoplasmic buffering of lactate production (Lane et al., 2009)

Initially, lipids (triglycerids) have to be processed in liposomes by lipases, which separate fatty acids from glycerol (Zechner et al., 2005). Fatty acids undergo process of  $\beta$ -oxidation, whereas glycerol can be used in glycolysis or other synthetic pathways (Brisson et al., 2001). There is one preliminary step before  $\beta$ -oxidation, when fatty acids must be activated by CoA to enter mitochondrial matrix. Activated fatty acids are then processed in a four step mechanism producing one molecule of acetyl-CoA and fatty acid shortened by two carbons. Truncated fatty acid is a substrate for another round of  $\beta$ -oxidation until the complete breakdown of the fatty acid. Similar to

glycolysis, other products are generated, including NADH, FADH<sub>2</sub> and hydrogen protons (Donald Voet, Judith G. Voet, 2013).

Amino acids are very weak source of energy and therefore they are mostly used in gluconeogenesis to fuel glycolysis or through series of transamination reactions directly enter TCA cycle. Mammalian cells can use the most abundant amino acid glutamine, or any amino acid from glutamine family as energy source. Glutamine is converted into glutamate, which is then transformed into α-ketoglutarate, an intermediate of TCA cycle (Brosnan, 2000; Fan et al., 2013).

Both glycolysis and β-oxidation produce acetyl-CoA, which is the starting molecule of TCA cycle. The TCA cycle comprises eight reactions where carbon atoms of acetyl-CoA are stepwise oxidised into CO<sub>2</sub> and citrate, whilst electrons produced in these reactions are transferred to electron carriers NADH and FADH<sub>2</sub>. These electron carriers are utilised by the main energy producing mechanism, electron transport chain. Electron transport chain consists of five mitochondrial multiprotein complexes marked as Complex I-V. Complex I and Complex II are responsible for transferring electrons to CoQ from NADH and FADH<sub>2</sub> respectively. CoQ is utilised by Complex III which sends electrons to Complex IV via Cytochrome C. In Complex IV electrons are used to reduce oxygen into water. All these reactions, except those in Complex II are responsible for increased proton concentration in intermembrane space. Mentioned proton gradient is a driving force for ATP synthase, a subunit of Complex V, which utilise energy of free protons to catalyse addition of inorganic phosphate (P<sub>i</sub>) to ADP, producing ATP. From every molecule of NADH and FADH<sub>2</sub>, 2.5 and 1.5 molecules of ATP are produced, respectively (Donald Voet, Judith G. Voet, 2013).

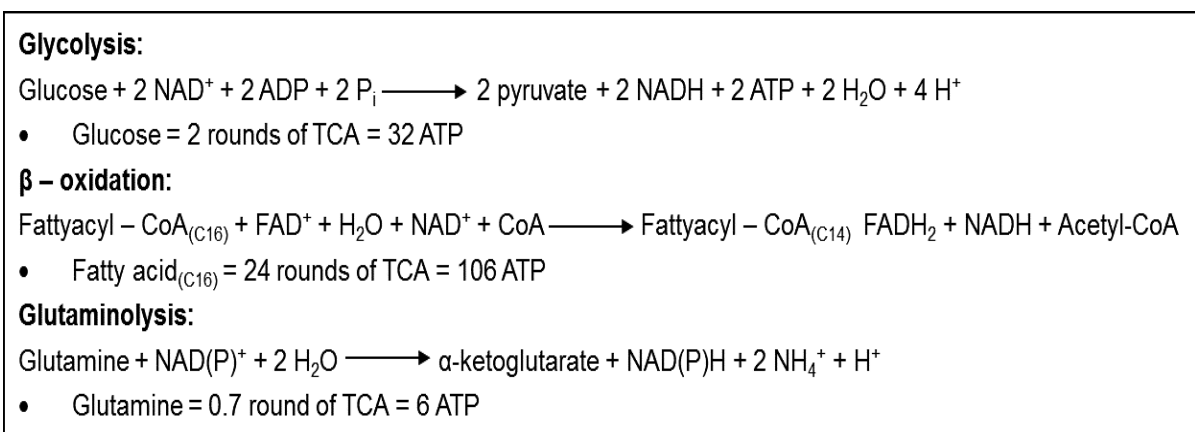

**Figure 8: Energy producing catabolic reactions.** Simplified scheme of three main catabolic reactions responsible for fuelling the TCA cycle with estimated net yield of ATP from one molecule of substrate (Donald Voet, Judith G. Voet, 2013).

### 1.3.2 Regulation of metabolism by Notch signalling

Numerous studies have shown that Notch signalling plays crucial role in cell proliferation, differentiation and apoptosis. Proliferation and apoptosis are highly energy-dependent processes, therefore there must be a close collaboration between Notch signalling and metabolic pathways.

#### 1.3.2.1 Catabolism

Impact of Notch signalling on catabolism, especially glucose metabolism, was mostly described in cancerous human cell lines and adult mice (Bi and Kuang, 2015). For example: in breast cancer cells, Notch participates on metabolic switch from oxidative phosphorylation to glycolysis by two distinct mechanisms. When the Notch is hyper-activated, a glycolytic switch is achieved by activation PI3K/AKT pathway. Alternatively, in Notch hypo-activated conditions, glycolytic switch happens through p53 mediated attenuation of mitochondrial activity (Landor et al., 2011).

Proteomic analysis of mitochondrial protein composition after Notch activation showed alternation of several proteins responsible for oxidative phosphorylation, glutamine metabolism, TCA cycle and  $\beta$  – oxidation. Mechanistically, Notch downregulates two subunits of Complex I followed by decrease of ADP/ATP and  $\text{NAD}^+$ / $\text{NADH}$  ratios and increase in  $\text{NADPH}$  levels, suggesting a switch to glycolysis. This switch was supported by fact that amongst dampened proteins were proteins responsible for extracellular glutamine intake and glutaminolysis, suggesting bypass of initial reactions of TCA cycle (Basak et al., 2014).

Study of Xu et al. confirmed that Notch increases glycolytic rate in mouse hepatic macrofages. However, they also observed increased flux of glucose into TCA cycle and increased oxygen consumption, suggesting enhanced oxidative phosphorylation. Based on the Notch1-NICD and ChIP-qPCR data they observed enrichment in pyruvate dehydrogenase phosphatase 1 (Pdp1) control region. Pdp1 is positive regulator of pyruvate dehydrogenase responsible for converting pyruvate to acetyl-CoA. Increased fuelling of TCA cycle was supported by NICD1 enriched regulatory regions of several subunits and assembly proteins of electron transport chain complexes and other regulatory genes coded in mitochondrial genome (Xu et al., 2015).

More evidence as to the mechanism of the glycolytic switch was published by Slaninova et al. They proposed that even a short burst of Notch activity can lead to

inhibition of TCA cycle and boosting of glycolysis in PI3K/AKT independent manner. This is happening through Notch dependent expression of hairy which is responsible for turning off expression of several TCA cycle genes. Downregulation of TCA cycle is compensated by glycolysis through increased expression of glucose transporter Glut1 and first enzyme of glycolysis Hexokinase. In their model, effect of hairy was supported by increased expression of Impl3 and CG13334 lactate dehydrogenases responsible for converting pyruvate, the product of glycolysis and main TCA substrate, to lactate, product of nonoxidative metabolism. (Slaninova et al., 2016; Zhou et al., 2008).

Notch dependent deregulation of oxidative phosphorylation occurs in mammalian white adipose tissue. In this example, Notch acts as a main repressor of Ucp1, mitochondrial protein playing role in thermogenesis. Ucp1 disrupts proton gradient by changes in mitochondrial inner membrane permeability. This results in rapid oxidation of fatty acids localised in mitochondria favouring generating heat over ATP production (Bi et al., 2014; Shabalina et al., 2013).

### **1.3.2.2 Anabolism**

In contrast to the catabolic processes, Notch also regulates anabolic processes. This regulation is usually in cooperation with other pathways. In mouse hepatocytes Notch participates on gluconeogenesis and regulation of insulin resistance in mice. For this effect, interaction with FoxO1, the main transcription factor of metabolic genes, is necessary. Interaction of Notch1 activation complex and FoxO1 boosts Glucose – 6 – phosphatase expression and secretion of glucose from the cell (Nakae et al., 2008; Pajvani et al., 2011).

Another study from Pajvani et al. shows that Notch participates also on lipogenesis, in mouse hepatocytes. For this effect, Notch helps to stabilize mTorc1 which promotes cleavage of Srebp1c precursor. The resulting cleaved Srebp1c acts as a transcription factor responsible for upregulation of genes playing role in fatty acid and lipid production (Ferré and Foufelle, 2010; Pajvani et al., 2013)

### **1.3.3 Regulation of Notch signalling by basal metabolism**

During evolution, cells developed mechanisms for sensing intracellular and extracellular levels of macronutrients and different metabolites. Some of the sensors are known, however the exact mechanisms are not fully understood. Nutrient sensing

involves the activation or inhibition of several signalling pathways such as the PI3K/Akt (glucose, lipids), mTOR (amino acids, glucose) or HIF (oxygen) pathways (Efeyan et al., 2015; Krejčí, 2012). The master cellular energy sensor AMP activated protein kinase (AMPK) plays a pivotal role in intracellular nutrient sensing. AMPK is activated by increased levels of AMP. After activation, AMPK modulates proteins of basal metabolism, cell growth, proliferation and polarity, mitochondrial biogenesis and autophagy to achieve survival of the cell (Hardie, 2011; Hardie et al., 2012).

There are numerous examples of the emerging importance of Notch signalling in regulation of metabolism (Bi and Kuang, 2015), however, some of the pathways act reciprocally. For example, under certain conditions AMPK is able to suppress activity of mTOR and Notch signalling (Li et al., 2014). Hif-1 $\alpha$  upregulates Notch signalling via stabilisation of N<sup>ICD</sup> in hypoxia condition and promotes survival of cancer cells (Y.-Y. Hu et al., 2014; Qiang et al., 2012). In melanoma cells, Akt is responsible for NF- $\kappa$ B dependent expression of Notch1 gene (Bedogni et al., 2008). In T-ALL cells, inhibition of PI3K/Akt pathway resulted in decreased levels of Notch1 protein but had no effect on Notch1 gene expression (Calzavara et al., 2008). Additionally, active Akt and mTOR pathways may also have negative effect on expression of Notch1 gene and stability of Notch1 protein (Shepherd et al., 2012; Song et al., 2008). In theory, Hif-1, mTOR, AMPK and PI3K/Akt pathways may work as metabolic sensors for the Notch pathway. However, other metabolic sensors exist that bind or respond to certain cellular metabolites (for example NAD(H), 2-oxoglutarate, acetyl-CoA, ATP, lipids). and it is highly probable that they are also involved in modulation of Notch pathway activity, through their crosstalk with core Notch signalling components. We cannot exclude either, that Notch signalling possess a metabolic sensor of its own.

It is well established that in some cases cells respond to changes in metabolism via the activation or inhibition of certain genes. One of the ways how this is happening is through PTM changes of proteins, where many of the metabolites act as a source of functional groups for these modifications; examples include acetylation, ribosylation, phosphorylation, methylation and others (**Fig. 9**) (Hitosugi and Chen, 2014). As discussed in the previous chapter, the Notch receptor is heavily post-translationally modified, and together with histone PTMs, we can presume that availability of functional groups for PTMs can play a role in modulation of Notch signalling.

Recently, several protein modifiers were discovered among the enzymes utilizing metabolic cofactors such as FAD, NAD and NADP. These cofactors are utilized by these proteins in numerous ways: as an electron donor, acceptor of functional group or allosteric modulator. Interestingly, not only presence of the cofactor but also its redox form plays a role in the enzyme function (Shi and Shi, 2004). It is possible that these enzymes provide the missing link to explain Notch sensitivity to metabolic changes. In next chapter I will focus on NAD<sup>+</sup>/NADH, and provide a brief overview of NAD(H) binding enzymes with a focus on Sirt1, the main member of the class III protein deacetylases, the sirtuins.

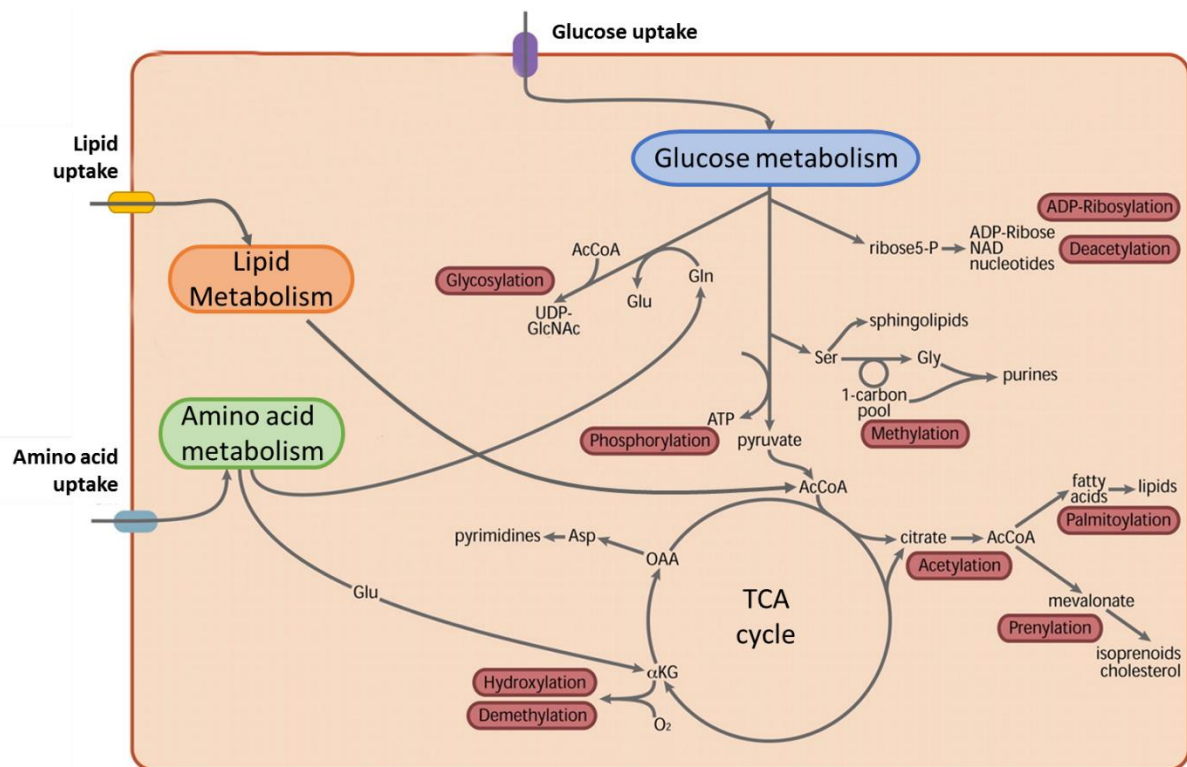

**Fig. 9: Metabolic pathways as a source of functional groups for PTMs.** Simplified diagram of catabolic pathways producing metabolites which are used for selected PTMs. Abbreviations: AcCoA – Acetyl Coenzyme A, NAD – Nicotinamide adenine dinucleotide, Gln – Glutamine, Glu – Glutamic acid, Gly – Glycine, Asp – Aspartic acid, Ser – Serine, OAA- Oxaloacetate, αKG – α-Ketoglutarate, UDP-GlcNAc - Uridine diphosphate N-acetylglucosamine (adapted from Metallo et al. 2010).

## 1.4 NAD<sup>+</sup> and NAD<sup>+</sup> converting enzymes

NAD (nicotinamide adenine dinucleotide) was discovered in 1906, although it took 30 years and three Nobel laureates, Harden, Euler-Chelpin, Warburg, to decipher its chemical structure and biological role. Today's textbook definition describes NAD as a sugar phosphate playing a role as a cofactor of oxidoreductases in citric acid cycle and oxidative phosphorylation. The chemical role of NAD is to accept hydride (electron) from one reaction and bring it to another. Therefore, NAD can be found in

two forms oxidised ( $\text{NAD}^+$ ) and reduced ( $\text{NADH}$ ). Additionally,  $\text{NAD}$  can be also phosphorylated ( $\text{NADP}^+$ ,  $\text{NADPH}$ ), increasing number of  $\text{NAD}$  forms to four (Houtkooper et al., 2010).

### 1.4.1 Biosynthesis of $\text{NAD}^+$

$\text{NAD}^+$  can be synthesized either directly from tryptophan, or from any  $\text{NAD}^+$  precursors available in the cellular environment. Both tryptophan and precursors are acquired from the diet (Bender, 1983; Spencer and Preiss, 1967).

The *de novo* synthesis of  $\text{NAD}^+$  (**Fig. 10B**) starts by converting tryptophan to N-formylkynurenin, which is then converted to unstable  $\alpha$ -amin- $\beta$ -carboxymuconate- $\epsilon$ -semialdehyde (ACMS) in four enzymatic reactions. ACMS can either enter TCA cycle through glutarate pathway (**Fig. 10C**), or undergoes spontaneous cyclisation producing quinolinic acid (QA). In next step, QA reacts with 5-phospho- $\alpha$ -D-ribose-1-diphosphate forming nicotinamide mononucleotide (NAMN). NAMN is converted to nicotinamide adenine dinucleotide (NAAD) by NAM mononucleotide adenylyltransferase (NMNAT) in presence of AMP. The final step is catalysed by  $\text{NAD}^+$  synthase using ATP as a source of energy and glutamine as a source of amide group.

Cells are unable to cover all the  $\text{NAD}^+$  requirements from *de novo* synthesis because availability of tryptophan is limited, thanks to its presence in numerous biosynthetic reactions. A more efficient method to synthesize  $\text{NAD}^+$  is through the salvage of  $\text{NAD}^+$  metabolites (**Fig. 10D**) and already synthesized precursors present in the diet (**Fig. 10A**). There are three main precursors: nicotinic acid (NA), nicotine amide (NAM) and NAM riboside (NR) (Cantó et al., 2015).

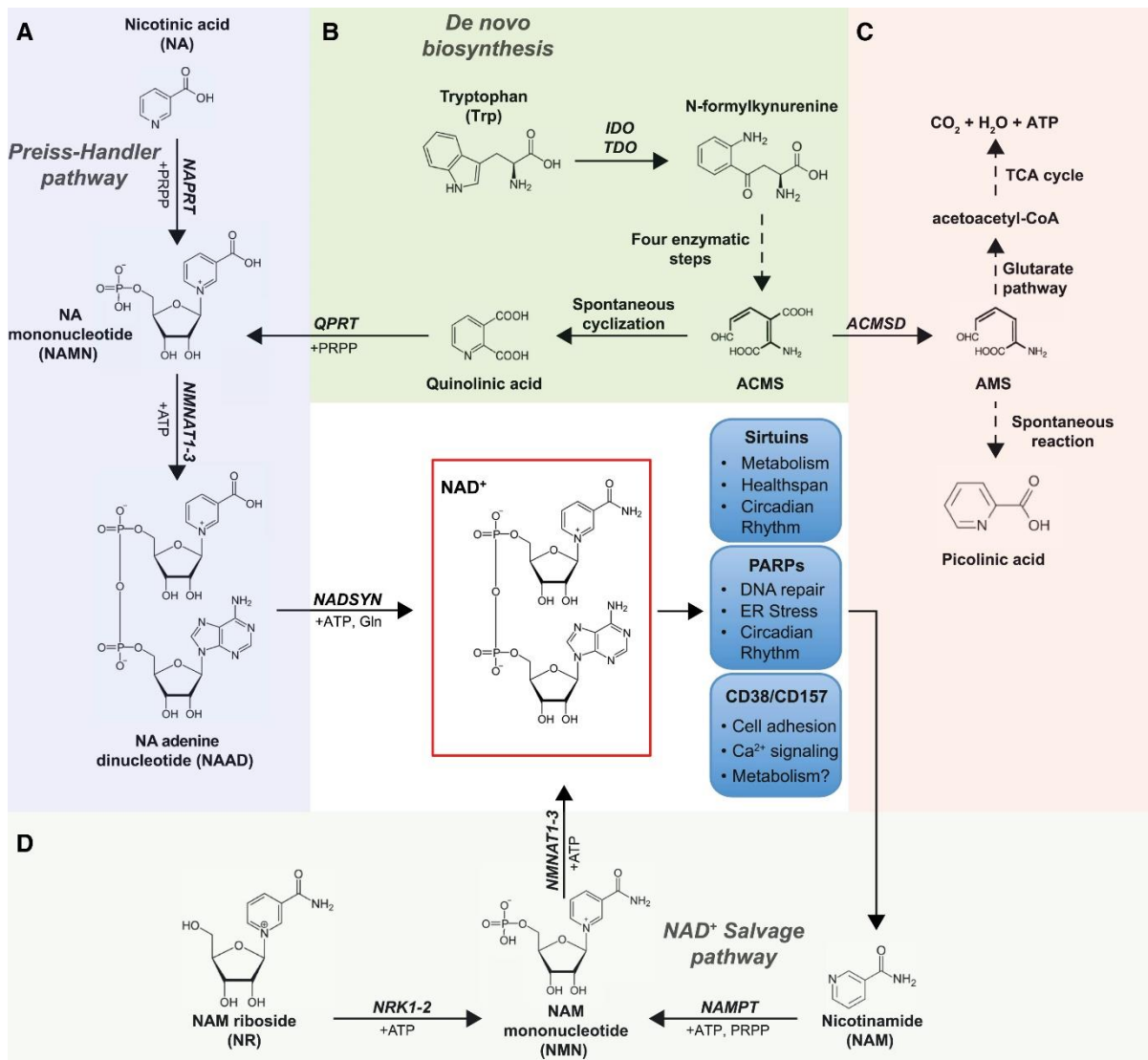

**Fig. 10: Metabolism of NAD<sup>+</sup>.** Biosynthetic pathways producing NAD<sup>+</sup>: **(A)** Preiss-Handler pathway produces NAD<sup>+</sup> from Nicotinic acid. **(B)** *de novo* synthesis of NAD<sup>+</sup> from Tryptophan. **(C)** ACMS degradation pathway branching either to utilisation in TCA cycle or to synthesize Picolinic acid. **(D)** Salvage pathways producing NAD<sup>+</sup> from nicotinamide (by-product of NAD converting enzymes) or nicotinamide riboside (precursor from diet/vitamin B<sub>3</sub>). Blue boxes represent three NAD<sup>+</sup> consuming protein families with their main biological roles. Abbreviations: ACMS -  $\alpha$ -amino- $\beta$ -carboxymuconate- $\epsilon$ -semialdehyde, ACMSD - ACMS decarboxylase, AMS -  $\alpha$ -amino- $\beta$ -muconate- $\epsilon$ -semialdehyde, IDO - indoleamine 2,3-dioxygenase, NA - nicotinic acid, NAAD - NA adenine dinucleotide, NADSYN - NAD<sup>+</sup> synthetase, NAMN - NA mononucleotide, NAMPT - Nicotinamide Phosphoribosyltransferase, NAPRT - Nicotinate phosphoribosyltransferase, NMN - NAM mononucleotide, NMNAT - NMN adenyltransferase, NR - nicotinamide riboside, NRK - NR kinase, PRPP - phosphoribosyl pyrophosphate, QPRT - quinolinate phosphoribosyltransferase, TDO - tryptophan 2,3-dioxygenase, Gln - Glutamine, Trp - Tryptophan (Cantó et al., 2015)

## 1.2.2 Overview of NAD<sup>+</sup> converting enzymes

Extensive studies of NAD mainly because of its role in pellagra disease (niacin deficiency) discovered that the physiological significance of NAD is far beyond redox reactions. NAD<sup>+</sup>/ NADH ratio is one of the most important markers of cell metabolic



status. Subtle changes in this ratio can be recognized by sensor proteins which can modulate wide spectrum of cellular processes.

Whereas in redox reactions important part of NAD is nicotineamide, proteins sensitive to  $\text{NAD}^+/\text{NADH}$  ratio use NAD as a source of adenosine diphosphoribose (ADPR). ADPR is utilised as a functional group in mono- or poly-ribosylation reactions mediated by ADP ribose transferases (ARTs) or as an acceptor of acetyl group in deacetylation reactions mediated by Sirtuins (SRTs). ADPR can be also cyclized or modified by substitution to produce second messenger molecules in  $\text{Ca}^{2+}$  signalling mediated by NADases. (**Fig. 11**).

All members of mentioned protein groups evolved specific NAD binding motif called Rossman fold. Structurally, a Rossman fold consists of three parallel  $\beta$ -sheets between which are two  $\alpha$ -helices. (Houtkooper et al., 2010). Rossman fold can be slightly modified based on the cofactor type and its redox form. Under certain conditions, other forms of NAD can bind to specific Rossman fold with lower affinity which may affect function of the enzyme. (Hanukoglu, 2015; Shi and Shi, 2004).

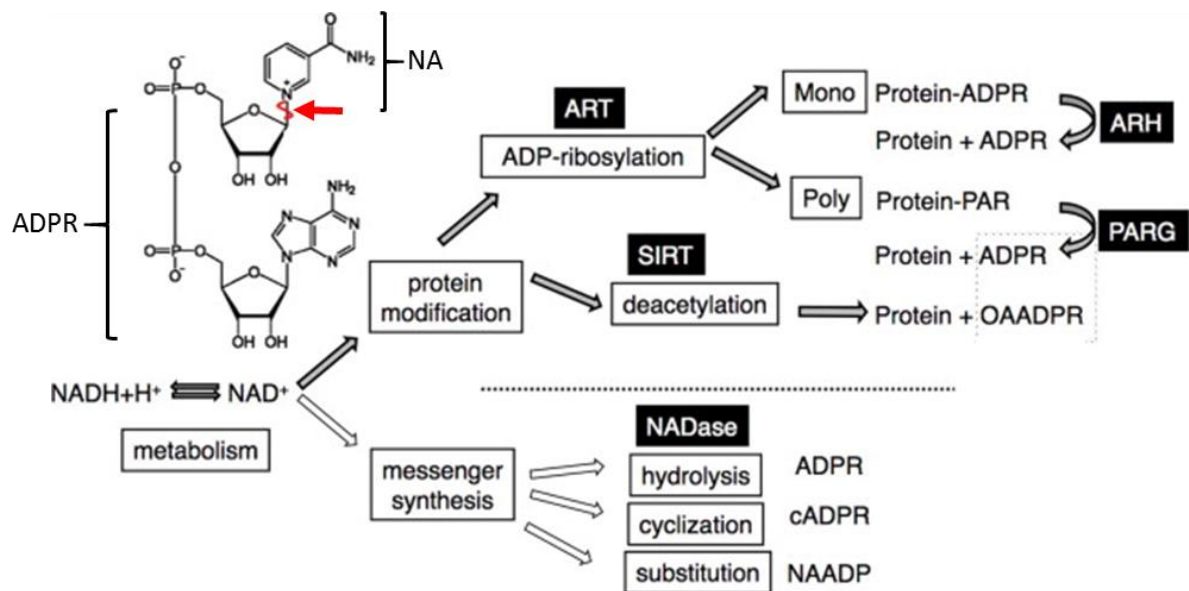

**Fig. 11: Overview of  $\text{NAD}^+$  converting enzymes with their molecular function and products.**  $\text{NAD}^+$  is used by  $\text{NAD}^+$  converting enzymes as a source of ADPR released from  $\text{NAD}^+$  by cleaving the glycoside bond (red arrow). ADPR is then used in protein modifications either by ARTs as a functional group producing mono- and poly-ADP-ribosylated proteins, or as an acceptor of acyl- moieties in deacetylation reactions catalysed by Sirtuins. ADPR can undergo cyclization, hydrolysis or substitution catalysed by NADases to produce second messenger molecules. Abbreviations: NA – Nicotine amide, ADPR - Adenosine diphosphoribose, PAR – Poly-ADPR, OAADPR - O-acetyl ADPR, cADPR – cyclic ADPR, NAADP - Nicotinic acid adenine dinucleotide phosphate, ART – ADP-ribose transferase protein family, SIRT – Silent Information Regulator Two protein family, NADase - NAD glycohydrolase protein family, ARH – ADP-ribosylhydrolase protein family, PARG -Poly-ADP-ribosyl-glycohydrolase (Koch-Nolte et al., 2011).

#### **1.4.2.1 ADP-ribose transferase (ARTs)**

ARTs are NAD<sup>+</sup> converting proteins, localised all over the cell, which attach one or more ADP-ribose moieties (PARylation) not only to protein substrates, but also to another molecules like dipthamide, rifampin, water, guanosine and tRNAs (Koch-Nolte et al., 2008). *Drosophila* genome contains only two ARTs. In mammals, ART family consists of 17 members from which PARP1 and PARP2 are the most abundant and active members of this protein family (Hottiger et al., 2010)

PARP activity is stimulated mostly by DNA damage, however other activation pathways independent from DNA damage were described. To the group of proteins able to stimulate PARP autoPARylation belong: ERK (Cohen-Armon et al., 2007), HSP70 (Petesch and Lis, 2012) and Tyrosyl tRNA synthetase (Sajish and Schimmel, 2015).

Functionally, PARPs participate in multiple physiological events. The most important role of PARPs is in DNA damage response, coordinating spatial and temporal organisation of the repairs (Wei and Yu, 2016). PARP2 and Tankyrases maintain genomic stability (Schreiber et al., 2002; Smith et al., 1998). Although, the spectrum of PARP action is wider. PARPs play important role during inflammation, cell death, circadian rhythm coordination, neuronal function, metabolism and mitosis (Gibson and Kraus, 2012; Schreiber et al., 2006)

#### **1.4.2.2 NADase**

Systematically, NADases are NAD<sup>+</sup> glycohydrolases catalysing hydrolysis of NAD<sup>+</sup> to nicotinamide and ADPR. Except their hydrolysis activity, NADases can catalyse either cyclisation of ADPR to produce cADPR or base-exchange of the nicotinamide moiety in NADP<sup>+</sup> by nicotinic acid to produce nicotinic acid adenine dinucleotide phosphate (NAADP), all playing role in calcium signalling (Lee, 2012; Malavasi et al., 2008).

The most important members of NADase family are ubiquitously distributed CD38 and its homolog CD157. Both proteins are single pass transmembrane proteins highly conserved in all metazoans. Except second messenger production, they participate on control of free NAD<sup>+</sup> in the cell. Knock-down of CD38 can increase levels of free NAD<sup>+</sup> by 10 - 20 fold and activate Sirtuins (Aksoy et al., 2006; Barbosa et al., 2007). CD38 can be anchored to the plasma membrane in two orientations, with the catalytic domain inside or outside the cell. Inside orientation was connected

with increased levels of intracellular cADPR, revealing mechanism of second messenger production and of controlling intracellular NAD<sup>+</sup> levels (Zhao et al., 2012).

The exact mechanism of CD38 role in cellular and tissue processes is not yet known. However, CD38 physiologically participates in many cellular processes including regulation of glycolysis, RNA processing, protein synthesis, antioxidant and DNA repair (Y. Hu et al., 2014). Inter- and intra-tissue roles of CD38 are in increased resistance to obesity, liver steatosis and glucose intake (Barbosa et al., 2007). Although, recent evidence suggests that Sirt1 is a true effector behind CD38 physiological effects (Chini, 2009).

Studies in CD38 deficient mice revealed that subjects still maintained cADPR synthase and NAD<sup>+</sup> glycohydrolase activity, suggesting presence of more NADase family members in mammalian genome (Ceni et al., 2003; Kannt et al., 2012; Nam et al., 2006).

#### 1.4.2.3 Sirtuins

Sirtuins belong to an ancient family of proteins present in almost all living organisms from Archea to mammals (Frye, 2000). All proteins of this family share conserved catalytic core enabling them to bind substrate and NAD<sup>+</sup>, respectively (Brachmann et al., 1995; Hoff et al., 2006). Sirtuins are Class III protein deacetylases using ADPR of NAD<sup>+</sup> as an acceptor of acetyl group from substrate, releasing NAM, O-acetyl ADPR and deacetylated substrate (Sauve et al., 2006). Recent discoveries showed that some sirtuins can not only remove acetyl moieties from lysines but also larger acyl groups (**Fig. 12**) (H. Lin et al., 2012). Enzymatic activity of sirtuins is also not bound to deacylation. A number of sirtuins have been reported to have ADP-ribosylation activity, however this type of reaction is not very efficient in terms of chemical kinetics *in vitro*. Therefore, deacylation is still the molecular function with higher *in vivo* significance with exception of Sirt4 and Sirt6 (Du et al., 2009; Haigis et al., 2006a; Van Meter et al., 2011).

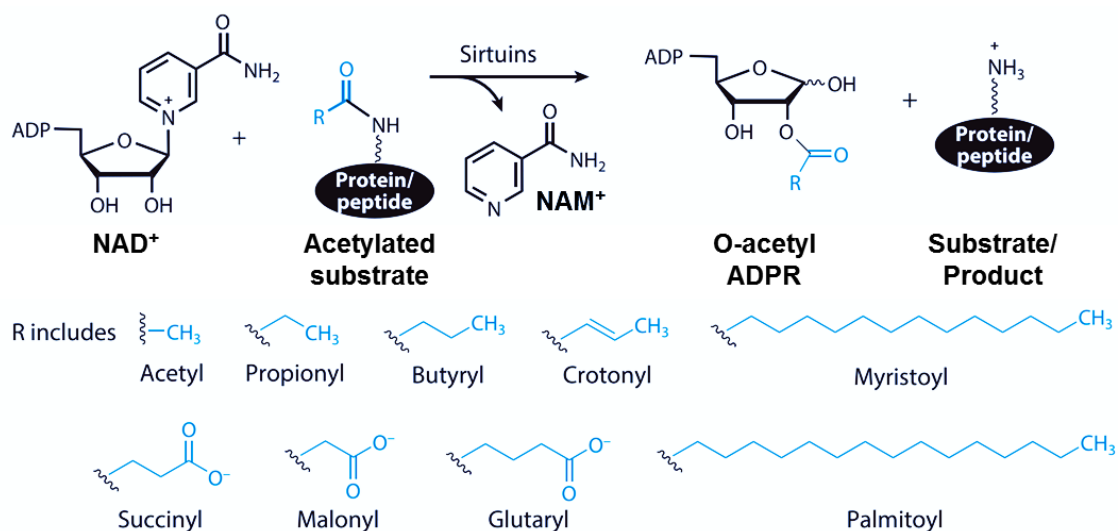

**Fig. 12:** Mechanism of deacetylation reaction catalysed by Sirtuins, with a list of target acyl moieties removed from substrate (Bheda et al., 2016).

Number of sirtuins in the cell ranges from one to two in prokaryotes, through five in yeast and *Drosophila*, to seven in mammals. Phylogenetical analysis of sirtuins showed that proteins in this group contains variable regions around catalytic core. Based on these regions, sirtuins are divided into five subclasses (I-IV and U) (Brachmann et al., 1995). It is believed that these evolutionary modifications are the reason why sirtuins, especially in higher eukaryotes with multiple sirtuin homologs, differ in their subcellular localisation, function and substrate preferences (Bheda et al., 2016; Michishita, 2005).

To this day, the most studied sirtuins, among the first discovered yeast Sir2, are mammalian sirtuins (Shore et al., 1984). Seven mammalian sirtuins, SIRT1-SIRT7, are present in all tissues, whereas the levels of expression differ significantly based on the tissue, age and other stimuli (Sidorova-Darmos et al., 2014; Uhlen et al., 2015). Mammalian sirtuins are mostly nuclear proteins, which are enriched in nucleoplasm (SIRT1, SIRT6) and nucleolus (SIRT7), but they also can be found in cytoplasm (SIRT2) and mitochondria (SIRT3, SIRT4, SIRT5) (Michishita, 2005; Uhlen et al., 2015). It is believed, that localisation of Sirtuins can be changed depending on cellular signals (SIRT1, SIRT2, SIRT5) (Pfister et al., 2008; Tanno et al., 2007; Vaquero et al., 2006).

Multiple molecular functions and almost no sequence specificity around the target lysines, allows sirtuins to modify different proteins and participate on various cell events (**Tab. 3**) (Bheda et al., 2016). The general role of sirtuins is to improve metabolic efficiency of the cell in the time of energy insufficiency. Model cases of this

event connected with activation of sirtuins are: exercise (Cantó and Auwerx, 2009), calorie restriction (Chen et al., 2008), fasting (Cantó et al., 2010; Rodgers et al., 2005) or simply lack of carbohydrates (Fulco et al., 2008). Dietary restrictions and Sirtuin activation are also connected with increase of lifespan (Dang, 2014; Guarente and Guarente, 2013; Houtkooper et al., 2012).

**SIRT1** influences transcription of metabolic genes by modulating acetylation status or stability of their transcription factors and cofactors (Feige and Johan, 2008). Additionally, they are known to coordinate metabolic rate based on circadian rhythms (Asher et al., 2008; Chang and Guarente, 2013; Masri, 2015; Nakahata et al., 2008). Sirt1 also plays role in inflammation, stress response and apoptosis (Mo et al., 2007; Yeung et al., 2004). Tissue specific and context dependent targets of SIRT1 with affected biological function are listed in **Tab. 4**.

**SIRT2** was found to deacetylate  $\alpha$ -Tubulin and H4K16, markers of cell cycle progression (Dryden et al., 2003; Inoue et al., 2007; Vaquero et al., 2006) SIRT2 also plays role in oxidative stress response and apoptosis via FOXO3a interaction (Wang 2007)

**SIRT3** is the main mitochondrial sirtuin, therefore most of its roles are connected with energy homeostasis (Ahn et al., 2008). It upregulates fuelling of TCA cycle through interaction with ACS2 (Hallows et al., 2006; Schwer et al., 2006), GDH (Lombard et al., 2007) and ACAD (Hirschey et al., 2010). Through interaction with subunits of Complex I, II, III, V (Ahn et al., 2008; Finley et al., 2011; Jing et al., 2011) and PGC-1 $\alpha$ , it boosts mitochondrial energy production and participates in thermogenesis (T. Shi et al., 2005). All these events are connected with increased ROS production. Physiological levels of ROS are maintained by SOD2, controlled also by SIRT3 (Y. Chen et al., 2011; Qiu et al., 2010; Randa Tao et al., 2010).

**SIRT4** participates in insulin secretion by downregulating subunit of ATP/ADP translocase and IDE. SIRT4 shares GDH as a substrate with SIRT3. During calorie restriction SIRT4 inhibitory effect on GDH ADP-ribosylation is overpowered by activating effect of SIRT3 deacetylation, resulting in in favoured amino acid- over glucose-dependent secretion of insulin (Ahuja et al., 2007; Haigis et al., 2006b)

**SIRT5** role in cell is not clear yet. Its translocation from nucleus to mitochondria is connected with apoptosis and urea detoxifying cycle (Nakagawa et al., 2009; Ogura et al., 2010; Pfister et al., 2008).

**SIRT6** activity is tightly connected with telomeric chromatin maintenance and DNA damage repair (Mostoslavsky et al., 2006). Anti-age effect of SIRT6 is

strengthen by downregulation of NF- $\kappa$ B expression, responsible for inflammatory response and age related gene expression (Kanfi et al., 2012; Kawahara et al., 2009). SIRT6 also interacts with HIF-1 $\alpha$  and participates in regulation of apoptosis and glucose metabolism (Zhong et al., 2010)

**SIRT7** stimulates transcription of ribosomal DNA (Ford et al., 2006), prevents apoptosis and regulates proliferation (Vakhrusheva et al., 2008).

**Tab. 3:** Overview of basic information about mammalian Sirtuins and some of their substrates. Underlining in molecular function refers to efficiency of the reaction type: double underlining - high efficiency, single underlining - average efficiency, no underlining – low efficiency (adapted from Haigis & Sinclair 2010; Nakagawa & Guarente 2011; Martínez-Redondo & Vaquero 2013; Cantó et al. 2015; Chen et al. 2015; Pougovkina & de Boer 2016; Yang & Sauve 2016).

Sirtuin	<u>SIRT1</u>	<u>SIRT2</u>	<u>SIRT3</u>	<u>SIRT4</u>	<u>SIRT5</u>	<u>SIRT6</u>	<u>SIRT7</u>
<b>Class</b>	I.	I.	I.	II.	III.	IV.	IV.
<b>NAD<sup>+</sup> K<sub>n</sub> value</b>	94-96 μM	83 μM	880 μM	35 μM	980 μM	26 μM	N.A.
<b>Localisation</b>	Nucleus Cytoplasm	Nucleus Cytoplasm	Mitochondria	Mitochondria	Mitochondria (Cytoplasm, Nucleus)	Nucleus	Nucleolus
<b>Molecular function</b>	<u>Deacetylation (S)</u> <u>Deacetylation (S)</u>	<u>Deacetylation (S)</u> <u>Deacetylation (S)</u>	<u>Deacetylation (S)</u> <u>Deacetylation (S)</u> <u>ADP ribosylation</u>	<u>Deacetylation (W)</u> <u>ADP ribosylation</u> <u>Lipoamidation</u>	<u>Deacetylation (W)</u> <u>Demalonylation</u> <u>Desuccinylation</u> <u>De-glutrylation</u>	<u>Deacetylation (W)</u> <u>ADP ribosylation</u> <u>Demethylstoylation</u>	<u>Deacetylation</u>
<b>Null phenotype</b>	Developmental defects, lethal in some backgrounds	Normal development	Normal development	Normal development	Normal development	Premature ageing	Smaller size, short lifespan, heart defects
<b>Biological function</b>	<b>Known substrates</b>						
<b>Histones</b>	H1, H3, H4	H3, H4	H3, H4	N.A.	N.A.	H3	H3
<b>Chromatin remodeling</b>	p300, HDAC1, MOF, TIP60, Suv39h1	p300					
<b>DNA repair</b>	Ku70, XPA, NBS1, PARP1		Ku70			CtIP, PARP1, DNA pol-β	
<b>Stress response</b>	p53, FOXO1, FOXO3, FOXO4, NF-κB, HIF1A, HIF2α, c-FOS, C-JUN, E2F1	p53, FOXO1, FOXO3A, NF-κB, MYC,	p53, FOXO3A, SOD2			HIF1A, NF-κB	p53
<b>Metabolism</b>	ACS1, PGC-1α, CXR, FXR, SREBP-1c, LKB1, TORC1, TORC2, eNOS	PEPCK1	LCAD, HMGCS2, IDH2, GDH, SOD2, OXPHOS Complexes (I, II, III, V)	GDH, PDH, MCD	CPS1, SDH, PDH, Glutaminase, Urate oxidase,		
<b>Others</b>	NICD, RIP1, Cortactin, RAR-β, TAU	α-Tubulin, CDH1, CDC20	Cyclophylin D				RNA pol I

**Tab. 4:** Function of SIRT1 in tissue specific and input specific context with selected substrates. Substrates marked in blue are suppressed by SIRT1 activity and substrates marked in red are activated. Substrates in black colour are both (adapted from Nakagawa & Guarente 2011).

Function	Substrates	Cancer	Cardiovascular System	Metabolism of				Nervous system	Inflammation/ Stress response
				Liver	Fat	Muscle	Pancreas		
Transcriptional suppression Heterochromatin formation Methylation Acetylation	Histone H3K9 Histone H3K59 Histone H4K16 Histone H1K26 Suv39h1 p300	p53 β-catenin Survivin Ku70 E2F1 Rb TSC2	eNOS NF-κB LKB1 PGC1α PARP1	PGC1α FOXO CRTG2 PPARα LXR SREBP-1/2 HNF4a	PGC1α PPARγ	PGC1α MyoD PCAF FOXO PTP1B FXR AceCS1	UCP2 FOXO	RARβ miR-134 OX2R Tie1 BMAL1 Per2 PIPSKY	NF-κB Ku70 HIF1a Smad7 HIF2α HSF1 NBS1 PARP1 WRN
Cell survival Apoptosis Oncogens Tumor suppression				Gluconeogenesis, Fatty acid oxidation, Insulin secretion, Insulin sensitivity, Fat mobilisation, Muscle differentiation, Cholesterol metabolism, Mitochondrial biogenesis, Respiration				Alzheimer's disease, Memory formation, Feeding behaviour, Adult neurogenesis, Circadian rhythm, Hormone release	Response to: Inflammation Hypoxia Heat shock DNA damage

SIRT1 function in



## 1.5 Regulation of SIRT1 activity

Molecular characterization of Sirt1 and general description of Sirtuin family was described in previous chapter. This chapter is focused mostly on regulation of mammalian SIRT1 activity on transcriptional, post-transcriptional and post-translational levels. The effect of NAD<sup>+</sup> availability will be also discussed here.

### 1.5.1 Regulation of Sirt1 activity at the transcriptional level

Sirt1, similarly as the rest of the Sirtuins is ubiquitously expressed in almost all tissues at moderate levels. However, transcript or protein levels can rapidly increase in response to metabolic stress, exercise or nutrient availability (Cohen et al., 2004; Radak et al., 2011). For example, 25% calorie restriction in human subjects, increased Sirt1 mRNA levels in muscle tissue by 113% (Civitarese et al., 2007). Alternatively, levels of Sirt1 transcript/protein are downgraded by excessive nutrient intake (Chalkiadaki and Guarente, 2012). Transcription factors responsible for up and downregulation of Sirt1 expression are summarized in **Fig. 13** and will be discussed later in this part.

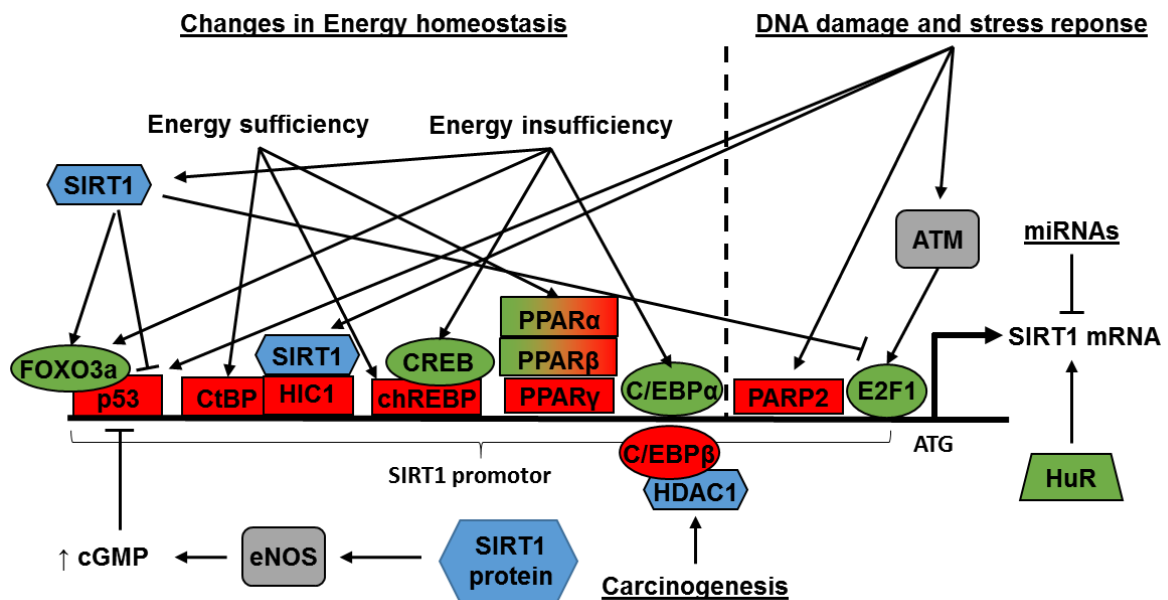

**Fig. 13: Transcription factors responsible for regulation of SIRT1 expression.** Proteins in green directly upregulate SIRT1 expression, proteins in red directly downregulate SIRT1 expression. Proteins in blue and grey are part of a regulatory complex or affect SIRT1 expression indirectly (adapted from Yang & Sauve 2016)

### 1.5.1.1. Regulation of SIRT1 expression as a response to changes in basal metabolism

**p53 and FOXOs:** p53 is a well-known tumour suppressor and stress-responsive transcription factor (Fridman and Lowe, 2003). Two functional binding sites of p53 were identified in the promoter of Sirt1. In the state of energy homeostasis, p53 is actively repressing transcription of SIRT1 by binding to both identified sites. When the energy homeostasis is disrupted, FOXO3a is activated and translocated into the nucleus where it removes p53 from the Sirt1 promoter, stimulating activation of SIRT1 transcription. (Nemoto et al., 2004; Xiong et al., 2011). Interestingly, SIRT1 is boosting its own expression by inactivating p53 and activating FOXO3a which are direct substrates of SIRT1 (Brunet et al., 2004; Gonfloni et al., 2014).

**eNOS:** Another protein playing part in SIRT1 autoregulation is eNOS. eNOS activated by SIRT1 deacetylation is responsible for increased production of cGMP which results in degradation of p53 and activation of SIRT1 expression (Fraser et al., 2006).

**HIC1 and CtBP:** SIRT1 participates not only positively but also negatively on its own expression. Together with HIC1, SIRT1 can form a repressor complex able to bind to SIRT1 promoter (Wen et al., 2005). HIC1 is forming repressor complex also with CtBP, a major transcription repressor for many genes. Similarly to SIRT1, CtBP is sensitive to NAD<sup>+</sup>/NADH ratio. Compared to SIRT1, CtBP can bind both forms of NAD, but has no enzymatic activity. Binding to NADH allows CtBP to change conformation and form active homodimers. Active CtBP has increased affinity towards HIC1 and chromatin, resulting in repression of SIRT1 expression. Contradictory, calorie restriction (increase of NAD<sup>+</sup>/decrease of NADH) weakens CtBP-HIC1-chromatin interaction and activates SIRT1 expression (Byun and Gardner, 2013; Stankovic-Valentin et al., 2007; Zhang et al., 2007).

**ChREBP and CREB:** Similarly to CtBP, works ChREBP. During nutrient abundance ChREBP binds to SIRT1 promoter and repress its expression. When the nutrient availability is decreased, ChREBP is translocated to cytosol which allows CREB to bind to previously blocked sites and initiate transcription (Noriega et al., 2011)

**PPARs:** PPARs are nuclear receptors playing role in lipid metabolism (Michalik et al., 2006). During nutrient overload, PPAR $\gamma$  binds to its responsive elements in SIRT1 promotor and downregulates expression (Costa et al., 2010; Coste et al., 2008;

Han et al., 2010). PPAR $\alpha$  and PPAR $\beta$  were reported to regulate SIRT1 expression both positively and negatively (Hayashida et al., 2010; Kim et al., 2012; Okazaki et al., 2010). However, there are still some uncertainties about effect of this protein group on SIRT1 expression (Chiang et al., 2013; Okazaki et al., 2010).

**C/EBPs:** Another group of proteins playing role in lipid metabolism and regulation of SIRT1 expression are C/EBPs. Like previously discussed proteins, C/EBP $\alpha$  affinity towards SIRT1 promoter is increased after fasting and decreased by feeding, regulating the expression in positive manner (Jin et al., 2010). Contradictory, in the context of cancer, C/EBP $\beta$  forms complex with HDAC1 resulting in SIRT1 repression, increased proliferation and cancer progression (Jin et al., 2013).

### **1.5.1.2 Regulation of SIRT1 expression as a response to DNA damage**

**E2F1:** As a part of DNA damage response many pathways and proteins are activated. One of the proteins is ATM, a stress responsive kinase, which activates E2F1 transcription factor, playing role in cell cycle progression (DeGregori et al., 1995). Phosphorylation of E2F1 is associated with binding to SIRT1 promoter and upregulated expression. In this context, SIRT1 participates on its own repression. SIRT1 can bind to E2F1 and remove it from the promoter (Wang et al., 2006).

**PARP2:** Another important protein activated by DNA damage is PARP2. PARP2 was found to bind to the proximal region of SIRT1 promoter and actively participate on SIRT1 repression (Bai et al., 2011).

## **1.5.2 Post-transcriptional regulation of SIRT1**

### **1.5.2.1 miRNAs**

miRNAs are well known regulators of expression in mammalian genome. They either target specific mRNAs for cleavage or block progression of ribosome during translation (Asi Neilson and Sharp 2008). To this date, sixteen miRNAs have been identified to regulate SIRT1 mRNA, mostly through blocking of translation (**Tab. 5**) (Yamakuchi, 2012; Yamakuchi et al., 2008).

### **1.5.2.2 RNA binding proteins**

SIRT1 mRNA was found to associate with HuR RNA binding protein. HuR is responsible for stabilizing of SIRT1 transcripts, however this association can be easily

disrupted by oxidative stress or phosphorylation of HuR by Chk2, resulting in significant drop of SIRT1 transcript levels (Abdelmohsen et al., 2007).

**Tab. 5:** List of miRNAs participating in post-transcriptional regulation of SIRT1 expression in mammals (adapted from Yamakuchi 2012)

miRNAs regulating SIRT1	Tissue/cells/diseases	Regulation/function
miR-34a	Cancer cell lines	Inhibition of growth, apoptosis
miR-449a	Cancer cell lines	Inhibition of growth, apoptosis
miR-449	Gastric cancer	Apoptosis, senescence
miR-22	Fibroblast and cancer	Inhibition of growth and metastasis, senescence
miR-200a	Mammary epithelial cell	Epithelial to mesenchymal transition (EMT)
miR-143/145	Pancreatic cancer	Growth arrest, apoptosis
miR-217	Endothelial cells	Senescence
miR-195	Cardiomyocyte	Palmitate induced apoptosis
miR-199a	Heart	Ischemia
miR-132	Adipocyte	Stress-induced chemokine production
miR-181c, miR-9	Alzheimer disease	Down-regulated by amyloid- $\beta$ (A $\beta$ )
miR-9	Pancreatic $\beta$ -cell	Insulin secretion
miR-93	Liver	Senescence
miR-181a/b, miR-9, miR-204, miR-199b, miR-135a	Mouse ES cell	Differentiation
miR-100, miR-137	Mouse ES cell	Differentiation

## 1.5.3 Post-translational regulation of SIRT1

### 1.5.3.1 Phosphorylation

The most common mechanism of SIRT1 post-translational regulation is phosphorylation, therefore this will be my primary focus. Fifteen phosphorylation sites were identified on mammalian SIRT1 protein where seven are located on N terminus and eight on C terminus (Hwang et al., 2013; Sasaki et al., 2008).

**JNKs:** JNKs are MAPK type kinases typically activated when cell is exposed to heat shock, radiation or oxidative stress (Bode and Dong, 2007). In human, stress activated JNK1 can phosphorylate SIRT1 on three sites (S27, S47, T530). In general, SIRT1 phosphorylation by JNK1 is associated with enriched localisation of SIRT1 in nucleus and increased affinity towards histones over p53 (Nasrin et al., 2009). Suggesting SIRT1 playing role in prevention of DNA damage by heterochromatin formation (Berthiaume et al., 2006). However, under different stimulus, insulin or glucose treatment, JNK1 phosphorylation on S47 sends SIRT1 towards proteasome degradation pathway (Gao et al., 2011). In cancer cells, phosphorylation of S27 by JNK2 is associated with SIRT1 protein stability (Ford et al., 2008).

**p38:** p38 is another member of MAPK family, activated by cellular stress and promoting cellular senescence (Nebreda and Porras, 2000). After exposure to ionizing radiation, ERK activates p38 in ROS dependent manner. In turn, p38 promotes ROS production and phosphorylation of SIRT1 on a MAPK binding site (AA:

221-261). This phosphorylation is a mark for proteasome dependent degradation and promotes apoptosis independently from JNK activation (Hong et al., 2010).

**CK2:** CK2 is a versatile kinase playing important role in cell survival controlling proliferation, differentiation and apoptosis (Volodina and Shtil, 2012). After exposure to ionizing radiation, CK2 is activated and phosphorylates SIRT1 on multiple sites in N- and C- terminus (S154, S649, S651, S683). As a result, phosphorylated SIRT1 has increased activity and higher affinity towards his specific substrates, especially p53, promoting cell survival (Kang et al., 2009).

**CDKs:** SIRT1 is also phosphorylated by Cyclin B/ CDK1 complex, necessary for G2/M transition. Phosphorylation of SIRT1 on specific residues (T530, S540) is important for SIRT1 to mediate cell cycle progression (Nigg, 2001; Sasaki et al., 2008).

**DYRKs:** DYRKs similarly to previous kinases are pro-survival kinases regulating cell proliferation and apoptosis. After cellular stress, SIRT1 is phosphorylated by DYRKs on T530, what stimulates p53 deacetylation and promotes cell survival (Guo et al., 2010).

**PKA:** PKA is a main effector of cAMP/PKA pathway triggered by GPCR signalling and having multiple roles in cell (Sassone-Corsi, 2012). PKA phosphorylates SIRT1 on S434 located in catalytic domain. This phosphorylation resulted in activation of SIRT1 independently from changes in NAD<sup>+</sup>/NADH levels (decrease of K<sub>m</sub> for NAD<sup>+</sup>) and triggered expression of metabolic genes responsible for fatty acid oxidation (Gerhart-Hines et al., 2011).

**AMPK:** AMPK is a metabolic sensor activated by increased AMP levels (Hardie, 2011). In cancer cells, AMPK was found to directly bind catalytic domain of SIRT1 and phosphorylate T344. This phosphorylation resulted in abolishing of SIRT1's deacetylation activity, increased acetylation of p53 and apoptosis (Lee et al., 2012).

### 1.5.3.2 Other PTMs of SIRT1

**Sumoylation:** During normal conditions, SIRT1 is SUMOylated in K734 promoting its active state and binding towards its substrates. After application of various stress conditions (UV, hydrogen peroxide, DNA damage), SIRT1 is deSUMOylated by SENP1, deactivated and p53 dependent apoptotic pathway is activated (Y. Yang et al., 2007).

**Methylation:** Methylation is another PTM negatively influencing SIRT1 activity. However, it is not clear if the decreased activity of SIRT1 is because of methylation on one of the lysines (K233, K235, K236, K237) or simply because the binding of Set7/9 mono-methyltransferase disrupts SIRT1-p53 interaction (Liu et al., 2011).

**S-Nitrosylation:** SIRT1 is not nitrosylated directly, instead the nitric oxide is transferred from previously nitrosylated GAPDH to C387 and C390 of SIRT1. Nitrosylation results in blocking of SIRT1 enzymatic activity. Interestingly, both cysteins have extra role in proper Zn<sup>2+</sup> atom localisation in SIRT1 structure, necessary for SIRT1 activity (Kornberg et al., 2010).

**Ubyquitylation:** In general, polyubiquitylation targets proteins for proteasome degradation and SIRT1 is no exception (Gao et al., 2011; Glickman and Ciechanover, 2002). The half-life of SIRT1 under normal conditions is more than nine hours, however under stress condition this time can be significantly increased or decreased (Ford et al., 2008; Han et al., 2014; Z. Lin et al., 2012). Ubiquitination does not only affect SIRT1 stability but also its cellular localisation. During DNA damage response, ubiquitylation status of SIRT1 is dynamically regulated and ubiquitination of K311 is responsible for targeting SIRT1 to nucleus and preventing apoptosis (Peng et al., 2015).

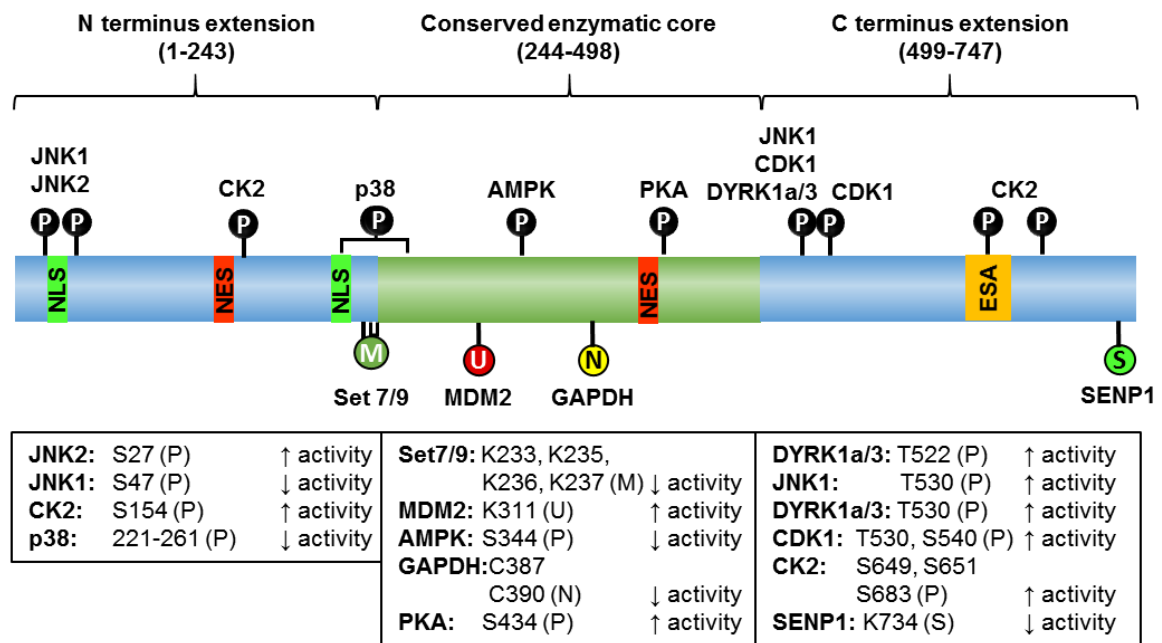

**Fig. 14: Summary of Sirt1 regulatory PTMs.** (P- phosphorylation, M – methylation, U – ubiquitylation, N – nitrosylation, S – sumoylation) regulating mammalian SIRT1 with enzymes responsible for modification. Nuclear localisation sequence (NLS): 31-38, 223-230; Nuclear export sequence (NES): 138-145, 425-431; Region essential for SIRT1 activity (ESA): 641-665 (adapted from Revollo & Li 2013; Hwang et al. 2013)

### 1.5.4 Modulation of SIRT1 activity by NAD<sup>+</sup> availability

After translation and context dependent PTMs, SIRT1 activity can be further modulated. One of the modulations is protein-protein interaction with either repressor DBC1, blocks catalytic domain of SIRT1 or activator AROS, exact mechanism is not known (Kim et al., 2008; Knight et al., 2013; Raynes et al., 2013). However, both proteins are not limiting factors for SIRT1 activity. The most important regulator of SIRT1 activity is binding of NAD<sup>+</sup> to the catalytic domain, event starting the deacetylation reaction (Hoff et al., 2006).

Average levels of NAD<sup>+</sup> in mammalian cell ranges from 200  $\mu$ M to 500  $\mu$ M. However, it is difficult to estimate exact concentration in organelles due to several problems: 1. Most of the NAD<sup>+</sup> is not free but bound to proteins. 2. Even within the organelles, NAD<sup>+</sup> concentrations can change locally (for example, SIRT1 was found to recruit NMNAT-1 to the target promoters to cover NAD<sup>+</sup> needs). 3. NAD<sup>+</sup> is a small molecule, which in theory can move freely through nuclear pores, however NAD<sup>+</sup> cannot pass through membranes and must be actively transported (out of the cell or to the mitochondria). Active transport is another process influencing NAD<sup>+</sup> levels between organelles. 4. Most measurements were performed using indirect methods. Despite all these challenges total NAD<sup>+</sup> levels were estimated: for nucleus  $\sim$ 70  $\mu$ M, for cytosol  $\sim$ 100  $\mu$ M, for mitochondria  $\sim$ 400  $\mu$ M and for extracellular space  $\sim$ 1  $\mu$ M (Fjeld et al., 2003; Houtkooper et al., 2010; Nakagawa et al., 2009; H. Yang et al., 2007; Zhang et al., 2009).

The theory behind the modulation of SIRT1 activity by NAD<sup>+</sup> availability is supported by several examples: 1. Increased activity of SIRT1 is in correlation with increased levels of NAD<sup>+</sup> propagated by exercise, CR, cellular stress (Hayashida et al., 2010; Chabi et al., 2009; Chen et al., 2008). 2. Contradictory, decreased SIRT1 activity is correlated with events connected with decreased levels of NAD<sup>+</sup> like high fat diet, feeding, ageing (Braidy et al., 2011; Kim et al., 2011) 3.  $K_m$  of SIRT1 for NAD<sup>+</sup> is within the physiological range -  $94\pm 5$   $\mu$ M (Pacholec et al., 2010) 4. During normal condition, NAD<sup>+</sup> concentration in nucleus is under  $K_m$  of SIRT1, which is connected with acetylated nuclear substrates of SIRT1. After physiological input, NAD<sup>+</sup> levels in nucleus increase and SIRT1 substrates are deacetylated (Canto and Auwerx, 2012). SIRT1 can work within normal nuclear NAD<sup>+</sup> levels after phosphorylation by PKA which decreases SIRT1's  $K_m$  for NAD<sup>+</sup> (Gerhart-Hines et al., 2011). 5. Knock-down of other NAD<sup>+</sup> consuming enzymes (CD38 and PARPs) is connected with increased free

NAD<sup>+</sup> levels and increased SIRT1 activity (Bai et al., 2011; Chini, 2009) 6. Upregulating of NAD<sup>+</sup> salvage pathway is also connected with increase in NAD<sup>+</sup> levels and boosted SIRT1 activity (Cantó et al., 2012; Revollo et al., 2004; Yoshino et al., 2011; Zhang et al., 2009). 7. Efficiency of SIRT1 activity is not dependent on SIRT1 protein levels, rather on amount of free NAD<sup>+</sup> in the cell (Braidy et al., 2011; Smith et al., 2009).

SIRT1 activity can be inhibited by NADH which is able to block the NAD<sup>+</sup> pocket of SIRT1 and prevent deacetylation reaction (Lin et al., 2004), but IC<sub>50</sub> of NADH for SIRT1 is around 17mM, which is far above physiological levels – 50-100 μM (Schmidt et al., 2004).

More potent natural inhibitor of SIRT1 is NAM with IC<sub>50</sub> between 50 and 100 μM. Compared to the NADH, inhibition by NAM is non-competitive (Anderson et al., 2003; Bitterman, 2002; Borra et al., 2004; Schmidt et al., 2004). At low levels NAM is able to promote SIRT1 activity by stimulating NAD<sup>+</sup> salvage pathway (Houtkooper et al., 2010; Revollo et al., 2004).



## 2.0 Aims

During my PhD studies, we investigated several leads related to connection of Sirt1 with Notch signalling. However, this thesis is based on following aims:

1. To investigate if Notch signalling pathway is sensitive to changes in basal metabolism in *Drosophila*.
2. To investigate if Notch signalling sensitivity to changes in basal metabolism is mediated by Sirt1.
3. To identify what part of the interactome do Notch and Sirt1 have in common.
4. To deduce possible Sirt1 substrates that can regulate Notch response.
5. To investigate the role of Sirt1 in Notch regulated developmental processes.

## 3.0 Materials and Methods

### Note

Part of this chapter are also supplementary tables containing all primers (**Supp. 1**), antibodies (**Supp. 2**) and other chemicals (**Supp. 3**) used in mentioned experiments.

### 3.1 Fly Work

#### 3.1.1 General maintenance of flies and used fly strains

All flies used in this thesis are summarized in **Tab. 6** and were ordered from Bloomington *Drosophila* Stock Centre (BDSC). Flies were kept in incubators tempered to 25°C without the humidity control and on a cornmeal diet with yeast and sucrose as a source of amino acids and sugars, respectively.

Fly strains prepared for genetic interaction studies with Notch pathway members (Notch, Delta, Hairless) were evaluated by conventional PCR for presence of Sirt1 deletion using primers Sirt1-C1 and Sirt1-C2.

**Tab. 6:** The list of fly strains used in this thesis. LOF–loss of function allele, GOF–gain of function allele.

line	gene	Name	Description	Note	Stock No.
w <sup>1118</sup>	w	white	LOF, partial deletion of gene	deletion of 1st exon	BDSC 3605
Sirt1 <sup>2A711</sup>	Sirt1	Sirtuin 1	LOF, complete deletion of gene	complete deletion of ORF	BDSC 8838
Sirt1 <sup>EP2300</sup>	Sirt1	Sirtuin 1	GOF, P element construct	endogenous Sirt1 under UAS promoter	BDSC 24859
N <sup>55e11</sup>	N	Notch	LOF, P element insertion	P element insertion in 1st exon	BDSC 28813
DI <sup>REV10</sup>	DI	Delta	LOF, partial deletion of gene	promoter and 1st exon missing	BDSC 6300
H <sup>2</sup>	H	Hairless	LOF, P element insertion	P element insertion in 2nd intron	BDSC 517
Kis <sup>1</sup>	Kis	Kismet	LOF, EMS mutation	-	BDSC 431
CoREST <sup>GF60</sup>	CoREST	CoREST	LOF, EMS mutation	mutation of 1st nucleotide of the 3rd intron	BDSC 52219
Bre1 <sup>01640</sup>	Bre1	Bre1	LOF, P element insertion	P element insertion upstream translation start	BDSC 11541
Df(2L)ED784			Partial deletion of II. chromosome	defficiency covering Sirt1 region (2L:34A4-34B6)	BDSC 7421
UAS-GFP	Src	Src	GFP marker, cell membrane	Src tagged by GFP under UAS promoter	BDSC 5432
sca-Gal4	Sca	Scabrous	driver line	Express Gal4 in proneural clusters and SOPs	BDSC 6479

#### 3.1.2 Quantification of observed phenotype

At least 100 flies were counted for each phenotypic analysis.

**Bristles:** Notch LOF bristle phenotype was quantified by counting *macrocheate* bristles on scutellum of fly's thorax. Average number of scutellar bristles per fly were plotted with standard error of the mean, and evaluated by two-way ANOVA.

**Wing veins:** Three types of Notch phenotype were quantified on wing veins:

1. Width of wing vein deltas on L5 vein – LOF of Notch, interaction with N<sup>55e11</sup>.
2. Size of the gap on L5 vein– GOF of Notch, interaction with H<sup>2</sup>.
3. Overall wing phenotype - LOF of Notch, interaction with DI<sup>REV10</sup>.

Width of delta present on L5 vein was measured by number of wing border bristles covering the delta. Average number of bristles per delta were plotted with standard error of mean, and evaluated by two-tailed Student's t-test.

Size of gap on L5 vein was measured as a ratio of relative size of the L5 vein gap and the length of presumptive complete L5 vein towards the end of the wing. Average size of the gap was plotted with standard error of the mean and evaluated by two-tailed Student's t-test.

Wing phenotype in DI<sup>REV10</sup> genetic interactions studies could not have been objectively measured therefore we established five phenotypic classes based on this description: Class I. represented normal/wild type wings. Class II. represented wings with a single type of aberration like bifurcation of the vein or thickening of veins or small delta or extra vein material. Class III. represented wings which had different combination of aberrations from Class II plus incomplete L5 vein. Class IV. represented wings with Class III. type of phenotype, however the phenotype was much worse: wider deltas, more extra veins, etc. Class V. represented wings with the most severe defects affecting also the wing shape. Result was plotted as percentage of flies in particular phenotype class from the quantified population. Data were not statistically evaluated.

### 3.1.3 Immunostaining of SOPs in wing imaginal discs

Wing imaginal discs of late L3 larvae were dissected in ice cold 1xPBS for maximal period of 10 min and then fixed in 4% formaldehyde in PBS for 30 min at room temperature (RT). Discs were washed with PBST (1x PBS + 0.2% Triton X-100) three times 10 min at room temperature with mild agitation. After washes discs were incubated with blocking solution: PBST + 0.5% BSA. 30 min, RT, agitated, then incubated with fresh blocking solution containing primary antibody ( $\alpha$ -Senseless,  $\alpha$ -Cut) overnight at 4°C. The following day, discs were washed three times 10 min at RT with blocking solution, agitated, then incubated with secondary antibodies (anti-guinea pig Alexa Fluor 488 for Senseless, anti-mouse Alexa Fluor 555 for Cut) for 2 hours in RT, agitated, protected from light. After three 10 min washes in blocking

solution and RT, discs were incubated in 80% glycerol in PBS for 30 min, mounted on a microscopic slide with antifade agent and examined on a confocal microscope.

## 3.2 Expression studies of Notch target genes

### 3.2.1 Notch pathway activation

The Notch signalling pathway was activated in two different *Drosophila* cell lines: *DmD8* – derived from 3<sup>rd</sup> instar larvae wing disc, naturally expressing Notch receptor and S2N –stably transformed S2 cell line (derived from late embryo) able to express wild-type Notch receptor from a Cu<sup>2+</sup>-inducible metallothionein promoter.

Both cell lines were grown in Schneider's *Drosophila* Medium (ThermoFisher Scientific) supplemented with 10% fetal bovine serum (Sigma-Aldrich) and 100 U/ml penicillin and 100 µg/ml streptomycin (Sigma-Aldrich). S2N cells were kept under permanent selection using 10 µM methotrexate. Expression of full-length Notch receptor in S2N cells was induced overnight by 600 µM CuSO<sub>4</sub> (Sigma-Aldrich) in cell culture medium. Notch pathway activation was triggered by incubation of cells with 2 mM EDTA in PBS for 25 min.

### 3.2.2 S2N treatments

**Sirt1 RNAi:** To knock down Sirt1 in S2N cells, we prepared 677 bp long double stranded RNA (dsRNA) targeting the first exon of Sirt1. dsRNA was produced using a PCR template with T7 promoter sequences attached to each end, and transcribed with the T7 RiboMAX™ Express Large Scale RNA Production System (Promega), following the manufacturer's protocol. S2N cells selected for Sirt1 knock down were treated as follows: Schneider medium was replaced by Opti-MEM® Reduced Serum Medium (ThermoFisher Scientific), containing 20 µg of dsRNA, incubated for 30 min followed by the addition of fresh Schneider's medium. Cells were treated again, 48 hours later, with dsRNA following the same protocol and harvested after further 48 hours.

**Drugs:** Freshly split S2N cells were treated with multiple drugs, alone or simultaneously, for 16 hours before mRNA harvest in following concentrations: 10mM 2-Deoxy-D-glucose (Sigma-Aldrich), 20 µM SRT1720 (Selleckchem), 25 µM Ex527 (Sigma-Aldrich).

### 3.2.3 mRNA quantification

RNA from six-well dishes of S2N cells was extracted in 0.5 ml of TRI Reagent® (Sigma-Aldrich) following the manufacturer's protocol. Extracted RNA was two times purified by ethanol precipitation and then purified from residual genomic DNA by TURBO DNA-free™ Kit (ThermoFisher Scientific), following the manufacturer's protocol. Integrity of extracted mRNA was tested by running on 1% agarose gels in 1x TAE buffer. Undamaged mRNA was reverse transcribed with M-MLV Reverse Transcriptase (Sigma-Aldrich), and specific mRNAs were quantified by real-time PCR using GoTaq® qPCR Master Mix (Promega) on a CFX96 Touch™ Real-Time PCR Detection System (Bio-Rad). Primers were designed not to span introns, and a calibration curve from the serially diluted genomic DNA was used, in every run, to accurately quantify the cDNA. All values were normalized to the mRNA levels of housekeeping gene CG16941 (Sf3a1, Splicing factor 3a subunit 1).

### 3.2.4 Luciferase assay

Reporters of Notch activity containing wild type Notch responsive element (NRE) or control version with mutated Su(H) binding sites were obtained as a generous gift from the lab of Sarah J. Bray. Reporter plasmids were co-transfected into S2 cells with FuGENE® 6 Transfection Reagent (Promega), together with copper-inducible expression vector containing sequence of intracellular domain of Notch receptor (pMT-N<sup>ICD</sup>) or full coding region of Sirt1 (pMT-Sirt1). As a normalizing construct, we used pRL-TK Renilla Luciferase Control Reporter Vector (Promega), a vector constitutively expressing *Renilla* luciferase. In control variant, an empty pMT vector was used to substitute for missing vectors expressing Sirt1 or N<sup>ICD</sup>.

Cells transfected as previously described were harvested after 24 hours of vector expression stimulated by adding 600 μM of CuSO<sub>4</sub>. Specific expression of *Luciferase* and unspecific expression of *Renilla* were measured by the Dual Luciferase Reporter Assay system (Promega) on the Orion II Microplate Lumimometer (Titertek Berthold) according to manufacturer protocols.

Values obtained for the NRE reporter were normalized to the signal from the control NME reporter, plotted as a fold change and evaluated by one-tailed Student's t-test.

### **3.3 Proteomic studies of Sirt1 interactors**

#### **3.3.1 Embryo collection**

Oregon strain of *Drosophila* was kept in large populations in insectarium in 25°C, 60% relative humidity and 12h/12h light/dark cycles. All tools and fly management was done according to Sisson (2000).

#### **3.3.2 Nuclear protein extracts**

Embryonic nuclear extract was obtained from four-day collections of 12 hours old embryos. Pure nuclear protein extract was obtained according to Kamakaka & Kadonaga (1994).

#### **3.3.3 Immunoprecipitation**

Nuclear protein extracts were incubated with three different antibodies against Sirt1: p4A10 (DSHB), p2E2 (DSHB), d-300 (Santa Cruz Biotechnology) or with antibodies against positive candidates from mass spectrometry list:  $\alpha$ -Kis,  $\alpha$ -Nap1, both custom made antibodies and generous gift from the lab of Peter C. Verrijzer.

S2, S2N cells were lysed in IP buffer: 25 mM HEPES/KOH, pH 7.6, 0.1 mM EDTA, 12.5 mM MgCl<sub>2</sub>, 10% glycerol, 100 mM KCl, 1% NP-40, 125 U/ml of Benzonase<sup>®</sup> Nuclease (Sigma-Aldrich), 1x cOmplete<sup>™</sup>, EDTA-free Protease Inhibitor Cocktail (Roche) and incubated with  $\alpha$ -Sirt1 antibody d-300 (Santa Cruz Biotechnology).

Both immunoprecipitation were done according to Chalkley & Verrijzer (2004), resolved by SDS/PAGE and analysed by mass spectrometry (MS) or Western blotting (WB).

#### **3.3.4 Mass spectrometry**

Samples for Mass spectrometry analysis of immunopurified protein peptides was prepared as described in Wilm et al. (1996) and analysed by LTQ Orbitrap XL<sup>™</sup> Hybrid Ion Trap-Orbitrap Mass Spectrometer (ThermoFisher Scientific). Detected peptides were matched against the FlyBase database (<http://www.flybase.org/>), using a MaxQuant search algorithm (Cox and Mann, 2008) and Label Free Quantification (LFQ) method (Cox et al., 2014). Identified proteins, their Mascot scores (cut-off 40) and number of unique peptides can be provided upon request.

In case of nuclear extract pulldowns, only peptides pulled down with at least two out of the three antibodies are shown. In case of S2/S2N pulldowns, only proteins with changed intensity and selected by Yuri Mochkin's personal algorithm are shown.

## **3.4 Baculovirus expression and purification of Su(H) from Hi5 cells**

### **3.4.1 Baculovirus stocks**

Full length Su(H) sequence was cloned into pFastBAC/CT vector (Bac-to-Bac<sup>®</sup> C-His TOPO<sup>®</sup> Cloning Kit, ThermoFisher Scientific) to produce bacmid expressing Su(H) protein tagged with 6x His tag at the C-terminus, following manufacturer instructions. P3 baculovirus stock, prepared as suggested in supplied manual, was used to infect Hi5 cells (ThermoFisher Scientific).

### **3.4.2 Su(H) expression**

Hi5 cells (*Trichoplusia ni*) were infected with P3 baculovirus stock and cultivated in Express Five<sup>®</sup> Serum free media (ThermoFisher Scientific) supplied with 10% of complete TNM-FH insect media (Sigma-Aldrich). After 4 hours, drugs affecting Sirt1 activity were added: 25  $\mu$ M Ex527 (Sigma-Aldrich) + 10  $\mu$ M Sirtinol (Sigma-Aldrich) = inhibitors of Sirt1; 20  $\mu$ M SRT1720 (Selleckchem) + 20  $\mu$ M Resveratrol (Sigma-Aldrich) = activators of Sirt1. In control variants, drug equivalent volume of DMSO was added. Hi5 cells were incubated in 27°C incubator without humidity control for 48 hours.

### **3.4.3 Quantification of Su(H) acetylation**

48 hours post baculovirus infection, Hi5 cells were harvested and lysed in lysis buffer: 20 mM NaH<sub>2</sub>PO<sub>4</sub>, 300 mM NaCl, 10 mM imidazole, 1% Triton X-100, 1x cOmplete<sup>™</sup>, EDTA-free Protease Inhibitor Cocktail (ThermoFisher Scientific) and 125 U/ml of Benzonase<sup>®</sup> Nuclease (Sigma-Aldrich). Su(H)-His was immunopurified by HisPur<sup>™</sup> Ni-NTA Superflow Agarose (ThermoFisher Scientific), following manufacturer protocol, resolved by SDS/PAGE and analysed by Western blotting.

Blotted membranes were blocked with 5% BSA and probed with either  $\alpha$ - His (C-term) HRP conjugated antibody (ThermoFisher Scientific) or with  $\alpha$ -acetyl lysine antibody (PTM Biolabs), following the standard WB protocol. Membrane probed with

$\alpha$ -acetyl lysine antibody was later incubated with  $\alpha$ -rabbit IgG HRP conjugated secondary antibody (Jackson ImmunoResearch).

Both membranes were developed using Clarity™ Western ECL Blotting Substrate (Bio-Rad) and chemiluminescence was captured by ChemiDoc MP Imaging Systems (Bio-Rad). Acquired images were analysed and relative band intensities measured by ImageLab software (Bio-Rad).

Relative band intensities were first normalised to loading control, intensity of  $\alpha$ - His (C-term) signal and then plotted as a ratio between the intensity of  $\alpha$ -acetyl lysine signal from drug treated sample and DMSO treated sample. Obtained values were evaluated by one-tailed Student's t-test.



## 4.0 Results

### 4.1 Notch pathway is sensitive to changes in cellular metabolism.

It has been discussed for a long time if there is any connection between Notch signalling pathway and basal metabolism of the cell. One of the parameters characterizing the status of basal metabolism is the cytosolic  $\text{NAD}^+/\text{NADH}$  ratio, which can change depending on the cellular priorities towards catabolic or anabolic processes. Such changes can be introduced also artificially by starving the cell, oxidative stress or by introducing specific drugs (Houtkooper et al., 2010). For this purpose, we decided to use a glucose analogue 2-deoxyglucose (2-DG). 2-DG enters the cell normally, however after phosphorylation by hexokinase in glycolytic pathway, 2-DG-phosphate (2-DG-P) is not further metabolized by phosphoglucose isomerase (PGI) and is accumulated in cell (Wick et al., 1957). 2-DG-P was described to block both HK and PGI (Brown, 1962; Chen and Guéron, 1992). This results in the termination of glycolysis, followed by deceleration of TCA cycle (Barban and Schulze, 1961). To investigate whether changes in basal metabolic activity affects Notch signalling, we treated S2N cells with different concentrations of 2-DG and measure mRNA levels of E(Spl) genes in basal state and after Notch pathway activation. S2N cell line is derived from S2 cells, containing a construct with  $\text{Cu}^{2+}$  inducible expression of Notch receptor. In this setup, Notch pathway can be easily activated by treating cells with EDTA (Krejčí and Bray, 2007). EDTA treatment simulates S2 cleavage and results in promoting of receptor proteolytic cascade, the starting point of Notch signalling pathway.

Cells cultivated in Schneider media were treated with 2-DG which concentration ranged from 2.5 mM to 50 mM. After 18 hours, we either activated Notch by EDTA or harvested cell without Notch activation (basal state, before Notch signalling). We extracted RNA and qPCR was performed to determine relative levels of E(Spl) genes mRNAs. Members of E(spl) gene cluster are classical Notch targets that share homology at their protein levels but differ in their regulatory regions, and therefore in their expression patterns. In the basal state, most E(Spl) genes show low expression levels, with the exceptions of E(Spl)m $\beta$  and E(Spl)m3 that are expressed relatively high, compared to the rest of the cluster members (**Fig. 15A**).

We observed that majority of the genes with low levels of their basal expression were slightly upregulated after 2-DG treatment, namely: E(Spl)m $\delta$ , E(Spl)m $\gamma$ ,

E(Spl)m $\alpha$ , E(Spl)m2, E(Spl)m4, E(Spl)m5, E(Spl)m6 and E(Spl)m7. Increase in mRNA levels was directly proportional to higher 2-DG concentration. Some of the genes were able to achieve expression levels similar to activated state of Notch pathway: E(Spl)m $\delta$ , E(Spl)m $\gamma$ , E(Spl)m4 and E(Spl)m5. Genes with higher levels of their basal expression, E(Spl)m $\beta$  and E(Spl)m3, did not change after 2-DG treatment (**Fig.15A**).

After the Notch pathway activation, we observed sensitivity to 2-DG treatment at E(Spl)m2, E(Spl)m3, E(Spl)m6, E(Spl)m7, E(Spl)m8 genes where the Notch dependent activation of did not reach the maximal levels observed in control conditions. In the group of genes not sensitive to 2-DG treatment were E(Spl)m $\beta$  and E(Spl)m $\alpha$ . In some genes, high variation in expression did not allow us to estimate any trend: E(Spl)m $\delta$ , E(Spl)m $\gamma$  and E(Spl)m5. We subdivided the negatively affected genes in two subgroups: Group A: E(Spl)m2, E(Spl)m3 and E(Spl)m7, where decrease in expression was directly proportional to 2-DG concentration and Group B: E(Spl)m6 and E(Spl)m8 where we initially observed a negative effect, and then a positive effect of high doses of 2-DG on gene expression (**Fig.15A**). We should note that while 10 mM 2-DG leads to an approximate 50% decrease in the rate of glycolysis and respiration (Slaninova, unpublished data), the high 2-DG concentration (>10 mM) almost certainly led to severe cell starving, and hence represents extreme conditions.

Taken together, the titration of 2-DG indicated that Notch signalling pathway is sensitive to changes in basal metabolism of the cell, however there is no uniform response common to all E(Spl) genes. While the basal expression of genes without Notch activation was only mildly affected, the response to Notch activation of five of the E(spl) genes was compromised in the presence of 2-DG: E(Spl)m2, E(Spl)m3, E(Spl)m6, E(Spl)m7, E(Spl)m8 (**Fig.15B**). For further experiments, we decided to use 10 mM concentration of 2-DG that represents similar concentration of glucose in Schneider media (11 mM).

**Fig.15: Notch pathway is sensitive to changes in metabolic state of the cell.** (next page) **A.** Relative levels of mRNA of all E(Spl) genes normalized to CG16941 after treatment with different concentration of 2-DG for 18h. Black bars represent gene expression before Notch activation (BNA) and grey bars represent genes expression after Notch activation (ANA). Error bars represent standard error of deviation from 3 biological replicates Genes are grouped in the same order as they are located on the chromosome (from E(Spl)m $\delta$  to E(Spl)m8). **B.** Fold change representation of Notch target gene expression after treatment with 10 mM 2-DG and after Notch activation. Blue arrows mark genes that do not respond efficiently to Notch activation when metabolism is impaired by 2-DG, resembling the Sirt1 RNAi effect. Significance according to one-tailed Student's t-test, \*P  $\leq$  0.05, \*\*\*P  $\leq$  0.001.

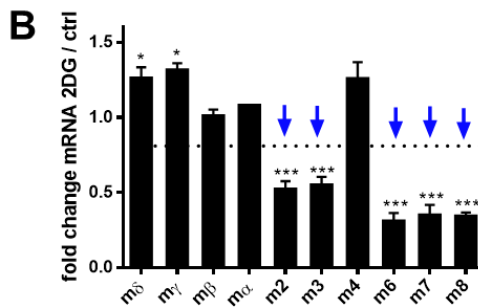
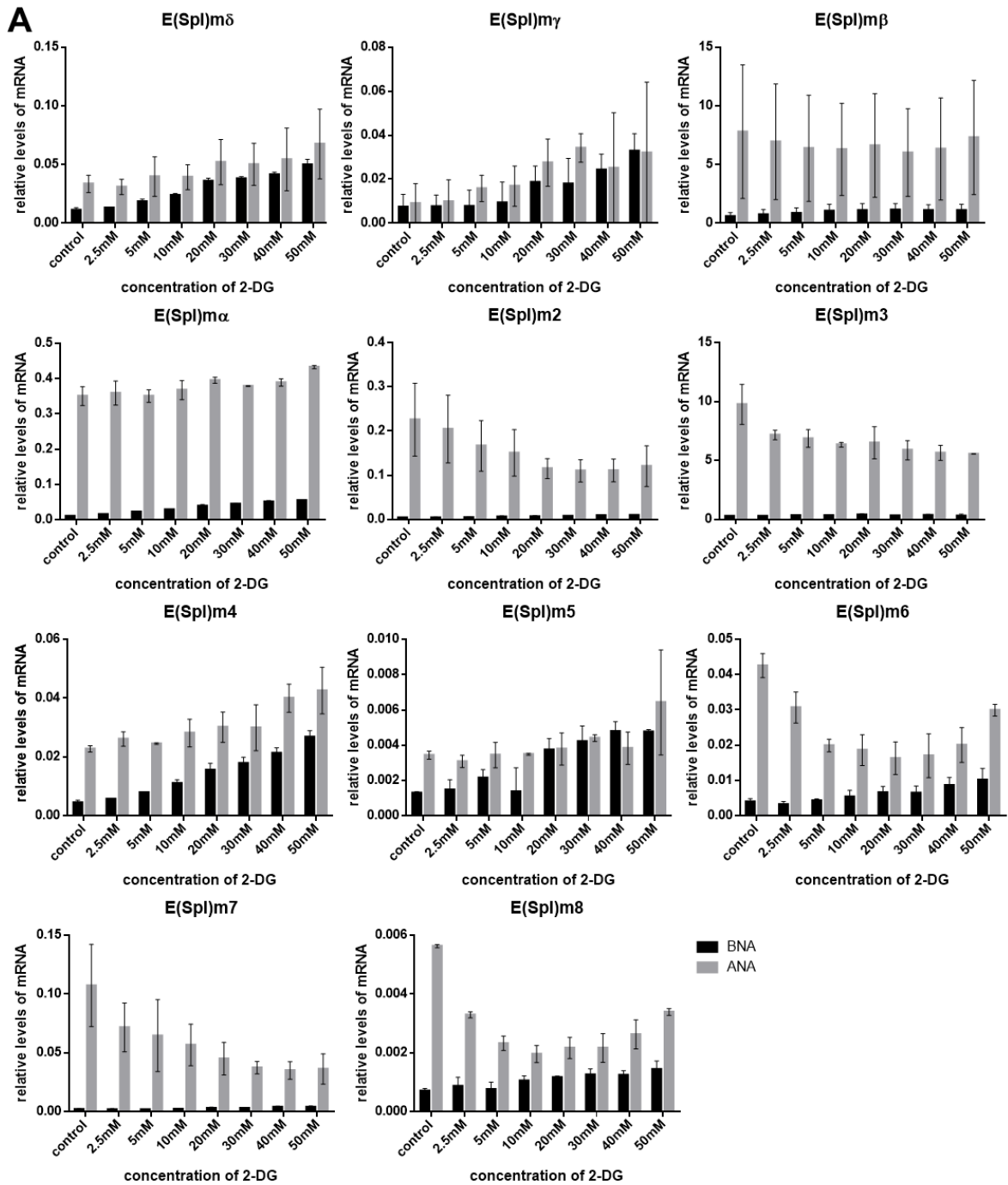

## 4.2 Sirt1 is needed for proper expression of E(Spl) genes

During the treatment of cells with 2-DG profound metabolic changes occur in the cell that will be reflected in the changes in the cellular NAD/NADH ratio as well as in changes of concentrations of other cellular metabolites. We reasoned that some of the NAD(H) binding proteins might work as metabolic sensors for the Notch pathway. As Sirt1 protein is an NAD-sensitive protein deacetylase it was an obvious candidate for a metabolic sensor that could affect the activity of Notch signalling in a NAD/NADH manner.

To investigate the effect of Sirt1 on Notch signalling we decided to knock down Sirt1 in S2N cells and measure mRNA levels of all genes from E(Spl) cluster before and after Notch activation using qPCR. After multiple experiments, we excluded E(Spl)m5 from analysis because its expression, even after Notch pathway activation, is outside reliable detection limit of our qPCR setup.

After Sirt1 knock down we were unable to see any significant differences in expression of E(Spl) genes, except in the case of E(Spl)m7, which increased by 1.3-fold (**Fig. 16A, B**). Some of the tested genes did not achieve the full potential of Notch dependent activation after the Sirt1 knock down (**Fig. 16B, C**), resembling the effect of 2-DG treatment. We observed that the decrease in expression ranged from 15% for E(Spl)m3, to more than 50% in the case of E(Spl)m7 (**Fig. 16D**). Several genes, namely E(Spl)m2, E(Spl)m3, E(Spl)m6, E(Spl)m7, E(Spl)m8, did not respond sufficiently to Notch activation when basal metabolism was blocked with 2-DG, nor did they respond sufficiently to Notch activation when Sirt1 protein was downregulated. This correlation sparked an idea that these genes may bind Sirt1 to their regulatory regions, which in turn affects their Notch response in a metabolism dependent manner.

To exclude possibility that downregulation of E(Spl) genes after the Sirt1 RNAi is due to the lowered protein levels of Notch receptor, we performed western blot (WB) analysis of EDTA treated cells, probing for Sirt1 and Notch intracellular domain (N<sup>ICD</sup>). Despite the Sirt1 RNAi efficiency varied throughout experiments (**Fig. 16E**), we were able to deplete Sirt1 protein levels below the WB detection limit. WB also showed that Sirt1 knock-down did not have effect on protein levels of N<sup>ICD</sup> in S2N cells (**Fig. 16F**). As S2N cells express very high levels of Notch receptor after the induction with Cu<sup>2+</sup>, we decided to include DmD8 cells as controls. DmD8 cells have naturally induced expression of Notch receptor at moderate levels. As expected Sirt1 RNAi did not have any effect on N<sup>ICD</sup> levels (**Fig. 16F**).

To further support positive role of SIRT1 in activation of E(Spl) genes, we used Notch-inducible luciferase reporter containing Su(H) binding site (NRE – Notch response element). This reporter was co-expressed with copper-inducible vectors expressing SIRT1 or N<sup>ICD</sup> and normalizing Renilla construct. Overexpression of Sirt1 alone led to the small but significant induction of the reporter. After co-expression of Sirt1 with N<sup>ICD</sup>, we saw 1.6-fold increase in activation of luciferase reporter compared to the activation by N<sup>ICD</sup> alone (**Fig. 16G**). These results provide further support that Sirt1 has a positive effect on Notch signalling.

From the above described Sirt1 knock-down experiments we can conclude that Sirt1 has no significant role in the repression of E(Spl) genes without Notch pathway activation. Conversely, when the Notch pathway is active, Sirt1 appears to be necessary for proper activation of some E(Spl) genes, suggesting its positive role in Notch signalling. Positive effect of Sirt1 is not simply due to a change of N<sup>ICD</sup> protein levels after Sirt1 RNAi. Furthermore, data from luciferase assay are in agreement with previous experiment, and support the theory of Sirt1 being a positive regulator of Notch target gene activation.

**Figure 16: Sirt1 is needed for proper expression of E(Spl) genes** (next page). **A.** The mRNA levels of E(spl) genes before Notch pathway activation, treated with Sirt1 RNAi or with control GFP RNAi. Bottom panel shows results plotted at smaller scale. **B.** The effect of Sirt1 RNAi on the basal mRNA expression of E(spl) genes before Notch activation; calculated as the ratio between normalized expression levels in cells treated with Sirt1 RNAi and cells treated with control GFP RNAi. Significance according to one tailed Student's t-test, \* p<0.05. **C.** The mRNA levels of E(spl) genes 25 minutes after Notch pathway activation, treated with Sirt1 RNAi or with control GFP RNAi. Bottom panel shows results plotted at smaller scale. **D.** The effect of Sirt1 RNAi on the mRNA expression of E(spl) genes after Notch activation; calculated as the ratio between normalized expression levels in cells treated with Sirt1 RNAi and cells treated with control GFP RNAi. Significance according to one tailed Student's t-test, \* p<0.05. **E.** Average efficiency of Sirt1 knock down in tested S2N cells. **F.** Protein levels of N<sup>ICD</sup> after Sirt1 knock down and 15min Notch activation in DmD8 cells and S2N cells. **G.** The intensity of NRE luciferase reporter response alone and with simultaneous expression with SIRT1 and/or N<sup>ICD</sup> normalised to same version of the reporter with mutated NRE site. Significance according to one-tailed Student's t/test, \*P<0.05. Error bars in A, B, C, D, E and G represent standard errors of the means from three to five independent biological replicates.

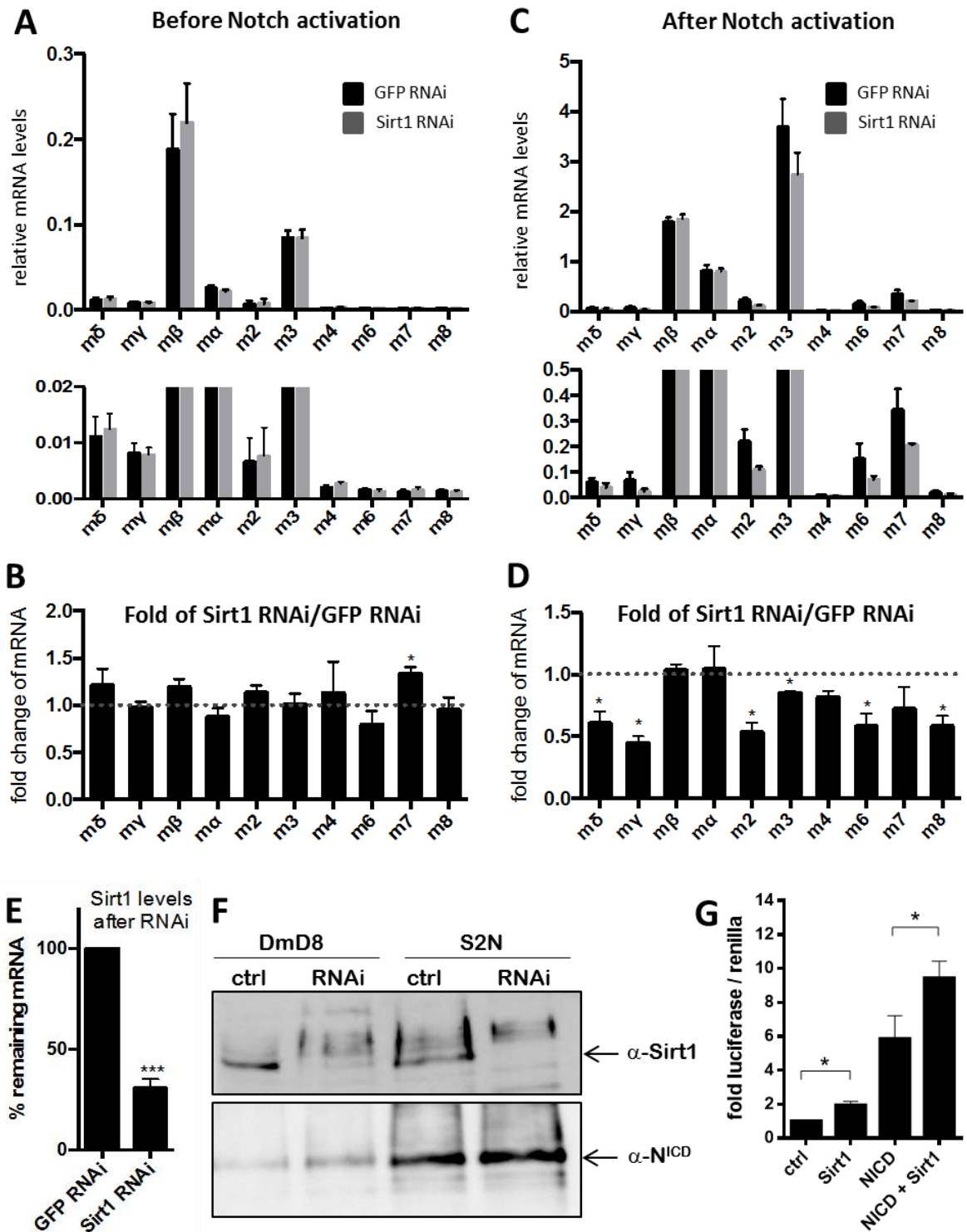

### 4.3 Metabolic sensitivity of E(Spl) genes is mediated by Sirt1

After comparing results from two previous experiments (4.1 and 4.2) we realised that E(Spl) genes which were down-regulated by 10 mM 2-DG treatment were also down-regulated after Sirt1 knock-down. Therefore, we started to pursue idea that Sirt1 can act as a metabolic sensor for this subset of E(Spl) genes (**Fig. 17A**). We wanted to test the model where Sirt1 has a positive effect on Notch dependent activation of these E(Spl) genes, but under the conditions of metabolic stress (2-DG) Sirt1 loses this effect, either because it is no more present at the genes enhancers, or it is not active (**Fig. 17B**).

If the above-mentioned model is correct and the activity of Sirt1 is diminished after 2-DG treatment, then using a specific Sirt1 activator might be able to rescue the 2-DG effect. Therefore, we decided to treat the cells with SRT1720, an allosteric activator of mammalian SIRT1. Currently, it is the most efficient and specific potent activator of Sirt1 commercially available, with *in vitro* EC<sub>50</sub> of 0.16 µM. It can also enhance activity of SIRT2 and SIRT3, however the EC<sub>50</sub> of SIRT2 is 37 µM and of SIRT3 is more than 300 µM, far from the molar range of Sirt1. Any effects on the other classes of HDACs has not been described. SRT1720 similarly to resveratrol binds to active site of Sirtuin and lowers K<sub>m</sub> of enzyme-substrate complex (Milne et al., 2007).

Having everything mentioned above in mind, we treated control and metabolically stressed S2N cells with 20 µM of SRT1720, the most effective concentration from our titration experiments (**Fig. 18A**). Indeed, SRT1720 was able to restore or even boost activation of 2-DG-sensitive E(Spl) genes under the condition of metabolic stress caused by 2-DG treatment. This result is compatible with the idea that under the 2-DG conditions Sirt1 activity is lost, and therefore we see less efficient response of E(Spl) genes to Notch activation.

If our model is correct, then under the 2-DG conditions Sirt1 RNAi should not have any effect as Sirt1 is not active or present on the regulatory regions of studied genes. In fact, this is what we observed when we decided to knock-down Sirt1 in metabolically stressed S2N cells (**Fig. 18B**). After Sirt1 knock-down, the expression levels of 2-DG sensitive E(Spl) genes were similar to controls treated only with 2-DG (or sometimes even lower), suggesting that 2-DG treatment negatively affects the function of Sirt1.

To further confirm the results with Sirt1 RNAi we decided to test if we would observe the same effects using a Sirt1 chemical inhibitor, Ex527. This compound is an indole analogue with *in vitro* IC<sub>50</sub> of 38 nM. It can also inhibit Sirt2 and Sirt3 with

IC<sub>50</sub> values 19.6  $\mu$ M and 48.7  $\mu$ M, respectively. The rest of the sirtuins and HDACs are resistant to its inhibitory effect (Napper et al., 2005). Ex527 binds to the active site of Sirt1 displacing NAD<sup>+</sup> from active site, and forces NAD<sup>+</sup> to change into extended conformation which sterically prevents substrate binding (Zhao et al., 2013).

In agreement with our hypothesis, the treatment of metabolically stressed S2N cells with 25  $\mu$ M of Ex527 led to very similar effect on E(spl) genes as with Sirt1 RNAi (Fig. 18C). The Notch dependent response of some genes treated with Ex527 under 2-DG conditions, was lower than after Sirt1 RNAi. Data suggest that both Sirt1 RNAi and 2-DG treatment are not able to fully inhibit Sirt1 activity, which can participate in regulation of E(Spl) gene expression.

In both cases, the Notch dependent response of some genes under 2-DG conditions was even lower when inhibiting Sirt1 with Ex527 or Sirt1 RNAi, suggesting that under the 10 mM 2-DG there are some Sirt1 molecules still present or active at the E(spl) enhancers.

In summary, downregulation of E(spl) genes in metabolically stressed S2N cells is due to the negative effect of 2-DG on Sirt1 biological function. The 2-DG mediated inhibition of Sirt1 is not able to properly propagate activation of Notch-induced E(Spl) gene expression. However, it is not clear if 2-DG blocks the enzymatic activity of Sirt1 or by unknown mechanism it disassembles the activation complex from the promoters of 2-DG sensitive E(Spl) genes.

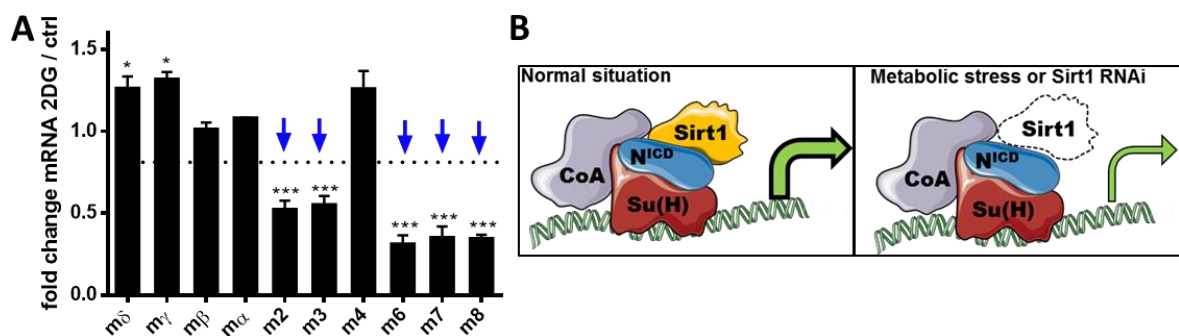

**Fig. 17: Metabolic sensitivity of the E(spl) genes is mediated by Sirt1.** **A.** Fold change in mRNA levels of the E(spl) genes in S2N cells treated with 10 mM 2-DG and after Notch activation. Blue arrows mark genes that do not respond efficiently to Notch activation when metabolism is impaired by 2-DG, resembling the Sirt1 RNAi effect. Significance according to one-tailed Student's t-test, \*P  $\leq$  0.05, \*\*\*P  $\leq$  0.001. **B.** Proposed model of Sirt1 action on metabolically sensitive E(spl) genes (m2, m3, m6, m7 and m8) after Notch activation. Under normal conditions, Sirt1 protein helps efficient activation of E(spl) genes. Under metabolic stress caused by 2-DG, the Sirt1 activity is lowered, perhaps by its post-translational modifications or by partial dissociation from the Notch activation complexes at target genes enhancers, resulting in a less efficient response to Notch pathway activity (arrow thickness represents the strength of gene transcriptional activity). Sirt1 may be part of the Notch activation complex or act indirectly. Co-A, co-activator complex; Nicd, Notch intracellular domain.



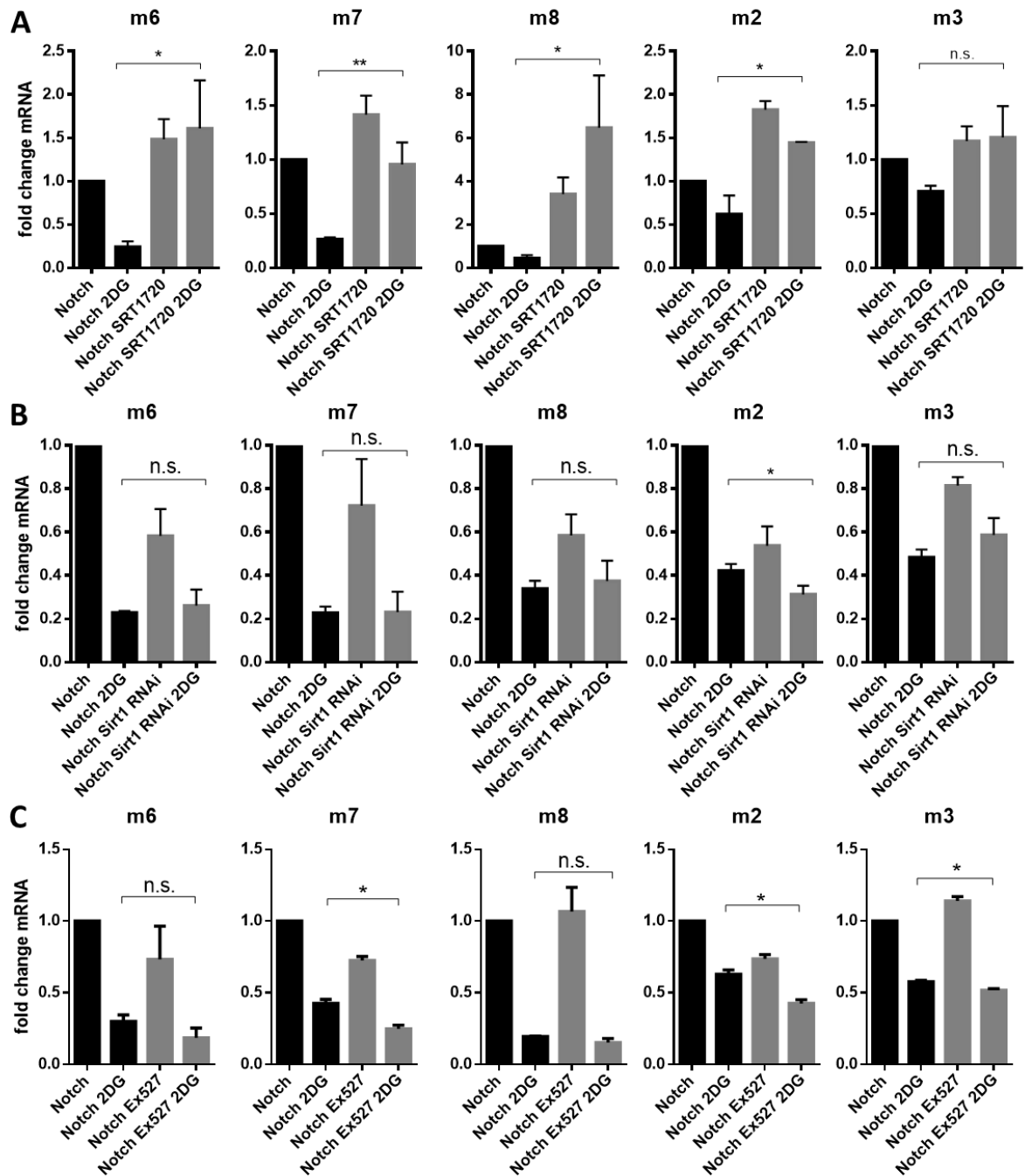

**Fig 18: A.** Fold change in mRNA levels of the E(Spl) genes in S2N cells after Notch activation treated with 10 mM 2-DG and 20  $\mu$ M SRT1720, normalized to mRNA expression relative to Notch-stimulated response without SRT1720 and 2-DG treatments (first column). SRT1720 in S2N cells restores the efficient Notch activation of metabolically sensitive E(spl) genes during 2-DG treatment ( $*P \leq 0.05$ , n.s., not significant). **B.** Fold change in mRNA levels of the E(Spl) genes in S2N cells after Notch activation treated with 10 mM 2-DG and Sirt1 RNAi, normalized to mRNA expression relative to Notch-stimulated response without Sirt1 RNAi and 2-DG treatments (first column). The levels of Notch-dependent induction after 2-DG treatment are similar regardless of Sirt1 RNAi treatment ( $*P \leq 0.05$ , n.s., not significant). **C.** Fold change in mRNA levels of the E(Spl) genes in S2N cells after Notch activation treated with 10 mM 2-DG and 25  $\mu$ M of Ex527, normalized to mRNA expression relative to Notch-stimulated response without Ex527 and 2-DG treatments (first column). Ex527 treatment empowers 2-DG effect on metabolically sensitive E(Spl) genes ( $*P \leq 0.05$ , n.s., not significant). Error bars in A, B, C and D represent standard errors of the means from three to five independent biological replicates.

## **4.4 Sirt1 positively influences Notch pathway during development of *D. melanogaster***

As we saw a positive effect of Sirt1 on Notch dependent activation in tissue culture cells, we decided to further investigate the relevance of Sirt1 in Notch signalling during development *in vivo*. The role of Notch during the specification of sensory organ precursors (SOP) and sensoric bristles on the fly body, as well as the role of Notch during the wing development in *D. melanogaster* is well described (Chapter 1.1.3) and the phenotype caused by Notch pathway malfunction is easily visible. Upregulation of Notch pathway in these tissues results in less thoracic bristles and less wing vein material. Contradictory, downregulation of Notch pathway results in more bristles inside and outside of traditional pattern and more wing vein material or even whole wing malformations (vein deltas, wing notches).

### **4.4.1 Sirt1 positively interacts with Notch pathway during specification of SOP cells.**

In our experiments, we used Sirt1 loss of function allele (LOF) 2A711 which has deleted coding region of Sirt1 gene. Animals bearing this allele developed numerous bristles on scutellum. On average, the number of scutellar bristles raised from 4 to 4.7 (**Fig. 19B, E**). On the contrary, after Sirt1 overexpression in proneuronal cluster (allele EP2300 driven by scabrous – Gal4), number of scutellar bristles declined to 3.7 (**Fig. 19C, E**). These phenotypes suggest that Sirt1 plays a positive role in Notch dependent bristle specification.

In the next step, we aimed to confirm that change in average scutellar bristle count is due to deregulation of Notch pathway during ESO development from SOPs. We stained wing disc of third instar larvae for an early SOP marker Senseless and a late SOP marker Cut (Cut is not a Notch target in these cells, as opposed to the D/V boundary of the wing pouch). Indeed, wing discs with Sirt1 deletion showed more Senseless and Cut positive cells (future SOPs and bristles) compared to the wing discs overexpressing Sirt1 (**Fig. 19B, C, D**) suggesting that Sirt1 plays a role as early as the specification of SOPs that will later give rise to bristles.

To investigate role of Sirt1 in bristle development further, we performed genetic interactions studies with main members of Notch signalling: Notch receptor and Delta ligand. If Sirt1 plays a role in Notch signalling we should see genetic interactions of Sirt1 allele with the members of the Notch pathway. Loss of function alleles of Delta (DI<sup>REV10</sup>) and Notch (N<sup>55e11</sup>) showed mild but significant increase in the average

number of scutellar bristles: 4.3 and 4.6, respectively. After putting these alleles to *Sirt1*<sup>2A711</sup> homozygous genetic background the number of bristles almost doubled, with 7.5 for Delta-*Sirt1* and 7 for Notch-*Sirt1* double mutants (**Fig. 19F**). These results confirmed that *Sirt1* genetically interacts with the Notch pathway during the development of sensory bristles.

Based on the phenotype of *Sirt1* mutant, the genetic interaction data and immunostaining of SOPs, we can conclude that *Sirt1* positively interacts with Notch pathway and participates in proper development of SOPs in *Drosophila*.

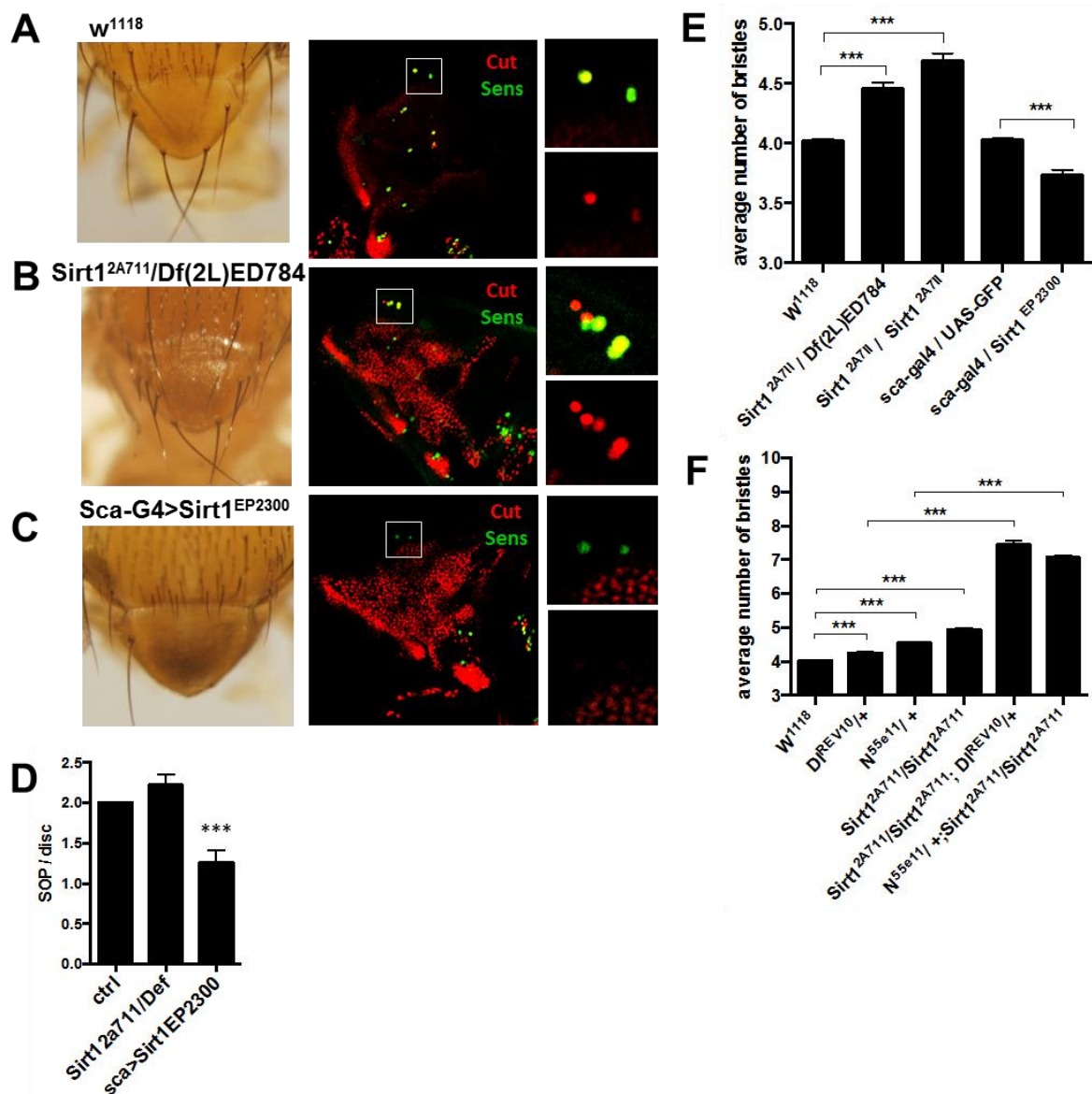

**Fig. 19: *Sirt1* interacts positively with the Notch pathway in SOP precursor cells.** (next page) **A.** Sensory bristles on the scutellum of *w*<sup>1118</sup> control flies. Immunostaining of wing discs from 3<sup>rd</sup> instar larvae for SOP markers *Sensless* (green) and *Cut* (red) **B.** Sensory bristles on the scutellum of *Sirt1*<sup>2A711</sup> mutant allele over *Sirt1* deficiency (*Df*(2L)<sup>*ED784*</sup>) Immunostaining of wing discs from 3<sup>rd</sup> instar larvae for SOP markers *Sensless* (green) and *Cut* (red) **C.** Sensory bristles on the scutellum after *Sirt1* overexpression in SOPs using *Sirt1*<sup>EP2300</sup> driven by *sca-Gal4* driver. **D.** Representation of average number of *Sensless* positive cells (SOPs) in control (*w*<sup>1118</sup>, N = 9) and in *Sirt1* deficient (*Sirt1*<sup>2A711</sup> over

Df(2L)<sup>ED784</sup>, N = 18) and Sirt1 overexpressed (Sirt1<sup>EP2300</sup> driven by SOP-specific sca-Gal4, N = 26) wing discs. Significance according to two-way ANOVA, \*\*\* P ≤ 0.001) **E.** Representation of average scutellar bristle count in controls (w<sup>1118</sup> and sca-Gal4, UAS-GFP), Sirt1 mutants (Sirt1<sup>2A711</sup> over Sirt1 deficiency Df(2L)<sup>ED784</sup>, or Sirt1<sup>2A711</sup> homozygous flies) and overexpression of Sirt1 in SOP precursors (Sirt1<sup>EP2300</sup> driven by SOP-specific sca-Gal4 driver). Significance according to two-way ANOVA, \*\*\*P ≤ 0.001. **F.** Genetic interactions of Sirt1 with Notch and Delta during the formation of scutellar bristles. Representation of average scutellar bristle count in heterozygous N<sup>55e11</sup> and DI<sup>REV10</sup> mutant alleles alone or combined with Sirt1 mutant (Sirt1<sup>2A711</sup>). Significance according to two-way ANOVA, \*\*\* P ≤ 0.001).

#### 4.4.2 Sirt1 positively interacts with Notch pathway during wing development

Besides the specification of SOPs, Notch is also involved in wing veins and wing margin development. Flies heterozygous for N<sup>55e11</sup> loss of function (LOF) allele develop thick veins with a characteristic delta-like structure at their ends and occasional notches at the wing margin. During our experiments, we observed that Notch LOF phenotype is visibly enhanced on the Sirt1<sup>2A711</sup> genetic background (**Fig. 20B**). It is important to say that on its own Sirt1<sup>2A711</sup> causes wing phenotype similar to Delta LOF (**Fig. 20A**). We quantified the strength of the phenotype by measuring width of delta formed by L5 vein. As a measurement unit, we used the number of wing marginal bristles in the delta area. Width of delta in Notch LOF was 10 bristles on average. With every copy of Sirt1 missing, phenotype got stronger: 12 bristles for heterozygote and 13.5 bristles for complete loss of Sirt1 (**Fig. 20F**). These genetic interactions confirmed a positive effect of Sirt1 on Notch signalling during wing vein development.

Quantification of heterozygotic Delta LOF phenotype (DI<sup>REV10/+</sup>) in wings and its genetic interactions with Sirt1 was more challenging because of the extra vein material and vein malformations presented (**Fig. 20D**). Therefore, we decided to arrange wings into five classes based on the strength of the phenotype (**Fig. 20E**). Class I. represented normal/wild type wings (**Fig. 20A**). Class II. represented wings with single type of aberration: bifurcation of vein or thickening of veins or small delta or extra vein material. Class III. represented wings which had different combination of aberrations from Class II plus incomplete L5 vein. Class IV. represented wings with Class III. type of phenotype, however the phenotype was more pronounced: wider deltas, more extra veins, etc. Class V. represented wings with the most severe defects affecting also the wing shape. Most common phenotype in DI<sup>REV10</sup> heterozygotes was

Class II. with around 50% animals in this category. Combination of  $DI^{REV10}$  with  $Sirt1^{2A711}$  resulted in shifting 73% of animals into the Class IV. category and 22% of animals in Class V. category (**Fig. 20H**). Again, these genetic interactions confirmed a positive effect of Sirt1 on Notch signalling during wing vein development.

Easily visible wing phenotype is also observed in a mutation of the Notch co-repressor Hairless. Flies carrying the Hairless loss-of-function allele ( $H^2$ ) show mild up-regulation of the Notch pathway, manifesting in partial loss of the L5 vein (**Fig. 20C**). To quantify the genetic interactions with Sirt1, we calculated the ratio between the length of the L5 vein gap and the length of presumptive complete L5 vein towards the end of the wing, thus measuring the relative size of the L5 gap. The ratio in  $H^2$  was 0.3 on average. With every copy of Sirt1 missing, the L5 vein gap shortened: 0.17 for heterozygotes and 0.03 for complete loss of Sirt1 (**Fig. 20G**), confirming the positive genetic interactions of Sirt1 and Notch pathway in the wing

Data from genetic interactions in wing model clearly shows that Sirt1 positively interacts with the Notch pathway, supporting the positive role of Sirt1 in Notch signalling during the wing development.

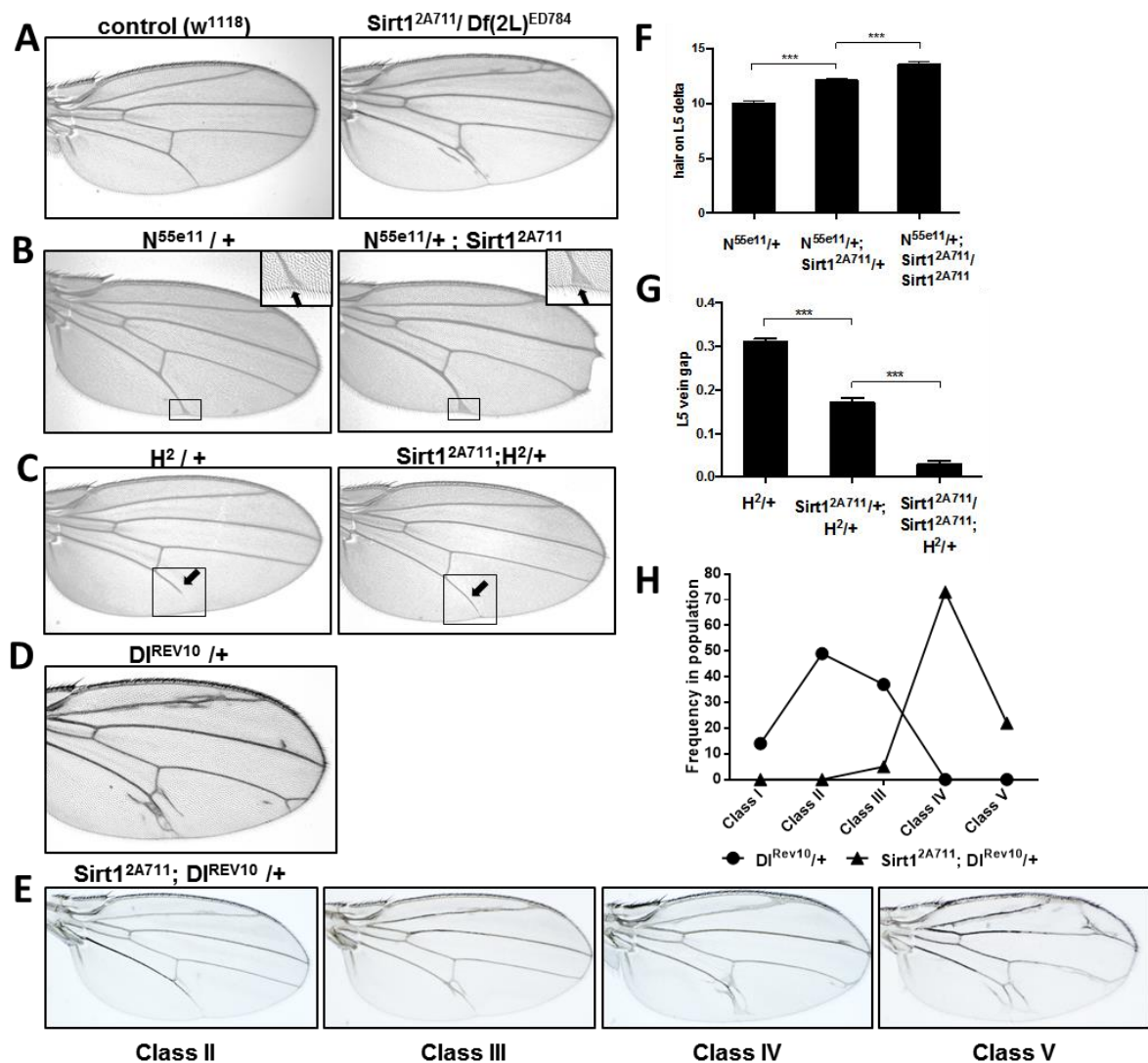

**Fig. 20: Sirt1 interacts positively with the Notch pathway during wing development.** **A.** Wings of control flies ( $w^{1118}$ ) and  $Sirt1$  homozygous mutant ( $Sirt1^{2A711}$  over  $Sirt1$  deficiency) **B.** Wings of heterozygous Notch mutant  $N^{55e11}$  flies crossed to control or combined with  $Sirt1^{2A711}$  mutant allele. (magnification in the top right frame, arrow points to the differences in the thickness of the L5 vein delta) **C.** Wings of heterozygous Hairless mutant  $H^2$  flies crossed to control or combined with  $Sirt1^{2A711}$  mutant allele. Arrows in the black box point to the differences between the size of the L5 vein gap typical for the  $H^2$  phenotype. **D.** Wings of heterozygous Delta mutant  $Dl^{REV10}$  flies crossed to control. **E.** Wing phenotype classes for heterozygous Delta mutant  $Dl^{REV10}$  flies crossed with  $Sirt1^{2A711}$  mutant allele. **F.** Quantification of the number of individual hairs covering the L5 vein delta. Significance according to two-tailed Student's t-test, \*\*\* $P \leq 0.001$ . **G.** Quantification of the relative size of the gap at the end of the L5 vein. Significance according to two-tailed Student's t-test, \*\*\* $P \leq 0.001$ . **H.** Percental representation of animals in defined phenotypic classes based on the strength of wing phenotype for heterozygous Delta mutant  $Dl^{REV10}$  flies crossed with  $Sirt1^{2A711}$  mutant allele. Error bars represent standard errors of the mean.

## 4.5 Sirt1 physically interacts with members of Notch pathway

From the genetic and transcriptional studies described above we know that Sirt1 plays a positive role in Notch signalling, however the mechanism is not clear. There are three possibilities of how Sirt1 can affect Notch signalling: 1. Sirt1 associates with and deacetylates core components of Notch pathway. 2. Sirt1 participates in Notch-regulated transcriptional machinery. 3. Sirt1 associates with and deacetylates other intermediate protein targets that cross-talk to the Notch pathway, acting upstream of Notch target genes expression.

To address these possibilities, we performed a proteomic survey of the Sirt1 interaction network. We precipitated Sirt1-interacting partners from *Drosophila* embryonic nuclear protein extracts, using three distinct antibodies against Sirt1, followed by mass spectrometry analysis. Overlapping the individual results of these screens permitted the creation of a robust list of Sirt1-interacting partners in the *Drosophila* embryo. Collectively, we identified 1547 protein isoforms encoded by 1246 genes that associate with Sirt1. Sirt1 interactors are mainly represented by regulators of cell cycle regulators; regulators of cytoskeleton biogenesis and organisation; metabolic regulators; regulators of gene expression; proteins involved in response to DNA damage and cellular stress (**Fig. 21A**). This is largely in agreement with Sirt1-associated factors identified in mammals (Chen et al., 2012; Rauh et al., 2013). However, approximately one quarter (397) of the proteins identified for *Drosophila* represent novel interaction partners of Sirt1 (**Fig. 21B**). We identified Sirt1 in association with many proteins involved in Notch pathway, comprising both its negative and positive regulators (**Fig. 21C**). Among negative regulators of Notch, we identified: CtBP and Gro co-repressors, which are tethered by Hairless to Notch target genes; subunits of RLAF complex, which is associated with histone chaperone Nap1 and include histone H3K4 demethylase Lid (KDM5) and histone deacetylase Rpd3 (HDAC1) (Moshkin et al., 2009); subunits of histone demethylase Lsd1 (KDM1) co-repressor complex (Mulligan et al., 2011); and Tip60 acetyltransferase, which adds a destabilizing acetyl mark on NICD (Kim et al., 2007). At the same time, Sirt1 is also associated with a plethora of positive Notch regulators: subunits of the Tip60 complex, Domino and Nipped-A (Gause et al., 2006); chromatin remodelling complexes: NURF, Brm, kis; histone H2B deubiquitinase Bre1; the corepressor/coactivator exchange factor Ebi, and others.

We were able to confirm several of above mentioned interaction genetically. Loss of function alleles of positive Notch regulators kis and Bre1 enhanced Sirt1<sup>2A711</sup>

bristle phenotype in heterozygous flies. Conversely, the loss of function allele of negative Notch regulator CoREST completely rescued Sirt1 bristle phenotype (**Fig. 21D**).

To increase the MS data relevance, we performed conventional immunoprecipitation assays of selected candidates for which *Drosophila* specific antibodies were available. We detected the association of endogenous Sirt1 with kis and Nap1, confirming the validity of our mass spectrometry data (**Fig. 21E**).

After successful use of MS in *Drosophila* embryos, we were interested in comparing the substrate preferences of Sirt1 directly before and after Notch pathway activation. Therefore, we used S2N cells with Copper-inducible Notch expression and EDTA-induced activation of the Notch pathway. As a baseline, we used both S2 cells (not expressing Notch receptor) and non-activated S2N cells (treated with Cu to induce Notch expression but without EDTA treatment that would trigger Notch activation). Data were analysed by Label Free Quantification (LFQ) method combined with Yuri Moshkin's personal algorithm for data evaluation (Cox et al., 2014). We found out that after Notch pathway activation Sirt1 strongly interacts with Notch receptor in S2N cells. Other upregulated interacting partners of Sirt1 were transcription repressors Lid, Sin3A and activators RNA polymerase III, Nipped-B. Sirt1 interacted also with RNA binding proteins pUf68, CG9684. Interestingly, Sirt1 interacted with proteins playing role in vesicle - Golgi and transmembrane transport – CG1824. Sirt1 interacted also with members of other signalling pathways: Tor (mTOR signalling, upregulated), Aru (EGFR signalling, upregulated) and Glo (JAK-STAT signalling, down-regulated) (**Fig. 21F**).

In summary, the extensive set of Sirt1-associated factors suggests a context-dependent activity of Sirt1, comprising both positive and negative regulation of Notch and other cellular processes and pathways.



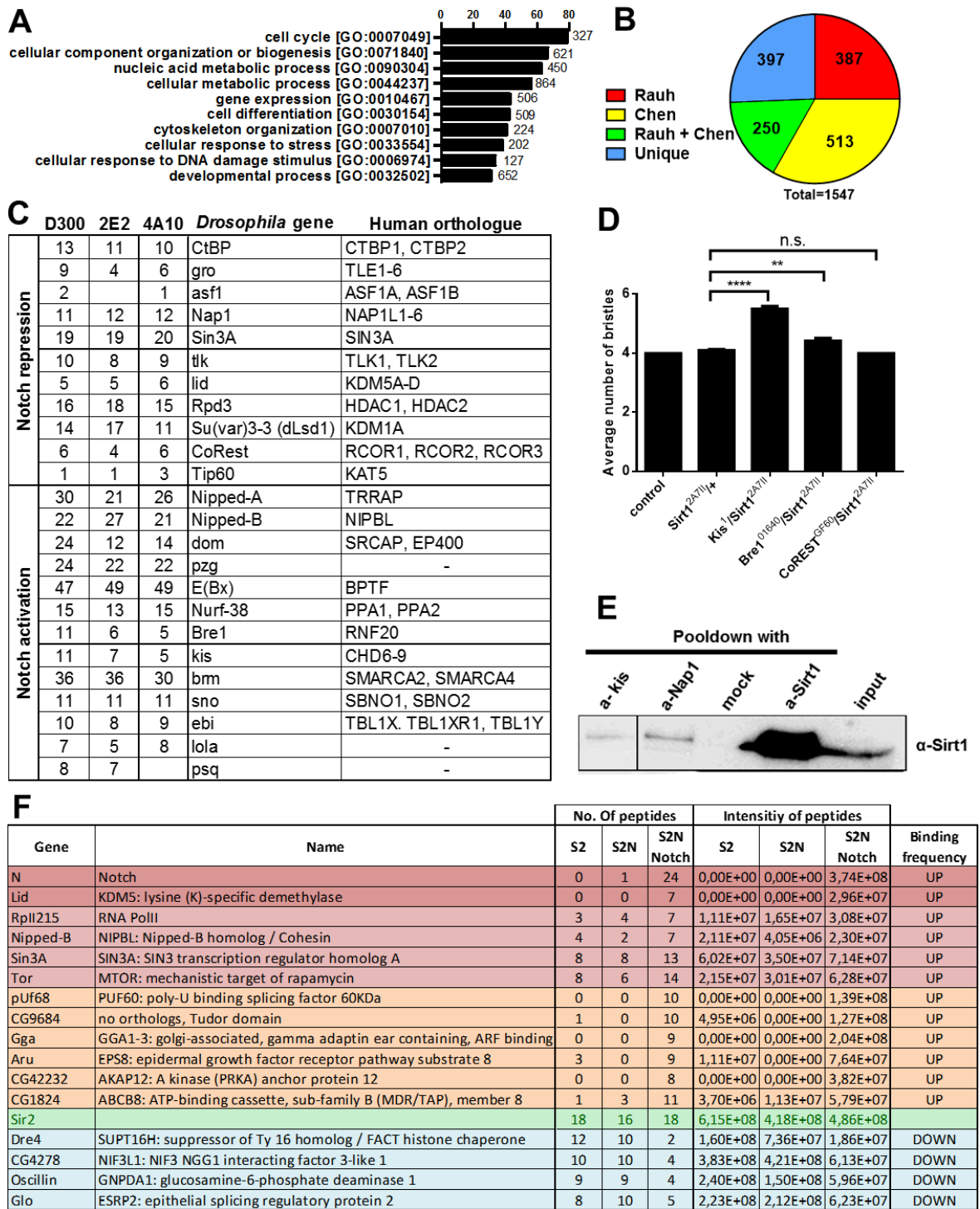

**Figure 21: Sirt1 physically interacts with Notch repressor as well as activator complexes. A.** Gene ontology analysis of Sirt1 interactors from *Drosophila* embryonic extract searching for enrichment terms related to biological processes. **B.** The overlay between Sirt1 protein interactors identified in this thesis with previous studies from Sirt1(-/-) mammalian MEF cells (Chen et al.) and from peptide array-based study (Rauh et al.). **C.** Summary of Notch-related proteins we identified as Sirt1 interactors in *Drosophila* embryos. The number of peptides identified by mass spectrometry analysis using three different Sirt1 antibodies (d-300 from Santa Cruz Biotechnology and p2E2 and p4A10 from DSHB). **D.** Genetic interactions of Sirt1<sup>2A711</sup> heterozygous flies with heterozygous loss of function alleles for selected Sirt1-interacting partners from (C). Phenotype quantified as the average number of scutellar bristles. Significance according to two-way ANOVA. \*\*\*\*P ≤ 0.0001, \*\*P ≤ 0.01, n.s. not significant. **E.** Immunoprecipitation of endogenous kismet and Nap1 proteins from *Drosophila* embryonic protein extract and detection of Sirt1 association by western blot using Sirt1-specific p4A10 antibody (DSHB) **F.** Heat map of selected results from LFQ analysis of MS data of Sirt1 pool-down from S2, S2N and S2N cells with activated Notch pathway (N=1).

## 4.6 Sirt1 physically interacts and deacetylates Su(H)

Mass spectrometry data of Sirt1 interactors revealed many members of Notch pathway, Notch receptor included. However, thinking about Sirt1 knock-down experiments we were wondering if Sirt1 also associates with Su(H), the key transcription factor of Notch signalling. As the Su(H) protein has an amino acid composition that makes it resistant to the digest with common proteases used for MS analysis, it would have never appeared on our list of Sirt1 interactors based on MS. From this reason, we performed immunoprecipitation of endogenous Sirt1 protein from S2N cells and detected its association with Su(H) by a conventional western blot. It revealed that Sirt1 interacts with Su(H) and this interaction is enhanced after Notch activation (**Fig. 22A**). We, therefore speculated whether Su(H) can serve as a substrate for Sirt1-dependent deacetylation. We expressed and purified Su(H), using a baculoviral-based system in Hi5 cells, and analysed its acetylation levels by immunoblotting with anti-acetylated lysine antibody. Su(H) expressed in Hi5 cells appeared with the same two band pattern on a western blot as the endogenous protein in S2N cells, suggesting that Hi5 cells and S2N cells share the same PTMs to produce mature Su(H) (**Fig. 22B', C'**). However, why and how are these two bands formed, even though Su(H) has only one transcript, is still not known.

Immunoblotting with anti-acetylated lysine antibody revealed that both of the isoforms are acetylated in purified Su(H) fraction (**Fig. 22B', C'**). Incubation of Hi5 cells with the Sirt1 activators significantly decreased the acetylation of both Su(H) isoforms (**Fig. 22B''**), supporting the role of Sirt1 in Su(H) deacetylation. Incubation with Sirt1 inhibitors increased the acetylation of the faster migrating Su(H) isoform (**Fig. 22C''**).

As the changes in Su(H) acetylation status are relatively mild, it is possible that Su(H) may be acetylated on multiple sites but only a subset serve as targets for deacetylation by Sirt1. Thus, we propose that Sirt1 functions in the activation of Notch target genes by deacetylation of Su(H) and presumably of other substrates involved in Notch signalling.

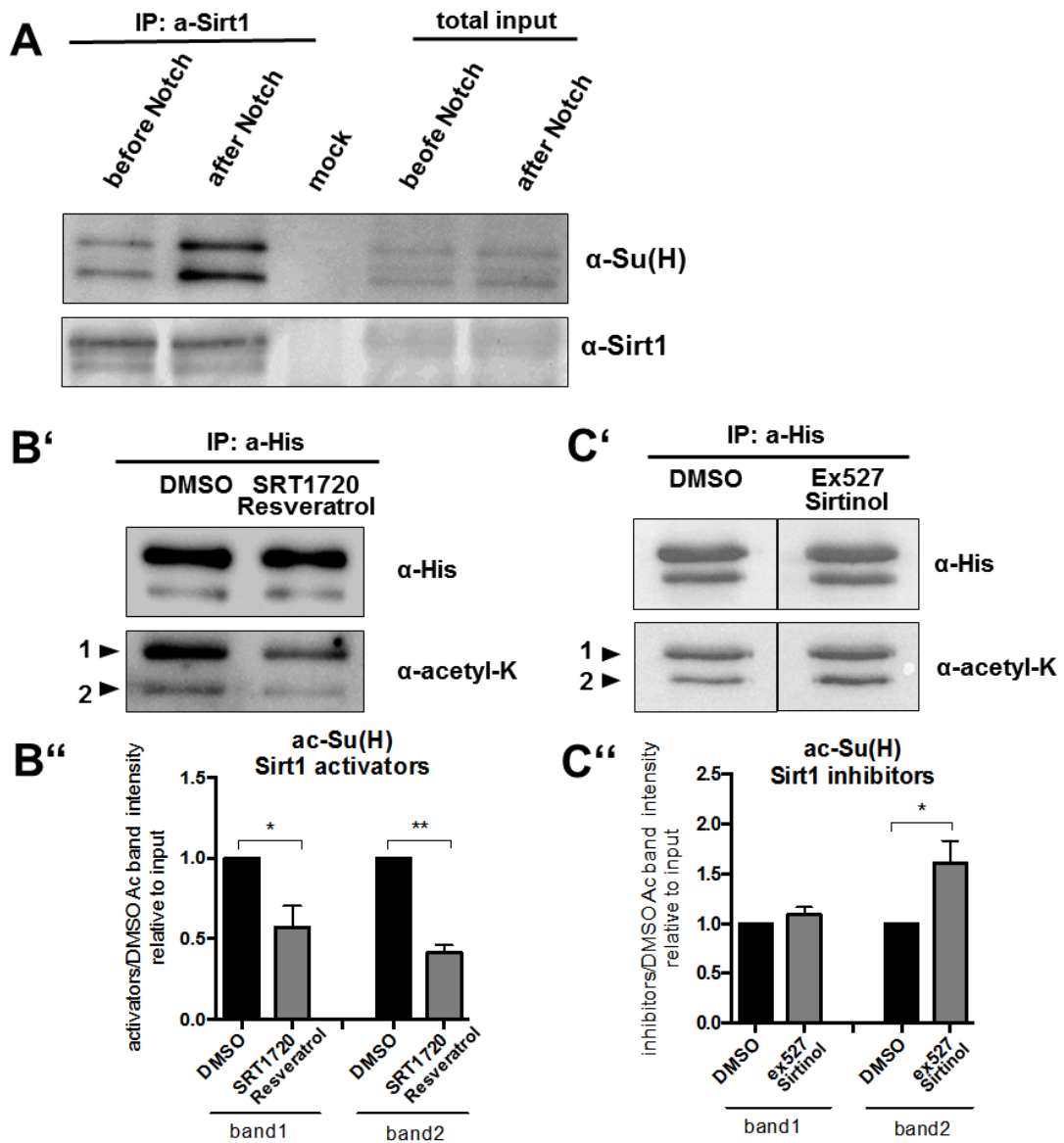

**Figure 22: Su(H) is deacetylated by Sirt1.** **A.** Immunoprecipitation of endogenous Sirt1 protein from S2N cells before and after Notch activation. Levels of immunoprecipitated Sirt1 and associated Su(H) protein were detected by western blot. **B'.** Western Blot of C-term His tagged full length Su(H), expressed in Hi5 cells after 48h treatment with Sirt1 activators: SRT1720 (20  $\mu$ M) and resveratrol (20  $\mu$ M). **C'.** Western Blot of C-term His tagged full length Su(H), expressed in Hi5 cells after 48h treatment with Sirt1 inhibitors: Ex527(25  $\mu$ M) and Sirtinol (10  $\mu$ M). **B'' and C''.** Quantification of Su(H) bands marked by arrows. Values were calculated as a ratio between the intensity of  $\alpha$ -acetyl-lysine(K) signal from drug-treated sample and the signal from DMSO-treated controls, normalized to Su(H) total input detected with  $\alpha$ -His antibody. Error bars represent standard error of the means from three independent biological replicates, significance according to one-tailed paired Student's t-test, \*P < 0.05, \*\*P < 0.01.

## 5.0 Discussion

The mechanism of Notch signalling pathway, its role during development and connection with many developmental disorders and cancer types are known for a long time (Lobry et al., 2011; Penton et al., 2012). Similarly, the connection of SIRT1 with the regulation of metabolism, DNA damage, immune response, lifespan, circadian rhythms, apoptosis and cancer, is also well established (Wang et al. 2012; Lin & Fang 2013; Satoh et al. 2013; Bmoutant & Cantó 2014; Yang et al. 2015; X. Chen et al. 2015; Masri 2015). However, research focused on a crosstalk between Notch signalling pathway and sirtuins has not revealed much. Especially in cancer, there are many known events where Notch and Sirt1 are active at the same time and play important roles. There is only little evidence regarding direct regulation of Sirt1 activity by Notch. This means that Sirt1 is most probably upstream and independent of the Notch signalling pathway, and thanks to large pool of SIRT1 substrates (histones, transcription factors, enzymes) (Chen et al., 2012; Rauh et al., 2013), Sirt1 can regulate Notch signalling on all levels. It is important to have in mind that expression of Sirt1 is upregulated by various stress events (DNA damage, hypoxia, cellular energy deprivation), however, Sirt1 enzymatic activity is crucially dependent on subcellular localisation and presence of free NAD<sup>+</sup> (Braidly et al., 2011). More complexity to the Sirt1 regulation of the Notch pathway bring the interactions of Sirt1 with other important signalling pathways: NF- $\kappa$ B (Kauppinen et al., 2013), Wnt (Iyer et al., 2014), TGF $\beta$  (X. Z. Huang et al., 2014), HIF-1 (Liu et al., 2015), AMPK (B. Huang et al., 2014) and mTOR (Hong et al., 2014) that are also known to interact with Notch pathway on their own.

### 5.1 Known connections of Sirt1 with Notch signalling

So far, Sirt1 interaction with Notch signalling pathway was described in following cases:

Mulligan et al. found Sirt1 as part of the Lsd1–CtBP co-repressor complex and they suggested a negative role of Sirt1 on the activity of E(Spl)m5 and HEY1 Notch target genes. However, direct association of Sirt1 with Notch dependent enhancers or the association of Sirt1 with the CSL complex was not proven (Mulligan et al., 2011).

In another study, Guarani et al. showed that Notch can be acetylated by p300 and PCAF acetyltransferases *in vivo*. They identified 14 acetylation sites and showed

that acetylation is important for N<sup>ICD</sup> stability. They further confirmed, that N<sup>ICD</sup> is deacetylated by Sirt1. In their model, Sirt1 mediated deacetylation of N<sup>ICD</sup> promotes ubiquitin-dependent proteasomal degradation, indicating that Sirt1 acts as a rheostat fine-tuning the Notch response (Guarani et al., 2011).

Work of Guarani et al. was confirmed by Xie et al. They showed that N<sup>ICD</sup> is indeed acetylated by p300 and deacetylated by Sirt1 in lung endothelial cancer cells. Additionally, they found that Sirt1 is localised 500 bp upstream of Notch gene transcriptional start site and it negatively regulates its expression. (Xie et al., 2012).

Another work supporting negative role of Sirt1 in Notch signalling was undertaken by Tiberi et al. They showed that Bcl6, an oncogene transcription factor, is responsible for switching Mastermind in the CLS-associated activation complex for Sirt1, to promote deacetylation of histones on HES5 promoter and repression of transcription during neuronal progenitor cells differentiation (Tiberi et al., 2012). The role of Sirt1 in Notch target gene repression has also been observed in neural stem cells (Ma et al., 2014).

On the other hand, there is one line of evidence about the regulation of Sirt1 by Notch signalling. On a model of metastatic Ewing Sarcoma, Ban et al. showed that the Notch target HEY1 which is under the regulation of Sirt1 (Mulligan et al., 2011; Xie et al., 2012), is able to directly downregulate expression of Sirt1 and promote further Notch pathway mediated tumour suppression (Ban et al., 2014).

Collectively, evidence reporting negative effects of Sirt1 on Notch signalling prevail, although they differ in their proposed mechanisms of action. The Sirt1 activator resveratrol has been identified as the strongest activator of Notch signalling in a large drug-based screen (Pinchot et al., 2011). Positive effect of resveratrol on Notch signalling was also confirmed in several other contexts (Lin et al., 2011; Truong et al., 2011; Yu et al., 2013). Moreover, acetylation of N<sup>ICD</sup> has diverse effects on N<sup>ICD</sup> stability and does not always lead to N<sup>ICD</sup> stabilization. Acetylation by p300 leads to N<sup>ICD</sup> stabilization and increased Notch activity (Popko-Scibor et al., 2011) while acetylation by Tip60 causes destabilization (Kim et al., 2007). Taken together, there is set of experimental and indirect evidence for Sirt1 having both positive and negative effects on Notch signalling.

The data presented in this thesis show that Sirt1 has a positive role on Notch signalling in the *Drosophila* model. We provide evidence that Sirt1 fine-tunes the response of Notch target genes to Notch pathway activation in a positive manner under certain cellular and developmental contexts such as embryonic S2N cells,

specification of SOP cells and wing development. The regulation of Notch pathway by Sirt1 may be tissue specific and the two opposing mechanisms (positive versus negative effects on Notch activity) may coexist depending on cell type or physiological context of the tissue.

## **5.2 Sirt1 activity counters the 2-DG sensitivity of several E(Spl) genes**

The response of Notch signalling to changes in basal metabolism is one of the aims of this thesis. Extensive literature examination revealed that this topic has been only poorly explored with the exception of two studies (Bonfini et al., 2015; Saj et al., 2010), although no molecular mechanism was proposed to explain it. In this thesis, we showed that subset of Notch target genes, namely E(Spl)m2, E(Spl)m3, E(Spl)m6, E(Spl)m7, E(Spl)m8 are inefficiently expressed after Notch pathway activation in 2-DG treated S2N cells. 2-DG is known to be a potent inhibitor of glycolysis. It is important to remember that inhibition of glycolysis activates multiple pathways to compensate for the energy loss and promote survival (Zhong et al., 2009). Three pathways, the most sensitive to the changes in glucose metabolism, are first to respond: Akt (Simons et al., 2012), AMPK (Wu et al., 2015) and Sirt1 (Ma et al., 2014). There is an ongoing discussion about relations between these pathways, however evidence regarding AMPK supremacy prevail (Fulco et al., 2008; Suchankova et al., 2009; R Tao et al., 2010). However, all mentioned pathways converge on the mTOR, the master sensor and regulator of cellular metabolism (Howell and Manning, 2011).

Importantly, our data from treatment with putative inhibitor of Sirt1 EX527 and with Sirt1 RNAi revealed that Sirt1 probably acts as a metabolic sensor for the mentioned E(Spl) genes in 2-DG treated S2N cells. Additionally, boosting Sirt1 activity with the putative Sirt1 activator SRT1720 is able not only to overcome 2-DG inhibitory effect, but sometimes even boost the expression of these genes above the normal level. Sirt1 activator resveratrol was shown to have similar positive effect on Notch signalling in several occasions (Lin et al., 2011; Pinchot et al., 2011; Yu et al., 2013).

It has to be noted that there is a controversy about specificity and type of effect for resveratrol (Baur, 2010; Dang, 2014). SRT1720 is the most Sirt1 specific drug on the market although evidence emerged that its effects on Sirt1 activity may not be direct (Pacholec et al., 2010) and they are probably mediated by AMPK activation (Feige et al., 2008). Other report has suggested that SRT1720 exerts either no or even inhibitory effects on Sirt1. However, it seems not to be the case in our studied

cellular context as knock-down of Sirt1 did not restore E(Spl) gene response to Notch under the metabolic stress conditions. Additionally, in our experimental setup the SRT1720 treatment had the opposite effect to the Sirt1 RNAi knock down (or the Ex527 treatment), suggesting that SRT1720 has a positive role on Sirt1, and is indeed the activator of Sirt1 in our cellular context. Another paper compromising SRT1720 specificity showed that SRT1720 is responsible for inhibition of p300 *in vitro* (Huber et al., 2010). Acetylation of N<sup>ICD</sup> by p300 is important in regulation of amplitude and duration of Notch dependent E(Spl) gene expression, thus SRT1720 inhibition of p300 can significantly affect our results (Guarani et al., 2011; Hansson et al., 2009). However, if this was the case then we would expect SRT1720 treatment to diminish, not enhance, the Notch target gene responses. The most recent study about the direct allosteric binding of SRT type compounds to the Sirt1 provides further evidence for generally believed function of SRT1720 as the activator of Sirt1 (Hubbard et al., 2013).

Only five genes from whole E(Spl) cluster showed mutual sensitivity to the 2-DG and Sirt1 knock-down, suggesting that these genes are regulated by Sirt1 under metabolic stress condition. The question remains as to why some of the E(Spl) genes sensitive to 2-DG are not affected by Sirt1 knockdown. One possible explanation could be the gene-specific protein composition on their promoters or enhancers, or that specific chromatin modifications do not allow Sirt1 recruitment or action. Despite years of study very little is known about the proteins on promoters and enhancers of E(Spl) genes responsible for context dependent expression. From our study, we can suggest that Sirt1 is one of the proteins that is selectively recruited to certain, but not all, Notch responsive enhancers.

Contradictory evidence exist in the literature, regarding the 2-DG effect on NAD<sup>+</sup>/NADH ratio. While low levels of glycolysis would suggest increase in NAD<sup>+</sup>/NADH ratio, experiments showed that 2-DG treatment as well as limiting nutrient availability leads to decreased of NAD<sup>+</sup>/NADH ratio (as shown in rat liver and in *Drosophila* (Williamson et al., 1967; Zhu and Rand, 2012). From our experimental evidence, we know that both glycolysis and respiration is lowered by 2-DG treatment so the increase in NADH may be due to its insufficient consumption by the respiratory chain. If NAD<sup>+</sup> levels drop after 2-DG treatment, Sirt1 activity should decrease, in agreement with our observations (Notch dependent response is lower under 2-DG condition as well as after Sirt1 knockdown).

Moreover, loss of Sirt1 activity under 2-DG conditions could also be explained by its negative regulation by AMPK. AMPK is strongly activated under energetic stress

and promotes downregulation of Sirt1 activity via phosphorylation of Sirt1 active site (Lee et al., 2012). Possibly, the 2-DG and Sirt1 sensitive E(Spl) genes may play a role in proliferation, and therefore they must be silenced during metabolic stress conditions that do not allow sufficiency of energy or building blocks for proliferation. Also, 2-DG treated cells are reverted to their quiescent (G0) phase (Muley et al., 2015) and initiate autophagy (Jeon et al., 2015), suggesting promotion of pro-survival pathways until better conditions for development arise.

Fillion et al. performed DamID-Sirt1 protein location mapping in Kc167 *Drosophila* embryonic cell line and found Sirt1 to be present in E(Spl) gene locus prior to Notch pathway activation (Filion et al., 2010). This is also in agreement with our Sirt1 pull-down data where we identified binding of Sirt1 with Su(H) even before Notch pathway activation. Thus, Sirt1 may be present on Notch dependent enhancers as part of the repressor complex, ready to mediate exchange of co-repressors for co-activators when N<sup>ICD</sup> is present. The fact that we found Sirt1 associated with the co-activator exchange protein Ebi supports this idea. We did not observe any notable effect on the basal expression of E(Spl) genes after 2-DG treatment, simply because Sirt1 has a role only during Notch activation, regardless of 2-DG perturbations in the basal state.

### **5.3 Sirt1 may fine-tune Notch signalling via protein-protein interaction with Notch pathway members and transcription regulatory proteins**

We suggest that Sirt1 acts to fine-tune Notch response towards the higher levels of activation. However, how and where is Sirt1 affecting Notch signalling requires further investigation, in addition to the upstream events before Sirt1 activation. Undoubtedly, Sirt1 effects on Notch and other cellular pathways are likely to be pleiotropic. Sirt1 was found to have little sequence selectivity near the target acetyl-lysine (Bheda et al., 2016) and therefore has a bulk of putative targets (Choudhary et al., 2014). Many of the mammalian targets were confirmed by our proteomic analysis of Sirt1 binding partners in *Drosophila* embryos. More importantly, we identified that Sirt1 was bound to members of both Notch repressor and Notch activator complexes. All mentioned arguments, together with the possibility that some of the Sirt1 targets could escape proteomic analysis, are widening the spectra of possible regulatory nodes of Sirt1 for Notch signalling.



In our proteomics analysis, we identified that Sirt1 associates with the promoter-specific exchange factor Ebi (TBL1 orthologue in humans). Ebi serves as a sensor for signal-specific dismissal of distinct co-repressors, including CtBP and CoREST, involved also in Notch target repression (Perissi et al., 2008). Therefore, Sirt1 might be tethered to Notch target genes, such as E(Spl), prior to Notch activation to facilitate the exchange of co-repressor for co-activator complexes after Notch activation. This mechanism may potentially explain why Sirt1 appears to associate with components of both Notch repression and activation complexes, while clearly imparting a positive role in the mechanism of Notch signalling

Alternatively or complementary to the cofactor exchange mechanism mediated by Sirt1-Ebi interactions, Sirt1 may exert its positive effects on Notch signalling by deacetylation of the CSL transcription factor Su(H). We identified Su(H) to be acetylated *in vivo*, and its acetylation status is controlled in a Sirt1-dependent manner as was shown by modulation of Sirt1 activity. After several attempts, we failed to detect the majority of the Su(H) acetylation sites by mass spectrometry. This probably is because of Su(H) regions with lysines of interest are resistant to proteolytic digests used generally in mass spectrometry. The generation of specifically defined and ionized peptides is a crucial prerequisite for mass spectrometry analysis. *In vitro* resistance of these regions to proteases, may be a reason why they are often missing in mass spectrometry results. However, immunopurifications of Sirt1 from cellular extracts followed by immunoblotting revealed association of Su(H) with Sirt1 which is enhanced after Notch pathway activation. To our knowledge, we are the first to identify Su(H) acetylation status in cell culture system and its modulation by Sirt1. So far, Su(H) has been identified to be subjected to phosphorylation, which counters the activation of Notch target genes (Auer et al., 2015). Thus, in future studies, it would be of significant interest to overcome technical difficulties and identify specific lysines acetylated in Su(H). This should help to decipher the role of Su(H) acetylation status in response to Notch signalling and proteins responsible for these modification, hopefully, Sirt1 included.

We showed that Sirt1 is also associated with N<sup>ICD</sup> and, similarly to Su(H), this interaction is more frequent after Notch pathway activation. In general, acetylation of N<sup>ICD</sup> has diverse effects on N<sup>ICD</sup> stability. Acetylation by p300 leads to N<sup>ICD</sup> stabilization and increased Notch activity (Popko-Scibor et al., 2011), while acetylation by Tip60 causes destabilization (Kim et al., 2007). We were not able to confirm acetylation status of N<sup>ICD</sup> in *Drosophila*, however we hypothesise that Sirt1 can be directly

involved in the regulation of N<sup>ICD</sup> acetylation by counteracting effects of Tip60. Sirt1 was described to associate with Tip60 complex and decrease its activity (Lu et al., 2011; Yamagata and Kitabayashi, 2009) which make it plausible that the antagonistic action between Sirt1 and Tip60 could enhance N<sup>ICD</sup> stability in specific contexts, explaining the positive effects of Sirt1 on Notch signalling.

HDAC1 (Rpd3) is a known member of the Notch co-repressor complex (Kao et al., 1998; Moshkin et al., 2009) and in specific context it is deacetylation by Sirt1 increases affinity towards its substrates (H Yang et al., 2015). In T-cell leukaemia, HDAC1 was described to deacetylate intracellular domain of Notch3 receptor on conserved lysines, shared with Notch1, and prevent N<sup>ICD</sup> from ubiquitin mediated proteasomal degradation (Palermo et al., 2012). We hypothesise that by deacetylating HDAC1, Sirt1 can prevent N<sup>ICD</sup> degradation and promote E(Spl) gene expression, supporting the positive role of Sirt1 in Notch signalling. However, if the same HDAC1 molecule is part of the Notch co-repressor complex it should lead to gene repression. It may be the balance between acetylated and deacetylated HDAC1 that dictates the outcome of Sirt1 action on Notch signalling.

In our pull-down we found members of RLAF repressor complex (Sin3 in mammals): HDAC1, Sin3A, Lsd1, Lid and NAP1, in relatively high abundance (Moshkin et al., 2009). RLAF complex is regulating multiple cellular and developmental events (Eissenberg et al., 2007; Sharma et al., 2008; Spain et al., 2010; Swaminathan and Pile, 2010)(Saha et al., 2016; Sharma et al., 2008; Swaminathan and Pile, 2010), including repression of Notch target genes (Moshkin et al., 2009; Mourikis et al., 2010). Sin3A complex was also found near the transcription start of Su(H) gene (Saha et al., 2016) adding another involvement in Notch signalling. In mammalian system, Sirt1 negatively regulates Sin3A mediated transcriptional repression activity (Binda et al., 2008), suggesting a further regulatory node of Sirt1 in Notch signalling. Additionally, association of Sirt1 with members of RLAF complex are enhanced after Notch pathway activation in S2N cells, suggesting that Sirt1 is probably responsible for dissociation of this repressor complex from regulatory regions of Notch target genes and promoting their expression. This is also in agreement with our model of Sirt1 as a mediator of cofactor exchange. Association of Sirt1 with RLAF complex also supports our model of 2-DG mediated Sirt1 inhibition. 2-DG treated cells are arrested in G0/G1 phase of cell cycle (Muley et al., 2015) and Sin3 complex is responsible for repression of genes involved in cell cycle progression (McDonel et al., 2012; Pile et al., 2002). Therefore, it is evident that if cells are stuck

in G0/G1 phase, Sirt1 cannot overcome RLA<sup>F</sup> inhibitory effect, suggesting that 2-DG inhibitory effect on Sirt1 is genuine and global.

With the exception of N<sup>ICD</sup> and Mastermind (Popko-Scibor et al., 2011), there is lack of evidence regarding the acetylation of proteins involved in Notch signalling. However, N<sup>ICD</sup> provides an excellent illustration that acetylation of specific lysines/regions of the protein may have opposing effects on the protein function or stability. Without analysing the specific acetylation mutants, it is difficult to predict the roles of these post-translational modifications, and to find the protein acetylases or deacetylases responsible. Consequently, an analysis of the context-dependent deacetylation of various Sirt1 substrates involved in the Notch pathway can potentially provide an explanation for both the reported positive and negative effects of Sirt1 on Notch signalling.

#### 5.4 Role of Sirt1-Notch interaction in *Drosophila* development

In mouse, Sirt1 play a crucial role in the embryonic development. Only 20% of progeny can survive till adulthood without any notable developmental defects (Cheng et al., 2003). *Drosophila*'s Sirt1 share 75-80% homology with its mammalian orthologue, but does not share the same importance during development (Rosenberg and Parkhurst, 2002). Phenotype of Sirt1 deficient flies is similar to Notch loss of function phenotype. In agreement with our data, overexpression of Sirt1 in the SOP precursors has the opposite effect and resembles Notch gain of function phenotype. Both phenotypes suggest positive role of Sirt1 in Notch signalling. Additionally, we confirmed the positive role of Sirt1 in Notch signalling during development in our genetic interaction studies with alleles of the key members of Notch signalling: Notch, Delta and Hairless. Sadly, we could not detect any effect of Sirt1 deletion (Sirt1<sup>2a711</sup> clones) on Notch reporters in the L3 wing discs (**Supp.4**). This suggests that either there is a redundancy of Sirt1 function with other sirtuins from the family, or that the effects on adult wing that we see in Sirt1 mutant happens later, perhaps during pupal development. On the first day of metamorphosis, metabolic rate of pupa stage drops by 67% compared to 3<sup>rd</sup> instar larvae and remain low for the next 24 hours. Two days after pupa formation, metabolic rates start to rapidly rise, together with extensive lipid utilisation and hypoxia conditions (Merkey et al., 2011). Lipid metabolism in theory should keep the Sirt1 inactive due to high consumption of NAD<sup>+</sup> and production of ATP. However, during  $\beta$ -oxidation of lipids, ROS are generated which are known activators of Sirt1 (Rosca et al., 2012; Salminen et al., 2013). Also hypoxia is known

to promote Sirt1 expression and activation (Balaiya et al., 2012; R. Chen et al., 2011). Taken together, this timepoint in *Drosophila* development provides conditions for Sirt1 to be active and eventually participate on regulation of Notch signalling during wing development.

Based on our results, the role of Sirt1 in the regulation of SOP development through fine-tuning of Notch signalling is evident. Certainly, it is true that Sirt1 in flies is not as important as its mammalian ortholog since flies develop only with minor defects. However, the obvious phenotype in the bristles and wings points towards the modulation of spatio-temporal activation and amplitude of Notch signalling. It would be interesting to investigate whether the key role of Sirt1 becomes evident mainly during stress conditions, such as during metabolic stress at the beginning of pupal metamorphosis.

## 5.5 Summary

In this dissertation thesis, we examined the role of Sirt1 in three models associated with Notch pathway: 1. Metabolically stressed S2 cells stably expressing full length wild type Notch receptor under inducible promoter (S2N cells). 2. Sensory organ precursor specifications and scutellar bristle development. 3. Wing D/V boundary formation and wing vein development. In all three models, we were able to demonstrate that Sirt1 positively influences the Notch pathway. Sirt1 participates in modulation of the expression of a subset of E(Spl) genes in metabolically stressed S2N cells and shows positive genetic interaction with main Notch signalling members: Notch receptor, Delta ligand and repressor of Notch signalling, Hairless.

To further examine role of Sirt1 in Notch signalling we performed proteomic analysis of Sirt1 associated proteins in *Drosophila* embryos and in S2N cells. Surprisingly, Sirt1 was found both with activator and repressor complexes involved in Notch target genes regulation, suggesting a direct link between Sirt1 and the Notch pathway. Moreover, modulating Sirt1 activity in Hi5 cells, using chemical activators and inhibitors, showed that acetylation status of the Su(H) is controlled via Sirt1 activity. We were able to show that association of Sirt1 with N<sup>ICD</sup> and Su(H) is increased after Notch pathway activation, suggesting more exclusive role of Sirt1 in this pathway

Taken together, we are the first to demonstrate three new context-dependent findings about Sirt1, never shown before:

1. Activity of Sirt1 is inhibited by 2-deoxyglucose in *Drosophila* embryonic tissue culture.

2. Sirt1 works as a positive regulator of Notch signalling in *Drosophila*.

3. Sirt1 participates in regulation of acetylation status of Su(H).

However, due to a plethora of Sirt1-interacting partners and potential substrates, Sirt1 functions may differ in other specific molecular and cellular contexts.

## 6.0 Bibliography

- Abdelmohsen, K., Pullmann, R., Lal, A., Kim, H.H., Galban, S., Yang, X., Blethrow, J., Walker, M., Shubert, J., Gillespie, D.A., Furneaux, H., Gorospe, M., 2007. Phosphorylation of HuR by Chk2 regulates SIRT1 expression. *Mol. Cell* 25, 543–557. doi:10.1016/j.molcel.2007.01.011
- Acar, M., Jafar-Nejad, H., Takeuchi, H., Rajan, A., Ibrani, D., Rana, N.A., Pan, H., Haltiwanger, R.S., Bellen, H.J., 2008. Rumi Is a CAP10 Domain Glycosyltransferase that Modifies Notch and Is Required for Notch Signaling. *Cell* 132, 247–258. doi:10.1016/j.cell.2007.12.016
- Ahn, B.H., Kim, H.S., Song, S., Lee, I.H., Liu, J., Vassilopoulos, A., Deng, C.X., Finkel, T., 2008. A role for the mitochondrial deacetylase Sirt3 in regulating energy homeostasis. *Proc Natl Acad Sci U S A* 105, 14447–14452. doi:10.1073/pnas.0803790105
- Ahuja, N., Schwer, B., Carobbio, S., Waltregny, D., North, B.J., Castronovo, V., Maechler, P., Verdin, E., 2007. Regulation of insulin secretion by SIRT4, a mitochondrial ADP-ribosyltransferase. *J. Biol. Chem.* 282, 33583–33592. doi:10.1074/jbc.M705488200
- Aksoy, P., White, T.A., Thompson, M., Chini, E.N., 2006. Regulation of intracellular levels of NAD: A novel role for CD38. *Biochem. Biophys. Res. Commun.* 345, 1386–1392. doi:10.1016/j.bbrc.2006.05.042
- Anderson, R.M., Bitterman, K.J., Wood, J.G., Medvedik, O., Sinclair, D.A., 2003. Nicotinamide and PNC1 govern lifespan extension by calorie restriction in *Saccharomyces cerevisiae*. *Nature* 423, 181–5. doi:10.1038/nature01578
- Arias, A.M., Fiuza, U.-M., 2007. Cell and molecular biology of Notch. *J Endocrinol* 194, 459–474. doi:10.1677/JOE-07-0242
- Artavanis-Tsakonas, S., Matsuno, K., Fortini, M.E., 1995. Notch signaling. *Science* (80- ). 268, 225 LP-232.
- Artavanis-Tsakonas, S., Muskavitch, M.A., Yedvobnick, B., 1983. Molecular cloning of Notch, a locus affecting neurogenesis in *Drosophila melanogaster*. *Proc Natl Acad Sci U S A* 80, 1977–1981. doi:10.1073/pnas.80.7.1977
- Artavanis-Tsakonas, S., Muskavitch, M.A.T., 2010. Notch: The past, the present, and the future. *Curr. Top. Dev. Biol.* 92, 1–29. doi:10.1016/S0070-2153(10)92001-2
- Asher, G., Gatfield, D., Stratmann, M., Reinke, H., Dibner, C., Kreppel, F., Mostoslavsky, R., Alt, F.W., Schibler, U., 2008. SIRT1 Regulates Circadian Clock Gene Expression through PER2 Deacetylation. *Cell* 134, 317–328. doi:10.1016/j.cell.2008.06.050
- Auer, J.S., Nagel, A.C., Schulz, A., Wahl, V., Preiss, A., 2015. MAPK-dependent phosphorylation modulates the activity of Suppressor of Hairless in *Drosophila*. *Cell. Signal.* 27, 115–124. doi:10.1016/j.cellsig.2014.10.007
- Bai, P., Canto, C., Brunyánszki, A., Huber, A., Szántó, M., Cen, Y., Yamamoto, H., Houten, S.M., Kiss, B., Oudart, H., Gergely, P., Menissier-De Murcia, J., Schreiber, V., Sauve, A.A., Auwerx, J., 2011. PARP-2 regulates SIRT1 expression and whole-body energy expenditure. *Cell Metab.* 13, 450–460. doi:10.1016/j.cmet.2011.03.013
- Balaiya, S., Khetpal, V., Chalam, K. V, 2012. Hypoxia initiates sirtuin1-mediated vascular endothelial growth factor activation in choroidal endothelial cells through hypoxia inducible factor-2 $\alpha$ . *Mol. Vis.* 18, 114–20.
- Ban, J., Aryee, D.N.T., Fourtouna, A., Van Der Ent, W., Kauer, M., Niedan, S., Machado, I., Rodriguez-Galindo, C., Tirado, O.M., Schwentner, R., Picci, P., Flanagan, A.M., Berg, V., Strauss, S.J., Scotlandi, K., Lawlor, E.R., Snaar-

- Jagalska, E., Llombart-Bosch, A., Kovar, H., 2014. Suppression of deacetylase SIRT1 mediates tumor-suppressive NOTCH response and offers a novel treatment option in metastatic Ewing sarcoma. *Cancer Res.* 74, 6578–6588. doi:10.1158/0008-5472.CAN-14-1736
- Barban, S., Schulze, H. O., 1961. The Effects of 2-Deoxyglucose on the Growth and Metabolism of Cultured Human Cells\* Preparation of Cell-free Extracts-Cells. *J. OFBIOLOGICAL Chem.* Vol 236.
- Barbosa, M.T.P., Soares, S.M., Novak, C.M., Sinclair, D., Levine, J. a, Aksoy, P., Chini, E.N., 2007. The enzyme CD38 (a NAD glycohydrolase, EC 3.2.2.5) is necessary for the development of diet-induced obesity. *FASEB J.* 21, 3629–3639. doi:10.1096/fj.07-8290com
- Bardin, A.J., Schweisguth, F., 2006. Bearded family members inhibit neuralized-mediated endocytosis and signaling activity of Delta in Drosophila. *Dev. Cell* 10, 245–255. doi:10.1016/j.devcel.2005.12.017
- Basak, N.P., Roy, A., Banerjee, S., 2014. Alteration of mitochondrial proteome due to activation of Notch1 signaling pathway. *J. Biol. Chem.* 289, 7320–7334. doi:10.1074/jbc.M113.519405
- Baur, J.A., 2010. Resveratrol, sirtuins, and the promise of a DR mimetic. *Mech. Ageing Dev.* 131, 261–269. doi:10.1016/j.mad.2010.02.007
- Bedogni, B., Warneke, J.A., Nickoloff, B.J., Giaccia, A.J., Powell, M.B., 2008. Notch1 is an effector of Akt and hypoxia in melanoma development. *J. Clin. Invest.* 118, 3660–3670. doi:10.1172/JCI36157
- Bender, D.A., 1983. Biochemistry of tryptophan in health and disease. *Mol. Aspects Med.* 6, 101–197. doi:10.1016/0098-2997(83)90005-5
- Berthiaume, M., Boufaied, N., Moisan, A., Gaudreau, L., 2006. High levels of oxidative stress globally inhibit gene transcription and histone acetylation. *DNA Cell Biol.* 25, 124–34. doi:10.1089/dna.2006.25.124
- Bhanushali, A.A., Babu, S., Thangapandi, V.R., Pillai, R., Chheda, P., Das, B.R., 2010. Mutations in the HD and PEST domain of Notch-1 receptor in T-cell acute lymphoblastic leukemia: report of novel mutations from Indian population. *Oncol. Res.* 19, 99–104. doi:10.3727/096504010X12864748215007
- Bheda, P., Jing, H., Wolberger, C., Lin, H., 2016. The Substrate Specificity of Sirtuins. *Annu. Rev. Biochem.* 85, 405–29. doi:10.1146/annurev-biochem-060815-014537
- Bi, P., Kuang, S., 2015. Notch signaling as a novel regulator of metabolism. *Trends Endocrinol. Metab.* 26, 248–255. doi:10.1016/j.tem.2015.02.006
- Bi, P., Shan, T., Liu, W., Yue, F., Yang, X., Liang, X.-R., Wang, J., Li, J., Carlesso, N., Liu, X., Kuang, S., 2014. Inhibition of Notch signaling promotes browning of white adipose tissue and ameliorates obesity. *Nat. Med.* 20, 911–8. doi:10.1038/nm.3615
- Binda, O., Nassif, C., Branton, P., 2008. SIRT1 negatively regulates HDAC1-dependent transcriptional repression by the RBP1 family of proteins. *Oncogene* 27, 3384–3392. doi:10.1038/sj.onc.1211014
- Biosynthesis, P.-L., 2016. Biochemistry and Enzymology of, in: Houtkooper, R.H. (Ed.), *Sirtuins*. Springer Netherlands, Dordrecht, pp. 1–27. doi:10.1007/978-3-642-12453-2
- Bitterman, K.J., 2002. Inhibition of Silencing and Accelerated Aging by Nicotinamide, a Putative Negative Regulator of Yeast Sir2 and Human SIRT1. *J. Biol. Chem.* 277, 45099–45107. doi:10.1074/jbc.M205670200
- Blaumueller, C.M., Qi, H., Zagouras, P., Artavanis-Tsakonas, S., 1997. Intracellular cleavage of Notch leads to a heterodimeric receptor on the plasma membrane. *Cell* 90, 281–291. doi:10.1016/S0092-8674(00)80336-0

- Bode, A.M., Dong, Z., 2007. The functional contrariety of JNK. *Mol. Carcinog.* 46, 591–598. doi:10.1002/mc.20348
- Bonfini, A., Wilkin, M.B., Baron, M., 2015. Reversible regulation of stem cell niche size associated with dietary control of Notch signalling. *BMC Dev. Biol.* 15, 8. doi:10.1186/s12861-015-0059-8
- Borra, M.T., Langer, M.R., Slama, J.T., Denu, J.M., 2004. Substrate specificity and kinetic mechanism of the Sir2 family of NAD<sup>+</sup>-dependent histone/protein deacetylases. *Biochemistry* 43, 9877–9887. doi:10.1021/bi049592e
- Boutant, M., Cantó, C., 2014. SIRT1 metabolic actions: Integrating recent advances from mouse models. *Mol. Metab.* 3, 5–18. doi:10.1016/j.molmet.2013.10.006
- Brachmann, C.B., Sherman, J.M., Devine, S.E., Cameron, E.E., Pillus, L., Boeke, J.D., 1995. The SIR2 gene family, conserved from bacteria to humans, functions in silencing, cell cycle progression, and chromosome stability. *Genes Dev.* 9, 2888–2902. doi:10.1101/GAD.9.23.2888
- Braidy, N., Guillemin, G.J., Mansour, H., Can-Ling, T., Poljak, A., Grant, R., 2011. Age related changes in NAD<sup>+</sup> metabolism oxidative stress and SIRT1 activity in Wistar rats. *PLoS One* 6, e19194.
- Bray, S., 2006. Notch signalling: a simple pathway becomes complex. *Nat. Rev. Mol. Cell Biol.* 7, 678–689. doi:10.1038/nrm2009
- Brisson, D., Vohl, M.C., St-Pierre, J., Hudson, T.J., Gaudet, D., 2001. Glycerol: A neglected variable in metabolic processes? *BioEssays* 23, 534–542. doi:10.1002/bies.1073
- Brosnan, J.T., 2000. Glutamate, at the Interface between Amino Acid and Carbohydrate Metabolism. *J. Nutr.* 130, 988S–990S.
- Brown, J., 1962. Effects of 2-deoxyglucose on carbohydrate metabolism: review of the literature and studies in the rat. *Metabolism.* 11, 1098–112.
- Brunet, A., Sweeney, L.B., Sturgill, J.F., Chua, K.F., Greer, P.L., Lin, Y., Tran, H., Ross, S.E., Mostoslavsky, R., Cohen, H.Y., Hu, L.S., Cheng, H.-L., Jedrychowski, M.P., Gygi, S.P., Sinclair, D.A., Alt, F.W., Greenberg, M.E., 2004. Stress-dependent regulation of FOXO transcription factors by the SIRT1 deacetylase. *Science* 303, 2011–5. doi:10.1126/science.1094637
- Buceta, J., Herranz, H., Canela-Xandri, O., Reigada, R., Sagués, F., Milán, M., 2007. Robustness and stability of the gene regulatory network involved in DV boundary formation in the *Drosophila* wing. *PLoS One* 2, e602. doi:10.1371/journal.pone.0000602
- Bush, G., Disibio, G., Miyamoto, A., Denault, J.-B.B., Leduc, R., Weinmaster, G., 2001. Ligand-induced signaling in the absence of furin processing of Notch1. *Dev. Biol.* 229, 494–502. doi:10.1006/dbio.2000.9992
- Byun, J.S., Gardner, K., 2013. C-terminal binding protein: A molecular link between metabolic imbalance and epigenetic regulation in breast cancer. *Int. J. Cell Biol.* 2013, 647975. doi:10.1155/2013/647975
- Calzavara, E., Chiamonte, R., Cesana, D., Basile, A., Sherbet, G. V., Comi, P., 2008. Reciprocal regulation of Notch and PI3K/Akt signalling in T-ALL cells in vitro. *J. Cell. Biochem.* 103, 1405–1412. doi:10.1002/jcb.21527
- Canto, C., Auwerx, J., 2012. Targeting sirtuin 1 to improve metabolism: all you need is NAD(+)? *Pharmacol Rev* 64, 166–187. doi:10.1124/pr.110.003905
- Cantó, C., Auwerx, J., 2009. Caloric restriction, SIRT1 and longevity. *Trends Endocrinol. Metab.* 20, 325–331. doi:10.1016/j.tem.2009.03.008
- Cantó, C., Houtkooper, R.H., Pirinen, E., Youn, D.Y., Oosterveer, M.H., Cen, Y., Fernandez-Marcos, P.J., Yamamoto, H., Andreux, P.A., Cettour-Rose, P., Gademann, K., Rinsch, C., Schoonjans, K., Sauve, A.A., Auwerx, J., 2012. The NAD<sup>+</sup> precursor nicotinamide riboside enhances oxidative metabolism and



- protects against high-fat diet-induced obesity. *Cell Metab.* 15, 838–847. doi:10.1016/j.cmet.2012.04.022
- Cantó, C., Jiang, L.Q., Deshmukh, A.S., Matakı, C., Coste, A., Lagouge, M., Zierath, J.R., Auwerx, J., 2010. Interdependence of AMPK and SIRT1 for Metabolic Adaptation to Fasting and Exercise in Skeletal Muscle. *Cell Metab.* 11, 213–219. doi:10.1016/j.cmet.2010.02.006
- Cantó, C., Menzies, K.J., Auwerx, J., 2015. NAD<sup>+</sup> Metabolism and the Control of Energy Homeostasis: A Balancing Act between Mitochondria and the Nucleus. *Cell Metab.* 22, 31–53. doi:10.1016/j.cmet.2015.05.023
- Caron, C., Boyault, C., Khochbin, S., 2005. Regulatory cross-talk between lysine acetylation and ubiquitination: Role in control of protein stability. *BioEssays* 27, 408–415. doi:10.1002/bies.20210
- Castro, B., Barolo, S., Bailey, A.M., Posakony, J.W., 2005. Lateral inhibition in proneural clusters: cis-regulatory logic and default repression by Suppressor of Hairless. *Development* 132, 3333–3344. doi:10.1242/dev.01920
- Caussinus, E., Gonzalez, C., 2005. Induction of tumor growth by altered stem-cell asymmetric division in *Drosophila melanogaster*. *Nat. Genet.* 37, 1125–1129. doi:10.1038/ng1632
- Ceni, C., Muller-Steffner, H., Lund, F., Pochon, N., Schweitzer, A., De Waard, M., Schuber, F., Villaz, M., Moutin, M.J., 2003. Evidence for an Intracellular ADP-ribosyl Cyclase/NAD<sup>+</sup>-glycohydrolase in Brain from CD38-deficient Mice. *J. Biol. Chem.* 278, 40670–40678. doi:10.1074/jbc.M301196200
- Civitarese, A.E., Carling, S., Heilbronn, L.K., Hulver, M.H., Ukropcova, B., Deutsch, W.A., Smith, S.R., Ravussin, E., CALERIE Pennington Team, 2007. Calorie restriction increases muscle mitochondrial biogenesis in healthy humans. *PLoS Med.* 4, e76. doi:10.1371/journal.pmed.0040076
- Coffman, C., Harris, W., Kintner, C., 1990. Xotch, the *Xenopus* homolog of *Drosophila* notch. *Science* (80-. ). 249, 1438–1441. doi:10.1126/science.2402639
- Cohen-Armon, M., Visochek, L., Rozensal, D., Kalal, A., Geistrikh, I., Klein, R., Bendetz-Nezer, S., Yao, Z., Seger, R., 2007. DNA-Independent PARP-1 Activation by Phosphorylated ERK2 Increases Elk1 Activity: A Link to Histone Acetylation. *Mol. Cell* 25, 297–308. doi:10.1016/j.molcel.2006.12.012
- Cohen, H.Y., Miller, C., Bitterman, K.J., Wall, N.R., Hekking, B., Kessler, B., Howitz, K.T., Gorospe, M., Cabo, R. de, Sinclair, D.A., 2004. Calorie Restriction Promotes Mammalian Cell Survival by Inducing the SIRT1 Deacetylase. *Science* (80-. ). 305, 390–392. doi:10.1126/science.1099196
- Cornell, M., Evans, D.A.P., Mann, R., Fostier, M., Flaszka, M., Monthatong, M., Artavanis-Tsakonas, S., Baron, M., 1999. The *Drosophila melanogaster* Suppressor of deltex gene, a regulator of the Notch receptor signaling pathway, is an E3 class ubiquitin ligase. *Genetics* 152, 567–576.
- Correia, T., Papayannopoulos, V., Panin, V., Woronoff, P., Jiang, J., Vogt, T.F., Irvine, K.D., 2003. Molecular genetic analysis of the glycosyltransferase Fringe in *Drosophila*. *Proc. Natl. Acad. Sci. U. S. A.* 100, 6404–6409. doi:10.1073/pnas.1131007100
- Costa, C.D.S., Hammes, T.O., Rohden, F., Margis, R., Bortolotto, J.W., Padoin, A.V., Mottin, C.C., Guaragna, R.M., 2010. SIRT1 transcription is decreased in visceral adipose tissue of morbidly obese patients with severe hepatic steatosis. *Obes. Surg.* 20, 633–639. doi:10.1007/s11695-009-0052-z
- Coste, A., Louet, J., Lagouge, M., Lerin, C., Antal, M.C., Meziane, H., Schoonjans, K., Puigserver, P., O'Malley, B.W., Auwerx, J., 2008. The genetic ablation of SRC-3 protects against obesity and improves insulin sensitivity by reducing the acetylation of PGC-1{alpha}. *Pnas* 105, 17187–17192.

- doi:10.1073/pnas.0808207105
- Couturier, L., Mazouni, K., Schweisguth, F., 2013. Numb localizes at endosomes and controls the endosomal sorting of notch after asymmetric division in drosophila. *Curr. Biol.* 23, 588–593. doi:10.1016/j.cub.2013.03.002
- Couturier, L., Trylinski, M., Mazouni, K., Darnet, L., Schweisguth, F., 2014. A fluorescent tagging approach in *Drosophila* reveals late endosomal trafficking of Notch and Sanpodo. *J. Cell Biol.* 207, 351–363. doi:10.1083/jcb.201407071
- Cox, J., Hein, M.Y., Lubner, C. a, Paron, I., 2014. Accurate proteome-wide label-free quantification by delayed normalization and maximal peptide ratio extraction, termed MaxLFQ. *Mol. Cell.* ... 13, 2513–2526. doi:10.1074/mcp.M113.031591
- Cox, J., Mann, M., 2008. MaxQuant enables high peptide identification rates, individualized p.p.b.-range mass accuracies and proteome-wide protein quantification. *Nat. Biotechnol.* 26, 1367–72. doi:10.1038/nbt.1511
- Dang, W., 2014. The controversial world of sirtuins. *Drug Discov. Today Technol.* 12, e9–e17. doi:10.1016/j.ddtec.2012.08.003
- de Celis, J.F., Bray, S., 1997. Feed-back mechanisms affecting Notch activation at the dorsoventral boundary in the *Drosophila* wing. *Development* 124, 3241–3251.
- DeGregori, J., Kowalik, T., Nevins, J.R., 1995. Cellular targets for activation by the E2F1 transcription factor include DNA synthesis- and G1/S-regulatory genes. *Mol. Cell. Biol.* 15, 4215–24. doi:10.1128/MCB.15.8.4215
- Dexter, J.S., 1914. The Analysis of a Case of Continuous Variation in *Drosophila* by a Study of Its Linkage Relations. *Am. Nat.* 48, 712–758. doi:10.1086/279446
- Donald Voet, Judith G. Voet, C.W.P., 2013. *Fundamentals of Biochemistry: Life at the Molecular Level* - Donald Voet, Judith G. Voet, Charlotte W. Pratt - Google Knihy. Wiley, Hoboken NJ.
- Drazic, A., Myklebust, L.M., Ree, R., Arnesen, T., 2016. The world of protein acetylation. *Biochim. Biophys. Acta - Proteins Proteomics* 1864, 1372–1401. doi:10.1016/j.bbapap.2016.06.007
- Dryden, S.C., Nahhas, F.A., Nowak, J.E., Goustin, A.-S., Tainsky, M.A., 2003. Role for human SIRT2 NAD-dependent deacetylase activity in control of mitotic exit in the cell cycle. *Mol. Cell. Biol.* 23, 3173–85. doi:10.1128/MCB.23.9.3173
- Du, J., Jiang, H., Lin, H., 2009. Investigating the ADP-ribosyltransferase activity of sirtuins with NAD analogues and 32P-NAD. *Biochemistry* 48, 2878–2890. doi:10.1021/bi802093g
- Efeyan, A., Comb, W.C., Sabatini, D.M., 2015. Nutrient-sensing mechanisms and pathways. *Nature* 517, 302–310. doi:10.1038/nature14190
- Eissenberg, J.C., Lee, M.G., Schneider, J., Ilvarsonn, A., Shiekhhattar, R., Shilatifard, A., 2007. The trithorax-group gene in *drosophila* little imaginal discs encodes a trimethylated histone H3 Lys4 demethylase. *Nat Struct Mol Biol* 14. doi:10.1038/nsmb1217
- Ellisen, L.W., Bird, J., West, D.C., Soreng, A.L., Reynolds, T.C., Smith, S.D., Sklar, J., 1991. TAN-1, the human homolog of the *Drosophila* Notch gene, is broken by chromosomal translocations in T lymphoblastic neoplasms. *Cell* 66, 649–661. doi:10.1016/0092-8674(91)90111-B
- Espinosa, L., Inglés-Esteve, J., Aguilera, C., Bigas, A., 2003. Phosphorylation by glycogen synthase kinase-3 $\beta$  down-regulates Notch activity, a link for Notch and Wnt pathways. *J. Biol. Chem.* 278, 32227–32235. doi:10.1074/jbc.M304001200
- Fan, J., Kamphorst, J.J., Mathew, R., Chung, M.K., White, E., Shlomi, T., Rabinowitz, J.D., 2013. Glutamine-driven oxidative phosphorylation is a major ATP source in transformed mammalian cells in both normoxia and hypoxia. *Mol. Syst. Biol.* 9, 712. doi:10.1038/msb.2013.65

- Feige, J.N., Johan, A., 2008. Transcriptional targets of sirtuins in the coordination of mammalian physiology. *Curr. Opin. Cell Biol.* 20, 303–309. doi:10.1016/j.ceb.2008.03.012
- Feige, J.N., Lagouge, M., Canto, C., Strehle, A., Houten, S.M., Milne, J.C., Lambert, P.D., Matak, C., Elliott, P.J., Auwerx, J., 2008. Specific SIRT1 Activation Mimics Low Energy Levels and Protects against Diet-Induced Metabolic Disorders by Enhancing Fat Oxidation. *Cell Metab.* 8, 347–358. doi:10.1016/j.cmet.2008.08.017
- Ferjentsik, Z., Hayashi, S., Dale, J.K., Bessho, Y., Herreman, A., De Strooper, B., Del Monte, G., De La Pompa, J.L., Maroto, M., 2009. Notch is a critical component of the mouse somitogenesis oscillator and is essential for the formation of the somites. *PLoS Genet.* 5, e1000662. doi:10.1371/journal.pgen.1000662
- Fernandez-Martinez, J., Vela, E.M., Tora-Ponsioen, M., Ocaña, O.H., Nieto, M.A., Galceran, J., 2009. Attenuation of Notch signalling by the Down-syndrome-associated kinase DYRK1A. *J. Cell Sci.* 122, 1574–83. doi:10.1242/jcs.044354
- Ferré, P., Fougelle, F., 2010. Hepatic steatosis: A role for de novo lipogenesis and the transcription factor SREBP-1c. *Diabetes, Obes. Metab.* 12, 83–92. doi:10.1111/j.1463-1326.2010.01275.x
- Fichelson, P., Gho, M., 2003. The glial cell undergoes apoptosis in the microchaete lineage of *Drosophila*. *Development* 130, 123–133. doi:10.1242/dev.00198
- Filion, G.J., van Bommel, J.G., Braunschweig, U., Talhout, W., Kind, J., Ward, L.D., Brugman, W., de Castro, I.J., Kerkhoven, R.M., Bussemaker, H.J., van Steensel, B., 2010. Systematic Protein Location Mapping Reveals Five Principal Chromatin Types in *Drosophila* Cells. *Cell* 143, 212–224. doi:10.1016/j.cell.2010.09.009
- Finley, L.W.S., Haas, W., Desquirit-Dumas, V., Wallace, D.C., Procaccio, V., Gygi, S.P., Haigis, M.C., 2011. Succinate dehydrogenase is a direct target of sirtuin 3 deacetylase activity. *PLoS One* 6, e23295. doi:10.1371/journal.pone.0023295
- Fjeld, C.C., Birdsong, W.T., Goodman, R.H., 2003. Differential binding of NAD<sup>+</sup> and NADH allows the transcriptional corepressor carboxyl-terminal binding protein to serve as a metabolic sensor. *Proc. Natl. Acad. Sci. U. S. A.* 100, 9202–7. doi:10.1073/pnas.1633591100
- Fleming, R.J., Nelson Scottgale, T., Diederich, R.J., Artavanis-Tsakonas, S., 1990. The gene *Serrate* encodes a putative EGF-like transmembrane protein essential for proper ectodermal development in *Drosophila melanogaster*. *Genes Dev.* 4, 2188–2201. doi:10.1101/gad.4.12a.2188
- Foltz, D.R., Santiago, M.C., Berechid, B.E., Nye, J.S., 2002. Glycogen synthase kinase-3beta modulates notch signaling and stability. *Curr. Biol.* 12, 1006–1011. doi:S0960982202008886 [pii]
- Ford, E., Voit, R., Liszt, G., Magin, C., Grummt, I., Guarente, L., 2006. Mammalian Sir2 homolog SIRT7 is an activator of RNA polymerase I transcription. *Genes Dev.* 20, 1075–1080. doi:10.1101/gad.1399706
- Ford, J., Ahmed, S., Allison, S., Jiang, M., Milner, J., 2008. JNK2-dependent regulation of SIRT1 protein stability. *Cell Cycle* 7, 3091–3097. doi:10.4161/cc.7.19.6799
- Fortini, M.E., Artavanis-Tsakonas, S., 1994. The suppressor of hairless protein participates in notch receptor signaling. *Cell* 79, 273–282. doi:10.1016/0092-8674(94)90196-1
- Fostier, M., Evans, D.A.P., Artavanis-Tsakonas, S., Baron, M., 1998. Genetic characterization of the *Drosophila melanogaster* Suppressor of *deltex* gene: A regulator of Notch signaling. *Genetics* 150, 1477–1485.
- Fraser, M., Chan, S.L., Chan, S.S., Fiscus, R.R., Tsang, B.K., 2006. Regulation of p53 and suppression of apoptosis by the soluble guanylyl cyclase/cGMP

- pathway in human ovarian cancer cells. *Oncogene* 25, 2203–2212. doi:10.1038/sj.onc.1209251
- Fridman, J.S., Lowe, S.W., 2003. Control of apoptosis by p53. *Oncogene* 22, 9030–9040. doi:10.1038/sj.onc.1207116
- Frye, R.A., 2000. Phylogenetic Classification of Prokaryotic and Eukaryotic Sir2-like Proteins. *Biochem. Biophys. Res. Commun.* 273, 793–798. doi:10.1006/bbrc.2000.3000
- Fryer, C.J., White, J.B., Jones, K.A., 2004a. Mastermind recruits CycC:CDK8 to phosphorylate the Notch ICD and coordinate activation with turnover. *Mol. Cell* 16, 509–520. doi:10.1016/j.molcel.2004.10.014
- Fryer, C.J., White, J.B., Jones, K.A., 2004b. Mastermind recruits CycC:CDK8 to phosphorylate the Notch ICD and coordinate activation with turnover. *Mol. Cell* 16, 509–520. doi:10.1016/j.molcel.2004.10.014
- Fulco, M., Cen, Y., Zhao, P., Hoffman, E.P., McBurney, M.W., Sauve, A.A., Sartorelli, V., 2008. Glucose Restriction Inhibits Skeletal Myoblast Differentiation by Activating SIRT1 through AMPK-Mediated Regulation of Nampt. *Dev. Cell* 14, 661–673. doi:10.1016/j.devcel.2008.02.004
- Fuwa, T.J., Hori, K., Sasamura, T., Higgs, J., Baron, M., Matsuno, K., 2006. The first *deltex* null mutant indicates tissue-specific *deltex*-dependent Notch signaling in *Drosophila*. *Mol. Genet. Genomics* 275, 251–263. doi:10.1007/s00438-005-0087-3
- Gao, Z., Zhang, J., Kheterpal, I., Kennedy, N., Davis, R.J., Ye, J., 2011. Sirtuin 1 (SIRT1) protein degradation in response to persistent c-Jun N-terminal Kinase 1 (JNK1) activation contributes to hepatic steatosis in obesity. *J. Biol. Chem.* 286, 22227–22234. doi:10.1074/jbc.M111.228874
- Gause, M., Eissenberg, J.C., Macrae, A.F., Dorsett, M., Misulovin, Z., Dorsett, D., 2006. Nipped-A, the Tra1/TRRAP Subunit of the *Drosophila* SAGA and Tip60 Complexes, Has Multiple Roles in Notch Signaling during Wing Development. *Mol. Cell. Biol.* 26, 2347–2359. doi:10.1128/MCB.26.6.2347
- Gerhart-Hines, Z., Dominy, J.E., Blättler, S.M., Jedrychowski, M.P., Banks, A.S., Lim, J.H., Chim, H., Gygi, S.P., Puigserver, P., 2011. The cAMP/PKA Pathway Rapidly Activates SIRT1 to Promote Fatty Acid Oxidation Independently of Changes in NAD<sup>+</sup>. *Mol. Cell* 44, 851–863. doi:10.1016/j.molcel.2011.12.005
- Gibson, B.A., Kraus, W.L., 2012. New insights into the molecular and cellular functions of poly(ADP-ribose) and PARPs. *Nat. Rev. Mol. Cell Biol.* 13, 411–424. doi:10.1038/nrm3376
- Glickman, M.H., Ciechanover, A., 2002. The Ubiquitin-Proteasome Proteolytic Pathway: Destruction for the Sake of Construction. *Physiol. Rev.* 82, 373–428. doi:10.1152/physrev.00027.2001
- Gonfloni, S., Iannizzotto, V., Maiani, E., Bellusci, G., Ciccone, S., Diederich, M., 2014. P53 and Sirt1: Routes of metabolism and genome stability. *Biochem. Pharmacol.* 92, 149–156. doi:10.1016/j.bcp.2014.08.034
- Gordon, W.R., Vardar-Ulu, D., Histen, G., Sanchez-Irizarry, C., Aster, J.C., Blacklow, S.C., 2007. Structural basis for autoinhibition of Notch. *Nat. Struct. Mol. Biol.* 14, 295–300. doi:10.1038/nsmb1227
- Gramates, L.S., Marygold, S.J., Santos, G. dos, Urbano, J.-M., Antonazzo, G., Matthews, B.B., Rey, A.J., Tabone, C.J., Crosby, M.A., Emmert, D.B., Falls, K., Goodman, J.L., Hu, Y., Ponting, L., Schroeder, A.J., Strelets, V.B., Thurmond, J., Zhou, P., H., A., S.J., M., S.J., M., R.A., H., G., dos S., S., R., B.R., G., R.A., H., B.B., M., M.A., C., S., N.-J., S., N.-J., A.C., S., K.J.T., V., M., C., D., O.-S., W.A., K., G.H., M., S.M., B., R.D., F., K.J., V., E.Z., K., Y., H., E.V., K., J.S., A., R.A., P., J.T., E., A., M., G., D., P., B., B., A., E., B., J., W., S., B., L., C., G., J., M., R.,

- R.P., Z., 2016. FlyBase at 25: looking to the future. *Nucleic Acids Res.* 44, gkw1016. doi:10.1093/nar/gkw1016
- Gridley, T., 2003. Notch signaling and inherited disease syndromes. *Hum. Mol. Genet.* 12, 9R–13. doi:10.1093/hmg/ddg052
- Guarani, V., Deflorian, G., Franco, C.A., Krüger, M., Phng, L.-K., Bentley, K., Toussaint, L., Dequiedt, F., Mostoslavsky, R., Schmidt, M.H.H., Zimmermann, B., Brandes, R.P., Mione, M., Westphal, C.H., Braun, T., Zeiher, A.M., Gerhardt, H., Dimmeler, S., Potente, M., 2011. Acetylation-dependent regulation of endothelial Notch signalling by the SIRT1 deacetylase. *Nature* 473, 234–8. doi:10.1038/nature09917
- Guarente, L., Guarente, L., 2013. Calorie restriction and sirtuins revisited Calorie restriction and sirtuins revisited. *Genes Dev.* 27, 2072–2085. doi:10.1101/gad.227439.113
- Guilmeau, S., Flandez, M., Bancroft, L., Sellers, R.S., Tear, B., Stanley, P., Augenlicht, L.H., 2008. Intestinal Deletion of Pofut1 in the Mouse Inactivates Notch Signaling and Causes Enterocolitis. *Gastroenterology* 135, 849–60, 860–6. doi:10.1053/j.gastro.2008.05.050
- Guo, X., Williams, J.G., Schug, T.T., Li, X., 2010. DYRK1A and DYRK3 promote cell survival through phosphorylation and activation of SIRT1. *J. Biol. Chem.* 285, 13223–13232. doi:10.1074/jbc.M110.102574
- Haigis, M.C., Mostoslavsky, R., Haigis, K.M., Fahie, K., Christodoulou, D.C., Murphy, A.J., Valenzuela, D.M., Yancopoulos, G.D., Karow, M., Blander, G., Wolberger, C., Prolla, T.A., Weindruch, R., Alt, F.W., Guarente, L., 2006a. SIRT4 Inhibits Glutamate Dehydrogenase and Opposes the Effects of Calorie Restriction in Pancreatic  $\beta$  Cells. *Cell* 126, 941–954. doi:10.1016/j.cell.2006.06.057
- Haigis, M.C., Mostoslavsky, R., Haigis, K.M., Fahie, K., Christodoulou, D.C., Murphy, A.J., Valenzuela, D.M., Yancopoulos, G.D., Karow, M., Blander, G., Wolberger, C., Prolla, T.A., Weindruch, R., Alt, F.W., Guarente, L., 2006b. SIRT4 Inhibits Glutamate Dehydrogenase and Opposes the Effects of Calorie Restriction in Pancreatic  $\beta$  Cells. *Cell* 126, 941–954. doi:10.1016/j.cell.2006.06.057
- Haigis, M.C., Sinclair, D. a., 2010. Mammalian Sirtuins: Biological Insights and Disease Relevance. *Annu. Rev. Pathol.* 5, 253–295. doi:10.1146/annurev.pathol.4.110807.092250
- Hallows, W.C., Lee, S., Denu, J.M., 2006. Sirtuins deacetylate and activate mammalian acetyl-CoA synthetases. *Proc. Natl. Acad. Sci. U. S. A.* 103, 10230–10235. doi:10.1073/pnas.0604392103
- Han, L., Zhao, G., Wang, H., Tong, T., Chen, J., 2014. Calorie restriction upregulated sirtuin 1 by attenuating its ubiquitin degradation in cancer cells. *Clin. Exp. Pharmacol. Physiol.* 41, 165–168. doi:10.1111/1440-1681.12199
- Han, L., Zhou, R., Niu, J., McNutt, M.A., Wang, P., Tong, T., 2010. SIRT1 is regulated by a PPAR $\gamma$ -SIRT1 negative feedback loop associated with senescence. *Nucleic Acids Res.* 38, 7458–7471. doi:10.1093/nar/gkq609
- Hansson, M.L., Popko-Ścibor, A.E., Saint Just Ribeiro, M., Dancy, B.M., Lindberg, M.J., Cole, P.A., Wallberg, A.E., 2009. The transcriptional coactivator MAML1 regulates p300 autoacetylation and HAT activity. *Nucleic Acids Res.* 37, 2996–3006. doi:10.1093/nar/gkp163
- Hanukoglu, I., 2015. Proteopedia: Rossmann fold: A beta-alpha-beta fold at dinucleotide binding sites. *Biochem. Mol. Biol. Educ.* 43, 206–209. doi:10.1002/bmb.20849
- Hardie, D.G., 2011. AMP-activated protein kinase-an energy sensor that regulates all aspects of cell function. *Genes Dev.* 25, 1895–1908. doi:10.1101/gad.17420111
- Hardie, D.G., Ross, F. a., Hawley, S. a., 2012. AMPK: a nutrient and energy sensor

- that maintains energy homeostasis. *Nat. Rev. Mol. Cell Biol.* 13, 251–262. doi:10.1038/nrm3311
- Harvey, B.M., Rana, N.A., Moss, H., Leonardi, J., Jafar-Nejad, H., Haltiwanger, R.S., 2016. Mapping sites of O-glycosylation and fringe elongation on *Drosophila* Notch. *J. Biol. Chem.* 291, 16348–16360. doi:10.1074/jbc.M116.732537
- Hayashida, S., Arimoto, A., Kuramoto, Y., Kozako, T., Honda, S.I., Shimeno, H., Soeda, S., 2010. Fasting promotes the expression of SIRT1, an NAD<sup>+</sup>-dependent protein deacetylase, via activation of PPAR $\alpha$  in mice. *Mol. Cell. Biochem.* 339, 285–292. doi:10.1007/s11010-010-0391-z
- Hirschey, M.D., Shimazu, T., Goetzman, E., Jing, E., Schwer, B., Lombard, D.B., Grueter, C.A., Harris, C., Biddinger, S., Ilkayeva, O.R., Stevens, R.D., Li, Y., Saha, A.K., Ruderman, N.B., Bain, J.R., Newgard, C.B., Farese Jr., R. V, Alt, F.W., Kahn, C.R., Verdin, E., 2010. SIRT3 regulates mitochondrial fatty-acid oxidation by reversible enzyme deacetylation. *Nature* 464, 121–125. doi:10.1038/nature08778
- Hitosugi, T., Chen, J., 2014. Post-translational modifications and the Warburg effect. *Oncogene* 33, 4279–4285. doi:10.1038/onc.2013.406
- Hoff, K.G., Avalos, J.L., Sens, K., Wolberger, C., 2006. Insights into the Sirtuin Mechanism from Ternary Complexes Containing NAD<sup>+</sup> and Acetylated Peptide. *Structure* 14, 1231–1240. doi:10.1016/j.str.2006.06.006
- Hong, E.H., Lee, S.J., Kim, J.S., Lee, K.H., Um, H.D., Kim, J.H., Kim, S.J., Kim, J. II, Hwang, S.G., 2010. Ionizing radiation induces cellular senescence of articular chondrocytes via negative regulation of SIRT1 by p38 kinase. *J. Biol. Chem.* 285, 1283–1295. doi:10.1074/jbc.M109.058628
- Hong, S., Zhao, B., Lombard, D.B., Fingar, D.C., Inoki, K., 2014. Cross-talk between sirtuin and mammalian target of rapamycin complex 1 (mTORC1) signaling in the regulation of S6 kinase 1 (S6K1) phosphorylation. *J. Biol. Chem.* 289, 13132–13141. doi:10.1074/jbc.M113.520734
- Hori, K., 2004. *Drosophila* Deltex mediates Suppressor of Hairless-independent and late-endosomal activation of Notch signaling. *Development* 131, 5527–5537. doi:10.1242/dev.01448
- Hori, K., Sen, A., Kirchhausen, T., Artavanis-Tsakonas, S., 2012. Regulation of ligand-independent notch signal through intracellular trafficking. *Commun. Integr. Biol.* 5, 374–376. doi:10.4161/cib.19995
- Hottiger, M.O., Hassa, P.O., Lüscher, B., Schüler, H., Koch-Nolte, F., 2010. Toward a unified nomenclature for mammalian ADP-ribosyltransferases. *Trends Biochem. Sci.* 35, 208–219. doi:10.1016/j.tibs.2009.12.003
- Houtkooper, R.H., Cantó, C., Wanders, R.J., Auwerx, J., 2010. The secret life of NAD<sup>+</sup>: An old metabolite controlling new metabolic signaling pathways. *Endocr. Rev.* 31, 194–223. doi:10.1210/er.2009-0026
- Houtkooper, R.H., Pirinen, E., Auwerx, J., 2012. Sirtuins as regulators of metabolism and healthspan. *Nat. Rev. Mol. Cell Biol.* 13, 225–238. doi:10.1038/nrm3293
- Howell, J.J., Manning, B.D., 2011. mTOR couples cellular nutrient sensing to organismal metabolic homeostasis. *Trends Endocrinol. Metab.* 22, 94–102. doi:10.1016/j.tem.2010.12.003
- Hu, Y.-Y., Fu, L.-A., Li, S.-Z., Chen, Y., Li, J.-C., Han, J., Liang, L., Li, L., Ji, C.-C., Zheng, M.-H., Han, H., 2014. Hif-1 $\alpha$  and Hif-2 $\alpha$  differentially regulate Notch signaling through competitive interaction with the intracellular domain of Notch receptors in glioma stem cells. *Cancer Lett.* 349, 67–76. doi:10.1016/j.canlet.2014.03.035
- Hu, Y., Wang, H., Wang, Q., Deng, H., 2014. Overexpression of CD38 decreases cellular NAD levels and alters the expression of proteins involved in energy

- metabolism and antioxidant defense. *J. Proteome Res.* 13, 786–795. doi:10.1021/pr4010597
- Huang, B., Cheng, X., Wang, D., Peng, M., Xue, Z., Da, Y., Zhang, N., Yao, Z., Li, M., Xu, A., Zhang, R., Huang, B., Cheng, X., Wang, D., Peng, M., Xue, Z., Da, Y., Zhang, N., Yao, Z., Li, M., Xu, A., Zhang, R., 2014. Adiponectin promotes pancreatic cancer progression by inhibiting apoptosis via the activation of AMPK/Sirt1/PGC-1 $\alpha$  signaling. *Oncotarget* 5, 4732–4745. doi:10.18632/oncotarget.1963
- Huang, X.Z., Wen, D., Zhang, M., Xie, Q., Ma, L., Guan, Y., Ren, Y., Chen, J., Hao, C.M., 2014. Sirt1 Activation Ameliorates Renal Fibrosis by Inhibiting the TGF- $\beta$ /Smad3 Pathway. *J. Cell. Biochem.* 115, 996–1005. doi:10.1002/jcb.24748
- Hubbard, B.P., Gomes, A.P., Dai, H., Li, J., Case, A.W., Considine, T., Riera, T. V., Lee, J.E., E, S.Y., Lamming, D.W., Pentelute, B.L., Schuman, E.R., Stevens, L.A., Ling, A.J.Y., Armour, S.M., Michan, S., Zhao, H., Jiang, Y., Sweitzer, S.M., Blum, C.A., Disch, J.S., Ng, P.Y., Howitz, K.T., Rolo, A.P., Hamuro, Y., Moss, J., Perni, R.B., Ellis, J.L., Vlasuk, G.P., Sinclair, D.A., 2013. Evidence for a common mechanism of SIRT1 regulation by allosteric activators. *Science* 339, 1216–9. doi:10.1126/science.1231097
- Huber, J.L., McBurney, M.W., Distefano, P.S., McDonagh, T., 2010. SIRT1-independent mechanisms of the putative sirtuin enzyme activators SRT1720 and SRT2183. *Future Med. Chem.* 2, 1751–9. doi:10.4155/fmc.10.257
- Hwang, J.W., Yao, H., Caito, S., Sundar, I.K., Rahman, I., 2013. Redox regulation of SIRT1 in inflammation and cellular senescence. *Free Radic. Biol. Med.* 61, 95–110. doi:10.1016/j.freeradbiomed.2013.03.015
- Chabi, B., Adhietty, P.J., O’Leary, M.F., Menzies, K.J., Hood, D.A., 2009. Relationship between Sirt1 expression and mitochondrial proteins during conditions of chronic muscle use and disuse. *J. Appl. Physiol. (Bethesda, MD 1985)* 107, 1730–1735. doi:10.1152/japplphysiol.91451.2008
- Chalkiadaki, A., Guarente, L., 2012. High-fat diet triggers inflammation-induced cleavage of SIRT1 in adipose tissue to promote metabolic dysfunction. *Cell Metab.* 16, 180–188. doi:10.1016/j.cmet.2012.07.003
- Chalkley, G.E., Verrijzer, C.P., 2004. Immuno-Depletion and Purification Strategies to Study Chromatin-Remodeling Factors In Vitro, in: *Methods in Enzymology*. pp. 421–442. doi:10.1016/S0076-6879(03)77028-1
- Chang, H.C., Guarente, L., 2013. SIRT1 mediates central circadian control in the SCN by a mechanism that decays with aging. *Cell* 153, 1448–1460. doi:10.1016/j.cell.2013.05.027
- Chen, B., Zang, W., Wang, J., Huang, Y., He, Y., Yan, L., Liu, J., Zheng, W., 2015. The chemical biology of sirtuins. *Chem. Soc. Rev. Chem. Soc.* 5246, 5246–5264. doi:10.1039/c4cs00373j
- Chen, D., Bruno, J., Easlson, E., Lin, S.J., Cheng, H.L., Alt, F.W., Guarente, L., 2008. Tissue-specific regulation of SIRT1 by calorie restriction. *Genes Dev.* 22, 1753–1757. doi:10.1101/gad.1650608
- Chen, R., Dioum, E.M., Hogg, R.T., Gerard, R.D., Garcia, J.A., 2011. Hypoxia increases sirtuin 1 expression in a hypoxia-inducible factor-dependent manner. *J. Biol. Chem.* 286, 13869–13878. doi:10.1074/jbc.M110.175414
- Chen, W., Guéron, M., 1992. The inhibition of bovine heart hexokinase by 2-deoxy-d-glucose-6-phosphate: characterization by <sup>31</sup>P NMR and metabolic implications. *Biochimie* 74, 867–873. doi:10.1016/0300-9084(92)90070-U
- Chen, X., Lu, Y., Zhang, Z., Wang, J., Yang, H., Liu, G., 2015. Intercellular interplay between Sirt1 signalling and cell metabolism in immune cell biology. *Immunology* 145, 455–467. doi:10.1111/imm.12473

- Chen, Y., Zhang, J., Lin, Y., Lei, Q., Guan, K.-L., Zhao, S., Xiong, Y., 2011. Tumour suppressor SIRT3 deacetylates and activates manganese superoxide dismutase to scavenge ROS. *EMBO Rep.* 12, 534–541. doi:10.1038/embor.2011.65
- Chen, Y., Zhao, W., Yang, J.S., Cheng, Z., Luo, H., Lu, Z., Tan, M., Gu, W., Zhao, Y., 2012. Quantitative acetylome analysis reveals the roles of SIRT1 in regulating diverse substrates and cellular pathways. *Mol. Cell. Proteomics* 11, 1048–1062. doi:10.1074/mcp.M112.019547
- Cheng, H.-L., Mostoslavsky, R., Saito, S., Manis, J.P., Gu, Y., Patel, P., Bronson, R., Appella, E., Alt, F.W., Chua, K.F., 2003. Developmental defects and p53 hyperacetylation in Sir2 homolog (SIRT1)-deficient mice. *Proc. Natl. Acad. Sci. U. S. A.* 100, 10794–10799. doi:10.1073/pnas.1934713100
- Chiang, M.-C., Cheng, Y.-C., Lin, K.-H., Yen, C.-H., 2013. PPAR $\gamma$  regulates the mitochondrial dysfunction in human neural stem cells with tumor necrosis factor  $\alpha$ . *Neuroscience* 229, 118–29. doi:10.1016/j.neuroscience.2012.11.003
- Chiba, S., 2006. Notch signaling in stem cell systems. *Stem Cells* 24, 2437–2447. doi:10.1634/stemcells.2005-0661
- Chini, E.N., 2009. CD38 as a regulator of cellular NAD: a novel potential pharmacological target for metabolic conditions. *Curr. Pharm. Des.* 15, 57–63. doi:10.2174/138161209787185788
- Choudhary, C., Weinert, B.T., Nishida, Y., Verdin, E., Mann, M., 2014. The growing landscape of lysine acetylation links metabolism and cell signalling. *Nat. Rev. Mol. Cell Biol.* 15, 536–550. doi:10.1038/nrm3841
- Inglés-Esteve, J., Espinosa, L., Milner, L.A., Caelles, C., Bigas, A., 2001. Phosphorylation of Ser2078 Modulates the Notch2 Function in 32D Cell Differentiation. *J. Biol. Chem.* 276, 44873–44880. doi:10.1074/jbc.M104703200
- Inoue, T., Hiratsuka, M., Osaki, M., Yamada, H., Kishimoto, I., Yamaguchi, S., Nakano, S., Katoh, M., Ito, H., Oshimura, M., 2007. SIRT2, a tubulin deacetylase, acts to block the entry to chromosome condensation in response to mitotic stress. *Oncogene* 26, 945–957. doi:10.1038/sj.onc.1209857
- Irvine, K.D., Wieschaus, E., 1994. fringe, a boundary-specific signaling molecule, mediates interactions between dorsal and ventral cells during *Drosophila* wing development. *Cell* 79, 595–606. doi:10.1016/0092-8674(94)90545-2
- Ishitani, T., Hirao, T., Suzuki, M., Isoda, M., Ishitani, S., Harigaya, K., Kitagawa, M., Matsumoto, K., Itoh, M., 2010. Nemo-like kinase suppresses Notch signalling by interfering with formation of the Notch active transcriptional complex. *Nat. Cell Biol.* 12, 278–285. doi:10.1038/ncb2028
- Iyer, S., Han, L., Bartell, S.M., Kim, H.N., Gubrij, I., De Cabo, R., O'Brien, C.A., Manolagas, S.C., Almeida, M., 2014. Sirtuin1 (Sirt1) promotes cortical bone formation by preventing  $\beta$ -catenin sequestration by FoxO transcription factors in osteoblast progenitors. *J. Biol. Chem.* 289, 24069–24078. doi:10.1074/jbc.M114.561803
- Jafar-Nejad, H., Leonardi, J., Fernandez-Valdivia, R., 2010. Role of glycans and glycosyltransferases in the regulation of Notch signaling. *Glycobiology* 20, 931–949. doi:10.1093/glycob/cwq053
- Jeon, J.Y., Kim, S.W., Park, K.C., Yun, M., 2015. The bifunctional autophagic flux by 2-deoxyglucose to control survival or growth of prostate cancer cells. *BMC Cancer* 15, 623. doi:10.1186/s12885-015-1640-z
- Jin, J., Iakova, P., Jiang, Y., Lewis, K., Sullivan, E., Jawanmardi, N., Donehower, L., Timchenko, L., Timchenko, N.A., 2013. Transcriptional and translational regulation of C/EBP $\beta$ -HDAC1 protein complexes controls different levels of p53, SIRT1, and PGC1 $\alpha$  proteins at the early and late stages of liver cancer. *J. Biol. Chem.* 288, 14451–62. doi:10.1074/jbc.M113.460840



- Jin, Q., Zhang, F., Yan, T., Liu, Z., Wang, C., Ge, X., Zhai, Q., 2010. C/EBPalpha regulates SIRT1 expression during adipogenesis. *Cell Res.* 20, 470–479. doi:10.1038/cr.2010.24
- Jin, Y.H., Kim, H., Oh, M., Ki, H., Kim, K., 2009. Regulation of Notch1/NICD and Hes1 expressions by GSK-3alpha/beta. *Mol. Cells* 27, 15–19. doi:10.1007/s10059-009-0001-7
- Jing, E., Emanuelli, B., Hirschey, M.D., Boucher, J., Lee, K.Y., Lombard, D., Verdin, E.M., Kahn, C.R., 2011. Sirtuin-3 (Sirt3) regulates skeletal muscle metabolism and insulin signaling via altered mitochondrial oxidation and reactive oxygen species production. *Proc. Natl. Acad. Sci. U. S. A.* 108, 14608–14613. doi:10.1073/pnas.1111308108
- Johnson, S.A., Zitserman, D., Roegiers, F., 2016. Numb regulates the balance between Notch recycling and late-endosome targeting in *Drosophila* neural progenitor cells. *Mol. Biol. Cell* 27, 2857–66. doi:10.1091/mbc.E15-11-0751
- Kamakaka, R.T., Kadonaga, J.T., 1994. The Soluble Nuclear Fraction, a Highly Efficient Transcription Extract from *Drosophila* Embryos, in: *Methods in Cell Biology*. pp. 225–235. doi:10.1016/S0091-679X(08)60916-4
- Kanfi, Y., Naiman, S., Amir, G., Peshti, V., Zinman, G., Nahum, L., Bar-Joseph, Z., Cohen, H.Y., 2012. The sirtuin SIRT6 regulates lifespan in male mice. *Nature* 483, 218–221. doi:10.1038/nature10815
- Kang, H., Jung, J.W., Kim, M.K., Chung, J.H., 2009. CK2 is the regulator of SIRT1 substrate-binding affinity, deacetylase activity and cellular response to DNA-damage. *PLoS One* 4, e6611. doi:10.1371/journal.pone.0006611
- Kannt, A., Sicka, K., Kroll, K., Kadereit, D., Gögelein, H., 2012. Selective inhibitors of cardiac ADPR cyclase as novel anti-arrhythmic compounds. *Naunyn-Schmiedeberg's Arch. Pharmacol.* 385, 717–727. doi:10.1007/s00210-012-0750-2
- Kao, H., Ordentlich, P., Koyano-nakagawa, N., Tang, Z., 1998. A histone deacetylase corepressor complex regulates the Notch signal transduction? pathway A histone deacetylase corepressor complex regulates the Notch signal transduction pathway. *Genes Dev.* 2, 2269–2277. doi:10.1101/gad.12.15.2269
- Kauppinen, A., Suuronen, T., Ojala, J., Kaarniranta, K., Salminen, A., 2013. Antagonistic crosstalk between NF-κB and SIRT1 in the regulation of inflammation and metabolic disorders. *Cell. Signal.* 25, 1939–1948. doi:10.1016/j.cellsig.2013.06.007
- Kawahara, T.L.A., Michishita, E., Adler, A.S., Damian, M., Berber, E., Lin, M., McCord, R.A., Ongaigui, K.C.L., Boxer, L.D., Chang, H.Y., Chua, K.F., 2009. SIRT6 Links Histone H3 Lysine 9 Deacetylation to NF-κB-Dependent Gene Expression and Organismal Life Span. *Cell* 136, 62–74. doi:10.1016/j.cell.2008.10.052
- Kidd, S., Kelley, M.R., Young, M.W., 1986. Sequence of the notch locus of *Drosophila melanogaster*: relationship of the encoded protein to mammalian clotting and growth factors. *Mol. Cell. Biol.* 6, 3094–108. doi:10.1128/MCB.6.9.3094.Updated
- Kidd, S., Lieber, T., 2002. Furin cleavage is not a requirement for *Drosophila* Notch function. *Mech. Dev.* 115, 41–51. doi:10.1016/S0925-4773(02)00120-X
- Kiernan, A.E., Cordes, R., Kopan, R., Gossler, A., Gridley, T., 2005. The Notch ligands DLL1 and JAG2 act synergistically to regulate hair cell development in the mammalian inner ear. *Development* 132, 4353–4362. doi:10.1242/dev.02002
- Kim, H.J., Kim, J.H., Noh, S., Hur, H.J., Sung, M.J., Hwang, J.T., Park, J.H., Yang, H.J., Kim, M.S., Kwon, D.Y., Yoon, S.H., 2011. Metabolomic analysis of livers and serum from high-fat diet induced obese mice. *J. Proteome Res.* 10, 722–731. doi:10.1021/pr100892r

- Kim, J.E., Chen, J., Lou, Z., 2008. DBC1 is a negative regulator of SIRT1. *Nature* 451, 583–586. doi:10.1038/nature06500
- Kim, M.-Y., Ann, E.-J., Kim, J.-Y., Mo, J.-S., Park, J.-H., Kim, S.-Y., Seo, M.-S., Park, H.-S., 2007. Tip60 histone acetyltransferase acts as a negative regulator of Notch1 signaling by means of acetylation. *Mol. Cell. Biol.* 27, 6506–19. doi:10.1128/MCB.01515-06
- Kim, M.Y., Kang, E.S., Ham, S.A., Hwang, J.S., Yoo, T.S., Lee, H., Paek, K.S., Park, C., Lee, H.T., Kim, J.H., Han, C.W., Seo, H.G., 2012. The PPAR $\delta$ -mediated inhibition of angiotensin II-induced premature senescence in human endothelial cells is SIRT1-dependent. *Biochem. Pharmacol.* 84, 1627–1634. doi:10.1016/j.bcp.2012.09.008
- Knight, J.R.P., Allison, S.J., Milner, J., 2013. Active regulator of SIRT1 is required for cancer cell survival but not for SIRT1 activity. *Open Biol.* 3, 130130. doi:10.1098/rsob.130130
- Koch-Nolte, F., Fischer, S., Haag, F., Ziegler, M., 2011. Compartmentation of NAD<sup>+</sup>-dependent signalling. *FEBS Lett.* 585, 1651–1656. doi:10.1016/j.febslet.2011.03.045
- Koch-Nolte, F., Kernstock, S., Mueller-Dieckmann, C., Weiss, M.S., Haag, F., 2008. Mammalian ADP-ribosyltransferases and ADP-ribosylhydrolases. *Front. Biosci.* 13, 6716–29. doi:10.1071/SHv11n2toc
- Koch, U., Radtke, F., 2007. Notch and cancer: A double-edged sword. *Cell. Mol. Life Sci.* 64, 2746–2762. doi:10.1007/s00018-007-7164-1
- Kopan, R., Ilagan, M.X.G., 2009. The Canonical Notch Signaling Pathway: Unfolding the Activation Mechanism. *Cell* 137, 216–233. doi:10.1016/j.cell.2009.03.045
- Kornberg, M.D., Sen, N., Hara, M.R., Juluri, K.R., Nguyen, J.V.K., Snowman, A.M., Law, L., Hester, L.D., Snyder, S.H., 2010. GAPDH mediates nitrosylation of nuclear proteins. *Nat. Cell Biol.* 12, 1094–100. doi:10.1038/ncb2114
- Krejčí, A., 2012. Metabolic sensors and their interplay with cell signalling and transcription. *Biochem. Soc. Trans.* 40, 311–323. doi:10.1042/BST20110767
- Krejčí, A., Bray, S., 2007. Notch activation stimulates transient and selective binding of Su(H)/CSL to target enhancers. *Genes Dev.* 21, 1322–1327. doi:10.1101/gad.424607
- Kurooka, H., Honjo, T., 2000. Functional interaction between the mouse Notch1 intracellular region and histone acetyltransferases PCAF and GCN5. *J. Biol. Chem.* 275, 17211–17220. doi:10.1074/jbc.M000909200
- Lai, E.C., Deblandre, G.A., Kintner, C., Rubin, G.M., 2001. Drosophila Neuralized Is a Ubiquitin Ligase that Promotes the Internalization and Degradation of Delta. *Dev. Cell* 1, 783–794. doi:10.1016/S1534-5807(01)00092-2
- Lai, E.C., Roegiers, F., Qin, X., Jan, Y.N., Rubin, G.M., 2005. The ubiquitin ligase Drosophila Mind bomb promotes Notch signaling by regulating the localization and activity of Serrate and Delta. *Development* 132, 2319–2332. doi:10.1242/dev.01825
- Lake, R.J., Grimm, L.M., Veraksa, A., Banos, A., Artavanis-Tsakonas, S., 2009. In Vivo analysis of the Notch receptor S1 cleavage. *PLoS One* 4, e6728. doi:10.1371/journal.pone.0006728
- Landor, S.K.-J., Mutvei, A.P., Mamaeva, V., Jin, S., Busk, M., Borra, R., Grönroos, T.J., Kronqvist, P., Lendahl, U., Sahlgren, C.M., 2011. Hypo- and hyperactivated Notch signaling induce a glycolytic switch through distinct mechanisms. *Proc. Natl. Acad. Sci. U. S. A.* 108, 18814–9. doi:10.1073/pnas.1104943108
- Lane, A.N., Fan, T.W.M., Higashi, R.M., 2009. Metabolic acidosis and the importance of balanced equations. *Metabolomics* 5, 163–165. doi:10.1007/s11306-008-0142-2

- Le, A., Lane, A.N., Hamaker, M., Bose, S., Gouw, A., Barbi, J., Tsukamoto, T., Rojas, C.J., Slusher, B.S., Zhang, H., Zimmerman, L.J., Liebler, D.C., Slebos, R.J.C., Lorkiewicz, P.K., Higashi, R.M., Fan, T.W.M., Dang, C. V., 2012. Glucose-independent glutamine metabolism via TCA cycling for proliferation and survival in b cells. *Cell Metab.* 15, 110–121. doi:10.1016/j.cmet.2011.12.009
- Le Borgne, R., Bardin, A., Schweisguth, F., 2005a. The roles of receptor and ligand endocytosis in regulating Notch signaling. *Development* 132, 1751–1762. doi:10.1242/dev.01789
- Le Borgne, R., Remaud, S., Hamel, S., Schweisguth, F., 2005b. Two distinct E3 ubiquitin ligases have complementary functions in the regulation of delta and serrate signaling in *Drosophila*. *PLoS Biol.* 3, 0688–0696. doi:10.1371/journal.pbio.0030096
- Le Bras, S., Loyer, N., Le Borgne, R., 2011. The Multiple Facets of Ubiquitination in the Regulation of Notch Signaling Pathway. *Traffic* 12, 149–161. doi:10.1111/j.1600-0854.2010.01126.x
- Lee, C.W., Wong, L.L.Y., Tse, E.Y.T., Liu, H.F., Leong, V.Y.L., Lee, J.M.F., Hardie, D.G., Ng, I.O.L., Ching, Y.P., 2012. AMPK promotes p53 acetylation via phosphorylation and inactivation of SIRT1 in liver cancer cells. *Cancer Res.* 72, 4394–4404. doi:10.1158/0008-5472.CAN-12-0429
- Lee, H.C., 2012. Cyclic ADP-ribose and nicotinic acid adenine dinucleotide phosphate (NAADP) as messengers for calcium mobilization. *J. Biol. Chem.* 287, 31633–31640. doi:10.1074/jbc.R112.349464
- Lee, H.J., Kim, M.Y., Park, H.S., 2015. Phosphorylation-dependent regulation of Notch1 signaling: The fulcrum of Notch1 signaling. *BMB Rep.* 48, 431–437. doi:10.5483/BMBRep.2015.48.8.107
- Lee, T. V., Sethi, M.K., Leonardi, J., Rana, N.A., Buettner, F.F.R., Haltiwanger, R.S., Bakker, H., Jafar-Nejad, H., 2013. Negative Regulation of Notch Signaling by Xylose. *PLoS Genet.* 9, e1003547. doi:10.1371/journal.pgen.1003547
- Lehmann, R., Dietrich, U., Jimenez, F., Campos-Ortega, J.A., 1981. Mutations of early neurogenesis in *Drosophila*. *Wilhelm Roux's Arch. Dev. Biol.* 190, 226–229. doi:10.1007/BF00848307
- Leonardi, J., Fernandez-Valdivia, R., Li, Y.D., Simcox, A.A., Jafar-Nejad, H., 2011. Multiple O-glucosylation sites on Notch function as a buffer against temperature-dependent loss of signaling. *Development* 138, 3569–3578. doi:10.1242/dev.068361
- Li, H., Lee, J., He, C., Zou, M.-H., Xie, Z., 2014. Suppression of the mTORC1/STAT3/Notch1 pathway by activated AMPK prevents hepatic insulin resistance induced by excess amino acids. *Am. J. Physiol. Endocrinol. Metab.* 306, E197–209. doi:10.1152/ajpendo.00202.2013
- Lin, H., Su, X., He, B., 2012. Protein lysine acylation and cysteine succination by intermediates of energy metabolism. *ACS Chem. Biol.* 7, 947–960. doi:10.1021/cb3001793
- Lin, H., Xiong, W., Zhang, X., Liu, B., Zhang, W., Zhang, Y., Cheng, J., Huang, H., 2011. Notch-1 activation-dependent p53 restoration contributes to resveratrol-induced apoptosis in glioblastoma cells. *Oncol. Rep.* 26, 925–930. doi:10.3892/or.2011.1380
- Lin, S.J., Ford, E., Haigis, M., Liszt, G., Guarente, L., 2004. Calorie restriction extends yeast life span by lowering the level of NADH. *Genes Dev.* 18, 12–16. doi:10.1101/gad.1164804
- Lin, Z., Fang, D., 2013. The Roles of SIRT1 in Cancer. *Genes Cancer* 4, 97–104. doi:10.1177/1947601912475079
- Lin, Z., Yang, H., Kong, Q., Li, J., Lee, S.M., Gao, B., Dong, H., Wei, J., Song, J.,

- Zhang, D.D., Fang, D., 2012. USP22 Antagonizes p53 Transcriptional Activation by Deubiquitinating Sirt1 to Suppress Cell Apoptosis and Is Required for Mouse Embryonic Development. *Mol. Cell* 46, 484–494. doi:10.1016/j.molcel.2012.03.024
- Liu, G., Bi, Y., Xue, L., Zhang, Y., Yang, H., Chen, X., Lu, Y., Zhang, Z., Liu, H., Wang, X., Wang, R., Chu, Y., Yang, R., 2015. Dendritic cell SIRT1-HIF1 $\alpha$  axis programs the differentiation of CD4<sup>+</sup> T cells through IL-12 and TGF- $\beta$ 1. *Proc. Natl. Acad. Sci. U. S. A.* 112, E957-65. doi:10.1073/pnas.1420419112
- Liu, X., Wang, D., Zhao, Y., Tu, B., Zheng, Z., Wang, L., Wang, H., Gu, W., Roeder, R.G., Zhu, W.-G., 2011. Methyltransferase Set7/9 regulates p53 activity by interacting with Sirtuin 1 (SIRT1). *Proc. Natl. Acad. Sci. U. S. A.* 108, 1925–1930. doi:10.1073/pnas.1019619108
- Lobry, C., Oh, P., Aifantis, I., 2011. Oncogenic and tumor suppressor functions of Notch in cancer: it's NOTCH what you think. *J. Exp. Med.* 208, 1931–1935. doi:10.1084/jem.20111855
- Logeat, F., Bessia, C., Brou, C., LeBail, O., Jarriault, S., Seidah, N.G., Israël, a, 1998. The Notch1 receptor is cleaved constitutively by a furin-like convertase. *Proc. Natl. Acad. Sci. U. S. A.* 95, 8108–8112. doi:10.1073/pnas.95.14.8108
- Lombard, D.B., Alt, F.W., Cheng, H.-L.H.-L., Bunkenborg, J., Streeper, R.S., Mostoslavsky, R., Kim, J., Yancopoulos, G., Valenzuela, D., Murphy, A., Yang, Y., Chen, Y., Hirschev, M.D., Bronson, R.T., Haigis, M., Guarente, L.P., Farese, R. V., Weissman, S., Verdin, E., Schwer, B., 2007. Mammalian Sir2 homolog SIRT3 regulates global mitochondrial lysine acetylation. *Mol. Cell. Biol.* 27, 8807–14. doi:10.1128/MCB.01636-07
- Louvi, A., Artavanis-Tsakonas, S., 2012. Notch and disease: A growing field. *Semin. Cell Dev. Biol.* 23, 473–480. doi:10.1016/j.semcdb.2012.02.005
- Lu, L., Li, L., Lv, X., Wu, X.-S., Liu, D.-P., Liang, C.-C., 2011. Modulations of hMOF autoacetylation by SIRT1 regulate hMOF recruitment and activities on the chromatin. *Cell Res.* 21, 1182–1195. doi:10.1038/cr.2011.71
- Luo, Y., Haltiwanger, R.S., 2005. O-fucosylation of notch occurs in the endoplasmic reticulum. *J. Biol. Chem.* 280, 11289–11294. doi:10.1074/jbc.M414574200
- Luther, K.B., Haltiwanger, R.S., 2009. Role of unusual O-glycans in intercellular signaling. *Int. J. Biochem. Cell Biol.* 41, 1011–1024. doi:10.1016/j.biocel.2008.10.001
- Ma, C.C. -y., Yao, M. -j. M., Zhai, Q., Jiao, J.J. -w., Yuan, X. -b. X., Poo, M., 2014. SIRT1 suppresses self-renewal of adult hippocampal neural stem cells. *Development* 141, 4697–4709. doi:10.1242/dev.117937
- Malavasi, F., Deaglio, S., Funaro, a D. a, Ferrero, E., Horenstein, A.L., Ortolan, E., Vaisitti, T., Aydin, S., 2008. Evolution and Function of the ADP Ribosyl Cyclase / CD38 Gene Family in Physiology and Pathology. *Physiol. Rev.* 88, 841–886. doi:10.1152/physrev.00035.2007.
- Martínez-Redondo, P., Vaquero, A., 2013. The diversity of histone versus nonhistone sirtuin substrates. *Genes Cancer* 4, 148–63. doi:10.1177/1947601913483767
- Masri, S., 2015. Sirtuin-dependent clock control. *Curr. Opin. Clin. Nutr. Metab. Care* 18, 1. doi:10.1097/MCO.0000000000000219
- Matsuno, K., Diederich, R.J., Go, M.J., Blaumueller, C.M., Artavanis-Tsakonas, S., 1995. Deltex acts as a positive regulator of Notch signaling through interactions with the Notch ankyrin repeats. *Development* 121, 2633–2644.
- Mazaleyrat, S.L., Fostier, M., Wilkin, M.B., Aslam, H., Evans, D.A.P., Cornell, M., Baron, M., 2003. Down-regulation of Notch target gene expression by Suppressor of deltex. *Dev. Biol.* 255, 363–372. doi:10.1016/S0012-1606(02)00086-6

- McDonel, P., Demmers, J., Tan, D.W.M., Watt, F., Hendrich, B.D., 2012. Sin3a is essential for the genome integrity and viability of pluripotent cells. *Dev. Biol.* 363, 62–73. doi:10.1016/j.ydbio.2011.12.019
- Merkey, A.B., Wong, C.K., Hoshizaki, D.K., Gibbs, A.G., 2011. Energetics of metamorphosis in *Drosophila melanogaster*. *J. Insect Physiol.* 57, 1437–1445. doi:10.1016/j.jinsphys.2011.07.013
- Metallo, C.M., Heiden, M.G. Vander, Metallo, C.M., Heiden, M.G. Vander, 2010. Metabolism strikes back: metabolic flux regulates cell signaling. *Genes Dev.* 24, 2717–2722. doi:10.1101/gad.2010510
- Michalik, L., Auwerx, J., Berger, J.P., Chatterjee, V.K., Glass, C.K., Gonzalez, F.J., Grimaldi, P.A., Kadowaki, T., Lazar, M.A., O’Rahilly, S., Palmer, C.N.A., Plutzky, J., Reddy, J.K., Spiegelman, B.M., Staels, B., Wahli, W., 2006. International Union of Pharmacology. LXI. Peroxisome proliferator-activated receptors. *Pharmacol. Rev.* 58, 726–41. doi:10.1124/pr.58.4.5
- Michishita, E., 2005. Evolutionarily Conserved and Nonconserved Cellular Localizations and Functions of Human SIRT Proteins. *Mol. Biol. Cell* 16, 4623–4635. doi:10.1091/mbc.E05-01-0033
- Milne, J., Lambert, P., Schenk, S., Carney, D., Smith, J., Gagne, D., Jin, L., Boss, O., Perni, R., Vu, C., Bemis, J., Xie, R., Disch, J., Ng, P., Nunes, J., Lynch, A., Yang, H., Galonek, H., Israelian, K., Choy, W., Iffland, A., Lavu, S., Medvedik, O., Sinclair, D., Olefsky, J., Jirousek, M., Elliott, P., Westphal, C., 2007. Small molecule activators of {SIRT1} as therapeutics for the treatment of type 2 diabetes. *Nature* 450, 712–716. doi:10.1038/nature06261
- Mo, J.-S., Kim, M.-Y., Han, S.-O., Kim, I.-S., Ann, E.-J., Lee, K.S., Seo, M.-S., Kim, J.-Y., Lee, S.-C., Park, J.-W., Choi, E.-J., Seong, J.Y., Joe, C.O., Faessler, R., Park, H.-S., 2007. Integrin-linked kinase controls Notch1 signaling by down-regulation of protein stability through Fbw7 ubiquitin ligase. *Mol. Cell. Biol.* 27, 5565–74. doi:10.1128/MCB.02372-06
- Morgan, T.H., 1917. The theory of gene. *Am. Nat.* 513–544.
- Moshkin, Y.M., Kan, T.W., Goodfellow, H., Bezstarosti, K., Maeda, R.K., Pilyugin, M., Karch, F., Bray, S.J., Demmers, J.A.A., Verrijzer, C.P., 2009. Histone Chaperones ASF1 and NAP1 Differentially Modulate Removal of Active Histone Marks by LID-RPD3 Complexes during NOTCH Silencing. *Mol. Cell* 35, 782–793. doi:10.1016/j.molcel.2009.07.020
- Mostoslavsky, R., Chua, K.F., Lombard, D.B., Pang, W.W., Fischer, M.R., Gellon, L., Liu, P., Mostoslavsky, G., Franco, S., Murphy, M.M., Mills, K.D., Patel, P., Hsu, J.T., Hong, A.L., Ford, E., Cheng, H.L., Kennedy, C., Nunez, N., Bronson, R., Frendewey, D., Auerbach, W., Valenzuela, D., Karow, M., Hottiger, M.O., Hursting, S., Barrett, J.C., Guarente, L., Mulligan, R., Demple, B., Yancopoulos, G.D., Alt, F.W., 2006. Genomic instability and aging-like phenotype in the absence of mammalian SIRT6. *Cell* 124, 315–329. doi:10.1016/j.cell.2005.11.044
- Mourikis, P., Lake, R.J., Firnhaber, C.B., DeDecker, B.S., 2010. Modifiers of notch transcriptional activity identified by genome-wide RNAi. *BMC Dev Biol* 10, 107. doi:10.1186/1471-213x-10-107
- Muley, P., Olinger, A., Tummala, H., 2015. 2-Deoxyglucose induces cell cycle arrest and apoptosis in colorectal cancer cells independent of its glycolysis inhibition. *Nutr. Cancer* 67, 514–522. doi:10.1080/01635581.2015.1002626
- Müller, R., Jenny, A., Stanley, P., 2013. The EGF Repeat-Specific O-GlcNAc-Transferase Eogt Interacts with Notch Signaling and Pyrimidine Metabolism Pathways in *Drosophila*. *PLoS One* 8, e62835.

- doi:10.1371/journal.pone.0062835
- Mulligan, P., Yang, F., Di Stefano, L., Ji, J.Y., Ouyang, J., Nishikawa, J.L., Toiber, D., Kulkarni, M., Wang, Q., Najafi-Shoushtari, S.H., Mostoslavsky, R., Gygi, S.P., Gill, G., Dyson, N.J., Näär, A.M., 2011. A SIRT1-LSD1 Corepressor Complex Regulates Notch Target Gene Expression and Development. *Mol. Cell* 42, 689–699. doi:10.1016/j.molcel.2011.04.020
- Mutvei, A.P., Fredlund, E., Lendahl, U., 2015. Frequency and distribution of Notch mutations in tumor cell lines. *BMC Cancer* 15, 311. doi:10.1186/s12885-015-1278-x
- Nakae, J., Oki, M., Cao, Y., 2008. The FoxO transcription factors and metabolic regulation. *FEBS Lett.* doi:10.1016/j.febslet.2007.11.025
- Nakagawa, T., Guarente, L., 2011. Sirtuins at a glance. *J. Cell Sci.* 124, 833–838. doi:10.1242/jcs.081067
- Nakagawa, T., Lomb, D.J., Haigis, M.C., Guarente, L., 2009. SIRT5 Deacetylates Carbamoyl Phosphate Synthetase 1 and Regulates the Urea Cycle. *Cell* 137, 560–570. doi:10.1016/j.cell.2009.02.026
- Nakahata, Y., Kaluzova, M., Grimaldi, B., Sahar, S., Hirayama, J., Chen, D., Guarente, L.P., Sassone-Corsi, P., 2008. The NAD<sup>+</sup>-Dependent Deacetylase SIRT1 Modulates CLOCK-Mediated Chromatin Remodeling and Circadian Control. *Cell* 134, 329–340. doi:10.1016/j.cell.2008.07.002
- Nam, T.-S., Choi, S.H., Rah, S.-Y., Kim, S.-Y., Jang, W., Im, M.-J., Kwon, H.J., Kim, U.-H., 2006. Discovery of a small-molecule inhibitor for kidney ADP-ribosyl cyclase: Implication for intracellular calcium signal mediated by cyclic ADP-ribose. *Exp. Mol. Med.* 38, 718–26. doi:10.1038/emm.2006.84
- Napper, A.D., Hixon, J., McDonagh, T., Keavey, K., Pons, J.F., Barker, J., Yau, W.T., Amouzegh, P., Flegg, A., Hamelin, E., Thomas, R.J., Kates, M., Jones, S., Navia, M.A., Saunders, J.O., DiStefano, P.S., Curtis, R., 2005. Discovery of indoles as potent and selective inhibitors of the deacetylase SIRT1. *J. Med. Chem.* 48, 8045–8054. doi:10.1021/jm050522v
- Nasrin, N., Kaushik, V.K., Fortier, E., Wall, D., Pearson, K.J., de Cabo, R., Bordone, L., 2009. JNK1 phosphorylates SIRT1 and promotes its enzymatic activity. *PLoS One* 4, e8414. doi:10.1371/journal.pone.0008414
- Nebreda, A.R., Porras, A., 2000. p38 MAP kinases: Beyond the stress response. *Trends Biochem. Sci.* 25, 257–260. doi:10.1016/S0968-0004(00)01595-4
- Nemoto, S., Fergusson, M.M., Finkel, T., 2004. Nutrient Availability Regulates SIRT1 Through a Forkhead-Dependent Pathway. *Science* (80-. ). 306, 2105–2108. doi:10.1126/science.1101731
- Nigg, E.A., 2001. Mitotic Kinases As Regulators of Cell Division and Its Checkpoints. *Nat Rev Mol Cell Biol* 2, 21–32.
- Nichols, J.T., Miyamoto, A., Weinmaster, G., 2007. Notch signaling - Constantly on the move. *Traffic* 8, 959–969. doi:10.1111/j.1600-0854.2007.00592.x
- Noriega, L.G., Feige, J.N., Cantó, C., Yamamoto, H., Yu, J., Herman, M.A., Matak, C., Kahn, B.B., Auwerx, J., 2011. CREB and ChREBP oppositely regulate SIRT1 expression in response to energy availability. *Nat. Publ. Gr.* 12, 1069–1076. doi:10.1038/embor.2011.151
- Ogura, M., Nakamura, Y., Tanaka, D., Zhuang, X., Fujita, Y., Obara, A., Hamasaki, A., Hosokawa, M., Inagaki, N., 2010. Overexpression of SIRT5 confirms its involvement in deacetylation and activation of carbamoyl phosphate synthetase 1, *Biochemical and Biophysical Research Communications.* doi:10.1016/j.bbrc.2010.01.081
- Okajima, T., 2007. Chaperone Activity of Protein. *Science* (80-. ). 1599, 1599–603. doi:10.1126/science.1108995

- Okajima, T., Irvine, K.D., 2002. Regulation of Notch signaling by O-linked fucose. *Cell* 111, 893–904. doi:10.1016/S0092-8674(02)01114-5
- Okajima, T., Reddy, B., Matsuda, T., Irvine, K.D., 2008. Contributions of chaperone and glycosyltransferase activities of O-fucosyltransferase 1 to Notch signaling. *BMC Biol.* 6, 1. doi:10.1186/1741-7007-6-1
- Okamura, Y., Saga, Y., 2008a. Pofut1 is required for the proper localization of the Notch receptor during mouse development. *Mech. Dev.* 125, 663–673. doi:10.1016/j.mod.2008.04.007
- Okamura, Y., Saga, Y., 2008b. Notch signaling is required for the maintenance of enteric neural crest progenitors. *Development* 135, 3555–65. doi:10.1242/dev.022319
- Okazaki, M., Iwasaki, Y., Nishiyama, M., Taguchi, T., Tsugita, M., Nakayama, S., Kambayashi, M., Hashimoto, K., Terada, Y., 2010. PPARbeta/delta regulates the human SIRT1 gene transcription via Sp1. *Endocr. J.* 57, 403–413. doi:10.1507/endocrj.K10E-004
- Oswald, F., Täuber, B., Dobner, T., Bourteele, S., Kostezka, U., Adler, G., Liptay, S., Schmid, R.M., 2001. p300 acts as a transcriptional coactivator for mammalian Notch-1. *Mol. Cell. Biol.* 21, 7761–7774. doi:10.1128/MCB.21.22.7761-7774.2001
- Pacholec, M., Bleasdale, J.E., Chrnyk, B., Cunningham, D., Flynn, D., Garofalo, R.S., Griffith, D., Griffor, M., Loulakis, P., Pabst, B., Qiu, X., Stockman, B., Thanabal, V., Varghese, A., Ward, J., Withka, J., Ahn, K., 2010. SRT1720, SRT2183, SRT1460, and resveratrol are not direct activators of SIRT1. *J. Biol. Chem.* 285, 8340–8351. doi:10.1074/jbc.M109.088682
- Pai, L.-M., Barcelo, G., Schüpbach, T., 2000. D-cbl, a Negative Regulator of the Egfr Pathway, Is Required for Dorsoventral Patterning in Drosophila Oogenesis. *Cell* 103, 51–61. doi:10.1016/S0092-8674(00)00104-5
- Pajvani, U.B., Qiang, L., Kangsamaksin, T., Kitajewski, J., Ginsberg, H.N., Accili, D., 2013. Inhibition of Notch uncouples Akt activation from hepatic lipid accumulation by decreasing mTORc1 stability. *Nat. Med.* 19, 1054–60. doi:10.1038/nm.3259
- Pajvani, U.B., Shawber, C.J., Samuel, V.T., Birkenfeld, A.L., Shulman, G.I., Kitajewski, J., Accili, D., 2011. Inhibition of Notch signaling ameliorates insulin resistance in a FoxO1-dependent manner. *Nat. Med.* 17, 961–967. doi:10.1038/nm.2378
- Palermo, R., Checquolo, S., Giovenco, a, Grazioli, P., Kumar, V., Campese, a F., Giorgi, a, Napolitano, M., Canettieri, G., Ferrara, G., Schininà, M.E., Maroder, M., Frati, L., Gulino, a, Vacca, a, Screpanti, I., 2012. Acetylation controls Notch3 stability and function in T-cell leukemia. *Oncogene* 31, 3807–3817. doi:10.1038/onc.2011.533
- Palmer, W.H., Deng, W.M., 2015. Ligand-Independent Mechanisms of Notch Activity. *Trends Cell Biol.* 25, 697–707. doi:10.1016/j.tcb.2015.07.010
- Parks, a L., Klueg, K.M., Stout, J.R., Muskavitch, M. a, 2000. Ligand endocytosis drives receptor dissociation and activation in the Notch pathway. *Development* 127, 1373–1385. doi:10.1038/ng0797-212
- Peng, L., Yuan, Z., Li, Y., Ling, H., Izumi, V., Fang, B., Fukasawa, K., Koomen, J., Chen, J., Seto, E., 2015. Ubiquitinated Sirtuin 1 (SIRT1) function is modulated during DNA damage-induced cell death and survival. *J. Biol. Chem.* 290, 8904–8912. doi:10.1074/jbc.M114.612796
- Penton, A.L., Leonard, L.D., Spinner, N.B., 2012. Notch signaling in human development and disease. *Semin. Cell Dev. Biol.* 23, 450–7. doi:10.1016/j.semcd.2012.01.010
- Perissi, V., Scafoglio, C., Zhang, J., Ohgi, K.A., Rose, D.W., Glass, C.K., Rosenfeld,

- M.G., 2008. TBL1 and TBLR1 Phosphorylation on Regulated Gene Promoters Overcomes Dual CtBP and NCoR/SMRT Transcriptional Repression Checkpoints. *Mol. Cell* 29, 755–766. doi:10.1016/j.molcel.2008.01.020
- Petes, S.J., Lis, J.T., 2012. Activator-induced spread of poly(ADP-Ribose) polymerase promotes nucleosome Loss at Hsp70. *Mol. Cell* 45, 64–74. doi:10.1016/j.molcel.2011.11.015
- Pfister, J.A., Ma, C., Morrison, B.E., Mello, S.R., 2008. Opposing effects of sirtuins on neuronal survival: SIRT1-mediated neuroprotection is independent of its deacetylase activity. *PLoS One* 3, e4090. doi:10.1371/journal.pone.0004090
- Pile, L.A., Schlag, E.M., Wassarman, D.A., 2002. The SIN3/RPD3 deacetylase complex is essential for G(2) phase cell cycle progression and regulation of SMRTER corepressor levels. *Mol. Cell. Biol.* 22, 4965–76. doi:10.1128/MCB.22.14.4965-4976.2002
- Pinchot, S.N., Jaskula-Sztul, R., Ning, L., Peters, N.R., Cook, M.R., Kunnimalaiyaan, M., Chen, H., 2011. Identification and validation of Notch pathway activating compounds through a novel high-throughput screening method. *Cancer* 117, 1386–1398. doi:10.1002/cncr.25652
- Pitsouli, C., Delidakis, C., 2005. The interplay between DSL proteins and ubiquitin ligases in Notch signaling. *Development* 132, 4041–50. doi:10.1242/dev.01979
- Popko-Scibor, A.E., Lindberg, M.J., Hansson, M.L., Holmlund, T., Wallberg, A.E., 2011. Ubiquitination of Notch1 is regulated by MAML1-mediated p300 acetylation of Notch1, *Biochemical and Biophysical Research Communications*. doi:10.1016/j.bbrc.2011.11.030
- Pougovkina, O., de Boer, V.C.J., 2016. Protein Lysine Acylation: Abundance, Dynamics and Function, in: Houtkooper, R.H. (Ed.), *Sirtuins*. Springer Netherlands, Dordrecht, pp. 41–69. doi:10.1007/978-94-024-0962-8\_3
- Poulson, D.F., 1937. Chromosomal Deficiencies and the Embryonic Development of *Drosophila Melanogaster*. *Proc. Natl. Acad. Sci. U. S. A.* 23, 133–137.
- Priess, J.R., Schnabel, H., Schnabel, R., 1987. The glp-1 locus and cellular interactions in early *C. elegans* embryos. *Cell* 51, 601–611. doi:0092-8674(87)90129-2 [pii]
- Qiang, L., Wu, T., Zhang, H.-W., Lu, N., Hu, R., Wang, Y.-J., Zhao, L., Chen, F.-H., Wang, X.-T., You, Q.-D., Guo, Q.-L., 2012. HIF-1 $\alpha$  is critical for hypoxia-mediated maintenance of glioblastoma stem cells by activating Notch signaling pathway. *Cell Death Differ.* 19, 284–294. doi:10.1038/cdd.2011.95
- Qiu, X., Brown, K., Hirschey, M.D., Verdin, E., Chen, D., 2010. Calorie restriction reduces oxidative stress by SIRT3-mediated SOD2 activation. *Cell Metab.* 12, 662–667. doi:10.1016/j.cmet.2010.11.015
- Radak, Z., Bori, Z., Koltai, E., Fatouros, I.G., Jamurtas, A.Z., Douroudos, I.I., Terzis, G., Nikolaidis, M.G., Chatzinikolaou, A., Sovatzidis, A., Kumagai, S., Naito, H., Boldogh, I., 2011. Age-dependent changes in 8-oxoguanine-DNA glycosylase activity are modulated by adaptive responses to physical exercise in human skeletal muscle. *Free Radic. Biol. Med.* 51, 417–423. doi:10.1016/j.freeradbiomed.2011.04.018
- Ranganathan, P., Vasquez-Del Carpio, R., Kaplan, F.M., Wang, H., Gupta, A., VanWye, J.D., Capobianco, A.J., 2011. Hierarchical phosphorylation within the ankyrin repeat domain defines a phosphoregulatory loop that regulates notch transcriptional activity. *J. Biol. Chem.* 286, 28844–28857. doi:10.1074/jbc.M111.243600
- Rauh, D., Fischer, F., Gertz, M., Lakshminarasimhan, M., Bergbrede, T., Aladini, F., Kambach, C., Becker, C.F.W., Zerweck, J., Schutkowski, M., Steegborn, C., 2013. An acetylome peptide microarray reveals specificities and deacetylation



- substrates for all human sirtuin isoforms. *Nat. Commun.* 4, 2327. doi:10.1038/ncomms3327
- Raynes, R., Pombier, K.M., Nguyen, K., Brunquell, J., Mendez, J.E., Westerheide, S.D., 2013. The SIRT1 Modulators AROS and DBC1 Regulate HSF1 Activity and the Heat Shock Response. *PLoS One* 8, e54364. doi:10.1371/journal.pone.0054364
- Rebay, I., Fleming, R.J., Fehon, R.G., Cherbas, L., Cherbas, P., Artavanis-Tsakonas, S., 1991. Specific EGF repeats of Notch mediate interactions with Delta and serrate: Implications for notch as a multifunctional receptor. *Cell* 67, 687–699. doi:10.1016/0092-8674(91)90064-6
- Rebeiz, M., Miller, S.W., Posakony, J.W., Adams, M.D., Celniker, S.E., Holt, R.A., Evans, C.A., Gocayne, J.D., Amanatides, P.G., Scherer, S.E., Li, P.W., Hoskins, R.A., Galle, R.F., Bailey, A.M., Posakony, J.W., Barolo, S., Posakony, J.W., Barolo, S., Carver, L.A., Posakony, J.W., Bellaiche, Y., Gho, M., Kaltschmidt, J., Brand, A., Schweisguth, F., Blochlinger, K., Bodmer, R., Jan, L.Y., Jan, Y.N., Blochlinger, K., Jan, L.Y., Jan, Y.N., Brand, A.H., Perrimon, N., Buescher, M., Yeo, S., Udolph, G., Zavortink, M., Yang, X., Tear, G., Chia, W., Calleja, M., Moreno, E., Pelaz, S., Morata, G., Castro, B., Barolo, S., Bailey, A.M., Posakony, J.W., Frankel, N., Davis, G., Vargas, D., Wang, S., Payre, F., Stern, D., Frise, E., Knoblich, J.A., Younger-Shepherd, S., Jan, L.Y., Jan, Y.N., Grimwade, B.G., Muskavitch, M.A., Welshons, W.J., Yedvobnick, B., Artavanis-Tsakonas, S., Guo, M., Jan, L.Y., Jan, Y.N., Haley, B., Hendrix, D., Trang, V., Levine, M., Hartenstein, V., Posakony, J.W., Hartenstein, V., Posakony, J.W., Hinz, U., Giebel, B., Campos-Ortega, J.A., Ho, S.N., Hunt, H.D., Horton, R.M., Pullen, J.K., Pease, L.R., Hong, J., Hendrix, D., Levine, M., Hoskins, R., Nelson, C., Berman, B., Lavery, T., George, R., Ciesiolka, L., Naeemuddin, M., Arenson, A., Durbin, J., David, R., Lai, E.C., Bodner, R., Posakony, J.W., Li, L., Zhu, Q., He, X., Sinha, S., Halfon, M., Malicki, J., Bogarad, L., Martin, M., Ruddle, F., McGinnis, W., Miller, S., Avidor-Reiss, T., Polyanovsky, A., Posakony, J., Moore, A.W., Jan, L.Y., Jan, Y.N., Moore, A., Roegiers, F., Jan, L., Jan, Y., Nellesen, D.T., Lai, E.C., Posakony, J.W., Nolo, R., Abbott, L.A., Bellen, H.J., O'Connor-Giles, K.M., Skeath, J., Posakony, J.W., Rebeiz, M., Posakony, J.W., Rebeiz, M., Reeves, N.L., Posakony, J.W., Reddy, G. V., Rodrigues, V., Reddy, G. V., Rodrigues, V., Reeves, N., Posakony, J.W., Rhyu, M.S., Jan, L.Y., Jan, Y.N., Rubin, G.M., Spradling, A.C., Schweisguth, F., Shellenbarger, D.L., Mohler, J.D., Spana, E.P., Doe, C.Q., Tun, T., Hamaguchi, Y., Matsunami, N., Furukawa, T., Honjo, T., Kawaichi, M., Tweedie, S., Ashburner, M., Falls, K., Leyland, P., Mcquilton, P., Marygold, S., Millburn, G., Osumi-Sutherland, D., Schroeder, A., Seal, R., Uemura, T., Shepherd, S., Ackerman, L., Jan, L.Y., Jan, Y.N., Wang, S., Younger-Shepherd, S., Jan, L.Y., Jan, Y.N., 2011. Notch regulates numb: integration of conditional and autonomous cell fate specification. *Development* 138, 215–25. doi:10.1242/dev.050161
- Redmond, L., Oh, S.R., Hicks, C., Weinmaster, G., Ghosh, a, 2000. Nuclear Notch1 signaling and the regulation of dendritic development. *Nat. Neurosci.* 3, 30–40. doi:10.1038/71104
- Revollo, J.R., Grimm, A.A., Imai, S.I., 2004. The NAD biosynthesis pathway mediated by nicotinamide phosphoribosyltransferase regulates Sir2 activity in mammalian cells. *J. Biol. Chem.* 279, 50754–50763. doi:10.1074/jbc.M408388200
- Revollo, J.R., Li, X., 2013. The ways and means that fine tune Sirt1 activity. *Trends Biochem. Sci.* 38, 160–167. doi:10.1016/j.tibs.2012.12.004
- Rhyu, M.S., Jan, L.Y., Jan, Y.N., 1994. Asymmetric distribution of numb protein during division of the sensory organ precursor cell confers distinct fates to daughter

- cells. *Cell* 76, 477–491. doi:10.1016/0092-8674(94)90112-0
- Rodgers, J.T., Lerin, C., Haas, W., Gygi, S.P., Spiegelman, B.M., Puigserver, P., 2005. Nutrient control of glucose homeostasis through a complex of PGC-1[alpha] and SIRT1. *Nature* 434, 113–118.
- Ronchini, C., Capobianco, J., 2000. Notch(ic)-ER chimeras display hormone-dependent transformation, nuclear accumulation, phosphorylation and CBF1 activation. *Oncogene* 19, 3914–24. doi:10.1038/sj.onc.1203719
- Rosca, M.G., Vazquez, E.J., Chen, Q., Kerner, J., Kern, T.S., Hoppel, C.L., 2012. Oxidation of fatty acids is the source of increased mitochondrial reactive oxygen species production in kidney cortical tubules in early diabetes. *Diabetes* 61, 2074–2083. doi:10.2337/db11-1437
- Rosenberg, M.I., Parkhurst, S.M., 2002. *Drosophila* Sir2 is required for heterochromatic silencing and by euchromatic Hairy/E(Spl) bHLH repressors in segmentation and sex determination. *Cell* 109, 447–458. doi:10.1016/S0092-8674(02)00732-8
- Saha, N., Liu, M., Gajan, A., Pile, L.A., 2016. Genome-wide studies reveal novel and distinct biological pathways regulated by SIN3 isoforms. *BMC Genomics* 17, 111. doi:10.1186/s12864-016-2428-5
- Saint Just Ribeiro, M., Hansson, M.L., Wallberg, A.E., 2007. A proline repeat domain in the Notch co-activator MAML1 is important for the p300-mediated acetylation of MAML1. *Biochem. J.* 404, 289–98. doi:10.1042/BJ20061900
- Saj, A., Arziman, Z., Stempfle, D., van Belle, W., Sauder, U., Horn, T., Dürrenberger, M., Paro, R., Boutros, M., Merdes, G., 2010. A combined ex vivo and in vivo RNAi screen for Notch regulators in *Drosophila* reveals an extensive Notch interaction network. *Dev. Cell* 18, 862–876. doi:10.1016/j.devcel.2010.03.013
- Sajish, M., Schimmel, P., 2015. A human tRNA synthetase is a potent PARP1-activating effector target for resveratrol. *Nature* 519, 370–3. doi:10.1038/nature14028
- Sakaidani, Y., Nomura, T., Matsuura, A., Ito, M., Suzuki, E., Murakami, K., Nadano, D., Matsuda, T., Furukawa, K., Okajima, T., 2011. O-linked-N-acetylglucosamine on extracellular protein domains mediates epithelial cell-matrix interactions. *Nat. Commun.* 2, 583. doi:10.1038/ncomms1591
- Sakata, T., Sakaguchi, H., Tsuda, L., Higashitani, A., Aigaki, T., Matsuno, K., Hayashi, S., 2004. *Drosophila* Nedd4 regulates endocytosis of Notch and suppresses its ligand-independent activation. *Curr. Biol.* 14, 2228–2236. doi:10.1016/j.cub.2004.12.028
- Salminen, A., Kaarniranta, K., Kauppinen, A., 2013. Crosstalk between oxidative stress and SIRT1: Impact on the aging process. *Int. J. Mol. Sci.* 14, 3834–3859. doi:10.3390/ijms14023834
- Sasaki, T., Maier, B., Koclega, K.D., Chruszcz, M., Gluba, W., Stukenberg, P.T., Minor, W., Scrable, H., 2008. Phosphorylation regulates SIRT1 function. *PLoS One* 3, e4020. doi:10.1371/journal.pone.0004020
- Sasamura, T., Ishikawa, H.O., Sasaki, N., Higashi, S., Kanai, M., Nakao, S., Ayukawa, T., Aigaki, T., Noda, K., Miyoshi, E., Taniguchi, N., Matsuno, K., 2007. The O-fucosyltransferase O-fut1 is an extracellular component that is essential for the constitutive endocytic trafficking of Notch in *Drosophila*. *Development* 134, 1347–1356. doi:10.1242/dev.02811
- Sasamura, T., Sasaki, N., Miyashita, F., Nakao, S., Ishikawa, H.O., Ito, M., Kitagawa, M., Harigaya, K., Spana, E., Bilder, D., Perrimon, N., Matsuno, K., 2003. neurotic, a novel maternal neurogenic gene, encodes an O-fucosyltransferase that is essential for Notch-Delta interactions. *Development* 130, 4785–4795. doi:10.1242/dev.00679

- Sassone-Corsi, P., 2012. The Cyclic AMP pathway. *Cold Spring Harb. Perspect. Biol.* 4. doi:10.1101/cshperspect.a011148
- Satoh, A., Brace, C.S., Rensing, N., Clifton, P., Wozniak, D.F., Herzog, E.D., Yamada, K.A., Imai, S., 2013. Sirt1 extends life span and delays aging in mice through the regulation of Nk2 homeobox 1 in the DMH and LH. *Cell Metab.* 18, 416–430. doi:10.1016/j.cmet.2013.07.013
- Sauve, A.A., Wolberger, C., Schramm, V.L., Boeke, J.D., 2006. The biochemistry of sirtuins. *Annu. Rev. Biochem.* 75, 435–465. doi:10.1146/annurev.biochem.74.082803.133500
- Shabalina, I., Petrovic, N., deJong, J.A., Kalinovich, A., Cannon, B., Nedergaard, J., 2013. UCP1 in Brite/Beige adipose tissue mitochondria is functionally thermogenic. *Cell Rep.* 5, 1196–1203. doi:10.1016/j.celrep.2013.10.044
- Sharma, V., Swaminathan, A., Bao, R., Pile, L.A., 2008. Drosophila SIN3 is required at multiple stages of development. *Dev Dyn* 237. doi:10.1002/dvdy.21706
- Shepherd, C., Banerjee, L., Cheung, C.W., Mansour, M.R., Jenkinson, S., Gale, R.E., Khwaja, a, 2012. PI3K/mTOR inhibition upregulates NOTCH-MYC signalling leading to an impaired cytotoxic response. *Leukemia* 27, 1–36. doi:10.1038/leu.2012.285
- Shi, S., Stahl, M., Lu, L., Stanley, P., 2005. Canonical Notch signaling is dispensable for early cell fate specifications in mammals. *Mol. Cell. Biol.* 25, 9503–8. doi:10.1128/MCB.25.21.9503-9508.2005
- Shi, S., Stanley, P., 2003. Protein O-fucosyltransferase 1 is an essential component of Notch signaling pathways. *Proc. Natl. Acad. Sci. U. S. A.* 100, 5234–9. doi:10.1073/pnas.0831126100
- Shi, T., Wang, F., Stieren, E., Tong, Q., 2005. 2005. SIRT3, a mitochondrial sirtuin deacetylase, regulates mitochondrial function and thermogenesis in brown adipocytes. *J. Biol. Chem.* 280, e13560–e13567. doi:10.1074/jbc.M414670200
- Shi, Y., Shi, Y., 2004. Metabolic enzymes and coenzymes in transcription - A direct link between metabolism and transcription? *Trends Genet.* 20, 445–452. doi:10.1016/j.tig.2004.07.004
- Shimizu, H., Woodcock, S.A., Wilkin, M.B., Trubenová, B., Monk, N.A.M., Baron, M., 2014. Compensatory flux changes within an endocytic trafficking network maintain thermal robustness of notch signaling. *Cell* 157, 1160–1174. doi:10.1016/j.cell.2014.03.050
- Shimizu, K., Chiba, S., Hosoya, N., Kumano, K., Saito, T., Kurokawa, M., Kanda, Y., Hamada, Y., Hirai, H., 2000. Binding of Delta1, Jagged1, and Jagged2 to Notch2 rapidly induces cleavage, nuclear translocation, and hyperphosphorylation of Notch2. *Mol. Cell. Biol.* 20, 6913–22. doi:10.1128/MCB.20.18.6913-6922.2000
- Shore, D., Squire, M., Nasmyth, K. a, 1984. Characterization of two genes required for the position-effect control of yeast mating-type genes. *EMBO J.* 3, 2817–2823.
- Schmidt, M.T., Smith, B.C., Jackson, M.D., Denu, J.M., 2004. Coenzyme specificity of Sir2 protein deacetylases. Implications for physiological regulation. *J. Biol. Chem.* 279, 40122–40129. doi:10.1074/jbc.M407484200
- Schreiber, V., Amé, J.C., Dollé, P., Schultz, I., Rinaldi, B., Fraulob, V., Ménissier-de Murcia, J., De Murcia, G., 2002. Poly(ADP-ribose) polymerase-2 (PARP-2) is required for efficient base excision DNA repair in association with PARP-1 and XRCC1. *J. Biol. Chem.* 277, 23028–23036. doi:10.1074/jbc.M202390200
- Schreiber, V., Dantzer, F., Ame, J.-C., de Murcia, G., 2006. Poly(ADP-ribose): novel functions for an old molecule. *Nat. Rev. Mol. Cell Biol.* 7, 517–28. doi:10.1038/nrm1963
- Schweisguth, F., 2015. Asymmetric cell division in the Drosophila bristle lineage:

- From the polarization of sensory organ precursor cells to Notch-mediated binary fate decision. *Wiley Interdiscip. Rev. Dev. Biol.* 4, 299–309. doi:10.1002/wdev.175
- Schwer, B., Bunkenborg, J., Verdin, R.O., Andersen, J.S., Verdin, E., 2006. Reversible lysine acetylation controls the activity of the mitochondrial enzyme acetyl-CoA synthetase 2. *Proc. Natl. Acad. Sci. U. S. A.* 103, 10224–10229. doi:10.1073/pnas.0603968103
- Sidorova-Darmos, E., Wither, R.G., Shulyakova, N., Fisher, C., Ratnam, M., Aarts, M., Lilge, L., Monnier, P.P., Eubanks, J.H., 2014. Differential expression of sirtuin family members in the developing, adult, and aged rat brain. *Front. Aging Neurosci.* 6, 333. doi:10.3389/fnagi.2014.00333
- Simons, A.L., Orcutt, K.P., Madsen, J.M., Scarbrough, P.M., Spitz, D.R., 2012. The role of Akt pathway signaling in glucose metabolism and metabolic oxidative stress, in: Spitz, D.R., Dornfeld, K.J., Krishnan, K., Gius, D. (Eds.), *Oxidative Stress in Cancer Biology and Therapy*. Humana Press, Totowa, NJ, pp. 21–46. doi:10.1007/978-1-61779-397-4
- Sisson, J., 2000. Culturing large populations of *Drosophila* for protein biochemistry. *Drosoph. Protoc.* 2007, 541–551. doi:10.1101/pdb.top4
- Sjöqvist, M., Antfolk, D., Ferraris, S., Rraklli, V., Haga, C., Antila, C., Mutvei, A., Imanishi, S.Y., Holmberg, J., Jin, S., Eriksson, J.E., Lendahl, U., Sahlgren, C., 2014. PKC $\zeta$  regulates Notch receptor routing and activity in a Notch signaling-dependent manner. *Cell Res.* 24, 433–50. doi:10.1038/cr.2014.34
- Slaninova, V., Krafcikova, M., Perez-gomez, R., Steffal, P., Trantirek, L., Bray, S.J., Krejci, A., Krejci, A., 2016. Notch stimulates growth by direct regulation of genes involved in the control of glycolysis and the tricarboxylic acid cycle. *Open Biol* 6. doi:10.1098/rsob.150155
- Smith, B.C., Hallows, W.C., Denu, J.M., 2009. A continuous microplate assay for sirtuins and nicotinamide-producing enzymes. *Anal. Biochem.* 394, 101–109. doi:10.1016/j.ab.2009.07.019
- Smith, S., Giriat, I., Schmitt, A., de Lange, T., 1998. Tankyrase, a poly (ADP-ribose) polymerase at human telomeres. *Science* (80-. ). 282, 1484–1487. doi:10.1126/science.282.5393.1484
- Song, J., Park, S., Kim, M., Shin, I., 2008. Down-regulation of Notch-dependent transcription by Akt in vitro. *FEBS Lett.* 582, 1693–1699. doi:10.1016/j.febslet.2008.04.024
- Spain, M.M., Caruso, J.A., Swaminathan, A., Pile, L.A., 2010. *Drosophila* SIN3 isoforms interact with distinct proteins and have unique biological functions. *J. Biol. Chem.* 285, 27457–27467. doi:10.1074/jbc.M110.130245
- Spencer, R.L., Preiss, J., 1967. Biosynthesis of Diphosphopyridine Nucleotide. *J. Biol. Chem.* 242, 385–392.
- Stahl, M., Uemura, K., Ge, C., Shi, S., Tashima, Y., Stanley, P., 2008. Roles of Pofut1 and O-fucose in mammalian Notch signaling. *J. Biol. Chem.* 283, 13638–13651. doi:10.1074/jbc.M802027200
- Stankovic-Valentin, N., Deltour, S., Seeler, J., Pinte, S., Vergoten, G., Guérardel, C., Dejean, A., Leprince, D., 2007. An acetylation/deacetylation-SUMOylation switch through a phylogenetically conserved psiKXEP motif in the tumor suppressor HIC1 regulates transcriptional repression activity. *Mol. Cell. Biol.* 27, 2661–75. doi:10.1128/MCB.01098-06
- Stanley, P., 2007. Regulation of Notch signaling by glycosylation. *Curr. Opin. Struct. Biol.* 17, 530–535. doi:10.1016/j.sbi.2007.09.007
- Stanley, P., Okajima, T., 2010. Roles of glycosylation in notch signaling, in: *Current Topics in Developmental Biology*. pp. 131–164. doi:10.1016/S0070-

2153(10)92004-8

- Suchankova, G., Nelson, L.E., Gerhart-Hines, Z., Kelly, M., Gauthier, M.S., Saha, A.K., Ido, Y., Puigserver, P., Ruderman, N.B., 2009. Concurrent regulation of AMP-activated protein kinase and SIRT1 in mammalian cells. *Biochem. Biophys. Res. Commun.* 378, 836–841. doi:10.1016/j.bbrc.2008.11.130
- Swaminathan, A., Pile, L.A., 2010. Regulation of cell proliferation and wing development by *Drosophila* SIN3 and String. *Mech. Dev.* 127, 96–106. doi:10.1016/j.mod.2009.10.003
- Tanno, M., Sakamoto, J., Miura, T., Shimamoto, K., Horio, Y., 2007. Nucleocytoplasmic shuttling of the NAD<sup>+</sup>-dependent histone deacetylase SIRT1. *J. Biol. Chem.* 282, 6823–6832. doi:10.1074/jbc.M609554200
- Tao, R., Coleman, M.C., Pennington, J.D., Ozden, O., Park, S.H., Jiang, H., Kim, H.S., Flynn, C.R., Hill, S., McDonald, W.H., Olivier, A.K., Spitz, D.R., Gius, D., 2010. Sirt3-Mediated Deacetylation of Evolutionarily Conserved Lysine 122 Regulates MnSOD Activity in Response to Stress. *Mol. Cell* 40, 893–904. doi:10.1016/j.molcel.2010.12.013
- Tao, R., Gong, J., Luo, X., Zang, M., Guo, W., Wen, R., Luo, Z., 2010. AMPK exerts dual regulatory effects on the PI3K pathway. *J. Mol. Signal.* 5, 1. doi:10.1186/1750-2187-5-1
- Tiberi, L., van den Ameele, J., Dimidschstein, J., Piccirilli, J., Gall, D., Herpoel, A., Bilheu, A., Bonnefont, J., Iacovino, M., Kyba, M., Bouschet, T., Vanderhaeghen, P., 2012. BCL6 controls neurogenesis through Sirt1-dependent epigenetic repression of selective Notch targets. *Nat. Neurosci.* 15, 1627–35. doi:10.1038/nn.3264
- Truong, M., Cook, M.R., Pinchot, S.N., Kunnimalaiyaan, M., Chen, H., 2011. Resveratrol induces Notch2-mediated apoptosis and suppression of neuroendocrine markers in medullary thyroid cancer. *Ann. Surg. Oncol.* 18, 1506–1511. doi:10.1245/s10434-010-1488-z
- Tsao, P.N., Vasconcelos, M., Izvolsky, K.I., Qian, J., Lu, J., Cardoso, W. V., 2009. Notch signaling controls the balance of ciliated and secretory cell fates in developing airways. *Development* 136, 2297–2307. doi:10.1242/dev.034884
- Uhlen, M., Fagerberg, L., Hallstrom, B.M., Lindskog, C., Oksvold, P., Mardinoglu, A., Sivertsson, A., Kampf, C., Sjostedt, E., Asplund, A., Olsson, I., Edlund, K., Lundberg, E., Navani, S., Szigartyo, C.A.-K., Odeberg, J., Djureinovic, D., Takanen, J.O., Hober, S., Alm, T., Edqvist, P.-H., Berling, H., Tegel, H., Mulder, J., Rockberg, J., Nilsson, P., Schwenk, J.M., Hamsten, M., von Feilitzen, K., Forsberg, M., Persson, L., Johansson, F., Zwahlen, M., von Heijne, G., Nielsen, J., Ponten, F., 2015. Tissue-based map of the human proteome. *Science* (80-. ). 347, 1260419–1260419. doi:10.1126/science.1260419
- Vakhrusheva, O., Smolka, C., Gajawada, P., Kostin, S., Boettger, T., Kubin, T., Braun, T., Bober, E., 2008. Sirt7 increases stress resistance of cardiomyocytes and prevents apoptosis and inflammatory cardiomyopathy in mice. *Circ. Res.* 102, 703–710. doi:10.1161/CIRCRESAHA.107.164558
- Van Meter, M., Mao, Z., Gorbunova, V., Seluanov, A., 2011. Repairing split ends: SIRT6, mono-ADP ribosylation and DNA repair. *Aging (Albany. NY)*. 3, 829–835. doi:100389 [pii]
- Vaquero, A., Scher, M.B., Dong, H.L., Sutton, A., Cheng, H.L., Alt, F.W., Serrano, L., Sternglanz, R., Reinberg, D., 2006. SirT2 is a histone deacetylase with preference for histone H4 Lys 16 during mitosis. *Genes Dev.* 20, 1256–1261. doi:10.1101/gad.1412706
- Volodina, I.L., Shtil, A.A., 2012. Casein kinase 2, the versatile regulator of cell survival. *Mol Biol* 46, 423–433. doi:10.1134/S0026893312020203

- Wang, C., Chen, L., Hou, X., Li, Z., Kabra, N., Ma, Y., Nemoto, S., Finkel, T., Gu, W., Cress, W.D., Chen, J., 2006. Interactions between E2F1 and SirT1 regulate apoptotic response to DNA damage. *Nat. Cell Biol.* 8, 1025–1031. doi:10.1038/ncb1468
- Wang, K., Zhang, Q., Li, D., Ching, K., Zhang, C., Zheng, X., Ozeck, M., Shi, S., Li, X., Wang, H., Rejto, P., Christensen, J., Olson, P., 2015. PEST domain mutations in Notch receptors comprise an oncogenic driver segment in triple-negative breast cancer sensitive to a  $\gamma$ -secretase inhibitor. *Clin. Cancer Res.* 21, 1487–1496. doi:10.1158/1078-0432.CCR-14-1348
- Wang, Y., Chen, Z., Bergmann, A., 2010. Regulation of EGFR and Notch signaling by distinct isoforms of D-cbl during *Drosophila* development. *Dev. Biol.* 342, 1–10. doi:10.1016/j.ydbio.2010.03.005
- Wang, Y., Xu, C., Liang, Y., Vanhoutte, P.M., 2012. SIRT1 in metabolic syndrome: Where to target matters. *Pharmacol. Ther.* 136, 305–318. doi:10.1016/j.pharmthera.2012.08.009
- Wei, H., Yu, X., 2016. Functions of PARylation in DNA Damage Repair Pathways. *Genomics. Proteomics Bioinformatics* 14, 131–139. doi:10.1016/j.gpb.2016.05.001
- Wen, Y.C., Wang, D.H., RayWhay, C.Y., Luo, J., Gu, W., Baylin, S.B., 2005. Tumor suppressor HIC1 directly regulates SIRT1 to modulate p53-dependent DNA-damage responses. *Cell* 123, 437–448. doi:10.1016/j.cell.2005.08.011
- Wesley, C.S., Saez, L., 2000. Analysis of Notch lacking the carboxyl terminus identified in *Drosophila* embryos. *J. Cell Biol.* 149, 683–696. doi:10.1083/jcb.149.3.683
- Wharton, K.A., Johansen, K.M., Xu, T., Artavanis-Tsakonas, S., 1985. Nucleotide sequence from the neurogenic locus Notch implies a gene product that shares homology with proteins containing EGF-like repeats. *Cell* 43, 567–581. doi:10.1016/0092-8674(85)90229-6
- Wick, A.N., Drury, D.R., Nakada, H.I., Wolfe, J.B., 1957. Localization of the primary metabolic block produced by 2-deoxyglucose. *J. Biol. Chem.* 224, 963–969. doi:10.1126/science.1321497
- Wilkin, M., Tongngok, P., Gensch, N., Clemence, S., Motoki, M., Yamada, K., Hori, K., Taniguchi-Kanai, M., Franklin, E., Matsuno, K., Baron, M., 2008. *Drosophila* HOPS and AP-3 Complex Genes Are Required for a Deltex-Regulated Activation of Notch in the Endosomal Trafficking Pathway. *Dev. Cell* 15, 762–772. doi:10.1016/j.devcel.2008.09.002
- Wilkin, M.B., Carbery, A.M., Fostier, M., Aslam, H., Mazaleyrat, S.L., Higgs, J., Myat, A., Evans, D.A.P., Cornell, M., Baron, M., 2004. Regulation of Notch endosomal sorting and signaling by *Drosophila* Nedd4 family proteins. *Curr. Biol.* 14, 2237–2244. doi:10.1016/j.cub.2004.11.030
- Williamson, D.H., Lund, P., Krebs, H. a, 1967. The redox state of free nicotinamide-adenine dinucleotide in the cytoplasm and mitochondria of rat liver. *Biochem. J.* 103, 514–527. doi:10.1042/bj1030514
- Wilm, M., Shevchenko, A., Houthaeve, T., Breit, S., Schweigerer, L., Fotsis, T., Mann, M., 1996. Femtomole sequencing of proteins from polyacrylamide gels by nano-electrospray mass spectrometry. *Nature* 379, 466–9. doi:10.1038/379466a0
- Wolpert, L., 1997. *Principles of Development*. Oxford University Press.
- Wu, G., Lyapina, S., Das, I., Li, J., Gurney, M., Pauley, A., Chui, I., Deshaies, R.J., Kitajewski, J., 2001. SEL-10 is an inhibitor of notch signaling that targets notch for ubiquitin-mediated protein degradation. *Mol Cell Biol* 21, 7403–7415. doi:10.1128/MCB.21.21.7403-7415.2001
- Wu, Y., Sarkissyan, M., Mcghee, E., Lee, S., Vadgama, J. V., 2015. Combined

- inhibition of glycolysis and AMPK induces synergistic breast cancer cell killing. *Breast Cancer Res. Treat.* 151, 529–539. doi:10.1007/s10549-015-3386-3
- Xie, M., Liu, M., He, C.S., 2012. SIRT1 Regulates Endothelial Notch Signaling in Lung Cancer. *PLoS One* 7, e45331. doi:10.1371/journal.pone.0045331
- Xiong, S., Salazar, G., Patrushev, N., Alexander, R.W., 2011. FoxO1 mediates an autofeedback loop regulating SIRT1 expression. *J. Biol. Chem.* 286, 5289–5299. doi:10.1074/jbc.M110.163667
- Xu, A., Haines, N., Dlugosz, M., Rana, N.A., Takeuchi, H., Haltiwanger, R.S., Irvine, K.D., 2007. In vitro reconstitution of the modulation of Drosophila Notch-ligand binding by fringe. *J. Biol. Chem.* 282, 35153–35162. doi:10.1074/jbc.M707040200
- Xu, J., Chi, F., Guo, T., Punj, V., Paul Lee, W.N., French, S.W., Tsukamoto, H., 2015. NOTCH reprograms mitochondrial metabolism for proinflammatory macrophage activation. *J. Clin. Invest.* 125, 1579–1590. doi:10.1172/JCI76468
- Yamada, K., Fuwa, T.J., Ayukawa, T., Tanaka, T., Nakamura, A., Wilkin, M.B., Baron, M., Matsuno, K., 2011. Roles of Drosophila Deltex in Notch receptor endocytic trafficking and activation. *Genes to Cells* 16, 261–272. doi:10.1111/j.1365-2443.2011.01488.x
- Yamagata, K., Kitabayashi, I., 2009. Sirt1 physically interacts with Tip60 and negatively regulates Tip60-mediated acetylation of H2AX, *Biochemical and Biophysical Research Communications.* doi:10.1016/j.bbrc.2009.10.156
- Yamakuchi, M., 2012. MicroRNA Regulation of SIRT1. *Front. Physiol.* 3, 68. doi:10.3389/fphys.2012.00068
- Yamakuchi, M., Ferlito, M., Lowenstein, C.J., 2008. miR-34a repression of SIRT1 regulates apoptosis. *Proc. Natl. Acad. Sci.* 105, 13421–13426. doi:10.1073/pnas.0801613105
- Yamamoto, S., Schulze, K.L., Bellen, H.J., 2014. Introduction to Notch signaling, in: *Methods in Molecular Biology (Clifton, N.J.)*. pp. 1–14. doi:10.1007/978-1-4939-1139-4\_1
- Yang, H., Bi, Y., Xue, L., Wang, J., Lu, Y., Zhang, Z., Chen, X., Chu, Y., Yang, R., Wang, R., Liu, G., 2015. Multifaceted Modulation of SIRT1 in Cancer and Inflammation. *Crit. Rev. Oncog.* 20, 49–64. doi:10.1615/CritRevOncog.2014012374
- Yang, H., Yan, B., Liao, D., Huang, S., Qiu, Y., 2015. Acetylation of HDAC1 and degradation of SIRT1 form a positive feedback loop to regulate p53 acetylation during heat-shock stress. *Cell Death Dis.* 6, e1747. doi:10.1038/cddis.2015.106
- Yang, H., Yang, T., Baur, J.A., Perez, E., Matsui, T., Carmona, J.J., Lamming, D.W.W., Souza-Pinto, N.C., Bohr, V.A., Rosenzweig, A., de Cabo, R., Sauve, A.A.A., Sinclair, D.A., 2007. Nutrient-Sensitive Mitochondrial NAD<sup>+</sup> Levels Dictate Cell Survival. *Cell* 130, 1095–1107. doi:10.1016/j.cell.2007.07.035
- Yang, Y., Fu, W., Chen, J., Olashaw, N., Zhang, X., Nicosia, S. V., Bhalla, K., Bai, W., 2007. SIRT1 sumoylation regulates its deacetylase activity and cellular response to genotoxic stress. *Nat. Cell Biol.* 9, 1253–62. doi:10.1038/ncb1645
- Yeh, E., Zhou, L., Rudzik, N., Boulianne, G.L., Basler, K., Hafen, E., Bellen, H., O’Kane, C., Wilson, C., Grossniklaus, U., Pearson, R., Gehring, W., Boulianne, G., Concha, A. de la, Campos-Ortega, J., Jan, L., Jan, Y., Brand, A., Perrimon, N., Brand, M., Campos-Ortega, J., Carthew, R., Rubin, G., Concha, A. de la, Dietrich, U., Weigel, D., Campos-Ortega, J., Dietrich, U., Campos-Ortega, J., Dubreuil, R., Maddux, P., Grushko, T., MacVicar, G., Garcia-Bellido, A., Gho, M., Bellaiche, Y., Schweisguth, F., Ghysen, A., O’Kane, C., Ghysen, A., Dambly-Chaudière, C., Jan, L., Jan, Y., Golic, K., Lindquist, S., Gustafson, K., Boulianne, G., Hartenstein, V., Posakony, J., Hartenstein, V., Posakony, J., Heitzler, P.,

- Simpson, P., Hendzel, M., Wei, Y., Mancini, M., Hooser, A. Van, Ranalli, T., Brinkley, B., Bazett-Jones, D., Allis, C., Hinz, U., Giebel, B., Campos-Ortega, J., Huang, F., Dambly-Chaudiere, C., Ghysen, A., Joazeiro, C., Wing, S., Huang, H., Levenson, J., Hunter, T., Liu, Y., Lee, J., Brandin, E., Branton, D., Goldstein, L., Lehmann, R., Jiménez, F., Dietrich, U., Campos-Ortega, J., Nakamura, H., Parks, A., Muskavitch, M., Posakony, J., Price, B., Chang, Z., Smith, R., Bockheim, S., Laughon, A., Ruohola-Baker, H., Jan, L., Jan, Y., Schneider, I., Simpson, P., Singson, A., Leviten, M., Bang, A., Hua, X., Posakony, J., Wilson, R., Xu, T., Rubin, G., 2000. Neuralized functions cell autonomously to regulate *Drosophila* sense organ development. *EMBO J.* 19, 4827–37. doi:10.1093/emboj/19.17.4827
- Yeung, F., Hoberg, J.E., Ramsey, C.S., Keller, M.D., Jones, D.R., Frye, R.A., Mayo, M.W., 2004. Modulation of NF- $\kappa$ B-dependent transcription and cell survival by the SIRT1 deacetylase. *EMBO J.* 23, 2369–80. doi:10.1038/sj.emboj.7600244
- Yoshino, J., Mills, K.F., Yoon, M.J., Imai, S.I., 2011. Nicotinamide mononucleotide, a key NAD<sup>+</sup> intermediate, treats the pathophysiology of diet- and age-induced diabetes in mice. *Cell Metab.* 14, 528–536. doi:10.1016/j.cmet.2011.08.014
- Yu, X.-M., Jaskula-Sztul, R., Ahmed, K., Harrison, A.D., Kunnimalaiyaan, M., Chen, H., 2013. Resveratrol induces differentiation markers expression in anaplastic thyroid carcinoma via activation of Notch1 signaling and suppresses cell growth. *Mol. Cancer Ther.* 12, 1276–87. doi:10.1158/1535-7163.MCT-12-0841
- Zechner, R., Strauss, J.G., Haemmerle, G., Lass, A., Zimmermann, R., 2005. Lipolysis: pathway under construction. *Curr. Opin. Lipidol.* 16, 333–340. doi:10.1097/01.mol.0000169354.20395.1c
- Zhang, Q., Wang, S.Y., Fleuriet, C., Leprince, D., Rocheleau, J. V, Piston, D.W., Goodman, R.H., 2007. Metabolic regulation of SIRT1 transcription via a HIC1:CtBP corepressor complex. *Proc Natl Acad Sci U S A* 104, 829–833. doi:10.1073/pnas.0610590104
- Zhang, T., Berrocal, J.G., Frizzell, K.M., Gamble, M.J., DuMond, M.E., Krishnakumar, R., Yang, T., Sauve, A.A., Kraus, W.L., 2009. Enzymes in the NAD(+) Salvage Pathway Regulate SIRT1 Activity at Target Gene Promoters. *J. Biol. Chem.* 284, 20408–20417. doi:10.1074/jbc.M109.016469
- Zhao, X., Allison, D., Condon, B., Zhang, F., Gheyi, T., Zhang, A., Ashok, S., Russell, M., MacEwan, I., Qian, Y., Jamison, J.A., Luz, J.G., 2013. The 2.5 Å crystal structure of the SIRT1 catalytic domain bound to nicotinamide adenine dinucleotide (NAD<sup>+</sup>) and an indole (EX527 analogue) reveals a novel mechanism of histone deacetylase inhibition. *J. Med. Chem.* 56, 963–969. doi:10.1021/jm301431y
- Zhao, Y.J., Lam, C.M.C., Lee, H.C., 2012. The membrane-bound enzyme CD38 exists in two opposing orientations. *Sci. Signal.* 5, ra67. doi:10.1126/scisignal.2002700
- Zhong, D., Xiong, L., Liu, T., Liu, X., Liu, X., Chen, J., Sun, S.-Y., Khuri, F.R., Zong, Y., Zhou, Q., Zhou, W., 2009. The Glycolytic Inhibitor 2-Deoxyglucose Activates Multiple Prosurvival Pathways through IGF1R. *J. Biol. Chem.* 284, 23225–23233. doi:10.1074/jbc.M109.005280
- Zhong, L., D'Urso, A., Toiber, D., Sebastian, C., Henry, R.E., Vadysirisack, D.D., Guimaraes, A., Marinelli, B., Wikstrom, J.D., Nir, T., Clish, C.B., Vaitheesvaran, B., Iliopoulos, O., Kurland, I., Dor, Y., Weissleder, R., Shirihai, O.S., Ellisen, L.W., Espinosa, J.M., Mostoslavsky, R., 2010. The Histone Deacetylase Sirt6 Regulates Glucose Homeostasis via Hif1 $\alpha$ . *Cell* 140, 280–293. doi:10.1016/j.cell.2009.12.041
- Zhou, D., Xue, J., Lai, J.C.K., Schork, N.J., White, K.P., Haddad, G.G., 2008.



Mechanisms Underlying Hypoxia Tolerance in *Drosophila melanogaster*: hairy as a Metabolic Switch. PLoS Genet. 4, e1000221. doi:10.1371/journal.pgen.1000221

Zhou, Y., Atkins, J.B., Rompani, S.B., Bancescu, D.L., Petersen, P.H., Tang, H., Zou, K., Stewart, S.B., Zhong, W., 2007. The Mammalian Golgi Regulates Numb Signaling in Asymmetric Cell Division by Releasing ACBD3 during Mitosis. *Cell* 129, 163–178. doi:10.1016/j.cell.2007.02.037

Zhu, C.-T., Rand, D.M., 2012. A Hydrazine Coupled Cycling Assay Validates the Decrease in Redox Ratio under Starvation in *Drosophila*. *PLoS One* 7, e47584.

## 7.0 Supplement

**Supp.1:** Sequences of all used primers.

<b>name of primer</b>	<b>primer sequence (5' → 3')</b>
<b>Sirt1 deletion</b>	
Sirt1-C1	CCAAATGGGTGCGAAGCTGACG
Sirt1-C2	GGCCCTCGGCTACGATTTTCGCAG
<b>Sirt1 RNAi</b>	
Sirt1-RNAi F	GAATTAATACGACTCACTATAGGGAGAATTACGAGGAAATTCGCCTG
Sirt1_RNAi R	GAATTAATACGACTCACTATAGGGAGACCGTTAGCACAAATGATCTTC
<b>House keeping gene</b>	
CG16941 S	CCACAAGGTTAAGGGACTG
CG16941 A	AGTGACTGTGCTGCGACTTG
<b>E(Spl) genes ORF</b>	
M2 anti	TTCAGTGATGGGATGAGGTG
M2 sense	CACCCACATTGATTAGCAGC
M3 real anti	CGTCTGCAGCTCAATTAGTC
M3 real sense	AGCCACCCACCTCAACCAG
M4 anti	CCAGAAGAATGTGCCGTGAG
M4 sense	TGTGCCAGAACAAGATCAAC
M5 anti new	GTGGAAGACAGGATTCAATG
M5 sense new	TCAGCGAGATCTCCCCTGTG
M6 sense	GTAAAGAACTTATTGGCCAAAATG
M6 anti	CTGCGAGTGCCAGTAGAAGC
M7 sense	CGTTGCTCAGACTGGCGATG
m7.6	ATCAGTGTGGTTCCAAAAGC
m8 down s	AACTCGATGGACTGCTCCTC
m8 down a	CCTGCCACTTAACCCCTTG
alpha real s	GCAGGAGGACGAGGAGGATG
alpha real a	GATCCTGGAATTGCATGGAG
Mbeta real anti	AGAAGTGAGCAGCAGCCATC
Mbeta reak sense	GCTGGACTTGAAACCGCACC
M_gamma anti	TAGGTGGGAGTCGACTGGTG
M_gamma sense	CTCCCGTTCCTCTCCCAGC
M_delta sense	AGGATCTCATCGTGGACACC
M_delta anti	CAGACTTCTTCGCCATGATG

**Supp. 2:** The list of all used antibodies.

<b>Name</b>	<b>Antigen</b>	<b>dilution</b>	<b>host</b>	<b>Clonality</b>	<b>Catalog No.</b>	<b>Supplier</b>
p4A10	Sirt1	1:100	mouse	monoclonal	AB_1553778	DSHB
p2E2	Sirt1	1:100	mouse	monoclonal	AB_1553776	DSHB
d300	Sirt1	1:200	rabbit	polyclonal	SC-98262	SCBT
$\alpha$ -Su(H)	Su(H)	1:200	goat	polyclonal	sc-15813	SCBT
$\alpha$ -His-HRP	6x C-term His tag	1:5000	mouse	monoclonal	R931-25	TFS
$\alpha$ -Cut	Cut	1:20	mouse	monoclonal	AB_528186	DSHB
$\alpha$ -senseless	senseless	1:2000	guinea pig	polyclonal	custom made	Bray lab
$\alpha$ -GFP	GFP	1:500	rabbit	monoclonal	G10362	TFS
$\alpha$ -pan AcK	acetylated BSA	1:500	rabbit	polyclonal	PTM-105	PTM Biolabs
$\alpha$ -kis	kissmet-L	1:100	rabbit	polyclonal	custom made	Verrijzer lab
$\alpha$ -Nap1	Nap1	1:100	rabbit	polyclonal	custom made	Verrijzer lab
Alexa Fluor 488	guinea pig IgG	1:500	goat	polyclonal	A-11073	TFS
Alexa Fluor 555	mouse IgG	1:500	goat	polyclonal	A-21424	TFS
Anti-Rabbit-HRP	rabbit IgG	1:5000	donkey	polyclonal	711-035-152	JIR

**SCBT=** Santa Cruz Biotechnology

**DSHB=** Developmental Studies Hybridoma Bank

**TFS=** ThermoFisher Scientific

**JIR=** Jackson ImmunoResearch

**Supp. 3:** The list of used chemicals and kits.

<b>Name</b>	<b>Catalog No.</b>	<b>Supplier</b>
<b>Drugs</b>		
Ex527	E7034	Sigma-Aldrich
Sirtinol	S7942	Sigma-Aldrich
SRT1720	S1129	Selleckchem
Resveratrol	R5010	Sigma-Aldrich
Methotrexate	M8407	Sigma-Aldrich
2-deoxy-D-glucose	D8375	Sigma-Aldrich
<b>Cell culture media</b>		
Schneider's Drosophila Medium	21720024	TFS
Express Five® SFM	10486025	TFS
TNM-FH insect medium	T1032	Sigma-Aldrich
Opti-MEM® I Reduced Serum Medium	31985070	TFS
<b>Kits</b>		
T7 RiboMAX™ Express Large Scale RNA Production System	P1320	Promega
TURBO DNA-free™ Kit	AM1907	TFS
M-MLV Reverse Transcriptase	M1302	Sigma-Aldrich
GoTaq® qPCR Master Mix	A6002	Promega
Dual Luciferase Reporter Assay system	E1910	Promega
Bac-to-Bac® C-His TOPO® Cloning Kit	A11098	TFS
<b>Others</b>		
Copper sulfate	C8027	Sigma-Aldrich
Penicillin-Streptomycin	P4333	Sigma-Aldrich
TRI Reagent®	T9424	Sigma-Aldrich
Benzonase® Nuclease	E1014	Sigma-Aldrich
cOmplete™, EDTA-free Protease Inhibitor Cocktail	11873580001	Roche
FuGENE® 6 Transfection Reagent	E2691	Promega
HisPur™ Ni-NTA Superflow Agarose	25214	TFS
pRL-TK Renilla Luciferase Control Reporter Vector	E2241	Promega
Clarity™ Western ECL Blotting Substrate	1705061	Biorad
CitiFluor™ AF1, Mounting Medium	CT17970-25	CitiFluor
Fetal Bovine Serum	F7524	Sigma-Aldrich

**TFS=** ThermoFisher Scientific

**Supp. 4** (next page): Effect of Sirt1 deficiency on the expression of Notch reporters in 3<sup>rd</sup> instar wing imaginal discs, using MARCM clones. GFP positive cells (green) are homozygous for Sirt1<sup>2A711</sup> allele while the rest of the cells contains are heterozygous for Sirt1. Notch reporters are stained in red.

**mβ.LacZ**

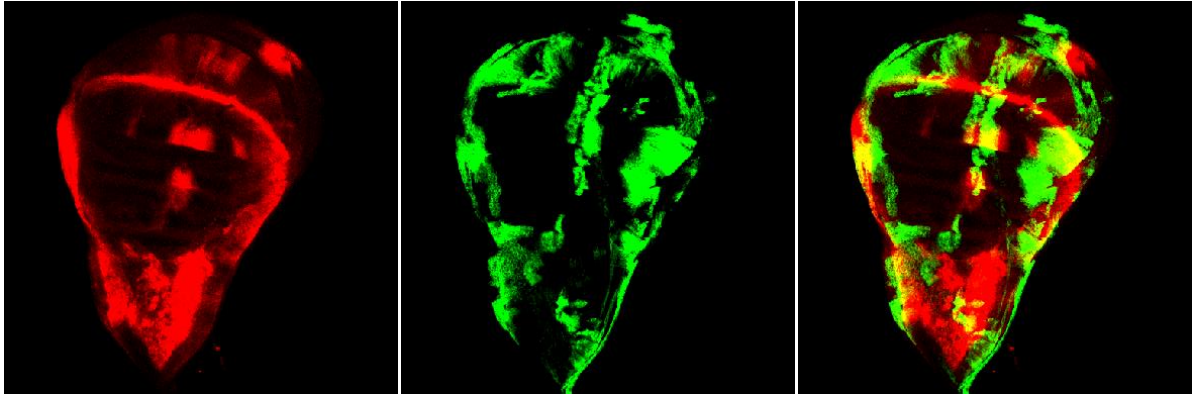

**Gbe.Su(H)**

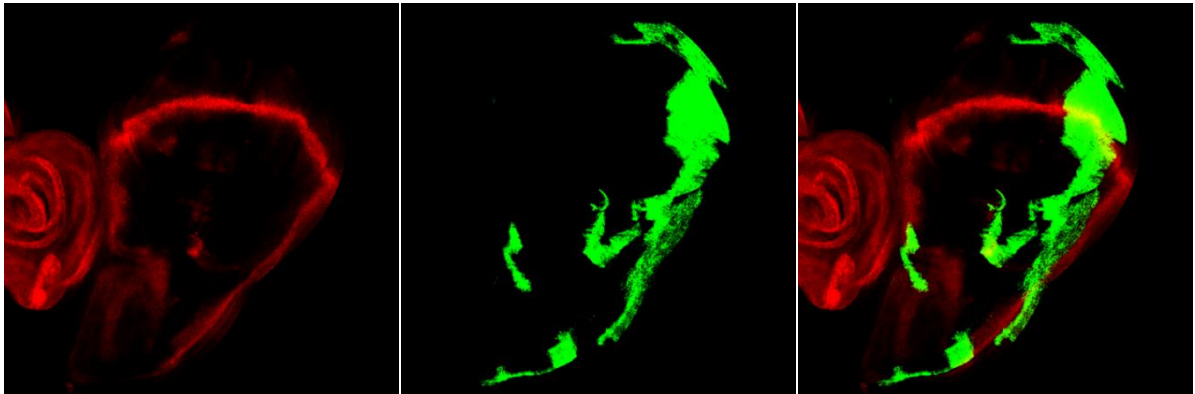

**NRE.RFP(1)**

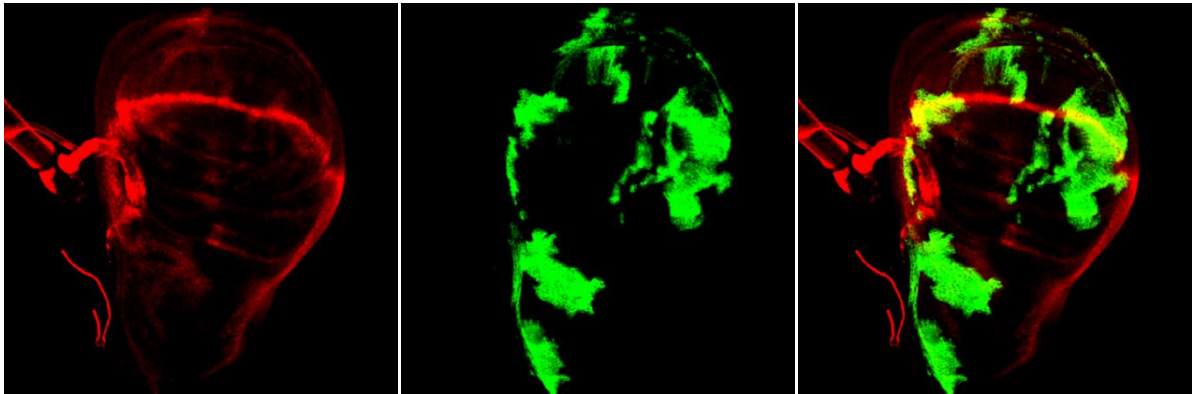

NRE.RFP(2)

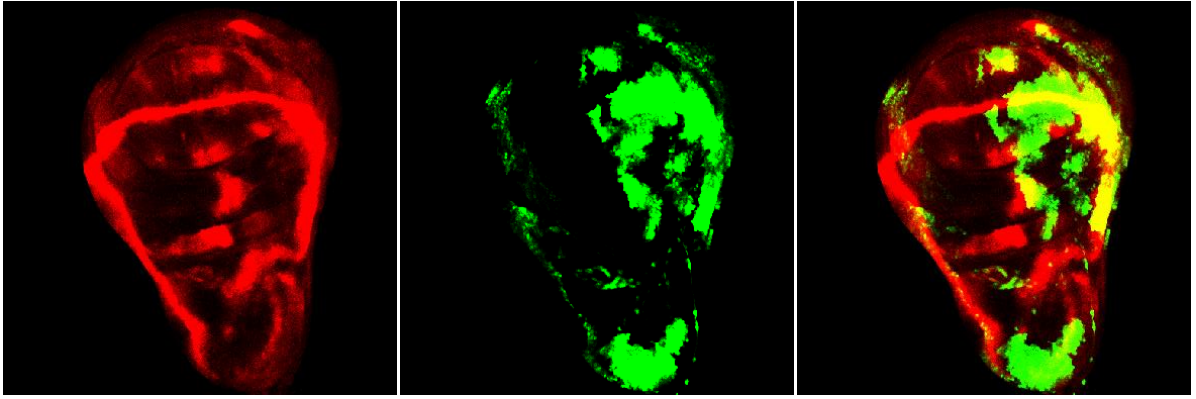

Supp. 5: Truthful joke about the life in academia.

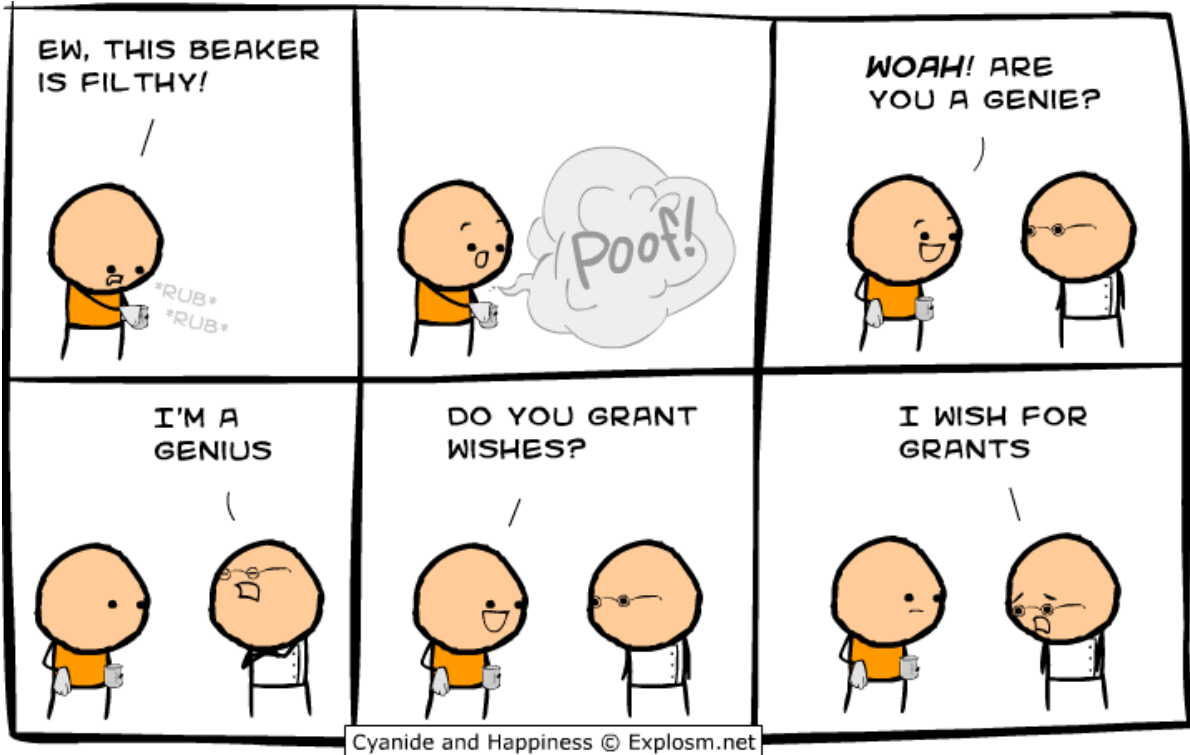

© for non-published parts Matej Horváth

horvath.mm@mail.com

**A role of Sirt1 in the Notch signalling**

Ph.D. Thesis, 2017

All rights reserved  
For non-commercial use only

Printed in the Czech Republic

University of South Bohemia in České Budějovice  
Faculty of Science  
Branišovská 1760  
CZ-37005 České Budějovice, Czech Republic

Phone: +420 387 776 201  
www.prf.jcu.cz, e-mail: sekret-fpr@prf.jcu.cz