



Application of perpendicularly laid nonwovens in automotive industry

Diplomová práce

Studijní program: N3106 – Textile Engineering
Studijní obor: 3106T017 – Clothing and Textile Engineering
Autor práce: **Karthik Kolappan**
Vedoucí práce: Ing. Jiří Chaloupek, Ph.D.





TECHNICAL UNIVERSITY OF LIBEREC
Faculty of Textile Engineering ■

Application of perpendicularly laid nonwovens in automotive industry

Master thesis

Study programme: N3106 – Textile Engineering
Study branch: 3106T017 – Clothing and Textile Engineering
Author: **Karthik Kolappan**
Supervisor: Ing. Jiří Chaloupek, Ph.D.





Master Thesis Assignment Form

Application of perpendicularly laid nonwovens in automotive industry

Name and Surname: **Karthik Kolappan**
Identification Number: T17000380
Study Programme: N3106 Textile Engineering
Specialisation: Clothing and Textile Engineering
Assigning Department: Department of material engineering
Academic Year: **2017/2018**

Rules for Elaboration:

1. Learn the problems of used textiles in the automotive industry. Perform a search on the topic.
2. Focus on the fabrics used in car interiors and the possibility of replacing polyurethane foam in these car parts.
3. Design the manufacturing process. Make a series of samples in which the polyurethane foam will be replaced by a cross layer and perpendicular nonwoven fabric.
4. Test the selected mechanical properties on the samples. Compare and evaluate the results. Look for context between structure and measured results.
5. Discuss the results and suggest other solutions to the problem.

Scope of Report:

45

Thesis Form:

printed

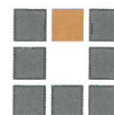

List of Specialised Literature:

1. W. Albrecht, H. Fuchs, W. Kittelmann: Nonwovens Fabrics, Wiley-VCH, Weinheim 2003, ISBN: 3-527-30406-1
2. RUSSELL, Edited by S.J. Handbook of nonwovens. Boca Raton, Fla. [etc.] : Cambridge: CRC press ; Woodhead, 2007. ISBN 978-185-5736-030.
3. Jirsák, O., Wadsworth, L.C. Nonwoven Textiles, Carolina Academic Press, Durham, NC 1999, ISBN 0-89089-978-8

Thesis Supervisor:

Ing. Jiří Chaloupek, Ph.D.
Department of Nonwovens and Nanofibrous materials

Date of Thesis Assignment:

4 February 2018

Date of Thesis Submission:

18 April 2019

Ing. Jana Drašarová, Ph.D.
Dean

Liberec 4 February 2018



Ing. Blanka Tomková, Ph.D.
Head of Department

Declaration

I hereby certify I have been informed that my master thesis is fully governed by Act No. 121/2000 Coll., the Copyright Act, in particular Article 60 – School Work.

I acknowledge that the Technical University of Liberec (TUL) does not infringe my copyrights by using my master thesis for the TUL's internal purposes.

I am aware of my obligation to inform the TUL on having used or granted license to use the results of my master thesis; in such a case the TUL may require reimbursement of the costs incurred for creating the result up to their actual amount.

I have written my master thesis myself using the literature listed below and consulting it with my thesis supervisor and my tutor.

At the same time, I honestly declare that the texts of the printed version of my master thesis and of the electronic version uploaded into the IS STAG are identical.

18. 4. 2019

Karthik Kolappan

ACKNOWLEDGMENT

It pleases me immensely to recount the people, who have helped me through my endeavour, sometimes by just “being a friend or a dedicated ear that listened”, sometimes by helping me technically or philosophically to overcome the hurdles in my research. First and foremost, I would like to thank my supervisor Ing. Jiří Chaloupek, Ph.D, who had been lending his valuable time and knowledge to my research work whenever it was possible. This research work would not have been possible without his assistance.

Next up, I am highly obliged for my instructor Bc. Filip Sanetnik for his technical suggestions and comments on several meetings. I am grateful to all my colleagues from the company Adient Strakonice, s.r.o., for their insightful directions towards my research work. I am also grateful to Tomáš Drbohlav from Adient Strakonice for his helpful contribution with research study.

Finally, I would like to show my gratitude towards my parents and friends for their continuous encouragement that always drives me forward.

Liberec

20.02.19

Karthik Kolappan

ABSTRACT

In contrast to composites and woven fabrics, nonwoven materials have a unique web structure, which is composed of randomly oriented fibres bonded in a pattern by mechanical, thermal or chemical techniques. The physical and mechanical properties of thermal bonded textile nonwovens have been experimented for the replacement of polyurethane (PU) foams in car interiors cushioning materials for car seats. The objective of research work is to development of the approach starts with experimental studies on thermally bonded nonwovens with different layering of web formation to achieve some better characteristics in comparison of polyurethane foams (PU) which extensively used in automotive seating industries.

PU foam does not ability for recyclable or reusable commercially up to greater extent requires delamination steps. Polyethylene terephthalate (PET) fibres and bicomponent binder fibres were used to manufacture automotive nonwovens by carding processes using perpendicular laid and cross laid thermo-bonded voluminous nonwoven materials with different blend proportion of polyester (PET) fibres and bi-component fibres and post bonding process with thermal bonding technology.

At the initial part of experimental studies, Perpendicular laid and cross laid thermo-bonded voluminous of thermally bonded nonwoven materials compared with polyurethane (PU) foam were characterised with several mechanical tests such as compression test, rigidity test. Finally, fabric lamination with thermal-bonded nonwovens are compared with respective experimental results of polyurethane (PU) laminated with different fabric to evaluate the efficiency of both materials.

Keywords: Thermally bonded nonwoven; Bicomponent fibre; Struto lapper; Cross lapper; Perpendicular laid and Cross Laid Web, Fabric lamination.

Abstrakt

Na rozdíl od kompozitů a tkanin mají netkané materiály jedinečnou strukturu, která je tvořena náhodně orientovanými vlákny spojenými ve vzoru mechanickými, tepelnými nebo chemickými technikami. Fyzikální a mechanické vlastnosti textilních netkaných textilií s termickým pojivem byly experimentovány pro výměnu polyuretanových (PU) pěn ve výplňových materiálech interiéru automobilů pro autosedačky. Cílem výzkumné práce je vyvinout přístup, který začíná experimentálními studiemi na tepelně spojených netkaných textiliích s různým vrstvením struktury pásu, aby se dosáhlo lepších vlastností ve srovnání polyuretanových pěn (PU), které se široce používají v automobilovém průmyslu.

Polyuretanová pěna není schopna recyklovat nebo se opakovaně použít komerčně až do větší míry, ale vyžaduje delaminační kroky. Polyetyléntereftalátová (PET) vlákna a dvousložková pojivová vlákna byla použita k výrobě automobilových netkaných textilií mykacími procesy s použitím kolmých polohovaných a křížově uložených objemově spojených objemných netkaných materiálů s různým podílem směsí polyesterových (PET) vláken a dvousložkových vláken a procesu dodatečného lepení s technologií tepelného lepení.

V úvodu experimentální části byly porovnány podélně a příčně pokládané tepelně spojené netkané materiály s polyuretanovou (PU) pěnou. Nakonec se laminovaná tkanina tepelně spojená s netkanou textilií porovná s příslušnými experimentálními výsledky polyuretanu (PU) laminovaného s různými materiály, aby se vyhodnotila účinnost obou materiálů.

Klíčová slova: tepelně spojená netkaná textilie, dvousložkové vlákno, Struto lapper, Cross lapper, laminování tkaniny.

CONTENTS

1. Introduction.....	14
1.1 Nonwoven and definitions.....	14
1.2 Background of the study.....	14
1.3 Problem definitions.....	14
1.4 Aim and study method.....	14
1.5 Justification goals.....	15
2. Literature review	
2.1 Automotive Industry for textiles.....	16
2.2 Textile in automobile industry.....	17
2.3 Woven and Knit fabric in automotive textile.....	18
2.3.1 Woven structure fabric.....	18
2.3.2 Knitted structure fabric.....	18
2.4 Nonwoven in automotive industry.....	19
2.4.1 Nonwoven in seats.....	19
2.5 Nonwoven definitions and classifications.....	20
2.5.1 Nonwoven definitions.....	20
2.5.2 Nonwoven classifications.....	21
2.6 Web laid system.....	21
2.6.1 Dry laid system.....	21
2.6.2 Wet laid system.....	21
2.6.3 Random laid system.....	22
2.7 Nonwoven web bonding techniques.....	22
2.7.1 Mechanical bonding.....	23
2.7.2 Chemical bonding.....	23
2.7.3 Thermal bonding.....	23
2.8 Thermal bonding.....	23
2.8.1 Principle of thermal bonding.....	25
2.8.2 Bonding formation.....	25
2.9 Carding Process.....	26
2.9.1 Struto lapper carding.....	26
2.9.2 Cross lapper carding.....	28
3. Plan of work	
3.1 Objective.....	29

3.2 Selection of fibre/ Blend proportion of fibres.....	29
3.3 Preparation of web formation using Struto and cross lapper.....	29
3.4 Mechanical bonding of web by thermal bonding.....	30
3.5 Lamination of thermal bonded nonwoven with face fabric.....	30
3.5.1 Specification of face fabric - Woven and Knitted structure.....	31
3.5.2 Laminated fabric with Poly-urethane foam specification.....	31
4. Results and Discussions.....	32
4.1 Summary overview of Nonwoven web and laminated samples.....	32
4.2 Comparison for compression test for PU foam and Perpendicular laid web.....	34
4.3 Comparison for compression test for PU foam and Perpendicular laid web with different weight.....	37
4.4 Comparison for compression test for PU foam and Cross laid web with different weight.....	40
4.5 Comparison for compression test for Laminated Woven fabric with Poly-urethane foam (Commercial).....	43
4.6 Comparison for compression test for Laminated woven fabric with Poly-urethane foam (Commercial) and Perpendicular laid web.....	45
4.7 Comparison for compression test for Laminated woven fabric with Poly-urethane foam (Commercial) and Perpendicular laid web with different weight	48
4.8 Comparison for compression test for Laminated woven fabric with Poly-urethane foam (Commercial) and Cross laid web with different weight.....	51
4.9 Comparison for compression test for Laminated knitted fabric with Poly-urethane foam (Commercial) and Perpendicular web with different weight.....	54
4.10 Comparison for compression test for Laminated Knitted fabric with Poly-urethane foam (Commercial) and Cross web with different weight.....	56
4.11 Comparison for S tiffness test (bending length) woven laminated with PU foam and Struto web with different fibre blend proportion.....	59
4.12 Comparison for Stiffness test (bending length) Woven laminated with PU foam and Struto web with GSM 100, 200 & 300.....	60
4.13 Comparison for Stiffness test (bending length) Knitted laminated with PU foam and Struto web with GSM 200 & 300.....	61
4.14 Comparison for Stiffness test (bending length) Woven laminated with PU foam and Cross web with GSM 100, 200 & 300.....	62

4.15 Comparison for Stiffness test (bending length) Knitted laminated with PU foam and Cross web with GSM 100, 200 & 300.....	63
5. Conclusion.....	64
6. Future Work.....	65
7. References.....	66
8. Appendix.....	67

List of Tables

Sr. No	Description	Page No.
1	Forecast of automotive sales and production	17
2	Application of textiles in automotive industry	20
3	Classification of nonwovens	22
4	Machine parameters of thermal bonding	30
5	Machine parameters of lamination for thermal bonding web	30
6	Specification of face fabric for lamination	31
7	Description of nonwoven web samples	32
8	Description of laminated with nonwoven web samples	33
9	Compression test result for samples S2, S3 and S10	35
10	Descriptive analysis test result for samples S2, S3 and S10	36
11	Compression test result for samples S5, S6 and S10	38
12	Descriptive analysis test result for samples S5, S6 and S10	38
13	Compression test result for samples S7, S8, S9 and S10	41
14	Descriptive analysis test result for samples S7, S8, S9 and S10	42
15	Compression test result for samples S25 and S26	44
16	Descriptive analysis test result for samples S25 and S26	44
17	Compression test result for samples S11, S12, S13 and S25	46
18	Descriptive analysis test result for samples S11, S12, S13 and S25	47
19	Compression test result for samples S15, S16 and S26	49
20	Descriptive analysis test result for samples S15, S16 and S26	49
21	Compression test result for samples S17, S18, S19 and S26	52
22	Descriptive analysis test result for samples S17, S18, S19 and S26	53
23	Compression test result for samples S20, S21 and S28	55
24	Descriptive analysis test result for samples S20, S21 and S28	55
25	Compression test result for samples S22, S23, S24 and S28	57
26	Descriptive analysis test result for samples S22, S23, S24 and S28	58

27	Bending length test result for samples S11, S12, S13 and S26	59
28	Bending length test result for samples S13, S15, S16 and S26	60
29	Bending length test result for samples S20, S21 and S28	61
30	Bending length test result for samples S17, S18, S19 and S28	62
31	Bending length test result for samples S22, S23, S24 and S28	63

List of Figures

Sr. No	Description	Page No.
1	Compression test of PU foam and Struto web of 100 GSM with different blend proportion S2, S3 and S10	34
2	Compression test result for blend proportion (80:20) GSM 100 with perpendicular laid web (Struto)	34
3	Compression test result for blend proportion (70:30) GSM 100 with perpendicular laid web (Struto)	35
4	Compression test result for commercial sample (S10) poly-urethane foam (PU)	35
5	Compression test of PU foam and Struto web of 200 & 300 GSM with same blend ratio S5, S6 and S10	37
6	Compression test result for sample S5 with weight 200 GSM	37
7	Compression test result for sample S6 with weight 300 GSM	38
8	Compression test of PU foam & Cross web of 100, 200 & 300 GSM with same blend ratio S7, S9 and S10	40
9	Compression test result for sample S7 with weight 100 GSM	40
10	Compression test result for sample S8 with weight 200 GSM	41
11	Compression test result for sample S9 with weight 300 GSM	41
12	Compression test of Laminated woven with PU foam	43
13	Compression test result for sample S25 with PU foam	43
14	Compression test of Laminated woven with PU foam of sample S25 and perpendicular laid web of samples S11, S12 & S13	45
15	Compression test result for sample S11 with perpendicular laid web	45
16	Compression test result for sample S12 with perpendicular laid web	46
17	Compression test result for sample S25 with PU foam	46
18	Compression test of Laminated woven with PU foam of sample S26 and perpendicular laid web of samples S15 & S16	48
19	Compression test result for sample S16	48
20	Compression test result for sample S15	49

21	Compression test of Laminated woven with PU foam of sample S26 and cross laid web of samples S17, S18 & S16	51
22	Compression test result for sample S17	51
23	Compression test result for sample S18	52
24	Compression test result for sample S19	52
25	Compression test of Laminated Knit with PU foam of sample S28 and cross laid web of samples S20 & S21	54
26	Compression test result for sample S28	54
27	Compression test of Laminated Knit with PU foam of sample S28 and cross laid web of samples S22, S23 & S24	56
28	Compression test result for sample S22	56
29	Compression test result for sample S23	57
30	Compression test result for sample S24	57
31	Bending length test result for sample S26 with samples S11, S12 & S13	59
32	Bending length test result for sample S26 with samples S13, S15 & S16	60
33	Bending length test result for sample S28 with samples S20 & S21	61
34	Bending length test result for sample S28 with samples S17, S18 & S19	62
35	Bending length test result for sample S28 with samples S22, S23 & S24	63

1. Introduction

1.1 Nonwoven and definitions

Technical textiles are differentiated from other textiles in that they are designed and made to have functional properties and technical performance, rather than having aesthetic or decorative properties [1]. The manufacture of nonwovens has expanded rapidly, and the use of such products has penetrated many aspects of industry and of private life. Nonwovens are found in hygiene and health care, in roofing and civil engineering, household and automotive, in cleaning, filtration, clothing, food wrap and packaging, to name only a few end-uses. Nonwovens are engineered fabrics that can form products that are disposable, for single or short-term use or durable, with a long life, depending on the application [2]. Nonwoven fabrics describe as sheet or web structures bonded together by entangling fibres or filaments, by various mechanical, thermal and/or chemical processes [2].

1.2 Background of the study

This thesis aims at generating alternative and optimal concepts for future seat cushioning material in replacement of poly-urethane foam in automotive textile industries, considering changes and factors affecting the operational environment. The research experimental work is jointly carried out with company Adient Strakonice S.R.O, Czech Republic.

1.3 Problem definition

Polyurethane (PU) foam has been widely used for seat cushions in automotive passenger vehicles due to the excellent cushioning performance and the ability to shape mold. Presently automotive manufacturers taken account of legislation on End Life Vehicle (ELV) as per European directive 2000/53/CE which constraints that automotive products to be at 85% recyclable and 95% reusable. PU foam does not ability for recyclable or reusable commercially up to greater extent requires delamination steps. This process is not optimal due to leftovers of PU foam in fabric after delamination. Flammability and gas emissions during lamination process leads to CO₂ emission [5].

1.4 Aim and Study Method

The main aim of the thesis includes possibilities of alternative solution for non-degradable poly-urethane foam. Furthermore, environmental impact of CO₂ emission will be more during flame lamination. The aim to develop the seat cushioning material using nonwovens for the better

replacement of poly-urethane foam. The nonwovens can be recycled after delamination process which impacts less impact on environment. It can follow current and future regulation legislation on End Life Vehicle (ELV) as per European directive 2000/53/CE which constraints that automotive products to be at 85% recyclable and 95% reusable.

1.5 Justification Goals

1. Learn the problems of used textiles in the automotive industry. Perform a search on the topic.
2. Focus on the fabrics used in car interiors and the possibility of replacing polyurethane foam in these car parts.
3. Design manufacturing process. Make a series of samples in which the polyurethane foam will be replaced by a cross lapper and perpendicular nonwoven fabric.
4. Test the selected mechanical properties on the sample. Compare and evaluate the results. Look for the context between and measured results.
5. Discuss the results and suggest other solutions to the problem.

2. Literature Review

2.1. Automotive Industry for textiles

Automotive textiles represent the most valued world market for technical textiles and there is a wide-ranging of products including innovative textile structures with performance properties and design [1]. According to automotive news 2007, the production of cars and light trucks was approx. 67,723,891 units in the year 2006 [2]. The international market for automotive interiors in the year 2005 was estimated US\$165 billion and projected up to US\$210 billion by the year 2015 [1]. Automotive technical textiles cover an extensive application which includes upholstery and seating, floor covering, trunk liners, headliners, door and side-panel coverings, pillar coverings, safety belts, airbags, thermal and sound insulators, filter fabrics, battery separators, hose/belt products, tyres and a variety of textile-reinforced flexible and hard composites [3]. The textiles for interior furnishing are mostly made of woven, weft knitted, warp knitted, tufted and laminated fabrics and nonwovens. According to automotive news, the projected forecast is 1billion by the year 2020 for cars and light trucks [8, 9].

There are various prospects for growth in terms of aesthetics, comfort and safety of passengers as well as the environmental problems such as low weight, less energy consumption and recycling after a vehicle's life cycle in automotive textile [8]. Many industrial research and development working on new fibre and fabric/web-forming technologies, finishing and coating processes, testing specifications. As per environmental aspects for reduce a vehicle's fuel consumption and thereby reduce the CO₂ emission [5]. Textiles always play a crucial part in composites to replace the heavy metal-based load-bearing components. According to the European Directive on end-of-life vehicles, it is compulsory to develop textile material which are 100% recyclable [5,9]. Nowadays, many automotive textile products are composite materials, which are difficult to separate, and are only partially recyclable.

2.2. Textiles in Automotive Industry

Textiles are used in cars for a huge variety to improve comfort, thermal insulation, design, vehicle safety and acoustic properties. The textiles represent only 3% of the raw materials used in motor vehicle (compared with 60% steel, 20% plastics, 15% aluminium, etc.) [3]. The universal growth of automotive textiles, likely to increase for nonwovens, as well as for woven structures, composites [1]. Nonwovens are used in automotive industry for a variety of purposes due to their advantages: lightweight, sound efficiency, flexibility and easily tailored properties, moldability, recyclability, low process and resources costing as well as an attractive cost/performance ratio [2]. According to INDA (Association of the Nonwovens Fabrics Industry) the most common technologies used to process nonwovens for automotive applications are the following (sqm): spunbonded (66%), needle punching (27%), hydroentangled/resin (6%), others (1%). According to the same source, the dissemination of nonwovens on product group shows that insulations represent 17% (sq/m) from the total applications. Other applications are: carpet related products (43%), trunk (13%), hood liner (10%), seat (6%), headliner (6%), rear shelf (3%), door (1%), others (1%). [1,15]

Forecast 2010	Region	Sales	Production
	Europe	17,934,370	20,694,029
	North America	20,699,218	17,275,662
	India	1,860,699	2,277,656
**	China	8,831,707	8,834,815
	Japan	6,108,709	10,639,100
Total		55,434,703	59,721,263

**2002 China production was 3 million, and in 2005 5.06 million, 2002 China Sales were 2.7 million and in 2005 4.99 million

Source: Global Insight, 2007, Automotive News Data Center, J.D. Power Automotive Forecasting, and Mexican Automotive Manufacturers Association, Japan Automobile Importers Association, Japan Automobile Dealers.

Table 1. Forecast of automotive sales and production [1]

It has been found that around 88% of the fabrics used in the automotive industry are used in seating and door covers. Polymer materials are used as follows:

- polyester (mainly for upholstery)
- polyamide (mainly for carpet, and on a limited scale for upholstery)
- polypropylene (for carpet, and on a limited scale for upholstery)

- polyurethane (as an additive fibre for technical applications, e.g. elasthan)
- polyacrylic (for convertible roofs)
- wool or cotton (as additional fibres).

Majorly spun-dyed polyester fibres with approx. 40000 tons of polyester yarns used in Europe and even natural fibres such as cotton and wool fibres are used in upholstery Polyester leads the raw materials used in fabrics in the automotive industry, its major segment of the total materials used to be about 78% containing 59.4% air-textured PES yarn (ATY), and friction-textured yarn (FTY) at 30.6% [3]. In automotive textile, texturized yarns consume approx. 70% in which majorly being used is air-textured yarn also Known as teslan yarn around 60% and rest 40% is false twisted texturized yarn. The quality of the yarns used has improved, so the desired abrasion resistance properties can be achieved, even using a finer count [4].

2.3. Woven and Knit fabric

2.3.1 Woven fabrics

Majorly on upholstery products, the woven patterned fabric used as the face fabric which are mainly dobby weaves consist of 32% stake and Jacquard weaves of 18%. The end use of these face fabrics are seat and door cover. The plain-woven pattern fabric used in the seat wings, bolsters and rear covers of the front seats [4].

2.3.2 Flat Knits

The second major consumption of the face fabric in upholstery are Circular Knits are the second with 19% share of this automotive textile. Foremost circular knitted velour fabrics are 15% and circular flat fabrics (single or double jersey) with approximately 4%. Circular velour is used on the seat and door covers, with flat circular knits used in rear covers, front seats and headliners. In the meantime, warp knitted fabrics also been used with a 12% market share [4].

2.4. Nonwoven in Automotive Industry

The worldwide market for automotive interiors in the year 2005 was nearly US\$165 billion and predictable to produce up to US\$210 billion up by the year 2017. The total weight of textile components including nonwovens as a quantity of the total vehicle weight has progressively increased. The weight of textile materials is projected to increase from an existing average of about 21 kg to 35 kg by 2020 in which interior textiles are around 8 kg and floor cover are approx. 4.5 kg and the headliner and upholstery consist of 3.5kg [1,4].

2.4.1. Nonwoven in Seats

Nonwovens are extensively used in backings or cushioning, bolster fabrics, reinforcements including needle punched, thermal bonded and spun bond fabrics [4]. Nonwoven fabrics as face fabric have limitation to durability, strength as comparable to woven and knit structures fabrics. In backings material, extensive study has been showed on foam-replacement materials composed of PET and other polymeric fibres produced from perpendicular-laid nonwovens, based principally on the STRUTO process [3]. Carded webs containing bicomponent or low-melt fibres are continuously wavy (the corrugations aligned in the CD) and bonded through hot air. The vertical orientation of fibres increases the adjacent compression-resistance and recovery of the fabrics as compared to a carded and cross-lapped fabric [3,4].

Nonwovens are particularly attractive in the automotive industry because of their ability to:

- Multi-layer, modular components with other materials including foam
- Lightweight and low-density modules
- Cost-performance targets in what is a highly price-sensitive industry
- Recycled raw materials and still meet performance requirements
- Compatible with emerging recycling processes

Some of the existing automotive applications for nonwoven fabrics are summarised in below Table

Facing fabrics	Backings and fillings	Filter media	Miscellaneous components
Headliner	Headliner	Cabin air	Electrical insulation
Main floorcovering and boot liner	Main floorcovering and boot liner	Engine air	Composite (panel) reinforcement and veils
Seating and rear seat backs	Seating	Transmission	Tyre reinforcement
Bonnet liner	Door and dashboard panels	Oil	Gaskets and seals
Parcel shelf	Acoustic insulation	Brake hose	Catalytic converter
Door panel and trim	Thermal insulation		Battery separator
A, B, C pillar coverings	Adhesive layers		Side impact airbag sleeves
	Fire barriers		

Table 2. Application of textiles in automotive industry [2]

2.5. Nonwoven definitions and classifications

2.5.1. Nonwoven definition

According to EDANA, (The European Disposables and Nonwovens Association) defines a nonwoven as ‘a manufactured sheet, web or batt of directionally or randomly orientated fibres, bonded by friction, and/or cohesion and/or adhesion’, but goes on to exclude a number of materials from the definition, including paper, products which are woven, kitted, tufted or stitch bonded (incorporating binding yarns or filaments), or felted by wet-milling, whether or not additionally needled[6,7].

According to INDA, North America’s Association of the Nonwoven Fabrics Industry, describes nonwoven fabrics as ‘sheet or web structures bonded together by entangling fibres or filaments, by various mechanical, thermal and/or chemical processes [6]. These are made directly from separate fibres or from molten plastic or plastic film.’ Nonwovens are engineered fabrics that can form products that are disposable, for single or short-term use or durable, with a long life, depending on the application [7].

2.5.2. Nonwoven classification

There are three main routes to web forming:

- the dry laid system with carding or air laying to form the web;
- the wet laid system;
- the polymer-based system, which includes spun laying (spun bonding) or specialized technologies like melt blown, or flash spun fabrics etc.

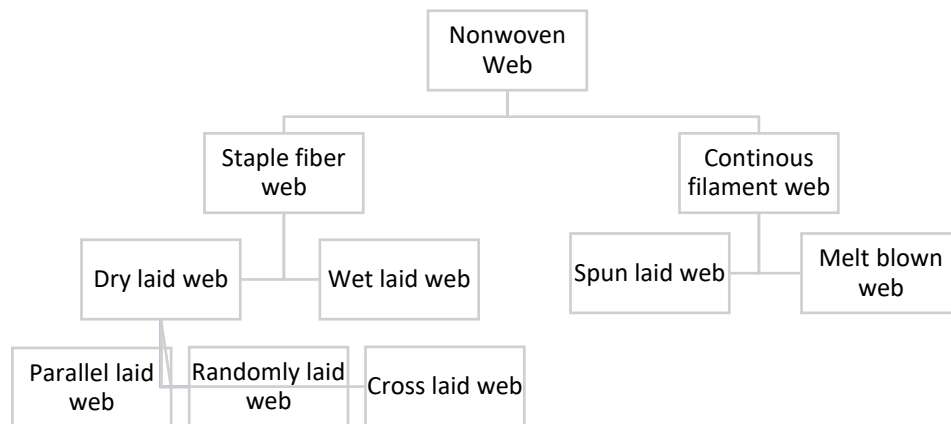

2.6. Web laid system

Fibres or filaments are placed onto a forming surface to form a web or are shortened into a web and feed to a conveyor belt. In the initial stage, the polymer can be dry, wet, or molten – dry laid, wet laid or polymer-laid (spun laid or spun melt process) [4]. Web formation includes changing staple fibres or filaments into a flat web or a three-dimensional web assembly (batt), which is the precursor for the final fabric [3].

2.6.1 Dry-laid nonwovens

The web formation of the dry laid, the fibres are initially carded are carded (with roller carding and cross-lapping) or aerodynamically formed (air laid) and then bonded by mechanical, chemical or thermal methods. These processes include needle punching, hydroentanglement, stitch bonding (mechanical), thermal bonding and chemical bonding [2,3].

2.6.2 Wet-laid nonwovens

Wet laid are staple length fibres suspended in liquid as per machinery equipment. To differentiate wet laid nonwovens from wet laid papers, more than 50% by mass of its fibrous

content is made up of fibres with a length to diameter ratio greater than 300, or more than 30% fibre content for materials with a density less than 0.40 g/cm³ [2,3].

2.6.3 Random-laid nonwovens

Polymer-laid or ‘spun melt’ nonwovens including spun bond, melt blown, flash-spun, films as well as layered composites of these materials, are manufactured with machinery developed from polymer extrusion [2]. In a basic spun bonding system, sheets of synthetic filaments are extruded from molten polymer onto a moving conveyor as a randomly orientated web in the closest approximation to a continuous polymer-to fabric operation [3].

2.7. Nonwoven web bonding techniques

The different types of bonding methods can be classified as follows

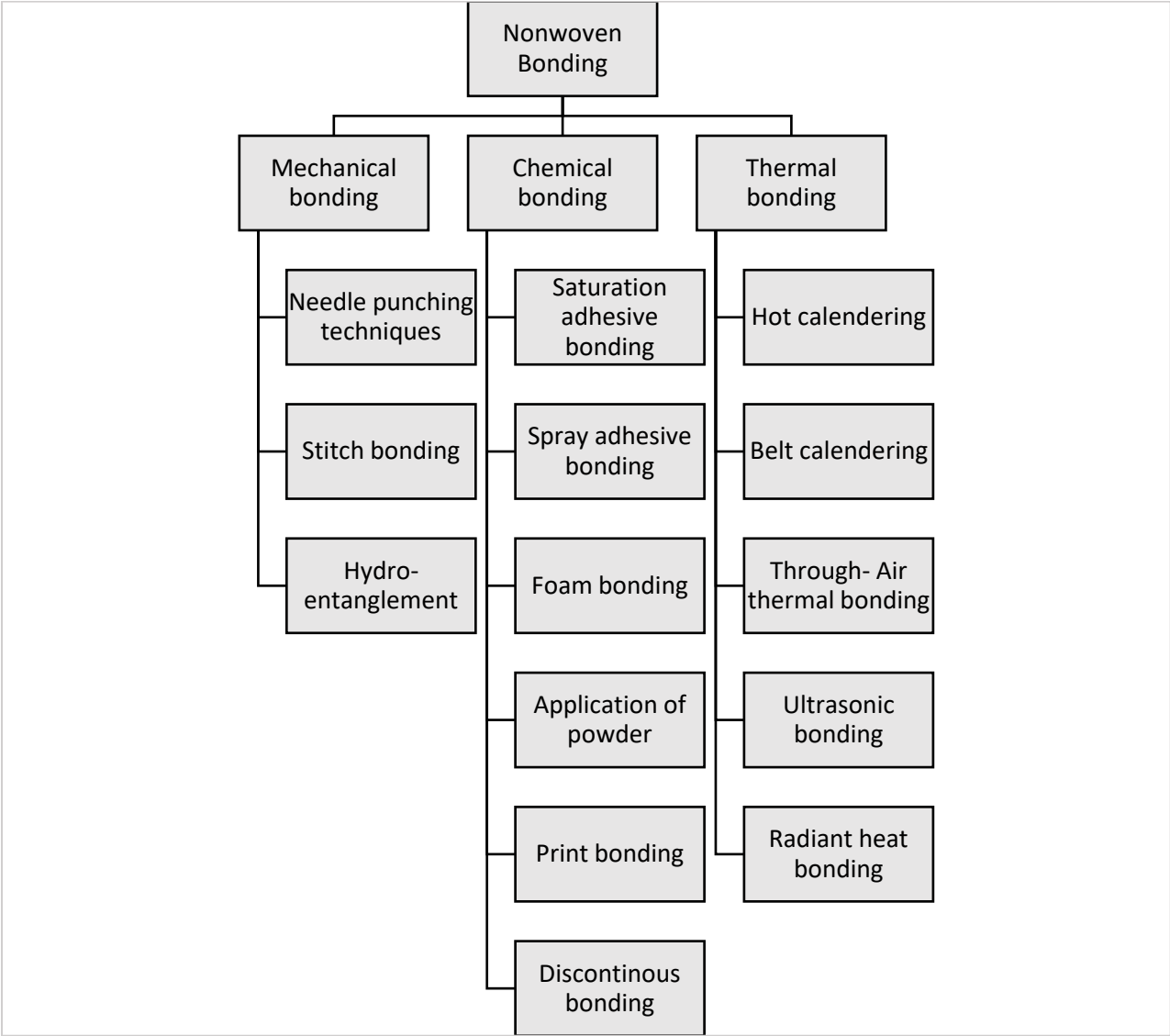

Table 3. Classification of nonwovens

2.7.1. Mechanical Bonding

Mechanical bonding processes include needle punching, stitch bonding and hydroentanglement. The needle punching process called as needle felting, a batt of fibres is drawn through a spikes of needle loom [2]. Fibres are mechanically entangled by reciprocating barbed needles. In stitch bonding, the warp and filling yarns are arranged loosely over each other while a third set of yarns stitches the warp and weft yarns together to produce the completed fabric. Hydroentanglement, which has grown considerably in popularity in recent years, involves bonding fibres in a web by means of high-velocity water jets. Fibre entanglement is introduced by the combined effects of the water jets and the turbulent water flow created in the web which links neighbouring fibres [3,4].

2.7.2. Chemical Bonding

Chemical bonding includes spreading of adhesive on the webs by means of steeping, spraying, printing or foaming techniques [2]. In solvent bonding fibre surfaces are softened or partially solvated with chemicals to provide self- or autogenously-bonded fibres at the crossover points. [3]. The water-based latex emulsion is added to the thinned fibre suspension prior to feeding into the forming wire. When the web is subsequently dried, the latex binder particles form cross-links and stable bonds between the fibres. Hydrogen bonding uses the properties of cellulose fibre to produce hydrogen bonds between the hydroxyl groups on the molecular surface of the fibres to bind the fibres together [3,4].

2.7.3. Thermal Bonding

Thermal bonding uses heat often combined with pressure to soften and then fuse or bond fibres together without tempting melting [3]

2.8. Thermal bonding

Thermal bonding is an important technology which deliver high production rates because bonding is done at high productivity with heated calendar rolls or ovens. It has been used effectively with numerous thermoplastic fibres [3]. It bids noteworthy energy conservation with respect to fluid bonding because of actual thermal contact and because no water needs to be evaporated after bonding. The thermal bonded process are environmentally friendly because of no residual ingredients and implies huge range of fibres [4]. These include homofil and bicomponent fibers, which allow a wide range of fabric properties and aesthetics. Thermal

bonding requires a thermoplastic component, which may be present as a fibre, powder, film, or hot melt or as a sheath on a bicomponent fibre. The bonding options available in thermal bonding are as follows.

(a) Area Bond calendaring: This produces materials that are stiff, thin, moderately and strong. This material is thin shaped structure with permeability properties.

(b) Point Bond calendaring: The properties of the material are thin, inextensible, stiff, strong, bulky, elastic, soft and weak, depending on the size and density of bond points and the conditions of temperature, pressure, and nip contact time. Area and point bonding are used for nonwoven fabrics below with the weight of 25-30 g/sq.mtr which end use for medical and sanitary webs and weight of 100 g/sq.mtr use for interlining and filtration purpose [17].

(c) Through air Bonding: The web is having high bulkiness bulky, soft, good strength, breathability, and good absorbency. The process used for medium to heavy weight nonwoven fabrics which can be used for the application in geotextiles and carpet backing and even for filtration and furniture applications [16].

(d) Ultrasonic Bonding: In this process, the material goes through high compressive deformations, thereby producing heat through internal friction of the polymer itself which causes fibre to soften and bond while heating. It involves pattern- or point-bonding principle which can yield strong and flexible and breathable products for precise end use [17].

(e) Radiant Bonding: This method completed by exposing the web to infra-red radiation, which increases the temperature of the web and softens the binder component. It is used for scatter powdered nonwoven fabrics to enhance flexibility, softness, resilience and absorbency.. The most broadly experienced method is point-bonding with a heated calendar roll, and the following review mainly focuses on point-bonding. [17]

2.8.1 Principle of thermal bonding

Thermal bonding requires thermoplastic material which are homophil fibre, powder, film, cloth, hot melt or as a sheath as part of a two-component fibre. The thermoplastic component becomes viscous or melts. The interconnection region is formed between fibres when the polymer flows through the surface tension and capillary action [3]. These connection regions are fixed by subsequent cooling. There is no chemical reaction between the binder and the fibre. Mechanical bond is formed by subsequent cooling when the binders melt and flow in and around the fibre crossing points, and in the surface cracks of the nearby fibres. In thermal bonding, the formation of mechanical bond because of thermal reduction of the bonding material [4]. The diffusion and interpenetration of the molecules through the interface can occur and the interface can disappear. This can be happen only when there are companionable polymers with almost comparable solubility parameters and cohesive links is formed between the fibres [3,4].

Some of the main advantages of thermal bonding are as follows:

- Products can be relatively soft and textile-like depending on blend composition and bond area.
- Good economic efficiency compared to chemical bonding involving high thermal energy requirements and less expensive machinery.
- High bulk products can be bonded uniformly throughout the web cross section.
- 100% recycling of fibre components can be achieved.
- Environmentally friendly since no latex binders are required.

2.8.2 Bonding formation

The formation of bond between the different molecules after cooling or solidification because of physiochemical attractive force. According to adsorption theory, during thermal bonding viscoelastic deformation of the interface occurs along with diffusion of molecules [3]. The formation of molecules bonding because of the mutual diffusion of in between interface molecules. Molecules are fascinated by Vander Waals force of attraction. This type of bond is called cohesive bond [4].

Diffusion theory states that bonding between the companionable polymers involve wetting of interface followed by mutual diffusion of molecules. The bond is formed by entanglement of diffused molecules entangle with each. [4]. Thermal bonding occurs in three steps; melting due

to thermal energy, formation of bond through diffusion, entanglement of molecules and finally cooling or solidification.

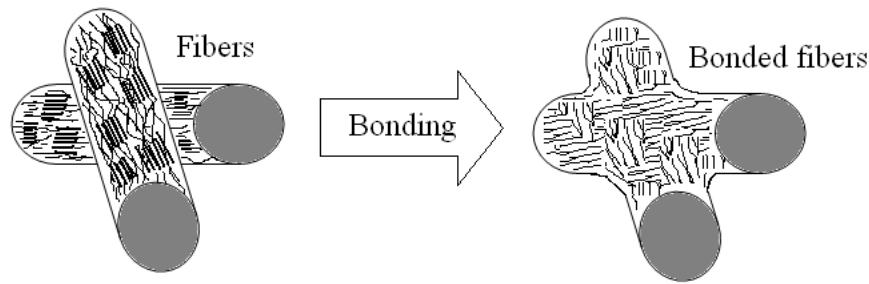

Diagram 1. Bonding of fibres [2]

2.9. Carding Process

2.9.1 Struto Lapper

Vertically lapped (perpendicular-laid) nonwovens are used as foam replacement materials in the automotive industry, depth filtration media and thermal insulation [3]. A carded web, which contain thermoplastic fibres, stereotypically a bicomponent fibre, formation of vertical folds that are fixed through-air thermal bonding. The fibre blends can be collected from thermoplastic synthetic fibres, reclaimed waste materials and natural fibres such as cotton and wool [4]. In addition to fibre composition in the carding, the frequency of the folded fibres influences packing density and even affects fabric properties. The fold frequency and orientation of the fibres are measured by the lapping tool and by the setting of web overfeed. A reciprocating lapping device is used to continuously combine the carded web into a vertically folded batt when passing to heating chamber [3,4].

The blend proportion of low melt thermoplastic fibres allows thermal bonding of the structure lapped formation or in aggregation with a scrim or support fabric before passing to the heating chamber [4]. The compression properties of the fabrics are strongly influenced by the proportion of thermoplastic bicomponent fibre present and the fibre diameter, which governs fibre rigidity. The bicomponent having more than 5 dtex can produce high stiffness properties. The material having good compression resistance and better elastic recovery depending on composition and fabric structure comparing to cross-lapped. The high-loft airlaid Struto fabrics are used in a variety of applications including foam replacement materials, sound insulation in automotive interiors, thermal insulation, bedding products and air filtration [2]. The

Wavemaker system (Santex, Italy) use rotating forming disc for folding of webs. The first rotary and reciprocating lappers originated at the University of Liberec [17]. While the rotary lapper leads to expressively higher production rates than the reciprocating version used by the Struto system, the latter produces z-directional fold orientation which are nearly perpendicular to the fabric plane. The rotary lappers shape the fold structures tend to slant slightly to the fabric plane and therefore the resistance to compression of fabrics produced by rotary and reciprocating lappers is different. Through-air thermal bonding is used to stabilise the resulting structure [4,17].

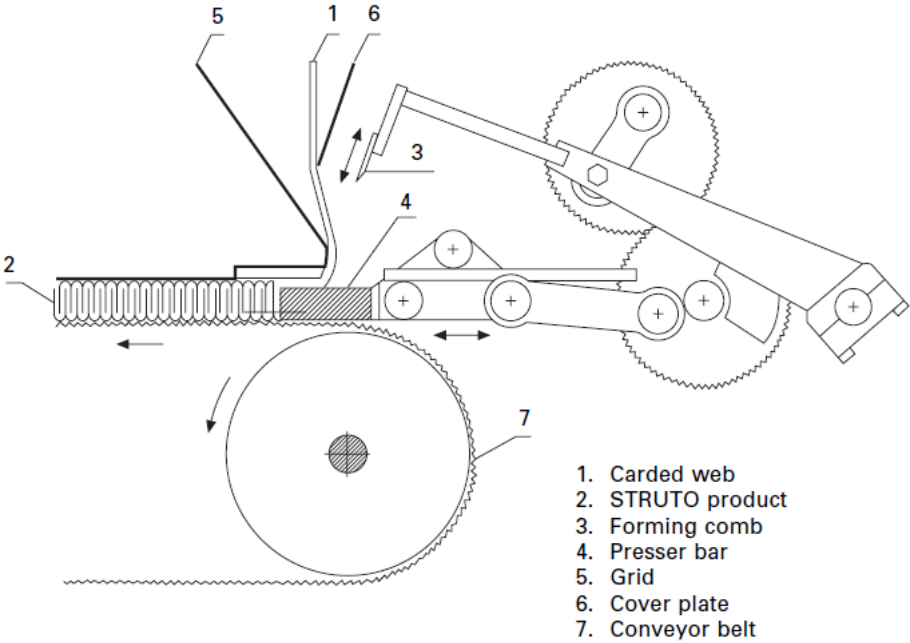

Diagram 2. Layout Struto lapper [3]

2.9.2 Cross lapper

A cross-lapper (or cross-folder) is a continuous web transmission machine which follows a card machine as part of an integrated web formation system. The layering of the web is from side to side onto a lower conveyor or bottom lattice of the machine, which runs perpendicular to the feeding of web to form a diagonally batt, wadding or fleece, which typically contains of 4–>15 layers according to the end usage specifications [4]. The weight of the material cab ranges from 50 to 1500 gm/sq.mtr depending on fibre properties and the web weight. The laydown angle of the web can be determined by the ratio of the web in-feed speed to the output speed [3,4]. The fibres in the carded web entering the cross-lapper tendency through machine direction (MD). Since during cross-lapping the cross-laid web (or batt) leaves the machine perpendicular to the card, the fibres in the batt have a preferential fibre orientation which is nearer to the CD [17].

In many end uses such as filtration, reinforcing scrim or yarns are introduced into the centre of the batt during cross-lapping to increase fabric dimensional stability [3]. More than one web can be lapped together from two different cards as per requirement. During the production, cross-lapping machines undergo significant swings in mass at high speed. There are chances of air currents and inter-belt tension variations results in web faults since the webs are extremely delicate and are easily deformed by mechanical and aerodynamic forces [4].

More commonly, horizontal cross-lappers are used consisting of a number of interacting conveyor aprons that operate in conjunction with traversing carriages and drive rollers. The carding machine delivers the web to the infeed conveyor, which transports it onto the top sheet or belt assembly. The carriages reciprocate as the web is transported within the belts [3,4].

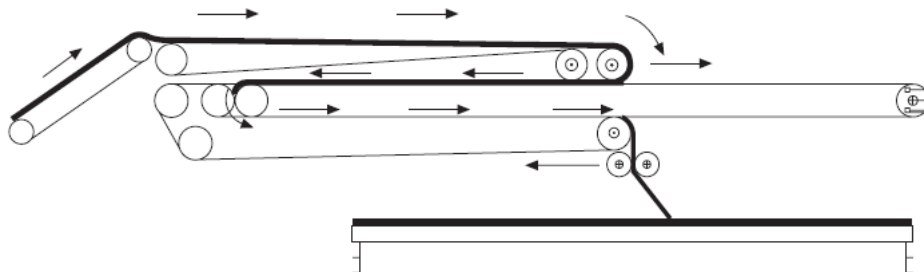

Diagram 3. Layout of Cross lapper [3]

3. Experimental Procedure (Plan of work)

In this section materials and experimental methods used are discussed.

3.1. Objective

- i. Selection of fibre/ Blend proportion of fibres
- ii. Preparation of web formation using struto and cross lapper
- iii. Mechanical bonding of web by thermal bonding
- iv. Lamination of thermal bonded nonwoven with face fabric
- v. Measuring mechanical tests and comparing among the samples

3.2. Selection of fibre/ Blend proportion of fibres

In the first stage, we have selected 100% polyester fibre and 100% Bi-component fibre has been used. The polyester fibre is most commonly used for thermal bonded nonwoven and Bicomponent fibre used binder which is generally Known as binder fibres. The polyester fibre is staple length fibre with fineness of 3.3 dtex and natural colour of white. Whereas the Bi-component fibre having fineness of 2.2 dtex with average staple length of 3.5 mm and coloured in black.

In the initial experiment, the blend proportion of fibres between polyester and Bi-component fibres been selected as follows;

- i. Sample 1 - 90% Polyester + 10% Bi-component (Ratio - 90:10)
- ii. Sample 2 - 80% Polyester + 20% Bi-component (Ratio - 80:20)
- iii. Sample 3 - 70% Polyester + 30% Bi-component (Ratio - 70:30)

3.3. Preparation of web formation using Struto and cross lapper

After selection of blend proportion ratio for polyester fibre and Bi-component fibres, the blended fibre was carded using roller carding and then preformed of web using struto lapper and cross laying lapper.

The weight of the material i.e. GSM (gram square meter) of the web was strategic arranged as follows for further lamination;

- i. 100

- ii. 200
- iii. 300

3.4. Mechanical bonding of web by thermal bonding

The pre-formed web of different blend proportion and different samples has been bonded through hot air chamber with the following machine parameters. The samples bonded consists of different blend proportion such as Polyester/Bi-component - 90:10; 80:20; 70:30 with perpendicular laid web and vertical laid web.

Sr. No	GSM (gm/sq.mtr)	Belt Speed (mtr/min)	Thermal Bond Temperature (°C)	Speed (hz)
1	100	7	150	37,5
2	200	7	150	27,5
3	300	7	150	25

Table 4. Machine parameters of thermal bonding

3.5. Lamination of thermal bonded nonwoven with face fabric

Further the nonwoven thermal bonded web been laminated with the face fabric such as woven and kitted structures in laminate compression machine. The lamination carried out using between face fabric and web with spun bonded web as binding layer or adhesive material. The spunbonded material was 100% polyester with 5 gm/sq.mtr. The lamination process carried out at Adient Strakonice s.r.o company. The lamination process parameters as follows;

Upper Plate temperature (°C)	Lower Plate temperature (°C)	Time of contact (seconds)	Pressure (kg)
130	129	10	4,4 - 4,5

Table 5. Machine parameters of lamination for thermal bonding web

3.5.1 Specification of face fabric - Woven and knitted structure

The woven and knitted fabric laminated with thermal bonded nonwoven web having the following specification or structure parameters;

Structure	GSM (gms/sq.mtr)	Design/ Pattern	Thickness (mm)	Yarn
Woven	260	Twill 2-1	0.55	100% Polyester 550 dtex False Twist textured
Knit	259	2 bar	0.6	100% Polyester 70 & 178 dtex False twist textured

Table 6. Specification of face fabric for lamination

3.5.2 Laminated fabric with Poly-urethane foam specification

All the laminated samples with perpendicular laid nonwoven and cross laid nonwoven compared with commercial laminated fabric with following specification and structures;

Structure	GSM (gms/sq.mtr)	Design/ Pattern	Thickness (mm)	PU Foam density (kg/m ³)
Woven	423	Twill 2-1	3.61	38 (5 mm)
Knit	419	2 bar	3.4	38 (4.5 mm)

Table 6. Specification of laminated face fabric with PU foam

The above material is having structure of 3 layers i.e. face fabric, PU foam and backing material. There are two different samples of commercial samples been used for comparison i.e. with backing material and without backing material. The specification of the backing material is net fabric 100% Polyester with weight of 30 gm/sq.mtr.

4. Results and Discussions

In the results and discussions, all the samples of perpendicular laid web and cross laid web nonwoven and laminated samples of perpendicular laid web and cross laid web tested for mechanical test such as compression test and flexural rigidity test compared with commercial samples of Poly-urethane foam and laminated Poly-urethane foam (PU) with face fabric of woven and knitted material.

4.1. Summary overview of Nonwoven web and laminated samples

The following table description of number of samples for thermal bonded nonwoven web and commercial samples with poly-urethane foam;

Sr. No	Sample No.	Description			
		Fibre Material	Blend Proportion	GSM (gm/sq.mtr)	Laid Web
1	S1	PES/BiC	90:10	118	Perpendicular
2	S2	PES/BiC	80:20	112	Perpendicular
3	S3	PES/BiC	70:30	115	Perpendicular
4	S4	PES/BiC	80:20	202	Perpendicular
5	S5	PES/BiC	70:30	208	Perpendicular
6	S6	PES/BiC	70:30	212	Perpendicular
7	S7	PES/BiC	70:30	119	Cross laid
8	S8	PES/BiC	70:30	210	Cross laid
9	S9	PES/BiC	70:30	312	Cross laid
10	S10	Poly-urethane foam (PU)			

Table 7. Description of nonwoven web samples

The following table description of number of samples for laminated thermal bonded nonwoven web with woven and knitted structure face materials and commercial samples with poly-urethane foam;

Sr. No	Sample No.	Description			
		Face Material (Laminated)	Blend Proportion	GSM (gm/sq.mtr)	Laid Web
1	S11	Woven + S1	90:10	369	Perpendicular laid
2	S12	Woven + S2	80:10	372	Perpendicular laid
3	S13	Woven + S3	70:30	376	Perpendicular laid
4	S14	Woven + S4	80:20	474	Perpendicular laid
5	S15	Woven + S5	70:30	479	Perpendicular laid
6	S16	Woven + S6	70:30	568	Perpendicular laid
7	S17	Woven + S7	70:30	371	Cross Laid
8	S18	Woven + S8	70:30	473	Cross Laid
9	S19	Woven + S9	70:30	576	Cross Laid
10	S20	Knit + S5	70:30	477	Perpendicular laid
11	S21	Knit + S6	70:30	578	Perpendicular laid
12	S22	Knit + S7	70:30	375	Cross Laid
13	S23	Knit + S8	70:30	476	Cross Laid
14	S24	Knit + S9	70:30	581	Cross Laid
15	S25	Laminated Woven + Poly-urethane foam (PU) + Backing			
16	S26	Laminated Woven + Poly-urethane foam (PU)			
17	S27	Laminated Knit + Poly-urethane foam (PU) + Backing			
18	S28	Laminated Knit + Poly-urethane foam (PU)			

Table 8. Description of laminated with nonwoven web samples

4.2. Comparison for compression test for PU foam and Perpendicular laid web

In the initial experiment, the compression test has been compared between the commercial poly-urethane foam and perpendicular laid web of different blend proportion with the gm/sq.mtr of 100 (GSM). During this experiment, the perpendicular laid web with 100 GSM (S1) was not tested due to poor handling and performance as comparable to another blend proportion.

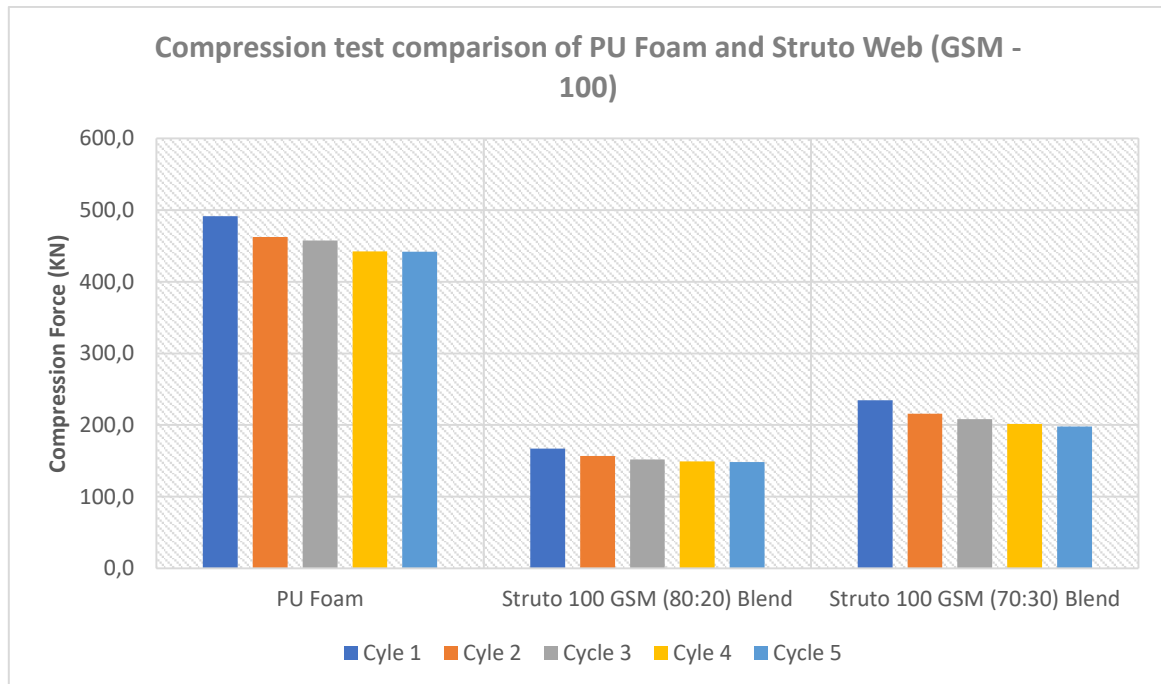

Graph 1. Compression test of PU foam and Struto web of 100 GSM with different blend proportion S2,S3 and S10

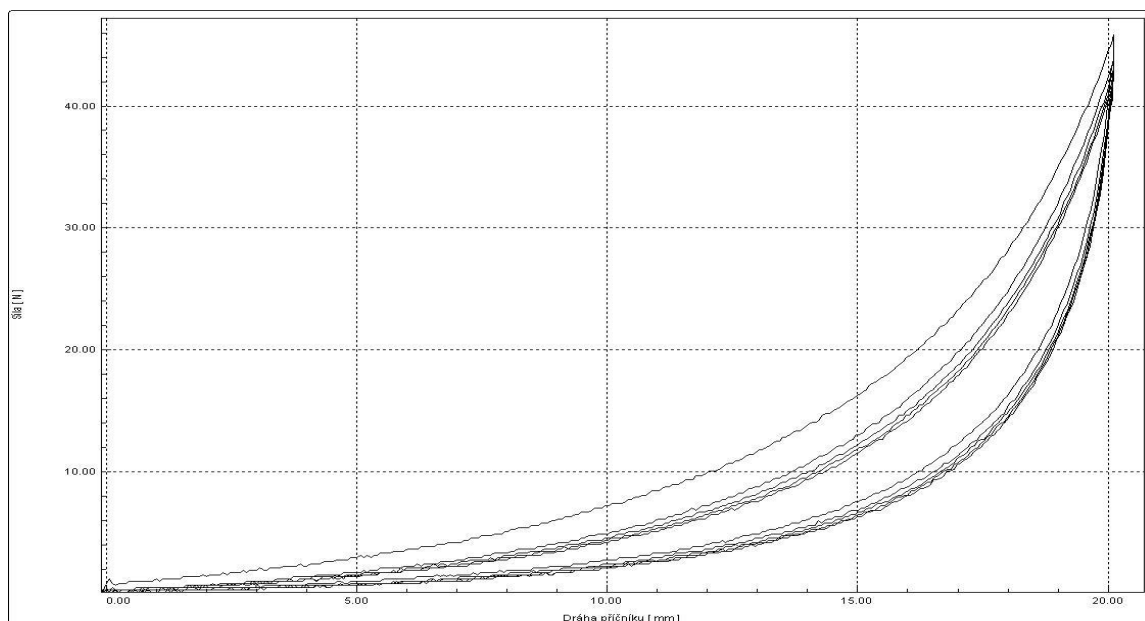

Graph 2. Compression test result for blend proportion (80:20) GSM 100 with perpendicular laid web (Struto)

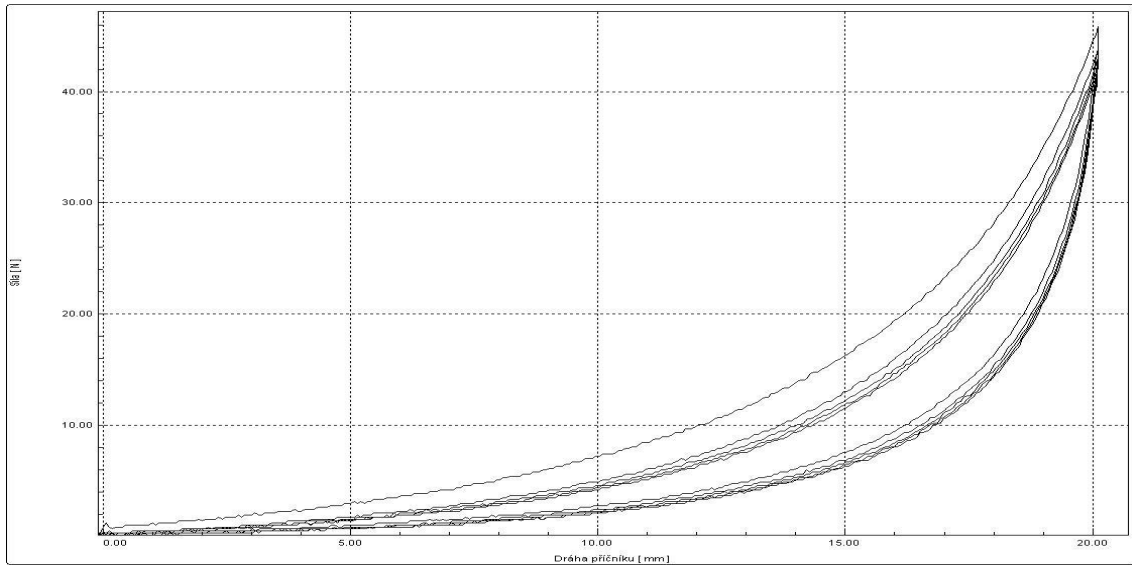

Graph 3. Compression test result for blend proportion (70:30) GSM 100 with perpendicular laid web (Struto)

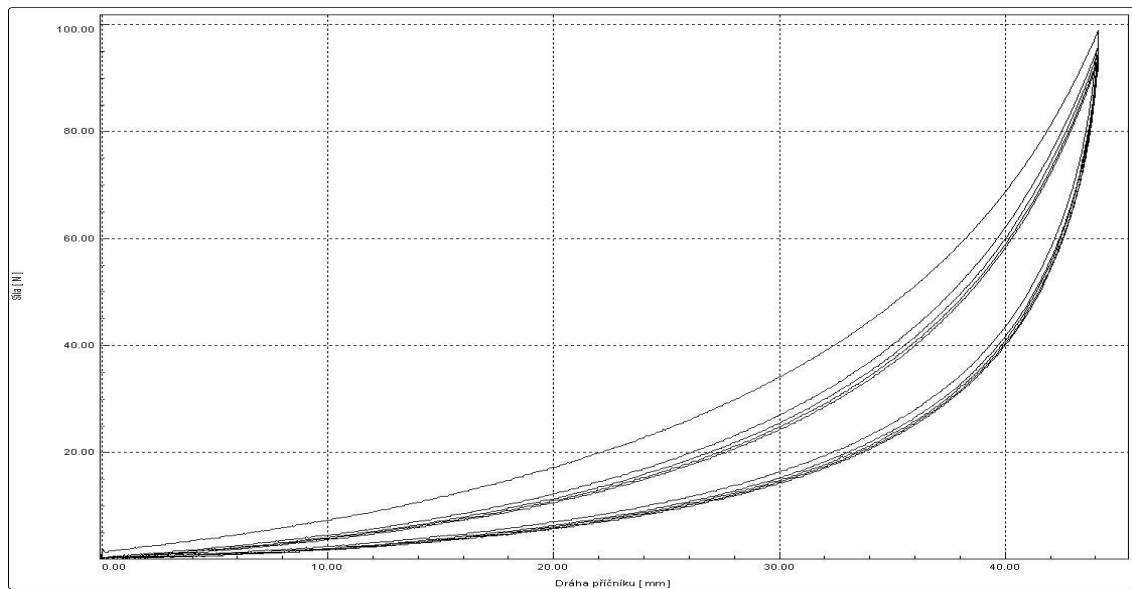

Graph 4. Compression test result for commercial sample (S10) poly-urethane foam (PU)

Material	Cycle 1	Cycle 2	Cycle 3	Cycle 4	Cycle 5	Difference	Difference %
PU Foam	491,6	462,5	457,7	442,5	442,0	-49,7	10,1
Struto 100 GSM (80:20) Blend	166,9	156,7	151,9	149,1	148,4	-18,5	11,1
Struto 100 GSM (70:30) Blend	234,6	215,8	208,4	201,4	198,1	-36,5	15,6

Table 9. Compression test result for samples S2, S3 and S10

<i>Descriptive analysis</i>	PU Foam	Struto 100 GSM (80:20) Blend	Struto 100 GSM (70:30) Blend
Mean	459,3	154,6	211,6
Standard Error	9,1	3,4	6,5
Median	457,7	151,9	208,4
Standard Deviation	20,3	7,6	14,5
Sample Variance	410,3	57,7	210,7
Covariance	328,3	46,2	168,5
Count	5	5	5

Table 10. Descriptive analysis test result for samples S2, S3 and S10

The above samples S1, S2, S3 and S10 from the Graph 1 Sample S1 i.e. Perpendicular laid web (struto) blend proportion of 90:10 with the GSM 100 has been not tested due to poor handling of the material which could not able to measure with instrument. From the table 9, we can see the compression result of commercial sample S10 i.e. poly urethane foam showing great resistance results as comparable to samples S2 and sample S3.

As comparable with sample S2 and S3, from the table 9 S3 shown marginal better results with average value of 211,6% than S2 with average value of 154,5 KN and the compression difference between the cycles, S2 with 11,1% shown better result than S3 15,6% whereas S10 with 10% having the great compression results. Since we know that, according to the literature the poly-urethane foam having the best results in terms of compression commercially.

From the overview of the results, in comparison of the perpendicular laid web S2 and S3 with different fibre blend proportion. Further test carried out with fibre blend proportion of ratio of 70:30 with different weight

4.3. Comparison for compression test for PU foam and Perpendicular laid web with different weight

In this experiment, we have tested the samples S5 and S6 which are having same fibre blend proportion 70:30 with different weight of 200 and 300 gm/sq.mtr and compared the results with commercial sample S10 i.e. poly-urethane (PU) foam.

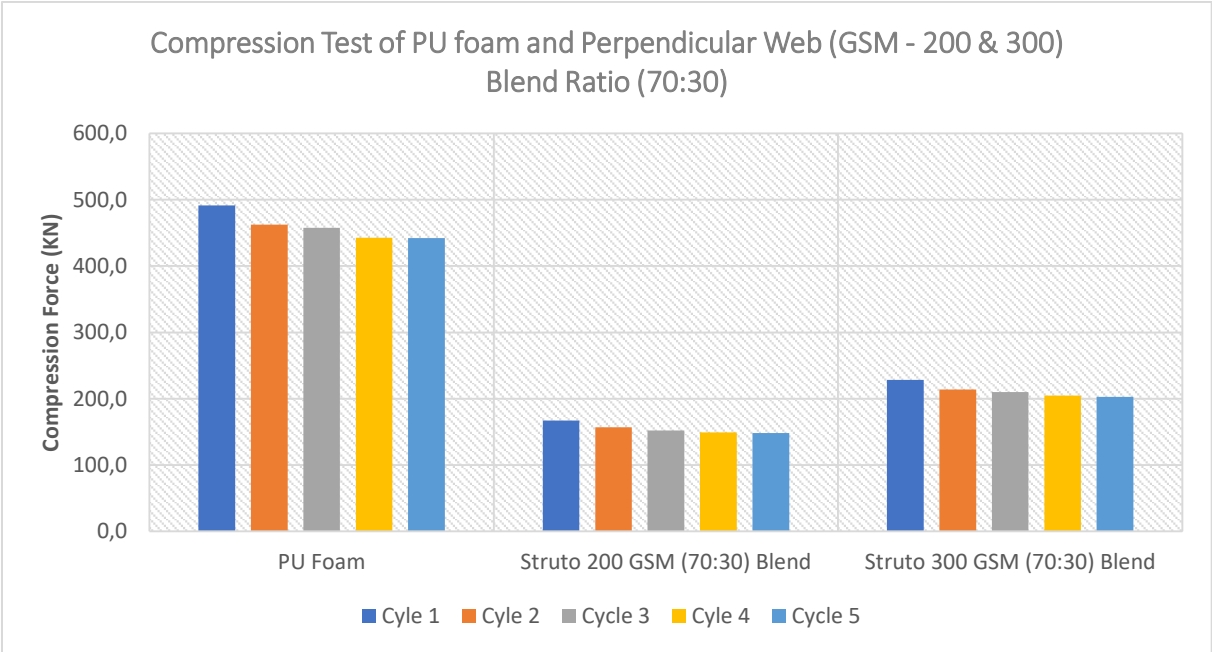

Graph 5. Compression test of PU foam and Struto web of 200 & 300 GSM with same blend ratio S5, S6 and S10

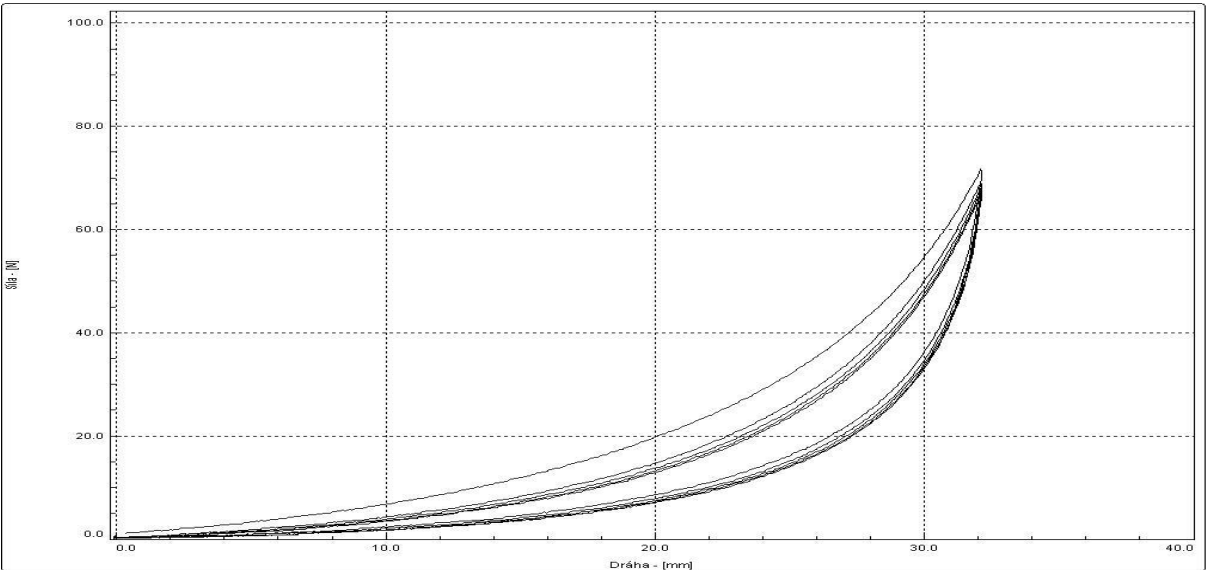

Graph 6. Compression test result for sample S5 with weight 200 GSM

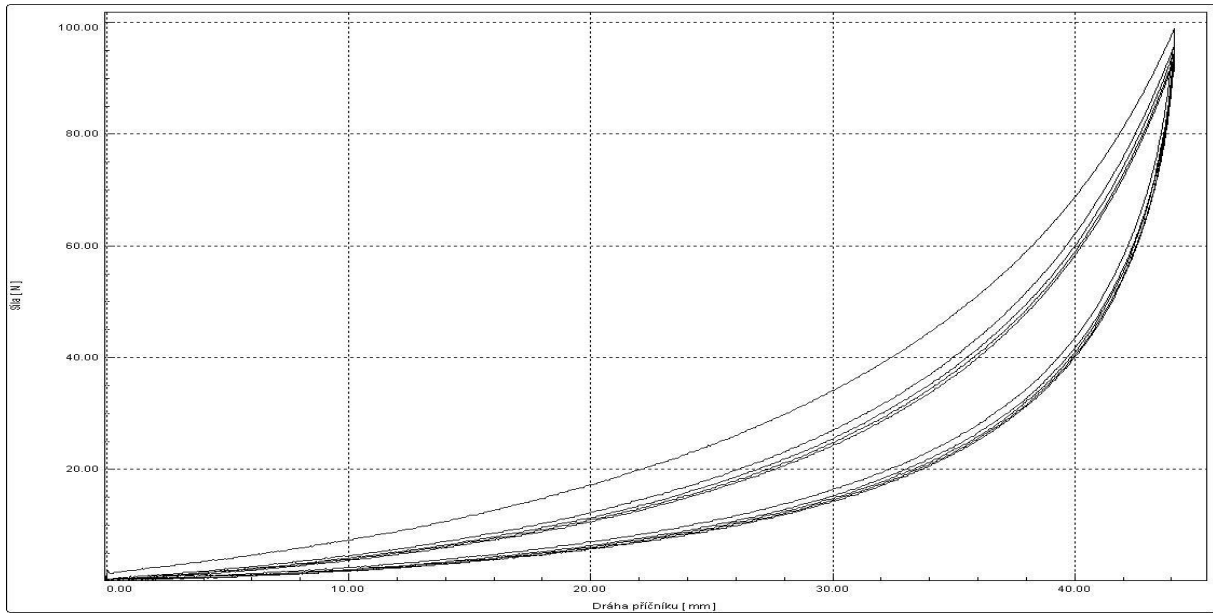

Graph 7. Compression test result for sample S6 with weight 300 GSM

Material	Cycle 1	Cycle 2	Cycle 3	Cycle 4	Cycle 5	Difference	Difference %
PU Foam	491,6	462,5	457,7	442,5	442,0	-49,7	10,1
Struto 200 GSM (70:30) Blend	166,9	156,7	151,9	149,1	148,4	-18,5	11,1
Struto 300 GSM (70:30) Blend	228,1	214,0	209,8	204,7	202,9	-25,2	11,1

Table 11. Compression test result for samples S5, S6 and S10

<i>Descriptive analysis</i>	PU Foam	Struto 200 GSM (70:30) Blend	Struto 300 GSM (70:30) Blend
Mean	459,3	154,6	211,9
Standard Error	9,1	3,4	4,5
Median	457,7	151,9	209,8
Standard Deviation	20,3	7,6	10,1
Sample Variance	410,3	57,7	101,4
Covariance	328,3	46,2	81,1
Count	5,0	5,0	5,0

Table 12. Descriptive analysis test result for samples S5, S6 and S10

The above samples S5, S6 and S10 from the graph 5 we can see the samples S5 and S6 having the sample blend proportion of ratio 70:30 with different weight of 200 and 300 GSM (gm/sq.mtr) and compared the results with commercial sample S10 i.e. polyurethane foam.

From the initial experiment we have seen that the fibre blend proportion of ratio 70:30 have given marginal better results as comparable to another blend proportion i.e. ratio of 80:20.

From the table 11, we can see that the sample S6 shown better results with average value of 211,9 kN force as compare to the sample S5 with average value of 154,6 kN. In this experiment we can state the perpendicular laid web of weight of 300 gm/sq.mtr shown good compression results but not as comparable to commercial sample S10 which having average value of 459,3.

In the compression cycles difference, we can see that the samples of S5, S6 and S10 having almost similar value between cycle 1 and cycles. The cycles difference of S10 10,1% and the cycles difference of the sample S5 and S6 having difference of 11,1%.

In the further experiment, Fibre blend ratio of 70:30 consider to be suitable value fibre proposition since we know that the fibre price of Bi-component fibre is very expensive. Therefore, in the overall experiments, we have not exceeded the blend proportion of Bi-component fibre because of the costing limits.

4.4. Comparison for compression test for PU foam and Cross laid web with different weight

In this experiment, we have tested the samples S7, S8 and S9 are the conventional thermal bonded nonwoven i.e. cross laid web having same fibre blend proportion 70:30 with different weight of 100, 200 and 300 gm/sq.mtr and compared the results with commercial sample S10 i.e. poly-urethane (PU) foam.

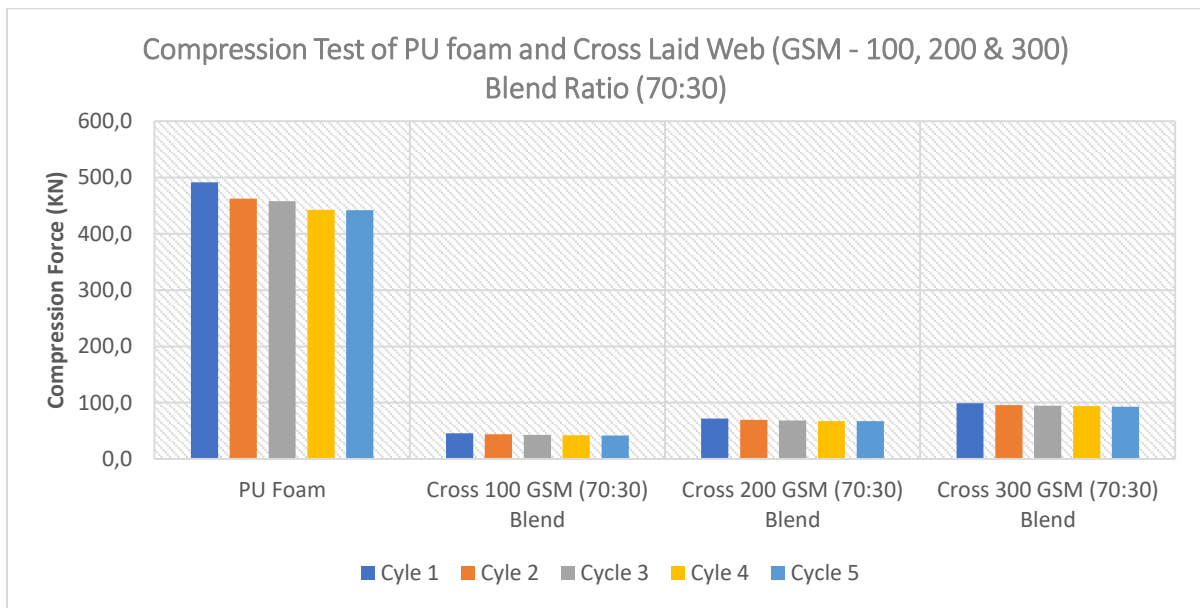

Graph 8. Compression test of PU foam & Cross web of 100, 200 & 300 GSM with same blend ratio S7, S9 and S10

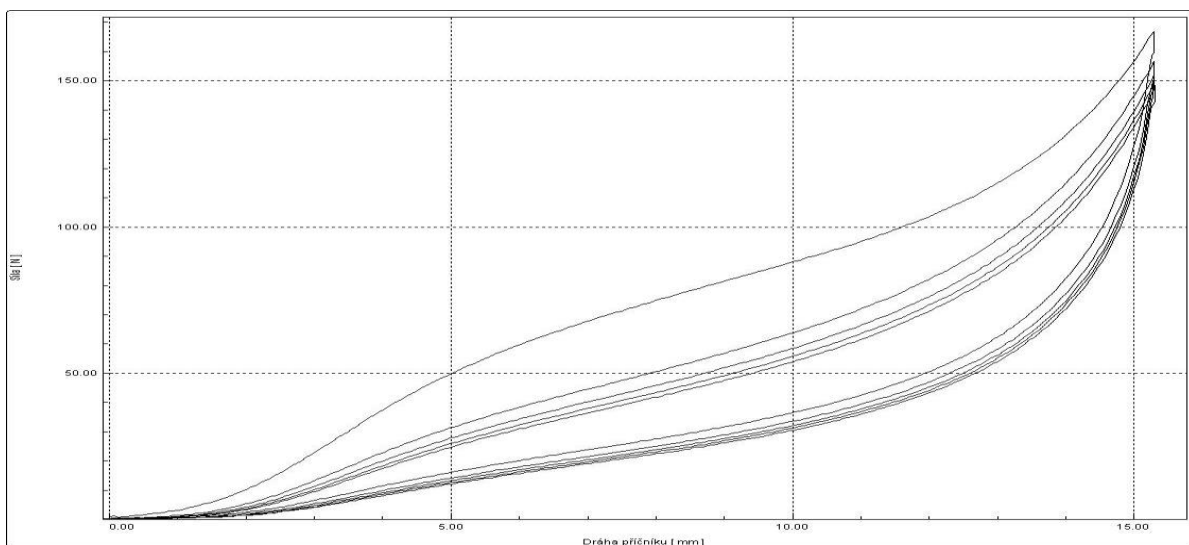

Graph 9. Compression test result for sample S7 with weight 100 GSM

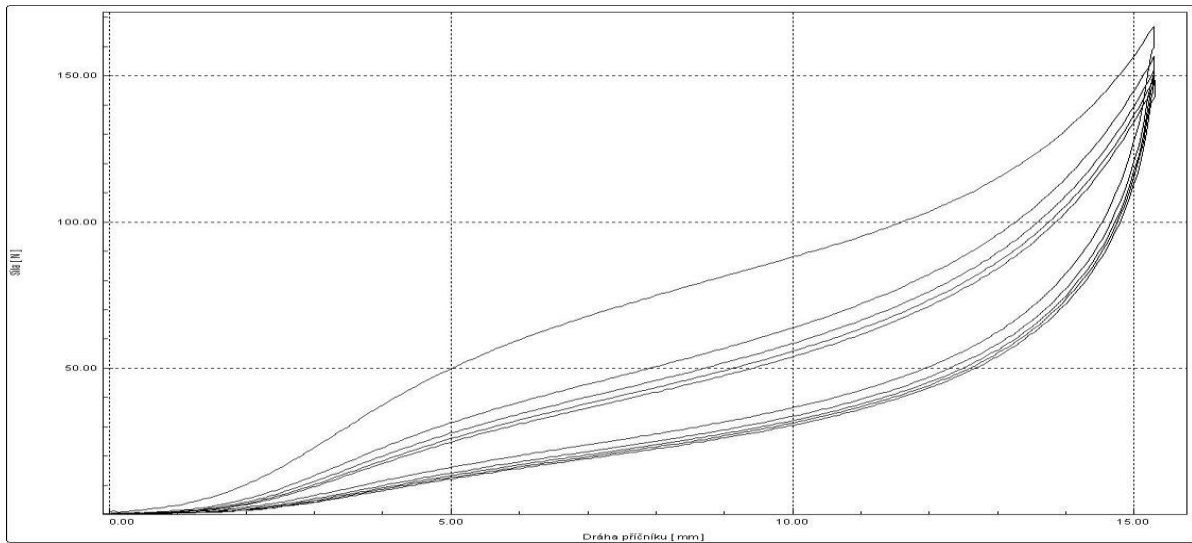

Graph 10. Compression test result for sample S8 with weight 200 GSM

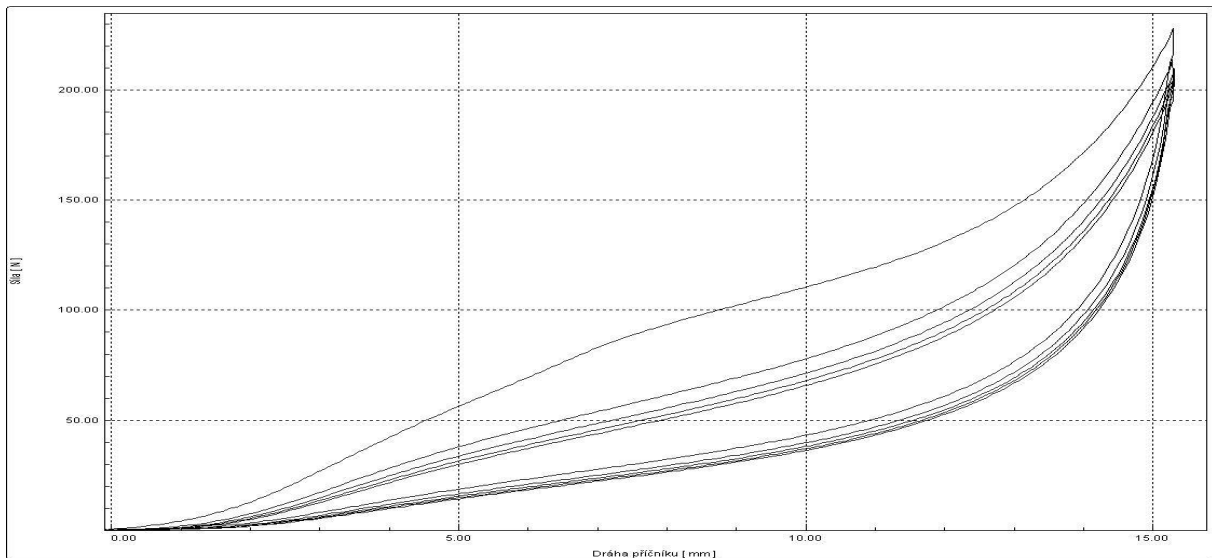

Graph 11. Compression test result for sample S9 with weight 300 GSM

Material	Cycle 1	Cycle 2	Cycle 3	Cycle 4	Cycle 5	Difference	Difference %
PU Foam	491,6	462,5	457,7	442,5	442,0	-49,7	10,1
Cross 100 GSM (70:30) Blend	45,9	43,8	42,9	42,3	41,8	-4,0	8,8
Cross 200 GSM (70:30) Blend	72,0	69,3	68,3	67,4	67,4	-4,6	6,4
Cross 300 GSM (70:30) Blend	99,0	95,8	94,4	93,8	93,0	-6,0	6,1

Table 13. Compression test result for samples S7, S8, S9 and S10

<i>Descriptive Analysis</i>	PU Foam	Cross 100 GSM (70:30) Blend	Cross 200 GSM (70:30) Blend	Cross 300 GSM (70:30) Blend
Mean	459,3	43,3	68,9	95,2
Standard Error	9,1	0,7	0,9	1,1
Median	457,7	42,9	68,3	94,4
Standard Deviation	20,3	1,6	1,9	2,4
Sample Variance	410,3	2,5	3,7	5,5
Covariance	328,3	2	2,9	4,4
Count	5,0	5,0	5,0	5,0

Table 14. Descriptive analysis test result for samples S7, S8, S9 and S10

In this experiment results, the above samples S7, S8 and S9 are the cross laid thermal bonded nonwoven web with the same fibre blend proportion of 70:30 ratio with different weight (gm/sq.mtr) of 100, 200 and 300 compared with the commercial poly-urethane foam sample.

The conventional cross laid web material overall shown poor compression results as comparable with the standard commercial samples. From the graph 8, we can see that average compression value of sample S7 with 43,3 kN, S8 with 68,9 kN and S9 with 95,2 whereas the commercial sample S10 with 459,3 kN. All the samples having the huge difference outcomes with sample S10.

We can say that all the conventional cross laid nonwoven web is not much suitable for the cushioning material for automotive seats commercially as per current results shown above.

4.5. Comparison for compression test for Laminated Woven fabric with Poly-urethane foam (Commercial)

In this experiment, we have tested the samples of S25 with S26 and samples S27 with S28. In which the samples S25 and S26 are the commercial product laminated with face fabric of woven structure with backing material and without backing material.

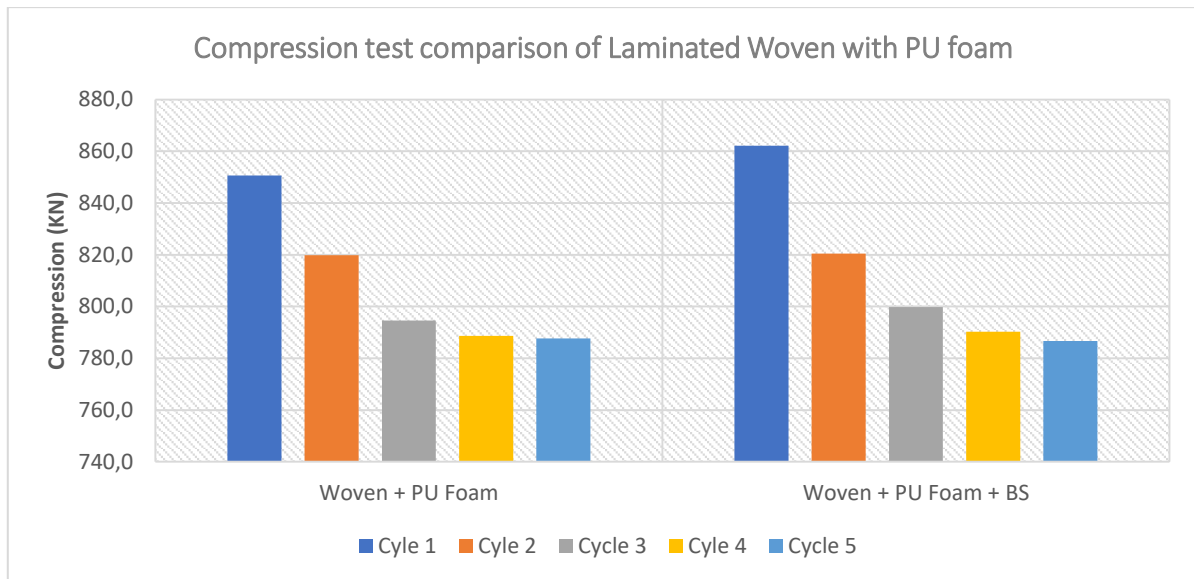

Graph 12. Compression test of Laminated woven with PU foam

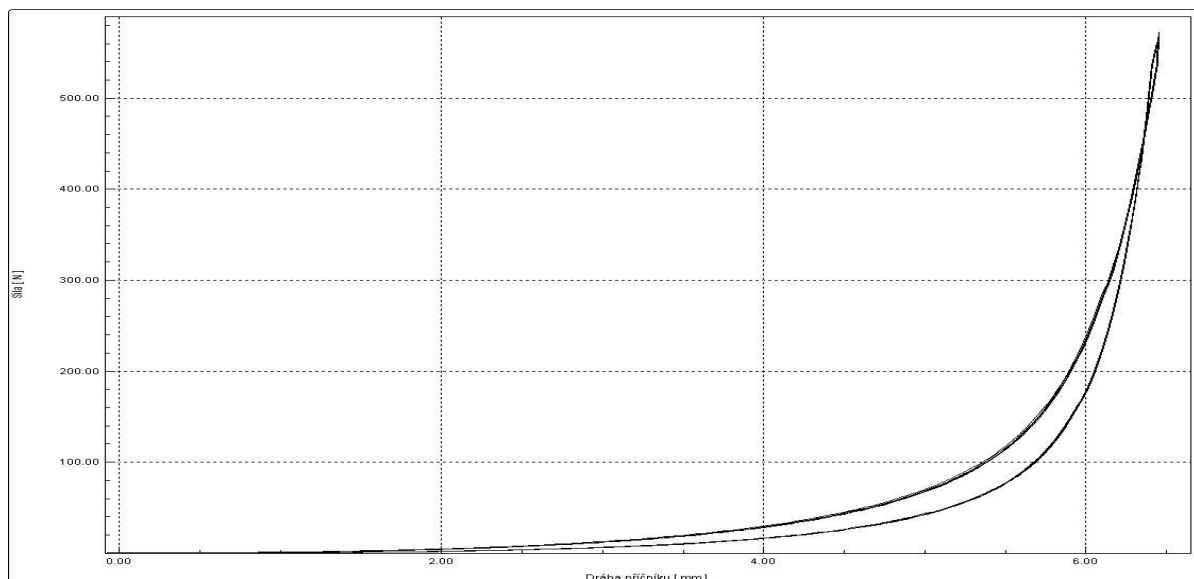

Graph 13. Compression test result for sample S25 with PU foam

Material	Cycle 1	Cycle 2	Cycle 3	Cycle 4	Cycle 5	Difference	Difference %
Woven + PU Foam	850,6	819,9	794,6	788,7	787,6	63,0	7,4
Woven + PU Foam + BS	862,2	820,5	799,8	790,3	786,7	75,5	8,8

Table 15. Compression test result for samples S25 and S26

Descriptive Analysis	Woven + PU Foam	Woven + PU Foam + BS
Mean	808,3	811,9
Standard Error	12,1	13,9
Median	794,6	799,8
Standard Deviation	27,1	31,0
Sample Variance	731,8	963,0
Covariance	585,4	590,2
Count	5,0	5,0

Table 16. Descriptive analysis test result for samples S25 and S26

In this experimental part, the above samples S25 and S26 are the commercial product material meant for automotive seating usage. The sample S26 are the laminated material with woven structure face fabric with poly-urethane foam whereas the sample S25 also the commercial material laminated with poly-urethane foam along with backing material which is 100% polyester net fabric.

From the graph 12, as comparison between both the material having the marginal difference of compression results S25 with average value of 808,3 kN and S25 with average value of 811,9 kN. Therefore, In the further comparison test the sample S26 consider for comparison with other laminated material due to low marginal difference between each other of sample S25 and sample S26.

4.6. Comparison for compression test for Laminated woven fabric with Poly-urethane foam (Commercial) and Perpendicular laid web

In this experimental part, the samples S11, S12 and S13 are laminated samples with face fabric of woven structure with perpendicular laid web nonwoven with different fibre blend ratio of sample S1, S2, and S3 with same weight of 100 GSM (gm/sq.mtr) and compared with the sample S26 which is commercial laminated product with face fabric of woven structure without backing material.

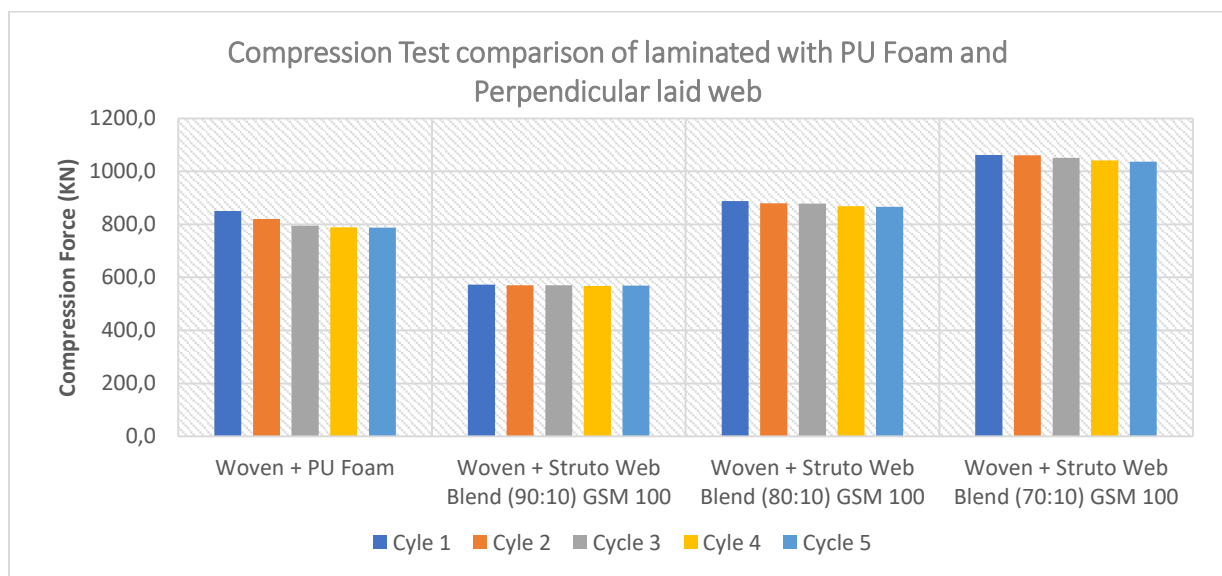

Graph 14. Compression test of Laminated woven with PU foam of sample S25 and perpendicular laid web of samples S11, S12 & S13

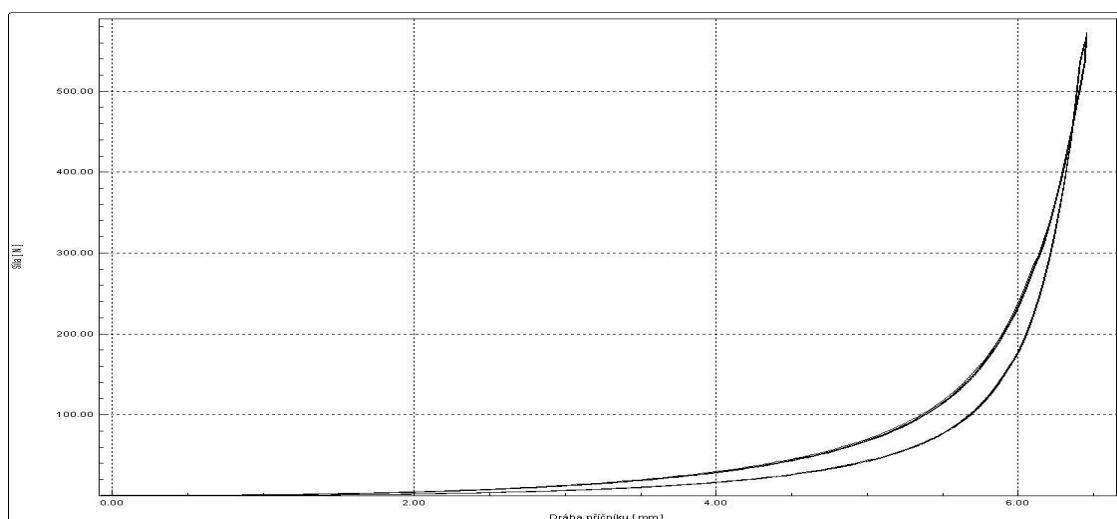

Graph 15. Compression test result for sample S11 with perpendicular laid web

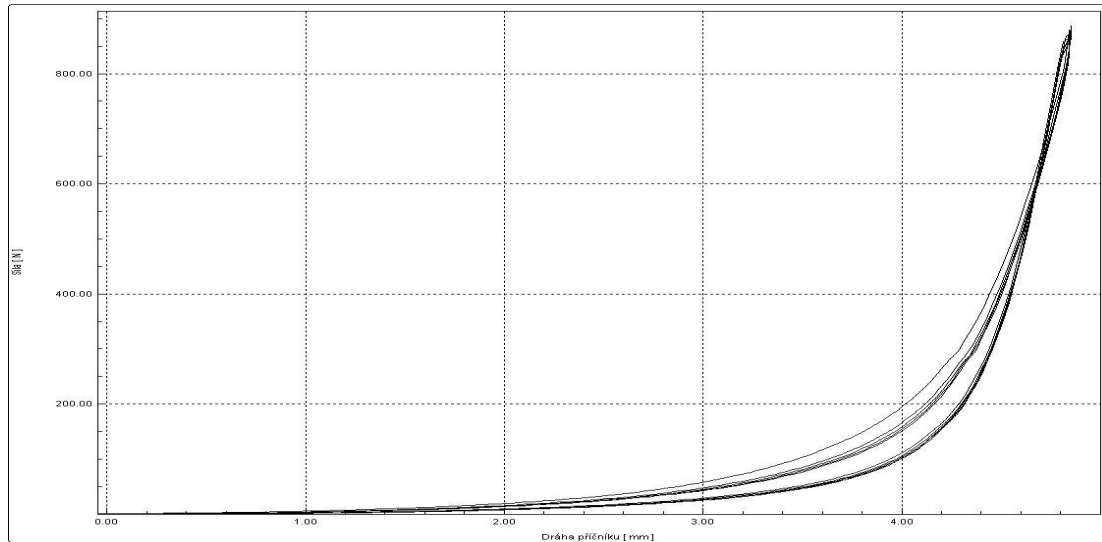

Graph 16. Compression test result for sample S12 with perpendicular laid web

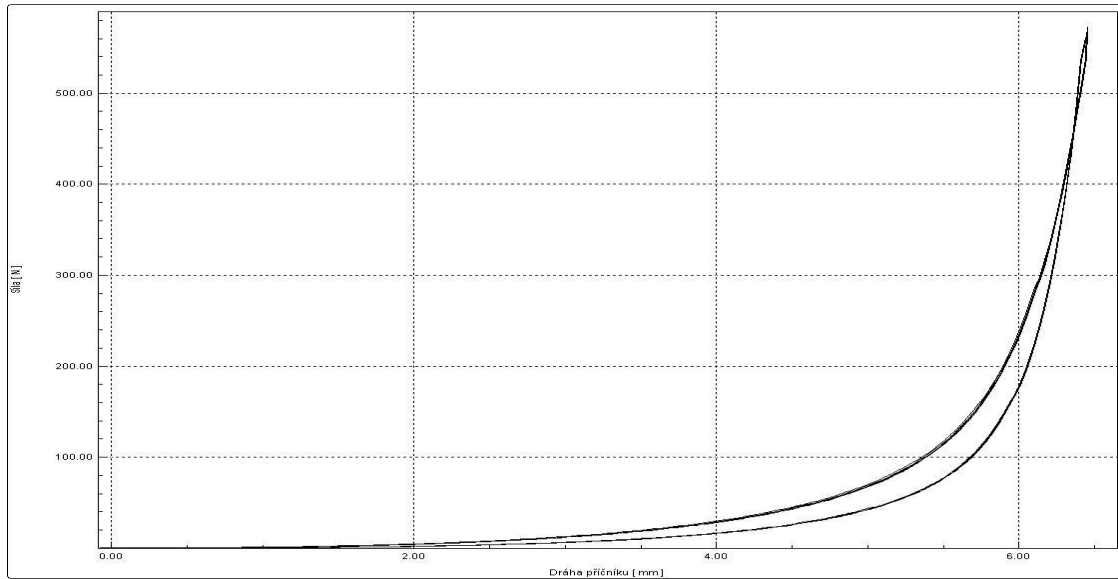

Graph 17. Compression test result for sample S25 with PU foam

Material	Cycle 1	Cycle 2	Cycle 3	Cycle 4	Cycle 5	Difference	Difference %
Woven + PU Foam	850,6	819,9	794,6	788,7	787,6	63,0	7,4
Woven + Struto Web Blend (90:10) GSM 100	573,0	570,3	570,2	568,2	569,0	4,0	0,7
Woven + Struto Web Blend (80:10) GSM 100	887,7	879,5	878,8	868,7	866,9	20,8	2,3
Woven + Struto Web Blend (70:10) GSM 100	1061,58	1060,56	1051,1	1041,24	1036,8	24,8	2,3

Table 17. Compression test result for samples S11, S12, S13 and S25

Descriptive Analysis	Woven + PU Foam	Woven + Struto Web Blend (90:10) GSM 100	Woven + Struto Web Blend (80:10) GSM 100	Woven + Struto Web Blend (70:10) GSM 100
Mean	808,3	570,1	876,3	1050,3
Standard Error	12,1	0,8	3,8	5,0
Median	794,6	570,2	878,8	1051,1
Standard Deviation	27,1	1,8	8,6	11,2
Sample Variance	731,8	3,3	73,4	124,4
Covariance	585,4	2,7	58,7	99,5
Count	5,0	5,0	5,0	5,0

Table 18. Descriptive analysis test result for samples S11, S12, S13 and S25

In the previous experimental part, we have seen the comparison result of compression between the nonwoven and the poly-urethane foam. In this experimental part, we have compared the actual commercial material laminated of face fabric with foam and perpendicular laid web laminated with woven structure face fabric.

From the graph 14, we can see that the compression force results of sample S13 which blend proportion of 70:30 showing better results with the highest value of 1061,6 kN and sample S12 with highest value of 887,7 kN and Sample S11 with 573,0 kN whereas the sample S25 have highest value of 850,6 kN. In the overall comparison of compression force, Sample S12 and sample S13 shown very good results. From the above figure, we can say that the fibre proportion of 70:30 suitable for the backing material with great results.

In the compression cycles difference between the samples S11, S12, S13 and S25, sample S11 having least difference of 0,7% as comparable with Sample S12 and S13 with 2,3%. The highest difference between cycles is sample S26 with 7%.

4.7. Comparison for compression test for Laminated woven fabric with Poly-urethane foam (Commercial) and Perpendicular laid web with different weight

In this experiment, the samples S15 and S16 tested and compared with sample S26. The sample S15 and S16 are the perpendicular laid web with blend proportion of 70:30 with the weight of 200 GSM and 300 GSM (gm/sq.mtr) laminated with woven structure face fabric whereas the sample S26 is the commercial laminated with poly-urethane foam.

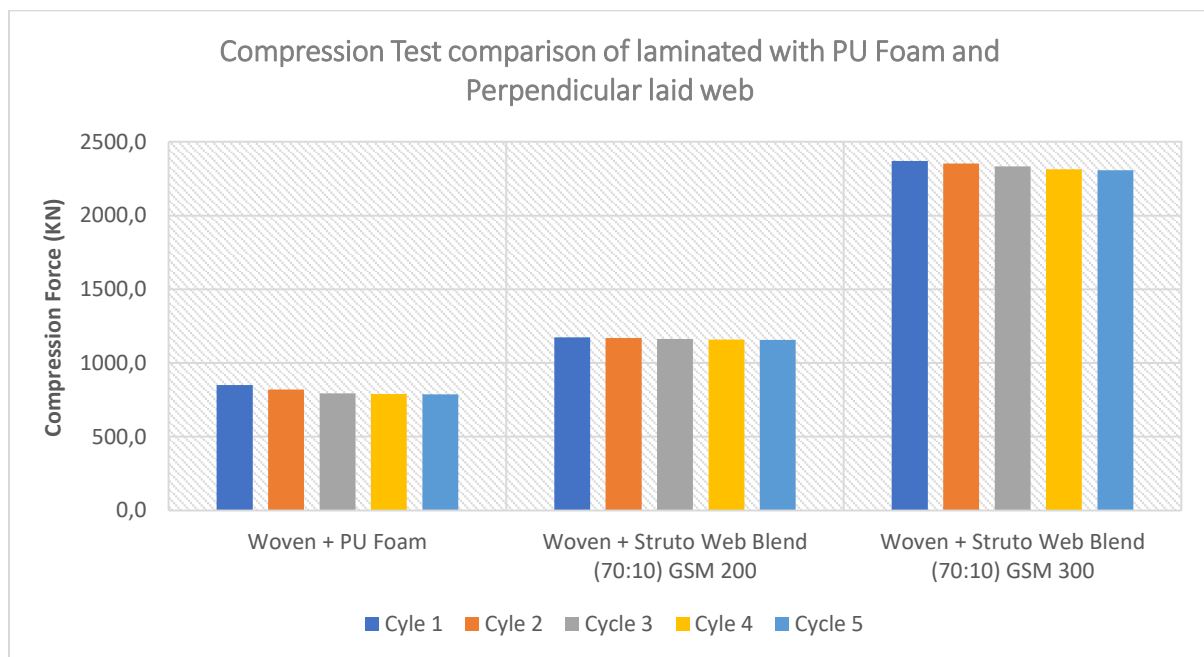
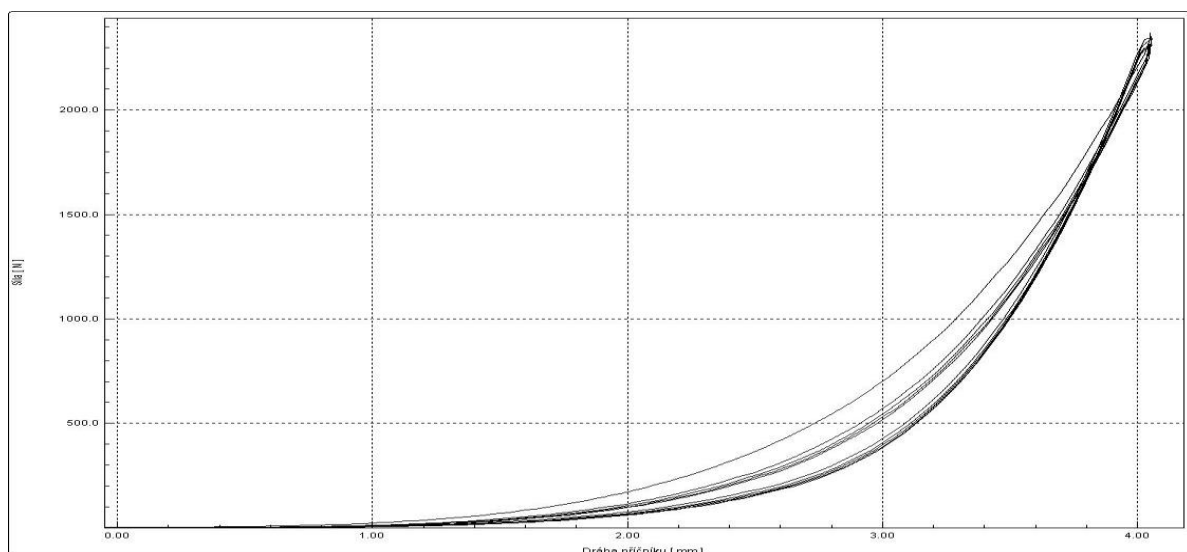
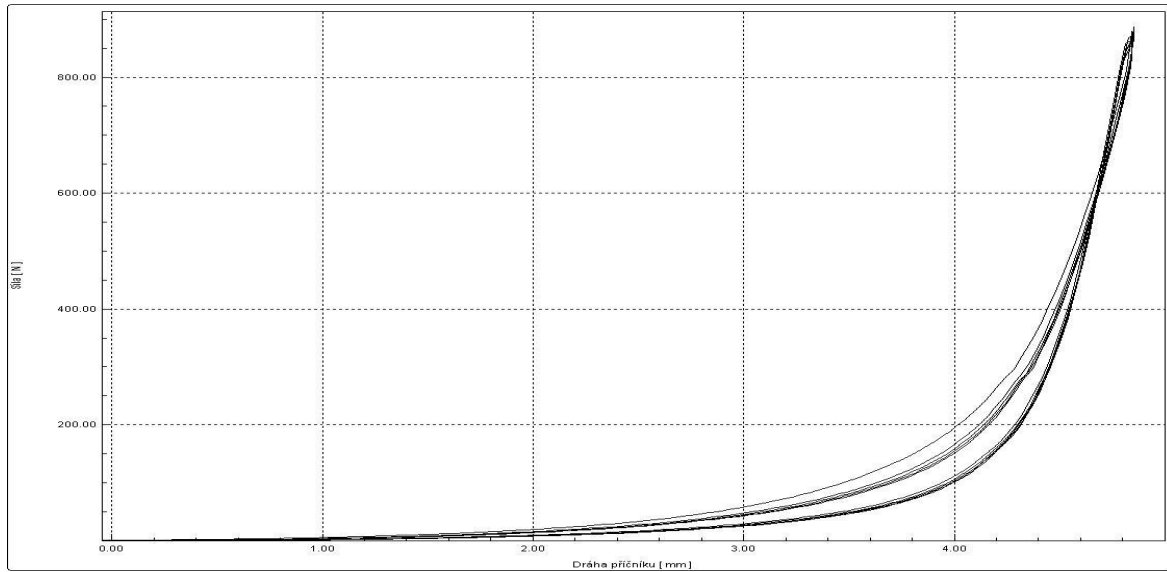

Table 18. Compression test of Laminated woven with PU foam of sample S26 and perpendicular laid web of samples S15 & S16



Graph 19. Compression test result for sample S16



Graph 20. Compression test result for sample S15

Material	Cycle 1	Cycle 2	Cycle 3	Cycle 4	Cycle 5	Difference	Difference %
Woven + PU Foam	850,6	819,9	794,6	788,7	787,6	63,0	7,4
Woven + Struto Web Blend (70:10) GSM 200	1173,09	1170,29	1162,08	1157,98	1156,46	16,6	1,4
Woven + Struto Web Blend (70:10) GSM 300	2370,0	2353,5	2333,1	2314,2	2307,2	62,8	2,7

Table 19. Compression test result for samples S15, S16 and S26

Descriptive Analysis	Woven + PU Foam	Woven + Struto Web Blend (70:10) GSM 200	Woven + Struto Web Blend (70:10) GSM 300
Mean	808,3	1164,0	2335,6
Standard Error	12,1	3,3	11,8
Median	794,6	1162,1	2333,1
Standard Deviation	27,1	7,4	26,4
Covariance	585,4	43,8	555,6
Sample Variance	731,8	54,7	694,6
Count	5,0	5,0	5,0

Table 20. Descriptive analysis test result for samples S15, S16 and S26

From the graph 18, we can see the sample S15 and S16 shown better compression force results as comparable to the commercial product S26. The compression force results of sample S15 was range of 1156,5 kN to 1173,1 kN and the sample S16 with range of 2307,2 to 2370 kN

whereas the sample S26 with range of 787,6 to 850,6 kN. Sample 16 shown the great compression force results.

In the table 19, we can see the compression difference between the cycles of sample S15 with difference of 1,4% and S16 with 2,7% having better results among the cycles as comparable to S26 with difference of 7,4%.

From the above results, we can say the sample of perpendicular laid web of same blend proportion with 70:30 on increasing the weight of the material (gm/sq.mtr) gives better compression force results with minimum cycle difference.

4.8. Comparison for compression test for Laminated woven fabric with Poly-urethane foam (Commercial) and Cross laid web with different weight

In this experimental part, the samples S17, S18 and S19 are cross laid nonwoven web with fibre blend proportion of 70:30 with different weight of the material 100, 200 and 300 GSM (gm/sq.mtr) laminated with woven structure face fabric and compared with commercial samples S26.

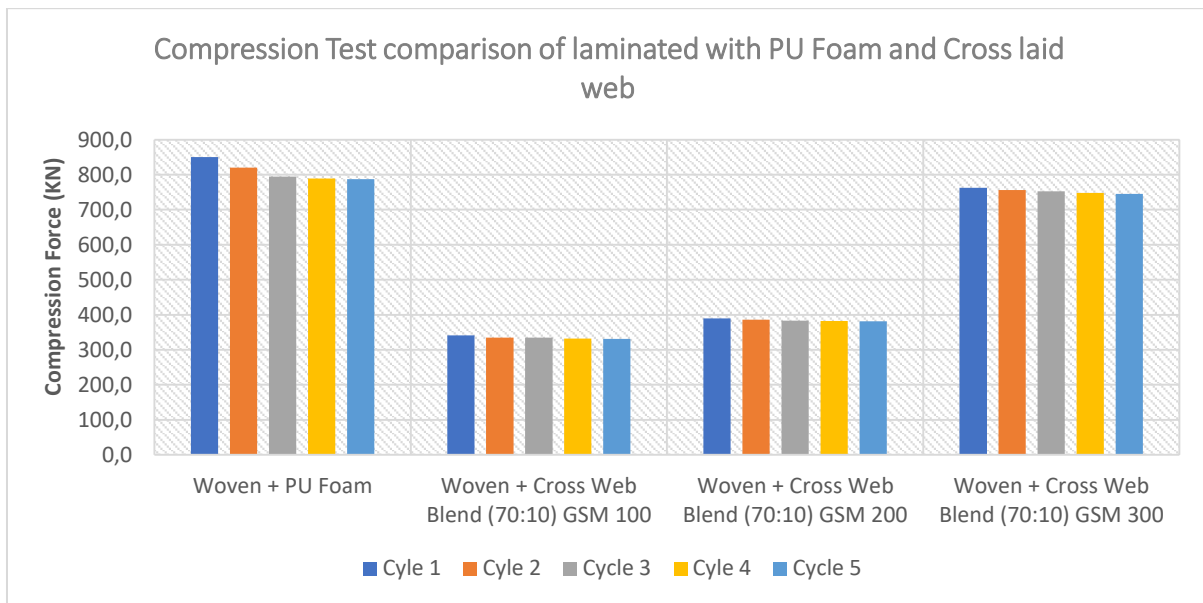

Graph 21. Compression test of Laminated woven with PU foam of sample S26 and cross laid web of samples S17, S18 & S16

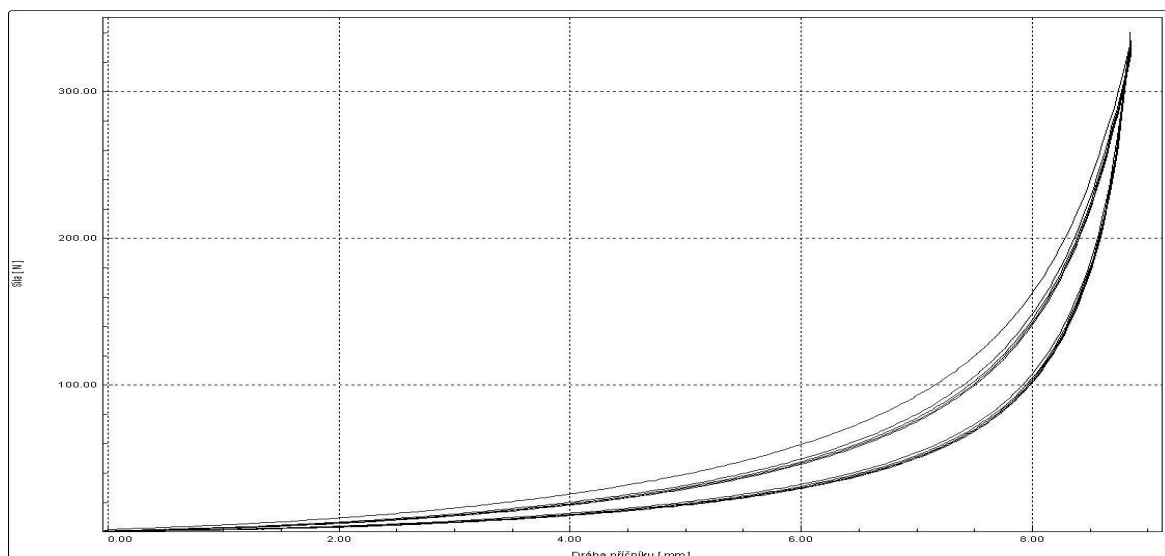

Graph 22. Compression test result for sample S17

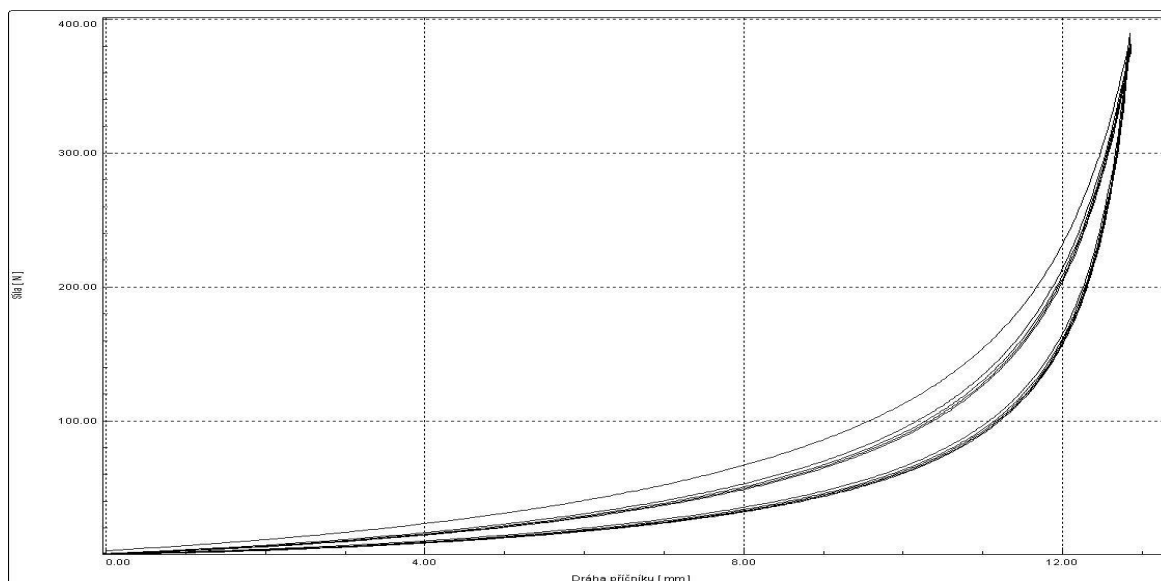

Graph 23. Compression test result for sample S18

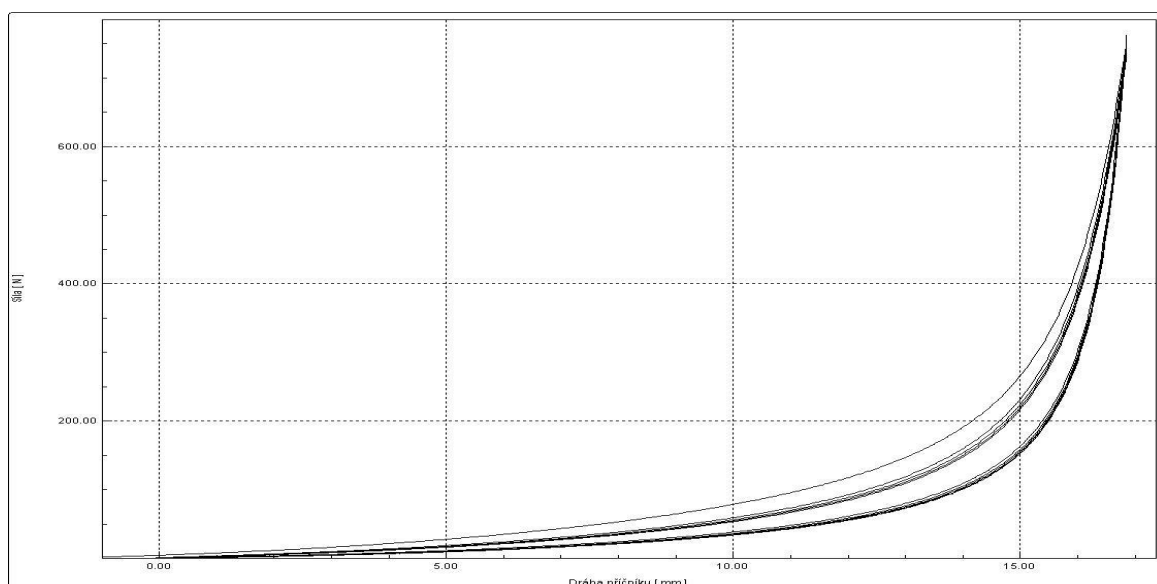

Graph 24. Compression test result for sample S19

Material	Cycle 1	Cycle 2	Cycle 3	Cycle 4	Cycle 5	Difference	Difference %
Woven + PU Foam	850,6	819,9	794,6	788,7	787,6	63,0	7,4
Woven + Cross Web Blend (70:10) GSM 100	340,8	334,8	334,4	332,2	331,4	9,4	2,7
Woven + Cross Web Blend (70:10) GSM 200	389,8	386,3	383,1	382,4	381,6	8,2	2,1
Woven + Cross Web Blend (70:10) GSM 300	762,5	755,7	752,2	748,3	744,9	17,6	2,3

Table 21. Compression test result for samples S17, S18, S19 and S26

Descriptive Analysis	Woven + PU Foam	Woven + Cross Web Blend (70:10) GSM 100	Woven + Cross Web Blend (70:10) GSM 200	Woven + Cross Web Blend (70:10) GSM 300
Mean	808,3	334,7	384,6	752,7
Standard Error	12,1	1,6	1,5	3,1
Median	794,6	334,4	383,1	752,2
Standard Deviation	27,1	3,7	3,4	6,8
Sample Variance	731,8	13,6	11,7	46,5
Covariance	585,4	10,8	9,3	37,2
Count	5,0	5,0	5,0	5,0

Table 22. Descriptive analysis test result for samples S17, S18, S19 and S26

From the graph 21, we can see that overall results of compression force of samples S17, S18 and S19 having poor results as comparable to the sample S26. The range of the compression force of sample S17 and S18 from 340 to 390 kN which is comparable very less than the commercial material of sample S26. In sample S19 with range of 764 to 744 kN having marginally close to the sample with range of 850, 6 kN.

In appearance aspects, some of the perpendicular laid perpendicular having more bulkiness with increasing of weight, which are practically not suitable for lamination due to difficult in material handling. Moreover, we have seen the crease marks after the lamination which are demerit to the final product appearance.

4.9. Comparison for compression test for Laminated knitted fabric with Poly-urethane foam (Commercial) and Perpendicular web with different weight

In this experiments part, the samples 20, 21 are cross laid nonwoven web are laminated with face fabric of knitted structure and compared with the commercial material of sample 28 which is the laminated face fabric of knitted structure with polyurethane foam.

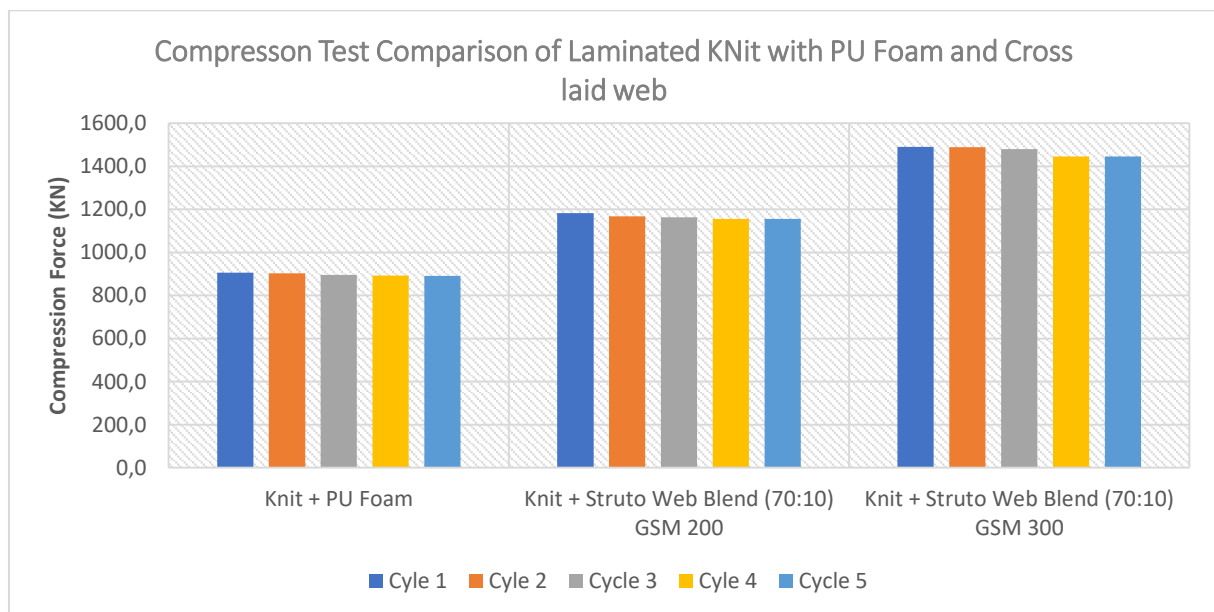

Graph 25. Compression test of Laminated Knit with PU foam of sample S28 and cross laid web of samples S20 & S21

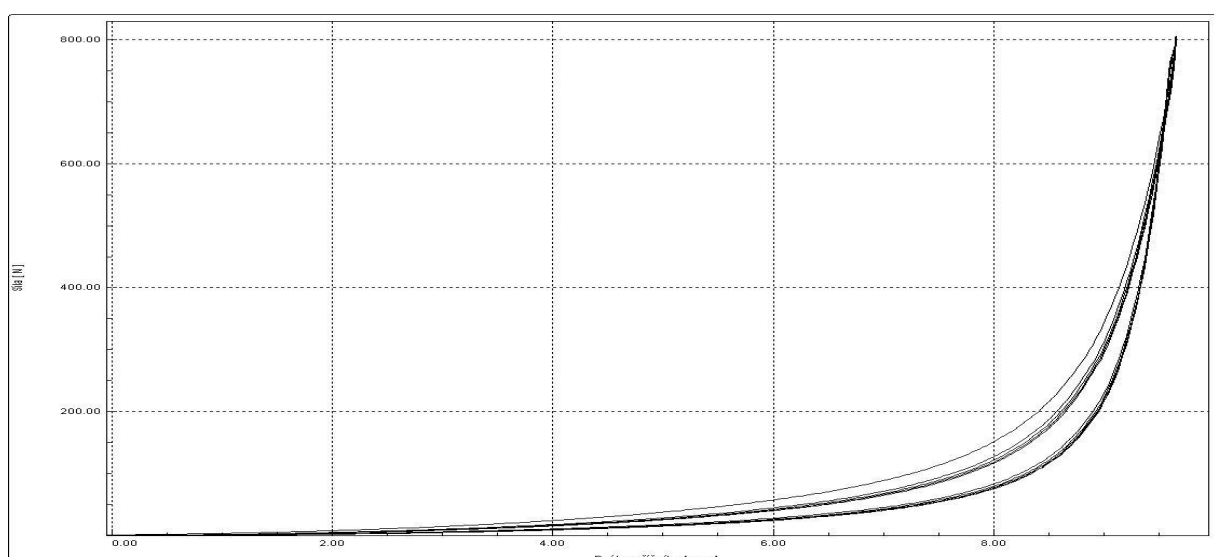

Graph 26. Compression test result for sample S28

Material	Cycle 1	Cycle 2	Cycle 3	Cycle 4	Cycle 5	Difference	Difference %
Knit + PU Foam	905,5	902,1	895,8	892,7	890,2	15,3	1,7
Knit + Struto Web Blend (70:10) GSM 200	1182,24	1166,86	1163,58	1155,72	1155,4	26,8	2,3
Knit + Struto Web Blend (70:10) GSM 300	1489,72	1489,1	1479,33	1446,07	1445,45	44,3	3,0

Table 23. Compression test result for samples S20, S21 and S28

Descriptive Analysis	Knit + PU Foam	Knit + Strut Web Blend (70:10) GSM 200	Knit + Struto Web Blend (70:10) GSM 300
Mean	897,3	1164,8	1469,9
Standard Error	2,9	4,9	10,0
Median	895,8	1163,6	1479,3
Standard Deviation	6,4	11,0	22,5
Sample Variance	41,0	120,2	504,0
Co-variance	32,8	96,1	403,2
Count	5,0	5,0	5,0

Table 24. Descriptive analysis test result for samples S20, S21 and S28

In the graph 25, We can see compression force result of sample 20 and S21 with range of 1000 to 1400 kN approx. which seems to be good results as comparable to the commercial product having the compression force with the range of 900kN. In aspects of the compression cycles difference, sample 20 and 21 having the marginal difference with 2,3% and 3% which can be within the tolerance limit.

In appearance aspects, some of the cross laid perpendicular having more bulkiness with increasing of weight, which are practically not suitable for lamination due to difficult in material handling. Moreover, we have seen the crease marks after the lamination which are demerit to the final product appearance.

4.10. Comparison for compression test for Laminated Knitted fabric with Poly-urethane foam (Commercial) and Cross web with different weight

In this experiments part, the samples 22, 23 and 24 are cross laid nonwoven web with same fibre blend proportion having different weight of the material such as 100, 200 and 300 GSM (gm/sq.mtr) and are laminated with face fabric of Knitted structure and compared with the commercial material of sample 28 which is the laminated face fabric of Knitted structure with polyurethane foam.

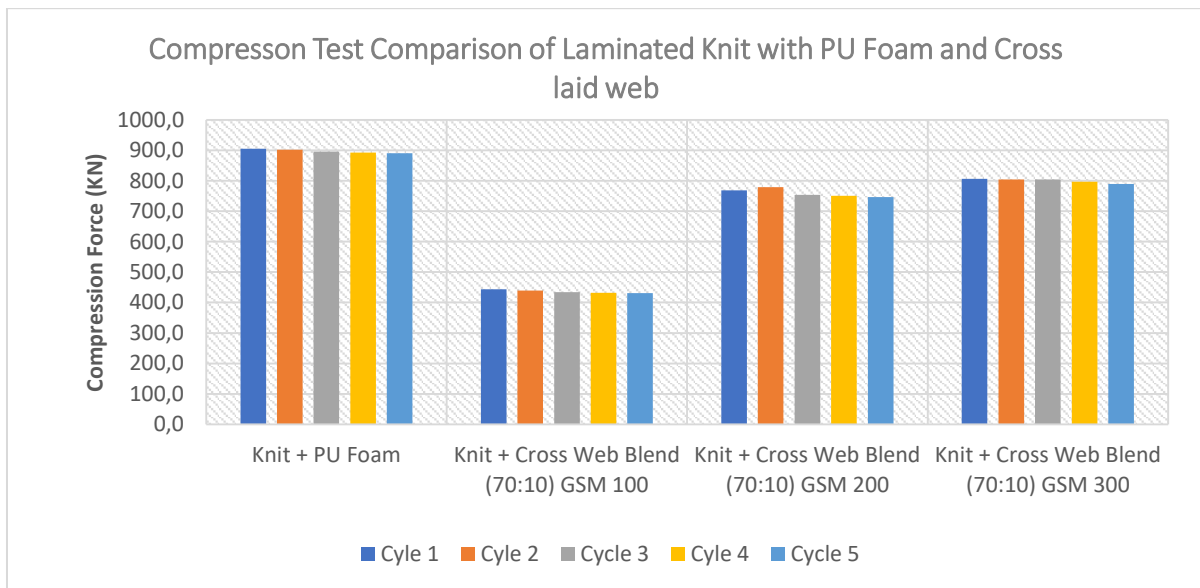

Graph 27. Compression test of Laminated Knit with PU foam of sample S28 and cross laid web of samples S22, S23 & S24

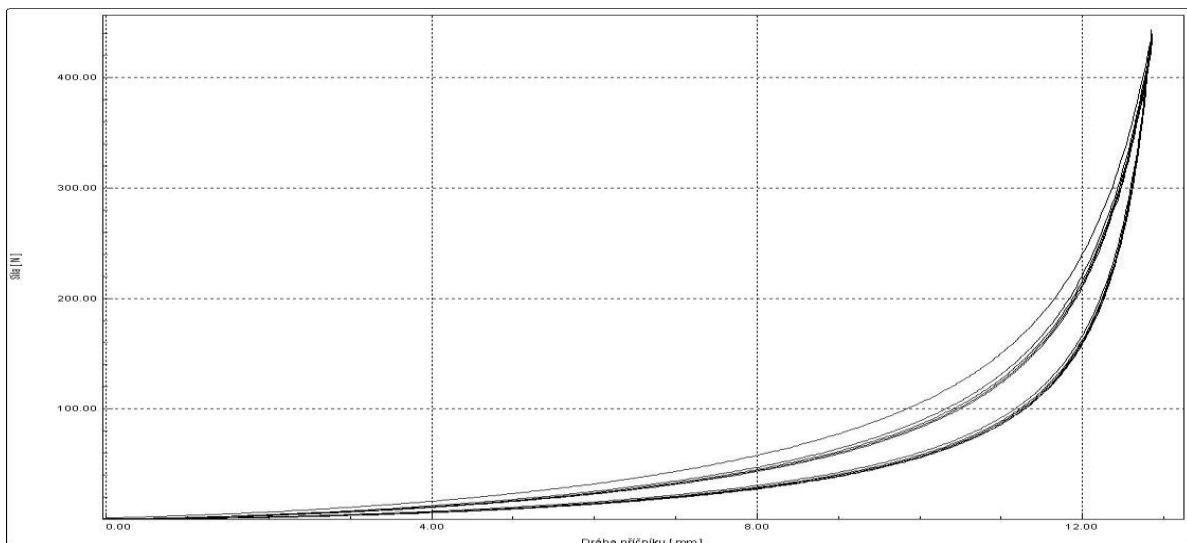

Graph 28. Compression test result for sample S22

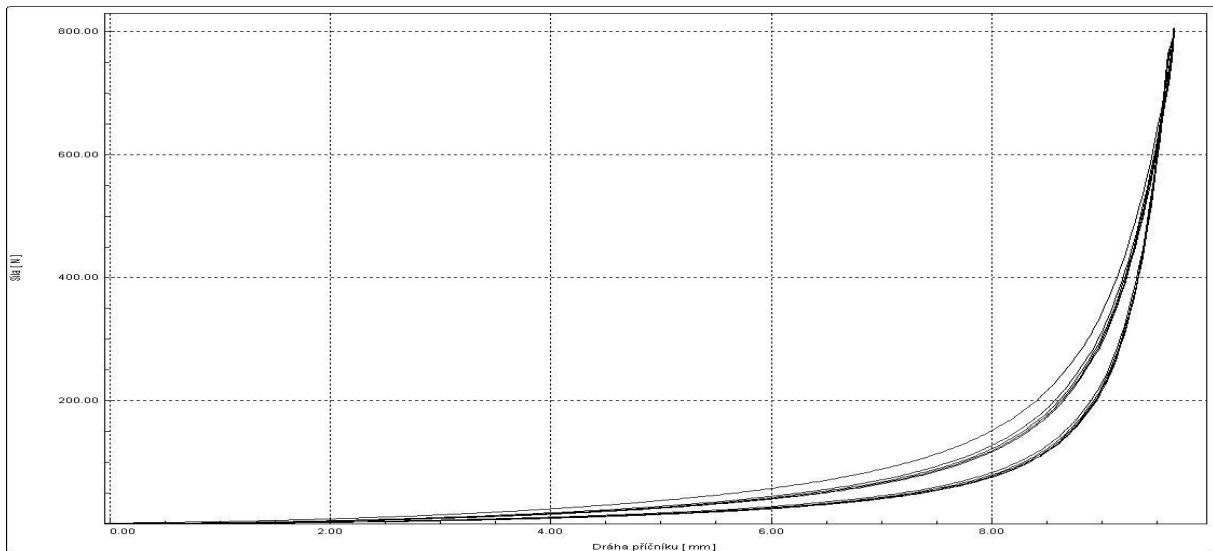

Graph 29. Compression test result for sample S23

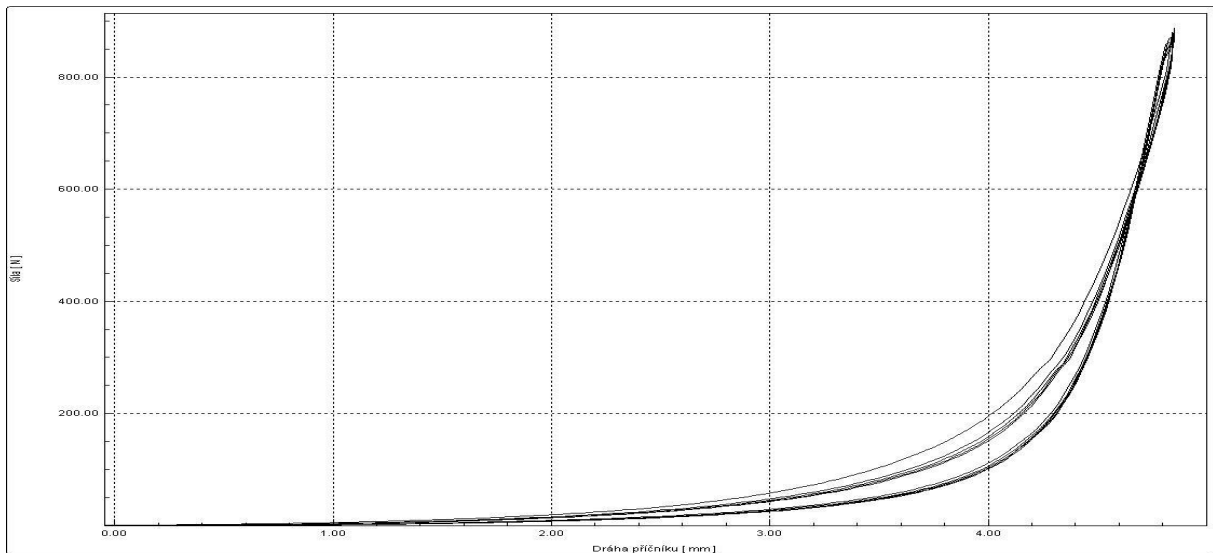

Graph 30. Compression test result for sample S24

Material	Cyle 1	Cyle 2	Cycle 3	Cyle 4	Cycle 5	Difference	Difference %
Knit + PU Foam	905,5	902,1	895,8	892,7	890,2	15,3	1,7
Knit + Cross Web Blend (70:10) GSM 100	443,4	439,6	434,5	432,5	430,5	12,9	2,9
Knit + Cross Web Blend (70:10) GSM 200	768,9	778,8	754,2	750,1	746,8	22,1	2,9
Knit + Cross Web Blend (70:10) GSM 300	806,4	804,6	804,3	796,8	789,0	17,4	2,2

Table 25. Compression test result for samples S22, S23, S24 and S28

Descriptive Analysis	Knit + PU Foam	Knit + Cross Web Blend (70:10) GSM 100	Knit + Cross Web Blend (70:10) GSM 200	Knit + Cross Web Blend (70:10) GSM 300
Mean	897,3	436,1	759,8	800,2
Standard Error	2,9	2,4	6,1	3,2
Median	895,8	434,5	754,2	804,3
Standard Deviation	6,4	5,3	13,6	7,3
Sample Variance	41,0	28,3	184,6	52,8
Covariance	32,8	22,6	147,7	42,2
Count	5,0	5,0	5,0	5,0

Table 26. Descriptive analysis test result for samples S22, S23, S24 and S28

In the graph 27, we can see the sample S22 which having cross laid web weight of 100 GSM (gm/sq.mtr) show comparably less compression results with approx. range of 440 kN whereas sample S23 have a less difference in between with range approx. 768kN to 740kN as compare to the commercial sample S28 with range of 900kN. The sample S24 having range of 800kN shown marginal difference with the commercial sample S28.

In appearance aspects, some of the cross laid perpendicular having more bulkiness with increasing of weight, which are practically not suitable for lamination due to difficult in material handling. Moreover, we have seen the crease marks after the lamination which are demerit to the final product appearance.

4.11 Comparison for Stiffness test (bending length) woven laminated with PU foam and Struto web with different fibre blend proportion

In this experimental part, we have tested samples for bending length i.e. stiffness of the material and compared with the commercial samples. The sample S26 are the woven laminated with PU foam which is the commercial sample compared with the samples S11, S12 and S13 are the perpendicular laid web with different fibre blend proportion.

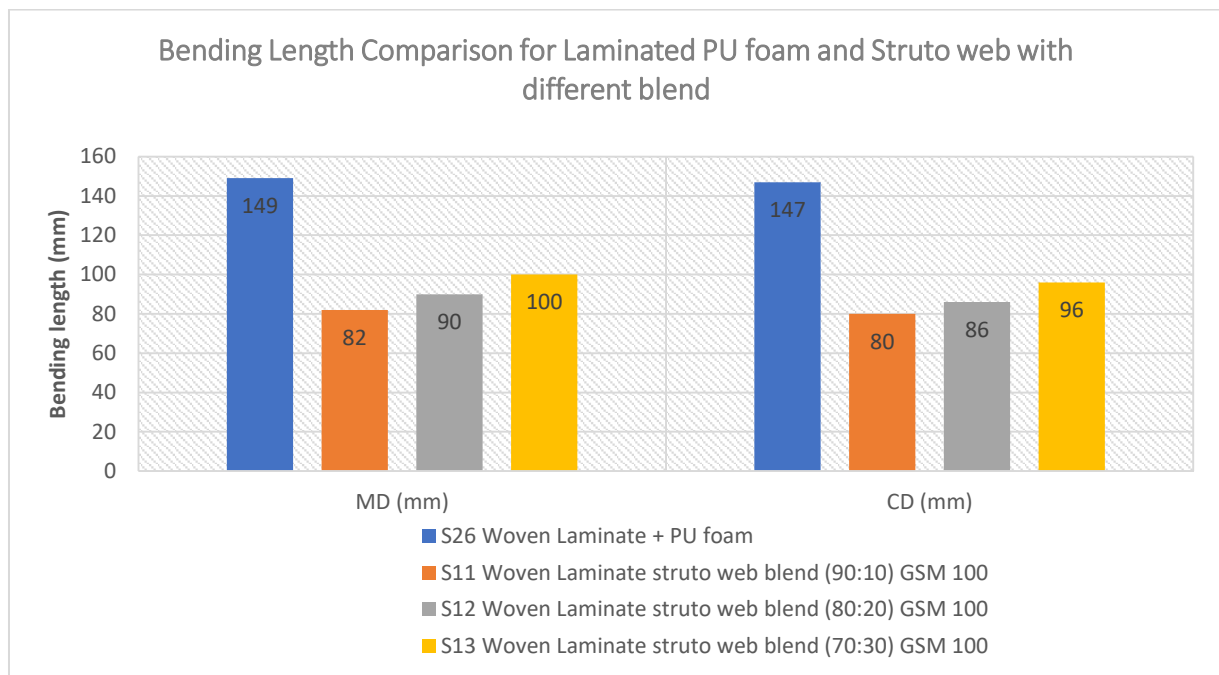

Graph 31. Bending length test result for sample S26 with samples S11, S12 & S13

Sr. No	Samples	Material	MD (mm)	CD (mm)
1	S26	Woven Laminate + PU foam	149	147
2	S11	Woven Laminate struto web blend (90:10) GSM 100	82	80
3	S12	Woven Laminate struto web blend (80:20) GSM 100	90	86
4	S13	Woven Laminate struto web blend (70:30) GSM 100	100	96

Table 27. Bending length test result for samples S11, S12, S13 and S26

In the graph 21, we can see that the sample 26 having a bending length of 149mm which is comparable higher than other samples S11 with 82mm, S12 with 90mm and S13 with 100mm. In the bending length test, higher the bending length more will be the stiffness. The sample S11, S12 and S13 shown less stiffness as comparable to the standard commercial samples.

4.12 Comparison for Stiffness test (bending length) Woven laminated with PU foam and Struto web with GSM 100, 200 & 300

In this experimental part, the samples S13, S15 and S18 are the perpendicular laid web with same fibre blend proportion having different GSM 100, 200 and 300 compared the commercial sample S26.

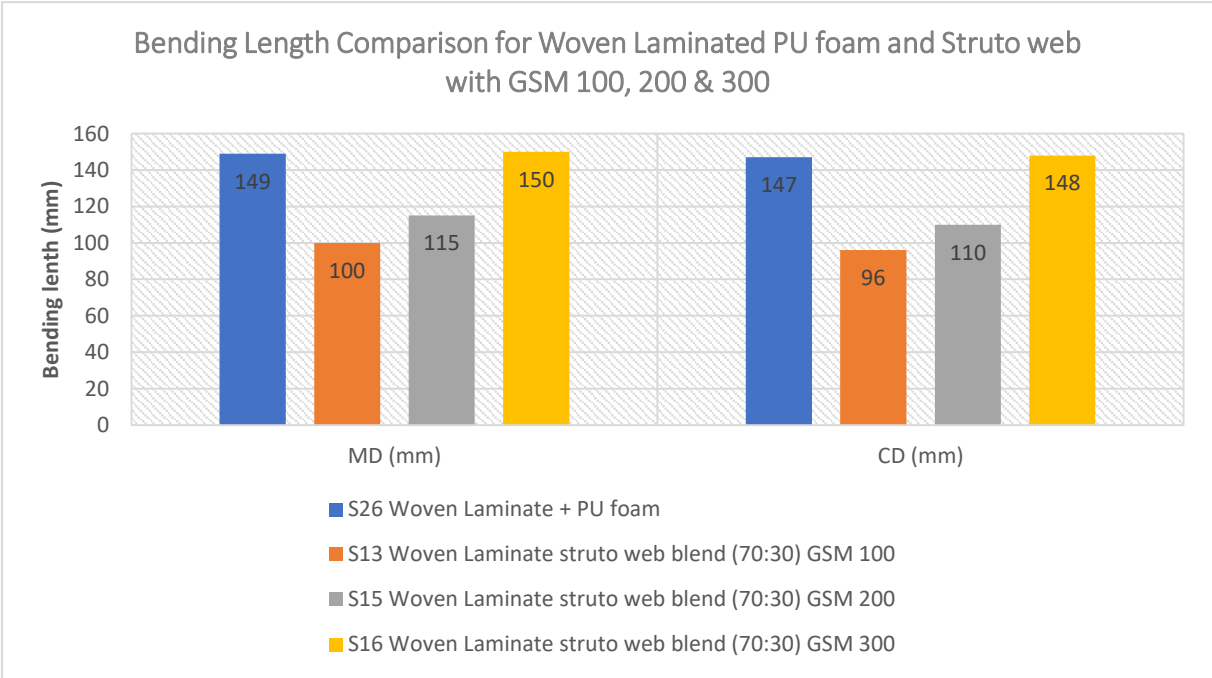

Graph 32. Bending length test result for sample S26 with samples S13, S15 & S16

Samples	Material	MD (mm)	CD (mm)
S26	Woven Laminate + PU foam	149	147
S13	Woven Laminate struto web blend (70:30) GSM 100	100	96
S15	Woven Laminate struto web blend (70:30) GSM 200	115	110
S16	Woven Laminate struto web blend (70:30) GSM 300	150	148

Table 28. Bending length test result for samples S13, S15, S16 and S26

From the graph 32, we can see the commercial sample 26 and samples S16 with weight of 300 GSM having almost same results which mean that ideally it can be use for the cushioning material. The sample S13 and S15 shown less stiffness because of less weight of GSM 100 and 200.

4.13 Comparison for Stiffness test (bending length) Knitted laminated with PU foam and Struto web with GSM 200 & 300

In this experimental part, the samples S20 and S21 are the perpendicular laid web with same fibre blend proportion having different GSM 200 and 300 compared the commercial sample S26.

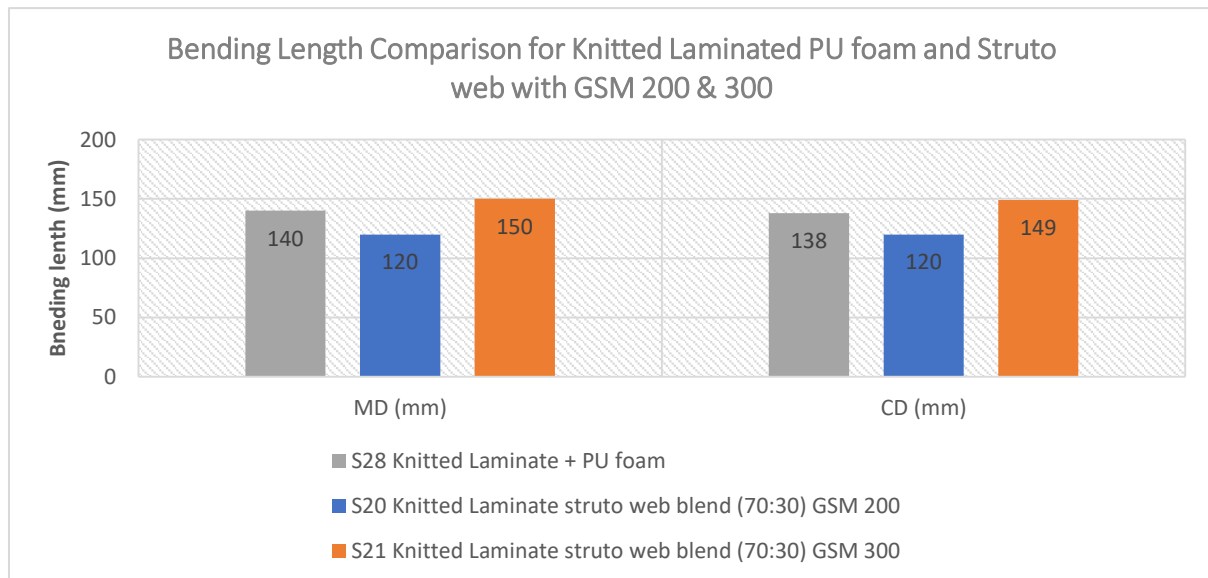

Graph 33. Bending length test result for sample S28 with samples S20 & S21

Samples	Material	MD (mm)	CD (mm)
S28	knitted Laminate + PU foam	140	138
S20	knitted Laminate struto web blend (70:30) GSM 200	120	120
S21	knitted Laminate struto web blend (70:30) GSM 300	150	149

Table 29. Bending length test result for samples S20, S21 and S28

From the graph 32, we can see the commercial sample 28 and samples S21 with weight of 300 GSM having almost higher results which mean that ideally it cannot be use for the cushioning material. The sample S20 shown less stiffness because of less weight of GSM 200.

4.14 Comparison for Stiffness test (bending length) Woven laminated with PU foam and Cross web with GSM 100, 200 & 300

In this experimental part, the samples S17, S18 and S19 are the cross laid web with same fibre blend proportion having different GSM 100, 200 and 300 compared the commercial sample S28.

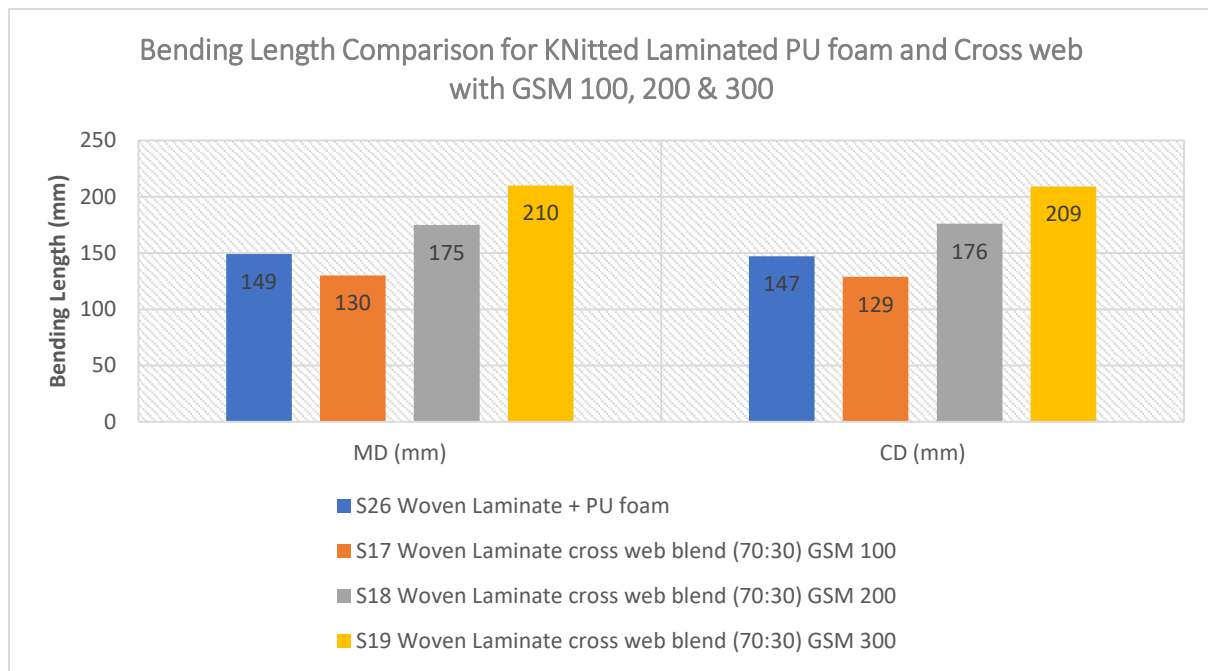

Graph 34. Bending length test result for sample S28 with samples S17, S18 & S19

Samples	Material	MD (mm)	CD (mm)
S17	Woven Laminate cross web blend (70:30) GSM 100	130	129
S18	Woven Laminate cross web blend (70:30) GSM 200	175	176
S19	Woven Laminate cross web blend (70:30) GSM 300	210	209
S28	Woven Laminate + PU foam	140	138

Table 30. Bending length test result for samples S17, S18, S19 and S28

From the graph 34, We can see that the sample S19 which having web weight of 300 GSM shown very high stiffness as comparable to the commercial sample S28 with 140mm bending length. We can say that sample S19 is not suitable for the cushioning material. The other sample S18 also shown high stiffness which is also not suitable commercially. The problem facing with cross laid web was high bulkiness result in difficult to handle.

4.15 Comparison for Stiffness test (bending length) Knitted laminated with PU foam and Cross web with GSM 100, 200 & 300

In this experimental part, the samples S22, S23 and S24 are the cross laid web with same fibre blend proportion having different GSM 100, 200 and 300 compared the commercial sample S28.

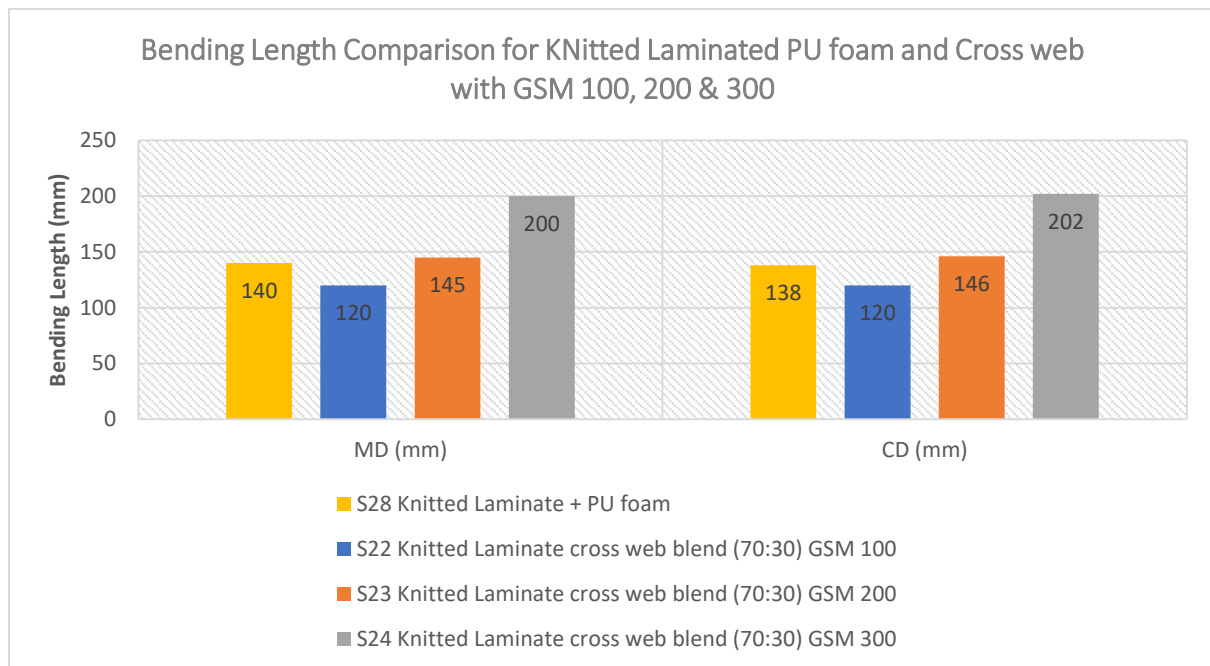

Graph 35. Bending length test result for sample S28 with samples S22, S23 & S24

Samples	Material	MD (mm)	CD (mm)
S22	knitted Laminated cross web blend (70:30) GSM 100	120	120
S23	knitted Laminated cross web blend (70:30) GSM 200	145	146
S24	knitted Laminated cross web blend (70:30) GSM 300	200	202
S28	knitted Laminated + PU foam	140	138

Table 31. Bending length test result for samples S22, S23, S24 and S28

From the graph 35, We can see that the sample S24 which having web weight of 300 GSM shown very high stiffness as comparable to the commercial sample S28 with 140mm bending length. We can say that sample S24 is not suitable for the cushioning material. The problem facing with cross laid web was high bulkiness result in difficult to handle.

5 Conclusion

From the overall experimental work with different types of thermal bonded nonwoven, we can conclude about thesis work with the following points.

Based on the fibre blend proportion and weightage of the different thermal bonded we can conclude in the following points;

- In terms of preparation of web i.e. perpendicular laid web from the struto lapper and the cross laid web from the cross lapper given certain merits and de-merits of the material with different fibre blend proportion. From the experiment 4.2 to 4.3, We have seen that fibre blend proportion of PES/BiC with blend ratio 70:30 given better results compared to the commercial sample of Poly-urethane foam in compression test. The results of the material weight with 300 GSM (gm/sq.mtr) performed better positively.
- In the comparison between perpendicular laid web and cross laid web, the perpendicular laid web performance was thrilling with positive results whereas cross laid had de-merit of high bulkiness with increasing of the weight.

Based on the lamination experimental part with face fabric of woven and KNitted structure, we can conclude on the following points;

- From the lamination experiment 4.4 to 4.10, We have seen the laminated material of woven and KNitted structures with perpendicular laid web containing fibre blend proportion of PES/BiC with blend ratio 70:30 shown better result consequently. The weight of material 300 GSM (gm/sq.mtr) had pleasant results comparatively with commercial laminated samples for compression testing and stiffness test.
- The lamination bonding strength with face fabric with perpendicular laid web containing different fibre blend proportion with ratio of 80:20 and 70:30 and weight of 200 and 300 GSM (gm/sq.mtr) was very high as comparable to the other laminated samples. The bonding force between the material given splendid performance. The performance of the cross laid material with the weightage of GSM 200 and 300 was good.

Based on the testing part for the compression force test and the stiffness of the material, we can conclude on the below points;

- From the testing experimental part 4.4 to 4.10 for mechanical testing with compression force testing given enormous pleasant results for laminated samples with perpendicular laid web. The compression force results difference between the cycles was better than the laminated samples with cross laid web with different blend proportion and weight. Even as comparable to the commercial sample with poly-urethane foam and laminated samples with poly-urethane foam, the compression force cycles difference was very less.
- In the experimental part 5.1 to 5.5 for testing of bending length i.e. the stiffness of the material for the laminated material had given admirable result as comparing with commercial samples. The positive result achieved from the laminated material with perpendicular laid web from the struto lapper containing fibre blend proportion with ratio 70:30 of the weight GSM 300 (gm/sq.mtr). The bending length was almost same compared to the commercial laminated samples.
- From the overall experiments, we can conclude that perpendicular laid web from the struto lapper with the fibre blend proportion 70:30 and the weight more than 200 GSM (gm/sq.mtr) will be suitable for the cushioning material of the automotive seating segments.

6 Future Work

- Accuracy of the blend proportion for the Bi-component fibre because of the expensive prices and substitution of different fibre material
- Fibres with different fineness or physical properties
- The textile comfort properties such as air permeability.
- Flammability of the material
- Textile comfort such as thermal properties of the fibre and laminated materials

7 REFERENCES

1. R. Shishoo, Textile advances in automotive industry, The Textile Institute, Woodhead Publishing.
2. R.A Chapman, Applications of nonwovens in technical textiles, The Textile Institute, Woodhead Publishing, 2010.
3. W. Albrecht, H. Fuchs, W. Kittelmann, Nonwoven Fabrics: Raw Materials, Manufacture, Applications, Characteristics, Testing Processes, Copyright © 2003 WILEY-VCH Verlag GmbH & Co. KGaA, Weinheim ISBN: 3-527-30406-1
4. S.J. Russell, Handbooks of nonwovens, The Textile Institute, Woodhead Publishing.
5. Ki-Young Kim, Sung Jun Doh, Jung Nam Im, Won Young Jeong, Hyo Jin An and Dae Youn Lim, Preparation of textile nonwoven foam using elastomeric binder fibers for automotive cushioning materials, Department of textile convergence of biotechnology & nanotechnology, Korea Institute of Industrial Technology, Ansan, South Korea.
6. Batra S.K, Cook F.L, Goswami B, Vaughn E, Wadsworth C. L, Nonwoven Fabrics Handbook, "Introduction" INDA, Association of the Nonwoven Fabrics Industry (1999).
7. The Nonwovens Handbook, INDA, Association of the Nonwoven Fabrics Industry, (1988).
8. A. Wilson, Automotive Textiles: The Global Supply Chain to OEMs, Textile Media Services, 2007, pp. 13–18.
9. W.C. Smith, Nonwovens in Automotives – More than Just a Pretty Face, International Nonwovens Journal, Fall, 2004, p. 60.
10. S. Yan, L. Sun, O. Chiparus, I. Negulescu, V. Yachmenev, M. Warnock, Kenaf/ Ramie Composite for Automotive Headliner, Journal of Polymers and the Environment, Vol. 13, No. 2, April 2005, pp. 107–114
11. C. Kalogeridis, Stage is set: a new range of advanced nonwoven fabric technologies is gearing up to challenge the market dominance of conventional textiles in the automotive interior supply chain, Automotive Industries, Jan, 2005.
12. Bottcher, P., Textile composites, their use in motor vehicle manufacture, and old care regulations, Industrial textile, ITS Publishing
13. Hunger, M., Naumann, S, Schimanz, B., Bottcher, P., Nonwovens for the interior of cars with recycling potential in accordance to Regulations on disposal of used cars, lecture Techtexil 2003, Frankfurt/Main

14. Schuh, T., Daimler-Chrysler AG, Stuttgart, Renewable Materials for Automotive Applications
15. Eller, R., Role of nonwovens in automotive interior surface and construction applications, Auto Interior 2003, Detroit
16. R. K. Dharmadhikary , T. F. Gilmore , H. A. Davis & S. K. Batra (1995): Thermal bonding of nonwoven fabrics, Textile Progress, 26:2, 1-37 8
17. Jirsák, O., Wadsworth, L.C. Nonwoven Textile, Carolina Academic Press. Durham; 1999.
18. X.Y. Wang *, R.H. Gong, Z. Dong, I. Porat, Abrasion resistance of thermally bonded 3D nonwoven fabrics, Textiles and Paper, School of Materials, The University of Manchester, P.O. Box 88, Sackville Street, Manchester, M60 1QD, UK, 24 July 2006
19. Oldrich Jirsak, Telem Gok Sadikoglu and Bulent Ozipek, Ning Pan, Thermo-Insulating Properties of Prependicular Laid Versus Cross Laid Lofty Nonwoven Fabrics, Technical university of liberec, Istanbul Technical university, University of Calofornia, Feb 2000.
20. Sizo Ncube, Lloyd Ndlovu, PethileSibanda, Yvonne Tusiimire, Airrpermeabilty properties of thermal bonded nonwoven fabrics, National University of Science and Technology, PO AC939, Ascot, Bulawayo, (ZIMBABWE) Airrpermeabilty properties of th ermal bonded nonwoven fabrics, MSAIJ, 12(7) 2015
21. Mevlut Tascan, Ph.D., Edward A. Vaughn, Ph.D. , Effects of Fiber Denier, Fiber Cross-Sectional Shape and Fabric Density on Acoustical Behavior of Vertically Lapped Nonwoven Fabrics, Clemson University, Clemson, South Carolina, USA, Journal of Engineered Fibers and Fabrics 32 <http://www.jeffjournal.org> Volume 3, Issue 2—2008

ABBREVIATIONS

Cm	Centimetre
g/m^2	Grams per square area
mm	Milligram metre
m/min	Metre per minute
$^{\circ}C$	Degrees Celsius
Kg/m^2	Mass per square area
A	Area of the specimen
C	The mean of bending length
CD	Cross machine direction/Transverse direction
G_{MD}	Flexural rigidity of machine direction
G_{CD}	Flexural rigidity of cross machine direction
MD	Machine direction/Longitudinal direction
PET	Polyethylene terephthalate
BiC	Bi-Component
SB	Spun bond material
W	Weight of the sample in grams per square area