

Czech University of Life Sciences Prague

Faculty of Economics and Management

Department of Information Technology



Bachelor Thesis

Smart Home using Pi

Meet Bagadia

© 2023 CZU Prague

CZECH UNIVERSITY OF LIFE SCIENCES PRAGUE

Faculty of Economics and Management

BACHELOR THESIS ASSIGNMENT

Bc. Meet Bagadia

Informatics

Thesis title

Smart Home using Pi

Objectives of thesis

The objective of this thesis is to devise an ambient environment, that will adjust the lightning and temperature according to the outdoor weather. Utilization of open APIs will be done to fetch the weather data. Raspberry pie 3 will be used for hardware and for coding python will be used. Motion sensors will also be incorporated to detect absence of people and switch off accordingly.

Methodology

Comprehensively study the existing models and applications of smart homes. Utilization of Raspberry pie 3 board for the devising the system by programming appropriate software needed.

The proposed extent of the thesis

40-50

Keywords

IoT, Smart home, Smart device, Raspberry, python, UX, APIs, Sensors

Recommended information sources

- Adib F, M. H. (2015). . Smart homes that monitor breathing and heart rate. . Proceedings of the 33rd annual ACM Conference on Human Factors in Computing Systems, Seoul, Republic of Korea. Korea.
- Alam MR, R. M. (2012). A review of smart homes: past, present,. IEEE Transactions on Systems, Man, and Cybernetics, Part C (Applications and Reviews),. 1190–1203.
- Anindya Nag, M. E. (2019). IoT for smart homes.
- Ghayvat H, M. S. (2015). Internet of things for smart homes and buildings. Australian Journal of Telecommunications and the Digital Economy., 33-47

Expected date of thesis defence

2022/23 WS – FEM

The Bachelor Thesis Supervisor

Ing. Tomáš Vokoun

Supervising department

Department of Information Technologies

Electronic approval: 23. 8. 2021

doc. Ing. Jiří Vaněk, Ph.D.

Head of department

Electronic approval: 5. 10. 2021

Ing. Martin Pelikán, Ph.D.

Dean

Prague on 20. 02. 2023

Declaration

I declare that I have worked on my bachelor thesis titled "**Smart Home using Pi**" by myself and I have used only the sources mentioned at the end of the thesis. As the author of the bachelor thesis, I declare that the thesis does not break any copyrights.

In Prague on 2023

Acknowledgement

I would like to thank The **Czech University of Life Sciences Prague** and my supervisor, **Ing. Tomas Vokoun**, for providing me with this excellent thesis topic and allowing me to conduct research on it. They were constantly encouraging while I was researching on my thesis.

I'd also like to thank all my family, friends, and incredible worldwide friends and acquaintances who have consistently believed in me and assisted me in achieving my goals.

IoT in Smart Home

Abstract

The utilization of smart homes in real-time applications has surged due to the quality of life they provide to the residents. Internet of things (IoT) based smart homes use many IoT-connected daily used commercially available items. These devices are utilized in smart homes for ubiquitous monitoring of the different activities of the residents. The main objective of this thesis is to design a home surveillance and automation system by utilizing microcontrollers like Raspberry Pi and integrating various sensors like LPG sensors, Fire detecting sensors, Infrared sensors, etc. Through this system, the owner will be able to seek surveillance remotely and can perform various actions according to the situation.

Keywords: IoT, Smart home, Smart device, Raspberry, python, UX, APIs, Sensors

IoT v chytré domácnosti

Abstraktní

Využití chytrých domů v aplikacích v reálném čase prudce vzrostlo kvůli kvalitě života, kterou poskytují obyvatelům. Chytré domácnosti založené na internetu věcí (IoT) využívají mnoho denně používaných komerčně dostupných položek připojených k internetu věcí. Tato zařízení se využívají v chytrých domácnostech pro všudypřítomné sledování různých aktivit obyvatel. Hlavním cílem této práce je navrhnout domácí dohledový a automatizační systém s využitím mikrokontrolérů jako Raspberry Pi a integrací různých senzorů, jako jsou LPG senzory, senzory pro detekci požáru, infračervené senzory atd. Prostřednictvím tohoto systému bude majitel moci vyhledávat dohled na dálku a může provádět různé akce podle situace.

Klíčová slova: IoT, chytrá domácnost, chytré zařízení, Raspberry, python, UX, API, sensory

Table of Contents

1. Introduction	1
2. Objective & Methodology	2
2.1 Objectives.....	2
2.2 Methodology	2
3. Literature Review	3
3.1 IoT based smart homes.....	3
3.2 Classic smart home overview.....	4
3.2.1 Smart home administrations	5
3.3 IoT Overview	6
3.3.1 Distributed computing and its commitment to IoT and smart home	6
3.4 Research on the current situation of IoT	8
3.4.1 Research on the assistance processing and part innovations	9
3.4.2 A sample about smart home to use IOT and component technologies	10
3.5 Models for smart home	15
3.6 Architecture of smart homes	18
4. Practical Part.....	25
4.1 Implementation	25
4.2 Image of Sensor.....	30
4.2.1 Tasks	32
4.3 Exploring the time series.....	33
5. Results and Discussion	39
6. Conclusion.....	40
7. References	42
8. Attachment	47

List of Figures

Figure 1: Schematic diagram of the working phenomenon of a general smart (Kim, M.J., Cho, M.E. and Jun, H.J., 2020).....	4
Figure 2: Schematic diagram of an IoT-enabled smart home (Stolojescu-Crisan, C., Crisan, C. and Butunoi, B.P., 2021)	12
Figure 3: Commercial thermostat used in smart homes (Nag, A. et al., 2019).....	13
Figure 4: Commercial video cameras used in smart homes (Nag, A. et al., 2019).....	14
Figure 5: Framework of our study (Own Source).....	25
Figure 6: The utilisation of items to frame the Smart home IOT system (Alavi, A.H., Jiao, P., Buttlar, W.G. and Lajnef, N., 2018)	26
Figure 7: Flow of work (Own Source).....	27
Figure 8: Results (Own Source).....	29
Figure 9: Sample reading from different IOT devices (Own Source)	34
Figure 10: Different parameters detected by IOT devices (Own Source)	35
Figure 11: Time series data collected by IOT devices on daily and hourly basis (Own Source).....	37

List of Tables

Table 1: Sensors (Alam, M.R., Reaz, M.B.I. and Ali, M.A.M., 2012).....	15
Table 2: Dataset (Own Source)	31

List of Attachment

Attachment 1: Dynamo Dataset (Own Source)	47
---	----

1. Introduction

With the growth of science and technology, many ways are being employed to improve the quality of human life. Intensive research and works have been conducted for the implementation of specific methodologies in terms of electronic assistance to increase the longevity of human life. One of the prominent ways of achieving this goal has been the implementation of smart homes (Nag, A. et al., 2019). The significance of smart homes lies in the precise monitoring of people and their day-to-day life and identifying any abnormality in comparison to their normal life. Among the different types of specialized accommodations for monitoring people in research-based conditions, smart homes have been a standout. In these smart homes, the sensors are incorporated at different locations to identify the movements and activities of the residential elderly people. One of the biggest advantages of smart homes is the automated monitoring system that efficiently keeps track of the minute changes taking place in every individual's life. The following figure depicts a schematic diagram of the operating phenomena of a smart home (Chan, M., Estève, D., Escriba, C. and Campo, E., 2008). The sensors in the figure form a sensor network to communicate among each other to provide signals to the monitoring unit through a gateway. The monitoring unit immediately prompts the family members or medical staff in case of emergency. This approach is an effective way to significantly reduce the probability of casualties.

These smart sensing devices utilize the Internet of Things (IoT) enabled technology to control and monitor operations taking place inside the home in a controlled and easy manner. In this thesis, I will be comprehensively talking about some of the IoT- embedded commercial smart sensing devices that are utilized in smart homes. I will also be discussing the numerous parameters that are monitored along with their associated sensing systems in these specialized homes. The present Internet is presently extending towards Internet of Things (IoT).

2. Objective & Methodology

2.1 Objectives

The objective of this thesis is to devise an ambient environment, that will adjust the lightning and temperature according to the outdoor weather. Utilization of open APIs will be done to fetch the weather data. Raspberry pie 3 will be used for hardware and for coding python will be used. Motion sensors will also be incorporated to detect absence of people and switch off accordingly.

2.2 Methodology

Comprehensively study the existing models and applications of smart homes. Utilization of Raspberry pie 3 board for the devising the system by programming appropriate software needed.

The Raspberry Pi board would monitor and direct the sensing transducers and visionary devices for automation and surveillance. By utilizing PIR sensors to detect motion by sensing the infrared light radiating from a human, a GSM module that will communicate between a mobile device and a GSM system, an LPG gas sensor to identify gas leakage, and a fire detecting sensor. Figure 5 shows the Framework.

3. Literature Review

3.1 IoT based smart homes

- **Internet-of-Things:** The web where the existing organization of web to the PC frameworks will interface with this present reality items or things. Things may incorporate any articles, home machines, gadgets, vehicles, and so forth. What's more, when these things associate with the web in explicit foundation by means of standard conventions then the entire framework is supposed to be Internet of Things (IoT).
- **Things:** Things might be genuine or virtual, moving, or consistent however things will be dynamic members in the entirety framework. Things will speak with one another, called as things-to-things correspondence. Things will likewise be ready to impart or interface with human then it is called as things-to-human correspondence. Anyway, the web of things isn't simply profound vision for future. It is as of now here and is affecting something other than mechanical turn of events. These things, furthermore, imparting objects which used to convey with the web can arrange themselves autonomously, furthermore, can work without human mediation.
- **Smart Home:** A smart home is the home or that living climate having innovation to permit all the family gadgets/home apparatuses to be controlled naturally and can be controlled remotely. In Smart homes client can without much of a stretch screen and control all home gadgets/home apparatuses through web. Home apparatuses associate in predefined legitimate organization design and utilizing standard conventions. Fundamental thought for Savvy Homes utilizing IoT is displayed in figure 1. (Kim, M.J., Cho, M.E. and Jun, H.J., 2020)

The entire framework can be partitioned into two sections: in one section comprise every one of the home gadgets and switch modules furthermore, RF transmitter collector and in second part incorporate all the connection point gadget, processor, information authority, GPRS module that will speak with the web.

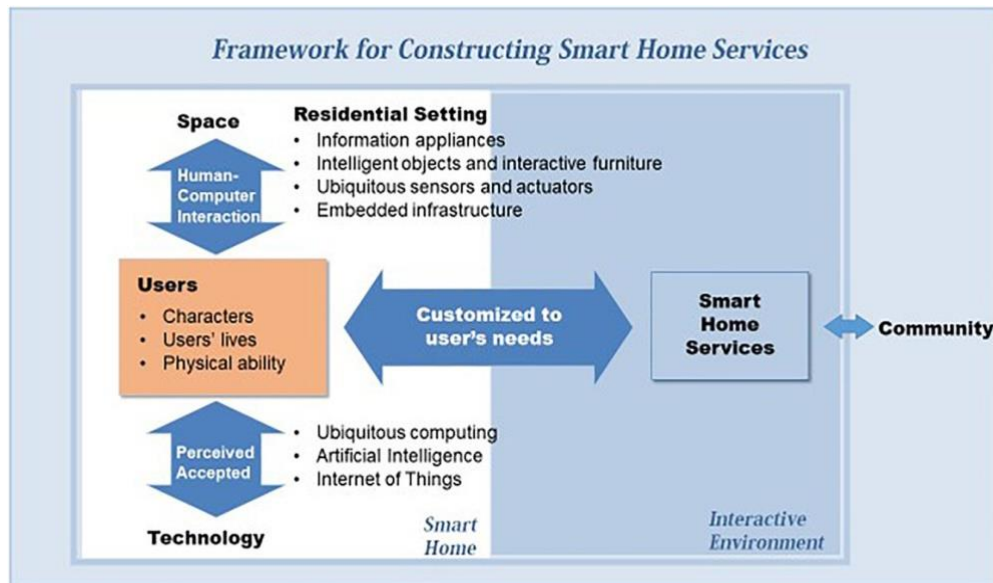

Figure 1: Schematic diagram of the working phenomenon of a general smart (Kim, M.J., Cho, M.E. and Jun, H.J., 2020)

3.2 Classic smart home overview

Smart home is the private augmentation of building mechanization and includes the control and robotization of all its implanted innovation. It characterizes a home that has machines, lighting, warming, cooling, TVs, PCs, amusement systems, large home apparatuses like washers/dryers and fridges/coolers, security also, camera frameworks equipped for speaking with one another and being controlled from a distance by a period plan, telephone, portable or web. These frameworks comprise of switches and sensors associated with a focal centre point constrained by the home occupant utilizing divider mounted terminal or portable unit associated with web cloud administrations.

Smart home gives security, energy productivity, low working expenses and accommodation. Establishment of Smart items give comfort and reserve funds of time, cash, and energy. Such frameworks are versatile and customizable to meet the continuous changing necessities of the home inhabitants. Much of the time its foundation is sufficiently adaptable to coordinate with a wide scope of gadgets from various suppliers what's more, guidelines.

The fundamental design empowers estimating home circumstances, process instrumented information, using microcontroller-empowered sensors for estimating home conditions and actuators for checking home installed gadgets.

The prominence and entrance of the Smart home idea is filling in a decent pace, as it turned out to be essential for the modernization and decrease of cost patterns. This is accomplished by installing the capacity to keep an incorporated occasion log, execute AI cycles to give principal cost components, saving recommendations and other helpful reports.

3.2.1 Smart home administrations

Measuring home circumstances

A run of the mill Smart home is furnished with a bunch of sensors for estimating home conditions, for example, temperature, dampness, light and closeness. Every sensor is committed to catch at least one estimation. Temperature and moistness may be estimated by one sensor, different sensors work out the light proportion for a given region what's more, the separation from it to each protest presented to it. All sensors permit putting away the information and imagining it so the client can see it anyplace and whenever. To do thus, it incorporates a sign processor, a correspondence interface, and a host on a cloud framework.

Managing home machines

Makes the cloud administration for overseeing home machines which will be facilitated on a cloud foundation. The overseeing administration permits the client, controlling the results of Smart actuators related with home apparatuses, for example, lights and fans. Smart actuators are gadgets, like valves and switches, which perform activities like turning things on or off or changing a functional system. Actuator gives an assortment of functionalities, for example, on/off valve administration, situating to rate open, balancing to control changes on stream conditions, crisis closure. To enact an actuator, a computerized compose order is given to the actuator. (Tayyaba, S. et al., 2020)

Controlling home access

Home access advancements are generally utilized for community entryways. A common framework utilizes a data set with the distinguishing proof credits of approved individuals. At the point when an individual is moving toward the entrance control framework, the individual's ID credits are gathered in a split second and contrasted with the data set. Assuming it matches the data set information, the entrance is permitted, in any case, the entrance is denied. For a wide dispersed establishment, I might utilize cloud administrations

for midway gathering people's information and handling it. Some utilization attractive or closeness recognizable proof cards, other use face acknowledgment frameworks, finger impression and RFID.

In a model execution, a RFID card and a RFID per user have been utilized. Each approved individual has a RFID card. The individual examined the card through RFID per user situated close to the entryway. The filtered ID has been sent by means of the web to the cloud framework. The framework presented the ID on the controlling help which compares the filtered ID against the approved IDs in the data set.

3.3 IoT Overview

The Internet of things (IoT) worldview alludes to gadgets associated with the internet. Gadgets are items like sensors and actuators, outfitted with a telecommunication interface, a handling unit, restricted capacity, and programming applications.

It empowers the mix of articles into the web, laying out the cooperation among individuals and gadgets. The vital innovation of IoT incorporates Radio-frequency identification (RFID), sensor innovation and knowledge technology. RFID is the establishment and systems administration centre of the development of IoT. Its handling and correspondence capacities alongside extraordinary calculations permits the reconciliation of an assortment of components to work as a coordinated unit however at the same time permit simple expansion and expulsion of parts with least effect, making IoT hearty yet adaptable to retain changes in the climate and client inclinations. To limit transmission capacity utilization, it is utilizing JSON, a lightweight variant of XML, for entomb parts and outside informing. (Das, A., Dash, P. and Mishra, B.K., 2017)

3.3.1 Distributed computing and its commitment to IoT and smart home

Distributed computing is a common pool of registering assets prepared to give a assortment of processing administrations in various levels, from essential foundation to most complex application administrations, handily allotted and delivered with negligible endeavours or specialist co-op association. Practically speaking, it oversees figuring, capacity, and

correspondence assets that are shared by various clients in a virtualized and segregated climate.

IoT and Smart home can profit from the wide assets and functionalities of cloud to repay its impediment away, handling, correspondence, and support in pick interest, reinforcement and recuperation. For instance, cloud can uphold IoT administration the board and satisfaction and execute corresponding applications utilizing the information created by it. Smart home can be consolidated and centre just around the essential and basic capacities thus limit the neighbourhood home assets and depend on the cloud abilities and assets. Smart home and IoT will zero in on information assortment, essential handling, and transmission to the cloud for additional handling. To adapt to security challenges, cloud might be private for exceptionally got information and public for the rest.

IoT, Smart home and distributed computing are not only a converge of innovations. Yet rather, a harmony among neighbourhood and focal registering alongside streamlining of assets utilization. A registering undertaking can be either executed on the IoT and Smart home gadgets or moved to the cloud. Where to process rely upon the upward trade-offs, information accessibility, information reliance, measure of information transportation, interchanges reliance and security contemplations. From one viewpoint, the triple registering model including the cloud, IoT and Smart home, ought to limit the whole framework cost, as a rule with more spotlight on decreasing asset utilizations at home. Then again, an IoT and Smart home figuring administration model, ought to further develop IoT clients to satisfy their interest while utilizing cloud applications and address complex issues emerging from the new IoT, smart home what's more, cloud administration model. A few instances of medical care administrations given by cloud and IoT reconciliation:

- Appropriately overseeing data, sharing electronic medical services records empower high quality clinical a benefit, overseeing medical services sensor information, makes cell phone.
- Appropriate for wellbeing information conveyance, security, protection, and dependability, by improving clinical information security and administration accessibility and overt repetitiveness and helped living administrations continuously, and cloud execution of media-based wellbeing administrations.

3.4 Research on the current situation of IoT

Principally includes the momentum circumstance about execution innovation of IOT, the new ocean figuring model of IOT, and so forth.

IOT advancements

In the framework construction of IOT, it principally has EPC Global framework structure with the backing of the Europe and America and Japan's Ubiquitous ID (UID) content systems administration framework. EPC Global chiefly incorporates EPC coding framework, radio recurrence distinguishing proof framework and data organization framework three sections. UID has the perceiving code, the specialized gadgets, and data framework server and code logical server four sections. China additionally effectively partakes in the above happy organizing framework design and standard exploration and is effectively working to the guidelines to adjust to China's advancement of the circumstance.

As of now, beyond China, the turn of events and use of systems administration fundamentally gathered in the United States, Europe, Japan, Korea and a couple of nations, the underlying exploration course is for the most part bar code, for example, RFID innovation in business retail, planned operations field application, as of late applications start extended to the natural observing, organic and clinical treatment, clever foundation, and so on. Common of the United States "Smartness the Earth" Smart vital, Japan's u-Japan, south Korea's u-Korea methodology, the European IOT activity plan, all the intention is to help a new age of IT innovation take advantage of in varying backgrounds. China as of now support at to the max the improvement of IOT whether public science and innovation plan and the modern norm of things for systems administration and has begun a lot of exploration and application work.

(Ng, C.K. et al., 2018)

The new Sea Computing application construction of IOT

Through the processing and interchanges hardware and keen calculation objects Embodiment objects in the actual world, let the interconnect between objects, ahead of the capricious judgment to acknowledge in the communication between things in the scene, and that it is fundamental for data hardware can contact in genuine physical at all over, will grow to the actual world data. The idea about ocean registering was first and foremost set forward

by the Chinese institute of sciences on April 12, 2010, in Beijing at the Chinese foundation of sciences high innovation arranging methodology course. The Cloud Computing is the help side estimation mode, yet the Sea Computing is on benefit of terminal of the whole world figuring, all things considered, the Sea Computing is actual world between the object of the registering mode. According to the perspective of the processing model the application model of IOT can be partitioned into two sections, the discernment mode and the ocean figuring model. Presently the explores about the use of IOT are generally applied in systems administration discernment mode, and the degree of knowledge to higher things organizing new registering model in view of the Sea Registering model of the application is less at home and abroad. What's more, insight mode to look at, the Ocean Computing model that more accentuation on appropriated processing organization (Decentralized) structure, simpler to wipe out a solitary control focuses, a solitary bottleneck and a weak link grow more adaptable. Insight of Crows come from the Sea Computing can make IOT more powerful, more adjust to the clients' requirements and the difference in climate.

3.4.1 Research on the assistance processing and part innovations

Administration registering or administration science as another examination field has acquired and more consideration. It has gone through two improvement stages:

At first stage, Garter Group proposed the idea of SOA (Service Oriented Architecture) in 1996, to make administration processing advancement quickly. The main elevated tide of administration processing showed up. At this stage, SOA is a consideration innovation. Administration arranged programming worldview' decoupling, in view of open guidelines interoperability, huge molecule reuse, supporting dynamic growing advances have started appreciates well known help. An ever-increasing number of undertakings have started to involve SOA strategy in EAI (Enterprise Application Integration) and other application fields, for example, End-to-End asset arranging to look for the product reuse, adaptability, minimal expense, and quick development.

At second phase of administration registering, IOT (the Internet of Things), Social Information Network and Distributed computing have step by step become the most concern centre. SOA, SaaS (Software as a Service) and SOC (Service Oriented Computing) address

the general pattern representing things to come. The improvement of administration figuring is going into the subsequent elevated tide.

It mostly reflected in two perspectives: One is programming and assets are placed in the cloud and as the framework, and afterward the customers need not arrangement or send them on their neighbourhood PCs. Another is the product utilizing and Working mode about XaaS (Anything as a Service) will uphold clients to utilize instead of buying, to consume and utilize data and correspondence innovation assets with pay-on-request mode.

Administration isn't just the connection or cement among the foundation and the client encounters yet additionally the piece transporter of the different sorts of the uncovered knowledge in new organization conditions with dynamic, open, indeterminacy and gathering characters.

The help parts are gathering and restricting as indicated by the business cycle however ESB (Endeavour Service Bus). Obviously, they ought to remain by the SCA (Service part Design)/SDO (Service Data Object) principles so that to be reused in the always different conditions.

3.4.2 A sample about smart home to use IOT and component technologies

Smart home is the centre part of Intelligent Residential District. At the point when the idea of IOT innovation is acquainted with the execution of Smart home, conventional Smart home is out of style. It will cover a lot more extensive scope of control. For instance, savvy home includes family security, family clinical treatment, family information handling, family amusement and privately-run company. The engineering of Smart home application in view of IOT and part advancements.

- **Family Security Service:** The host can stay in contact with the most recent security elements of the entire family whenever and anyplace if family security gadgets, like camera, infrared finder, smoke alarm, and so on, can be admittance to the organization of IOT. Another technique is to concede assent of the gadgets to property the executive's office or specific office.
- **Family Medical Service:** If there are elderly folks' individuals or kids in the family, we can put a camera in the right situation to comprehend what is going on opportune. Family clinical gadgets like sphygmomanometer are admittance to the organization

of IOT and local area medical clinic. So, specialists can stay in contact with the patients' medical issue helpfully and make convenient therapy.

- **Family Data:** Service Large measures of information in the family, like movies, music, games, and so on, can be put away in the organization information servers through Internet of Things and can be checked helpfully.
- **Family Entertainment Service:** The normal data, like weather conditions conjecture, discussion data, and so on, can be educated well through family terminal gadgets which are admittance to Internet of Things.
- **Privately-run company Service:** Family business focus can complete a progression of undertakings, like instalment, shopping, and so forth. So, individuals can remain inside to manage their insignificant regular routine.

The utilization of smart sensing devices in the specialized smart home has commenced in the last two decades (Chan, M., Estève, D., Escriba, C. and Campo, E., 2008) until the sensors were available commercially to be used for ubiquitous applications. The sensing devices have been utilized in everyday items and formed a cognitive network for the individuals living in the house and rendered an independent life (Chan, M., Hariton, C., Ringeard, P. and Campo, E., 1995). Few established research works around the world utilized IoT-based smart sensing devices. Few of them being Gator Tech Smart House, University of Florida (Gator Tech Smart House), Smart Community Alliance, Japan (Yamashita, J., 2018), etc. The goal of these projects is to monitor the healthy lifestyle of elderly people residing in these homes. This section will discuss IoTs, their utilization in smart homes in association with the commercial smart devices, and the details about the different sensors utilized in IoT to devise an efficient smart home.

IoT is one of the most common concepts of things that are controllable, addressable, readable, and locatable through the internet in the twenty-first century. Due to the fast-growing computing and communication abilities, all the devices in our surroundings can be associated with the internet. The following figure illustrates a schematic diagram of a smart home that employs different IoT utilities. IoT-based smart home compromise of numerous sensors that are connected wirelessly to devise supporting distributed networks. Every IoT-enabled sensor node consists of three subsystems- (1) sensor subsystem for environment sensing, such as humidity, light intensity, and temperature; (2) processing subsystem, which

consists of a microcontroller and integrated circuit to process the sensor data for computation and (3) a communication subsystem for exchanging the collected between varied sensors (Ghayvat, H. et al., 2015).

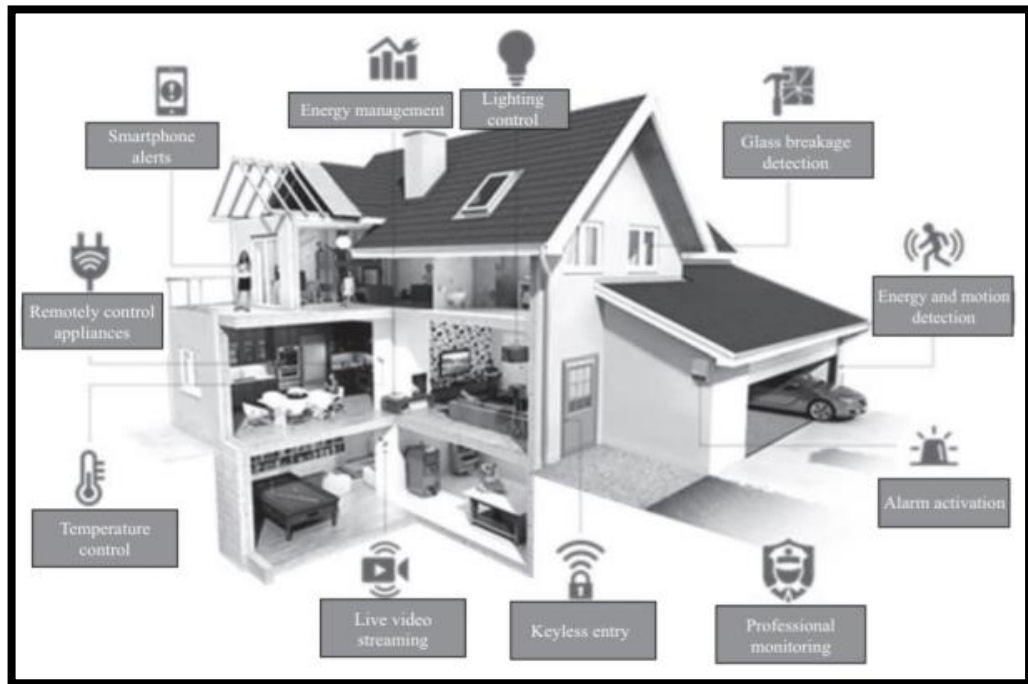

Figure 2: Schematic diagram of an IoT-enabled smart home (Stolojescu-Crisan, C., Crisan, C. and Butunoi, B.P., 2021)

As shown in figure 2, The IoT-based infrastructure, unlike the traditional Wireless Sensor Networks (WSNs) that offer specific applications and are mostly designed as a closed system. In the majority of the IoT-based smart home systems, the sensors and actuators are installed within the home environment to supervise and control operations. It is also incorporated with smart devices to prevent human intervention. Some of the applications include lighting, security camera, home appliances, and alarm systems. These smart devices are connected to the local server through a wireless medium for data analysis and collection. The following sensors are important to develop a smart home:

- **Humidity Detector:** Water leakage in a smart home is detected by a leak sensor. The moisture detector sensors alert the people of the leaks in the home and assists in fixing the problem preventing any kind of damage. The sensors can be stationed around water heaters, dishwashers, refrigerators, and waters pumps. The sensors

detect an uneven water flow and immediately inform the user. The following figure shows a commercial humidity detector that is used in smart homes (Smart humidity monitor, 2018).

- **Fire/Smoke detector:** Smoke or Fire detectors are one of the most important sensors to be embedded in a smart home to prevent a hazardous fire. The function of the smoke detector includes detecting the first sign of smoke or fire and prompts the fire department. Alarm systems relate to these sensors to alert the inhabitants. A few of the detectors notify all the family members in their mobile applications.
- **Smart Thermostat:** The thermostat controls cooling and heating in a smart home. They automatically monitor the humidity and temperature outside the home and adjust the temperature accordingly. A thermostat considers numerous factors that influence temperature control. A smart thermostat adjusts itself on a room-by-room basis and maintains the ideal temperature and can also change the temperature to energy-saving mode when no one is in the room.



Figure 3: Commercial thermostat used in smart homes (Nag, A. et al., 2019)

- **Motion Sensors:** Motions and movements can be detected by these sensors. These sensors play a critical role in security as they alert the resident of any suspicious movement or opening of doors and windows during odd hours. The sensors can even control the switching on and off lights by detecting the closing and opening of the doors. This promotes saving a huge amount of energy and prevents wastage. (Motion Sensors, n.d.)
- **Video cameras:** These devices enable the residents to visually locate the positions of different people of people inside and outside the house through their smartphones.

These devices are highly useful to keep an eye on intruders and ensure security in the absence of the owner.



Figure 4: Commercial video cameras used in smart homes (Nag, A. et al., 2019)

From the research point of view, different devices are utilized in the smart home to monitor the usage of devices. The following table illustrates some of the devices based on the purpose and category they are utilized for (Alam, M.R., Reaz, M.B.I. and Ali, M.A.M., 2012). Although, wireless medium of data transmission is considered the most reliable, hybrid media is also utilized in smart homes with the significance of having a Zeno configuration. A few of the hybrid media are Infrared, Ethernet and Radiofrequency.

Category	Name	Purpose
Sensor	Light PIR Temperature Pressure Switch Sensor RFID Ultrasonic Current Power Water	Measurement intensity of light Identify user location Measure room temperature and body temperature Identify inhabitant location Door open or close status detection Object and people identification Location tracking Measure current usage Calculate power usage Measure volume of water usage
Physiological device	ECG PPG Spirometer Galvanic Skin Response Colorimeter Pulse Oximeter Sphygmomanometer Weight Pulse Meter	Pulse rate and variability Pulse rate and blood velocity Respiration rate, peak flow, inhale/exhale ratio Sweating Pallor, throat inflammation Measure oxygen saturation of blood Blood-pressure measurement Measure patient weight Monitor heart weight
Multimedia Device	Camera Microphone Speaker or headset Display (LCD, Plasma panel)	Monitoring and tracking Voice command Announce alert and information Show visual information

Table 1: Sensors (Alam, M.R., Reaz, M.B.I. and Ali, M.A.M., 2012)

3.5 Models for smart home

Patchava, V. (2015) introduced a smart home automation technique using Raspberry Pi. It displays an automation system in which home appliance is controlled by laptop or mobile using the internet. Also provides live video streaming to any place using the internet. (Patchava, V., Kandala, H.B. and Babu, P.R., 2015)

ShariqSuhail, M. et al. (2016) introduced Multifunctional Secured Smart Home using a GSM module and Raspberry Pi. The owner will get alerts through GSM whenever Secured Smart

Home (SSH) detects smoke, the system activates or deactivates, etc. Also sends captured images through the mail to the owner. (ShariqSuhail, M. et al., 2016)

Kumar, P. (2016) introduced IoT Based Monitoring and Control of Appliances for Smart homes using Raspberry Pi, Arduino, and Graphical user interface (GUI). It provides live video streaming and an option through which turning home appliances to ON or OFF can be done. (Kumar, P. and Pati, U.C., 2016)

Shete, V. (2016) introduced an Automated IoT-based system for Home Automation and Prediction of Electricity usage and comparative analysis of various Electricity providers: Smart Plug. It provides the design of a smart plug which an energy monitoring and control system which can control the devices, shows the power consumed by the devices, and calculates the electricity bills based on total energy usage depending on different vendors available. (Shete, V. and Ukunde, N., 2016)

Jain, A. (2017) introduced an Intelligent Embedded Video Monitoring system for Home surveillance. It is NOT based image processing unit with an internet connection so that data can be transferred to any remote server such as Cloud. (Jain, A., Basantwani, S., Kazi, O. and Bang, Y., 2017)

Sruthy, S. (2017) introduced Wi Fi Enabled Home Security Surveillance System using Raspberry Pi and IoT Module. This provides surveillance with live video streaming, sending email alerts to the owner, and designed web servers that help the owner to watch the status of the sensor. The use of Simple Mail Transfer Protocol (SMTP) object to send emails using Python. This approach ensures that the email is sent through an SMTP server, which is a standard protocol for email transmission and ensures reliable delivery of the message. Additionally, the system is designed to trigger email alerts as part of a sequence of functions when a logic high sensor value is detected, indicating an event of interest. This helps ensure that the email alerts are triggered promptly and reliably when required. The system also saves the live video for future reference before deleting it once it is sent to the user by email. This ensures that the user has a backup copy of the video in case they need to refer to it later. (Sruthy, S. and George, S.N., 2017)

Magar, S. et al. (2017) introduced Smart home automation by GSM using an android application. Focused on control household appliances like lights, fans, AC, refrigerators, etc.

Malche, T. (2017) introduced the Internet of Things (IoT) for building a Smart Home System. It describes FLIP (Frugal Labs IoT Platform) architecture with Smart Home service implementations using FLIP through a proposed system. (Malche, T. and Maheshwary, P., 2017)

Intensive research is being conducted on smart homes along with a range of work done on the behavior detection of residence (Suryadevara, N.K., Mukhopadhyay, S.C., Wang, R. and Rayudu, R.K., 2013). Suryadevara, N.K. (2012) gave one such idea where two functions b_1 and b_2 were introduced to determine the duration of the use of different appliances at a defined time t . The time series modelling was applied to establish the updated time parameters and maximum durations to analyse the trend in usage of household objects for past, current, and future conditions. (Suryadevara, N.K. and Mukhopadhyay, S.C., 2012)

Over the years, smart homes have conceptualized various models to analyse, understand and predict the behaviour of the residents (Lotfi, A., Langensiepen, C., Mahmoud, S.M. and Akhlaghinia, M.J., 2012). The prediction of data is also performed utilizing support vector machines (SVM) where the activities of daily living (ADL) were recorded utilizing different kinds of wearable devices like kinetic sensors (Fleury, A., Vacher, M. and Noury, N., 2009). These sensors helped in detecting postural transitions and walk periods and further classify each temporal frame into one of the daily activities. An array of sensors including activity detection sensors, motion detectors, etc., are affixed in different locations of the residence to procure a large data set, which is then studied with different methods like a predictive algorithm (Virone, G. et al., 2008), neural networks (Robles, R.J., Kim, T.H., Cook, D. and Das, S., 2010), hidden Markov model (Van Kasteren, T.L.M., Englebienne, G. and Kröse, B.J., 2010), etc. to predict the anomalous behaviour in future.

The most prominent approaches towards the IoT- based smart home are related to the Web-based system which is utilized by formulating an application framework that supports the concurrent interaction of the residents (Kamilaris, A., Trifa, V. and Pitsillides, A., 2011). The system consisted of a 6LoWPAN- based WSN inside the smart that worked on HTTP caching and push messaging techniques. Various complaints including device discovery and service descriptions were addressed while utilizing this proposed algorithm. For the connection of the web with household appliances Representational State Transfer (REST) algorithm has

been employed. The architecture of the web-based system was principally based on three layers: control, device, and presentation for the device management and control, processing of the data, and representing the available devices dynamically, respectively. Web application description language (WADL) was adapted for the services to the HTTP-based application. With commercial ZMOTION sensors, experiments were executed and used in the event-based scenarios utilizing push technology. The results helped in identifying the amount of time required by the motion detector to notify the application framework.

Another intriguing research work consists of the utilization of vital radio inside smart homes, which sensed breathing and heart rate through wireless activity monitoring devices (Adib, F. et al., 2015). The change in the positions of the chest wall due to exhalation and inhalation generated results. One of the most appreciated attributes of this system is the wireless sensing capabilities of the physiological parameters of the residents. Another intriguing project consists of evaluating the necessities of elderly people to adapt existing technologies as a part of smart home projects (Portet, F. et al., 2013). This is vital as most elderly people wish to have an independent life without any breach of privacy and interference. A proactive architecture has also been proposed that deploys an event-condition-action (ECA) method for the management of heterogeneous devices in smart homes. This was termed as significant work from the management point of view as heterogeneous sensing devices were deployed inside a smart home, leading to the generation of a huge amount of data as a result of which it is difficult for the monitoring unit to identify the significant ones. Other than the device API and device stub in the system, the modules comprised of SQL statements that communicated with proactive architecture. SQL statements were generated by modules following the rules of the system. The IoT-based system consisted of a surveillance device, an audio device, and an alarm for the execution of the tasks.

3.6 Architecture of smart homes

To improve the architecture system, the researchers have tried improving the quality of service by developing a model that categorizes the monitoring system into three levels. These levels are termed as control, monitoring, and user-level services. The first category can be defined as the data acquisition level where different devices were utilized for ubiquitous monitoring of activities. This is termed as the primary level where the sensor data is gathered and calibrated for the second level.

The second step is the information processing one where the sensor data are processed with the threshold values set according to user requirements. The final step is context making where the model brings out awareness to the monitoring unit for the required action based on the information brought by the knowledge engine.

Work on adaptation capability of the IoT-based systems has also been carried out by the researchers for the activity recognition in the smart homes utilizing a Spatial-temporal feature technique which carries out semi-supervised learning. The model consisted of five major processes: Temporal feature-based verification, initial classification, spatial features-based clustering model update, and Spatial-temporal match evaluation. To conduct the classification, the data is divided into unrecognized and recognized ones. The recognized data then goes to the second step for verification while the unrecognized ones go for the third step to form clustered instances. The output of both the steps is then fed into the match evaluation step to join the candidate activities together to make multiple groups of new instances perform a comparative study between each activity of each group for evaluation.

The difference of this proposed model from the conventional semi-supervised adaptation model lies in its Spatial-temporal features, which gives a higher chance to discover more instances of different activities that are useful for training purposes to increase the performance efficiency of the model.

The activity recognition was also carried out utilizing a pattern clustering technique to a temporal ANN algorithm (Bourobou, S.T.M. and Yoo, Y., 2015). The model consists of two steps, where it commences with an efficient unsupervised learning technique called the K-pattern clustering algorithm. The second step is the training of the environment to predict the activities of a person utilizing an artificial neural network based on Allen's temporal relations. Initially, the large amount of data acquired from the sensors in the IoT-based smart home goes through an unsupervised learning algorithm. The entire data is computed and grouped into clusters with similar user activity patterns. The algorithm is also capable to identify the discontinuous and interleaved activity pattern of the users, resistance towards the noise in the overall data in the set, and computing data efficiently by grouping similar activities. The processing of the perceived data was carried out to identify the temporal

relations between them. The second part of the algorithm carries out the conversion of the perceived data, observation, and mining of the most frequency pattern and again grouping of similar patterns. The detection, mining, and grouping of the patterns were at a faster rate in comparison to that of the threshold set in the first part of the algorithm. The advantages of this approach are the decreased amount of time and space required to intercept the activities happening in the smart home environment.

The application layer can be categorized into three layers, namely, Agent Layer, Kernel layer, and Interface layer (Jie, Y. et al., 2013). The initial layer is responsible for the data transportation and agent management from the application layer to the other layers. Interaction between this layer and the network layer is done to transfer the collected data for analysis purposes. The interface layer is responsible for rendering different kinds of interfaces in terms of resources to the application layer. The modelling of the resources to the upper layers is done at this level. The agent level is responsible for defining the type of different smart devices used in smart homes. The most significant level in this architecture is the Kernel level, which manages all the levels in the application layer. It is also responsible for the management, transportation, authentication, and authorization of the data and monitoring of its transfer from the application layer to the upper layers. Even though the authorization and authentication are done on the application layer, it is specially controlled by the certification authority (CA), which is centrally located in the smart home for controlling purposes. The CA performs the double-checking process on the call of an agent during an operation. When the CA sends its certification to the agent to validate its decision, the agent sends back its response to CA through certification. If the responses between the CA and the agent are positive, the CA informs its subordinate agents to work with the other controllers. Research work also includes the use of commercially available ARM microprocessors like SAMSUNG S3C2440A (Gaikwad, P.P., Gabhane, J.P. and Golait, S.S., 2015) to collect the data from the sensors and process it. These data are then communicated through Zig Bee protocol to the monitoring unit. The WSN also prefers using CPLD, which is a complex programmable logic device, but mainly for industrial purposes. Sensors can be controlled using a radio-frequency wireless sensor and actuator network (WSAN) at a frequency of 433 MHz to control, monitor, and manage the appliances in smart homes. The

use of CPLD/ FPGA is sometimes more preferable to the microprocessors in smart homes due to their advantages of real-time performance and synchronicity.

Bing, K. (2011) Layered engineering of the IoT-based Smart Home Framework is depicted by him. The savvy home framework is partitioned into three layers: application layer, network layer, and detecting layer. Beginning from the base, detecting layer is liable for information assortment from every one of the home machines and it sends information to the centre layer that is network layer. Network layer utilizes web for sending information to the upper most application layer which has various applications on various level for various purposes. For information assortment and information handling at the detecting layer it utilized chip which is a kind of ARM microcontroller. To move the gathered information to the organization layer it utilizes Zig bee module which depends on IEEE 802.15.4 remote standard. (Bing, K., Fu, L., Zhuo, Y. and Yanlei, L., 2011)

For modern remote sensor network in IoT climate the issue is in regard to with the information procurement of multi sensor hubs. Assuming microcontroller is utilized as the connection point gadget it plays out an errand via intrude, which makes these multisensory obtaining interfaces not exactly lined up in gathering multisensory information however microcontroller enjoys the benefits of minimal expense and low power utilization. CPLD is a complex programmable rationale gadget. Both microcontroller and CPLD are close to about same. In any case, both enjoy their benefits furthermore, burdens. CPLD/FPGA is utilized in modern remote sensor organization. FPGA is a field programmable entryway exhibit which has remarkable equipment rationale control; it has on-going execution and synchronicity.

CPLD/FPGA has more interest on account of its benefits over microcontrollers. It is for the most part utilized in remote sensor network as point of interaction gadget. CPLD/FPGA can secure multisensory information in equal and works on constant execution of the framework.

IoT has a multidisciplinary vision to give its benefit to a few spaces, for example, natural, modern, public/private, clinical, transportation and so forth. Different scientists have made sense of the IoT differently regarding specific interests and angles. The potential and force of IoT should be visible in a few application spaces.

Different significant IoT projects have assumed responsibility over the market in most recent couple of years. A worldwide circulation of these IoT projects is displayed among American, European and Asia/ Pacific district. It tends to be seen that American mainland are offering more in the medical care and Smart store network projects though contribution of European mainland is more in the Smart city projects. It is obvious that industry, Smart city, savvy energy, and Smart vehicle based IoT projects have a major piece of the pie in contrast with others.

The savvy home business economy is going to cross the 100 billion bucks by 2022. Savvy home doesn't just give the in-house solace yet in addition benefits the house proprietor in cost cutting in a few perspectives for example low energy utilization will results in nearly lower power bill. Other than savvy homes, one more classification that goes inside Smart city is Smart vehicles. Current vehicles are outfitted with canny gadgets and sensors that control most of the components from the headlights of the vehicle to the motor. The IoT is committed towards fostering other Smart vehicle frameworks that consolidates remote correspondence between vehicle to-vehicle and vehicle to-driver to guarantee prescient upkeep with agreeable and safe driving experience. (Liu, T., Yuan, R. and Chang, H., 2012)

Khajenasiri, I. (2017) played out a review on the IoT answers for savvy energy control to benefit the Smart city applications. They expressed that at present IoT has been sent in not many application regions to serve the innovation and individuals. The extent of IoT is extremely wide and in not-so-distant future IoT can catch practically all application regions. They referenced that energy saving is one of the significant pieces of the general public and IoT can help with fostering a Smart energy control framework that will set aside both energy and cash. They portrayed IoT engineering as for Smart city idea. The creators too talked about that one of the difficult undertaking in accomplishing this is the adolescence of IoT equipment and programming. They recommended that these issues should be set out to guarantee a dependable, efficient, and easy to use IoT framework. (Khajenasiri, I., Estebasari, A., Verhelst, M. and Gielen, G., 2017)

The urbanization issue in the urban communities. The development of individuals from rustic to metropolitan air bringing about developing populace of the urban areas. Therefore,

there is a need to give Smart answers for versatility, energy, medical care and infrastructure. Smart city is one of the significant application regions for IoT engineers. It investigates a few issues, for example, traffic the board, air quality administration, public wellbeing solutions; they mentioned that IoT is striving to handle these difficult issues. The need for gotten to the next level Smart city foundation with developing urbanization has opened the entryways for entrepreneurs in the field of Smart city advancements. The creators inferred that IoT empowered innovation is vital for the improvement of reasonable savvy urban communities. One more significant issue of IoT that requires consideration, and a great deal of examination is security. (Alavi, A.H., Jiao, P., Buttler, W.G. and Lajnef, N., 2018)

Weber, R.H., (2010) focused in on these issues and proposed that a confidential association benefiting IoT should consolidate information verification, access control, flexibility to also assaults client protection into their business exercises that would be an extra benefit Weber proposed that to define worldwide security and security issues, IoT developers should consider the geological constraints of the different nations. A conventional structure should be intended to fit the worldwide necessities concerning protection and security. It is strongly prescribed to explore and perceive the issues and difficulties in protection and security prior to fostering the full fledged working IoT system. (Weber, R.H., 2010)

Afterward, Keoh, S.L. et al., (2011) thought of a security issue in IP based IoT framework. They referenced that web is spine for the correspondence among gadgets that takes place in an IoT framework. Therefore, security issues in IP based IoT frameworks are an important concern. Furthermore, security engineering ought to be planned thinking about the life cycle and abilities of any article in the IoT framework. It likewise incorporates the inclusion of the confided in outsider and the security conventions. The security engineering with scalability potential to serve the limited scale to huge scope things in IoT is exceptionally alluring. (Heer, T. et al., 2011)

The concentrate on brought up that IoT led to a better approach for correspondence among several things across the organization subsequently customary start to finish web convention are not ready to offer expected help to this correspondence. Therefore, new conventions must

be planned considering the interpretations at the entryways to guarantee start to finish security. Additionally, every one of the layers liable for correspondence has their own security issues and necessities. Therefore, fulfilling the necessities for one specific layer will leave the framework into a weak state and security ought to be guaranteed for every one of the layers. Verification and access control is one more issue in IoT that necessities promising solutions to fortify the security.

Ning, H. (2012) raised an answer for handle authentication and access control. Validation is vital to check the imparting gatherings to forestall the deficiency of confidential data. Liu et al. gave an authentication conspire in view of Elliptic Curve Cryptosystem and verified it on different security dangers for example snooping, man-in-the-centre assault, key control and replay assault. They guaranteed that there proposed plans can give better confirmation and access control in IoT based correspondence. (Ning, H. and Liu, H., 2012)

Afterward, Kothmayr, T. et al. (2013) proposed a two-way verification conspire based of datagram transport layer security (DTLS) for IoT. The aggressors over the web are dependably dynamic to take the got data. The proposed approach can give message security, respectability, genuineness and confidentiality, memory upward and start to finish idleness in the IoT based correspondence network. (Kothmayr, T. et al., 2013)

Li, Y. et al. (2019) proposed a unique methodology for information driven IoT applications regarding cloud stages. The need of a proper gadget, programming configuration what's more, foundation requires efficient answers for help enormous measure of IoT applications that are running on cloud stages. IoT designers and analysts are effectively taken part in creating arrangements thinking about both monstrous stages and heterogeneous nature of IoT items and gadgets. (Li, Y. et al., 2019)

Olivier, F. (2015) made sense of the idea of programming defined organizing based engineering that performs well regardless of whether a well-defined design isn't accessible. Tey suggested that SDN based security design is more flexible and efficient for IoT. (Olivier, F., Carlos, G. and Florent, N., 2015)

Luk, M. (2007) expressed that the principal errand of a safe sensor Network (SSN) is to provide information security, insurance from replay assaults and validation. They examined two famous SSN benefits. (Luk, M., Mezzour, G., Perrig, A. and Gligor, V., 2007)

4. Practical Part

4.1 Implementation

The following Hardware and Software are used to build the Smart home IOT system

1. RPI
2. Python
3. PIR Sensor,
4. IR sensor,
5. Gas Sensor,
6. Fire Detector,
7. LDR sensor
8. AWS (Dynamo DB, SNS, AWS IoT Hubs, CloudWatch)

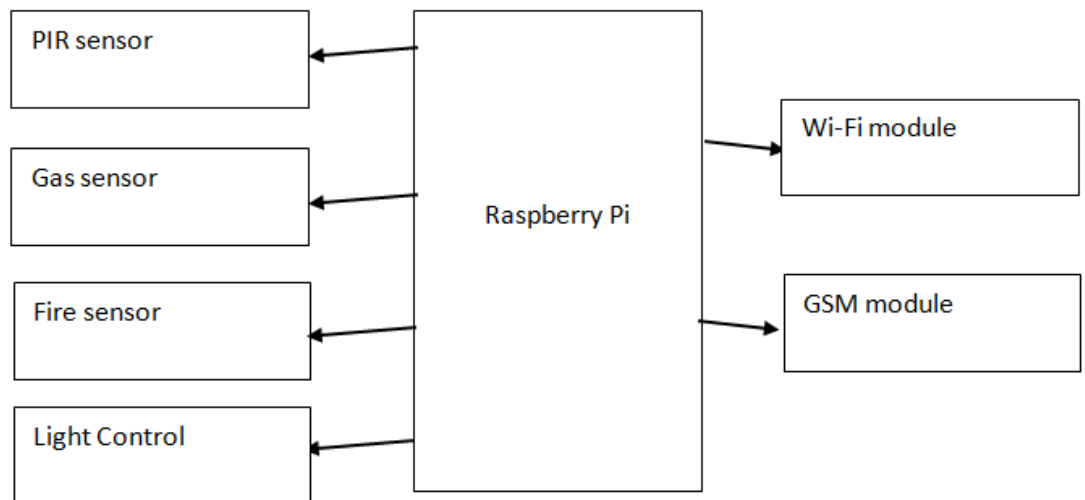

Figure 5: Framework of our study (Own Source)

Given its highly affordable cost and size, Raspberry Pi has been a popular name in the computing world. And with its capability to run on a special version of Windows 10 called Windows 10 IoT Core, it categorizes itself as an “Internet of Things” device. It stands out to be one of the key learning platforms for IoT. Let’s see how? Well, if the experts from the field are to be believed, Raspberry Pi makes up for a great IoT device. Some of its features

such as its small size, low power consumption, and ease of managing over cloud, makes it for a favourable IoT device. Further divulging into the details, Raspberry Pi is a full computer that uses variety of languages including Python, Ruby, PHP, and Java. IoT apps can easily be developed in JavaScript with the Johnny-Five framework. The Raspberry Pi also provides 8 I/O pins, which are digital in nature. To interact with other devices, an additional chip would be required to be wired to the digital pins. One of the major perks of Raspberry in the IoT space is its network connectivity. Majority of Raspberry Pi boards come with an in-built ethernet connector. Furthermore, the USB ports on it make it easy to connect Wi-Fi dongle. The newly launched Raspberry Pi Zero, which comes without Ethernet and requires networking by connecting a Wi-Fi adapter to the USB port, has lower power requirements making it somewhat more suitable to battery powered applications. With an ever-increasing demand in the IoT device market, newer boards are making an ever-growing appearance. But with devices like Raspberry Pi, it is going to keep up the competitive quotient for other entrants.

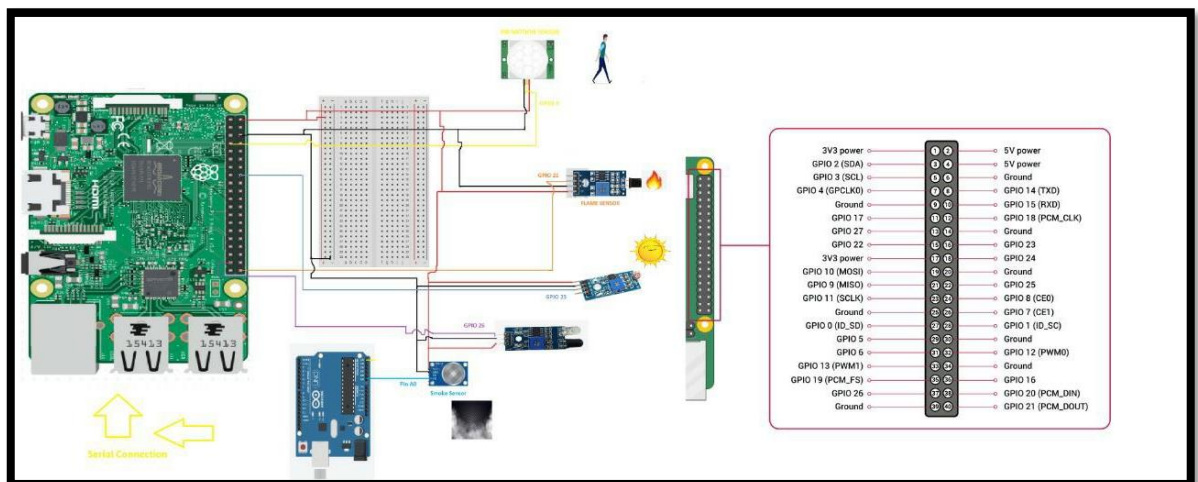
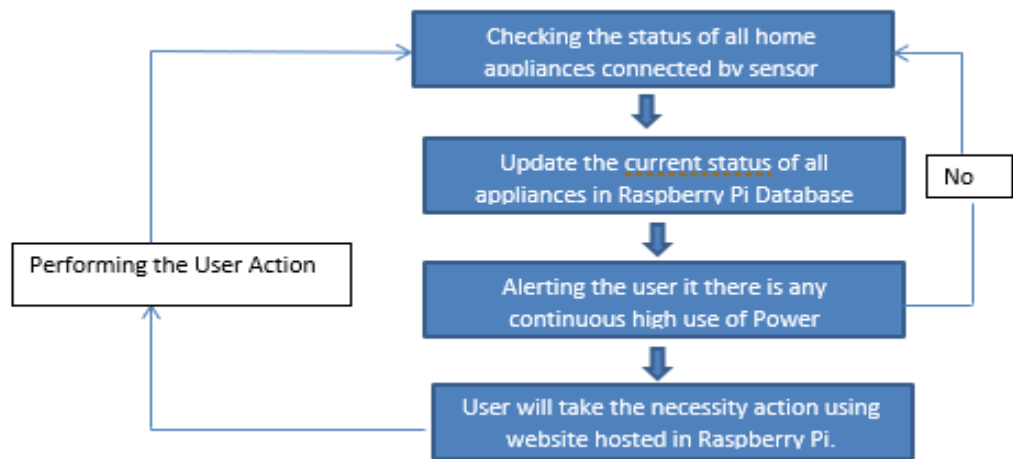

Figure 6: The utilisation of items to frame the Smart home IOT system (Alavi, A.H., Jiao, P., Buttlar, W.G. and Lajnef, N., 2018)

- I have imported all the required modules i.e., Simple CV, MYSQLDB, Serial Module.
- The system will check the status (ON/OFF) of all home appliances connected to Raspberry Pi.
- The system will also it will verify whether the Raspberry Pi captures the surroundings using the camera.

- The sensors will be ON and sensing everything in the surrounding. As soon as the sensors sense something the respective activity like switching on the alarm or Switching of lights will take place.
- I have utilized PIR sensors to detect motion by sensing the infrared light radiating from a human, an LPG gas sensor to identify gas leakage, and a fire detecting sensor.,
- LDR sensor to detect the light.

(a)



(b)

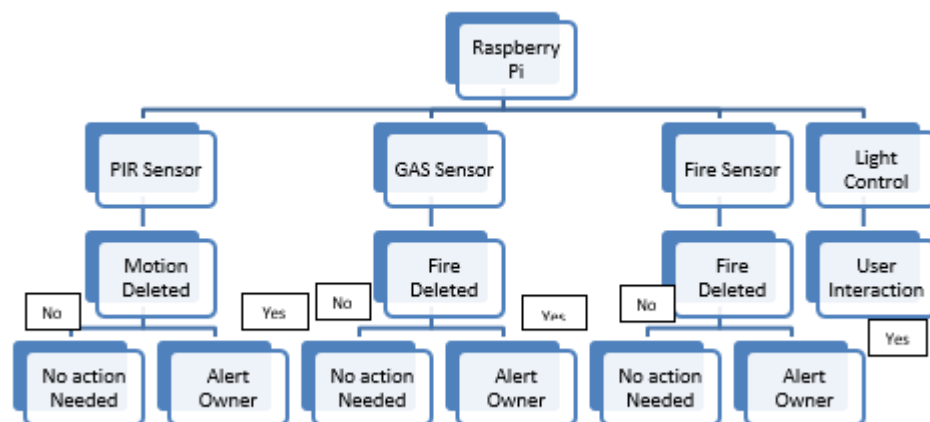

Figure 7: Flow of work (Own Source)

Python code may be used to access the Raspberry Pi's GPIO. Here, a PIR motion sensor is being used. Passive infrared is referred to as PIR. A Fresnel lens, an infrared detector, and associated detecting electronics make up this motion sensor. The sensor's lens directs any nearby infrared light toward the infrared detector. The motion sensor detects the infrared heat that our bodies produce by picking up on it. As soon as it recognises a human, the sensor emits a 5V signal for duration of one minute. It is very sensitive and provides a rough detection range of 6–7 metres. Over Python programming, we specify what the Raspberry Pi should do when it detects an intruder. When the PIR motion sensor detects a human, it sends a 5V signal to the Raspberry Pi through its GPIO. We are just printing "Intruder detected" here.

The centralization of a gas is given in PPM (parts per million). One trouble of the MQ-2 is that a solitary simple worth is given with which the gas content in the air must be determined for the different upheld gases. the strategy for fire identification by utilizing sensors are now not exceptionally powerful because they create cautions when fire has arrived at its greatest level which is extremely perilous to that end the framework is suggested that recognizes fire in the beginning which is vital to stop it exceptionally before so the misfortune or harms should not be possible by it.

The primary goal of the system's design is to allow users to operate their home appliances using a Raspberry Pi and a mobile device or laptop with an internet connection. It is possible to use a Raspberry Pi camera to feed live video to a computer running a programme that controls various household appliances and determines the current condition of those appliances (i.e., ON or OFF). There is an application that utilises this software to gather information about appliances, save it in a database for future reference, and show it on a monitor linked through HDMI.

In addition, it may be used to broadcast video over the internet, allowing viewers to see it from any location. Using an HDMI extension switch, I may connect it to many displays at once. For the home appliances and website database, Raspberry Pi will serve as the central authority. Amazon Services are used to directly connect with the client mobile and store data of the events which are happening in the home. In addition, you can establish a searchable fleet index for all your connected devices and on board, manage, and monitor them all with the help of AWS IoT Device Management. You may also distribute bug fixes and firmware upgrades with only a few clicks of the mouse. When it comes to IoT analytics, AWS IoT

Analytics may be able to assist you in gaining insight into how your devices are being used, how well they are operating, and even how frequently they will need to be repaired. AWS IoT Core supports MQTT, a lightweight protocol designed to tolerate intermittent connections, minimise the code footprint on devices, and reduce the amount of network bandwidth required by connected devices. AWS Internet of Things enables low-latency, scalable, and bidirectional communication between devices and the cloud and it does it using cloud computing (IoT). When you use AWS IoT Core, you'll have access to AWS's worldwide presence in more than 20 locations across the world.

It has been decided to use PIR sensors to detect motion by measuring the infrared light emanating from a human, an LPG gas sensor to detect gas leakage, and a fire detection sensor to detect fire. The light is detected using an LDR sensor. I'm also setting up a connection with AWS IOT Hub using the MQTT protocol and storing all the data collected by the sensor in a NoSQL database hosted by AWS DynamoDB, with CloudWatch Alarms setup to automatically send an SMS to the home's owner in the event of a problem. Database data may be seen on a mobile phone by logging in. The user may also configure the system to automatically switch on and off the lights, fans, and any other devices that are linked to the internet system.

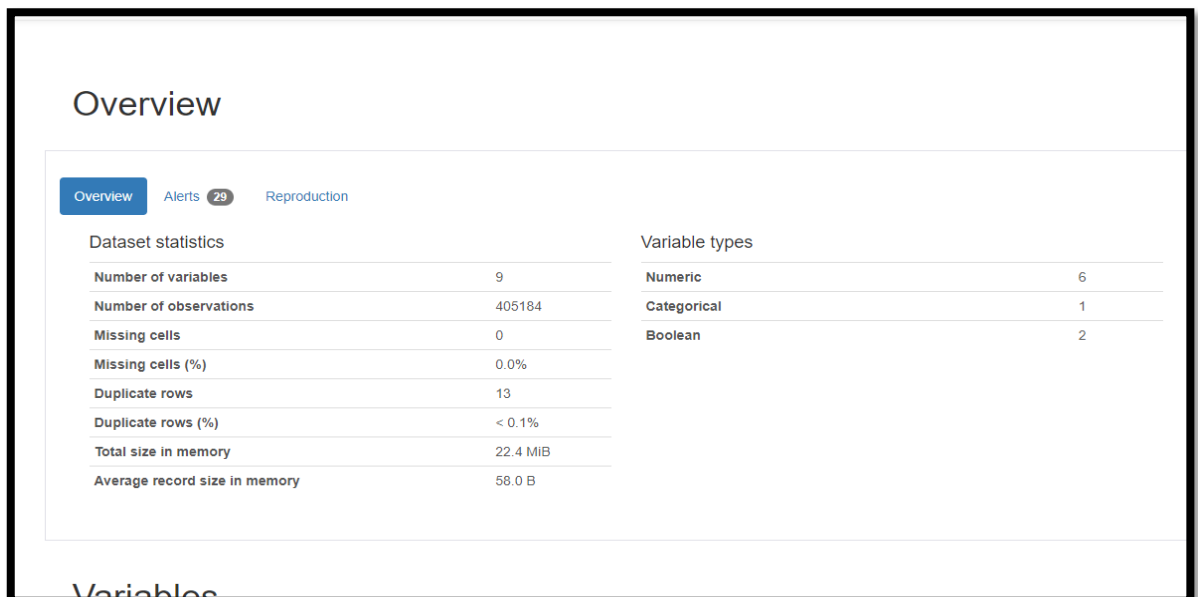

Figure 8: Results (Own Source)

To connect a PIR motion sensor and an LED to the Raspberry Pi, needed to use jumper wires and a resistor. When motion is detected, the Amazon SES and Amazon SNS services would

be utilised to send an email and a text message to the homeowner, and the red LED would also be activated to alert them. To avoid sending emails and SMS messages constantly (i.e., within a short time frame), a log file containing the timestamps of the last email and SMS message sent is maintained, and emails/SMS are only sent if the difference between the motion detected timestamp and the most recent email/SMS timestamp is greater than 10 minutes (by default), meaning that the next notification email/SMS would be sent only after 10 minutes even if continuous motion detection was used. Lights, air conditioners, and televisions in a smart home may be automatically turned on or off based on whether or not a smartphone is connected to the network using this functionality. As an alternative to turning on and off lights, air conditioners, or television sets to replicate the behaviour of the actual equipment, an LED is used to simulate the behaviour of the actual equipment instead. According on whether a certain device registered in the script is located on the network, the LED is either illuminated or deactivated, respectively. Once the LED is turned off, Amazon SES also sends an email to the homeowner to let them know. Overall, 100 percent of those who responded gave the system a rating of 4/5, and 83.3 percent said they had a positive experience using the system. The overall system received a rating of 4/5 from 83.3 percent of respondents, with 16.7 percent of those who thought it was extremely beneficial giving it a rating of 5/5.

4.2 Image of Sensor

The processes taken by the suggested system are direct environment sensing, data collection and analysis, and finally allowing the user to alter the settings and issue particular commands. The design and implementation of a useful and straightforward smart home system, which is expandable, were presented in this study. A collection of sensors, a Raspberry Pi device acting as a server, and Bluetooth serving as the communication mechanism make up the system. With an Android phone's user-friendly interface, these devices are simple to handle. The key benefit of the suggested system is that it offers users a stylish home automation solution while being reasonable, safe, and simple to configure.

Each IoT device collected a total of seven different readings from the four sensors on a regular interval. Sensor readings include temperature, humidity, carbon monoxide (CO), liquid petroleum gas (LPG), smoke, light, and motion. The data spans the period from

07/12/2020 00:00:00 UTC – 07/19/2020 23:59:59 UTC. There is a total of 405,184 rows of data.

The sensor readings, along with a unique device ID and timestamp, were published as a single message, using the ISO standard Message Queuing Telemetry Transport (MQTT) network protocol. Below is an example of an MQTT message payload.

```
{
  "data": {
    "co": 0.006104480269226063
    "humidity": 55.099998474121094
    "light": true ,
    "lpg": 0.008895956948783413,
    "motion": false,
    "smoke": 0.023978358312270912,
    "temp": 31.799999237060547
  },
  "device_id": "6e: 81: c9: d4: 9e: 58",
  "ts": 15944191953292461
}
```

Column	Description	Units
Ts	Timestamp of event	Epoch
Device	Unique device name	String
Co	Carbon monoxide	ppm (%)
Humidity	Humidity	Percentage
Light	Light detected?	Boolean
LPG	Liquid petroleum gas	ppm (%)
Motion	Motion detected?	Boolean
Smoke	Smoke	ppm(%)
Temp	Temperature	Fahrenheit

Table 2: Dataset (Own Source)

4.2.1 Tasks

The task at hand is to use machine learning (ML) to determine when a person is near an IoT device. However, the task is limited to unsupervised methods since there are no labels of time stamps where people are near the IoT device. Despite this limitation, there are three different devices in different locations, each with about a week of time series data recorded at a sampling interval of 5-10 seconds between measurements. This data can be used for unsupervised learning approaches to detect patterns or anomalies in the data that may indicate the presence of a person near the IoT device. By leveraging this data and applying unsupervised ML techniques, it may be possible to develop a model that can accurately detect when a person is near an IoT device without requiring explicit labels of these events.

The proximity of a person could affect the recorded parameters in the various ways:

There are several ways in which the presence of an individual can impact the levels of various environmental factors measured by sensors. For example, the carbon monoxide (CO) levels may be impacted as a person breathes in air near the sensor, and the CO sticks to their haemoglobin, effectively filtering some of it from the atmosphere and leading to a detectable reduction in CO ppm. Similarly, the humidity levels may increase if a person exhales into the room, while light levels may drop if a person is occluding the light sensor. On the other hand, light levels may increase if a person turns on a light or opens a closet door. Additionally, the levels of LPG (liquefied petroleum gas) may drop if a person breathes it in, thereby filtering it from the local atmosphere. The movement of an individual near to a sensor would also create detectable motion, although some information about other sources of motion/vibration would be needed to attribute it to a nearby person. Smoke levels could be reduced by the filtering effect of a person's lungs, or increased if a person lights up a cigarette in front of the smoke sensor. Finally, the ambient temperature might be increased by the presence of one or more individuals next to the temperature sensor for a period of time. By considering these various factors, it may be possible to develop more accurate models for detecting the presence of individuals near sensors measuring environmental factors.

4.3 Exploring the time series.

To analyze the data and identify when humans are nearby, several steps can be taken. First, the time series data can be plotted with a meaningful time scale to identify patterns that may indicate when people are more likely to be nearby. Additionally, daily patterns in the data can be analyzed to identify any recurring trends. Second, the sensor time series data can be compared between the three locations to determine if there are any significant differences that may affect the analysis. Finally, thresholds, confidence intervals, or clustering techniques can be applied to windows of time series data to define plausible intervals when humans are likely to be nearby. By analyzing changes in light, motion, atmospheric, and temperature factors, it may be possible to define intervals that correspond to when humans are likely present. Overall, by applying these steps to the time series data, it may be possible to identify patterns and thresholds that can be used to accurately detect the presence of humans near the sensors.

The provided data suggests several patterns and differences between the three devices. Firstly, there are clusters of motion spikes interspersed with motionless intervals, with b8 and 1c displaying far more motion spikes than 00. Additionally, 1c shows continuous illumination, while the other devices have light and dark intervals. Furthermore, device 00 displays worse spikes in air quality compared to the other devices. Overall, these variations between the devices indicate that they are in distinct environments.

(a)

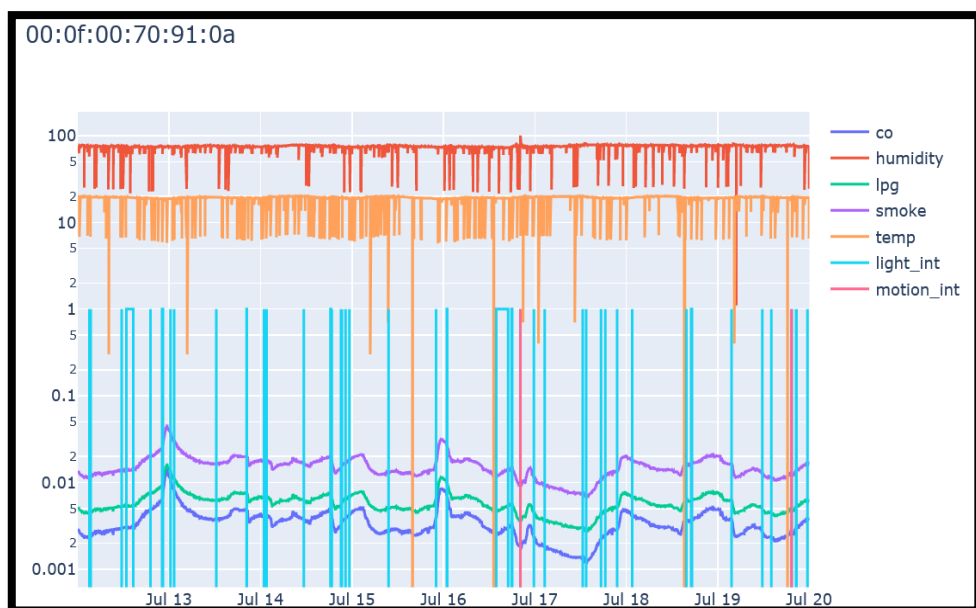

(b)

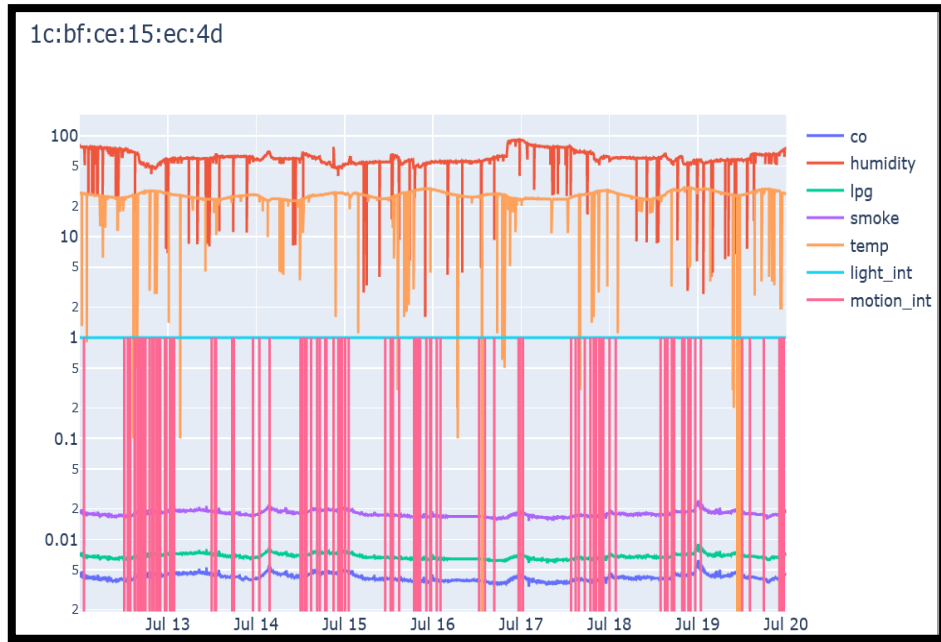

(c)

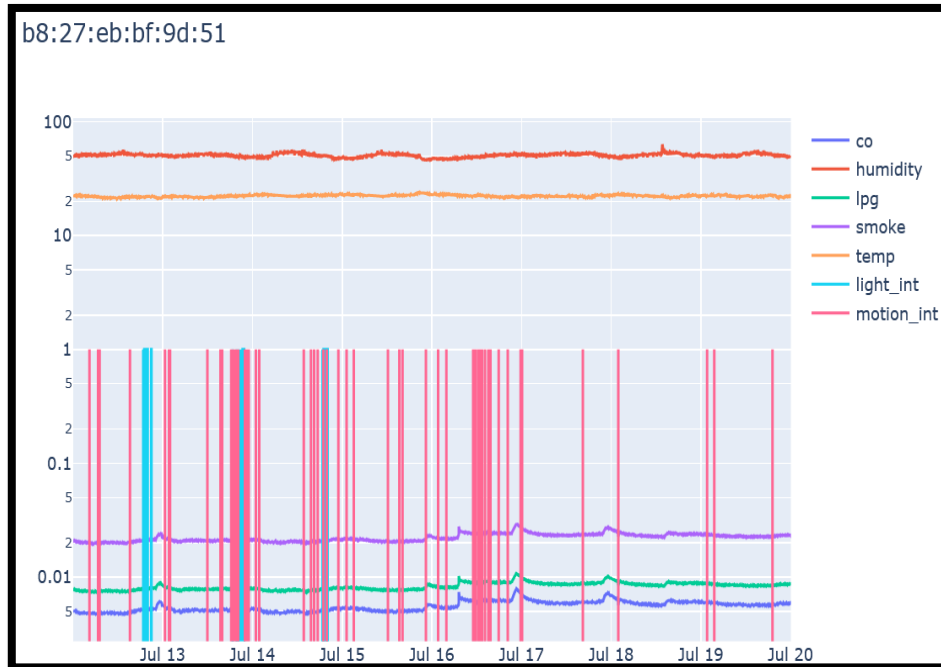

Figure 9: Sample reading from different IOT devices (Own Source)

From the Figure below I can see a few things:

This observation is further supported by the boxplots above, which clearly demonstrate that each device has unique characteristics that differentiate it from the others. These differences in behaviour and environmental conditions highlight the importance of considering each device independently when interpreting the data collected from them.

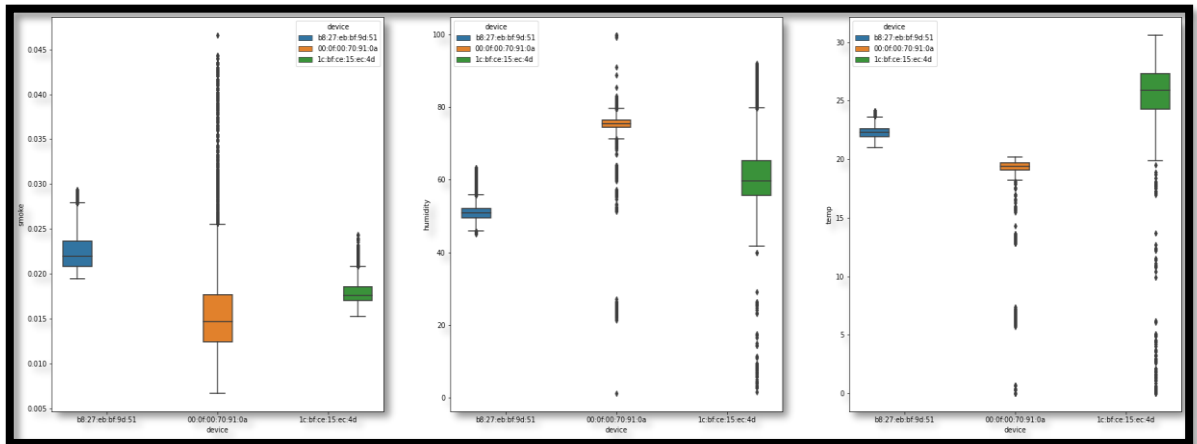

Figure 10: Different parameters detected by IOT devices (Own Source)

Any differences between the three sensor devices in different locations?

00:0f:00:70:91:0a = 00

1c:bf:ce:15:ec:4d = 1c

b8:27:eb:bf:9d:51 = b8

The data indicates that there are groups of activity spikes separated by periods of inactivity. Device b8 and 1c exhibit significantly more activity spikes than device 00. Additionally, device 1c shows consistent illumination, while the others alternate between light and dark intervals. Furthermore, device 00 demonstrates poorer air quality spikes compared to the other devices. Overall, based on the boxplots presented, it is evident that these three devices are situated in distinct environments.

The data shows that ambient air pollution levels are highest in device b8, followed by device 1c and then device 00. While device 00 generally has lower pollution levels, it experiences more significant spikes in air pollution than the other devices.

Furthermore, the three devices are situated in locations with slightly different average temperatures, ranging from 20-30 degC. Devices 00 and 1c exhibit significant outliers in temperature drops.

Additionally, the devices are in environments with varying humidity levels, ranging from approximately 50-75%. All three devices show outliers indicating fluctuations in humidity levels, with devices 1c and 00 experiencing substantial changes (from 65% to 0%).

We are able to conduct MANOVA (Multivariate Analysis of Variance) to obtain numerical values for the mean differences of these variables among the three devices. The stats models library provides a class called MANOVA for this purpose. However, the variations are evident from the boxplots, so let us proceed without the need for further analysis.

We can explore if there are any daily patterns in the data by analyzing hourly trends using Facebook Prophet. This tool can quickly and easily generate plots to help us visualize trends in the data. As an example, we can examine the smoke levels across the three devices. By using Facebook Prophet, we can analyze and plot hourly patterns to gain a better understanding of any daily trends present in the data.

Daily Patterns in the Data.

(a)

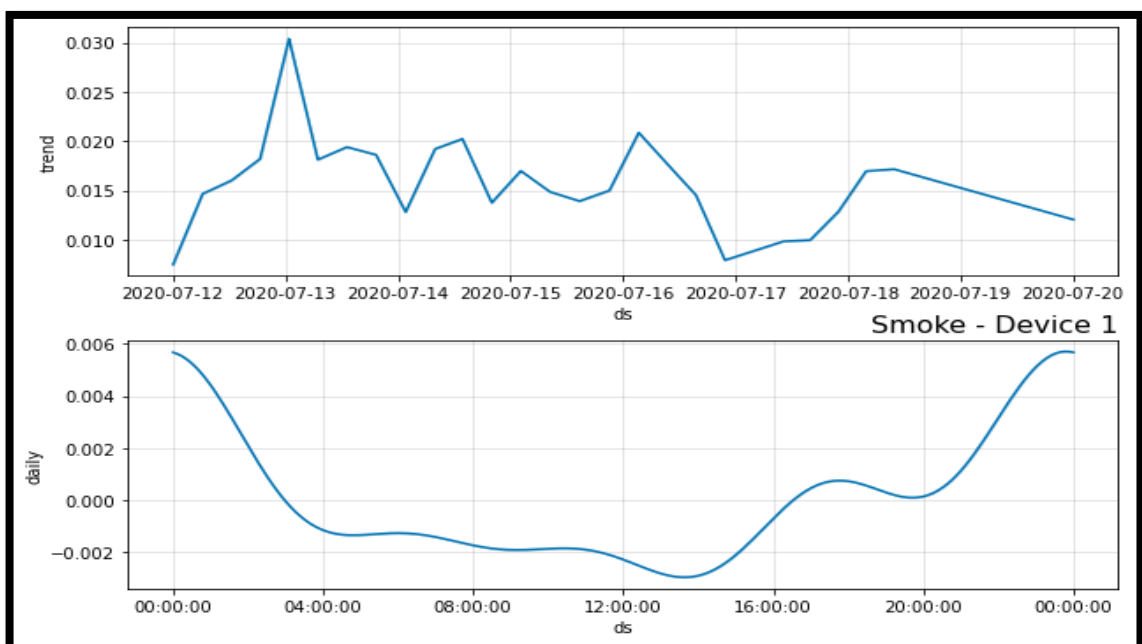

(b)

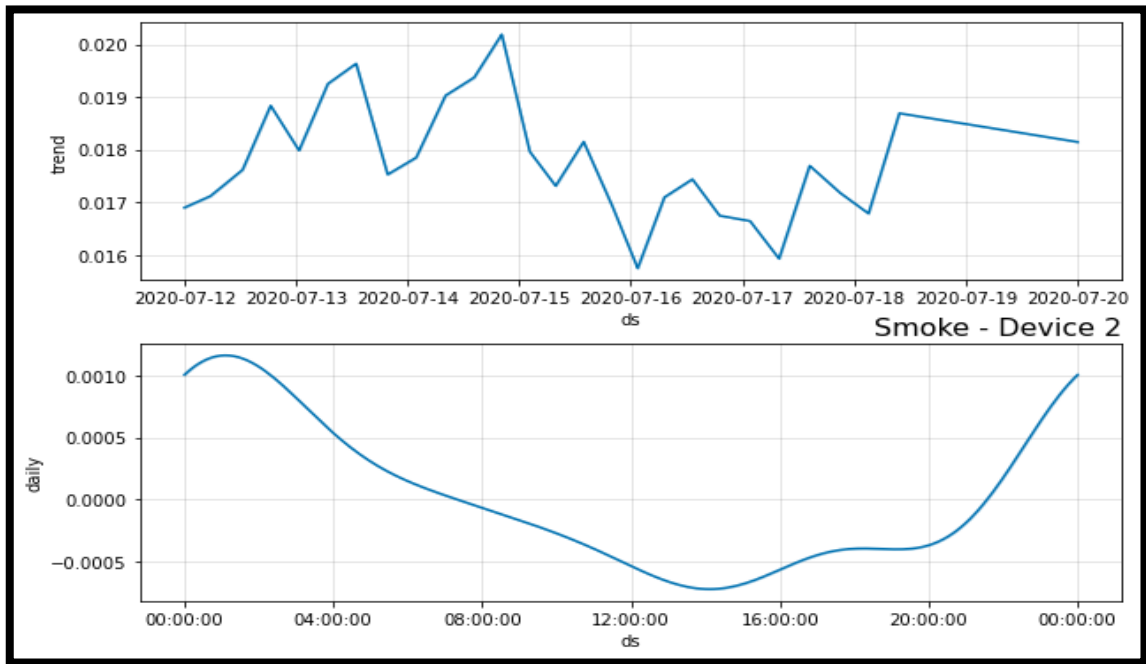

(c)

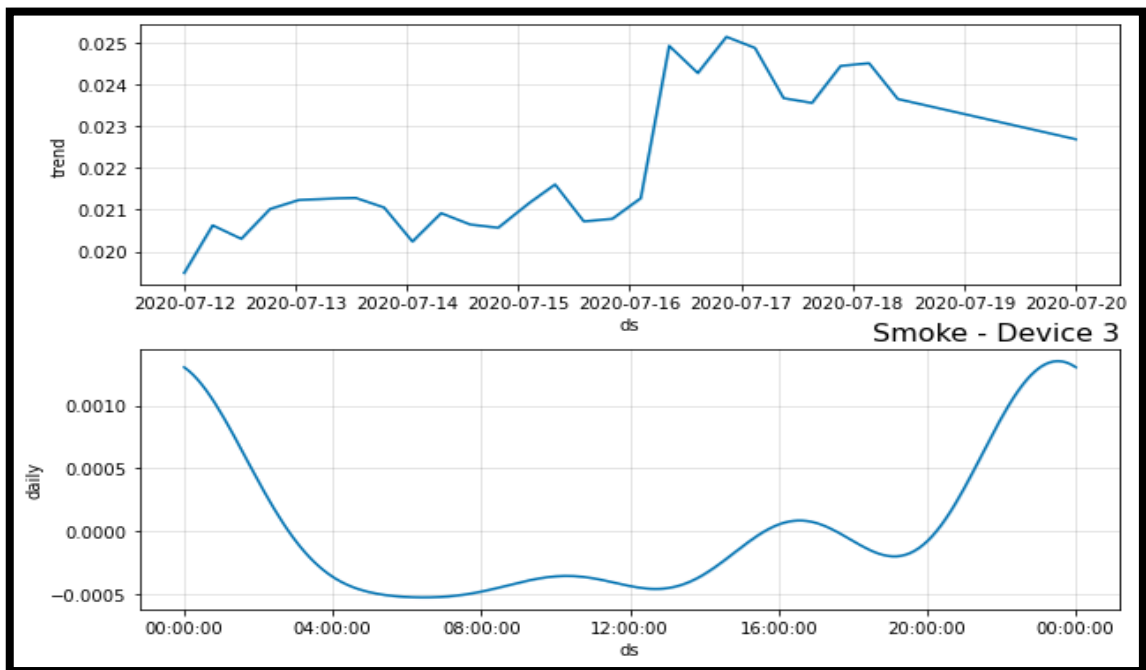

Figure 11: Time series data collected by IOT devices on daily and hourly basis (Own Source)

The Facebook Prophet model above reveals a daily trend in smoke levels across all three device locations. Specifically, there is a noticeable decline in smoke levels from around 6am to 8pm and a subsequent increase in smoke levels around midnight each day.

To generate trend data for other sensor types, a similar approach could be taken for each device. Additionally, the date time column could be used to group the data by daytime frames and calculate means and confidence intervals. This method would provide comparable trend information to that generated by Facebook Prophet.

Using these calculated confidence intervals, it is possible to develop an anomaly detection system such as a smoke alarm or human alarm. These systems can detect any deviations from the expected trend and trigger an alarm when necessary. The central question in using unsupervised learning to identify time series windows where humans are present is determining which aspects of the time series can be attributed to human activity. These aspects may include motion spikes, which occur when humans are near the accelerometer, light spikes, which occur when humans open a door and light falls on the detector, spikes in air pollution, which occur when humans drive up to a sensor or turn on a machine, and spikes in temperature and humidity, which occur when humans open a door and cause shifts in these variables. By identifying and analysing these patterns in the time series data, we can develop an unsupervised learning algorithm to recognize when humans are present in the environment being monitored.

5. Results and Discussion

As more people begin to make use of smart home devices, security will become a major source of worry. There is no question that smart home security software and gadgets will become increasingly popular in the not-too-distant future. It is becoming more and more common to see apps that function in combination with smart home devices on the market. When you provide them access to your home's security system, they may be able to conduct tasks such as opening and closing your smart lock, which is a crucial element of always keeping your family secure.

If a hacker acquires access to these programmes, he or she will be able to manage the entrance to your home. This has enormous implications for national security. Preventing this from happening may be accomplished by keeping your smart home applications up to date and applying any software or security upgrades that become available for the applications. Almost all smart gadgets rely on some sort of wireless communication to carry out their duties, and this is especially true for smartphones (Wi-Fi or Bluetooth). Hackers who intercept wireless signals, as they do with all digital communications, may put your smart home gadgets at danger, as they do with any other digital communication. Because Wi-Fi is one of the most often used means of connecting smart home devices, it is vital to always maintain your router safe.

The efficiency of this system can increase by utilising the advanced mechanisms and services provided by Amazon web services. Sensor items, as well as gadgets, will become increasingly popular in the future, allowing us to automate virtually every aspect of our daily lives at home. A high humidity level results in condensation and mould growth; a low humidity level increases the danger of respiratory ailments and the ability of viruses and bacteria to reproduce. Consequently, humidity sensors will safeguard buildings and possessions by monitoring humidity levels, and they may be configured to notify the client if indoor humidity levels fluctuate to unacceptably high levels in the future. Using an AWS IoT solution, it is feasible to provide your consumers with real-time information about their household appliances, such as refrigerators and microwave ovens, as well as the ability to control these appliances from any location. Users may safely share the status of their device with other family members, as well as multimedia content such as images and movies, with whoever they want to share information about them. As a result of this, end users will enjoy how much more time they will have to spend with their families and on other activities.

6. Conclusion

This research constructed realistic "people are nearby" intervals, as well as confidence intervals and clustering on time series data. The primary goal of the system is to enable users to remotely control their household appliances through a Raspberry Pi and an internet-connected device such as a smartphone or laptop. The system also includes a surveillance component using a Raspberry Pi camera to monitor the status of various appliances in real-time. The collected data is stored in a database for future use and displayed on a monitor.

This article describes an advanced automation system that reduces human interaction by utilizing the Internet of Things (IoT). The system is cost-effective and can be used in conjunction with various energy monitoring systems. Furthermore, a future system may be designed to warn users of excessive energy consumption. The Smart Home technology also includes powerful lighting control features that can be operated through an application on a mobile device. The system can automatically turn on and off the lights when a customer enters and exits a room or adjust the brightness of the light to save power. Additionally, customers can control the fan speed using sensor data or have it adjusted automatically based on the current room temperature to increase energy efficiency and reduce power costs.

From an economic standpoint, the advanced automation system reduces human interaction and utilizes the Internet of Things (IoT). By automating tasks and remotely controlling household appliances, the system can save time and energy for the user, which can translate into cost savings in the long run.

In terms of labour cost, the installation and setup of the system may require some technical expertise, particularly in setting up the Raspberry Pi and integrating it with the IoT devices. However, once the system is up and running, it requires minimal maintenance and can be remotely controlled and monitored, reducing the need for additional labour.

The system's ability to monitor and analyze time-series data also presents opportunities for energy savings and cost reductions. By collecting and storing data on appliance usage patterns, the system can identify opportunities for energy-efficient behavior and suggest adjustments to the user. For example, the system can automatically adjust the brightness of lights or fan speed based on current room temperature or occupancy, reducing power consumption, and lowering costs.

The uniqueness of this thesis lies in the integration of IoT, time-series data analysis, and automation systems to improve energy efficiency and reduce human interaction with household appliances. The study also presents practical applications of Smart Home technology that can be remotely controlled and monitored using a Raspberry Pi and internet-connected devices.

7. References

1. Nag, A., Alahi, M.E.E., Afsarimanesh, N., Prabhu, S. and Mukhopadhyay, S.C., 2019. IoT for smart homes. *Sensors in the Age of the Internet of Things: Technologies and Applications*, 171..
2. Chan, M., Estève, D., Escriba, C. and Campo, E., 2008. A review of smart homes— Present state and future challenges. *Computer methods and programs in biomedicine*, 91(1), pp.55-81.
3. Kim, M.J., Cho, M.E. and Jun, H.J., 2020. Developing design solutions for smart homes through user-centered scenarios. *Frontiers in psychology*, 11, p.335.
4. Chan, M., Hariton, C., Ringoard, P. and Campo, E., 1995, October. Smart house automation system for the elderly and the disabled. In *1995 IEEE International Conference on Systems, Man and Cybernetics. Intelligent Systems for the 21st Century* (Vol. 2, pp. 1586-1589). IEEE.
5. Ghayvat, H., Liu, J., Babu, A., Alahi, E.E., Gui, X. and Mukhopadhyay, S.C., 2015. Internet of Things for smart homes and buildings: Opportunities and Challenges. *Journal of Telecommunications and the Digital Economy*, 3(4), pp.33-47.
6. Stolojescu-Crisan, C., Crisan, C. and Butunoi, B.P., 2021. An IoT-based smart home automation system. *Sensors*, 21(11), p.3784.
7. Alam, M.R., Reaz, M.B.I. and Ali, M.A.M., 2012. A review of smart homes—Past, present, and future. *IEEE transactions on systems, man, and cybernetics, part C (applications and reviews)*, 42(6), pp.1190-1203.
8. Patchava, V., Kandala, H.B. and Babu, P.R., 2015, December. A smart home automation technique with raspberry pi using iot. In *2015 International conference on smart sensors and systems (IC-SSS)* (pp. 1-4). IEEE.
9. ShariqSuhail, M., ViswanathaReddy, G., Rambabu, G., DharmaSavarni, C.V.R. and Mittal, V.K., 2016, September. Multi-functional secured smart home. In *2016 International Conference on Advances in Computing, Communications and Informatics (ICACCI)* (pp. 2629-2634). IEEE.
10. Kumar, P. and Pati, U.C., 2016, May. IoT based monitoring and control of appliances for smart home. In *2016 IEEE International Conference on Recent Trends in Electronics, Information & Communication Technology (RTEICT)* (pp. 1145-1150). IEEE.

11. Shete, V. and Ukunde, N., 2016, August. Intelligent embedded video monitoring system for home surveillance. In *2016 International Conference on Inventive Computation Technologies (ICICT)* (Vol. 1, pp. 1-4). IEEE.
12. Jain, A., Basantwani, S., Kazi, O. and Bang, Y., 2017, February. Smart surveillance monitoring system. In *2017 International Conference on Data Management, Analytics and Innovation (ICDMAI)* (pp. 269-273). IEEE.
13. Sruthy, S. and George, S.N., 2017, August. WiFi enabled home security surveillance system using Raspberry Pi and IoT module. In *2017 IEEE International Conference on Signal Processing, Informatics, Communication and Energy Systems (SPICES)* (pp. 1-6). IEEE.
14. Magar, S., Saste, V., Lahane, A., Konde, S. and Madne, S., 2017, February. Smart home automation by GSM using android application. In *2017 International conference on information communication and embedded systems (ICICES)* (pp. 1-4). IEEE.
15. Malche, T. and Maheshwary, P., 2017, February. Internet of Things (IoT) for building smart home system. In *2017 International Conference on I-SMAC (IoT in Social, Mobile, Analytics and Cloud)(I-SMAC)* (pp. 65-70). IEEE.
16. Suryadevara, N.K., Mukhopadhyay, S.C., Wang, R. and Rayudu, R.K., 2013. Forecasting the behavior of an elderly using wireless sensors data in a smart home. *Engineering Applications of Artificial Intelligence*, 26(10), pp.2641-2652.
17. Suryadevara, N.K. and Mukhopadhyay, S.C., 2012. Wireless sensor network based home monitoring system for wellness determination of elderly. *IEEE sensors journal*, 12(6), pp.1965-1972.
18. Lotfi, A., Langensiepen, C., Mahmoud, S.M. and Akhlaghinia, M.J., 2012. Smart homes for the elderly dementia sufferers: identification and prediction of abnormal behaviour. *Journal of ambient intelligence and humanized computing*, 3, pp.205-218.
19. Fleury, A., Vacher, M. and Noury, N., 2009. SVM-based multimodal classification of activities of daily living in health smart homes: sensors, algorithms, and first experimental results. *IEEE transactions on information technology in biomedicine*, 14(2), pp.274-283.

20. Virone, G., Alwan, M., Dalal, S., Kell, S.W., Turner, B., Stankovic, J.A. and Felder, R., 2008. Behavioral patterns of older adults in assisted living. *IEEE transactions on information technology in biomedicine*, 12(3), pp.387-398.
21. Robles, R.J., Kim, T.H., Cook, D. and Das, S., 2010. A review on security in smart home development. *International Journal of Advanced Science and Technology*, 15.
22. Van Kasteren, T.L.M., Englebienne, G. and Kröse, B.J., 2010. Activity recognition using semi-Markov models on real world smart home datasets. *Journal of ambient intelligence and smart environments*, 2(3), pp.311-325.
23. Kamilaris, A., Trifa, V. and Pitsillides, A., 2011, May. HomeWeb: An application framework for Web-based smart homes. In *2011 18th International Conference on Telecommunications* (pp. 134-139). IEEE.
24. Adib, F., Mao, H., Kabelac, Z., Katabi, D. and Miller, R.C., 2015, April. Smart homes that monitor breathing and heart rate. In *Proceedings of the 33rd annual ACM conference on human factors in computing systems* (pp. 837-846).
25. Portet, F., Vacher, M., Golanski, C., Roux, C. and Meillon, B., 2013. Design and evaluation of a smart home voice interface for the elderly: acceptability and objection aspects. *Personal and Ubiquitous Computing*, 17, pp.127-144.
26. Bourobou, S.T.M. and Yoo, Y., 2015. User activity recognition in smart homes using pattern clustering applied to temporal ANN algorithm. *Sensors*, 15(5), pp.11953-11971.
27. Jie, Y., Pei, J.Y., Jun, L., Yun, G. and Wei, X., 2013, June. Smart home system based on iot technologies. In *2013 International conference on computational and information sciences* (pp. 1789-1791). IEEE.
28. Gaikwad, P.P., Gabhane, J.P. and Golait, S.S., 2015, April. A survey based on Smart Homes system using Internet-of-Things. In *2015 International Conference on Computation of Power, Energy, Information and Communication (ICCPEIC)* (pp. 0330-0335). IEEE.
29. Bing, K., Fu, L., Zhuo, Y. and Yanlei, L., 2011, July. Design of an Internet of Things-based smart home system. In *2011 2nd International Conference on Intelligent Control and Information Processing* (Vol. 2, pp. 921-924). IEEE.
30. Liu, T., Yuan, R. and Chang, H., 2012, October. Research on the Internet of Things in the Automotive Industry. In *2012 International Conference on Management of e-Commerce and e-Government* (pp. 230-233). IEEE.

31. Khajenasiri, I., Estebasari, A., Verhelst, M. and Gielen, G., 2017. A review on Internet of Things solutions for intelligent energy control in buildings for smart city applications. *Energy Procedia*, 111, pp.770-779.
32. Alavi, A.H., Jiao, P., Buttlar, W.G. and Lajnef, N., 2018. Internet of Things-enabled smart cities: State-of-the-art and future trends. *Measurement*, 129, pp.589-606.
33. Weber, R.H., 2010. Internet of Things—New security and privacy challenges. *Computer law & security review*, 26(1), pp.23-30.
34. Heer, T., Garcia-Morchon, O., Hummen, R., Keoh, S.L., Kumar, S.S. and Wehrle, K., 2011. Security Challenges in the IP-based Internet of Things. *Wireless Personal Communications*, 61, pp.527-542.
35. Ning, H. and Liu, H., 2012. Cyber-physical-social based security architecture for future internet of things. *Advances in Internet of Things*, 2(01), p.1.
36. Kothmayr, T., Schmitt, C., Hu, W., Brünig, M. and Carle, G., 2013. DTLS based security and two-way authentication for the Internet of Things. *Ad Hoc Networks*, 11(8), pp.2710-2723.
37. Li, Y., Alqahtani, A., Solaiman, E., Perera, C., Jayaraman, P.P., Buyya, R., Morgan, G. and Ranjan, R., 2019. IoT-CANE: A unified knowledge management system for data-centric Internet of Things application systems. *Journal of parallel and distributed computing*, 131, pp.161-172.
38. Olivier, F., Carlos, G. and Florent, N., 2015. New security architecture for IoT network. *Procedia Computer Science*, 52, pp.1028-1033.
39. Luk, M., Mezzour, G., Perrig, A. and Gligor, V., 2007, April. MiniSec: a secure sensor network communication architecture. In *Proceedings of the 6th international conference on Information processing in sensor networks* (pp. 479-488).
40. Yamashita, J., 2018. Japanese experiences of smart city policies: User-driven innovation in smart community projects. *World Technopolis Review*, 7(2), pp.113-124.
41. Tayyaba, S., Khan, S.A., Ashraf, M.W. and Balas, V.E., 2020. Home automation using iot. *Recent trends and advances in artificial intelligence and internet of things*, pp.343-388.

42. Das, A., Dash, P. and Mishra, B.K., 2017. An innovation model for smart traffic management system using internet of things (IoT). In *Cognitive Computing for Big Data Systems Over IoT: Frameworks, Tools and Applications* (pp. 355-370). Cham: Springer International Publishing.
43. Ng, C.K., Wu, C.H., Yung, K.L., Ip, W.H. and Cheung, T., 2018. A semantic similarity analysis of Internet of Things. *Enterprise Information Systems*, 12(7), pp.820-855.

8. Attachment

	ts	device	co	humidi ty	Light	Ipg	Motio n	Smoke	tem p
1	1.59E+ 09	B8:27: eb	0.00048 56	57	FALS E	0.00074 05	TRU E	0.0125 1	22.5
2	1.59E+ 09	00:0f:0 0	0.00042 53	42	TRU E	0.00077 7	FALS E	0.0122 21	22
3	1.59E+ 09	B8:27: eb	0.00041 22	75	TRU E	0.00074 55	TRU E	0.0152 3	26.3
4	1.59E+ 09	B8:27: eb	0.00041 25	63	FALS E	0.00078 8	TRU E	0.0152 2	35.2
5	1.59E+ 09	00:0f:0 0	0.00041 85	65	FALS E	0.00074 4	TRU E	0.0122 3	33
6	1.59E+ 09	B8:27: eb	0.00042 36	50.3	FALS E	0.00074 7	FALS E	0.0125 2	37.2
7	1.59E+ 09	B8:27: eb	0.00042 33	55	FALS E	0.00074 5	TRU E	0.0122 2	42.3
8	1.59E+ 09	B8:27: eb	0.00048 51	56.3	TRU E	0.00077 4	TRU E	0.0122 5	25.1
9	1.59E+ 09	00:0f:0 0	0.00048 55	54.2	TRU E	0.00047 85	TRU E	0.0425 3	20.1
1 0	1.59E+ 09	B8:27: eb	0.00041 25	52.3	FALS E	0.00041 22	FALS E	0.0412 2	22.1

Attachment 1: Dynamo Dataset (Own Source)